

Jarvis standing desk

Assembly instructions for
use with Jarvis Desktops
48" and larger

For assembly assistance,
visit fully.com/howtojarvis
call 888-508-3725
or email support@fully.com

In Europe call +32 9 269 44 83
or email help@fully.com

fully

Thank you for choosing a Jarvis desk
from Fully.

Cautions and Use	1
Before starting	2
Specs	2
In the box	3
Assembly	4
Initial calibration/Reset	10
Custom settings	12
Using your own desktop	13
Contact	14

Cautions

Please read this manual carefully. If this desk changes hands, please provide this manual to the new owner.

Make sure the desktop is not touching any obstacles or walls and that no obstacles are in the desk's path. Make sure all cords are an appropriate length to accommodate the full range of height adjustment.

Keep children away from desk components. There is risk of injury and electric shock.

Do not sit or stand on the desk frame. Do not crawl or lie under the desk frame.

Do not open or modify any of the components, including the Lifting Columns, Control Box, or Handset. Doing so risks electric shock and voids any warranty claims.

Placing objects taller than 20" underneath the desk will obstruct the desk's movement and may result in physical damage.

Voltage Converters

Using a voltage converter could cause damage to the desk and is considered improper use. Resulting damage is not covered by the warranty.

Verify the voltage of the Control Box as labeled to avoid damage. Alternative voltage Control Boxes are available from Fully.

Use & liability

This Jarvis height adjustable desk has electric motors and is designed for use in dry work environments only.

This Jarvis desk is adjustable so it can be positioned at an optimal ergonomic height. Any extracurricular use is at user's own risk.

Under no circumstances does the manufacturer accept warranty claims or liability claims for damage caused by improper use or handling of the desk frame.

Jarvis is a registered trademark of Fully, LLC. All rights reserved.

Before starting

On a padded or carpeted area, take all of the items out of your Jarvis frame box and confirm that nothing is missing. Reference the included parts listings on page 3.

Using your own desktop

If you are using your own desktop, refer to page 12 for instructions before beginning assembly.

Specs

	Mid Range Jarvis	Extended Range Jarvis
Height range (w/o desktop)	29" - 48.25"	24.5" - 50"
Travel speed	1.3" per second	1.5" per second
Operating noise	<50dB w/o top	<50dB w/o top
Load capacity	1000N	1000N
Duty cycle	10% with Max 2 mins on	10% with Max 2 mins on
Frame width min-max	42.5" - 74"	42.5" - 74"

Tools



3mm Hex Wrench

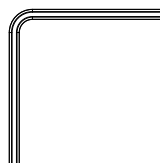

4mm Hex Wrench

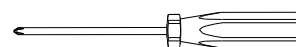

Phillips Screw Driver
(Not Included)

Jarvis standing desk

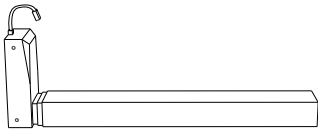

A — Lifting Column x2

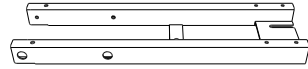

B — Frame End (w/Capture Plate)

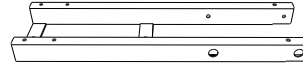

C — Frame End



D — Foot x2

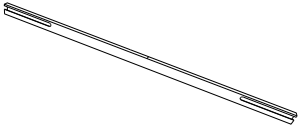

E — Center Rail x2



F — Right Side Bracket



G — Left Side Bracket



H — Control Box

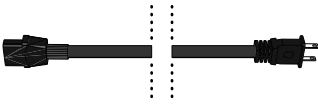

I — Power Cable

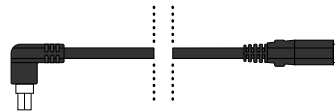

J — Leg Cable

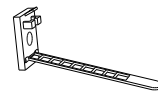

K — Cable Clip x10

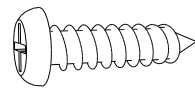

L — Wood Screw x12

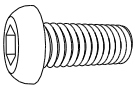

M — Medium Machine Screw x12

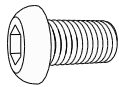

N — Small Machine Screw x8



O — Medium Set Screw x8 (Pre-Installed)



P — Noise Attenuation Grommet x5 (Extra)

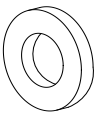

Q — Desktop Washer x9

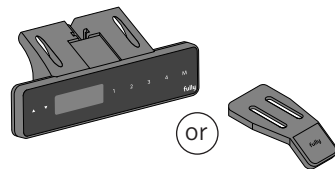

R — Handset (Memory or Up/Down)

Pro tip

Most of our desktops come with machine screw inserts preinstalled.

Wood Screws: Pointy End

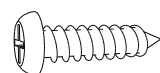

If using your own desktop, you'll use Wood Screws.

Machine Screws: Flat End

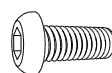

If using Jarvis Desktop, use Machine Screws to attach your desktop to frame.

Assembly

Step 1

Insert one of the Lifting Columns (either one; they're identical) into the Frame End with the Capture Plate.

To secure the Frame End to the leg, thread four (4) of the Small Machine Screws into the holes as shown, but do not tighten them all the way.

Once all four screws are in place, tighten completely.

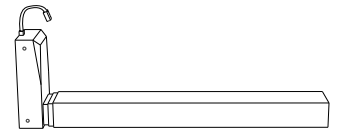
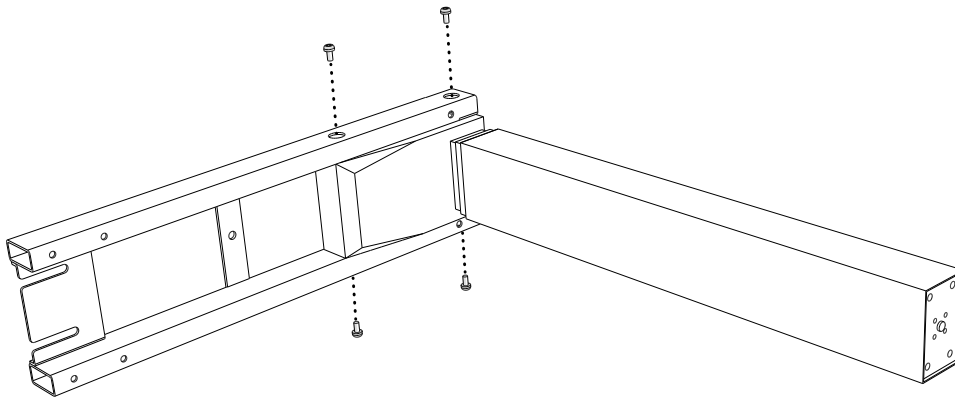

A — Lifting Column x1

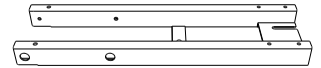

B — Frame End (w/Capture Plate)

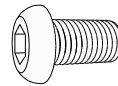

N — Small Machine Screw x4

Decision Point

Decide if you want your Handset on the left side or the right side of your finished desk.

Step 2

Select the Left or Right Side Bracket (corresponding to the side your Handset will be mounted on). The two tabs on the Side Bracket will slot into the Frame End with Capture Plate, around the Lifting Column.

Use two of the Medium Machine Screws to secure the Side Bracket. As before, don't tighten all the way until both screws are in place and then tighten completely.

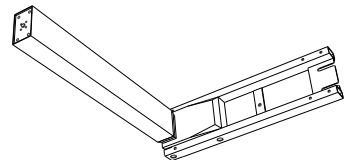
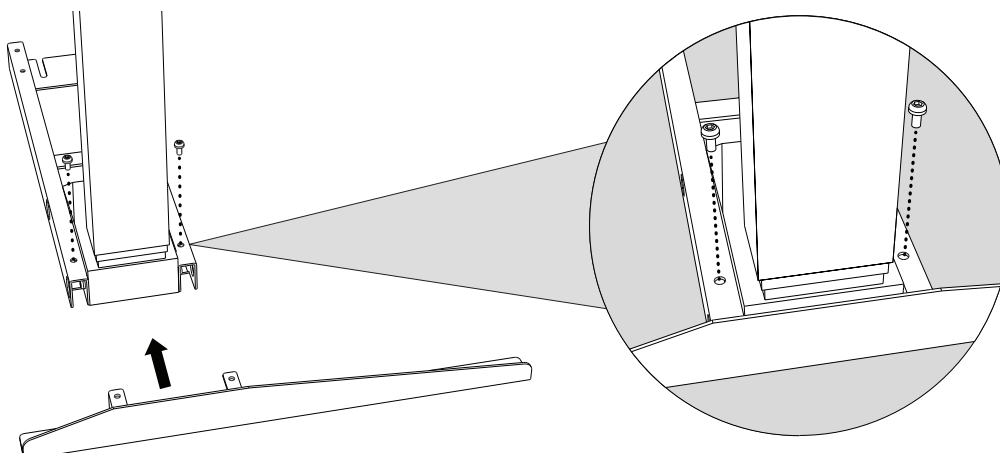

Step 1 Assembly

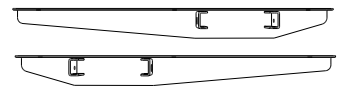

F/G — Left or Right Side Bracket

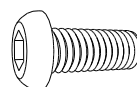

M — Medium Machine Screw x2

Step 3

Repeat Steps 1-2 for the remaining Lifting Column, Frame End, and Side Bracket.

Step 4

Lay your desktop on a padded surface with the underside facing up, and the front of the desktop towards you.

Place the Left Leg Assembly on the desktop to your right, with the Frame End pointing towards the center of the top. (Once you flip your desk over, this will become the left side, and the world will make sense again.)

Insert all screws part way. Once they are all in place, tighten them all completely.

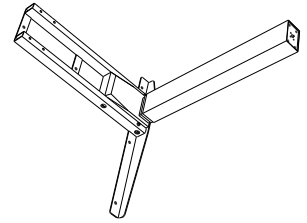
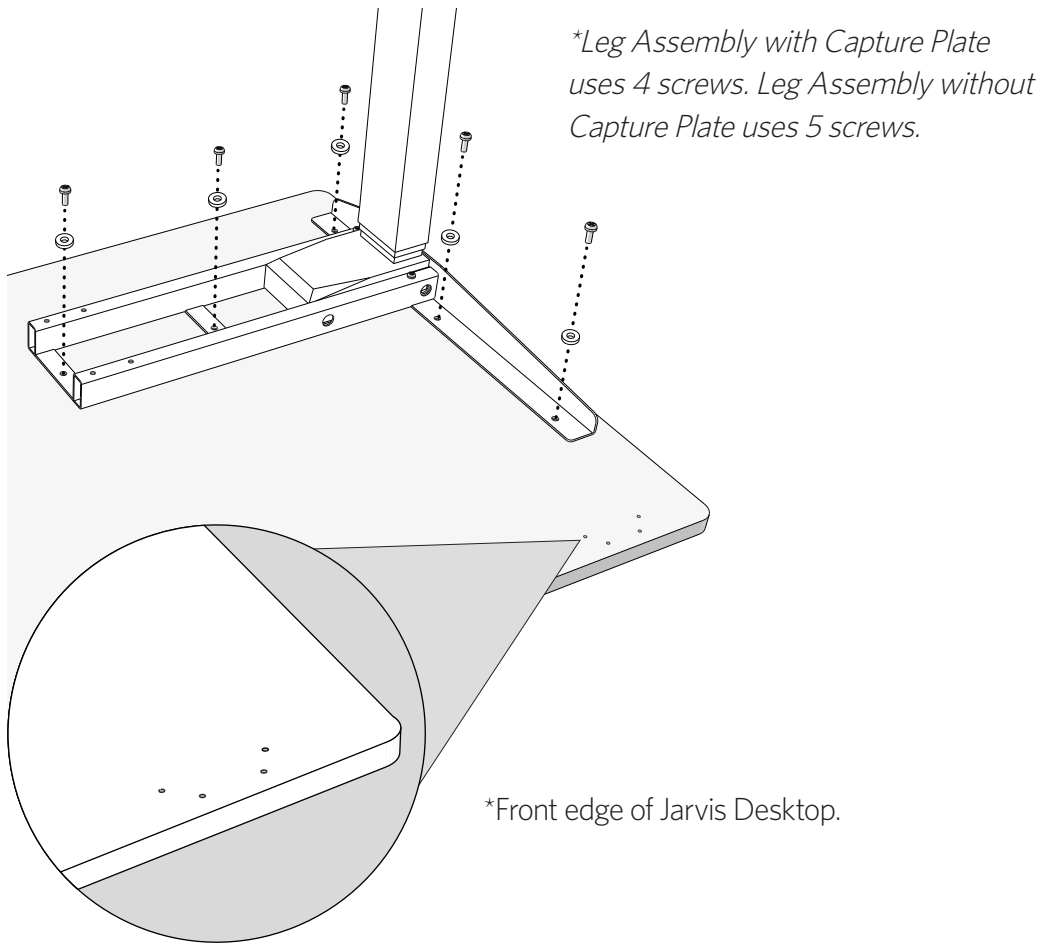

Step 2 Assembly

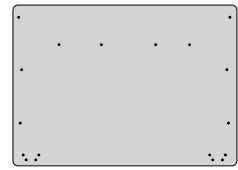

Jarvis Desktop

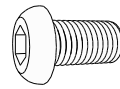

Desktop Machine Screw x4/5
(Included with Jarvis Desktop)

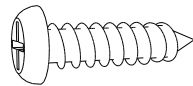

L — Wood Screw x4/5
(If using own desktop)

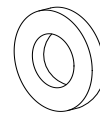

Q — Desktop Washer x4/5

Important

If your Jarvis Desktop's pre-drilled holes have metal inserts, you will need to use the Machine Screws packaged with the Jarvis Desktop to secure the frame.

Step 5

Slide the Center Rails into the Frame End attached to the desktop, so that the midpoint mark is facing up and the cut-out slots are facing inwards.

Slide the Right Leg Assembly onto the other end of the Center Rails (your left-hand side). The entire frame should now fit onto the desktop.

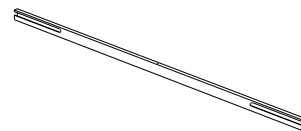

E — Center Rail x2

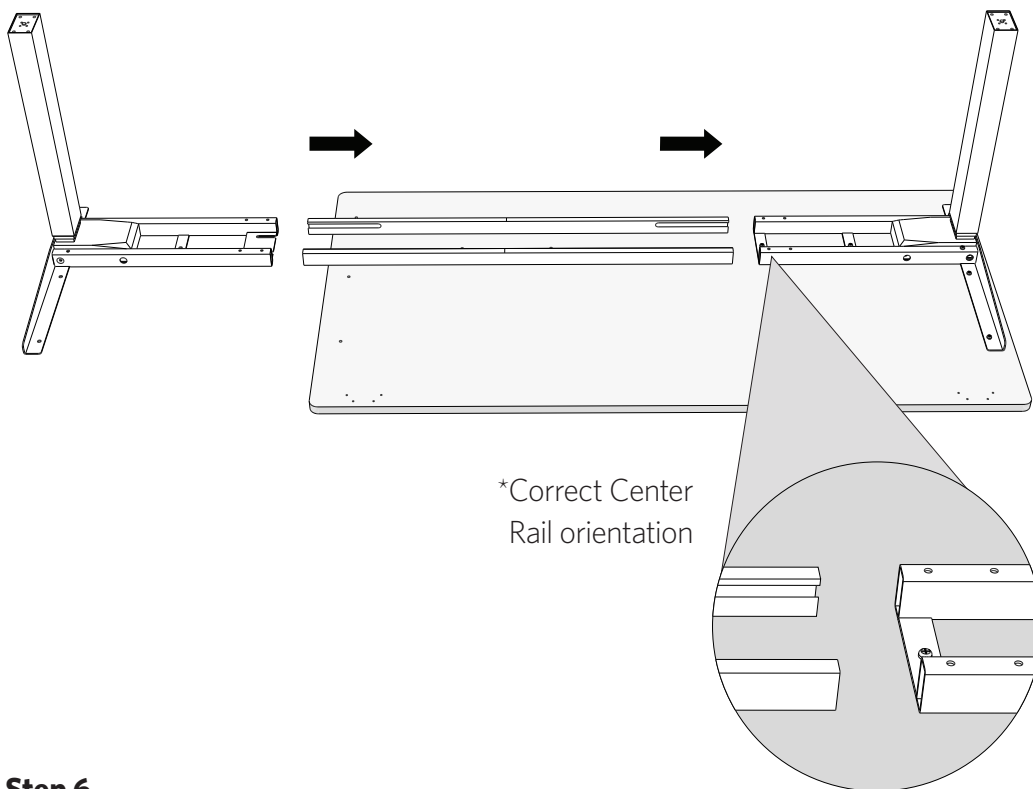

Step 6

Secure the Right Leg Assembly to the desktop with the appropriate screws.

Again, if the pre-drilled holes have metal inserts, you will need to use the Machine Screws packaged with the desktop to secure the frame; otherwise use Wood Screws.

Insert all screws part way. Once they are in place, tighten them all completely.

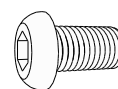

Desktop Machine Screw x4/5
(Included with Jarvis Desktop)

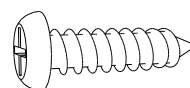
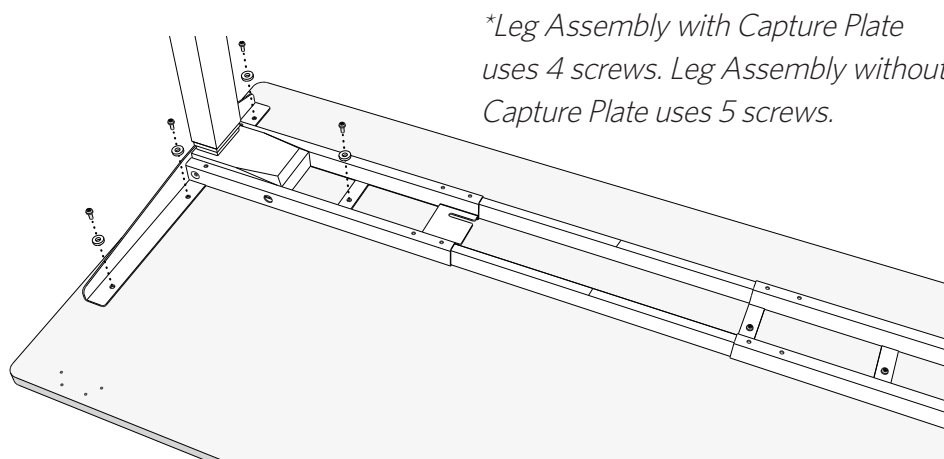

L — Wood Screw x4/5
(If using own desktop)



Q — Desktop Washer x4/5

Step 7

Center the labeled midpoint marks on both Center Rails between the two Frame Ends, and use the pre-installed Set Screws to lock the Center Rails down firmly.



O — Medium Set Screw x8 (Pre-Installed)

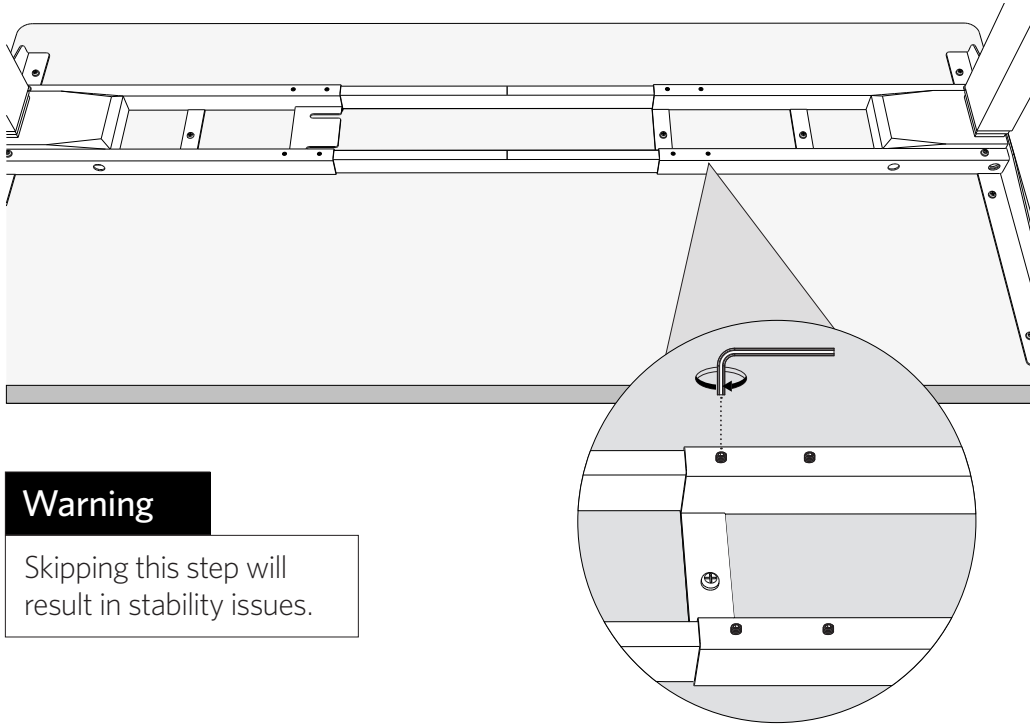

Warning

Skipping this step will result in stability issues.

Step 8

If you have a Jarvis desktop, there will be pre-drilled holes for attaching your Handset along the front of the desktop, on both the left and right sides. Keep in mind that when you turn your desk over, the sides of your desk will be reversed.

If you haven't already, now is a great time to decide which side you want your Handset on.



To attach the Memory Handset use included Wood Screws and holes 3 and 4 as shown.

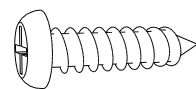
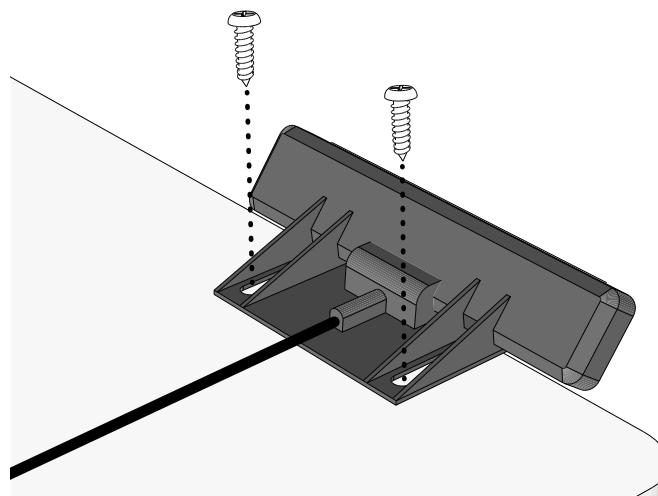
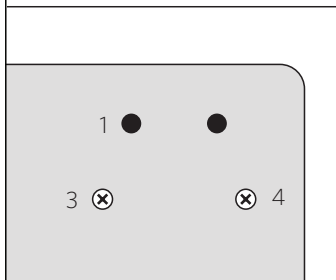

L — Wood Screw x2

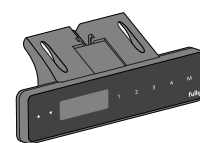

Memory Handset



To attach the Up/Down Handset use included Wood Screws and holes

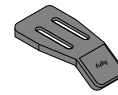
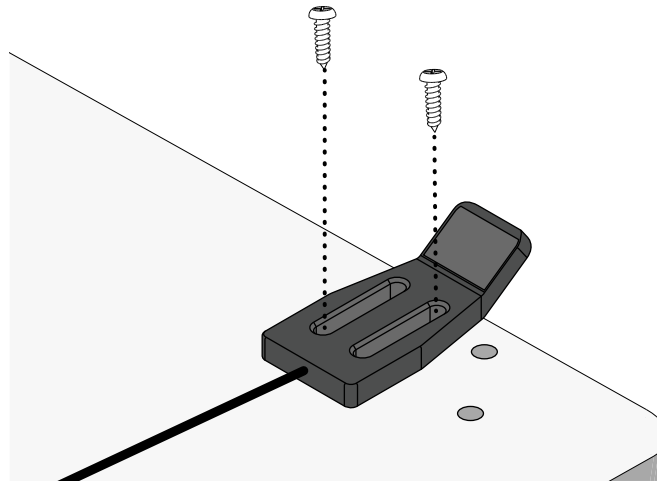
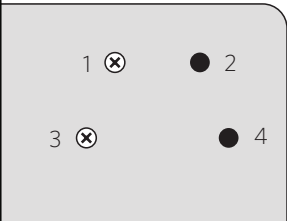

Up/Down Handset

Step 9

Slide the Control Box onto the Frame End with the Capture Plate.

Connect the Extension Cable to one of the leg cables and insert the 90-degree plug into the M1 port on the control box. The remaining leg cable inserts into the M2 port. Connect the Handset to the Control Box via the socket labeled HS. Connect the Power Cable via the power socket.



H — Control Box

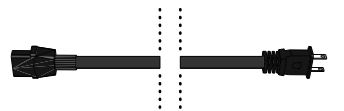
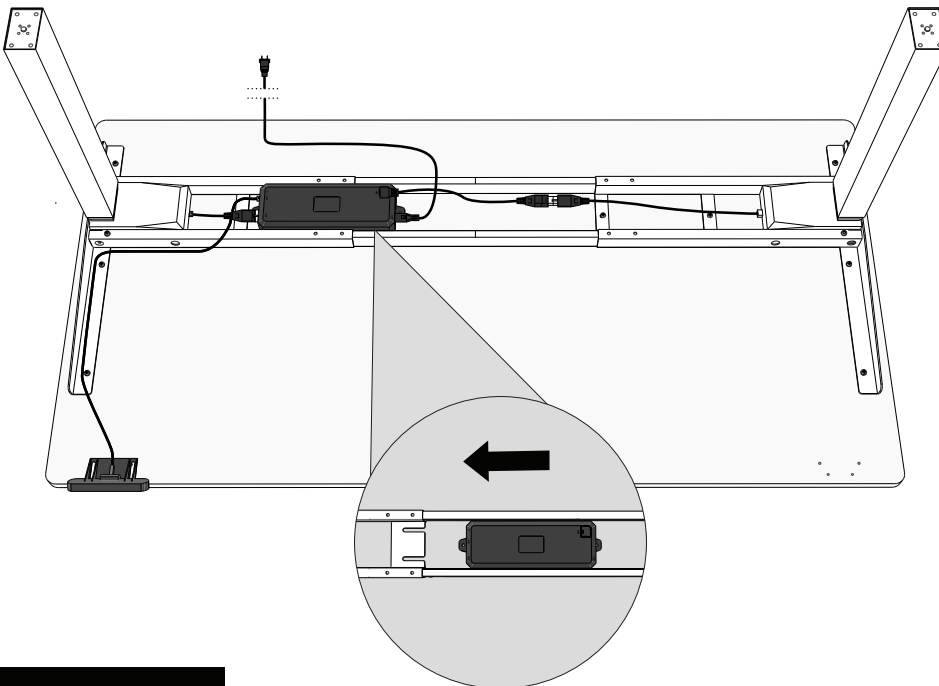

I — Power Cable

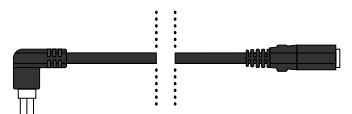

J — Leg Cable

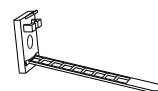

K — Cable Clip x10

Pro Tip

Cable Management Cable Clips work best adhered directly to the Jarvis metal frame. Route your Power Cord and Leg Cable towards the side of your nearest wall outlet, or use a cable management tray for optimal cable taming.

Step 10

Loosely attach a Foot to the bottom of each Lifting Column using four (4) Medium Machine Screws per Foot.

Once all the screws are in place, tighten them down the rest of the way in an X pattern.

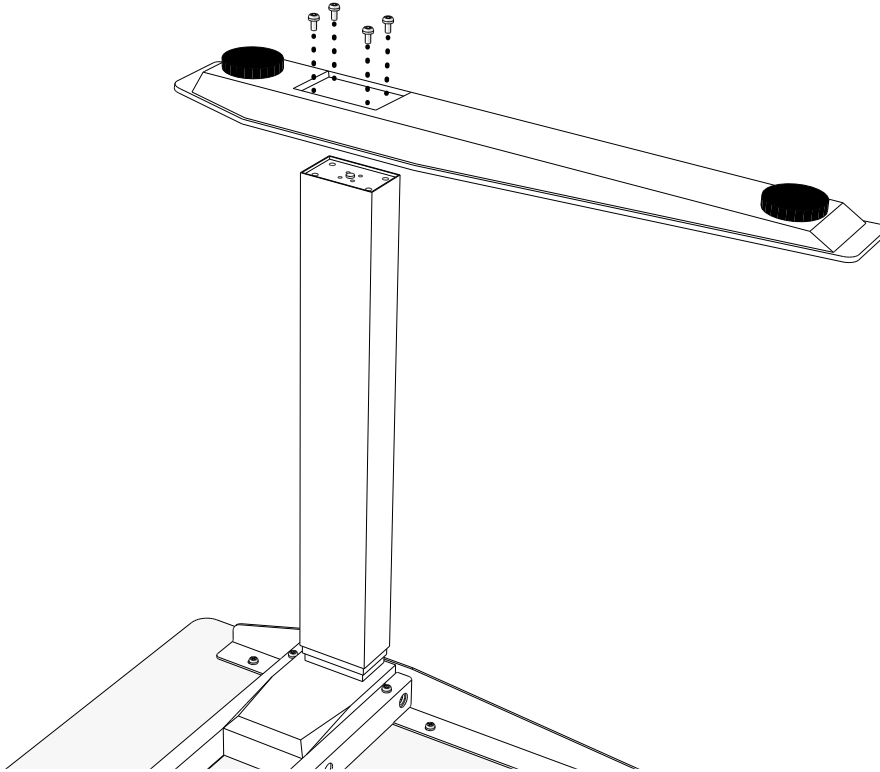

D — Foot x2

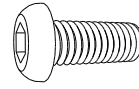

M — Medium Machine Screw x8

Step 11

Double-check that all screws everywhere on the desk are tight. Triple-check that all screws everywhere on the desk are tight.

Pro Tip

If using casters, remove and replace the pre-installed leveling glides before proceeding with Step 12.

Step 12

With one friend (or more), lift the desk and gently flip it onto its feet. As you flip it support both the top and the frame, being careful not to put weight on the Handset.

Adjust the pre-installed leveling glides on the feet as needed.

Plug in the desk.

Step 13

Initial calibration/Reset

Before you start using your Jarvis, you'll need to get all the parts synced. Don't worry — it's easy.

Up/Down Handset

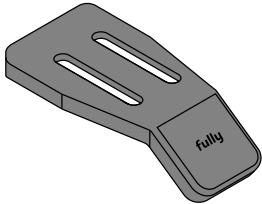

1. Touch the Fully logo located on the front face of the Up/Down handset until Jarvis reaches its lowest position. Release.
2. Press and hold the Fully logo for about 10 seconds. Release.
3. Press and hold the Fully logo again, this time until the Jarvis first lowers slightly, then rises slightly, and finally stops. Remove your finger from the handset.
4. You can now use your Jarvis.

Using Up/Down Handset

To raise desk - touch one finger to the underside of the handset. Hold it there until the desk reaches the desired height

To lower desk - touch one finger to the fully logo on the front of the handset. Hold finger in place until the desk reaches the desired height.

Programmable Memory Handset

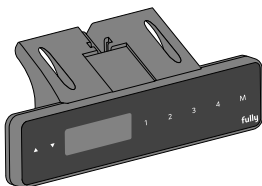

1. Press and hold the ▼ icon until Jarvis reaches its lowest position. Release.
2. Press and hold the ▼ icon until the display reads **RESET**.
3. Press and hold the ▼ icon again, this time until Jarvis first lowers slightly, then rises slightly, and finally stops. Release the ▼ icon.
4. You can now use your Jarvis.

Programming memory presets

To program your memory presets, raise or lower your Jarvis to your preferred height. Then, press the **M** icon followed by one of the four numbers you want to preset. This number will return Jarvis to your preferred height from now on.

Custom settings for Programmable Memory Handset

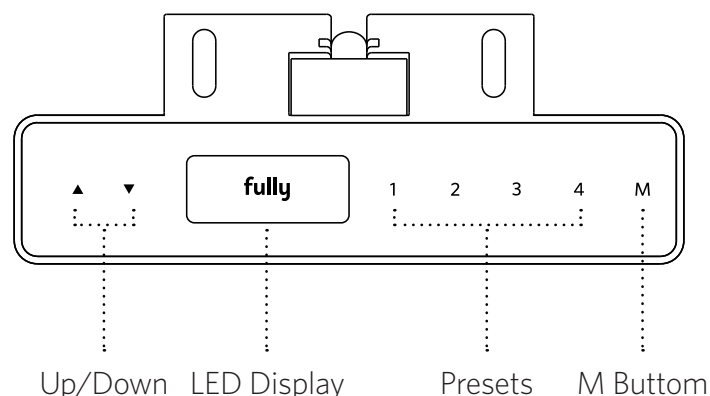

Getting started

To begin, access the menu by holding down **M** for 3 seconds until **Lock/Unlock desk** appears on screen. Use the ▲ and ▼ icons to navigate through the menu. **'1'** selects the feature you want to change and also confirms your selection. **'4'** takes you back to the main menu.

Lock/Unlock Jarvis

To lock Jarvis and prevent any further changes to the height or menu settings use **Lock**. **Unlock** will allow you to once again use all of Jarvis's features.

Max height

If you want to limit how high your Jarvis can go, set a **Max height** limit. Simply raise Jarvis to the desired maximum height and navigate to **Max height** on the menu, then press **'1'** to confirm.

Min height

To limit how low your Jarvis can go, set a **Minimum height** limit. Move Jarvis to the desired minimum height and navigate to **Min height** on the menu, then press **'1'** to confirm.

Units

Prefer to work in centimeters instead of inches? Choose the unit of measurement you'd like under the **Units** menu option.

Anti-collision

To help prevent damage, Jarvis is outfitted with an accelerometer that stops it if it runs into something. You can set the sensitivity with the anti-collision options.

Screen brightness

Adjust the screen brightness on your memory handset to the level that suits you—and your eyes.

Button brightness

You can also adjust the button brightness on your memory handset. Choose from 3 different brightness levels to help you navigate through your presets and menu options.

Memory preset mode

Use **One touch** to move your Jarvis to a memory preset height with the touch of a button, or use **Constant touch** and keep your finger on the button until Jarvis gets to the memory preset height.

Calibrate height

To calibrate your handset's height display, lower Jarvis all the way down and then use a tape measure to determine the height from the top of your desktop to the floor. Select the **Calibrate height** menu option and use the ▲ and ▼ icons to adjust the height readout to match your previously measured height.

Using your own desktop

The Jarvis comes in two foot lengths: **short** and **long**.

If your foot is engraved with **YQ-140**, it is the Short Foot, which we recommend for desktops with depths between 24" and 27".

Bottom view of Short Foot:



For positioning the short foot (**YQ-140**), the maximum distance from the front desktop edge to the first hole in the side bracket is 5.5".

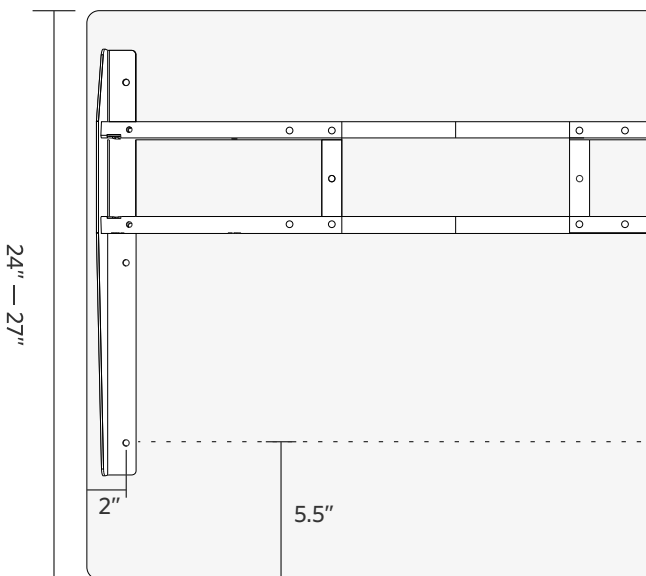

If your foot is engraved with **YQ-141**, it is the Long Foot, which we recommended for desktops between 27" and 30".

Bottom view of Long Foot:



For positioning the long foot (**YQ-141**), the maximum distance from the front desktop edge to the first hole in the side bracket is 6.75".

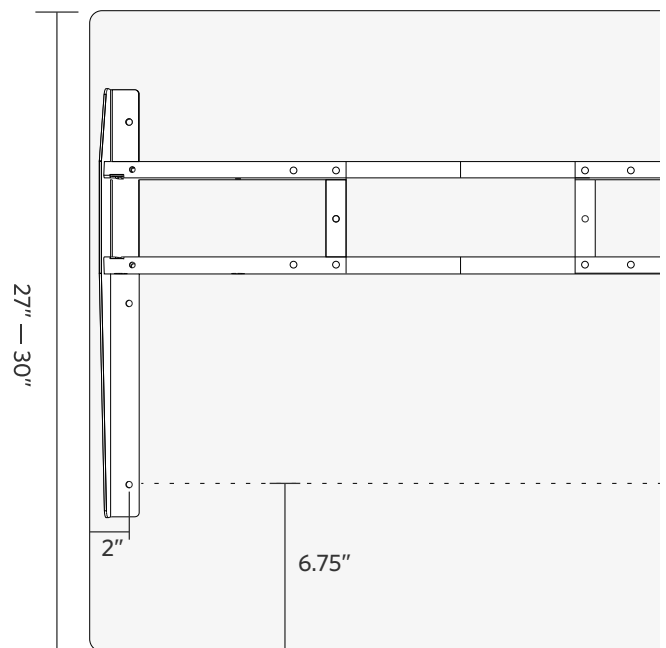

There's no one right way to position your frame on your desktop but there are a few things you'll want to keep in mind. Generally speaking, the desktop should be centered over the frame side-to-side, and positioned slightly forward of center (towards the user) front-to-back.

Side-to-side position

In our experience, desks have better lateral stability the further apart the legs are. We position the screw holes for the Side Brackets 2 inches in from the sides of the desktop. This leaves about 1" of desktop overhang and maximizes lateral stability.

Placing the holes at least 2 inches in from the sides lowers the chance that your desktop will split during drilling.

Depending on the rigidity and strength of your desktop material you can leave more of it overhanging the Side Brackets. For example, on our 78" tops the Side Bracket holes are 5" in from the edge with 4" of overhang.

Laying it out

The easiest way to position your own desktop on Jarvis is to partially assemble the frame and use it as a guide.

1. Lay your desktop on a padded workspace with the underside facing up, and the front of the desktop towards you.
2. Without the Lifting Columns, attach the Side Brackets to the Frame Ends as shown in steps 2 and 3, on pages 4 and 5.
3. Slide the Center Rails into the Frame Ends.
4. Position the frame assembly on the underside of your desktop, with the screw holes in the Side Brackets 2" or more from the side edges of the top, and the front-most hole appropriate depth from the front (user-facing) edge of the top.

Contact

Fully North America

Portland, Oregon

888-508-3725

support@fully.com

www.fully.com

Fully Europe

Ghent, Belgium

EU +32 9 296 44 83

UK +44 80 0069 8262

DE +49 30 7001 4476

help@fully.com

Everything you need
to find your work flow

