

Enumeration of Standard Puzzles

Guo-Niu Han
I.R.M.A., UMR 7501
Université de Strasbourg et CNRS
7 rue René-Descartes, 67084 Strasbourg, France
guoniu.han@unistra.fr

Abstract

We introduce a large family of combinatorial objects, called standard puzzles, defined by very simple rules. We focus on the standard puzzles for which the enumeration problems can be solved by explicit formulas or by classical numbers, such as binomial coefficients, Fibonacci numbers, tangent numbers, Catalan numbers, . . .

1 Introduction

We introduce a large family of combinatorial objects, called *standard puzzles*, defined by very simple rules, and study their enumeration problems. The topic of the paper may be classified as belonging to *Enumerative Combinatorics*, since several of those standard puzzles can be solved by explicit formulas or by using classical numbers, such as binomial coefficients, Fibonacci numbers, tangent numbers, Catalan numbers, . . .

The general definition of a standard puzzle is inspired by the following classical topics in Enumerative Combinatorics: (1) polyominoes [[WikiP](#)] ; (2) standard Young tableaux [[WikiY](#)] ; (3) permutation patterns [[WikiPP](#)] ; (4) doubloons, which were introduced recently [[GZ](#), [FHa](#), [FHb](#)].

We do not pretend to establish a general principle that will make the enumeration of all those standard puzzles possible. We will only provide a large list of standard puzzles with their first values, and the OEIS outputs whenever the sequence is already listed in the On-Line Encyclopedia of Integer Sequences [[S](#)]. Up to order 4 there are 114 sequences identified in OEIS, meaning that those sequences have already been found in various analytical, arithmetical or combinatorial contexts and can also be derived in our puzzle model, but 1339 are still unknown, that is, do have puzzle descriptions, but have not been encountered in other contexts.

2 Definition of standard puzzle

A *piece* is a square having four numbers, called *labels*, written on its corners. A *puzzle* is a connected arrangement of pieces in the $\mathbb{Z} \times \mathbb{Z}$ -plane such that the joining corners of all the pieces have the same labels (see Fig. 1). Pieces and puzzles can be translated, but can be neither rotated, nor reflected. The *shape* of each puzzle is a polyomino obtained from the puzzle by removing the labels.

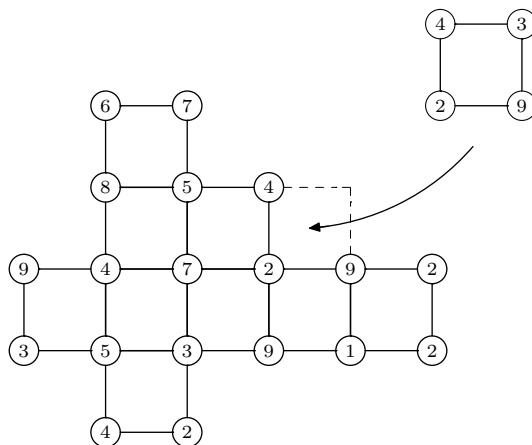

Figure 1: Adding a piece to a puzzle

A *standard puzzle* of shape λ is a puzzle such that the multi-set of all its labels is simply $\{1, 2, \dots, m\}$. This implies that m is the number of vertices of the polyomino λ . In particular, the four labels of a piece occurring in a standard puzzle are all distinct. Replacing the four labels by $\{1, 2, 3, 4\}$ respecting the label ordering yields a *standard piece*. This operation is called a *reduction* and will be denoted by Ω (see Fig. 2). Two pieces are said to be *identical* if they have the same reductions. In the rest of the paper, puzzle means standard puzzle and piece means standard piece. We then have only twenty-four different pieces which are listed and coded in Table 1. Note that the letters “I” and “O” have not even used.

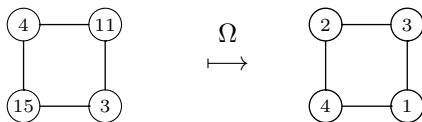

Figure 2: Reduction of a piece

Given a standard puzzle α , a set \mathcal{P} of standard pieces is called *support* of the puzzle α if the reduction of each piece occurring in the puzzle α is an element of \mathcal{P} . Hence, the minimal support of α is the set of all different pieces of α after reduction. For example, the standard puzzle given in Fig. 3 contains seven pieces, but only four of them are different $\begin{bmatrix} 2 & 3 \\ 4 & 1 \end{bmatrix}$, $\begin{bmatrix} 3 & 2 \\ 1 & 4 \end{bmatrix}$, $\begin{bmatrix} 1 & 4 \\ 3 & 2 \end{bmatrix}$, $\begin{bmatrix} 3 & 2 \\ 4 & 1 \end{bmatrix}$. The minimal support is the set of those four pieces and each set of pieces containing those four pieces is a support of the puzzle. The main problem discussed in the paper is the following.

$$\begin{array}{cccccc}
A = \begin{bmatrix} 4 & 3 \\ 1 & 2 \end{bmatrix} & B = \begin{bmatrix} 3 & 4 \\ 1 & 2 \end{bmatrix} & C = \begin{bmatrix} 4 & 2 \\ 1 & 3 \end{bmatrix} & D = \begin{bmatrix} 2 & 4 \\ 1 & 3 \end{bmatrix} & E = \begin{bmatrix} 3 & 2 \\ 1 & 4 \end{bmatrix} & F = \begin{bmatrix} 2 & 3 \\ 1 & 4 \end{bmatrix} \\
G = \begin{bmatrix} 4 & 3 \\ 2 & 1 \end{bmatrix} & H = \begin{bmatrix} 3 & 4 \\ 2 & 1 \end{bmatrix} & J = \begin{bmatrix} 4 & 1 \\ 2 & 3 \end{bmatrix} & K = \begin{bmatrix} 1 & 4 \\ 2 & 3 \end{bmatrix} & L = \begin{bmatrix} 3 & 1 \\ 2 & 4 \end{bmatrix} & M = \begin{bmatrix} 1 & 3 \\ 2 & 4 \end{bmatrix} \\
N = \begin{bmatrix} 4 & 2 \\ 3 & 1 \end{bmatrix} & P = \begin{bmatrix} 2 & 4 \\ 3 & 1 \end{bmatrix} & Q = \begin{bmatrix} 4 & 1 \\ 3 & 2 \end{bmatrix} & R = \begin{bmatrix} 1 & 4 \\ 3 & 2 \end{bmatrix} & S = \begin{bmatrix} 2 & 1 \\ 3 & 4 \end{bmatrix} & T = \begin{bmatrix} 1 & 2 \\ 3 & 4 \end{bmatrix} \\
U = \begin{bmatrix} 3 & 2 \\ 4 & 1 \end{bmatrix} & V = \begin{bmatrix} 2 & 3 \\ 4 & 1 \end{bmatrix} & W = \begin{bmatrix} 3 & 1 \\ 4 & 2 \end{bmatrix} & X = \begin{bmatrix} 1 & 3 \\ 4 & 2 \end{bmatrix} & Y = \begin{bmatrix} 2 & 1 \\ 4 & 3 \end{bmatrix} & Z = \begin{bmatrix} 1 & 2 \\ 4 & 3 \end{bmatrix}
\end{array}$$

Table 1: The twenty-four pieces and its codes

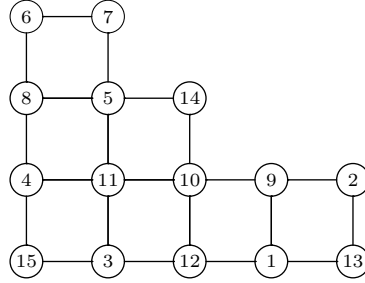
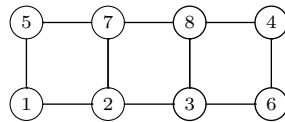

Figure 3: A standard puzzle

Problem 1. Given a set of pieces \mathcal{P} and a polyomino λ , count the number of standard puzzles of shape λ whose support is equal to \mathcal{P} .

If the support is $\left\{ \begin{bmatrix} 3 & 4 \\ 1 & 2 \end{bmatrix}, \begin{bmatrix} 2 & 4 \\ 1 & 3 \end{bmatrix} \right\}$ and the shape is a partition, then a standard puzzle is just a standard Young tableau [WikiY]. Hence, the number of standard puzzles is the number of standard Young tableaux of fixed shape (See Fig. 4 in Section 4). Problem 1 can be solved by using the famous hook length formula [FRT].

However, the problem is very hard to solve in general. In the rest of the paper we focus our attention to a very special shape, namely, the $2 \times n$ matrix. For convenience puzzles of shape $2 \times n$ will be represented by two-row matrices. For example $\begin{bmatrix} 5784 \\ 1236 \end{bmatrix}$ stands for



In this case the set of all puzzles made by using the support \mathcal{P} is denoted by \mathcal{P}^n . For example, take $\mathcal{P} = BC = \{B, C\} = \left\{ \begin{bmatrix} 3 & 4 \\ 1 & 2 \end{bmatrix}, \begin{bmatrix} 4 & 2 \\ 1 & 3 \end{bmatrix} \right\}$. Then

$$\begin{aligned}
BC^2 &= \left\{ \begin{bmatrix} 34 \\ 12 \end{bmatrix}, \begin{bmatrix} 42 \\ 13 \end{bmatrix} \right\} \\
BC^3 &= \left\{ \begin{bmatrix} 563 \\ 124 \end{bmatrix}, \begin{bmatrix} 463 \\ 125 \end{bmatrix}, \begin{bmatrix} 456 \\ 123 \end{bmatrix}, \begin{bmatrix} 364 \\ 125 \end{bmatrix}, \begin{bmatrix} 356 \\ 124 \end{bmatrix} \right\} \\
BC^4 &= \left\{ \begin{bmatrix} 6784 \\ 1235 \end{bmatrix}, \begin{bmatrix} 5784 \\ 1236 \end{bmatrix}, \begin{bmatrix} 5684 \\ 1237 \end{bmatrix}, \begin{bmatrix} 5678 \\ 1234 \end{bmatrix}, \begin{bmatrix} 4785 \\ 1236 \end{bmatrix}, \begin{bmatrix} 4685 \\ 1237 \end{bmatrix}, \begin{bmatrix} 4678 \\ 1235 \end{bmatrix}, \right. \\
&\quad \left. \begin{bmatrix} 4586 \\ 1237 \end{bmatrix}, \begin{bmatrix} 4578 \\ 1236 \end{bmatrix}, \begin{bmatrix} 3785 \\ 1246 \end{bmatrix}, \begin{bmatrix} 3685 \\ 1247 \end{bmatrix}, \begin{bmatrix} 3678 \\ 1245 \end{bmatrix}, \begin{bmatrix} 3586 \\ 1247 \end{bmatrix}, \begin{bmatrix} 3578 \\ 1246 \end{bmatrix} \right\}
\end{aligned}$$

The sequence $(|BC^n|)_n = (|BC^2|, |BC^3|, |BC^4|, \dots)$, equal to

$$(2, 5, 14, 42, 132, 429, 1430, 4862, 16796, 58786, 208012, \dots),$$

is the well-known sequence of the Catalan numbers. However, many sequences defined by other supports are not identified in OEIS. For example, with $\mathcal{P} = CK = \left\{ \begin{bmatrix} 4 & 2 \\ 1 & 3 \end{bmatrix}, \begin{bmatrix} 4 & 1 \\ 2 & 3 \end{bmatrix} \right\}$ we have

$$\begin{aligned} CK^2 &= \left\{ \begin{bmatrix} 42 \\ 13 \end{bmatrix}, \begin{bmatrix} 14 \\ 23 \end{bmatrix} \right\} \\ CK^3 &= \left\{ \begin{bmatrix} 625 \\ 134 \end{bmatrix}, \begin{bmatrix} 526 \\ 134 \end{bmatrix}, \begin{bmatrix} 426 \\ 135 \end{bmatrix}, \begin{bmatrix} 164 \\ 235 \end{bmatrix} \right\} \\ CK^4 &= \left\{ \begin{bmatrix} 8275 \\ 1346 \end{bmatrix}, \begin{bmatrix} 7285 \\ 1346 \end{bmatrix}, \begin{bmatrix} 6285 \\ 1347 \end{bmatrix}, \begin{bmatrix} 5286 \\ 1347 \end{bmatrix}, \begin{bmatrix} 4286 \\ 1357 \end{bmatrix}, \begin{bmatrix} 1847 \\ 2356 \end{bmatrix}, \begin{bmatrix} 1748 \\ 2356 \end{bmatrix}, \begin{bmatrix} 1648 \\ 2357 \end{bmatrix} \right\} \end{aligned}$$

The sequence $(|CK^n|)_n$ is

$$(2, 4, 8, 26, 66, 276, 816, 4050, 13410, 75780, 274680 \dots)$$

which is not in OEIS.

3 The two-line matrix shape

When the shape is a $2 \times n$ matrix, the enumeration problems for the supports \mathcal{P} and \mathcal{P}' are equivalent, denoted by $\mathcal{P} \equiv \mathcal{P}'$, if \mathcal{P}' is obtained from \mathcal{P} by applying the following basic transformations one or more times:

- (T1) exchanging left column and right column in every piece;
- (T2) exchanging top row and bottom row in every piece;
- (T3) replacing each label a by $(5 - a)$ in every piece.

For example, the support $\left\{ \begin{bmatrix} 4 & 3 \\ 1 & 2 \end{bmatrix}, \begin{bmatrix} 3 & 4 \\ 1 & 2 \end{bmatrix} \right\}$ is equivalent to $\left\{ \begin{bmatrix} 3 & 4 \\ 2 & 1 \end{bmatrix}, \begin{bmatrix} 4 & 3 \\ 2 & 1 \end{bmatrix} \right\}$ by (T1), to $\left\{ \begin{bmatrix} 1 & 2 \\ 4 & 3 \end{bmatrix}, \begin{bmatrix} 1 & 2 \\ 3 & 4 \end{bmatrix} \right\}$ by (T2) and to $\left\{ \begin{bmatrix} 1 & 2 \\ 4 & 3 \end{bmatrix}, \begin{bmatrix} 2 & 1 \\ 4 & 3 \end{bmatrix} \right\}$ by (T3). The enumeration problems for the following supports \mathcal{P} are all equivalent.

$$\begin{aligned} &\left\{ \begin{bmatrix} 4 & 3 \\ 1 & 2 \end{bmatrix}, \begin{bmatrix} 3 & 4 \\ 1 & 2 \end{bmatrix} \right\} \equiv \left\{ \begin{bmatrix} 1 & 2 \\ 3 & 4 \end{bmatrix}, \begin{bmatrix} 1 & 2 \\ 4 & 3 \end{bmatrix} \right\} \equiv \left\{ \begin{bmatrix} 4 & 3 \\ 2 & 1 \end{bmatrix}, \begin{bmatrix} 3 & 4 \\ 2 & 1 \end{bmatrix} \right\} \equiv \left\{ \begin{bmatrix} 2 & 1 \\ 3 & 4 \end{bmatrix}, \begin{bmatrix} 2 & 1 \\ 4 & 3 \end{bmatrix} \right\} \\ &\equiv \left\{ \begin{bmatrix} 2 & 1 \\ 4 & 3 \end{bmatrix}, \begin{bmatrix} 1 & 2 \\ 4 & 3 \end{bmatrix} \right\} \equiv \left\{ \begin{bmatrix} 4 & 3 \\ 1 & 2 \end{bmatrix}, \begin{bmatrix} 4 & 3 \\ 2 & 1 \end{bmatrix} \right\} \equiv \left\{ \begin{bmatrix} 2 & 1 \\ 3 & 4 \end{bmatrix}, \begin{bmatrix} 1 & 2 \\ 3 & 4 \end{bmatrix} \right\} \equiv \left\{ \begin{bmatrix} 3 & 4 \\ 1 & 2 \end{bmatrix}, \begin{bmatrix} 3 & 4 \\ 2 & 1 \end{bmatrix} \right\}. \end{aligned}$$

A support \mathcal{P} is said to be *connected* if for every pair of pieces from \mathcal{P} , there is a puzzle containing those two pieces. The non-connected supports \mathcal{P} can be fully characterized, and have one of the following three forms:

$$\begin{aligned} (a) &\left\{ \begin{bmatrix} \dot{\wedge} & \dot{\wedge} \\ \dot{\cdot} & \dot{\cdot} \end{bmatrix}, \begin{bmatrix} \dot{\wedge} & \dot{\wedge} \\ \dot{\cdot} & \dot{\cdot} \end{bmatrix}, \dots, \begin{bmatrix} \dot{\wedge} & \dot{\wedge} \\ \dot{\cdot} & \dot{\cdot} \end{bmatrix}; \begin{bmatrix} \dot{\vee} & \dot{\vee} \\ \dot{\cdot} & \dot{\cdot} \end{bmatrix}, \begin{bmatrix} \dot{\vee} & \dot{\vee} \\ \dot{\cdot} & \dot{\cdot} \end{bmatrix}, \dots, \begin{bmatrix} \dot{\vee} & \dot{\vee} \\ \dot{\cdot} & \dot{\cdot} \end{bmatrix} \right\} \\ (b) &\left\{ \begin{bmatrix} \dot{\wedge} & \dot{\vee} \\ \dot{\cdot} & \dot{\cdot} \end{bmatrix}; \begin{bmatrix} \dot{\wedge} & \dot{\vee} \\ \dot{\cdot} & \dot{\cdot} \end{bmatrix}; \dots; \begin{bmatrix} \dot{\wedge} & \dot{\vee} \\ \dot{\cdot} & \dot{\cdot} \end{bmatrix} \right\} \end{aligned}$$

$$(c) \quad \left\{ \left[\begin{array}{cc} \dot{\vee} & \dot{\wedge} \\ \dot{\cdot} & \dot{\cdot} \end{array} \right]; \left[\begin{array}{cc} \dot{\vee} & \dot{\wedge} \\ \dot{\cdot} & \dot{\cdot} \end{array} \right]; \cdots ; \left[\begin{array}{cc} \dot{\vee} & \dot{\wedge} \\ \dot{\cdot} & \dot{\cdot} \end{array} \right] \right\}$$

For example, the support $\left\{ \begin{bmatrix} 4 & 3 \\ 1 & 2 \end{bmatrix}, \begin{bmatrix} 3 & 4 \\ 1 & 2 \end{bmatrix}; \begin{bmatrix} 1 & 2 \\ 4 & 3 \end{bmatrix} \right\}$ is not-connected (type (a)). It contains two connected components. For studying the enumeration problem we need only consider the connected supports. After reduction by (T1-T3), the number of possible connected supports \mathcal{P} is shown in the following table

$$\begin{array}{lcccccccc} |\mathcal{P}| & : & 1 & 2 & 3 & 4 & 5 & 6 & \cdots \\ \#\{\mathcal{P}\} & : & 6 & 37 & 259 & 1391 & 5460 & ? & \cdots \end{array}$$

The list of all those sets \mathcal{P} with the sequences can be found in Section 6.

Problem 2. *What is the sequence of the numbers of possible connected supports $\#\{\mathcal{P}\}$?*

Fix a support \mathcal{P} . Let $f_n[X_Y]$ be the number of all puzzles of shape $2 \times n$ such that the rightmost column is $\begin{bmatrix} X \\ Y \end{bmatrix}$. Then, the number f_n of all puzzles of shape $2 \times n$ is then

$$f_n = \sum_{X,Y} f_n[X_Y], \quad (1)$$

where the sum ranges over all ordered pairs of $[2n] \times [2n]$.

The *inverse reduction* $x' = \Omega^{-1}(x; X, Y)$ of x by $\{X, Y\}$ is defined by

$$x' = \begin{cases} x; & \text{if } x \leq a - 1 \\ x + 1; & \text{if } a \leq x \leq b - 2 \\ x + 2, & \text{if } b - 1 \leq x \end{cases}$$

where $a = \min(X, Y)$ and $b = \max(X, Y)$.

Proposition 1. *Let $1 \leq X, Y \leq 2n$ and $X \neq Y$. Then*

$$f_n[X_Y] = \sum_{x,y} f_{n-1} \begin{bmatrix} x \\ y \end{bmatrix} \quad (2)$$

where the sum ranges over all ordered pairs (x, y) of $[2n-2] \times [2n-2]$ such that the reduction of $\begin{bmatrix} \Omega^{-1}(x; X, Y) & X \\ \Omega^{-1}(y; X, Y) & Y \end{bmatrix}$ is a piece in \mathcal{P} .

Formulas (1) and (2) are used for computing the first values of the number of standard puzzles (f_n).

4 Selected examples

In Section 6 we display the full list of all standard puzzle sequences including the outputs from OEIS if any. Each item in the dictionary may contain the following fields:

- Codes and pieces: The support \mathcal{P} of the standard puzzles
- See also: List of other supports \mathcal{P}' such $|\mathcal{P}^n| = |\mathcal{P}'^n|$
- Seq: The sequence $(|\mathcal{P}^n|)$ for $n = 2, 3, 4, \dots$
- Var: This is a variant of the sequence of $(|\mathcal{P}^n|)$. Sometimes the sequence is not in OEIS but a slight modification of that sequence is in OEIS.
- OEIS: The OEIS output contains three parts: the OEIS code, the number of results found (written in square brackets []), and the description of the first result found in OEIS.

In the present paper we will not reproduce all the formulas observed in the same way as formulas (3-10) further derived. In fact, we have 114 sequences identified in OEIS up to order $|\mathcal{P}| = 4$. It corresponds to 309 supports \mathcal{P} , that is, we have 309 formulas to prove!

For example, we find the following item in the dictionary.

BC $\left\{ \begin{bmatrix} 3 & 4 \\ 1 & 2 \end{bmatrix}, \begin{bmatrix} 4 & 2 \\ 1 & 3 \end{bmatrix} \right\}$ See also **BD**

Seq= 2, 5, 14, 42, 132, 429, 1430, 4862, 16796, 58786, 208012

OEIS: [A000108](#) [5] Catalan numbers: $C(n) = \text{binomial}(2n, n) / (n+1) = (2n)! / (n!(n+1)!)$. Also called Segner numbers.

From the above item BC in the dictionary we extract the following results.

Theorem 2. *We have*

$$|BC^n| = \left| \left\{ \begin{bmatrix} 3 & 4 \\ 1 & 2 \end{bmatrix}, \begin{bmatrix} 4 & 2 \\ 1 & 3 \end{bmatrix} \right\}^n \right| = C_n; \quad (3)$$

$$|BD^n| = \left| \left\{ \begin{bmatrix} 3 & 4 \\ 1 & 2 \end{bmatrix}, \begin{bmatrix} 2 & 4 \\ 1 & 3 \end{bmatrix} \right\}^n \right| = C_n, \quad (4)$$

where $C_n = \frac{1}{n+1} \binom{2n}{n}$ is the Catalan numbers [[WikiC](#)].

Proof. Equation (4) is well-known since the puzzles with support $BD = \left\{ \begin{bmatrix} 3 & 4 \\ 1 & 2 \end{bmatrix}, \begin{bmatrix} 2 & 4 \\ 1 & 3 \end{bmatrix} \right\}$ are just the standard Young tableaux, which can be counted by the famous hook length formula [[FRT](#)]. In fact, each puzzle with support BD is just a labelling of the vertices of the following diagram such that the labels are increasing in the sense of the arrows [[St](#), p. 227].

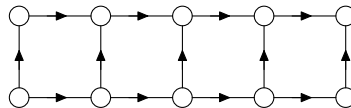

Figure 4: Puzzles having the support BD

However, identity (3) cannot be directly found in the references. A further bijection is to be constructed to map a puzzle from BC^n onto a puzzle from BD^n . Each puzzle with

support BC contains no piece C , or only one piece C at the rightmost position. Hence, the puzzles with support BC can be characterized by the following two diagrams:

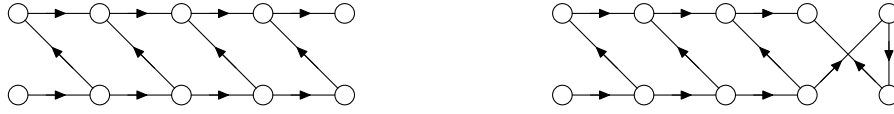

Figure 5: Puzzles having the support BC

In Fig. 4 and 5 the labels of certain vertices can only have fixed values, in particular maximal or minimal values. Removing those vertices yields the simplified diagrams Figures 6 and 7. The standard labellings of the diagram in Fig. 6 such that $a < b$ (resp. $a > b$) are in bijection with the standard labellings of the left diagram (resp. right diagram) in Fig. 7. This gives a bijection between BC^n and BD^n . \square

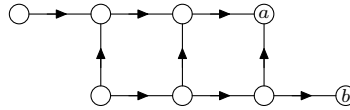

Figure 6: Puzzles having the support BD (after simplification)



Figure 7: Puzzles having the support BC (after simplification)

Recall that the classical tangent numbers T_{2n+1} , secant numbers E_{2n} and the unsigned Genocchi numbers G_{2n} are defined by the following generating functions [WikiT].

$$\begin{aligned} \tan u &= \sum_{n \geq 0} \frac{u^{2n+1}}{(2n+1)!} T_{2n+1} \\ \sec u &= \sum_{n \geq 0} \frac{u^{2n}}{(2n)!} E_{2n} \\ \frac{2u}{e^u + 1} &= u + \sum_{n \geq 1} (-1)^n \frac{u^{2n}}{(2n)!} G_{2n} \end{aligned}$$

It is well-known that T_{2n+1} and E_{2n} count the numbers of alternating permutations of length $2n+1$ and $2n$ respectively [WikiT]. The unsigned Genocchi numbers $G_{2n} = nT_{2n-1}/2^{2n-2}$ count the numbers of surjective staircases [Du]. The support $\mathcal{P} = BCEG$ involves those numbers.

BCEG $\{ \begin{bmatrix} 3 & 4 \\ 1 & 2 \end{bmatrix}, \begin{bmatrix} 4 & 2 \\ 1 & 3 \end{bmatrix}, \begin{bmatrix} 3 & 2 \\ 1 & 4 \end{bmatrix}, \begin{bmatrix} 4 & 3 \\ 2 & 1 \end{bmatrix} \}$ See also **BEGJ**, **BEGY**, **BEJV**, **BEVY**, **BJTV**, **EJRV**

Seq= 4, 24, 272, 4960, 132672, 4893056, 237969664, 14756156928

Var= 1, 3, 17, 155, 2073, 38227, 929569, 28820619, 1109652905

OEIS: [A110501](#) [2] Unsigned Genocchi numbers (of first kind) of even index.

From the above item *BCEG* in the dictionary we read the following seven identities as shown in Theorem 3 and Conjecture 4.

Theorem 3. *We have*

$$|BEGJ^n| = |\{ \begin{bmatrix} 3 & 4 \\ 1 & 2 \end{bmatrix}, \begin{bmatrix} 3 & 2 \\ 1 & 4 \end{bmatrix}, \begin{bmatrix} 4 & 3 \\ 2 & 1 \end{bmatrix}, \begin{bmatrix} 4 & 1 \\ 2 & 3 \end{bmatrix} \}^n| = nT_{2n-1}/2^{n-2}; \quad (5)$$

$$|BEGY^n| = |\{ \begin{bmatrix} 3 & 4 \\ 1 & 2 \end{bmatrix}, \begin{bmatrix} 3 & 2 \\ 1 & 4 \end{bmatrix}, \begin{bmatrix} 4 & 3 \\ 2 & 1 \end{bmatrix}, \begin{bmatrix} 2 & 1 \\ 4 & 3 \end{bmatrix} \}^n| = nT_{2n-1}/2^{n-2}; \quad (6)$$

$$|BEJV^n| = |\{ \begin{bmatrix} 3 & 4 \\ 1 & 2 \end{bmatrix}, \begin{bmatrix} 3 & 2 \\ 1 & 4 \end{bmatrix}, \begin{bmatrix} 4 & 1 \\ 2 & 3 \end{bmatrix}, \begin{bmatrix} 2 & 3 \\ 4 & 1 \end{bmatrix} \}^n| = nT_{2n-1}/2^{n-2}; \quad (7)$$

$$|BEVY^n| = |\{ \begin{bmatrix} 3 & 4 \\ 1 & 2 \end{bmatrix}, \begin{bmatrix} 3 & 2 \\ 1 & 4 \end{bmatrix}, \begin{bmatrix} 2 & 3 \\ 4 & 1 \end{bmatrix}, \begin{bmatrix} 2 & 1 \\ 4 & 3 \end{bmatrix} \}^n| = nT_{2n-1}/2^{n-2}; \quad (8)$$

$$|BJTV^n| = |\{ \begin{bmatrix} 3 & 4 \\ 1 & 2 \end{bmatrix}, \begin{bmatrix} 4 & 1 \\ 2 & 3 \end{bmatrix}, \begin{bmatrix} 1 & 2 \\ 3 & 4 \end{bmatrix}, \begin{bmatrix} 2 & 3 \\ 4 & 1 \end{bmatrix} \}^n| = nT_{2n-1}/2^{n-2}; \quad (9)$$

$$|EJRV^n| = |\{ \begin{bmatrix} 3 & 2 \\ 1 & 4 \end{bmatrix}, \begin{bmatrix} 4 & 1 \\ 2 & 3 \end{bmatrix}, \begin{bmatrix} 1 & 4 \\ 3 & 2 \end{bmatrix}, \begin{bmatrix} 2 & 3 \\ 4 & 1 \end{bmatrix} \}^n| = nT_{2n-1}/2^{n-2}. \quad (10)$$

Proof. The enumeration of $|BJTV^n|$ is derived in [GZ, FHa] and identity (9) is proven to be true. Notice that no easy direct proof of (9) is known. We prove that all the six left-hand sides of equations (5-10) are equal to

$$|BGTY^n| = |\{ \begin{bmatrix} 3 & 4 \\ 1 & 2 \end{bmatrix}, \begin{bmatrix} 4 & 3 \\ 2 & 1 \end{bmatrix}, \begin{bmatrix} 1 & 2 \\ 3 & 4 \end{bmatrix}, \begin{bmatrix} 2 & 1 \\ 4 & 3 \end{bmatrix} \}^n|. \quad (11)$$

Let S be a subset of $\{1, 2, \dots, n\}$. The *flip map* $\phi_S : \alpha \mapsto \beta$ is a transformation which maps a puzzle $\alpha = \begin{bmatrix} x_1 & x_2 & \dots & x_n \\ y_1 & y_2 & \dots & y_n \end{bmatrix}$ onto $\beta = \begin{bmatrix} a_1 & a_2 & \dots & a_n \\ b_1 & b_2 & \dots & b_n \end{bmatrix}$ such that $a_i = x_i, b_i = y_i$ for $i \notin S$ and $a_i = y_i, b_i = x_i$ for $i \in S$. Notice that the flip map is an involution. The following diagram shows the actions of the flip maps onto some pieces:

$$\begin{array}{ccc} (B, G, T, Y) & \xrightarrow{\phi_{\{1,2\}}} & (T, Y, B, G) \\ & \downarrow \phi_{\{2\}} & \\ (E, J, R, V) & \xrightarrow{\phi_{\{1,2\}}} & (R, V, E, J) \end{array}$$

The *important facts* are that the flip map $\phi_{\{1,2\}}$ does not change the two supports $\{B, G, T, Y\}$ and $\{E, J, R, V\}$; moreover, those two supports do not contain any common piece. We can prove that all the $2^4 = 16$ supports \mathcal{P} derived from the Cartesian product $\Gamma := \{B, E\} \times \{G, J\} \times \{T, R\} \times \{Y, V\}$ yield the same enumeration sequences ($|\mathcal{P}^n|$). For example, we will explain why

$$|BGTY^n| = |BJRY^n|. \quad (12)$$

Notice that

$$|BGTY^n| = |BG^n| + |TY^n| = 2|BG^n|. \quad (13)$$

	puzzle	first G/T	position	flip
→	$\begin{bmatrix} 11 & 13 & 10 & 6 & 12 & 8 & 14 \\ & B & G & G & B & G & B \\ 7 & 9 & 2 & 1 & 4 & 3 & 5 \end{bmatrix}$	G	$(2, 3)$	$S = \{3, 4, 5, 6, 7\}$
→	$\begin{bmatrix} 11 & 13 & 2 & 1 & 4 & 3 & 5 \\ & B & J & Y & T & Y & T \\ 7 & 9 & 10 & 6 & 12 & 8 & 14 \end{bmatrix}$	T	$(4, 5)$	$S = \{5, 6, 7\}$
→	$\begin{bmatrix} 11 & 13 & 2 & 1 & 12 & 8 & 14 \\ & B & J & Y & R & G & B \\ 7 & 9 & 10 & 6 & 4 & 3 & 5 \end{bmatrix}$	G	$(5, 6)$	$S = \{6, 7\}$
→	$\begin{bmatrix} 11 & 13 & 2 & 1 & 12 & 3 & 5 \\ & B & J & Y & R & J & T \\ 7 & 9 & 10 & 6 & 4 & 8 & 14 \end{bmatrix}$	T	$(6, 7)$	$S = \{7\}$
→	$\begin{bmatrix} 11 & 13 & 2 & 1 & 12 & 3 & 14 \\ & B & J & Y & R & J & R \\ 7 & 9 & 10 & 6 & 4 & 8 & 5 \end{bmatrix}$			

Table 2: Bijection from $BGTY^n$ onto $BJRY^n$

Let α be a puzzle in $BGTY^n$. We construct a puzzle β in $BJRY^n$ in a unique manner by applying an adequate sequence of flip maps.

Start at $\gamma := \alpha$; from left to right look for the first piece in γ that is not in $\{B, J, R, Y\}$, that is, the first piece equal to G or T . Let $(i, i+1)$ be the position of that piece. Apply the flip map $\phi_{\{i+1, i+2, \dots, n-1\}}$ to γ , to obtain a new puzzle. By convention, let $\gamma := \phi_{\{i+1, i+2, \dots, n-1\}}(\gamma)$. Hence, the piece at position $(i, i+1)$ becomes J or R , and all pieces on the right of that position are still in $\{B, G, T, Y\}$, by the important facts mentioned above. Repeat this process until no more G or T are in γ to get the puzzle $\beta := \gamma$ in $BJRY^n$.

For example, take $\alpha = \begin{bmatrix} 11 & 13 & 10 & 6 & 12 & 8 & 14 \\ 7 & 9 & 2 & 1 & 4 & 3 & 5 \end{bmatrix} \in BGTY^n$. The calculation in Table 4 shows that $\beta = \begin{bmatrix} 11 & 13 & 2 & 1 & 12 & 3 & 14 \\ 7 & 9 & 10 & 6 & 4 & 8 & 5 \end{bmatrix} \in BJRY^n$. Note that the number of a piece, for example B , common to two different supports, is not preserved.

This process is reversible thanks to the important facts mentioned above. Hence, identity (12) is proved. Now, since $BJTV, EJRV \in \Gamma$, identities (9) and (10) are proved. In the same manner, $BGRV, EGTY, BJRV, BJRY \in \Gamma$ and $BGRV \equiv BEGJ, EGTY \equiv BEGY, BJRV \equiv BEJV, EJRY \equiv BEVY$. This achieves the proof of (5-8). \square

The next identity cannot be proved in the same manner, since the flip maps are not enough to produce the bijection. Further operations are to be constructed.

Conjecture 4. We have

$$|BCEG^n| = |\{ \begin{bmatrix} 3 & 4 \\ 1 & 2 \end{bmatrix}, \begin{bmatrix} 4 & 2 \\ 1 & 3 \end{bmatrix}, \begin{bmatrix} 3 & 2 \\ 1 & 4 \end{bmatrix}, \begin{bmatrix} 4 & 3 \\ 2 & 1 \end{bmatrix} \}^n| = nT_{2n-1}/2^{n-2}. \quad (14)$$

Other supports \mathcal{P} giving classical numbers are listed below without proof.

ACX: Fibonacci numbers;

AB, ABCD: double factorial numbers;

CDW: Koch snowflake, number of angles after n iterations;

ACET: The number of branching configurations of RNA with n or fewer hairpins;

ACMT: super-Catalan numbers or little Schroeder numbers;

ADHN: Number of permutations of length $2n-1$ with no local maxima or minima in even positions;

AELM: Number of permutations of length n which avoid the patterns 231, 12534;

BDFK: Number of Dyck paths of semilength n having no DUDU's starting at level 1.

5 Where are the secant numbers ?

Since the tangent number sequence is a puzzle sequence with support $BCEG$ (using a slight modification, see (4.3)), a natural question rises: what about the secant numbers $(E_{2n})_{n \geq 2}$:

$$(5, 61, 1385, 50521, 2702765, 199360981, 19391512145, \dots) ? \quad (15)$$

The initial motivation was to define a support that would generate a puzzle sequence for the secant numbers. We developed a computer programme to generate the puzzle sequences up to order $|\mathcal{P}| = 4$. Unfortunately, no secant number sequence could be found.

Notice that the secant numbers appeared in the puzzle sequence for the support $BJTV$, but a non-trivial modification is required. By (9) we have

$$|BJTV^n| = \sum_{X,Y} |BJTV^n[X]_Y| = \frac{n}{2^{n-2}} T_{2n-1}, \quad (16)$$

where $BJTV^n[X]_Y$ is the subset of puzzles in $NJTV^n$ such that the rightmost column is $[X]_Y$. In [Fhb] we obtained the following identity by using the signed doubleton model:

$$\sum_{X,Y} |BJTV^n[X]_Y| \times Q_n(X, Y) = 2^{-n} E_{2n}, \quad (17)$$

where

$$Q_n(X, Y) = \begin{cases} \sum_{k=X}^{Y-1} \binom{2n}{k} & \text{if } X < Y \\ 0 & \text{if } X > Y \end{cases}$$

However, the secant number sequence (15) does not directly appear in the dictionary without the coefficient $Q_n(X, Y)$. It is possible that order $|\mathcal{P}| \leq 4$ is not large enough. Why do not choose a bigger support, for example $\mathcal{P} = CEHJLPRVX$. The puzzle sequence is

$$(9, 111, 2505, 91961, 4913789, 364074545, 35418898477, \dots) \quad (18)$$

We don't obtain the secant sequence (15). It is amusing that the quotient of (18) by the secant sequence (15) is approximately 1.8:

$$(1.800, 1.820, 1.809, 1.820, 1.818, 1.826, 1.827, \dots)$$

What does it mean ?

6 Dictionary of the standard puzzle sequences

Sequence identified for $|\mathcal{P}| = 1$

A $\left\{ \begin{bmatrix} 4 & 3 \\ 1 & 2 \end{bmatrix} \right\}$ See also **D**

Seq= 1, 1, 1, 1, 1, 1, 1, 1, 1, 1, 1

OEIS: [A000012](#) [1450] The simplest sequence of positive numbers: the all 1's sequence.

B $\left\{ \begin{bmatrix} 3 & 4 \\ 1 & 2 \end{bmatrix} \right\}$

Seq= 1, 2, 5, 14, 42, 132, 429, 1430, 4862, 16796, 58786

OEIS: [A000108](#) [5] Catalan numbers: $C(n) = \text{binomial}(2n,n)/(n+1) = (2n)!/(n!(n+1)!)$.

Also called Segner numbers.

C $\left\{ \begin{bmatrix} 4 & 2 \\ 1 & 3 \end{bmatrix} \right\}$ See also **E**, **F**

Seq= 1, 0, 0, 0, 0, 0, 0, 0, 0, 0, 0

OEIS: [A121373](#) [1470] Expansion of $f(q) = f(q, -q^2)$ in powers of q where $f(q,r)$ is the Ramanujan two variable theta function.

Sequence identified for $|\mathcal{P}| = 2$

AB $\left\{ \begin{bmatrix} 4 & 3 \\ 1 & 2 \end{bmatrix}, \begin{bmatrix} 3 & 4 \\ 1 & 2 \end{bmatrix} \right\}$

Seq= 2, 8, 48, 384, 3840, 46080, 645120, 10321920, 185794560, 3715891200

OEIS: [A000165](#) [1] Double factorial numbers: $(2n)!! = 2^n n!$.

AC $\left\{ \begin{bmatrix} 4 & 3 \\ 1 & 2 \end{bmatrix}, \begin{bmatrix} 4 & 2 \\ 1 & 3 \end{bmatrix} \right\}$ See also **AK**, **AX**, **CD**, **CX**, **DE**, **DF**, **EK**, **FK**

Seq= 2, 2, 2, 2, 2, 2, 2, 2, 2, 2, 2

OEIS: [A055642](#) [327] Number of digits in decimal expansion of n .

AD $\left\{ \begin{bmatrix} 4 & 3 \\ 1 & 2 \end{bmatrix}, \begin{bmatrix} 2 & 4 \\ 1 & 3 \end{bmatrix} \right\}$

Seq= 2, 6, 23, 106, 567, 3434, 23137, 171174, 1376525, 11934581, 110817423

OEIS: [A125273](#) [1] Eigensequence of triangle A085478: $a(n) = \text{Sum}_{\{k=0..n-1\}} A085478(n-1,k) * a(k)$ for $n > 0$ with $a(0) = 1$.

AE $\left\{ \begin{bmatrix} 4 & 3 \\ 1 & 2 \end{bmatrix}, \begin{bmatrix} 3 & 2 \\ 1 & 4 \end{bmatrix} \right\}$

Seq= 2, 3, 4, 5, 6, 7, 8, 9, 10, 11, 12

OEIS: [A000027](#) [618] The natural numbers. Also called the whole numbers, the counting numbers or the positive integers.

AF $\left\{ \begin{bmatrix} 4 & 3 \\ 1 & 2 \end{bmatrix}, \begin{bmatrix} 2 & 3 \\ 1 & 4 \end{bmatrix} \right\}$

Seq= 2, 4, 7, 11, 16, 22, 29, 37, 46, 56, 67

OEIS: [A000124](#) [6] Central polygonal numbers (the Lazy Caterer's sequence): $n(n+1)/2 + 1$; or, maximal number of pieces formed when slicing a pa...

AL $\left\{ \begin{bmatrix} 4 & 3 \\ 1 & 2 \end{bmatrix}, \begin{bmatrix} 3 & 1 \\ 2 & 4 \end{bmatrix} \right\}$

Seq= 2, 5, 10, 17, 26, 37, 50, 65, 82, 101, 122

OEIS: [A002522](#) [2] $n^2 + 1$.

AP $\left\{ \begin{bmatrix} 4 & 3 \\ 1 & 2 \end{bmatrix}, \begin{bmatrix} 2 & 4 \\ 3 & 1 \end{bmatrix} \right\}$ See also **DQ**

Seq= 2, 7, 16, 29, 46, 67, 92, 121, 154, 191, 232

OEIS: [A130883](#) [1] $2n^2 - n + 1$.

AR $\left\{ \begin{bmatrix} 4 & 3 \\ 1 & 2 \end{bmatrix}, \begin{bmatrix} 1 & 4 \\ 3 & 2 \end{bmatrix} \right\}$ See also **CM, DJ**

Seq= 2, 4, 6, 8, 10, 12, 14, 16, 18, 20, 22

OEIS: [A005843](#) [25] The even numbers: $a(n) = 2n$.

BC $\left\{ \begin{bmatrix} 3 & 4 \\ 1 & 2 \end{bmatrix}, \begin{bmatrix} 4 & 2 \\ 1 & 3 \end{bmatrix} \right\}$ See also **BD**

Seq= 2, 5, 14, 42, 132, 429, 1430, 4862, 16796, 58786, 208012

OEIS: [A000108](#) [5] Catalan numbers: $C(n) = \text{binomial}(2n, n) / (n+1) = (2n)! / (n!(n+1)!)$.
Also called Segner numbers.

BE $\left\{ \begin{bmatrix} 3 & 4 \\ 1 & 2 \end{bmatrix}, \begin{bmatrix} 3 & 2 \\ 1 & 4 \end{bmatrix} \right\}$ See also **ER**

Seq= 2, 4, 10, 28, 84, 264, 858, 2860, 9724, 33592, 117572

OEIS: [A068875](#) [2] Expansion of $(1+x^*C)^*C$, where $C = (1-(1-4*x)^{(1/2)}) / (2*x)$ is g.f. for Catalan numbers, A000108.

BF $\left\{ \begin{bmatrix} 3 & 4 \\ 1 & 2 \end{bmatrix}, \begin{bmatrix} 2 & 3 \\ 1 & 4 \end{bmatrix} \right\}$

Seq= 2, 3, 7, 19, 56, 174, 561, 1859, 6292, 21658, 75582

OEIS: [A005807](#) [2] Sum of adjacent Catalan numbers.

BG $\left\{ \begin{bmatrix} 3 & 4 \\ 1 & 2 \end{bmatrix}, \begin{bmatrix} 4 & 3 \\ 2 & 1 \end{bmatrix} \right\}$

Seq= 2, 12, 136, 2480, 66336, 2446528, 118984832, 7378078464, 568142287360

OEIS: [A117513](#) [1] Number of ways of arranging $2n$ tokens in a row, with 2 copies of each token from 1 through n , such that between every pair o...

BJ $\left\{ \begin{bmatrix} 3 & 4 \\ 1 & 2 \end{bmatrix}, \begin{bmatrix} 4 & 1 \\ 2 & 3 \end{bmatrix} \right\}$

Seq= 2, 6, 22, 84, 324, 1254, 4862, 18876, 73372, 285532, 1112412

OEIS: [A121686](#) [1] Number of branches in all binary trees with n edges. A binary tree is a rooted tree in which each vertex has at most two chi...

BL $\left\{ \begin{bmatrix} 3 & 4 \\ 1 & 2 \end{bmatrix}, \begin{bmatrix} 3 & 1 \\ 2 & 4 \end{bmatrix} \right\}$

Seq= 2, 4, 12, 40, 140, 504, 1848, 6864, 25740, 97240, 369512

OEIS: [A028329](#) [1] Twice central binomial coefficients.

Sequence unknown for $|\mathcal{P}| = 2$

AH $\left\{ \begin{bmatrix} 4 & 3 \\ 1 & 2 \end{bmatrix}, \begin{bmatrix} 3 & 4 \\ 2 & 1 \end{bmatrix} \right\}$

Seq= 2, 12, 132, 2372, 62304, 2261668, 108184432, 6600715188, 500046044352

BN $\left\{ \begin{bmatrix} 3 & 4 \\ 1 & 2 \end{bmatrix}, \begin{bmatrix} 4 & 2 \\ 3 & 1 \end{bmatrix} \right\}$

Seq= 2, 9, 74, 974, 18831, 502459, 17671764, 792391014, 44129928926, 2987912108763

BQ $\left\{ \begin{bmatrix} 3 & 4 \\ 1 & 2 \end{bmatrix}, \begin{bmatrix} 4 & 1 \\ 3 & 2 \end{bmatrix} \right\}$

Seq= 2, 5, 21, 96, 440, 1989, 8855, 38896, 168948, 727090, 3105322

CK $\left\{ \begin{bmatrix} 4 & 2 \\ 1 & 3 \end{bmatrix}, \begin{bmatrix} 1 & 4 \\ 2 & 3 \end{bmatrix} \right\}$

Seq= 2, 4, 8, 26, 66, 276, 816, 4050, 13410, 75780, 274680

CP $\left\{ \begin{bmatrix} 4 & 2 \\ 1 & 3 \end{bmatrix}, \begin{bmatrix} 2 & 4 \\ 3 & 1 \end{bmatrix} \right\}$

Seq= 2, 10, 82, 1162, 23026, 657148, 23719394, 1137763610, 65032729314

CR $\left\{ \begin{bmatrix} 4 & 2 \\ 1 & 3 \end{bmatrix}, \begin{bmatrix} 1 & 4 \\ 3 & 2 \end{bmatrix} \right\}$

Seq= 2, 5, 18, 91, 563, 4299, 37686, 384543, 4357567, 55614775, 772479331

DN $\left\{ \begin{bmatrix} 2 & 4 \\ 1 & 3 \end{bmatrix}, \begin{bmatrix} 4 & 2 \\ 3 & 1 \end{bmatrix} \right\}$

Seq= 2, 14, 168, 3352, 96816, 3875904, 204185344, 13726330128, 1145508631264

EU $\left\{ \begin{bmatrix} 3 & 2 \\ 1 & 4 \end{bmatrix}, \begin{bmatrix} 3 & 2 \\ 4 & 1 \end{bmatrix} \right\}$

Seq= 2, 6, 26, 150, 1230, 10038, 125490, 1292166, 22184550, 271843110, 6022023210

EV $\left\{ \begin{bmatrix} 3 & 2 \\ 1 & 4 \end{bmatrix}, \begin{bmatrix} 2 & 3 \\ 4 & 1 \end{bmatrix} \right\}$

Seq= 2, 8, 58, 712, 12564, 310256, 10025978, 415159208, 21288518044, 1329526717840

FU $\left\{ \begin{bmatrix} 2 & 3 \\ 1 & 4 \end{bmatrix}, \begin{bmatrix} 3 & 2 \\ 4 & 1 \end{bmatrix} \right\}$

Seq= 2, 12, 106, 1680, 37434, 1171968, 48008850, 2516016384, 163509808050

Sequence identified for $|\mathcal{P}| = 3$

ABC $\left\{ \begin{bmatrix} 4 & 3 \\ 1 & 2 \end{bmatrix}, \begin{bmatrix} 3 & 4 \\ 1 & 2 \end{bmatrix}, \begin{bmatrix} 4 & 2 \\ 1 & 3 \end{bmatrix} \right\}$ See also **ABE**, **ABF**

Seq= 3, 12, 72, 576, 5760, 69120, 967680, 15482880, 278691840, 5573836800

OEIS: [A052676](#) [1] A simple regular expression in a labeled universe.

ABD $\left\{ \begin{bmatrix} 4 & 3 \\ 1 & 2 \end{bmatrix}, \begin{bmatrix} 3 & 4 \\ 1 & 2 \end{bmatrix}, \begin{bmatrix} 2 & 4 \\ 1 & 3 \end{bmatrix} \right\}$

Seq= 3, 15, 105, 945, 10395, 135135, 2027025, 34459425, 654729075, 13749310575

OEIS: [A001147](#) [1] Double factorial numbers: $(2n-1)!! = 1.3.5....(2n-1)$.

ABK $\left\{ \begin{bmatrix} 4 & 3 \\ 1 & 2 \end{bmatrix}, \begin{bmatrix} 3 & 4 \\ 1 & 2 \end{bmatrix}, \begin{bmatrix} 1 & 4 \\ 2 & 3 \end{bmatrix} \right\}$

Seq= 3, 10, 56, 432, 4224, 49920, 691200, 10967040, 196116480, 3901685760

Var= 3, 10, 28, 72, 176, 416, 960, 2176, 4864, 10752, 23552

OEIS: [A128135](#) [1] Row sums of A128134.

ACE $\left\{ \begin{bmatrix} 4 & 3 \\ 1 & 2 \end{bmatrix}, \begin{bmatrix} 4 & 2 \\ 1 & 3 \end{bmatrix}, \begin{bmatrix} 3 & 2 \\ 1 & 4 \end{bmatrix} \right\}$ See also **ACZ**, **AKM**, **AKS**, **AMX**, **DEM**, **DFM**

Seq= 3, 4, 5, 6, 7, 8, 9, 10, 11, 12, 13

OEIS: [A000027](#) [527] The natural numbers. Also called the whole numbers, the counting numbers or the positive integers.

ACF $\left\{ \begin{bmatrix} 4 & 3 \\ 1 & 2 \end{bmatrix}, \begin{bmatrix} 4 & 2 \\ 1 & 3 \end{bmatrix}, \begin{bmatrix} 2 & 3 \\ 1 & 4 \end{bmatrix} \right\}$

Seq= 3, 5, 8, 12, 17, 23, 30, 38, 47, 57, 68

OEIS: [A022856](#) [4] $a(n) = n-2 + \text{Sum of } a(i+1) \bmod(a(i)) \text{ for } i = 1 \text{ to } n-2, \text{ for } n \geq 3$.

ACL $\left\{ \begin{bmatrix} 4 & 3 \\ 1 & 2 \end{bmatrix}, \begin{bmatrix} 4 & 2 \\ 1 & 3 \end{bmatrix}, \begin{bmatrix} 3 & 1 \\ 2 & 4 \end{bmatrix} \right\}$ See also **AMR**, **CDM**

Seq= 3, 6, 11, 18, 27, 38, 51, 66, 83, 102, 123

OEIS: [A059100](#) [4] n^2+2 .

ACM $\left\{ \begin{bmatrix} 4 & 3 \\ 1 & 2 \end{bmatrix}, \begin{bmatrix} 4 & 2 \\ 1 & 3 \end{bmatrix}, \begin{bmatrix} 1 & 3 \\ 2 & 4 \end{bmatrix} \right\}$ See also **AFM**, **AFZ**

Seq= 3, 6, 14, 35, 90, 234, 611, 1598, 4182, 10947, 28658

OEIS: [A032908](#) [2] One of 4 3rd-order recurring sequences for which the first derived sequence and the Galois transformed sequence coincide.

ACS $\left\{ \begin{bmatrix} 4 & 3 \\ 1 & 2 \end{bmatrix}, \begin{bmatrix} 4 & 2 \\ 1 & 3 \end{bmatrix}, \begin{bmatrix} 2 & 1 \\ 3 & 4 \end{bmatrix} \right\}$ See also **ATX**

Seq= 3, 7, 21, 71, 253, 925, 3433, 12871, 48621, 184757, 705433

Var= 0, 4, 18, 68, 250, 922, 3430, 12868, 48618, 184754, 705430

OEIS: [A115112](#) [1] Number of different ways to select n elements from two sets of n elements under the condition of choosing at least one el...

ACT $\left\{ \begin{bmatrix} 4 & 3 \\ 1 & 2 \end{bmatrix}, \begin{bmatrix} 4 & 2 \\ 1 & 3 \end{bmatrix}, \begin{bmatrix} 1 & 2 \\ 3 & 4 \end{bmatrix} \right\}$

Seq= 3, 6, 17, 62, 259, 1162, 5441, 26234, 129283, 648142, 3294865

Var= 2, 5, 16, 61, 258, 1161, 5440, 26233, 129282, 648141, 3294864

OEIS: [A104858](#) [1] Partial sums of the little Schroeder numbers (A001003).

ACX $\left\{ \begin{bmatrix} 4 & 3 \\ 1 & 2 \end{bmatrix}, \begin{bmatrix} 4 & 2 \\ 1 & 3 \end{bmatrix}, \begin{bmatrix} 1 & 3 \\ 4 & 2 \end{bmatrix} \right\}$ See also **DEK**, **DFK**

Seq= 3, 5, 8, 13, 21, 34, 55, 89, 144, 233, 377

OEIS: [A000045](#) [15] Fibonacci numbers: $F(n) = F(n-1) + F(n-2)$, $F(0) = 0$, $F(1) = 1$, $F(2) = 1$, ...

AEF $\left\{ \begin{bmatrix} 4 & 3 \\ 1 & 2 \end{bmatrix}, \begin{bmatrix} 3 & 2 \\ 1 & 4 \end{bmatrix}, \begin{bmatrix} 2 & 3 \\ 1 & 4 \end{bmatrix} \right\}$ See also **AEQ**

Seq= 3, 6, 10, 15, 21, 28, 36, 45, 55, 66, 78

OEIS: [A000217](#) [29] Triangular numbers: $a(n) = C(n+1,2) = n(n+1)/2 = 0+1+2+\dots+n$.

AEJ $\left\{ \begin{bmatrix} 4 & 3 \\ 1 & 2 \end{bmatrix}, \begin{bmatrix} 3 & 2 \\ 1 & 4 \end{bmatrix}, \begin{bmatrix} 4 & 1 \\ 2 & 3 \end{bmatrix} \right\}$ See also **AKR**, **AKV**, **ARX**, **CDJ**, **CDL**, **CEM**, **CFM**, **DEJ**, **DFJ**

Seq= 3, 5, 7, 9, 11, 13, 15, 17, 19, 21, 23

OEIS: [A005408](#) [34] The odd numbers: $a(n) = 2n+1$.

AEL $\left\{ \begin{bmatrix} 4 & 3 \\ 1 & 2 \end{bmatrix}, \begin{bmatrix} 3 & 2 \\ 1 & 4 \end{bmatrix}, \begin{bmatrix} 3 & 1 \\ 2 & 4 \end{bmatrix} \right\}$ See also **AFQ**

Seq= 3, 7, 13, 21, 31, 43, 57, 73, 91, 111, 133

OEIS: [A002061](#) [2] Central polygonal numbers: $n^2 - n + 1$.

AEM $\left\{ \begin{bmatrix} 4 & 3 \\ 1 & 2 \end{bmatrix}, \begin{bmatrix} 3 & 2 \\ 1 & 4 \end{bmatrix}, \begin{bmatrix} 1 & 3 \\ 2 & 4 \end{bmatrix} \right\}$

Seq= 3, 5, 10, 23, 57, 146, 379, 989, 2586, 6767, 17713

Var= 0, 2, 7, 20, 54, 143, 376, 986, 2583, 6764, 17710

OEIS: [A035508](#) [2] $Fibonacci(2n+2)-1$.

AES $\left\{ \begin{bmatrix} 4 & 3 \\ 1 & 2 \end{bmatrix}, \begin{bmatrix} 3 & 2 \\ 1 & 4 \end{bmatrix}, \begin{bmatrix} 2 & 1 \\ 3 & 4 \end{bmatrix} \right\}$

Seq= 3, 6, 17, 58, 212, 794, 3005, 11442, 43760, 167962, 646648

Var= 1, 4, 15, 56, 210, 792, 3003, 11440, 43758, 167960, 646646

OEIS: [A001791](#) [2] Binomial coefficients $C(2n,n-1)$.

AEW $\left\{ \begin{bmatrix} 4 & 3 \\ 1 & 2 \end{bmatrix}, \begin{bmatrix} 3 & 2 \\ 1 & 4 \end{bmatrix}, \begin{bmatrix} 3 & 1 \\ 4 & 2 \end{bmatrix} \right\}$

Seq= 3, 7, 22, 73, 237, 746, 2287, 6867, 20286, 59157, 170713

Var= 1, 5, 20, 71, 235, 744, 2285, 6865, 20284, 59155, 170711

OEIS: [A054444](#) [1] Even indexed members of A001629(n), $n \geq 2$, (Fibonacci convolution).

AEZ $\left\{ \begin{bmatrix} 4 & 3 \\ 1 & 2 \end{bmatrix}, \begin{bmatrix} 3 & 2 \\ 1 & 4 \end{bmatrix}, \begin{bmatrix} 1 & 2 \\ 4 & 3 \end{bmatrix} \right\}$

Seq= 3, 7, 19, 52, 140, 372, 981, 2577, 6757, 17702, 46358

Var= 0, 4, 16, 49, 137, 369, 978, 2574, 6754, 17699, 46355

OEIS: [A114185](#) [1] $F(2n)-n-1$, where $F(n)$ =Fibonacci number.

AFL $\left\{ \begin{bmatrix} 4 & 3 \\ 1 & 2 \end{bmatrix}, \begin{bmatrix} 2 & 3 \\ 1 & 4 \end{bmatrix}, \begin{bmatrix} 3 & 1 \\ 2 & 4 \end{bmatrix} \right\}$

Seq= 3, 8, 16, 27, 41, 58, 78, 101, 127, 156, 188

OEIS: [A104249](#) [1] $(3*n^2+n+2)/2$.

AFS $\left\{ \begin{bmatrix} 4 & 3 \\ 1 & 2 \end{bmatrix}, \begin{bmatrix} 2 & 3 \\ 1 & 4 \end{bmatrix}, \begin{bmatrix} 2 & 1 \\ 3 & 4 \end{bmatrix} \right\}$

Seq= 3, 8, 31, 132, 564, 2382, 9951, 41228, 169768, 695862, 2842228

Var= 1, 6, 29, 130, 562, 2380, 9949, 41226, 169766, 695860, 2842226

OEIS: [A008549](#) [1] Number of ways of choosing at most $n-1$ items from a set of size $2n+1$.

AKP $\left\{ \begin{bmatrix} 4 & 3 \\ 1 & 2 \end{bmatrix}, \begin{bmatrix} 1 & 4 \\ 2 & 3 \end{bmatrix}, \begin{bmatrix} 2 & 4 \\ 3 & 1 \end{bmatrix} \right\}$ See also **APX**, **CDQ**, **DEQ**, **DFQ**

Seq= 3, 8, 17, 30, 47, 68, 93, 122, 155, 192, 233

OEIS: [A033816](#) [1] $2n^2 + 3n + 3$.

AKT $\left\{ \begin{bmatrix} 4 & 3 \\ 1 & 2 \end{bmatrix}, \begin{bmatrix} 1 & 4 \\ 2 & 3 \end{bmatrix}, \begin{bmatrix} 1 & 2 \\ 3 & 4 \end{bmatrix} \right\}$ See also **BFM**

Seq= 3, 5, 10, 24, 66, 198, 627, 2057, 6919, 23715, 82501

OEIS: [A155587](#) [1] Expansion of $(1+x*c(x))/(1-x)$, $c(x)$ the g.f. of A000108.

AKU $\left\{ \begin{bmatrix} 4 & 3 \\ 1 & 2 \end{bmatrix}, \begin{bmatrix} 1 & 4 \\ 2 & 3 \end{bmatrix}, \begin{bmatrix} 3 & 2 \\ 4 & 1 \end{bmatrix} \right\}$ See also **AKX**, **CDE**, **CDF**, **DEF**

Seq= 3, 3, 3, 3, 3, 3, 3, 3, 3, 3, 3

OEIS: [A010701](#) [202] Constant sequence.

AKW $\left\{ \begin{bmatrix} 4 & 3 \\ 1 & 2 \end{bmatrix}, \begin{bmatrix} 1 & 4 \\ 2 & 3 \end{bmatrix}, \begin{bmatrix} 3 & 1 \\ 4 & 2 \end{bmatrix} \right\}$ See also **APS**, **DFW**

Seq= 3, 9, 33, 129, 513, 2049, 8193, 32769, 131073, 524289, 2097153

OEIS: [A084508](#) [2] Partial sums of A084509. Positions of ones in the first differences of A084506.

AMV $\left\{ \begin{bmatrix} 4 & 3 \\ 1 & 2 \end{bmatrix}, \begin{bmatrix} 1 & 3 \\ 2 & 4 \end{bmatrix}, \begin{bmatrix} 2 & 3 \\ 4 & 1 \end{bmatrix} \right\}$ See also **ARS**

Seq= 3, 8, 31, 126, 509, 2044, 8187, 32762, 131065, 524280, 2097143

Var= 0, 5, 28, 123, 506, 2041, 8184, 32759, 131062, 524277, 2097140

OEIS: [A124133](#) [1] $a(n)=(-1/2)*\sum_{\{i1+i2+i3=2n\}} ((2*n)!/(i1! i2! i3!))*B(i1)$ where B are the Bernoulli numbers.

APR $\left\{ \begin{bmatrix} 4 & 3 \\ 1 & 2 \end{bmatrix}, \begin{bmatrix} 2 & 4 \\ 3 & 1 \end{bmatrix}, \begin{bmatrix} 1 & 4 \\ 3 & 2 \end{bmatrix} \right\}$ See also **CFW**, **DJQ**

Seq= 3, 10, 21, 36, 55, 78, 105, 136, 171, 210, 253

OEIS: [A014105](#) [1] Second hexagonal numbers: $n(2n+1)$.

ART $\left\{ \begin{bmatrix} 4 & 3 \\ 1 & 2 \end{bmatrix}, \begin{bmatrix} 1 & 4 \\ 3 & 2 \end{bmatrix}, \begin{bmatrix} 1 & 2 \\ 3 & 4 \end{bmatrix} \right\}$ See also **BET**

Seq= 3, 8, 25, 84, 294, 1056, 3861, 14300, 53482, 201552, 764218

OEIS: [A038665](#) [1] Convolution of A007054 (super ballot numbers) with A000984 (central binomial coefficients).

ARV $\left\{ \begin{bmatrix} 4 & 3 \\ 1 & 2 \end{bmatrix}, \begin{bmatrix} 1 & 4 \\ 3 & 2 \end{bmatrix}, \begin{bmatrix} 2 & 3 \\ 4 & 1 \end{bmatrix} \right\}$ See also **CEW**

Seq= 3, 7, 11, 15, 19, 23, 27, 31, 35, 39, 43

OEIS: [A004767](#) [7] $4n+3$.

BCD $\left\{ \begin{bmatrix} 3 & 4 \\ 1 & 2 \end{bmatrix}, \begin{bmatrix} 4 & 2 \\ 1 & 3 \end{bmatrix}, \begin{bmatrix} 2 & 4 \\ 1 & 3 \end{bmatrix} \right\}$

Seq= 3, 9, 28, 90, 297, 1001, 3432, 11934, 41990, 149226, 534888

OEIS: [A000245](#) [3] $3(2n)!/((n+2)!(n-1)!)$.

BCE $\left\{ \begin{bmatrix} 3 & 4 \\ 1 & 2 \end{bmatrix}, \begin{bmatrix} 4 & 2 \\ 1 & 3 \end{bmatrix}, \begin{bmatrix} 3 & 2 \\ 1 & 4 \end{bmatrix} \right\}$ See also **BDF**, **BEK**

Seq= 3, 7, 19, 56, 174, 561, 1859, 6292, 21658, 75582, 266798

OEIS: [A005807](#) [3] Sum of adjacent Catalan numbers.

BDE $\left\{ \begin{bmatrix} 3 & 4 \\ 1 & 2 \end{bmatrix}, \begin{bmatrix} 2 & 4 \\ 1 & 3 \end{bmatrix}, \begin{bmatrix} 3 & 2 \\ 1 & 4 \end{bmatrix} \right\}$

Seq= 3, 8, 23, 70, 222, 726, 2431, 8294, 28730, 100776, 357238

OEIS: [A000782](#) [2] $2 * \text{Catalan}(n) - \text{Catalan}(n-1)$.

BDL $\left\{ \begin{bmatrix} 3 & 4 \\ 1 & 2 \end{bmatrix}, \begin{bmatrix} 2 & 4 \\ 1 & 3 \end{bmatrix}, \begin{bmatrix} 3 & 1 \\ 2 & 4 \end{bmatrix} \right\}$

Seq= 3, 10, 35, 126, 462, 1716, 6435, 24310, 92378, 352716, 1352078

OEIS: [A001700](#) [3] $C(2n+1, n+1)$: number of ways to put $n+1$ indistinguishable balls into $n+1$ distinguishable boxes = number of $(n+1)$ -st degree m...

BEM $\left\{ \begin{bmatrix} 3 & 4 \\ 1 & 2 \end{bmatrix}, \begin{bmatrix} 3 & 2 \\ 1 & 4 \end{bmatrix}, \begin{bmatrix} 1 & 3 \\ 2 & 4 \end{bmatrix} \right\}$

Seq= 3, 6, 14, 37, 107, 329, 1055, 3486, 11780, 40510, 141286

OEIS: [A081293](#) [1] $a(n) = A000108(n) + A014137(n)$.

BFL $\left\{ \begin{bmatrix} 3 & 4 \\ 1 & 2 \end{bmatrix}, \begin{bmatrix} 2 & 3 \\ 1 & 4 \end{bmatrix}, \begin{bmatrix} 3 & 1 \\ 2 & 4 \end{bmatrix} \right\}$

Seq= 3, 5, 14, 45, 154, 546, 1980, 7293, 27170, 102102, 386308

OEIS: [A078718](#) [1] Let $f(i,j) = \text{Sum}(\text{binom}(2*i,k) * \text{binom}(2*j,i+j-k) * (-1)^{(i+j-k)}, k=0..2*i)$ (this is essentially the same as the triangle in...

BFT $\left\{ \begin{bmatrix} 3 & 4 \\ 1 & 2 \end{bmatrix}, \begin{bmatrix} 2 & 3 \\ 1 & 4 \end{bmatrix}, \begin{bmatrix} 1 & 2 \\ 3 & 4 \end{bmatrix} \right\}$

Seq= 3, 6, 15, 42, 126, 396, 1287, 4290, 14586, 50388, 176358

OEIS: [A120589](#) [1] Self-convolution of A120588, such that $a(n) = 3 * A120588(n)$ for $n \geq 2$.

BLM $\left\{ \begin{bmatrix} 3 & 4 \\ 1 & 2 \end{bmatrix}, \begin{bmatrix} 3 & 1 \\ 2 & 4 \end{bmatrix}, \begin{bmatrix} 1 & 3 \\ 2 & 4 \end{bmatrix} \right\}$

Seq= 3, 6, 16, 51, 177, 639, 2355, 8790, 33100, 125478, 478194

Var= 1, 4, 14, 49, 175, 637, 2353, 8788, 33098, 125476, 478192

OEIS: [A079309](#) [1] $a(n) = C(1,1) + C(3,2) + C(5,3) + \dots + C(2n-1,n)$.

CDW $\left\{ \begin{bmatrix} 4 & 2 \\ 1 & 3 \end{bmatrix}, \begin{bmatrix} 2 & 4 \\ 1 & 3 \end{bmatrix}, \begin{bmatrix} 3 & 1 \\ 4 & 2 \end{bmatrix} \right\}$ See also **DEW**

Seq= 3, 6, 18, 66, 258, 1026, 4098, 16386, 65538, 262146, 1048578

OEIS: [A178789](#) [1] Koch snowflake: number of angles after n iterations.

DJM $\left\{ \begin{bmatrix} 2 & 4 \\ 1 & 3 \end{bmatrix}, \begin{bmatrix} 4 & 1 \\ 2 & 3 \end{bmatrix}, \begin{bmatrix} 1 & 3 \\ 2 & 4 \end{bmatrix} \right\}$

Seq= 3, 8, 21, 46, 87, 148, 233, 346, 491, 672, 893

OEIS: [A179903](#) [1] (1, 3, 5, 7, 9...) convolved with (1, 0, 3, 5, 7, 9,...)

EFK $\left\{ \begin{bmatrix} 3 & 2 \\ 1 & 4 \end{bmatrix}, \begin{bmatrix} 2 & 3 \\ 1 & 4 \end{bmatrix}, \begin{bmatrix} 1 & 4 \\ 2 & 3 \end{bmatrix} \right\}$

Seq= 3, 4, 6, 8, 12, 16, 24, 32, 48, 64, 96

OEIS: [A029744](#) [8] Numbers of the form 2^n or $3 \cdot 2^n$.

Sequence unknown for $|\mathcal{P}| = 3$ (partial)

ABG $\left\{ \begin{bmatrix} 4 & 3 \\ 1 & 2 \end{bmatrix}, \begin{bmatrix} 3 & 4 \\ 1 & 2 \end{bmatrix}, \begin{bmatrix} 4 & 3 \\ 2 & 1 \end{bmatrix} \right\}$

Seq= 3, 23, 327, 7465, 249885, 11532671, 701867995, 54461600179, 5247921916235

ABH $\left\{ \begin{bmatrix} 4 & 3 \\ 1 & 2 \end{bmatrix}, \begin{bmatrix} 3 & 4 \\ 1 & 2 \end{bmatrix}, \begin{bmatrix} 3 & 4 \\ 2 & 1 \end{bmatrix} \right\}$

Seq= 3, 24, 345, 7920, 264873, 12190108, 739050425, 57109234080, 5479466654645

ABJ $\left\{ \begin{bmatrix} 4 & 3 \\ 1 & 2 \end{bmatrix}, \begin{bmatrix} 3 & 4 \\ 1 & 2 \end{bmatrix}, \begin{bmatrix} 4 & 1 \\ 2 & 3 \end{bmatrix} \right\}$ See also **ABL**

Seq= 3, 14, 96, 858, 9420, 122490, 1839600, 31325490, 596291220, 12546094050

ABN $\left\{ \begin{bmatrix} 4 & 3 \\ 1 & 2 \end{bmatrix}, \begin{bmatrix} 3 & 4 \\ 1 & 2 \end{bmatrix}, \begin{bmatrix} 4 & 2 \\ 3 & 1 \end{bmatrix} \right\}$

Seq= 3, 19, 217, 3985, 107547, 4001027, 196224625, 12270923649, 953000374835

ABP $\left\{ \begin{bmatrix} 4 & 3 \\ 1 & 2 \end{bmatrix}, \begin{bmatrix} 3 & 4 \\ 1 & 2 \end{bmatrix}, \begin{bmatrix} 2 & 4 \\ 3 & 1 \end{bmatrix} \right\}$

Seq= 3, 17, 116, 1048, 11712, 155520, 2388480, 41610240, 810270720, 17433722880

ABQ $\left\{ \begin{bmatrix} 4 & 3 \\ 1 & 2 \end{bmatrix}, \begin{bmatrix} 3 & 4 \\ 1 & 2 \end{bmatrix}, \begin{bmatrix} 4 & 1 \\ 3 & 2 \end{bmatrix} \right\}$

Seq= 3, 14, 104, 1020, 12264, 173580, 2818080, 51535260, 1047274200, 23400192060

⋮

Sequence identified for $|\mathcal{P}| = 4$

ABCD $\left\{ \begin{bmatrix} 4 & 3 \\ 1 & 2 \end{bmatrix}, \begin{bmatrix} 3 & 4 \\ 1 & 2 \end{bmatrix}, \begin{bmatrix} 4 & 2 \\ 1 & 3 \end{bmatrix}, \begin{bmatrix} 2 & 4 \\ 1 & 3 \end{bmatrix} \right\}$ See also **ABDE**, **ABDF**

Seq= 4, 20, 140, 1260, 13860, 180180, 2702700, 45945900, 872972100, 18332414100

Var= 1, 5, 35, 315, 3465, 45045, 675675, 11486475, 218243025, 4583103525

OEIS: [A051577](#) [2] $(2^{*n+3})!/3$, related to A001147 (odd double factorials).

ABCE $\left\{ \begin{bmatrix} 4 & 3 \\ 1 & 2 \end{bmatrix}, \begin{bmatrix} 3 & 4 \\ 1 & 2 \end{bmatrix}, \begin{bmatrix} 4 & 2 \\ 1 & 3 \end{bmatrix}, \begin{bmatrix} 3 & 2 \\ 1 & 4 \end{bmatrix} \right\}$ See also **ABCF**, **ABCM**, **ABCT**, **ABEF**, **ABEZ**, **ABRX**, **ABRZ**, **ABTX**, **ACER**, **ACRT**, **AERX**, **AERZ**, **AETX**, **BCEX**, **BCRX**, **BCTX**, **CERX**

Seq= 4, 16, 96, 768, 7680, 92160, 1290240, 20643840, 371589120, 7431782400

OEIS: [A032184](#) [2] "CIJ" (necklace, indistinct, labeled) transform of 1,3,5,7...

ABCJ $\left\{ \begin{bmatrix} 4 & 3 \\ 1 & 2 \end{bmatrix}, \begin{bmatrix} 3 & 4 \\ 1 & 2 \end{bmatrix}, \begin{bmatrix} 4 & 2 \\ 1 & 3 \end{bmatrix}, \begin{bmatrix} 4 & 1 \\ 2 & 3 \end{bmatrix} \right\}$ See also **ABCK**, **ABCL**, **ABDK**, **ABEJ**, **ABEL**, **ABFJ**, **ABFL**

Seq= 4, 18, 120, 1050, 11340, 145530, 2162160, 36486450, 689188500, 14404039650

Var= 2, 6, 30, 210, 1890, 20790, 270270, 4054050, 68918850, 1309458150

OEIS: [A097801](#) [2] $(2^{*n})!/(n! \cdot 2^{(n-1)})$.

ABCZ $\left\{ \begin{bmatrix} 4 & 3 \\ 1 & 2 \end{bmatrix}, \begin{bmatrix} 3 & 4 \\ 1 & 2 \end{bmatrix}, \begin{bmatrix} 4 & 2 \\ 1 & 3 \end{bmatrix}, \begin{bmatrix} 1 & 2 \\ 4 & 3 \end{bmatrix} \right\}$ See also **ABEM, ABFM, ABFZ**

Seq= 4, 14, 80, 634, 6332, 75974, 1063624, 17017970, 306323444, 6126468862

Var= 3, 13, 79, 633, 6331, 75973, 1063623, 17017969, 306323443, 6126468861

OEIS: [A010844](#) [1] $a(n) = 2^n a(n-1) + 1$ with $a(0)=1$.

ABDJ $\left\{ \begin{bmatrix} 4 & 3 \\ 1 & 2 \end{bmatrix}, \begin{bmatrix} 3 & 4 \\ 1 & 2 \end{bmatrix}, \begin{bmatrix} 2 & 4 \\ 1 & 3 \end{bmatrix}, \begin{bmatrix} 4 & 1 \\ 2 & 3 \end{bmatrix} \right\}$ See also **ABDL**

Seq= 4, 24, 192, 1920, 23040, 322560, 5160960, 92897280, 1857945600, 40874803200

OEIS: [A002866](#) [3] $a(0) = 1$; for $n > 0$, $a(n) = 2^{(n-1)} n!$.

ABDP $\left\{ \begin{bmatrix} 4 & 3 \\ 1 & 2 \end{bmatrix}, \begin{bmatrix} 3 & 4 \\ 1 & 2 \end{bmatrix}, \begin{bmatrix} 2 & 4 \\ 1 & 3 \end{bmatrix}, \begin{bmatrix} 2 & 4 \\ 3 & 1 \end{bmatrix} \right\}$ See also **ABDU, ABDV**

Seq= 4, 25, 210, 2205, 27720, 405405, 6756750, 126351225, 2618916300, 59580345825

Var= 1, 5, 35, 315, 3465, 45045, 675675, 11486475, 218243025, 4583103525

OEIS: [A051577](#) [2] $(2^{*n+3})!/3$, related to A001147 (odd double factorials).

ABKM $\left\{ \begin{bmatrix} 4 & 3 \\ 1 & 2 \end{bmatrix}, \begin{bmatrix} 3 & 4 \\ 1 & 2 \end{bmatrix}, \begin{bmatrix} 1 & 4 \\ 2 & 3 \end{bmatrix}, \begin{bmatrix} 1 & 3 \\ 2 & 4 \end{bmatrix} \right\}$ See also **ABKS**

Seq= 4, 12, 60, 444, 4284, 50364, 695484, 11017404, 196811964, 3912703164

OEIS: [A004400](#) [1] $1 + \text{Sum } 2^k k!, k = 1 \dots n$.

ABMX $\left\{ \begin{bmatrix} 4 & 3 \\ 1 & 2 \end{bmatrix}, \begin{bmatrix} 3 & 4 \\ 1 & 2 \end{bmatrix}, \begin{bmatrix} 1 & 3 \\ 2 & 4 \end{bmatrix}, \begin{bmatrix} 1 & 3 \\ 4 & 2 \end{bmatrix} \right\}$

Seq= 4, 13, 73, 577, 5761, 69121, 967681, 15482881, 278691841, 5573836801

Var= 3, 12, 72, 576, 5760, 69120, 967680, 15482880, 278691840, 5573836800

OEIS: [A052676](#) [1] A simple regular expression in a labeled universe.

ACDF $\left\{ \begin{bmatrix} 4 & 3 \\ 1 & 2 \end{bmatrix}, \begin{bmatrix} 4 & 2 \\ 1 & 3 \end{bmatrix}, \begin{bmatrix} 2 & 4 \\ 1 & 3 \end{bmatrix}, \begin{bmatrix} 2 & 3 \\ 1 & 4 \end{bmatrix} \right\}$ See also **ACDM, ACFK, ACKM, ADFM, ADFZ, ADKX, ADKZ, ADMX, AFKX, AFKZ, AFMX, CDFX, CDKX, CDMX, CFKX**

Seq= 4, 12, 46, 212, 1134, 6868, 46274, 342348, 2753050, 23869162, 221634846

Var= 2, 6, 23, 106, 567, 3434, 23137, 171174, 1376525, 11934581, 110817423

OEIS: [A125273](#) [1] Eigensequence of triangle A085478: $a(n) = \text{Sum}_{k=0..n-1} A085478(n-1, k) * a(k)$ for $n > 0$ with $a(0)=1$.

ACEF $\left\{ \begin{bmatrix} 4 & 3 \\ 1 & 2 \end{bmatrix}, \begin{bmatrix} 4 & 2 \\ 1 & 3 \end{bmatrix}, \begin{bmatrix} 3 & 2 \\ 1 & 4 \end{bmatrix}, \begin{bmatrix} 2 & 3 \\ 1 & 4 \end{bmatrix} \right\}$ See also **ACEQ**

Seq= 4, 7, 11, 16, 22, 29, 37, 46, 56, 67, 79

OEIS: [A000124](#) [7] Central polygonal numbers (the Lazy Caterer's sequence): $n(n+1)/2 + 1$; or, maximal number of pieces formed when slicing a pa...

ACEJ $\left\{ \begin{bmatrix} 4 & 3 \\ 1 & 2 \end{bmatrix}, \begin{bmatrix} 4 & 2 \\ 1 & 3 \end{bmatrix}, \begin{bmatrix} 3 & 2 \\ 1 & 4 \end{bmatrix}, \begin{bmatrix} 4 & 1 \\ 2 & 3 \end{bmatrix} \right\}$ See also **AKMX, AKRU, AKRX, AKSU, AKVX, CDEJ, CDEL, CDFJ, CDFL, CEFM, DEFJ, DEFM**

Seq= 4, 6, 8, 10, 12, 14, 16, 18, 20, 22, 24

OEIS: [A005843](#) [41] The even numbers: $a(n) = 2n$.

ACEL $\left\{ \begin{bmatrix} 4 & 3 \\ 1 & 2 \end{bmatrix}, \begin{bmatrix} 4 & 2 \\ 1 & 3 \end{bmatrix}, \begin{bmatrix} 3 & 2 \\ 1 & 4 \end{bmatrix}, \begin{bmatrix} 3 & 1 \\ 2 & 4 \end{bmatrix} \right\}$ See also **ACFQ, AKMR, AMRX, CDEM, CDFM**

Seq= 4, 8, 14, 22, 32, 44, 58, 74, 92, 112, 134

OEIS: [A014206](#) [2] $n^2 + n + 2$.

ACEM $\left\{ \begin{bmatrix} 4 & 3 \\ 1 & 2 \end{bmatrix}, \begin{bmatrix} 4 & 2 \\ 1 & 3 \end{bmatrix}, \begin{bmatrix} 3 & 2 \\ 1 & 4 \end{bmatrix}, \begin{bmatrix} 1 & 3 \\ 2 & 4 \end{bmatrix} \right\}$ See also **ACEZ**, **AEFM**

Seq= 4, 9, 22, 56, 145, 378, 988, 2585, 6766, 17712, 46369

OEIS: [A055588](#) [2] $a(n)=3a(n-1)-a(n-2)-1$; $a(0)=1$, $a(1)=2$.

ACES $\left\{ \begin{bmatrix} 4 & 3 \\ 1 & 2 \end{bmatrix}, \begin{bmatrix} 4 & 2 \\ 1 & 3 \end{bmatrix}, \begin{bmatrix} 3 & 2 \\ 1 & 4 \end{bmatrix}, \begin{bmatrix} 2 & 1 \\ 3 & 4 \end{bmatrix} \right\}$ See also **AMTX**, **BCFM**

Seq= 4, 11, 36, 127, 463, 1717, 6436, 24311, 92379, 352717, 1352079

OEIS: [A112849](#) [1] Number of congruence classes (epimorphisms/vertex partitionings induced by graph endomorphisms) of undirected cycles of even...

ACET $\left\{ \begin{bmatrix} 4 & 3 \\ 1 & 2 \end{bmatrix}, \begin{bmatrix} 4 & 2 \\ 1 & 3 \end{bmatrix}, \begin{bmatrix} 3 & 2 \\ 1 & 4 \end{bmatrix}, \begin{bmatrix} 1 & 2 \\ 3 & 4 \end{bmatrix} \right\}$

Seq= 4, 10, 32, 122, 516, 2322, 10880, 52466, 258564, 1296282, 6589728

OEIS: [A176006](#) [1] The number of branching configurations of RNA (see Sankoff, 1985) with n or fewer hairpins.

ACEW $\left\{ \begin{bmatrix} 4 & 3 \\ 1 & 2 \end{bmatrix}, \begin{bmatrix} 4 & 2 \\ 1 & 3 \end{bmatrix}, \begin{bmatrix} 3 & 2 \\ 1 & 4 \end{bmatrix}, \begin{bmatrix} 3 & 1 \\ 4 & 2 \end{bmatrix} \right\}$ See also **AEQW**

Seq= 4, 11, 34, 106, 325, 978, 2896, 8463, 24466, 70102, 199369

Var= 3, 10, 33, 105, 324, 977, 2895, 8462, 24465, 70101, 199368

OEIS: [A027989](#) [1] $a(n)$ = self-convolution of row n of array T given by A027926.

ACFL $\left\{ \begin{bmatrix} 4 & 3 \\ 1 & 2 \end{bmatrix}, \begin{bmatrix} 4 & 2 \\ 1 & 3 \end{bmatrix}, \begin{bmatrix} 2 & 3 \\ 1 & 4 \end{bmatrix}, \begin{bmatrix} 3 & 1 \\ 2 & 4 \end{bmatrix} \right\}$

Seq= 4, 9, 17, 28, 42, 59, 79, 102, 128, 157, 189

Var= 0, 5, 13, 24, 38, 55, 75, 98, 124, 153, 185

OEIS: [A140090](#) [1] $n(3n+7)/2$.

ACFM $\left\{ \begin{bmatrix} 4 & 3 \\ 1 & 2 \end{bmatrix}, \begin{bmatrix} 4 & 2 \\ 1 & 3 \end{bmatrix}, \begin{bmatrix} 2 & 3 \\ 1 & 4 \end{bmatrix}, \begin{bmatrix} 1 & 3 \\ 2 & 4 \end{bmatrix} \right\}$ See also **AFQZ**

Seq= 4, 10, 26, 68, 178, 466, 1220, 3194, 8362, 21892, 57314

OEIS: [A052995](#) [3] A simple regular expression.

ACLS $\left\{ \begin{bmatrix} 4 & 3 \\ 1 & 2 \end{bmatrix}, \begin{bmatrix} 4 & 2 \\ 1 & 3 \end{bmatrix}, \begin{bmatrix} 3 & 1 \\ 2 & 4 \end{bmatrix}, \begin{bmatrix} 2 & 1 \\ 3 & 4 \end{bmatrix} \right\}$ See also **ARTX**, **BCEM**, **BDET**, **BDFL**

Seq= 4, 12, 40, 140, 504, 1848, 6864, 25740, 97240, 369512, 1410864

OEIS: [A100320](#) [2] A Catalan transform of $(1+2x)/(1-2x)$.

ACMT $\left\{ \begin{bmatrix} 4 & 3 \\ 1 & 2 \end{bmatrix}, \begin{bmatrix} 4 & 2 \\ 1 & 3 \end{bmatrix}, \begin{bmatrix} 1 & 3 \\ 2 & 4 \end{bmatrix}, \begin{bmatrix} 1 & 2 \\ 3 & 4 \end{bmatrix} \right\}$

Seq= 4, 12, 46, 198, 904, 4280, 20794, 103050, 518860, 2646724, 13648870

Var= 3, 11, 45, 197, 903, 4279, 20793, 103049, 518859, 2646723, 13648869

OEIS: [A001003](#) [2] Schroeder's second problem (generalized parentheses); also called super-Catalan numbers or little Schroeder numbers.

ACXZ $\left\{ \begin{bmatrix} 4 & 3 \\ 1 & 2 \end{bmatrix}, \begin{bmatrix} 4 & 2 \\ 1 & 3 \end{bmatrix}, \begin{bmatrix} 1 & 3 \\ 4 & 2 \end{bmatrix}, \begin{bmatrix} 1 & 2 \\ 4 & 3 \end{bmatrix} \right\}$ See also **DEFK**, **DEKM**, **DFKM**

Seq= 4, 8, 16, 32, 64, 128, 256, 512, 1024, 2048, 4096

OEIS: [A000079](#) [30] Powers of 2: $a(n) = 2^n$.

ADHN $\left\{ \begin{bmatrix} 4 & 3 \\ 1 & 2 \end{bmatrix}, \begin{bmatrix} 2 & 4 \\ 1 & 3 \end{bmatrix}, \begin{bmatrix} 3 & 4 \\ 2 & 1 \end{bmatrix}, \begin{bmatrix} 4 & 2 \\ 3 & 1 \end{bmatrix} \right\}$

Seq= 4, 42, 816, 25520, 1170240, 73992912, 6169370368, 655847011584

Var= 2, 14, 204, 5104, 195040, 10570416, 771171296, 72871890176, 8658173200896

OEIS: [A122647](#) [1] Number of permutations of length $2n-1$ with no local maxima or minima in even positions.

AEFJ $\left\{ \begin{bmatrix} 4 & 3 \\ 1 & 2 \end{bmatrix}, \begin{bmatrix} 3 & 2 \\ 1 & 4 \end{bmatrix}, \begin{bmatrix} 2 & 3 \\ 1 & 4 \end{bmatrix}, \begin{bmatrix} 4 & 1 \\ 2 & 3 \end{bmatrix} \right\}$

Seq= 4, 8, 13, 19, 26, 34, 43, 53, 64, 76, 89

OEIS: [A034856](#) [1] $C(n + 1, 2) + n - 1$.

AEFL $\left\{ \begin{bmatrix} 4 & 3 \\ 1 & 2 \end{bmatrix}, \begin{bmatrix} 3 & 2 \\ 1 & 4 \end{bmatrix}, \begin{bmatrix} 2 & 3 \\ 1 & 4 \end{bmatrix}, \begin{bmatrix} 3 & 1 \\ 2 & 4 \end{bmatrix} \right\}$ See also **AELQ**

Seq= 4, 10, 19, 31, 46, 64, 85, 109, 136, 166, 199

OEIS: [A005448](#) [1] Centered triangular numbers: $3n(n-1)/2 + 1$.

AEFQ $\left\{ \begin{bmatrix} 4 & 3 \\ 1 & 2 \end{bmatrix}, \begin{bmatrix} 3 & 2 \\ 1 & 4 \end{bmatrix}, \begin{bmatrix} 2 & 3 \\ 1 & 4 \end{bmatrix}, \begin{bmatrix} 4 & 1 \\ 3 & 2 \end{bmatrix} \right\}$ See also **AEJL**

Seq= 4, 9, 16, 25, 36, 49, 64, 81, 100, 121, 144

OEIS: [A000290](#) [9] The squares: $a(n) = n^2$.

AEFS $\left\{ \begin{bmatrix} 4 & 3 \\ 1 & 2 \end{bmatrix}, \begin{bmatrix} 3 & 2 \\ 1 & 4 \end{bmatrix}, \begin{bmatrix} 2 & 3 \\ 1 & 4 \end{bmatrix}, \begin{bmatrix} 2 & 1 \\ 3 & 4 \end{bmatrix} \right\}$ See also **AEQS**

Seq= 4, 12, 46, 188, 774, 3174, 12954, 52668, 213526, 863822, 3488874

Var= 2, 10, 44, 186, 772, 3172, 12952, 52666, 213524, 863820, 3488872

OEIS: [A068551](#) [1] $4^n - \text{binomial}(2n, n)$.

AEFZ $\left\{ \begin{bmatrix} 4 & 3 \\ 1 & 2 \end{bmatrix}, \begin{bmatrix} 3 & 2 \\ 1 & 4 \end{bmatrix}, \begin{bmatrix} 2 & 3 \\ 1 & 4 \end{bmatrix}, \begin{bmatrix} 1 & 2 \\ 4 & 3 \end{bmatrix} \right\}$ See also **AEQZ**

Seq= 4, 11, 31, 85, 228, 604, 1590, 4173, 10937, 28647, 75014

Var= 2, 9, 29, 83, 226, 602, 1588, 4171, 10935, 28645, 75012

OEIS: [A152891](#) [1] $a=b=0; b(n)=b+n+a; a(n)=a+n+b$.

AEJS $\left\{ \begin{bmatrix} 4 & 3 \\ 1 & 2 \end{bmatrix}, \begin{bmatrix} 3 & 2 \\ 1 & 4 \end{bmatrix}, \begin{bmatrix} 4 & 1 \\ 2 & 3 \end{bmatrix}, \begin{bmatrix} 2 & 1 \\ 3 & 4 \end{bmatrix} \right\}$

Seq= 4, 10, 32, 114, 422, 1586, 6008, 22882, 87518, 335922, 1293294

Var= 2, 8, 30, 112, 420, 1584, 6006, 22880, 87516, 335920, 1293292

OEIS: [A162551](#) [1] $2 * C(2n, n-1)$.

AELM $\left\{ \begin{bmatrix} 4 & 3 \\ 1 & 2 \end{bmatrix}, \begin{bmatrix} 3 & 2 \\ 1 & 4 \end{bmatrix}, \begin{bmatrix} 3 & 1 \\ 2 & 4 \end{bmatrix}, \begin{bmatrix} 1 & 3 \\ 2 & 4 \end{bmatrix} \right\}$

Seq= 4, 10, 28, 82, 242, 710, 2064, 5946, 16992, 48222, 136034

Var= 2, 5, 14, 41, 121, 355, 1032, 2973, 8496, 24111, 68017

OEIS: [A116845](#) [1] Number of permutations of length n which avoid the patterns 231, 12534.

AELW $\left\{ \begin{bmatrix} 4 & 3 \\ 1 & 2 \end{bmatrix}, \begin{bmatrix} 3 & 2 \\ 1 & 4 \end{bmatrix}, \begin{bmatrix} 3 & 1 \\ 2 & 4 \end{bmatrix}, \begin{bmatrix} 3 & 1 \\ 4 & 2 \end{bmatrix} \right\}$

Seq= 4, 12, 40, 132, 422, 1310, 3972, 11824, 34692, 100612, 289034

Var= 3, 11, 39, 131, 421, 1309, 3971, 11823, 34691, 100611, 289033

OEIS: [A166336](#) [1] Expansion of $(1-4x+7x^2-4x^3+x^4)/(1-7x+17x^2-17x^3+7x^4-x^5)$

AFLQ $\left\{ \begin{bmatrix} 4 & 3 \\ 1 & 2 \end{bmatrix}, \begin{bmatrix} 2 & 3 \\ 1 & 4 \end{bmatrix}, \begin{bmatrix} 3 & 1 \\ 2 & 4 \end{bmatrix}, \begin{bmatrix} 4 & 1 \\ 3 & 2 \end{bmatrix} \right\}$ See also **AKPR**, **AKPV**, **APRX**, **CDJQ**, **CDLQ**,

CEMQ, **CFMQ**, **DEJQ**, **DFJQ**

Seq= 4, 11, 22, 37, 56, 79, 106, 137, 172, 211, 254

OEIS: [A084849](#) [1] $1+n+2n^2$.

AKMP $\left\{ \begin{bmatrix} 4 & 3 \\ 1 & 2 \end{bmatrix}, \begin{bmatrix} 1 & 4 \\ 2 & 3 \end{bmatrix}, \begin{bmatrix} 1 & 3 \\ 2 & 4 \end{bmatrix}, \begin{bmatrix} 2 & 4 \\ 3 & 1 \end{bmatrix} \right\}$ See also **AMPX**

Seq= 4, 13, 56, 241, 1000, 4061, 16336, 65473, 262064, 1048477, 4194184

Var= 3, 12, 55, 240, 999, 4060, 16335, 65472, 262063, 1048476, 4194183

OEIS: [A024038](#) [1] $4^n - n^2$.

AKMT $\left\{ \begin{bmatrix} 4 & 3 \\ 1 & 2 \end{bmatrix}, \begin{bmatrix} 1 & 4 \\ 2 & 3 \end{bmatrix}, \begin{bmatrix} 1 & 3 \\ 2 & 4 \end{bmatrix}, \begin{bmatrix} 1 & 2 \\ 3 & 4 \end{bmatrix} \right\}$ See also **BDFM**

Seq= 4, 9, 23, 65, 197, 626, 2056, 6918, 23714, 82500, 290512

OEIS: [A014137](#) [1] Partial sums of Catalan numbers (A000108).

AKMV $\left\{ \begin{bmatrix} 4 & 3 \\ 1 & 2 \end{bmatrix}, \begin{bmatrix} 1 & 4 \\ 2 & 3 \end{bmatrix}, \begin{bmatrix} 1 & 3 \\ 2 & 4 \end{bmatrix}, \begin{bmatrix} 2 & 3 \\ 4 & 1 \end{bmatrix} \right\}$ See also **AKRS, AKSV, AMVX, CDEW, CDJW, CDLW, DEJW**

Seq= 4, 10, 34, 130, 514, 2050, 8194, 32770, 131074, 524290, 2097154

Var= 2, 5, 17, 65, 257, 1025, 4097, 16385, 65537, 262145, 1048577

OEIS: [A052539](#) [2] $4^n + 1$.

AKPU $\left\{ \begin{bmatrix} 4 & 3 \\ 1 & 2 \end{bmatrix}, \begin{bmatrix} 1 & 4 \\ 2 & 3 \end{bmatrix}, \begin{bmatrix} 2 & 4 \\ 3 & 1 \end{bmatrix}, \begin{bmatrix} 3 & 2 \\ 4 & 1 \end{bmatrix} \right\}$ See also **AKPX, CDEQ, CDFQ, DEFQ**

Seq= 4, 9, 18, 31, 48, 69, 94, 123, 156, 193, 234

OEIS: [A100037](#) [1] Positions of occurrences of the natural numbers as second subsequence in A100035.

AKRV $\left\{ \begin{bmatrix} 4 & 3 \\ 1 & 2 \end{bmatrix}, \begin{bmatrix} 1 & 4 \\ 2 & 3 \end{bmatrix}, \begin{bmatrix} 1 & 4 \\ 3 & 2 \end{bmatrix}, \begin{bmatrix} 2 & 3 \\ 4 & 1 \end{bmatrix} \right\}$ See also **ARVX, CDJL, CEJM, CEQW**

Seq= 4, 8, 12, 16, 20, 24, 28, 32, 36, 40, 44

OEIS: [A008586](#) [6] Multiples of 4.

AKRW $\left\{ \begin{bmatrix} 4 & 3 \\ 1 & 2 \end{bmatrix}, \begin{bmatrix} 1 & 4 \\ 2 & 3 \end{bmatrix}, \begin{bmatrix} 1 & 4 \\ 3 & 2 \end{bmatrix}, \begin{bmatrix} 3 & 1 \\ 4 & 2 \end{bmatrix} \right\}$ See also **AMPR, APRS**

Seq= 4, 15, 62, 253, 1020, 4091, 16378, 65529, 262136, 1048567, 4194294

Var= 3, 14, 61, 252, 1019, 4090, 16377, 65528, 262135, 1048566, 4194293

OEIS: [A024037](#) [1] 4^{n-n} .

AKUX $\left\{ \begin{bmatrix} 4 & 3 \\ 1 & 2 \end{bmatrix}, \begin{bmatrix} 1 & 4 \\ 2 & 3 \end{bmatrix}, \begin{bmatrix} 3 & 2 \\ 4 & 1 \end{bmatrix}, \begin{bmatrix} 1 & 3 \\ 4 & 2 \end{bmatrix} \right\}$ See also **CDEF**

Seq= 4, 4, 4, 4, 4, 4, 4, 4, 4, 4

OEIS: [A000523](#) [213] $\log_2(n)$ rounded down.

AKWY $\left\{ \begin{bmatrix} 4 & 3 \\ 1 & 2 \end{bmatrix}, \begin{bmatrix} 1 & 4 \\ 2 & 3 \end{bmatrix}, \begin{bmatrix} 3 & 1 \\ 4 & 2 \end{bmatrix}, \begin{bmatrix} 2 & 1 \\ 4 & 3 \end{bmatrix} \right\}$ See also **BDQW**

Seq= 4, 16, 92, 604, 4214, 30538, 227476, 1730788, 13393690, 105089230, 834086422

Var= 3, 15, 91, 603, 4213, 30537, 227475, 1730787, 13393689, 105089229, 834086421

OEIS: [A099251](#) [1] Bisection of A005043.

APRV $\left\{ \begin{bmatrix} 4 & 3 \\ 1 & 2 \end{bmatrix}, \begin{bmatrix} 2 & 4 \\ 3 & 1 \end{bmatrix}, \begin{bmatrix} 1 & 4 \\ 3 & 2 \end{bmatrix}, \begin{bmatrix} 2 & 3 \\ 4 & 1 \end{bmatrix} \right\}$ See also **CEFW**

Seq= 4, 13, 26, 43, 64, 89, 118, 151, 188, 229, 274

OEIS: [A091823](#) [1] $a(n) = 2n^2 + 3n - 1$.

APSX $\left\{ \begin{bmatrix} 4 & 3 \\ 1 & 2 \end{bmatrix}, \begin{bmatrix} 2 & 4 \\ 3 & 1 \end{bmatrix}, \begin{bmatrix} 2 & 1 \\ 3 & 4 \end{bmatrix}, \begin{bmatrix} 1 & 3 \\ 4 & 2 \end{bmatrix} \right\}$ See also **DFQW**

Seq= 4, 16, 64, 256, 1024, 4096, 16384, 65536, 262144, 1048576, 4194304

OEIS: [A000302](#) [2] Powers of 4.

ARSV $\left\{ \begin{bmatrix} 4 & 3 \\ 1 & 2 \end{bmatrix}, \begin{bmatrix} 1 & 4 \\ 3 & 2 \end{bmatrix}, \begin{bmatrix} 2 & 1 \\ 3 & 4 \end{bmatrix}, \begin{bmatrix} 2 & 3 \\ 4 & 1 \end{bmatrix} \right\}$

Seq= 4, 14, 60, 250, 1016, 4086, 16372, 65522, 262128, 1048558, 4194284

Var= 2, 12, 58, 248, 1014, 4084, 16370, 65520, 262126, 1048556, 4194282

OEIS: [A100103](#) [1] $2^{(2n)} - (2^n)$.

BCEG $\left\{ \begin{bmatrix} 3 & 4 \\ 1 & 2 \end{bmatrix}, \begin{bmatrix} 4 & 2 \\ 1 & 3 \end{bmatrix}, \begin{bmatrix} 3 & 2 \\ 1 & 4 \end{bmatrix}, \begin{bmatrix} 4 & 3 \\ 2 & 1 \end{bmatrix} \right\}$ See also **BEGJ**, **BEGY**, **BEJV**, **BEVY**, **BJTV**, **EJRV**

Seq= 4, 24, 272, 4960, 132672, 4893056, 237969664, 14756156928, 1136284574720

Var= 1, 3, 17, 155, 2073, 38227, 929569, 28820619, 1109652905, 51943281731

OEIS: [A110501](#) [2] Unsigned Genocchi numbers (of first kind) of even index.

BCEK $\left\{ \begin{bmatrix} 3 & 4 \\ 1 & 2 \end{bmatrix}, \begin{bmatrix} 4 & 2 \\ 1 & 3 \end{bmatrix}, \begin{bmatrix} 3 & 2 \\ 1 & 4 \end{bmatrix}, \begin{bmatrix} 1 & 4 \\ 2 & 3 \end{bmatrix} \right\}$

Seq= 4, 14, 62, 324, 1936, 12962, 95786, 772196, 6729124, 62920648, 627487330

Var= 2, 7, 31, 162, 968, 6481, 47893, 386098, 3364562, 31460324, 313743665

OEIS: [A125275](#) [1] Eigensequence of triangle A039599: $a(n) = \text{Sum}_{\{k=0..n-1\}} A039599(n-1, k) * a(k)$ for $n > 0$ with $a(0) = 1$.

BDEF $\left\{ \begin{bmatrix} 3 & 4 \\ 1 & 2 \end{bmatrix}, \begin{bmatrix} 2 & 4 \\ 1 & 3 \end{bmatrix}, \begin{bmatrix} 3 & 2 \\ 1 & 4 \end{bmatrix}, \begin{bmatrix} 2 & 3 \\ 1 & 4 \end{bmatrix} \right\}$ See also **BDEM**, **BDFT**, **BEFK**, **BEKM**, **BFKT**, **DEFR**, **DEMR**, **EFKR**

Seq= 4, 10, 28, 84, 264, 858, 2860, 9724, 33592, 117572, 416024

OEIS: [A068875](#) [2] Expansion of $(1+x*C)^C$, where $C = (1-(1-4*x)^{1/2})/(2*x)$ is g.f. for Catalan numbers, A000108.

BDEK $\left\{ \begin{bmatrix} 3 & 4 \\ 1 & 2 \end{bmatrix}, \begin{bmatrix} 2 & 4 \\ 1 & 3 \end{bmatrix}, \begin{bmatrix} 3 & 2 \\ 1 & 4 \end{bmatrix}, \begin{bmatrix} 1 & 4 \\ 2 & 3 \end{bmatrix} \right\}$

Seq= 4, 12, 38, 126, 430, 1498, 5300, 18980, 68636, 250208, 918304

Var= 2, 6, 19, 63, 215, 749, 2650, 9490, 34318, 125104, 459152

OEIS: [A109262](#) [1] A Catalan transform of the Fibonacci numbers.

BDFK $\left\{ \begin{bmatrix} 3 & 4 \\ 1 & 2 \end{bmatrix}, \begin{bmatrix} 2 & 4 \\ 1 & 3 \end{bmatrix}, \begin{bmatrix} 2 & 3 \\ 1 & 4 \end{bmatrix}, \begin{bmatrix} 1 & 4 \\ 2 & 3 \end{bmatrix} \right\}$

Seq= 4, 11, 32, 99, 318, 1051, 3550, 12200, 42520, 149930, 533890

OEIS: [A135339](#) [1] Number of Dyck paths of semilength n having no DUDU's starting at level 1.

BEFM $\left\{ \begin{bmatrix} 3 & 4 \\ 1 & 2 \end{bmatrix}, \begin{bmatrix} 3 & 2 \\ 1 & 4 \end{bmatrix}, \begin{bmatrix} 2 & 3 \\ 1 & 4 \end{bmatrix}, \begin{bmatrix} 1 & 3 \\ 2 & 4 \end{bmatrix} \right\}$

Seq= 4, 8, 18, 46, 130, 394, 1252, 4112, 13836, 47428, 165000

Var= 2, 4, 9, 23, 65, 197, 626, 2056, 6918, 23714, 82500

OEIS: [A014137](#) [1] Partial sums of Catalan numbers (A000108).

BEFT $\left\{ \begin{bmatrix} 3 & 4 \\ 1 & 2 \end{bmatrix}, \begin{bmatrix} 3 & 2 \\ 1 & 4 \end{bmatrix}, \begin{bmatrix} 2 & 3 \\ 1 & 4 \end{bmatrix}, \begin{bmatrix} 1 & 2 \\ 3 & 4 \end{bmatrix} \right\}$

Seq= 4, 10, 30, 98, 336, 1188, 4290, 15730, 58344, 218348, 823004

Var= 1, 2, 5, 14, 42, 132, 429, 1430, 4862, 16796, 58786

OEIS: [A000108](#) [5] Catalan numbers: $C(n) = \text{binomial}(2n, n)/(n+1) = (2n)!/(n!(n+1)!)$. Also called Segner numbers.

BERT $\left\{ \begin{bmatrix} 3 & 4 \\ 1 & 2 \end{bmatrix}, \begin{bmatrix} 3 & 2 \\ 1 & 4 \end{bmatrix}, \begin{bmatrix} 1 & 4 \\ 3 & 2 \end{bmatrix}, \begin{bmatrix} 1 & 2 \\ 3 & 4 \end{bmatrix} \right\}$

Seq= 4, 16, 80, 448, 2688, 16896, 109824, 732160, 4978688, 34398208, 240787456

OEIS: [A025225](#) [2] $a(n) = a(1)*a(n-1) + a(2)*a(n-2) + \dots + a(n-1)*a(1)$ for $n \geq 2$. Also $a(n) = (2^n)*C(n-1)$, where $C = A000108$ (Catalan numbers).

BFKM $\left\{ \begin{bmatrix} 3 & 4 \\ 1 & 2 \end{bmatrix}, \begin{bmatrix} 2 & 3 \\ 1 & 4 \end{bmatrix}, \begin{bmatrix} 1 & 4 \\ 2 & 3 \end{bmatrix}, \begin{bmatrix} 1 & 3 \\ 2 & 4 \end{bmatrix} \right\}$

Seq= 4, 9, 22, 58, 163, 483, 1494, 4783, 15740, 52956, 181391

OEIS: [A059019](#) [1] Number of Dyck paths of semilength n with no peak at height 3.

BFLM $\left\{ \begin{bmatrix} 3 & 4 \\ 1 & 2 \end{bmatrix}, \begin{bmatrix} 2 & 3 \\ 1 & 4 \end{bmatrix}, \begin{bmatrix} 3 & 1 \\ 2 & 4 \end{bmatrix}, \begin{bmatrix} 1 & 3 \\ 2 & 4 \end{bmatrix} \right\}$

Seq= 4, 8, 20, 60, 200, 704, 2552, 9416, 35156, 132396, 501908

Var= 1, 2, 5, 15, 50, 176, 638, 2354, 8789, 33099, 125477

OEIS: [A024718](#) [1] $(1/2) * (1 + \text{sum of } C(2k,k) \text{ for } k = 0,1,2,\dots,n)$.

CDEK $\left\{ \begin{bmatrix} 4 & 2 \\ 1 & 3 \end{bmatrix}, \begin{bmatrix} 2 & 4 \\ 1 & 3 \end{bmatrix}, \begin{bmatrix} 3 & 2 \\ 1 & 4 \end{bmatrix}, \begin{bmatrix} 1 & 4 \\ 2 & 3 \end{bmatrix} \right\}$ See also **CDFK**

Seq= 4, 10, 32, 106, 412, 1634, 7240, 32722, 160436, 803002, 4279024

Var= 2, 5, 16, 53, 206, 817, 3620, 16361, 80218, 401501, 2139512

OEIS: [A081126](#) [1] Binomial transform of $n!/\text{floor}(n/2)!$.

CDFW $\left\{ \begin{bmatrix} 4 & 2 \\ 1 & 3 \end{bmatrix}, \begin{bmatrix} 2 & 4 \\ 1 & 3 \end{bmatrix}, \begin{bmatrix} 2 & 3 \\ 1 & 4 \end{bmatrix}, \begin{bmatrix} 3 & 1 \\ 4 & 2 \end{bmatrix} \right\}$ See also **CDQW**, **DEFW**, **DEQW**

Seq= 4, 13, 49, 193, 769, 3073, 12289, 49153, 196609, 786433, 3145729

OEIS: [A140660](#) [1] $3 * 4^{n+1}$.

CDJM $\left\{ \begin{bmatrix} 4 & 2 \\ 1 & 3 \end{bmatrix}, \begin{bmatrix} 2 & 4 \\ 1 & 3 \end{bmatrix}, \begin{bmatrix} 4 & 1 \\ 2 & 3 \end{bmatrix}, \begin{bmatrix} 1 & 3 \\ 2 & 4 \end{bmatrix} \right\}$

Seq= 4, 12, 30, 62, 112, 184, 282, 410, 572, 772, 1014

Var= 2, 6, 15, 31, 56, 92, 141, 205, 286, 386, 507

OEIS: [A056520](#) [1] $(n+2) * (2^{n-2} - n + 3) / 6$

CDKM $\left\{ \begin{bmatrix} 4 & 2 \\ 1 & 3 \end{bmatrix}, \begin{bmatrix} 2 & 4 \\ 1 & 3 \end{bmatrix}, \begin{bmatrix} 1 & 4 \\ 2 & 3 \end{bmatrix}, \begin{bmatrix} 1 & 3 \\ 2 & 4 \end{bmatrix} \right\}$

Seq= 4, 12, 40, 152, 624, 2768, 13024, 64800, 337984, 1842368, 10444416

Var= 2, 6, 20, 76, 312, 1384, 6512, 32400, 168992, 921184, 5222208

OEIS: [A000898](#) [1] $a(n) = 2(a(n-1) + (n-1)a(n-2))$.

CDLM $\left\{ \begin{bmatrix} 4 & 2 \\ 1 & 3 \end{bmatrix}, \begin{bmatrix} 2 & 4 \\ 1 & 3 \end{bmatrix}, \begin{bmatrix} 3 & 1 \\ 2 & 4 \end{bmatrix}, \begin{bmatrix} 1 & 3 \\ 2 & 4 \end{bmatrix} \right\}$

Seq= 4, 10, 20, 34, 52, 74, 100, 130, 164, 202, 244

OEIS: [A005893](#) [1] Number of points on surface of tetrahedron: $2n^2 + 2$ (coordination sequence for sodalite net) for $n > 0$.

CMPW $\left\{ \begin{bmatrix} 4 & 2 \\ 1 & 3 \end{bmatrix}, \begin{bmatrix} 1 & 3 \\ 2 & 4 \end{bmatrix}, \begin{bmatrix} 2 & 4 \\ 3 & 1 \end{bmatrix}, \begin{bmatrix} 3 & 1 \\ 4 & 2 \end{bmatrix} \right\}$

Seq= 4, 36, 568, 14560, 546492, 28289184, 1930982576, 168054225408, 18162775533620

Var= 2, 18, 284, 7280, 273246, 14144592, 965491288, 84027112704, 9081387766810

OEIS: [A131455](#) [1] Number of inequivalent properly oriented and labeled planar chord diagrams whose associated planar tree is a path on $n+1$ ver...

DEJM $\left\{ \begin{bmatrix} 2 & 4 \\ 1 & 3 \end{bmatrix}, \begin{bmatrix} 3 & 2 \\ 1 & 4 \end{bmatrix}, \begin{bmatrix} 4 & 1 \\ 2 & 3 \end{bmatrix}, \begin{bmatrix} 1 & 3 \\ 2 & 4 \end{bmatrix} \right\}$ See also **DFJM**

Seq= 4, 10, 24, 50, 92, 154, 240, 354, 500, 682, 904

Var= 2, 5, 12, 25, 46, 77, 120, 177, 250, 341, 452

OEIS: [A116731](#) [1] Number of permutations of length n which avoid the patterns 321, 2143, 3124; or avoid the patterns 132, 2314, 4312, etc.

References

- [Du] Dumont, Dominique, Interprétations combinatoires des nombres de Genocchi, *Duke math. J.*, **41(2)** (1974), pp. 305–318.
- [FHa] Foata, Dominique; Han, Guo-Niu, Doubloons and new q -tangent numbers, *Quarterly Journal of Mathematics*, in press, 2009, 17 pages.
- [FHb] Foata, Dominique; Han, Guo-Niu, Doubloons and q -secant numbers, *Munster J. of Math.*, **3** (2010), pp. 89–110.
- [FRT] Frame, J. Sutherland; Robinson, Gilbert de Beauregard; Thrall, Robert M., The hook graphs of the symmetric groups, *Canadian J. Math.*, **6** (1954), pp. 316–324.
- [GZ] Graham, Ron; Zang, Nan, Enumerating split-pair arrangements, *J. Combin. Theory, Ser. A*, **115** (2008), p. 293–303.
- [S] Sloane, N. J. A., The On-Line Encyclopedia of Integer Sequences. Published electronically at <http://oeis.org/>.
- [St] Stanley, Richard P., *Enumerative Combinatorics*, vol. 2, Cambridge University Press, 1999.
- [WikiC] Wikipedia: [Catalan number](#).
- [WikiP] Wikipedia [Polyomino](#).
- [WikiPP] Wikipedia: [Permutation pattern](#).
- [WikiT] Wikipedia: [Alternating permutation](#).
- [WikiY] Wikipedia: [Young tableaux](#).

2010 *Mathematics Subject Classification*: Primary 05A15, 05A19, 05A05; Secondary 05B50.
Keywords: standard puzzles, integer sequences, Fibonacci numbers, tangent numbers, Catalan numbers.

(Concerned with sequences [A000012](#), [A000108](#), [A121373](#), [A000165](#), [A055642](#), [A125273](#), [A000027](#), [A000124](#), [A002522](#), [A130883](#), [A005843](#), [A000108](#), [A068875](#), [A005807](#), [A117513](#), [A121686](#), [A028329](#), [A052676](#), [A001147](#), [A128135](#), [A000027](#), [A022856](#), [A059100](#), [A032908](#), [A115112](#), [A104858](#), [A000045](#), [A000217](#), [A005408](#), [A002061](#), [A035508](#), [A001791](#), [A054444](#), [A114185](#), [A104249](#), [A008549](#), [A033816](#), [A155587](#), [A010701](#), [A084508](#), [A124133](#), [A014105](#), [A038665](#), [A004767](#), [A000245](#), [A005807](#), [A000782](#), [A001700](#), [A081293](#), [A078718](#), [A120589](#), [A079309](#), [A178789](#), [A179903](#), [A029744](#), [A051577](#), [A032184](#), [A097801](#), [A010844](#), [A002866](#), [A051577](#), [A004400](#), [A052676](#), [A125273](#), [A000124](#), [A005843](#), [A014206](#), [A055588](#), [A112849](#), [A176006](#), [A027989](#), [A140090](#), [A052995](#), [A100320](#), [A001003](#), [A000079](#), [A122647](#), [A034856](#), [A005448](#), [A000290](#), [A068551](#), [A152891](#), [A162551](#), [A116845](#), [A166336](#), [A084849](#), [A024038](#), [A014137](#), [A052539](#), [A100037](#), [A008586](#), [A024037](#), [A000523](#), [A099251](#), [A091823](#), [A000302](#), [A100103](#),

A110501, A125275, A068875, A109262, A135339, A014137, A000108, A025225, A059019, A024718,
A081126, A140660, A056520, A000898, A005893, A131455 and A116731.)
