

MySQL NDB Cluster 7.5, MySQL NDB Cluster 7.6

Abstract

This is the MySQL NDB Cluster 7.5 and MySQL NDB Cluster 7.6 extract from the MySQL 8.0 Reference Manual.

For legal information, see the [Legal Notices](#).

For help with using MySQL, please visit the [MySQL Forums](#), where you can discuss your issues with other MySQL users.

Document generated on: 2021-10-28 (revision: 71192)

Table of Contents

Preface and Legal Notices	vii
1 General Information	1
2 NDB Cluster Overview	5
2.1 NDB Cluster Core Concepts	7
2.2 NDB Cluster Nodes, Node Groups, Fragment Replicas, and Partitions	9
2.3 NDB Cluster Hardware, Software, and Networking Requirements	12
2.4 What is New in NDB Cluster	14
2.4.1 What is New in NDB Cluster 7.5	14
2.4.2 What is New in NDB Cluster 7.6	20
2.5 NDB: Added, Deprecated, and Removed Options, Variables, and Parameters	29
2.5.1 Options, Variables, and Parameters Added, Deprecated or Removed in NDB 7.5 ...	29
2.5.2 Options, Variables, and Parameters Added, Deprecated or Removed in NDB 7.6 ...	31
2.6 MySQL Server Using InnoDB Compared with NDB Cluster	33
2.6.1 Differences Between the NDB and InnoDB Storage Engines	33
2.6.2 NDB and InnoDB Workloads	34
2.6.3 NDB and InnoDB Feature Usage Summary	35
2.7 Known Limitations of NDB Cluster	35
2.7.1 Noncompliance with SQL Syntax in NDB Cluster	36
2.7.2 Limits and Differences of NDB Cluster from Standard MySQL Limits	39
2.7.3 Limits Relating to Transaction Handling in NDB Cluster	40
2.7.4 NDB Cluster Error Handling	43
2.7.5 Limits Associated with Database Objects in NDB Cluster	43
2.7.6 Unsupported or Missing Features in NDB Cluster	44
2.7.7 Limitations Relating to Performance in NDB Cluster	44
2.7.8 Issues Exclusive to NDB Cluster	45
2.7.9 Limitations Relating to NDB Cluster Disk Data Storage	46
2.7.10 Limitations Relating to Multiple NDB Cluster Nodes	46
3 NDB Cluster Installation	49
3.1 Installation of NDB Cluster on Linux	51
3.1.1 Installing an NDB Cluster Binary Release on Linux	52
3.1.2 Installing NDB Cluster from RPM	54
3.1.3 Installing NDB Cluster Using .deb Files	57
3.1.4 Building NDB Cluster from Source on Linux	58
3.2 Installing NDB Cluster on Windows	59
3.2.1 Installing NDB Cluster on Windows from a Binary Release	59
3.2.2 Compiling and Installing NDB Cluster from Source on Windows	62
3.2.3 Initial Startup of NDB Cluster on Windows	63
3.2.4 Installing NDB Cluster Processes as Windows Services	65
3.3 Initial Configuration of NDB Cluster	67
3.4 Initial Startup of NDB Cluster	69
3.5 NDB Cluster Example with Tables and Data	70
3.6 Safe Shutdown and Restart of NDB Cluster	73
3.7 Upgrading and Downgrading NDB Cluster	74
3.7.1 Upgrading and Downgrading NDB 7.5	74
3.7.2 Upgrading and Downgrading NDB 7.6	76
3.8 The NDB Cluster Auto-Installer (NDB 7.5) (No longer supported)	78
3.8.1 NDB Cluster Auto-Installer Requirements	78
3.8.2 Using the NDB Cluster Auto-Installer	80
3.9 The NDB Cluster Auto-Installer (NDB 7.6) (No longer supported)	89
3.9.1 NDB Cluster Auto-Installer Requirements	89
3.9.2 Using the NDB Cluster Auto-Installer	91
4 Configuration of NDB Cluster	111
4.1 Quick Test Setup of NDB Cluster	111
4.2 Overview of NDB Cluster Configuration Parameters, Options, and Variables	113
4.2.1 NDB Cluster Data Node Configuration Parameters	114

4.2.2 NDB Cluster Management Node Configuration Parameters	120
4.2.3 NDB Cluster SQL Node and API Node Configuration Parameters	121
4.2.4 Other NDB Cluster Configuration Parameters	122
4.2.5 NDB Cluster mysqld Option and Variable Reference	123
4.3 NDB Cluster Configuration Files	131
4.3.1 NDB Cluster Configuration: Basic Example	132
4.3.2 Recommended Starting Configuration for NDB Cluster	135
4.3.3 NDB Cluster Connection Strings	138
4.3.4 Defining Computers in an NDB Cluster	139
4.3.5 Defining an NDB Cluster Management Server	140
4.3.6 Defining NDB Cluster Data Nodes	146
4.3.7 Defining SQL and Other API Nodes in an NDB Cluster	216
4.3.8 Defining the System	224
4.3.9 MySQL Server Options and Variables for NDB Cluster	225
4.3.10 NDB Cluster TCP/IP Connections	268
4.3.11 NDB Cluster TCP/IP Connections Using Direct Connections	273
4.3.12 NDB Cluster Shared Memory Connections	274
4.3.13 Configuring NDB Cluster Send Buffer Parameters	280
4.4 Using High-Speed Interconnects with NDB Cluster	281
5 NDB Cluster Programs	283
5.1 ndbd — The NDB Cluster Data Node Daemon	284
5.2 ndbinfo_select_all — Select From ndbinfo Tables	294
5.3 ndbmtd — The NDB Cluster Data Node Daemon (Multi-Threaded)	299
5.4 ndb_mgmd — The NDB Cluster Management Server Daemon	300
5.5 ndb_mgm — The NDB Cluster Management Client	311
5.6 ndb_blob_tool — Check and Repair BLOB and TEXT columns of NDB Cluster Tables	316
5.7 ndb_config — Extract NDB Cluster Configuration Information	322
5.8 ndb_cpced — Automate Testing for NDB Development	333
5.9 ndb_delete_all — Delete All Rows from an NDB Table	333
5.10 ndb_desc — Describe NDB Tables	338
5.11 ndb_drop_index — Drop Index from an NDB Table	347
5.12 ndb_drop_table — Drop an NDB Table	352
5.13 ndb_error_reporter — NDB Error-Reporting Utility	356
5.14 ndb_import — Import CSV Data Into NDB	357
5.15 ndb_index_stat — NDB Index Statistics Utility	375
5.16 ndb_move_data — NDB Data Copy Utility	383
5.17 ndb_perror — Obtain NDB Error Message Information	388
5.18 ndb_print_backup_file — Print NDB Backup File Contents	390
5.19 ndb_print_file — Print NDB Disk Data File Contents	390
5.20 ndb_print_frag_file — Print NDB Fragment List File Contents	391
5.21 ndb_print_schema_file — Print NDB Schema File Contents	392
5.22 ndb_print_sys_file — Print NDB System File Contents	392
5.23 ndb_redo_log_reader — Check and Print Content of Cluster Redo Log	393
5.24 ndb_restore — Restore an NDB Cluster Backup	395
5.24.1 Restoring an NDB Backup to a Different Version of NDB Cluster	419
5.24.2 Restoring to a different number of data nodes	420
5.25 ndb_select_all — Print Rows from an NDB Table	423
5.26 ndb_select_count — Print Row Counts for NDB Tables	430
5.27 ndb_setup.py — Start browser-based Auto-Installer for NDB Cluster (DEPRECATED) ...	434
5.28 ndb_show_tables — Display List of NDB Tables	437
5.29 ndb_size.pl — NDBCLUSTER Size Requirement Estimator	442
5.30 ndb_top — View CPU usage information for NDB threads	445
5.31 ndb_waiter — Wait for NDB Cluster to Reach a Given Status	451
6 Management of NDB Cluster	459
6.1 Commands in the NDB Cluster Management Client	461
6.2 NDB Cluster Log Messages	466
6.2.1 NDB Cluster: Messages in the Cluster Log	466
6.2.2 NDB Cluster Log Startup Messages	482

6.2.3 Event Buffer Reporting in the Cluster Log	482
6.2.4 NDB Cluster: NDB Transporter Errors	484
6.3 Event Reports Generated in NDB Cluster	485
6.3.1 NDB Cluster Logging Management Commands	486
6.3.2 NDB Cluster Log Events	488
6.3.3 Using CLUSTERLOG STATISTICS in the NDB Cluster Management Client	494
6.4 Summary of NDB Cluster Start Phases	497
6.5 Performing a Rolling Restart of an NDB Cluster	498
6.6 NDB Cluster Single User Mode	500
6.7 Adding NDB Cluster Data Nodes Online	501
6.7.1 Adding NDB Cluster Data Nodes Online: General Issues	501
6.7.2 Adding NDB Cluster Data Nodes Online: Basic procedure	503
6.7.3 Adding NDB Cluster Data Nodes Online: Detailed Example	504
6.8 Online Backup of NDB Cluster	512
6.8.1 NDB Cluster Backup Concepts	512
6.8.2 Using The NDB Cluster Management Client to Create a Backup	512
6.8.3 Configuration for NDB Cluster Backups	515
6.8.4 NDB Cluster Backup Troubleshooting	516
6.9 MySQL Server Usage for NDB Cluster	516
6.10 NDB Cluster Disk Data Tables	517
6.10.1 NDB Cluster Disk Data Objects	518
6.10.2 Using Symbolic Links with Disk Data Objects	523
6.10.3 NDB Cluster Disk Data Storage Requirements	523
6.11 Online Operations with ALTER TABLE in NDB Cluster	523
6.12 Distributed Privileges Using Shared Grant Tables	526
6.13 NDB API Statistics Counters and Variables	529
6.14 ndbinfo: The NDB Cluster Information Database	540
6.14.1 The ndbinfo arbitrator_validity_detail Table	544
6.14.2 The ndbinfo arbitrator_validity_summary Table	545
6.14.3 The ndbinfo blocks Table	546
6.14.4 The ndbinfo cluster_locks Table	546
6.14.5 The ndbinfo cluster_operations Table	547
6.14.6 The ndbinfo cluster_transactions Table	549
6.14.7 The ndbinfo config_nodes Table	550
6.14.8 The ndbinfo config_params Table	551
6.14.9 The ndbinfo config_values Table	551
6.14.10 The ndbinfo counters Table	554
6.14.11 The ndbinfo cpustat Table	555
6.14.12 The ndbinfo cpustat_50ms Table	556
6.14.13 The ndbinfo cpustat_1sec Table	557
6.14.14 The ndbinfo cpustat_20sec Table	558
6.14.15 The ndbinfo dict_obj_info Table	559
6.14.16 The ndbinfo dict_obj_types Table	560
6.14.17 The ndbinfo disk_write_speed_base Table	560
6.14.18 The ndbinfo disk_write_speed_aggregate Table	561
6.14.19 The ndbinfo disk_write_speed_aggregate_node Table	562
6.14.20 The ndbinfo diskpagebuffer Table	562
6.14.21 The ndbinfo error_messages Table	564
6.14.22 The ndbinfo locks_per_fragment Table	565
6.14.23 The ndbinfo logbuffers Table	567
6.14.24 The ndbinfo logspaces Table	568
6.14.25 The ndbinfo membership Table	569
6.14.26 The ndbinfo memoryusage Table	571
6.14.27 The ndbinfo memory_per_fragment Table	572
6.14.28 The ndbinfo nodes Table	574
6.14.29 The ndbinfo operations_per_fragment Table	575
6.14.30 The ndbinfo processes Table	579
6.14.31 The ndbinfo resources Table	580

6.14.32	The ndbinfo restart_info Table	581
6.14.33	The ndbinfo server_locks Table	584
6.14.34	The ndbinfo server_operations Table	586
6.14.35	The ndbinfo server_transactions Table	587
6.14.36	The ndbinfo table_distribution_status Table	589
6.14.37	The ndbinfo table_fragments Table	590
6.14.38	The ndbinfo table_info Table	591
6.14.39	The ndbinfo table_replicas Table	592
6.14.40	The ndbinfo tc_time_track_stats Table	593
6.14.41	The ndbinfo threadblocks Table	594
6.14.42	The ndbinfo threads Table	595
6.14.43	The ndbinfo threadstat Table	596
6.14.44	The ndbinfo transporters Table	597
6.15	INFORMATION_SCHEMA Tables for NDB Cluster	599
6.16	Quick Reference: NDB Cluster SQL Statements	600
6.17	NDB Cluster Security Issues	608
6.17.1	NDB Cluster Security and Networking Issues	608
6.17.2	NDB Cluster and MySQL Privileges	612
6.17.3	NDB Cluster and MySQL Security Procedures	613
7	NDB Cluster Replication	617
7.1	NDB Cluster Replication: Abbreviations and Symbols	618
7.2	General Requirements for NDB Cluster Replication	619
7.3	Known Issues in NDB Cluster Replication	620
7.4	NDB Cluster Replication Schema and Tables	627
7.5	Preparing the NDB Cluster for Replication	632
7.6	Starting NDB Cluster Replication (Single Replication Channel)	634
7.7	Using Two Replication Channels for NDB Cluster Replication	635
7.8	Implementing Failover with NDB Cluster Replication	636
7.9	NDB Cluster Backups With NDB Cluster Replication	638
7.9.1	NDB Cluster Replication: Automating Synchronization of the Replica to the Source Binary Log	640
7.9.2	Point-In-Time Recovery Using NDB Cluster Replication	643
7.10	NDB Cluster Replication: Bidirectional and Circular Replication	644
7.11	NDB Cluster Replication Conflict Resolution	648
A	NDB Cluster FAQ	661

Preface and Legal Notices

Licensing information—MySQL NDB Cluster 7.5. This product may include third-party software, used under license. If you are using a *Commercial* release of NDB Cluster 7.5, see the [MySQL NDB Cluster 7.5 Commercial Release License Information User Manual](#) for licensing information relating to third-party software that may be included in this Commercial release. If you are using a *Community* release of NDB Cluster 7.5, see the [MySQL NDB Cluster 7.5 Community Release License Information User Manual](#) for licensing information relating to third-party software that may be included in this Community release.

Licensing information—MySQL NDB Cluster 7.6. If you are using a *Commercial* release of MySQL NDB Cluster 7.6, see the [MySQL NDB Cluster 7.6 Community Release License Information User Manual](#) for licensing information, including licensing information relating to third-party software that may be included in this Commercial release. If you are using a *Community* release of MySQL NDB Cluster 7.6, see the [MySQL NDB Cluster 7.6 Community Release License Information User Manual](#) for licensing information, including licensing information relating to third-party software that may be included in this Community release.

Legal Notices

Copyright © 1997, 2021, Oracle and/or its affiliates.

This software and related documentation are provided under a license agreement containing restrictions on use and disclosure and are protected by intellectual property laws. Except as expressly permitted in your license agreement or allowed by law, you may not use, copy, reproduce, translate, broadcast, modify, license, transmit, distribute, exhibit, perform, publish, or display any part, in any form, or by any means. Reverse engineering, disassembly, or decompilation of this software, unless required by law for interoperability, is prohibited.

The information contained herein is subject to change without notice and is not warranted to be error-free. If you find any errors, please report them to us in writing.

If this is software or related documentation that is delivered to the U.S. Government or anyone licensing it on behalf of the U.S. Government, then the following notice is applicable:

U.S. GOVERNMENT END USERS: Oracle programs (including any operating system, integrated software, any programs embedded, installed or activated on delivered hardware, and modifications of such programs) and Oracle computer documentation or other Oracle data delivered to or accessed by U.S. Government end users are "commercial computer software" or "commercial computer software documentation" pursuant to the applicable Federal Acquisition Regulation and agency-specific supplemental regulations. As such, the use, reproduction, duplication, release, display, disclosure, modification, preparation of derivative works, and/or adaptation of i) Oracle programs (including any operating system, integrated software, any programs embedded, installed or activated on delivered hardware, and modifications of such programs), ii) Oracle computer documentation and/or iii) other Oracle data, is subject to the rights and limitations specified in the license contained in the applicable contract. The terms governing the U.S. Government's use of Oracle cloud services are defined by the applicable contract for such services. No other rights are granted to the U.S. Government.

This software or hardware is developed for general use in a variety of information management applications. It is not developed or intended for use in any inherently dangerous applications, including applications that may create a risk of personal injury. If you use this software or hardware in dangerous applications, then you shall be responsible to take all appropriate fail-safe, backup, redundancy, and other measures to ensure its safe use. Oracle Corporation and its affiliates disclaim any liability for any damages caused by use of this software or hardware in dangerous applications.

Oracle and Java are registered trademarks of Oracle and/or its affiliates. Other names may be trademarks of their respective owners.

Intel and Intel Inside are trademarks or registered trademarks of Intel Corporation. All SPARC trademarks are used under license and are trademarks or registered trademarks of SPARC

International, Inc. AMD, Epyc, and the AMD logo are trademarks or registered trademarks of Advanced Micro Devices. UNIX is a registered trademark of The Open Group.

This software or hardware and documentation may provide access to or information about content, products, and services from third parties. Oracle Corporation and its affiliates are not responsible for and expressly disclaim all warranties of any kind with respect to third-party content, products, and services unless otherwise set forth in an applicable agreement between you and Oracle. Oracle Corporation and its affiliates will not be responsible for any loss, costs, or damages incurred due to your access to or use of third-party content, products, or services, except as set forth in an applicable agreement between you and Oracle.

This documentation is NOT distributed under a GPL license. Use of this documentation is subject to the following terms:

You may create a printed copy of this documentation solely for your own personal use. Conversion to other formats is allowed as long as the actual content is not altered or edited in any way. You shall not publish or distribute this documentation in any form or on any media, except if you distribute the documentation in a manner similar to how Oracle disseminates it (that is, electronically for download on a Web site with the software) or on a CD-ROM or similar medium, provided however that the documentation is disseminated together with the software on the same medium. Any other use, such as any dissemination of printed copies or use of this documentation, in whole or in part, in another publication, requires the prior written consent from an authorized representative of Oracle. Oracle and/or its affiliates reserve any and all rights to this documentation not expressly granted above.

Documentation Accessibility

For information about Oracle's commitment to accessibility, visit the Oracle Accessibility Program website at <https://www.oracle.com/corporate/accessibility/>.

Access to Oracle Support for Accessibility

Oracle customers that have purchased support have access to electronic support through My Oracle Support. For information, visit <https://www.oracle.com/corporate/accessibility/learning-support.html#support-tab>.

Chapter 1 General Information

MySQL NDB Cluster uses the MySQL server with the [NDB](#) storage engine. Support for the [NDB](#) storage engine is not included in standard MySQL Server 5.7 binaries built by Oracle. Instead, users of NDB Cluster binaries from Oracle should upgrade to the most recent binary release of NDB Cluster for supported platforms—these include RPMs that should work with most Linux distributions. NDB Cluster users who build from source should use the sources provided for NDB Cluster. (Locations where the sources can be obtained are listed later in this section.)

Important

MySQL NDB Cluster does not support InnoDB Cluster, which must be deployed using MySQL Server 5.7 with the [InnoDB](#) storage engine as well as additional applications that are not included in the NDB Cluster distribution. MySQL Server 5.7 binaries cannot be used with MySQL NDB Cluster. For more information about deploying and using InnoDB Cluster, see [MySQL AdminAPI, Section 2.6, “MySQL Server Using InnoDB Compared with NDB Cluster”](#), discusses differences between the [NDB](#) and [InnoDB](#) storage engines.

Supported Platforms. NDB Cluster is currently available and supported on a number of platforms. For exact levels of support available for on specific combinations of operating system versions, operating system distributions, and hardware platforms, please refer to <https://www.mysql.com/support/supportedplatforms/cluster.html>.

Availability. NDB Cluster binary and source packages are available for supported platforms from <https://dev.mysql.com/downloads/cluster/>.

NDB Cluster release numbers. NDB Cluster follows a somewhat different release pattern from the mainline MySQL Server 5.7 series of releases. In this *Manual* and other MySQL documentation, we identify these and later NDB Cluster releases employing a version number that begins with “NDB”. This version number is that of the [NDBCLUSTER](#) storage engine used in the release, and not of the MySQL server version on which the NDB Cluster release is based.

Version strings used in NDB Cluster software. The version string displayed by NDB Cluster programs uses this format:

```
mysql-mysql_server_version-ndb-ndb_engine_version
```

mysql_server_version represents the version of the MySQL Server on which the NDB Cluster release is based. For all NDB Cluster 7.5 and NDB Cluster 7.6 releases, this is “5.7”. *ndb_engine_version* is the version of the [NDB](#) storage engine used by this release of the NDB Cluster software. You can see this format used in the `mysql` client, as shown here:

```
$> mysql
Welcome to the MySQL monitor.  Commands end with ; or \g.
Your MySQL connection id is 2
Server version: 5.7.36-ndb-7.5.25 Source distribution

Type 'help;' or '\h' for help. Type '\c' to clear the buffer.

mysql> SELECT VERSION()\G
***** 1. row *****
VERSION(): 5.7.36-ndb-7.5.25
1 row in set (0.00 sec)
```

This version string is also displayed in the output of the `SHOW` command in the `ndb_mgm` client:

```
ndb_mgm> SHOW
Connected to Management Server at: localhost:1186
Cluster Configuration
-----
[nbdb(NDB)]      2 node(s)
id=1             @10.0.10.6 (5.7.36-ndb-7.5.25, Nodegroup: 0, *)
```

```
id=2 @10.0.10.8 (5.7.36-ndb-7.5.25, Nodegroup: 0)

[ndb_mgmd(MGM)] 1 node(s)
id=3 @10.0.10.2 (5.7.36-ndb-7.5.25)

[mysqld(API)] 2 node(s)
id=4 @10.0.10.10 (5.7.36-ndb-7.5.25)
id=5 (not connected, accepting connect from any host)
```

The version string identifies the mainline MySQL version from which the NDB Cluster release was branched and the version of the NDB storage engine used. For example, the full version string for NDB 7.5.4 (the first NDB 7.5 GA release) was `mysql-5.7.16-ndb-7.5.4`. From this we can determine the following:

- Since the portion of the version string preceding `-ndb-` is the base MySQL Server version, this means that NDB 7.5.4 derived from MySQL 5.7.16, and contained all feature enhancements and bug fixes from MySQL 5.7 up to and including MySQL 5.7.16.
- Since the portion of the version string following `-ndb-` represents the version number of the NDB (or `NDBCLUSTER`) storage engine, NDB 7.5.4 used version 7.5.4 of the `NDBCLUSTER` storage engine.

New NDB Cluster releases are numbered according to updates in the NDB storage engine, and do not necessarily correspond in a one-to-one fashion with mainline MySQL Server releases. For example, NDB 7.5.4 (as previously noted) was based on MySQL 5.7.16, while NDB 7.5.3 was based on MySQL 5.7.13 (version string: `mysql-5.7.13-ndb-7.5.3`).

Compatibility with standard MySQL 5.7 releases. While many standard MySQL schemas and applications can work using NDB Cluster, it is also true that unmodified applications and database schemas may be slightly incompatible or have suboptimal performance when run using NDB Cluster (see [Section 2.7, “Known Limitations of NDB Cluster”](#)). Most of these issues can be overcome, but this also means that you are very unlikely to be able to switch an existing application datastore—that currently uses, for example, `MyISAM` or `InnoDB`—to use the NDB storage engine without allowing for the possibility of changes in schemas, queries, and applications. In addition, the MySQL Server and NDB Cluster codebases diverge considerably, so that the standard `mysqld` cannot function as a drop-in replacement for the version of `mysqld` supplied with NDB Cluster.

NDB Cluster development source trees. NDB Cluster development trees can also be accessed from <https://github.com/mysql/mysql-server>.

The NDB Cluster development sources maintained at <https://github.com/mysql/mysql-server> are licensed under the GPL. For information about obtaining MySQL sources using Git and building them yourself, see [Installing MySQL Using a Development Source Tree](#).

Note

As with MySQL Server 5.7, NDB Cluster 7.5 and NDB Cluster 7.6 releases are built using `CMake`.

NDB Cluster 8.0 is available beginning with NDB 8.0.19 as a General Availability release, and is recommended for new deployments; see [What is New in NDB Cluster](#), for more information. NDB Cluster 7.6 and 7.5 are previous GA releases still supported in production. NDB Cluster 7.4 and 7.3 are previous GA releases still supported in production, although we recommend that new deployments for production use NDB Cluster 8.0; see [MySQL NDB Cluster 7.3 and NDB Cluster 7.4](#).

The contents of this chapter are subject to revision as NDB Cluster continues to evolve. Additional information regarding NDB Cluster can be found on the MySQL website at <http://www.mysql.com/products/cluster/>.

Additional Resources. More information about NDB Cluster can be found in the following places:

- For answers to some commonly asked questions about NDB Cluster, see [Appendix A, NDB Cluster FAQ](#).

-
- The NDB Cluster Forum: <https://forums.mysql.com/list.php?25>.
 - Many NDB Cluster users and developers blog about their experiences with NDB Cluster, and make feeds of these available through [PlanetMySQL](#).

Chapter 2 NDB Cluster Overview

Table of Contents

2.1 NDB Cluster Core Concepts	7
2.2 NDB Cluster Nodes, Node Groups, Fragment Replicas, and Partitions	9
2.3 NDB Cluster Hardware, Software, and Networking Requirements	12
2.4 What is New in NDB Cluster	14
2.4.1 What is New in NDB Cluster 7.5	14
2.4.2 What is New in NDB Cluster 7.6	20
2.5 NDB: Added, Deprecated, and Removed Options, Variables, and Parameters	29
2.5.1 Options, Variables, and Parameters Added, Deprecated or Removed in NDB 7.5	29
2.5.2 Options, Variables, and Parameters Added, Deprecated or Removed in NDB 7.6	31
2.6 MySQL Server Using InnoDB Compared with NDB Cluster	33
2.6.1 Differences Between the NDB and InnoDB Storage Engines	33
2.6.2 NDB and InnoDB Workloads	34
2.6.3 NDB and InnoDB Feature Usage Summary	35
2.7 Known Limitations of NDB Cluster	35
2.7.1 Noncompliance with SQL Syntax in NDB Cluster	36
2.7.2 Limits and Differences of NDB Cluster from Standard MySQL Limits	39
2.7.3 Limits Relating to Transaction Handling in NDB Cluster	40
2.7.4 NDB Cluster Error Handling	43
2.7.5 Limits Associated with Database Objects in NDB Cluster	43
2.7.6 Unsupported or Missing Features in NDB Cluster	44
2.7.7 Limitations Relating to Performance in NDB Cluster	44
2.7.8 Issues Exclusive to NDB Cluster	45
2.7.9 Limitations Relating to NDB Cluster Disk Data Storage	46
2.7.10 Limitations Relating to Multiple NDB Cluster Nodes	46

NDB Cluster is a technology that enables clustering of in-memory databases in a shared-nothing system. The shared-nothing architecture enables the system to work with very inexpensive hardware, and with a minimum of specific requirements for hardware or software.

NDB Cluster is designed not to have any single point of failure. In a shared-nothing system, each component is expected to have its own memory and disk, and the use of shared storage mechanisms such as network shares, network file systems, and SANs is not recommended or supported.

NDB Cluster integrates the standard MySQL server with an in-memory clustered storage engine called **NDB** (which stands for “*Network DataBase*”). In our documentation, the term **NDB** refers to the part of the setup that is specific to the storage engine, whereas “MySQL NDB Cluster” refers to the combination of one or more MySQL servers with the **NDB** storage engine.

An NDB Cluster consists of a set of computers, known as *hosts*, each running one or more processes. These processes, known as *nodes*, may include MySQL servers (for access to NDB data), data nodes (for storage of the data), one or more management servers, and possibly other specialized data access programs. The relationship of these components in an NDB Cluster is shown here:

Figure 2.1 NDB Cluster Components

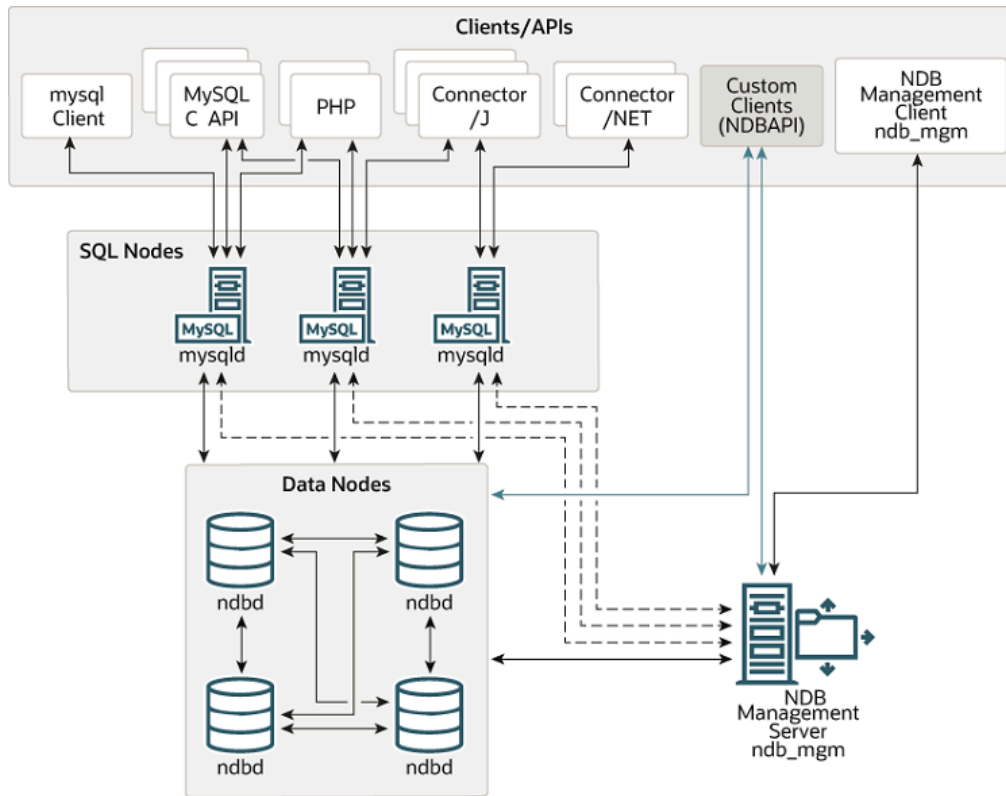

All these programs work together to form an NDB Cluster (see [Chapter 5, NDB Cluster Programs](#)). When data is stored by the NDB storage engine, the tables (and table data) are stored in the data nodes. Such tables are directly accessible from all other MySQL servers (SQL nodes) in the cluster. Thus, in a payroll application storing data in a cluster, if one application updates the salary of an employee, all other MySQL servers that query this data can see this change immediately.

Although an NDB Cluster SQL node uses the `mysqld` server daemon, it differs in a number of critical respects from the `mysqld` binary supplied with the MySQL 5.7 distributions, and the two versions of `mysqld` are not interchangeable.

In addition, a MySQL server that is not connected to an NDB Cluster cannot use the NDB storage engine and cannot access any NDB Cluster data.

The data stored in the data nodes for NDB Cluster can be mirrored; the cluster can handle failures of individual data nodes with no other impact than that a small number of transactions are aborted due to losing the transaction state. Because transactional applications are expected to handle transaction failure, this should not be a source of problems.

Individual nodes can be stopped and restarted, and can then rejoin the system (cluster). Rolling restarts (in which all nodes are restarted in turn) are used in making configuration changes and software upgrades (see [Section 6.5, “Performing a Rolling Restart of an NDB Cluster”](#)). Rolling restarts are also used as part of the process of adding new data nodes online (see [Section 6.7, “Adding NDB Cluster Data Nodes Online”](#)). For more information about data nodes, how they are organized in an NDB Cluster, and how they handle and store NDB Cluster data, see [Section 2.2, “NDB Cluster Nodes, Node Groups, Fragment Replicas, and Partitions”](#).

Backing up and restoring NDB Cluster databases can be done using the NDB-native functionality found in the NDB Cluster management client and the `ndb_restore` program included in the NDB Cluster distribution. For more information, see [Section 6.8, “Online Backup of NDB Cluster”](#), and [Section 5.24, “ndb_restore — Restore an NDB Cluster Backup”](#). You can also use the standard MySQL functionality provided for this purpose in `mysqldump` and the MySQL server. See [mysqldump — A Database Backup Program](#), for more information.

NDB Cluster nodes can employ different transport mechanisms for inter-node communications; TCP/IP over standard 100 Mbps or faster Ethernet hardware is used in most real-world deployments.

2.1 NDB Cluster Core Concepts

NDBCLUSTER (also known as **NDB**) is an in-memory storage engine offering high-availability and data-persistence features.

The **NDBCLUSTER** storage engine can be configured with a range of failover and load-balancing options, but it is easiest to start with the storage engine at the cluster level. NDB Cluster's **NDB** storage engine contains a complete set of data, dependent only on other data within the cluster itself.

The “Cluster” portion of NDB Cluster is configured independently of the MySQL servers. In an NDB Cluster, each part of the cluster is considered to be a *node*.

Note

In many contexts, the term “node” is used to indicate a computer, but when discussing NDB Cluster it means a *process*. It is possible to run multiple nodes on a single computer; for a computer on which one or more cluster nodes are being run we use the term *cluster host*.

There are three types of cluster nodes, and in a minimal NDB Cluster configuration, there must be at least three nodes, one of each of these types:

- *Management node*: The role of this type of node is to manage the other nodes within the NDB Cluster, performing such functions as providing configuration data, starting and stopping nodes, and running backups. Because this node type manages the configuration of the other nodes, a node of this type should be started first, before any other node. A management node is started with the command `ndb_mgmd`.
- *Data node*: This type of node stores cluster data. There are as many data nodes as there are fragment replicas, times the number of fragments (see [Section 2.2, “NDB Cluster Nodes, Node Groups, Fragment Replicas, and Partitions”](#)). For example, with two fragment replicas, each having two fragments, you need four data nodes. One fragment replica is sufficient for data storage, but provides no redundancy; therefore, it is recommended to have two (or more) fragment replicas to provide redundancy, and thus high availability. A data node is started with the command `ndbd` (see [Section 5.1, “ndbd — The NDB Cluster Data Node Daemon”](#)) or `ndbmtd` (see [Section 5.3, “ndbmtd — The NDB Cluster Data Node Daemon \(Multi-Threaded\)”](#)).

NDB Cluster tables are normally stored completely in memory rather than on disk (this is why we refer to NDB Cluster as an *in-memory* database). However, some NDB Cluster data can be stored on disk; see [Section 6.10, “NDB Cluster Disk Data Tables”](#), for more information.

- *SQL node*: This is a node that accesses the cluster data. In the case of NDB Cluster, an SQL node is a traditional MySQL server that uses the **NDBCLUSTER** storage engine. An SQL node is a `mysqld` process started with the `--ndbcluster` and `--ndb-connectstring` options, which are explained elsewhere in this chapter, possibly with additional MySQL server options as well.

An SQL node is actually just a specialized type of *API node*, which designates any application which accesses NDB Cluster data. Another example of an API node is the `ndb_restore` utility that is used to restore a cluster backup. It is possible to write such applications using the NDB API. For basic information about the NDB API, see [Getting Started with the NDB API](#).

Important

It is not realistic to expect to employ a three-node setup in a production environment. Such a configuration provides no redundancy; to benefit from NDB Cluster's high-availability features, you must use multiple data and SQL nodes. The use of multiple management nodes is also highly recommended.

For a brief introduction to the relationships between nodes, node groups, fragment replicas, and partitions in NDB Cluster, see [Section 2.2, “NDB Cluster Nodes, Node Groups, Fragment Replicas, and Partitions”](#).

Configuration of a cluster involves configuring each individual node in the cluster and setting up individual communication links between nodes. NDB Cluster is currently designed with the intention that data nodes are homogeneous in terms of processor power, memory space, and bandwidth. In addition, to provide a single point of configuration, all configuration data for the cluster as a whole is located in one configuration file.

The management server manages the cluster configuration file and the cluster log. Each node in the cluster retrieves the configuration data from the management server, and so requires a way to determine where the management server resides. When interesting events occur in the data nodes, the nodes transfer information about these events to the management server, which then writes the information to the cluster log.

In addition, there can be any number of cluster client processes or applications. These include standard MySQL clients, NDB-specific API programs, and management clients. These are described in the next few paragraphs.

Standard MySQL clients. NDB Cluster can be used with existing MySQL applications written in PHP, Perl, C, C++, Java, Python, Ruby, and so on. Such client applications send SQL statements to and receive responses from MySQL servers acting as NDB Cluster SQL nodes in much the same way that they interact with standalone MySQL servers.

MySQL clients using an NDB Cluster as a data source can be modified to take advantage of the ability to connect with multiple MySQL servers to achieve load balancing and failover. For example, Java clients using Connector/J 5.0.6 and later can use `jdbc:mysql:loadbalance://` URLs (improved in Connector/J 5.1.7) to achieve load balancing transparently; for more information about using Connector/J with NDB Cluster, see [Using Connector/J with NDB Cluster](#).

NDB client programs. Client programs can be written that access NDB Cluster data directly from the `NDBCLUSTER` storage engine, bypassing any MySQL Servers that may be connected to the cluster, using the *NDB API*, a high-level C++ API. Such applications may be useful for specialized purposes where an SQL interface to the data is not needed. For more information, see [The NDB API](#).

NDB-specific Java applications can also be written for NDB Cluster using the *NDB Cluster Connector for Java*. This NDB Cluster Connector includes *ClusterJ*, a high-level database API similar to object-relational mapping persistence frameworks such as Hibernate and JPA that connect directly to `NDBCLUSTER`, and so does not require access to a MySQL Server. See [Java and NDB Cluster](#), and [The ClusterJ API and Data Object Model](#), for more information.

Management clients. These clients connect to the management server and provide commands for starting and stopping nodes gracefully, starting and stopping message tracing (debug versions only), showing node versions and status, starting and stopping backups, and so on. An example of this type of program is the `ndb_mgm` management client supplied with NDB Cluster (see [Section 5.5, “ndb_mgm — The NDB Cluster Management Client”](#)). Such applications can be written using the *MGM API*, a C-language API that communicates directly with one or more NDB Cluster management servers. For more information, see [The MGM API](#).

Oracle also makes available MySQL Cluster Manager, which provides an advanced command-line interface simplifying many complex NDB Cluster management tasks, such restarting an NDB Cluster with a large number of nodes. The MySQL Cluster Manager client also supports commands for getting and setting the values of most node configuration parameters as well as `mysqld` server options and variables relating to NDB Cluster. See [MySQL Cluster Manager 1.4.8 User Manual](#), for more information.

Event logs. NDB Cluster logs events by category (startup, shutdown, errors, checkpoints, and so on), priority, and severity. A complete listing of all reportable events may be found in [Section 6.3, “Event Reports Generated in NDB Cluster”](#). Event logs are of the two types listed here:

- *Cluster log*: Keeps a record of all desired reportable events for the cluster as a whole.
- *Node log*: A separate log which is also kept for each individual node.

Note

Under normal circumstances, it is necessary and sufficient to keep and examine only the cluster log. The node logs need be consulted only for application development and debugging purposes.

Checkpoint. Generally speaking, when data is saved to disk, it is said that a *checkpoint* has been reached. More specific to NDB Cluster, a checkpoint is a point in time where all committed transactions are stored on disk. With regard to the [NDB](#) storage engine, there are two types of checkpoints which work together to ensure that a consistent view of the cluster's data is maintained. These are shown in the following list:

- *Local Checkpoint (LCP)*: This is a checkpoint that is specific to a single node; however, LCPs take place for all nodes in the cluster more or less concurrently. An LCP usually occurs every few minutes; the precise interval varies, and depends upon the amount of data stored by the node, the level of cluster activity, and other factors.

Previously, an LCP involved saving all of a node's data to disk. NDB 7.6 introduces support for partial LCPs, which can significantly improve recovery time under some conditions. See [Section 2.4.2, "What is New in NDB Cluster 7.6"](#), for more information, as well as the descriptions of the [EnablePartialLcp](#) and [RecoveryWork](#) configuration parameters which enable partial LCPs and control the amount of storage they use.

- *Global Checkpoint (GCP)*: A GCP occurs every few seconds, when transactions for all nodes are synchronized and the redo-log is flushed to disk.

For more information about the files and directories created by local checkpoints and global checkpoints, see [NDB Cluster Data Node File System Directory](#).

2.2 NDB Cluster Nodes, Node Groups, Fragment Replicas, and Partitions

This section discusses the manner in which NDB Cluster divides and duplicates data for storage.

A number of concepts central to an understanding of this topic are discussed in the next few paragraphs.

Data node. An [ndbd](#) or [ndbmt_d](#) process, which stores one or more *fragment replicas*—that is, copies of the *partitions* (discussed later in this section) assigned to the node group of which the node is a member.

Each data node should be located on a separate computer. While it is also possible to host multiple data node processes on a single computer, such a configuration is not usually recommended.

It is common for the terms “node” and “data node” to be used interchangeably when referring to an [ndbd](#) or [ndbmt_d](#) process; where mentioned, management nodes ([ndb_mgmd](#) processes) and SQL nodes ([mysqld](#) processes) are specified as such in this discussion.

Node group. A node group consists of one or more nodes, and stores partitions, or sets of *fragment replicas* (see next item).

The number of node groups in an NDB Cluster is not directly configurable; it is a function of the number of data nodes and of the number of fragment replicas ([NoOfReplicas](#) configuration parameter), as shown here:

```
[# of node groups] = [# of data nodes] / NoOfReplicas
```

Thus, an NDB Cluster with 4 data nodes has 4 node groups if `NoOfReplicas` is set to 1 in the `config.ini` file, 2 node groups if `NoOfReplicas` is set to 2, and 1 node group if `NoOfReplicas` is set to 4. Fragment replicas are discussed later in this section; for more information about `NoOfReplicas`, see [Section 4.3.6, “Defining NDB Cluster Data Nodes”](#).

Note

All node groups in an NDB Cluster must have the same number of data nodes.

You can add new node groups (and thus new data nodes) online, to a running NDB Cluster; see [Section 6.7, “Adding NDB Cluster Data Nodes Online”](#), for more information.

Partition. This is a portion of the data stored by the cluster. Each node is responsible for keeping at least one copy of any partitions assigned to it (that is, at least one fragment replica) available to the cluster.

The number of partitions used by default by NDB Cluster depends on the number of data nodes and the number of LDM threads in use by the data nodes, as shown here:

```
[# of partitions] = [# of data nodes] * [# of LDM threads]
```

When using data nodes running `ndbmttd`, the number of LDM threads is controlled by the setting for `MaxNoOfExecutionThreads`. When using `ndbd` there is a single LDM thread, which means that there are as many cluster partitions as nodes participating in the cluster. This is also the case when using `ndbmttd` with `MaxNoOfExecutionThreads` set to 3 or less. (You should be aware that the number of LDM threads increases with the value of this parameter, but not in a strictly linear fashion, and that there are additional constraints on setting it; see the description of `MaxNoOfExecutionThreads` for more information.)

NDB and user-defined partitioning. NDB Cluster normally partitions `NDBCLUSTER` tables automatically. However, it is also possible to employ user-defined partitioning with `NDBCLUSTER` tables. This is subject to the following limitations:

1. Only the `KEY` and `LINEAR KEY` partitioning schemes are supported in production with `NDB` tables.
2. The maximum number of partitions that may be defined explicitly for any `NDB` table is $8 * [\textit{number of LDM threads}] * [\textit{number of node groups}]$, the number of node groups in an NDB Cluster being determined as discussed previously in this section. When running `ndbd` for data node processes, setting the number of LDM threads has no effect (since `ThreadConfig` applies only to `ndbmttd`); in such cases, this value can be treated as though it were equal to 1 for purposes of performing this calculation.

See [Section 5.3, “ndbmttd — The NDB Cluster Data Node Daemon \(Multi-Threaded\)”](#), for more information.

For more information relating to NDB Cluster and user-defined partitioning, see [Section 2.7, “Known Limitations of NDB Cluster”](#), and [Partitioning Limitations Relating to Storage Engines](#).

Fragment replica. This is a copy of a cluster partition. Each node in a node group stores a fragment replica. Also sometimes known as a *partition replica*. The number of fragment replicas is equal to the number of nodes per node group.

A fragment replica belongs entirely to a single node; a node can (and usually does) store several fragment replicas.

The following diagram illustrates an NDB Cluster with four data nodes running `ndbd`, arranged in two node groups of two nodes each; nodes 1 and 2 belong to node group 0, and nodes 3 and 4 belong to node group 1.

Note

Only data nodes are shown here; although a working NDB Cluster requires an `ndb_mgmd` process for cluster management and at least one SQL node to access the data stored by the cluster, these have been omitted from the figure for clarity.

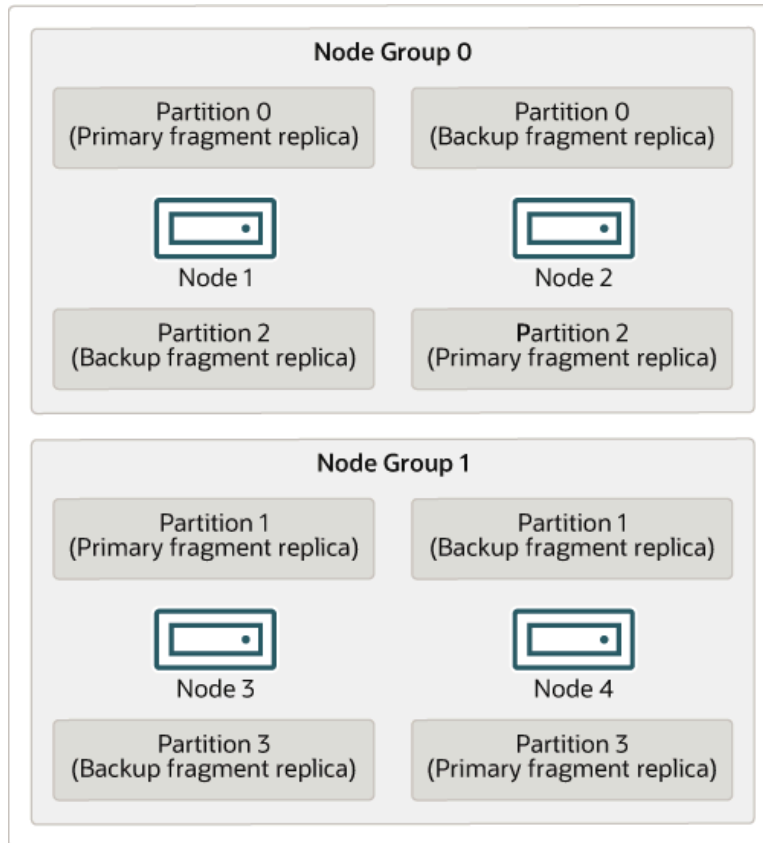
Figure 2.2 NDB Cluster with Two Node Groups

The data stored by the cluster is divided into four partitions, numbered 0, 1, 2, and 3. Each partition is stored—in multiple copies—on the same node group. Partitions are stored on alternate node groups as follows:

- Partition 0 is stored on node group 0; a *primary fragment replica* (primary copy) is stored on node 1, and a *backup fragment replica* (backup copy of the partition) is stored on node 2.
- Partition 1 is stored on the other node group (node group 1); this partition's primary fragment replica is on node 3, and its backup fragment replica is on node 4.
- Partition 2 is stored on node group 0. However, the placing of its two fragment replicas is reversed from that of Partition 0; for Partition 2, the primary fragment replica is stored on node 2, and the backup on node 1.
- Partition 3 is stored on node group 1, and the placement of its two fragment replicas are reversed from those of partition 1. That is, its primary fragment replica is located on node 4, with the backup on node 3.

What this means regarding the continued operation of an NDB Cluster is this: so long as each node group participating in the cluster has at least one node operating, the cluster has a complete copy of all data and remains viable. This is illustrated in the next diagram.

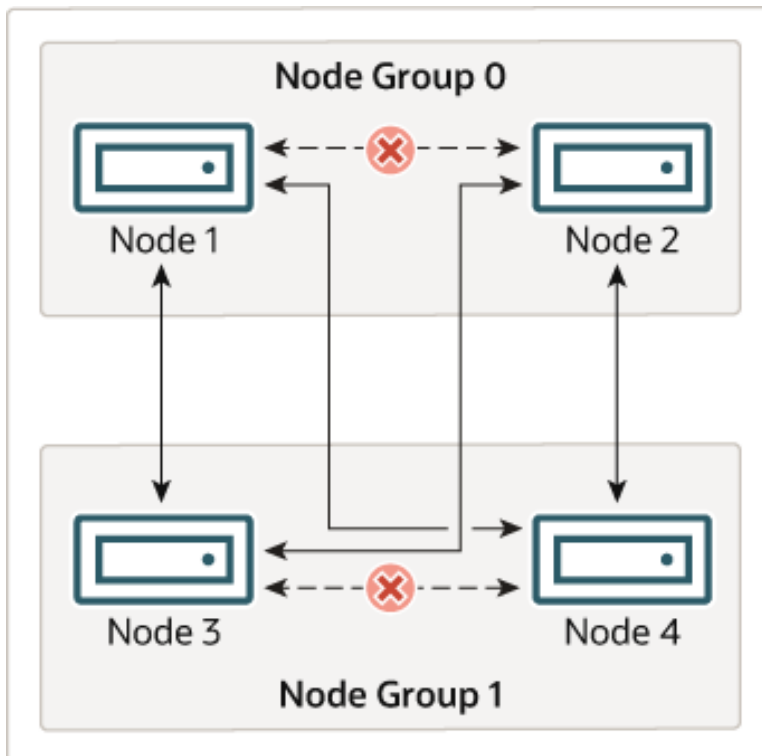
Figure 2.3 Nodes Required for a 2x2 NDB Cluster

In this example, the cluster consists of two node groups each consisting of two data nodes. Each data node is running an instance of `ndbd`. Any combination of at least one node from node group 0 and at least one node from node group 1 is sufficient to keep the cluster “alive”. However, if both nodes from a single node group fail, the combination consisting of the remaining two nodes in the other node group is not sufficient. In this situation, the cluster has lost an entire partition and so can no longer provide access to a complete set of all NDB Cluster data.

In NDB 7.5.4 and later, the maximum number of node groups supported for a single NDB Cluster instance is 48 (Bug#80845, Bug #22996305).

2.3 NDB Cluster Hardware, Software, and Networking Requirements

One of the strengths of NDB Cluster is that it can be run on commodity hardware and has no unusual requirements in this regard, other than for large amounts of RAM, due to the fact that all live data storage is done in memory. (It is possible to reduce this requirement using Disk Data tables—see [Section 6.10, “NDB Cluster Disk Data Tables”](#), for more information about these.) Naturally, multiple and faster CPUs can enhance performance. Memory requirements for other NDB Cluster processes are relatively small.

The software requirements for NDB Cluster are also modest. Host operating systems do not require any unusual modules, services, applications, or configuration to support NDB Cluster. For supported operating systems, a standard installation should be sufficient. The MySQL software requirements are simple: all that is needed is a production release of NDB Cluster. It is not strictly necessary to compile MySQL yourself merely to be able to use NDB Cluster. We assume that you are using the binaries appropriate to your platform, available from the NDB Cluster software downloads page at <https://dev.mysql.com/downloads/cluster/>.

For communication between nodes, NDB Cluster supports TCP/IP networking in any standard topology, and the minimum expected for each host is a standard 100 Mbps Ethernet card, plus a switch, hub, or router to provide network connectivity for the cluster as a whole. We strongly

recommend that an NDB Cluster be run on its own subnet which is not shared with machines not forming part of the cluster for the following reasons:

- **Security.** Communications between NDB Cluster nodes are not encrypted or shielded in any way. The only means of protecting transmissions within an NDB Cluster is to run your NDB Cluster on a protected network. If you intend to use NDB Cluster for Web applications, the cluster should definitely reside behind your firewall and not in your network's De-Militarized Zone ([DMZ](#)) or elsewhere.

See [Section 6.17.1, "NDB Cluster Security and Networking Issues"](#), for more information.

- **Efficiency.** Setting up an NDB Cluster on a private or protected network enables the cluster to make exclusive use of bandwidth between cluster hosts. Using a separate switch for your NDB Cluster not only helps protect against unauthorized access to NDB Cluster data, it also ensures that NDB Cluster nodes are shielded from interference caused by transmissions between other computers on the network. For enhanced reliability, you can use dual switches and dual cards to remove the network as a single point of failure; many device drivers support failover for such communication links.

Network communication and latency. NDB Cluster requires communication between data nodes and API nodes (including SQL nodes), as well as between data nodes and other data nodes, to execute queries and updates. Communication latency between these processes can directly affect the observed performance and latency of user queries. In addition, to maintain consistency and service despite the silent failure of nodes, NDB Cluster uses heartbeating and timeout mechanisms which treat an extended loss of communication from a node as node failure. This can lead to reduced redundancy. Recall that, to maintain data consistency, an NDB Cluster shuts down when the last node in a node group fails. Thus, to avoid increasing the risk of a forced shutdown, breaks in communication between nodes should be avoided wherever possible.

The failure of a data or API node results in the abort of all uncommitted transactions involving the failed node. Data node recovery requires synchronization of the failed node's data from a surviving data node, and re-establishment of disk-based redo and checkpoint logs, before the data node returns to service. This recovery can take some time, during which the Cluster operates with reduced redundancy.

Heartbeating relies on timely generation of heartbeat signals by all nodes. This may not be possible if the node is overloaded, has insufficient machine CPU due to sharing with other programs, or is experiencing delays due to swapping. If heartbeat generation is sufficiently delayed, other nodes treat the node that is slow to respond as failed.

This treatment of a slow node as a failed one may or may not be desirable in some circumstances, depending on the impact of the node's slowed operation on the rest of the cluster. When setting timeout values such as `HeartbeatIntervalDbDb` and `HeartbeatIntervalDbApi` for NDB Cluster, care must be taken care to achieve quick detection, failover, and return to service, while avoiding potentially expensive false positives.

Where communication latencies between data nodes are expected to be higher than would be expected in a LAN environment (on the order of 100 μ s), timeout parameters must be increased to ensure that any allowed periods of latency periods are well within configured timeouts. Increasing timeouts in this way has a corresponding effect on the worst-case time to detect failure and therefore time to service recovery.

LAN environments can typically be configured with stable low latency, and such that they can provide redundancy with fast failover. Individual link failures can be recovered from with minimal and controlled latency visible at the TCP level (where NDB Cluster normally operates). WAN environments may offer a range of latencies, as well as redundancy with slower failover times. Individual link failures may require route changes to propagate before end-to-end connectivity is restored. At the TCP level this can appear as large latencies on individual channels. The worst-case observed TCP latency in these scenarios is related to the worst-case time for the IP layer to reroute around the failures.

2.4 What is New in NDB Cluster

The following sections describe changes in the implementation of NDB Cluster in MySQL NDB Cluster 7.6 through 5.7.36-ndb-7.6.21 and NDB Cluster 7.5 through 5.7.36-ndb-7.5.25 as compared to earlier release series. NDB Cluster 8.0 is available as a General Availability (GA) release, beginning with NDB 8.0.19; see [What is New in NDB Cluster](#), for more information about new features and other changes in NDB 8.0. NDB Cluster 7.6 and 7.5 are previous GA releases still supported in production; for information about NDB Cluster 7.6, see [Section 2.4.2, “What is New in NDB Cluster 7.6”](#). For similar information about NDB Cluster 7.5, see [Section 2.4.1, “What is New in NDB Cluster 7.5”](#). NDB Cluster 7.4 and 7.3 are previous GA releases still supported in production, although we recommend that new deployments for production use NDB Cluster 8.0; see [MySQL NDB Cluster 7.3 and NDB Cluster 7.4](#).

2.4.1 What is New in NDB Cluster 7.5

Major changes and new features in NDB Cluster 7.5 which are likely to be of interest are shown in the following list:

- **ndbinfo Enhancements.** A number of changes are made in the `ndbinfo` database, chief of which is that it now provides detailed information about NDB Cluster node configuration parameters.

The `config_params` table has been made read-only, and has been enhanced with additional columns providing information about each configuration parameter, including the parameter's type, default value, maximum and minimum values (where applicable), a brief description of the parameter, and whether the parameter is required. This table also provides each parameter with a unique `param_number`.

A row in the `config_values` table shows the current value of a given parameter on the node having a specified ID. The parameter is identified by the value of the `config_param` column, which maps to the `config_params` table's `param_number`.

Using this relationship you can write a join on these two tables to obtain the default, maximum, minimum, and current values for one or more NDB Cluster configuration parameters by name. An example SQL statement using such a join is shown here:

```
SELECT  p.param_name AS Name,
        v.node_id AS Node,
        p.param_type AS Type,
        p.param_default AS 'Default',
        p.param_min AS Minimum,
        p.param_max AS Maximum,
        CASE p.param_mandatory WHEN 1 THEN 'Y' ELSE 'N' END AS 'Required',
        v.config_value AS Current
FROM    config_params p
JOIN    config_values v
ON      p.param_number = v.config_param
WHERE   p.param_name IN ('NodeId', 'HostName', 'DataMemory', 'IndexMemory');
```

For more information about these changes, see [Section 6.14.8, “The ndbinfo config_params Table”](#). See [Section 6.14.9, “The ndbinfo config_values Table”](#), for further information and examples.

In addition, the `ndbinfo` database no longer depends on the `MyISAM` storage engine. All `ndbinfo` tables and views now use `NDB` (shown as `NDBINFO`).

Several new `ndbinfo` tables were introduced in NDB 7.5.4. These tables are listed here, with brief descriptions:

- `dict_obj_info` provides the names and types of database objects in `NDB`, as well as information about parent objects where applicable
- `table_distribution_status` provides `NDB` table distribution status information
- `table_fragments` provides information about the distribution of `NDB` table fragments

- `table_info` provides information about logging, checkpointing, storage, and other options in force for each NDB table
- `table_replicas` provides information about fragment replicas

See the descriptions of the individual tables for more information.

- **Default row and column format changes.** Starting with NDB 7.5.1, the default value for both the `ROW_FORMAT` option and the `COLUMN_FORMAT` option for `CREATE TABLE` can be set to `DYNAMIC` rather than `FIXED`, using a new MySQL server variable `ndb_default_column_format` is added as part of this change; set this to `FIXED` or `DYNAMIC` (or start `mysqld` with the equivalent option `--ndb-default-column-format=FIXED`) to force this value to be used for `COLUMN_FORMAT` and `ROW_FORMAT`. Prior to NDB 7.5.4, the default for this variable was `DYNAMIC`; in this and later versions, the default is `FIXED`, which provides backwards compatibility with prior releases (Bug #24487363).

The row format and column format used by existing table columns are unaffected by this change. New columns added to such tables use the new defaults for these (possibly overridden by `ndb_default_column_format`), and existing columns are changed to use these as well, provided that the `ALTER TABLE` statement performing this operation specifies `ALGORITHM=COPY`.

Note

A copying `ALTER TABLE` cannot be done implicitly if `mysqld` is run with `--ndb-allow-copying-alter-table=FALSE`.

- **ndb_binlog_index no longer dependent on MyISAM.** As of NDB 7.5.2, the `ndb_binlog_index` table employed in NDB Cluster Replication now uses the InnoDB storage engine instead of MyISAM. When upgrading, you can run `mysql_upgrade` with `--force --upgrade-system-tables` to cause it to execute `ALTER TABLE ... ENGINE=INNODB` on this table. Use of MyISAM for this table remains supported for backward compatibility.

A benefit of this change is that it makes it possible to depend on transactional behavior and lock-free reads for this table, which can help alleviate concurrency issues during purge operations and log rotation, and improve the availability of this table.

- **ALTER TABLE changes.** NDB Cluster formerly supported an alternative syntax for online `ALTER TABLE`. This is no longer supported in NDB Cluster 7.5, which makes exclusive use of `ALGORITHM = DEFAULT | COPY | INPLACE` for table DDL, as in the standard MySQL Server.

Another change affecting the use of this statement is that `ALTER TABLE ... ALGORITHM=INPLACE RENAME` may now contain DDL operations in addition to the renaming.

- **ExecuteOnComputer parameter deprecated.** The `ExecuteOnComputer` configuration parameter for `management nodes`, `data nodes`, and `API nodes` has been deprecated and is now subject to removal in a future release of NDB Cluster. You should use the equivalent `HostName` parameter for all three types of nodes.
- **records-per-key optimization.** The NDB handler now uses the records-per-key interface for index statistics implemented for the optimizer in MySQL 5.7.5. Some of the benefits from this change include those listed here:
 - The optimizer now chooses better execution plans in many cases where a less optimal join index or table join order would previously have been chosen
 - Row estimates shown by `EXPLAIN` are more accurate
 - Cardinality estimates shown by `SHOW INDEX` are improved

- **Connection pool node IDs.** NDB 7.5.0 adds the `mysqld --ndb-cluster-connection-pool-nodeids` option, which allows a set of node IDs to be set for the connection pool. This setting overrides `--ndb-nodeid`, which means that it also overrides both the `--ndb-connectstring` option and the `NDB_CONNECTSTRING` environment variable.

Note

You can set the size for the connection pool using the `--ndb-cluster-connection-pool` option for `mysqld`.

- **create_old_temporals removed.** The `create_old_temporals` system variable was deprecated in NDB Cluster 7.4, and has now been removed.
- **ndb_mgm Client PROMPT command.** NDB Cluster 7.5 adds a new command for setting the client's command-line prompt. The following example illustrates the use of the `PROMPT` command:

```
ndb_mgm> PROMPT mgm#1:
mgm#1: SHOW
Cluster Configuration
-----
[ndbd(NDB)] 4 node(s)
id=5 @10.100.1.1 (mysql-5.7.36-ndb-7.5.25, Nodegroup: 0, *)
id=6 @10.100.1.3 (mysql-5.7.36-ndb-7.5.25, Nodegroup: 0)
id=7 @10.100.1.9 (mysql-5.7.36-ndb-7.5.25, Nodegroup: 1)
id=8 @10.100.1.11 (mysql-5.7.36-ndb-7.5.25, Nodegroup: 1)

[ndb_mgmd(MGM)] 1 node(s)
id=50 @10.100.1.8 (mysql-5.7.36-ndb-7.5.25)

[mysqld(API)] 2 node(s)
id=100 @10.100.1.8 (5.7.36-ndb-7.5.25)
id=101 @10.100.1.10 (5.7.36-ndb-7.5.25)

mgm#1: PROMPT
ndb_mgm> EXIT
jon@valhaj:/usr/local/mysql/bin>
```

For additional information and examples, see [Section 6.1, “Commands in the NDB Cluster Management Client”](#).

- **Increased FIXED column storage per fragment.** NDB Cluster 7.5 and later supports a maximum of 128 TB per fragment of data in `FIXED` columns. In NDB Cluster 7.4 and earlier, this was 16 GB per fragment.
- **Deprecated parameters removed.** The following NDB Cluster data node configuration parameters were deprecated in previous releases of NDB Cluster, and were removed in NDB 7.5.0:
 - `Id`: deprecated in NDB 7.1.9; replaced by `NodeId`.
 - `NoOfDiskPagesToDiskDuringRestartTUP`, `NoOfDiskPagesToDiskDuringRestartACC`: both deprecated, had no effect; replaced in MySQL 5.1.6 by

`DiskCheckpointSpeedInRestart`, which itself was later deprecated (in NDB 7.4.1) and is now also removed.

- `NoOfDiskPagesToDiskAfterRestartACC`, `NoOfDiskPagesToDiskAfterRestartTUP`: both deprecated, and had no effect; replaced in MySQL 5.1.6 by `DiskCheckpointSpeed`, which itself was later deprecated (in NDB 7.4.1) and is now also removed.
- `ReservedSendBufferMemory`: Deprecated, and no longer had any effect.
- `MaxNoOfIndexes`: archaic (pre-MySQL 4.1), had no effect; long since replaced by `MaxNoOfOrderedIndexes` or `MaxNoOfUniqueHashIndexes`.
- `Discless`: archaic (pre-MySQL 4.1) synonym for and long since replaced by `Diskless`.

The archaic and unused (and for this reason also previously undocumented) `ByteOrder` computer configuration parameter was also removed in NDB 7.5.0.

The parameters just described are not supported in NDB 7.5. Attempting to use any of these parameters in an NDB Cluster configuration file now results in an error.

- **DBTC scan enhancements.** Scans have been improved by reducing the number of signals used for communication between the `DBTC` and `DBDIH` kernel blocks in `NDB`, enabling higher scalability of data nodes when used for scan operations by decreasing the use of CPU resources for scan operations, in some cases by an estimated five percent.

Also as result of these changes response times should be greatly improved, which could help prevent issues with overload of the main threads. In addition, scans made in the `BACKUP` kernel block have also been improved and made more efficient than in previous releases.

- **JSON column support.** NDB 7.5.2 and later supports the `JSON` column type for `NDB` tables and the `JSON` functions found in the MySQL Server, subject to the limitation that an `NDB` table can have at most 3 `JSON` columns.
- **Read from any fragment replica; specify number of hashmap partition fragments.** Previously, all reads were directed towards the primary fragment replica except for simple reads. (A simple read is a read that locks the row while reading it.) Beginning with NDB 7.5.2, it is possible to enable reads from any fragment replica. This is disabled by default but can be enabled for a given SQL node using the `ndb_read_backup` system variable added in this release.

Previously, it was possible to define tables with only one type of partition mapping, with one primary partition on each LDM in each node, but in NDB 7.5.2 it becomes possible to be more flexible about the assignment of partitions by setting a partition balance (fragment count type). Possible balance schemes are one per node, one per node group, one per LDM per node, and one per LDM per node group.

This setting can be controlled for individual tables by means of a `PARTITION_BALANCE` option (renamed from `FRAGMENT_COUNT_TYPE` in NDB 7.5.4) embedded in `NDB_TABLE` comments in `CREATE TABLE` or `ALTER TABLE` statements. Settings for table-level `READ_BACKUP` are also supported using this syntax. For more information and examples, see [Setting NDB_TABLE Options](#).

In NDB API applications, a table's partition balance can also be get and set using methods supplied for this purpose; see `Table::getPartitionBalance()`, and `Table::setPartitionBalance()`, as well as `Object::PartitionBalance`, for more information about these.

As part of this work, NDB 7.5.2 also introduces the `ndb_data_node_neighbour` system variable. This is intended for use, in transaction hinting, to provide a “nearby” data node to this SQL node.

In addition, when restoring table schemas, `ndb_restore --restore-meta` now uses the target cluster's default partitioning, rather than using the same number of partitions as the original cluster from which the backup was taken. See [Section 5.24.2.2, “Restoring to More Nodes Than the Original”](#), for more information and an example.

NDB 7.5.3 adds a further enhancement to `READ_BACKUP`: In this and later versions, it is possible to set `READ_BACKUP` for a given table online as part of `ALTER TABLE ... ALGORITHM=INPLACE ...`.

- **ThreadConfig improvements.** A number of enhancements and feature additions are implemented in NDB 7.5.2 for the `ThreadConfig` multithreaded data node (`ndbmt`) configuration parameter, including support for an increased number of platforms. These changes are described in the next few paragraphs.

Non-exclusive CPU locking is now supported on FreeBSD and Windows, using `cpubind` and `cpuset`. Exclusive CPU locking is now supported on Solaris (only) using the `cpubind_exclusive` and `cpuset_exclusive` parameters which are introduced in this release.

Thread prioritization is now available, controlled by the new `thread_prio` parameter. `thread_prio` is supported on Linux, FreeBSD, Windows, and Solaris, and varies somewhat by platform. For more information, see the description of `ThreadConfig`.

The `realtime` parameter is now supported on Windows platforms.

- **Partitions larger than 16 GB.** Due to an improvement in the hash index implementation used by NDB Cluster data nodes, partitions of NDB tables may now contain more than 16 GB of data for fixed columns, and the maximum partition size for fixed columns is now raised to 128 TB. The previous limitation was due to the fact that the `DBACC` block in the NDB kernel used only 32-bit references to the fixed-size part of a row in the `DBTUP` block, although 45-bit references to this data are used in `DBTUP` itself and elsewhere in the kernel outside `DBACC`; all such references in to the data handled in the `DBACC` block now use 45 bits instead.
- **Print SQL statements from `ndb_restore`.** NDB 7.5.4 adds the `--print-sql-log` option for the `ndb_restore` utility provided with the NDB Cluster distribution. This option enables SQL logging to `stdout`. **Important:** Every table to be restored using this option must have an explicitly defined primary key.

See [Section 5.24, “ndb_restore — Restore an NDB Cluster Backup”](#), for more information.

- **Organization of RPM packages.** Beginning with NDB 7.5.4, the naming and organization of RPM packages provided for NDB Cluster align more closely with those released for the MySQL server. The names of all NDB Cluster RPMs are now prefixed with `mysql-cluster`. Data nodes are now installed using the `data-node` package; management nodes are now installed from the `management-server` package; and SQL nodes require the `server` and `common` packages. MySQL and NDB client programs, including the `mysql` client and the `ndb_mgm` management client, are now included in the `client` RPM.

For a detailed listing of NDB Cluster RPMs and other information, see [Section 3.1.2, “Installing NDB Cluster from RPM”](#).

- **ndbinfo processes and config_nodes tables.** NDB 7.5.7 adds two tables to the `ndbinfo` information database to provide information about cluster nodes; these tables are listed here:
 - `config_nodes`: This table provides the node ID, process type, and host name for each node listed in an NDB cluster's configuration file.
 - The `processes` shows information about nodes currently connected to the cluster; this information includes the process name and system process ID; for each data node and SQL node, it also shows the process ID of the node's angel process. In addition, the table shows a service address for each connected node; this address can be set in NDB API applications using the `Ndb_cluster_connection::set_service_uri()` method, which is also added in NDB 7.5.7.
- **System name.** The system name of an NDB cluster can be used to identify a specific cluster. Beginning with NDB 7.5.7, the MySQL Server shows this name as the

value of the `Ndb_system_name` status variable; NDB API applications can use the `Ndb_cluster_connection::get_system_name()` method which is added in the same release.

A system name based on the time the management server was started is generated automatically; you can override this value by adding a `[system]` section to the cluster's configuration file and setting the `Name` parameter to a value of your choice in this section, prior to starting the management server.

- **ndb_restore options.** Beginning with NDB 7.5.13, the `--nodeid` and `--backupid` options are both required when invoking `ndb_restore`.
- **ndb_blob_tool enhancements.** Beginning with NDB 7.5.18, the `ndb_blob_tool` utility can detect missing blob parts for which inline parts exist and replace these with placeholder blob parts (consisting of space characters) of the correct length. To check whether there are missing blob parts, use the `--check-missing` option with this program. To replace any missing blob parts with placeholders, use the `--add-missing` option.

For more information, see [Section 5.6, “ndb_blob_tool — Check and Repair BLOB and TEXT columns of NDB Cluster Tables”](#).

- **--ndb-log-fail-terminate option.** Beginning with NDB 7.5.18, you can cause the SQL node to terminate whenever it is unable to log all row events fully. This can be done by starting `mysqld` with the `--ndb-log-fail-terminate` option.
- **NDB programs—NDBT dependency removal.** The dependency of a number of NDB utility programs on the NDBT library has been removed. This library is used internally for development, and is not required for normal use; its inclusion in these programs could lead to unwanted issues when testing.

Affected programs are listed here, along with the NDB versions in which the dependency was removed:

- `ndb_restore`, in NDB 7.5.15
- `ndb_show_tables`, in NDB 7.5.18
- `ndb_waiter`, in NDB 7.5.18

The principal effect of this change for users is that these programs no longer print `NDBT_ProgramExit - status` following completion of a run. Applications that depend upon such behavior should be updated to reflect the change when upgrading to the indicated versions.

- **Auto-Installer deprecation and removal.** The MySQL NDB Cluster Auto-Installer web-based installation tool (`ndb_setup.py`) is deprecated in NDB 7.5.20, and is removed in NDB 7.5.21 and later. It is no longer supported.
- **ndbmemcache deprecation and removal.** `ndbmemcache` is no longer supported. `ndbmemcache` was deprecated in NDB 7.5.20, and removed in NDB 7.5.21.
- **Node.js support removed.** Beginning with the NDB Cluster 7.5.20 release, support for Node.js by NDB 7.5 has been removed.

Support for Node.js by NDB Cluster is maintained in NDB 8.0 only.

- **Conversion between NULL and NOT NULL during restore operations.** Beginning with NDB 7.5.23, `ndb_restore` can support restoring of `NULL` columns as `NOT NULL` and the reverse, using the options listed here:
 - To restore a `NULL` column as `NOT NULL`, use the `--lossy-conversions` option.

The column originally declared as `NULL` must not contain any `NULL` rows; if it does, `ndb_restore` exits with an error.

- To restore a `NOT NULL` column as `NULL`, use the `--promote-attributes` option.

For more information, see the descriptions of the indicated `ndb_restore` options.

ClusterJPA is no longer supported beginning with NDB 7.5.7; its source code and binary have been removed from the NDB Cluster distribution.

NDB Cluster 7.5 is also supported by MySQL Cluster Manager, which provides an advanced command-line interface that can simplify many complex NDB Cluster management tasks. See [MySQL Cluster Manager 1.4.8 User Manual](#), for more information.

2.4.2 What is New in NDB Cluster 7.6

New features and other important changes in NDB Cluster 7.6 which are likely to be of interest are shown in the following list:

- **New Disk Data table file format.** A new file format is used in NDB 7.6 for NDB Disk Data tables, which makes it possible for each Disk Data table to be uniquely identified without reusing any table IDs. This should help resolve issues with page and extent handling that were visible to the user as problems with rapid creating and dropping of Disk Data tables, and for which the old format did not provide a ready means to fix.

The new format is now used whenever new undo log file groups and tablespace data files are created. Files relating to existing Disk Data tables continue to use the old format until their tablespaces and undo log file groups are re-created.

Important

The old and new formats are not compatible; different data files or undo log files that are used by the same Disk Data table or tablespace cannot use a mix of formats.

To avoid problems relating to the changes in format, you should re-create any existing tablespaces and undo log file groups when upgrading to NDB 7.6. You can do this by performing an initial restart of each data node (that is, using the `--initial` option) as part of the upgrade process. You can expect this step to be made mandatory as part of upgrading from NDB 7.5 or an earlier release series to NDB 7.6 or later.

If you are using Disk Data tables, a downgrade from *any* NDB 7.6 release—without regard to release status—to any NDB 7.5 or earlier release requires that you restart all data nodes with `--initial` as part of the downgrade process. This is because NDB 7.5 and earlier release series are not able to read the new Disk Data file format.

For more information, see [Section 3.7, “Upgrading and Downgrading NDB Cluster”](#).

- **Data memory pooling and dynamic index memory.** Memory required for indexes on `NDB` table columns is now allocated dynamically from that allocated for `DataMemory`. For this reason, the `IndexMemory` configuration parameter is now deprecated, and subject to removal in a future release series.

Important

In NDB 7.6, if `IndexMemory` is set in the `config.ini` file, the management server issues the warning `IndexMemory is deprecated, use Number bytes on each ndbd(DB) node allocated for storing indexes instead` on startup, and any memory assigned to this parameter is automatically added to `DataMemory`.

In addition, the default value for `DataMemory` has been increased to 98M; the default for `IndexMemory` has been decreased to 0.

The pooling together of index memory with data memory simplifies the configuration of [NDB](#); a further benefit of these changes is that scaling up by increasing the number of LDM threads is no longer limited by having set an insufficiently large value for [IndexMemory](#). This is because index memory is no longer a static quantity which is allocated only once (when the cluster starts), but can now be allocated and deallocated as required. Previously, it was sometimes the case that increasing the number of LDM threads could lead to index memory exhaustion while large amounts of [DataMemory](#) remained available.

As part of this work, a number of instances of [DataMemory](#) usage not directly related to storage of table data now use transaction memory instead.

For this reason, it may be necessary on some systems to increase [SharedGlobalMemory](#) to allow transaction memory to increase when needed, such as when using NDB Cluster Replication, which requires a great deal of buffering on the data nodes. On systems performing initial bulk loads of data, it may be necessary to break up very large transactions into smaller parts.

In addition, data nodes now generate [MemoryUsage](#) events (see [Section 6.3.2, "NDB Cluster Log Events"](#)) and write appropriate messages in the cluster log when resource usage reaches 99%, as well as when it reaches 80%, 90%, or 100%, as before.

Other related changes are listed here:

- [IndexMemory](#) is no longer one of the values displayed in the `ndbinfo.memoryusage` table's `memory_type` column; is also no longer displayed in the output of `ndb_config`.
- `REPORT MEMORYUSAGE` and other commands which expose memory consumption now shows index memory consumption using 32K pages (previously these were 8K pages).
- The `ndbinfo.resources` table now shows the `DISK_OPERATIONS` resource as `TRANSACTION_MEMORY`, and the `RESERVED` resource has been removed.
- **ndbinfo processes and config_nodes tables.** NDB 7.6 adds two tables to the `ndbinfo` information database to provide information about cluster nodes; these tables are listed here:
 - `config_nodes`: This table the node ID, process type, and host name for each node listed in an NDB cluster's configuration file.
 - The `processes` shows information about nodes currently connected to the cluster; this information includes the process name and system process ID; for each data node and SQL node, it also shows the process ID of the node's angel process. In addition, the table shows a service address for each connected node; this address can be set in NDB API applications using the `Ndb_cluster_connection::set_service_uri()` method, which is also added in NDB 7.6.
- **System name.** The system name of an NDB cluster can be used to identify a specific cluster. In NDB 7.6, the MySQL Server shows this name as the value of the `Ndb_system_name` status variable; NDB API applications can use the `Ndb_cluster_connection::get_system_name()` method which is added in the same release.

A system name based on the time the management server was started is generated automatically>; you can override this value by adding a `[system]` section to the cluster's configuration file and setting the `Name` parameter to a value of your choice in this section, prior to starting the management server.

- **ndb_import CSV import tool.** `ndb_import`, added in NDB Cluster 7.6, loads CSV-formatted data directly into an [NDB](#) table using the NDB API (a MySQL server is needed only to create the table and database in which it is located). `ndb_import` can be regarded as an analog of `mysqlimport`

or the `LOAD DATA` SQL statement, and supports many of the same or similar options for formatting of the data.

Assuming that the database and target NDB table exist, `ndb_import` needs only a connection to the cluster's management server (`ndb_mgmd`) to perform the importation; for this reason, there must be an `[api]` slot available to the tool in the cluster's `config.ini` file purpose.

See [Section 5.14, “ndb_import — Import CSV Data Into NDB”](#), for more information.

- **ndb_top monitoring tool.** Added the `ndb_top` utility, which shows CPU load and usage information for an NDB data node in real time. This information can be displayed in text format, as an ASCII graph, or both. The graph can be shown in color, or using grayscale.

`ndb_top` connects to an NDB Cluster SQL node (that is, a MySQL Server). For this reason, the program must be able to connect as a MySQL user having the `SELECT` privilege on tables in the `ndbinfo` database.

`ndb_top` is available for Linux, Solaris, and macOS platforms, but is not currently available for Windows platforms.

For more information, see [Section 5.30, “ndb_top — View CPU usage information for NDB threads”](#).

- **Code cleanup.** A significant number of debugging statements and printouts not necessary for normal operations have been moved into code used only when testing or debugging NDB, or dispensed with altogether. This removal of overhead should result in a noticeable improvement in the performance of LDM and TC threads on the order of 10% in many cases.
- **LDM thread and LCP improvements.** Previously, when a local data management thread experienced I/O lag, it wrote to local checkpoints more slowly. This could happen, for example, during a disk overload condition. Problems could occur because other LDM threads did not always observe this state, or do likewise. NDB now tracks I/O lag mode globally, so that this state is reported as soon as at least one thread is writing in I/O lag mode; it then makes sure that the reduced write speed for this LCP is enforced for all LDM threads for the duration of the slowdown condition. Because the reduction in write speed is now observed by other LDM instances, overall capacity is increased; this enables the disk overload (or other condition inducing I/O lag) to be overcome more quickly in such cases than it was previously.
- **NDB error identification.** Error messages and information can be obtained using the `mysql` client in NDB 7.6 from a new `error_messages` table in the `ndbinfo` information database. In addition, NDB 7.6 introduces a new command-line client `ndb_perror` for obtaining information from NDB error codes; this replaces using `perror` with `--ndb`, which is now deprecated and subject to removal in a future release.

For more information, see [Section 6.14.21, “The ndbinfo error_messages Table”](#), and [Section 5.17, “ndb_perror — Obtain NDB Error Message Information”](#).

- **SPJ improvements.** When executing a scan as a pushed join (that is, the root of the query is a scan), the `DBTC` block sends an SPJ request to a `DBSPJ` instance on the same node as the fragment to be scanned. Formerly, one such request was sent for each of the node's fragments. As the number of `DBTC` and `DBSPJ` instances is normally set less than the number of LDM instances, this means that all SPJ instances were involved in the execution of a single query, and, in fact, some SPJ instances could (and did) receive multiple requests from the same query. NDB 7.6 makes it possible for a single SPJ request to handle a set of root fragments to be scanned, so that only a single SPJ request (`SCAN_FRAGREQ`) needs to be sent to any given SPJ instance (`DBSPJ` block) on each node.

Since `DBSPJ` consumes a relatively small amount of the total CPU used when evaluating a pushed join, unlike the LDM block (which is responsible for the majority of the CPU usage), introducing multiple SPJ blocks adds some parallelism, but the additional overhead also increases. By enabling a single SPJ request to handle a set of root fragments to be scanned, such that only a single

SPJ request is sent to each `DBSPJ` instance on each node and batch sizes are allocated per fragment, the multi-fragment scan can obtain a larger total batch size, allowing for some scheduling optimizations to be done within the SPJ block, which can scan a single fragment at a time (giving it the total batch size allocation), scan all fragments in parallel using smaller sub-batches, or some combination of the two.

This work is expected to increase performance of pushed-down joins for the following reasons:

- Since multiple root fragments can be scanned for each SPJ request, it is necessary to request fewer SPJ instances when executing a pushed join
- Increased available batch size allocation, and for each fragment, should also in most cases result in fewer requests being needed to complete a join
- **Improved `O_DIRECT` handling for redo logs.** NDB 7.6 provides a new data node configuration parameter `ODirectSyncFlag` which causes completed redo log writes using `O_DIRECT` to be handled as `fsync` calls. `ODirectSyncFlag` is disabled by default; to enable it, set it to `true`.

You should bear in mind that the setting for this parameter is ignored when at least one of the following conditions is true:

- `ODirect` is not enabled.
- `InitFragmentLogFiles` is set to `SPARSE`.
- **Locking of CPUs to offline index build threads.** In NDB 7.6, offline index builds by default use all cores available to `ndbmttd`, instead of being limited to the single core reserved for the I/O thread. It also becomes possible to specify a desired set of cores to be used for I/O threads performing offline multithreaded builds of ordered indexes. This can improve restart and restore times and performance, as well as availability.

Note

“Offline” as used here refers to an ordered index build that takes place while a given table is not being written to. Such index builds occur during a node or system restart, or when restoring a cluster from backup using `ndb_restore --rebuild-indexes`.

This improvement involves several related changes. The first of these is to change the default value for the `BuildIndexThreads` configuration parameter (from 0 to 128), means that offline ordered index builds are now multithreaded by default. The default value for the `TwoPassInitialNodeRestartCopy` is also changed (from `false` to `true`), so that an initial node restart first copies all data without any creation of indexes from a “live” node to the node which is being started, builds the ordered indexes offline after the data has been copied, then again synchronizes with the live node; this can significantly reduce the time required for building indexes. In addition, to facilitate explicit locking of offline index build threads to specific CPUs, a new thread type (`idxbld`) is defined for the `ThreadConfig` configuration parameter.

As part of this work, NDB can now distinguish between execution thread types and other types of threads, and between types of threads which are permanently assigned to specific tasks, and those whose assignments are merely temporary.

NDB 7.6 also introduces the `nosend` parameter for `ThreadConfig`. By setting this to 1, you can keep a `main`, `ldm`, `rep`, or `tc` thread from assisting the send threads. This parameter is 0 by default, and cannot be used with I/O threads, send threads, index build threads, or watchdog threads.

For additional information, see the descriptions of the parameters.

- **Variable batch sizes for DDL bulk data operations.** As part of work ongoing to optimize bulk DDL performance by `ndbmttd`, it is now possible to obtain performance improvements by increasing the batch size for the bulk data parts of DDL operations processing data using scans. Batch sizes

are now made configurable for unique index builds, foreign key builds, and online reorganization, by setting the respective data node configuration parameters listed here:

- `MaxUIBuildBatchSize`: Maximum scan batch size used for building unique keys.
- `MaxFKBuildBatchSize`: Maximum scan batch size used for building foreign keys.
- `MaxReorgBuildBatchSize`: Maximum scan batch size used for reorganization of table partitions.

For each of the parameters just listed, the default value is 64, the minimum is 16, and the maximum is 512.

Increasing the appropriate batch size or sizes can help amortize inter-thread and inter-node latencies and make use of more parallel resources (local and remote) to help scale DDL performance. In each case there can be a tradeoff with ongoing traffic.

- **Partial LCPs.** NDB 7.6 implements partial local checkpoints. Formerly, an LCP always made a copy of the entire database. When working with terabytes of data this process could require a great deal of time, with an adverse impact on node and cluster restarts especially, as well as more space for the redo logs. It is now no longer strictly necessary for LCPs to do this—instead, an LCP now by default saves only a number of records that is based on the quantity of data changed since the previous LCP. This can vary between a full checkpoint and a checkpoint that changes nothing at all. In the event that the checkpoint reflects any changes, the minimum is to write one part of the 2048 making up a local LCP.

As part of this change, two new data node configuration parameters are introduced in this release: `EnablePartialLcp` (default `true`, or enabled) enables partial LCPs. `RecoveryWork` controls the percentage of space given over to LCPs; it increases with the amount of work which must be performed on LCPs during restarts as opposed to that performed during normal operations. Raising this value causes LCPs during normal operations to require writing fewer records and so decreases the usual workload. Raising this value also means that restarts can take longer.

You must disable partial LCPs explicitly by setting `EnablePartialLcp=false`. This uses the least amount of disk, but also tends to maximize the write load for LCPs. To optimize for the lowest workload on LCPs during normal operation, use `EnablePartialLcp=true` and `RecoveryWork=100`. To use the least disk space for partial LCPs, but with bounded writes, use `EnablePartialLcp=true` and `RecoveryWork=25`, which is the minimum for `RecoveryWork`. The default is `EnablePartialLcp=true` with `RecoveryWork=50`, which means LCP files require approximately 1.5 times `DataMemory`; using `CompressedLcp=1`, this can be further reduced by half. Recovery times using the default settings should also be much faster than when `EnablePartialLcp` is set to `false`.

Note

The default value for `RecoveryWork` was increased from 50 to 60.

In addition the data node configuration parameters `BackupDataBufferSize`, `BackupWriteSize`, and `BackupMaxWriteSize` are all now deprecated, and subject to removal in a future release of MySQL NDB Cluster.

As part of this enhancement, work has been done to correct several issues with node restarts wherein it was possible to run out of undo log in various situations, most often when restoring a node that had been down for a long time during a period of intensive write activity.

Additional work was done to improve data node survival of long periods of synchronization without timing out, by updating the LCP watchdog during this process, and keeping better track of the

progress of disk data synchronization. Previously, there was the possibility of spurious warnings or even node failures if synchronization took longer than the LCP watchdog timeout.

Important

When upgrading an NDB Cluster that uses disk data tables to NDB 7.6 or downgrading it from NDB 7.6, it is necessary to restart all data nodes with `--initial`.

- **Parallel undo log record processing.** Formerly, the data node `LGMAN` kernel block processed undo log records serially; now this is done in parallel. The rep thread, which hands off undo records to LDM threads, waited for an LDM to finish applying a record before fetching the next one; now the rep thread no longer waits, but proceeds immediately to the next record and LDM.

A count of the number of outstanding log records for each LDM in `LGMAN` is kept, and decremented whenever an LDM has completed the execution of a record. All the records belonging to a page are sent to the same LDM thread but are not guaranteed to be processed in order, so a hash map of pages that have outstanding records maintains a queue for each of these pages. When the page is available in the page cache, all records pending in the queue are applied in order.

A few types of records continue to be processed serially: `UNDO_LCP`, `UNDO_LCP_FIRST`, `UNDO_LOCAL_LCP`, `UNDO_LOCAL_LCP_FIRST`, `UNDO_DROP`, and `UNDO_END`.

There are no user-visible changes in functionality directly associated with this performance enhancement; it is part of work done to improve undo long handling in support of partial local checkpoints in NDB Cluster 7.6.

- **Reading table and fragment IDs from extent for undo log applier.** When applying an undo log, it is necessary to obtain the table ID and fragment ID from the page ID. This was done previously by reading the page from the `PGMAN` kernel block using an extra `PGMAN` worker thread, but when applying the undo log it was necessary to read the page again.

when using `O_DIRECT` this was very inefficient since the page was not cached in the OS kernel. To correct this issue, mapping from page ID to table ID and fragment ID is now done using information from the extent header the table IDs and fragment IDs for the pages used within a given extent. The extent pages are always present in the page cache, so no extra reads from disk are required for performing the mapping. In addition, the information can already be read, using existing `TSMAN` kernel block data structures.

See the description of the `ODirect` data node configuration parameter, for more information.

- **Shared memory transporter.** User-defined shared memory (SHM) connections between a data node and an API node on the same host computer are fully supported in NDB 7.6, and are no longer considered experimental. You can enable an explicit shared memory connection by setting the `UseShm` configuration parameter to `1` for the relevant data node. When explicitly defining shared memory as the connection method, it is also necessary that both the data node and the API node are identified by `HostName`.

Performance of SHM connections can be enhanced through setting parameters such as `ShmSize`, `ShmSpintime`, and `SendBufferMemory` in an `[shm]` or `[shm default]` section of the cluster configuration file (`config.ini`). Configuration of SHM is otherwise similar to that of the TCP transporter.

The `SigNum` parameter is not used in the new SHM implementation, and any settings made for it are now ignored. [Section 4.3.12, “NDB Cluster Shared Memory Connections”](#), provides more information about these parameters. In addition, as part of this work, NDB code relating to the old SCI transporter has been removed.

For more information, see [Section 4.3.12, “NDB Cluster Shared Memory Connections”](#).

- **SPJ block inner join optimization.** In NDB 7.6, the [SPJ](#) kernel block can take into account when it is evaluating a join request in which at least some of the tables are INNER-joined. This means that it can eliminate requests for row, ranges, or both as soon as it becomes known that one or more of the preceding requests did not return any results for a parent row. This saves both the data nodes and the [SPJ](#) block from having to handle requests and result rows which never take part in an INNER-joined result row.

Consider this join query, where `pk` is the primary key on tables `t2`, `t3`, and `t4`, and columns `x`, `y`, and `z` are nonindexed columns:

```
SELECT * FROM t1
  JOIN t2 ON t2.pk = t1.x
  JOIN t3 ON t3.pk = t1.y
  JOIN t4 ON t4.pk = t1.z;
```

Previously, this resulted in an [SPJ](#) request including a scan on table `t1`, and lookups on each of the tables `t2`, `t3`, and `t4`; these were evaluated for every row returned from `t1`. For these, [SPJ](#) created [LQHKEYREQ](#) requests for tables `t2`, `t3`, and `t4`. Now [SPJ](#) takes into consideration the requirement that, to produce any result rows, an inner join must find a match in all tables joined; as soon as no matches are found for one of the tables, any further requests to tables having the same parent or tables are now skipped.

Note

This optimization cannot be applied until all of the data nodes and all of the API nodes in the cluster have been upgraded to NDB 7.6.

- **NDB wakeup thread.** [NDB](#) uses a poll receiver to read from sockets, to execute messages from the sockets, and to wake up other threads. When making only intermittent use of a receive thread, poll ownership is given up before starting to wake up other threads, which provides some degree of parallelism in the receive thread, but, when making constant use of the receive thread, the thread can be overburdened by tasks including wakeup of other threads.

NDB 7.6 supports offloading by the receiver thread of the task of waking up other threads to a new thread that wakes up other threads on request (and otherwise simply sleeps), making it possible to improve the capacity of a single cluster connection by roughly ten to twenty percent.

- **Adaptive LCP control.** NDB 7.6.7 implements an adaptive LCP control mechanism which acts in response to changes in redo log space usage. By controlling LCP disk write speed, you can help protect against a number of resource-related issues, including the following:
 - Insufficient CPU resources for traffic applications
 - Disk overload
 - Insufficient redo log buffer
 - GCP Stop conditions
 - Insufficient redo log space
 - Insufficient undo log space

This work includes the following changes relating to [NDB](#) configuration parameters:

- The default value of the [RecoveryWork](#) data node parameter is increased from 50 to 60; that is, [NDB](#) now uses 1.6 times the size of the data for storage of LCPs.
- A new data node configuration parameter [InsertRecoveryWork](#) provides additional tuning capabilities through controlling the percentage of [RecoveryWork](#) that is reserved for insert operations. The default value is 40 (that is, 40% of the storage space already reserved by [RecoveryWork](#)); the minimum and maximum are 0 and 70, respectively. Increasing this value

allows for more writes to be performed during an LCP, while limiting the total size of the LCP. Decreasing `InsertRecoveryWork` limits the number of writes used during an LCP, but results in more space being used for the LCP, which means that recovery takes longer.

This work implements control of LCP speed chiefly to minimize the risk of running out of redo log. This is done in adaptive fashion, based on the amount of redo log space used, using the alert levels, with the responses taken when these levels are attained, shown here:

- **Low:** Redo log space usage is greater than 25%, or estimated usage shows insufficient redo log space at a very high transaction rate. In response, use of LCP data buffers is increased during LCP scans, priority of LCP scans is increased, and the amount of data that can be written per real-time break in an LCP scan is also increased.
- **High:** Redo log space usage is greater than 40%, or estimate to run out of redo log space at a high transaction rate. When this level of usage is reached, `MaxDiskWriteSpeed` is increased to the value of `MaxDiskWriteSpeedOtherNodeRestart`. In addition, the minimum speed is doubled, and priority of LCP scans and what can be written per real-time break are both increased further.
- **Critical:** Redo log space usage is greater than 60%, or estimated usage shows insufficient redo log space at a normal transaction rate. At this level, `MaxDiskWriteSpeed` is increased to the value of `MaxDiskWriteSpeedOwnRestart`; `MinDiskWriteSpeed` is also set to this value. Priority of LCP scans and the amount of data that can be written per real-time break are increased further, and the LCP data buffer is completely available during the LCP scan.

Raising the level also has the effect of increasing the calculated target checkpoint speed.

LCP control has the following benefits for NDB installations:

- Clusters should now survive very heavy loads using default configurations much better than previously.
- It should now be possible for NDB to run reliably on systems where the available disk space is (at a rough minimum) 2.1 times the amount of memory allocated to it (`DataMemory`). You should note that this figure does *not* include any disk space used for Disk Data tables.
- **ndb_restore options.** Beginning with NDB 7.6.9, the `--nodeid` and `--backupid` options are both required when invoking `ndb_restore`.
- **Restoring by slices.** Beginning with NDB 7.6.13, it is possible to divide a backup into roughly equal portions (slices) and to restore these slices in parallel using two new options implemented for `ndb_restore`:
 - `--num-slices` determines the number of slices into which the backup should be divided.
 - `--slice-id` provides the ID of the slice to be restored by the current instance of `ndb_restore`.

This makes it possible to employ multiple instances of `ndb_restore` to restore subsets of the backup in parallel, potentially reducing the amount of time required to perform the restore operation.

For more information, see the description of the `ndb_restore --num-slices` option.

- **ndb_restore: primary key schema changes.** NDB 7.6.14 (and later) supports different primary key definitions for source and target tables when restoring an NDB native backup with `ndb_restore` when it is run with the `--allow-pk-changes` option. Both increasing and decreasing the number of columns making up the original primary key are supported.

When the primary key is extended with an additional column or columns, any columns added must be defined as `NOT NULL`, and no values in any such columns may be changed during the time that the backup is being taken. Because some applications set all column values in a row when updating

it, whether or not all values are actually changed, this can cause a restore operation to fail even if no values in the column to be added to the primary key have changed. You can override this behavior using the `--ignore-extended-pk-updates` option also added in NDB 7.6.14; in this case, you must ensure that no such values are changed.

A column can be removed from the table's primary key whether or not this column remains part of the table.

For more information, see the description of the `--allow-pk-changes` option for `ndb_restore`.

- **ndb_blob_tool enhancements.** Beginning with NDB 7.6.14, the `ndb_blob_tool` utility can detect missing blob parts for which inline parts exist and replace these with placeholder blob parts (consisting of space characters) of the correct length. To check whether there are missing blob parts, use the `--check-missing` option with this program. To replace any missing blob parts with placeholders, use the `--add-missing` option.

For more information, see [Section 5.6, “ndb_blob_tool — Check and Repair BLOB and TEXT columns of NDB Cluster Tables”](#).

- **Merging backups with ndb_restore.** In some cases, it may be desirable to consolidate data originally stored in different instances of NDB Cluster (all using the same schema) into a single target NDB Cluster. This is now supported when using backups created in the `ndb_mgm` client (see [Section 6.8.2, “Using The NDB Cluster Management Client to Create a Backup”](#)) and restoring them with `ndb_restore`, using the `--remap-column` option added in NDB 7.6.14 along with `--restore-data` (and possibly additional compatible options as needed or desired). `--remap-column` can be employed to handle cases in which primary and unique key values are overlapping between source clusters, and it is necessary that they do not overlap in the target cluster, as well as to preserve other relationships between tables such as foreign keys.

`--remap-column` takes as its argument a string having the format `db.tbl.col:fn:args`, where `db`, `tbl`, and `col` are, respectively, the names of the database, table, and column, `fn` is the name of a remapping function, and `args` is one or more arguments to `fn`. There is no default value. Only `offset` is supported as the function name, with `args` as the integer offset to be applied to the value of the column when inserting it into the target table from the backup. This column must be one of `INT` or `BIGINT`; the allowed range of the offset value is the same as the signed version of that type (this allows the offset to be negative if desired).

The new option can be used multiple times in the same invocation of `ndb_restore`, so that you can remap to new values multiple columns of the same table, different tables, or both. The offset value does not have to be the same for all instances of the option.

In addition, two new options are provided for `ndb_desc`, also beginning in NDB 7.6.14:

- `--auto-inc` (short form `-a`): Includes the the next auto-increment value in the output, if the table has an `AUTO_INCREMENT` column.
- `--context` (short form `-x`): Provides extra information about the table, including the schema, database name, table name, and internal ID.

For more information and examples, see the description of the `--remap-column` option.

- **--ndb-log-fail-terminate option.** Beginning with NDB 7.6.14, you can cause the SQL node to terminate whenever it is unable to log all row events fully. This can be done by starting `mysqld` with the `--ndb-log-fail-terminate` option.
- **NDB programs—NDBT dependency removal.** The dependency of a number of NDB utility programs on the `NDBT` library has been removed. This library is used internally for development, and

is not required for normal use; its inclusion in these programs could lead to unwanted issues when testing.

Affected programs are listed here, along with the [NDB](#) versions in which the dependency was removed:

- [ndb_restore](#), in NDB 7.6.11
- [ndb_show_tables](#), in NDB 7.6.14
- [ndb_waiter](#), in NDB 7.6.14

The principal effect of this change for users is that these programs no longer print `NDBT_ProgramExit - status` following completion of a run. Applications that depend upon such behavior should be updated to reflect the change when upgrading to the indicated versions.

- **Auto-Installer deprecation and removal.** The MySQL NDB Cluster Auto-Installer web-based installation tool ([ndb_setup.py](#)) is deprecated in NDB 7.6.16, and is removed in NDB 7.6.17 and later. It is no longer supported.
- **ndbmemcache deprecation and removal.** [ndbmemcache](#) is no longer supported. [ndbmemcache](#) was deprecated in NDB 7.6.16, and removed in NDB 7.6.17.
- **Node.js support removed.** Beginning with the NDB Cluster 7.6.16 release, support for Node.js by NDB 7.6 has been removed.

Support for Node.js by NDB Cluster is maintained in NDB 8.0 only.

- **Conversion between NULL and NOT NULL during restore operations.** Beginning with NDB 7.6.19, [ndb_restore](#) can support restoring of `NULL` columns as `NOT NULL` and the reverse, using the options listed here:

- To restore a `NULL` column as `NOT NULL`, use the `--lossy-conversions` option.

The column originally declared as `NULL` must not contain any `NULL` rows; if it does, [ndb_restore](#) exits with an error.

- To restore a `NOT NULL` column as `NULL`, use the `--promote-attributes` option.

For more information, see the descriptions of the indicated [ndb_restore](#) options.

2.5 NDB: Added, Deprecated, and Removed Options, Variables, and Parameters

2.5.1 Options, Variables, and Parameters Added, Deprecated or Removed in NDB 7.5

- [Parameters Introduced in NDB 7.5](#)
- [Parameters Deprecated in NDB 7.5](#)
- [Parameters Removed in NDB 7.5](#)
- [Options and Variables Introduced in NDB 7.5](#)
- [Options and Variables Deprecated in NDB 7.5](#)
- [Options and Variables Removed in NDB 7.5](#)

The next few sections contain information about [NDB](#) node configuration parameters and NDB-specific `mysqld` options and variables that have been added to, deprecated in, or removed from NDB 7.5.

Parameters Introduced in NDB 7.5

The following node configuration parameters have been added in NDB 7.5.

- [ApiVerbose](#): Enable NDB API debugging; for NDB development. Added in NDB 7.5.2.

Parameters Deprecated in NDB 7.5

The following node configuration parameters have been deprecated in NDB 7.5.

- [ExecuteOnComputer](#): String referencing earlier defined COMPUTER. Deprecated in NDB 7.5.0.
- [ExecuteOnComputer](#): String referencing earlier defined COMPUTER. Deprecated in NDB 7.5.0.
- [ExecuteOnComputer](#): String referencing earlier defined COMPUTER. Deprecated in NDB 7.5.0.

Parameters Removed in NDB 7.5

The following node configuration parameters have been removed in NDB 7.5.

- [DiskCheckpointSpeed](#): Bytes allowed to be written by checkpoint, per second. Removed in NDB 7.5.0.
- [DiskCheckpointSpeedInRestart](#): Bytes allowed to be written by checkpoint during restart, per second. Removed in NDB 7.5.0.
- [Id](#): Number identifying data node. Now deprecated; use Nodeld instead. Removed in NDB 7.5.0.
- [MaxNoOfSavedEvents](#): Not used. Removed in NDB 7.5.0.
- [PortNumber](#): Port used for SCI transporter. Removed in NDB 7.5.1.
- [PortNumber](#): Port used for SHM transporter. Removed in NDB 7.5.1.
- [PortNumber](#): Port used for TCP transporter. Removed in NDB 7.5.1.
- [ReservedSendBufferMemory](#): This parameter is present in NDB code but is not enabled. Removed in NDB 7.5.2.

Options and Variables Introduced in NDB 7.5

The following system variables, status variables, and server options have been added in NDB 7.5.

- [Ndb_system_name](#): Configured cluster system name; empty if server not connected to NDB. Added in NDB 7.5.7.
- [ndb-allow-copying-alter-table](#): Set to OFF to keep ALTER TABLE from using copying operations on NDB tables. Added in NDB 7.5.0.
- [ndb-cluster-connection-pool-nodeids](#): Comma-separated list of node IDs for connections to cluster used by MySQL; number of nodes in list must match value set for --ndb-cluster-connection-pool. Added in NDB 7.5.0.
- [ndb-default-column-format](#): Use this value (FIXED or DYNAMIC) by default for COLUMN_FORMAT and ROW_FORMAT options when creating or adding table columns. Added in NDB 7.5.1.
- [ndb-log-fail-terminate](#): Terminate mysqld process if complete logging of all found row events is not possible. Added in NDB 7.5.18.
- [ndb-log-update-minimal](#): Log updates in minimal format. Added in NDB 7.5.7.
- [ndb_data_node_neighbour](#): Specifies cluster data node "closest" to this MySQL Server, for transaction hinting and fully replicated tables. Added in NDB 7.5.2.

- [ndb_default_column_format](#): Sets default row format and column format (FIXED or DYNAMIC) used for new NDB tables. Added in NDB 7.5.1.
- [ndb_fully_replicated](#): Whether new NDB tables are fully replicated. Added in NDB 7.5.2.
- [ndb_read_backup](#): Enable read from any replica for all NDB tables; use `NDB_TABLE=READ_BACKUP={0|1}` with `CREATE TABLE` or `ALTER TABLE` to enable or disable for individual NDB tables. Added in NDB 7.5.2.

Options and Variables Deprecated in NDB 7.5

No system variables, status variables, or server options have been deprecated in NDB 7.5.

Options and Variables Removed in NDB 7.5

No system variables, status variables, or options have been removed in NDB 7.5.

2.5.2 Options, Variables, and Parameters Added, Deprecated or Removed in NDB 7.6

- [Parameters Introduced in NDB 7.6](#)
- [Parameters Deprecated in NDB 7.6](#)
- [Parameters Removed in NDB 7.6](#)
- [Options and Variables Introduced in NDB 7.6](#)
- [Options and Variables Deprecated in NDB 7.6](#)
- [Options and Variables Removed in NDB 7.6](#)

The next few sections contain information about [NDB](#) node configuration parameters and NDB-specific [mysqld](#) options and variables that have been added to, deprecated in, or removed from NDB 7.6.

Parameters Introduced in NDB 7.6

The following node configuration parameters have been added in NDB 7.6.

- [EnablePartialLcp](#): Enable partial LCP (true); if this is disabled (false), all LCPs write full checkpoints. Added in NDB 7.6.4.
- [EnableRedoControl](#): Enable adaptive checkpointing speed for controlling redo log usage. Added in NDB 7.6.7.
- [InsertRecoveryWork](#): Percentage of RecoveryWork used for inserted rows; has no effect unless partial local checkpoints are in use. Added in NDB 7.6.5.
- [LocationDomainId](#): Assign this API node to specific availability domain or zone. 0 (default) leaves this unset. Added in NDB 7.6.4.
- [LocationDomainId](#): Assign this management node to specific availability domain or zone. 0 (default) leaves this unset. Added in NDB 7.6.4.
- [LocationDomainId](#): Assign this data node to specific availability domain or zone. 0 (default) leaves this unset. Added in NDB 7.6.4.
- [MaxFKBuildBatchSize](#): Maximum scan batch size to use for building foreign keys. Increasing this value may speed up builds of foreign keys but impacts ongoing traffic as well. Added in NDB 7.6.4.
- [MaxReorgBuildBatchSize](#): Maximum scan batch size to use for reorganization of table partitions. Increasing this value may speed up table partition reorganization but impacts ongoing traffic as well. Added in NDB 7.6.4.

- [MaxUIBuildBatchSize](#): Maximum scan batch size to use for building unique keys. Increasing this value may speed up builds of unique keys but impacts ongoing traffic as well. Added in NDB 7.6.4.
- [ODirectSyncFlag](#): O_DIRECT writes are treated as synchronized writes; ignored when ODirect is not enabled, InitFragmentLogFiles is set to SPARSE, or both. Added in NDB 7.6.4.
- [PreSendChecksum](#): If this parameter and Checksum are both enabled, perform pre-send checksum checks, and check all SHM signals between nodes for errors. Added in NDB 7.6.6.
- [PreSendChecksum](#): If this parameter and Checksum are both enabled, perform pre-send checksum checks, and check all TCP signals between nodes for errors. Added in NDB 7.6.6.
- [RecoveryWork](#): Percentage of storage overhead for LCP files; greater value means less work in normal operations, more work during recovery. Added in NDB 7.6.4.
- [SendBufferMemory](#): Bytes in shared memory buffer for signals sent from this node. Added in NDB 7.6.6.
- [ShmSpinTime](#): When receiving, number of microseconds to spin before sleeping. Added in NDB 7.6.6.
- [UseShm](#): Use shared memory connections between this data node and API node also running on this host. Added in NDB 7.6.6.
- [WatchDogImmediateKill](#): When true, threads are immediately killed whenever watchdog issues occur; used for testing and debugging. Added in NDB 7.6.7.

Parameters Deprecated in NDB 7.6

The following node configuration parameters have been deprecated in NDB 7.6.

- [BackupDataBufferSize](#): Default size of databuffer for backup (in bytes). Deprecated in NDB 7.6.4.
- [BackupMaxWriteSize](#): Maximum size of file system writes made by backup (in bytes). Deprecated in NDB 7.6.4.
- [BackupWriteSize](#): Default size of file system writes made by backup (in bytes). Deprecated in NDB 7.6.4.
- [IndexMemory](#): Number of bytes on each data node allocated for storing indexes; subject to available system RAM and size of DataMemory. Deprecated in NDB 7.6.2.
- [Signal](#): Signal number to be used for signalling. Deprecated in NDB 7.6.6.

Parameters Removed in NDB 7.6

No node configuration parameters have been removed in NDB 7.6.

Options and Variables Introduced in NDB 7.6

The following system variables, status variables, and server options have been added in NDB 7.6.

- [Ndb_system_name](#): Configured cluster system name; empty if server not connected to NDB. Added in NDB 7.6.2.
- [ndb-log-fail-terminate](#): Terminate mysqld process if complete logging of all found row events is not possible. Added in NDB 7.6.14.
- [ndb-log-update-minimal](#): Log updates in minimal format. Added in NDB 7.6.3.
- [ndb_row_checksum](#): When enabled, set row checksums; enabled by default. Added in NDB 7.6.8.

Options and Variables Deprecated in NDB 7.6

No system variables, status variables, or server options have been deprecated in NDB 7.6.

Options and Variables Removed in NDB 7.6

No system variables, status variables, or options have been removed in NDB 7.6.

2.6 MySQL Server Using InnoDB Compared with NDB Cluster

MySQL Server offers a number of choices in storage engines. Since both [NDB](#) and [InnoDB](#) can serve as transactional MySQL storage engines, users of MySQL Server sometimes become interested in NDB Cluster. They see [NDB](#) as a possible alternative or upgrade to the default [InnoDB](#) storage engine in MySQL 5.7. While [NDB](#) and [InnoDB](#) share common characteristics, there are differences in architecture and implementation, so that some existing MySQL Server applications and usage scenarios can be a good fit for NDB Cluster, but not all of them.

In this section, we discuss and compare some characteristics of the [NDB](#) storage engine used by NDB 7.5 with [InnoDB](#) used in MySQL 5.7. The next few sections provide a technical comparison. In many instances, decisions about when and where to use NDB Cluster must be made on a case-by-case basis, taking all factors into consideration. While it is beyond the scope of this documentation to provide specifics for every conceivable usage scenario, we also attempt to offer some very general guidance on the relative suitability of some common types of applications for [NDB](#) as opposed to [InnoDB](#) back ends.

NDB Cluster 7.5 uses a `mysqld` based on MySQL 5.7, including support for [InnoDB](#) 1.1. While it is possible to use [InnoDB](#) tables with NDB Cluster, such tables are not clustered. It is also not possible to use programs or libraries from an NDB Cluster 7.5 distribution with MySQL Server 5.7, or the reverse.

While it is also true that some types of common business applications can be run either on NDB Cluster or on MySQL Server (most likely using the [InnoDB](#) storage engine), there are some important architectural and implementation differences. [Section 2.6.1, “Differences Between the NDB and InnoDB Storage Engines”](#), provides a summary of the these differences. Due to the differences, some usage scenarios are clearly more suitable for one engine or the other; see [Section 2.6.2, “NDB and InnoDB Workloads”](#). This in turn has an impact on the types of applications that better suited for use with [NDB](#) or [InnoDB](#). See [Section 2.6.3, “NDB and InnoDB Feature Usage Summary”](#), for a comparison of the relative suitability of each for use in common types of database applications.

For information about the relative characteristics of the [NDB](#) and [MEMORY](#) storage engines, see [When to Use MEMORY or NDB Cluster](#).

See [Alternative Storage Engines](#), for additional information about MySQL storage engines.

2.6.1 Differences Between the NDB and InnoDB Storage Engines

The [NDB](#) storage engine is implemented using a distributed, shared-nothing architecture, which causes it to behave differently from [InnoDB](#) in a number of ways. For those unaccustomed to working with [NDB](#), unexpected behaviors can arise due to its distributed nature with regard to transactions, foreign keys, table limits, and other characteristics. These are shown in the following table:

Table 2.1 Differences between InnoDB and NDB storage engines

Feature	InnoDB (MySQL 5.7)	NDB 7.5/7.6
MySQL Server Version	5.7	5.7
InnoDB Version	InnoDB 5.7.36	InnoDB 5.7.36
NDB Cluster Version	N/A	NDB 7.5.25/7.6.21
Storage Limits	64TB	128TB (as of NDB 7.5.2)
Foreign Keys	Yes	Yes
Transactions	All standard types	READ COMMITTED

Feature	InnoDB (MySQL 5.7)	NDB 7.5/7.6
<i>MVCC</i>	Yes	No
<i>Data Compression</i>	Yes	No (NDB checkpoint and backup files can be compressed)
<i>Large Row Support (> 14K)</i>	Supported for VARBINARY , VARCHAR , BLOB , and TEXT columns	Supported for BLOB and TEXT columns only (Using these types to store very large amounts of data can lower NDB performance)
<i>Replication Support</i>	Asynchronous and semisynchronous replication using MySQL Replication; MySQL Group Replication	Automatic synchronous replication within an NDB Cluster; asynchronous replication between NDB Clusters, using MySQL Replication (Semisynchronous replication is not supported)
<i>Scaleout for Read Operations</i>	Yes (MySQL Replication)	Yes (Automatic partitioning in NDB Cluster; NDB Cluster Replication)
<i>Scaleout for Write Operations</i>	Requires application-level partitioning (sharding)	Yes (Automatic partitioning in NDB Cluster is transparent to applications)
<i>High Availability (HA)</i>	Built-in, from InnoDB cluster	Yes (Designed for 99.999% uptime)
<i>Node Failure Recovery and Failover</i>	From MySQL Group Replication	Automatic (Key element in NDB architecture)
<i>Time for Node Failure Recovery</i>	30 seconds or longer	Typically < 1 second
<i>Real-Time Performance</i>	No	Yes
<i>In-Memory Tables</i>	No	Yes (Some data can optionally be stored on disk; both in-memory and disk data storage are durable)
<i>NoSQL Access to Storage Engine</i>	Yes	Yes (Multiple APIs, including Memcached, Node.js/JavaScript, Java, JPA, C++, and HTTP/REST)
<i>Concurrent and Parallel Writes</i>	Yes	Up to 48 writers, optimized for concurrent writes
<i>Conflict Detection and Resolution (Multiple Replication Surces)</i>	Yes (MySQL Group Replication)	Yes
<i>Hash Indexes</i>	No	Yes
<i>Online Addition of Nodes</i>	Read/write replicas using MySQL Group Replication	Yes (all node types)
<i>Online Upgrades</i>	Yes (using replication)	Yes
<i>Online Schema Modifications</i>	Yes, as part of MySQL 5.7	Yes

2.6.2 NDB and InnoDB Workloads

NDB Cluster has a range of unique attributes that make it ideal to serve applications requiring high availability, fast failover, high throughput, and low latency. Due to its distributed architecture and multi-node implementation, NDB Cluster also has specific constraints that may keep some workloads from

performing well. A number of major differences in behavior between the [NDB](#) and [InnoDB](#) storage engines with regard to some common types of database-driven application workloads are shown in the following table::

Table 2.2 Differences between InnoDB and NDB storage engines, common types of data-driven application workloads.

Workload	InnoDB	NDB Cluster (NDB)
<i>High-Volume OLTP Applications</i>	Yes	Yes
<i>DSS Applications (data marts, analytics)</i>	Yes	Limited (Join operations across OLTP datasets not exceeding 3TB in size)
<i>Custom Applications</i>	Yes	Yes
<i>Packaged Applications</i>	Yes	Limited (should be mostly primary key access); NDB Cluster 7.5 supports foreign keys
<i>In-Network Telecoms Applications (HLR, HSS, SDP)</i>	No	Yes
<i>Session Management and Caching</i>	Yes	Yes
<i>E-Commerce Applications</i>	Yes	Yes
<i>User Profile Management, AAA Protocol</i>	Yes	Yes

2.6.3 NDB and InnoDB Feature Usage Summary

When comparing application feature requirements to the capabilities of [InnoDB](#) with [NDB](#), some are clearly more compatible with one storage engine than the other.

The following table lists supported application features according to the storage engine to which each feature is typically better suited.

Table 2.3 Supported application features according to the storage engine to which each feature is typically better suited

Preferred application requirements for InnoDB	Preferred application requirements for NDB
<ul style="list-style-type: none"> Foreign keys <div style="border-left: 2px solid black; padding-left: 10px; margin-left: 20px;"> <p>Note</p> <p>NDB Cluster 7.5 supports foreign keys</p> </div> <ul style="list-style-type: none"> Full table scans Very large databases, rows, or transactions Transactions other than READ COMMITTED 	<ul style="list-style-type: none"> Write scaling 99.999% uptime Online addition of nodes and online schema operations Multiple SQL and NoSQL APIs (see NDB Cluster APIs: Overview and Concepts) Real-time performance Limited use of BLOB columns Foreign keys are supported, although their use may have an impact on performance at high throughput

2.7 Known Limitations of NDB Cluster

In the sections that follow, we discuss known limitations in current releases of NDB Cluster as compared with the features available when using the [MyISAM](#) and [InnoDB](#) storage engines. If you check the “Cluster” category in the MySQL bugs database at <http://bugs.mysql.com>, you can find known bugs in the following categories under “MySQL Server:” in the MySQL bugs database at <http://bugs.mysql.com>, which we intend to correct in upcoming releases of NDB Cluster:

- NDB Cluster
- Cluster Direct API (NDBAPI)
- Cluster Disk Data
- Cluster Replication
- ClusterJ

This information is intended to be complete with respect to the conditions just set forth. You can report any discrepancies that you encounter to the MySQL bugs database using the instructions given in [How to Report Bugs or Problems](#). Any problem which we do not plan to fix in NDB Cluster 7.5 is added to the list.

See [Previous NDB Cluster Issues Resolved in NDB Cluster 8.0](#) for a list of issues in earlier releases that have been resolved in NDB Cluster 7.5.

Note

Limitations and other issues specific to NDB Cluster Replication are described in [Section 7.3, “Known Issues in NDB Cluster Replication”](#).

2.7.1 Noncompliance with SQL Syntax in NDB Cluster

Some SQL statements relating to certain MySQL features produce errors when used with [NDB](#) tables, as described in the following list:

- **Temporary tables.** Temporary tables are not supported. Trying either to create a temporary table that uses the [NDB](#) storage engine or to alter an existing temporary table to use [NDB](#) fails with the error `Table storage engine 'ndbcluster' does not support the create option 'TEMPORARY'`.
- **Indexes and keys in NDB tables.** Keys and indexes on NDB Cluster tables are subject to the following limitations:
 - **Column width.** Attempting to create an index on an [NDB](#) table column whose width is greater than 3072 bytes succeeds, but only the first 3072 bytes are actually used for the index. In such cases, a warning `Specified key was too long; max key length is 3072 bytes` is issued, and a `SHOW CREATE TABLE` statement shows the length of the index as 3072.
 - **TEXT and BLOB columns.** You cannot create indexes on [NDB](#) table columns that use any of the [TEXT](#) or [BLOB](#) data types.
 - **FULLTEXT indexes.** The [NDB](#) storage engine does not support [FULLTEXT](#) indexes, which are possible for [MyISAM](#) and [InnoDB](#) tables only.

However, you can create indexes on [VARCHAR](#) columns of [NDB](#) tables.

- **USING HASH keys and NULL.** Using nullable columns in unique keys and primary keys means that queries using these columns are handled as full table scans. To work around this issue, make the column `NOT NULL`, or re-create the index without the `USING HASH` option.
- **Prefixes.** There are no prefix indexes; only entire columns can be indexed. (The size of an [NDB](#) column index is always the same as the width of the column in bytes, up to and including

3072 bytes, as described earlier in this section. Also see [Section 2.7.6, “Unsupported or Missing Features in NDB Cluster”](#), for additional information.)

- **BIT columns.** A `BIT` column cannot be a primary key, unique key, or index, nor can it be part of a composite primary key, unique key, or index.
- **AUTO_INCREMENT columns.** Like other MySQL storage engines, the `NDB` storage engine can handle a maximum of one `AUTO_INCREMENT` column per table. However, in the case of an `NDB` table with no explicit primary key, an `AUTO_INCREMENT` column is automatically defined and used as a “hidden” primary key. For this reason, you cannot define a table that has an explicit `AUTO_INCREMENT` column unless that column is also declared using the `PRIMARY KEY` option. Attempting to create a table with an `AUTO_INCREMENT` column that is not the table's primary key, and using the `NDB` storage engine, fails with an error.
- **Restrictions on foreign keys.** Support for foreign key constraints in `NDB 7.5` is comparable to that provided by `InnoDB`, subject to the following restrictions:
 - Every column referenced as a foreign key requires an explicit unique key, if it is not the table's primary key.
 - `ON UPDATE CASCADE` is not supported when the reference is to the parent table's primary key.

This is because an update of a primary key is implemented as a delete of the old row (containing the old primary key) plus an insert of the new row (with a new primary key). This is not visible to the `NDB` kernel, which views these two rows as being the same, and thus has no way of knowing that this update should be cascaded.

- As of `NDB 7.5.14` and `NDB 7.6.10`: `ON DELETE CASCADE` is not supported where the child table contains one or more columns of any of the `TEXT` or `BLOB` types. (Bug #89511, Bug #27484882)
- `SET DEFAULT` is not supported. (Also not supported by `InnoDB`.)
- The `NO ACTION` keywords are accepted but treated as `RESTRICT`. (Also the same as with `InnoDB`.)
- In earlier versions of `NDB Cluster`, when creating a table with foreign key referencing an index in another table, it sometimes appeared possible to create the foreign key even if the order of the columns in the indexes did not match, due to the fact that an appropriate error was not always returned internally. A partial fix for this issue improved the error used internally to work in most cases; however, it remains possible for this situation to occur in the event that the parent index is a unique index. (Bug #18094360)
- Prior to `NDB 7.5.6`, when adding or dropping a foreign key using `ALTER TABLE`, the parent table's metadata is not updated, which makes it possible subsequently to execute `ALTER TABLE` statements on the parent that should be invalid. To work around this issue, execute `SHOW CREATE TABLE` on the parent table immediately after adding or dropping the foreign key; this forces the parent's metadata to be reloaded.

This issue is fixed in `NDB 7.5.6`. (Bug #82989, Bug #24666177)

For more information, see [FOREIGN KEY Constraints](#), and [FOREIGN KEY Constraints](#).

- **NDB Cluster and geometry data types.** Geometry data types (`WKT` and `WKB`) are supported for `NDB` tables. However, spatial indexes are not supported.
- **Character sets and binary log files.** Currently, the `ndb_apply_status` and `ndb_binlog_index` tables are created using the `latin1` (ASCII) character set. Because names of binary logs are recorded in this table, binary log files named using non-Latin characters are not referenced correctly in these tables. This is a known issue, which we are working to fix. (Bug #50226)

To work around this problem, use only Latin-1 characters when naming binary log files or setting any the `--basedir`, `--log-bin`, or `--log-bin-index` options.

- **Creating NDB tables with user-defined partitioning.** Support for user-defined partitioning in NDB Cluster is restricted to `[LINEAR] KEY` partitioning. Using any other partitioning type with `ENGINE=NDB` or `ENGINE=NDBCLUSTER` in a `CREATE TABLE` statement results in an error.

It is possible to override this restriction, but doing so is not supported for use in production settings. For details, see [User-defined partitioning and the NDB storage engine \(NDB Cluster\)](#).

Default partitioning scheme. All NDB Cluster tables are by default partitioned by `KEY` using the table's primary key as the partitioning key. If no primary key is explicitly set for the table, the “hidden” primary key automatically created by the NDB storage engine is used instead. For additional discussion of these and related issues, see [KEY Partitioning](#).

`CREATE TABLE` and `ALTER TABLE` statements that would cause a user-partitioned `NDBCLUSTER` table not to meet either or both of the following two requirements are not permitted, and fail with an error:

1. The table must have an explicit primary key.
2. All columns listed in the table's partitioning expression must be part of the primary key.

Exception. If a user-partitioned `NDBCLUSTER` table is created using an empty column-list (that is, using `PARTITION BY [LINEAR] KEY()`), then no explicit primary key is required.

Maximum number of partitions for NDBCLUSTER tables. The maximum number of partitions that can be defined for a `NDBCLUSTER` table when employing user-defined partitioning is 8 per node group. (See [Section 2.2, “NDB Cluster Nodes, Node Groups, Fragment Replicas, and Partitions”](#), for more information about NDB Cluster node groups.)

DROP PARTITION not supported. It is not possible to drop partitions from NDB tables using `ALTER TABLE ... DROP PARTITION`. The other partitioning extensions to `ALTER TABLE`—`ADD PARTITION`, `REORGANIZE PARTITION`, and `COALESCE PARTITION`—are supported for NDB tables, but use copying and so are not optimized. See [Management of RANGE and LIST Partitions and ALTER TABLE Statement](#).

- **JSON data type.** The MySQL `JSON` data type is supported for NDB tables in the `mysqld` supplied with NDB 7.5.2 and later.

An NDB table can have a maximum of 3 `JSON` columns.

The NDB API has no special provision for working with `JSON` data, which it views simply as `BLOB` data. Handling data as `JSON` must be performed by the application.

- **CPU and thread info ndbinfo tables.** NDB 7.5.2 adds several new tables to the `ndbinfo` information database providing information about CPU and thread activity by node, thread ID, and thread type. The tables are listed here:

- `cpustat`: Provides per-second, per-thread CPU statistics
- `cpustat_50ms`: Raw per-thread CPU statistics data, gathered every 50ms
- `cpustat_1sec`: Raw per-thread CPU statistics data, gathered each second
- `cpustat_20sec`: Raw per-thread CPU statistics data, gathered every 20 seconds
- `threads`: Names and descriptions of thread types

For more information about these tables, see [Section 6.14, “ndbinfo: The NDB Cluster Information Database”](#).

- **Lock info ndbinfo tables.** NDB 7.5.3 adds new tables to the `ndbinfo` information database providing information about locks and lock attempts in a running NDB Cluster. These tables are listed here:

- `cluster_locks`: Current lock requests which are waiting for or holding locks; this information can be useful when investigating stalls and deadlocks. Analogous to `cluster_operations`.
- `locks_per_fragment`: Counts of lock claim requests, and their outcomes per fragment, as well as total time spent waiting for locks successfully and unsuccessfully. Analogous to `operations_per_fragment` and `memory_per_fragment`.
- `server_locks`: Subset of cluster transactions—those running on the local `mysqld`, showing a connection id per transaction. Analogous to `server_operations`.

2.7.2 Limits and Differences of NDB Cluster from Standard MySQL Limits

In this section, we list limits found in NDB Cluster that either differ from limits found in, or that are not found in, standard MySQL.

Memory usage and recovery. Memory consumed when data is inserted into an NDB table is not automatically recovered when deleted, as it is with other storage engines. Instead, the following rules hold true:

- A `DELETE` statement on an NDB table makes the memory formerly used by the deleted rows available for re-use by inserts on the same table only. However, this memory can be made available for general re-use by performing `OPTIMIZE TABLE`.

A rolling restart of the cluster also frees any memory used by deleted rows. See [Section 6.5, “Performing a Rolling Restart of an NDB Cluster”](#).

- A `DROP TABLE` or `TRUNCATE TABLE` operation on an NDB table frees the memory that was used by this table for re-use by any NDB table, either by the same table or by another NDB table.

Note

Recall that `TRUNCATE TABLE` drops and re-creates the table. See [TRUNCATE TABLE Statement](#).

- **Limits imposed by the cluster's configuration.** A number of hard limits exist which are configurable, but available main memory in the cluster sets limits. See the complete list of configuration parameters in [Section 4.3, “NDB Cluster Configuration Files”](#). Most configuration parameters can be upgraded online. These hard limits include:
 - Database memory size and index memory size (`DataMemory` and `IndexMemory`, respectively).

`DataMemory` is allocated as 32KB pages. As each `DataMemory` page is used, it is assigned to a specific table; once allocated, this memory cannot be freed except by dropping the table.

See [Section 4.3.6, “Defining NDB Cluster Data Nodes”](#), for more information.

- The maximum number of operations that can be performed per transaction is set using the configuration parameters `MaxNoOfConcurrentOperations` and `MaxNoOfLocalOperations`.

Note

Bulk loading, `TRUNCATE TABLE`, and `ALTER TABLE` are handled as special cases by running multiple transactions, and so are not subject to this limitation.

- Different limits related to tables and indexes. For example, the maximum number of ordered indexes in the cluster is determined by `MaxNoOfOrderedIndexes`, and the maximum number of ordered indexes per table is 16.
- **Node and data object maximums.** The following limits apply to numbers of cluster nodes and metadata objects:
 - The maximum number of data nodes is 48.

A data node must have a node ID in the range of 1 to 48, inclusive. (Management and API nodes may use node IDs in the range 1 to 255, inclusive.)

- The total maximum number of nodes in an NDB Cluster is 255. This number includes all SQL nodes (MySQL Servers), API nodes (applications accessing the cluster other than MySQL servers), data nodes, and management servers.
- The maximum number of metadata objects in current versions of NDB Cluster is 20320. This limit is hard-coded.

See [Previous NDB Cluster Issues Resolved in NDB Cluster 8.0](#), for more information.

2.7.3 Limits Relating to Transaction Handling in NDB Cluster

A number of limitations exist in NDB Cluster with regard to the handling of transactions. These include the following:

- **Transaction isolation level.** The `NDBCLUSTER` storage engine supports only the `READ COMMITTED` transaction isolation level. (`InnoDB`, for example, supports `READ COMMITTED`, `READ UNCOMMITTED`, `REPEATABLE READ`, and `SERIALIZABLE`.) You should keep in mind that `NDB` implements `READ COMMITTED` on a per-row basis; when a read request arrives at the data node storing the row, what is returned is the last committed version of the row at that time.

Uncommitted data is never returned, but when a transaction modifying a number of rows commits concurrently with a transaction reading the same rows, the transaction performing the read can observe “before” values, “after” values, or both, for different rows among these, due to the fact that a given row read request can be processed either before or after the commit of the other transaction.

To ensure that a given transaction reads only before or after values, you can impose row locks using `SELECT ... LOCK IN SHARE MODE`. In such cases, the lock is held until the owning transaction is committed. Using row locks can also cause the following issues:

- Increased frequency of lock wait timeout errors, and reduced concurrency
- Increased transaction processing overhead due to reads requiring a commit phase

- Possibility of exhausting the available number of concurrent locks, which is limited by `MaxNoOfConcurrentOperations`

NDB uses `READ COMMITTED` for all reads unless a modifier such as `LOCK IN SHARE MODE` or `FOR UPDATE` is used. `LOCK IN SHARE MODE` causes shared row locks to be used; `FOR UPDATE` causes exclusive row locks to be used. Unique key reads have their locks upgraded automatically by NDB to ensure a self-consistent read; `BLOB` reads also employ extra locking for consistency.

See [Section 6.8.4, “NDB Cluster Backup Troubleshooting”](#), for information on how NDB Cluster's implementation of transaction isolation level can affect backup and restoration of NDB databases.

- **Transactions and BLOB or TEXT columns.** `NDBCLUSTER` stores only part of a column value that uses any of MySQL's `BLOB` or `TEXT` data types in the table visible to MySQL; the remainder of the `BLOB` or `TEXT` is stored in a separate internal table that is not accessible to MySQL. This gives rise to two related issues of which you should be aware whenever executing `SELECT` statements on tables that contain columns of these types:
 1. For any `SELECT` from an NDB Cluster table: If the `SELECT` includes a `BLOB` or `TEXT` column, the `READ COMMITTED` transaction isolation level is converted to a read with read lock. This is done to guarantee consistency.
 2. For any `SELECT` which uses a unique key lookup to retrieve any columns that use any of the `BLOB` or `TEXT` data types and that is executed within a transaction, a shared read lock is held on the table for the duration of the transaction—that is, until the transaction is either committed or aborted.

This issue does not occur for queries that use index or table scans, even against NDB tables having `BLOB` or `TEXT` columns.

For example, consider the table `t` defined by the following `CREATE TABLE` statement:

```
CREATE TABLE t (
  a INT NOT NULL AUTO_INCREMENT PRIMARY KEY,
  b INT NOT NULL,
  c INT NOT NULL,
  d TEXT,
  INDEX i(b),
  UNIQUE KEY u(c)
) ENGINE = NDB,
```

The following query on `t` causes a shared read lock, because it uses a unique key lookup:

```
SELECT * FROM t WHERE c = 1;
```

However, none of the four queries shown here causes a shared read lock:

```
SELECT * FROM t WHERE b = 1;
SELECT * FROM t WHERE d = '1';
SELECT * FROM t;
SELECT b,c WHERE a = 1;
```

This is because, of these four queries, the first uses an index scan, the second and third use table scans, and the fourth, while using a primary key lookup, does not retrieve the value of any `BLOB` or `TEXT` columns.

You can help minimize issues with shared read locks by avoiding queries that use unique key lookups that retrieve `BLOB` or `TEXT` columns, or, in cases where such queries are not avoidable, by committing transactions as soon as possible afterward.

- **Unique key lookups and transaction isolation.** Unique indexes are implemented in NDB using a hidden index table which is maintained internally. When a user-created NDB table is accessed using a unique index, the hidden index table is first read to find the primary key that is then used to read the user-created table. To avoid modification of the index during this double-read operation, the row found in the hidden index table is locked. When a row referenced by a unique index in the user-created NDB table is updated, the hidden index table is subject to an exclusive lock by the transaction in which the update is performed. This means that any read operation on the same (user-created) NDB table must wait for the update to complete. This is true even when the transaction level of the read operation is `READ COMMITTED`.

One workaround which can be used to bypass potentially blocking reads is to force the SQL node to ignore the unique index when performing the read. This can be done by using the `IGNORE INDEX` index hint as part of the `SELECT` statement reading the table (see [Index Hints](#)). Because the MySQL server creates a shadowing ordered index for every unique index created in NDB, this lets the ordered index be read instead, and avoids unique index access locking. The resulting read is as consistent as a committed read by primary key, returning the last committed value at the time the row is read.

Reading via an ordered index makes less efficient use of resources in the cluster, and may have higher latency.

It is also possible to avoid using the unique index for access by querying for ranges rather than for unique values.

- **Rollbacks.** There are no partial transactions, and no partial rollbacks of transactions. A duplicate key or similar error causes the entire transaction to be rolled back.

This behavior differs from that of other transactional storage engines such as `InnoDB` that may roll back individual statements.

- **Transactions and memory usage.**

As noted elsewhere in this chapter, NDB Cluster does not handle large transactions well; it is better to perform a number of small transactions with a few operations each than to attempt a single large transaction containing a great many operations. Among other considerations, large transactions require very large amounts of memory. Because of this, the transactional behavior of a number of MySQL statements is affected as described in the following list:

- `TRUNCATE TABLE` is not transactional when used on NDB tables. If a `TRUNCATE TABLE` fails to empty the table, then it must be re-run until it is successful.
- `DELETE FROM` (even with no `WHERE` clause) is transactional. For tables containing a great many rows, you may find that performance is improved by using several `DELETE FROM . . . LIMIT . . .` statements to “chunk” the delete operation. If your objective is to empty the table, then you may wish to use `TRUNCATE TABLE` instead.
- **LOAD DATA statements.** `LOAD DATA` is not transactional when used on NDB tables.

Important

When executing a `LOAD DATA` statement, the NDB engine performs commits at irregular intervals that enable better utilization of the communication network. It is not possible to know ahead of time when such commits take place.

- **ALTER TABLE and transactions.** When copying an NDB table as part of an `ALTER TABLE`, the creation of the copy is nontransactional. (In any case, this operation is rolled back when the copy is deleted.)
- **Transactions and the COUNT() function.** When using NDB Cluster Replication, it is not possible to guarantee the transactional consistency of the `COUNT()` function on the replica. In other words,

when performing on the source a series of statements (`INSERT`, `DELETE`, or both) that changes the number of rows in a table within a single transaction, executing `SELECT COUNT(*) FROM table` queries on the replica may yield intermediate results. This is due to the fact that `SELECT COUNT(...)` may perform dirty reads, and is not a bug in the NDB storage engine. (See Bug #31321 for more information.)

2.7.4 NDB Cluster Error Handling

Starting, stopping, or restarting a node may give rise to temporary errors causing some transactions to fail. These include the following cases:

- **Temporary errors.** When first starting a node, it is possible that you may see Error 1204 `Temporary failure, distribution changed` and similar temporary errors.
- **Errors due to node failure.** The stopping or failure of any data node can result in a number of different node failure errors. (However, there should be no aborted transactions when performing a planned shutdown of the cluster.)

In either of these cases, any errors that are generated must be handled within the application. This should be done by retrying the transaction.

See also [Section 2.7.2, “Limits and Differences of NDB Cluster from Standard MySQL Limits”](#).

2.7.5 Limits Associated with Database Objects in NDB Cluster

Some database objects such as tables and indexes have different limitations when using the `NDBCLUSTER` storage engine:

- **Database and table names.** When using the NDB storage engine, the maximum allowed length both for database names and for table names is 63 characters. A statement using a database name or table name longer than this limit fails with an appropriate error.
- **Number of database objects.** The maximum number of *all* NDB database objects in a single NDB Cluster—including databases, tables, and indexes—is limited to 20320.
- **Attributes per table.** The maximum number of attributes (that is, columns and indexes) that can belong to a given table is 512.
- **Attributes per key.** The maximum number of attributes per key is 32.
- **Row size.** The maximum permitted size of any one row is 14000 bytes.

Each `BLOB` or `TEXT` column contributes $256 + 8 = 264$ bytes to this total; this includes `JSON` columns. See [String Type Storage Requirements](#), as well as [JSON Storage Requirements](#), for more information relating to these types.

In addition, the maximum offset for a fixed-width column of an NDB table is 8188 bytes; attempting to create a table that violates this limitation fails with NDB error 851 `Maximum offset for fixed-size columns exceeded`. For memory-based columns, you can work around this limitation by using a variable-width column type such as `VARCHAR` or defining the column as `COLUMN_FORMAT=DYNAMIC`; this does not work with columns stored on disk. For disk-based columns, you may be able to do so by reordering one or more of the table's disk-based columns such that the combined width of all but the disk-based column defined last in the `CREATE TABLE` statement used to create the table does not exceed 8188 bytes, less any possible rounding performed for some data types such as `CHAR` or `VARCHAR`; otherwise it is necessary to use memory-based storage for one or more of the offending column or columns instead.

- **BIT column storage per table.** The maximum combined width for all `BIT` columns used in a given NDB table is 4096.
- **FIXED column storage.** NDB Cluster 7.5 and later supports a maximum of 128 TB per fragment of data in `FIXED` columns. (Previously, this was 16 GB.)

2.7.6 Unsupported or Missing Features in NDB Cluster

A number of features supported by other storage engines are not supported for [NDB](#) tables. Trying to use any of these features in NDB Cluster does not cause errors in or of itself; however, errors may occur in applications that expects the features to be supported or enforced. Statements referencing such features, even if effectively ignored by [NDB](#), must be syntactically and otherwise valid.

- **Index prefixes.** Prefixes on indexes are not supported for [NDB](#) tables. If a prefix is used as part of an index specification in a statement such as `CREATE TABLE`, `ALTER TABLE`, or `CREATE INDEX`, the prefix is not created by [NDB](#).

A statement containing an index prefix, and creating or modifying an [NDB](#) table, must still be syntactically valid. For example, the following statement always fails with Error 1089 `Incorrect prefix key; the used key part isn't a string, the used length is longer than the key part, or the storage engine doesn't support unique prefix keys`, regardless of storage engine:

```
CREATE TABLE t1 (
  c1 INT NOT NULL,
  c2 VARCHAR(100),
  INDEX i1 (c2(500))
);
```

This happens on account of the SQL syntax rule that no index may have a prefix larger than itself.

- **Savepoints and rollbacks.** Savepoints and rollbacks to savepoints are ignored as in [MyISAM](#).
- **Durability of commits.** There are no durable commits on disk. Commits are replicated, but there is no guarantee that logs are flushed to disk on commit.
- **Replication.** Statement-based replication is not supported. Use `--binlog-format=ROW` (or `--binlog-format=MIXED`) when setting up cluster replication. See [Chapter 7, NDB Cluster Replication](#), for more information.

Replication using global transaction identifiers (GTIDs) is not compatible with NDB Cluster, and is not supported in NDB Cluster 7.5 or NDB Cluster 7.6. Do not enable GTIDs when using the [NDB](#) storage engine, as this is very likely to cause problems up to and including failure of NDB Cluster Replication.

Semisynchronous replication is not supported in NDB Cluster.

When replicating between clusters, it is possible to use IPv6 addresses between SQL nodes in different clusters, but all connections within a given cluster must use IPv4 addressing. For more information, see [NDB Cluster Replication and IPv6](#).

- **Generated columns.** The [NDB](#) storage engine does not support indexes on virtual generated columns.

As with other storage engines, you can create an index on a stored generated column, but you should bear in mind that [NDB](#) uses [DataMemory](#) for storage of the generated column as well as [IndexMemory](#) for the index. See [JSON columns and indirect indexing in NDB Cluster](#), for an example.

NDB Cluster writes changes in stored generated columns to the binary log, but does not log those made to virtual columns. This should not effect NDB Cluster Replication or replication between [NDB](#) and other MySQL storage engines.

Note

See [Section 2.7.3, "Limits Relating to Transaction Handling in NDB Cluster"](#), for more information relating to limitations on transaction handling in [NDB](#).

2.7.7 Limitations Relating to Performance in NDB Cluster

The following performance issues are specific to or especially pronounced in NDB Cluster:

- **Range scans.** There are query performance issues due to sequential access to the [NDB](#) storage engine; it is also relatively more expensive to do many range scans than it is with either [MyISAM](#) or [InnoDB](#).
- **Reliability of Records in range.** The [Records in range](#) statistic is available but is not completely tested or officially supported. This may result in nonoptimal query plans in some cases. If necessary, you can employ [USE INDEX](#) or [FORCE INDEX](#) to alter the execution plan. See [Index Hints](#), for more information on how to do this.
- **Unique hash indexes.** Unique hash indexes created with [USING HASH](#) cannot be used for accessing a table if [NULL](#) is given as part of the key.

2.7.8 Issues Exclusive to NDB Cluster

The following are limitations specific to the [NDB](#) storage engine:

- **Machine architecture.** All machines used in the cluster must have the same architecture. That is, all machines hosting nodes must be either big-endian or little-endian, and you cannot use a mixture of both. For example, you cannot have a management node running on a PowerPC which directs a data node that is running on an x86 machine. This restriction does not apply to machines simply running [mysql](#) or other clients that may be accessing the cluster's SQL nodes.
- **Binary logging.**
NDB Cluster has the following limitations or restrictions with regard to binary logging:
 - [sql_log_bin](#) has no effect on data operations; however, it is supported for schema operations.
 - NDB Cluster cannot produce a binary log for tables having [BLOB](#) columns but no primary key.
 - Only the following schema operations are logged in a cluster binary log which is *not* on the [mysqld](#) executing the statement:
 - [CREATE TABLE](#)
 - [ALTER TABLE](#)
 - [DROP TABLE](#)
 - [CREATE DATABASE / CREATE SCHEMA](#)
 - [DROP DATABASE / DROP SCHEMA](#)
 - [CREATE TABLESPACE](#)
 - [ALTER TABLESPACE](#)
 - [DROP TABLESPACE](#)
 - [CREATE LOGFILE GROUP](#)
 - [ALTER LOGFILE GROUP](#)
 - [DROP LOGFILE GROUP](#)
- **Schema operations.** Schema operations (DDL statements) are rejected while any data node restarts. Schema operations are also not supported while performing an online upgrade or downgrade.
- **Number of fragment replicas.** The number of fragment replicas, as determined by the [NoOfReplicas](#) data node configuration parameter, is the number of copies of all data stored

by NDB Cluster. Setting this parameter to 1 means there is only a single copy; in this case, no redundancy is provided, and the loss of a data node entails loss of data. To guarantee redundancy, and thus preservation of data even if a data node fails, set this parameter to 2, which is the default and recommended value in production.

Setting `NoOfReplicas` to a value greater than 2 is possible (to a maximum of 4) but unnecessary to guard against loss of data. In addition, *values greater than 2 for this parameter are not supported in production.*

See also [Section 2.7.10, “Limitations Relating to Multiple NDB Cluster Nodes”](#).

2.7.9 Limitations Relating to NDB Cluster Disk Data Storage

Disk Data object maximums and minimums. Disk data objects are subject to the following maximums and minimums:

- Maximum number of tablespaces: 2^{32} (4294967296)
- Maximum number of data files per tablespace: 2^{16} (65536)
- The minimum and maximum possible sizes of extents for tablespace data files are 32K and 2G, respectively. See [CREATE TABLESPACE Statement](#), for more information.

In addition, when working with NDB Disk Data tables, you should be aware of the following issues regarding data files and extents:

- Data files use `DataMemory`. Usage is the same as for in-memory data.
- Data files use file descriptors. It is important to keep in mind that data files are always open, which means the file descriptors are always in use and cannot be re-used for other system tasks.
- Extents require sufficient `DiskPageBufferMemory`; you must reserve enough for this parameter to account for all memory used by all extents (number of extents times size of extents).

Disk Data tables and diskless mode. Use of Disk Data tables is not supported when running the cluster in diskless mode.

2.7.10 Limitations Relating to Multiple NDB Cluster Nodes

Multiple SQL nodes.

The following are issues relating to the use of multiple MySQL servers as NDB Cluster SQL nodes, and are specific to the `NDBCLUSTER` storage engine:

- **Stored programs not distributed.** Stored procedures, stored functions, triggers, and scheduled events are all supported by tables using the `NDB` storage engine, but these do *not* propagate automatically between MySQL Servers acting as Cluster SQL nodes, and must be re-created separately on each SQL node. See [Stored Programs in NDB Cluster](#).
- **No distributed table locks.** A `LOCK TABLES` statement or `GET_LOCK()` call works only for the SQL node on which the lock is issued; no other SQL node in the cluster “sees” this lock. This is true for a lock issued by any statement that locks tables as part of its operations. (See next item for an example.)

Implementing table locks in `NDBCLUSTER` can be done in an API application, and ensuring that all applications start by setting `LockMode` to `LM_Read` or `LM_Exclusive`. For more information about how to do this, see the description of `NdbOperation::getLockHandle()` in the *NDB Cluster API Guide*.

- **ALTER TABLE operations.** `ALTER TABLE` is not fully locking when running multiple MySQL servers (SQL nodes). (As discussed in the previous item, NDB Cluster does not support distributed table locks.)

Multiple management nodes.

When using multiple management servers:

- If any of the management servers are running on the same host, you must give nodes explicit IDs in connection strings because automatic allocation of node IDs does not work across multiple management servers on the same host. This is not required if every management server resides on a different host.
- When a management server starts, it first checks for any other management server in the same NDB Cluster, and upon successful connection to the other management server uses its configuration data. This means that the management server `--reload` and `--initial` startup options are ignored unless the management server is the only one running. It also means that, when performing a rolling restart of an NDB Cluster with multiple management nodes, the management server reads its own configuration file if (and only if) it is the only management server running in this NDB Cluster. See [Section 6.5, “Performing a Rolling Restart of an NDB Cluster”](#), for more information.

Multiple network addresses. Multiple network addresses per data node are not supported. Use of these is liable to cause problems: In the event of a data node failure, an SQL node waits for confirmation that the data node went down but never receives it because another route to that data node remains open. This can effectively make the cluster inoperable.

Note

It is possible to use multiple network hardware *interfaces* (such as Ethernet cards) for a single data node, but these must be bound to the same address. This also means that it not possible to use more than one `[tcp]` section per connection in the `config.ini` file. See [Section 4.3.10, “NDB Cluster TCP/IP Connections”](#), for more information.

Chapter 3 NDB Cluster Installation

Table of Contents

3.1 Installation of NDB Cluster on Linux	51
3.1.1 Installing an NDB Cluster Binary Release on Linux	52
3.1.2 Installing NDB Cluster from RPM	54
3.1.3 Installing NDB Cluster Using .deb Files	57
3.1.4 Building NDB Cluster from Source on Linux	58
3.2 Installing NDB Cluster on Windows	59
3.2.1 Installing NDB Cluster on Windows from a Binary Release	59
3.2.2 Compiling and Installing NDB Cluster from Source on Windows	62
3.2.3 Initial Startup of NDB Cluster on Windows	63
3.2.4 Installing NDB Cluster Processes as Windows Services	65
3.3 Initial Configuration of NDB Cluster	67
3.4 Initial Startup of NDB Cluster	69
3.5 NDB Cluster Example with Tables and Data	70
3.6 Safe Shutdown and Restart of NDB Cluster	73
3.7 Upgrading and Downgrading NDB Cluster	74
3.7.1 Upgrading and Downgrading NDB 7.5	74
3.7.2 Upgrading and Downgrading NDB 7.6	76
3.8 The NDB Cluster Auto-Installer (NDB 7.5) (No longer supported)	78
3.8.1 NDB Cluster Auto-Installer Requirements	78
3.8.2 Using the NDB Cluster Auto-Installer	80
3.9 The NDB Cluster Auto-Installer (NDB 7.6) (No longer supported)	89
3.9.1 NDB Cluster Auto-Installer Requirements	89
3.9.2 Using the NDB Cluster Auto-Installer	91

This section describes the basics for planning, installing, configuring, and running an NDB Cluster. Whereas the examples in [Chapter 4, Configuration of NDB Cluster](#) provide more in-depth information on a variety of clustering options and configuration, the result of following the guidelines and procedures outlined here should be a usable NDB Cluster which meets the *minimum* requirements for availability and safeguarding of data.

For information about upgrading or downgrading an NDB Cluster between release versions, see [Section 3.7, “Upgrading and Downgrading NDB Cluster”](#).

This section covers hardware and software requirements; networking issues; installation of NDB Cluster; basic configuration issues; starting, stopping, and restarting the cluster; loading of a sample database; and performing queries.

Assumptions. The following sections make a number of assumptions regarding the cluster's physical and network configuration. These assumptions are discussed in the next few paragraphs.

Cluster nodes and host computers. The cluster consists of four nodes, each on a separate host computer, and each with a fixed network address on a typical Ethernet network as shown here:

Table 3.1 Network addresses of nodes in example cluster

Node	IP Address
Management node (<code>mgmd</code>)	198.51.100.10
SQL node (<code>mysqld</code>)	198.51.100.20
Data node "A" (<code>ndbd</code>)	198.51.100.30
Data node "B" (<code>ndbd</code>)	198.51.100.40

This setup is also shown in the following diagram:

Figure 3.1 NDB Cluster Multi-Computer Setup

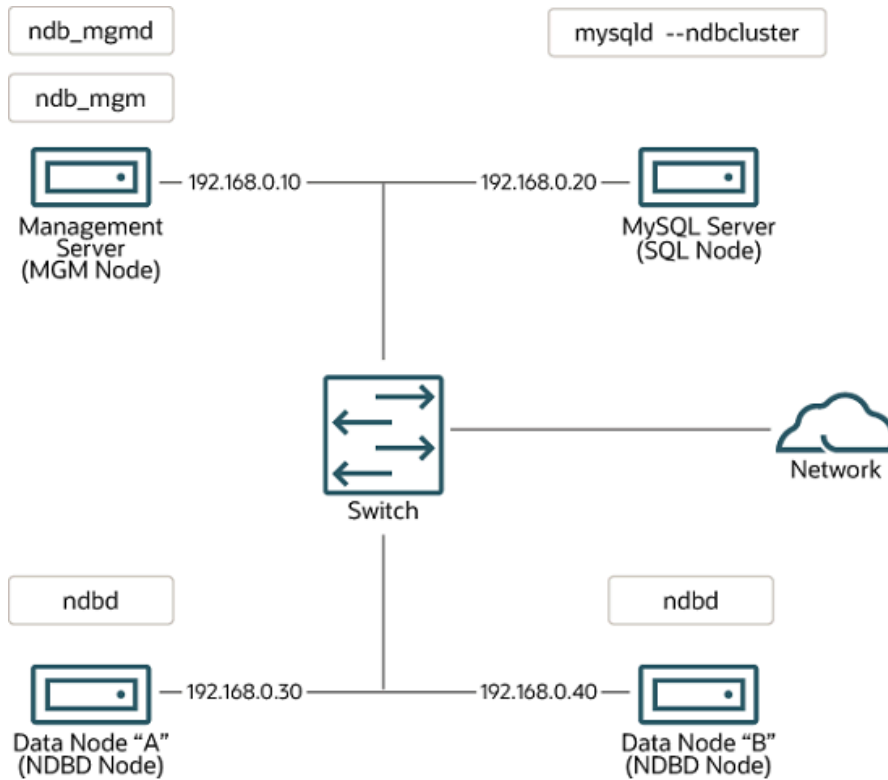

Network addressing. In the interest of simplicity (and reliability), this *How-To* uses only numeric IP addresses. However, if DNS resolution is available on your network, it is possible to use host names in lieu of IP addresses in configuring Cluster. Alternatively, you can use the `hosts` file (typically `/etc/hosts` for Linux and other Unix-like operating systems, `C:\WINDOWS\system32\drivers\etc\hosts` on Windows, or your operating system's equivalent) for providing a means to do host lookup if such is available.

Potential hosts file issues. A common problem when trying to use host names for Cluster nodes arises because of the way in which some operating systems (including some Linux distributions) set up the system's own host name in the `/etc/hosts` during installation. Consider two machines with the host names `ndb1` and `ndb2`, both in the `cluster` network domain. Red Hat Linux (including some derivatives such as CentOS and Fedora) places the following entries in these machines' `/etc/hosts` files:

```
# ndb1 /etc/hosts:
127.0.0.1 ndb1.cluster ndb1 localhost.localdomain localhost
```

```
# ndb2 /etc/hosts:
127.0.0.1 ndb2.cluster ndb2 localhost.localdomain localhost
```

SUSE Linux (including OpenSUSE) places these entries in the machines' `/etc/hosts` files:

```
# ndb1 /etc/hosts:
127.0.0.1 localhost
127.0.0.2 ndb1.cluster ndb1
```

```
# ndb2 /etc/hosts:
127.0.0.1 localhost
127.0.0.2 ndb2.cluster ndb2
```

In both instances, `ndb1` routes `ndb1.cluster` to a loopback IP address, but gets a public IP address from DNS for `ndb2.cluster`, while `ndb2` routes `ndb2.cluster` to a loopback address and obtains a public address for `ndb1.cluster`. The result is that each data node connects to the management server, but cannot tell when any other data nodes have connected, and so the data nodes appear to hang while starting.

Caution

You cannot mix `localhost` and other host names or IP addresses in `config.ini`. For these reasons, the solution in such cases (other than to use IP addresses for all `config.ini` `HostName` entries) is to remove the fully qualified host names from `/etc/hosts` and use these in `config.ini` for all cluster hosts.

Host computer type. Each host computer in our installation scenario is an Intel-based desktop PC running a supported operating system installed to disk in a standard configuration, and running no unnecessary services. The core operating system with standard TCP/IP networking capabilities should be sufficient. Also for the sake of simplicity, we also assume that the file systems on all hosts are set up identically. In the event that they are not, you should adapt these instructions accordingly.

Network hardware. Standard 100 Mbps or 1 gigabit Ethernet cards are installed on each machine, along with the proper drivers for the cards, and that all four hosts are connected through a standard-issue Ethernet networking appliance such as a switch. (All machines should use network cards with the same throughput. That is, all four machines in the cluster should have 100 Mbps cards *or* all four machines should have 1 Gbps cards.) NDB Cluster works in a 100 Mbps network; however, gigabit Ethernet provides better performance.

Important

NDB Cluster is *not* intended for use in a network for which throughput is less than 100 Mbps or which experiences a high degree of latency. For this reason (among others), attempting to run an NDB Cluster over a wide area network such as the Internet is not likely to be successful, and is not supported in production.

Sample data. We use the `world` database which is available for download from the MySQL website (see <https://dev.mysql.com/doc/index-other.html>). We assume that each machine has sufficient memory for running the operating system, required NDB Cluster processes, and (on the data nodes) storing the database.

For general information about installing MySQL, see [Installing and Upgrading MySQL](#). For information about installation of NDB Cluster on Linux and other Unix-like operating systems, see [Section 3.1, “Installation of NDB Cluster on Linux”](#). For information about installation of NDB Cluster on Windows operating systems, see [Section 3.2, “Installing NDB Cluster on Windows”](#).

For general information about NDB Cluster hardware, software, and networking requirements, see [Section 2.3, “NDB Cluster Hardware, Software, and Networking Requirements”](#).

3.1 Installation of NDB Cluster on Linux

This section covers installation methods for NDB Cluster on Linux and other Unix-like operating systems. While the next few sections refer to a Linux operating system, the instructions and procedures given there should be easily adaptable to other supported Unix-like platforms. For manual installation and setup instructions specific to Windows systems, see [Section 3.2, “Installing NDB Cluster on Windows”](#).

Each NDB Cluster host computer must have the correct executable programs installed. A host running an SQL node must have installed on it a MySQL Server binary (`mysqld`). Management nodes require the management server daemon (`ndb_mgmd`); data nodes require the data node daemon (`ndbd` or `ndbmt.d`). It is not necessary to install the MySQL Server binary on management node hosts and data node hosts. It is recommended that you also install the management client (`ndb_mgm`) on the management server host.

Installation of NDB Cluster on Linux can be done using precompiled binaries from Oracle (downloaded as a `.tar.gz` archive), with RPM packages (also available from Oracle), or from source code. All three of these installation methods are described in the section that follow.

Regardless of the method used, it is still necessary following installation of the NDB Cluster binaries to create configuration files for all cluster nodes, before you can start the cluster. See [Section 3.3, “Initial Configuration of NDB Cluster”](#).

3.1.1 Installing an NDB Cluster Binary Release on Linux

This section covers the steps necessary to install the correct executables for each type of Cluster node from precompiled binaries supplied by Oracle.

For setting up a cluster using precompiled binaries, the first step in the installation process for each cluster host is to download the binary archive from the [NDB Cluster downloads page](#). (For the most recent 64-bit NDB 7.6 release, this is `mysql-cluster-gpl-7.6.20-linux-glibc2.12-x86_64.tar.gz`.) We assume that you have placed this file in each machine's `/var/tmp` directory.

If you require a custom binary, see [Installing MySQL Using a Development Source Tree](#).

Note

After completing the installation, do not yet start any of the binaries. We show you how to do so following the configuration of the nodes (see [Section 3.3, “Initial Configuration of NDB Cluster”](#)).

SQL nodes. On each of the machines designated to host SQL nodes, perform the following steps as the system `root` user:

1. Check your `/etc/passwd` and `/etc/group` files (or use whatever tools are provided by your operating system for managing users and groups) to see whether there is already a `mysql` group and `mysql` user on the system. Some OS distributions create these as part of the operating system installation process. If they are not already present, create a new `mysql` user group, and then add a `mysql` user to this group:

```
$> groupadd mysql
$> useradd -g mysql -s /bin/false mysql
```

The syntax for `useradd` and `groupadd` may differ slightly on different versions of Unix, or they may have different names such as `adduser` and `addgroup`.

2. Change location to the directory containing the downloaded file, unpack the archive, and create a symbolic link named `mysql` to the `mysql` directory.

Note

The actual file and directory names vary according to the NDB Cluster version number.

```
$> cd /var/tmp
$> tar -C /usr/local -xzvf mysql-cluster-gpl-7.6.20-linux-glibc2.12-x86_64.tar.gz
$> ln -s /usr/local/mysql-cluster-gpl-7.6.20-linux-glibc2.12-x86_64 /usr/local/mysql
```

3. Change location to the `mysql` directory and set up the system databases using `mysqld --initialize` as shown here:

```
$> cd mysql
$> mysqld --initialize
```

This generates a random password for the MySQL `root` account. If you do *not* want the random password to be generated, you can substitute the `--initialize-insecure` option for `--initialize`. In either case, you should review [Initializing the Data Directory](#), for additional information before performing this step. See also [mysql_secure_installation — Improve MySQL Installation Security](#).

4. Set the necessary permissions for the MySQL server and data directories:

```
$> chown -R root .
$> chown -R mysql data
$> chgrp -R mysql .
```

- Copy the MySQL startup script to the appropriate directory, make it executable, and set it to start when the operating system is booted up:

```
$> cp support-files/mysql.server /etc/rc.d/init.d/
$> chmod +x /etc/rc.d/init.d/mysql.server
$> chkconfig --add mysql.server
```

(The startup scripts directory may vary depending on your operating system and version—for example, in some Linux distributions, it is `/etc/init.d`.)

Here we use Red Hat's `chkconfig` for creating links to the startup scripts; use whatever means is appropriate for this purpose on your platform, such as `update-rc.d` on Debian.

Remember that the preceding steps must be repeated on each machine where an SQL node is to reside.

Data nodes. Installation of the data nodes does not require the `mysqld` binary. Only the NDB Cluster data node executable `ndbd` (single-threaded) or `ndbmtbd` (multithreaded) is required. These binaries can also be found in the `.tar.gz` archive. Again, we assume that you have placed this archive in `/var/tmp`.

As system `root` (that is, after using `sudo`, `su root`, or your system's equivalent for temporarily assuming the system administrator account's privileges), perform the following steps to install the data node binaries on the data node hosts:

- Change location to the `/var/tmp` directory, and extract the `ndbd` and `ndbmtbd` binaries from the archive into a suitable directory such as `/usr/local/bin`:

```
$> cd /var/tmp
$> tar -zxvf mysql-cluster-gpl-7.6.20-linux-glibc2.12-x86_64.tar.gz
$> cd mysql-cluster-gpl-7.6.20-linux-glibc2.12-x86_64
$> cp bin/ndbd /usr/local/bin/ndbd
$> cp bin/ndbmtbd /usr/local/bin/ndbmtbd
```

(You can safely delete the directory created by unpacking the downloaded archive, and the files it contains, from `/var/tmp` once `ndb_mgm` and `ndb_mgmd` have been copied to the executables directory.)

- Change location to the directory into which you copied the files, and then make both of them executable:

```
$> cd /usr/local/bin
$> chmod +x ndb*
```

The preceding steps should be repeated on each data node host.

Although only one of the data node executables is required to run an NDB Cluster data node, we have shown you how to install both `ndbd` and `ndbmtbd` in the preceding instructions. We recommend that you do this when installing or upgrading NDB Cluster, even if you plan to use only one of them, since this should save time and trouble in the event that you later decide to change from one to the other.

Note

The data directory on each machine hosting a data node is `/usr/local/mysql/data`. This piece of information is essential when configuring the management node. (See [Section 3.3, “Initial Configuration of NDB Cluster”](#).)

Management nodes. Installation of the management node does not require the `mysqld` binary. Only the NDB Cluster management server (`ndb_mgmd`) is required; you most likely want to install the

management client (`ndb_mgm`) as well. Both of these binaries also be found in the `.tar.gz` archive. Again, we assume that you have placed this archive in `/var/tmp`.

As system `root`, perform the following steps to install `ndb_mgmd` and `ndb_mgm` on the management node host:

1. Change location to the `/var/tmp` directory, and extract the `ndb_mgm` and `ndb_mgmd` from the archive into a suitable directory such as `/usr/local/bin`:

```
$> cd /var/tmp
$> tar -zxvf mysql-cluster-gpl-7.6.20-linux-glibc2.12-x86_64.tar.gz
$> cd mysql-cluster-gpl-7.6.20-linux-glibc2.12-x86_64
$> cp bin/ndb_mgm* /usr/local/bin
```

(You can safely delete the directory created by unpacking the downloaded archive, and the files it contains, from `/var/tmp` once `ndb_mgm` and `ndb_mgmd` have been copied to the executables directory.)

2. Change location to the directory into which you copied the files, and then make both of them executable:

```
$> cd /usr/local/bin
$> chmod +x ndb_mgm*
```

In [Section 3.3, “Initial Configuration of NDB Cluster”](#), we create configuration files for all of the nodes in our example NDB Cluster.

3.1.2 Installing NDB Cluster from RPM

This section covers the steps necessary to install the correct executables for each type of NDB Cluster node using RPM packages supplied by Oracle.

As an alternative to the method described in this section, Oracle provides MySQL Repositories for NDB Cluster 7.5.6 and later that are compatible with many common Linux distributions. Two repositories, listed here, are available for RPM-based distributions:

- For distributions using `yum` or `dnf`, you can use the MySQL Yum Repository for NDB Cluster. See [Installing MySQL NDB Cluster Using the Yum Repository](#), for instructions and additional information.
- For SLES, you can use the MySQL SLES Repository for NDB Cluster. See [Installing MySQL NDB Cluster Using the SLES Repository](#), for instructions and additional information.

RPMs are available for both 32-bit and 64-bit Linux platforms. The filenames for these RPMs use the following pattern:

```
mysql-cluster-community-data-node-7.5.8-1.el7.x86_64.rpm
mysql-cluster-license-component-ver-rev.distro.arch.rpm

license:= {commercial | community}

component: {management-server | data-node | server | client | other-see text}

ver: major.minor.release

rev: major[.minor]

distro: {el6 | el7 | sles12}

arch: {i686 | x86_64}
```

`license` indicates whether the RPM is part of a Commercial or Community release of NDB Cluster. In the remainder of this section, we assume for the examples that you are installing a Community release.

Possible values for `component`, with descriptions, can be found in the following table:

Table 3.2 Components of the NDB Cluster RPM distribution

Component	Description
<code>auto-installer</code>	NDB Cluster Auto Installer program (DEPRECATED); see Section 3.8, “The NDB Cluster Auto-Installer (NDB 7.5) (No longer supported)” , for usage
<code>client</code>	MySQL and NDB client programs; includes <code>mysql</code> client, <code>ndb_mgm</code> client, and other client tools
<code>common</code>	Character set and error message information needed by the MySQL server
<code>data-node</code>	<code>ndbd</code> and <code>ndbmt</code> data node binaries
<code>devel</code>	Headers and library files needed for MySQL client development
<code>embedded</code>	Embedded MySQL server
<code>embedded-compat</code>	Backwards-compatible embedded MySQL server
<code>embedded-devel</code>	Header and library files for developing applications for embedded MySQL
<code>java</code>	JAR files needed for support of ClusterJ applications
<code>libs</code>	MySQL client libraries
<code>libs-compat</code>	Backwards-compatible MySQL client libraries
<code>management-server</code>	The NDB Cluster management server (<code>ndb_mgmd</code>)
<code>memcached</code>	Files needed to support <code>ndbmemcache</code>
<code>minimal-debuginfo</code>	Debug information for package server-minimal; useful when developing applications that use this package or when debugging this package
<code>ndbclient</code>	NDB client library for running NDB API and MGM API applications (<code>libndbclient</code>)
<code>ndbclient-devel</code>	Header and other files needed for developing NDB API and MGM API applications
<code>nodejs</code>	Files needed to set up Node.JS support for NDB Cluster
<code>server</code>	The MySQL server (<code>mysqld</code>) with NDB storage engine support included, and associated MySQL server programs
<code>server-minimal</code>	Minimal installation of the MySQL server for NDB and related tools
<code>test</code>	<code>mysqltest</code> , other MySQL test programs, and support files

A single bundle (`.tar` file) of all NDB Cluster RPMs for a given platform and architecture is also available. The name of this file follows the pattern shown here:

```
mysql-cluster-license-ver-rev.distro.arch.rpm-bundle.tar
```

You can extract the individual RPM files from this file using `tar` or your preferred tool for extracting archives.

The components required to install the three major types of NDB Cluster nodes are given in the following list:

- *Management node:* `management-server`
- *Data node:* `data-node`
- *SQL node:* `server` and `common`

In addition, the `client` RPM should be installed to provide the `ndb_mgm` management client on at least one management node. You may also wish to install it on SQL nodes, to have `mysql` and other MySQL client programs available on these. We discuss installation of nodes by type later in this section.

`ver` represents the three-part NDB storage engine version number in 7.6.x format, shown as 7.6.20 in the examples. `rev` provides the RPM revision number in `major.minor` format. In the examples shown in this section, we use 1.1 for this value.

The `distro` (Linux distribution) is one of `rhel5` (Oracle Linux 5, Red Hat Enterprise Linux 4 and 5), `e16` (Oracle Linux 6, Red Hat Enterprise Linux 6), `e17` (Oracle Linux 7, Red Hat Enterprise Linux 7), or `sles12` (SUSE Enterprise Linux 12). For the examples in this section, we assume that the host runs Oracle Linux 7, Red Hat Enterprise Linux 7, or the equivalent (`e17`).

`arch` is `i686` for 32-bit RPMs and `x86_64` for 64-bit versions. In the examples shown here, we assume a 64-bit platform.

The NDB Cluster version number in the RPM file names (shown here as 7.6.20) can vary according to the version which you are actually using. *It is very important that all of the Cluster RPMs to be installed have the same version number.* The architecture should also be appropriate to the machine on which the RPM is to be installed; in particular, you should keep in mind that 64-bit RPMs (`x86_64`) cannot be used with 32-bit operating systems (use `i686` for the latter).

Data nodes. On a computer that is to host an NDB Cluster data node it is necessary to install only the `data-node` RPM. To do so, copy this RPM to the data node host, and run the following command as the system root user, replacing the name shown for the RPM as necessary to match that of the RPM downloaded from the MySQL website:

```
$> rpm -Uhv mysql-cluster-community-data-node-7.6.20-1.e17.x86_64.rpm
```

This installs the `ndbd` and `ndbmttd` data node binaries in `/usr/sbin`. Either of these can be used to run a data node process on this host.

SQL nodes. Copy the `server` and `common` RPMs to each machine to be used for hosting an NDB Cluster SQL node (`server` requires `common`). Install the `server` RPM by executing the following command as the system root user, replacing the name shown for the RPM as necessary to match the name of the RPM downloaded from the MySQL website:

```
$> rpm -Uhv mysql-cluster-community-server-7.6.20-1.e17.x86_64.rpm
```

This installs the MySQL server binary (`mysqld`), with NDB storage engine support, in the `/usr/sbin` directory. It also installs all needed MySQL Server support files and useful MySQL server programs, including the `mysql.server` and `mysqld_safe` startup scripts (in `/usr/share/mysql` and `/usr/bin`, respectively). The RPM installer should take care of general configuration issues (such as creating the `mysql` user and group, if needed) automatically.

Important

You must use the versions of these RPMs released for NDB Cluster ; those released for the standard MySQL server do not provide support for the NDB storage engine.

To administer the SQL node (MySQL server), you should also install the `client` RPM, as shown here:

```
$> rpm -Uhv mysql-cluster-community-client-7.6.20-1.e17.x86_64.rpm
```

This installs the `mysql` client and other MySQL client programs, such as `mysqladmin` and `mysqldump`, to `/usr/bin`.

Management nodes. To install the NDB Cluster management server, it is necessary only to use the `management-server` RPM. Copy this RPM to the computer intended to host the management node, and then install it by running the following command as the system root user (replace the name shown for the RPM as necessary to match that of the `management-server` RPM downloaded from the MySQL website):

```
$> rpm -Uvh mysql-cluster-community-management-server-7.6.20-1.el7.x86_64.rpm
```

This RPM installs the management server binary `ndb_mgmd` in the `/usr/sbin` directory. While this is the only program actually required for running a management node, it is also a good idea to have the `ndb_mgm` NDB Cluster management client available as well. You can obtain this program, as well as other NDB client programs such as `ndb_desc` and `ndb_config`, by installing the `client` RPM as described previously.

Note

Previously, `ndb_mgm` was installed by the same RPM used to install the management server. In NDB 7.5 (and later), all NDB client programs are obtained from the same `client` RPM that installs `mysql` and other MySQL clients.

See [Installing MySQL on Linux Using RPM Packages from Oracle](#), for general information about installing MySQL using RPMs supplied by Oracle.

After installing from RPM, you still need to configure the cluster; see [Section 3.3, “Initial Configuration of NDB Cluster”](#), for the relevant information.

See [Installing MySQL on Linux Using RPM Packages from Oracle](#), for general information about installing MySQL using RPMs supplied by Oracle. See [Section 3.3, “Initial Configuration of NDB Cluster”](#), for information about required post-installation configuration.

3.1.3 Installing NDB Cluster Using .deb Files

The section provides information about installing NDB Cluster on Debian and related Linux distributions such as Ubuntu using the `.deb` files supplied by Oracle for this purpose.

For NDB Cluster 7.5.6 and later, Oracle also provides an APT repository for Debian and other distributions. See [Installing MySQL NDB Cluster Using the APT Repository](#), for instructions and additional information.

Oracle provides `.deb` installer files for NDB Cluster 7.5 and later for 32-bit and 64-bit platforms. For a Debian-based system, only a single installer file is necessary. This file is named using the pattern shown here, according to the applicable NDB Cluster version, Debian version, and architecture:

```
mysql-cluster-gpl-ndbver-debiandebianver-arch.deb
```

Here, `ndbver` is the 3-part NDB engine version number, `debianver` is the major version of Debian (8 or 9), and `arch` is one of `i686` or `x86_64`. In the examples that follow, we assume you wish to install NDB 7.6.20 on a 64-bit Debian 9 system; in this case, the installer file is named `mysql-cluster-gpl-7.6.20-debian9-x86_64.deb-bundle.tar`.

Once you have downloaded the appropriate `.deb` file, you can untar it, and then install it from the command line using `dpkg`, like this:

```
$> dpkg -i mysql-cluster-gpl-7.6.20-debian9-i686.deb
```

You can also remove it using `dpkg` as shown here:

```
$> dpkg -r mysql
```

The installer file should also be compatible with most graphical package managers that work with `.deb` files, such as `GDebi` for the Gnome desktop.

The `.deb` file installs NDB Cluster under `/opt/mysql/server-version/`, where `version` is the 2-part release series version for the included MySQL server. For NDB 7.5 and later, this is always `5.7`. The directory layout is the same as that for the generic Linux binary distribution (see [MySQL Installation Layout for Generic Unix/Linux Binary Package](#)), with the exception that startup scripts and configuration files are found in `support-files` instead of `share`. All NDB Cluster executables, such as `ndb_mgm`, `ndbd`, and `ndb_mgmd`, are placed in the `bin` directory.

3.1.4 Building NDB Cluster from Source on Linux

This section provides information about compiling NDB Cluster on Linux and other Unix-like platforms. Building NDB Cluster from source is similar to building the standard MySQL Server, although it differs in a few key respects discussed here. For general information about building MySQL from source, see [Installing MySQL from Source](#). For information about compiling NDB Cluster on Windows platforms, see [Section 3.2.2, “Compiling and Installing NDB Cluster from Source on Windows”](#).

Building NDB Cluster requires using the NDB Cluster sources. These are available from the NDB Cluster downloads page at <https://dev.mysql.com/downloads/cluster/>. The archived source file should have a name similar to `mysql-cluster-gpl-7.6.20.tar.gz`. You can also obtain NDB Cluster sources from GitHub at <https://github.com/mysql/mysql-server/tree/cluster-7.5> (NDB 7.5) and <https://github.com/mysql/mysql-server/tree/cluster-7.6> (NDB 7.6). *Building NDB Cluster 7.5 or 7.6 from standard MySQL Server 5.7 sources is not supported.*

The `WITH_NDBCLUSTER_STORAGE_ENGINE` option for `CMake` causes the binaries for the management nodes, data nodes, and other NDB Cluster programs to be built; it also causes `mysqld` to be compiled with NDB storage engine support. This option (or its alias `WITH_NDBCLUSTER`) is required when building NDB Cluster.

Important

The `WITH_NDB_JAVA` option is enabled by default. This means that, by default, if `CMake` cannot find the location of Java on your system, the configuration process fails; if you do not wish to enable Java and ClusterJ support, you must indicate this explicitly by configuring the build using `-DWITH_NDB_JAVA=OFF`. Use `WITH_CLASSPATH` to provide the Java classpath if needed.

For more information about `CMake` options specific to building NDB Cluster, see [Options for Compiling NDB Cluster](#).

After you have run `make && make install` (or your system's equivalent), the result is similar to what is obtained by unpacking a precompiled binary to the same location.

Management nodes. When building from source and running the default `make install`, the management server and management client binaries (`ndb_mgmd` and `ndb_mgm`) can be found in `/usr/local/mysql/bin`. Only `ndb_mgmd` is required to be present on a management node host; however, it is also a good idea to have `ndb_mgm` present on the same host machine. Neither of these executables requires a specific location on the host machine's file system.

Data nodes. The only executable required on a data node host is the data node binary `ndbd` or `ndbmt.d`. (`mysqld`, for example, does not have to be present on the host machine.) By default, when building from source, this file is placed in the directory `/usr/local/mysql/bin`. For installing on multiple data node hosts, only `ndbd` or `ndbmt.d` need be copied to the other host machine or machines. (This assumes that all data node hosts use the same architecture and operating system; otherwise you may need to compile separately for each different platform.) The data node binary need not be in any particular location on the host's file system, as long as the location is known.

When compiling NDB Cluster from source, no special options are required for building multithreaded data node binaries. Configuring the build with NDB storage engine support causes `ndbmt.d` to be built automatically; `make install` places the `ndbmt.d` binary in the installation `bin` directory along with `mysqld`, `ndbd`, and `ndb_mgm`.

SQL nodes. If you compile MySQL with clustering support, and perform the default installation (using `make install` as the system `root` user), `mysqld` is placed in `/usr/local/mysql/bin`. Follow the steps given in [Installing MySQL from Source](#) to make `mysqld` ready for use. If you want to run multiple SQL nodes, you can use a copy of the same `mysqld` executable and its associated support files on several machines. The easiest way to do this is to copy the entire `/usr/local/mysql` directory and all directories and files contained within it to the other SQL node host or hosts, then repeat the steps from [Installing MySQL from Source](#) on each machine. If you configure the build with a nondefault `PREFIX` option, you must adjust the directory accordingly.

In [Section 3.3, “Initial Configuration of NDB Cluster”](#), we create configuration files for all of the nodes in our example NDB Cluster.

3.2 Installing NDB Cluster on Windows

This section describes installation procedures for NDB Cluster on Windows hosts. NDB Cluster 7.5 and 7.6 binaries for Windows can be obtained from <https://dev.mysql.com/downloads/cluster/>. For information about installing NDB Cluster on Windows from a binary release provided by Oracle, see [Section 3.2.1, “Installing NDB Cluster on Windows from a Binary Release”](#).

It is also possible to compile and install NDB Cluster from source on Windows using Microsoft Visual Studio. For more information, see [Section 3.2.2, “Compiling and Installing NDB Cluster from Source on Windows”](#).

3.2.1 Installing NDB Cluster on Windows from a Binary Release

This section describes a basic installation of NDB Cluster on Windows using a binary “no-install” NDB Cluster release provided by Oracle, using the same 4-node setup outlined in the beginning of this section (see [Chapter 3, NDB Cluster Installation](#)), as shown in the following table:

Table 3.3 Network addresses of nodes in example cluster

Node	IP Address
Management node (<code>mgmd</code>)	198.51.100.10
SQL node (<code>mysqld</code>)	198.51.100.20
Data node "A" (<code>ndbd</code>)	198.51.100.30
Data node "B" (<code>ndbd</code>)	198.51.100.40

As on other platforms, the NDB Cluster host computer running an SQL node must have installed on it a MySQL Server binary (`mysqld.exe`). You should also have the MySQL client (`mysql.exe`) on this host. For management nodes and data nodes, it is not necessary to install the MySQL Server binary; however, each management node requires the management server daemon (`ndb_mgmd.exe`); each data node requires the data node daemon (`ndbd.exe` or `ndbmttd.exe`). For this example, we refer to `ndbd.exe` as the data node executable, but you can install `ndbmttd.exe`, the multithreaded version of this program, instead, in exactly the same way. You should also install the management client (`ndb_mgm.exe`) on the management server host. This section covers the steps necessary to install the correct Windows binaries for each type of NDB Cluster node.

Note

As with other Windows programs, NDB Cluster executables are named with the `.exe` file extension. However, it is not necessary to include the `.exe` extension when invoking these programs from the command line. Therefore, we often simply refer to these programs in this documentation as `mysqld`, `mysql`, `ndb_mgmd`, and so on. You should understand that, whether we refer (for example) to `mysqld` or `mysqld.exe`, either name means the same thing (the MySQL Server program).

For setting up an NDB Cluster using Oracle's `no-install` binaries, the first step in the installation process is to download the latest NDB Cluster Windows ZIP binary archive from <https://dev.mysql.com/>

[downloads/cluster/](#). This archive has a filename of the `mysql-cluster-gpl-ver-winarch.zip`, where `ver` is the NDB storage engine version (such as 7.6.20), and `arch` is the architecture (32 for 32-bit binaries, and 64 for 64-bit binaries). For example, the NDB Cluster 7.6.20 archive for 64-bit Windows systems is named `mysql-cluster-gpl-7.6.20-win64.zip`.

You can run 32-bit NDB Cluster binaries on both 32-bit and 64-bit versions of Windows; however, 64-bit NDB Cluster binaries can be used only on 64-bit versions of Windows. If you are using a 32-bit version of Windows on a computer that has a 64-bit CPU, then you must use the 32-bit NDB Cluster binaries.

To minimize the number of files that need to be downloaded from the Internet or copied between machines, we start with the computer where you intend to run the SQL node.

SQL node. We assume that you have placed a copy of the archive in the directory `C:\Documents and Settings\username\My Documents\Downloads` on the computer having the IP address 198.51.100.20, where `username` is the name of the current user. (You can obtain this name using `ECHO %USERNAME%` on the command line.) To install and run NDB Cluster executables as Windows services, this user should be a member of the `Administrators` group.

Extract all the files from the archive. The Extraction Wizard integrated with Windows Explorer is adequate for this task. (If you use a different archive program, be sure that it extracts all files and directories from the archive, and that it preserves the archive's directory structure.) When you are asked for a destination directory, enter `C:\`, which causes the Extraction Wizard to extract the archive to the directory `C:\mysql-cluster-gpl-ver-winarch`. Rename this directory to `C:\mysql`.

It is possible to install the NDB Cluster binaries to directories other than `C:\mysql\bin`; however, if you do so, you must modify the paths shown in this procedure accordingly. In particular, if the MySQL Server (SQL node) binary is installed to a location other than `C:\mysql` or `C:\Program Files\MySQL\MySQL Server 5.7`, or if the SQL node's data directory is in a location other than `C:\mysql\data` or `C:\Program Files\MySQL\MySQL Server 5.7\data`, extra configuration options must be used on the command line or added to the `my.ini` or `my.cnf` file when starting the SQL node. For more information about configuring a MySQL Server to run in a nonstandard location, see [Installing MySQL on Microsoft Windows Using a noinstall ZIP Archive](#).

For a MySQL Server with NDB Cluster support to run as part of an NDB Cluster, it must be started with the options `--ndbcluster` and `--ndb-connectstring`. While you can specify these options on the command line, it is usually more convenient to place them in an option file. To do this, create a new text file in Notepad or another text editor. Enter the following configuration information into this file:

```
[mysqld]
# Options for mysqld process:
ndbcluster                # run NDB storage engine
ndb-connectstring=198.51.100.10 # location of management server
```

You can add other options used by this MySQL Server if desired (see [Creating an Option File](#)), but the file must contain the options shown, at a minimum. Save this file as `C:\mysql\my.ini`. This completes the installation and setup for the SQL node.

Data nodes. An NDB Cluster data node on a Windows host requires only a single executable, one of either `ndbd.exe` or `ndbmtbd.exe`. For this example, we assume that you are using `ndbd.exe`, but the same instructions apply when using `ndbmtbd.exe`. On each computer where you wish to run a data node (the computers having the IP addresses 198.51.100.30 and 198.51.100.40), create the directories `C:\mysql`, `C:\mysql\bin`, and `C:\mysql\cluster-data`; then, on the computer where you downloaded and extracted the `no-install` archive, locate `ndbd.exe` in the `C:\mysql\bin` directory. Copy this file to the `C:\mysql\bin` directory on each of the two data node hosts.

To function as part of an NDB Cluster, each data node must be given the address or hostname of the management server. You can supply this information on the command line using the `--ndb-connectstring` or `-c` option when starting each data node process. However, it is usually preferable to put this information in an option file. To do this, create a new text file in Notepad or another text editor and enter the following text:

```
[mysql_cluster]
# Options for data node process:
ndb-connectstring=198.51.100.10 # location of management server
```

Save this file as `C:\mysql\my.ini` on the data node host. Create another text file containing the same information and save it on as `C:mysql\my.ini` on the other data node host, or copy the `my.ini` file from the first data node host to the second one, making sure to place the copy in the second data node's `C:\mysql` directory. Both data node hosts are now ready to be used in the NDB Cluster, which leaves only the management node to be installed and configured.

Management node. The only executable program required on a computer used for hosting an NDB Cluster management node is the management server program `ndb_mgmd.exe`. However, in order to administer the NDB Cluster once it has been started, you should also install the NDB Cluster management client program `ndb_mgm.exe` on the same machine as the management server. Locate these two programs on the machine where you downloaded and extracted the `no-install` archive; this should be the directory `C:\mysql\bin` on the SQL node host. Create the directory `C:\mysql\bin` on the computer having the IP address 198.51.100.10, then copy both programs to this directory.

You should now create two configuration files for use by `ndb_mgmd.exe`:

1. A local configuration file to supply configuration data specific to the management node itself. Typically, this file needs only to supply the location of the NDB Cluster global configuration file (see item 2).

To create this file, start a new text file in Notepad or another text editor, and enter the following information:

```
[mysql_cluster]
# Options for management node process
config-file=C:/mysql/bin/config.ini
```

Save this file as the text file `C:\mysql\bin\my.ini`.

2. A global configuration file from which the management node can obtain configuration information governing the NDB Cluster as a whole. At a minimum, this file must contain a section for each node in the NDB Cluster, and the IP addresses or hostnames for the management node and all data nodes (`HostName` configuration parameter). It is also advisable to include the following additional information:

- The IP address or hostname of any SQL nodes
- The data memory and index memory allocated to each data node (`DataMemory` and `IndexMemory` configuration parameters)
- The number of fragment replicas, using the `NoOfReplicas` configuration parameter (see [Section 2.2, "NDB Cluster Nodes, Node Groups, Fragment Replicas, and Partitions"](#))
- The directory where each data node stores its data and log file, and the directory where the management node keeps its log files (in both cases, the `DataDir` configuration parameter)

Create a new text file using a text editor such as Notepad, and input the following information:

```
[ndbd default]
# Options affecting ndbd processes on all data nodes:
NoOfReplicas=2 # Number of fragment replicas
DataDir=C:/mysql/cluster-data # Directory for each data node's data files
# Forward slashes used in directory path,
# rather than backslashes. This is correct;
# see Important note in text

DataMemory=80M # Memory allocated to data storage
IndexMemory=18M # Memory allocated to index storage
# For DataMemory and IndexMemory, we have used the
# default values. Since the "world" database takes up
# only about 500KB, this should be more than enough for
# this example Cluster setup.
```

```
[ndb_mgmd]
# Management process options:
HostName=198.51.100.10      # Hostname or IP address of management node
DataDir=C:/mysql/bin/cluster-logs  # Directory for management node log files

[ndbd]
# Options for data node "A":
                                 # (one [ndbd] section per data node)
HostName=198.51.100.30      # Hostname or IP address

[ndbd]
# Options for data node "B":
                                 # (one [ndbd] section per data node)
HostName=198.51.100.40      # Hostname or IP address

[mysqld]
# SQL node options:
HostName=198.51.100.20      # Hostname or IP address
```

Save this file as the text file `C:\mysql\bin\config.ini`.

Important

A single backslash character (\) cannot be used when specifying directory paths in program options or configuration files used by NDB Cluster on Windows. Instead, you must either escape each backslash character with a second backslash (\\), or replace the backslash with a forward slash character (/). For example, the following line from the `[ndb_mgmd]` section of an NDB Cluster `config.ini` file does not work:

```
DataDir=C:\mysql\bin\cluster-logs
```

Instead, you may use either of the following:

```
DataDir=C:\\mysql\\bin\\cluster-logs # Escaped backslashes
```

```
DataDir=C:/mysql/bin/cluster-logs # Forward slashes
```

For reasons of brevity and legibility, we recommend that you use forward slashes in directory paths used in NDB Cluster program options and configuration files on Windows.

3.2.2 Compiling and Installing NDB Cluster from Source on Windows

Oracle provides precompiled NDB Cluster binaries for Windows which should be adequate for most users. However, if you wish, it is also possible to compile NDB Cluster for Windows from source code. The procedure for doing this is almost identical to the procedure used to compile the standard MySQL Server binaries for Windows, and uses the same tools. However, there are two major differences:

- Building NDB Cluster requires using the NDB Cluster sources. These are available from the NDB Cluster downloads page at <https://dev.mysql.com/downloads/cluster/>. The archived source file should have a name similar to `mysql-cluster-gpl-7.6.20.tar.gz`. You can also obtain NDB Cluster sources from GitHub at <https://github.com/mysql/mysql-server/tree/cluster-7.5> (NDB 7.5) and <https://github.com/mysql/mysql-server/tree/cluster-7.6> (NDB 7.6). *Building NDB Cluster 7.5 or 7.6 from standard MySQL Server 5.7 sources is not supported.*
- You must configure the build using the `WITH_NDBCLUSTER_STORAGE_ENGINE` or `WITH_NDBCLUSTER` option in addition to any other build options you wish to use with CMake. (`WITH_NDBCLUSTER` is supported as an alias for `WITH_NDBCLUSTER_STORAGE_ENGINE`, and works in exactly the same way.)

Important

The `WITH_NDB_JAVA` option is enabled by default. This means that, by default, if CMake cannot find the location of Java on your system, the configuration

process fails; if you do not wish to enable Java and ClusterJ support, you must indicate this explicitly by configuring the build using `-DWITH_NDB_JAVA=OFF`. (Bug #12379735) Use `WITH_CLASSPATH` to provide the Java classpath if needed.

For more information about CMake options specific to building NDB Cluster, see [Options for Compiling NDB Cluster](#).

Once the build process is complete, you can create a Zip archive containing the compiled binaries; [Installing MySQL Using a Standard Source Distribution](#) provides the commands needed to perform this task on Windows systems. The NDB Cluster binaries can be found in the `bin` directory of the resulting archive, which is equivalent to the `no-install` archive, and which can be installed and configured in the same manner. For more information, see [Section 3.2.1, “Installing NDB Cluster on Windows from a Binary Release”](#).

3.2.3 Initial Startup of NDB Cluster on Windows

Once the NDB Cluster executables and needed configuration files are in place, performing an initial start of the cluster is simply a matter of starting the NDB Cluster executables for all nodes in the cluster. Each cluster node process must be started separately, and on the host computer where it resides. The management node should be started first, followed by the data nodes, and then finally by any SQL nodes.

1. On the management node host, issue the following command from the command line to start the management node process. The output should appear similar to what is shown here:

```
C:\mysql\bin> ndb_mgmd
2010-06-23 07:53:34 [MgmtSrvr] INFO -- NDB Cluster Management Server. mysql-5.7.36-ndb-7.6.21
2010-06-23 07:53:34 [MgmtSrvr] INFO -- Reading cluster configuration from 'config.ini'
```

The management node process continues to print logging output to the console. This is normal, because the management node is not running as a Windows service. (If you have used NDB Cluster on a Unix-like platform such as Linux, you may notice that the management node's default behavior in this regard on Windows is effectively the opposite of its behavior on Unix systems, where it runs by default as a Unix daemon process. This behavior is also true of NDB Cluster data node processes running on Windows.) For this reason, do not close the window in which `ndb_mgmd.exe` is running; doing so kills the management node process. (See [Section 3.2.4, “Installing NDB Cluster Processes as Windows Services”](#), where we show how to install and run NDB Cluster processes as Windows services.)

The required `-f` option tells the management node where to find the global configuration file (`config.ini`). The long form of this option is `--config-file`.

Important

An NDB Cluster management node caches the configuration data that it reads from `config.ini`; once it has created a configuration cache, it ignores the `config.ini` file on subsequent starts unless forced to do otherwise. This means that, if the management node fails to start due to an error in this file, you must make the management node re-read `config.ini` after you have corrected any errors in it. You can do this by starting `ndb_mgmd.exe` with the `--reload` or `--initial` option on the command line. Either of these options works to refresh the configuration cache.

It is not necessary or advisable to use either of these options in the management node's `my.ini` file.

2. On each of the data node hosts, run the command shown here to start the data node processes:

```
C:\mysql\bin> ndbd
```

```
2010-06-23 07:53:46 [ndbd] INFO -- Configuration fetched from 'localhost:1186', generation: 1
```

In each case, the first line of output from the data node process should resemble what is shown in the preceding example, and is followed by additional lines of logging output. As with the management node process, this is normal, because the data node is not running as a Windows service. For this reason, do not close the console window in which the data node process is running; doing so kills `ndbd.exe`. (For more information, see [Section 3.2.4, “Installing NDB Cluster Processes as Windows Services”](#).)

- Do not start the SQL node yet; it cannot connect to the cluster until the data nodes have finished starting, which may take some time. Instead, in a new console window on the management node host, start the NDB Cluster management client `ndb_mgm.exe`, which should be in `C:\mysql\bin` on the management node host. (Do not try to re-use the console window where `ndb_mgmd.exe` is running by typing **CTRL+C**, as this kills the management node.) The resulting output should look like this:

```
C:\mysql\bin> ndb_mgm
-- NDB Cluster -- Management Client --
ndb_mgm>
```

When the prompt `ndb_mgm>` appears, this indicates that the management client is ready to receive NDB Cluster management commands. You can observe the status of the data nodes as they start by entering `ALL STATUS` at the management client prompt. This command causes a running report of the data nodes's startup sequence, which should look something like this:

```
ndb_mgm> ALL STATUS
Connected to Management Server at: localhost:1186
Node 2: starting (Last completed phase 3) (mysql-5.7.36-ndb-7.6.21)
Node 3: starting (Last completed phase 3) (mysql-5.7.36-ndb-7.6.21)

Node 2: starting (Last completed phase 4) (mysql-5.7.36-ndb-7.6.21)
Node 3: starting (Last completed phase 4) (mysql-5.7.36-ndb-7.6.21)

Node 2: Started (version 7.6.21)
Node 3: Started (version 7.6.21)

ndb_mgm>
```

Note

Commands issued in the management client are not case-sensitive; we use uppercase as the canonical form of these commands, but you are not required to observe this convention when inputting them into the `ndb_mgm` client. For more information, see [Section 6.1, “Commands in the NDB Cluster Management Client”](#).

The output produced by `ALL STATUS` is likely to vary from what is shown here, according to the speed at which the data nodes are able to start, the release version number of the NDB Cluster software you are using, and other factors. What is significant is that, when you see that both data nodes have started, you are ready to start the SQL node.

You can leave `ndb_mgm.exe` running; it has no negative impact on the performance of the NDB Cluster, and we use it in the next step to verify that the SQL node is connected to the cluster after you have started it.

- On the computer designated as the SQL node host, open a console window and navigate to the directory where you unpacked the NDB Cluster binaries (if you are following our example, this is `C:\mysql\bin`).

Start the SQL node by invoking `mysqld.exe` from the command line, as shown here:

```
C:\mysql\bin> mysqld --console
```

The `--console` option causes logging information to be written to the console, which can be helpful in the event of problems. (Once you are satisfied that the SQL node is running in a satisfactory manner, you can stop it and restart it out without the `--console` option, so that logging is performed normally.)

In the console window where the management client (`ndb_mgm.exe`) is running on the management node host, enter the `SHOW` command, which should produce output similar to what is shown here:

```
ndb_mgm> SHOW
Connected to Management Server at: localhost:1186
Cluster Configuration
-----
[ndbd(NDB)]      2 node(s)
id=2      @198.51.100.30  (Version: 5.7.36-ndb-7.6.21, Nodegroup: 0, *)
id=3      @198.51.100.40  (Version: 5.7.36-ndb-7.6.21, Nodegroup: 0)

[ndb_mgmd(MGM)] 1 node(s)
id=1      @198.51.100.10  (Version: 5.7.36-ndb-7.6.21)

[mysqld(API)]   1 node(s)
id=4      @198.51.100.20  (Version: 5.7.36-ndb-7.6.21)
```

You can also verify that the SQL node is connected to the NDB Cluster in the `mysql` client (`mysql.exe`) using the `SHOW ENGINE NDB STATUS` statement.

You should now be ready to work with database objects and data using NDB Cluster's `NDBCLUSTER` storage engine. See [Section 3.5, "NDB Cluster Example with Tables and Data"](#), for more information and examples.

You can also install `ndb_mgmd.exe`, `ndbd.exe`, and `ndbmtbd.exe` as Windows services. For information on how to do this, see [Section 3.2.4, "Installing NDB Cluster Processes as Windows Services"](#).

3.2.4 Installing NDB Cluster Processes as Windows Services

Once you are satisfied that NDB Cluster is running as desired, you can install the management nodes and data nodes as Windows services, so that these processes are started and stopped automatically whenever Windows is started or stopped. This also makes it possible to control these processes from the command line with the appropriate `SC START` and `SC STOP` commands, or using the Windows graphical `Services` utility. `NET START` and `NET STOP` commands can also be used.

Installing programs as Windows services usually must be done using an account that has Administrator rights on the system.

To install the management node as a service on Windows, invoke `ndb_mgmd.exe` from the command line on the machine hosting the management node, using the `--install` option, as shown here:

```
C:\> C:\mysql\bin\ndb_mgmd.exe --install
Installing service 'NDB Cluster Management Server'
as '"C:\mysql\bin\ndbd.exe" "--service=ndb_mgmd"'
Service successfully installed.
```

Important

When installing an NDB Cluster program as a Windows service, you should always specify the complete path; otherwise the service installation may fail with the error `The system cannot find the file specified`.

The `--install` option must be used first, ahead of any other options that might be specified for `ndb_mgmd.exe`. However, it is preferable to specify such options in an options file instead. If your options file is not in one of the default locations as shown in the output of `ndb_mgmd.exe --help`, you can specify the location using the `--config-file` option.

Now you should be able to start and stop the management server like this:

```
C:\> SC START ndb_mgmd
C:\> SC STOP ndb_mgmd
```

Note

If using `NET` commands, you can also start or stop the management server as a Windows service using the descriptive name, as shown here:

```
C:\> NET START 'NDB Cluster Management Server'
The NDB Cluster Management Server service is starting.
The NDB Cluster Management Server service was started successfully.

C:\> NET STOP 'NDB Cluster Management Server'
The NDB Cluster Management Server service is stopping..
The NDB Cluster Management Server service was stopped successfully.
```

It is usually simpler to specify a short service name or to permit the default service name to be used when installing the service, and then reference that name when starting or stopping the service. To specify a service name other than `ndb_mgmd`, append it to the `--install` option, as shown in this example:

```
C:\> C:\mysql\bin\ndb_mgmd.exe --install=mgmdl
Installing service 'NDB Cluster Management Server'
as 'C:\mysql\bin\ndb_mgmd.exe' "--service=mgmdl"
Service successfully installed.
```

Now you should be able to start or stop the service using the name you have specified, like this:

```
C:\> SC START mgmdl
C:\> SC STOP mgmdl
```

To remove the management node service, use `SC DELETE service_name`:

```
C:\> SC DELETE mgmdl
```

Alternatively, invoke `ndb_mgmd.exe` with the `--remove` option, as shown here:

```
C:\> C:\mysql\bin\ndb_mgmd.exe --remove
Removing service 'NDB Cluster Management Server'
Service successfully removed.
```

If you installed the service using a service name other than the default, pass the service name as the value of the `ndb_mgmd.exe --remove` option, like this:

```
C:\> C:\mysql\bin\ndb_mgmd.exe --remove=mgmdl
Removing service 'mgmdl'
Service successfully removed.
```

Installation of an NDB Cluster data node process as a Windows service can be done in a similar fashion, using the `--install` option for `ndbd.exe` (or `ndbmttd.exe`), as shown here:

```
C:\> C:\mysql\bin\ndbd.exe --install
Installing service 'NDB Cluster Data Node Daemon' as '"C:\mysql\bin\ndbd.exe" "--service=ndbd"'
Service successfully installed.
```

Now you can start or stop the data node as shown in the following example:

```
C:\> SC START ndbd
C:\> SC STOP ndbd
```

To remove the data node service, use `SC DELETE service_name`:

```
C:\> SC DELETE ndbd
```

Alternatively, invoke `ndbd.exe` with the `--remove` option, as shown here:

```
C:\> C:\mysql\bin\ndbd.exe --remove
Removing service 'NDB Cluster Data Node Daemon'
Service successfully removed.
```

As with `ndb_mgmd.exe` (and `mysqld.exe`), when installing `ndbd.exe` as a Windows service, you can also specify a name for the service as the value of `--install`, and then use it when starting or stopping the service, like this:

```
C:\> C:\mysql\bin\ndbd.exe --install=dnodel
Installing service 'dnodel' as '"C:\mysql\bin\ndbd.exe" "--service=dnodel"'
Service successfully installed.
C:\> SC START dnodel
C:\> SC STOP dnodel
```

If you specified a service name when installing the data node service, you can use this name when removing it as well, as shown here:

```
C:\> SC DELETE dnodel
```

Alternatively, you can pass the service name as the value of the `ndbd.exe --remove` option, as shown here:

```
C:\> C:\mysql\bin\ndbd.exe --remove=dnodel
Removing service 'dnodel'
Service successfully removed.
```

Installation of the SQL node as a Windows service, starting the service, stopping the service, and removing the service are done in a similar fashion, using `mysqld --install`, `SC START`, `SC STOP`, and `SC DELETE` (or `mysqld --remove`). `NET` commands can also be used to start or stop a service. For additional information, see [Starting MySQL as a Windows Service](#).

3.3 Initial Configuration of NDB Cluster

In this section, we discuss manual configuration of an installed NDB Cluster by creating and editing configuration files.

For our four-node, four-host NDB Cluster (see [Cluster nodes and host computers](#)), it is necessary to write four configuration files, one per node host.

- Each data node or SQL node requires a `my.cnf` file that provides two pieces of information: a *connection string* that tells the node where to find the management node, and a line telling the MySQL server on this host (the machine hosting the data node) to enable the `NDBCLUSTER` storage engine.

For more information on connection strings, see [Section 4.3.3, “NDB Cluster Connection Strings”](#).

- The management node needs a `config.ini` file telling it how many fragment replicas to maintain, how much memory to allocate for data and indexes on each data node, where to find the data nodes, where to save data to disk on each data node, and where to find any SQL nodes.

Configuring the data nodes and SQL nodes. The `my.cnf` file needed for the data nodes is fairly simple. The configuration file should be located in the `/etc` directory and can be edited using any text editor. (Create the file if it does not exist.) For example:

```
$> vi /etc/my.cnf
```

Note

We show `vi` being used here to create the file, but any text editor should work just as well.

For each data node and SQL node in our example setup, `my.cnf` should look like this:

```
[mysqld]
# Options for mysqld process:
ndbcluster                # run NDB storage engine

[mysql_cluster]
# Options for NDB Cluster processes:
ndb-connectstring=198.51.100.10 # location of management server
```

After entering the preceding information, save this file and exit the text editor. Do this for the machines hosting data node “A”, data node “B”, and the SQL node.

Important

Once you have started a `mysqld` process with the `ndbcluster` and `ndb-connectstring` parameters in the `[mysqld]` and `[mysql_cluster]` sections of the `my.cnf` file as shown previously, you cannot execute any `CREATE TABLE` or `ALTER TABLE` statements without having actually started the cluster. Otherwise, these statements fail with an error. This is by design.

Configuring the management node. The first step in configuring the management node is to create the directory in which the configuration file can be found and then to create the file itself. For example (running as `root`):

```
$> mkdir /var/lib/mysql-cluster
$> cd /var/lib/mysql-cluster
$> vi config.ini
```

For our representative setup, the `config.ini` file should read as follows:

```
[ndbd default]
# Options affecting ndbd processes on all data nodes:
NoOfReplicas=2      # Number of fragment replicas
DataMemory=80M     # How much memory to allocate for data storage
IndexMemory=18M    # How much memory to allocate for index storage
# For DataMemory and IndexMemory, we have used the
# default values. Since the "world" database takes up
# only about 500KB, this should be more than enough for
# this example NDB Cluster setup.
# NOTE: IndexMemory is deprecated in NDB 7.6 and later; in
# these versions, resources for all data and indexes are
# allocated by DataMemory and any that are set for IndexMemory
# are added to the DataMemory resource pool
ServerPort=2202    # This the default value; however, you can use any
# port that is free for all the hosts in the cluster
# Note1: It is recommended that you do not specify the port
# number at all and simply allow the default value to be used
# instead
# Note2: The port was formerly specified using the PortNumber
```

```

# TCP parameter; this parameter is no longer available in NDB
# Cluster 7.5.

[ndb_mgmd]
# Management process options:
HostName=198.51.100.10      # Hostname or IP address of management node
DataDir=/var/lib/mysql-cluster # Directory for management node log files

[ndbd]
# Options for data node "A":
# (one [ndbd] section per data node)
HostName=198.51.100.30     # Hostname or IP address
NodeId=2                   # Node ID for this data node
DataDir=/usr/local/mysql/data # Directory for this data node's data files

[ndbd]
# Options for data node "B":
HostName=198.51.100.40     # Hostname or IP address
NodeId=3                   # Node ID for this data node
DataDir=/usr/local/mysql/data # Directory for this data node's data files

[mysqld]
# SQL node options:
HostName=198.51.100.20     # Hostname or IP address
# (additional mysqld connections can be
# specified for this node for various
# purposes such as running ndb_restore)

```

Note

The `world` database can be downloaded from <https://dev.mysql.com/doc/index-other.html>.

After all the configuration files have been created and these minimal options have been specified, you are ready to proceed with starting the cluster and verifying that all processes are running. We discuss how this is done in [Section 3.4, “Initial Startup of NDB Cluster”](#).

For more detailed information about the available NDB Cluster configuration parameters and their uses, see [Section 4.3, “NDB Cluster Configuration Files”](#), and [Chapter 4, *Configuration of NDB Cluster*](#). For configuration of NDB Cluster as relates to making backups, see [Section 6.8.3, “Configuration for NDB Cluster Backups”](#).

Note

The default port for Cluster management nodes is 1186; the default port for data nodes is 2202. However, the cluster can automatically allocate ports for data nodes from those that are already free.

3.4 Initial Startup of NDB Cluster

Starting the cluster is not very difficult after it has been configured. Each cluster node process must be started separately, and on the host where it resides. The management node should be started first, followed by the data nodes, and then finally by any SQL nodes:

1. On the management host, issue the following command from the system shell to start the management node process:

```
$> ndb_mgmd --initial -f /var/lib/mysql-cluster/config.ini
```

The first time that it is started, `ndb_mgmd` must be told where to find its configuration file, using the `-f` or `--config-file` option. This option requires that `--initial` or `--reload` also be specified; see [Section 5.4, “ndb_mgmd — The NDB Cluster Management Server Daemon”](#), for details.

2. On each of the data node hosts, run this command to start the `ndbd` process:

```
$> ndbd
```

- If you used RPM files to install MySQL on the cluster host where the SQL node is to reside, you can (and should) use the supplied startup script to start the MySQL server process on the SQL node.

If all has gone well, and the cluster has been set up correctly, the cluster should now be operational. You can test this by invoking the `ndb_mgm` management node client. The output should look like that shown here, although you might see some slight differences in the output depending upon the exact version of MySQL that you are using:

```
$> ndb_mgm
-- NDB Cluster -- Management Client --
ndb_mgm> SHOW
Connected to Management Server at: localhost:1186
Cluster Configuration
-----
[ndbd(NDB)]      2 node(s)
id=2      @198.51.100.30 (Version: 5.7.36-ndb-7.6.21, Nodegroup: 0, *)
id=3      @198.51.100.40 (Version: 5.7.36-ndb-7.6.21, Nodegroup: 0)

[ndb_mgmd(MGM)]  1 node(s)
id=1      @198.51.100.10 (Version: 5.7.36-ndb-7.6.21)

[mysqld(API)]   1 node(s)
id=4      @198.51.100.20 (Version: 5.7.36-ndb-7.6.21)
```

The SQL node is referenced here as `[mysqld(API)]`, which reflects the fact that the `mysqld` process is acting as an NDB Cluster API node.

Note

The IP address shown for a given NDB Cluster SQL or other API node in the output of `SHOW` is the address used by the SQL or API node to connect to the cluster data nodes, and not to any management node.

You should now be ready to work with databases, tables, and data in NDB Cluster. See [Section 3.5, “NDB Cluster Example with Tables and Data”](#), for a brief discussion.

3.5 NDB Cluster Example with Tables and Data

Note

The information in this section applies to NDB Cluster running on both Unix and Windows platforms.

Working with database tables and data in NDB Cluster is not much different from doing so in standard MySQL. There are two key points to keep in mind:

- For a table to be replicated in the cluster, it must use the `NDBCLUSTER` storage engine. To specify this, use the `ENGINE=NDBCLUSTER` or `ENGINE=NDB` option when creating the table:

```
CREATE TABLE tbl_name (col_name column_definitions) ENGINE=NDBCLUSTER;
```

Alternatively, for an existing table that uses a different storage engine, use `ALTER TABLE` to change the table to use `NDBCLUSTER`:

```
ALTER TABLE tbl_name ENGINE=NDBCLUSTER;
```

- Every `NDBCLUSTER` table has a primary key. If no primary key is defined by the user when a table is created, the `NDBCLUSTER` storage engine automatically generates a hidden one. Such a key takes up space just as does any other table index. (It is not uncommon to encounter problems due to insufficient memory for accommodating these automatically created indexes.)

If you are importing tables from an existing database using the output of `mysqldump`, you can open the SQL script in a text editor and add the `ENGINE` option to any table creation statements, or replace any existing `ENGINE` options. Suppose that you have the `world` sample database on another MySQL server that does not support NDB Cluster, and you want to export the `City` table:

```
$> mysqldump --add-drop-table world City > city_table.sql
```

The resulting `city_table.sql` file contains this table creation statement (and the `INSERT` statements necessary to import the table data):

```
DROP TABLE IF EXISTS `City`;
CREATE TABLE `City` (
  `ID` int(11) NOT NULL auto_increment,
  `Name` char(35) NOT NULL default '',
  `CountryCode` char(3) NOT NULL default '',
  `District` char(20) NOT NULL default '',
  `Population` int(11) NOT NULL default '0',
  PRIMARY KEY (`ID`)
) ENGINE=MyISAM DEFAULT CHARSET=latin1;

INSERT INTO `City` VALUES (1,'Kabul','AFG','Kabol',1780000);
INSERT INTO `City` VALUES (2,'Qandahar','AFG','Qandahar',237500);
INSERT INTO `City` VALUES (3,'Herat','AFG','Herat',186800);
(remaining INSERT statements omitted)
```

You need to make sure that MySQL uses the `NDBCLUSTER` storage engine for this table. There are two ways that this can be accomplished. One of these is to modify the table definition *before* importing it into the Cluster database. Using the `City` table as an example, modify the `ENGINE` option of the definition as follows:

```
DROP TABLE IF EXISTS `City`;
CREATE TABLE `City` (
  `ID` int(11) NOT NULL auto_increment,
  `Name` char(35) NOT NULL default '',
  `CountryCode` char(3) NOT NULL default '',
  `District` char(20) NOT NULL default '',
  `Population` int(11) NOT NULL default '0',
  PRIMARY KEY (`ID`)
) ENGINE=NDBCLUSTER DEFAULT CHARSET=latin1;

INSERT INTO `City` VALUES (1,'Kabul','AFG','Kabol',1780000);
INSERT INTO `City` VALUES (2,'Qandahar','AFG','Qandahar',237500);
INSERT INTO `City` VALUES (3,'Herat','AFG','Herat',186800);
(remaining INSERT statements omitted)
```

This must be done for the definition of each table that is to be part of the clustered database. The easiest way to accomplish this is to do a search-and-replace on the file that contains the definitions and replace all instances of `TYPE=engine_name` or `ENGINE=engine_name` with `ENGINE=NDBCLUSTER`. If you do not want to modify the file, you can use the unmodified file to create the tables, and then use `ALTER TABLE` to change their storage engine. The particulars are given later in this section.

Assuming that you have already created a database named `world` on the SQL node of the cluster, you can then use the `mysql` command-line client to read `city_table.sql`, and create and populate the corresponding table in the usual manner:

```
$> mysql world < city_table.sql
```

It is very important to keep in mind that the preceding command must be executed on the host where the SQL node is running (in this case, on the machine with the IP address `198.51.100.20`).

To create a copy of the entire `world` database on the SQL node, use `mysqldump` on the noncluster server to export the database to a file named `world.sql` (for example, in the `/tmp` directory). Then modify the table definitions as just described and import the file into the SQL node of the cluster like this:

```
$> mysql world < /tmp/world.sql
```

If you save the file to a different location, adjust the preceding instructions accordingly.

Running `SELECT` queries on the SQL node is no different from running them on any other instance of a MySQL server. To run queries from the command line, you first need to log in to the MySQL Monitor in the usual way (specify the `root` password at the `Enter password:` prompt):

```
$> mysql -u root -p
Enter password:
Welcome to the MySQL monitor.  Commands end with ; or \g.
Your MySQL connection id is 1 to server version: 5.7.36-ndb-7.6.21

Type 'help;' or '\h' for help. Type '\c' to clear the buffer.

mysql>
```

We simply use the MySQL server's `root` account and assume that you have followed the standard security precautions for installing a MySQL server, including setting a strong `root` password. For more information, see [Securing the Initial MySQL Account](#).

It is worth taking into account that Cluster nodes do *not* make use of the MySQL privilege system when accessing one another. Setting or changing MySQL user accounts (including the `root` account) effects only applications that access the SQL node, not interaction between nodes. See [Section 6.17.2, "NDB Cluster and MySQL Privileges"](#), for more information.

If you did not modify the `ENGINE` clauses in the table definitions prior to importing the SQL script, you should run the following statements at this point:

```
mysql> USE world;
mysql> ALTER TABLE City ENGINE=NDBCLUSTER;
mysql> ALTER TABLE Country ENGINE=NDBCLUSTER;
mysql> ALTER TABLE CountryLanguage ENGINE=NDBCLUSTER;
```

Selecting a database and running a `SELECT` query against a table in that database is also accomplished in the usual manner, as is exiting the MySQL Monitor:

```
mysql> USE world;
mysql> SELECT Name, Population FROM City ORDER BY Population DESC LIMIT 5;
+-----+-----+
| Name      | Population |
+-----+-----+
| Bombay    | 10500000  |
| Seoul     | 9981619   |
| São Paulo | 9968485   |
| Shanghai  | 9696300   |
| Jakarta   | 9604900   |
+-----+-----+
5 rows in set (0.34 sec)

mysql> \q
Bye

$>
```

Applications that use MySQL can employ standard APIs to access `NDB` tables. It is important to remember that your application must access the SQL node, and not the management or data nodes. This brief example shows how we might execute the `SELECT` statement just shown by using the PHP 5.X `mysqli` extension running on a Web server elsewhere on the network:

```
<!DOCTYPE HTML PUBLIC "-//W3C//DTD HTML 4.01 Transitional//EN"
"http://www.w3.org/TR/html4/loose.dtd">
<html>
<head>
  <meta http-equiv="Content-Type"
        content="text/html; charset=iso-8859-1">
  <title>SIMPLE mysqli SELECT</title>
</head>
<body>
```



```

<?php
# connect to SQL node:
$link = new mysqli('198.51.100.20', 'root', 'root_password', 'world');
# parameters for mysqli constructor are:
#  host, user, password, database

if( mysqli_connect_errno() )
    die("Connect failed: " . mysqli_connect_error());

$query = "SELECT Name, Population
          FROM City
          ORDER BY Population DESC
          LIMIT 5";

# if no errors...
if( $result = $link->query($query) )
{
?>
<table border="1" width="40%" cellpadding="4" cellspacing="1">
  <tbody>
    <tr>
      <th width="10%">City</th>
      <th>Population</th>
    </tr>
  </tbody>
<?
  # then display the results...
  while($row = $result->fetch_object())
    printf("<tr>\n  <td align=\"center\">%s</td><td>%d</td>\n</tr>\n",
          $row->Name, $row->Population);
?>
  </tbody>
</table>
<?
# ...and verify the number of rows that were retrieved
printf("<p>Affected rows: %d</p>\n", $link->affected_rows);
}
else
# otherwise, tell us what went wrong
echo mysqli_error();

# free the result set and the mysqli connection object
$result->close();
$link->close();
?>
</body>
</html>

```

We assume that the process running on the Web server can reach the IP address of the SQL node.

In a similar fashion, you can use the MySQL C API, Perl-DBI, Python-mysql, or MySQL Connectors to perform the tasks of data definition and manipulation just as you would normally with MySQL.

3.6 Safe Shutdown and Restart of NDB Cluster

To shut down the cluster, enter the following command in a shell on the machine hosting the management node:

```
$> ndb_mgm -e shutdown
```

The `-e` option here is used to pass a command to the `ndb_mgm` client from the shell. The command causes the `ndb_mgm`, `ndb_mgmd`, and any `ndbd` or `ndbmtbd` processes to terminate gracefully. Any SQL nodes can be terminated using `mysqladmin shutdown` and other means. On Windows platforms, assuming that you have installed the SQL node as a Windows service, you can use `SC STOP service_name` or `NET STOP service_name`.

To restart the cluster on Unix platforms, run these commands:

- On the management host (198.51.100.10 in our example setup):

```
$> ndb_mgmd -f /var/lib/mysql-cluster/config.ini
```

- On each of the data node hosts (198.51.100.30 and 198.51.100.40):

```
$> ndbd
```

- Use the `ndb_mgm` client to verify that both data nodes have started successfully.

- On the SQL host (198.51.100.20):

```
$> mysqld_safe &
```

On Windows platforms, assuming that you have installed all NDB Cluster processes as Windows services using the default service names (see [Section 3.2.4, “Installing NDB Cluster Processes as Windows Services”](#)), you can restart the cluster as follows:

- On the management host (198.51.100.10 in our example setup), execute the following command:

```
C:\> SC START ndb_mgmd
```

- On each of the data node hosts (198.51.100.30 and 198.51.100.40), execute the following command:

```
C:\> SC START ndbd
```

- On the management node host, use the `ndb_mgm` client to verify that the management node and both data nodes have started successfully (see [Section 3.2.3, “Initial Startup of NDB Cluster on Windows”](#)).

- On the SQL node host (198.51.100.20), execute the following command:

```
C:\> SC START mysql
```

In a production setting, it is usually not desirable to shut down the cluster completely. In many cases, even when making configuration changes, or performing upgrades to the cluster hardware or software (or both), which require shutting down individual host machines, it is possible to do so without shutting down the cluster as a whole by performing a *rolling restart* of the cluster. For more information about doing this, see [Section 6.5, “Performing a Rolling Restart of an NDB Cluster”](#).

3.7 Upgrading and Downgrading NDB Cluster

The following sections provide information about upgrading and downgrading NDB Cluster 7.5 and 7.6.

3.7.1 Upgrading and Downgrading NDB 7.5

This section provides information about compatibility between different NDB Cluster 7.5 releases with regard to performing upgrades and downgrades as well as compatibility matrices and notes. Additional information can also be found here regarding downgrades from NDB 7.5 to previous NDB release series. You should already be familiar with installing and configuring NDB Cluster prior to attempting an upgrade or downgrade. See [Chapter 4, *Configuration of NDB Cluster*](#).

Schema operations, including SQL DDL statements, cannot be performed while any data nodes are restarting, and thus during an online upgrade or downgrade of the cluster. For other information regarding the rolling restart procedure used to perform an online upgrade, see [Section 6.5, “Performing a Rolling Restart of an NDB Cluster”](#).

Important

Only compatibility between MySQL versions with regard to `NDBCLUSTER` is taken into account in this section, and there are likely other issues to be considered. As with any other MySQL software upgrade or downgrade,

you are strongly encouraged to review the relevant portions of the MySQL Manual for the MySQL versions from which and to which you intend to migrate, before attempting an upgrade or downgrade of the NDB Cluster software. See [Upgrading MySQL](#). For information about upgrades to NDB 7.6, see [Section 3.7.2, "Upgrading and Downgrading NDB 7.6"](#).

The table shown here provides information on NDB Cluster upgrade and downgrade compatibility among different releases of NDB 7.5. Additional notes about upgrades and downgrades to, from, or within the NDB Cluster 7.5 release series can be found following the table.

Figure 3.2 NDB Cluster Upgrade and Downgrade Compatibility, MySQL NDB Cluster 7.5

MySQL NDB Cluster 7.5	
7.5.25	
7.5.24	
7.5.23	
7.5.22	
7.5.21	
7.5.20	
7.5.19	
7.5.18	
7.5.17	
7.5.16	
7.5.15	
7.5.14	
7.5.13	
7.5.12	
7.5.11*	
7.5.10	
7.5.9	
7.5.8	
7.5.7	
7.5.6	
7.5.5	
7.5.4	

KEY:	
↑ ↓	Online upgrades and downgrades possible

Version support. The following versions of NDB Cluster are supported for upgrades to GA releases of NDB Cluster 7.5 (7.5.4 and later):

- NDB Cluster 7.4 GA releases (7.4.4 and later)
- NDB Cluster 7.3 GA releases (7.3.2 and later)

Known Issues. The following issues are known to occur when upgrading to or between NDB 7.5 releases:

- When run with `--initialize`, the server does not require NDB support; having NDB enabled at this time can cause problems with `ndbinfo` tables. To keep this from happening, the `--initialize` option now causes `mysqld` to ignore the `--ndbcluster` option if the latter is also specified.

A workaround for an upgrade that has failed for these reasons can be accomplished as follows:

1. Perform a rolling restart of the entire cluster
2. Delete all `.frm` files in the `data/ndbinfo` directory
3. Run `mysql_upgrade`.

(Bug #81689, Bug #82724, Bug #24521927, Bug #23518923)

- During an online upgrade from an NDB Cluster 7.3 release to an NDB 7.4 (or later) release, the failures of several data nodes running the lower version during local checkpoints (LCPs), and just prior to upgrading these nodes, led to additional node failures following the upgrade. This was due to lingering elements of the `EMPTY_LCP` protocol initiated by the older nodes as part of an LCP-plus-restart sequence, and which is no longer used in NDB 7.4 and later due to LCP optimizations implemented in those versions. This issue was fixed in NDB 7.5.4. (Bug #23129433)
- In NDB 7.5 (and later), the `ndb_binlog_index` table uses the InnoDB storage engine. Use of the MyISAM storage engine for this table continues to be supported for backward compatibility.

When upgrading a previous release to NDB 7.5 (or later), you can use the `--force --upgrade-system-tables` options with `mysql_upgrade` so that it performs `ALTER TABLE ... ENGINE=INNODB` on the `ndb_binlog_index` table.

For more information, see [Section 7.4, “NDB Cluster Replication Schema and Tables”](#).

3.7.2 Upgrading and Downgrading NDB 7.6

This section provides information about compatibility between different NDB Cluster 7.6 releases with regard to performing upgrades and downgrades as well as compatibility matrices and notes. Additional information can also be found here regarding downgrades from NDB 7.6 to previous NDB release series. You should already be familiar with installation and configuration of NDB Cluster prior to attempting an upgrade or downgrade. See [Chapter 4, Configuration of NDB Cluster](#).

The table shown here provides information on NDB Cluster upgrade and downgrade compatibility among different releases of NDB 7.6. Additional notes about upgrades and downgrades to, from, or within the NDB Cluster 7.6 release series can be found following the table.

Figure 3.3 NDB Cluster Upgrade and Downgrade Compatibility, MySQL NDB Cluster 7.6

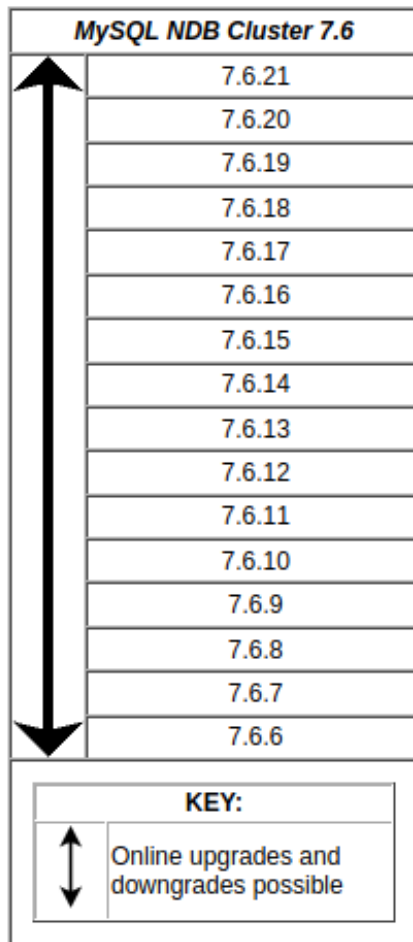

Version support. The following versions of NDB Cluster are supported for upgrades to GA releases of NDB Cluster 7.6 (7.6.6 and later):

- NDB Cluster 7.5 GA releases (7.5.4 and later)
- NDB Cluster 7.4 GA releases (7.4.4 and later)
- NDB Cluster 7.3 GA releases (7.3.2 and later)

Known issues. The following issues are known to occur when upgrading to, downgrading from, or between NDB 7.6 releases:

Changes in Disk Data file format. Due to changes in disk format, upgrading to or downgrading from either of the versions listed here requires an initial node restart of each data node:

- NDB 7.6.2
- NDB 7.6.4

To avoid problems relating to the old format, you should re-create any existing tablespaces and undo log file groups when upgrading. You can do this by performing an initial restart of each data node (that is, using the `--initial` option) as part of the upgrade process.

If you are using Disk Data tables, a downgrade from *any* NDB 7.6 release to any NDB 7.5 or earlier release requires that you restart all data nodes with `--initial` as part of the downgrade process. This is because NDB 7.5 and earlier release series are not able to read the new Disk Data file format.

IndexMemory changes. If you are downgrading from NDB 7.6 to NDB 7.5 (or earlier), you must set an explicit value for `IndexMemory` in the cluster configuration file if none is already present. This is because NDB 7.6 does not use this parameter and sets it to 0 by default, whereas it is required in NDB 7.5 and earlier releases, in which the cluster refuses to start with `Invalid configuration received from Management Server...` if `IndexMemory` is not set to a nonzero value.

Important

Upgrading to NDB 7.6 from an earlier release, or downgrading from NDB 7.6 to an earlier release, requires purging then re-creating the NDB data node file system, which means that each data node must be restarted using the `--initial` option as part of the rolling restart or system restart normally required. (Starting a data node with no file system is already equivalent to an initial restart; in such cases, `--initial` is implied and not required. This is unchanged from previous releases of NDB Cluster.)

When such a restart is performed as part of an upgrade to NDB 7.6, any existing LCP files are checked for the presence of the LCP `Sysfile`, indicating that the existing data node file system was written using NDB 7.6. If such a node file system exists, but does not contain the `Sysfile`, and if any data nodes are restarted without the `--initial` option, NDB causes the restart to fail with an appropriate error message.

You should also be aware that no such protection is possible when downgrading from NDB 7.6 to a release previous to NDB 7.6.

3.8 The NDB Cluster Auto-Installer (NDB 7.5) (No longer supported)

Note

This feature is deprecated and should be avoided. It is subject to removal in a future version of NDB Cluster.

This section describes the web-based graphical configuration installer included as part of the NDB Cluster 7.5 distribution. If you are using NDB 7.6, see [Section 3.9, “The NDB Cluster Auto-Installer \(NDB 7.6\) \(No longer supported\)”](#), for information about the updated installer that is supplied with NDB 7.6 releases.

Topics discussed in the following sections include an overview of the installer and its parts, software and other requirements for running the installer, navigating the GUI, and using the installer to set up, start, or stop an NDB Cluster on one or more host computers.

The NDB Cluster Auto-Installer is made up of two components. The front end is a GUI client implemented as a Web page that loads and runs in a standard Web browser such as Firefox or Microsoft Internet Explorer. The back end is a server process (`ndb_setup.py`) that runs on the local machine or on another host to which you have access.

These two components (client and server) communicate with each other using standard HTTP requests and responses. The back end can manage NDB Cluster software programs on any host where the back end user has granted access. If the NDB Cluster software is on a different host, the back end relies on SSH for access.

3.8.1 NDB Cluster Auto-Installer Requirements

This section provides information on supported operating platforms and software, required software, and other prerequisites for running the NDB Cluster Auto-Installer.

Supported platforms. The NDB Cluster Auto-Installer is available with most NDB 7.5 and 7.6 distributions for recent versions of Linux, Windows, Solaris, and macOS. For more detailed

information about platform support for NDB Cluster and the NDB Cluster Auto-Installer, see <https://www.mysql.com/support/supportedplatforms/cluster.html>.

Supported Web browsers. The Web-based installer is supported with recent versions of Firefox and Microsoft Internet Explorer. It should also work with recent versions of Opera, Safari, and Chrome, although we have not thoroughly tested for compatibility with these browsers.

Required software—server. The following software must be installed on the host where the Auto-Installer is run:

- **Python 2.6 or higher.** The Auto-Installer requires the Python interpreter and standard libraries. If these are not already installed on the system, you may be able to add them using the system's package manager. Otherwise, they can be downloaded from <http://python.org/download/>.
- **Paramiko 1.7.7.1 or higher.** You can download this from <http://www.lag.net/paramiko/> if it is not available from your system's package manager.
- **Pycrypto version 1.9 or higher.** This cryptography module is required by Paramiko. If it is not available using your system's package manager, you can download it from <https://www.dlitz.net/software/pycrypto/>.

All of the software in the preceding list is included in the Windows version of the configuration tool, and does not need to be installed separately.

Required software—remote hosts. The only software required for remote hosts where you wish to deploy NDB Cluster nodes is the SSH server, which is usually installed by default on Linux and Solaris systems. Several alternatives are available for Windows; for an overview of these, see http://en.wikipedia.org/wiki/Comparison_of_SSH_servers.

An additional requirement when using multiple hosts is that it is possible to authenticate to any of the remote hosts using SSH and the proper keys or user credentials, as discussed in the next few paragraphs:

Authentication and security. Three basic security or authentication mechanisms for remote access are available to the Auto-Installer, which we list and describe here:

- **SSH.** A secure shell connection is used to enable the back end to perform actions on remote hosts. For this reason, an SSH server must be running on the remote host. In addition, the operating system user running the installer must have access to the remote server, either with a user name and password, or by using public and private keys.

Important

You should never use the system `root` account for remote access, as this is extremely insecure. In addition, `mysqld` cannot normally be started by system `root`. For these and other reasons, you should provide SSH credentials for a regular user account on the target system, and not for system `root`. For more information about this issue, see [How to Run MySQL as a Normal User](#).

- **HTTPS.** Remote communication between the Web browser front end and the back end is not encrypted by default, which means that information such as the user's SSH password is transmitted as cleartext that is readable to anyone. For communication from a remote client to be encrypted, the back end must have a certificate, and the front end must communicate with the back end using HTTPS rather than HTTP. Enabling HTTPS is accomplished most easily through issuing a self-signed certificate. Once the certificate is issued, you must make sure that it is used. You can do this by starting `ndb_setup.py` from the command line with the `--use-https` and `--cert-file` options.
- **Certificate-based authentication.** The back end `ndb_setup.py` process can execute commands on the local host as well as remote hosts. This means that anyone connecting to the

back end can take charge of how commands are executed. To reject unwanted connections to the back end, a certificate may be required for authentication of the client. In this case, a certificate must be issued by the user, installed in the browser, and made available to the back end for authentication purposes. You can enact this requirement (together with or in place of password or key authentication) by starting `ndb_setup.py` with the `--ca-certs-file` option.

There is no need or requirement for secure authentication when the client browser is running on the same host as the Auto-Installer back end.

See also [Section 6.17, “NDB Cluster Security Issues”](#), which discusses security considerations to take into account when deploying NDB Cluster, as well as [Security](#), for more general MySQL security information.

3.8.2 Using the NDB Cluster Auto-Installer

The NDB Cluster Auto-Installer consists of several pages, each corresponding to a step in the process used to configure and deploy an NDB Cluster, and listed here:

- **Welcome:** Begin using the Auto-Installer by choosing either to configure a new NDB Cluster, or to continue configuring an existing one.
- **Define Cluster:** Set basic information about the cluster as a whole, such as name, hosts, and load type. Here you can also set the SSH authentication type for accessing remote hosts, if needed.
- **Define Hosts:** Identify the hosts where you intend to run NDB Cluster processes.
- **Define Processes:** Assign one or more processes of a given type or types to each cluster host.
- **Define Attributes:** Set configuration attributes for processes or types of processes.
- **Deploy Cluster:** Deploy the cluster with the configuration set previously; start and stop the deployed cluster.

The following sections describe in greater detail the purpose and function of each of these pages, in the order just listed.

Starting the NDB Cluster Auto-Installer

The Auto-Installer is provided together with the NDB Cluster software. (See [Chapter 3, NDB Cluster Installation](#).) The present section explains how to start the installer. You can do by invoking the `ndb_setup.py` executable.

Important

You should run the `ndb_setup.py` as a normal user; no special privileges are needed to do so. You should *not* run this program as the `mysql` user, or using the system `root` or Administrator account; doing so may cause the installation to fail.

`ndb_setup.py` is found in the `bin` within the NDB Cluster installation directory; a typical location might be `/usr/local/mysql/bin` on a Linux system or `C:\Program Files\MySQL\MySQL Server 5.6\bin` on a Windows system, but this can vary according to where the NDB Cluster software is installed on your system.

On Windows, you can also start the installer by running `setup.bat` in the NDB Cluster installation directory. When invoked from the command line, it accepts the same options as does `ndb_setup.py`.

`ndb_setup.py` can be started with any of several options that affect its operation, but it is usually sufficient to allow the default settings be used, in which case you can start `ndb_setup.py` by either of the following two methods:

1. Navigate to the NDB Cluster `bin` directory in a terminal and invoke it from the command line, without any additional arguments or options, like this:

```
$> ndb_setup
```

This works regardless of operating platform.

2. Navigate to the NDB Cluster `bin` directory in a file browser (such Windows Explorer on Windows, or Konqueror, Dolphin, or Nautilus on Linux) and activate (usually by double-clicking) the **`ndb_setup.py`** file icon. This works on Windows, and should work with most common Linux desktops as well.

On Windows, you can also navigate to the NDB Cluster installation directory and activate the **`setup.bat`** file icon.

In either case, once `ndb_setup.py` is invoked, the Auto-Installer's **Welcome screen** should open in the system's default Web browser.

In some cases, you may wish to use non-default settings for the installer, such as specifying a different port for the Auto-Installer's included Web server to run on, in which case you must invoke `ndb_setup.py` with one or more startup options with values overriding the necessary defaults. The same startup options can be used on Windows systems with the `setup.bat` file supplied for such platforms in the NDB Cluster software distribution. This can be done using the command line, but if you want or need to start the installer from a desktop or file browser while employing one or more of these options, it is also possible to create a script or batch file containing the proper invocation, then to double-click its file icon in the file browser to start the installer. (On Linux systems, you might also need to make the script file executable first.) For information about advanced startup options for the NDB Cluster Auto-Installer, see [Section 5.27, “ndb_setup.py — Start browser-based Auto-Installer for NDB Cluster \(DEPRECATED\)”](#).

NDB Cluster Auto-Installer Welcome Screen

The **Welcome** screen is loaded in the default browser when `ndb_setup.py` is invoked, as shown here:

Figure 3.4 The NDB Cluster Auto-Installer Welcome screen (Closeup)



This screen provides the following two choices for entering the installer, one of which must be selected to continue:

1. **Create New NDB Cluster:** Start the Auto-Installer with a completely new cluster to be set up and deployed.
2. **Continue Previous Cluster Configuration:** Start the Auto-Installer at the same point where the previous session ended, with all previous settings preserved.

The second option requires that the browser be able to access its cookies from the previous session, as these provide the mechanism by which configuration and other information generated during a session is stored. In other words, to continue the previous session with the Auto-Installer, you must use the same web browser running on the same host as you did for the previous session.

NDB Cluster Auto-Installer Define Cluster Screen

The **Define Cluster** screen is the first screen to appear following the choice made in the [Welcome screen](#), and is used for setting general properties of the cluster. The layout of the **Define Cluster** screen is shown here:

Figure 3.5 The NDB Cluster Auto-Installer Define Cluster screen

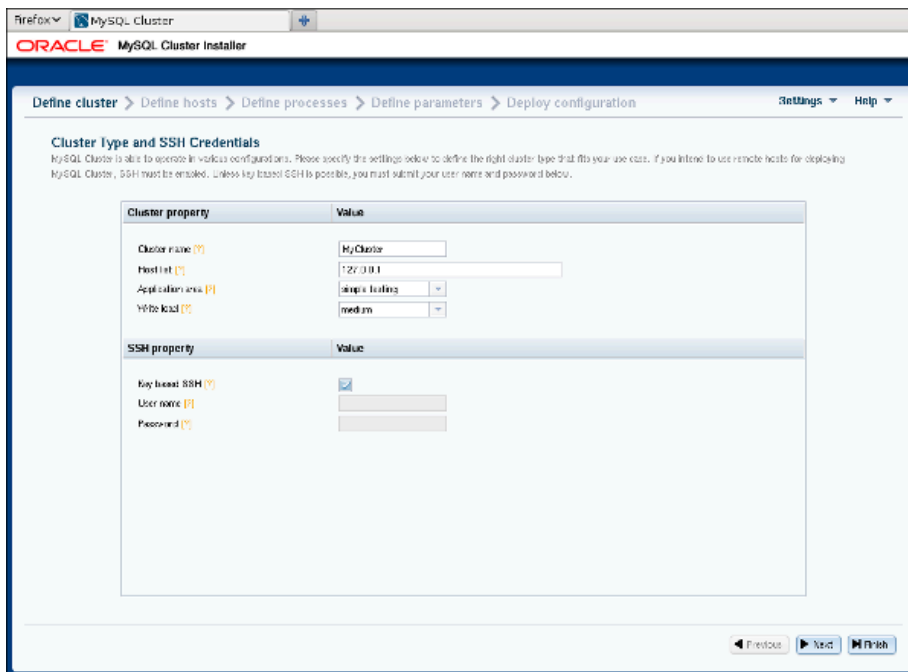

The **Define Cluster** screen allows you to set a number of general properties for the cluster, as described in this list:

- **Cluster name:** A name that identifies the cluster. The default is [MyCluster](#).
- **Host list:** A comma-delimited list of one or more hosts where cluster processes should run. By default, this is [127.0.0.1](#). If you add remote hosts to the list, you must be able to connect to them using the **SSH Credentials** supplied.
- **Application type:** Choose one of the following:
 1. **Simple testing:** Minimal resource usage for small-scale testing. This the default. *Not intended for production environments.*
 2. **Web:** Maximize performance for the given hardware.
 3. **Real-time:** Maximize performance while maximizing sensitivity to timeouts in order to minimize the time needed to detect failed cluster processes.

- **Write load:** Choose a level for the anticipated number of writes for the cluster as a whole. You can choose any one of the following levels:
 1. **Low:** The expected load includes fewer than 100 write transactions for second.
 2. **Medium:** The expected load includes 100 to 1000 write transactions per second.
 3. **High:** The expected load includes more than 1000 write transactions per second.
- **SSH Credentials:** Choose **Key-Based SSH** or enter **User** and **Password** credentials. The SSH key or a user name with password is required for connecting to any remote hosts specified in the **Host list**. By default, **Key-Based SSH** is selected, and the **User** and **Password** fields are blank.

NDB Cluster Auto-Installer Define Hosts Screen

The **Define Hosts** screen, shown here, provides a means of viewing and specifying several key properties of each cluster host:

Figure 3.6 NDB Cluster Define Hosts screen

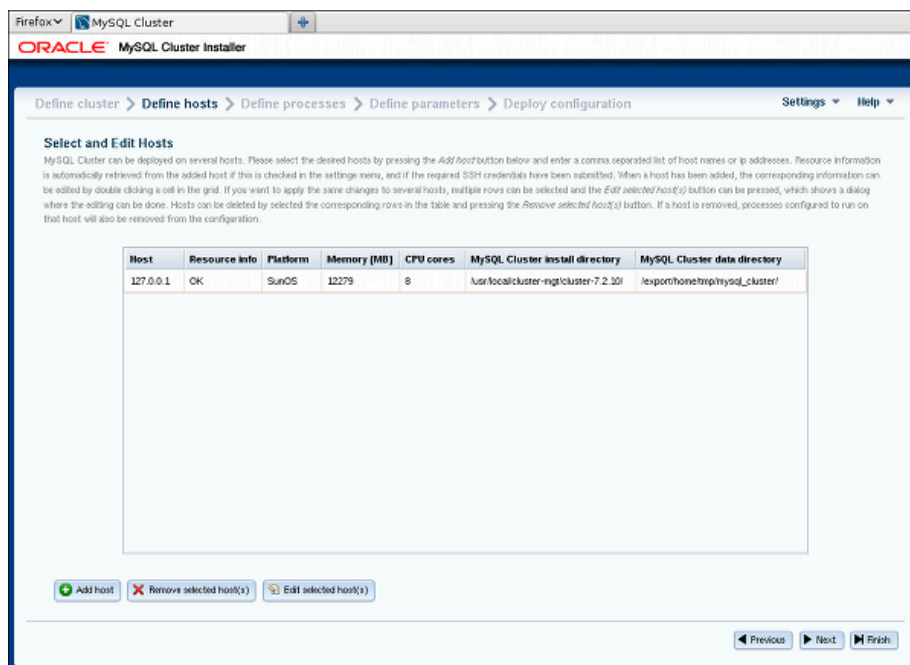

The hosts currently entered are displayed in the grid with various pieces of information. You can add hosts by clicking the **Add hosts** button and entering a list of one or more comma-separated host names, IP addresses, or both (as when editing the host list on the [Define Cluster screen](#)).

Similarly, you can remove one or more hosts using the button labelled **Remove selected host(s)**. When you remove a host in this fashion, any process which was configured for that host is also removed.

If **Automatically get resource information for new hosts** is checked in the **Settings** menu, the Auto-Installer attempts to retrieve the platform name, amount of memory, and number of CPU cores and to fill these in automatically. The status of this is displayed in the *Resource info* column. Fetching the information from remote hosts is not instantaneous and may take some time, particularly from remote hosts running Windows.

If the SSH user credentials on the [Define Cluster screen](#) are changed, the tool tries to refresh the hardware information from any hosts for which information is missing. However, if a given field has already been edited, the user-supplied information is *not* overwritten by any value fetched from that host.

The hardware resource information, platform name, installation directory, and data directory can be edited by the user by clicking the corresponding cell in the grid, by selecting one or more hosts and clicking the button labelled **Edit selected host(s)**. This causes a dialog box to appear, in which these fields can be edited, as shown here:

Figure 3.7 NDB Cluster Auto-Installer Edit Hosts dialog

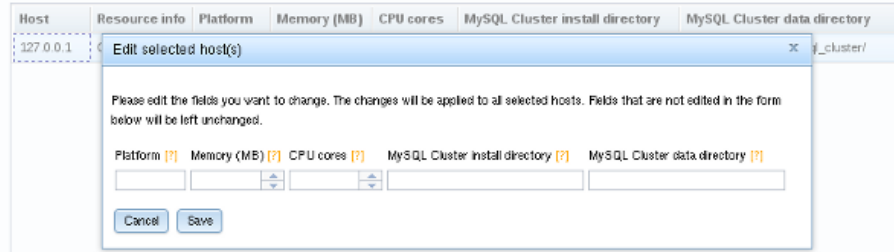

When more than one host is selected, any edited values are applied to all selected hosts.

NDB Cluster Auto-Installer Define Processes Screen

The **Define Processes** screen, shown here, provides a way to assign NDB Cluster processes (nodes) to cluster hosts:

Figure 3.8 NDB Cluster Auto-Installer Define Processes dialog

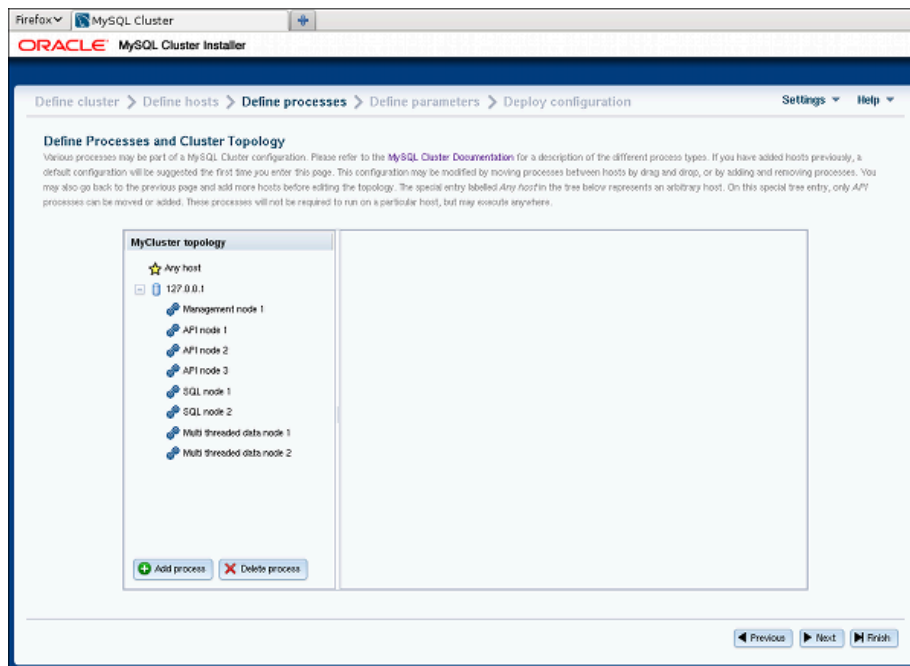

This screen contains a process tree showing cluster hosts and processes set up to run on each one, as well as a panel which displays information about the item currently selected in the tree.

When this screen is accessed for the first time for a given cluster, a default set of processes is defined for you, based on the number of hosts. If you later return to the **Define Hosts** screen, remove all hosts, and add new hosts, this also causes a new default set of processes to be defined.

NDB Cluster processes are of the following types:

- **Management node.** Performs administrative tasks such as stopping individual data nodes, querying node and cluster status, and making backups. Executable: `ndb_mgmd`.
- **Single-threaded data node.** Stores data and executes queries. Executable: `ndbd`.

- **Multi threaded data node.** Stores data and executes queries with multiple worker threads executing in parallel. Executable: `ndbmt.d`.
- **SQL node.** MySQL server for executing SQL queries against NDB. Executable: `mysqld`.
- **API node.** A client accessing data in NDB by means of the NDB API or other low-level client API, rather than by using SQL. See [MySQL NDB Cluster API Developer Guide](#), for more information.

For more information about process (node) types, see [Section 2.1, “NDB Cluster Core Concepts”](#).

Processes shown in the tree are numbered sequentially by type, for each host—for example, [SQL node 1](#), [SQL node 2](#), and so on—to simplify identification.

Each management node, data node, or SQL process must be assigned to a specific host, and is not allowed to run on any other host. An API node *may* be assigned to a single host, but this is not required. Instead, you can assign it to the special **Any host** entry which the tree also contains in addition to any other hosts, and which acts as a placeholder for processes that are allowed to run on any host. *Only API processes may use this **Any host** entry.*

Adding processes. To add a new process to a given host, either right-click that host's entry in the tree, then select the **Add process** popup when it appears, or select a host in the process tree, and press the **Add process** button below the process tree. Performing either of these actions opens the add process dialog, as shown here:

Figure 3.9 NDB Cluster Auto-Installer Add Process Dialog

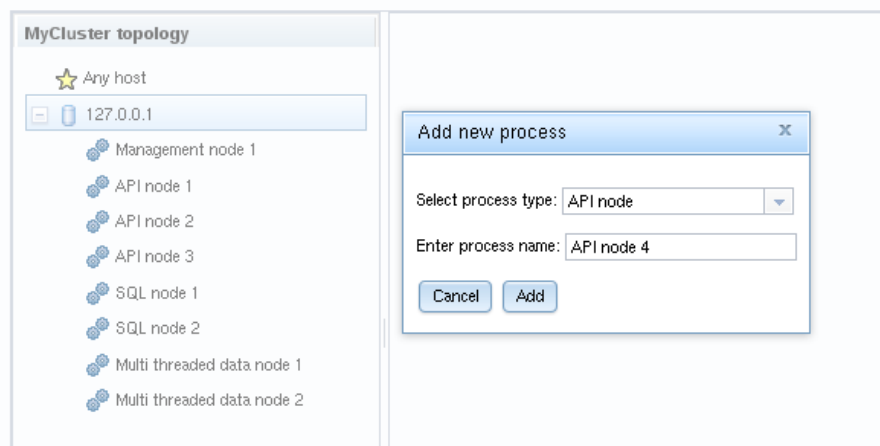

Here you can select from among the available process types described earlier this section; you can also enter an arbitrary process name to take the place of the suggested value, if desired.

Removing processes. To delete a process, right-click on a process in the tree and select **delete process** from the pop up menu that appears, or select a process, then use the **delete process** button below the process tree.

When a process is selected in the process tree, information about that process is displayed in the information panel, where you can change the process name and possibly its type. *Important.* Currently, you can change a single-threaded data node (`ndbd`) to a multithreaded data node (`ndbmt.d`), or the reverse, only; no other process type changes are allowed. If you want to make a change between any other process types, you must delete the original process first, then add a new process of the desired type.

NDB Cluster Auto-Installer Define Attributes Screen

This screen has a layout similar to that of the [Define Processes screen](#), including a process tree. Unlike that screen's tree, the **Define Attributes** process tree is organized by process or node type, with

single-threaded and multithreaded data nodes considered to be of the same type for this purpose, in groups labelled **Management Layer**, **Data Layer**, **SQL Layer**, and **API Layer**. An information panel displays information regarding the item currently selected. The **Define Attributes** screen is shown here:

Figure 3.10 NDB Cluster Auto-Installer Define Attributes screen

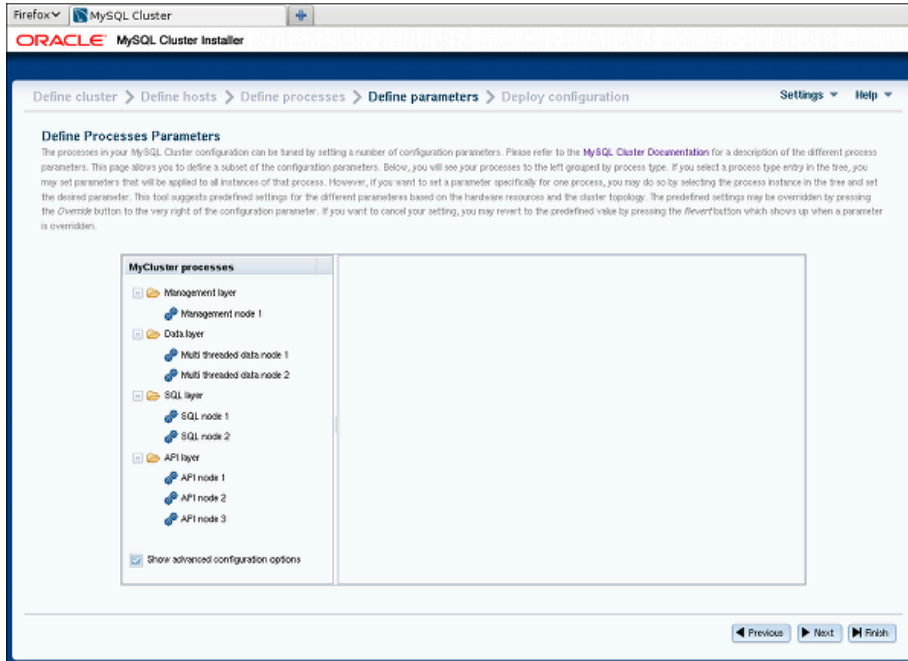

The check box labelled **Show advanced configuration**, when checked, makes advanced options visible in the information pane. These options are set and used whether or not they are visible.

You can edit attributes for a single process by selecting that process from the tree, or for all processes of the same type in the cluster by selecting one of the **Layer** folders. A per-process value set for a given attribute overrides any per-group setting for that attribute that would otherwise apply to the process in question. An example of such an information panel (for an SQL process) is shown here:

Figure 3.11 Define Attributes Detail With SQL Process Attributes

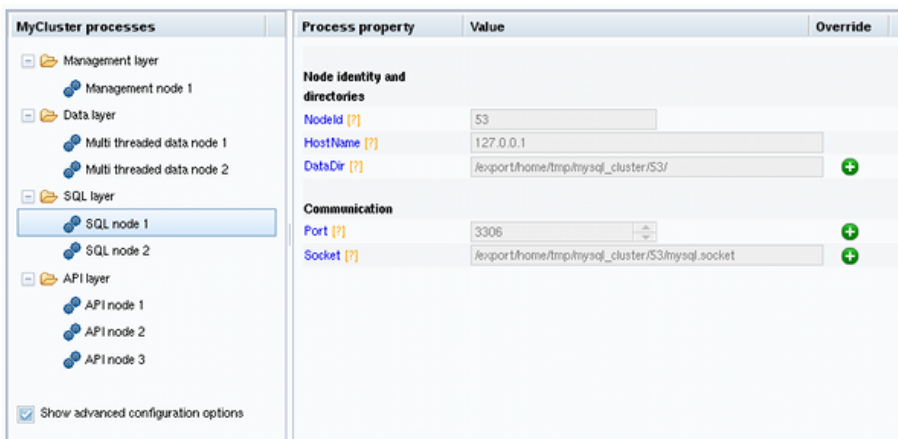

For some of the attributes shown in the information panel, a button bearing a plus sign is displayed, which means that the value of the attribute can be overridden. This + button activates an input widget for the attribute, enabling you to change its value. When the value has been overridden, this button changes into a button showing an **X**, as shown here:

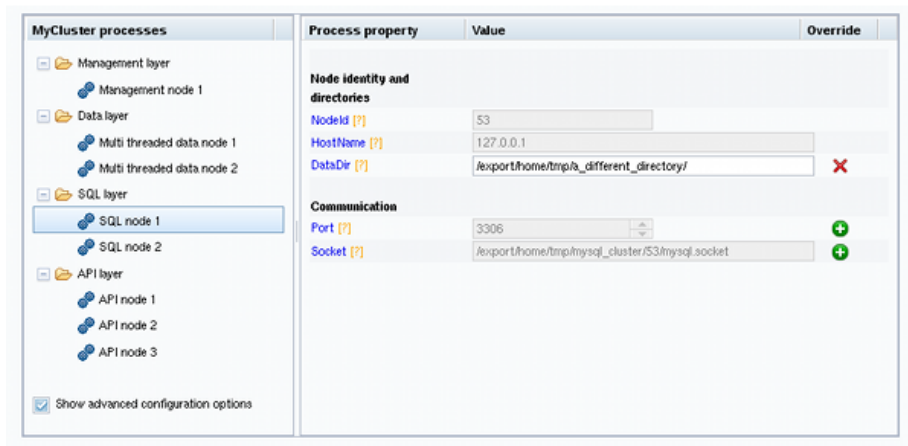
Figure 3.12 Define Attributes Detail, Overriding Attribute Default Value

Clicking the **X** button next to an attribute undoes any changes made to it; it immediately reverts to the predefined value.

All configuration attributes have predefined values calculated by the installer, based such factors as host name, node ID, node type, and so on. In most cases, these values may be left as they are. If you are not familiar with it already, it is highly recommended that you read the applicable documentation before making changes to any of the attribute values. To make finding this information easier, each attribute name shown in the information panel is linked to its description in the online NDB Cluster documentation.

NDB Cluster Auto-Installer Deploy Cluster Screen

This screen allows you to perform the following tasks:

- Review process startup commands and configuration files to be applied
- Distribute configuration files by creating any necessary files and directories on all cluster hosts—that is, *deploy* the cluster as presently configured
- Start and stop the cluster

The **Deploy Cluster** screen is shown here:

Figure 3.13 NDB Cluster Auto-Installer Deploy Cluster Configuration screen

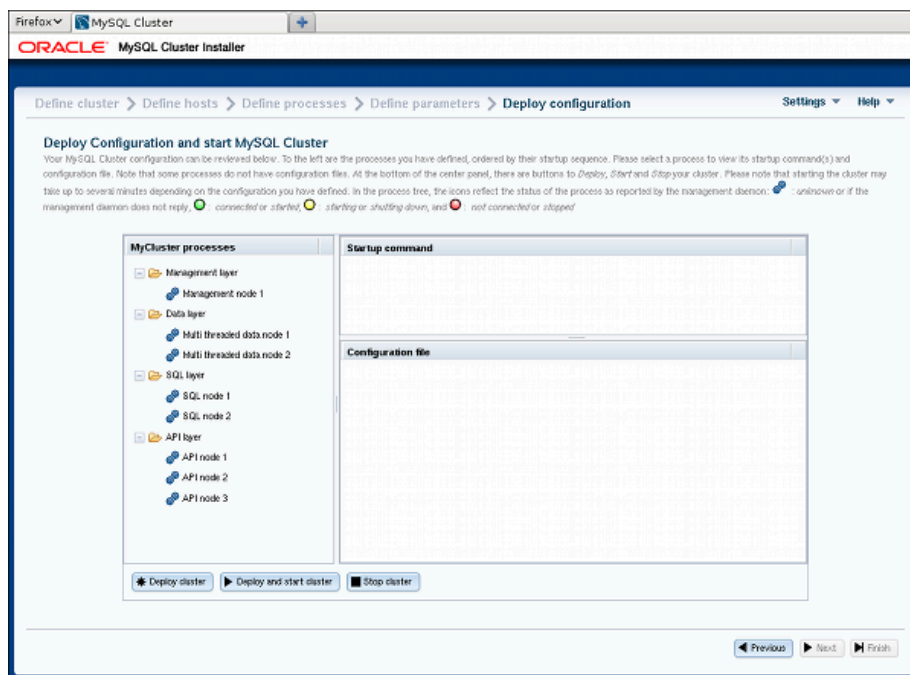

Like the [Define Attributes screen](#), this screen features a process tree which is organized by process type. Next to each process in the tree is a status icon indicating the current status of the process: connected (**CONNECTED**), starting (**STARTING**), running (**STARTED**), stopping (**STOPPING**), or disconnected (**NO_CONTACT**). The icon shows green if the process is connected or running; yellow if it is starting or stopping; red if the process is stopped or cannot be contacted by the management server.

This screen also contains two information panels, one showing the startup command or commands needed to start the selected process. (For some processes, more than one command may be required—for example, if initialization is necessary.) The other panel shows the contents of the configuration file, if any, for the given process; currently, the management node process is only type of process having a configuration file. Other process types are configured using command-line parameters when starting the process, or by obtaining configuration information from the management nodes as needed in real time.

This screen also contains three buttons, labelled as and performing the functions described in the following list:

- **Deploy cluster:** Verify that the configuration is valid. Create any directories required on the cluster hosts, and distribute the configuration files onto the hosts. A progress bar shows how far the deployment has proceeded.
- **Start cluster:** The cluster is deployed as with **Deploy cluster**, after which all cluster processes are started in the correct order.

Starting these processes may take some time. If the estimated time to completion is too large, the installer provides an opportunity to cancel or to continue of the startup procedure. A progress bar indicates the current status of the startup procedure, as shown here:

Figure 3.14 Progress Bar With Status of Node Startup Process

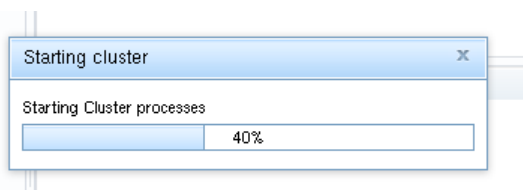

The process status icons adjoining the process tree mentioned previously also update with the status of each process.

- **Stop cluster:** After the cluster has been started, you can stop it using this. As with starting the cluster, cluster shutdown is not instantaneous, and may require some time complete. A progress bar, similar to that displayed during cluster startup, shows the approximate current status of the cluster shutdown procedure, as do the process status icons adjoining the process tree.

The Auto-Installer generates a `my.cnf` file containing the appropriate options for each `mysqld` process in the cluster.

3.9 The NDB Cluster Auto-Installer (NDB 7.6) (No longer supported)

Note

This feature has been removed from NDB Cluster, and is no longer supported. See [Section 2.4, “What is New in NDB Cluster”](#), for more information.

This section describes the web-based graphical configuration installer included as part of the NDB Cluster 7.6 distribution. This version of the installer differs in many respects from that supplied with NDB 7.5 and earlier releases; if you are using NDB 7.5, see [Section 3.8, “The NDB Cluster Auto-Installer \(NDB 7.5\) \(No longer supported\)”](#), for relevant information. Some of the key improvements are listed here:

- Persistent storage in an encrypted file as an alternative to cookie-based storage, now used by default
- Secure (HTTPS) connections by default
- Upgraded Paramiko security library
- Ability to use passwords for encrypted private keys, and to use different credentials with different hosts
- Improved host information retrieval
- Improved configuration; advanced configuration parameters

See also [Section 2.4.2, “What is New in NDB Cluster 7.6”](#).

Topics discussed in the following sections include an overview of the installer and its parts, software and other requirements for running the installer, navigating the GUI, and using the installer to set up and start or stop an NDB Cluster on one or more host computers.

The NDB Cluster Auto-Installer is made up of two components. The front end is a GUI client implemented as a Web page that loads and runs in a standard Web browser such as Firefox or Microsoft Internet Explorer. The back end is a server process (`ndb_setup.py`) that runs on the local machine or on another host to which you have access.

These two components (client and server) communicate with each other using standard HTTP requests and responses. The back end can manage NDB Cluster software programs on any host where the back end user has granted access. If the NDB Cluster software is on a different host, the back end relies on SSH for access, using the Paramiko library for executing commands remotely (see [Section 3.9.1, “NDB Cluster Auto-Installer Requirements”](#)).

3.9.1 NDB Cluster Auto-Installer Requirements

This section provides information on supported operating platforms and software, required software, and other prerequisites for running the NDB Cluster Auto-Installer.

Supported platforms. The NDB Cluster Auto-Installer is available with NDB 8.0 distributions for recent versions of Linux, Windows, Solaris, and macOS. For more detailed information about platform support for NDB Cluster and the NDB Cluster Auto-Installer, see <https://www.mysql.com/support/supportedplatforms/cluster.html>.

Supported web browsers. The web-based installer is supported with recent versions of Firefox and Microsoft Internet Explorer. It should also work with recent versions of Opera, Safari, and Chrome, although we have not thoroughly tested for compability with these browsers.

Required software—server. The following software must be installed on the host where the Auto-Installer is run:

- **Python 2.6 or higher.** The Auto-Installer requires the Python interpreter and standard libraries. If these are not already installed on the system, you may be able to add them using the system's package manager. Otherwise, you can download them from <http://python.org/download/>.
- **Paramiko 2 or higher.** This is required to communicate with remote hosts using SSH. You can download it from <http://www.lag.net/paramiko/>. Paramiko may also be available from your system's package manager.
- **Pycrypto version 2.6 or higher.** This cryptography module is required by Paramiko, and can be iunstalled using `pip install cryptography`. If `pip` is not installed, and the module is not available using your system's package manage, you can download it from <https://www.dlitz.net/software/pycrypto/>.

All of the software in the preceding list is included in the Windows version of the configuration tool, and does not need to be installed separately.

The Paramiko and Pycrypto libraries are required only if you intend to deploy NDB Cluster nodes on remote hosts, and are not needed if all nodes are on the same host where the installer is run.

Required software—remote hosts. The only software required for remote hosts where you wish to deploy NDB Cluster nodes is the SSH server, which is usually installed by default on Linux and Solaris systems. Several alternatives are available for Windows; for an overview of these, see http://en.wikipedia.org/wiki/Comparison_of_SSH_servers.

An additional requirement when using multiple hosts is that it is possible to authenticate to any of the remote hosts using SSH and the proper keys or user credentials, as discussed in the next few paragraphs:

Authentication and security. Three basic security or authentication mechanisms for remote access are available to the Auto-Installer, which we list and describe here:

- **SSH.** A secure shell connection is used to enable the back end to perform actions on remote hosts. For this reason, an SSH server must be running on the remote host. In addition, the operating system user running the installer must have access to the remote server, either with a user name and password, or by using public and private keys.

Important

You should never use the system `root` account for remote access, as this is extremely insecure. In addition, `mysqld` cannot normally be started by system `root`. For these and other reasons, you should provide SSH credentials for a regular user account on the target system, and not for system `root`. For more information about this issue, see [How to Run MySQL as a Normal User](#).

- **HTTPS.** Remote communication between the Web browser front end and the back end is not encrypted by default, which means that information such as the user's SSH password is transmitted as cleartext that is readable to anyone. For communication from a remote client to be encrypted,

the back end must have a certificate, and the front end must communicate with the back end using HTTPS rather than HTTP. Enabling HTTPS is accomplished most easily through issuing a self-signed certificate. Once the certificate is issued, you must make sure that it is used. You can do this by starting `ndb_setup.py` from the command line with the `--use-https (-S)` and `--cert-file (-c)` options.

A sample certificate file `cfg.pem` is included and is used by default. This file is located in the `mcc` directory under the installation share directory; on Linux, the full path to the file is normally `/usr/share/mysql/mcc/cfg.pem`. On Windows systems, this is usually `C:\Program Files\MySQL\MySQL Server 5.7\share\mcc\cfg.pem`. Letting the default be used means that, for testing purposes, you can simply start the installer with the `-S` option to use an HTTPS connection between the browser and the back end.

The Auto-Installer saves the configuration file for a given cluster `mycluster01` as `mycluster01.mcc` in the home directory of the user invoking the `ndb_setup.py` executable. This file is encrypted with a passphrase supplied by the user (using [Fernet](#)); because HTTP transmits the passphrase in the clear, *it is strongly recommended that you always use an HTTPS connection to access the Auto-Installer on a remote host.*

- **Certificate-based authentication.** The back end `ndb_setup.py` process can execute commands on the local host as well as remote hosts. This means that anyone connecting to the back end can take charge of how commands are executed. To reject unwanted connections to the back end, a certificate may be required for authentication of the client. In this case, a certificate must be issued by the user, installed in the browser, and made available to the back end for authentication purposes. You can enact this requirement (together with or in place of password or key authentication) by starting `ndb_setup.py` with the `--ca-certs-file (-a)` option.

There is no need or requirement for secure authentication when the client browser is running on the same host as the Auto-Installer back end.

See also [Section 6.17, “NDB Cluster Security Issues”](#), which discusses security considerations to take into account when deploying NDB Cluster, as well as [Security](#), for more general MySQL security information.

3.9.2 Using the NDB Cluster Auto-Installer

The NDB Cluster Auto-Installer interface is made up of several pages, each corresponding to a step in the process used to configure and deploy an NDB Cluster. These pages are listed here, in order:

- **Welcome:** Begin using the Auto-Installer by choosing either to configure a new NDB Cluster, or to continue configuring an existing one.
- **Define Cluster:** Set basic information about the cluster as a whole, such as name, hosts, and load type. Here you can also set the SSH authentication type for accessing remote hosts, if needed.
- **Define Hosts:** Identify the hosts where you intend to run NDB Cluster processes.
- **Define Processes:** Assign one or more processes of a given type or types to each cluster host.
- **Define Parameters:** Set configuration attributes for processes or types of processes.
- **Deploy Configuration:** Deploy the cluster with the configuration set previously; start and stop the deployed cluster.

NDB Cluster Installer Settings and Help Menus

These menus are shown on all screens except for the **Welcome** screen. They provide access to installer settings and information. The **Settings** menu is shown here in more detail:

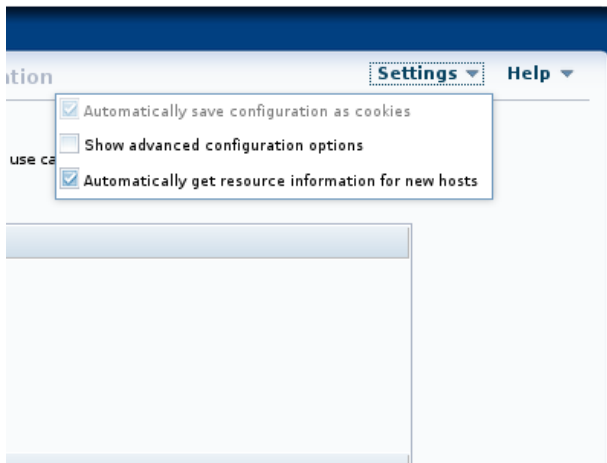
Figure 3.15 NDB Cluster Auto-Installer Settings menu

The **Settings** menu has the following entries:

- **Automatically save configuration as cookies:** Save your configuration information—such as host names, process data, and parameter values—as a cookie in the browser. When this option is chosen, all information except any SSH password is saved. This means that you can quit and restart the browser, and continue working on the same configuration from where you left off at the end of the previous session. This option is enabled by default.

The SSH password is never saved; if you use one, you must supply it at the beginning of each new session.

- **Show advanced configuration options:** Shows by default advanced configuration parameters where available.

Once set, the advanced parameters continue to be used in the configuration file until they are explicitly changed or reset. This is regardless of whether the advanced parameters are currently visible in the installer; in other words, disabling the menu item does not reset the values of any of these parameters.

You can also toggle the display of advanced parameters for individual processes on the [Define Parameters](#) screen.

This option is disabled by default.

- **Automatically get resource information for new hosts:** Query new hosts automatically for hardware resource information to pre-populate a number of configuration options and values. In this case, the suggested values are not mandatory, but they are used unless explicitly changed using the appropriate editing options in the installer.

This option is enabled by default.

The installer **Help** menu is shown here:

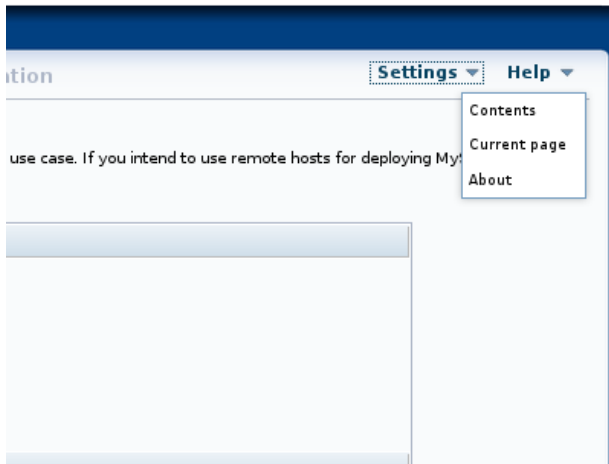
Figure 3.16 NDB Cluster Auto-Installer Help menu

The **Help** menu provides several options, described in the following list:

- **Contents:** Show the built-in user guide. This is opened in a separate browser window, so that it can be used simultaneously with the installer without interrupting workflow.
- **Current page:** Open the built-in user guide to the section describing the page currently displayed in the installer.
- **About:** open a dialog displaying the installer name and the version number of the NDB Cluster distribution with which it was supplied.

The Auto-Installer also provides context-sensitive help in the form of tooltips for most input widgets.

In addition, the names of most NDB configuration parameters are linked to their descriptions in the online documentation. The documentation is displayed in a separate browser window.

The next section discusses starting the Auto-Installer. The sections immediately following it describe in greater detail the purpose and function of each of these pages in the order listed previously.

Starting the NDB Cluster Auto-Installer

The Auto-Installer is provided together with the NDB Cluster software. Separate RPM and `.deb` packages containing only the Auto-Installer are also available for many Linux distributions. (See [Chapter 3, NDB Cluster Installation](#).)

The present section explains how to start the installer. You can do by invoking the `ndb_setup.py` executable.

User and privileges

You should run the `ndb_setup.py` as a normal user; no special privileges are needed to do so. You should *not* run this program as the `mysql` user, or using the system `root` or Administrator account; doing so may cause the installation to fail.

`ndb_setup.py` is found in the `bin` within the NDB Cluster installation directory; a typical location might be `/usr/local/mysql/bin` on a Linux system or `C:\Program Files\MySQL\MySQL Server 5.7\bin` on a Windows system. This can vary according to where the NDB Cluster software is installed on your system, and the installation method.

On Windows, you can also start the installer by running `setup.bat` in the NDB Cluster installation directory. When invoked from the command line, this batch file accepts the same options as `ndb_setup.py`.

`ndb_setup.py` can be started with any of several options that affect its operation, but it is usually sufficient to allow the default settings be used, in which case you can start `ndb_setup.py` by either of the following two methods:

1. Navigate to the NDB Cluster `bin` directory in a terminal and invoke it from the command line, without any additional arguments or options, like this:

```
$> ndb_setup.py
Running out of install dir: /usr/local/mysql/bin
Starting web server on port 8081
URL is https://localhost:8081/welcome.html
deathkey=627876
Press CTRL+C to stop web server.
The application should now be running in your browser.
(Alternatively you can navigate to https://localhost:8081/welcome.html to start it)
```

This works regardless of operating platform.

2. Navigate to the NDB Cluster `bin` directory in a file browser (such as Windows Explorer on Windows, or Konqueror, Dolphin, or Nautilus on Linux) and activate (usually by double-clicking) the `ndb_setup.py` file icon. This works on Windows, and should work with most common Linux desktops as well.

On Windows, you can also navigate to the NDB Cluster installation directory and activate the `setup.bat` file icon.

In either case, once `ndb_setup.py` is invoked, the Auto-Installer's **Welcome screen** should open in the system's default web browser. If not, you should be able to open the page <http://localhost:8081/welcome.html> or <https://localhost:8081/welcome.html> manually in the browser.

In some cases, you may wish to use non-default settings for the installer, such as specifying HTTPS for connections, or a different port for the Auto-Installer's included web server to run on, in which case you must invoke `ndb_setup.py` with one or more startup options with values overriding the necessary defaults. The same startup options can be used on Windows systems with the `setup.bat` file supplied for such platforms in the NDB Cluster software distribution. This can be done using the command line, but if you want or need to start the installer from a desktop or file browser while employing one or more of these options, it is also possible to create a script or batch file containing the proper invocation, then to double-click its file icon in the file browser to start the installer. (On Linux systems, you might also need to make the script file executable first.) If you plan to use the Auto-Installer from a remote host, you should start using the `-s` option. For information about this and other advanced startup options for the NDB Cluster Auto-Installer, see [Section 5.27, "ndb_setup.py — Start browser-based Auto-Installer for NDB Cluster \(DEPRECATED\)"](#).

NDB Cluster Auto-Installer Welcome Screen

The **Welcome** screen is loaded in the default browser when `ndb_setup.py` is invoked. The first time the Auto-Installer is run (or if for some other reason there are no existing configurations), this screen appears as shown here:

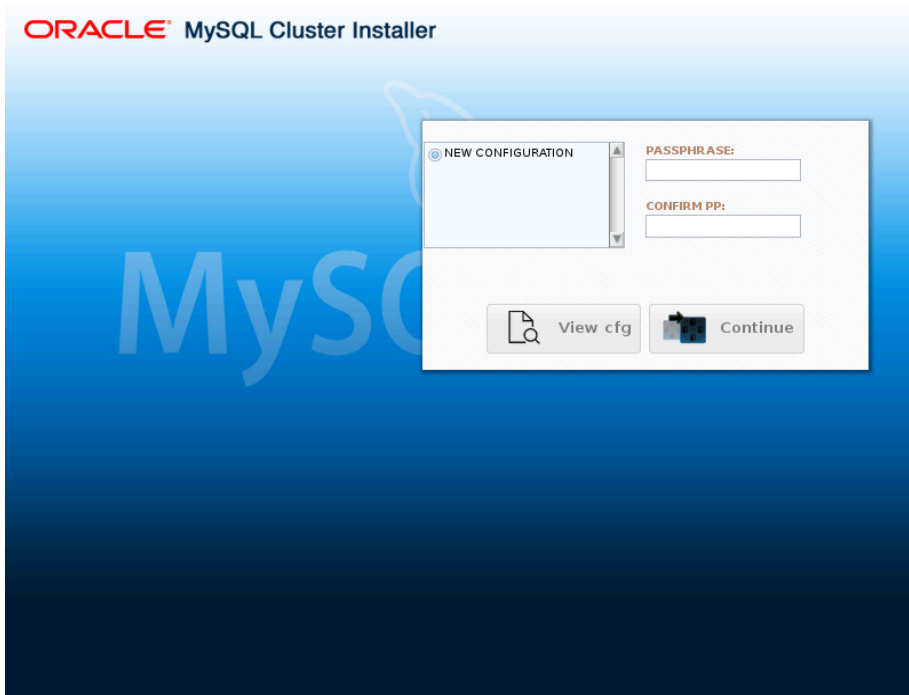
Figure 3.17 The NDB Cluster Auto-Installer Welcome screen, first run

In this case, the only choice of cluster listed is for configuration of a new cluster, and both the **View Cfg** and **Continue** buttons are inactive.

To create a new configuration, enter and confirm a passphrase in the text boxes provided. When this has been done, you can click **Continue** to proceed to the **Define Cluster** screen where you can assign a name to the new cluster.

If you have previously created one or more clusters with the Auto-Installer, they are listed by name. This example shows an existing cluster named `mycluster-1`:

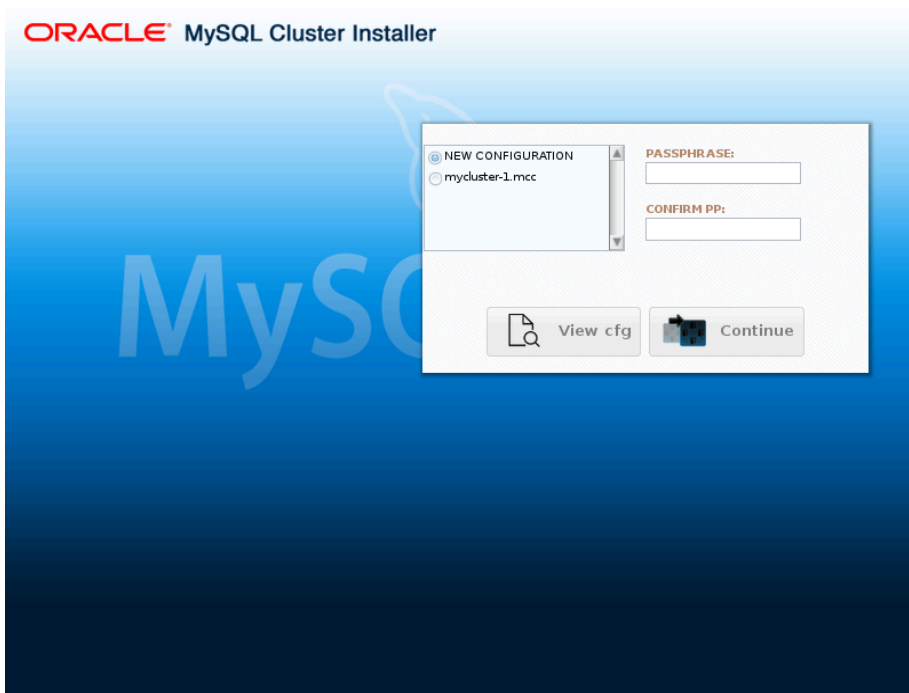
Figure 3.18 The NDB Cluster Auto-Installer Welcome screen, with previously created cluster mycluster-1

To view the configuration for and work with a given cluster, select the radiobutton next to its name in the list, then enter and confirm the passphrase that was used to create it. When you have done this correctly, you can click **View Cfg** to view and edit this cluster's configuration.

NDB Cluster Auto-Installer Define Cluster Screen

The **Define Cluster** screen is appears following the [Welcome screen](#), and is used for setting general properties of the cluster. The layout of the **Define Cluster** screen is shown here:

Figure 3.19 The NDB Cluster Auto-Installer Define Cluster screen

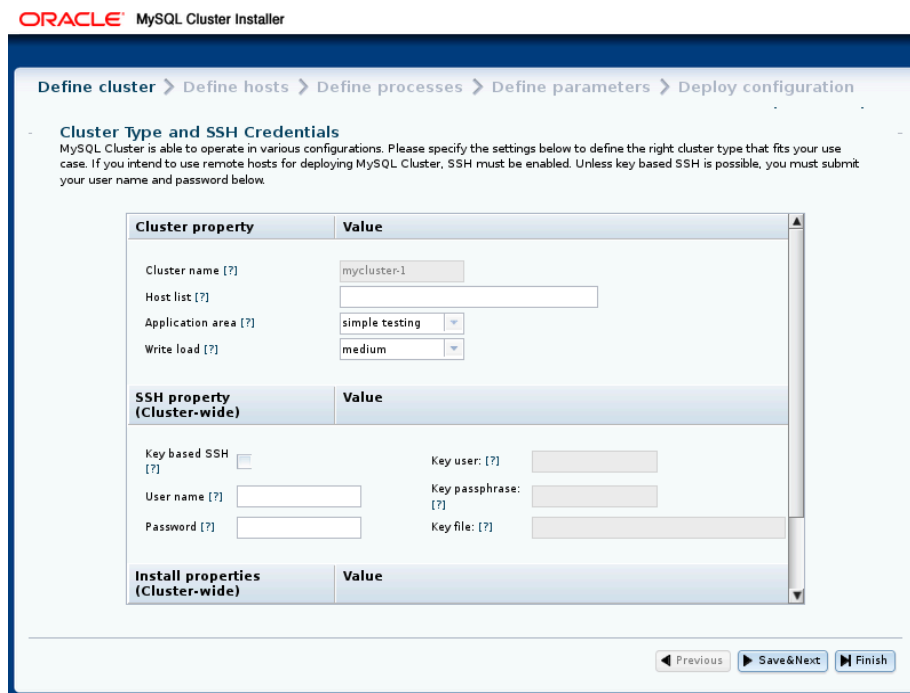

This screen and subsequent screens also include **Settings** and **Help** menus which are described later in this section; see [NDB Cluster Installer Settings and Help Menus](#).

The **Define Cluster** screen allows you to set three sorts of properties for the cluster: cluster properties, SSH properties, and installation properties.

Cluster properties that can be set on this screen are listed here:

- **Cluster name:** A name that identifies the cluster; in this example, this is `mycluster-1`. The name is set on the previous screen and cannot be changed here.
- **Host list:** A comma-delimited list of one or more hosts where cluster processes should run. By default, this is `127.0.0.1`. If you add remote hosts to the list, you must be able to connect to them using the credentials supplied as SSH properties.
- **Application type:** Choose one of the following:
 1. **Simple testing:** Minimal resource usage for small-scale testing. This the default. *Not intended for production environments.*
 2. **Web:** Maximize performance for the given hardware.
 3. **Real-time:** Maximize performance while maximizing sensitivity to timeouts in order to minimize the time needed to detect failed cluster processes.
- **Write load:** Choose a level for the anticipated number of writes for the cluster as a whole. You can choose any one of the following levels:

1. **Low:** The expected load includes fewer than 100 write transactions for second.
2. **Medium:** The expected load includes 100 to 1000 write transactions per second; this is the default.
3. **High:** The expected load includes more than 1000 write transactions per second.

SSH properties are described in the following list:

- **Key-Based SSH:** Check this box to use key-enabled login to the remote host. If checked, the key user and passphrase must also be supplied; otherwise, a user and password for a remote login account are needed.
- **User:** Name of user with remote login access.
- **Password:** Password for remote user.
- **Key user:** Name of the user for whom the key is valid, if not the same as the operating system user.
- **Key passphrase:** Passphrase for the key, if required.
- **Key file:** Path to the key file. The default is `~/.ssh/id_rsa`.

The SSH properties set on this page apply to all hosts in the cluster. They can be overridden for a given host by editing that host's properties on the **Define Hosts** screen.

Two installation properties can also be set on this screen:

- **Install MySQL Cluster:** This setting determines the source from which the Auto-Installer installs NDB Cluster software, if any, on the cluster hosts. Possible values and their effects are listed here:
 1. **DOCKER:** Try to install the MySQL Cluster Docker image from <https://hub.docker.com/r/mysql/mysql-cluster/> on each host
 2. **REPO:** Try to install the NDB Cluster software from the [MySQL Repositories](#) on each host
 3. **BOTH:** Try to install either the Docker image or the software from the repository on each host, giving preference to the repository
 4. **NONE:** Do not install the NDB Cluster software on the hosts; this is the default
- **Open FW Ports:** Check this check box to have the installer attempt to open ports required by NDB Cluster processes on all hosts.

The next figure shows the **Define Cluster** page with settings for a small test cluster with all nodes running on `localhost`:

Figure 3.20 The NDB Cluster Auto-Installer Define Cluster screen, with settings for a test cluster

ORACLE MySQL Cluster Installer

Define cluster > Define hosts > Define processes > Define parameters > Deploy configuration

Settings Help

Cluster Type and SSH Credentials
 MySQL Cluster is able to operate in various configurations. Please specify the settings below to define the right cluster type that fits your use case. If you intend to use remote hosts for deploying MySQL Cluster, SSH must be enabled. Unless key based SSH is possible, you must submit your user name and password below.

Cluster property	Value
Cluster name [?]	mycluster-1
Host list [?]	localhost
Application area [?]	simple testing
Write load [?]	low

SSH property (Cluster-wide)	Value
Key based SSH [?]	<input type="checkbox"/>
User name [?]	<input type="text"/>
Password [?]	<input type="text"/>
Key user: [?]	<input type="text"/>
Key passphrase: [?]	<input type="text"/>
Key file: [?]	<input type="text"/>

Install properties (Cluster-wide)	Value
Install MySQL Cluster [?]	NONE
Open FW ports [?]	<input type="checkbox"/>

Previous Save & Next Finish

After making the desired settings, you can save them to the configuration file and proceed to the **Define Hosts** screen by clicking the **Save & Next** button.

If you exit the installer without saving, no changes are made to the configuration file.

NDB Cluster Auto-Installer Define Hosts Screen

The **Define Hosts** screen, shown here, provides a means of viewing and specifying several key properties of each cluster host:

Figure 3.21 NDB Cluster Define Hosts screen, start

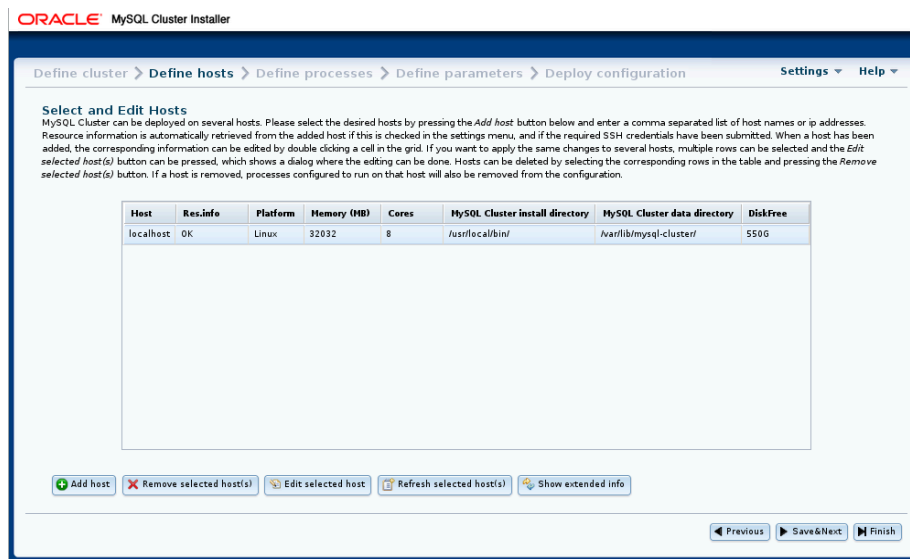

Properties shown include the following:

- **Host:** Name or IP address of this host
- **Res.info:** Shows **OK** if the installer was able to retrieve requested resource information from this host
- **Platform:** Operating system or platform
- **Memory (MB):** Amount of RAM on this host
- **Cores:** Number of CPU cores available on this host
- **MySQL Cluster install directory:** Path to directory where the NDB Cluster software is installed on this host; defaults to `/usr/local/bin`
- **MySQL Cluster data directory:** Path to directory used for data by NDB Cluster processes on this host; defaults to `/var/lib/mysql-cluster`.
- **DiskFree:** Free disk space in bytes

For hosts with multiple disks, only the space available on the disk used for the data directory is shown.

This screen also provides an extended view for each host that includes the following properties:

- **FDQN:** This host's fully qualified domain name, used by the installer to connect with it, distribute configuration information to it, and start and stop cluster processes on it.
- **Internal IP:** The IP address used for communication with cluster processes running on this host by processes running elsewhere.
- **OS Details:** Detailed operating system name and version information.
- **Open FW:** If this check box is enabled, the installer attempts to open ports in the host's firewall needed by cluster processes.
- **REPO URL:** URL for MySQL NDB Cluster repository
- **DOCKER URL:** URL for MySQL NDB Cluster Docker images; for NDB 8.0, this is `mysql/mysql-cluster:8.0`.
- **Install:** If this check box is enabled, the Auto-Installer attempts to install the NDB Cluster software on this host

The extended view is shown here:

Figure 3.22 NDB Cluster Define Hosts screen, extended host info view

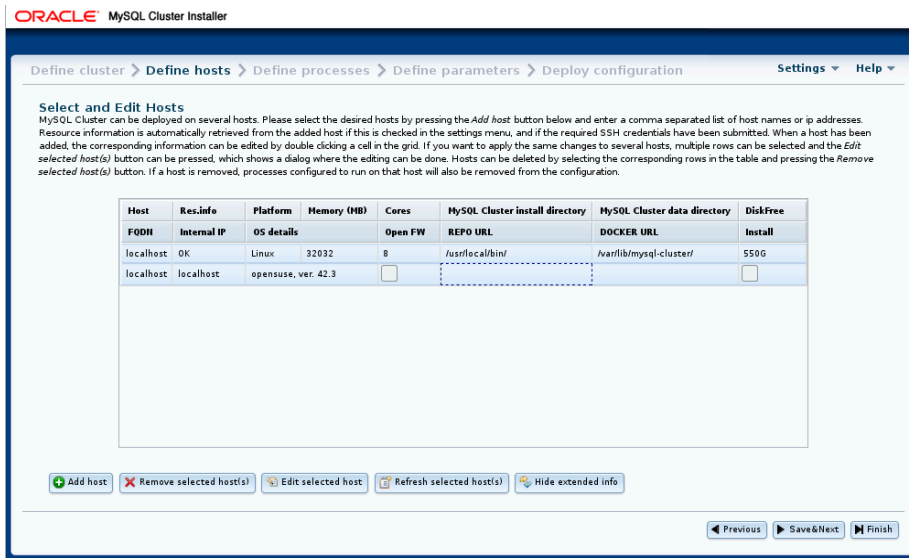

All cells in the display are editable, with the exceptions of those in the **Host**, **Res.info**, and **FQDN** columns.

Be aware that it may take some time for information to be retrieved from remote hosts. Fields for which no value could be retrieved are indicated with an ellipsis (...). You can retry the fetching of resource information from one or more hosts by selecting the hosts in the list and then clicking the **Refresh selected host(s)** button.

Adding and Removing Hosts

You can add one or more hosts by clicking the **Add Host** button and entering the required properties where indicated in the **Add new host** dialog, shown here:

Figure 3.23 NDB Cluster Add Host dialog

Add new host [X]

Host name: [?]
[Red border and warning icon]

Host internal IP (VPN): [?]
[Empty text box]

Key-based auth: [?]

User [?] Passphrase [?]
[Empty text box] [Empty text box]

Key file [?]
[Empty text box]

Ordinary login:
User [?] Password [?]
[Empty text box] [Empty text box]

Open FW ports [?] Configure installation [?]

Cancel **Add**

This dialog includes the following fields:

- **Host name:** A comma-separated list of one or more host names, IP addresses, or both. These must be accessible from the host where the Auto-Installer is running.
- **Host internal IP (VPN):** If you are setting up the cluster to run on a VPN or other internal network, enter the IP address or addresses used for contact by cluster nodes on other hosts.

- **Key-based auth:** If checked, enables key-based authentication. You can enter any additional needed information in the **User**, **Passphrase**, and **Key file** fields.
- **Ordinary login:** If accessing this host using a password-based login, enter the appropriate information in the **User** and **Password** fields.
- **Open FW ports:** Selecting this check box allows the installer try opening any ports needed by cluster processes in this host's firewall.
- **Configure installation:** Checking this allows the Auto-Install to attempt to set up the NDB Cluster software on this host.

To save the new host and its properties, click **Add**. If you wish to cancel without saving any changes, click **Cancel** instead.

Similarly, you can remove one or more hosts using the button labelled **Remove selected host(s)**. *When you remove a host, any process which was configured for that host is also removed.*

Warning

Remove selected host(s) acts immediately. There is no confirmation dialog. If you remove a host in error, you must re-enter its name and properties manually using **Add host**.

If the SSH user credentials on the [Define Cluster screen](#) are changed, the Auto-Installer attempts to refresh the resource information from any hosts for which information is missing.

You can edit the host's platform name, hardware resource information, installation directory, and data directory by clicking the corresponding cell in the grid, by selecting one or more hosts and clicking the button labelled **Edit selected host(s)**. This causes a dialog box to appear, in which these fields can be edited, as shown here:

Figure 3.24 NDB Cluster Auto-Installer Edit Hosts dialog

Please edit the fields you want to change. The changes will be applied to all selected hosts. Fields that are not edited in the form below will be left unchanged.

Platform [?]	Memory (MB) [?]	CPU cores [?]	MySQL Cluster install directory [?]	MySQL Cluster data directory [?]	DiskFree [?]
Linux	32,032	8			550G

Host external IP: [?]

Host internal IP (VPN): [?]

Key-based auth: [?]

User [?] Passphrase [?]

Key file [?]

Ordinary login:

User [?] Password [?]

Open FW ports [?] Configure installation [?]

When more than one host is selected, any edited values are applied to all selected hosts.

Once you have entered all desired host information, you can use the **Save & Next** button to save the information to the cluster's configuration file and proceed to the [Define Processes screen](#), where you can set up NDB Cluster processes on one or more hosts.

NDB Cluster Auto-Installer Define Processes Screen

The **Define Processes** screen, shown here, provides a way to assign NDB Cluster processes (nodes) to cluster hosts:

Figure 3.25 NDB Cluster Auto-Installer Define Processes dialog

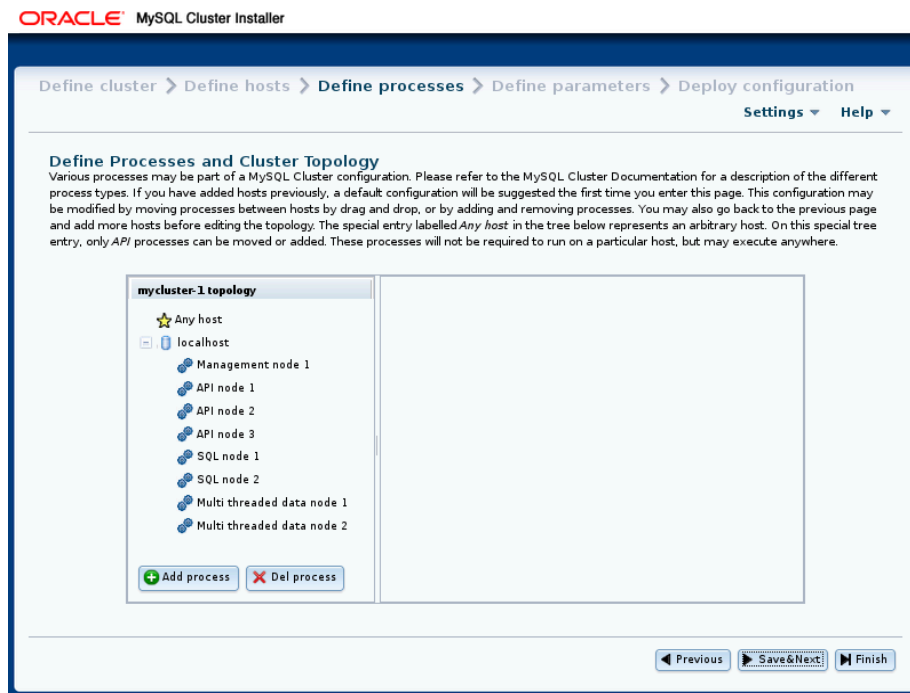

This screen contains a process tree showing cluster hosts and processes set up to run on each one, as well as a panel which displays information about the item currently selected in the tree.

When this screen is accessed for the first time for a given cluster, a default set of processes is defined for you, based on the number of hosts. If you later return to the [Define Hosts screen](#), remove all hosts, and add new hosts, this also causes a new default set of processes to be defined.

NDB Cluster processes are of the types described in this list:

- **Management node.** Performs administrative tasks such as stopping individual data nodes, querying node and cluster status, and making backups. Executable: `ndb_mgmd`.
- **Single-threaded data node.** Stores data and executes queries. Executable: `ndbd`.
- **Multi threaded data node.** Stores data and executes queries with multiple worker threads executing in parallel. Executable: `ndbmt.d`.
- **SQL node.** MySQL server for executing SQL queries against NDB. Executable: `mysqld`.
- **API node.** A client accessing data in NDB by means of the NDB API or other low-level client API, rather than by using SQL. See [MySQL NDB Cluster API Developer Guide](#), for more information.

For more information about process (node) types, see [Section 2.1, “NDB Cluster Core Concepts”](#).

Processes shown in the tree are numbered sequentially by type, for each host—for example, `SQL node 1`, `SQL node 2`, and so on—to simplify identification.

Each management node, data node, or SQL process must be assigned to a specific host, and is not allowed to run on any other host. An API node *may* be assigned to a single host, but this is not required. Instead, you can assign it to the special **Any host** entry which the tree also contains in addition to any other hosts, and which acts as a placeholder for processes that are allowed to run on any host. *Only API processes may use this Any host entry.*

Adding processes. To add a new process to a given host, either right-click that host's entry in the tree, then select the **Add process** popup when it appears, or select a host in the process tree, and press the **Add process** button below the process tree. Performing either of these actions opens the add process dialog, as shown here:

Figure 3.26 NDB Cluster Auto-Installer Add Process Dialog

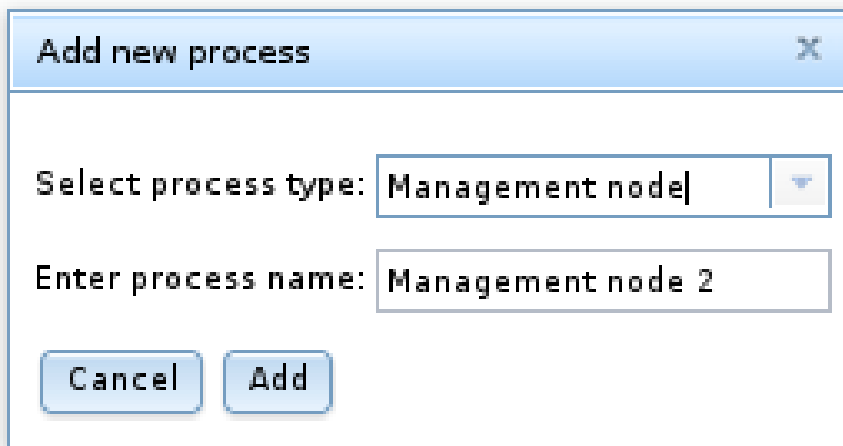

Here you can select from among the available process types described earlier in this section; you can also enter an arbitrary process name to take the place of the suggested value, if desired.

Removing processes. To delete a process, select that process in the tree and use the **Del process** button.

When you select a process in the process tree, information about that process is displayed in the information panel, where you can change the process name and possibly its type. You can change a multi-threaded data node (`ndbmt_d`) to a single-threaded data node (`ndbd`), or the reverse, only; no other process type changes are allowed. *If you want to make a change between any other process types, you must delete the original process first, then add a new process of the desired type.*

NDB Cluster Auto-Installer Define Parameters Screen

Like the [Define Processes screen](#), this screen includes a process tree; the **Define Parameters** process tree is organized by process or node type, in groups labelled **Management Layer**, **Data Layer**, **SQL Layer**, and **API Layer**. An information panel displays information regarding the item currently selected. The **Define Attributes** screen is shown here:

Figure 3.27 NDB Cluster Auto-Installer Define Parameters screen

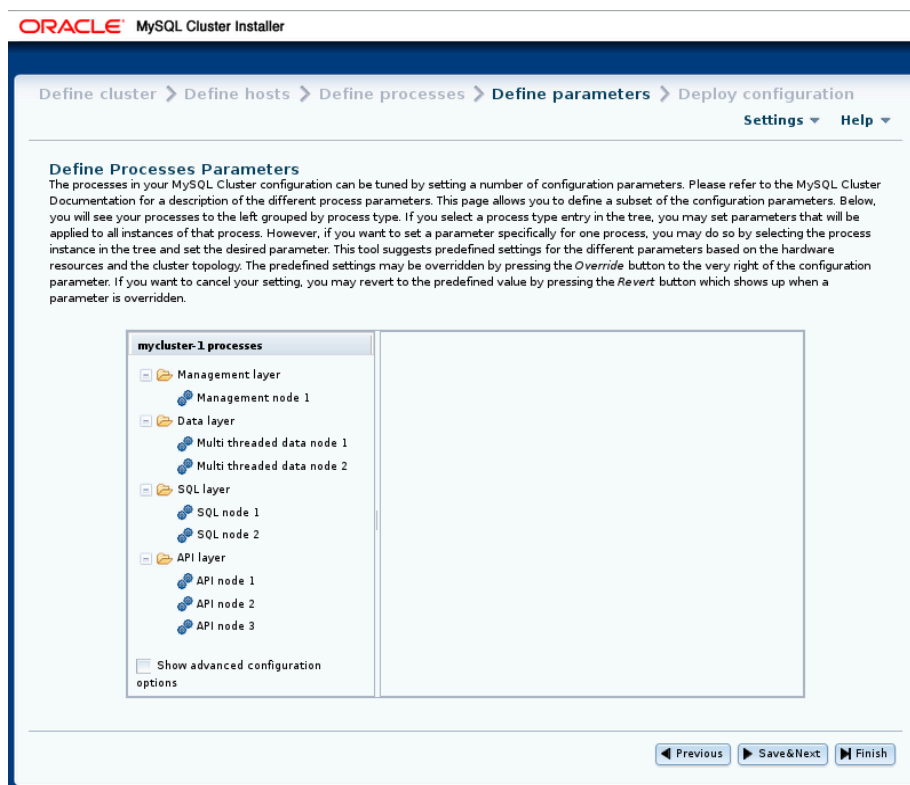

The check box labelled **Show advanced configuration**, when checked, makes advanced options for data node and SQL node processes visible in the information pane. These options are set and used whether or not they are visible. You can also enable this behavior globally by checking **Show advanced configuration options** under **Settings** (see [NDB Cluster Installer Settings and Help Menus](#)).

You can edit attributes for a single process by selecting that process from the tree, or for all processes of the same type in the cluster by selecting one of the **Layer** folders. A per-process value set for a given attribute overrides any per-group setting for that attribute that would otherwise apply to the process in question. An example of such an information panel (for an SQL process) is shown here:

Figure 3.28 Define Parameters—Process Attributes

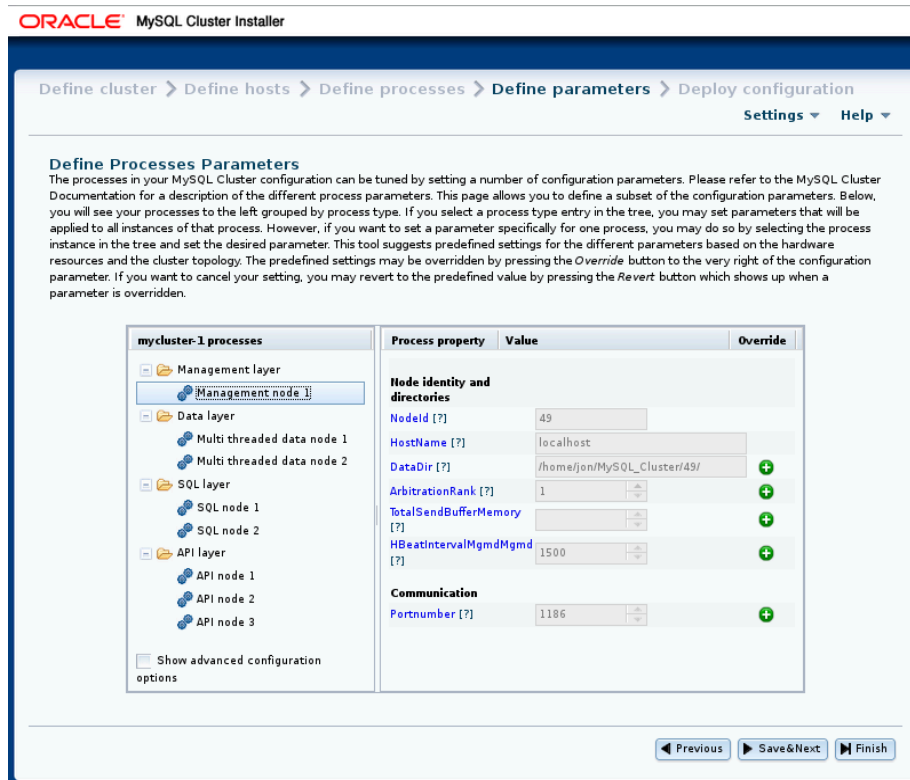

Attributes whose values can be overridden are shown in the information panel with a button bearing a plus sign. This + button activates an input widget for the attribute, enabling you to change its value. When the value has been overridden, this button changes into a button showing an X. The X button undoes any changes made to a given attribute, which immediately reverts to the predefined value.

All configuration attributes have predefined values calculated by the installer, based such factors as host name, node ID, node type, and so on. In most cases, these values may be left as they are. If you are not familiar with it already, it is highly recommended that you read the applicable documentation before making changes to any of the attribute values. To make finding this information easier, each attribute name shown in the information panel is linked to its description in the online NDB Cluster documentation.

NDB Cluster Auto-Installer Deploy Configuration Screen

This screen allows you to perform the following tasks:

- Review process startup commands and configuration files to be applied
- Distribute configuration files by creating any necessary files and directories on all cluster hosts—that is, *deploy* the cluster as presently configured
- Start and stop the cluster

The **Deploy Configuration** screen is shown here:

Figure 3.29 NDB Cluster Auto-Installer Deploy Configuration screen

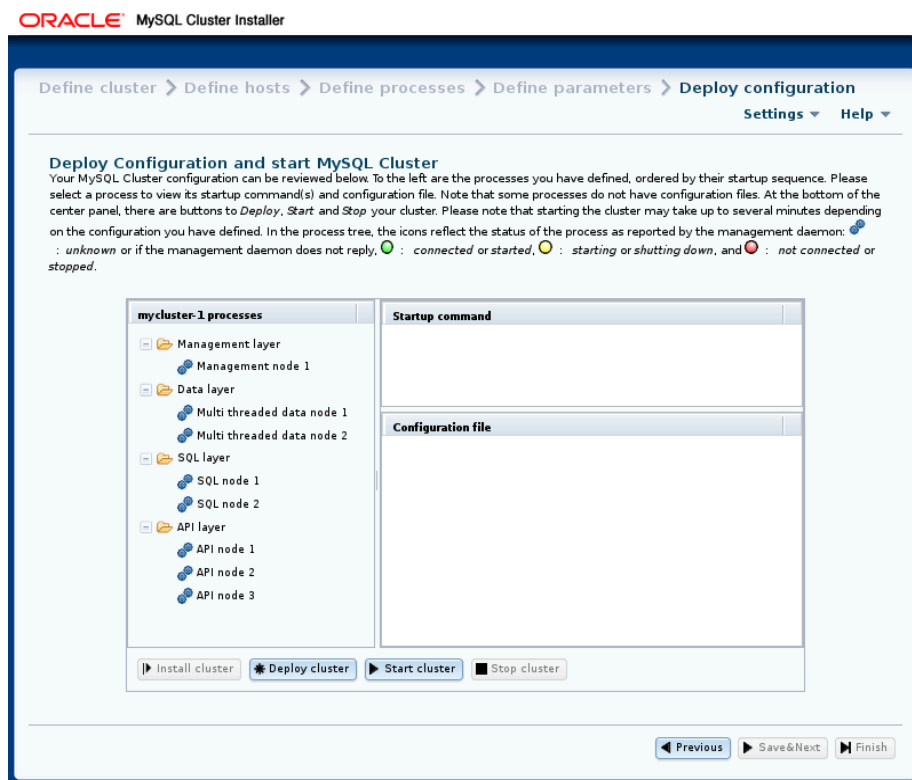

Like the [Define Parameters](#) screen, this screen features a process tree which is organized by process type. Next to each process in the tree is a status icon indicating the current status of the process: connected (**CONNECTED**), starting (**STARTING**), running (**STARTED**), stopping (**STOPPING**), or disconnected (**NO_CONTACT**). The icon shows green if the process is connected or running; yellow if it is starting or stopping; red if the process is stopped or cannot be contacted by the management server.

This screen also contains two information panels, one showing the startup command or commands needed to start the selected process. (For some processes, more than one command may be required—for example, if initialization is necessary.) The other panel shows the contents of the configuration file, if any, for the given process.

This screen also contains four buttons, labelled as and performing the functions described in the following list:

- **Install cluster:** Nonfunctional in this release; implementation intended for a future release.
- **Deploy cluster:** Verify that the configuration is valid. Create any directories required on the cluster hosts, and distribute the configuration files onto the hosts. A progress bar shows how far the deployment has proceeded, as shown here, and a dialog is displayed when the deployment has completed, as shown here:

Figure 3.30 Cluster Deployment Process

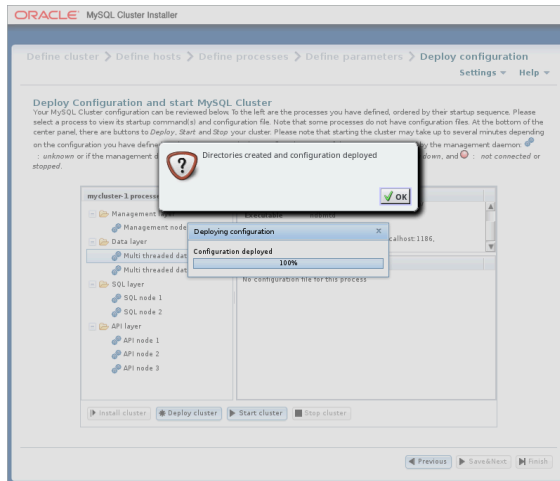

- **Start cluster:** The cluster is deployed as with **Deploy cluster**, after which all cluster processes are started in the correct order.

Starting these processes may take some time. If the estimated time to completion is too large, the installer provides an opportunity to cancel or to continue of the startup procedure. A progress bar indicates the current status of the startup procedure, as shown here:

Figure 3.31 Cluster Startup Process with Progress Bar

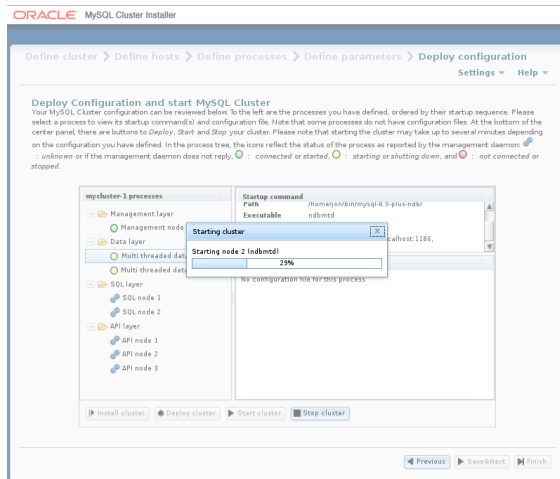

The process status icons next to the items shown in the process tree also update with the status of each process.

A confirmation dialog is shown when the startup process has completed, as shown here:

Figure 3.32 Cluster Startup, Process Completed Dialog

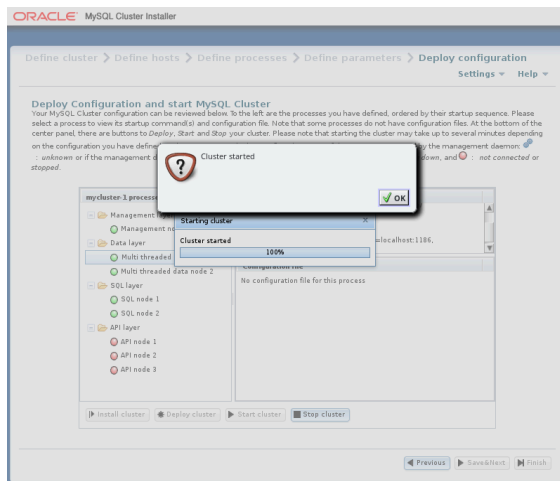

- **Stop cluster:** After the cluster has been started, you can stop it using this. As with starting the cluster, cluster shutdown is not instantaneous, and may require some time complete. A progress bar, similar to that displayed during cluster startup, shows the approximate current status of the cluster

shutdown procedure, as do the process status icons adjoining the process tree. The progress bar is shown here:

Figure 3.33 Cluster Shutdown Process, with Progress Bar

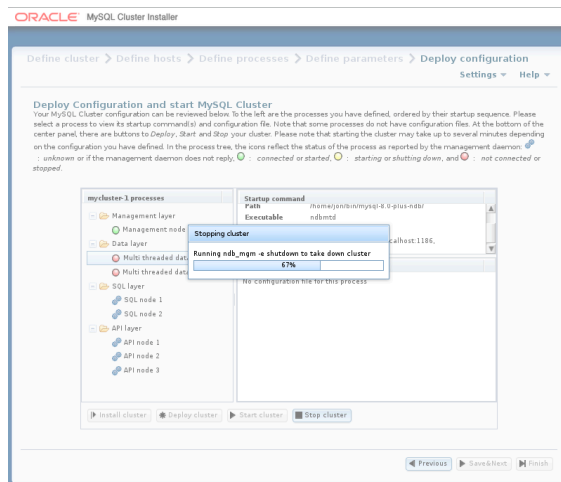

A confirmation dialog indicates when the shutdown process is complete:

Figure 3.34 Cluster Shutdown, Process Completed Dialog

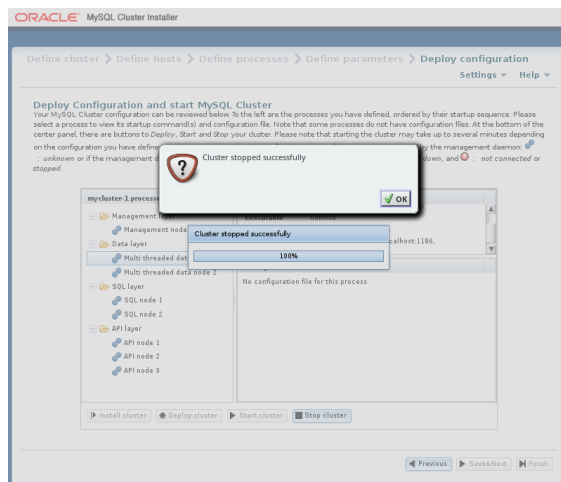

The Auto-Installer generates a `config.ini` file containing NDB node parameters for each management node, as well as a `my.cnf` file containing the appropriate options for each `mysqld` process in the cluster. No configuration files are created for data nodes or API nodes.

Chapter 4 Configuration of NDB Cluster

Table of Contents

4.1 Quick Test Setup of NDB Cluster	111
4.2 Overview of NDB Cluster Configuration Parameters, Options, and Variables	113
4.2.1 NDB Cluster Data Node Configuration Parameters	114
4.2.2 NDB Cluster Management Node Configuration Parameters	120
4.2.3 NDB Cluster SQL Node and API Node Configuration Parameters	121
4.2.4 Other NDB Cluster Configuration Parameters	122
4.2.5 NDB Cluster mysqld Option and Variable Reference	123
4.3 NDB Cluster Configuration Files	131
4.3.1 NDB Cluster Configuration: Basic Example	132
4.3.2 Recommended Starting Configuration for NDB Cluster	135
4.3.3 NDB Cluster Connection Strings	138
4.3.4 Defining Computers in an NDB Cluster	139
4.3.5 Defining an NDB Cluster Management Server	140
4.3.6 Defining NDB Cluster Data Nodes	146
4.3.7 Defining SQL and Other API Nodes in an NDB Cluster	216
4.3.8 Defining the System	224
4.3.9 MySQL Server Options and Variables for NDB Cluster	225
4.3.10 NDB Cluster TCP/IP Connections	268
4.3.11 NDB Cluster TCP/IP Connections Using Direct Connections	273
4.3.12 NDB Cluster Shared Memory Connections	274
4.3.13 Configuring NDB Cluster Send Buffer Parameters	280
4.4 Using High-Speed Interconnects with NDB Cluster	281

A MySQL server that is part of an NDB Cluster differs in one chief respect from a normal (nonclustered) MySQL server, in that it employs the [NDB](#) storage engine. This engine is also referred to sometimes as [NDBCLUSTER](#), although [NDB](#) is preferred.

To avoid unnecessary allocation of resources, the server is configured by default with the [NDB](#) storage engine disabled. To enable [NDB](#), you must modify the server's `my.cnf` configuration file, or start the server with the `--ndbcluster` option.

This MySQL server is a part of the cluster, so it also must know how to access a management node to obtain the cluster configuration data. The default behavior is to look for the management node on `localhost`. However, should you need to specify that its location is elsewhere, this can be done in `my.cnf`, or with the `mysql` client. Before the [NDB](#) storage engine can be used, at least one management node must be operational, as well as any desired data nodes.

For more information about `--ndbcluster` and other `mysqld` options specific to NDB Cluster, see [Section 4.3.9.1, “MySQL Server Options for NDB Cluster”](#).

For general information about installing NDB Cluster, see [Chapter 3, NDB Cluster Installation](#).

4.1 Quick Test Setup of NDB Cluster

To familiarize you with the basics, we describe the simplest possible configuration for a functional NDB Cluster. After this, you should be able to design your desired setup from the information provided in the other relevant sections of this chapter.

First, you need to create a configuration directory such as `/var/lib/mysql-cluster`, by executing the following command as the system `root` user:

```
$> mkdir /var/lib/mysql-cluster
```

In this directory, create a file named `config.ini` that contains the following information. Substitute appropriate values for `HostName` and `DataDir` as necessary for your system.

```
# file "config.ini" - showing minimal setup consisting of 1 data node,
# 1 management server, and 3 MySQL servers.
# The empty default sections are not required, and are shown only for
# the sake of completeness.
# Data nodes must provide a hostname but MySQL Servers are not required
# to do so.
# If you don't know the hostname for your machine, use localhost.
# The DataDir parameter also has a default value, but it is recommended to
# set it explicitly.
# Note: [db], [api], and [mgm] are aliases for [ndbd], [mysqld], and [ndb_mgmd],
# respectively. [db] is deprecated and should not be used in new installations.

[ndbd default]
NoOfReplicas= 1

[mysqld default]
[ndb_mgmd default]
[tcp default]

[ndb_mgmd]
HostName= myhost.example.com

[ndbd]
HostName= myhost.example.com
DataDir= /var/lib/mysql-cluster

[mysqld]
[mysqld]
[mysqld]
```

You can now start the `ndb_mgmd` management server. By default, it attempts to read the `config.ini` file in its current working directory, so change location into the directory where the file is located and then invoke `ndb_mgmd`:

```
$> cd /var/lib/mysql-cluster
$> ndb_mgmd
```

Then start a single data node by running `ndbd`:

```
$> ndbd
```

By default, `ndbd` looks for the management server at `localhost` on port 1186.

Note

If you have installed MySQL from a binary tarball, you must specify the path of the `ndb_mgmd` and `ndbd` servers explicitly. (Normally, these can be found in `/usr/local/mysql/bin`.)

Finally, change location to the MySQL data directory (usually `/var/lib/mysql` or `/usr/local/mysql/data`), and make sure that the `my.cnf` file contains the option necessary to enable the NDB storage engine:

```
[mysqld]
ndbcluster
```

You can now start the MySQL server as usual:

```
$> mysqld_safe --user=mysql &
```

Wait a moment to make sure the MySQL server is running properly. If you see the notice `mysql ended`, check the server's `.err` file to find out what went wrong.

If all has gone well so far, you now can start using the cluster. Connect to the server and verify that the `NDBCLUSTER` storage engine is enabled:

```
$> mysql
Welcome to the MySQL monitor.  Commands end with ; or \g.
Your MySQL connection id is 1 to server version: 5.7.36

Type 'help;' or '\h' for help. Type '\c' to clear the buffer.

mysql> SHOW ENGINES\G
...
***** 12. row *****
Engine: NDBCLUSTER
Support: YES
Comment: Clustered, fault-tolerant, memory-based tables
***** 13. row *****
Engine: NDB
Support: YES
Comment: Alias for NDBCLUSTER
...
```

The row numbers shown in the preceding example output may be different from those shown on your system, depending upon how your server is configured.

Try to create an `NDBCLUSTER` table:

```
$> mysql
mysql> USE test;
Database changed

mysql> CREATE TABLE ctest (i INT) ENGINE=NDBCLUSTER;
Query OK, 0 rows affected (0.09 sec)

mysql> SHOW CREATE TABLE ctest \G
***** 1. row *****
      Table: ctest
Create Table: CREATE TABLE `ctest` (
  `i` int(11) default NULL
) ENGINE=ndbcluster DEFAULT CHARSET=latin1
1 row in set (0.00 sec)
```

To check that your nodes were set up properly, start the management client:

```
$> ndb_mgm
```

Use the `SHOW` command from within the management client to obtain a report on the cluster's status:

```
ndb_mgm> SHOW
Cluster Configuration
-----
[ndbd(NDB)]      1 node(s)
id=2             @127.0.0.1 (Version: 5.7.36-ndb-7.5.25, Nodegroup: 0, *)

[ndb_mgmd(MGM)] 1 node(s)
id=1             @127.0.0.1 (Version: 5.7.36-ndb-7.5.25)

[mysqld(API)]   3 node(s)
id=3             @127.0.0.1 (Version: 5.7.36-ndb-7.5.25)
id=4 (not connected, accepting connect from any host)
id=5 (not connected, accepting connect from any host)
```

At this point, you have successfully set up a working NDB Cluster . You can now store data in the cluster by using any table created with `ENGINE=NDBCLUSTER` or its alias `ENGINE=NDB`.

4.2 Overview of NDB Cluster Configuration Parameters, Options, and Variables

The next several sections provide summary tables of NDB Cluster node configuration parameters used in the `config.ini` file to govern various aspects of node behavior, as well as of options and variables read by `mysqld` from a `my.cnf` file or from the command line when run as an NDB Cluster process. Each of the node parameter tables lists the parameters for a given type (`ndbd`, `ndb_mgmd`, `mysqld`,

`computer`, `tcp`, or `shm`). All tables include the data type for the parameter, option, or variable, as well as its default, minimum, and maximum values as applicable.

Considerations when restarting nodes. For node parameters, these tables also indicate what type of restart is required (node restart or system restart)—and whether the restart must be done with `--initial`—to change the value of a given configuration parameter. When performing a node restart or an initial node restart, all of the cluster's data nodes must be restarted in turn (also referred to as a *rolling restart*). It is possible to update cluster configuration parameters marked as `node` online—that is, without shutting down the cluster—in this fashion. An initial node restart requires restarting each `ndbd` process with the `--initial` option.

A system restart requires a complete shutdown and restart of the entire cluster. An initial system restart requires taking a backup of the cluster, wiping the cluster file system after shutdown, and then restoring from the backup following the restart.

In any cluster restart, all of the cluster's management servers must be restarted for them to read the updated configuration parameter values.

Important

Values for numeric cluster parameters can generally be increased without any problems, although it is advisable to do so progressively, making such adjustments in relatively small increments. Many of these can be increased online, using a rolling restart.

However, decreasing the values of such parameters—whether this is done using a node restart, node initial restart, or even a complete system restart of the cluster—is not to be undertaken lightly; it is recommended that you do so only after careful planning and testing. This is especially true with regard to those parameters that relate to memory usage and disk space, such as `MaxNoOfTables`, `MaxNoOfOrderedIndexes`, and `MaxNoOfUniqueHashIndexes`. In addition, it is generally the case that configuration parameters relating to memory and disk usage can be raised using a simple node restart, but they require an initial node restart to be lowered.

Because some of these parameters can be used for configuring more than one type of cluster node, they may appear in more than one of the tables.

Note

`4294967039` often appears as a maximum value in these tables. This value is defined in the `NDBCLUSTER` sources as `MAX_INT_RNII` and is equal to `0xFFFFFFFF`, or $2^{32} - 2^8 - 1$.

4.2.1 NDB Cluster Data Node Configuration Parameters

The listings in this section provide information about parameters used in the `[ndbd]` or `[ndbd default]` sections of a `config.ini` file for configuring NDB Cluster data nodes. For detailed descriptions and other additional information about each of these parameters, see [Section 4.3.6, “Defining NDB Cluster Data Nodes”](#).

These parameters also apply to `ndbmttd`, the multithreaded version of `ndbd`. A separate listing of parameters specific to `ndbmttd` follows.

- `Arbitration`: How arbitration should be performed to avoid split-brain issues in event of node failure.
- `ArbitrationTimeout`: Maximum time (milliseconds) database partition waits for arbitration signal.
- `BackupDataBufferSize`: Default size of databuffer for backup (in bytes).

- [BackupDataDir](#): Path to where to store backups. Note that string '/BACKUP' is always appended to this setting, so that *effective* default is FileSystemPath/BACKUP.
- [BackupDiskWriteSpeedPct](#): Sets percentage of data node's allocated maximum write speed (MaxDiskWriteSpeed) to reserve for LCPs when starting backup.
- [BackupLogBufferSize](#): Default size of log buffer for backup (in bytes).
- [BackupMaxWriteSize](#): Maximum size of file system writes made by backup (in bytes).
- [BackupMemory](#): Total memory allocated for backups per node (in bytes).
- [BackupReportFrequency](#): Frequency of backup status reports during backup in seconds.
- [BackupWriteSize](#): Default size of file system writes made by backup (in bytes).
- [BatchSizePerLocalScan](#): Used to calculate number of lock records for scan with hold lock.
- [BuildIndexThreads](#): Number of threads to use for building ordered indexes during system or node restart. Also applies when running `ndb_restore --rebuild-indexes`. Setting this parameter to 0 disables multithreaded building of ordered indexes.
- [CompressedBackup](#): Use zlib to compress backups as they are written.
- [CompressedLCP](#): Write compressed LCPs using zlib.
- [ConnectCheckIntervalDelay](#): Time between data node connectivity check stages. Data node is considered suspect after 1 interval and dead after 2 intervals with no response.
- [CrashOnCorruptedTuple](#): When enabled, forces node to shut down whenever it detects corrupted tuple.
- [DataDir](#): Data directory for this node.
- [DataMemory](#): Number of bytes on each data node allocated for storing data; subject to available system RAM and size of IndexMemory.
- [DefaultHashMapSize](#): Set size (in buckets) to use for table hash maps. Three values are supported: 0, 240, and 3840.
- [DictTrace](#): Enable DBDICT debugging; for NDB development.
- [DiskIOThreadPool](#): Number of unbound threads for file access, applies to disk data only.
- [Diskless](#): Run without using disk.
- [DiskPageBufferEntries](#): Memory to allocate in DiskPageBufferMemory; very large disk transactions may require increasing this value.
- [DiskPageBufferMemory](#): Number of bytes on each data node allocated for disk page buffer cache.
- [DiskSyncSize](#): Amount of data written to file before synch is forced.
- [EnablePartialLcp](#): Enable partial LCP (true); if this is disabled (false), all LCPs write full checkpoints.
- [EnableRedoControl](#): Enable adaptive checkpointing speed for controlling redo log usage.
- [EventLogBufferSize](#): Size of circular buffer for NDB log events within data nodes.
- [ExecuteOnComputer](#): String referencing earlier defined COMPUTER.
- [ExtraSendBufferMemory](#): Memory to use for send buffers in addition to any allocated by TotalSendBufferMemory or SendBufferMemory. Default (0) allows up to 16MB.
- [FileSystemPath](#): Path to directory where data node stores its data (directory must exist).

- [FileSystemPathDataFiles](#): Path to directory where data node stores its Disk Data files. Default value is `FileSystemPathDD`, if set; otherwise, `FileSystemPath` is used if it is set; otherwise, value of `DataDir` is used.
- [FileSystemPathDD](#): Path to directory where data node stores its Disk Data and undo files. Default value is `FileSystemPath`, if set; otherwise, value of `DataDir` is used.
- [FileSystemPathUndoFiles](#): Path to directory where data node stores its undo files for Disk Data. Default value is `FileSystemPathDD`, if set; otherwise, `FileSystemPath` is used if it is set; otherwise, value of `DataDir` is used.
- [FragmentLogFileSize](#): Size of each redo log file.
- [HeartbeatIntervalDbApi](#): Time between API node-data node heartbeats. (API connection closed after 3 missed heartbeats).
- [HeartbeatIntervalDbDb](#): Time between data node-to-data node heartbeats; data node considered dead after 3 missed heartbeats.
- [HeartbeatOrder](#): Sets order in which data nodes check each others' heartbeats for determining whether given node is still active and connected to cluster. Must be zero for all data nodes or distinct nonzero values for all data nodes; see documentation for further guidance.
- [HostName](#): Host name or IP address for this data node.
- [IndexMemory](#): Number of bytes on each data node allocated for storing indexes; subject to available system RAM and size of `DataMemory`.
- [IndexStatAutoCreate](#): Enable/disable automatic statistics collection when indexes are created.
- [IndexStatAutoUpdate](#): Monitor indexes for changes and trigger automatic statistics updates.
- [IndexStatSaveScale](#): Scaling factor used in determining size of stored index statistics.
- [IndexStatSaveSize](#): Maximum size in bytes for saved statistics per index.
- [IndexStatTriggerPct](#): Threshold percent change in DML operations for index statistics updates. Value is scaled down by `IndexStatTriggerScale`.
- [IndexStatTriggerScale](#): Scale down `IndexStatTriggerPct` by this amount, multiplied by base 2 logarithm of index size, for large index. Set to 0 to disable scaling.
- [IndexStatUpdateDelay](#): Minimum delay between automatic index statistics updates for given index. 0 means no delay.
- [InitFragmentLogFiles](#): Initialize fragment logfiles (sparse/full).
- [InitialLogFileGroup](#): Describes log file group that is created during initial start. See documentation for format.
- [InitialNoOfOpenFiles](#): Initial number of files open per data node. (One thread is created per file).
- [InitialTablespace](#): Describes tablespace that is created during initial start. See documentation for format.
- [InsertRecoveryWork](#): Percentage of `RecoveryWork` used for inserted rows; has no effect unless partial local checkpoints are in use.
- [LateAlloc](#): Allocate memory after connection to management server has been established.
- [LcpScanProgressTimeout](#): Maximum time that local checkpoint fragment scan can be stalled before node is shut down to ensure systemwide LCP progress. Use 0 to disable.
- [LockExecuteThreadToCPU](#): Comma-delimited list of CPU IDs.

- [LockMaintThreadsToCPU](#): CPU ID indicating which CPU runs maintenance threads.
- [LockPagesInMainMemory](#): 0=disable locking, 1=lock after memory allocation, 2=lock before memory allocation.
- [LogLevelCheckpoint](#): Log level of local and global checkpoint information printed to stdout.
- [LogLevelCongestion](#): Level of congestion information printed to stdout.
- [LogLevelConnection](#): Level of node connect/disconnect information printed to stdout.
- [LogLevelError](#): Transporter, heartbeat errors printed to stdout.
- [LogLevelInfo](#): Heartbeat and log information printed to stdout.
- [LogLevelNodeRestart](#): Level of node restart and node failure information printed to stdout.
- [LogLevelShutdown](#): Level of node shutdown information printed to stdout.
- [LogLevelStartup](#): Level of node startup information printed to stdout.
- [LogLevelStatistic](#): Level of transaction, operation, and transporter information printed to stdout.
- [LongMessageBuffer](#): Number of bytes allocated on each data node for internal long messages.
- [MaxAllocate](#): No longer used; has no effect.
- [MaxBufferedEpochs](#): Allowed numbered of epochs that subscribing node can lag behind (unprocessed epochs). Exceeding causes lagging subscribers to be disconnected.
- [MaxBufferedEpochBytes](#): Total number of bytes allocated for buffering epochs.
- [MaxDiskWriteSpeed](#): Maximum number of bytes per second that can be written by LCP and backup when no restarts are ongoing.
- [MaxDiskWriteSpeedOtherNodeRestart](#): Maximum number of bytes per second that can be written by LCP and backup when another node is restarting.
- [MaxDiskWriteSpeedOwnRestart](#): Maximum number of bytes per second that can be written by LCP and backup when this node is restarting.
- [MaxFKBuildBatchSize](#): Maximum scan batch size to use for building foreign keys. Increasing this value may speed up builds of foreign keys but impacts ongoing traffic as well.
- [MaxDMLOperationsPerTransaction](#): Limit size of transaction; aborts transaction if it requires more than this many DML operations. Set to 0 to disable.
- [MaxLCPStartDelay](#): Time in seconds that LCP polls for checkpoint mutex (to allow other data nodes to complete metadata synchronization), before putting itself in lock queue for parallel recovery of table data.
- [MaxNoOfAttributes](#): Suggests total number of attributes stored in database (sum over all tables).
- [MaxNoOfConcurrentIndexOperations](#): Total number of index operations that can execute simultaneously on one data node.
- [MaxNoOfConcurrentOperations](#): Maximum number of operation records in transaction coordinator.
- [MaxNoOfConcurrentScans](#): Maximum number of scans executing concurrently on data node.
- [MaxNoOfConcurrentSubOperations](#): Maximum number of concurrent subscriber operations.
- [MaxNoOfConcurrentTransactions](#): Maximum number of transactions executing concurrently on this data node, total number of transactions that can be executed concurrently is this value times number of data nodes in cluster.

- [MaxNoOfFiredTriggers](#): Total number of triggers that can fire simultaneously on one data node.
- [MaxNoOfLocalOperations](#): Maximum number of operation records defined on this data node.
- [MaxNoOfLocalScans](#): Maximum number of fragment scans in parallel on this data node.
- [MaxNoOfOpenFiles](#): Maximum number of files open per data node.(One thread is created per file).
- [MaxNoOfOrderedIndexes](#): Total number of ordered indexes that can be defined in system.
- [MaxNoOfSavedMessages](#): Maximum number of error messages to write in error log and maximum number of trace files to retain.
- [MaxNoOfSubscribers](#): Maximum number of subscribers.
- [MaxNoOfSubscriptions](#): Maximum number of subscriptions (default 0 = MaxNoOfTables).
- [MaxNoOfTables](#): Suggests total number of NDB tables stored in database.
- [MaxNoOfTriggers](#): Total number of triggers that can be defined in system.
- [MaxNoOfUniqueHashIndexes](#): Total number of unique hash indexes that can be defined in system.
- [MaxParallelCopyInstances](#): Number of parallel copies during node restarts. Default is 0, which uses number of LDMS on both nodes, to maximum of 16.
- [MaxParallelScansPerFragment](#): Maximum number of parallel scans per fragment. Once this limit is reached, scans are serialized.
- [MaxReorgBuildBatchSize](#): Maximum scan batch size to use for reorganization of table partitions. Increasing this value may speed up table partition reorganization but impacts ongoing traffic as well.
- [MaxStartFailRetries](#): Maximum retries when data node fails on startup, requires StopOnError = 0. Setting to 0 causes start attempts to continue indefinitely.
- [MaxUIBuildBatchSize](#): Maximum scan batch size to use for building unique keys. Increasing this value may speed up builds of unique keys but impacts ongoing traffic as well.
- [MemReportFrequency](#): Frequency of memory reports in seconds; 0 = report only when exceeding percentage limits.
- [MinDiskWriteSpeed](#): Minimum number of bytes per second that can be written by LCP and backup.
- [MinFreePct](#): Percentage of memory resources to keep in reserve for restarts.
- [NodeGroup](#): Node group to which data node belongs; used only during initial start of cluster.
- [NodeId](#): Number uniquely identifying data node among all nodes in cluster.
- [NoOfFragmentLogFiles](#): Number of 16 MB redo log files in each of 4 file sets belonging to data node.
- [NoOfReplicas](#): Number of copies of all data in database.
- [Numa](#): (Linux only; requires libnuma) Controls NUMA support. Setting to 0 permits system to determine use of interleaving by data node process; 1 means that it is determined by data node.
- [ODirect](#): Use O_DIRECT file reads and writes when possible.
- [ODirectSyncFlag](#): O_DIRECT writes are treated as synchronized writes; ignored when ODirect is not enabled, InitFragmentLogFiles is set to SPARSE, or both.
- [RealtimeScheduler](#): When true, data node threads are scheduled as real-time threads. Default is false.

- [RecoveryWork](#): Percentage of storage overhead for LCP files: greater value means less work in normal operations, more work during recovery.
- [RedoBuffer](#): Number of bytes on each data node allocated for writing redo logs.
- [RedoOverCommitCounter](#): When RedoOverCommitLimit has been exceeded this many times, transactions are aborted, and operations are handled as specified by DefaultOperationRedoProblemAction.
- [RedoOverCommitLimit](#): Each time that flushing current redo buffer takes longer than this many seconds, number of times that this has happened is compared to RedoOverCommitCounter.
- [ReservedSendBufferMemory](#): This parameter is present in NDB code but is not enabled.
- [RestartOnErrorInsert](#): Control type of restart caused by inserting error (when StopOnError is enabled).
- [SchedulerExecutionTimer](#): Number of microseconds to execute in scheduler before sending.
- [SchedulerResponsiveness](#): Set NDB scheduler response optimization 0-10; higher values provide better response time but lower throughput.
- [SchedulerSpinTimer](#): Number of microseconds to execute in scheduler before sleeping.
- [ServerPort](#): Port used to set up transporter for incoming connections from API nodes.
- [SharedGlobalMemory](#): Total number of bytes on each data node allocated for any use.
- [StartFailRetryDelay](#): Delay in seconds after start failure prior to retry; requires StopOnError = 0.
- [StartFailureTimeout](#): Milliseconds to wait before terminating. (0=Wait forever).
- [StartNoNodeGroupTimeout](#): Time to wait for nodes without nodegroup before trying to start (0=forever).
- [StartPartialTimeout](#): Milliseconds to wait before trying to start without all nodes. (0=Wait forever).
- [StartPartitionedTimeout](#): Milliseconds to wait before trying to start partitioned. (0=Wait forever).
- [StartupStatusReportFrequency](#): Frequency of status reports during startup.
- [StopOnError](#): When set to 0, data node automatically restarts and recovers following node failures.
- [StringMemory](#): Default size of string memory (0 to 100 = % of maximum, 101+ = actual bytes).
- [TcpBind_INADDR_ANY](#): Bind IP_ADDR_ANY so that connections can be made from anywhere (for autogenerated connections).
- [TimeBetweenEpochs](#): Time between epochs (synchronization used for replication).
- [TimeBetweenEpochsTimeout](#): Timeout for time between epochs. Exceeding causes node shutdown.
- [TimeBetweenGlobalCheckpoints](#): Time between group commits of transactions to disk.
- [TimeBetweenGlobalCheckpointsTimeout](#): Minimum timeout for group commit of transactions to disk.
- [TimeBetweenInactiveTransactionAbortCheck](#): Time between checks for inactive transactions.
- [TimeBetweenLocalCheckpoints](#): Time between taking snapshots of database (expressed in base-2 logarithm of bytes).

- [TimeBetweenWatchDogCheck](#): Time between execution checks inside data node.
- [TimeBetweenWatchDogCheckInitial](#): Time between execution checks inside data node (early start phases when memory is allocated).
- [TotalSendBufferMemory](#): Total memory to use for all transporter send buffers..
- [TransactionBufferMemory](#): Dynamic buffer space (in bytes) for key and attribute data allocated for each data node.
- [TransactionDeadlockDetectionTimeout](#): Time transaction can spend executing within data node. This is time that transaction coordinator waits for each data node participating in transaction to execute request. If data node takes more than this amount of time, transaction is aborted.
- [TransactionInactiveTimeout](#): Milliseconds that application waits before executing another part of transaction. This is time transaction coordinator waits for application to execute or send another part (query, statement) of transaction. If application takes too much time, then transaction is aborted. Timeout = 0 means that application never times out.
- [TwoPassInitialNodeRestartCopy](#): Copy data in 2 passes during initial node restart, which enables multithreaded building of ordered indexes for such restarts.
- [UndoDataBuffer](#): Unused; has no effect.
- [UndoIndexBuffer](#): Unused; has no effect.
- [UseShm](#): Use shared memory connections between this data node and API node also running on this host.

The following parameters are specific to `ndbmysqld`:

- [MaxNoOfExecutionThreads](#): For `ndbmysqld` only, specify maximum number of execution threads.
- [NoOfFragmentLogParts](#): Number of redo log file groups belonging to this data node.
- [ThreadConfig](#): Used for configuration of multithreaded data nodes (`ndbmysqld`). Default is empty string; see documentation for syntax and other information.

4.2.2 NDB Cluster Management Node Configuration Parameters

The listing in this section provides information about parameters used in the `[ndb_mgmd]` or `[mgm]` section of a `config.ini` file for configuring NDB Cluster management nodes. For detailed descriptions and other additional information about each of these parameters, see [Section 4.3.5, “Defining an NDB Cluster Management Server”](#).

- [ArbitrationDelay](#): When asked to arbitrate, arbitrator waits this long before voting (milliseconds).
- [ArbitrationRank](#): If 0, then management node is not arbitrator. Kernel selects arbitrators in order 1, 2.
- [DataDir](#): Data directory for this node.
- [ExecuteOnComputer](#): String referencing earlier defined COMPUTER.
- [ExtraSendBufferMemory](#): Memory to use for send buffers in addition to any allocated by `TotalSendBufferMemory` or `SendBufferMemory`. Default (0) allows up to 16MB.
- [HeartbeatIntervalMgmdMgmd](#): Time between management-node-to-management-node heartbeats; connection between management nodes is considered lost after 3 missed heartbeats.
- [HeartbeatThreadPriority](#): Set heartbeat thread policy and priority for management nodes; see manual for allowed values.
- [HostName](#): Host name or IP address for this management node.

- `Id`: Number identifying management node. Now deprecated; use `NodeId` instead.
- `LogDestination`: Where to send log messages: console, system log, or specified log file.
- `NodeId`: Number uniquely identifying management node among all nodes in cluster.
- `PortNumber`: Port number to send commands to and fetch configuration from management server.
- `PortNumberStats`: Port number used to get statistical information from management server.
- `TotalSendBufferMemory`: Total memory to use for all transporter send buffers.
- `wan`: Use WAN TCP setting as default.

Note

After making changes in a management node's configuration, it is necessary to perform a rolling restart of the cluster for the new configuration to take effect. See [Section 4.3.5, “Defining an NDB Cluster Management Server”](#), for more information.

To add new management servers to a running NDB Cluster, it is also necessary perform a rolling restart of all cluster nodes after modifying any existing `config.ini` files. For more information about issues arising when using multiple management nodes, see [Section 2.7.10, “Limitations Relating to Multiple NDB Cluster Nodes”](#).

4.2.3 NDB Cluster SQL Node and API Node Configuration Parameters

The listing in this section provides information about parameters used in the `[mysqld]` and `[api]` sections of a `config.ini` file for configuring NDB Cluster SQL nodes and API nodes. For detailed descriptions and other additional information about each of these parameters, see [Section 4.3.7, “Defining SQL and Other API Nodes in an NDB Cluster”](#).

- `ApiVerbose`: Enable NDB API debugging; for NDB development.
- `ArbitrationDelay`: When asked to arbitrate, arbitrator waits this many milliseconds before voting.
- `ArbitrationRank`: If 0, then API node is not arbitrator. Kernel selects arbitrators in order 1, 2.
- `AutoReconnect`: Specifies whether an API node should reconnect fully when disconnected from cluster.
- `BatchByteSize`: Default batch size in bytes.
- `BatchSize`: Default batch size in number of records.
- `ConnectBackoffMaxTime`: Specifies longest time in milliseconds (~100ms resolution) to allow between connection attempts to any given data node by this API node. Excludes time elapsed while connection attempts are ongoing, which in worst case can take several seconds. Disable by setting to 0. If no data nodes are currently connected to this API node, `StartConnectBackoffMaxTime` is used instead.
- `ConnectionMap`: Specifies which data nodes to connect.
- `DefaultHashMapSize`: Set size (in buckets) to use for table hash maps. Three values are supported: 0, 240, and 3840.
- `DefaultOperationRedoProblemAction`: How operations are handled in event that `RedoOverCommitCounter` is exceeded.
- `ExecuteOnComputer`: String referencing earlier defined COMPUTER.
- `ExtraSendBufferMemory`: Memory to use for send buffers in addition to any allocated by `TotalSendBufferMemory` or `SendBufferMemory`. Default (0) allows up to 16MB.

- `HeartbeatThreadPriority`: Set heartbeat thread policy and priority for API nodes; see manual for allowed values.
- `HostName`: Host name or IP address for this SQL or API node.
- `Id`: Number identifying MySQL server or API node (Id). Now deprecated; use `NodeId` instead.
- `MaxScanBatchSize`: Maximum collective batch size for one scan.
- `NodeId`: Number uniquely identifying SQL node or API node among all nodes in cluster.
- `StartConnectBackoffMaxTime`: Same as `ConnectBackoffMaxTime` except that this parameter is used in its place if no data nodes are connected to this API node.
- `TotalSendBufferMemory`: Total memory to use for all transporter send buffers.
- `wan`: Use WAN TCP setting as default.

For a discussion of MySQL server options for NDB Cluster, see [Section 4.3.9.1, “MySQL Server Options for NDB Cluster”](#). For information about MySQL server system variables relating to NDB Cluster, see [Section 4.3.9.2, “NDB Cluster System Variables”](#).

Note

To add new SQL or API nodes to the configuration of a running NDB Cluster, it is necessary to perform a rolling restart of all cluster nodes after adding new `[mysqld]` or `[api]` sections to the `config.ini` file (or files, if you are using more than one management server). This must be done before the new SQL or API nodes can connect to the cluster.

It is *not* necessary to perform any restart of the cluster if new SQL or API nodes can employ previously unused API slots in the cluster configuration to connect to the cluster.

4.2.4 Other NDB Cluster Configuration Parameters

The listings in this section provide information about parameters used in the `[computer]`, `[tcp]`, and `[shm]` sections of a `config.ini` file for configuring NDB Cluster. For detailed descriptions and additional information about individual parameters, see [Section 4.3.10, “NDB Cluster TCP/IP Connections”](#), or [Section 4.3.12, “NDB Cluster Shared Memory Connections”](#), as appropriate.

The following parameters apply to the `config.ini` file's `[computer]` section:

- `HostName`: Host name or IP address of this computer.
- `Id`: Unique identifier for this computer.

The following parameters apply to the `config.ini` file's `[tcp]` section:

- `Checksum`: If checksum is enabled, all signals between nodes are checked for errors.
- `Group`: Used for group proximity; smaller value is interpreted as being closer.
- `HostName1`: Name or IP address of first of two computers joined by TCP connection.
- `HostName2`: Name or IP address of second of two computers joined by TCP connection.
- `NodeId1`: ID of node (data node, API node, or management node) on one side of connection.
- `NodeId2`: ID of node (data node, API node, or management node) on one side of connection.
- `NodeIdServer`: Set server side of TCP connection.
- `OverloadLimit`: When more than this many unsent bytes are in send buffer, connection is considered overloaded.

- `PortNumber`: Port used for TCP transporter.
- `PreSendChecksum`: If this parameter and `Checksum` are both enabled, perform pre-send checksum checks, and check all TCP signals between nodes for errors.
- `Proxy`:
- `ReceiveBufferMemory`: Bytes of buffer for signals received by this node.
- `SendBufferMemory`: Bytes of TCP buffer for signals sent from this node.
- `SendSignalId`: Sends ID in each signal. Used in trace files. Defaults to true in debug builds.
- `TCP_MAXSEG_SIZE`: Value used for `TCP_MAXSEG`.
- `TCP_RCV_BUF_SIZE`: Value used for `SO_RCVBUF`.
- `TCP_SND_BUF_SIZE`: Value used for `SO_SNDBUF`.
- `TcpBind_INADDR_ANY`: Bind `InAddrAny` instead of host name for server part of connection.

The following parameters apply to the `config.ini` file's `[shm]` section:

- `Checksum`: If checksum is enabled, all signals between nodes are checked for errors.
- `Group`: Used for group proximity; smaller value is interpreted as being closer.
- `HostName1`: Name or IP address of first of two computers joined by SHM connection.
- `HostName2`: Name or IP address of second of two computers joined by SHM connection.
- `NodeId1`: ID of node (data node, API node, or management node) on one side of connection.
- `NodeId2`: ID of node (data node, API node, or management node) on one side of connection.
- `NodeIdServer`: Set server side of SHM connection.
- `OverloadLimit`: When more than this many unsent bytes are in send buffer, connection is considered overloaded.
- `PortNumber`: Port used for SHM transporter.
- `PreSendChecksum`: If this parameter and `Checksum` are both enabled, perform pre-send checksum checks, and check all SHM signals between nodes for errors.
- `SendBufferMemory`: Bytes in shared memory buffer for signals sent from this node.
- `SendSignalId`: Sends ID in each signal. Used in trace files.
- `ShmKey`: Shared memory key; when set to 1, this is calculated by NDB.
- `ShmSpinTime`: When receiving, number of microseconds to spin before sleeping.
- `ShmSize`: Size of shared memory segment.
- `Signum`: Signal number to be used for signalling.

4.2.5 NDB Cluster `mysqld` Option and Variable Reference

The following table provides a list of the command-line options, server and status variables applicable within `mysqld` when it is running as an SQL node in an NDB Cluster. For a table showing *all* command-line options, server and status variables available for use with `mysqld`, see [Server Option, System Variable, and Status Variable Reference](#).

- `Com_show_ndb_status`: Count of SHOW NDB STATUS statements.
- `Handler_discover`: Number of times that tables have been discovered.

- `ndb-batch-size`: Size (in bytes) to use for NDB transaction batches.
- `ndb-blob-read-batch-bytes`: Specifies size in bytes that large BLOB reads should be batched into. 0 = no limit.
- `ndb-blob-write-batch-bytes`: Specifies size in bytes that large BLOB writes should be batched into. 0 = no limit.
- `ndb-cluster-connection-pool`: Number of connections to cluster used by MySQL.
- `ndb-cluster-connection-pool-nodeids`: Comma-separated list of node IDs for connections to cluster used by MySQL; number of nodes in list must match value set for `--ndb-cluster-connection-pool`.
- `ndb-connectstring`: Address of NDB management server distributing configuration information for this cluster.
- `ndb-default-column-format`: Use this value (FIXED or DYNAMIC) by default for `COLUMN_FORMAT` and `ROW_FORMAT` options when creating or adding table columns.
- `ndb-deferred-constraints`: Specifies that constraint checks on unique indexes (where these are supported) should be deferred until commit time. Not normally needed or used; for testing purposes only.
- `ndb-distribution`: Default distribution for new tables in NDBCLUSTER (KEYHASH or LINHASH, default is KEYHASH).
- `ndb-log-apply-status`: Cause MySQL server acting as replica to log `mysql.ndb_apply_status` updates received from its immediate source in its own binary log, using its own server ID. Effective only if server is started with `--ndbcluster` option.
- `ndb-log-empty-epochs`: When enabled, causes epochs in which there were no changes to be written to `ndb_apply_status` and `ndb_binlog_index` tables, even when `--log-slave-updates` is enabled.
- `ndb-log-empty-update`: When enabled, causes updates that produced no changes to be written to `ndb_apply_status` and `ndb_binlog_index` tables, even when `--log-slave-updates` is enabled.
- `ndb-log-exclusive-reads`: Log primary key reads with exclusive locks; allow conflict resolution based on read conflicts.
- `ndb-log-fail-terminate`: Terminate `mysqld` process if complete logging of all found row events is not possible.
- `ndb-log-orig`: Log originating server id and epoch in `mysql.ndb_binlog_index` table.
- `ndb-log-transaction-id`: Write NDB transaction IDs in binary log. Requires `--log-bin-v1-events=OFF`.
- `ndb-log-update-as-write`: Toggles logging of updates on source between updates (OFF) and writes (ON).
- `ndb-mgmd-host`: Set host (and port, if desired) for connecting to management server.
- `ndb-nodeid`: NDB Cluster node ID for this MySQL server.
- `ndb-optimized-node-selection`: Enable optimizations for selection of nodes for transactions. Enabled by default; use `--skip-ndb-optimized-node-selection` to disable.
- `ndb-transid-mysql-connection-map`: Enable or disable `ndb_transid_mysql_connection_map` plugin; that is, enable or disable `INFORMATION_SCHEMA` table having that name.
- `ndb-wait-connected`: Time (in seconds) for MySQL server to wait for connection to cluster management and data nodes before accepting MySQL client connections.
- `ndb-wait-setup`: Time (in seconds) for MySQL server to wait for NDB engine setup to complete.

- [ndb-allow-copying-alter-table](#): Set to OFF to keep ALTER TABLE from using copying operations on NDB tables.
- [Ndb_api_adaptive_send_deferred_count](#): Number of adaptive send calls not actually sent by this MySQL Server (SQL node).
- [Ndb_api_adaptive_send_deferred_count_session](#): Number of adaptive send calls not actually sent in this client session.
- [Ndb_api_adaptive_send_deferred_count_slave](#): Number of adaptive send calls not actually sent by this replica.
- [Ndb_api_adaptive_send_forced_count](#): Number of adaptive sends with forced-send set sent by this MySQL Server (SQL node).
- [Ndb_api_adaptive_send_forced_count_session](#): Number of adaptive sends with forced-send set in this client session.
- [Ndb_api_adaptive_send_forced_count_slave](#): Number of adaptive sends with forced-send set sent by this replica.
- [Ndb_api_adaptive_send_unforced_count](#): Number of adaptive sends without forced-send sent by this MySQL Server (SQL node).
- [Ndb_api_adaptive_send_unforced_count_session](#): Number of adaptive sends without forced-send in this client session.
- [Ndb_api_adaptive_send_unforced_count_slave](#): Number of adaptive sends without forced-send sent by this replica.
- [Ndb_api_bytes_received_count](#): Quantity of data (in bytes) received from data nodes by this MySQL Server (SQL node).
- [Ndb_api_bytes_received_count_session](#): Quantity of data (in bytes) received from data nodes in this client session.
- [Ndb_api_bytes_received_count_slave](#): Quantity of data (in bytes) received from data nodes by this replica.
- [Ndb_api_bytes_sent_count](#): Quantity of data (in bytes) sent to data nodes by this MySQL Server (SQL node).
- [Ndb_api_bytes_sent_count_session](#): Quantity of data (in bytes) sent to data nodes in this client session.
- [Ndb_api_bytes_sent_count_slave](#): Quantity of data (in bytes) sent to data nodes by this replica.
- [Ndb_api_event_bytes_count](#): Number of bytes of events received by this MySQL Server (SQL node).
- [Ndb_api_event_bytes_count_injector](#): Number of bytes of event data received by NDB binary log injector thread.
- [Ndb_api_event_data_count](#): Number of row change events received by this MySQL Server (SQL node).
- [Ndb_api_event_data_count_injector](#): Number of row change events received by NDB binary log injector thread.
- [Ndb_api_event_nondata_count](#): Number of events received, other than row change events, by this MySQL Server (SQL node).
- [Ndb_api_event_nondata_count_injector](#): Number of events received, other than row change events, by NDB binary log injector thread.

- [Ndb_api_pk_op_count](#): Number of operations based on or using primary keys by this MySQL Server (SQL node).
- [Ndb_api_pk_op_count_session](#): Number of operations based on or using primary keys in this client session.
- [Ndb_api_pk_op_count_slave](#): Number of operations based on or using primary keys by this replica.
- [Ndb_api_pruned_scan_count](#): Number of scans that have been pruned to one partition by this MySQL Server (SQL node).
- [Ndb_api_pruned_scan_count_session](#): Number of scans that have been pruned to one partition in this client session.
- [Ndb_api_pruned_scan_count_slave](#): Number of scans that have been pruned to one partition by this replica.
- [Ndb_api_range_scan_count](#): Number of range scans that have been started by this MySQL Server (SQL node).
- [Ndb_api_range_scan_count_session](#): Number of range scans that have been started in this client session.
- [Ndb_api_range_scan_count_slave](#): Number of range scans that have been started by this replica.
- [Ndb_api_read_row_count](#): Total number of rows that have been read by this MySQL Server (SQL node).
- [Ndb_api_read_row_count_session](#): Total number of rows that have been read in this client session.
- [Ndb_api_read_row_count_slave](#): Total number of rows that have been read by this replica.
- [Ndb_api_scan_batch_count](#): Number of batches of rows received by this MySQL Server (SQL node).
- [Ndb_api_scan_batch_count_session](#): Number of batches of rows received in this client session.
- [Ndb_api_scan_batch_count_slave](#): Number of batches of rows received by this replica.
- [Ndb_api_table_scan_count](#): Number of table scans that have been started, including scans of internal tables, by this MySQL Server (SQL node).
- [Ndb_api_table_scan_count_session](#): Number of table scans that have been started, including scans of internal tables, in this client session.
- [Ndb_api_table_scan_count_slave](#): Number of table scans that have been started, including scans of internal tables, by this replica.
- [Ndb_api_trans_abort_count](#): Number of transactions aborted by this MySQL Server (SQL node).
- [Ndb_api_trans_abort_count_session](#): Number of transactions aborted in this client session.
- [Ndb_api_trans_abort_count_slave](#): Number of transactions aborted by this replica.
- [Ndb_api_trans_close_count](#): Number of transactions aborted (may be greater than sum of TransCommitCount and TransAbortCount) by this MySQL Server (SQL node).
- [Ndb_api_trans_close_count_session](#): Number of transactions aborted (may be greater than sum of TransCommitCount and TransAbortCount) in this client session.

- [Ndb_api_trans_close_count_slave](#): Number of transactions aborted (may be greater than sum of TransCommitCount and TransAbortCount) by this replica.
- [Ndb_api_trans_commit_count](#): Number of transactions committed by this MySQL Server (SQL node).
- [Ndb_api_trans_commit_count_session](#): Number of transactions committed in this client session.
- [Ndb_api_trans_commit_count_slave](#): Number of transactions committed by this replica.
- [Ndb_api_trans_local_read_row_count](#): Total number of rows that have been read by this MySQL Server (SQL node).
- [Ndb_api_trans_local_read_row_count_session](#): Total number of rows that have been read in this client session.
- [Ndb_api_trans_local_read_row_count_slave](#): Total number of rows that have been read by this replica.
- [Ndb_api_trans_start_count](#): Number of transactions started by this MySQL Server (SQL node).
- [Ndb_api_trans_start_count_session](#): Number of transactions started in this client session.
- [Ndb_api_trans_start_count_slave](#): Number of transactions started by this replica.
- [Ndb_api_uk_op_count](#): Number of operations based on or using unique keys by this MySQL Server (SQL node).
- [Ndb_api_uk_op_count_session](#): Number of operations based on or using unique keys in this client session.
- [Ndb_api_uk_op_count_slave](#): Number of operations based on or using unique keys by this replica.
- [Ndb_api_wait_exec_complete_count](#): Number of times thread has been blocked while waiting for operation execution to complete by this MySQL Server (SQL node).
- [Ndb_api_wait_exec_complete_count_session](#): Number of times thread has been blocked while waiting for operation execution to complete in this client session.
- [Ndb_api_wait_exec_complete_count_slave](#): Number of times thread has been blocked while waiting for operation execution to complete by this replica.
- [Ndb_api_wait_meta_request_count](#): Number of times thread has been blocked waiting for metadata-based signal by this MySQL Server (SQL node).
- [Ndb_api_wait_meta_request_count_session](#): Number of times thread has been blocked waiting for metadata-based signal in this client session.
- [Ndb_api_wait_meta_request_count_slave](#): Number of times thread has been blocked waiting for metadata-based signal by this replica.
- [Ndb_api_wait_nanos_count](#): Total time (in nanoseconds) spent waiting for some type of signal from data nodes by this MySQL Server (SQL node).
- [Ndb_api_wait_nanos_count_session](#): Total time (in nanoseconds) spent waiting for some type of signal from data nodes in this client session.
- [Ndb_api_wait_nanos_count_slave](#): Total time (in nanoseconds) spent waiting for some type of signal from data nodes by this replica.
- [Ndb_api_wait_scan_result_count](#): Number of times thread has been blocked while waiting for scan-based signal by this MySQL Server (SQL node).

- [Ndb_api_wait_scan_result_count_session](#): Number of times thread has been blocked while waiting for scan-based signal in this client session.
- [Ndb_api_wait_scan_result_count_slave](#): Number of times thread has been blocked while waiting for scan-based signal by this replica.
- [ndb_autoincrement_prefetch_sz](#): NDB auto-increment prefetch size.
- [ndb_cache_check_time](#): Number of milliseconds between checks of cluster SQL nodes made by MySQL query cache.
- [ndb_clear_apply_status](#): Causes RESET SLAVE/RESET REPLICA to clear all rows from ndb_apply_status table; ON by default.
- [Ndb_cluster_node_id](#): Node ID of this server when acting as NDB Cluster SQL node.
- [Ndb_config_from_host](#): NDB Cluster management server host name or IP address.
- [Ndb_config_from_port](#): Port for connecting to NDB Cluster management server.
- [Ndb_conflict_fn_epoch](#): Number of rows that have been found in conflict by NDB\$EPOCH() conflict detection function.
- [Ndb_conflict_fn_epoch2](#): Number of rows that have been found in conflict by NDB\$EPOCH2() conflict detection function.
- [Ndb_conflict_fn_epoch2_trans](#): Number of rows that have been found in conflict by NDB \$EPOCH2_TRANS() conflict detection function.
- [Ndb_conflict_fn_epoch_trans](#): Number of rows that have been found in conflict by NDB \$EPOCH_TRANS() conflict detection function.
- [Ndb_conflict_fn_max](#): Number of times that conflict resolution based on "greater timestamp wins" has been applied when server is part of an NDB Cluster involved in cluster replication.
- [Ndb_conflict_fn_old](#): Number of times that "same timestamp wins" conflict resolution has been applied when this server is part of an NDB Cluster involved in cluster replication.
- [Ndb_conflict_last_conflict_epoch](#): Most recent NDB epoch on this replica in which some conflict was detected.
- [Ndb_conflict_last_stable_epoch](#): Number of rows found to be in conflict by transactional conflict function.
- [Ndb_conflict_reflected_op_discard_count](#): Number of reflected operations that were not applied due error during execution.
- [Ndb_conflict_reflected_op_prepare_count](#): Number of reflected operations received that have been prepared for execution.
- [Ndb_conflict_refresh_op_count](#): Number of refresh operations that have been prepared.
- [Ndb_conflict_trans_conflict_commit_count](#): Number of epoch transactions committed after requiring transactional conflict handling.
- [Ndb_conflict_trans_detect_iter_count](#): Number of internal iterations required to commit epoch transaction. Should be (slightly) greater than or equal to [Ndb_conflict_trans_conflict_commit_count](#).
- [Ndb_conflict_trans_reject_count](#): Number of transactions rejected after being found in conflict by transactional conflict function.
- [Ndb_conflict_trans_row_conflict_count](#): Number of rows found in conflict by transactional conflict function. Includes any rows included in or dependent on conflicting transactions.

- [Ndb_conflict_trans_row_reject_count](#): Total number of rows realigned after being found in conflict by transactional conflict function. Includes [Ndb_conflict_trans_row_conflict_count](#) and any rows included in or dependent on conflicting transactions.
- [ndb_data_node_neighbour](#): Specifies cluster data node "closest" to this MySQL Server, for transaction hinting and fully replicated tables.
- [ndb_default_column_format](#): Sets default row format and column format (FIXED or DYNAMIC) used for new NDB tables.
- [ndb_deferred_constraints](#): Specifies that constraint checks should be deferred (where these are supported). Not normally needed or used; for testing purposes only.
- [ndb_distribution](#): Default distribution for new tables in NDBCLUSTER (KEYHASH or LINHASH, default is KEYHASH).
- [Ndb_epoch_delete_delete_count](#): Number of delete-delete conflicts detected (delete operation is applied, but row does not exist).
- [ndb_eventbuffer_free_percent](#): Percentage of free memory that should be available in event buffer before resumption of buffering, after reaching limit set by [ndb_eventbuffer_max_alloc](#).
- [ndb_eventbuffer_max_alloc](#): Maximum memory that can be allocated for buffering events by NDB API. Defaults to 0 (no limit).
- [Ndb_execute_count](#): Number of round trips to NDB kernel made by operations.
- [ndb_extra_logging](#): Controls logging of NDB Cluster schema, connection, and data distribution events in MySQL error log.
- [ndb_force_send](#): Forces sending of buffers to NDB immediately, without waiting for other threads.
- [ndb_fully_replicated](#): Whether new NDB tables are fully replicated.
- [ndb_index_stat_enable](#): Use NDB index statistics in query optimization.
- [ndb_index_stat_option](#): Comma-separated list of tunable options for NDB index statistics; list should contain no spaces.
- [ndb_join_pushdown](#): Enables pushing down of joins to data nodes.
- [Ndb_last_commit_epoch_server](#): Epoch most recently committed by NDB.
- [Ndb_last_commit_epoch_session](#): Epoch most recently committed by this NDB client.
- [ndb_log_apply_status](#): Whether or not MySQL server acting as replica logs `mysql.ndb_apply_status` updates received from its immediate source in its own binary log, using its own server ID.
- [ndb_log_bin](#): Write updates to NDB tables in binary log. Effective only if binary logging is enabled with `--log-bin`.
- [ndb_log_binlog_index](#): Insert mapping between epochs and binary log positions into `ndb_binlog_index` table. Defaults to ON. Effective only if binary logging is enabled.
- [ndb_log_empty_epochs](#): When enabled, epochs in which there were no changes are written to `ndb_apply_status` and `ndb_binlog_index` tables, even when `log_replica_updates` or `log_slave_updates` is enabled.
- [ndb_log_empty_update](#): When enabled, updates which produce no changes are written to `ndb_apply_status` and `ndb_binlog_index` tables, even when `log_replica_updates` or `log_slave_updates` is enabled.
- [ndb_log_exclusive_reads](#): Log primary key reads with exclusive locks; allow conflict resolution based on read conflicts.

- [ndb_log_orig](#): Whether id and epoch of originating server are recorded in `mysql.ndb_binlog_index` table. Set using `--ndb-log-orig` option when starting `mysqld`.
- [ndb_log_transaction_id](#): Whether NDB transaction IDs are written into binary log (Read-only).
- [ndb-log-update-minimal](#): Log updates in minimal format.
- [ndb-log-updated-only](#): Log complete rows (ON) or updates only (OFF).
- [Ndb_number_of_data_nodes](#): Number of data nodes in this NDB cluster; set only if server participates in cluster.
- [ndb-optimization-delay](#): Number of milliseconds to wait between processing sets of rows by `OPTIMIZE TABLE` on NDB tables.
- [ndb_optimized_node_selection](#): Determines how SQL node chooses cluster data node to use as transaction coordinator.
- [Ndb_pruned_scan_count](#): Number of scans executed by NDB since cluster was last started where partition pruning could be used.
- [Ndb_pushed_queries_defined](#): Number of joins that API nodes have attempted to push down to data nodes.
- [Ndb_pushed_queries_dropped](#): Number of joins that API nodes have tried to push down, but failed.
- [Ndb_pushed_queries_executed](#): Number of joins successfully pushed down and executed on data nodes.
- [Ndb_pushed_reads](#): Number of reads executed on data nodes by pushed-down joins.
- [ndb_read_backup](#): Enable read from any replica for all NDB tables; use `NDB_TABLE=READ_BACKUP={0|1}` with `CREATE TABLE` or `ALTER TABLE` to enable or disable for individual NDB tables.
- [ndb_recv_thread_activation_threshold](#): Activation threshold when receive thread takes over polling of cluster connection (measured in concurrently active threads).
- [ndb_recv_thread_cpu_mask](#): CPU mask for locking receiver threads to specific CPUs; specified as hexadecimal. See documentation for details.
- [ndb_report_thresh_binlog_epoch_slip](#): NDB 7.5.4 and later: Threshold for number of epochs completely buffered, but not yet consumed by binlog injector thread which when exceeded generates `BUFFERED_EPOCHS_OVER_THRESHOLD` event buffer status message; prior to NDB 7.5.4: Threshold for number of epochs to lag behind before reporting binary log status.
- [ndb_report_thresh_binlog_mem_usage](#): Threshold for percentage of free memory remaining before reporting binary log status.
- [ndb_row_checksum](#): When enabled, set row checksums; enabled by default.
- [Ndb_scan_count](#): Total number of scans executed by NDB since cluster was last started.
- [ndb_show_foreign_key_mock_tables](#): Show mock tables used to support `foreign_key_checks=0`.
- [ndb_slave_conflict_role](#): Role for replica to play in conflict detection and resolution. Value is one of `PRIMARY`, `SECONDARY`, `PASS`, or `NONE` (default). Can be changed only when replication SQL thread is stopped. See documentation for further information.
- [Ndb_slave_max_replicated_epoch](#): Most recently committed NDB epoch on this replica. When this value is greater than or equal to `Ndb_conflict_last_conflict_epoch`, no conflicts have yet been detected.

- `Ndb_system_name`: Configured cluster system name; empty if server not connected to NDB.
- `ndb_table_no_logging`: NDB tables created when this setting is enabled are not checkpointed to disk (although table schema files are created). Setting in effect when table is created with or altered to use NDBCLUSTER persists for table's lifetime.
- `ndb_table_temporary`: NDB tables are not persistent on disk: no schema files are created and tables are not logged.
- `ndb_use_copying_alter_table`: Use copying ALTER TABLE operations in NDB Cluster.
- `ndb_use_exact_count`: Use exact row count when planning queries.
- `ndb_use_transactions`: Forces NDB to use a count of records during SELECT COUNT(*) query planning to speed up this type of query.
- `ndb_version`: Shows build and NDB engine version as an integer.
- `ndb_version_string`: Shows build information including NDB engine version in ndb-x.y.z format.
- `ndbcluster`: Enable NDB Cluster (if this version of MySQL supports it). Disabled by `--skip-ndbcluster`.
- `ndbinfo_database`: Name used for NDB information database; read only.
- `ndbinfo_max_bytes`: Used for debugging only.
- `ndbinfo_max_rows`: Used for debugging only.
- `ndbinfo_offline`: Put ndbinfo database into offline mode, in which no rows are returned from tables or views.
- `ndbinfo_show_hidden`: Whether to show ndbinfo internal base tables in mysql client; default is OFF.
- `ndbinfo_table_prefix`: Prefix to use for naming ndbinfo internal base tables; read only.
- `ndbinfo_version`: ndbinfo engine version; read only.
- `server_id_bits`: Number of least significant bits in server_id actually used for identifying server, permitting NDB API applications to store application data in most significant bits. server_id must be less than 2 to power of this value.
- `skip-ndbcluster`: Disable NDB Cluster storage engine.
- `slave_allow_batching`: Turns update batching on and off for replica.
- `transaction_allow_batching`: Allows batching of statements within one transaction. Disable AUTOCOMMIT to use.

4.3 NDB Cluster Configuration Files

Configuring NDB Cluster requires working with two files:

- `my.cnf`: Specifies options for all NDB Cluster executables. This file, with which you should be familiar with from previous work with MySQL, must be accessible by each executable running in the cluster.
- `config.ini`: This file, sometimes known as the *global configuration file*, is read only by the NDB Cluster management server, which then distributes the information contained therein to all processes participating in the cluster. `config.ini` contains a description of each node involved in the cluster. This includes configuration parameters for data nodes and configuration parameters for connections between all nodes in the cluster. For a quick reference to the sections that can appear in this file, and what sorts of configuration parameters may be placed in each section, see [Sections of the config.ini File](#).

Caching of configuration data. NDB uses *stateful configuration*. Rather than reading the global configuration file every time the management server is restarted, the management server caches the configuration the first time it is started, and thereafter, the global configuration file is read only when one of the following conditions is true:

- **The management server is started using the `--initial` option.** When `--initial` is used, the global configuration file is re-read, any existing cache files are deleted, and the management server creates a new configuration cache.
- **The management server is started using the `--reload` option.** The `--reload` option causes the management server to compare its cache with the global configuration file. If they differ, the management server creates a new configuration cache; any existing configuration cache is preserved, but not used. If the management server's cache and the global configuration file contain the same configuration data, then the existing cache is used, and no new cache is created.
- **The management server is started using `--config-cache=FALSE`.** This disables `--config-cache` (enabled by default), and can be used to force the management server to bypass configuration caching altogether. In this case, the management server ignores any configuration files that may be present, always reading its configuration data from the `config.ini` file instead.
- **No configuration cache is found.** In this case, the management server reads the global configuration file and creates a cache containing the same configuration data as found in the file.

Configuration cache files. The management server by default creates configuration cache files in a directory named `mysql-cluster` in the MySQL installation directory. (If you build NDB Cluster from source on a Unix system, the default location is `/usr/local/mysql-cluster`.) This can be overridden at runtime by starting the management server with the `--configdir` option. Configuration cache files are binary files named according to the pattern `ndb_node_id_config.bin.seq_id`, where `node_id` is the management server's node ID in the cluster, and `seq_id` is a cache identifier. Cache files are numbered sequentially using `seq_id`, in the order in which they are created. The management server uses the latest cache file as determined by the `seq_id`.

Note

It is possible to roll back to a previous configuration by deleting later configuration cache files, or by renaming an earlier cache file so that it has a higher `seq_id`. However, since configuration cache files are written in a binary format, you should not attempt to edit their contents by hand.

For more information about the `--configdir`, `--config-cache`, `--initial`, and `--reload` options for the NDB Cluster management server, see [Section 5.4, “ndb_mgmd — The NDB Cluster Management Server Daemon”](#).

We are continuously making improvements in Cluster configuration and attempting to simplify this process. Although we strive to maintain backward compatibility, there may be times when introduce an incompatible change. In such cases we try to let NDB Cluster users know in advance if a change is not backward compatible. If you find such a change and we have not documented it, please report it in the MySQL bugs database using the instructions given in [How to Report Bugs or Problems](#).

4.3.1 NDB Cluster Configuration: Basic Example

To support NDB Cluster, you must to update `my.cnf` as shown in the following example. You may also specify these parameters on the command line when invoking the executables.

Note

The options shown here should not be confused with those that are used in `config.ini` global configuration files. Global configuration options are discussed later in this section.

```
# my.cnf
```

```
# example additions to my.cnf for NDB Cluster
# (valid in MySQL 5.7)

# enable ndbcluster storage engine, and provide connection string for
# management server host (default port is 1186)
[mysqld]
ndbcluster
ndb-connectstring=ndb_mgmd.mysql.com

# provide connection string for management server host (default port: 1186)
[ndbd]
connect-string=ndb_mgmd.mysql.com

# provide connection string for management server host (default port: 1186)
[ndb_mgm]
connect-string=ndb_mgmd.mysql.com

# provide location of cluster configuration file
# IMPORTANT: When starting the management server with this option in the
# configuration file, the use of --initial or --reload on the command line when
# invoking ndb_mgmd is also required.
[ndb_mgmd]
config-file=/etc/config.ini
```

(For more information on connection strings, see [Section 4.3.3, “NDB Cluster Connection Strings”](#).)

```
# my.cnf
# example additions to my.cnf for NDB Cluster
# (works on all versions)

# enable ndbcluster storage engine, and provide connection string for management
# server host to the default port 1186
[mysqld]
ndbcluster
ndb-connectstring=ndb_mgmd.mysql.com:1186
```

Important

Once you have started a `mysqld` process with the `NDBCLUSTER` and `ndb-connectstring` parameters in the `[mysqld]` in the `my.cnf` file as shown previously, you cannot execute any `CREATE TABLE` or `ALTER TABLE` statements without having actually started the cluster. Otherwise, these statements fail with an error. *This is by design.*

You may also use a separate `[mysql_cluster]` section in the cluster `my.cnf` file for settings to be read and used by all executables:

```
# cluster-specific settings
[mysql_cluster]
ndb-connectstring=ndb_mgmd.mysql.com:1186
```

For additional `NDB` variables that can be set in the `my.cnf` file, see [Section 4.3.9.2, “NDB Cluster System Variables”](#).

The `NDB` Cluster global configuration file is by convention named `config.ini` (but this is not required). If needed, it is read by `ndb_mgmd` at startup and can be placed in any location that can be read by it. The location and name of the configuration are specified using `--config-file=path_name` with `ndb_mgmd` on the command line. This option has no default value, and is ignored if `ndb_mgmd` uses the configuration cache.

The global configuration file for `NDB` Cluster uses INI format, which consists of sections preceded by section headings (surrounded by square brackets), followed by the appropriate parameter names and values. One deviation from the standard INI format is that the parameter name and value can be separated by a colon (`:`) as well as the equal sign (`=`); however, the equal sign is preferred. Another deviation is that sections are not uniquely identified by section name. Instead, unique sections (such as

two different nodes of the same type) are identified by a unique ID specified as a parameter within the section.

Default values are defined for most parameters, and can also be specified in `config.ini`. To create a default value section, simply add the word `default` to the section name. For example, an `[ndbd]` section contains parameters that apply to a particular data node, whereas an `[ndbd default]` section contains parameters that apply to all data nodes. Suppose that all data nodes should use the same data memory size. To configure them all, create an `[ndbd default]` section that contains a `DataMemory` line to specify the data memory size.

If used, the `[ndbd default]` section must precede any `[ndbd]` sections in the configuration file. This is also true for `default` sections of any other type.

Note

In some older releases of NDB Cluster, there was no default value for `NoOfReplicas`, which always had to be specified explicitly in the `[ndbd default]` section. Although this parameter now has a default value of 2, which is the recommended setting in most common usage scenarios, it is still recommended practice to set this parameter explicitly.

The global configuration file must define the computers and nodes involved in the cluster and on which computers these nodes are located. An example of a simple configuration file for a cluster consisting of one management server, two data nodes and two MySQL servers is shown here:

```
# file "config.ini" - 2 data nodes and 2 SQL nodes
# This file is placed in the startup directory of ndb_mgmd (the
# management server)
# The first MySQL Server can be started from any host. The second
# can be started only on the host mysqld_5.mysql.com

[ndbd default]
NoOfReplicas= 2
DataDir= /var/lib/mysql-cluster

[ndb_mgmd]
Hostname= ndb_mgmd.mysql.com
DataDir= /var/lib/mysql-cluster

[ndbd]
HostName= ndbd_2.mysql.com

[ndbd]
HostName= ndbd_3.mysql.com

[mysqld]
[mysqld]
HostName= mysqld_5.mysql.com
```

Note

The preceding example is intended as a minimal starting configuration for purposes of familiarization with NDB Cluster, and is almost certain not to be sufficient for production settings. See [Section 4.3.2, "Recommended Starting Configuration for NDB Cluster"](#), which provides a more complete example starting configuration.

Each node has its own section in the `config.ini` file. For example, this cluster has two data nodes, so the preceding configuration file contains two `[ndbd]` sections defining these nodes.

Note

Do not place comments on the same line as a section heading in the `config.ini` file; this causes the management server not to start because it cannot parse the configuration file in such cases.

Sections of the config.ini File

There are six different sections that you can use in the `config.ini` configuration file, as described in the following list:

- `[computer]`: Defines cluster hosts. This is not required to configure a viable NDB Cluster, but be may used as a convenience when setting up a large cluster. See [Section 4.3.4, “Defining Computers in an NDB Cluster”](#), for more information.
- `[ndbd]`: Defines a cluster data node (`ndbd` process). See [Section 4.3.6, “Defining NDB Cluster Data Nodes”](#), for details.
- `[mysqld]`: Defines the cluster's MySQL server nodes (also called SQL or API nodes). For a discussion of SQL node configuration, see [Section 4.3.7, “Defining SQL and Other API Nodes in an NDB Cluster”](#).
- `[mgm]` or `[ndb_mgmd]`: Defines a cluster management server (MGM) node. For information concerning the configuration of management nodes, see [Section 4.3.5, “Defining an NDB Cluster Management Server”](#).
- `[tcp]`: Defines a TCP/IP connection between cluster nodes, with TCP/IP being the default transport protocol. Normally, `[tcp]` or `[tcp default]` sections are not required to set up an NDB Cluster, as the cluster handles this automatically; however, it may be necessary in some situations to override the defaults provided by the cluster. See [Section 4.3.10, “NDB Cluster TCP/IP Connections”](#), for information about available TCP/IP configuration parameters and how to use them. (You may also find [Section 4.3.11, “NDB Cluster TCP/IP Connections Using Direct Connections”](#) to be of interest in some cases.)
- `[shm]`: Defines shared-memory connections between nodes. In MySQL 5.7, it is enabled by default, but should still be considered experimental. For a discussion of SHM interconnects, see [Section 4.3.12, “NDB Cluster Shared Memory Connections”](#).
- `[sci]`: Defines Scalable Coherent Interface connections between cluster data nodes. Not supported in NDB 7.5 or 7.6.

You can define `default` values for each section. If used, a `default` section should come before any other sections of that type. For example, an `[ndbd default]` section should appear in the configuration file before any `[ndbd]` sections.

NDB Cluster parameter names are case-insensitive, unless specified in MySQL Server `my.cnf` or `my.ini` files.

4.3.2 Recommended Starting Configuration for NDB Cluster

Achieving the best performance from an NDB Cluster depends on a number of factors including the following:

- NDB Cluster software version
- Numbers of data nodes and SQL nodes
- Hardware
- Operating system
- Amount of data to be stored
- Size and type of load under which the cluster is to operate

Therefore, obtaining an optimum configuration is likely to be an iterative process, the outcome of which can vary widely with the specifics of each NDB Cluster deployment. Changes in configuration are also likely to be indicated when changes are made in the platform on which the cluster is run, or in applications that use the NDB Cluster 's data. For these reasons, it is not possible to offer a single

configuration that is ideal for all usage scenarios. However, in this section, we provide a recommended base configuration.

Starting config.ini file. The following `config.ini` file is a recommended starting point for configuring a cluster running NDB Cluster 7.5:

```
# TCP PARAMETERS

[tcp default]
SendBufferMemory=2M
ReceiveBufferMemory=2M

# Increasing the sizes of these 2 buffers beyond the default values
# helps prevent bottlenecks due to slow disk I/O.

# MANAGEMENT NODE PARAMETERS

[ndb_mgmd default]
DataDir=path/to/management/server/data/directory

# It is possible to use a different data directory for each management
# server, but for ease of administration it is preferable to be
# consistent.

[ndb_mgmd]
HostName=management-server-A-hostname
# NodeId=management-server-A-nodeid

[ndb_mgmd]
HostName=management-server-B-hostname
# NodeId=management-server-B-nodeid

# Using 2 management servers helps guarantee that there is always an
# arbitrator in the event of network partitioning, and so is
# recommended for high availability. Each management server must be
# identified by a HostName. You may for the sake of convenience specify
# a NodeId for any management server, although one is allocated
# for it automatically; if you do so, it must be in the range 1-255
# inclusive and must be unique among all IDs specified for cluster
# nodes.

# DATA NODE PARAMETERS

[ndbd default]
NoOfReplicas=2

# Using two fragment replicas is recommended to guarantee availability of data;
# using only one fragment replica does not provide any redundancy, which means
# that the failure of a single data node causes the entire cluster to
# shut down. We do not recommend using more than two fragment replicas, since
# two are sufficient to provide high availability, and we do not currently test
# with greater values for this parameter.

LockPagesInMainMemory=1

# On Linux and Solaris systems, setting this parameter locks data node
# processes into memory. Doing so prevents them from swapping to disk,
# which can severely degrade cluster performance.

DataMemory=3072M
IndexMemory=384M

# The values provided for DataMemory and IndexMemory assume 4 GB RAM
# per data node. However, for best results, you should first calculate
# the memory that would be used based on the data you actually plan to
# store (you may find the ndb_size.pl utility helpful in estimating
# this), then allow an extra 20% over the calculated values. Naturally,
# you should ensure that each data node host has at least as much
# physical memory as the sum of these two values.
# NOTE: IndexMemory is deprecated in NDB 7.6 and later.

# ODirect=1
```



```

# Enabling this parameter causes NDBCLUSTER to try using O_DIRECT
# writes for local checkpoints and redo logs; this can reduce load on
# CPUs. We recommend doing so when using NDB Cluster on systems running
# Linux kernel 2.6 or later.

NoOfFragmentLogFiles=300
DataDir=path/to/data/node/data/directory
MaxNoOfConcurrentOperations=100000

SchedulerSpinTimer=400
SchedulerExecutionTimer=100
RealTimeScheduler=1
# Setting these parameters allows you to take advantage of real-time scheduling
# of NDB threads to achieve increased throughput when using ndbd. They
# are not needed when using ndbmtl; in particular, you should not set
# RealTimeScheduler for ndbmtl data nodes.

TimeBetweenGlobalCheckpoints=1000
TimeBetweenEpochs=200
RedoBuffer=32M

# CompressedLCP=1
# CompressedBackup=1
# Enabling CompressedLCP and CompressedBackup causes, respectively, local
# checkpoint files and backup files to be compressed, which can result in a space
# savings of up to 50% over noncompressed LCPs and backups.

# MaxNoOfLocalScans=64
MaxNoOfTables=1024
MaxNoOfOrderedIndexes=256

[ndbd]
HostName=data-node-A-hostname
# NodeId=data-node-A-nodeid

LockExecuteThreadToCPU=1
LockMaintThreadsToCPU=0
# On systems with multiple CPUs, these parameters can be used to lock NDBCLUSTER
# threads to specific CPUs

[ndbd]
HostName=data-node-B-hostname
# NodeId=data-node-B-nodeid

LockExecuteThreadToCPU=1
LockMaintThreadsToCPU=0

# You must have an [ndbd] section for every data node in the cluster;
# each of these sections must include a HostName. Each section may
# optionally include a NodeId for convenience, but in most cases, it is
# sufficient to allow the cluster to allocate node IDs dynamically. If
# you do specify the node ID for a data node, it must be in the range 1
# to 48 inclusive and must be unique among all IDs specified for
# cluster nodes.

# SQL NODE / API NODE PARAMETERS

[mysqld]
# HostName=sql-node-A-hostname
# NodeId=sql-node-A-nodeid

[mysqld]

[mysqld]

# Each API or SQL node that connects to the cluster requires a [mysqld]
# or [api] section of its own. Each such section defines a connection
# "slot"; you should have at least as many of these sections in the
# config.ini file as the total number of API nodes and SQL nodes that
# you wish to have connected to the cluster at any given time. There is
# no performance or other penalty for having extra slots available in

```

```
# case you find later that you want or need more API or SQL nodes to
# connect to the cluster at the same time.
# If no HostName is specified for a given [mysqld] or [api] section,
# then any API or SQL node may use that slot to connect to the
# cluster. You may wish to use an explicit HostName for one connection slot
# to guarantee that an API or SQL node from that host can always
# connect to the cluster. If you wish to prevent API or SQL nodes from
# connecting from other than a desired host or hosts, then use a
# HostName for every [mysqld] or [api] section in the config.ini file.
# You can if you wish define a node ID (NodeId parameter) for any API or
# SQL node, but this is not necessary; if you do so, it must be in the
# range 1 to 255 inclusive and must be unique among all IDs specified
# for cluster nodes.
```

Recommended my.cnf options for SQL nodes. MySQL Servers acting as NDB Cluster SQL nodes must always be started with the `--ndbcluster` and `--ndb-connectstring` options, either on the command line or in `my.cnf`. In addition, set the following options for all `mysqld` processes in the cluster, unless your setup requires otherwise:

- `--ndb-use-exact-count=0`
- `--ndb-index-stat-enable=0`
- `--ndb-force-send=1`
- `--optimizer-switch=engine_condition_pushdown=on`

4.3.3 NDB Cluster Connection Strings

With the exception of the NDB Cluster management server (`ndb_mgmd`), each node that is part of an NDB Cluster requires a *connection string* that points to the management server's location. This connection string is used in establishing a connection to the management server as well as in performing other tasks depending on the node's role in the cluster. The syntax for a connection string is as follows:

```
[nodeid=node_id, ]host-definition[, host-definition[, ...]]
host-definition:
    host_name[:port_number]
```

`node_id` is an integer greater than or equal to 1 which identifies a node in `config.ini`. `host_name` is a string representing a valid Internet host name or IP address. `port_number` is an integer referring to a TCP/IP port number.

```
example 1 (long):    "nodeid=2,myhost1:1100,myhost2:1100,198.51.100.3:1200"
example 2 (short):  "myhost1"
```

`localhost:1186` is used as the default connection string value if none is provided. If `port_num` is omitted from the connection string, the default port is 1186. This port should always be available on the network because it has been assigned by IANA for this purpose (see <http://www.iana.org/assignments/port-numbers> for details).

By listing multiple host definitions, it is possible to designate several redundant management servers. An NDB Cluster data or API node attempts to contact successive management servers on each host in the order specified, until a successful connection has been established.

It is also possible to specify in a connection string one or more bind addresses to be used by nodes having multiple network interfaces for connecting to management servers. A bind address consists of a hostname or network address and an optional port number. This enhanced syntax for connection strings is shown here:

```
[nodeid=node_id, ]
    [bind-address=host-definition, ]
    host-definition[; bind-address=host-definition]
    host-definition[; bind-address=host-definition]
    [, ...]]
```

```
host-definition:
  host_name[:port_number]
```

If a single bind address is used in the connection string *prior* to specifying any management hosts, then this address is used as the default for connecting to any of them (unless overridden for a given management server; see later in this section for an example). For example, the following connection string causes the node to use `198.51.100.242` regardless of the management server to which it connects:

```
bind-address=198.51.100.242, poseidon:1186, perch:1186
```

If a bind address is specified *following* a management host definition, then it is used only for connecting to that management node. Consider the following connection string:

```
poseidon:1186;bind-address=localhost, perch:1186;bind-address=198.51.100.242
```

In this case, the node uses `localhost` to connect to the management server running on the host named `poseidon` and `198.51.100.242` to connect to the management server running on the host named `perch`.

You can specify a default bind address and then override this default for one or more specific management hosts. In the following example, `localhost` is used for connecting to the management server running on host `poseidon`; since `198.51.100.242` is specified first (before any management server definitions), it is the default bind address and so is used for connecting to the management servers on hosts `perch` and `orca`:

```
bind-address=198.51.100.242,poseidon:1186;bind-address=localhost,perch:1186,orca:2200
```

There are a number of different ways to specify the connection string:

- Each executable has its own command-line option which enables specifying the management server at startup. (See the documentation for the respective executable.)
- It is also possible to set the connection string for all nodes in the cluster at once by placing it in a `[mysql_cluster]` section in the management server's `my.cnf` file.
- For backward compatibility, two other options are available, using the same syntax:
 1. Set the `NDB_CONNECTSTRING` environment variable to contain the connection string.
 2. Write the connection string for each executable into a text file named `Ndb.cfg` and place this file in the executable's startup directory.

However, these are now deprecated and should not be used for new installations.

The recommended method for specifying the connection string is to set it on the command line or in the `my.cnf` file for each executable.

4.3.4 Defining Computers in an NDB Cluster

The `[computer]` section has no real significance other than serving as a way to avoid the need of defining host names for each node in the system. All parameters mentioned here are required.

- `Id`

Version (or later)	NDB 7.5.0
Type or units	string
Default	[...]
Range	...
Restart Type	S

This is a unique identifier, used to refer to the host computer elsewhere in the configuration file.

Important

The computer ID is *not* the same as the node ID used for a management, API, or data node. Unlike the case with node IDs, you cannot use `NodeId` in place of `Id` in the `[computer]` section of the `config.ini` file.

- `HostName`

Version (or later)	NDB 7.5.0
Type or units	name or IP address
Default	[...]
Range	...
Restart Type	S

This is the computer's hostname or IP address.

Restart types. Information about the restart types used by the parameter descriptions in this section is shown in the following table:

Table 4.1 NDB Cluster restart types

Symbol	Restart Type	Description
N	Node	The parameter can be updated using a rolling restart (see Section 6.5, “Performing a Rolling Restart of an NDB Cluster”)
S	System	All cluster nodes must be shut down completely, then restarted, to effect a change in this parameter
I	Initial	Data nodes must be restarted using the <code>--initial</code> option

4.3.5 Defining an NDB Cluster Management Server

The `[ndb_mgmd]` section is used to configure the behavior of the management server. If multiple management servers are employed, you can specify parameters common to all of them in an `[ndb_mgmd default]` section. `[mgm]` and `[mgm default]` are older aliases for these, supported for backward compatibility.

All parameters in the following list are optional and assume their default values if omitted.

Note

If neither the `ExecuteOnComputer` nor the `HostName` parameter is present, the default value `localhost` is assumed for both.

- `Id`

Version (or later)	NDB 7.5.0
Type or units	unsigned
Default	[...]
Range	1 - 255
Restart Type	S

Each node in the cluster has a unique identity. For a management node, this is represented by an integer value in the range 1 to 255, inclusive. This ID is used by all internal cluster messages for addressing the node, and so must be unique for each NDB Cluster node, regardless of the type of node.

Note

Data node IDs must be less than 49. If you plan to deploy a large number of data nodes, it is a good idea to limit the node IDs for management nodes (and API nodes) to values greater than 48.

The use of the `Id` parameter for identifying management nodes is deprecated in favor of `NodeId`. Although `Id` continues to be supported for backward compatibility, it now generates a warning and is subject to removal in a future version of NDB Cluster.

- `NodeId`

Version (or later)	NDB 7.5.0
Type or units	unsigned
Default	[...]
Range	1 - 255
Restart Type	S

Each node in the cluster has a unique identity. For a management node, this is represented by an integer value in the range 1 to 255 inclusive. This ID is used by all internal cluster messages for addressing the node, and so must be unique for each NDB Cluster node, regardless of the type of node.

Note

Data node IDs must be less than 49. If you plan to deploy a large number of data nodes, it is a good idea to limit the node IDs for management nodes (and API nodes) to values greater than 48.

`NodeId` is the preferred parameter name to use when identifying management nodes. Although the older `Id` continues to be supported for backward compatibility, it is now deprecated and generates a warning when used; it is also subject to removal in a future NDB Cluster release.

- `ExecuteOnComputer`

Version (or later)	NDB 7.5.0
Type or units	name
Default	[...]
Range	...
Deprecated	NDB 7.5.0
Restart Type	S

This refers to the `Id` set for one of the computers defined in a `[computer]` section of the `config.ini` file.

Important

This parameter is deprecated as of NDB 7.5.0, and is subject to removal in a future release. Use the `HostName` parameter instead.

- `PortNumber`

Version (or later)	NDB 7.5.0
Type or units	unsigned
Default	1186
Range	0 - 64K
Restart Type	S

This is the port number on which the management server listens for configuration requests and management commands.

- [HostName](#)

Version (or later)	NDB 7.5.0
Type or units	name or IP address
Default	[...]
Range	...
Restart Type	S

Specifying this parameter defines the hostname of the computer on which the management node is to reside. To specify a hostname other than `localhost`, either this parameter or [ExecuteOnComputer](#) is required.

- [LocationDomainId](#)

Version (or later)	NDB 7.6.4
Type or units	integer
Default	0
Range	0 - 16
Added	NDB 7.6.4
Restart Type	S (NDB 7.6.4)

Assigns a management node to a specific [availability domain](#) (also known as an availability zone) within a cloud. By informing `NDB` which nodes are in which availability domains, performance can be improved in a cloud environment in the following ways:

- If requested data is not found on the same node, reads can be directed to another node in the same availability domain.
- Communication between nodes in different availability domains are guaranteed to use `NDB` transporters' WAN support without any further manual intervention.
- The transporter's group number can be based on which availability domain is used, such that also SQL and other API nodes communicate with local data nodes in the same availability domain whenever possible.
- The arbitrator can be selected from an availability domain in which no data nodes are present, or, if no such availability domain can be found, from a third availability domain.

[LocationDomainId](#) takes an integer value between 0 and 16 inclusive, with 0 being the default; using 0 is the same as leaving the parameter unset.

- [LogDestination](#)

Version (or later)	NDB 7.5.0
--------------------	-----------

Type or units	{CONSOLE SYSLOG FILE}
Default	FILE: filename=ndb_nodeid_cluster.log, maxsize=1000000, maxfiles=6
Range	...
Restart Type	S

This parameter specifies where to send cluster logging information. There are three options in this regard—`CONSOLE`, `SYSLOG`, and `FILE`—with `FILE` being the default:

- `CONSOLE` outputs the log to `stdout`:

```
CONSOLE
```

- `SYSLOG` sends the log to a `syslog` facility, possible values being one of `auth`, `authpriv`, `cron`, `daemon`, `ftp`, `kern`, `lpr`, `mail`, `news`, `syslog`, `user`, `uucp`, `local0`, `local1`, `local2`, `local3`, `local4`, `local5`, `local6`, or `local7`.

Note

Not every facility is necessarily supported by every operating system.

```
SYSLOG:facility=syslog
```

- `FILE` pipes the cluster log output to a regular file on the same machine. The following values can be specified:

- `filename`: The name of the log file.

The default log file name used in such cases is `ndb_nodeid_cluster.log`.

- `maxsize`: The maximum size (in bytes) to which the file can grow before logging rolls over to a new file. When this occurs, the old log file is renamed by appending `.N` to the file name, where `N` is the next number not yet used with this name.
- `maxfiles`: The maximum number of log files.

```
FILE:filename=cluster.log,maxsize=1000000,maxfiles=6
```

The default value for the `FILE` parameter is

```
FILE:filename=ndb_node_id_cluster.log,maxsize=1000000,maxfiles=6
```

where `node_id` is the ID of the node.

It is possible to specify multiple log destinations separated by semicolons as shown here:

```
CONSOLE;SYSLOG:facility=local0;FILE:filename=/var/log/mgmd
```

- `ArbitrationRank`

Version (or later)	NDB 7.5.0
Type or units	0-2
Default	1
Range	0 - 2
Restart Type	S

This parameter is used to define which nodes can act as arbitrators. Only management nodes and SQL nodes can be arbitrators. `ArbitrationRank` can take one of the following values:

- `0`: The node is never used as an arbitrator.

- **1**: The node has high priority; that is, it is preferred as an arbitrator over low-priority nodes.
- **2**: Indicates a low-priority node which is used as an arbitrator only if a node with a higher priority is not available for that purpose.

Normally, the management server should be configured as an arbitrator by setting its `ArbitrationRank` to 1 (the default for management nodes) and those for all SQL nodes to 0 (the default for SQL nodes).

You can disable arbitration completely either by setting `ArbitrationRank` to 0 on all management and SQL nodes, or by setting the `Arbitration` parameter in the `[ndbd default]` section of the `config.ini` global configuration file. Setting `Arbitration` causes any settings for `ArbitrationRank` to be disregarded.

- `ArbitrationDelay`

Version (or later)	NDB 7.5.0
Type or units	milliseconds
Default	0
Range	0 - 4294967039 (0xFFFFFFFF)
Restart Type	S

An integer value which causes the management server's responses to arbitration requests to be delayed by that number of milliseconds. By default, this value is 0; it is normally not necessary to change it.

- `DataDir`

Version (or later)	NDB 7.5.0
Type or units	path
Default	.
Range	...
Restart Type	S

This specifies the directory where output files from the management server are placed. These files include cluster log files, process output files, and the daemon's process ID (PID) file. (For log files, this location can be overridden by setting the `FILE` parameter for `LogDestination` as discussed previously in this section.)

The default value for this parameter is the directory in which `ndb_mgmd` is located.

- `PortNumberStats`

Version (or later)	NDB 7.5.0
Type or units	unsigned
Default	[...]
Range	0 - 64K
Restart Type	S

This parameter specifies the port number used to obtain statistical information from an NDB Cluster management server. It has no default value.

- [Wan](#)

Version (or later)	NDB 7.5.0
Type or units	boolean
Default	false
Range	true, false
Restart Type	S

Use WAN TCP setting as default.

- [HeartbeatThreadPriority](#)

Version (or later)	NDB 7.5.0
Type or units	string
Default	[...]
Range	...
Restart Type	S

Set the scheduling policy and priority of heartbeat threads for management and API nodes.

The syntax for setting this parameter is shown here:

```
HeartbeatThreadPriority = policy[, priority]

policy:
{FIFO | RR}
```

When setting this parameter, you must specify a policy. This is one of [FIFO](#) (first in, first out) or [RR](#) (round robin). The policy value is followed optionally by the priority (an integer).

- [ExtraSendBufferMemory](#)

Version (or later)	NDB 7.5.0
Type or units	bytes
Default	0
Range	0 - 32G
Restart Type	S

This parameter specifies the amount of transporter send buffer memory to allocate in addition to any that has been set using [TotalSendBufferMemory](#), [SendBufferMemory](#), or both.

- [TotalSendBufferMemory](#)

Version (or later)	NDB 7.5.0
Type or units	bytes
Default	0
Range	256K - 4294967039 (0xFFFFFFFF)

Restart Type	S
--------------	---

This parameter is used to determine the total amount of memory to allocate on this node for shared send buffer memory among all configured transporters.

If this parameter is set, its minimum permitted value is 256KB; 0 indicates that the parameter has not been set. For more detailed information, see [Section 4.3.13, “Configuring NDB Cluster Send Buffer Parameters”](#).

- [HeartbeatIntervalMgmdMgmd](#)

Version (or later)	NDB 7.5.0
Type or units	milliseconds
Default	1500
Range	100 - 4294967039 (0xFFFFFFFF)
Restart Type	S

Specify the interval between heartbeat messages used to determine whether another management node is on contact with this one. The management node waits after 3 of these intervals to declare the connection dead; thus, the default setting of 1500 milliseconds causes the management node to wait for approximately 1600 ms before timing out.

Note

After making changes in a management node's configuration, it is necessary to perform a rolling restart of the cluster for the new configuration to take effect.

To add new management servers to a running NDB Cluster, it is also necessary to perform a rolling restart of all cluster nodes after modifying any existing `config.ini` files. For more information about issues arising when using multiple management nodes, see [Section 2.7.10, “Limitations Relating to Multiple NDB Cluster Nodes”](#).

Restart types. Information about the restart types used by the parameter descriptions in this section is shown in the following table:

Table 4.2 NDB Cluster restart types

Symbol	Restart Type	Description
N	Node	The parameter can be updated using a rolling restart (see Section 6.5, “Performing a Rolling Restart of an NDB Cluster”)
S	System	All cluster nodes must be shut down completely, then restarted, to effect a change in this parameter
I	Initial	Data nodes must be restarted using the <code>--initial</code> option

4.3.6 Defining NDB Cluster Data Nodes

The `[ndbd]` and `[ndbd default]` sections are used to configure the behavior of the cluster's data nodes.

`[ndbd]` and `[ndbd default]` are always used as the section names whether you are using `ndbd` or `ndbmtD` binaries for the data node processes.

There are many parameters which control buffer sizes, pool sizes, timeouts, and so forth. The only mandatory parameter is either one of `ExecuteOnComputer` or `HostName`; this must be defined in the local `[ndbd]` section.

The parameter `NoOfReplicas` should be defined in the `[ndbd default]` section, as it is common to all Cluster data nodes. It is not strictly necessary to set `NoOfReplicas`, but it is good practice to set it explicitly.

Most data node parameters are set in the `[ndbd default]` section. Only those parameters explicitly stated as being able to set local values are permitted to be changed in the `[ndbd]` section. Where present, `HostName`, `NodeId` and `ExecuteOnComputer` *must* be defined in the local `[ndbd]` section, and not in any other section of `config.ini`. In other words, settings for these parameters are specific to one data node.

For those parameters affecting memory usage or buffer sizes, it is possible to use `K`, `M`, or `G` as a suffix to indicate units of 1024, 1024×1024, or 1024×1024×1024. (For example, `100K` means 100 × 1024 = 102400.)

Parameter names and values are case-insensitive, unless used in a MySQL Server `my.cnf` or `my.ini` file, in which case they are case-sensitive.

Information about configuration parameters specific to NDB Cluster Disk Data tables can be found later in this section (see [Disk Data Configuration Parameters](#)).

All of these parameters also apply to `ndbmt`d (the multithreaded version of `ndbd`). Three additional data node configuration parameters—`MaxNoOfExecutionThreads`, `ThreadConfig`, and `NoOfFragmentLogParts`—apply to `ndbmt`d only; these have no effect when used with `ndbd`. For more information, see [Multi-Threading Configuration Parameters \(ndbmt\)](#). See also [Section 5.3, “ndbmt — The NDB Cluster Data Node Daemon \(Multi-Threaded\)”](#).

Identifying data nodes. The `NodeId` or `Id` value (that is, the data node identifier) can be allocated on the command line when the node is started or in the configuration file.

- `NodeId`

Version (or later)	NDB 7.5.0
Type or units	unsigned
Default	[...]
Range	1 - 48
Restart Type	S

A unique node ID is used as the node's address for all cluster internal messages. For data nodes, this is an integer in the range 1 to 48 inclusive. Each node in the cluster must have a unique identifier.

`NodeId` is the only supported parameter name to use when identifying data nodes. (`Id` was removed in NDB 7.5.0.)

- `ExecuteOnComputer`

Version (or later)	NDB 7.5.0
Type or units	name
Default	[...]
Range	...
Deprecated	NDB 7.5.0
Restart Type	S

This refers to the `Id` set for one of the computers defined in a `[computer]` section.

Important

This parameter is deprecated as of NDB 7.5.0, and is subject to removal in a future release. Use the `HostName` parameter instead.

- `HostName`

Version (or later)	NDB 7.5.0
Type or units	name or IP address
Default	localhost
Range	...
Restart Type	S

Specifying this parameter defines the hostname of the computer on which the data node is to reside. To specify a hostname other than `localhost`, either this parameter or `ExecuteOnComputer` is required.

- `ServerPort`

Version (or later)	NDB 7.5.0
Type or units	unsigned
Default	[...]
Range	1 - 64K
Restart Type	S

Each node in the cluster uses a port to connect to other nodes. By default, this port is allocated dynamically in such a way as to ensure that no two nodes on the same host computer receive the same port number, so it should normally not be necessary to specify a value for this parameter.

However, if you need to be able to open specific ports in a firewall to permit communication between data nodes and API nodes (including SQL nodes), you can set this parameter to the number of the desired port in an `[ndbd]` section or (if you need to do this for multiple data nodes) the `[ndbd default]` section of the `config.ini` file, and then open the port having that number for incoming connections from SQL nodes, API nodes, or both.

Note

Connections from data nodes to management nodes is done using the `ndb_mgmd` management port (the management server's `PortNumber`) so outgoing connections to that port from any data nodes should always be permitted.

- `TcpBind_INADDR_ANY`

Setting this parameter to `TRUE` or `1` binds `IP_ADDR_ANY` so that connections can be made from anywhere (for autogenerated connections). The default is `FALSE` (`0`).

- `NodeGroup`

Version (or later)	NDB 7.5.0
Type or units	unsigned
Default	[...]
Range	0 - 65536

Restart Type	S
------------------------------	---

This parameter can be used to assign a data node to a specific node group. It is read only when the cluster is started for the first time, and cannot be used to reassign a data node to a different node group online. It is generally not desirable to use this parameter in the `[ndbd default]` section of the `config.ini` file, and care must be taken not to assign nodes to node groups in such a way that an invalid numbers of nodes are assigned to any node groups.

The `NodeGroup` parameter is chiefly intended for use in adding a new node group to a running NDB Cluster without having to perform a rolling restart. For this purpose, you should set it to 65536 (the maximum value). You are not required to set a `NodeGroup` value for all cluster data nodes, only for those nodes which are to be started and added to the cluster as a new node group at a later time. For more information, see [Section 6.7.3, “Adding NDB Cluster Data Nodes Online: Detailed Example”](#).

- [LocationDomainId](#)

Version (or later)	NDB 7.6.4
Type or units	integer
Default	0
Range	0 - 16
Added	NDB 7.6.4
Restart Type	S (NDB 7.6.4)

Assigns a data node to a specific [availability domain](#) (also known as an availability zone) within a cloud. By informing NDB which nodes are in which availability domains, performance can be improved in a cloud environment in the following ways:

- If requested data is not found on the same node, reads can be directed to another node in the same availability domain.
- Communication between nodes in different availability domains are guaranteed to use NDB transporters' WAN support without any further manual intervention.
- The transporter's group number can be based on which availability domain is used, such that also SQL and other API nodes communicate with local data nodes in the same availability domain whenever possible.
- The arbitrator can be selected from an availability domain in which no data nodes are present, or, if no such availability domain can be found, from a third availability domain.

`LocationDomainId` takes an integer value between 0 and 16 inclusive, with 0 being the default; using 0 is the same as leaving the parameter unset.

- [NoOfReplicas](#)

Version (or later)	NDB 7.5.0
Type or units	integer
Default	2
Range	1 - 2

Restart Type	S
--------------	---

This global parameter can be set only in the `[ndb default]` section, and defines the number of fragment replicas for each table stored in the cluster. This parameter also specifies the size of node groups. A node group is a set of nodes all storing the same information.

Node groups are formed implicitly. The first node group is formed by the set of data nodes with the lowest node IDs, the next node group by the set of the next lowest node identities, and so on. By way of example, assume that we have 4 data nodes and that `NoOfReplicas` is set to 2. The four data nodes have node IDs 2, 3, 4 and 5. Then the first node group is formed from nodes 2 and 3, and the second node group by nodes 4 and 5. It is important to configure the cluster in such a manner that nodes in the same node groups are not placed on the same computer because a single hardware failure would cause the entire cluster to fail.

If no node IDs are provided, the order of the data nodes is the determining factor for the node group. Whether or not explicit assignments are made, they can be viewed in the output of the management client's `SHOW` command.

The default and recommended maximum value for `NoOfReplicas` is 2. *This is the recommended value for most production environments.*

Important

While it is theoretically possible for the value of this parameter to be 3 or 4, **NDB Cluster 7.5 and NDB Cluster 7.6 do not support setting `NoOfReplicas` to a value greater than 2 in production.**

Warning

Setting `NoOfReplicas` to 1 means that there is only a single copy of all Cluster data; in this case, the loss of a single data node causes the cluster to fail because there are no additional copies of the data stored by that node.

The number of data nodes in the cluster must be evenly divisible by the value of this parameter. For example, if there are two data nodes, then `NoOfReplicas` must be equal to either 1 or 2, since 2/3 and 2/4 both yield fractional values; if there are four data nodes, then `NoOfReplicas` must be equal to 1, 2, or 4.

- `DataDir`

Version (or later)	NDB 7.5.0
Type or units	path
Default	.
Range	...
Restart Type	S

This parameter specifies the directory where trace files, log files, pid files and error logs are placed.

The default is the data node process working directory.

- `FileSystemPath`

Version (or later)	NDB 7.5.0
Type or units	path
Default	DataDir
Range	...

Restart Type	S
--------------	---

This parameter specifies the directory where all files created for metadata, REDO logs, UNDO logs (for Disk Data tables), and data files are placed. The default is the directory specified by [DataDir](#).

Note

This directory must exist before the `ndbd` process is initiated.

The recommended directory hierarchy for NDB Cluster includes `/var/lib/mysql-cluster`, under which a directory for the node's file system is created. The name of this subdirectory contains the node ID. For example, if the node ID is 2, this subdirectory is named `ndb_2_fs`.

- [BackupDataDir](#)

Version (or later)	NDB 7.5.0
Type or units	path
Default	FileSystemPath
Range	...
Restart Type	S

This parameter specifies the directory in which backups are placed.

Important

The string `/'BACKUP'` is always appended to this value. For example, if you set the value of [BackupDataDir](#) to `/var/lib/cluster-data`, then all backups are stored under `/var/lib/cluster-data/BACKUP`. This also means that the *effective* default backup location is the directory named `BACKUP` under the location specified by the [FileSystemPath](#) parameter.

Data Memory, Index Memory, and String Memory

[DataMemory](#) and [IndexMemory](#) are `[ndbd]` parameters specifying the size of memory segments used to store the actual records and their indexes. In setting values for these, it is important to understand how [DataMemory](#) and [IndexMemory](#) are used, as they usually need to be updated to reflect actual usage by the cluster.

Note

[IndexMemory](#) is deprecated in NDB 7.6, and subject to removal in a future version of NDB Cluster. See the descriptions that follow for further information.

- [DataMemory](#)

Version (or later)	NDB 7.5.0
Type or units	bytes
Default	80M
Range	1M - 1T
Version (or later)	NDB 7.6.2
Type or units	bytes
Default	98M
Range	1M - 1T
Restart Type	S

This parameter defines the amount of space (in bytes) available for storing database records. The entire amount specified by this value is allocated in memory, so it is extremely important that the machine has sufficient physical memory to accommodate it.

The memory allocated by `DataMemory` is used to store both the actual records and indexes. There is a 16-byte overhead on each record; an additional amount for each record is incurred because it is stored in a 32KB page with 128 byte page overhead (see below). There is also a small amount wasted per page due to the fact that each record is stored in only one page.

For variable-size table attributes, the data is stored on separate data pages, allocated from `DataMemory`. Variable-length records use a fixed-size part with an extra overhead of 4 bytes to reference the variable-size part. The variable-size part has 2 bytes overhead plus 2 bytes per attribute.

The maximum record size is 14000 bytes.

In NDB 7.5 (and earlier), the memory space defined by `DataMemory` is also used to store ordered indexes, which use about 10 bytes per record. Each table row is represented in the ordered index. A common error among users is to assume that all indexes are stored in the memory allocated by `IndexMemory`, but this is not the case: Only primary key and unique hash indexes use this memory; ordered indexes use the memory allocated by `DataMemory`. However, creating a primary key or unique hash index also creates an ordered index on the same keys, unless you specify `USING HASH` in the index creation statement. This can be verified by running `ndb_desc -d db_name table_name`.

In NDB 7.6, resources assigned to `DataMemory` are used for storing *all* data and indexes; any memory configured as `IndexMemory` is automatically added to that used by `DataMemory` to form a common resource pool.

Currently, NDB Cluster can use a maximum of 512 MB for hash indexes per partition, which means in some cases it is possible to get `Table is full` errors in MySQL client applications even when `ndb_mgm -e "ALL REPORT MEMORYUSAGE"` shows significant free `DataMemory`. This can also pose a problem with data node restarts on nodes that are heavily loaded with data.

You can control the number of partitions per local data manager for a given table by setting the `NDB_TABLE` option `PARTITION_BALANCE` to one of the values `FOR_RA_BY_LDM`, `FOR_RA_BY_LDM_X_2`, `FOR_RA_BY_LDM_X_3`, or `FOR_RA_BY_LDM_X_4`, for 1, 2, 3, or 4 partitions per LDM, respectively, when creating the table (see [Setting NDB_TABLE Options](#)).

Note

In previous versions of NDB Cluster it was possible to create extra partitions for NDB Cluster tables and thus have more memory available for hash indexes by using the `MAX_ROWS` option for `CREATE TABLE`. While still supported for backward compatibility, using `MAX_ROWS` for this purpose is deprecated, and you should use `PARTITION_BALANCE` instead.

You can also use the `MinFreePct` configuration parameter to help avoid problems with node restarts.

The memory space allocated by `DataMemory` consists of 32KB pages, which are allocated to table fragments. Each table is normally partitioned into the same number of fragments as there are data nodes in the cluster. Thus, for each node, there are the same number of fragments as are set in `NoOfReplicas`.

Once a page has been allocated, it is currently not possible to return it to the pool of free pages, except by deleting the table. (This also means that `DataMemory` pages, once allocated to a given

table, cannot be used by other tables.) Performing a data node recovery also compresses the partition because all records are inserted into empty partitions from other live nodes.

The `DataMemory` memory space also contains UNDO information: For each update, a copy of the unaltered record is allocated in the `DataMemory`. There is also a reference to each copy in the ordered table indexes. Unique hash indexes are updated only when the unique index columns are updated, in which case a new entry in the index table is inserted and the old entry is deleted upon commit. For this reason, it is also necessary to allocate enough memory to handle the largest transactions performed by applications using the cluster. In any case, performing a few large transactions holds no advantage over using many smaller ones, for the following reasons:

- Large transactions are not any faster than smaller ones
- Large transactions increase the number of operations that are lost and must be repeated in event of transaction failure
- Large transactions use more memory

In NDB 7.5 (and earlier), the default value for `DataMemory` is 80MB; in NDB 7.6, this is 98MB. The minimum value is 1MB. There is no maximum size, but in reality the maximum size has to be adapted so that the process does not start swapping when the limit is reached. This limit is determined by the amount of physical RAM available on the machine and by the amount of memory that the operating system may commit to any one process. 32-bit operating systems are generally limited to 2–4GB per process; 64-bit operating systems can use more. For large databases, it may be preferable to use a 64-bit operating system for this reason.

- `IndexMemory`

Version (or later)	NDB 7.5.0
Type or units	bytes
Default	18M
Range	1M - 1T
Version (or later)	NDB 7.6.2
Type or units	bytes
Default	0
Range	1M - 1T
Deprecated	NDB 7.6.2
Restart Type	S

In NDB 7.5 and earlier, this parameter controls the amount of storage used for hash indexes in NDB Cluster. Hash indexes are always used for primary key indexes, unique indexes, and unique constraints. When defining a primary key or a unique index, two indexes are created, one of which is a hash index used for all tuple accesses as well as lock handling. This index is also used to enforce unique constraints.

In NDB 7.6.2, the `IndexMemory` parameter is deprecated (and subject to future removal); any memory assigned to `IndexMemory` is allocated instead to the same pool as `DataMemory`, which becomes solely responsible for all resources needed for storing data and indexes in memory. In NDB 7.6, the use of `IndexMemory` in the cluster configuration file triggers a warning from the management server.

You can estimate the size of a hash index using this formula:

```
size = ( (fragments * 32K) + (rows * 18) )
      * fragment_replicas
```

fragments is the number of fragments, *fragment_replicas* is the number of fragment replicas (normally two), and *rows* is the number of rows. If a table has one million rows, eight fragments, and two fragment replicas, the expected index memory usage is calculated as shown here:

```
((8 * 32K) + (1000000 * 18)) * 2 = ((8 * 32768) + (1000000 * 18)) * 2
= (262144 + 18000000) * 2
= 18262144 * 2 = 36524288 bytes = ~35MB
```

Index statistics for ordered indexes (when these are enabled) are stored in the `mysql.ndb_index_stat_sample` table. Since this table has a hash index, this adds to index memory usage. An upper bound to the number of rows for a given ordered index can be calculated as follows:

```
sample_size= key_size + ((key_attributes + 1) * 4)

sample_rows = IndexStatSaveSize
              * ((0.01 * IndexStatSaveScale * log2(rows * sample_size)) + 1)
              / sample_size
```

In the preceding formula, *key_size* is the size of the ordered index key in bytes, *key_attributes* is the number of attributes in the ordered index key, and *rows* is the number of rows in the base table.

Assume that table `t1` has 1 million rows and an ordered index named `ix1` on two four-byte integers. Assume in addition that `IndexStatSaveSize` and `IndexStatSaveScale` are set to their default values (32K and 100, respectively). Using the previous 2 formulas, we can calculate as follows:

```
sample_size = 8 + ((1 + 2) * 4) = 20 bytes

sample_rows = 32K
              * ((0.01 * 100 * log2(1000000*20)) + 1)
              / 20
              = 32768 * ( (1 * ~16.811) +1) / 20
              = 32768 * ~17.811 / 20
              = ~29182 rows
```

The expected index memory usage is thus $2 * 18 * 29182 = \sim 1050550$ bytes.

Prior to NDB 7.6, the default value for `IndexMemory` is 18MB and the minimum is 1 MB; in NDB 7.6, the minimum and default value for this parameter is 0 (zero). This has implications for downgrades from NDB 7.6 to earlier versions of NDB Cluster; see [Section 3.7, “Upgrading and Downgrading NDB Cluster”](#), for more information.

- [StringMemory](#)

Version (or later)	NDB 7.5.0
Type or units	% or bytes
Default	25
Range	0 - 4294967039 (0xFFFFFFFF)
Restart Type	S

This parameter determines how much memory is allocated for strings such as table names, and is specified in an `[ndbd]` or `[ndbd default]` section of the `config.ini` file. A value between 0 and 100 inclusive is interpreted as a percent of the maximum default value, which is calculated based on a number of factors including the number of tables, maximum table name size, maximum

size of `.FRM` files, `MaxNoOfTriggers`, maximum column name size, and maximum default column value.

A value greater than 100 is interpreted as a number of bytes.

The default value is 25—that is, 25 percent of the default maximum.

Under most circumstances, the default value should be sufficient, but when you have a great many NDB tables (1000 or more), it is possible to get Error 773 *Out of string memory, please modify StringMemory config parameter: Permanent error: Schema error*, in which case you should increase this value. 25 (25 percent) is not excessive, and should prevent this error from recurring in all but the most extreme conditions.

The following example illustrates how memory is used for a table. Consider this table definition:

```
CREATE TABLE example (
  a INT NOT NULL,
  b INT NOT NULL,
  c INT NOT NULL,
  PRIMARY KEY(a),
  UNIQUE(b)
) ENGINE=NDBCLUSTER;
```

For each record, there are 12 bytes of data plus 12 bytes overhead. Having no nullable columns saves 4 bytes of overhead. In addition, we have two ordered indexes on columns `a` and `b` consuming roughly 10 bytes each per record. There is a primary key hash index on the base table using roughly 29 bytes per record. The unique constraint is implemented by a separate table with `b` as primary key and `a` as a column. This other table consumes an additional 29 bytes of index memory per record in the `example` table as well 8 bytes of record data plus 12 bytes of overhead.

Thus, for one million records, we need 58MB for index memory to handle the hash indexes for the primary key and the unique constraint. We also need 64MB for the records of the base table and the unique index table, plus the two ordered index tables.

You can see that hash indexes takes up a fair amount of memory space; however, they provide very fast access to the data in return. They are also used in NDB Cluster to handle uniqueness constraints.

Currently, the only partitioning algorithm is hashing and ordered indexes are local to each node. Thus, ordered indexes cannot be used to handle uniqueness constraints in the general case.

An important point for both `IndexMemory` and `DataMemory` is that the total database size is the sum of all data memory and all index memory for each node group. Each node group is used to store replicated information, so if there are four nodes with two fragment replicas, there are two node groups. Thus, the total data memory available is $2 \times \text{DataMemory}$ for each data node.

It is highly recommended that `DataMemory` and `IndexMemory` be set to the same values for all nodes. Data distribution is even over all nodes in the cluster, so the maximum amount of space available for any node can be no greater than that of the smallest node in the cluster.

`DataMemory` (and in NDB 7.5 and earlier `IndexMemory`) can be changed, but decreasing it can be risky; doing so can easily lead to a node or even an entire NDB Cluster that is unable to restart due to there being insufficient memory space. Increases should be acceptable, but it is recommended that such upgrades are performed in the same manner as a software upgrade, beginning with an update of the configuration file, and then restarting the management server followed by restarting each data node in turn.

MinFreePct. A proportion (5% by default) of data node resources including `DataMemory` (and in NDB 7.5 and earlier, `IndexMemory`) is kept in reserve to insure that the data node does not exhaust its memory when performing a restart. This can be adjusted using the `MinFreePct` data node configuration parameter (default 5).

Version (or later)	NDB 7.5.0
Type or units	unsigned

Default	5
Range	0 - 100
Restart Type	S

Updates do not increase the amount of index memory used. Inserts take effect immediately; however, rows are not actually deleted until the transaction is committed.

Transaction parameters. The next few `[ndbd]` parameters that we discuss are important because they affect the number of parallel transactions and the sizes of transactions that can be handled by the system. `MaxNoOfConcurrentTransactions` sets the number of parallel transactions possible in a node. `MaxNoOfConcurrentOperations` sets the number of records that can be in update phase or locked simultaneously.

Both of these parameters (especially `MaxNoOfConcurrentOperations`) are likely targets for users setting specific values and not using the default value. The default value is set for systems using small transactions, to ensure that these do not use excessive memory.

`MaxDMLOperationsPerTransaction` sets the maximum number of DML operations that can be performed in a given transaction.

- `MaxNoOfConcurrentTransactions`

Version (or later)	NDB 7.5.0
Type or units	integer
Default	4096
Range	32 - 4294967039 (0xFFFFFFFF)
Deprecated	Yes (in NDB 8.0)
Restart Type	S

Each cluster data node requires a transaction record for each active transaction in the cluster. The task of coordinating transactions is distributed among all of the data nodes. The total number of transaction records in the cluster is the number of transactions in any given node times the number of nodes in the cluster.

Transaction records are allocated to individual MySQL servers. Each connection to a MySQL server requires at least one transaction record, plus an additional transaction object per table accessed by that connection. This means that a reasonable minimum for the total number of transactions in the cluster can be expressed as

```
TotalNoOfConcurrentTransactions =
    (maximum number of tables accessed in any single transaction + 1)
    * number of SQL nodes
```

Suppose that there are 10 SQL nodes using the cluster. A single join involving 10 tables requires 11 transaction records; if there are 10 such joins in a transaction, then $10 * 11 = 110$ transaction records are required for this transaction, per MySQL server, or $110 * 10 = 1100$ transaction records total. Each data node can be expected to handle `TotalNoOfConcurrentTransactions` / number of data nodes. For an NDB Cluster having 4 data nodes, this would mean setting `MaxNoOfConcurrentTransactions` on each data node to $1100 / 4 = 275$. In addition, you should provide for failure recovery by ensuring that a single node group can accommodate all concurrent transactions; in other words, that each data node's `MaxNoOfConcurrentTransactions` is sufficient to cover a number of transactions equal to `TotalNoOfConcurrentTransactions` / number of node groups. If this cluster has a single node group, then `MaxNoOfConcurrentTransactions` should be set to 1100 (the same as the total number of concurrent transactions for the entire cluster).

In addition, each transaction involves at least one operation; for this reason, the value set for `MaxNoOfConcurrentTransactions` should always be no more than the value of `MaxNoOfConcurrentOperations`.

This parameter must be set to the same value for all cluster data nodes. This is due to the fact that, when a data node fails, the oldest surviving node re-creates the transaction state of all transactions that were ongoing in the failed node.

It is possible to change this value using a rolling restart, but the amount of traffic on the cluster must be such that no more transactions occur than the lower of the old and new levels while this is taking place.

The default value is 4096.

- [MaxNoOfConcurrentOperations](#)

Version (or later)	NDB 7.5.0
Type or units	integer
Default	32K
Range	32 - 4294967039 (0xFFFFFFFF)
Restart Type	S

It is a good idea to adjust the value of this parameter according to the size and number of transactions. When performing transactions which involve only a few operations and records, the default value for this parameter is usually sufficient. Performing large transactions involving many records usually requires that you increase its value.

Records are kept for each transaction updating cluster data, both in the transaction coordinator and in the nodes where the actual updates are performed. These records contain state information needed to find UNDO records for rollback, lock queues, and other purposes.

This parameter should be set at a minimum to the number of records to be updated simultaneously in transactions, divided by the number of cluster data nodes. For example, in a cluster which has four data nodes and which is expected to handle one million concurrent updates using transactions, you should set this value to $1000000 / 4 = 250000$. To help provide resiliency against failures, it is suggested that you set this parameter to a value that is high enough to permit an individual data node to handle the load for its node group. In other words, you should set the value equal to [total number of concurrent operations / number of node groups](#). (In the case where there is a single node group, this is the same as the total number of concurrent operations for the entire cluster.)

Because each transaction always involves at least one operation, the value of [MaxNoOfConcurrentOperations](#) should always be greater than or equal to the value of [MaxNoOfConcurrentTransactions](#).

Read queries which set locks also cause operation records to be created. Some extra space is allocated within individual nodes to accommodate cases where the distribution is not perfect over the nodes.

When queries make use of the unique hash index, there are actually two operation records used per record in the transaction. The first record represents the read in the index table and the second handles the operation on the base table.

The default value is 32768.

This parameter actually handles two values that can be configured separately. The first of these specifies how many operation records are to be placed with the transaction coordinator. The second part specifies how many operation records are to be local to the database.

A very large transaction performed on an eight-node cluster requires as many operation records in the transaction coordinator as there are reads, updates, and deletes involved in the transaction.

However, the operation records of the are spread over all eight nodes. Thus, if it is necessary to configure the system for one very large transaction, it is a good idea to configure the two parts separately. [MaxNoOfConcurrentOperations](#) is always used to calculate the number of operation records in the transaction coordinator portion of the node.

It is also important to have an idea of the memory requirements for operation records. These consume about 1KB per record.

- [MaxNoOfLocalOperations](#)

Version (or later)	NDB 7.5.0
Type or units	integer
Default	UNDEFINED
Range	32 - 4294967039 (0xFFFFFFFF)
Deprecated	Yes (in NDB 8.0)
Restart Type	S

By default, this parameter is calculated as $1.1 \times \text{MaxNoOfConcurrentOperations}$. This fits systems with many simultaneous transactions, none of them being very large. If there is a need to handle one very large transaction at a time and there are many nodes, it is a good idea to override the default value by explicitly specifying this parameter.

- [MaxDMLOperationsPerTransaction](#)

Version (or later)	NDB 7.5.0
Type or units	operations (DML)
Default	4294967295
Range	32 - 4294967295
Restart Type	S

This parameter limits the size of a transaction. The transaction is aborted if it requires more than this many DML operations. The minimum number of operations per transaction is 32; however, you can set [MaxDMLOperationsPerTransaction](#) to 0 to disable any limitation on the number of DML operations per transaction. The maximum (and default) is 4294967295.

Transaction temporary storage. The next set of `[ndbd]` parameters is used to determine temporary storage when executing a statement that is part of a Cluster transaction. All records are released when the statement is completed and the cluster is waiting for the commit or rollback.

The default values for these parameters are adequate for most situations. However, users with a need to support transactions involving large numbers of rows or operations may need to increase these values to enable better parallelism in the system, whereas users whose applications require relatively small transactions can decrease the values to save memory.

- [MaxNoOfConcurrentIndexOperations](#)

Version (or later)	NDB 7.5.0
Type or units	integer
Default	8K
Range	0 - 4294967039 (0xFFFFFFFF)
Deprecated	Yes (in NDB 8.0)
Restart Type	S

For queries using a unique hash index, another temporary set of operation records is used during a query's execution phase. This parameter sets the size of that pool of records. Thus, this record is allocated only while executing a part of a query. As soon as this part has been executed, the record is released. The state needed to handle aborts and commits is handled by the normal operation records, where the pool size is set by the parameter [MaxNoOfConcurrentOperations](#).

The default value of this parameter is 8192. Only in rare cases of extremely high parallelism using unique hash indexes should it be necessary to increase this value. Using a smaller value is possible and can save memory if the DBA is certain that a high degree of parallelism is not required for the cluster.

- [MaxNoOfFiredTriggers](#)

Version (or later)	NDB 7.5.0
Type or units	integer
Default	4000
Range	0 - 4294967039 (0xFFFFFFFF)
Deprecated	Yes (in NDB 8.0)
Restart Type	S

The default value of [MaxNoOfFiredTriggers](#) is 4000, which is sufficient for most situations. In some cases it can even be decreased if the DBA feels certain the need for parallelism in the cluster is not high.

A record is created when an operation is performed that affects a unique hash index. Inserting or deleting a record in a table with unique hash indexes or updating a column that is part of a unique hash index fires an insert or a delete in the index table. The resulting record is used to represent this index table operation while waiting for the original operation that fired it to complete. This operation is short-lived but can still require a large number of records in its pool for situations with many parallel write operations on a base table containing a set of unique hash indexes.

- [TransactionBufferMemory](#)

Version (or later)	NDB 7.5.0
Type or units	bytes
Default	1M
Range	1K - 4294967039 (0xFFFFFFFF)
Restart Type	S

The memory affected by this parameter is used for tracking operations fired when updating index tables and reading unique indexes. This memory is used to store the key and column information for these operations. It is only very rarely that the value for this parameter needs to be altered from the default.

The default value for [TransactionBufferMemory](#) is 1MB.

Normal read and write operations use a similar buffer, whose usage is even more short-lived. The compile-time parameter [ZATTRBUF_FILESIZE](#) (found in `ndb/src/kernel/blocks/Dbtc/Dbtc.hpp`) set to 4000 × 128 bytes (500KB). A similar buffer for key information, [ZDATABUF_FILESIZE](#) (also in `Dbtc.hpp`) contains 4000 × 16 = 62.5KB of buffer space. `Dbtc` is the module that handles transaction coordination.

Scans and buffering. There are additional `[ndbd]` parameters in the `Dblqh` module (in `ndb/src/kernel/blocks/Dblqh/Dblqh.hpp`) that affect reads and updates. These include [ZATTRINBUF_FILESIZE](#), set by default to 10000 × 128 bytes (1250KB) and [ZDATABUF_FILE_SIZE](#),

set by default to 10000*16 bytes (roughly 156KB) of buffer space. To date, there have been neither any reports from users nor any results from our own extensive tests suggesting that either of these compile-time limits should be increased.

- [BatchSizePerLocalScan](#)

Version (or later)	NDB 7.5.0
Type or units	integer
Default	256
Range	1 - 992
Deprecated	Yes (in NDB 8.0)
Restart Type	S

This parameter is used to calculate the number of lock records used to handle concurrent scan operations.

[BatchSizePerLocalScan](#) has a strong connection to the [BatchSize](#) defined in the SQL nodes.

- [LongMessageBuffer](#)

Version (or later)	NDB 7.5.0
Type or units	bytes
Default	64M
Range	512K - 4294967039 (0xFFFFFFFF)
Restart Type	S

This is an internal buffer used for passing messages within individual nodes and between nodes. The default is 64MB.

This parameter seldom needs to be changed from the default.

- [MaxFKBuildBatchSize](#)

Version (or later)	NDB 7.6.4
Type or units	integer
Default	64
Range	16 - 512
Added	NDB 7.6.4
Restart Type	S (NDB 7.6.4)

Maximum scan batch size used for building foreign keys. Increasing the value set for this parameter may speed up building of foreign key builds at the expense of greater impact to ongoing traffic.

- [MaxNoOfConcurrentScans](#)

Version (or later)	NDB 7.5.0
Type or units	integer
Default	256
Range	2 - 500

Restart Type	S
------------------------------	---

This parameter is used to control the number of parallel scans that can be performed in the cluster. Each transaction coordinator can handle the number of parallel scans defined for this parameter. Each scan query is performed by scanning all partitions in parallel. Each partition scan uses a scan record in the node where the partition is located, the number of records being the value of this parameter times the number of nodes. The cluster should be able to sustain [MaxNoOfConcurrentScans](#) scans concurrently from all nodes in the cluster.

Scans are actually performed in two cases. The first of these cases occurs when no hash or ordered indexes exists to handle the query, in which case the query is executed by performing a full table scan. The second case is encountered when there is no hash index to support the query but there is an ordered index. Using the ordered index means executing a parallel range scan. The order is kept on the local partitions only, so it is necessary to perform the index scan on all partitions.

The default value of [MaxNoOfConcurrentScans](#) is 256. The maximum value is 500.

- [MaxNoOfLocalScans](#)

Version (or later)	NDB 7.5.0
Type or units	integer
Default	$4 * \text{MaxNoOfConcurrentScans} * [\# \text{ of data nodes}] + 2$
Range	32 - 4294967039 (0xFFFFFFFF)
Deprecated	Yes (in NDB 8.0)
Restart Type	S

Specifies the number of local scan records if many scans are not fully parallelized. When the number of local scan records is not provided, it is calculated as shown here:

```
4 * MaxNoOfConcurrentScans * [# data nodes] + 2
```

The minimum value is 32.

- [MaxParallelCopyInstances](#)

Version (or later)	NDB 7.5.0
Type or units	integer
Default	0
Range	0 - 64
Restart Type	S

This parameter sets the parallelization used in the copy phase of a node restart or system restart, when a node that is currently just starting is synchronised with a node that already has current data by copying over any changed records from the node that is up to date. Because full parallelism in such cases can lead to overload situations, [MaxParallelCopyInstances](#) provides a means to decrease it. This parameter's default value 0. This value means that the effective parallelism is equal to the number of LDM instances in the node just starting as well as the node updating it.

- [MaxParallelScansPerFragment](#)

Version (or later)	NDB 7.5.0
Type or units	bytes
Default	256
Range	1 - 4294967039 (0xFFFFFFFF)

Restart Type	S
------------------------------	---

It is possible to configure the maximum number of parallel scans ([TUP](#) scans and [TUX](#) scans) allowed before they begin queuing for serial handling. You can increase this to take advantage of any unused CPU when performing large number of scans in parallel and improve their performance.

- [MaxReorgBuildBatchSize](#)

Version (or later)	NDB 7.6.4
Type or units	integer
Default	64
Range	16 - 512
Added	NDB 7.6.4
Restart Type	S (NDB 7.6.4)

Maximum scan batch size used for reorganization of table partitions. Increasing the value set for this parameter may speed up reorganization at the expense of greater impact to ongoing traffic.

- [MaxUIBuildBatchSize](#)

Version (or later)	NDB 7.6.4
Type or units	integer
Default	64
Range	16 - 512
Added	NDB 7.6.4
Restart Type	S (NDB 7.6.4)

Maximum scan batch size used for building unique keys. Increasing the value set for this parameter may speed up such builds at the expense of greater impact to ongoing traffic.

Memory Allocation

[MaxAllocate](#)

Version (or later)	NDB 7.5.0
Type or units	unsigned
Default	32M
Range	1M - 1G
Deprecated	Yes (in NDB 8.0)
Restart Type	S

This parameter was used in older versions of NDB Cluster, but has no effect in NDB 7.5 or NDB 7.6.

Hash Map Size

[DefaultHashMapSize](#)

Version (or later)	NDB 7.5.0
Type or units	LDM threads
Default	240

Range	0 - 3840
Restart Type	S

The size of the table hash maps used by [NDB](#) is configurable using this parameter. [DefaultHashMapSize](#) can take any of three possible values (0, 240, 3840).

The original intended use for this parameter was to facilitate upgrades and especially downgrades to and from very old releases with differing default hash map sizes. This is not an issue when upgrading from NDB Cluster 7.3 (or later) to later versions.

Decreasing this parameter online after any tables have been created or modified with [DefaultHashMapSize](#) equal to 3840 is not supported.

Logging and checkpointing. The following [\[ndbd\]](#) parameters control log and checkpoint behavior.

- [FragmentLogFileSize](#)

Version (or later)	NDB 7.5.0
Type or units	bytes
Default	16M
Range	4M - 1G
Restart Type	S

Setting this parameter enables you to control directly the size of redo log files. This can be useful in situations when NDB Cluster is operating under a high load and it is unable to close fragment log files quickly enough before attempting to open new ones (only 2 fragment log files can be open at one time); increasing the size of the fragment log files gives the cluster more time before having to open each new fragment log file. The default value for this parameter is 16M.

For more information about fragment log files, see the description for [NoOfFragmentLogFiles](#).

- [InitialNoOfOpenFiles](#)

Version (or later)	NDB 7.5.0
Type or units	files
Default	27
Range	20 - 4294967039 (0xFFFFFFFF)
Restart Type	S

This parameter sets the initial number of internal threads to allocate for open files.

The default value is 27.

- [InitFragmentLogFiles](#)

Version (or later)	NDB 7.5.0
Type or units	[see values]
Default	SPARSE
Range	SPARSE, FULL
Restart Type	S

By default, fragment log files are created sparsely when performing an initial start of a data node—that is, depending on the operating system and file system in use, not all bytes are

necessarily written to disk. However, it is possible to override this behavior and force all bytes to be written, regardless of the platform and file system type being used, by means of this parameter. `InitFragmentLogFiles` takes either of two values:

- `SPARSE`. Fragment log files are created sparsely. This is the default value.
- `FULL`. Force all bytes of the fragment log file to be written to disk.

Depending on your operating system and file system, setting `InitFragmentLogFiles=FULL` may help eliminate I/O errors on writes to the REDO log.

- `EnablePartialLcp`

Version (or later)	NDB 7.6.4
Type or units	boolean
Default	true
Range	...
Added	NDB 7.6.4
Restart Type	S (NDB 7.6.4)

When `true`, enable partial local checkpoints: This means that each LCP records only part of the full database, plus any records containing rows changed since the last LCP; if no rows have changed, the LCP updates only the LCP control file and does not update any data files.

If `EnablePartialLcp` is disabled (`false`), each LCP uses only a single file and writes a full checkpoint; this requires the least amount of disk space for LCPs, but increases the write load for each LCP. The default value is enabled (`true`). The proportion of space used by partial LCPS can be modified by the setting for the `RecoveryWork` configuration parameter.

For more information about files and directories used for full and partial LCPs, see [NDB Cluster Data Node File System Directory](#).

In NDB 7.6.7 and later, setting this parameter to `false` also disables the calculation of disk write speed used by the adaptive LCP control mechanism.

- `LcpScanProgressTimeout`

Version (or later)	NDB 7.5.0
Type or units	second
Default	60
Range	0 - 4294967039 (0xFFFFFFFF)
Restart Type	S

A local checkpoint fragment scan watchdog checks periodically for no progress in each fragment scan performed as part of a local checkpoint, and shuts down the node if there is no progress after a given amount of time has elapsed. This interval can be set using the `LcpScanProgressTimeout` data node configuration parameter, which sets the maximum time for which the local checkpoint can be stalled before the LCP fragment scan watchdog shuts down the node.

The default value is 60 seconds (providing compatibility with previous releases). Setting this parameter to 0 disables the LCP fragment scan watchdog altogether.

- `MaxNoOfOpenFiles`

Version (or later)	NDB 7.5.0
Type or units	unsigned

Default	0
Range	20 - 4294967039 (0xFFFFFFFF)
Restart Type	S

This parameter sets a ceiling on how many internal threads to allocate for open files. *Any situation requiring a change in this parameter should be reported as a bug.*

The default value is 0. However, the minimum value to which this parameter can be set is 20.

- [MaxNoOfSavedMessages](#)

Version (or later)	NDB 7.5.0
Type or units	integer
Default	25
Range	0 - 4294967039 (0xFFFFFFFF)
Restart Type	S

This parameter sets the maximum number of errors written in the error log as well as the maximum number of trace files that are kept before overwriting the existing ones. Trace files are generated when, for whatever reason, the node crashes.

The default is 25, which sets these maximums to 25 error messages and 25 trace files.

- [MaxLCPStartDelay](#)

Version (or later)	NDB 7.5.0
Type or units	seconds
Default	0
Range	0 - 600
Restart Type	S

In parallel data node recovery, only table data is actually copied and synchronized in parallel; synchronization of metadata such as dictionary and checkpoint information is done in a serial fashion. In addition, recovery of dictionary and checkpoint information cannot be executed in parallel with performing of local checkpoints. This means that, when starting or restarting many data nodes concurrently, data nodes may be forced to wait while a local checkpoint is performed, which can result in longer node recovery times.

It is possible to force a delay in the local checkpoint to permit more (and possibly all) data nodes to complete metadata synchronization; once each data node's metadata synchronization is complete, all of the data nodes can recover table data in parallel, even while the local checkpoint is being executed. To force such a delay, set [MaxLCPStartDelay](#), which determines the number of seconds the cluster can wait to begin a local checkpoint while data nodes continue to synchronize metadata. This parameter should be set in the `[ndbd default]` section of the `config.ini` file, so that it is the same for all data nodes. The maximum value is 600; the default is 0.

- [NoOfFragmentLogFiles](#)

Version (or later)	NDB 7.5.0
Type or units	integer
Default	16
Range	3 - 4294967039 (0xFFFFFFFF)

Restart Type	S
--------------	---

This parameter sets the number of REDO log files for the node, and thus the amount of space allocated to REDO logging. Because the REDO log files are organized in a ring, it is extremely important that the first and last log files in the set (sometimes referred to as the “head” and “tail” log files, respectively) do not meet. When these approach one another too closely, the node begins aborting all transactions encompassing updates due to a lack of room for new log records.

A REDO log record is not removed until both required local checkpoints have been completed since that log record was inserted. Checkpointing frequency is determined by its own set of configuration parameters discussed elsewhere in this chapter.

The default parameter value is 16, which by default means 16 sets of 4 16MB files for a total of 1024MB. The size of the individual log files is configurable using the `FragmentLogFileSize` parameter. In scenarios requiring a great many updates, the value for `NoOfFragmentLogFiles` may need to be set as high as 300 or even higher to provide sufficient space for REDO logs.

If the checkpointing is slow and there are so many writes to the database that the log files are full and the log tail cannot be cut without jeopardizing recovery, all updating transactions are aborted with internal error code 410 (`Out of log file space temporarily`). This condition prevails until a checkpoint has completed and the log tail can be moved forward.

Important

This parameter cannot be changed “on the fly”; you must restart the node using `--initial`. If you wish to change this value for all data nodes in a running cluster, you can do so using a rolling node restart (using `--initial` when starting each data node).

- `RecoveryWork`

Version (or later)	NDB 7.6.4
Type or units	integer
Default	50
Range	25 - 100
Version (or later)	NDB 7.6.5
Type or units	integer
Default	60
Range	25 - 100
Added	NDB 7.6.4
Restart Type	S (NDB 7.6.4)

Percentage of storage overhead for LCP files. This parameter has an effect only when `EnablePartialLcp` is true, that is, only when partial local checkpoints are enabled. A higher value means:

- Fewer records are written for each LCP, LCPs use more space
- More work is needed during restarts

A lower value for `RecoveryWork` means:

- More records are written during each LCP, but LCPs require less space on disk.

- Less work during restart and thus faster restarts, at the expense of more work during normal operations

For example, setting `RecoveryWork` to 60 means that the total size of an LCP is roughly $1 + 0.6 = 1.6$ times the size of the data to be checkpointed. This means that 60% more work is required during the restore phase of a restart compared to the work done during a restart that uses full checkpoints. (This is more than compensated for during other phases of the restart such that the restart as a whole is still faster when using partial LCPs than when using full LCPs.) In order not to fill up the redo log, it is necessary to write at $1 + (1 / \text{RecoveryWork})$ times the rate of data changes during checkpoints—thus, when `RecoveryWork` = 60, it is necessary to write at approximately $1 + (1 / 0.6) = 2.67$ times the change rate. In other words, if changes are being written at 10 MByte per second, the checkpoint needs to be written at roughly 26.7 MByte per second.

Setting `RecoveryWork` = 40 means that only 1.4 times the total LCP size is needed (and thus the restore phase takes 10 to 15 percent less time. In this case, the checkpoint write rate is 3.5 times the rate of change.

The NDB source distribution includes a test program for simulating LCPs. `lcp_simulator.cc` can be found in `storage/ndb/src/kernel/blocks/backup/`. To compile and run it on Unix platforms, execute the commands shown here:

```
$> gcc lcp_simulator.cc
$> ./a.out
```

This program has no dependencies other than `stdio.h`, and does not require a connection to an NDB cluster or a MySQL server. By default, it simulates 300 LCPs (three sets of 100 LCPs, each consisting of inserts, updates, and deletes, in turn), reporting the size of the LCP after each one. You can alter the simulation by changing the values of `recovery_work`, `insert_work`, and `delete_work` in the source and recompiling. For more information, see the source of the program.

- `InsertRecoveryWork`

Version (or later)	NDB 7.6.5
Type or units	integer
Default	40
Range	0 - 70
Added	NDB 7.6.5
Restart Type	S (NDB 7.6.5)

Percentage of `RecoveryWork` used for inserted rows. A higher value increases the number of writes during a local checkpoint, and decreases the total size of the LCP. A lower value decreases the number of writes during an LCP, but results in more space being used for the LCP, which means that recovery takes longer. This parameter has an effect only when `EnablePartialLcp` is true, that is, only when partial local checkpoints are enabled.

- `EnableRedoControl`

Version (or later)	NDB 7.6.7
Type or units	boolean
Default	false
Range	...
Added	NDB 7.6.7

Restart Type	S (NDB 7.6.7)
------------------------------	---------------

Enable adaptive checkpointing speed for controlling redo log usage. Set to `false` to disable (the default). Setting `EnablePartialLcp` to `false` also disables the adaptive calculation.

When enabled, `EnableRedoControl` allows the data nodes greater flexibility with regard to the rate at which they write LCPs to disk. More specifically, enabling this parameter means that higher write rates can be employed, so that LCPs can complete and Redo logs be trimmed more quickly, thereby reducing recovery time and disk space requirements. This functionality allows data nodes to make better use of the higher rate of I/O and greater bandwidth available from modern solid-state storage devices and protocols, such as solid-state drives (SSDs) using Non-Volatile Memory Express (NVMe).

The parameter currently defaults to `false` (disabled) due to the fact that NDB is still deployed widely on systems whose I/O or bandwidth is constrained relative to those employing solid-state technology, such as those using conventional hard disks (HDDs). In settings such as these, the `EnableRedoControl` mechanism can easily cause the I/O subsystem to become saturated, increasing wait times for data node input and output. In particular, this can cause issues with NDB Disk Data tables which have tablespaces or log file groups sharing a constrained IO subsystem with data node LCP and redo log files; such problems potentially include node or cluster failure due to GCP stop errors.

Metadata objects. The next set of `[ndbd]` parameters defines pool sizes for metadata objects, used to define the maximum number of attributes, tables, indexes, and trigger objects used by indexes, events, and replication between clusters.

Note

These act merely as “suggestions” to the cluster, and any that are not specified revert to the default values shown.

- [MaxNoOfAttributes](#)

Version (or later)	NDB 7.5.0
Type or units	integer
Default	1000
Range	32 - 4294967039 (0xFFFFFFFF)
Restart Type	S

This parameter sets a suggested maximum number of attributes that can be defined in the cluster; like `MaxNoOfTables`, it is not intended to function as a hard upper limit.

(In older NDB Cluster releases, this parameter was sometimes treated as a hard limit for certain operations. This caused problems with NDB Cluster Replication, when it was possible to create more tables than could be replicated, and sometimes led to confusion when it was possible [or not possible, depending on the circumstances] to create more than `MaxNoOfAttributes` attributes.)

The default value is 1000, with the minimum possible value being 32. The maximum is 4294967039. Each attribute consumes around 200 bytes of storage per node due to the fact that all metadata is fully replicated on the servers.

When setting `MaxNoOfAttributes`, it is important to prepare in advance for any `ALTER TABLE` statements that you might want to perform in the future. This is due to the fact, during the execution of `ALTER TABLE` on a Cluster table, 3 times the number of attributes as in the original table are used, and a good practice is to permit double this amount. For example, if the NDB Cluster table having the greatest number of attributes (`greatest_number_of_attributes`) has 100 attributes, a good starting point for the value of `MaxNoOfAttributes` would be $6 * \text{greatest_number_of_attributes} = 600$.

You should also estimate the average number of attributes per table and multiply this by `MaxNoOfTables`. If this value is larger than the value obtained in the previous paragraph, you should use the larger value instead.

Assuming that you can create all desired tables without any problems, you should also verify that this number is sufficient by trying an actual `ALTER TABLE` after configuring the parameter. If this is not successful, increase `MaxNoOfAttributes` by another multiple of `MaxNoOfTables` and test it again.

- `MaxNoOfTables`

Version (or later)	NDB 7.5.0
Type or units	integer
Default	128
Range	8 - 20320
Restart Type	S

A table object is allocated for each table and for each unique hash index in the cluster. This parameter sets a suggested maximum number of table objects for the cluster as a whole; like `MaxNoOfAttributes`, it is not intended to function as a hard upper limit.

(In older NDB Cluster releases, this parameter was sometimes treated as a hard limit for certain operations. This caused problems with NDB Cluster Replication, when it was possible to create more tables than could be replicated, and sometimes led to confusion when it was possible [or not possible, depending on the circumstances] to create more than `MaxNoOfTables` tables.)

For each attribute that has a `BLOB` data type an extra table is used to store most of the `BLOB` data. These tables also must be taken into account when defining the total number of tables.

The default value of this parameter is 128. The minimum is 8 and the maximum is 20320. Each table object consumes approximately 20KB per node.

Note

The sum of `MaxNoOfTables`, `MaxNoOfOrderedIndexes`, and `MaxNoOfUniqueHashIndexes` must not exceed $2^{32} - 2$ (4294967294).

- `MaxNoOfOrderedIndexes`

Version (or later)	NDB 7.5.0
Type or units	integer
Default	128
Range	0 - 4294967039 (0xFFFFFFFF)
Restart Type	S

For each ordered index in the cluster, an object is allocated describing what is being indexed and its storage segments. By default, each index so defined also defines an ordered index. Each unique

index and primary key has both an ordered index and a hash index. [MaxNoOfOrderedIndexes](#) sets the total number of ordered indexes that can be in use in the system at any one time.

The default value of this parameter is 128. Each index object consumes approximately 10KB of data per node.

Note

The sum of [MaxNoOfTables](#), [MaxNoOfOrderedIndexes](#), and [MaxNoOfUniqueHashIndexes](#) must not exceed $2^{32} - 2$ (4294967294).

- [MaxNoOfUniqueHashIndexes](#)

Version (or later)	NDB 7.5.0
Type or units	integer
Default	64
Range	0 - 4294967039 (0xFFFFFFFF)
Restart Type	S

For each unique index that is not a primary key, a special table is allocated that maps the unique key to the primary key of the indexed table. By default, an ordered index is also defined for each unique index. To prevent this, you must specify the `USING HASH` option when defining the unique index.

The default value is 64. Each index consumes approximately 15KB per node.

Note

The sum of [MaxNoOfTables](#), [MaxNoOfOrderedIndexes](#), and [MaxNoOfUniqueHashIndexes](#) must not exceed $2^{32} - 2$ (4294967294).

- [MaxNoOfTriggers](#)

Version (or later)	NDB 7.5.0
Type or units	integer
Default	768
Range	0 - 4294967039 (0xFFFFFFFF)
Restart Type	S

Internal update, insert, and delete triggers are allocated for each unique hash index. (This means that three triggers are created for each unique hash index.) However, an *ordered* index requires only a single trigger object. Backups also use three trigger objects for each normal table in the cluster.

Replication between clusters also makes use of internal triggers.

This parameter sets the maximum number of trigger objects in the cluster.

The default value is 768.

- [MaxNoOfSubscriptions](#)

Version (or later)	NDB 7.5.0
Type or units	unsigned
Default	0
Range	0 - 4294967039 (0xFFFFFFFF)

Restart Type	S
--------------	---

Each NDB table in an NDB Cluster requires a subscription in the NDB kernel. For some NDB API applications, it may be necessary or desirable to change this parameter. However, for normal usage with MySQL servers acting as SQL nodes, there is not any need to do so.

The default value for `MaxNoOfSubscriptions` is 0, which is treated as equal to `MaxNoOfTables`. Each subscription consumes 108 bytes.

- `MaxNoOfSubscribers`

Version (or later)	NDB 7.5.0
Type or units	unsigned
Default	0
Range	0 - 4294967039 (0xFFFFFFFF)
Restart Type	S

This parameter is of interest only when using NDB Cluster Replication. The default value is 0, which is treated as $2 * \text{MaxNoOfTables}$; that is, there is one subscription per NDB table for each of two MySQL servers (one acting as the replication source and the other as the replica). Each subscriber uses 16 bytes of memory.

When using circular replication, multi-source replication, and other replication setups involving more than 2 MySQL servers, you should increase this parameter to the number of `mysqld` processes included in replication (this is often, but not always, the same as the number of clusters). For example, if you have a circular replication setup using three NDB Cluster s, with one `mysqld` attached to each cluster, and each of these `mysqld` processes acts as a source and as a replica, you should set `MaxNoOfSubscribers` equal to $3 * \text{MaxNoOfTables}$.

For more information, see [Chapter 7, NDB Cluster Replication](#).

- `MaxNoOfConcurrentSubOperations`

Version (or later)	NDB 7.5.0
Type or units	unsigned
Default	256
Range	0 - 4294967039 (0xFFFFFFFF)
Restart Type	S

This parameter sets a ceiling on the number of operations that can be performed by all API nodes in the cluster at one time. The default value (256) is sufficient for normal operations, and might need to be adjusted only in scenarios where there are a great many API nodes each performing a high volume of operations concurrently.

Boolean parameters. The behavior of data nodes is also affected by a set of `[ndbd]` parameters taking on boolean values. These parameters can each be specified as `TRUE` by setting them equal to `1` or `Y`, and as `FALSE` by setting them equal to `0` or `N`.

- `CompressedLCP`

Version (or later)	NDB 7.5.0
Type or units	boolean
Default	false
Range	true, false

Restart Type	S
------------------------------	---

Setting this parameter to `1` causes local checkpoint files to be compressed. The compression used is equivalent to `gzip --fast`, and can save 50% or more of the space required on the data node to store uncompressed checkpoint files. Compressed LCPs can be enabled for individual data nodes, or for all data nodes (by setting this parameter in the `[ndbd default]` section of the `config.ini` file).

Important

You cannot restore a compressed local checkpoint to a cluster running a MySQL version that does not support this feature.

The default value is `0` (disabled).

- [CrashOnCorruptedTuple](#)

Version (or later)	NDB 7.5.0
Type or units	boolean
Default	true
Range	true, false
Restart Type	S

When this parameter is enabled, it forces a data node to shut down whenever it encounters a corrupted tuple. In NDB 7.5, it is enabled by default.

- [Diskless](#)

Version (or later)	NDB 7.5.0
Type or units	true false (1 0)
Default	false
Range	true, false
Restart Type	S

It is possible to specify NDB Cluster tables as *diskless*, meaning that tables are not checkpointed to disk and that no logging occurs. Such tables exist only in main memory. A consequence of using diskless tables is that neither the tables nor the records in those tables survive a crash. However, when operating in diskless mode, it is possible to run `ndbd` on a diskless computer.

Important

This feature causes the *entire* cluster to operate in diskless mode.

When this feature is enabled, Cluster online backup is disabled. In addition, a partial start of the cluster is not possible.

`Diskless` is disabled by default.

- [LateAlloc](#)

Version (or later)	NDB 7.5.0
Type or units	numeric
Default	1
Range	0 - 1
Restart Type	S

Allocate memory for this data node after a connection to the management server has been established. Enabled by default.

- `LockPagesInMainMemory`

Version (or later)	NDB 7.5.0
Type or units	numeric
Default	0
Range	0 - 2
Restart Type	S

For a number of operating systems, including Solaris and Linux, it is possible to lock a process into memory and so avoid any swapping to disk. This can be used to help guarantee the cluster's real-time characteristics.

This parameter takes one of the integer values 0, 1, or 2, which act as shown in the following list:

- 0: Disables locking. This is the default value.
- 1: Performs the lock after allocating memory for the process.
- 2: Performs the lock before memory for the process is allocated.

If the operating system is not configured to permit unprivileged users to lock pages, then the data node process making use of this parameter may have to be run as system root. (`LockPagesInMainMemory` uses the `mlockall` function. From Linux kernel 2.6.9, unprivileged users can lock memory as limited by `max locked memory`. For more information, see `ulimit -l` and <http://linux.die.net/man/2/mlock>).

Note

In older NDB Cluster releases, this parameter was a Boolean. 0 or `false` was the default setting, and disabled locking. 1 or `true` enabled locking of the process after its memory was allocated. NDB Cluster 7.5 treats `true` or `false` for the value of this parameter as an error.

Important

Beginning with `glibc` 2.10, `glibc` uses per-thread arenas to reduce lock contention on a shared pool, which consumes real memory. In general, a data node process does not need per-thread arenas, since it does not perform any memory allocation after startup. (This difference in allocators does not appear to affect performance significantly.)

The `glibc` behavior is intended to be configurable via the `MALLOC_ARENA_MAX` environment variable, but a bug in this mechanism prior to `glibc` 2.16 meant that this variable could not be set to less than 8, so that the wasted memory could not be reclaimed. (Bug #15907219; see also http://sourceware.org/bugzilla/show_bug.cgi?id=13137 for more information concerning this issue.)

One possible workaround for this problem is to use the `LD_PRELOAD` environment variable to preload a `jemalloc` memory allocation library to take the place of that supplied with `glibc`.

- `ODirect`

Version (or later)	NDB 7.5.0
--------------------	-----------

Type or units	boolean
Default	false
Range	true, false
Restart Type	S

Enabling this parameter causes [NDB](#) to attempt using `O_DIRECT` writes for LCP, backups, and redo logs, often lowering `kswapd` and CPU usage. When using NDB Cluster on Linux, enable `ODirect` if you are using a 2.6 or later kernel.

`ODirect` is disabled by default.

- [ODirectSyncFlag](#)

Version (or later)	NDB 7.6.4
Type or units	boolean
Default	false
Range	true, false
Added	NDB 7.6.4
Restart Type	S (NDB 7.6.4)

When this parameter is enabled, redo log writes are performed such that each completed file system write is handled as a call to `fsync`. The setting for this parameter is ignored if at least one of the following conditions is true:

- `ODirect` is not enabled.
- `InitFragmentLogFiles` is set to `SPARSE`.

Disabled by default.

- [RestartOnErrorInsert](#)

Version (or later)	NDB 7.5.0
Type or units	error code
Default	2
Range	0 - 4
Restart Type	S

This feature is accessible only when building the debug version where it is possible to insert errors in the execution of individual blocks of code as part of testing.

This feature is disabled by default.

- [StopOnError](#)

Version (or later)	NDB 7.5.0
Type or units	boolean
Default	1
Range	0, 1

Restart Type	S
------------------------------	---

This parameter specifies whether a data node process should exit or perform an automatic restart when an error condition is encountered.

This parameter's default value is 1; this means that, by default, an error causes the data node process to halt.

When an error is encountered and `StopOnError` is 0, the data node process is restarted.

Prior to NDB Cluster 7.5.5, if the data node process exits in an uncontrolled fashion (due, for example, to performing `kill -9` on the data node process while performing a query, or to a segmentation fault), and `StopOnError` is set to 0, the angel process attempts to restart it in exactly the same way as it was started previously—that is, using the same startup options that were employed the last time the node was started. Thus, if the data node process was originally started using the `--initial` option, it is also restarted with `--initial`. This means that, in such cases, if the failure occurs on a sufficient number of data nodes in a very short interval, the effect is the same as if you had performed an initial restart of the entire cluster, leading to loss of all data. This issue is resolved in NDB Cluster 7.5.5 and later NDB 7.5 releases (Bug #83510, Bug #24945638).

Users of MySQL Cluster Manager should note that, when `StopOnError` equals 1, this prevents the MySQL Cluster Manager agent from restarting any data nodes after it has performed its own restart and recovery. See [Starting and Stopping the Agent on Linux](#), for more information.

- [UseShm](#)

Version (or later)	NDB 7.6.6
Type or units	boolean
Default	false
Range	true, false
Added	NDB 7.6.6
Restart Type	S (NDB 7.6.6)

Use shared memory connections between this data node and the API node also running on this host. Set to 1 to enable.

See [Section 4.3.12, “NDB Cluster Shared Memory Connections”](#), for more information.

Controlling Timeouts, Intervals, and Disk Paging

There are a number of `[ndbd]` parameters specifying timeouts and intervals between various actions in Cluster data nodes. Most of the timeout values are specified in milliseconds. Any exceptions to this are mentioned where applicable.

- [TimeBetweenWatchDogCheck](#)

Version (or later)	NDB 7.5.0
Type or units	milliseconds
Default	6000
Range	70 - 4294967039 (0xFFFFFFFF)
Restart Type	S

To prevent the main thread from getting stuck in an endless loop at some point, a “watchdog” thread checks the main thread. This parameter specifies the number of milliseconds between checks. If the process remains in the same state after three checks, the watchdog thread terminates it.

This parameter can easily be changed for purposes of experimentation or to adapt to local conditions. It can be specified on a per-node basis although there seems to be little reason for doing so.

The default timeout is 6000 milliseconds (6 seconds).

- [TimeBetweenWatchDogCheckInitial](#)

Version (or later)	NDB 7.5.0
Type or units	milliseconds
Default	6000
Range	70 - 4294967039 (0xFFFFFFFF)
Restart Type	S

This is similar to the [TimeBetweenWatchDogCheck](#) parameter, except that [TimeBetweenWatchDogCheckInitial](#) controls the amount of time that passes between execution checks inside a storage node in the early start phases during which memory is allocated.

The default timeout is 6000 milliseconds (6 seconds).

- [StartPartialTimeout](#)

Version (or later)	NDB 7.5.0
Type or units	milliseconds
Default	30000
Range	0 - 4294967039 (0xFFFFFFFF)
Restart Type	S

This parameter specifies how long the Cluster waits for all data nodes to come up before the cluster initialization routine is invoked. This timeout is used to avoid a partial Cluster startup whenever possible.

This parameter is overridden when performing an initial start or initial restart of the cluster.

The default value is 30000 milliseconds (30 seconds). 0 disables the timeout, in which case the cluster may start only if all nodes are available.

- [StartPartitionedTimeout](#)

Version (or later)	NDB 7.5.0
Type or units	milliseconds
Default	60000
Range	0 - 4294967039 (0xFFFFFFFF)
Version (or later)	NDB 7.6.4
Type or units	milliseconds
Default	0
Range	0 - 4294967039 (0xFFFFFFFF)
Restart Type	S

If the cluster is ready to start after waiting for [StartPartialTimeout](#) milliseconds but is still possibly in a partitioned state, the cluster waits until this timeout has also passed. If

`StartPartitionedTimeout` is set to 0, the cluster waits indefinitely ($2^{32}-1$ ms, or approximately 49.71 days).

This parameter is overridden when performing an initial start or initial restart of the cluster.

The default value in NDB 7.6 is 0; previously it was 60000 (60 seconds).

- `StartFailureTimeout`

Version (or later)	NDB 7.5.0
Type or units	milliseconds
Default	0
Range	0 - 4294967039 (0xFFFFFFFF)
Restart Type	S

If a data node has not completed its startup sequence within the time specified by this parameter, the node startup fails. Setting this parameter to 0 (the default value) means that no data node timeout is applied.

For nonzero values, this parameter is measured in milliseconds. For data nodes containing extremely large amounts of data, this parameter should be increased. For example, in the case of a data node containing several gigabytes of data, a period as long as 10–15 minutes (that is, 600000 to 1000000 milliseconds) might be required to perform a node restart.

- `StartNoNodeGroupTimeout`

Version (or later)	NDB 7.5.0
Type or units	milliseconds
Default	15000
Range	0 - 4294967039 (0xFFFFFFFF)
Restart Type	S

When a data node is configured with `Nodegroup = 65536`, is regarded as not being assigned to any node group. When that is done, the cluster waits `StartNoNodegroupTimeout` milliseconds, then treats such nodes as though they had been added to the list passed to the `--nowait-nodes` option, and starts. The default value is 15000 (that is, the management server waits 15 seconds). Setting this parameter equal to 0 means that the cluster waits indefinitely.

`StartNoNodegroupTimeout` must be the same for all data nodes in the cluster; for this reason, you should always set it in the `[ndbd default]` section of the `config.ini` file, rather than for individual data nodes.

See [Section 6.7, “Adding NDB Cluster Data Nodes Online”](#), for more information.

- `HeartbeatIntervalDbDb`

Version (or later)	NDB 7.5.0
Type or units	milliseconds
Default	5000
Range	10 - 4294967039 (0xFFFFFFFF)
Restart Type	S

One of the primary methods of discovering failed nodes is by the use of heartbeats. This parameter states how often heartbeat signals are sent and how often to expect to receive them. Heartbeats cannot be disabled.

After missing four heartbeat intervals in a row, the node is declared dead. Thus, the maximum time for discovering a failure through the heartbeat mechanism is five times the heartbeat interval.

The default heartbeat interval is 5000 milliseconds (5 seconds). This parameter must not be changed drastically and should not vary widely between nodes. If one node uses 5000 milliseconds and the node watching it uses 1000 milliseconds, obviously the node is declared dead very quickly. This parameter can be changed during an online software upgrade, but only in small increments.

See also [Network communication and latency](#), as well as the description of the [ConnectCheckIntervalDelay](#) configuration parameter.

- [HeartbeatIntervalDbApi](#)

Version (or later)	NDB 7.5.0
Type or units	milliseconds
Default	1500
Range	100 - 4294967039 (0xFFFFFFFF)
Restart Type	S

Each data node sends heartbeat signals to each MySQL server (SQL node) to ensure that it remains in contact. If a MySQL server fails to send a heartbeat in time it is declared “dead,” in which case all ongoing transactions are completed and all resources released. The SQL node cannot reconnect until all activities initiated by the previous MySQL instance have been completed. The three-heartbeat criteria for this determination are the same as described for [HeartbeatIntervalDbDb](#).

The default interval is 1500 milliseconds (1.5 seconds). This interval can vary between individual data nodes because each data node watches the MySQL servers connected to it, independently of all other data nodes.

For more information, see [Network communication and latency](#).

- [HeartbeatOrder](#)

Version (or later)	NDB 7.5.0
Type or units	numeric
Default	0
Range	0 - 65535
Restart Type	S

Data nodes send heartbeats to one another in a circular fashion whereby each data node monitors the previous one. If a heartbeat is not detected by a given data node, this node declares the previous data node in the circle “dead” (that is, no longer accessible by the cluster). The determination that a data node is dead is done globally; in other words; once a data node is declared dead, it is regarded as such by all nodes in the cluster.

It is possible for heartbeats between data nodes residing on different hosts to be too slow compared to heartbeats between other pairs of nodes (for example, due to a very low heartbeat interval or temporary connection problem), such that a data node is declared dead, even though the node can still function as part of the cluster. .

In this type of situation, it may be that the order in which heartbeats are transmitted between data nodes makes a difference as to whether or not a particular data node is declared dead. If this

declaration occurs unnecessarily, this can in turn lead to the unnecessary loss of a node group and as thus to a failure of the cluster.

Consider a setup where there are 4 data nodes A, B, C, and D running on 2 host computers `host1` and `host2`, and that these data nodes make up 2 node groups, as shown in the following table:

Table 4.3 Four data nodes A, B, C, D running on two host computers `host1`, `host2`; each data node belongs to one of two node groups.

Node Group	Nodes Running on <code>host1</code>	Nodes Running on <code>host2</code>
Node Group 0:	Node A	Node B
Node Group 1:	Node C	Node D

Suppose the heartbeats are transmitted in the order `A->B->C->D->A`. In this case, the loss of the heartbeat between the hosts causes node B to declare node A dead and node C to declare node B dead. This results in loss of Node Group 0, and so the cluster fails. On the other hand, if the order of transmission is `A->B->D->C->A` (and all other conditions remain as previously stated), the loss of the heartbeat causes nodes A and D to be declared dead; in this case, each node group has one surviving node, and the cluster survives.

The `HeartbeatOrder` configuration parameter makes the order of heartbeat transmission user-configurable. The default value for `HeartbeatOrder` is zero; allowing the default value to be used on all data nodes causes the order of heartbeat transmission to be determined by NDB. If this parameter is used, it must be set to a nonzero value (maximum 65535) for every data node in the cluster, and this value must be unique for each data node; this causes the heartbeat transmission to proceed from data node to data node in the order of their `HeartbeatOrder` values from lowest to highest (and then directly from the data node having the highest `HeartbeatOrder` to the data node having the lowest value, to complete the circle). The values need not be consecutive. For example, to force the heartbeat transmission order `A->B->D->C->A` in the scenario outlined previously, you could set the `HeartbeatOrder` values as shown here:

Table 4.4 `HeartbeatOrder` values to force a heartbeat transition order of `A->B->D->C->A`.

Node	<code>HeartbeatOrder</code> Value
A	10
B	20
C	30
D	25

To use this parameter to change the heartbeat transmission order in a running NDB Cluster, you must first set `HeartbeatOrder` for each data node in the cluster in the global configuration (`config.ini`) file (or files). To cause the change to take effect, you must perform either of the following:

- A complete shutdown and restart of the entire cluster.
- 2 rolling restarts of the cluster in succession. *All nodes must be restarted in the same order in both rolling restarts.*

You can use `DUMP 908` to observe the effect of this parameter in the data node logs.

- `ConnectCheckIntervalDelay`

Version (or later)	NDB 7.5.0
Type or units	milliseconds
Default	0

Range	0 - 4294967039 (0xFFFFFFFF)
Restart Type	S

This parameter enables connection checking between data nodes after one of them has failed heartbeat checks for 5 intervals of up to `HeartbeatIntervalDbDb` milliseconds.

Such a data node that further fails to respond within an interval of `ConnectCheckIntervalDelay` milliseconds is considered suspect, and is considered dead after two such intervals. This can be useful in setups with known latency issues.

The default value for this parameter is 0 (disabled).

- [TimeBetweenLocalCheckpoints](#)

Version (or later)	NDB 7.5.0
Type or units	number of 4-byte words, as base-2 logarithm
Default	20
Range	0 - 31
Restart Type	S

This parameter is an exception in that it does not specify a time to wait before starting a new local checkpoint; rather, it is used to ensure that local checkpoints are not performed in a cluster where relatively few updates are taking place. In most clusters with high update rates, it is likely that a new local checkpoint is started immediately after the previous one has been completed.

The size of all write operations executed since the start of the previous local checkpoints is added. This parameter is also exceptional in that it is specified as the base-2 logarithm of the number of 4-byte words, so that the default value 20 means 4MB (4×2^{20}) of write operations, 21 would mean 8MB, and so on up to a maximum value of 31, which equates to 8GB of write operations.

All the write operations in the cluster are added together. Setting [TimeBetweenLocalCheckpoints](#) to 6 or less means that local checkpoints are executed continuously without pause, independent of the cluster's workload.

- [TimeBetweenGlobalCheckpoints](#)

Version (or later)	NDB 7.5.0
Type or units	milliseconds
Default	2000
Range	20 - 32000
Restart Type	S

When a transaction is committed, it is committed in main memory in all nodes on which the data is mirrored. However, transaction log records are not flushed to disk as part of the commit. The reasoning behind this behavior is that having the transaction safely committed on at least two autonomous host machines should meet reasonable standards for durability.

It is also important to ensure that even the worst of cases—a complete crash of the cluster—is handled properly. To guarantee that this happens, all transactions taking place within a given interval are put into a global checkpoint, which can be thought of as a set of committed transactions that has been flushed to disk. In other words, as part of the commit process, a transaction is placed in a global checkpoint group. Later, this group's log records are flushed to disk, and then the entire group of transactions is safely committed to disk on all computers in the cluster.

This parameter defines the interval between global checkpoints. The default is 2000 milliseconds.

- [TimeBetweenGlobalCheckpointsTimeout](#)

Version (or later)	NDB 7.5.0
Type or units	milliseconds
Default	120000
Range	10 - 4294967039 (0xFFFFFFFF)
Restart Type	S

This parameter defines the minimum timeout between global checkpoints. The default is 120000 milliseconds.

- [TimeBetweenEpochs](#)

Version (or later)	NDB 7.5.0
Type or units	milliseconds
Default	100
Range	0 - 32000
Restart Type	S

This parameter defines the interval between synchronization epochs for NDB Cluster Replication. The default value is 100 milliseconds.

[TimeBetweenEpochs](#) is part of the implementation of “micro-GCPs”, which can be used to improve the performance of NDB Cluster Replication.

- [TimeBetweenEpochsTimeout](#)

Version (or later)	NDB 7.5.0
Type or units	milliseconds
Default	0
Range	0 - 256000
Restart Type	S

This parameter defines a timeout for synchronization epochs for NDB Cluster Replication. If a node fails to participate in a global checkpoint within the time determined by this parameter, the node is shut down. The default value is 0; in other words, the timeout is disabled.

[TimeBetweenEpochsTimeout](#) is part of the implementation of “micro-GCPs”, which can be used to improve the performance of NDB Cluster Replication.

The current value of this parameter and a warning are written to the cluster log whenever a GCP save takes longer than 1 minute or a GCP commit takes longer than 10 seconds.

Setting this parameter to zero has the effect of disabling GCP stops caused by save timeouts, commit timeouts, or both. The maximum possible value for this parameter is 256000 milliseconds.

- [MaxBufferedEpochs](#)

Version (or later)	NDB 7.5.0
Type or units	epochs
Default	100
Range	0 - 100000
Restart Type	S

The number of unprocessed epochs by which a subscribing node can lag behind. Exceeding this number causes a lagging subscriber to be disconnected.

The default value of 100 is sufficient for most normal operations. If a subscribing node does lag enough to cause disconnections, it is usually due to network or scheduling issues with regard to processes or threads. (In rare circumstances, the problem may be due to a bug in the [NDB client](#).) It may be desirable to set the value lower than the default when epochs are longer.

Disconnection prevents client issues from affecting the data node service, running out of memory to buffer data, and eventually shutting down. Instead, only the client is affected as a result of the disconnect (by, for example gap events in the binary log), forcing the client to reconnect or restart the process.

- [MaxBufferedEpochBytes](#)

Version (or later)	NDB 7.5.0
Type or units	bytes
Default	26214400
Range	26214400 (0x01900000) - 4294967039 (0xFFFFFFFF)
Restart Type	S

The total number of bytes allocated for buffering epochs by this node.

- [TimeBetweenInactiveTransactionAbortCheck](#)

Version (or later)	NDB 7.5.0
Type or units	milliseconds
Default	1000
Range	1000 - 4294967039 (0xFFFFFFFF)
Restart Type	S

Timeout handling is performed by checking a timer on each transaction once for every interval specified by this parameter. Thus, if this parameter is set to 1000 milliseconds, every transaction is checked for timing out once per second.

The default value is 1000 milliseconds (1 second).

- [TransactionInactiveTimeout](#)

Version (or later)	NDB 7.5.0
Type or units	milliseconds
Default	4294967039 (0xFFFFFFFF)
Range	0 - 4294967039 (0xFFFFFFFF)
Restart Type	S

This parameter states the maximum time that is permitted to lapse between operations in the same transaction before the transaction is aborted.

The default for this parameter is 4G (also the maximum). For a real-time database that needs to ensure that no transaction keeps locks for too long, this parameter should be set to a relatively small value. Setting it to 0 means that the application never times out. The unit is milliseconds.

- [TransactionDeadlockDetectionTimeout](#)

Version (or later)	NDB 7.5.0
Type or units	milliseconds
Default	1200
Range	50 - 4294967039 (0xFFFFFFFF)
Restart Type	S

When a node executes a query involving a transaction, the node waits for the other nodes in the cluster to respond before continuing. This parameter sets the amount of time that the transaction can spend executing within a data node, that is, the time that the transaction coordinator waits for each data node participating in the transaction to execute a request.

A failure to respond can occur for any of the following reasons:

- The node is “dead”
- The operation has entered a lock queue
- The node requested to perform the action could be heavily overloaded.

This timeout parameter states how long the transaction coordinator waits for query execution by another node before aborting the transaction, and is important for both node failure handling and deadlock detection.

The default timeout value is 1200 milliseconds (1.2 seconds).

The minimum for this parameter is 50 milliseconds.

- [DiskSyncSize](#)

Version (or later)	NDB 7.5.0
Type or units	bytes
Default	4M
Range	32K - 4294967039 (0xFFFFFFFF)
Restart Type	S

This is the maximum number of bytes to store before flushing data to a local checkpoint file. This is done to prevent write buffering, which can impede performance significantly. This parameter is *not* intended to take the place of [TimeBetweenLocalCheckpoints](#).

Note

When [ODirect](#) is enabled, it is not necessary to set [DiskSyncSize](#); in fact, in such cases its value is simply ignored.

The default value is 4M (4 megabytes).

- [MaxDiskWriteSpeed](#)

Version (or later)	NDB 7.5.0
Type or units	numeric
Default	20M
Range	1M - 1024G

Restart Type	S
------------------------------	---

Set the maximum rate for writing to disk, in bytes per second, by local checkpoints and backup operations when no restarts (by this data node or any other data node) are taking place in this NDB Cluster.

For setting the maximum rate of disk writes allowed while this data node is restarting, use [MaxDiskWriteSpeedOwnRestart](#). For setting the maximum rate of disk writes allowed while other data nodes are restarting, use [MaxDiskWriteSpeedOtherNodeRestart](#). The minimum speed for disk writes by all LCPs and backup operations can be adjusted by setting [MinDiskWriteSpeed](#).

- [MaxDiskWriteSpeedOtherNodeRestart](#)

Version (or later)	NDB 7.5.0
Type or units	numeric
Default	50M
Range	1M - 1024G
Restart Type	S

Set the maximum rate for writing to disk, in bytes per second, by local checkpoints and backup operations when one or more data nodes in this NDB Cluster are restarting, other than this node.

For setting the maximum rate of disk writes allowed while this data node is restarting, use [MaxDiskWriteSpeedOwnRestart](#). For setting the maximum rate of disk writes allowed when no data nodes are restarting anywhere in the cluster, use [MaxDiskWriteSpeed](#). The minimum speed for disk writes by all LCPs and backup operations can be adjusted by setting [MinDiskWriteSpeed](#).

- [MaxDiskWriteSpeedOwnRestart](#)

Version (or later)	NDB 7.5.0
Type or units	numeric
Default	200M
Range	1M - 1024G
Restart Type	S

Set the maximum rate for writing to disk, in bytes per second, by local checkpoints and backup operations while this data node is restarting.

For setting the maximum rate of disk writes allowed while other data nodes are restarting, use [MaxDiskWriteSpeedOtherNodeRestart](#). For setting the maximum rate of disk writes allowed when no data nodes are restarting anywhere in the cluster, use [MaxDiskWriteSpeed](#). The minimum speed for disk writes by all LCPs and backup operations can be adjusted by setting [MinDiskWriteSpeed](#).

- [MinDiskWriteSpeed](#)

Version (or later)	NDB 7.5.0
Type or units	numeric
Default	10M
Range	1M - 1024G

Restart Type	S
------------------------------	---

Set the minimum rate for writing to disk, in bytes per second, by local checkpoints and backup operations.

The maximum rates of disk writes allowed for LCPs and backups under various conditions are adjustable using the parameters [MaxDiskWriteSpeed](#), [MaxDiskWriteSpeedOwnRestart](#), and [MaxDiskWriteSpeedOtherNodeRestart](#). See the descriptions of these parameters for more information.

- [ArbitrationTimeout](#)

Version (or later)	NDB 7.5.0
Type or units	milliseconds
Default	7500
Range	10 - 4294967039 (0xFFFFFFFF)
Restart Type	S

This parameter specifies how long data nodes wait for a response from the arbitrator to an arbitration message. If this is exceeded, the network is assumed to have split.

The default value is 7500 milliseconds (7.5 seconds).

- [Arbitration](#)

Version (or later)	NDB 7.5.0
Type or units	enumeration
Default	Default
Range	Default, Disabled, WaitExternal
Restart Type	S

The [Arbitration](#) parameter enables a choice of arbitration schemes, corresponding to one of 3 possible values for this parameter:

- **Default.** This enables arbitration to proceed normally, as determined by the [ArbitrationRank](#) settings for the management and API nodes. This is the default value.
- **Disabled.** Setting [Arbitration](#) = `Disabled` in the `[nldb default]` section of the `config.ini` file to accomplish the same task as setting [ArbitrationRank](#) to 0 on all management and API nodes. When [Arbitration](#) is set in this way, any [ArbitrationRank](#) settings are ignored.
- **WaitExternal.** The [Arbitration](#) parameter also makes it possible to configure arbitration in such a way that the cluster waits until after the time determined by [ArbitrationTimeout](#) has passed for an external cluster manager application to perform arbitration instead of handling arbitration internally. This can be done by setting [Arbitration](#) = `WaitExternal` in the `[nldb default]` section of the `config.ini` file. For best results with the `WaitExternal` setting, it is recommended that [ArbitrationTimeout](#) be 2 times as long as the interval required by the external cluster manager to perform arbitration.

Important

This parameter should be used only in the `[nldb default]` section of the cluster configuration file. The behavior of the cluster is unspecified when [Arbitration](#) is set to different values for individual data nodes.

- [RestartSubscriberConnectTimeout](#)

Version (or later)	NDB 7.5.0
Type or units	ms
Default	12000
Range	0 - 4294967039 (0xFFFFFFFF)
Restart Type	S

This parameter determines the time that a data node waits for subscribing API nodes to connect. Once this timeout expires, any “missing” API nodes are disconnected from the cluster. To disable this timeout, set [RestartSubscriberConnectTimeout](#) to 0.

While this parameter is specified in milliseconds, the timeout itself is resolved to the next-greatest whole second.

Buffering and logging. Several [\[ndbd\]](#) configuration parameters enable the advanced user to have more control over the resources used by node processes and to adjust various buffer sizes at need.

These buffers are used as front ends to the file system when writing log records to disk. If the node is running in diskless mode, these parameters can be set to their minimum values without penalty due to the fact that disk writes are “faked” by the NDB storage engine's file system abstraction layer.

- [UndoIndexBuffer](#)

Version (or later)	NDB 7.5.0
Type or units	unsigned
Default	2M
Range	1M - 4294967039 (0xFFFFFFFF)
Deprecated	Yes (in NDB 8.0)
Restart Type	S

This parameter formerly set the size of the undo index buffer, but has no effect in current versions of NDB Cluster.

- [UndoDataBuffer](#)

Version (or later)	NDB 7.5.0
Type or units	unsigned
Default	16M
Range	1M - 4294967039 (0xFFFFFFFF)
Deprecated	Yes (in NDB 8.0)
Restart Type	S

This parameter formerly set the size of the undo data buffer, but has no effect in current versions of NDB Cluster.

- [RedoBuffer](#)

Version (or later)	NDB 7.5.0
Type or units	bytes
Default	32M
Range	1M - 4294967039 (0xFFFFFFFF)

Restart Type	S
--------------	---

All update activities also need to be logged. The REDO log makes it possible to replay these updates whenever the system is restarted. The NDB recovery algorithm uses a “fuzzy” checkpoint of the data together with the UNDO log, and then applies the REDO log to play back all changes up to the restoration point.

`RedoBuffer` sets the size of the buffer in which the REDO log is written. The default value is 32MB; the minimum value is 1MB.

If this buffer is too small, the NDB storage engine issues error code 1221 (`REDO log buffers overloaded`). For this reason, you should exercise care if you attempt to decrease the value of `RedoBuffer` as part of an online change in the cluster's configuration.

`ndbmt` allocates a separate buffer for each LDM thread (see `ThreadConfig`). For example, with 4 LDM threads, an `ndbmt` data node actually has 4 buffers and allocates `RedoBuffer` bytes to each one, for a total of $4 * \text{RedoBuffer}$ bytes.

- `EventLogBufferSize`

Version (or later)	NDB 7.5.0
Type or units	bytes
Default	8192
Range	0 - 64K
Restart Type	S

Controls the size of the circular buffer used for NDB log events within data nodes.

Controlling log messages. In managing the cluster, it is very important to be able to control the number of log messages sent for various event types to `stdout`. For each event category, there are 16 possible event levels (numbered 0 through 15). Setting event reporting for a given event category to level 15 means all event reports in that category are sent to `stdout`; setting it to 0 means that there are no event reports made in that category.

By default, only the startup message is sent to `stdout`, with the remaining event reporting level defaults being set to 0. The reason for this is that these messages are also sent to the management server's cluster log.

An analogous set of levels can be set for the management client to determine which event levels to record in the cluster log.

- `LogLevelStartup`

Version (or later)	NDB 7.5.0
Type or units	integer
Default	1
Range	0 - 15
Restart Type	S

The reporting level for events generated during startup of the process.

The default level is 1.

- `LogLevelShutdown`

Version (or later)	NDB 7.5.0
--------------------	-----------

Type or units	integer
Default	0
Range	0 - 15
Restart Type	S

The reporting level for events generated as part of graceful shutdown of a node.

The default level is 0.

- [LogLevelStatistic](#)

Version (or later)	NDB 7.5.0
Type or units	integer
Default	0
Range	0 - 15
Restart Type	S

The reporting level for statistical events such as number of primary key reads, number of updates, number of inserts, information relating to buffer usage, and so on.

The default level is 0.

- [LogLevelCheckpoint](#)

Version (or later)	NDB 7.5.0
Type or units	log level
Default	0
Range	0 - 15
Restart Type	S

The reporting level for events generated by local and global checkpoints.

The default level is 0.

- [LogLevelNodeRestart](#)

Version (or later)	NDB 7.5.0
Type or units	integer
Default	0
Range	0 - 15
Restart Type	S

The reporting level for events generated during node restart.

The default level is 0.

- [LogLevelConnection](#)

Version (or later)	NDB 7.5.0
Type or units	integer
Default	0
Range	0 - 15

Restart Type	S
------------------------------	---

The reporting level for events generated by connections between cluster nodes.

The default level is 0.

- [LogLevelError](#)

Version (or later)	NDB 7.5.0
Type or units	integer
Default	0
Range	0 - 15
Restart Type	S

The reporting level for events generated by errors and warnings by the cluster as a whole. These errors do not cause any node failure but are still considered worth reporting.

The default level is 0.

- [LogLevelCongestion](#)

Version (or later)	NDB 7.5.0
Type or units	level
Default	0
Range	0 - 15
Restart Type	S

The reporting level for events generated by congestion. These errors do not cause node failure but are still considered worth reporting.

The default level is 0.

- [LogLevelInfo](#)

Version (or later)	NDB 7.5.0
Type or units	integer
Default	0
Range	0 - 15
Restart Type	S

The reporting level for events generated for information about the general state of the cluster.

The default level is 0.

- [MemReportFrequency](#)

Version (or later)	NDB 7.5.0
Type or units	unsigned
Default	0
Range	0 - 4294967039 (0xFFFFFFFF)

Restart Type	S
------------------------------	---

This parameter controls how often data node memory usage reports are recorded in the cluster log; it is an integer value representing the number of seconds between reports.

Each data node's data memory and index memory usage is logged as both a percentage and a number of 32 KB pages of the [DataMemory](#) and (NDB 7.5 and earlier) [IndexMemory](#), respectively, set in the `config.ini` file. For example, if [DataMemory](#) is equal to 100 MB, and a given data node is using 50 MB for data memory storage, the corresponding line in the cluster log might look like this:

```
2006-12-24 01:18:16 [MgmSrvr] INFO -- Node 2: Data usage is 50%(1280 32K pages of total 2560)
```

[MemReportFrequency](#) is not a required parameter. If used, it can be set for all cluster data nodes in the `[ndbd default]` section of `config.ini`, and can also be set or overridden for individual data nodes in the corresponding `[ndbd]` sections of the configuration file. The minimum value—which is also the default value—is 0, in which case memory reports are logged only when memory usage reaches certain percentages (80%, 90%, and 100%), as mentioned in the discussion of statistics events in [Section 6.3.2, “NDB Cluster Log Events”](#).

- [StartupStatusReportFrequency](#)

Version (or later)	NDB 7.5.0
Type or units	seconds
Default	0
Range	0 - 4294967039 (0xFFFFFFFF)
Restart Type	S

When a data node is started with the `--initial`, it initializes the redo log file during Start Phase 4 (see [Section 6.4, “Summary of NDB Cluster Start Phases”](#)). When very large values are set for [NoOfFragmentLogFiles](#), [FragmentLogFileSize](#), or both, this initialization can take a long time. You can force reports on the progress of this process to be logged periodically, by means of the [StartupStatusReportFrequency](#) configuration parameter. In this case, progress is reported in the cluster log, in terms of both the number of files and the amount of space that have been initialized, as shown here:

```
2009-06-20 16:39:23 [MgmSrvr] INFO -- Node 1: Local redo log file initialization status:
#Total files: 80, Completed: 60
#Total MBytes: 20480, Completed: 15557
2009-06-20 16:39:23 [MgmSrvr] INFO -- Node 2: Local redo log file initialization status:
#Total files: 80, Completed: 60
#Total MBytes: 20480, Completed: 15570
```

These reports are logged each [StartupStatusReportFrequency](#) seconds during Start Phase 4. If [StartupStatusReportFrequency](#) is 0 (the default), then reports are written to the cluster log only when at the beginning and at the completion of the redo log file initialization process.

Data Node Debugging Parameters

The following parameters are intended for use during testing or debugging of data nodes, and not for use in production.

- [DictTrace](#)

Version (or later)	NDB 7.5.0
Type or units	bytes
Default	undefined
Range	0 - 100
Restart Type	S

It is possible to cause logging of traces for events generated by creating and dropping tables using [DictTrace](#). This parameter is useful only in debugging NDB kernel code. [DictTrace](#) takes an integer value. 0 disables logging; 1 enables it; setting this parameter to 2 enables logging of additional [DBDICT](#) debugging output (Bug #20368450).

- [WatchdogImmediateKill](#)

Version (or later)	NDB 7.6.7
Type or units	boolean
Default	false
Range	true, false
Added	NDB 7.6.7
Restart Type	S (NDB 7.6.7)

In NDB 7.6.7 and later, you can cause threads to be killed immediately whenever watchdog issues occur by enabling the [WatchdogImmediateKill](#) data node configuration parameter. This parameter should be used only when debugging or troubleshooting, to obtain trace files reporting exactly what was occurring the instant that execution ceased.

Backup parameters. The [\[ndbd\]](#) parameters discussed in this section define memory buffers set aside for execution of online backups.

- [BackupDataBufferSize](#)

Version (or later)	NDB 7.5.0
Type or units	bytes
Default	16M
Range	2M - 4294967039 (0xFFFFFFFF)
Version (or later)	NDB 7.5.1
Type or units	bytes
Default	16M
Range	512K - 4294967039 (0xFFFFFFFF)
Deprecated	NDB 7.6.4
Restart Type	S

In creating a backup, there are two buffers used for sending data to the disk. The backup data buffer is used to fill in data recorded by scanning a node's tables. Once this buffer has been filled to the level specified as [BackupWriteSize](#), the pages are sent to disk. While flushing data to disk, the backup process can continue filling this buffer until it runs out of space. When this happens, the backup process pauses the scan and waits until some disk writes have completed freeing up memory so that scanning may continue.

- [BackupDiskWriteSpeedPct](#)

Version (or later)	NDB 7.5.0
Type or units	percent
Default	50
Range	0 - 90
Restart Type	S

During normal operation, data nodes attempt to maximize the disk write speed used for local checkpoints and backups while remaining within the bounds set by `MinDiskWriteSpeed` and `MaxDiskWriteSpeed`. Disk write throttling gives each LDM thread an equal share of the total budget. This allows parallel LCPs to take place without exceeding the disk I/O budget. Because a backup is executed by only one LDM thread, this effectively caused a budget cut, resulting in longer backup completion times, and—if the rate of change is sufficiently high—in failure to complete the backup when the backup log buffer fill rate is higher than the achievable write rate.

This problem can be addressed by using the `BackupDiskWriteSpeedPct` configuration parameter, which takes a value in the range 0-90 (inclusive) which is interpreted as the percentage of the node's maximum write rate budget that is reserved prior to sharing out the remainder of the budget among LDM threads for LCPs. The LDM thread running the backup receives the whole write rate budget for the backup, plus its (reduced) share of the write rate budget for local checkpoints. (This makes the disk write rate budget behave similarly to how it was handled in NDB Cluster 7.3 and earlier.)

The default value for this parameter is 50 (interpreted as 50%).

- `BackupLogBufferSize`

Version (or later)	NDB 7.5.0
Type or units	bytes
Default	16M
Range	2M - 4294967039 (0xFFFFFFFF)
Restart Type	S

The backup log buffer fulfills a role similar to that played by the backup data buffer, except that it is used for generating a log of all table writes made during execution of the backup. The same principles apply for writing these pages as with the backup data buffer, except that when there is no more space in the backup log buffer, the backup fails. For that reason, the size of the backup log buffer must be large enough to handle the load caused by write activities while the backup is being made. See [Section 6.8.3, "Configuration for NDB Cluster Backups"](#).

The default value for this parameter should be sufficient for most applications. In fact, it is more likely for a backup failure to be caused by insufficient disk write speed than it is for the backup log buffer to become full. If the disk subsystem is not configured for the write load caused by applications, the cluster is unlikely to be able to perform the desired operations.

It is preferable to configure cluster nodes in such a manner that the processor becomes the bottleneck rather than the disks or the network connections.

The default value for this parameter is 16MB.

- `BackupMemory`

Version (or later)	NDB 7.5.0
Type or units	bytes
Default	32M
Range	0 - 4294967039 (0xFFFFFFFF)
Deprecated	Yes (in NDB 7.4)
Restart Type	S

This parameter is deprecated, and subject to removal in a future version of NDB Cluster. Any setting made for it is ignored.

- [BackupReportFrequency](#)

Version (or later)	NDB 7.5.0
Type or units	seconds
Default	0
Range	0 - 4294967039 (0xFFFFFFFF)
Restart Type	S

This parameter controls how often backup status reports are issued in the management client during a backup, as well as how often such reports are written to the cluster log (provided cluster event logging is configured to permit it—see [Logging and checkpointing](#)). [BackupReportFrequency](#) represents the time in seconds between backup status reports.

The default value is 0.

- [BackupWriteSize](#)

Version (or later)	NDB 7.5.0
Type or units	bytes
Default	256K
Range	32K - 4294967039 (0xFFFFFFFF)
Deprecated	NDB 7.6.4
Restart Type	S

This parameter specifies the default size of messages written to disk by the backup log and backup data buffers.

The default value for this parameter is 256KB.

- [BackupMaxWriteSize](#)

Version (or later)	NDB 7.5.0
Type or units	bytes
Default	1M
Range	256K - 4294967039 (0xFFFFFFFF)
Deprecated	NDB 7.6.4
Restart Type	S

This parameter specifies the maximum size of messages written to disk by the backup log and backup data buffers.

The default value for this parameter is 1MB.

- [CompressedBackup](#)

Version (or later)	NDB 7.5.0
Type or units	boolean
Default	false
Range	true, false

Restart Type	S
--------------	---

Enabling this parameter causes backup files to be compressed. The compression used is equivalent to `gzip --fast`, and can save 50% or more of the space required on the data node to store uncompressed backup files. Compressed backups can be enabled for individual data nodes, or for all data nodes (by setting this parameter in the `[ndbd default]` section of the `config.ini` file).

Important

You cannot restore a compressed backup to a cluster running a MySQL version that does not support this feature.

The default value is 0 (disabled).

Note

The location of the backup files is determined by the `BackupDataDir` data node configuration parameter.

Additional requirements. When specifying these parameters, the following relationships must hold true. Otherwise, the data node cannot start.

- `BackupDataBufferSize >= BackupWriteSize + 188KB`
- `BackupLogBufferSize >= BackupWriteSize + 16KB`
- `BackupMaxWriteSize >= BackupWriteSize`

NDB Cluster Realtime Performance Parameters

The `[ndbd]` parameters discussed in this section are used in scheduling and locking of threads to specific CPUs on multiprocessor data node hosts.

Note

To make use of these parameters, the data node process must be run as system root.

- `BuildIndexThreads`

Version (or later)	NDB 7.5.0
Type or units	numeric
Default	0
Range	0 - 128
Version (or later)	NDB 7.6.4
Type or units	numeric
Default	128
Range	0 - 128
Restart Type	S

This parameter determines the number of threads to create when rebuilding ordered indexes during a system or node start, as well as when running `ndb_restore --rebuild-indexes`. It is supported only when there is more than one fragment for the table per data node (for example, when `COMMENT="NDB_TABLE=PARTITION_BALANCE=FOR_RA_BY_LDM_X_2"` is used with `CREATE TABLE`).

Setting this parameter to 0 (the default) disables multithreaded building of ordered indexes.

This parameter is supported when using `ndbd` or `ndbmt.d`.

You can enable multithreaded builds during data node initial restarts by setting the `TwoPassInitialNodeRestartCopy` data node configuration parameter to `TRUE`.

- `LockExecuteThreadToCPU`

Version (or later)	NDB 7.5.0
Type or units	set of CPU IDs
Default	0
Range	...
Restart Type	S

When used with `ndbd`, this parameter (now a string) specifies the ID of the CPU assigned to handle the `NDBCLUSTER` execution thread. When used with `ndbmt.d`, the value of this parameter is a comma-separated list of CPU IDs assigned to handle execution threads. Each CPU ID in the list should be an integer in the range 0 to 65535 (inclusive).

The number of IDs specified should match the number of execution threads determined by `MaxNoOfExecutionThreads`. However, there is no guarantee that threads are assigned to CPUs in any given order when using this parameter. You can obtain more finely-grained control of this type using `ThreadConfig`.

`LockExecuteThreadToCPU` has no default value.

- `LockMaintThreadsToCPU`

Version (or later)	NDB 7.5.0
Type or units	CPU ID
Default	0
Range	0 - 64K
Restart Type	S

This parameter specifies the ID of the CPU assigned to handle `NDBCLUSTER` maintenance threads.

The value of this parameter is an integer in the range 0 to 65535 (inclusive). *There is no default value.*

- `Numa`

Version (or later)	NDB 7.5.0
Type or units	numeric
Default	1
Range	...
Restart Type	S

This parameter determines whether Non-Uniform Memory Access (NUMA) is controlled by the operating system or by the data node process, whether the data node uses `ndbd` or `ndbmt.d`. By default, `NDB` attempts to use an interleaved NUMA memory allocation policy on any data node where the host operating system provides NUMA support.

Setting `Numa = 0` means that the datanode process does not itself attempt to set a policy for memory allocation, and permits this behavior to be determined by the operating system, which may be further guided by the separate `numactl` tool. That is, `Numa = 0` yields the system default

behavior, which can be customised by `numactl`. For many Linux systems, the system default behavior is to allocate socket-local memory to any given process at allocation time. This can be problematic when using `ndbmt`; this is because `ndbmt` allocates all memory at startup, leading to an imbalance, giving different access speeds for different sockets, especially when locking pages in main memory.

Setting `Numa = 1` means that the data node process uses `libnuma` to request interleaved memory allocation. (This can also be accomplished manually, on the operating system level, using `numactl`.) Using interleaved allocation in effect tells the data node process to ignore non-uniform memory access but does not attempt to take any advantage of fast local memory; instead, the data node process tries to avoid imbalances due to slow remote memory. If interleaved allocation is not desired, set `Numa` to 0 so that the desired behavior can be determined on the operating system level.

The `Numa` configuration parameter is supported only on Linux systems where `libnuma.so` is available.

- `RealtimeScheduler`

Version (or later)	NDB 7.5.0
Type or units	boolean
Default	false
Range	true, false
Restart Type	S

Setting this parameter to 1 enables real-time scheduling of data node threads.

The default is 0 (scheduling disabled).

- `SchedulerExecutionTimer`

Version (or later)	NDB 7.5.0
Type or units	µs
Default	50
Range	0 - 11000
Restart Type	S

This parameter specifies the time in microseconds for threads to be executed in the scheduler before being sent. Setting it to 0 minimizes the response time; to achieve higher throughput, you can increase the value at the expense of longer response times.

The default is 50 µsec, which our testing shows to increase throughput slightly in high-load cases without materially delaying requests.

- `SchedulerResponsiveness`

Version (or later)	NDB 7.5.0
Type or units	integer
Default	5
Range	0 - 10
Restart Type	S

Set the balance in the NDB scheduler between speed and throughput. This parameter takes an integer whose value is in the range 0-10 inclusive, with 5 as the default. Higher values provide better response times relative to throughput. Lower values provide increased throughput at the expense of longer response times.

- [SchedulerSpinTimer](#)

Version (or later)	NDB 7.5.0
Type or units	µs
Default	0
Range	0 - 500
Restart Type	S

This parameter specifies the time in microseconds for threads to be executed in the scheduler before sleeping.

The default value is 0.

- [TwoPassInitialNodeRestartCopy](#)

Version (or later)	NDB 7.5.0
Type or units	boolean
Default	false
Range	true, false
Version (or later)	NDB 7.6.4
Type or units	boolean
Default	true
Range	true, false
Restart Type	S

Multithreaded building of ordered indexes can be enabled for initial restarts of data nodes by setting this configuration parameter to `true`, which enables two-pass copying of data during initial node restarts. In NDB 7.6, this is the default value (Bug #26704312, Bug #27109117).

You must also set [BuildIndexThreads](#) to a nonzero value.

Multi-Threading Configuration Parameters (ndbmtd). `ndbmtd` runs by default as a single-threaded process and must be configured to use multiple threads, using either of two methods, both of which require setting configuration parameters in the `config.ini` file. The first method is simply to set an appropriate value for the [MaxNoOfExecutionThreads](#) configuration parameter. A second method, makes it possible to set up more complex rules for `ndbmtd` multithreading using [ThreadConfig](#). The next few paragraphs provide information about these parameters and their use with multithreaded data nodes.

- [MaxNoOfExecutionThreads](#)

Version (or later)	NDB 7.5.0
Type or units	integer
Default	2
Range	2 - 72
Restart Type	IS S

This parameter directly controls the number of execution threads used by `ndbmtd`, up to a maximum of 72. Although this parameter is set in `[ndbd]` or `[ndbd default]` sections of the `config.ini` file, it is exclusive to `ndbmtd` and does not apply to `ndbd`.

Setting `MaxNoOfExecutionThreads` sets the number of threads for each type as determined by a matrix in the file `storage/ndb/src/kernel/vm/mt_thr_config.cpp`. This table shows these numbers of threads for possible values of `MaxNoOfExecutionThreads`.

Table 4.5 MaxNoOfExecutionThreads values and the corresponding number of threads by thread type (LQH, TC, Send, Receive).

MaxNoOfExecutionThreads Value	LDM Threads	TC Threads	Send Threads	Receive Threads
0 .. 3	1	0	0	1
4 .. 6	2	0	0	1
7 .. 8	4	0	0	1
9	4	2	0	1
10	4	2	1	1
11	4	3	1	1
12	6	2	1	1
13	6	3	1	1
14	6	3	1	2
15	6	3	2	2
16	8	3	1	2
17	8	4	1	2
18	8	4	2	2
19	8	5	2	2
20	10	4	2	2
21	10	5	2	2
22	10	5	2	3
23	10	6	2	3
24	12	5	2	3
25	12	6	2	3
26	12	6	3	3
27	12	7	3	3
28	12	7	3	4
29	12	8	3	4
30	12	8	4	4
31	12	9	4	4
32	16	8	3	3
33	16	8	3	4
34	16	8	4	4
35	16	9	4	4
36	16	10	4	4
37	16	10	4	5
38	16	11	4	5
39	16	11	5	5
40	20	10	4	4

MaxNoOfExecutionValue	LDM Threads	TC Threads	Send Threads	Receive Threads
41	20	10	4	5
42	20	11	4	5
43	20	11	5	5
44	20	12	5	5
45	20	12	5	6
46	20	13	5	6
47	20	13	6	6
48	24	12	5	5
49	24	12	5	6
50	24	13	5	6
51	24	13	6	6
52	24	14	6	6
53	24	14	6	7
54	24	15	6	7
55	24	15	7	7
56	24	16	7	7
57	24	16	7	8
58	24	17	7	8
59	24	17	8	8
60	24	18	8	8
61	24	18	8	9
62	24	19	8	9
63	24	19	9	9
64	32	16	7	7
65	32	16	7	8
66	32	17	7	8
67	32	17	8	8
68	32	18	8	8
69	32	18	8	9
70	32	19	8	9
71	32	20	8	9
72	32	20	8	10

There is always one SUMA (replication) thread.

`NoOfFragmentLogParts` should be set equal to the number of LDM threads used by `ndbmt_d`, as determined by the setting for this parameter. This ratio should not be any greater than 4:1; beginning with NDB 7.5.7, a configuration in which this is the case is specifically disallowed. (Bug #25333414)

The number of LDM threads also determines the number of partitions used by an NDB table that is not explicitly partitioned; this is the number of LDM threads times the number of data nodes in the cluster. (If `ndbd` is used on the data nodes rather than `ndbmt_d`, then there is always a single LDM thread; in this case, the number of partitions created automatically is simply equal to the

number of data nodes. See [Section 2.2, “NDB Cluster Nodes, Node Groups, Fragment Replicas, and Partitions”](#), for more information.

Adding large tablespaces for Disk Data tables when using more than the default number of LDM threads may cause issues with resource and CPU usage if the disk page buffer is insufficiently large; see the description of the [DiskPageBufferMemory](#) configuration parameter, for more information.

The thread types are described later in this section (see [ThreadConfig](#)).

Setting this parameter outside the permitted range of values causes the management server to abort on startup with the error `Error line number: Illegal value value for parameter MaxNoOfExecutionThreads`.

For [MaxNoOfExecutionThreads](#), a value of 0 or 1 is rounded up internally by [NDB](#) to 2, so that 2 is considered this parameter's default and minimum value.

[MaxNoOfExecutionThreads](#) is generally intended to be set equal to the number of CPU threads available, and to allocate a number of threads of each type suitable to typical workloads. It does not assign particular threads to specified CPUs. For cases where it is desirable to vary from the settings provided, or to bind threads to CPUs, you should use [ThreadConfig](#) instead, which allows you to allocate each thread directly to a desired type, CPU, or both.

The multithreaded data node process always spawns, at a minimum, the threads listed here:

- 1 local query handler (LDM) thread
- 1 receive thread
- 1 subscription manager (SUMA or replication) thread

For a [MaxNoOfExecutionThreads](#) value of 8 or less, no TC threads are created, and TC handling is instead performed by the main thread.

Prior to [NDB 7.6](#), changing the number of LDM threads always requires a system restart, whether it is changed using this parameter or [ThreadConfig](#). In [NDB 7.6](#) and later it is possible to effect the change using a node initial restart (*N*) provided the following conditions are met:

- If, following the change, the number of LDM threads remains the same as before, nothing more than a simple node restart (rolling restart, or *N*) is required to implement the change.
- Otherwise (that is, if the number of LDM threads changes), it is still possible to effect the change using a node initial restart (*N*) provided the following two conditions are met:
 - a. Each LDM thread handles a maximum of 8 fragments, and
 - b. The total number of table fragments is an integer multiple of the number of LDM threads.

Prior to [NDB 7.6](#), if the cluster's [IndexMemory](#) usage is greater than 50%, changing this requires an initial restart of the cluster. (A maximum of 30-35% [IndexMemory](#) usage is recommended in such cases.) Otherwise, resource usage and LDM thread allocation cannot be balanced between nodes, which can result in underutilized and overutilized LDM threads, and ultimately data node failures. In [NDB 7.6](#) and later, an initial restart is *not* required to effect a change in this parameter.

- [NoOfFragmentLogParts](#)

Version (or later)	NDB 7.5.0
Type or units	numeric
Default	4
Range	4, 6, 8, 10, 12, 16, 20, 24, 32

Restart Type	S
--------------	---

Set the number of log file groups for redo logs belonging to this `ndbmtid`. The value of this parameter should be set equal to the number of LDM threads used by `ndbmtid` as determined by the setting for `MaxNoOfExecutionThreads`. Beginning with NDB 7.5.7, a configuration using more than 4 redo log parts per LDM is disallowed. (Bug #25333414)

See the description of `MaxNoOfExecutionThreads` for more information.

- `ThreadConfig`

Version (or later)	NDB 7.5.0
Type or units	string
Default	"
Range	...
Restart Type	IS S

This parameter is used with `ndbmtid` to assign threads of different types to different CPUs. Its value is a string whose format has the following syntax:

```
ThreadConfig := entry[,entry[,...]]
entry := type={param[,param[,...]]}
type := ldm | main | recv | send | rep | io | tc | watchdog | idxbld
param := count=number
| cpubind=cpu_list
| cpuset=cpu_list
| spintime=number
| realtime={0|1}
| nosend={0|1}
| thread_prio={0..10}
| cpubind_exclusive=cpu_list
| cpuset_exclusive=cpu_list
```

The curly braces (`{...}`) surrounding the list of parameters are required, even if there is only one parameter in the list.

A `param` (parameter) specifies any or all of the following information:

- The number of threads of the given type (`count`).
- The set of CPUs to which the threads of the given type are to be nonexclusively bound. This is determined by either one of `cpubind` or `cpuset`. `cpubind` causes each thread to be bound (nonexclusively) to a CPU in the set; `cpuset` means that each thread is bound (nonexclusively) to the set of CPUs specified.

On Solaris, you can instead specify a set of CPUs to which the threads of the given type are to be bound exclusively. `cpubind_exclusive` causes each thread to be bound exclusively to a CPU in the set; `cpuset_exclusive` means that each thread is bound exclusively to the set of CPUs specified.

Only one of `cpubind`, `cpuset`, `cpubind_exclusive`, or `cpuset_exclusive` can be provided in a single configuration.

- `spintime` determines the wait time in microseconds the thread spins before going to sleep.

The default value for `spintime` is the value of the `SchedulerSpinTimer` data node configuration parameter.

`spintime` does not apply to I/O threads, watchdog, or offline index build threads, and so cannot be set for these thread types.

- `realtime` can be set to 0 or 1. If it is set to 1, the threads run with real-time priority. This also means that `thread_prio` cannot be set.

The `realtime` parameter is set by default to the value of the `RealtimeScheduler` data node configuration parameter.

`realtime` cannot be set for offline index build threads.

- By setting `nosend` to 1, you can prevent a `main`, `ldm`, `rep`, or `tc` thread from assisting the send threads. This parameter is 0 by default, and cannot be used with other types of threads.
- `thread_prio` is a thread priority level that can be set from 0 to 10, with 10 representing the greatest priority. The default is 5. The precise effects of this parameter are platform-specific, and are described later in this section.

The thread priority level cannot be set for offline index build threads.

thread_prio settings and effects by platform. The implementation of `thread_prio` differs between Linux/FreeBSD, Solaris, and Windows. In the following list, we discuss its effects on each of these platforms in turn:

- *Linux and FreeBSD:* We map `thread_prio` to a value to be supplied to the `nice` system call. Since a lower niceness value for a process indicates a higher process priority, increasing `thread_prio` has the effect of lowering the `nice` value.

Table 4.6 Mapping of thread_prio to nice values on Linux and FreeBSD

<code>thread_prio</code> value	<code>nice</code> value
0	19
1	16
2	12
3	8
4	4
5	0
6	-4
7	-8
8	-12
9	-16
10	-20

Some operating systems may provide for a maximum process niceness level of 20, but this is not supported by all targeted versions; for this reason, we choose 19 as the maximum `nice` value that can be set.

- *Solaris*: Setting `thread_prio` on Solaris sets the Solaris FX priority, with mappings as shown in the following table:

Table 4.7 Mapping of `thread_prio` to FX priority on Solaris

<code>thread_prio</code> value	Solaris FX priority
0	15
1	20
2	25
3	30
4	35
5	40
6	45
7	50
8	55
9	59
10	60

A `thread_prio` setting of 9 is mapped on Solaris to the special FX priority value 59, which means that the operating system also attempts to force the thread to run alone on its own CPU core.

- *Windows*: We map `thread_prio` to a Windows thread priority value passed to the Windows API `SetThreadPriority()` function. This mapping is shown in the following table:

Table 4.8 Mapping of `thread_prio` to Windows thread priority

<code>thread_prio</code> value	Windows thread priority
0 - 1	<code>THREAD_PRIORITY_LOWEST</code>
2 - 3	<code>THREAD_PRIORITY_BELOW_NORMAL</code>
4 - 5	<code>THREAD_PRIORITY_NORMAL</code>
6 - 7	<code>THREAD_PRIORITY_ABOVE_NORMAL</code>
8 - 10	<code>THREAD_PRIORITY_HIGHEST</code>

The `type` attribute represents an NDB thread type. The thread types supported, and the range of permitted `count` values for each, are provided in the following list:

- `ldm`: Local query handler (`DBLQH` kernel block) that handles data. The more LDM threads that are used, the more highly partitioned the data becomes. Each LDM thread maintains its own sets of data and index partitions, as well as its own redo log. The value set for `ldm` must be one of the values 1, 2, 4, 6, 8, 12, 16, 24, or 32.

Changing the number of LDM threads normally requires an initial system restart to be effective and safe for cluster operations. This requirement is relaxed in NDB 7.6, as explained later in this section. (This is also true when this is done using `MaxNoOfExecutionThreads`.) *NDB 7.5 and earlier*. If `IndexMemory` usage is in excess of 50%, an initial restart of the cluster is required; a maximum of 30-35% `IndexMemory` usage is recommended in such cases. Otherwise, allocation

of memory and LDM threads cannot be balanced between nodes, which can ultimately lead to data node failures.

Adding large tablespaces (hundreds of gigabytes or more) for Disk Data tables when using more than the default number of LDMs may cause issues with resource and CPU usage if `DiskPageBufferMemory` is not sufficiently large.

- `tc`: Transaction coordinator thread (`DBTC` kernel block) containing the state of an ongoing transaction. The maximum number of TC threads is 32.

Optimally, every new transaction can be assigned to a new TC thread. In most cases 1 TC thread per 2 LDM threads is sufficient to guarantee that this can happen. In cases where the number of writes is relatively small when compared to the number of reads, it is possible that only 1 TC thread per 4 LQH threads is required to maintain transaction states. Conversely, in applications that perform a great many updates, it may be necessary for the ratio of TC threads to LDM threads to approach 1 (for example, 3 TC threads to 4 LDM threads).

Setting `tc` to 0 causes TC handling to be done by the main thread. In most cases, this is effectively the same as setting it to 1.

Range: 0 - 32

- `main`: Data dictionary and transaction coordinator (`DBDIH` and `DBTC` kernel blocks), providing schema management. This is always handled by a single dedicated thread.

Range: 1 only.

- `recv`: Receive thread (`CMVMI` kernel block). Each receive thread handles one or more sockets for communicating with other nodes in an NDB Cluster, with one socket per node. NDB Cluster supports multiple receive threads; the maximum is 16 such threads.

Range: 1 - 16

- `send`: Send thread (`CMVMI` kernel block). To increase throughput, it is possible to perform sends from one or more separate, dedicated threads (maximum 8).

Previously, all threads handled their own sending directly; this can still be made to happen by setting the number of send threads to 0 (this also happens when `MaxNoOfExecutionThreads` is set less than 10). While doing so can have an adverse impact on throughput, it can also in some cases provide decreased latency.

Range: 0 - 16

- `rep`: Replication thread (`SUMA` kernel block). Asynchronous replication operations are always handled by a single, dedicated thread.

Range: 1 only.

- `io`: File system and other miscellaneous operations. These are not demanding tasks, and are always handled as a group by a single, dedicated I/O thread.

Range: 1 only.

- `watchdog`: Parameters settings associated with this type are actually applied to several threads, each having a specific use. These threads include the `SocketServer` thread, which receives connection setups from other nodes; the `SocketClient` thread, which attempts to set up connections to other nodes; and the thread watchdog thread that checks that threads are progressing.

Range: 1 only.

- `idxbld`: Offline index build threads. Unlike the other thread types listed previously, which are permanent, these are temporary threads which are created and used only during node or system restarts, or when running `ndb_restore --rebuild-indexes`. They may be bound to CPU sets which overlap with CPU sets bound to permanent thread types.

`thread_prio`, `realtime`, and `spintime` values cannot be set for offline index build threads. In addition, `count` is ignored for this type of thread.

If `idxbld` is not specified, the default behavior is as follows:

- Offline index build threads are not bound if the I/O thread is also not bound, and these threads use any available cores.
- If the I/O thread is bound, then the offline index build threads are bound to the entire set of bound threads, due to the fact that there should be no other tasks for these threads to perform.

Range: 0 - 1.

This thread type was added in NDB 7.6. (Bug #25835748, Bug #26928111)

Prior to NDB 7.6, changing `ThreadConfig` requires a system initial restart. In NDB 7.6 (and later), this requirement can be relaxed under certain circumstances:

- If, following the change, the number of LDM threads remains the same as before, nothing more than a simple node restart (rolling restart, or *N*) is required to implement the change.
- Otherwise (that is, if the number of LDM threads changes), it is still possible to effect the change using a node initial restart (*N*) provided the following two conditions are met:
 - a. Each LDM thread handles a maximum of 8 fragments, and
 - b. The total number of table fragments is an integer multiple of the number of LDM threads.

In any other case, a system initial restart is needed to change this parameter.

NDB 7.6 can distinguish between thread types by both of the following criteria:

- Whether the thread is an execution thread. Threads of type `main`, `ldm`, `recv`, `rep`, `tc`, and `send` are execution threads; `io`, `watchdog`, and `idxbld` threads are not considered execution threads.
- Whether the allocation of threads to a given task is permanent or temporary. Currently all thread types except `idxbld` are considered permanent; `idxbld` threads are regarded as temporary threads.

Simple examples:

```
# Example 1.
ThreadConfig=ldm={count=2,cpubind=1,2},main={cpubind=12},rep={cpubind=11}

# Example 2.
Threadconfig=main={cpubind=0},ldm={count=4,cpubind=1,2,5,6},io={cpubind=3}
```

It is usually desirable when configuring thread usage for a data node host to reserve one or more number of CPUs for operating system and other tasks. Thus, for a host machine with 24 CPUs, you might want to use 20 CPU threads (leaving 4 for other uses), with 8 LDM threads, 4 TC threads (half the number of LDM threads), 3 send threads, 3 receive threads, and 1 thread each for schema management, asynchronous replication, and I/O operations. (This is almost the same distribution of

threads used when `MaxNoOfExecutionThreads` is set equal to 20.) The following `ThreadConfig` setting performs these assignments, additionally binding all of these threads to specific CPUs:

```
ThreadConfig=ldm={count=8,cpubind=1,2,3,4,5,6,7,8},main={cpubind=9},io={cpubind=9}, \
rep={cpubind=10},tc={count=4,cpubind=11,12,13,14},recv={count=3,cpubind=15,16,17}, \
send={count=3,cpubind=18,19,20}
```

It should be possible in most cases to bind the main (schema management) thread and the I/O thread to the same CPU, as we have done in the example just shown.

The following example incorporates groups of CPUs defined using both `cpuset` and `cpubind`, as well as use of thread prioritization.

```
ThreadConfig=ldm={count=4,cpuset=0-3,thread_prio=8,spintime=200}, \
ldm={count=4,cpubind=4-7,thread_prio=8,spintime=200}, \
tc={count=4,cpuset=8-9,thread_prio=6},send={count=2,thread_prio=10,cpubind=10-11}, \
main={count=1,cpubind=10},rep={count=1,cpubind=11}
```

In this case we create two LDM groups; the first uses `cpubind` and the second uses `cpuset`. `thread_prio` and `spintime` are set to the same values for each group. This means there are eight LDM threads in total. (You should ensure that `NoOfFragmentLogParts` is also set to 8.) The four TC threads use only two CPUs; it is possible when using `cpuset` to specify fewer CPUs than threads in the group. (This is not true for `cpubind`.) The send threads use two threads using `cpubind` to bind these threads to CPUs 10 and 11. The main and rep threads can reuse these CPUs.

This example shows how `ThreadConfig` and `NoOfFragmentLogParts` might be set up for a 24-CPU host with hyperthreading, leaving CPUs 10, 11, 22, and 23 available for operating system functions and interrupts:

```
NoOfFragmentLogParts=10
ThreadConfig=ldm={count=10,cpubind=0-4,12-16,thread_prio=9,spintime=200}, \
tc={count=4,cpuset=6-7,18-19,thread_prio=8},send={count=1,cpuset=8}, \
recv={count=1,cpuset=20},main={count=1,cpuset=9,21},rep={count=1,cpuset=9,21}, \
io={count=1,cpuset=9,21,thread_prio=8},watchdog={count=1,cpuset=9,21,thread_prio=9}
```

The next few examples include settings for `idxbld`. The first two of these demonstrate how a CPU set defined for `idxbld` can overlap those specified for other (permanent) thread types, the first using `cpuset` and the second using `cpubind`:

```
ThreadConfig=main,ldm={count=4,cpuset=1-4},tc={count=4,cpuset=5,6,7}, \
io={cpubind=8},idxbld={cpuset=1-8}

ThreadConfig=main,ldm={count=1,cpubind=1},idxbld={count=1,cpubind=1}
```

The next example specifies a CPU for the I/O thread, but not for the index build threads:

```
ThreadConfig=main,ldm={count=4,cpuset=1-4},tc={count=4,cpuset=5,6,7}, \
io={cpubind=8}
```

Since the `ThreadConfig` setting just shown locks threads to eight cores numbered 1 through 8, it is equivalent to the setting shown here:

```
ThreadConfig=main,ldm={count=4,cpuset=1-4},tc={count=4,cpuset=5,6,7}, \
io={cpubind=8},idxbld={cpuset=1,2,3,4,5,6,7,8}
```

In order to take advantage of the enhanced stability that the use of `ThreadConfig` offers, it is necessary to insure that CPUs are isolated, and that they not subject to interrupts, or to being scheduled for other tasks by the operating system. On many Linux systems, you can do this by setting `IRQBALANCE_BANNED_CPUS` in `/etc/sysconfig/irqbalance` to `0xFFFFF0`, and by using the `isolcpus` boot option in `grub.conf`. For specific information, see your operating system or platform documentation.

Disk Data Configuration Parameters. Configuration parameters affecting Disk Data behavior include the following:

- [DiskPageBufferEntries](#)

Version (or later)	NDB 7.5.0
Type or units	32K pages
Default	10
Range	1 - 1000
Restart Type	S

This is the number of page entries (page references) to allocate. It is specified as a number of 32K pages in [DiskPageBufferMemory](#). The default is sufficient for most cases but you may need to increase the value of this parameter if you encounter problems with very large transactions on Disk Data tables. Each page entry requires approximately 100 bytes.

- [DiskPageBufferMemory](#)

Version (or later)	NDB 7.5.0
Type or units	bytes
Default	64M
Range	4M - 1T
Restart Type	S

This determines the amount of space used for caching pages on disk, and is set in the `[ndbd]` or `[ndbd default]` section of the `config.ini` file. It is measured in bytes. Each page takes up 32 KB. This means that NDB Cluster Disk Data storage always uses $N * 32$ KB memory where N is some nonnegative integer.

The default value for this parameter is `64M` (2000 pages of 32 KB each).

If the value for [DiskPageBufferMemory](#) is set too low in conjunction with using more than the default number of LDM threads in [ThreadConfig](#) (for example `{ldm=6...}`), problems can arise when trying to add a large (for example 500G) data file to a disk-based NDB table, wherein the process takes indefinitely long while occupying one of the CPU cores.

This is due to the fact that, as part of adding a data file to a tablespace, extent pages are locked into memory in an extra PGMAN worker thread, for quick metadata access. When adding a large file, this worker has insufficient memory for all of the data file metadata. In such cases, you should either increase [DiskPageBufferMemory](#), or add smaller tablespace files. You may also need to adjust [DiskPageBufferEntries](#).

You can query the `ndbinfo.diskpagebuffer` table to help determine whether the value for this parameter should be increased to minimize unnecessary disk seeks. See [Section 6.14.20, "The ndbinfo diskpagebuffer Table"](#), for more information.

- [SharedGlobalMemory](#)

Version (or later)	NDB 7.5.0
Type or units	bytes
Default	128M
Range	0 - 64T

Restart Type	S
--------------	---

This parameter determines the amount of memory that is used for log buffers, disk operations (such as page requests and wait queues), and metadata for tablespaces, log file groups, [UNDO](#) files, and data files. The shared global memory pool also provides memory used for satisfying the memory requirements of the [UNDO_BUFFER_SIZE](#) option used with [CREATE LOGFILE GROUP](#) and [ALTER LOGFILE GROUP](#) statements, including any default value implied for this options by the setting of the [InitialLogFileGroup](#) data node configuration parameter. [SharedGlobalMemory](#) can be set in the `[ndbd]` or `[ndbd default]` section of the `config.ini` configuration file, and is measured in bytes.

The default value is 128M.

- [DiskIOThreadPool](#)

Version (or later)	NDB 7.5.0
Type or units	threads
Default	2
Range	0 - 4294967039 (0xFFFFFFFF)
Restart Type	S

This parameter determines the number of unbound threads used for Disk Data file access. Before [DiskIOThreadPool](#) was introduced, exactly one thread was spawned for each Disk Data file, which could lead to performance issues, particularly when using very large data files. With [DiskIOThreadPool](#), you can—for example—access a single large data file using several threads working in parallel.

This parameter applies to Disk Data I/O threads only.

The optimum value for this parameter depends on your hardware and configuration, and includes these factors:

- **Physical distribution of Disk Data files.** You can obtain better performance by placing data files, undo log files, and the data node file system on separate physical disks. If you do this with some or all of these sets of files, then you can set [DiskIOThreadPool](#) higher to enable separate threads to handle the files on each disk.
- **Disk performance and types.** The number of threads that can be accommodated for Disk Data file handling is also dependent on the speed and throughput of the disks. Faster disks and higher throughput allow for more disk I/O threads. Our test results indicate that solid-state disk drives can handle many more disk I/O threads than conventional disks, and thus higher values for [DiskIOThreadPool](#).

The default value for this parameter is 2.

- **Disk Data file system parameters.** The parameters in the following list make it possible to place NDB Cluster Disk Data files in specific directories without the need for using symbolic links.
- [FileSystemPathDD](#)

Version (or later)	NDB 7.5.0
Type or units	filename
Default	FileSystemPath
Range	...

Restart Type	S
--------------	---

If this parameter is specified, then NDB Cluster Disk Data data files and undo log files are placed in the indicated directory. This can be overridden for data files, undo log files, or both, by specifying values for `FileSystemPathDataFiles`, `FileSystemPathUndoFiles`, or both, as explained for these parameters. It can also be overridden for data files by specifying a path in the `ADD DATAFILE` clause of a `CREATE TABLESPACE` or `ALTER TABLESPACE` statement, and for undo log files by specifying a path in the `ADD UNDOFILE` clause of a `CREATE LOGFILE GROUP` or `ALTER LOGFILE GROUP` statement. If `FileSystemPathDD` is not specified, then `FileSystemPath` is used.

If a `FileSystemPathDD` directory is specified for a given data node (including the case where the parameter is specified in the `[ndbd default]` section of the `config.ini` file), then starting that data node with `--initial` causes all files in the directory to be deleted.

- `FileSystemPathDataFiles`

Version (or later)	NDB 7.5.0
Type or units	filename
Default	FileSystemPathDD
Range	...
Restart Type	S

If this parameter is specified, then NDB Cluster Disk Data data files are placed in the indicated directory. This overrides any value set for `FileSystemPathDD`. This parameter can be overridden for a given data file by specifying a path in the `ADD DATAFILE` clause of a `CREATE TABLESPACE` or `ALTER TABLESPACE` statement used to create that data file. If `FileSystemPathDataFiles` is not specified, then `FileSystemPathDD` is used (or `FileSystemPath`, if `FileSystemPathDD` has also not been set).

If a `FileSystemPathDataFiles` directory is specified for a given data node (including the case where the parameter is specified in the `[ndbd default]` section of the `config.ini` file), then starting that data node with `--initial` causes all files in the directory to be deleted.

- `FileSystemPathUndoFiles`

Version (or later)	NDB 7.5.0
Type or units	filename
Default	FileSystemPathDD
Range	...
Restart Type	S

If this parameter is specified, then NDB Cluster Disk Data undo log files are placed in the indicated directory. This overrides any value set for `FileSystemPathDD`. This parameter can be overridden for a given data file by specifying a path in the `ADD UNDO` clause of a `CREATE LOGFILE GROUP` or `ALTER LOGFILE GROUP` statement used to create that data file. If `FileSystemPathUndoFiles` is not specified, then `FileSystemPathDD` is used (or `FileSystemPath`, if `FileSystemPathDD` has also not been set).

If a `FileSystemPathUndoFiles` directory is specified for a given data node (including the case where the parameter is specified in the `[ndbd default]` section of the `config.ini` file), then starting that data node with `--initial` causes all files in the directory to be deleted.

For more information, see [Section 6.10.1, “NDB Cluster Disk Data Objects”](#).

- **Disk Data object creation parameters.** The next two parameters enable you—when starting the cluster for the first time—to cause a Disk Data log file group, tablespace, or both, to be created without the use of SQL statements.
- [InitialLogFileGroup](#)

Version (or later)	NDB 7.5.0
Type or units	string
Default	[see documentation]
Range	...
Restart Type	S

This parameter can be used to specify a log file group that is created when performing an initial start of the cluster. [InitialLogFileGroup](#) is specified as shown here:

```
InitialLogFileGroup = [name=name;) [undo_buffer_size=size;) file-specification-list

file-specification-list:
    file-specification[; file-specification[; ...]]

file-specification:
    filename:size
```

The [name](#) of the log file group is optional and defaults to `DEFAULT-LG`. The [undo_buffer_size](#) is also optional; if omitted, it defaults to `64M`. Each *file-specification* corresponds to an undo log file, and at least one must be specified in the *file-specification-list*. Undo log files are placed according to any values that have been set for [FileSystemPath](#), [FileSystemPathDD](#), and [FileSystemPathUndoFiles](#), just as if they had been created as the result of a `CREATE LOGFILE GROUP` or `ALTER LOGFILE GROUP` statement.

Consider the following:

```
InitialLogFileGroup = name=LG1; undo_buffer_size=128M; undo1.log:250M; undo2.log:150M
```

This is equivalent to the following SQL statements:

```
CREATE LOGFILE GROUP LG1
  ADD UNDOFILE 'undo1.log'
  INITIAL_SIZE 250M
  UNDO_BUFFER_SIZE 128M
  ENGINE NDBCLUSTER;

ALTER LOGFILE GROUP LG1
  ADD UNDOFILE 'undo2.log'
  INITIAL_SIZE 150M
  ENGINE NDBCLUSTER;
```

This logfile group is created when the data nodes are started with `--initial`.

Resources for the initial log file group are added to the global memory pool along with those indicated by the value of [SharedGlobalMemory](#).

This parameter, if used, should always be set in the `[ndbd default]` section of the `config.ini` file. The behavior of an NDB Cluster when different values are set on different data nodes is not defined.

- [InitialTablespace](#)

Version (or later)	NDB 7.5.0
Type or units	string
Default	[see documentation]

Range	...
Restart Type	S

This parameter can be used to specify an NDB Cluster Disk Data tablespace that is created when performing an initial start of the cluster. `InitialTablespace` is specified as shown here:

```
InitialTablespace = [name=name]; [extent_size=size]; file-specification-list
```

The `name` of the tablespace is optional and defaults to `DEFAULT-TS`. The `extent_size` is also optional; it defaults to `1M`. The `file-specification-list` uses the same syntax as shown with the `InitialLogfileGroup` parameter, the only difference being that each `file-specification` used with `InitialTablespace` corresponds to a data file. At least one must be specified in the `file-specification-list`. Data files are placed according to any values that have been set for `FileSystemPath`, `FileSystemPathDD`, and `FileSystemPathDataFiles`, just as if they had been created as the result of a `CREATE TABLESPACE` or `ALTER TABLESPACE` statement.

For example, consider the following line specifying `InitialTablespace` in the `[ndbd default]` section of the `config.ini` file (as with `InitialLogfileGroup`, this parameter should always be set in the `[ndbd default]` section, as the behavior of an NDB Cluster when different values are set on different data nodes is not defined):

```
InitialTablespace = name=TS1; extent_size=8M; data1.dat:2G; data2.dat:4G
```

This is equivalent to the following SQL statements:

```
CREATE TABLESPACE TS1
  ADD DATAFILE 'data1.dat'
  EXTENT_SIZE 8M
  INITIAL_SIZE 2G
  ENGINE NDBCLUSTER;

ALTER TABLESPACE TS1
  ADD DATAFILE 'data2.dat'
  INITIAL_SIZE 4G
  ENGINE NDBCLUSTER;
```

This tablespace is created when the data nodes are started with `--initial`, and can be used whenever creating NDB Cluster Disk Data tables thereafter.

Disk Data and GCP Stop errors. Errors encountered when using Disk Data tables such as `Node nodeid killed this node because GCP stop was detected` (error 2303) are often referred to as “GCP stop errors”. Such errors occur when the redo log is not flushed to disk quickly enough; this is usually due to slow disks and insufficient disk throughput.

You can help prevent these errors from occurring by using faster disks, and by placing Disk Data files on a separate disk from the data node file system. Reducing the value of `TimeBetweenGlobalCheckpoints` tends to decrease the amount of data to be written for each global checkpoint, and so may provide some protection against redo log buffer overflows when trying to write a global checkpoint; however, reducing this value also permits less time in which to write the GCP, so this must be done with caution.

In addition to the considerations given for `DiskPageBufferMemory` as explained previously, it is also very important that the `DiskIOThreadPool` configuration parameter be set correctly; having `DiskIOThreadPool` set too high is very likely to cause GCP stop errors (Bug #37227).

GCP stops can be caused by save or commit timeouts; the `TimeBetweenEpochsTimeout` data node configuration parameter determines the timeout for commits. However, it is possible to disable both types of timeouts by setting this parameter to 0.

Parameters for configuring send buffer memory allocation. Send buffer memory is allocated dynamically from a memory pool shared between all transporters, which means that the size of the

send buffer can be adjusted as necessary. (Previously, the NDB kernel used a fixed-size send buffer for every node in the cluster, which was allocated when the node started and could not be changed while the node was running.) The `TotalSendBufferMemory` and `OverLoadLimit` data node configuration parameters permit the setting of limits on this memory allocation. For more information about the use of these parameters (as well as `SendBufferMemory`), see [Section 4.3.13, “Configuring NDB Cluster Send Buffer Parameters”](#).

- `ExtraSendBufferMemory`

This parameter specifies the amount of transporter send buffer memory to allocate in addition to any set using `TotalSendBufferMemory`, `SendBufferMemory`, or both.

- `TotalSendBufferMemory`

This parameter is used to determine the total amount of memory to allocate on this node for shared send buffer memory among all configured transporters.

If this parameter is set, its minimum permitted value is 256KB; 0 indicates that the parameter has not been set. For more detailed information, see [Section 4.3.13, “Configuring NDB Cluster Send Buffer Parameters”](#).

See also [Section 6.7, “Adding NDB Cluster Data Nodes Online”](#).

Redo log over-commit handling. It is possible to control a data node's handling of operations when too much time is taken flushing redo logs to disk. This occurs when a given redo log flush takes longer than `RedoOverCommitLimit` seconds, more than `RedoOverCommitCounter` times, causing any pending transactions to be aborted. When this happens, the API node that sent the transaction can handle the operations that should have been committed either by queuing the operations and re-trying them, or by aborting them, as determined by `DefaultOperationRedoProblemAction`. The data node configuration parameters for setting the timeout and number of times it may be exceeded before the API node takes this action are described in the following list:

- `RedoOverCommitCounter`

Version (or later)	NDB 7.5.0
Type or units	numeric
Default	3
Range	0 - 4294967039 (0xFFFFFFFF)
Version (or later)	NDB 7.5.17
Type or units	numeric
Default	3
Range	1 - 4294967039 (0xFFFFFFFF)
Version (or later)	NDB 7.6.13
Type or units	numeric
Default	3
Range	1 - 4294967039 (0xFFFFFFFF)
Restart Type	S

When `RedoOverCommitLimit` is exceeded when trying to write a given redo log to disk this many times or more, any transactions that were not committed as a result are aborted, and an API node where any of these transactions originated handles the operations making up those transactions according to its value for `DefaultOperationRedoProblemAction` (by either queuing the operations to be re-tried, or aborting them).

- `RedoOverCommitLimit`

Version (or later)	NDB 7.5.0
Type or units	seconds
Default	20
Range	0 - 4294967039 (0xFFFFFFFF)
Version (or later)	NDB 7.5.17
Type or units	seconds
Default	20
Range	1 - 4294967039 (0xFFFFFFFF)
Version (or later)	NDB 7.6.13
Type or units	seconds
Default	20
Range	1 - 4294967039 (0xFFFFFFFF)
Restart Type	S

This parameter sets an upper limit in seconds for trying to write a given redo log to disk before timing out. The number of times the data node tries to flush this redo log, but takes longer than [RedoOverCommitLimit](#), is kept and compared with [RedoOverCommitCounter](#), and when flushing takes too long more times than the value of that parameter, any transactions that were not committed as a result of the flush timeout are aborted. When this occurs, the API node where any of these transactions originated handles the operations making up those transactions according to its [DefaultOperationRedoProblemAction](#) setting (it either queues the operations to be re-tried, or aborts them).

Controlling restart attempts. It is possible to exercise finely-grained control over restart attempts by data nodes when they fail to start using the [MaxStartFailRetries](#) and [StartFailRetryDelay](#) data node configuration parameters.

[MaxStartFailRetries](#) limits the total number of retries made before giving up on starting the data node, [StartFailRetryDelay](#) sets the number of seconds between retry attempts. These parameters are listed here:

- [StartFailRetryDelay](#)

Version (or later)	NDB 7.5.0
Type or units	unsigned
Default	0
Range	0 - 4294967039 (0xFFFFFFFF)
Restart Type	S

Use this parameter to set the number of seconds between restart attempts by the data node in the event on failure on startup. The default is 0 (no delay).

Both this parameter and [MaxStartFailRetries](#) are ignored unless [StopOnError](#) is equal to 0.

- [MaxStartFailRetries](#)

Version (or later)	NDB 7.5.0
Type or units	unsigned
Default	3
Range	0 - 4294967039 (0xFFFFFFFF)

Restart Type	S
------------------------------	---

Use this parameter to limit the number restart attempts made by the data node in the event that it fails on startup. The default is 3 attempts.

Both this parameter and [StartFailRetryDelay](#) are ignored unless [StopOnError](#) is equal to 0.

NDB index statistics parameters. The parameters in the following list relate to NDB index statistics generation.

- [IndexStatAutoCreate](#)

Version (or later)	NDB 7.5.0
Type or units	integer
Default	0
Range	0, 1
Restart Type	S

Enable (set equal to 1) or disable (set equal to 0) automatic statistics collection when indexes are created.

- [IndexStatAutoUpdate](#)

Version (or later)	NDB 7.5.0
Type or units	integer
Default	0
Range	0, 1
Restart Type	S

Enable (set equal to 1) or disable (set equal to 0) monitoring of indexes for changes, and trigger automatic statistics updates when these are detected. The degree of change needed to trigger the updates are determined by the settings for the [IndexStatTriggerPct](#) and [IndexStatTriggerScale](#) options.

- [IndexStatSaveSize](#)

Version (or later)	NDB 7.5.0
Type or units	bytes
Default	32768
Range	0 - 4294967039 (0xFFFFFFFF)
Restart Type	S

Maximum space in bytes allowed for the saved statistics of any given index in the NDB system tables and in the `mysqld` memory cache. In NDB 7.5 and earlier, this consumes [IndexMemory](#).

At least one sample is always produced, regardless of any size limit. This size is scaled by [IndexStatSaveScale](#).

The size specified by [IndexStatSaveSize](#) is scaled by the value of [IndexStatTriggerPct](#) for a large index, times 0.01. This is further multiplied by the logarithm to the base 2 of the index size. Setting [IndexStatTriggerPct](#) equal to 0 disables the scaling effect.

- [IndexStatSaveScale](#)

Version (or later)	NDB 7.5.0
--------------------	-----------

Type or units	percentage
Default	100
Range	0 - 4294967039 (0xFFFFFFFF)
Restart Type	S

The size specified by `IndexStatSaveSize` is scaled by the value of `IndexStatTriggerPct` for a large index, times 0.01. This is further multiplied by the logarithm to the base 2 of the index size. Setting `IndexStatTriggerPct` equal to 0 disables the scaling effect.

- `IndexStatTriggerPct`

Version (or later)	NDB 7.5.0
Type or units	percentage
Default	100
Range	0 - 4294967039 (0xFFFFFFFF)
Restart Type	S

Percentage change in updates that triggers an index statistics update. The value is scaled by `IndexStatTriggerScale`. You can disable this trigger altogether by setting `IndexStatTriggerPct` to 0.

- `IndexStatTriggerScale`

Version (or later)	NDB 7.5.0
Type or units	percentage
Default	100
Range	0 - 4294967039 (0xFFFFFFFF)
Restart Type	S

Scale `IndexStatTriggerPct` by this amount times 0.01 for a large index. A value of 0 disables scaling.

- `IndexStatUpdateDelay`

Version (or later)	NDB 7.5.0
Type or units	seconds
Default	60
Range	0 - 4294967039 (0xFFFFFFFF)
Restart Type	S

Minimum delay in seconds between automatic index statistics updates for a given index. Setting this variable to 0 disables any delay. The default is 60 seconds.

Restart types. Information about the restart types used by the parameter descriptions in this section is shown in the following table:

Table 4.9 NDB Cluster restart types

Symbol	Restart Type	Description
N	Node	The parameter can be updated using a rolling restart (see Section 6.5, “Performing a Rolling Restart of an NDB Cluster”)

Symbol	Restart Type	Description
S	System	All cluster nodes must be shut down completely, then restarted, to effect a change in this parameter
I	Initial	Data nodes must be restarted using the <code>--initial</code> option

4.3.7 Defining SQL and Other API Nodes in an NDB Cluster

The `[mysqld]` and `[api]` sections in the `config.ini` file define the behavior of the MySQL servers (SQL nodes) and other applications (API nodes) used to access cluster data. None of the parameters shown is required. If no computer or host name is provided, any host can use this SQL or API node.

Generally speaking, a `[mysqld]` section is used to indicate a MySQL server providing an SQL interface to the cluster, and an `[api]` section is used for applications other than `mysqld` processes accessing cluster data, but the two designations are actually synonymous; you can, for instance, list parameters for a MySQL server acting as an SQL node in an `[api]` section.

Note

For a discussion of MySQL server options for NDB Cluster, see [Section 4.3.9.1, “MySQL Server Options for NDB Cluster”](#). For information about MySQL server system variables relating to NDB Cluster, see [Section 4.3.9.2, “NDB Cluster System Variables”](#).

- `Id`

Version (or later)	NDB 7.5.0
Type or units	unsigned
Default	[...]
Range	1 - 255
Restart Type	S

The `Id` is an integer value used to identify the node in all cluster internal messages. The permitted range of values is 1 to 255 inclusive. This value must be unique for each node in the cluster, regardless of the type of node.

Note

Data node IDs must be less than 49, regardless of the NDB Cluster version used. If you plan to deploy a large number of data nodes, it is a good idea to limit the node IDs for API nodes (and management nodes) to values greater than 48.

`NodeId` is the preferred parameter name to use when identifying API nodes. (`Id` continues to be supported for backward compatibility, but is now deprecated and generates a warning when used. It is also subject to future removal.)

- `ConnectionMap`

Version (or later)	NDB 7.5.0
Type or units	string
Default	[...]
Range	...
Restart Type	S

Specifies which data nodes to connect.

- [NodeId](#)

Version (or later)	NDB 7.5.0
Type or units	unsigned
Default	[...]
Range	1 - 255
Restart Type	S

The [NodeId](#) is an integer value used to identify the node in all cluster internal messages. The permitted range of values is 1 to 255 inclusive. This value must be unique for each node in the cluster, regardless of the type of node.

Note

Data node IDs must be less than 49, regardless of the NDB Cluster version used. If you plan to deploy a large number of data nodes, it is a good idea to limit the node IDs for API nodes (and management nodes) to values greater than 48.

[NodeId](#) is the preferred parameter name to use when identifying management nodes. An alias, [Id](#), was used for this purpose in very old versions of NDB Cluster, and continues to be supported for backward compatibility; it is now deprecated and generates a warning when used, and is subject to removal in a future release of NDB Cluster.

- [ExecuteOnComputer](#)

Version (or later)	NDB 7.5.0
Type or units	name
Default	[...]
Range	...
Deprecated	NDB 7.5.0
Restart Type	S

This refers to the [Id](#) set for one of the computers (hosts) defined in a [[computer](#)] section of the configuration file.

Important

This parameter is deprecated as of NDB 7.5.0, and is subject to removal in a future release. Use the [HostName](#) parameter instead.

- [HostName](#)

Version (or later)	NDB 7.5.0
Type or units	name or IP address
Default	[...]
Range	...

Restart Type	S
--------------	---

Specifying this parameter defines the hostname of the computer on which the SQL node (API node) is to reside. To specify a hostname, either this parameter or `ExecuteOnComputer` is required.

If no `HostName` or `ExecuteOnComputer` is specified in a given `[mysql]` or `[api]` section of the `config.ini` file, then an SQL or API node may connect using the corresponding “slot” from any host which can establish a network connection to the management server host machine. *This differs from the default behavior for data nodes, where `localhost` is assumed for `HostName` unless otherwise specified.*

- `LocationDomainId`

Version (or later)	NDB 7.6.4
Type or units	integer
Default	0
Range	0 - 16
Added	NDB 7.6.4
Restart Type	S (NDB 7.6.4)

Assigns an SQL or other API node to a specific `availability domain` (also known as an availability zone) within a cloud. By informing `NDB` which nodes are in which availability domains, performance can be improved in a cloud environment in the following ways:

- If requested data is not found on the same node, reads can be directed to another node in the same availability domain.
- Communication between nodes in different availability domains are guaranteed to use `NDB` transporters' WAN support without any further manual intervention.
- The transporter's group number can be based on which availability domain is used, such that also SQL and other API nodes communicate with local data nodes in the same availability domain whenever possible.
- The arbitrator can be selected from an availability domain in which no data nodes are present, or, if no such availability domain can be found, from a third availability domain.

`LocationDomainId` takes an integer value between 0 and 16 inclusive, with 0 being the default; using 0 is the same as leaving the parameter unset.

- `ArbitrationRank`

Version (or later)	NDB 7.5.0
Type or units	0-2
Default	0
Range	0 - 2
Restart Type	S

This parameter defines which nodes can act as arbitrators. Both management nodes and SQL nodes can be arbitrators. A value of 0 means that the given node is never used as an arbitrator, a value of 1 gives the node high priority as an arbitrator, and a value of 2 gives it low priority. A normal configuration uses the management server as arbitrator, setting its `ArbitrationRank` to 1 (the default for management nodes) and those for all SQL nodes to 0 (the default for SQL nodes).

By setting `ArbitrationRank` to 0 on all management and SQL nodes, you can disable arbitration completely. You can also control arbitration by overriding this parameter; to do so, set the

`Arbitration` parameter in the `[ndbd default]` section of the `config.ini` global configuration file.

- `ArbitrationDelay`

Version (or later)	NDB 7.5.0
Type or units	milliseconds
Default	0
Range	0 - 4294967039 (0xFFFFFFFF)
Restart Type	S

Setting this parameter to any other value than 0 (the default) means that responses by the arbitrator to arbitration requests are delayed by the stated number of milliseconds. It is usually not necessary to change this value.

- `BatchByteSize`

Version (or later)	NDB 7.5.0
Type or units	bytes
Default	16K
Range	1K - 1M
Restart Type	S

For queries that are translated into full table scans or range scans on indexes, it is important for best performance to fetch records in properly sized batches. It is possible to set the proper size both in terms of number of records (`BatchSize`) and in terms of bytes (`BatchByteSize`). The actual batch size is limited by both parameters.

The speed at which queries are performed can vary by more than 40% depending upon how this parameter is set.

This parameter is measured in bytes. The default value is 16K.

- `BatchSize`

Version (or later)	NDB 7.5.0
Type or units	records
Default	256
Range	1 - 992
Restart Type	S

This parameter is measured in number of records and is by default set to 256. The maximum size is 992.

- `ExtraSendBufferMemory`

Version (or later)	NDB 7.5.0
Type or units	bytes
Default	0
Range	0 - 4294967039 (0xFFFFFFFF)

Restart Type	S
--------------	---

This parameter specifies the amount of transporter send buffer memory to allocate in addition to any that has been set using `TotalSendBufferMemory`, `SendBufferMemory`, or both.

- `HeartbeatThreadPriority`

Version (or later)	NDB 7.5.0
Type or units	string
Default	[...]
Range	...
Restart Type	S

Use this parameter to set the scheduling policy and priority of heartbeat threads for management and API nodes. The syntax for setting this parameter is shown here:

```
HeartbeatThreadPriority = policy[, priority]
```

```
policy:  
{FIFO | RR}
```

When setting this parameter, you must specify a policy. This is one of `FIFO` (first in, first in) or `RR` (round robin). This followed optionally by the priority (an integer).

- `MaxScanBatchSize`

Version (or later)	NDB 7.5.0
Type or units	bytes
Default	256K
Range	32K - 16M
Restart Type	S

The batch size is the size of each batch sent from each data node. Most scans are performed in parallel to protect the MySQL Server from receiving too much data from many nodes in parallel; this parameter sets a limit to the total batch size over all nodes.

The default value of this parameter is set to 256KB. Its maximum size is 16MB.

- `TotalSendBufferMemory`

Version (or later)	NDB 7.5.0
Type or units	bytes
Default	0
Range	256K - 4294967039 (0xFFFFFFFF)
Restart Type	S

This parameter is used to determine the total amount of memory to allocate on this node for shared send buffer memory among all configured transporters.

If this parameter is set, its minimum permitted value is 256KB; 0 indicates that the parameter has not been set. For more detailed information, see [Section 4.3.13, "Configuring NDB Cluster Send Buffer Parameters"](#).

- [AutoReconnect](#)

Version (or later)	NDB 7.5.0
Type or units	boolean
Default	false
Range	true, false
Restart Type	S

This parameter is `false` by default. This forces disconnected API nodes (including MySQL Servers acting as SQL nodes) to use a new connection to the cluster rather than attempting to re-use an existing one, as re-use of connections can cause problems when using dynamically-allocated node IDs. (Bug #45921)

Note

This parameter can be overridden using the NDB API. For more information, see [Ndb_cluster_connection::set_auto_reconnect\(\)](#), and [Ndb_cluster_connection::get_auto_reconnect\(\)](#).

- [DefaultOperationRedoProblemAction](#)

Version (or later)	NDB 7.5.0
Type or units	enumeration
Default	QUEUE
Range	ABORT, QUEUE
Restart Type	S

This parameter (along with [RedoOverCommitLimit](#) and [RedoOverCommitCounter](#)) controls the data node's handling of operations when too much time is taken flushing redo logs to disk. This occurs when a given redo log flush takes longer than [RedoOverCommitLimit](#) seconds, more than [RedoOverCommitCounter](#) times, causing any pending transactions to be aborted.

When this happens, the node can respond in either of two ways, according to the value of [DefaultOperationRedoProblemAction](#), listed here:

- **ABORT**: Any pending operations from aborted transactions are also aborted.
- **QUEUE**: Pending operations from transactions that were aborted are queued up to be re-tried. This the default. Pending operations are still aborted when the redo log runs out of space—that is, when **P_TAIL_PROBLEM** errors occur.

- [DefaultHashMapSize](#)

Version (or later)	NDB 7.5.0
Type or units	buckets
Default	3840
Range	0 - 3840
Restart Type	S

The size of the table hash maps used by **NDB** is configurable using this parameter. [DefaultHashMapSize](#) can take any of three possible values (0, 240, 3840).

The original intended use for this parameter was to facilitate upgrades and especially downgrades to and from very old releases with differing default hash map sizes. This is not an issue when upgrading from NDB Cluster 7.3 (or later) to later versions.

Decreasing this parameter online after any tables have been created or modified with `DefaultHashMapSize` equal to 3840 is not currently supported.

- [Wan](#)

Version (or later)	NDB 7.5.0
Type or units	boolean
Default	false
Range	true, false
Restart Type	S

Use WAN TCP setting as default.

- [ConnectBackoffMaxTime](#)

Version (or later)	NDB 7.5.0
Type or units	integer
Default	0
Range	0 - 4294967039 (0xFFFFFFFF)
Restart Type	S

In an NDB Cluster with many unstarted data nodes, the value of this parameter can be raised to circumvent connection attempts to data nodes which have not yet begun to function in the cluster, as well as moderate high traffic to management nodes. As long as the API node is not connected to any new data nodes, the value of the `StartConnectBackoffMaxTime` parameter is applied; otherwise, `ConnectBackoffMaxTime` is used to determine the length of time in milliseconds to wait between connection attempts.

Time elapsed *during* node connection attempts is not taken into account when calculating elapsed time for this parameter. The timeout is applied with approximately 100 ms resolution, starting with a 100 ms delay; for each subsequent attempt, the length of this period is doubled until it reaches `ConnectBackoffMaxTime` milliseconds, up to a maximum of 100000 ms (100s).

Once the API node is connected to a data node and that node reports (in a heartbeat message) that it has connected to other data nodes, connection attempts to those data nodes are no longer affected by this parameter, and are made every 100 ms thereafter until connected. Once a data node has started, it can take up `HeartbeatIntervalDbApi` for the API node to be notified that this has occurred.

- [StartConnectBackoffMaxTime](#)

Version (or later)	NDB 7.5.0
Type or units	integer
Default	0
Range	0 - 4294967039 (0xFFFFFFFF)
Restart Type	S

In an NDB Cluster with many unstarted data nodes, the value of this parameter can be raised to circumvent connection attempts to data nodes which have not yet begun to function in the cluster, as well as moderate high traffic to management nodes. As long as the API node is not connected to any new data nodes, the value of the `StartConnectBackoffMaxTime` parameter is applied;

otherwise, `ConnectBackoffMaxTime` is used to determine the length of time in milliseconds to wait between connection attempts.

Time elapsed *during* node connection attempts is not taken into account when calculating elapsed time for this parameter. The timeout is applied with approximately 100 ms resolution, starting with a 100 ms delay; for each subsequent attempt, the length of this period is doubled until it reaches `StartConnectBackoffMaxTime` milliseconds, up to a maximum of 100000 ms (100s).

Once the API node is connected to a data node and that node reports (in a heartbeat message) that it has connected to other data nodes, connection attempts to those data nodes are no longer affected by this parameter, and are made every 100 ms thereafter until connected. Once a data node has started, it can take up `HeartbeatIntervalDbApi` for the API node to be notified that this has occurred.

API Node Debugging Parameters. You can use the `ApiVerbose` configuration parameter to enable debugging output from a given API node. This parameter takes an integer value. 0 is the default, and disables such debugging; 1 enables debugging output to the cluster log; 2 adds `DBDICT` debugging output as well. (Bug #20638450) See also [DUMP 1229](#).

You can also obtain information from a MySQL server running as an NDB Cluster SQL node using `SHOW STATUS` in the `mysql` client, as shown here:

```
mysql> SHOW STATUS LIKE 'ndb%';
+-----+-----+
| Variable_name | Value |
+-----+-----+
| Ndb_cluster_node_id | 5 |
| Ndb_config_from_host | 198.51.100.112 |
| Ndb_config_from_port | 1186 |
| Ndb_number_of_storage_nodes | 4 |
+-----+-----+
4 rows in set (0.02 sec)
```

For information about the status variables appearing in the output from this statement, see [Section 4.3.9.3, “NDB Cluster Status Variables”](#).

Note

To add new SQL or API nodes to the configuration of a running NDB Cluster, it is necessary to perform a rolling restart of all cluster nodes after adding new `[mysqld]` or `[api]` sections to the `config.ini` file (or files, if you are using more than one management server). This must be done before the new SQL or API nodes can connect to the cluster.

It is *not* necessary to perform any restart of the cluster if new SQL or API nodes can employ previously unused API slots in the cluster configuration to connect to the cluster.

Restart types. Information about the restart types used by the parameter descriptions in this section is shown in the following table:

Table 4.10 NDB Cluster restart types

Symbol	Restart Type	Description
N	Node	The parameter can be updated using a rolling restart (see Section 6.5, “Performing a Rolling Restart of an NDB Cluster”)
S	System	All cluster nodes must be shut down completely, then

Symbol	Restart Type	Description
		restarted, to effect a change in this parameter
I	Initial	Data nodes must be restarted using the <code>--initial</code> option

4.3.8 Defining the System

The `[system]` section is used for parameters applying to the cluster as a whole. The `Name` system parameter is used with MySQL Enterprise Monitor; `ConfigGenerationNumber` and `PrimaryMGMNode` are not used in production environments. Except when using NDB Cluster with MySQL Enterprise Monitor, is not necessary to have a `[system]` section in the `config.ini` file.

More information about these parameters can be found in the following list:

- [ConfigGenerationNumber](#)

Version (or later)	NDB 7.5.0
Type or units	unsigned
Default	0
Range	0 - 4294967039 (0xFFFFFFFF)
Restart Type	S

Configuration generation number. This parameter is currently unused.

- [Name](#)

Version (or later)	NDB 7.5.0
Type or units	string
Default	[...]
Range	...
Restart Type	S

Set a name for the cluster. This parameter is required for deployments with MySQL Enterprise Monitor; it is otherwise unused.

You can obtain the value of this parameter by checking the `Ndb_system_name` status variable. In NDB API applications, you can also retrieve it using `get_system_name()`.

- [PrimaryMGMNode](#)

Version (or later)	NDB 7.5.0
Type or units	unsigned
Default	0
Range	0 - 4294967039 (0xFFFFFFFF)
Restart Type	S

Node ID of the primary management node. This parameter is currently unused.

Restart types. Information about the restart types used by the parameter descriptions in this section is shown in the following table:

Table 4.11 NDB Cluster restart types

Symbol	Restart Type	Description
N	Node	The parameter can be updated using a rolling restart (see Section 6.5, “Performing a Rolling Restart of an NDB Cluster”)
S	System	All cluster nodes must be shut down completely, then restarted, to effect a change in this parameter
I	Initial	Data nodes must be restarted using the <code>--initial</code> option

4.3.9 MySQL Server Options and Variables for NDB Cluster

This section provides information about MySQL server options, server and status variables that are specific to NDB Cluster. For general information on using these, and for other options and variables not specific to NDB Cluster, see [The MySQL Server](#).

For NDB Cluster configuration parameters used in the cluster configuration file (usually named `config.ini`), see [Chapter 4, Configuration of NDB Cluster](#).

4.3.9.1 MySQL Server Options for NDB Cluster

This section provides descriptions of `mysqld` server options relating to NDB Cluster. For information about `mysqld` options not specific to NDB Cluster, and for general information about the use of options with `mysqld`, see [Server Command Options](#).

For information about command-line options used with other NDB Cluster processes, see [Chapter 5, NDB Cluster Programs](#).

- `--ndbcluster`

Command-Line Format	<code>--ndbcluster[=value]</code>
Disabled by	<code>skip-ndbcluster</code>
Type	Boolean
Default Value	OFF

The `NDBCLUSTER` storage engine is necessary for using NDB Cluster. If a `mysqld` binary includes support for the `NDBCLUSTER` storage engine, the engine is disabled by default. Use the `--ndbcluster` option to enable it. Use `--skip-ndbcluster` to explicitly disable the engine.

It is not necessary or desirable to use this option together with `--initialize`. Beginning with NDB 7.5.4, `--ndbcluster` is ignored (and the `NDB` storage engine is *not* enabled) if `--initialize` is also used. (Bug #81689, Bug #23518923)

- `--ndb-allow-copying-alter-table=[ON|OFF]`

Command-Line Format	<code>--ndb-allow-copying-alter-table[={OFF ON}]</code>
Introduced	5.7.10-ndb-7.5.0
System Variable	<code>ndb_allow_copying_alter_table</code>
Scope	Global, Session

Dynamic	Yes
Type	Boolean
Default Value	ON

Let `ALTER TABLE` and other DDL statements use copying operations on NDB tables. Set to `OFF` to keep this from happening; doing so may improve performance of critical applications.

- `--ndb-batch-size=#`

Command-Line Format	<code>--ndb-batch-size</code>
System Variable	<code>ndb_batch_size</code>
Scope	Global
Dynamic	No
Type	Integer
Default Value	32768
Minimum Value	0
Maximum Value	31536000

This sets the size in bytes that is used for NDB transaction batches.

- `--ndb-cluster-connection-pool=#`

Command-Line Format	<code>--ndb-cluster-connection-pool</code>
System Variable	<code>ndb_cluster_connection_pool</code>
System Variable	<code>ndb_cluster_connection_pool</code>
Scope	Global
Scope	Global
Dynamic	No
Dynamic	No
Type	Integer
Default Value	1
Minimum Value	1
Maximum Value	63

By setting this option to a value greater than 1 (the default), a `mysqld` process can use multiple connections to the cluster, effectively mimicking several SQL nodes. Each connection requires its own `[api]` or `[mysqld]` section in the cluster configuration (`config.ini`) file, and counts against the maximum number of API connections supported by the cluster.

Suppose that you have 2 cluster host computers, each running an SQL node whose `mysqld` process was started with `--ndb-cluster-connection-pool=4`; this means that the cluster must have 8 API slots available for these connections (instead of 2). All of these connections are set up when the SQL node connects to the cluster, and are allocated to threads in a round-robin fashion.

This option is useful only when running `mysqld` on host machines having multiple CPUs, multiple cores, or both. For best results, the value should be smaller than the total number of cores available on the host machine. Setting it to a value greater than this is likely to degrade performance severely.

Important

Because each SQL node using connection pooling occupies multiple API node slots—each slot having its own node ID in the cluster—you must *not*

use a node ID as part of the cluster connection string when starting any `mysqld` process that employs connection pooling.

Setting a node ID in the connection string when using the `--ndb-cluster-connection-pool` option causes node ID allocation errors when the SQL node attempts to connect to the cluster.

- `--ndb-cluster-connection-pool-nodeids=list`

Command-Line Format	<code>--ndb-cluster-connection-pool-nodeids</code>
Introduced	5.7.10-ndb-7.5.0
System Variable (≥ 5.7.10-ndb-7.5.0)	<code>ndb_cluster_connection_pool_nodeids</code>
Scope (≥ 5.7.10-ndb-7.5.0)	Global
Dynamic (≥ 5.7.10-ndb-7.5.0)	No
Type	Set
Default Value	

Specifies a comma-separated list of node IDs for connections to the cluster used by an SQL node. The number of nodes in this list must be the same as the value set for the `--ndb-cluster-connection-pool` option.

`--ndb-cluster-connection-pool-nodeids` was added in NDB 7.5.0.

- `--ndb-blob-read-batch-bytes=bytes`

Command-Line Format	<code>--ndb-blob-read-batch-bytes</code>
System Variable	<code>ndb_blob_read_batch_bytes</code>
Scope	Global, Session
Dynamic	Yes
Type	Integer
Default Value	65536
Minimum Value	0
Maximum Value	4294967295

This option can be used to set the size (in bytes) for batching of `BLOB` data reads in NDB Cluster applications. When this batch size is exceeded by the amount of `BLOB` data to be read within the current transaction, any pending `BLOB` read operations are immediately executed.

The maximum value for this option is 4294967295; the default is 65536. Setting it to 0 has the effect of disabling `BLOB` read batching.

Note

In NDB API applications, you can control `BLOB` write batching with the `setMaxPendingBlobReadBytes()` and `getMaxPendingBlobReadBytes()` methods.

- `--ndb-blob-write-batch-bytes=bytes`

Command-Line Format	<code>--ndb-blob-write-batch-bytes</code>
System Variable	<code>ndb_blob_write_batch_bytes</code>
Scope	Global, Session

Dynamic	Yes
Type	Integer
Default Value	65536
Minimum Value	0
Maximum Value	4294967295

This option can be used to set the size (in bytes) for batching of `BLOB` data writes in NDB Cluster applications. When this batch size is exceeded by the amount of `BLOB` data to be written within the current transaction, any pending `BLOB` write operations are immediately executed.

The maximum value for this option is 4294967295; the default is 65536. Setting it to 0 has the effect of disabling `BLOB` write batching.

Note

In NDB API applications, you can control `BLOB` write batching with the `setMaxPendingBlobWriteBytes()` and `getMaxPendingBlobWriteBytes()` methods.

- `--ndb-connectstring=connection_string`

Command-Line Format	<code>--ndb-connectstring</code>
Type	String

When using the `NDBCLUSTER` storage engine, this option specifies the management server that distributes cluster configuration data. See [Section 4.3.3, “NDB Cluster Connection Strings”](#), for syntax.

- `--ndb-default-column-format=[FIXED|DYNAMIC]`

Command-Line Format	<code>--ndb-default-column-format={FIXED DYNAMIC}</code>
Introduced	5.7.11-ndb-7.5.1
System Variable	<code>ndb_default_column_format</code>
Scope	Global
Dynamic	Yes
Type	Enumeration
Default Value (≥ 5.7.16-ndb-7.5.4)	<code>FIXED</code>
Default Value (≥ 5.7.11-ndb-7.5.1, ≤ 5.7.13-ndb-7.5.3)	<code>DYNAMIC</code>
Valid Values	<code>FIXED</code> <code>DYNAMIC</code>

In NDB 7.5.1 and later, sets the default `COLUMN_FORMAT` and `ROW_FORMAT` for new tables (see [CREATE TABLE Statement](#)).

In NDB 7.5.1, the default for this option was `DYNAMIC`; in NDB 7.5.4, the default was changed to `FIXED` to maintain backwards compatibility with older release series (Bug #24487363).

- `--ndb-deferred-constraints=[0|1]`

Command-Line Format	<code>--ndb-deferred-constraints</code>
System Variable	<code>ndb_deferred_constraints</code>

Scope	Global, Session
Dynamic	Yes
Type	Integer
Default Value	0
Minimum Value	0
Maximum Value	1

Controls whether or not constraint checks on unique indexes are deferred until commit time, where such checks are supported. 0 is the default.

This option is not normally needed for operation of NDB Cluster or NDB Cluster Replication, and is intended primarily for use in testing.

- `--ndb-distribution={KEYHASH|LINHASH}`

Command-Line Format	<code>--ndb-distribution={KEYHASH LINHASH}</code>
System Variable	<code>ndb_distribution</code>
Scope	Global
Dynamic	Yes
Type	Enumeration
Default Value	KEYHASH
Valid Values	LINHASH KEYHASH

Controls the default distribution method for NDB tables. Can be set to either of KEYHASH (key hashing) or LINHASH (linear hashing). KEYHASH is the default.

- `--ndb-log-apply-status`

Command-Line Format	<code>--ndb-log-apply-status[={OFF ON}]</code>
System Variable	<code>ndb_log_apply_status</code>
Scope	Global
Dynamic	No
Type	Boolean
Default Value	OFF

Causes a replica `mysqld` to log any updates received from its immediate source to the `mysql.ndb_apply_status` table in its own binary log using its own server ID rather than the server ID of the source. In a circular or chain replication setting, this allows such updates to propagate to the `mysql.ndb_apply_status` tables of any MySQL servers configured as replicas of the current `mysqld`.

In a chain replication setup, using this option allows downstream (replica) clusters to be aware of their positions relative to all of their upstream contributors (sources).

In a circular replication setup, this option causes changes to `ndb_apply_status` tables to complete the entire circuit, eventually propagating back to the originating NDB Cluster. This also allows a cluster acting as a source to see when its changes (epochs) have been applied to the other clusters in the circle.

This option has no effect unless the MySQL server is started with the `--ndbcluster` option.

- `--ndb-log-empty-epochs=[ON|OFF]`

Command-Line Format	<code>--ndb-log-empty-epochs [= {OFF ON}]</code>
System Variable	<code>ndb_log_empty_epochs</code>
Scope	Global
Dynamic	Yes
Type	Boolean
Default Value	OFF

Causes epochs during which there were no changes to be written to the `ndb_apply_status` and `ndb_binlog_index` tables, even when `log_slave_updates` is enabled.

By default this option is disabled. Disabling `--ndb-log-empty-epochs` causes epoch transactions with no changes not to be written to the binary log, although a row is still written even for an empty epoch in `ndb_binlog_index`.

Because `--ndb-log-empty-epochs=1` causes the size of the `ndb_binlog_index` table to increase independently of the size of the binary log, users should be prepared to manage the growth of this table, even if they expect the cluster to be idle a large part of the time.

- `--ndb-log-empty-update=[ON|OFF]`

Command-Line Format	<code>--ndb-log-empty-update [= {OFF ON}]</code>
System Variable	<code>ndb_log_empty_update</code>
Scope	Global
Dynamic	Yes
Type	Boolean
Default Value	OFF

Causes updates that produced no changes to be written to the `ndb_apply_status` and `ndb_binlog_index` tables, when when `log_slave_updates` is enabled.

By default this option is disabled (OFF). Disabling `--ndb-log-empty-update` causes updates with no changes not to be written to the binary log.

- `--ndb-log-exclusive-reads=[0|1]`

Command-Line Format	<code>--ndb-log-exclusive-reads [= {OFF ON}]</code>
System Variable	<code>ndb_log_exclusive_reads</code>
Scope	Global, Session
Dynamic	Yes
Type	Boolean
Default Value	0

Starting the server with this option causes primary key reads to be logged with exclusive locks, which allows for NDB Cluster Replication conflict detection and resolution based on read conflicts. You can also enable and disable these locks at runtime by setting the value of the `ndb_log_exclusive_reads` system variable to 1 or 0, respectively. 0 (disable locking) is the default.

For more information, see [Read conflict detection and resolution](#).

- `--ndb-log-fail-terminate`

Command-Line Format	<code>--ndb-log-fail-terminate</code>
Introduced	5.7.29-ndb-7.6.14
System Variable	<code>ndb_log_fail_terminate</code>
Scope	Global
Dynamic	No
Type	Boolean
Default Value	<code>FALSE</code>

When this option is specified, and complete logging of all found row events is not possible, the `mysqld` process is terminated.

- `--ndb-log-orig`

Command-Line Format	<code>--ndb-log-orig[={OFF ON}]</code>
System Variable	<code>ndb_log_orig</code>
Scope	Global
Dynamic	No
Type	Boolean
Default Value	<code>OFF</code>

Log the originating server ID and epoch in the `ndb_binlog_index` table.

Note

This makes it possible for a given epoch to have multiple rows in `ndb_binlog_index`, one for each originating epoch.

For more information, see [Section 7.4, “NDB Cluster Replication Schema and Tables”](#).

- `--ndb-log-transaction-id`

Command-Line Format	<code>--ndb-log-transaction-id[={OFF ON}]</code>
System Variable	<code>ndb_log_transaction_id</code>
Scope	Global
Dynamic	No
Type	Boolean
Default Value	<code>OFF</code>

Causes a replica `mysqld` to write the NDB transaction ID in each row of the binary log. Such logging requires the use of the Version 2 event format for the binary log; thus, the `log_bin_use_v1_row_events` system variable must be disabled to use this option.

This option is not supported in mainline MySQL Server 5.7. It is required to enable NDB Cluster Replication conflict detection and resolution using the `NDB$EPOCH_TRANS()` function (see [NDB\\$EPOCH_TRANS\(\)](#)).

The default value is `FALSE`.

For more information, see [Section 7.11, “NDB Cluster Replication Conflict Resolution”](#).

- `--ndb-log-update-as-write`

Command-Line Format	<code>--ndb-log-update-as-write[={OFF ON}]</code>
System Variable	<code>ndb_log_update_as_write</code>
Scope	Global
Dynamic	Yes
Type	Boolean
Default Value	<code>ON</code>

Whether updates on the source are written to the binary log as updates (`OFF`) or writes (`ON`). Used in NDB Replication conflict resolution; for more information, see [Logging Changed Data as Updates](#).

- `--ndb-log-updated-only`

Command-Line Format	<code>--ndb-log-updated-only[={OFF ON}]</code>
System Variable	<code>ndb_log_updated_only</code>
Scope	Global
Dynamic	Yes
Type	Boolean
Default Value	<code>ON</code>

Whether `mysqld` writes complete rows (`ON`) or updates only (`OFF`) to the binary log. Used in NDB Replication conflict resolution; see [Logging Full or Partial Rows](#), for more information.

- `--ndb-log-update-minimal`

Command-Line Format	<code>--ndb-log-update-minimal[={OFF ON}]</code>
Introduced	5.7.18-ndb-7.6.3
System Variable	<code>ndb_log_update_minimal</code>
Scope	Global
Dynamic	Yes
Type	Boolean
Default Value	<code>OFF</code>

Log updates in a minimal fashion, by writing only the primary key values in the before image, and only the changed columns in the after image. This may cause compatibility problems if replicating to storage engines other than [NDB](#).

- `--ndb-mgmd-host=host[:port]`

Command-Line Format	<code>--ndb-mgmd-host=host_name[:port_num]</code>
Type	String
Default Value	<code>localhost:1186</code>

Can be used to set the host and port number of a single management server for the program to connect to. If the program requires node IDs or references to multiple management servers (or both) in its connection information, use the `--ndb-connectstring` option instead.

- `--ndb-nodeid=#`

Command-Line Format	<code>--ndb-nodeid=#</code>
---------------------	-----------------------------

Status Variable	<code>Ndb_cluster_node_id</code>
Scope	Global
Dynamic	No
Type	Integer
Minimum Value	1
Maximum Value	255
Maximum Value	63

Set this MySQL server's node ID in an NDB Cluster.

The `--ndb-nodeid` option overrides any node ID set with `--ndb-connectstring`, regardless of the order in which the two options are used.

In addition, if `--ndb-nodeid` is used, then either a matching node ID must be found in a `[mysqld]` or `[api]` section of `config.ini`, or there must be an "open" `[mysqld]` or `[api]` section in the file (that is, a section without a `NodeId` or `Id` parameter specified). This is also true if the node ID is specified as part of the connection string.

Regardless of how the node ID is determined, its is shown as the value of the global status variable `Ndb_cluster_node_id` in the output of `SHOW STATUS`, and as `cluster_node_id` in the `connection` row of the output of `SHOW ENGINE NDBCLUSTER STATUS`.

For more information about node IDs for NDB Cluster SQL nodes, see [Section 4.3.7, "Defining SQL and Other API Nodes in an NDB Cluster"](#).

- `--ndb-optimization-delay=milliseconds`

Command-Line Format	<code>--ndb-optimization-delay=#</code>
System Variable	<code>ndb_optimization_delay</code>
Scope	Global
Dynamic	Yes
Type	Integer
Default Value	10
Minimum Value	0
Maximum Value	100000

Set the number of milliseconds to wait between sets of rows by `OPTIMIZE TABLE` statements on `NDB` tables. The default is 10.

- `--ndb-optimized-node-selection`

Command-Line Format	<code>--ndb-optimized-node-selection</code>
---------------------	---

Enable optimizations for selection of nodes for transactions. Enabled by default; use `--skip-ndb-optimized-node-selection` to disable.

- `--ndb-transid-mysql-connection-map=state`

Command-Line Format	<code>--ndb-transid-mysql-connection-map[=state]</code>
Type	Enumeration
Default Value	ON
Valid Values	ON

	OFF
	FORCE

Enables or disables the plugin that handles the `ndb_transid_mysql_connection_map` table in the `INFORMATION_SCHEMA` database. Takes one of the values `ON`, `OFF`, or `FORCE`. `ON` (the default) enables the plugin. `OFF` disables the plugin, which makes `ndb_transid_mysql_connection_map` inaccessible. `FORCE` keeps the MySQL Server from starting if the plugin fails to load and start.

You can see whether the `ndb_transid_mysql_connection_map` table plugin is running by checking the output of `SHOW PLUGINS`.

- `--ndb-wait-connected=seconds`

Command-Line Format	<code>--ndb-wait-connected=#</code>
System Variable	<code>ndb_wait_connected</code>
Scope	Global
Dynamic	No
Type	Integer
Default Value	30
Minimum Value	0
Maximum Value	31536000

This option sets the period of time that the MySQL server waits for connections to NDB Cluster management and data nodes to be established before accepting MySQL client connections. The time is specified in seconds. The default value is 30.

- `--ndb-wait-setup=seconds`

Command-Line Format	<code>--ndb-wait-setup=#</code>
System Variable	<code>ndb_wait_setup</code>
Scope	Global
Dynamic	No
Type	Integer
Default Value	30
Default Value	30
Default Value	15
Default Value	15
Minimum Value	0
Maximum Value	31536000

This variable shows the period of time that the MySQL server waits for the `NDB` storage engine to complete setup before timing out and treating `NDB` as unavailable. The time is specified in seconds. The default value is 30.

- `--skip-ndbcluster`

Command-Line Format	<code>--skip-ndbcluster</code>
---------------------	--------------------------------

Disable the `NDBCLUSTER` storage engine. This is the default for binaries that were built with `NDBCLUSTER` storage engine support; the server allocates memory and other resources for this

storage engine only if the `--ndbcluster` option is given explicitly. See [Section 4.1, “Quick Test Setup of NDB Cluster”](#), for an example.

4.3.9.2 NDB Cluster System Variables

This section provides detailed information about MySQL server system variables that are specific to NDB Cluster and the `NDB` storage engine. For system variables not specific to NDB Cluster, see [Server System Variables](#). For general information on using system variables, see [Using System Variables](#).

- `ndb_autoincrement_prefetch_sz`

Command-Line Format	<code>--ndb-autoincrement-prefetch-sz=#</code>
System Variable	<code>ndb_autoincrement_prefetch_sz</code>
Scope	Global, Session
Dynamic	Yes
Type	Integer
Default Value	1
Minimum Value	1
Maximum Value	65536

Determines the probability of gaps in an autoincremented column. Set it to 1 to minimize this. Setting it to a high value for optimization makes inserts faster, but decreases the likelihood that consecutive autoincrement numbers are used in a batch of inserts.

This variable affects only the number of `AUTO_INCREMENT` IDs that are fetched between statements; within a given statement, at least 32 IDs are obtained at a time.

Important

This variable does not affect inserts performed using `INSERT ... SELECT`.

- `ndb_cache_check_time`

Command-Line Format	<code>--ndb-cache-check-time=#</code>
Deprecated	5.7.20
System Variable	<code>ndb_cache_check_time</code>
Scope	Global
Dynamic	Yes
Type	Integer
Default Value	0

The number of milliseconds that elapse between checks of NDB Cluster SQL nodes by the MySQL query cache. Setting this to 0 (the default and minimum value) means that the query cache checks for validation on every query.

The recommended maximum value for this variable is 1000, which means that the check is performed once per second. A larger value means that the check is performed and possibly invalidated due to updates on different SQL nodes less often. It is generally not desirable to set this to a value greater than 2000.

Note

The query cache is deprecated as of MySQL 5.7.20, and is removed in MySQL 8.0. Deprecation includes `ndb_cache_check_time`.

- `ndb_clear_apply_status`

Command-Line Format	<code>--ndb-clear-apply-status[={OFF ON}]</code>
System Variable	<code>ndb_clear_apply_status</code>
Scope	Global
Dynamic	Yes
Type	Boolean
Default Value	ON

By the default, executing `RESET SLAVE` causes an NDB Cluster replica to purge all rows from its `ndb_apply_status` table. You can disable this by setting `ndb_clear_apply_status=OFF`.

- `ndb_data_node_neighbour`

Command-Line Format	<code>--ndb-data-node-neighbour=#</code>
Introduced	5.7.12-ndb-7.5.2
System Variable	<code>ndb_data_node_neighbour</code>
Scope	Global
Dynamic	Yes
Type	Integer
Default Value	0
Minimum Value	0
Maximum Value	255

Sets the ID of a “nearest” data node—that is, a preferred nonlocal data node is chosen to execute the transaction, rather than one running on the same host as the SQL or API node. This used to ensure that when a fully replicated table is accessed, we access it on this data node, to ensure that the local copy of the table is always used whenever possible. This can also be used for providing hints for transactions.

This can improve data access times in the case of a node that is physically closer than and thus has higher network throughput than others on the same host.

See [Setting NDB_TABLE Options](#), for further information.

Added in NDB 7.5.2.

Note

An equivalent method `set_data_node_neighbour()` is provided for use in NDB API applications.

- `ndb_default_column_format`

Command-Line Format	<code>--ndb-default-column-format={FIXED DYNAMIC}</code>
Introduced	5.7.11-ndb-7.5.1
System Variable	<code>ndb_default_column_format</code>
Scope	Global
Dynamic	Yes
Type	Enumeration
Default Value (≥ 5.7.16-ndb-7.5.4)	<code>FIXED</code>

Default Value (≥ 5.7.11-ndb-7.5.1, ≤ 5.7.13-ndb-7.5.3)	DYNAMIC
Valid Values	FIXED DYNAMIC

In NDB 7.5.1 and later, sets the default `COLUMN_FORMAT` and `ROW_FORMAT` for new tables (see [CREATE TABLE Statement](#)).

In NDB 7.5.1, the default for this variable was `DYNAMIC`; in NDB 7.5.4, the default was changed to `FIXED` to maintain backwards compatibility with older release series (Bug #24487363).

- `ndb_deferred_constraints`

Command-Line Format	<code>--ndb-deferred-constraints=#</code>
System Variable	<code>ndb_deferred_constraints</code>
Scope	Global, Session
Dynamic	Yes
Type	Integer
Default Value	0
Minimum Value	0
Maximum Value	1

Controls whether or not constraint checks are deferred, where these are supported. 0 is the default.

This variable is not normally needed for operation of NDB Cluster or NDB Cluster Replication, and is intended primarily for use in testing.

- `ndb_distribution`

Command-Line Format	<code>--ndb-distribution={KEYHASH LINHASH}</code>
System Variable	<code>ndb_distribution</code>
Scope	Global
Dynamic	Yes
Type	Enumeration
Default Value	KEYHASH
Valid Values	LINHASH KEYHASH

Controls the default distribution method for NDB tables. Can be set to either of `KEYHASH` (key hashing) or `LINHASH` (linear hashing). `KEYHASH` is the default.

- `ndb_eventbuffer_free_percent`

Command-Line Format	<code>--ndb-eventbuffer-free-percent=#</code>
System Variable	<code>ndb_eventbuffer_free_percent</code>
Scope	Global
Dynamic	Yes
Type	Integer
Default Value	20

Minimum Value	1
Maximum Value	99

Sets the percentage of the maximum memory allocated to the event buffer (`ndb_eventbuffer_max_alloc`) that should be available in event buffer after reaching the maximum, before starting to buffer again.

- `ndb_eventbuffer_max_alloc`

Command-Line Format	<code>--ndb-eventbuffer-max-alloc=#</code>
System Variable	<code>ndb_eventbuffer_max_alloc</code>
Scope	Global
Dynamic	Yes
Type	Integer
Default Value	0
Minimum Value	0
Maximum Value (≥ 5.7.35-ndb-7.6.19)	9223372036854775807
Maximum Value (≥ 5.7.35-ndb-7.5.23)	9223372036854775807
Maximum Value (≤ 5.7.34-ndb-7.5.22)	4294967295
Maximum Value (≤ 5.7.34-ndb-7.6.18)	4294967295
Maximum Value	4294967295

Sets the maximum amount memory (in bytes) that can be allocated for buffering events by the NDB API. 0 means that no limit is imposed, and is the default.

- `ndb_extra_logging`

Command-Line Format	<code>ndb_extra_logging=#</code>
System Variable	<code>ndb_extra_logging</code>
Scope	Global
Dynamic	Yes
Type	Integer
Default Value	1

This variable enables recording in the MySQL error log of information specific to the NDB storage engine.

When this variable is set to 0, the only information specific to NDB that is written to the MySQL error log relates to transaction handling. If it set to a value greater than 0 but less than 10, NDB table schema and connection events are also logged, as well as whether or not conflict resolution is in use, and other NDB errors and information. If the value is set to 10 or more, information about NDB internals, such as the progress of data distribution among cluster nodes, is also written to the MySQL error log. The default is 1.

- `ndb_force_send`

Command-Line Format	<code>--ndb-force-send[={OFF ON}]</code>
System Variable	<code>ndb_force_send</code>
Scope	Global, Session
Dynamic	Yes

Type	Boolean
Default Value	ON

Forces sending of buffers to [NDB](#) immediately, without waiting for other threads. Defaults to [ON](#).

- [ndb_fully_replicated](#)

Command-Line Format	<code>--ndb-fully-replicated[={OFF ON}]</code>
Introduced	5.7.12-ndb-7.5.2
System Variable	ndb_fully_replicated
Scope	Global, Session
Dynamic	Yes
Type	Boolean
Default Value	OFF

Determines whether new [NDB](#) tables are fully replicated. This setting can be overridden for an individual table using `COMMENT="NDB_TABLE=FULLY_REPLICATED=..."` in a `CREATE TABLE` or `ALTER TABLE` statement; see [Setting NDB_TABLE Options](#), for syntax and other information.

Added in NDB 7.5.2.

- [ndb_index_stat_enable](#)

Command-Line Format	<code>--ndb-index-stat-enable[={OFF ON}]</code>
System Variable	ndb_index_stat_enable
Scope	Global, Session
Dynamic	Yes
Type	Boolean
Default Value	ON

Use [NDB](#) index statistics in query optimization. The default is [ON](#).

- [ndb_index_stat_option](#)

Command-Line Format	<code>--ndb-index-stat-option=value</code>
System Variable	ndb_index_stat_option
Scope	Global, Session
Dynamic	Yes
Type	String
Default Value	<code>loop_checkon=1000ms,loop_idle=1000ms,loop_b update_batch=1,read_batch=4,idle_batch=32,c check_delay=1m,delete_batch=8,clean_delay=0</code>

```
error_delay=1m,evict_batch=8,evict_delay=1m,ca
cache_lowpct=90
```

This variable is used for providing tuning options for NDB index statistics generation. The list consist of comma-separated name-value pairs of option names and values, and this list must not contain any space characters.

Options not used when setting `ndb_index_stat_option` are not changed from their default values. For example, you can set `ndb_index_stat_option = 'loop_idle=1000ms,cache_limit=32M'`.

Time values can be optionally suffixed with `h` (hours), `m` (minutes), or `s` (seconds). Millisecond values can optionally be specified using `ms`; millisecond values cannot be specified using `h`, `m`, or `s`.) Integer values can be suffixed with `K`, `M`, or `G`.

The names of the options that can be set using this variable are shown in the table that follows. The table also provides brief descriptions of the options, their default values, and (where applicable) their minimum and maximum values.

Table 4.12 `ndb_index_stat_option` options and values

Name	Description	Default/Units	Minimum/Maximum
<code>loop_enable</code>		1000 ms	0/4G
<code>loop_idle</code>	Time to sleep when idle	1000 ms	0/4G
<code>loop_busy</code>	Time to sleep when more work is waiting	100 ms	0/4G
<code>update_batch</code>		1	0/4G
<code>read_batch</code>		4	1/4G
<code>idle_batch</code>		32	1/4G
<code>check_batch</code>		8	1/4G
<code>check_delay</code>	How often to check for new statistics	10 m	1/4G
<code>delete_batch</code>		8	0/4G
<code>clean_delay</code>		1 m	0/4G
<code>error_batch</code>		4	1/4G
<code>error_delay</code>		1 m	1/4G
<code>evict_batch</code>		8	1/4G
<code>evict_delay</code>	Clean LRU cache, from read time	1 m	0/4G
<code>cache_limit</code>	Maximum amount of memory in bytes used for cached index statistics by this <code>mysqld</code> ; clean up the cache when this is exceeded.	32 M	0/4G
<code>cache_lowpct</code>		90	0/100
<code>zero_total</code>	Setting this to 1 resets all accumulating counters in <code>ndb_index_stat_status</code> to 0. This option value	0	0/1

Name	Description	Default/Units	Minimum/Maximum
	is also reset to 0 when this is done.		

- `ndb_join_pushdown`

System Variable	<code>ndb_join_pushdown</code>
Scope	Global, Session
Dynamic	Yes
Type	Boolean
Default Value	ON

This variable controls whether joins on `NDB` tables are pushed down to the `NDB` kernel (data nodes). Previously, a join was handled using multiple accesses of `NDB` by the SQL node; however, when `ndb_join_pushdown` is enabled, a pushable join is sent in its entirety to the data nodes, where it can be distributed among the data nodes and executed in parallel on multiple copies of the data, with a single, merged result being returned to `mysqld`. This can reduce greatly the number of round trips between an SQL node and the data nodes required to handle such a join.

By default, `ndb_join_pushdown` is enabled.

Conditions for NDB pushdown joins. In order for a join to be pushable, it must meet the following conditions:

1. Only columns can be compared, and all columns to be joined must use *exactly* the same data type.

This means that expressions such as `t1.a = t2.a + constant` cannot be pushed down, and that (for example) a join on an `INT` column and a `BIGINT` column also cannot be pushed down.

2. Queries referencing `BLOB` or `TEXT` columns are not supported.
3. Explicit locking is not supported; however, the `NDB` storage engine's characteristic implicit row-based locking is enforced.

This means that a join using `FOR UPDATE` cannot be pushed down.

4. In order for a join to be pushed down, child tables in the join must be accessed using one of the `ref`, `eq_ref`, or `const` access methods, or some combination of these methods.

Outer joined child tables can only be pushed using `eq_ref`.

If the root of the pushed join is an `eq_ref` or `const`, only child tables joined by `eq_ref` can be appended. (A table joined by `ref` is likely to become the root of another pushed join.)

If the query optimizer decides on `Using join cache` for a candidate child table, that table cannot be pushed as a child. However, it may be the root of another set of pushed tables.

5. Joins referencing tables explicitly partitioned by [`LINEAR`] `HASH`, `LIST`, or `RANGE` currently cannot be pushed down.

You can see whether a given join can be pushed down by checking it with `EXPLAIN`; when the join can be pushed down, you can see references to the `pushed join` in the `Extra` column of the output, as shown in this example:

```
mysql> EXPLAIN
-> SELECT e.first_name, e.last_name, t.title, d.dept_name
-> FROM employees e
-> JOIN dept_emp de ON e.emp_no=de.emp_no
```

```

-> JOIN departments d ON d.dept_no=de.dept_no
-> JOIN titles t ON e.emp_no=t.emp_no\G
***** 1. row *****
      id: 1
      select_type: SIMPLE
      table: d
      type: ALL
possible_keys: PRIMARY
      key: NULL
      key_len: NULL
      ref: NULL
      rows: 9
      Extra: Parent of 4 pushed join@1
***** 2. row *****
      id: 1
      select_type: SIMPLE
      table: de
      type: ref
possible_keys: PRIMARY,emp_no,dept_no
      key: dept_no
      key_len: 4
      ref: employees.d.dept_no
      rows: 5305
      Extra: Child of 'd' in pushed join@1
***** 3. row *****
      id: 1
      select_type: SIMPLE
      table: e
      type: eq_ref
possible_keys: PRIMARY
      key: PRIMARY
      key_len: 4
      ref: employees.de.emp_no
      rows: 1
      Extra: Child of 'de' in pushed join@1
***** 4. row *****
      id: 1
      select_type: SIMPLE
      table: t
      type: ref
possible_keys: PRIMARY,emp_no
      key: emp_no
      key_len: 4
      ref: employees.de.emp_no
      rows: 19
      Extra: Child of 'e' in pushed join@1
4 rows in set (0.00 sec)

```

Note

If inner joined child tables are joined by *ref*, and the result is ordered or grouped by a sorted index, this index cannot provide sorted rows, which forces writing to a sorted tempfile.

Two additional sources of information about pushed join performance are available:

1. The status variables `Ndb_pushed_queries_defined`, `Ndb_pushed_queries_dropped`, `Ndb_pushed_queries_executed`, and `Ndb_pushed_reads`.
 2. The counters in the `ndbinfo.counters` table that belong to the `DBSPJ` kernel block.
- `ndb_log_apply_status`

Command-Line Format	<code>--ndb-log-apply-status[={OFF ON}]</code>
System Variable	<code>ndb_log_apply_status</code>
Scope	Global
Dynamic	No

Type	Boolean
Default Value	OFF

A read-only variable which shows whether the server was started with the `--ndb-log-apply-status` option.

- [ndb_log_bin](#)

Command-Line Format	<code>--ndb-log-bin[={OFF ON}]</code>
System Variable	ndb_log_bin
Scope	Global, Session
Dynamic	No
Type	Boolean
Default Value	ON

Causes updates to [NDB](#) tables to be written to the binary log. Setting this variable has no effect if binary logging is not already enabled for the server using [log_bin](#). [ndb_log_bin](#) defaults to 1 (ON); normally, there is never any need to change this value in a production environment.

- [ndb_log_binlog_index](#)

Command-Line Format	<code>--ndb-log-binlog-index[={OFF ON}]</code>
System Variable	ndb_log_binlog_index
Scope	Global
Dynamic	Yes
Type	Boolean
Default Value	ON

Causes a mapping of epochs to positions in the binary log to be inserted into the [ndb_binlog_index](#) table. Setting this variable has no effect if binary logging is not already enabled for the server using [log_bin](#). (In addition, [ndb_log_bin](#) must not be disabled.) [ndb_log_binlog_index](#) defaults to 1 (ON); normally, there is never any need to change this value in a production environment.

- [ndb_log_empty_epochs](#)

Command-Line Format	<code>--ndb-log-empty-epochs[={OFF ON}]</code>
System Variable	ndb_log_empty_epochs
Scope	Global
Dynamic	Yes
Type	Boolean
Default Value	OFF

When this variable is set to 0, epoch transactions with no changes are not written to the binary log, although a row is still written even for an empty epoch in [ndb_binlog_index](#).

- [ndb_log_empty_update](#)

Command-Line Format	<code>--ndb-log-empty-update[={OFF ON}]</code>
System Variable	ndb_log_empty_update
Scope	Global

Dynamic	Yes
Type	Boolean
Default Value	OFF

When this variable is set to `ON (1)`, update transactions with no changes are written to the binary log, even when `log_slave_updates` is enabled.

- `ndb_log_exclusive_reads`

Command-Line Format	<code>--ndb-log-exclusive-reads[={OFF ON}]</code>
System Variable	<code>ndb_log_exclusive_reads</code>
Scope	Global, Session
Dynamic	Yes
Type	Boolean
Default Value	0

This variable determines whether primary key reads are logged with exclusive locks, which allows for NDB Cluster Replication conflict detection and resolution based on read conflicts. To enable these locks, set the value of `ndb_log_exclusive_reads` to 1. 0, which disables such locking, is the default.

For more information, see [Read conflict detection and resolution](#).

- `ndb_log_orig`

Command-Line Format	<code>--ndb-log-orig[={OFF ON}]</code>
System Variable	<code>ndb_log_orig</code>
Scope	Global
Dynamic	No
Type	Boolean
Default Value	OFF

Shows whether the originating server ID and epoch are logged in the `ndb_binlog_index` table. Set using the `--ndb-log-orig` server option.

- `ndb_log_transaction_id`

System Variable	<code>ndb_log_transaction_id</code>
Scope	Global
Dynamic	No
Type	Boolean
Default Value	OFF

This read-only, Boolean system variable shows whether a replica `mysqld` writes NDB transaction IDs in the binary log (required to use “active-active” NDB Cluster Replication with `NDB $EPOCH_TRANS()` conflict detection). To change the setting, use the `--ndb-log-transaction-id` option.

`ndb_log_transaction_id` is not supported in mainline MySQL Server 5.7.

For more information, see [Section 7.11, “NDB Cluster Replication Conflict Resolution”](#).

- `ndb_optimized_node_selection`

Command-Line Format	<code>--ndb-optimized-node-selection=#</code>
System Variable	<code>ndb_optimized_node_selection</code>
Scope	Global
Dynamic	No
Type	Integer
Default Value	3
Minimum Value	0
Maximum Value	3

There are two forms of optimized node selection, described here:

1. The SQL node uses *proximity* to determine the transaction coordinator; that is, the “closest” data node to the SQL node is chosen as the transaction coordinator. For this purpose, a data node having a shared memory connection with the SQL node is considered to be “closest” to the SQL node; the next closest (in order of decreasing proximity) are: TCP connection to `localhost`, followed by TCP connection from a host other than `localhost`.
2. The SQL thread uses *distribution awareness* to select the data node. That is, the data node housing the cluster partition accessed by the first statement of a given transaction is used as the transaction coordinator for the entire transaction. (This is effective only if the first statement of the transaction accesses no more than one cluster partition.)

This option takes one of the integer values 0, 1, 2, or 3. 3 is the default. These values affect node selection as follows:

- 0: Node selection is not optimized. Each data node is employed as the transaction coordinator 8 times before the SQL thread proceeds to the next data node.
- 1: Proximity to the SQL node is used to determine the transaction coordinator.
- 2: Distribution awareness is used to select the transaction coordinator. However, if the first statement of the transaction accesses more than one cluster partition, the SQL node reverts to the round-robin behavior seen when this option is set to 0.
- 3: If distribution awareness can be employed to determine the transaction coordinator, then it is used; otherwise proximity is used to select the transaction coordinator. (This is the default behavior.)

Proximity is determined as follows:

1. Start with the value set for the `Group` parameter (default 55).
2. For an API node sharing the same host with other API nodes, decrement the value by 1. Assuming the default value for `Group`, the effective value for data nodes on same host as the API node is 54, and for remote data nodes 55.
3. (*NDB 7.5.2 and later:*) Setting `ndb_data_node_neighbour` further decreases the effective `Group` value by 50, causing this node to be regarded as the nearest node. This is needed only when all data nodes are on hosts other than that hosts the API node and it is desirable to dedicate one of them to the API node. In normal cases, the default adjustment described previously is sufficient.

Frequent changes in `ndb_data_node_neighbour` are not advisable, since this changes the state of the cluster connection and thus may disrupt the selection algorithm for new transactions from each thread until it stabilizes.

- `ndb_read_backup`

Command-Line Format	<code>--ndb-read-backup[={OFF ON}]</code>
Introduced	5.7.12-ndb-7.5.2
System Variable	<code>ndb_read_backup</code>
Scope	Global
Dynamic	Yes
Type	Boolean
Default Value	<code>OFF</code>

Enable read from any fragment replica for any NDB table subsequently created; doing so greatly improves the table read performance at a relatively small cost to writes.

To enable or disable read from any fragment replica for an individual table, you can set the NDB_TABLE option `READ_BACKUP` for the table accordingly, in a `CREATE TABLE` or `ALTER TABLE` statement; see [Setting NDB_TABLE Options](#), for more information.

Added in NDB 7.5.2.

- `ndb_recv_thread_activation_threshold`

Command-Line Format	<code>--ndb-recv-thread-activation-threshold=#</code>
System Variable	<code>ndb_recv_thread_activation_threshold</code>
Scope	Global
Dynamic	Yes
Type	Integer
Default Value	8
Minimum Value	0 (<code>MIN_ACTIVATION_THRESHOLD</code>)
Maximum Value	16 (<code>MAX_ACTIVATION_THRESHOLD</code>)

When this number of concurrently active threads is reached, the receive thread takes over polling of the cluster connection.

This variable is global in scope. It can also be set at startup.

- `ndb_recv_thread_cpu_mask`

Command-Line Format	<code>--ndb-recv-thread-cpu-mask=mask</code>
System Variable	<code>ndb_recv_thread_cpu_mask</code>
Scope	Global
Dynamic	Yes
Type	Bitmap
Default Value	[empty]

CPU mask for locking receiver threads to specific CPUs. This is specified as a hexadecimal bitmask. For example, `0x33` means that one CPU is used per receiver thread. An empty string is the default; setting `ndb_recv_thread_cpu_mask` to this value removes any receiver thread locks previously set.

This variable is global in scope. It can also be set at startup.

- [ndb_report_thresh_binlog_epoch_slip](#)

Command-Line Format	<code>--ndb-report-thresh-binlog-epoch-slip=#</code>
System Variable	ndb_report_thresh_binlog_epoch_slip
Scope	Global
Dynamic	Yes
Type	Integer
Default Value (≥ 5.7.16-ndb-7.5.4)	10
Default Value (≤ 5.7.13-ndb-7.5.3)	3
Minimum Value	0
Maximum Value	256

In NDB 7.5.4 and later, this represents the threshold for the number of epochs completely buffered in the event buffer, but not yet consumed by the binlog injector thread. When this degree of slippage (lag) is exceeded, an event buffer status message is reported, with `BUFFERED_EPOCHS_OVER_THRESHOLD` supplied as the reason (see [Section 6.2.3, “Event Buffer Reporting in the Cluster Log”](#)). Slip is increased when an epoch is received from data nodes and buffered completely in the event buffer; it is decreased when an epoch is consumed by the binlog injector thread, it is reduced. Empty epochs are buffered and queued, and so included in this calculation only when this is enabled using the `Ndb::setEventBufferQueueEmptyEpoch()` method from the NDB API.

Prior to NDB 7.5.4, the value of this variable served as a threshold for the number of epochs to be behind before reporting binary log status. In these previous releases, a value of 3—the default—means that if the difference between which epoch has been received from the storage nodes and which epoch has been applied to the binary log is 3 or more, a status message is then sent to the cluster log.

- [ndb_report_thresh_binlog_mem_usage](#)

Command-Line Format	<code>--ndb-report-thresh-binlog-mem-usage=#</code>
System Variable	ndb_report_thresh_binlog_mem_usage
Scope	Global
Dynamic	Yes
Type	Integer
Default Value	10
Minimum Value	0
Maximum Value	10

This is a threshold on the percentage of free memory remaining before reporting binary log status. For example, a value of 10 (the default) means that if the amount of available memory for receiving binary log data from the data nodes falls below 10%, a status message is sent to the cluster log.

- [ndb_row_checksum](#)

Introduced	5.7.23-ndb-7.6.8
System Variable	ndb_row_checksum
Scope	Global, Session
Dynamic	Yes

Type	Integer
Default Value	1
Minimum Value	0
Maximum Value	1

Traditionally, NDB has created tables with row checksums, which checks for hardware issues at the expense of performance. Setting `ndb_row_checksum` to 0 means that row checksums are *not* used for new or altered tables, which has a significant impact on performance for all types of queries. This variable is set to 1 by default, to provide backward-compatible behavior.

- `ndb_show_foreign_key_mock_tables`

Command-Line Format	<code>--ndb-show-foreign-key-mock-tables[={OFF ON}]</code>
System Variable	<code>ndb_show_foreign_key_mock_tables</code>
Scope	Global
Dynamic	Yes
Type	Boolean
Default Value	OFF

Show the mock tables used by NDB to support `foreign_key_checks=0`. When this is enabled, extra warnings are shown when creating and dropping the tables. The real (internal) name of the table can be seen in the output of `SHOW CREATE TABLE`.

- `ndb_slave_conflict_role`

Command-Line Format	<code>--ndb-slave-conflict-role=value</code>
System Variable	<code>ndb_slave_conflict_role</code>
Scope	Global
Dynamic	Yes
Type	Enumeration
Default Value	NONE
Valid Values	NONE PRIMARY SECONDARY PASS

Determine the role of this SQL node (and NDB Cluster) in a circular (“active-active”) replication setup. `ndb_slave_conflict_role` can take any one of the values `PRIMARY`, `SECONDARY`, `PASS`, or `NULL` (the default). The replica SQL thread must be stopped before you can change `ndb_slave_conflict_role`. In addition, it is not possible to change directly between `PASS` and either of `PRIMARY` or `SECONDARY` directly; in such cases, you must ensure that the SQL thread is stopped, then execute `SET @@GLOBAL.ndb_slave_conflict_role = 'NONE'` first.

For more information, see [Section 7.11, “NDB Cluster Replication Conflict Resolution”](#).

- `ndb_table_no_logging`

System Variable	<code>ndb_table_no_logging</code>
Scope	Session

Dynamic	Yes
Type	Boolean
Default Value	OFF

When this variable is set to `ON` or `1`, it causes `NDB` tables not to be checkpointed to disk. More specifically, this setting applies to tables which are created or altered using `ENGINE NDB` when `ndb_table_no_logging` is enabled, and continues to apply for the lifetime of the table, even if `ndb_table_no_logging` is later changed. Suppose that `A`, `B`, `C`, and `D` are tables that we create (and perhaps also alter), and that we also change the setting for `ndb_table_no_logging` as shown here:

```
SET @@ndb_table_no_logging = 1;

CREATE TABLE A ... ENGINE NDB;

CREATE TABLE B ... ENGINE MYISAM;
CREATE TABLE C ... ENGINE MYISAM;

ALTER TABLE B ENGINE NDB;

SET @@ndb_table_no_logging = 0;

CREATE TABLE D ... ENGINE NDB;
ALTER TABLE C ENGINE NDB;

SET @@ndb_table_no_logging = 1;
```

After the previous sequence of events, tables `A` and `B` are not checkpointed; `A` was created with `ENGINE NDB` and `B` was altered to use `NDB`, both while `ndb_table_no_logging` was enabled. However, tables `C` and `D` are logged; `C` was altered to use `NDB` and `D` was created using `ENGINE NDB`, both while `ndb_table_no_logging` was disabled. Setting `ndb_table_no_logging` back to `1` or `ON` does *not* cause table `C` or `D` to be checkpointed.

Note

`ndb_table_no_logging` has no effect on the creation of `NDB` table schema files; to suppress these, use `ndb_table_temporary` instead.

- [ndb_table_temporary](#)

System Variable	<code>ndb_table_temporary</code>
Scope	Session
Dynamic	Yes
Type	Boolean
Default Value	OFF

When set to `ON` or `1`, this variable causes `NDB` tables not to be written to disk: This means that no table schema files are created, and that the tables are not logged.

Note

Setting this variable currently has no effect. This is a known issue; see Bug #34036.

- [ndb_use_copying_alter_table](#)

System Variable	<code>ndb_use_copying_alter_table</code>
Scope	Global, Session

Dynamic	No
---------	----

Forces **NDB** to use copying of tables in the event of problems with online **ALTER TABLE** operations. The default value is **OFF**.

- [ndb_use_exact_count](#)

System Variable	ndb_use_exact_count
Scope	Global, Session
Dynamic	Yes
Type	Boolean
Default Value	OFF

Forces **NDB** to use a count of records during **SELECT COUNT(*)** query planning to speed up this type of query. The default value is **OFF**, which allows for faster queries overall.

- [ndb_use_transactions](#)

Command-Line Format	<code>--ndb-use-transactions[={OFF ON}]</code>
System Variable	ndb_use_transactions
Scope	Global, Session
Dynamic	Yes
Type	Boolean
Default Value	ON

You can disable **NDB** transaction support by setting this variable's values to **OFF** (not recommended). The default is **ON**.

- [ndb_version](#)

System Variable	ndb_version
Scope	Global
Dynamic	No
Type	String
Default Value	

NDB engine version, as a composite integer.

- [ndb_version_string](#)

System Variable	ndb_version_string
Scope	Global
Dynamic	No
Type	String
Default Value	

NDB engine version in `ndb-x.y.z` format.

- [server_id_bits](#)

Command-Line Format	<code>--server-id-bits=#</code>
System Variable	server_id_bits

Scope	Global
Dynamic	No
Type	Integer
Default Value	32
Minimum Value	7
Maximum Value	32

This variable indicates the number of least significant bits within the 32-bit `server_id` which actually identify the server. Indicating that the server is actually identified by fewer than 32 bits makes it possible for some of the remaining bits to be used for other purposes, such as storing user data generated by applications using the NDB API's Event API within the `AnyValue` of an `OperationOptions` structure (NDB Cluster uses the `AnyValue` to store the server ID).

When extracting the effective server ID from `server_id` for purposes such as detection of replication loops, the server ignores the remaining bits. The `server_id_bits` variable is used to mask out any irrelevant bits of `server_id` in the I/O and SQL threads when deciding whether an event should be ignored based on the server ID.

This data can be read from the binary log by `mysqlbinlog`, provided that it is run with its own `server_id_bits` variable set to 32 (the default).

If the value of `server_id` greater than or equal to 2 to the power of `server_id_bits`; otherwise, `mysqld` refuses to start.

This system variable is supported only by NDB Cluster. It is not supported in the standard MySQL 5.7 Server.

- `slave_allow_batching`

Command-Line Format	<code>--slave-allow-batching[={OFF ON}]</code>
System Variable	<code>slave_allow_batching</code>
Scope	Global
Dynamic	Yes
Type	Boolean
Default Value	OFF

Whether or not batched updates are enabled on NDB Cluster replicas.

Setting this variable has an effect only when using replication with the NDB storage engine; in MySQL Server 5.7, it is present but does nothing. For more information, see [Section 7.6, "Starting NDB Cluster Replication \(Single Replication Channel\)"](#).

- `transaction_allow_batching`

System Variable	<code>transaction_allow_batching</code>
Scope	Session
Dynamic	Yes
Type	Boolean

Default Value	OFF
---------------	-----

When set to `1` or `ON`, this variable enables batching of statements within the same transaction. To use this variable, `autocommit` must first be disabled by setting it to `0` or `OFF`; otherwise, setting `transaction_allow_batching` has no effect.

It is safe to use this variable with transactions that performs writes only, as having it enabled can lead to reads from the “before” image. You should ensure that any pending transactions are committed (using an explicit `COMMIT` if desired) before issuing a `SELECT`.

Important

`transaction_allow_batching` should not be used whenever there is the possibility that the effects of a given statement depend on the outcome of a previous statement within the same transaction.

This variable is currently supported for NDB Cluster only.

The system variables in the following list all relate to the `ndbinfo` information database.

- `ndbinfo_database`

System Variable	<code>ndbinfo_database</code>
Scope	Global
Dynamic	No
Type	String
Default Value	<code>ndbinfo</code>

Shows the name used for the `NDB` information database; the default is `ndbinfo`. This is a read-only variable whose value is determined at compile time.

- `ndbinfo_max_bytes`

Command-Line Format	<code>--ndbinfo-max-bytes=#</code>
System Variable	<code>ndbinfo_max_bytes</code>
Scope	Global, Session
Dynamic	Yes
Type	Integer
Default Value	<code>0</code>

Used in testing and debugging only.

- `ndbinfo_max_rows`

Command-Line Format	<code>--ndbinfo-max-rows=#</code>
System Variable	<code>ndbinfo_max_rows</code>
Scope	Global, Session
Dynamic	Yes
Type	Integer
Default Value	<code>10</code>

Used in testing and debugging only.

- `ndbinfo_offline`

System Variable	<code>ndbinfo_offline</code>
Scope	Global
Dynamic	Yes
Type	Boolean
Default Value	OFF

Place the `ndbinfo` database into offline mode, in which tables and views can be opened even when they do not actually exist, or when they exist but have different definitions in `NDB`. No rows are returned from such tables (or views).

- `ndbinfo_show_hidden`

Command-Line Format	<code>--ndbinfo-show-hidden[={OFF ON}]</code>
System Variable	<code>ndbinfo_show_hidden</code>
Scope	Global, Session
Dynamic	Yes
Type	Boolean
Default Value	OFF
Valid Values	ON OFF

Whether or not the `ndbinfo` database's underlying internal tables are shown in the `mysql` client. The default is `OFF`.

Note

When `ndbinfo_show_hidden` is enabled, the internal tables are shown in the `ndbinfo` database only; they are not visible in `TABLES` or other `INFORMATION_SCHEMA` tables, regardless of the variable's setting.

- `ndbinfo_table_prefix`

System Variable	<code>ndbinfo_table_prefix</code>
Scope	Global
Dynamic	No
Type	String
Default Value	<code>ndb\$</code>

The prefix used in naming the `ndbinfo` database's base tables (normally hidden, unless exposed by setting `ndbinfo_show_hidden`). This is a read-only variable whose default value is `ndb$`; the prefix itself is determined at compile time.

- `ndbinfo_version`

System Variable	<code>ndbinfo_version</code>
Scope	Global
Dynamic	No
Type	String

Default Value	
---------------	--

Shows the version of the `ndbinfo` engine in use; read-only.

4.3.9.3 NDB Cluster Status Variables

This section provides detailed information about MySQL server status variables that relate to NDB Cluster and the `NDB` storage engine. For status variables not specific to NDB Cluster, and for general information on using status variables, see [Server Status Variables](#).

- `Handler_discover`

The MySQL server can ask the `NDBCLUSTER` storage engine if it knows about a table with a given name. This is called discovery. `Handler_discover` indicates the number of times that tables have been discovered using this mechanism.

- `Ndb_api_adaptive_send_deferred_count`

Number of adaptive send calls that were not actually sent.

For more information, see [Section 6.13, “NDB API Statistics Counters and Variables”](#).

- `Ndb_api_adaptive_send_deferred_count_session`

Number of adaptive send calls that were not actually sent.

For more information, see [Section 6.13, “NDB API Statistics Counters and Variables”](#).

- `Ndb_api_adaptive_send_deferred_count_slave`

Number of adaptive send calls that were not actually sent by this replica.

For more information, see [Section 6.13, “NDB API Statistics Counters and Variables”](#).

- `Ndb_api_adaptive_send_forced_count`

Number of adaptive send calls using forced-send sent by this MySQL Server (SQL node).

For more information, see [Section 6.13, “NDB API Statistics Counters and Variables”](#).

- `Ndb_api_adaptive_send_forced_count_session`

Number of adaptive send calls using forced-send sent in this client session.

For more information, see [Section 6.13, “NDB API Statistics Counters and Variables”](#).

- `Ndb_api_adaptive_send_forced_count_slave`

Number of adaptive send calls using forced-send sent by this replica.

For more information, see [Section 6.13, “NDB API Statistics Counters and Variables”](#).

- `Ndb_api_adaptive_send_unforced_count`

Number of adaptive send calls without forced-send sent by this MySQL server (SQL node).

For more information, see [Section 6.13, “NDB API Statistics Counters and Variables”](#).

- `Ndb_api_adaptive_send_unforced_count_session`

Number of adaptive send calls without forced-send sent in this client session.

For more information, see [Section 6.13, “NDB API Statistics Counters and Variables”](#).

- `Ndb_api_adaptive_send_unforced_count_slave`
Number of adaptive send calls without forced-send sent by this replica.
For more information, see [Section 6.13, “NDB API Statistics Counters and Variables”](#).
- `Ndb_api_bytes_sent_count_session`
Amount of data (in bytes) sent to the data nodes in this client session.
Although this variable can be read using either `SHOW GLOBAL STATUS` or `SHOW SESSION STATUS`, it relates to the current session only, and is not affected by any other clients of this `mysqld`.
For more information, see [Section 6.13, “NDB API Statistics Counters and Variables”](#).
- `Ndb_api_bytes_sent_count_slave`
Amount of data (in bytes) sent to the data nodes by this replica.
Although this variable can be read using either `SHOW GLOBAL STATUS` or `SHOW SESSION STATUS`, it is effectively global in scope. If this MySQL server does not act as a replica, or does not use NDB tables, this value is always 0.
For more information, see [Section 6.13, “NDB API Statistics Counters and Variables”](#).
- `Ndb_api_bytes_sent_count`
Amount of data (in bytes) sent to the data nodes by this MySQL Server (SQL node).
Although this variable can be read using either `SHOW GLOBAL STATUS` or `SHOW SESSION STATUS`, it is effectively global in scope.
For more information, see [Section 6.13, “NDB API Statistics Counters and Variables”](#).
- `Ndb_api_bytes_received_count_session`
Amount of data (in bytes) received from the data nodes in this client session.
Although this variable can be read using either `SHOW GLOBAL STATUS` or `SHOW SESSION STATUS`, it relates to the current session only, and is not affected by any other clients of this `mysqld`.
For more information, see [Section 6.13, “NDB API Statistics Counters and Variables”](#).
- `Ndb_api_bytes_received_count_slave`
Amount of data (in bytes) received from the data nodes by this replica.
Although this variable can be read using either `SHOW GLOBAL STATUS` or `SHOW SESSION STATUS`, it is effectively global in scope. If this MySQL server does not act as a replica, or does not use NDB tables, this value is always 0.
For more information, see [Section 6.13, “NDB API Statistics Counters and Variables”](#).
- `Ndb_api_bytes_received_count`
Amount of data (in bytes) received from the data nodes by this MySQL Server (SQL node).
Although this variable can be read using either `SHOW GLOBAL STATUS` or `SHOW SESSION STATUS`, it is effectively global in scope.
For more information, see [Section 6.13, “NDB API Statistics Counters and Variables”](#).
- `Ndb_api_event_data_count_injector`

The number of row change events received by the NDB binlog injector thread.

Although this variable can be read using either `SHOW GLOBAL STATUS` or `SHOW SESSION STATUS`, it is effectively global in scope.

For more information, see [Section 6.13, “NDB API Statistics Counters and Variables”](#).

- `Ndb_api_event_data_count`

The number of row change events received by this MySQL Server (SQL node).

Although this variable can be read using either `SHOW GLOBAL STATUS` or `SHOW SESSION STATUS`, it is effectively global in scope.

For more information, see [Section 6.13, “NDB API Statistics Counters and Variables”](#).

- `Ndb_api_event_nondata_count_injector`

The number of events received, other than row change events, by the NDB binary log injector thread.

Although this variable can be read using either `SHOW GLOBAL STATUS` or `SHOW SESSION STATUS`, it is effectively global in scope.

For more information, see [Section 6.13, “NDB API Statistics Counters and Variables”](#).

- `Ndb_api_event_nondata_count`

The number of events received, other than row change events, by this MySQL Server (SQL node).

Although this variable can be read using either `SHOW GLOBAL STATUS` or `SHOW SESSION STATUS`, it is effectively global in scope.

For more information, see [Section 6.13, “NDB API Statistics Counters and Variables”](#).

- `Ndb_api_event_bytes_count_injector`

The number of bytes of events received by the NDB binlog injector thread.

Although this variable can be read using either `SHOW GLOBAL STATUS` or `SHOW SESSION STATUS`, it is effectively global in scope.

For more information, see [Section 6.13, “NDB API Statistics Counters and Variables”](#).

- `Ndb_api_event_bytes_count`

The number of bytes of events received by this MySQL Server (SQL node).

Although this variable can be read using either `SHOW GLOBAL STATUS` or `SHOW SESSION STATUS`, it is effectively global in scope.

For more information, see [Section 6.13, “NDB API Statistics Counters and Variables”](#).

- `Ndb_api_pk_op_count_session`

The number of operations in this client session based on or using primary keys. This includes operations on blob tables, implicit unlock operations, and auto-increment operations, as well as user-visible primary key operations.

Although this variable can be read using either `SHOW GLOBAL STATUS` or `SHOW SESSION STATUS`, it relates to the current session only, and is not affected by any other clients of this `mysqld`.

For more information, see [Section 6.13, “NDB API Statistics Counters and Variables”](#).

- `Ndb_api_pk_op_count_slave`

The number of operations by this replica based on or using primary keys. This includes operations on blob tables, implicit unlock operations, and auto-increment operations, as well as user-visible primary key operations.

Although this variable can be read using either `SHOW GLOBAL STATUS` or `SHOW SESSION STATUS`, it is effectively global in scope. If this MySQL server does not act as a replica, or does not use NDB tables, this value is always 0.

For more information, see [Section 6.13, “NDB API Statistics Counters and Variables”](#).

- `Ndb_api_pk_op_count`

The number of operations by this MySQL Server (SQL node) based on or using primary keys. This includes operations on blob tables, implicit unlock operations, and auto-increment operations, as well as user-visible primary key operations.

Although this variable can be read using either `SHOW GLOBAL STATUS` or `SHOW SESSION STATUS`, it is effectively global in scope.

For more information, see [Section 6.13, “NDB API Statistics Counters and Variables”](#).

- `Ndb_api_pruned_scan_count_session`

The number of scans in this client session that have been pruned to a single partition.

Although this variable can be read using either `SHOW GLOBAL STATUS` or `SHOW SESSION STATUS`, it relates to the current session only, and is not affected by any other clients of this `mysqld`.

For more information, see [Section 6.13, “NDB API Statistics Counters and Variables”](#).

- `Ndb_api_pruned_scan_count_slave`

The number of scans by this replica that have been pruned to a single partition.

Although this variable can be read using either `SHOW GLOBAL STATUS` or `SHOW SESSION STATUS`, it is effectively global in scope. If this MySQL server does not act as a replica, or does not use NDB tables, this value is always 0.

For more information, see [Section 6.13, “NDB API Statistics Counters and Variables”](#).

- `Ndb_api_pruned_scan_count`

The number of scans by this MySQL Server (SQL node) that have been pruned to a single partition.

Although this variable can be read using either `SHOW GLOBAL STATUS` or `SHOW SESSION STATUS`, it is effectively global in scope.

For more information, see [Section 6.13, “NDB API Statistics Counters and Variables”](#).

- `Ndb_api_range_scan_count_session`

The number of range scans that have been started in this client session.

Although this variable can be read using either `SHOW GLOBAL STATUS` or `SHOW SESSION STATUS`, it relates to the current session only, and is not affected by any other clients of this `mysqld`.

For more information, see [Section 6.13, “NDB API Statistics Counters and Variables”](#).

- `Ndb_api_range_scan_count_slave`

The number of range scans that have been started by this replica.

Although this variable can be read using either `SHOW GLOBAL STATUS` or `SHOW SESSION STATUS`, it is effectively global in scope. If this MySQL server does not act as a replica, or does not use NDB tables, this value is always 0.

For more information, see [Section 6.13, “NDB API Statistics Counters and Variables”](#).

- `Ndb_api_range_scan_count`

The number of range scans that have been started by this MySQL Server (SQL node).

Although this variable can be read using either `SHOW GLOBAL STATUS` or `SHOW SESSION STATUS`, it is effectively global in scope.

For more information, see [Section 6.13, “NDB API Statistics Counters and Variables”](#).

- `Ndb_api_read_row_count_session`

The total number of rows that have been read in this client session. This includes all rows read by any primary key, unique key, or scan operation made in this client session.

Although this variable can be read using either `SHOW GLOBAL STATUS` or `SHOW SESSION STATUS`, it relates to the current session only, and is not affected by any other clients of this `mysqld`.

For more information, see [Section 6.13, “NDB API Statistics Counters and Variables”](#).

- `Ndb_api_read_row_count_slave`

The total number of rows that have been read by this replica. This includes all rows read by any primary key, unique key, or scan operation made by this replica.

Although this variable can be read using either `SHOW GLOBAL STATUS` or `SHOW SESSION STATUS`, it is effectively global in scope. If this MySQL server does not act as a replica, or does not use NDB tables, this value is always 0.

For more information, see [Section 6.13, “NDB API Statistics Counters and Variables”](#).

- `Ndb_api_read_row_count`

The total number of rows that have been read by this MySQL Server (SQL node). This includes all rows read by any primary key, unique key, or scan operation made by this MySQL Server (SQL node).

You should be aware that this value may not be completely accurate with regard to rows read by `SELECT COUNT(*)` queries, due to the fact that, in this case, the MySQL server actually reads pseudo-rows in the form `[table fragment ID]:[number of rows in fragment]` and sums the rows per fragment for all fragments in the table to derive an estimated count for all rows. `Ndb_api_read_row_count` uses this estimate and not the actual number of rows in the table.

Although this variable can be read using either `SHOW GLOBAL STATUS` or `SHOW SESSION STATUS`, it is effectively global in scope.

For more information, see [Section 6.13, “NDB API Statistics Counters and Variables”](#).

- `Ndb_api_scan_batch_count_session`

The number of batches of rows received in this client session. 1 batch is defined as 1 set of scan results from a single fragment.

Although this variable can be read using either `SHOW GLOBAL STATUS` or `SHOW SESSION STATUS`, it relates to the current session only, and is not affected by any other clients of this `mysqld`.

For more information, see [Section 6.13, “NDB API Statistics Counters and Variables”](#).

- `Ndb_api_scan_batch_count_slave`

The number of batches of rows received by this replica. 1 batch is defined as 1 set of scan results from a single fragment.

Although this variable can be read using either `SHOW GLOBAL STATUS` or `SHOW SESSION STATUS`, it is effectively global in scope. If this MySQL server does not act as a replica, or does not use NDB tables, this value is always 0.

For more information, see [Section 6.13, “NDB API Statistics Counters and Variables”](#).

- `Ndb_api_scan_batch_count`

The number of batches of rows received by this MySQL Server (SQL node). 1 batch is defined as 1 set of scan results from a single fragment.

Although this variable can be read using either `SHOW GLOBAL STATUS` or `SHOW SESSION STATUS`, it is effectively global in scope.

For more information, see [Section 6.13, “NDB API Statistics Counters and Variables”](#).

- `Ndb_api_table_scan_count_session`

The number of table scans that have been started in this client session, including scans of internal tables,.

Although this variable can be read using either `SHOW GLOBAL STATUS` or `SHOW SESSION STATUS`, it relates to the current session only, and is not affected by any other clients of this `mysqld`.

For more information, see [Section 6.13, “NDB API Statistics Counters and Variables”](#).

- `Ndb_api_table_scan_count_slave`

The number of table scans that have been started by this replica, including scans of internal tables,.

Although this variable can be read using either `SHOW GLOBAL STATUS` or `SHOW SESSION STATUS`, it is effectively global in scope. If this MySQL server does not act as a replica, or does not use NDB tables, this value is always 0.

For more information, see [Section 6.13, “NDB API Statistics Counters and Variables”](#).

- `Ndb_api_table_scan_count`

The number of table scans that have been started by this MySQL Server (SQL node), including scans of internal tables,.

Although this variable can be read using either `SHOW GLOBAL STATUS` or `SHOW SESSION STATUS`, it is effectively global in scope.

For more information, see [Section 6.13, “NDB API Statistics Counters and Variables”](#).

- `Ndb_api_trans_abort_count_session`

The number of transactions aborted in this client session.

Although this variable can be read using either `SHOW GLOBAL STATUS` or `SHOW SESSION STATUS`, it relates to the current session only, and is not affected by any other clients of this `mysqld`.

For more information, see [Section 6.13, “NDB API Statistics Counters and Variables”](#).

- `Ndb_api_trans_abort_count_slave`

The number of transactions aborted by this replica.

Although this variable can be read using either `SHOW GLOBAL STATUS` or `SHOW SESSION STATUS`, it is effectively global in scope. If this MySQL server does not act as a replica, or does not use NDB tables, this value is always 0.

For more information, see [Section 6.13, “NDB API Statistics Counters and Variables”](#).

- `Ndb_api_trans_abort_count`

The number of transactions aborted by this MySQL Server (SQL node).

Although this variable can be read using either `SHOW GLOBAL STATUS` or `SHOW SESSION STATUS`, it is effectively global in scope.

For more information, see [Section 6.13, “NDB API Statistics Counters and Variables”](#).

- `Ndb_api_trans_close_count_session`

The number of transactions closed in this client session. This value may be greater than the sum of `Ndb_api_trans_commit_count_session` and `Ndb_api_trans_abort_count_session`, since some transactions may have been rolled back.

Although this variable can be read using either `SHOW GLOBAL STATUS` or `SHOW SESSION STATUS`, it relates to the current session only, and is not affected by any other clients of this `mysqld`.

For more information, see [Section 6.13, “NDB API Statistics Counters and Variables”](#).

- `Ndb_api_trans_close_count_slave`

The number of transactions closed by this replica. This value may be greater than the sum of `Ndb_api_trans_commit_count_slave` and `Ndb_api_trans_abort_count_slave`, since some transactions may have been rolled back.

Although this variable can be read using either `SHOW GLOBAL STATUS` or `SHOW SESSION STATUS`, it is effectively global in scope. If this MySQL server does not act as a replica, or does not use NDB tables, this value is always 0.

For more information, see [Section 6.13, “NDB API Statistics Counters and Variables”](#).

- `Ndb_api_trans_close_count`

The number of transactions closed by this MySQL Server (SQL node). This value may be greater than the sum of `Ndb_api_trans_commit_count` and `Ndb_api_trans_abort_count`, since some transactions may have been rolled back.

Although this variable can be read using either `SHOW GLOBAL STATUS` or `SHOW SESSION STATUS`, it is effectively global in scope.

For more information, see [Section 6.13, “NDB API Statistics Counters and Variables”](#).

- `Ndb_api_trans_commit_count_session`

The number of transactions committed in this client session.

Although this variable can be read using either `SHOW GLOBAL STATUS` or `SHOW SESSION STATUS`, it relates to the current session only, and is not affected by any other clients of this `mysqld`.

For more information, see [Section 6.13, “NDB API Statistics Counters and Variables”](#).

- `Ndb_api_trans_commit_count_slave`

The number of transactions committed by this replica.

Although this variable can be read using either `SHOW GLOBAL STATUS` or `SHOW SESSION STATUS`, it is effectively global in scope. If this MySQL server does not act as a replica, or does not use NDB tables, this value is always 0.

For more information, see [Section 6.13, “NDB API Statistics Counters and Variables”](#).

- `Ndb_api_trans_commit_count`

The number of transactions committed by this MySQL Server (SQL node).

Although this variable can be read using either `SHOW GLOBAL STATUS` or `SHOW SESSION STATUS`, it is effectively global in scope.

For more information, see [Section 6.13, “NDB API Statistics Counters and Variables”](#).

- `Ndb_api_trans_local_read_row_count_session`

The total number of rows that have been read in this client session. This includes all rows read by any primary key, unique key, or scan operation made in this client session.

Although this variable can be read using either `SHOW GLOBAL STATUS` or `SHOW SESSION STATUS`, it relates to the current session only, and is not affected by any other clients of this `mysqld`.

For more information, see [Section 6.13, “NDB API Statistics Counters and Variables”](#).

- `Ndb_api_trans_local_read_row_count_slave`

The total number of rows that have been read by this replica. This includes all rows read by any primary key, unique key, or scan operation made by this replica.

Although this variable can be read using either `SHOW GLOBAL STATUS` or `SHOW SESSION STATUS`, it is effectively global in scope. If this MySQL server does not act as a replica, or does not use NDB tables, this value is always 0.

For more information, see [Section 6.13, “NDB API Statistics Counters and Variables”](#).

- `Ndb_api_trans_local_read_row_count`

The total number of rows that have been read by this MySQL Server (SQL node). This includes all rows read by any primary key, unique key, or scan operation made by this MySQL Server (SQL node).

Although this variable can be read using either `SHOW GLOBAL STATUS` or `SHOW SESSION STATUS`, it is effectively global in scope.

For more information, see [Section 6.13, “NDB API Statistics Counters and Variables”](#).

- `Ndb_api_trans_start_count_session`

The number of transactions started in this client session.

Although this variable can be read using either `SHOW GLOBAL STATUS` or `SHOW SESSION STATUS`, it relates to the current session only, and is not affected by any other clients of this `mysqld`.

For more information, see [Section 6.13, “NDB API Statistics Counters and Variables”](#).

- `Ndb_api_trans_start_count_slave`

The number of transactions started by this replica.

Although this variable can be read using either `SHOW GLOBAL STATUS` or `SHOW SESSION STATUS`, it is effectively global in scope. If this MySQL server does not act as a replica, or does not use NDB tables, this value is always 0.

For more information, see [Section 6.13, “NDB API Statistics Counters and Variables”](#).

- `Ndb_api_trans_start_count`

The number of transactions started by this MySQL Server (SQL node).

Although this variable can be read using either `SHOW GLOBAL STATUS` or `SHOW SESSION STATUS`, it is effectively global in scope.

For more information, see [Section 6.13, “NDB API Statistics Counters and Variables”](#).

- `Ndb_api_uk_op_count_session`

The number of operations in this client session based on or using unique keys.

Although this variable can be read using either `SHOW GLOBAL STATUS` or `SHOW SESSION STATUS`, it relates to the current session only, and is not affected by any other clients of this `mysqld`.

For more information, see [Section 6.13, “NDB API Statistics Counters and Variables”](#).

- `Ndb_api_uk_op_count_slave`

The number of operations by this replica based on or using unique keys.

Although this variable can be read using either `SHOW GLOBAL STATUS` or `SHOW SESSION STATUS`, it is effectively global in scope. If this MySQL server does not act as a replica, or does not use NDB tables, this value is always 0.

For more information, see [Section 6.13, “NDB API Statistics Counters and Variables”](#).

- `Ndb_api_uk_op_count`

The number of operations by this MySQL Server (SQL node) based on or using unique keys.

Although this variable can be read using either `SHOW GLOBAL STATUS` or `SHOW SESSION STATUS`, it is effectively global in scope.

For more information, see [Section 6.13, “NDB API Statistics Counters and Variables”](#).

- `Ndb_api_wait_exec_complete_count_session`

The number of times a thread has been blocked in this client session while waiting for execution of an operation to complete. This includes all `execute()` calls as well as implicit executes for blob and auto-increment operations not visible to clients.

Although this variable can be read using either `SHOW GLOBAL STATUS` or `SHOW SESSION STATUS`, it relates to the current session only, and is not affected by any other clients of this `mysqld`.

For more information, see [Section 6.13, “NDB API Statistics Counters and Variables”](#).

- `Ndb_api_wait_exec_complete_count_slave`

The number of times a thread has been blocked by this replica while waiting for execution of an operation to complete. This includes all `execute()` calls as well as implicit executes for blob and auto-increment operations not visible to clients.

Although this variable can be read using either `SHOW GLOBAL STATUS` or `SHOW SESSION STATUS`, it is effectively global in scope. If this MySQL server does not act as a replica, or does not use NDB tables, this value is always 0.

For more information, see [Section 6.13, “NDB API Statistics Counters and Variables”](#).

- `Ndb_api_wait_exec_complete_count`

The number of times a thread has been blocked by this MySQL Server (SQL node) while waiting for execution of an operation to complete. This includes all `execute()` calls as well as implicit executes for blob and auto-increment operations not visible to clients.

Although this variable can be read using either `SHOW GLOBAL STATUS` or `SHOW SESSION STATUS`, it is effectively global in scope.

For more information, see [Section 6.13, “NDB API Statistics Counters and Variables”](#).

- `Ndb_api_wait_meta_request_count_session`

The number of times a thread has been blocked in this client session waiting for a metadata-based signal, such as is expected for DDL requests, new epochs, and seizure of transaction records.

Although this variable can be read using either `SHOW GLOBAL STATUS` or `SHOW SESSION STATUS`, it relates to the current session only, and is not affected by any other clients of this `mysqld`.

For more information, see [Section 6.13, “NDB API Statistics Counters and Variables”](#).

- `Ndb_api_wait_meta_request_count_slave`

The number of times a thread has been blocked by this replica waiting for a metadata-based signal, such as is expected for DDL requests, new epochs, and seizure of transaction records.

Although this variable can be read using either `SHOW GLOBAL STATUS` or `SHOW SESSION STATUS`, it is effectively global in scope. If this MySQL server does not act as a replica, or does not use NDB tables, this value is always 0.

For more information, see [Section 6.13, “NDB API Statistics Counters and Variables”](#).

- `Ndb_api_wait_meta_request_count`

The number of times a thread has been blocked by this MySQL Server (SQL node) waiting for a metadata-based signal, such as is expected for DDL requests, new epochs, and seizure of transaction records.

Although this variable can be read using either `SHOW GLOBAL STATUS` or `SHOW SESSION STATUS`, it is effectively global in scope.

For more information, see [Section 6.13, “NDB API Statistics Counters and Variables”](#).

- `Ndb_api_wait_nanos_count_session`

Total time (in nanoseconds) spent in this client session waiting for any type of signal from the data nodes.

Although this variable can be read using either `SHOW GLOBAL STATUS` or `SHOW SESSION STATUS`, it relates to the current session only, and is not affected by any other clients of this `mysqld`.

For more information, see [Section 6.13, “NDB API Statistics Counters and Variables”](#).

- `Ndb_api_wait_nanos_count_slave`

Total time (in nanoseconds) spent by this replica waiting for any type of signal from the data nodes.

Although this variable can be read using either `SHOW GLOBAL STATUS` or `SHOW SESSION STATUS`, it is effectively global in scope. If this MySQL server does not act as a replica, or does not use NDB tables, this value is always 0.

For more information, see [Section 6.13, “NDB API Statistics Counters and Variables”](#).

- `Ndb_api_wait_nanos_count`

Total time (in nanoseconds) spent by this MySQL Server (SQL node) waiting for any type of signal from the data nodes.

Although this variable can be read using either `SHOW GLOBAL STATUS` or `SHOW SESSION STATUS`, it is effectively global in scope.

For more information, see [Section 6.13, “NDB API Statistics Counters and Variables”](#).

- `Ndb_api_wait_scan_result_count_session`

The number of times a thread has been blocked in this client session while waiting for a scan-based signal, such as when waiting for more results from a scan, or when waiting for a scan to close.

Although this variable can be read using either `SHOW GLOBAL STATUS` or `SHOW SESSION STATUS`, it relates to the current session only, and is not affected by any other clients of this `mysqld`.

For more information, see [Section 6.13, “NDB API Statistics Counters and Variables”](#).

- `Ndb_api_wait_scan_result_count_slave`

The number of times a thread has been blocked by this replica while waiting for a scan-based signal, such as when waiting for more results from a scan, or when waiting for a scan to close.

Although this variable can be read using either `SHOW GLOBAL STATUS` or `SHOW SESSION STATUS`, it is effectively global in scope. If this MySQL server does not act as a replica, or does not use NDB tables, this value is always 0.

For more information, see [Section 6.13, “NDB API Statistics Counters and Variables”](#).

- `Ndb_api_wait_scan_result_count`

The number of times a thread has been blocked by this MySQL Server (SQL node) while waiting for a scan-based signal, such as when waiting for more results from a scan, or when waiting for a scan to close.

Although this variable can be read using either `SHOW GLOBAL STATUS` or `SHOW SESSION STATUS`, it is effectively global in scope.

For more information, see [Section 6.13, “NDB API Statistics Counters and Variables”](#).

- `Ndb_cluster_node_id`

If the server is acting as an NDB Cluster node, then the value of this variable is its node ID in the cluster.

If the server is not part of an NDB Cluster, then the value of this variable is 0.

- `Ndb_config_from_host`

If the server is part of an NDB Cluster, the value of this variable is the host name or IP address of the Cluster management server from which it gets its configuration data.

If the server is not part of an NDB Cluster, then the value of this variable is an empty string.

- `Ndb_config_from_port`

If the server is part of an NDB Cluster, the value of this variable is the number of the port through which it is connected to the Cluster management server from which it gets its configuration data.

If the server is not part of an NDB Cluster, then the value of this variable is 0.

- `Ndb_conflict_fn_max_del_win`

Shows the number of times that a row was rejected on the current SQL node due to NDB Cluster Replication conflict resolution using `NDB$MAX_DELETE_WIN()`, since the last time that this `mysqld` was started.

For more information, see [Section 7.11, “NDB Cluster Replication Conflict Resolution”](#).

- `Ndb_conflict_fn_max`

Used in NDB Cluster Replication conflict resolution, this variable shows the number of times that a row was not applied on the current SQL node due to “greatest timestamp wins” conflict resolution since the last time that this `mysqld` was started.

For more information, see [Section 7.11, “NDB Cluster Replication Conflict Resolution”](#).

- `Ndb_conflict_fn_old`

Used in NDB Cluster Replication conflict resolution, this variable shows the number of times that a row was not applied as the result of “same timestamp wins” conflict resolution on a given `mysqld` since the last time it was restarted.

For more information, see [Section 7.11, “NDB Cluster Replication Conflict Resolution”](#).

- `Ndb_conflict_fn_epoch`

Used in NDB Cluster Replication conflict resolution, this variable shows the number of rows found to be in conflict using `NDB$EPOCH()` conflict resolution on a given `mysqld` since the last time it was restarted.

For more information, see [Section 7.11, “NDB Cluster Replication Conflict Resolution”](#).

- `Ndb_conflict_fn_epoch2`

Shows the number of rows found to be in conflict in NDB Cluster Replication conflict resolution, when using `NDB$EPOCH2()`, on the source designated as the primary since the last time it was restarted.

For more information, see `NDB$EPOCH2()`.

- `Ndb_conflict_fn_epoch_trans`

Used in NDB Cluster Replication conflict resolution, this variable shows the number of rows found to be in conflict using `NDB$EPOCH_TRANS()` conflict resolution on a given `mysqld` since the last time it was restarted.

For more information, see [Section 7.11, “NDB Cluster Replication Conflict Resolution”](#).

- `Ndb_conflict_fn_epoch2_trans`

Used in NDB Cluster Replication conflict resolution, this variable shows the number of rows found to be in conflict using `NDB$EPOCH_TRANS2()` conflict resolution on a given `mysqld` since the last time it was restarted.

For more information, see `NDB$EPOCH2_TRANS()`.

- `Ndb_conflict_last_conflict_epoch`

The most recent epoch in which a conflict was detected on this replica. You can compare this value with `Ndb_slave_max_replicated_epoch`; if `Ndb_slave_max_replicated_epoch` is greater than `Ndb_conflict_last_conflict_epoch`, no conflicts have yet been detected.

See [Section 7.11, “NDB Cluster Replication Conflict Resolution”](#), for more information.

- `Ndb_conflict_reflected_op_discard_count`

When using NDB Cluster Replication conflict resolution, this is the number of reflected operations that were not applied on the secondary, due to encountering an error during execution.

See [Section 7.11, “NDB Cluster Replication Conflict Resolution”](#), for more information.

- `Ndb_conflict_reflected_op_prepare_count`

When using conflict resolution with NDB Cluster Replication, this status variable contains the number of reflected operations that have been defined (that is, prepared for execution on the secondary).

See [Section 7.11, “NDB Cluster Replication Conflict Resolution”](#).

- `Ndb_conflict_refresh_op_count`

When using conflict resolution with NDB Cluster Replication, this gives the number of refresh operations that have been prepared for execution on the secondary.

See [Section 7.11, “NDB Cluster Replication Conflict Resolution”](#), for more information.

- `Ndb_conflict_last_stable_epoch`

Number of rows found to be in conflict by a transactional conflict function

See [Section 7.11, “NDB Cluster Replication Conflict Resolution”](#), for more information.

- `Ndb_conflict_trans_row_conflict_count`

Used in NDB Cluster Replication conflict resolution, this status variable shows the number of rows found to be directly in-conflict by a transactional conflict function on a given `mysqld` since the last time it was restarted.

Currently, the only transactional conflict detection function supported by NDB Cluster is `NDB$EPOCH_TRANS()`, so this status variable is effectively the same as `Ndb_conflict_fn_epoch_trans`.

For more information, see [Section 7.11, “NDB Cluster Replication Conflict Resolution”](#).

- `Ndb_conflict_trans_row_reject_count`

Used in NDB Cluster Replication conflict resolution, this status variable shows the total number of rows realigned due to being determined as conflicting by a transactional conflict detection function. This includes not only `Ndb_conflict_trans_row_conflict_count`, but any rows in or dependent on conflicting transactions.

For more information, see [Section 7.11, “NDB Cluster Replication Conflict Resolution”](#).

- `Ndb_conflict_trans_reject_count`

Used in NDB Cluster Replication conflict resolution, this status variable shows the number of transactions found to be in conflict by a transactional conflict detection function.

For more information, see [Section 7.11, “NDB Cluster Replication Conflict Resolution”](#).

- `Ndb_conflict_trans_detect_iter_count`

Used in NDB Cluster Replication conflict resolution, this shows the number of internal iterations required to commit an epoch transaction. Should be (slightly) greater than or equal to `Ndb_conflict_trans_conflict_commit_count`.

For more information, see [Section 7.11, “NDB Cluster Replication Conflict Resolution”](#).

- `Ndb_conflict_trans_conflict_commit_count`

Used in NDB Cluster Replication conflict resolution, this shows the number of epoch transactions committed after they required transactional conflict handling.

For more information, see [Section 7.11, “NDB Cluster Replication Conflict Resolution”](#).

- `Ndb_epoch_delete_delete_count`

When using delete-delete conflict detection, this is the number of delete-delete conflicts detected, where a delete operation is applied, but the indicated row does not exist.

- `Ndb_execute_count`

Provides the number of round trips to the `NDB` kernel made by operations.

- `Ndb_last_commit_epoch_server`

The epoch most recently committed by `NDB`.

- `Ndb_last_commit_epoch_session`

The epoch most recently committed by this `NDB` client.

- `Ndb_number_of_data_nodes`

If the server is part of an NDB Cluster, the value of this variable is the number of data nodes in the cluster.

If the server is not part of an NDB Cluster, then the value of this variable is 0.

- `Ndb_pushed_queries_defined`

The total number of joins pushed down to the NDB kernel for distributed handling on the data nodes.

Note

Joins tested using `EXPLAIN` that can be pushed down contribute to this number.

- `Ndb_pushed_queries_dropped`

The number of joins that were pushed down to the NDB kernel but that could not be handled there.

- `Ndb_pushed_queries_executed`

The number of joins successfully pushed down to NDB and executed there.

- `Ndb_pushed_reads`

The number of rows returned to `mysqld` from the NDB kernel by joins that were pushed down.

Note

Executing `EXPLAIN` on joins that can be pushed down to NDB does not add to this number.

- `Ndb_pruned_scan_count`

This variable holds a count of the number of scans executed by `NDBCLUSTER` since the NDB Cluster was last started where `NDBCLUSTER` was able to use partition pruning.

Using this variable together with `Ndb_scan_count` can be helpful in schema design to maximize the ability of the server to prune scans to a single table partition, thereby involving only a single data node.

- `Ndb_scan_count`

This variable holds a count of the total number of scans executed by `NDBCLUSTER` since the NDB Cluster was last started.

- `Ndb_slave_max_replicated_epoch`

The most recently committed epoch on this replica. You can compare this value with `Ndb_conflict_last_conflict_epoch`; if `Ndb_slave_max_replicated_epoch` is the greater of the two, no conflicts have yet been detected.

For more information, see [Section 7.11, “NDB Cluster Replication Conflict Resolution”](#).

- `Ndb_system_name`

If this MySQL Server is connected to an NDB cluster, this read-only variable shows the cluster system name. Otherwise, the value is an empty string.

4.3.10 NDB Cluster TCP/IP Connections

TCP/IP is the default transport mechanism for all connections between nodes in an NDB Cluster. Normally it is not necessary to define TCP/IP connections; NDB Cluster automatically sets up such connections for all data nodes, management nodes, and SQL or API nodes.

Note

For an exception to this rule, see [Section 4.3.11, “NDB Cluster TCP/IP Connections Using Direct Connections”](#).

To override the default connection parameters, it is necessary to define a connection using one or more `[tcp]` sections in the `config.ini` file. Each `[tcp]` section explicitly defines a TCP/IP connection between two NDB Cluster nodes, and must contain at a minimum the parameters `NodeId1` and `NodeId2`, as well as any connection parameters to override.

It is also possible to change the default values for these parameters by setting them in the `[tcp default]` section.

Important

Any `[tcp]` sections in the `config.ini` file should be listed *last*, following all other sections in the file. However, this is not required for a `[tcp default]` section. This requirement is a known issue with the way in which the `config.ini` file is read by the NDB Cluster management server.

Connection parameters which can be set in `[tcp]` and `[tcp default]` sections of the `config.ini` file are listed here:

- `Checksum`

Version (or later)	NDB 7.5.0
Type or units	boolean
Default	false
Range	true, false
Restart Type	S

This parameter is a boolean parameter (enabled by setting it to `Y` or `1`, disabled by setting it to `N` or `0`). It is disabled by default. When it is enabled, checksums for all messages are calculated before they placed in the send buffer. This feature ensures that messages are not corrupted while waiting in the send buffer, or by the transport mechanism.

- `Group`

When `ndb_optimized_node_selection` is enabled, node proximity is used in some cases to select which node to connect to. This parameter can be used to influence proximity by setting it to a lower value, which is interpreted as “closer”. See the description of the system variable for more information.

- `HostName1`

Version (or later)	NDB 7.5.0
Type or units	name or IP address
Default	[...]
Range	...
Restart Type	S

The `HostName1` and `HostName2` parameters can be used to specify specific network interfaces to be used for a given TCP connection between two nodes. The values used for these parameters can be host names or IP addresses.

- `HostName2`

Version (or later)	NDB 7.5.0
Type or units	name or IP address
Default	[...]
Range	...

Restart Type	S
--------------	---

The `HostName1` and `HostName2` parameters can be used to specify specific network interfaces to be used for a given TCP connection between two nodes. The values used for these parameters can be host names or IP addresses.

- `NodeId1`

Version (or later)	NDB 7.5.0
Type or units	numeric
Default	[none]
Range	1 - 255
Restart Type	S

To identify a connection between two nodes it is necessary to provide their node IDs in the `[tcp]` section of the configuration file as the values of `NodeId1` and `NodeId2`. These are the same unique `Id` values for each of these nodes as described in [Section 4.3.7, “Defining SQL and Other API Nodes in an NDB Cluster”](#).

- `NodeId2`

Version (or later)	NDB 7.5.0
Type or units	numeric
Default	[none]
Range	1 - 255
Restart Type	S

To identify a connection between two nodes it is necessary to provide their node IDs in the `[tcp]` section of the configuration file as the values of `NodeId1` and `NodeId2`. These are the same unique `Id` values for each of these nodes as described in [Section 4.3.7, “Defining SQL and Other API Nodes in an NDB Cluster”](#).

- `NodeIdServer`

Version (or later)	NDB 7.5.0
Type or units	numeric
Default	[none]
Range	1 - 63
Restart Type	S

Set the server side of a TCP connection.

- `OverloadLimit`

Version (or later)	NDB 7.5.0
Type or units	bytes
Default	0
Range	0 - 4294967039 (0xFFFFFFFF)

Restart Type	S
------------------------------	---

When more than this many unsent bytes are in the send buffer, the connection is considered overloaded.

This parameter can be used to determine the amount of unsent data that must be present in the send buffer before the connection is considered overloaded. See [Section 4.3.13, "Configuring NDB Cluster Send Buffer Parameters"](#), for more information.

- [PortNumber](#) (*OBSOLETE*)

This parameter formerly specified the port number to be used for listening for connections from other nodes. It is now deprecated (and removed in NDB Cluster 7.5); use the [ServerPort](#) data node configuration parameter for this purpose instead (Bug #77405, Bug #21280456).

- [PreSendChecksum](#)

Version (or later)	NDB 7.6.6
Type or units	boolean
Default	false
Range	true, false
Added	NDB 7.6.6
Restart Type	S (NDB 7.6.6)

If this parameter and [Checksum](#) are both enabled, perform pre-send checksum checks, and check all TCP signals between nodes for errors. Has no effect if [Checksum](#) is not also enabled.

- [Proxy](#)

Version (or later)	NDB 7.5.0
Type or units	string
Default	[...]
Range	...
Restart Type	S

Set a proxy for the TCP connection.

- [ReceiveBufferMemory](#)

Version (or later)	NDB 7.5.0
Type or units	bytes
Default	2M
Range	16K - 4294967039 (0xFFFFFFFF)
Restart Type	S

Specifies the size of the buffer used when receiving data from the TCP/IP socket.

The default value of this parameter is 2MB. The minimum possible value is 16KB; the theoretical maximum is 4GB.

- [SendBufferMemory](#)

Version (or later)	NDB 7.5.0
Type or units	unsigned

Default	2M
Range	256K - 4294967039 (0xFFFFFFFF)
Restart Type	S

TCP transporters use a buffer to store all messages before performing the send call to the operating system. When this buffer reaches 64KB its contents are sent; these are also sent when a round of messages have been executed. To handle temporary overload situations it is also possible to define a bigger send buffer.

If this parameter is set explicitly, then the memory is not dedicated to each transporter; instead, the value used denotes the hard limit for how much memory (out of the total available memory—that is, `TotalSendBufferMemory`) that may be used by a single transporter. For more information about configuring dynamic transporter send buffer memory allocation in NDB Cluster, see [Section 4.3.13, “Configuring NDB Cluster Send Buffer Parameters”](#).

The default size of the send buffer is 2MB, which is the size recommended in most situations. The minimum size is 64 KB; the theoretical maximum is 4 GB.

- `SendSignalId`

Version (or later)	NDB 7.5.0
Type or units	boolean
Default	false (debug builds: true)
Range	true, false
Restart Type	S

To be able to retrace a distributed message datagram, it is necessary to identify each message. When this parameter is set to `Y`, message IDs are transported over the network. This feature is disabled by default in production builds, and enabled in `-debug` builds.

- `TcpBind_INADDR_ANY`

Setting this parameter to `TRUE` or `1` binds `IP_ADDR_ANY` so that connections can be made from anywhere (for autogenerated connections). The default is `FALSE` (`0`).

- `TCP_MAXSEG_SIZE`

Version (or later)	NDB 7.5.0
Type or units	unsigned
Default	0
Range	0 - 2G
Restart Type	S

Determines the size of the memory set during TCP transporter initialization. The default is recommended for most common usage cases.

- `TCP_RCV_BUF_SIZE`

Version (or later)	NDB 7.5.0
Type or units	unsigned
Default	0
Range	0 - 2G

Restart Type	S
--------------	---

Determines the size of the receive buffer set during TCP transporter initialization. The default and minimum value is 0, which allows the operating system or platform to set this value. The default is recommended for most common usage cases.

- `TCP_SND_BUF_SIZE`

Version (or later)	NDB 7.5.0
Type or units	unsigned
Default	0
Range	0 - 2G
Restart Type	S

Determines the size of the send buffer set during TCP transporter initialization. The default and minimum value is 0, which allows the operating system or platform to set this value. The default is recommended for most common usage cases.

Restart types. Information about the restart types used by the parameter descriptions in this section is shown in the following table:

Table 4.13 NDB Cluster restart types

Symbol	Restart Type	Description
N	Node	The parameter can be updated using a rolling restart (see Section 6.5, “Performing a Rolling Restart of an NDB Cluster”)
S	System	All cluster nodes must be shut down completely, then restarted, to effect a change in this parameter
I	Initial	Data nodes must be restarted using the <code>--initial</code> option

4.3.11 NDB Cluster TCP/IP Connections Using Direct Connections

Setting up a cluster using direct connections between data nodes requires specifying explicitly the crossover IP addresses of the data nodes so connected in the `[tcp]` section of the cluster `config.ini` file.

In the following example, we envision a cluster with at least four hosts, one each for a management server, an SQL node, and two data nodes. The cluster as a whole resides on the `172.23.72.*` subnet of a LAN. In addition to the usual network connections, the two data nodes are connected directly using a standard crossover cable, and communicate with one another directly using IP addresses in the `1.1.0.*` address range as shown:

```
# Management Server
[ndb_mgmd]
Id=1
HostName=172.23.72.20

# SQL Node
[mysqld]
Id=2
HostName=172.23.72.21

# Data Nodes
```

```
[ndbd]
Id=3
HostName=172.23.72.22

[ndbd]
Id=4
HostName=172.23.72.23

# TCP/IP Connections
[tcp]
NodeId1=3
NodeId2=4
HostName1=1.1.0.1
HostName2=1.1.0.2
```

The `HostName1` and `HostName2` parameters are used only when specifying direct connections.

The use of direct TCP connections between data nodes can improve the cluster's overall efficiency by enabling the data nodes to bypass an Ethernet device such as a switch, hub, or router, thus cutting down on the cluster's latency.

Note

To take the best advantage of direct connections in this fashion with more than two data nodes, you must have a direct connection between each data node and every other data node in the same node group.

4.3.12 NDB Cluster Shared Memory Connections

Communications between NDB cluster nodes are normally handled using TCP/IP. The shared memory (SHM) transporter is distinguished by the fact that signals are transmitted by writing in memory rather than on a socket. The shared-memory transporter (SHM) can improve performance by negating up to 20% of the overhead required by a TCP connection when running an API node (usually an SQL node) and a data node together on the same host. You can enable a shared memory connection in either of the two ways listed here:

- By setting the `UseShm` data node configuration parameter to `1`, and setting `HostName` for the data node and `HostName` for the API node to the same value.
- By using `[shm]` sections in the cluster configuration file, each containing settings for `NodeId1` and `NodeId2`. This method is described in more detail later in this section.

Suppose a cluster is running a data node which has node ID 1 and an SQL node having node ID 51 on the same host computer at 10.0.0.1. To enable an SHM connection between these two nodes, all that is necessary is to insure that the following entries are included in the cluster configuration file:

```
[ndbd]
NodeId=1
HostName=10.0.0.1
UseShm=1

[mysqld]
NodeId=51
HostName=10.0.0.1
```

Important

The two entries just shown are in addition to any other entries and parameter settings needed by the cluster. A more complete example is shown later in this section.

Before starting data nodes that use SHM connections, it is also necessary to make sure that the operating system on each computer hosting such a data node has sufficient memory allocated to shared memory segments. See the documentation for your operating platform for information regarding this. In setups where multiple hosts are each running a data node and an API node, it is possible to

enable shared memory on all such hosts by setting `UseShm` in the `[ndbd default]` section of the configuration file. This is shown in the example later in this section.

While not strictly required, tuning for all SHM connections in the cluster can be done by setting one or more of the following parameters in the `[shm default]` section of the cluster configuration (`config.ini`) file:

- `ShmSize`: Shared memory size
- `ShmSpinTime`: Time in μ s to spin before sleeping
- `SendBufferMemory`: Size of buffer for signals sent from this node, in bytes.
- `SendSignalId`: Indicates that a signal ID is included in each signal sent through the transporter.
- `Checksum`: Indicates that a checksum is included in each signal sent through the transporter.
- `PreSendChecksum`: Checks of the checksum are made prior to sending the signal; Checksum must also be enabled for this to work

This example shows a simple setup with SHM connections defined on multiple hosts, in an NDB Cluster using 3 computers listed here by host name, hosting the node types shown:

1. `10.0.0.0`: The management server
2. `10.0.0.1`: A data node and an SQL node
3. `10.0.0.2`: A data node and an SQL node

In this scenario, each data node communicates with both the management server and the other data node using TCP transporters; each SQL node uses a shared memory transporter to communicate with the data nodes that is local to it, and a TCP transporter to communicate with the remote data node. A basic configuration reflecting this setup is enabled by the `config.ini` file whose contents are shown here:

```
[ndbd default]
DataDir=/path/to/datadir
UseShm=1

[shm default]
ShmSize=8M
ShmSpintime=200
SendBufferMemory=4M

[tcp default]
SendBufferMemory=8M

[ndb_mgmd]
NodeId=49
Hostname=10.0.0.0
DataDir=/path/to/datadir

[ndbd]
NodeId=1
Hostname=10.0.0.1
DataDir=/path/to/datadir

[ndbd]
NodeId=2
Hostname=10.0.0.2
DataDir=/path/to/datadir

[mysqld]
NodeId=51
Hostname=10.0.0.1

[mysqld]
NodeId=52
Hostname=10.0.0.2
```

[api]
[api]

Parameters affecting all shared memory transporters are set in the `[shm default]` section; these can be overridden on a per-connection basis in one or more `[shm]` sections. Each such section must be associated with a given SHM connection using `NodeId1` and `NodeId2`; the values required for these parameters are the node IDs of the two nodes connected by the transporter. You can also identify the nodes by host name using `HostName1` and `HostName2`, but these parameters are not required.

The API nodes for which no host names are set use the TCP transporter to communicate with data nodes independent of the hosts on which they are started; the parameters and values set in the `[tcp default]` section of the configuration file apply to all TCP transporters in the cluster.

For optimum performance, you can define a spin time for the SHM transporter (`ShmSpinTime` parameter); this affects both the data node receiver thread and the poll owner (receive thread or user thread) in NDB.

- [Checksum](#)

Version (or later)	NDB 7.5.0
Type or units	boolean
Default	true
Range	true, false
Restart Type	S

This parameter is a boolean (Y/N) parameter which is disabled by default. When it is enabled, checksums for all messages are calculated before being placed in the send buffer.

This feature prevents messages from being corrupted while waiting in the send buffer. It also serves as a check against data being corrupted during transport.

- [Group](#)

Version (or later)	NDB 7.5.0
Type or units	unsigned
Default	35
Range	0 - 200
Restart Type	S

Determines the group proximity; a smaller value is interpreted as being closer. The default value is sufficient for most conditions.

- [HostName1](#)

Version (or later)	NDB 7.5.0
Type or units	name or IP address
Default	[...]
Range	...
Restart Type	S

The `HostName1` and `HostName2` parameters can be used to specify specific network interfaces to be used for a given SHM connection between two nodes. The values used for these parameters can be host names or IP addresses.

- [HostName2](#)

Version (or later)	NDB 7.5.0
Type or units	name or IP address
Default	[...]
Range	...
Restart Type	S

The [HostName1](#) and [HostName2](#) parameters can be used to specify specific network interfaces to be used for a given SHM connection between two nodes. The values used for these parameters can be host names or IP addresses.

- [NodeId1](#)

Version (or later)	NDB 7.5.0
Type or units	numeric
Default	[none]
Range	1 - 255
Restart Type	S

To identify a connection between two nodes it is necessary to provide node identifiers for each of them, as [NodeId1](#) and [NodeId2](#).

- [NodeId2](#)

Version (or later)	NDB 7.5.0
Type or units	numeric
Default	[none]
Range	1 - 255
Restart Type	S

To identify a connection between two nodes it is necessary to provide node identifiers for each of them, as [NodeId1](#) and [NodeId2](#).

- [NodeIdServer](#)

Version (or later)	NDB 7.5.0
Type or units	numeric
Default	[none]
Range	1 - 63
Restart Type	S

Identify the server end of a shared memory connection. By default, this is the node ID of the data node.

- [OverloadLimit](#)

Version (or later)	NDB 7.5.0
Type or units	bytes
Default	0
Range	0 - 4294967039 (0xFFFFFFFF)
Restart Type	S

When more than this many unsend bytes are in the send buffer, the connection is considered overloaded.

This parameter can be used to determine the amount of unsend data that must be present in the send buffer before the connection is considered overloaded. See [Section 4.3.13, “Configuring NDB Cluster Send Buffer Parameters”](#), and [Section 6.14.44, “The ndbinfo transporters Table”](#), for more information.

- [PortNumber](#)

Version (or later)	NDB 7.5.0
Type or units	unsigned
Default	[...]
Range	0 - 64K
Removed	NDB 7.5.1
Restart Type	S

Set the port to be used by the SHM transporter.

- [PreSendChecksum](#)

Version (or later)	NDB 7.6.6
Type or units	boolean
Default	false
Range	true, false
Added	NDB 7.6.6
Restart Type	S (NDB 7.6.6)

If this parameter and [Checksum](#) are both enabled, perform pre-send checksum checks, and check all SHM signals between nodes for errors. Has no effect if [Checksum](#) is not also enabled.

- [SendBufferMemory](#)

Version (or later)	NDB 7.6.6
Type or units	integer
Default	2M
Range	256K - 4294967039 (0xFFFFFFFF)
Added	NDB 7.6.6
Restart Type	S (NDB 7.6.6)

Size (in bytes) of the shared memory buffer for signals sent from this node using a shared memory connection.

- [SendSignalId](#)

Version (or later)	NDB 7.5.0
Type or units	boolean
Default	false
Range	true, false

Restart Type	S
------------------------------	---

To retrace the path of a distributed message, it is necessary to provide each message with a unique identifier. Setting this parameter to [Y](#) causes these message IDs to be transported over the network as well. This feature is disabled by default in production builds, and enabled in `-debug` builds.

- [ShmKey](#)

Version (or later)	NDB 7.5.0
Type or units	unsigned
Default	0
Range	0 - 4294967039 (0xFFFFFFFF)
Restart Type	S

When setting up shared memory segments, a node ID, expressed as an integer, is used to identify uniquely the shared memory segment to use for the communication. There is no default value. If [UseShm](#) is enabled, the shared memory key is calculated automatically by [NDB](#).

- [ShmSize](#)

Version (or later)	NDB 7.5.0
Type or units	bytes
Default	1M
Range	64K - 4294967039 (0xFFFFFFFF)
Version (or later)	NDB 7.6.6
Type or units	bytes
Default	4M
Range	64K - 4294967039 (0xFFFFFFFF)
Restart Type	S

Each SHM connection has a shared memory segment where messages between nodes are placed by the sender and read by the reader. The size of this segment is defined by [ShmSize](#). The default value in NDB 7.6 is 4MB.

- [ShmSpinTime](#)

Version (or later)	NDB 7.6.6
Type or units	integer
Default	0
Range	0 - 2000
Added	NDB 7.6.6
Restart Type	S (NDB 7.6.6)

When receiving, the time to wait before sleeping, in microseconds.

- [SigNum](#)

Version (or later)	NDB 7.5.0
Type or units	unsigned
Default	[...]
Range	0 - 4294967039 (0xFFFFFFFF)

Deprecated	NDB 7.6.6
Restart Type	S

This parameter is no longer used in NDB 7.6, in which any setting for it is ignored.

The following applies only in NDB 7.5 (and earlier):

When using the shared memory transporter, a process sends an operating system signal to the other process when there is new data available in the shared memory. Should that signal conflict with an existing signal, this parameter can be used to change it. This is a possibility when using SHM due to the fact that different operating systems use different signal numbers.

The default value of `SigNum` is 0; therefore, it must be set to avoid errors in the cluster log when using the shared memory transporter. Typically, this parameter is set to 10 in the `[shm default]` section of the `config.ini` file.

Restart types. Information about the restart types used by the parameter descriptions in this section is shown in the following table:

Table 4.14 NDB Cluster restart types

Symbol	Restart Type	Description
N	Node	The parameter can be updated using a rolling restart (see Section 6.5, “Performing a Rolling Restart of an NDB Cluster”)
S	System	All cluster nodes must be shut down completely, then restarted, to effect a change in this parameter
I	Initial	Data nodes must be restarted using the <code>--initial</code> option

4.3.13 Configuring NDB Cluster Send Buffer Parameters

The NDB kernel employs a unified send buffer whose memory is allocated dynamically from a pool shared by all transporters. This means that the size of the send buffer can be adjusted as necessary. Configuration of the unified send buffer can be accomplished by setting the following parameters:

- **TotalSendBufferMemory.** This parameter can be set for all types of NDB Cluster nodes—that is, it can be set in the `[ndbd]`, `[mgm]`, and `[api]` (or `[mysql]`) sections of the `config.ini` file. It represents the total amount of memory (in bytes) to be allocated by each node for which it is set for use among all configured transporters. If set, its minimum is 256KB; the maximum is 4294967039.

To be backward-compatible with existing configurations, this parameter takes as its default value the sum of the maximum send buffer sizes of all configured transporters, plus an additional 32KB (one page) per transporter. The maximum depends on the type of transporter, as shown in the following table:

Table 4.15 Transporter types with maximum send buffer sizes

Transporter	Maximum Send Buffer Size (bytes)
TCP	<code>SendBufferMemory</code> (default = 2M)
SHM	20K

This enables existing configurations to function in close to the same way as they did with NDB Cluster 6.3 and earlier, with the same amount of memory and send buffer space available to

each transporter. However, memory that is unused by one transporter is not available to other transporters.

- **OverloadLimit.** This parameter is used in the `config.ini` file `[tcp]` section, and denotes the amount of unsent data (in bytes) that must be present in the send buffer before the connection is considered overloaded. When such an overload condition occurs, transactions that affect the overloaded connection fail with NDB API Error 1218 (`Send Buffers overloaded in NDB kernel`) until the overload status passes. The default value is 0, in which case the effective overload limit is calculated as `SendBufferMemory * 0.8` for a given connection. The maximum value for this parameter is 4G.
- **SendBufferMemory.** This value denotes a hard limit for the amount of memory that may be used by a single transporter out of the entire pool specified by `TotalSendBufferMemory`. However, the sum of `SendBufferMemory` for all configured transporters may be greater than the `TotalSendBufferMemory` that is set for a given node. This is a way to save memory when many nodes are in use, as long as the maximum amount of memory is never required by all transporters at the same time.
- **ReservedSendBufferMemory.** Removed prior to NDB 7.5 GA.

Version (or later)	NDB 7.5.0
Type or units	bytes
Default	256K
Range	0 - 4294967039 (0xFFFFFFFF)
Removed	NDB 7.5.2
Restart Type	S

Previously, this data node parameter was present, but not actually used (Bug #77404, Bug #21280428).

You can use the `ndbinfo.transporters` table to monitor send buffer memory usage, and to detect slowdown and overload conditions that can adversely affect performance.

4.4 Using High-Speed Interconnects with NDB Cluster

Even before design of `NDBCLUSTER` began in 1996, it was evident that one of the major problems to be encountered in building parallel databases would be communication between the nodes in the network. For this reason, `NDBCLUSTER` was designed from the very beginning to permit the use of a number of different data transport mechanisms. In this Manual, we use the term *transporter* for these.

The NDB Cluster codebase provides for four different transporters:

- *TCP/IP using 100 Mbps or gigabit Ethernet*, as discussed in [Section 4.3.10, “NDB Cluster TCP/IP Connections”](#).
- *Direct (machine-to-machine) TCP/IP*; although this transporter uses the same TCP/IP protocol as mentioned in the previous item, it requires setting up the hardware differently and is configured differently as well. For this reason, it is considered a separate transport mechanism for NDB Cluster. See [Section 4.3.11, “NDB Cluster TCP/IP Connections Using Direct Connections”](#), for details.
- *Shared memory (SHM)*. Supported in production in NDB 7.6. For more information about SHM, see [Section 4.3.12, “NDB Cluster Shared Memory Connections”](#).
- *Scalable Coherent Interface (SCI)*.

Note

Using SCI transporters in NDB Cluster requires specialized hardware, software, and MySQL binaries not available using an NDB 7.5 or 7.6 distribution.

Most users today employ TCP/IP over Ethernet because it is ubiquitous. TCP/IP is also by far the best-tested transporter for use with NDB Cluster.

Regardless of the transporter used, [NDB](#) attempts to make sure that communication with data node processes is done using chunks that are as large as possible since this benefits all types of data transmission.

Chapter 5 NDB Cluster Programs

Table of Contents

5.1 <code>ndbd</code> — The NDB Cluster Data Node Daemon	284
5.2 <code>ndbinfo_select_all</code> — Select From <code>ndbinfo</code> Tables	294
5.3 <code>ndbmt</code> — The NDB Cluster Data Node Daemon (Multi-Threaded)	299
5.4 <code>ndb_mgmd</code> — The NDB Cluster Management Server Daemon	300
5.5 <code>ndb_mgm</code> — The NDB Cluster Management Client	311
5.6 <code>ndb_blob_tool</code> — Check and Repair BLOB and TEXT columns of NDB Cluster Tables	316
5.7 <code>ndb_config</code> — Extract NDB Cluster Configuration Information	322
5.8 <code>ndb_cpctest</code> — Automate Testing for NDB Development	333
5.9 <code>ndb_delete_all</code> — Delete All Rows from an NDB Table	333
5.10 <code>ndb_desc</code> — Describe NDB Tables	338
5.11 <code>ndb_drop_index</code> — Drop Index from an NDB Table	347
5.12 <code>ndb_drop_table</code> — Drop an NDB Table	352
5.13 <code>ndb_error_reporter</code> — NDB Error-Reporting Utility	356
5.14 <code>ndb_import</code> — Import CSV Data Into NDB	357
5.15 <code>ndb_index_stat</code> — NDB Index Statistics Utility	375
5.16 <code>ndb_move_data</code> — NDB Data Copy Utility	383
5.17 <code>ndb_perror</code> — Obtain NDB Error Message Information	388
5.18 <code>ndb_print_backup_file</code> — Print NDB Backup File Contents	390
5.19 <code>ndb_print_file</code> — Print NDB Disk Data File Contents	390
5.20 <code>ndb_print_frag_file</code> — Print NDB Fragment List File Contents	391
5.21 <code>ndb_print_schema_file</code> — Print NDB Schema File Contents	392
5.22 <code>ndb_print_sys_file</code> — Print NDB System File Contents	392
5.23 <code>ndb_redo_log_reader</code> — Check and Print Content of Cluster Redo Log	393
5.24 <code>ndb_restore</code> — Restore an NDB Cluster Backup	395
5.24.1 Restoring an NDB Backup to a Different Version of NDB Cluster	419
5.24.2 Restoring to a different number of data nodes	420
5.25 <code>ndb_select_all</code> — Print Rows from an NDB Table	423
5.26 <code>ndb_select_count</code> — Print Row Counts for NDB Tables	430
5.27 <code>ndb_setup.py</code> — Start browser-based Auto-Installer for NDB Cluster (DEPRECATED)	434
5.28 <code>ndb_show_tables</code> — Display List of NDB Tables	437
5.29 <code>ndb_size.pl</code> — NDBCLUSTER Size Requirement Estimator	442
5.30 <code>ndb_top</code> — View CPU usage information for NDB threads	445
5.31 <code>ndb_waiter</code> — Wait for NDB Cluster to Reach a Given Status	451

Using and managing an NDB Cluster requires several specialized programs, which we describe in this chapter. We discuss the purposes of these programs in an NDB Cluster, how to use the programs, and what startup options are available for each of them.

These programs include the NDB Cluster data, management, and SQL node processes (`ndbd`, `ndbmt`, `ndb_mgmd`, and `mysqld`) and the management client (`ndb_mgm`).

Information about the program `ndb_setup.py`, used to start the NDB Cluster Auto-Installer (now deprecated), is also included in this section. You should be aware that [Section 5.27, “`ndb_setup.py` — Start browser-based Auto-Installer for NDB Cluster \(DEPRECATED\)”](#), contains information about the command-line client only; for information about using the GUI installer spawned by this program to configure and deploy an NDB Cluster, see [Section 3.8, “The NDB Cluster Auto-Installer \(NDB 7.5\) \(No longer supported\)”](#).

For information about using `mysqld` as an NDB Cluster process, see [Section 6.9, “MySQL Server Usage for NDB Cluster”](#).

Other NDB utility, diagnostic, and example programs are included with the NDB Cluster distribution. These include `ndb_restore`, `ndb_show_tables`, and `ndb_config`. These programs are also covered in this section.

The final portion of this section contains tables of options that are common to all the various NDB Cluster programs.

5.1 ndbd — The NDB Cluster Data Node Daemon

`ndbd` is the process that is used to handle all the data in tables using the NDB Cluster storage engine. This is the process that empowers a data node to accomplish distributed transaction handling, node recovery, checkpointing to disk, online backup, and related tasks.

In an NDB Cluster, a set of `ndbd` processes cooperate in handling data. These processes can execute on the same computer (host) or on different computers. The correspondences between data nodes and Cluster hosts is completely configurable.

Options that can be used with `ndbd` are shown in the following table. Additional descriptions follow the table.

Table 5.1 Command-line options used with the program `ndbd`

Format	Description	Added, Deprecated, or Removed
<code>--bind-address=name</code>	Local bind address	(Supported in all NDB releases based on MySQL 5.7)
<code>--character-sets-dir=path</code>	Directory containing character sets	(Supported in all NDB releases based on MySQL 5.7)
<code>--connect-delay=#</code>	Obsolete synonym for <code>--connect-retry-delay</code> , which should be used instead of this option	REMOVED: NDB 7.5.25, NDB 7.6.21
<code>--connect-retries=#</code>	Set the number of times to retry a connection before giving up; 0 means 1 attempt only (and no retries); -1 means continue retrying indefinitely	(Supported in all NDB releases based on MySQL 5.7)
<code>--connect-retry-delay=#, -r #</code>	Time to wait between attempts to contact a management server, in seconds; 0 means do not wait between attempts	(Supported in all NDB releases based on MySQL 5.7)
<code>--connect-string=connection_string, -c connection_string</code>	Same as <code>--ndb-connectstring</code>	(Supported in all NDB releases based on MySQL 5.7)
<code>--core-file</code>	Write core file on error; used in debugging	(Supported in all NDB releases based on MySQL 5.7)
<code>--daemon, -d</code>	Start <code>ndbd</code> as daemon (default); override with <code>--nodaemon</code>	(Supported in all NDB releases based on MySQL 5.7)
<code>--defaults-extra-file=path</code>	Read given file after global files are read	(Supported in all NDB releases based on MySQL 5.7)
<code>--defaults-file=path</code>	Read default options from given file only	(Supported in all NDB releases based on MySQL 5.7)
<code>--defaults-group-suffix=string</code>	Also read groups with <code>concat(group, suffix)</code>	(Supported in all NDB releases based on MySQL 5.7)

Format	Description	Added, Deprecated, or Removed
<code>--foreground</code>	Run ndbd in foreground, provided for debugging purposes (implies <code>--nodaemon</code>)	(Supported in all NDB releases based on MySQL 5.7)
<code>--help</code> , <code>-?</code>	Display help text and exit	(Supported in all NDB releases based on MySQL 5.7)
<code>--initial</code>	Perform initial start of ndbd, including file system cleanup; consult documentation before using this option	(Supported in all NDB releases based on MySQL 5.7)
<code>--initial-start</code>	Perform partial initial start (requires <code>--nowait-nodes</code>)	(Supported in all NDB releases based on MySQL 5.7)
<code>--install[=name]</code>	Used to install data node process as Windows service; does not apply on other platforms	(Supported in all NDB releases based on MySQL 5.7)
<code>--logbuffer-size=#</code>	Control size of log buffer; for use when debugging with many log messages being generated; default is sufficient for normal operations	ADDED: NDB 7.6.6
<code>--login-path=path</code>	Read given path from login file	(Supported in all NDB releases based on MySQL 5.7)
<code>--ndb-connectstring=connection_string</code> <code>-c connection_string</code>	Set connect string for connecting to <code>ndb_mgmd</code> . Syntax: "[nodeid=id;][host=]hostname[:port]". Overrides entries in <code>NDB_CONNECTSTRING</code> and <code>my.cnf</code>	(Supported in all NDB releases based on MySQL 5.7)
<code>--ndb-mgmd-host=connection_string</code> <code>-c connection_string</code>	Same as <code>--ndb-connectstring</code>	(Supported in all NDB releases based on MySQL 5.7)
<code>--ndb-nodeid=#</code>	Set node ID for this node, overriding any ID set by <code>--ndb-connectstring</code>	(Supported in all NDB releases based on MySQL 5.7)
<code>--nodaemon</code>	Do not start ndbd as daemon; provided for testing purposes	(Supported in all NDB releases based on MySQL 5.7)
<code>--no-defaults</code>	Do not read default options from any option file other than login file	(Supported in all NDB releases based on MySQL 5.7)
<code>--nostart</code> , <code>-n</code>	Do not start ndbd immediately; ndbd waits for command to start from <code>ndb_mgm</code>	(Supported in all NDB releases based on MySQL 5.7)
<code>--nowait-nodes=list</code>	Do not wait for these data nodes to start (takes comma-separated list of node IDs); requires <code>--ndb-nodeid</code>	(Supported in all NDB releases based on MySQL 5.7)
<code>--ndb-optimized-node-selection</code>	Enable optimizations for selection of nodes for transactions. Enabled by default;	(Supported in all NDB releases based on MySQL 5.7)

Format	Description	Added, Deprecated, or Removed
<code>--print-defaults</code>	use <code>--skip-ndb-optimized-node-selection</code> to disable Print program argument list and exit	(Supported in all NDB releases based on MySQL 5.7)
<code>--remove[=name]</code>	Used to remove data node process that was previously installed as Windows service; does not apply on other platforms	(Supported in all NDB releases based on MySQL 5.7)
<code>--usage,</code> <code>-?</code>	Display help text and exit; same as <code>--help</code>	(Supported in all NDB releases based on MySQL 5.7)
<code>--verbose,</code> <code>-v</code>	Write extra debugging information to node log	(Supported in all NDB releases based on MySQL 5.7)
<code>--version,</code> <code>-V</code>	Display version information and exit	(Supported in all NDB releases based on MySQL 5.7)

Note

All of these options also apply to the multithreaded version of this program (`ndbmt`) and you may substitute “`ndbmt`” for “`ndbd`” wherever the latter occurs in this section.

- `--bind-address`

Command-Line Format	<code>--bind-address=name</code>
Type	String
Default Value	

Causes `ndbd` to bind to a specific network interface (host name or IP address). This option has no default value.

- `--character-sets-dir`

Command-Line Format	<code>--character-sets-dir=path</code>
---------------------	--

Directory containing character sets.

- `--connect-delay=#`

Command-Line Format	<code>--connect-delay=#</code>
Deprecated	Yes (removed in 5.7.36-ndb-7.6.21)
Type	Numeric
Default Value	5
Minimum Value	0
Maximum Value	3600

Determines the time to wait between attempts to contact a management server when starting (the number of attempts is controlled by the `--connect-retries` option). The default is 5 seconds.

This option is deprecated, and is subject to removal in a future release of NDB Cluster. Use `--connect-retry-delay` instead.

- `--connect-retries=#`

Command-Line Format	<code>--connect-retries=#</code>
Type	Numeric
Default Value	12
Minimum Value (\geq 5.7.36-ndb-7.6.21)	-1
Minimum Value (\geq 5.7.36-ndb-7.5.25)	-1
Minimum Value (\leq 5.7.36-ndb-7.5.24)	0
Minimum Value (\leq 5.7.36-ndb-7.6.20)	0
Minimum Value	0
Maximum Value	65535

Set the number of times to retry a connection before giving up; 0 means 1 attempt only (and no retries). The default is 12 attempts. The time to wait between attempts is controlled by the `--connect-retry-delay` option.

Beginning with NDB 7.5.25 and NDB 7.6.21, you can set this option to -1, in which case, the data node process continues indefinitely to try to connect.

- `--connect-retry-delay=#`

Command-Line Format	<code>--connect-retry-delay=#</code>
Type	Numeric
Default Value	5
Minimum Value	0
Maximum Value	4294967295

Determines the time to wait between attempts to contact a management server when starting (the time between attempts is controlled by the `--connect-retries` option). The default is 5 seconds.

This option takes the place of the `--connect-delay` option, which is now deprecated and subject to removal in a future release of NDB Cluster.

The short form `-r` for this option is deprecated as of NDB 7.5.25 and NDB 7.6.21, and subject to removal in a future release of NDB Cluster. Use the long form instead.

- `--connect-string`

Command-Line Format	<code>--connect-string=connection_string</code>
Type	String
Default Value	[none]

Same as `--ndb-connectstring`.

- `--core-file`

Command-Line Format	<code>--core-file</code>
---------------------	--------------------------

Write core file on error; used in debugging.

- `--daemon, -d`

Command-Line Format	<code>--daemon</code>
---------------------	-----------------------

Instructs `ndbd` or `ndbmt` to execute as a daemon process. This is the default behavior. `--nodaemon` can be used to prevent the process from running as a daemon.

This option has no effect when running `ndbd` or `ndbmt` on Windows platforms.

- `--defaults-extra-file`

Command-Line Format	<code>--defaults-extra-file=path</code>
Type	String
Default Value	[none]

Read given file after global files are read.

- `--defaults-file`

Command-Line Format	<code>--defaults-file=path</code>
Type	String
Default Value	[none]

Read default options from given file only.

- `--defaults-group-suffix`

Command-Line Format	<code>--defaults-group-suffix=string</code>
Type	String
Default Value	[none]

Also read groups with `concat(group, suffix)`.

- `--foreground`

Command-Line Format	<code>--foreground</code>
---------------------	---------------------------

Causes `ndbd` or `ndbmt` to execute as a foreground process, primarily for debugging purposes. This option implies the `--nodaemon` option.

This option has no effect when running `ndbd` or `ndbmt` on Windows platforms.

- `--help`

Command-Line Format	<code>--help</code>
---------------------	---------------------

Display help text and exit.

- `--initial`

Command-Line Format	<code>--initial</code>
---------------------	------------------------

Instructs `ndbd` to perform an initial start. An initial start erases any files created for recovery purposes by earlier instances of `ndbd`. It also re-creates recovery log files. On some operating systems, this process can take a substantial amount of time.

An `--initial` start is to be used *only* when starting the `ndbd` process under very special circumstances; this is because this option causes all files to be removed from the NDB Cluster file system and all redo log files to be re-created. These circumstances are listed here:

- When performing a software upgrade which has changed the contents of any files.
- When restarting the node with a new version of `ndbd`.
- As a measure of last resort when for some reason the node restart or system restart repeatedly fails. In this case, be aware that this node can no longer be used to restore data due to the destruction of the data files.

Warning

To avoid the possibility of eventual data loss, it is recommended that you *not* use the `--initial` option together with `StopOnError = 0`. Instead, set `StopOnError` to 0 in `config.ini` only after the cluster has been started, then restart the data nodes normally—that is, without the `--initial` option. See the description of the `StopOnError` parameter for a detailed explanation of this issue. (Bug #24945638)

Use of this option prevents the `StartPartialTimeout` and `StartPartitionedTimeout` configuration parameters from having any effect.

Important

This option does *not* affect either of the following types of files:

- Backup files that have already been created by the affected node
- NDB Cluster Disk Data files (see [Section 6.10, “NDB Cluster Disk Data Tables”](#)).

This option also has no effect on recovery of data by a data node that is just starting (or restarting) from data nodes that are already running. This recovery of data occurs automatically, and requires no user intervention in an NDB Cluster that is running normally.

It is permissible to use this option when starting the cluster for the very first time (that is, before any data node files have been created); however, it is *not* necessary to do so.

- `--initial-start`

Command-Line Format	<code>--initial-start</code>
---------------------	------------------------------

This option is used when performing a partial initial start of the cluster. Each node should be started with this option, as well as `--nowait-nodes`.

Suppose that you have a 4-node cluster whose data nodes have the IDs 2, 3, 4, and 5, and you wish to perform a partial initial start using only nodes 2, 4, and 5—that is, omitting node 3:

```
$> ndbd --ndb-nodeid=2 --nowait-nodes=3 --initial-start
$> ndbd --ndb-nodeid=4 --nowait-nodes=3 --initial-start
$> ndbd --ndb-nodeid=5 --nowait-nodes=3 --initial-start
```

When using this option, you must also specify the node ID for the data node being started with the `--ndb-nodeid` option.

Important

Do not confuse this option with the `--nowait-nodes` option for `ndb_mgmd`, which can be used to enable a cluster configured with multiple management servers to be started without all management servers being online.

- `--install[=name]`

Command-Line Format	<code>--install[=name]</code>
Platform Specific	Windows
Type	String
Default Value	<code>ndbd</code>

Causes `ndbd` to be installed as a Windows service. Optionally, you can specify a name for the service; if not set, the service name defaults to `ndbd`. Although it is preferable to specify other `ndbd` program options in a `my.ini` or `my.cnf` configuration file, it is possible to use together with `--install`. However, in such cases, the `--install` option must be specified first, before any other options are given, for the Windows service installation to succeed.

It is generally not advisable to use this option together with the `--initial` option, since this causes the data node file system to be wiped and rebuilt every time the service is stopped and started. Extreme care should also be taken if you intend to use any of the other `ndbd` options that affect the starting of data nodes—including `--initial-start`, `--nostart`, and `--nowait-nodes`—together with `--install`, and you should make absolutely certain you fully understand and allow for any possible consequences of doing so.

The `--install` option has no effect on non-Windows platforms.

- `--logbuffer-size=#`

Command-Line Format	<code>--logbuffer-size=#</code>
Introduced	5.7.22-ndb-7.6.6
Type	Integer
Default Value	32768
Minimum Value	2048
Maximum Value	4294967295

Sets the size of the data node log buffer. When debugging with high amounts of extra logging, it is possible for the log buffer to run out of space if there are too many log messages, in which case some log messages can be lost. This should not occur during normal operations.

- `--login-path`

Command-Line Format	<code>--login-path=path</code>
Type	String
Default Value	<code>[none]</code>

Read given path from login file.

- `--ndb-connectstring`

Command-Line Format	<code>--ndb-connectstring=connection_string</code>
Type	String
Default Value	<code>[none]</code>

Set connect string for connecting to `ndb_mgmd`. Syntax: "[nodeid=id;][host=]hostname[:port]". Overrides entries in `NDB_CONNECTSTRING` and `my.cnf`.

- `--ndb-mgmd-host`

Command-Line Format	<code>--ndb-mgmd-host=connection_string</code>
Type	String
Default Value	[none]

Same as `--ndb-connectstring`.

- `--ndb-nodeid`

Command-Line Format	<code>--ndb-nodeid=#</code>
Type	Integer
Default Value	[none]

Set node ID for this node, overriding any ID set by `--ndb-connectstring`.

- `--ndb-optimized-node-selection`

Command-Line Format	<code>--ndb-optimized-node-selection</code>
---------------------	---

Enable optimizations for selection of nodes for transactions. Enabled by default; use `--skip-ndb-optimized-node-selection` to disable.

- `--nodaemon`

Command-Line Format	<code>--nodaemon</code>
---------------------	-------------------------

Prevents `ndbd` or `ndbmt` from executing as a daemon process. This option overrides the `--daemon` option. This is useful for redirecting output to the screen when debugging the binary.

The default behavior for `ndbd` and `ndbmt` on Windows is to run in the foreground, making this option unnecessary on Windows platforms, where it has no effect.

- `--no-defaults`

Command-Line Format	<code>--no-defaults</code>
---------------------	----------------------------

Do not read default options from any option file other than login file.

- `--nostart, -n`

Command-Line Format	<code>--nostart</code>
---------------------	------------------------

Instructs `ndbd` not to start automatically. When this option is used, `ndbd` connects to the management server, obtains configuration data from it, and initializes communication objects. However, it does not actually start the execution engine until specifically requested to do so by the management server. This can be accomplished by issuing the proper `START` command in the management client (see [Section 6.1, “Commands in the NDB Cluster Management Client”](#)).

- `--nowait-nodes=node_id_1[, node_id_2[, ...]]`

Command-Line Format	<code>--nowait-nodes=list</code>
Type	String

Default Value	
---------------	--

This option takes a list of data nodes which for which the cluster does not wait for before starting.

This can be used to start the cluster in a partitioned state. For example, to start the cluster with only half of the data nodes (nodes 2, 3, 4, and 5) running in a 4-node cluster, you can start each `ndbd` process with `--nowait-nodes=3,5`. In this case, the cluster starts as soon as nodes 2 and 4 connect, and does *not* wait `StartPartitionedTimeout` milliseconds for nodes 3 and 5 to connect as it would otherwise.

If you wanted to start up the same cluster as in the previous example without one `ndbd` (say, for example, that the host machine for node 3 has suffered a hardware failure) then start nodes 2, 4, and 5 with `--nowait-nodes=3`. Then the cluster starts as soon as nodes 2, 4, and 5 connect and does not wait for node 3 to start.

- `--print-defaults`

Command-Line Format	<code>--print-defaults</code>
---------------------	-------------------------------

Print program argument list and exit.

- `--remove[=name]`

Command-Line Format	<code>--remove[=name]</code>
Platform Specific	Windows
Type	String
Default Value	<code>ndbd</code>

Causes an `ndbd` process that was previously installed as a Windows service to be removed. Optionally, you can specify a name for the service to be uninstalled; if not set, the service name defaults to `ndbd`.

The `--remove` option has no effect on non-Windows platforms.

- `--usage`

Command-Line Format	<code>--usage</code>
---------------------	----------------------

Display help text and exit; same as `--help`.

- `--verbose, -v`

Causes extra debug output to be written to the node log.

In NDB 7.6, you can also use `NODELOG DEBUG ON` and `NODELOG DEBUG OFF` to enable and disable this extra logging while the data node is running.

- `--version`

Command-Line Format	<code>--version</code>
---------------------	------------------------

Display version information and exit.

`ndbd` generates a set of log files which are placed in the directory specified by `DataDir` in the `config.ini` configuration file.

These log files are listed below. `node_id` is and represents the node's unique identifier. For example, `ndb_2_error.log` is the error log generated by the data node whose node ID is 2.

- `ndb_node_id_error.log` is a file containing records of all crashes which the referenced `ndbd` process has encountered. Each record in this file contains a brief error string and a reference to a trace file for this crash. A typical entry in this file might appear as shown here:

```
Date/Time: Saturday 30 July 2004 - 00:20:01
Type of error: error
Message: Internal program error (failed ndbrequire)
Fault ID: 2341
Problem data: DbtupFixAlloc.cpp
Object of reference: DBTUP (Line: 173)
ProgramName: NDB Kernel
ProcessID: 14909
TraceFile: ndb_2_trace.log.2
***EOM***
```

Listings of possible `ndbd` exit codes and messages generated when a data node process shuts down prematurely can be found in [Data Node Error Messages](#).

Important

*The last entry in the error log file is not necessarily the newest one (nor is it likely to be). Entries in the error log are *not* listed in chronological order; rather, they correspond to the order of the trace files as determined in the `ndb_node_id_trace.log.next` file (see below). Error log entries are thus overwritten in a cyclical and not sequential fashion.*

- `ndb_node_id_trace.log.trace_id` is a trace file describing exactly what happened just before the error occurred. This information is useful for analysis by the NDB Cluster development team.

It is possible to configure the number of these trace files that are created before old files are overwritten. `trace_id` is a number which is incremented for each successive trace file.

- `ndb_node_id_trace.log.next` is the file that keeps track of the next trace file number to be assigned.
- `ndb_node_id_out.log` is a file containing any data output by the `ndbd` process. This file is created only if `ndbd` is started as a daemon, which is the default behavior.
- `ndb_node_id.pid` is a file containing the process ID of the `ndbd` process when started as a daemon. It also functions as a lock file to avoid the starting of nodes with the same identifier.
- `ndb_node_id_signal.log` is a file used only in debug versions of `ndbd`, where it is possible to trace all incoming, outgoing, and internal messages with their data in the `ndbd` process.

It is recommended not to use a directory mounted through NFS because in some environments this can cause problems whereby the lock on the `.pid` file remains in effect even after the process has terminated.

To start `ndbd`, it may also be necessary to specify the host name of the management server and the port on which it is listening. Optionally, one may also specify the node ID that the process is to use.

```
$> ndbd --connect-string="nodeid=2;host=ndb_mgmd.mysql.com:1186"
```

See [Section 4.3.3, “NDB Cluster Connection Strings”](#), for additional information about this issue. For more information about data node configuration parameters, see [Section 4.3.6, “Defining NDB Cluster Data Nodes”](#).

When `ndbd` starts, it actually initiates two processes. The first of these is called the “angel process”; its only job is to discover when the execution process has been completed, and then to restart the `ndbd` process if it is configured to do so. Thus, if you attempt to kill `ndbd` using the Unix `kill` command, it is necessary to kill both processes, beginning with the angel process. The preferred method of terminating an `ndbd` process is to use the management client and stop the process from there.

The execution process uses one thread for reading, writing, and scanning data, as well as all other activities. This thread is implemented asynchronously so that it can easily handle thousands of concurrent actions. In addition, a watch-dog thread supervises the execution thread to make sure that it does not hang in an endless loop. A pool of threads handles file I/O, with each thread able to handle one open file. Threads can also be used for transporter connections by the transporters in the `ndbd` process. In a multi-processor system performing a large number of operations (including updates), the `ndbd` process can consume up to 2 CPUs if permitted to do so.

For a machine with many CPUs it is possible to use several `ndbd` processes which belong to different node groups; however, such a configuration is still considered experimental and is not supported for MySQL 5.7 in a production setting. See [Section 2.7, “Known Limitations of NDB Cluster”](#).

5.2 ndbinfo_select_all — Select From ndbinfo Tables

`ndbinfo_select_all` is a client program that selects all rows and columns from one or more tables in the `ndbinfo` database

Not all `ndbinfo` tables available in the `mysql` client can be read by this program. In addition, `ndbinfo_select_all` can show information about some tables internal to `ndbinfo` which cannot be accessed using SQL, including the `tables` and `columns` metadata tables.

To select from one or more `ndbinfo` tables using `ndbinfo_select_all`, it is necessary to supply the names of the tables when invoking the program as shown here:

```
$> ndbinfo_select_all table_name1 [table_name2] [...]
```

For example:

```
$> ndbinfo_select_all logbuffers logspaces
== logbuffers ==
node_id log_type      log_id  log_part      total  used   high
5        0        0        0      33554432    262144  0
6        0        0        0      33554432    262144  0
7        0        0        0      33554432    262144  0
8        0        0        0      33554432    262144  0
== logspaces ==
node_id log_type      log_id  log_part      total  used   high
5        0        0        0      268435456     0     0
5        0        0        1      268435456     0     0
5        0        0        2      268435456     0     0
5        0        0        3      268435456     0     0
6        0        0        0      268435456     0     0
6        0        0        1      268435456     0     0
6        0        0        2      268435456     0     0
6        0        0        3      268435456     0     0
7        0        0        0      268435456     0     0
7        0        0        1      268435456     0     0
7        0        0        2      268435456     0     0
7        0        0        3      268435456     0     0
8        0        0        0      268435456     0     0
8        0        0        1      268435456     0     0
8        0        0        2      268435456     0     0
8        0        0        3      268435456     0     0
$>
```

Options that can be used with `ndbinfo_select_all` are shown in the following table. Additional descriptions follow the table.

Table 5.2 Command-line options used with the program `ndbinfo_select_all`

Format	Description	Added, Deprecated, or Removed
<code>--character-sets-dir=path</code>	Directory containing character sets	(Supported in all NDB releases based on MySQL 5.7)

Format	Description	Added, Deprecated, or Removed
<code>--connect-retries=#</code>	Number of times to retry connection before giving up	(Supported in all NDB releases based on MySQL 5.7)
<code>--connect-retry-delay=#</code>	Number of seconds to wait between attempts to contact management server	(Supported in all NDB releases based on MySQL 5.7)
<code>--connect-string=connection-string,</code> <code>-c connection_string</code>	Same as <code>--ndb-connectstring</code>	(Supported in all NDB releases based on MySQL 5.7)
<code>--core-file</code>	Write core file on error; used in debugging	(Supported in all NDB releases based on MySQL 5.7)
<code>--database=db_name,</code> <code>-d</code>	Name of database where table is located	(Supported in all NDB releases based on MySQL 5.7)
<code>--defaults-extra-file=path</code>	Read given file after global files are read	(Supported in all NDB releases based on MySQL 5.7)
<code>--defaults-file=path</code>	Read default options from given file only	(Supported in all NDB releases based on MySQL 5.7)
<code>--defaults-group-suffix=string</code>	Also read groups with <code>concat(group, suffix)</code>	(Supported in all NDB releases based on MySQL 5.7)
<code>--delay=#</code>	Set delay in seconds between loops	(Supported in all NDB releases based on MySQL 5.7)
<code>--help,</code> <code>-?</code>	Display help text and exit	(Supported in all NDB releases based on MySQL 5.7)
<code>--login-path=path</code>	Read given path from login file	(Supported in all NDB releases based on MySQL 5.7)
<code>--loops=#,</code> <code>-l</code>	Set number of times to perform select	(Supported in all NDB releases based on MySQL 5.7)
<code>--ndb-connectstring=connection-string,</code> <code>-c</code>	Set connect string for connecting to <code>ndb_mgmd</code> . Syntax: "[nodeid=id;][host=]hostname[:port]". Overrides entries in <code>NDB_CONNECTSTRING</code> and <code>my.cnf</code>	(Supported in all NDB releases based on MySQL 5.7)
<code>--ndb-mgmd-host=connection-string,</code> <code>-c</code>	Same as <code>--ndb-connectstring</code>	(Supported in all NDB releases based on MySQL 5.7)
<code>--ndb-nodeid=#</code>	Set node ID for this node, overriding any ID set by <code>--ndb-connectstring</code>	(Supported in all NDB releases based on MySQL 5.7)
<code>--no-defaults</code>	Do not read default options from any option file other than login file	(Supported in all NDB releases based on MySQL 5.7)
<code>--ndb-optimized-node-selection</code>	Enable optimizations for selection of nodes for transactions. Enabled by default;	(Supported in all NDB releases based on MySQL 5.7)

Format	Description	Added, Deprecated, or Removed
<code>--parallelism=#</code> , <code>-p</code>	use <code>--skip-ndb-optimized-node-selection</code> to disable Set degree of parallelism	(Supported in all NDB releases based on MySQL 5.7)
<code>--print-defaults</code>	Print program argument list and exit	(Supported in all NDB releases based on MySQL 5.7)
<code>--usage</code> , <code>-?</code>	Display help text and exit; same as <code>--help</code>	(Supported in all NDB releases based on MySQL 5.7)
<code>--version</code> , <code>-V</code>	Display version information and exit	(Supported in all NDB releases based on MySQL 5.7)

- `--character-sets-dir`

Command-Line Format	<code>--character-sets-dir=path</code>
---------------------	--

Directory containing character sets.

- `--connect-retries`

Command-Line Format	<code>--connect-retries=#</code>
Type	Integer
Default Value	12
Minimum Value	0
Maximum Value	12

Number of times to retry connection before giving up.

- `--connect-retry-delay`

Command-Line Format	<code>--connect-retry-delay=#</code>
Type	Integer
Default Value	5
Minimum Value	0
Maximum Value	5

Number of seconds to wait between attempts to contact management server.

- `--connect-string`

Command-Line Format	<code>--connect-string=connection-string</code>
Type	String
Default Value	[none]

Same as `--ndb-connectstring`.

- `--core-file`

Command-Line Format	<code>--core-file</code>
---------------------	--------------------------

Write core file on error; used in debugging.

- `--defaults-extra-file`

Command-Line Format	<code>--defaults-extra-file=path</code>
Type	String
Default Value	[none]

Read given file after global files are read.

- `--defaults-file`

Command-Line Format	<code>--defaults-file=path</code>
Type	String
Default Value	[none]

Read default options from given file only.

- `--defaults-group-suffix`

Command-Line Format	<code>--defaults-group-suffix=string</code>
Type	String
Default Value	[none]

Also read groups with `concat(group, suffix)`.

- `--delay=seconds`

Command-Line Format	<code>--delay=#</code>
Type	Numeric
Default Value	5
Minimum Value	0
Maximum Value	<code>MAX_INT</code>

This option sets the number of seconds to wait between executing loops. Has no effect if `--loops` is set to 0 or 1.

- `--help`

Command-Line Format	<code>--help</code>
---------------------	---------------------

Display help text and exit.

- `--login-path`

Command-Line Format	<code>--login-path=path</code>
Type	String
Default Value	[none]

Read given path from login file

- `--loops=number`, `-l number`

Command-Line Format	<code>--loops=#</code>
Type	Numeric
Default Value	1
Minimum Value	0
Maximum Value	MAX_INT

This option sets the number of times to execute the select. Use `--delay` to set the time between loops.

- `--ndb-connectstring`

Command-Line Format	<code>--ndb-connectstring=connection-string</code>
Type	String
Default Value	[none]

Set connect string for connecting to ndb_mgmd. Syntax: "[nodeid=id;][host=]hostname[:port]". Overrides entries in NDB_CONNECTSTRING and my.cnf.

- `--ndb-mgmd-host`

Command-Line Format	<code>--ndb-mgmd-host=connection-string</code>
Type	String
Default Value	[none]

Same as `--ndb-connectstring`.

- `--ndb-nodeid`

Command-Line Format	<code>--ndb-nodeid=#</code>
Type	Integer
Default Value	[none]

Set node ID for this node, overriding any ID set by `--ndb-connectstring`.

- `--ndb-optimized-node-selection`

Command-Line Format	<code>--ndb-optimized-node-selection</code>
---------------------	---

Enable optimizations for selection of nodes for transactions. Enabled by default; use `--skip-ndb-optimized-node-selection` to disable.

- `--no-defaults`

Command-Line Format	<code>--no-defaults</code>
---------------------	----------------------------

Do not read default options from any option file other than login file.

- `--print-defaults`

Command-Line Format	<code>--print-defaults</code>
---------------------	-------------------------------

- `--usage`

Command-Line Format	<code>--usage</code>
---------------------	----------------------

Display help text and exit; same as `--help`.

- `--version`

Command-Line Format	<code>--version</code>
---------------------	------------------------

Display version information and exit.

5.3 ndbmttd — The NDB Cluster Data Node Daemon (Multi-Threaded)

`ndbmttd` is a multithreaded version of `ndbd`, the process that is used to handle all the data in tables using the `NDBCLUSTER` storage engine. `ndbmttd` is intended for use on host computers having multiple CPU cores. Except where otherwise noted, `ndbmttd` functions in the same way as `ndbd`; therefore, in this section, we concentrate on the ways in which `ndbmttd` differs from `ndbd`, and you should consult [Section 5.1, “ndbd — The NDB Cluster Data Node Daemon”](#), for additional information about running NDB Cluster data nodes that apply to both the single-threaded and multithreaded versions of the data node process.

Command-line options and configuration parameters used with `ndbd` also apply to `ndbmttd`. For more information about these options and parameters, see [Section 5.1, “ndbd — The NDB Cluster Data Node Daemon”](#), and [Section 4.3.6, “Defining NDB Cluster Data Nodes”](#), respectively.

`ndbmttd` is also file system-compatible with `ndbd`. In other words, a data node running `ndbd` can be stopped, the binary replaced with `ndbmttd`, and then restarted without any loss of data. (However, when doing this, you must make sure that `MaxNoOfExecutionThreads` is set to an appropriate value before restarting the node if you wish for `ndbmttd` to run in multithreaded fashion.) Similarly, an `ndbmttd` binary can be replaced with `ndbd` simply by stopping the node and then starting `ndbd` in place of the multithreaded binary. It is not necessary when switching between the two to start the data node binary using `--initial`.

Using `ndbmttd` differs from using `ndbd` in two key respects:

1. Because `ndbmttd` runs by default in single-threaded mode (that is, it behaves like `ndbd`), you must configure it to use multiple threads. This can be done by setting an appropriate value in the `config.ini` file for the `MaxNoOfExecutionThreads` configuration parameter or the `ThreadConfig` configuration parameter. Using `MaxNoOfExecutionThreads` is simpler, but `ThreadConfig` offers more flexibility. For more information about these configuration parameters and their use, see [Multi-Threading Configuration Parameters \(ndbmttd\)](#).
2. Trace files are generated by critical errors in `ndbmttd` processes in a somewhat different fashion from how these are generated by `ndbd` failures. These differences are discussed in more detail in the next few paragraphs.

Like `ndbd`, `ndbmttd` generates a set of log files which are placed in the directory specified by `DataDir` in the `config.ini` configuration file. Except for trace files, these are generated in the same way and have the same names as those generated by `ndbd`.

In the event of a critical error, `ndbmttd` generates trace files describing what happened just prior to the error's occurrence. These files, which can be found in the data node's `DataDir`, are useful for analysis of problems by the NDB Cluster Development and Support teams. One trace file is generated for each `ndbmttd` thread. The names of these files have the following pattern:

```
ndb_node_id_trace.log.trace_id_tthread_id,
```

In this pattern, *node_id* stands for the data node's unique node ID in the cluster, *trace_id* is a trace sequence number, and *thread_id* is the thread ID. For example, in the event of the failure of an `ndbmt` process running as an NDB Cluster data node having the node ID 3 and with `MaxNoOfExecutionThreads` equal to 4, four trace files are generated in the data node's data directory. If this is the first time this node has failed, then these files are named `ndb_3_trace.log.1_t1`, `ndb_3_trace.log.1_t2`, `ndb_3_trace.log.1_t3`, and `ndb_3_trace.log.1_t4`. Internally, these trace files follow the same format as `ndbd` trace files.

The `ndbd` exit codes and messages that are generated when a data node process shuts down prematurely are also used by `ndbmt`. See [Data Node Error Messages](#), for a listing of these.

Note

It is possible to use `ndbd` and `ndbmt` concurrently on different data nodes in the same NDB Cluster. However, such configurations have not been tested extensively; thus, we cannot recommend doing so in a production setting at this time.

5.4 ndb_mgmd — The NDB Cluster Management Server Daemon

The management server is the process that reads the cluster configuration file and distributes this information to all nodes in the cluster that request it. It also maintains a log of cluster activities. Management clients can connect to the management server and check the cluster's status.

Options that can be used with `ndb_mgmd` are shown in the following table. Additional descriptions follow the table.

Table 5.3 Command-line options used with the program `ndb_mgmd`

Format	Description	Added, Deprecated, or Removed
<code>--bind-address=host</code>	Local bind address	(Supported in all NDB releases based on MySQL 5.7)
<code>--character-sets-dir=path</code>	Directory containing character sets	(Supported in all NDB releases based on MySQL 5.7)
<code>--config-cache[=TRUE FALSE]</code>	Enable management server configuration cache; true by default	(Supported in all NDB releases based on MySQL 5.7)
<code>--config-file=file,</code> <code>-f file</code>	Specify cluster configuration file; also specify <code>--reload</code> or <code>--initial</code> to override configuration cache if present	(Supported in all NDB releases based on MySQL 5.7)
<code>--configdir=directory,</code> <code>--config-dir=directory</code>	Specify cluster management server configuration cache directory	(Supported in all NDB releases based on MySQL 5.7)
<code>--connect-retries=#</code>	Number of times to retry connection before giving up	(Supported in all NDB releases based on MySQL 5.7)
<code>--connect-retry-delay=#</code>	Number of seconds to wait between attempts to contact management server	(Supported in all NDB releases based on MySQL 5.7)
<code>--connect-string=connection_string,</code> <code>-c connection_string</code>	Same as <code>--ndb-connectstring</code>	(Supported in all NDB releases based on MySQL 5.7)
<code>--core-file</code>	Write core file on error; used in debugging	(Supported in all NDB releases based on MySQL 5.7)

Format	Description	Added, Deprecated, or Removed
<code>--daemon,</code> <code>-d</code>	Run ndb_mgmd in daemon mode (default)	(Supported in all NDB releases based on MySQL 5.7)
<code>--defaults-extra-file=path</code>	Read given file after global files are read	(Supported in all NDB releases based on MySQL 5.7)
<code>--defaults-file=path</code>	Read default options from given file only	(Supported in all NDB releases based on MySQL 5.7)
<code>--defaults-group-suffix=string</code>	Also read groups with concat(group, suffix)	(Supported in all NDB releases based on MySQL 5.7)
<code>--help,</code> <code>-?</code>	Display help text and exit	(Supported in all NDB releases based on MySQL 5.7)
<code>--initial</code>	Causes management server to reload configuration data from configuration file, bypassing configuration cache	(Supported in all NDB releases based on MySQL 5.7)
<code>--install[=name]</code>	Used to install management server process as Windows service; does not apply on other platforms	(Supported in all NDB releases based on MySQL 5.7)
<code>--interactive</code>	Run ndb_mgmd in interactive mode (not officially supported in production; for testing purposes only)	(Supported in all NDB releases based on MySQL 5.7)
<code>--log-name=name</code>	Name to use when writing cluster log messages applying to this node	(Supported in all NDB releases based on MySQL 5.7)
<code>--login-path=path</code>	Read given path from login file	(Supported in all NDB releases based on MySQL 5.7)
<code>--mycnf</code>	Read cluster configuration data from my.cnf file	(Supported in all NDB releases based on MySQL 5.7)
<code>--ndb-connectstring=connection_string</code> <code>-c connection_string</code>	Set connect string for connecting to ndb_mgmd. Syntax: "[nodeid=id;][host=]hostname[:port]". Overrides entries in NDB_CONNECTSTRING and my.cnf	(Supported in all NDB releases based on MySQL 5.7)
<code>--ndb-mgmd-host=connection_string,</code> <code>-c connection_string</code>	Same as --ndb-connectstring	(Supported in all NDB releases based on MySQL 5.7)
<code>--ndb-nodeid=#</code>	Set node ID for this node, overriding any ID set by --ndb-connectstring	(Supported in all NDB releases based on MySQL 5.7)
<code>--ndb-optimized-node-selection</code>	Enable optimizations for selection of nodes for transactions. Enabled by default; use --skip-ndb-optimized-node-selection to disable	(Supported in all NDB releases based on MySQL 5.7)

Format	Description	Added, Deprecated, or Removed
<code>--no-defaults</code>	Do not read default options from any option file other than login file	(Supported in all NDB releases based on MySQL 5.7)
<code>--no-nodeid-checks</code>	Do not perform any node ID checks	(Supported in all NDB releases based on MySQL 5.7)
<code>--nodaemon</code>	Do not run ndb_mgmd as a daemon	(Supported in all NDB releases based on MySQL 5.7)
<code>--nowait-nodes=list</code>	Do not wait for management nodes specified when starting this management server; requires <code>--ndb-nodeid</code> option	(Supported in all NDB releases based on MySQL 5.7)
<code>--print-defaults</code>	Print program argument list and exit	(Supported in all NDB releases based on MySQL 5.7)
<code>--print-full-config,</code> <code>-P</code>	Print full configuration and exit	(Supported in all NDB releases based on MySQL 5.7)
<code>--reload</code>	Causes management server to compare configuration file with configuration cache	(Supported in all NDB releases based on MySQL 5.7)
<code>--remove[=name]</code>	Used to remove management server process that was previously installed as Windows service, optionally specifying name of service to be removed; does not apply on other platforms	(Supported in all NDB releases based on MySQL 5.7)
<code>--usage,</code> <code>-?</code>	Display help text and exit; same as <code>--help</code>	(Supported in all NDB releases based on MySQL 5.7)
<code>--skip-config-file</code>	Do not use configuration file	(Supported in all NDB releases based on MySQL 5.7)
<code>--verbose,</code> <code>-v</code>	Write additional information to log	(Supported in all NDB releases based on MySQL 5.7)
<code>--version,</code> <code>-V</code>	Display version information and exit	(Supported in all NDB releases based on MySQL 5.7)

- `--bind-address=host`

Command-Line Format	<code>--bind-address=host</code>
Type	String
Default Value	[none]

Causes the management server to bind to a specific network interface (host name or IP address). This option has no default value.

- `--character-sets-dir`

Command-Line Format	<code>--character-sets-dir=path</code>
---------------------	--

Directory containing character sets.

- `--config-cache`

Command-Line Format	<code>--config-cache[=TRUE FALSE]</code>
Type	Boolean
Default Value	<code>TRUE</code>

This option, whose default value is `1` (or `TRUE`, or `ON`), can be used to disable the management server's configuration cache, so that it reads its configuration from `config.ini` every time it starts (see Section 4.3, “NDB Cluster Configuration Files”). You can do this by starting the `ndb_mgmd` process with any one of the following options:

- `--config-cache=0`
- `--config-cache=FALSE`
- `--config-cache=OFF`
- `--skip-config-cache`

Using one of the options just listed is effective only if the management server has no stored configuration at the time it is started. If the management server finds any configuration cache files, then the `--config-cache` option or the `--skip-config-cache` option is ignored. Therefore, to disable configuration caching, the option should be used the *first* time that the management server is started. Otherwise—that is, if you wish to disable configuration caching for a management server that has *already* created a configuration cache—you must stop the management server, delete any existing configuration cache files manually, then restart the management server with `--skip-config-cache` (or with `--config-cache` set equal to `0`, `OFF`, or `FALSE`).

Configuration cache files are normally created in a directory named `mysql-cluster` under the installation directory (unless this location has been overridden using the `--configdir` option). Each time the management server updates its configuration data, it writes a new cache file. The files are named sequentially in order of creation using the following format:

```
ndb_node-id_config.bin.seq-number
```

`node-id` is the management server's node ID; `seq-number` is a sequence number, beginning with 1. For example, if the management server's node ID is 5, then the first three configuration cache files would, when they are created, be named `ndb_5_config.bin.1`, `ndb_5_config.bin.2`, and `ndb_5_config.bin.3`.

If your intent is to purge or reload the configuration cache without actually disabling caching, you should start `ndb_mgmd` with one of the options `--reload` or `--initial` instead of `--skip-config-cache`.

To re-enable the configuration cache, simply restart the management server, but without the `--config-cache` or `--skip-config-cache` option that was used previously to disable the configuration cache.

`ndb_mgmd` does not check for the configuration directory (`--configdir`) or attempts to create one when `--skip-config-cache` is used. (Bug #13428853)

- `--config-file=filename, -f filename`

Command-Line Format	<code>--config-file=file</code>
Disabled by	<code>skip-config-file</code>
Type	File name

Default Value	[none]
---------------	--------

Instructs the management server as to which file it should use for its configuration file. By default, the management server looks for a file named `config.ini` in the same directory as the `ndb_mgmd` executable; otherwise the file name and location must be specified explicitly.

This option has no default value, and is ignored unless the management server is forced to read the configuration file, either because `ndb_mgmd` was started with the `--reload` or `--initial` option, or because the management server could not find any configuration cache.

The `--config-file` option is also read if `ndb_mgmd` was started with `--config-cache=OFF`. See Section 4.3, “NDB Cluster Configuration Files”, for more information.

- `--configdir=dir_name`

Command-Line Format	<code>--configdir=directory</code> <code>--config-dir=directory</code>
Type	File name
Default Value	<code>\$INSTALLDIR/mysql-cluster</code>

Specifies the cluster management server's configuration cache directory. `--config-dir` is an alias for this option.

- `--connect-retries`

Command-Line Format	<code>--connect-retries=#</code>
Type	Integer
Default Value	12
Minimum Value	0
Maximum Value	12

Number of times to retry connection before giving up.

- `--connect-retry-delay`

Command-Line Format	<code>--connect-retry-delay=#</code>
Type	Integer
Default Value	5
Minimum Value	0
Maximum Value	5

Number of seconds to wait between attempts to contact management server.

- `--connect-string`

Command-Line Format	<code>--connect-string=connection_string</code>
Type	String
Default Value	[none]

Same as `--ndb-connectstring`.

- `--core-file`

Command-Line Format	<code>--core-file</code>
---------------------	--------------------------

Write core file on error; used in debugging.

- `--daemon, -d`

Command-Line Format	<code>--daemon</code>
---------------------	-----------------------

Instructs `ndb_mgmd` to start as a daemon process. This is the default behavior.

This option has no effect when running `ndb_mgmd` on Windows platforms.

- `--defaults-extra-file`

Command-Line Format	<code>--defaults-extra-file=path</code>
Type	String
Default Value	[none]

Read given file after global files are read.

- `--defaults-file`

Command-Line Format	<code>--defaults-file=path</code>
Type	String
Default Value	[none]

Read default options from given file only.

- `--defaults-group-suffix`

Command-Line Format	<code>--defaults-group-suffix=string</code>
Type	String
Default Value	[none]

Also read groups with `concat(group, suffix)`.

- `--help`

Command-Line Format	<code>--help</code>
---------------------	---------------------

Display help text and exit.

- `--initial`

Command-Line Format	<code>--initial</code>
---------------------	------------------------

Configuration data is cached internally, rather than being read from the cluster global configuration file each time the management server is started (see [Section 4.3, “NDB Cluster Configuration Files”](#)). Using the `--initial` option overrides this behavior, by forcing the management server to delete

any existing cache files, and then to re-read the configuration data from the cluster configuration file and to build a new cache.

This differs in two ways from the `--reload` option. First, `--reload` forces the server to check the configuration file against the cache and reload its data only if the contents of the file are different from the cache. Second, `--reload` does not delete any existing cache files.

If `ndb_mgmd` is invoked with `--initial` but cannot find a global configuration file, the management server cannot start.

When a management server starts, it checks for another management server in the same NDB Cluster and tries to use the other management server's configuration data. This behavior has implications when performing a rolling restart of an NDB Cluster with multiple management nodes. See [Section 6.5, "Performing a Rolling Restart of an NDB Cluster"](#), for more information.

When used together with the `--config-file` option, the cache is cleared only if the configuration file is actually found.

- `--install[=name]`

Command-Line Format	<code>--install[=name]</code>
Platform Specific	Windows
Type	String
Default Value	<code>ndb_mgmd</code>

Causes `ndb_mgmd` to be installed as a Windows service. Optionally, you can specify a name for the service; if not set, the service name defaults to `ndb_mgmd`. Although it is preferable to specify other `ndb_mgmd` program options in a `my.ini` or `my.cnf` configuration file, it is possible to use them together with `--install`. However, in such cases, the `--install` option must be specified first, before any other options are given, for the Windows service installation to succeed.

It is generally not advisable to use this option together with the `--initial` option, since this causes the configuration cache to be wiped and rebuilt every time the service is stopped and started. Care should also be taken if you intend to use any other `ndb_mgmd` options that affect the starting of the management server, and you should make absolutely certain you fully understand and allow for any possible consequences of doing so.

The `--install` option has no effect on non-Windows platforms.

- `--interactive`

Command-Line Format	<code>--interactive</code>
---------------------	----------------------------

Starts `ndb_mgmd` in interactive mode; that is, an `ndb_mgm` client session is started as soon as the management server is running. This option does not start any other NDB Cluster nodes.

- `--login-path`

Command-Line Format	<code>--login-path=path</code>
Type	String
Default Value	<code>[none]</code>

Read given path from login file.

- `--log-name=name`

Command-Line Format	<code>--log-name=name</code>
---------------------	------------------------------

Type	String
Default Value	MgmtSrvr

Provides a name to be used for this node in the cluster log.

- `--mycnf`

Command-Line Format	<code>--mycnf</code>
---------------------	----------------------

Read configuration data from the `my.cnf` file.

- `--ndb-connectstring`

Command-Line Format	<code>--ndb-connectstring=connection_string</code>
Type	String
Default Value	[none]

Set connection string. Syntax: `[nodeid=id;][host=]hostname[:port]`. Overrides entries in `NDB_CONNECTSTRING` and `my.cnf`; ignored if `--config-file` is specified.

- `--ndb-mgmd-host`

Command-Line Format	<code>--ndb-mgmd-host=connection_string</code>
Type	String
Default Value	[none]

Same as `--ndb-connectstring`.

- `--ndb-nodeid`

Command-Line Format	<code>--ndb-nodeid=#</code>
Type	Integer
Default Value	[none]

Set node ID for this node, overriding any ID set by `--ndb-connectstring`.

- `--ndb-optimized-node-selection`

Command-Line Format	<code>--ndb-optimized-node-selection</code>
---------------------	---

Enable optimizations for selection of nodes for transactions. Enabled by default; use `--skip-ndb-optimized-node-selection` to disable.

- `--no-defaults`

Command-Line Format	<code>--no-defaults</code>
---------------------	----------------------------

Do not read default options from any option file other than login file.

- `--no-nodeid-checks`

Command-Line Format	<code>--no-nodeid-checks</code>
---------------------	---------------------------------

Do not perform any checks of node IDs.

- `--nodaemon`

Command-Line Format	<code>--nodaemon</code>
---------------------	-------------------------

Instructs `ndb_mgmd` not to start as a daemon process.

The default behavior for `ndb_mgmd` on Windows is to run in the foreground, making this option unnecessary on Windows platforms.

- `--nowait-nodes`

Command-Line Format	<code>--nowait-nodes=list</code>
Type	Numeric
Default Value	[none]
Minimum Value	1
Maximum Value	255

When starting an NDB Cluster is configured with two management nodes, each management server normally checks to see whether the other `ndb_mgmd` is also operational and whether the other management server's configuration is identical to its own. However, it is sometimes desirable to start the cluster with only one management node (and perhaps to allow the other `ndb_mgmd` to be started later). This option causes the management node to bypass any checks for any other management nodes whose node IDs are passed to this option, permitting the cluster to start as though configured to use only the management node that was started.

For purposes of illustration, consider the following portion of a `config.ini` file (where we have omitted most of the configuration parameters that are not relevant to this example):

```
[ndbd]
NodeId = 1
HostName = 198.51.100.101

[ndbd]
NodeId = 2
HostName = 198.51.100.102

[ndbd]
NodeId = 3
HostName = 198.51.100.103

[ndbd]
NodeId = 4
HostName = 198.51.100.104

[ndb_mgmd]
NodeId = 10
HostName = 198.51.100.150

[ndb_mgmd]
NodeId = 11
HostName = 198.51.100.151

[api]
NodeId = 20
HostName = 198.51.100.200

[api]
NodeId = 21
HostName = 198.51.100.201
```

Assume that you wish to start this cluster using only the management server having node ID 10 and running on the host having the IP address 198.51.100.150. (Suppose, for example, that the host computer on which you intend to the other management server is temporarily unavailable due to

a hardware failure, and you are waiting for it to be repaired.) To start the cluster in this way, use a command line on the machine at 198.51.100.150 to enter the following command:

```
$> ndb_mgmd --ndb-nodeid=10 --nowait-nodes=11
```

As shown in the preceding example, when using `--nowait-nodes`, you must also use the `--ndb-nodeid` option to specify the node ID of this `ndb_mgmd` process.

You can then start each of the cluster's data nodes in the usual way. If you wish to start and use the second management server in addition to the first management server at a later time without restarting the data nodes, you must start each data node with a connection string that references both management servers, like this:

```
$> ndbd -c 198.51.100.150,198.51.100.151
```

The same is true with regard to the connection string used with any `mysqld` processes that you wish to start as NDB Cluster SQL nodes connected to this cluster. See [Section 4.3.3, “NDB Cluster Connection Strings”](#), for more information.

When used with `ndb_mgmd`, this option affects the behavior of the management node with regard to other management nodes only. Do not confuse it with the `--nowait-nodes` option used with `ndbd` or `ndbmta` to permit a cluster to start with fewer than its full complement of data nodes; when used with data nodes, this option affects their behavior only with regard to other data nodes.

Multiple management node IDs may be passed to this option as a comma-separated list. Each node ID must be no less than 1 and no greater than 255. In practice, it is quite rare to use more than two management servers for the same NDB Cluster (or to have any need for doing so); in most cases you need to pass to this option only the single node ID for the one management server that you do not wish to use when starting the cluster.

Note

When you later start the “missing” management server, its configuration must match that of the management server that is already in use by the cluster. Otherwise, it fails the configuration check performed by the existing management server, and does not start.

- `--print-defaults`

Command-Line Format	<code>--print-defaults</code>
---------------------	-------------------------------

Print program argument list and exit.

- `--print-full-config, -P`

Command-Line Format	<code>--print-full-config</code>
---------------------	----------------------------------

Shows extended information regarding the configuration of the cluster. With this option on the command line the `ndb_mgmd` process prints information about the cluster setup including an extensive list of the cluster configuration sections as well as parameters and their values. Normally used together with the `--config-file (-f)` option.

- `--reload`

Command-Line Format	<code>--reload</code>
---------------------	-----------------------

NDB Cluster configuration data is stored internally rather than being read from the cluster global configuration file each time the management server is started (see [Section 4.3, “NDB Cluster Configuration Files”](#)). Using this option forces the management server to check its internal data store

against the cluster configuration file and to reload the configuration if it finds that the configuration file does not match the cache. Existing configuration cache files are preserved, but not used.

This differs in two ways from the `--initial` option. First, `--initial` causes all cache files to be deleted. Second, `--initial` forces the management server to re-read the global configuration file and construct a new cache.

If the management server cannot find a global configuration file, then the `--reload` option is ignored.

When `--reload` is used, the management server must be able to communicate with data nodes and any other management servers in the cluster before it attempts to read the global configuration file; otherwise, the management server fails to start. This can happen due to changes in the networking environment, such as new IP addresses for nodes or an altered firewall configuration. In such cases, you must use `--initial` instead to force the existing cached configuration to be discarded and reloaded from the file. See [Section 6.5, “Performing a Rolling Restart of an NDB Cluster”](#), for additional information.

- `--remove[=name]`

Command-Line Format	<code>--remove[=name]</code>
Platform Specific	Windows
Type	String
Default Value	<code>ndb_mgmd</code>

Remove a management server process that has been installed as a Windows service, optionally specifying the name of the service to be removed. Applies only to Windows platforms.

- `--skip-config-file`

Command-Line Format	<code>--skip-config-file</code>
---------------------	---------------------------------

Do not read cluster configuration file; ignore `--initial` and `--reload` options if specified.

- `--usage`

Command-Line Format	<code>--usage</code>
---------------------	----------------------

Display help text and exit; same as `--help`.

- `--verbose, -v`

Command-Line Format	<code>--verbose</code>
---------------------	------------------------

Remove a management server process that has been installed as a Windows service, optionally specifying the name of the service to be removed. Applies only to Windows platforms.

- `--version`

Command-Line Format	<code>--version</code>
---------------------	------------------------

Display version information and exit.

It is not strictly necessary to specify a connection string when starting the management server. However, if you are using more than one management server, a connection string should be provided and each node in the cluster should specify its node ID explicitly.

See [Section 4.3.3, “NDB Cluster Connection Strings”](#), for information about using connection strings. [Section 5.4, “ndb_mgmd — The NDB Cluster Management Server Daemon”](#), describes other options for `ndb_mgmd`.

The following files are created or used by `ndb_mgmd` in its starting directory, and are placed in the `DataDir` as specified in the `config.ini` configuration file. In the list that follows, `node_id` is the unique node identifier.

- `config.ini` is the configuration file for the cluster as a whole. This file is created by the user and read by the management server. [Chapter 4, Configuration of NDB Cluster](#), discusses how to set up this file.
- `ndb_node_id_cluster.log` is the cluster events log file. Examples of such events include checkpoint startup and completion, node startup events, node failures, and levels of memory usage. A complete listing of cluster events with descriptions may be found in [Chapter 6, Management of NDB Cluster](#).

By default, when the size of the cluster log reaches one million bytes, the file is renamed to `ndb_node_id_cluster.log.seq_id`, where `seq_id` is the sequence number of the cluster log file. (For example: If files with the sequence numbers 1, 2, and 3 already exist, the next log file is named using the number 4.) You can change the size and number of files, and other characteristics of the cluster log, using the `LogDestination` configuration parameter.

- `ndb_node_id_out.log` is the file used for `stdout` and `stderr` when running the management server as a daemon.
- `ndb_node_id.pid` is the process ID file used when running the management server as a daemon.

5.5 ndb_mgm — The NDB Cluster Management Client

The `ndb_mgm` management client process is actually not needed to run the cluster. Its value lies in providing a set of commands for checking the cluster's status, starting backups, and performing other administrative functions. The management client accesses the management server using a C API. Advanced users can also employ this API for programming dedicated management processes to perform tasks similar to those performed by `ndb_mgm`.

To start the management client, it is necessary to supply the host name and port number of the management server:

```
$> ndb_mgm [host_name [port_num]]
```

For example:

```
$> ndb_mgm ndb_mgmd.mysql.com 1186
```

The default host name and port number are `localhost` and 1186, respectively.

Options that can be used with `ndb_mgm` are shown in the following table. Additional descriptions follow the table.

Table 5.4 Command-line options used with the program `ndb_mgm`

Format	Description	Added, Deprecated, or Removed
<code>--character-sets-dir=path</code>	Directory containing character sets	(Supported in all NDB releases based on MySQL 5.7)
<code>--connect-retry-delay=#</code>	Number of seconds to wait between attempts to contact management server	(Supported in all NDB releases based on MySQL 5.7)
<code>--connect-string=connection_string,</code>	Same as <code>--ndb-connectstring</code>	(Supported in all NDB releases based on MySQL 5.7)

Format	Description	Added, Deprecated, or Removed
<code>-c connection_string</code> <code>--core-file</code> <code>--defaults-extra-file=path</code> <code>--defaults-file=path</code> <code>--defaults-group-suffix=string</code> <code>--execute=command,</code> <code>-e command</code> <code>--help,</code> <code>-?</code> <code>--login-path=path</code>	Write core file on error; used in debugging Read given file after global files are read Read default options from given file only Also read groups with concat(group, suffix) Execute command and exit	(Supported in all NDB releases based on MySQL 5.7) (Supported in all NDB releases based on MySQL 5.7) (Supported in all NDB releases based on MySQL 5.7) (Supported in all NDB releases based on MySQL 5.7) (Supported in all NDB releases based on MySQL 5.7)
<code>--ndb-connectstring=connection_string</code> <code>-c connection_string</code> <code>--ndb-mgmd-host=connection_string,</code> <code>-c connection_string</code> <code>--ndb-nodeid=#</code> <code>--ndb-optimized-node-selection</code>	Set connect string for connecting to ndb_mgmd. Syntax: "[nodeid=id;][host=]hostname[:port]". Overrides entries in NDB_CONNECTSTRING and my.cnf Same as --ndb-connectstring Set node ID for this node, overriding any ID set by --ndb-connectstring Enable optimizations for selection of nodes for transactions. Enabled by default; use --skip-ndb-optimized-node-selection to disable	(Supported in all NDB releases based on MySQL 5.7) (Supported in all NDB releases based on MySQL 5.7) (Supported in all NDB releases based on MySQL 5.7)
<code>--no-defaults</code> <code>--print-defaults</code> <code>--try-reconnect=#,</code> <code>-t #</code> <code>--usage,</code> <code>-?</code> <code>--version,</code> <code>-V</code>	Do not read default options from any option file other than login file Print program argument list and exit Set number of times to retry connection before giving up; synonym for --connect-retries Display help text and exit; same as --help Display version information and exit	(Supported in all NDB releases based on MySQL 5.7) (Supported in all NDB releases based on MySQL 5.7) (Supported in all NDB releases based on MySQL 5.7) (Supported in all NDB releases based on MySQL 5.7)

- `--character-sets-dir`

Command-Line Format	<code>--character-sets-dir=path</code>
---------------------	--

Directory containing character sets.

- `--connect-retries=#`

Command-Line Format	<code>--connect-retries=#</code>
Type	Numeric
Default Value	3
Minimum Value	0
Maximum Value	4294967295

This option specifies the number of times following the first attempt to retry a connection before giving up (the client always tries the connection at least once). The length of time to wait per attempt is set using `--connect-retry-delay`.

This option is synonymous with the `--try-reconnect` option, which is now deprecated.

- `--connect-retry-delay`

Command-Line Format	<code>--connect-retry-delay=#</code>
Type	Integer
Default Value	5
Minimum Value	0
Maximum Value	5

Number of seconds to wait between attempts to contact management server.

- `--connect-string`

Command-Line Format	<code>--connect-string=connection_string</code>
Type	String
Default Value	[none]

Same as `--ndb-connectstring`.

- `--core-file`

Command-Line Format	<code>--core-file</code>
---------------------	--------------------------

Write core file on error; used in debugging.

- `--defaults-extra-file`

Command-Line Format	<code>--defaults-extra-file=path</code>
Type	String
Default Value	[none]

Read given file after global files are read.

- `--defaults-file`

Command-Line Format	<code>--defaults-file=path</code>
---------------------	-----------------------------------

Type	String
Default Value	[none]

Read default options from given file only.

- `--defaults-group-suffix`

Command-Line Format	<code>--defaults-group-suffix=string</code>
Type	String
Default Value	[none]

Also read groups with `concat(group, suffix)`.

- `--execute=command, -e command`

Command-Line Format	<code>--execute=command</code>
---------------------	--------------------------------

This option can be used to send a command to the NDB Cluster management client from the system shell. For example, either of the following is equivalent to executing `SHOW` in the management client:

```
$> ndb_mgm -e "SHOW"
$> ndb_mgm --execute="SHOW"
```

This is analogous to how the `--execute` or `-e` option works with the `mysql` command-line client. See [Using Options on the Command Line](#).

Note

If the management client command to be passed using this option contains any space characters, then the command *must* be enclosed in quotation marks. Either single or double quotation marks may be used. If the management client command contains no space characters, the quotation marks are optional.

- `--help`

Command-Line Format	<code>--help</code>
---------------------	---------------------

Display help text and exit.

- `--login-path`

Command-Line Format	<code>--login-path=path</code>
Type	String
Default Value	[none]

Read given path from login file.

- `--ndb-connectstring`

Command-Line Format	<code>--ndb-connectstring=connection_string</code>
Type	String
Default Value	[none]

Set connect string for connecting to `ndb_mgmd`. Syntax: `[nodeid=id;][host=]hostname[:port]`. Overrides entries in `NDB_CONNECTSTRING` and `my.cnf`.

- `--ndb-mgmd-host`

Command-Line Format	<code>--ndb-mgmd-host=connection_string</code>
Type	String
Default Value	[none]

Same as `--ndb-connectstring`.

- `--ndb-nodeid`

Command-Line Format	<code>--ndb-nodeid=#</code>
Type	Integer
Default Value	[none]

Set node ID for this node, overriding any ID set by `--ndb-connectstring`.

- `--ndb-optimized-node-selection`

Command-Line Format	<code>--ndb-optimized-node-selection</code>
---------------------	---

Enable optimizations for selection of nodes for transactions. Enabled by default; use `--skip-ndb-optimized-node-selection` to disable.

- `--no-defaults`

Command-Line Format	<code>--no-defaults</code>
---------------------	----------------------------

Do not read default options from any option file other than login file.

- `--print-defaults`

Command-Line Format	<code>--print-defaults</code>
---------------------	-------------------------------

Print program argument list and exit.

- `--try-reconnect=number`

Command-Line Format	<code>--try-reconnect=#</code>
Deprecated	Yes
Type (≥ 5.7.10-ndb-7.5.0)	Numeric
Type	Integer
Default Value (≥ 5.7.10-ndb-7.5.0)	12
Default Value	3
Minimum Value	0
Maximum Value	4294967295

If the connection to the management server is broken, the node tries to reconnect to it every 5 seconds until it succeeds. By using this option, it is possible to limit the number of attempts to `number` before giving up and reporting an error instead.

This option is deprecated and subject to removal in a future release. Use `--connect-retries`, instead.

- `--usage`

Command-Line Format	<code>--usage</code>
---------------------	----------------------

Display help text and exit; same as `--help`.

- `--version`

Command-Line Format	<code>--version</code>
---------------------	------------------------

Display version information and exit.

Additional information about using `ndb_mgm` can be found in [Section 6.1, “Commands in the NDB Cluster Management Client”](#).

5.6 ndb_blob_tool — Check and Repair BLOB and TEXT columns of NDB Cluster Tables

This tool can be used to check for and remove orphaned BLOB column parts from NDB tables, as well as to generate a file listing any orphaned parts. It is sometimes useful in diagnosing and repairing corrupted or damaged NDB tables containing BLOB or TEXT columns.

The basic syntax for `ndb_blob_tool` is shown here:

```
ndb_blob_tool [options] table [column, ...]
```

Unless you use the `--help` option, you must specify an action to be performed by including one or more of the options `--check-orphans`, `--delete-orphans`, or `--dump-file`. These options cause `ndb_blob_tool` to check for orphaned BLOB parts, remove any orphaned BLOB parts, and generate a dump file listing orphaned BLOB parts, respectively, and are described in more detail later in this section.

You must also specify the name of a table when invoking `ndb_blob_tool`. In addition, you can optionally follow the table name with the (comma-separated) names of one or more BLOB or TEXT columns from that table. If no columns are listed, the tool works on all of the table's BLOB and TEXT columns. If you need to specify a database, use the `--database (-d)` option.

The `--verbose` option provides additional information in the output about the tool's progress.

Options that can be used with `ndb_blob_tool` are shown in the following table. Additional descriptions follow the table.

Table 5.5 Command-line options used with the program `ndb_blob_tool`

Format	Description	Added, Deprecated, or Removed
<code>--add-missing</code>	Write dummy blob parts to take place of those which are missing	ADDED: NDB 7.5.18, NDB 7.6.14
<code>--character-sets-dir=path</code>	Directory containing character sets	(Supported in all NDB releases based on MySQL 5.7)
<code>--check-missing</code>	Check for blobs having inline parts but missing one or more parts from parts table	ADDED: NDB 7.5.18, NDB 7.6.14
<code>--check-orphans</code>	Check for blob parts having no corresponding inline parts	(Supported in all NDB releases based on MySQL 5.7)
<code>--connect-retries=#</code>	Number of times to retry connection before giving up	(Supported in all NDB releases based on MySQL 5.7)

Format	Description	Added, Deprecated, or Removed
<code>--connect-retry-delay=#</code>	Number of seconds to wait between attempts to contact management server	(Supported in all NDB releases based on MySQL 5.7)
<code>--connect-string=connection_string,</code> <code>-c connection_string</code>	Same as <code>--ndb-connectstring</code>	(Supported in all NDB releases based on MySQL 5.7)
<code>--core-file</code>	Write core file on error; used in debugging	(Supported in all NDB releases based on MySQL 5.7)
<code>--database=name,</code> <code>-d name</code>	Database to find the table in	(Supported in all NDB releases based on MySQL 5.7)
<code>--defaults-extra-file=path</code>	Read given file after global files are read	(Supported in all NDB releases based on MySQL 5.7)
<code>--defaults-file=path</code>	Read default options from given file only	(Supported in all NDB releases based on MySQL 5.7)
<code>--defaults-group-suffix=string</code>	Also read groups with <code>concat(group, suffix)</code>	(Supported in all NDB releases based on MySQL 5.7)
<code>--delete-orphans</code>	Delete blob parts having no corresponding inline parts	(Supported in all NDB releases based on MySQL 5.7)
<code>--dump-file=file</code>	Write orphan keys to specified file	(Supported in all NDB releases based on MySQL 5.7)
<code>--help,</code> <code>-?</code>	Display help text and exit	(Supported in all NDB releases based on MySQL 5.7)
<code>--login-path=path</code>	Read given path from login file	(Supported in all NDB releases based on MySQL 5.7)
<code>--ndb-connectstring=connection_string,</code> <code>-c connection_string</code>	Set connect string for connecting to <code>ndb_mgmd</code> . Syntax: "[nodeid=id;][host=]hostname[:port]". Overrides entries in <code>NDB_CONNECTSTRING</code> and <code>my.cnf</code>	(Supported in all NDB releases based on MySQL 5.7)
<code>--ndb-mgmd-host=connection_string,</code> <code>-c connection_string</code>	Same as <code>--ndb-connectstring</code>	(Supported in all NDB releases based on MySQL 5.7)
<code>--ndb-nodeid=#</code>	Set node ID for this node, overriding any ID set by <code>--ndb-connectstring</code>	(Supported in all NDB releases based on MySQL 5.7)
<code>--ndb-optimized-node-selection</code>	Enable optimizations for selection of nodes for transactions. Enabled by default; use <code>--skip-ndb-optimized-node-selection</code> to disable	(Supported in all NDB releases based on MySQL 5.7)
<code>--no-defaults</code>	Do not read default options from any option file other than login file	(Supported in all NDB releases based on MySQL 5.7)

Format	Description	Added, Deprecated, or Removed
<code>--print-defaults</code>	Print program argument list and exit	(Supported in all NDB releases based on MySQL 5.7)
<code>--usage</code> , <code>-?</code>	Display help text and exit; same as <code>--help</code>	(Supported in all NDB releases based on MySQL 5.7)
<code>--verbose</code> , <code>-v</code>	Verbose output	(Supported in all NDB releases based on MySQL 5.7)
<code>--version</code> , <code>-V</code>	Display version information and exit	(Supported in all NDB releases based on MySQL 5.7)

- `--add-missing`

Command-Line Format	<code>--add-missing</code>
Introduced	5.7.29-ndb-7.6.14

For each inline part in NDB Cluster tables which has no corresponding BLOB part, write a dummy BLOB part of the required length, consisting of spaces.

- `--character-sets-dir`

Command-Line Format	<code>--character-sets-dir=path</code>
---------------------	--

Directory containing character sets.

- `--check-missing`

Command-Line Format	<code>--check-missing</code>
Introduced	5.7.29-ndb-7.6.14

Check for inline parts in NDB Cluster tables which have no corresponding BLOB parts.

- `--check-orphans`

Command-Line Format	<code>--check-orphans</code>
---------------------	------------------------------

Check for BLOB parts in NDB Cluster tables which have no corresponding inline parts.

- `--connect-retries`

Command-Line Format	<code>--connect-retries=#</code>
Type	Integer
Default Value	12
Minimum Value	0
Maximum Value	12

Number of times to retry connection before giving up.

- `--connect-retry-delay`

Command-Line Format	<code>--connect-retry-delay=#</code>
Type	Integer

Default Value	5
Minimum Value	0
Maximum Value	5

Number of seconds to wait between attempts to contact management server.

- `--connect-string`

Command-Line Format	<code>--connect-string=connection_string</code>
Type	String
Default Value	[none]

Same as `--ndb-connectstring`.

- `--core-file`

Command-Line Format	<code>--core-file</code>
---------------------	--------------------------

Write core file on error; used in debugging.

- `--database=db_name, -d`

Command-Line Format	<code>--database=name</code>
Type	String
Default Value	[none]

Specify the database to find the table in.

- `--defaults-extra-file`

Command-Line Format	<code>--defaults-extra-file=path</code>
Type	String
Default Value	[none]

Read given file after global files are read.

- `--defaults-file`

Command-Line Format	<code>--defaults-file=path</code>
Type	String
Default Value	[none]

Read default options from given file only.

- `--defaults-group-suffix`

Command-Line Format	<code>--defaults-group-suffix=string</code>
Type	String
Default Value	[none]

Also read groups with `concat(group, suffix)`.

- `--delete-orphans`

Command-Line Format	<code>--delete-orphans</code>
---------------------	-------------------------------

Remove BLOB parts from NDB Cluster tables which have no corresponding inline parts.

- `--dump-file=file`

Command-Line Format	<code>--dump-file=file</code>
Type	File name
Default Value	[none]

Writes a list of orphaned BLOB column parts to *file*. The information written to the file includes the table key and BLOB part number for each orphaned BLOB part.

- `--help`

Command-Line Format	<code>--help</code>
---------------------	---------------------

Display help text and exit.

- `--login-path`

Command-Line Format	<code>--login-path=path</code>
Type	String
Default Value	[none]

Read given path from login file.

- `--ndb-connectstring`

Command-Line Format	<code>--ndb-connectstring=connection_string</code>
Type	String
Default Value	[none]

Set connect string for connecting to ndb_mgmd. Syntax: "[nodeid=id;][host=]hostname[:port]". Overrides entries in NDB_CONNECTSTRING and my.cnf.

- `--ndb-mgmd-host`

Command-Line Format	<code>--ndb-mgmd-host=connection_string</code>
Type	String
Default Value	[none]

Same as `--ndb-connectstring`.

- `--ndb-nodeid`

Command-Line Format	<code>--ndb-nodeid=#</code>
Type	Integer
Default Value	[none]

Set node ID for this node, overriding any ID set by `--ndb-connectstring`.

- `--ndb-optimized-node-selection`

Command-Line Format	<code>--ndb-optimized-node-selection</code>
---------------------	---

Enable optimizations for selection of nodes for transactions. Enabled by default; use `--skip-ndb-optimized-node-selection` to disable.

- `--no-defaults`

Command-Line Format	<code>--no-defaults</code>
---------------------	----------------------------

Do not read default options from any option file other than login file.

- `--print-defaults`

Command-Line Format	<code>--print-defaults</code>
---------------------	-------------------------------

Print program argument list and exit.

- `--usage`

Command-Line Format	<code>--usage</code>
---------------------	----------------------

Display help text and exit; same as `--help`.

- `--verbose`

Command-Line Format	<code>--verbose</code>
---------------------	------------------------

Provide extra information in the tool's output regarding its progress.

- `--version`

Command-Line Format	<code>--version</code>
---------------------	------------------------

Display version information and exit.

Example

First we create an NDB table in the `test` database, using the `CREATE TABLE` statement shown here:

```
USE test;

CREATE TABLE btest (
  c0 BIGINT UNSIGNED NOT NULL AUTO_INCREMENT PRIMARY KEY,
  c1 TEXT,
  c2 BLOB
) ENGINE=NDB;
```

Then we insert a few rows into this table, using a series of statements similar to this one:

```
INSERT INTO btest VALUES (NULL, 'x', REPEAT('x', 1000));
```

When run with `--check-orphans` against this table, `ndb_blob_tool` generates the following output:

```
$> ndb_blob_tool --check-orphans --verbose -d test btest
connected
processing 2 blobs
processing blob #0 c1 NDB$BLOB_19_1
NDB$BLOB_19_1: nextResult: res=1
total parts: 0
orphan parts: 0
processing blob #1 c2 NDB$BLOB_19_2
NDB$BLOB_19_2: nextResult: res=0
NDB$BLOB_19_2: nextResult: res=0
```

```
NDB$BLOB_19_2: nextResult: res=0
NDB$BLOB_19_2: nextResult: res=0
NDB$BLOB_19_2: nextResult: res=0
NDB$BLOB_19_2: nextResult: res=0
NDB$BLOB_19_2: nextResult: res=0
NDB$BLOB_19_2: nextResult: res=0
NDB$BLOB_19_2: nextResult: res=0
NDB$BLOB_19_2: nextResult: res=0
NDB$BLOB_19_2: nextResult: res=1
total parts: 10
orphan parts: 0
disconnected

NDBT_ProgramExit: 0 - OK
```

The tool reports that there are no NDB BLOB column parts associated with column `c1`, even though `c1` is a TEXT column. This is due to the fact that, in an NDB table, only the first 256 bytes of a BLOB or TEXT column value are stored inline, and only the excess, if any, is stored separately; thus, if there are no values using more than 256 bytes in a given column of one of these types, no BLOB column parts are created by NDB for this column. See [Data Type Storage Requirements](#), for more information.

5.7 ndb_config — Extract NDB Cluster Configuration Information

This tool extracts current configuration information for data nodes, SQL nodes, and API nodes from one of a number of sources: an NDB Cluster management node, or its `config.ini` or `my.cnf` file. By default, the management node is the source for the configuration data; to override the default, execute `ndb_config` with the `--config-file` or `--mycnf` option. It is also possible to use a data node as the source by specifying its node ID with `--config_from_node=node_id`.

`ndb_config` can also provide an offline dump of all configuration parameters which can be used, along with their default, maximum, and minimum values and other information. The dump can be produced in either text or XML format; for more information, see the discussion of the `--configinfo` and `--xml` options later in this section).

You can filter the results by section (`DB`, `SYSTEM`, or `CONNECTIONS`) using one of the options `--nodes`, `--system`, or `--connections`.

Options that can be used with `ndb_config` are shown in the following table. Additional descriptions follow the table.

Table 5.6 Command-line options used with the program `ndb_config`

Format	Description	Added, Deprecated, or Removed
<code>--character-sets-dir=path</code>	Directory containing character sets	(Supported in all NDB releases based on MySQL 5.7)
<code>--config-file=file_name</code>	Set the path to config.ini file	(Supported in all NDB releases based on MySQL 5.7)
<code>--config-from-node=#</code>	Obtain configuration data from the node having this ID (must be a data node)	(Supported in all NDB releases based on MySQL 5.7)
<code>--configinfo</code>	Dumps information about all NDB configuration parameters in text format with default, maximum, and minimum values. Use with <code>--xml</code> to obtain XML output	(Supported in all NDB releases based on MySQL 5.7)
<code>--connections</code>	Print information only about connections specified in [tcp], [tcp default], [sci], [sci default], [shm], or [shm default] sections	(Supported in all NDB releases based on MySQL 5.7)

Format	Description	Added, Deprecated, or Removed
	of cluster configuration file. Cannot be used with --system or --nodes	
<code>--connect-retries=#</code>	Number of times to retry connection before giving up	(Supported in all NDB releases based on MySQL 5.7)
<code>--connect-retry-delay=#</code>	Number of seconds to wait between attempts to contact management server	(Supported in all NDB releases based on MySQL 5.7)
<code>--connect-string=connection_string,</code> <code>-c connection_string</code>	Same as --ndb-connectstring	(Supported in all NDB releases based on MySQL 5.7)
<code>--core-file</code>	Write core file on error; used in debugging	(Supported in all NDB releases based on MySQL 5.7)
<code>--defaults-extra-file=path</code>	Read given file after global files are read	(Supported in all NDB releases based on MySQL 5.7)
<code>--defaults-file=path</code>	Read default options from given file only	(Supported in all NDB releases based on MySQL 5.7)
<code>--defaults-group-suffix=string</code>	Also read groups with concat(group, suffix)	(Supported in all NDB releases based on MySQL 5.7)
<code>--diff-default</code>	Print only configuration parameters that have non-default values	ADDED: NDB 7.5.7, NDB 7.6.3
<code>--fields=string,</code> <code>-f</code>	Field separator	(Supported in all NDB releases based on MySQL 5.7)
<code>--help,</code> <code>-?</code>	Display help text and exit	(Supported in all NDB releases based on MySQL 5.7)
<code>--host=name</code>	Specify host	(Supported in all NDB releases based on MySQL 5.7)
<code>--login-path=path</code>	Read given path from login file	(Supported in all NDB releases based on MySQL 5.7)
<code>--mycnf</code>	Read configuration data from my.cnf file	(Supported in all NDB releases based on MySQL 5.7)
<code>--ndb-connectstring=connection_string,</code> <code>-c connection_string</code>	Set connect string for connecting to ndb_mgmd. Syntax: "[nodeid=id;][host=]hostname[:port]". Overrides entries in NDB_CONNECTSTRING and my.cnf	(Supported in all NDB releases based on MySQL 5.7)
<code>--ndb-mgmd-host=connection_string,</code> <code>-c connection_string</code>	Same as --ndb-connectstring	(Supported in all NDB releases based on MySQL 5.7)
<code>--ndb-nodeid=#</code>	Set node ID for this node, overriding any ID set by --ndb-connectstring	(Supported in all NDB releases based on MySQL 5.7)

Format	Description	Added, Deprecated, or Removed
<code>--ndb-optimized-node-selection</code>	Enable optimizations for selection of nodes for transactions. Enabled by default; use <code>--skip-ndb-optimized-node-selection</code> to disable	(Supported in all NDB releases based on MySQL 5.7)
<code>--no-defaults</code>	Do not read default options from any option file other than login file	(Supported in all NDB releases based on MySQL 5.7)
<code>--nodeid=#</code>	Get configuration of node with this ID	(Supported in all NDB releases based on MySQL 5.7)
<code>--nodes</code>	Print node information ([<code>ndbd</code>] or [<code>ndbd default</code>] section of cluster configuration file) only. Cannot be used with <code>--system</code> or <code>--connections</code>	(Supported in all NDB releases based on MySQL 5.7)
<code>--query=string,</code> <code>-q string</code>	One or more query options (attributes)	(Supported in all NDB releases based on MySQL 5.7)
<code>--query-all,</code> <code>-a</code>	Dumps all parameters and values to a single comma-delimited string	ADDED: NDB 7.4.16, NDB 7.5.7
<code>--print-defaults</code>	Print program argument list and exit	(Supported in all NDB releases based on MySQL 5.7)
<code>--rows=string,</code> <code>-r string</code>	Row separator	(Supported in all NDB releases based on MySQL 5.7)
<code>--system</code>	Print SYSTEM section information only (see <code>ndb_config --configinfo</code> output). Cannot be used with <code>--nodes</code> or <code>--connections</code>	(Supported in all NDB releases based on MySQL 5.7)
<code>--type=name</code>	Specify node type	(Supported in all NDB releases based on MySQL 5.7)
<code>--usage,</code> <code>-?</code>	Display help text and exit; same as <code>--help</code>	(Supported in all NDB releases based on MySQL 5.7)
<code>--version,</code> <code>-V</code>	Display version information and exit	(Supported in all NDB releases based on MySQL 5.7)
<code>--configinfo --xml</code>	Use <code>--xml</code> with <code>--configinfo</code> to obtain a dump of all NDB configuration parameters in XML format with default, maximum, and minimum values	(Supported in all NDB releases based on MySQL 5.7)

- `--character-sets-dir`

Command-Line Format	<code>--character-sets-dir=path</code>
---------------------	--

Directory containing character sets.

- `--configinfo`

The `--configinfo` option causes `ndb_config` to dump a list of each NDB Cluster configuration parameter supported by the NDB Cluster distribution of which `ndb_config` is a part, including the following information:

- A brief description of each parameter's purpose, effects, and usage
- The section of the `config.ini` file where the parameter may be used
- The parameter's data type or unit of measurement
- Where applicable, the parameter's default, minimum, and maximum values
- NDB Cluster release version and build information

By default, this output is in text format. Part of this output is shown here:

```
$> ndb_config --configinfo

***** SYSTEM *****

Name (String)
Name of system (NDB Cluster)
MANDATORY

PrimaryMGMNode (Non-negative Integer)
Node id of Primary ndb_mgmd(MGM) node
Default: 0 (Min: 0, Max: 4294967039)

ConfigGenerationNumber (Non-negative Integer)
Configuration generation number
Default: 0 (Min: 0, Max: 4294967039)

***** DB *****

MaxNoOfSubscriptions (Non-negative Integer)
Max no of subscriptions (default 0 == MaxNoOfTables)
Default: 0 (Min: 0, Max: 4294967039)

MaxNoOfSubscribers (Non-negative Integer)
Max no of subscribers (default 0 == 2 * MaxNoOfTables)
Default: 0 (Min: 0, Max: 4294967039)

...
```

Use this option together with the `--xml` option to obtain output in XML format.

- `--config-file=path-to-file`

Command-Line Format	<code>--config-file=file_name</code>
Type	File name
Default Value	

Gives the path to the management server's configuration file (`config.ini`). This may be a relative or absolute path. If the management node resides on a different host from the one on which `ndb_config` is invoked, then an absolute path must be used.

- `--config_from_node=#`

Command-Line Format	<code>--config-from-node=#</code>
Type	Numeric
Default Value	<code>none</code>

Minimum Value	1
Maximum Value	48

Obtain the cluster's configuration data from the data node that has this ID.

If the node having this ID is not a data node, `ndb_config` fails with an error. (To obtain configuration data from the management node instead, simply omit this option.)

- `--connections`

Command-Line Format	<code>--connections</code>
---------------------	----------------------------

Tells `ndb_config` to print `CONNECTIONS` information only—that is, information about parameters found in the `[tcp]`, `[tcp default]`, `[shm]`, or `[shm default]` sections of the cluster configuration file (see [Section 4.3.10, “NDB Cluster TCP/IP Connections”](#), and [Section 4.3.12, “NDB Cluster Shared Memory Connections”](#), for more information).

This option is mutually exclusive with `--nodes` and `--system`; only one of these 3 options can be used.

- `--connect-retries`

Command-Line Format	<code>--connect-retries=#</code>
Type	Integer
Default Value	12
Minimum Value	0
Maximum Value	12

Number of times to retry connection before giving up.

- `--connect-retry-delay`

Command-Line Format	<code>--connect-retry-delay=#</code>
Type	Integer
Default Value	5
Minimum Value	0
Maximum Value	5

Number of seconds to wait between attempts to contact management server.

- `--connect-string`

Command-Line Format	<code>--connect-string=connection_string</code>
Type	String
Default Value	<code>[none]</code>

Same as `--ndb-connectstring`.

- `--core-file`

Command-Line Format	<code>--core-file</code>
---------------------	--------------------------

Write core file on error; used in debugging.

- `--defaults-extra-file`

Command-Line Format	<code>--defaults-extra-file=path</code>
Type	String
Default Value	[none]

Read given file after global files are read.

- `--defaults-file`

Command-Line Format	<code>--defaults-file=path</code>
Type	String
Default Value	[none]

Read default options from given file only.

- `--defaults-group-suffix`

Command-Line Format	<code>--defaults-group-suffix=string</code>
Type	String
Default Value	[none]

Also read groups with `concat(group, suffix)`.

- `--diff-default`

Command-Line Format	<code>--diff-default</code>
Introduced	5.7.18-ndb-7.6.3

Print only configuration parameters that have non-default values.

- `--fields=delimiter, -f delimiter`

Command-Line Format	<code>--fields=string</code>
Type	String
Default Value	

Specifies a *delimiter* string used to separate the fields in the result. The default is `,` (the comma character).

Note

If the *delimiter* contains spaces or escapes (such as `\n` for the linefeed character), then it must be quoted.

- `--help`

Command-Line Format	<code>--help</code>
---------------------	---------------------

Display help text and exit.

- `--host=hostname`

Command-Line Format	<code>--host=name</code>
Type	String
Default Value	

Specifies the host name of the node for which configuration information is to be obtained.

Note

While the hostname `localhost` usually resolves to the IP address `127.0.0.1`, this may not necessarily be true for all operating platforms and configurations. This means that it is possible, when `localhost` is used in `config.ini`, for `ndb_config --host=localhost` to fail if `ndb_config` is run on a different host where `localhost` resolves to a different address (for example, on some versions of SUSE Linux, this is `127.0.0.2`). In general, for best results, you should use numeric IP addresses for all NDB Cluster configuration values relating to hosts, or verify that all NDB Cluster hosts handle `localhost` in the same fashion.

- `--login-path`

Command-Line Format	<code>--login-path=path</code>
Type	String
Default Value	[none]

Read given path from login file.

- `--mycnf`

Command-Line Format	<code>--mycnf</code>
---------------------	----------------------

Read configuration data from the `my.cnf` file.

- `--ndb-connectstring=connection_string, -c connection_string`

Command-Line Format	<code>--ndb-connectstring=connection_string</code>
Type	String
Default Value	[none]

Specifies the connection string to use in connecting to the management server. The format for the connection string is the same as described in [Section 4.3.3, “NDB Cluster Connection Strings”](#), and defaults to `localhost:1186`.

- `--ndb-mgmd-host`

Command-Line Format	<code>--ndb-mgmd-host=connection_string</code>
Type	String
Default Value	[none]

Same as `--ndb-connectstring`.

- `--ndb-nodeid`

Command-Line Format	<code>--ndb-nodeid=#</code>
Type	Integer
Default Value	[none]

Set node ID for this node, overriding any ID set by `--ndb-connectstring`.

- `--ndb-optimized-node-selection`

Command-Line Format	<code>--ndb-optimized-node-selection</code>
---------------------	---

Enable optimizations for selection of nodes for transactions. Enabled by default; use `--skip-ndb-optimized-node-selection` to disable.

- `--no-defaults`

Command-Line Format	<code>--no-defaults</code>
---------------------	----------------------------

Do not read default options from any option file other than login file.

- `--nodeid=node_id`

Command-Line Format	<code>--ndb-nodeid=#</code>
Type	Integer
Default Value	[none]

Specify the node ID of the node for which configuration information is to be obtained. Formerly, `--id` could be used as a synonym for this option; in NDB 7.5 and later, the only form accepted is `--nodeid`.

- `--nodes`

Command-Line Format	<code>--nodes</code>
---------------------	----------------------

Tells `ndb_config` to print information relating only to parameters defined in an `[ndbd]` or `[ndbd default]` section of the cluster configuration file (see [Section 4.3.6, “Defining NDB Cluster Data Nodes”](#)).

This option is mutually exclusive with `--connections` and `--system`; only one of these 3 options can be used.

- `--query=query-options, -q query-options`

Command-Line Format	<code>--query=string</code>
Type	String
Default Value	

This is a comma-delimited list of *query options*—that is, a list of one or more node attributes to be returned. These include `nodeid` (node ID), `type` (node type—that is, `ndbd`, `mysqld`, or `ndb_mgmd`), and any configuration parameters whose values are to be obtained.

For example, `--query=nodeid,type,datamemory,datadir` returns the node ID, node type, `DataMemory`, and `DataDir` for each node.

Formerly, `id` was accepted as a synonym for `nodeid`, but has been removed in NDB 7.5 and later.

Note

If a given parameter is not applicable to a certain type of node, than an empty string is returned for the corresponding value. See the examples later in this section for more information.

- `--query-all, -a`

Command-Line Format	<code>--query-all</code>
Introduced	5.7.18-ndb-7.5.7

Type	String
Default Value	

Returns a comma-delimited list of all query options (node attributes; note that this list is a single string).

This option was introduced in NDB 7.5.7 (Bug #60095, Bug #11766869).

- `--print-defaults`

Command-Line Format	<code>--print-defaults</code>
---------------------	-------------------------------

Print program argument list and exit.

- `--rows=separator, -r separator`

Command-Line Format	<code>--rows=string</code>
Type	String
Default Value	

Specifies a *separator* string used to separate the rows in the result. The default is a space character.

Note

If the *separator* contains spaces or escapes (such as `\n` for the linefeed character), then it must be quoted.

- `--system`

Command-Line Format	<code>--system</code>
---------------------	-----------------------

Tells `ndb_config` to print `SYSTEM` information only. This consists of system variables that cannot be changed at run time; thus, there is no corresponding section of the cluster configuration file for them. They can be seen (prefixed with `***** SYSTEM *****`) in the output of `ndb_config --configinfo`.

This option is mutually exclusive with `--nodes` and `--connections`; only one of these 3 options can be used.

- `--type=node_type`

Command-Line Format	<code>--type=name</code>
Type	Enumeration
Default Value	[none]
Valid Values	<code>ndbd</code> <code>mysqld</code> <code>ndb_mgmd</code>

Filters results so that only configuration values applying to nodes of the specified *node_type* (`ndbd`, `mysqld`, or `ndb_mgmd`) are returned.

- `--usage`, `--help`, or `-?`

Command-Line Format	<code>--help</code>
---------------------	---------------------

Causes `ndb_config` to print a list of available options, and then exit. Synonym for `--help`.

- `--version`, `-V`

Command-Line Format	<code>--version</code>
---------------------	------------------------

Causes `ndb_config` to print a version information string, and then exit.

- `--configinfo --xml`

Command-Line Format	<code>--configinfo --xml</code>
---------------------	---------------------------------

Cause `ndb_config --configinfo` to provide output as XML by adding this option. A portion of such output is shown in this example:

```
$> ndb_config --configinfo --xml

<configvariables protocolversion="1" ndbversionstring="5.7.36-ndb-7.5.25"
  ndbversion="460032" ndbversionmajor="7" ndbversionminor="5"
  ndbversionbuild="0">
  <section name="SYSTEM">
    <param name="Name" comment="Name of system (NDB Cluster)" type="string"
      mandatory="true"/>
    <param name="PrimaryMGMNode" comment="Node id of Primary ndb_mgmd(MGM) node"
      type="unsigned" default="0" min="0" max="4294967039"/>
    <param name="ConfigGenerationNumber" comment="Configuration generation number"
      type="unsigned" default="0" min="0" max="4294967039"/>
  </section>
  <section name="MYSQLD" primarykeys="NodeId">
    <param name="wan" comment="Use WAN TCP setting as default" type="bool"
      default="false"/>
    <param name="HostName" comment="Name of computer for this node"
      type="string" default=""/>
    <param name="Id" comment="NodeId" type="unsigned" mandatory="true"
      min="1" max="255" deprecated="true"/>
    <param name="NodeId" comment="Number identifying application node (mysqld(API))"
      type="unsigned" mandatory="true" min="1" max="255"/>
    <param name="ExecuteOnComputer" comment="HostName" type="string"
      deprecated="true"/>
    ...
  </section>
  ...
</configvariables>
```

Note

Normally, the XML output produced by `ndb_config --configinfo --xml` is formatted using one line per element; we have added extra whitespace in the previous example, as well as the next one, for reasons of legibility. This should not make any difference to applications using this output, since most XML processors either ignore nonessential whitespace as a matter of course, or can be instructed to do so.

The XML output also indicates when changing a given parameter requires that data nodes be restarted using the `--initial` option. This is shown by the presence of an `initial="true"` attribute in the corresponding `<param>` element. In addition, the restart type (`system` or `node`) is also shown; if a given parameter requires a system restart, this is indicated by the presence of

a `restart="system"` attribute in the corresponding `<param>` element. For example, changing the value set for the `Diskless` parameter requires a system initial restart, as shown here (with the `restart` and `initial` attributes highlighted for visibility):

```
<param name="Diskless" comment="Run wo/ disk" type="bool" default="false"
      restart="system" initial="true" />
```

Currently, no `initial` attribute is included in the XML output for `<param>` elements corresponding to parameters which do not require initial restarts; in other words, `initial="false"` is the default, and the value `false` should be assumed if the attribute is not present. Similarly, the default restart type is `node` (that is, an online or “rolling” restart of the cluster), but the `restart` attribute is included only if the restart type is `system` (meaning that all cluster nodes must be shut down at the same time, then restarted).

Deprecated parameters are indicated in the XML output by the `deprecated` attribute, as shown here:

```
<param name="NoOfDiskPagesToDiskAfterRestartACC" comment="DiskCheckpointSpeed"
      type="unsigned" default="20" min="1" max="4294967039" deprecated="true" />
```

In such cases, the `comment` refers to one or more parameters that supersede the deprecated parameter. Similarly to `initial`, the `deprecated` attribute is indicated only when the parameter is deprecated, with `deprecated="true"`, and does not appear at all for parameters which are not deprecated. (Bug #21127135)

Beginning with NDB 7.5.0, parameters that are required are indicated with `mandatory="true"`, as shown here:

```
<param name="NodeId"
      comment="Number identifying application node (mysqld(API))"
      type="unsigned" mandatory="true" min="1" max="255" />
```

In much the same way that the `initial` or `deprecated` attribute is displayed only for a parameter that requires an initial restart or that is deprecated, the `mandatory` attribute is included only if the given parameter is actually required.

Important

The `--xml` option can be used only with the `--configinfo` option. Using `--xml` without `--configinfo` fails with an error.

Unlike the options used with this program to obtain current configuration data, `--configinfo` and `--xml` use information obtained from the NDB Cluster sources when `ndb_config` was compiled. For this reason, no connection to a running NDB Cluster or access to a `config.ini` or `my.cnf` file is required for these two options.

Combining other `ndb_config` options (such as `--query` or `--type`) with `--configinfo` (with or without the `--xml` option) is not supported. Currently, if you attempt to do so, the usual result is that all other options besides `--configinfo` or `--xml` are simply ignored. *However, this behavior is not guaranteed and is subject to change at any time.* In addition, since `ndb_config`, when used with the `--configinfo` option, does not access the NDB Cluster or read any files, trying to specify additional options such as `--ndb-connectstring` or `--config-file` with `--configinfo` serves no purpose.

Examples

1. To obtain the node ID and type of each node in the cluster:

```
$> ./ndb_config --query=nodeid,type --fields=':' --rows='\n'
1:ndbd
2:ndbd
3:ndbd
4:ndbd
```

```
5:ndb_mgmd
6:mysqld
7:mysqld
8:mysqld
9:mysqld
```

In this example, we used the `--fields` options to separate the ID and type of each node with a colon character (:), and the `--rows` options to place the values for each node on a new line in the output.

- To produce a connection string that can be used by data, SQL, and API nodes to connect to the management server:

```
$> ./ndb_config --config-file=usr/local/mysql/cluster-data/config.ini \
--query=hostname,portnumber --fields=: --rows=, --type=ndb_mgmd
198.51.100.179:1186
```

- This invocation of `ndb_config` checks only data nodes (using the `--type` option), and shows the values for each node's ID and host name, as well as the values set for its `DataMemory` and `DataDir` parameters:

```
$> ./ndb_config --type=ndbd --query=nodeid,host,datamemory,datadir -f ' : ' -r '\n'
1 : 198.51.100.193 : 83886080 : /usr/local/mysql/cluster-data
2 : 198.51.100.112 : 83886080 : /usr/local/mysql/cluster-data
3 : 198.51.100.176 : 83886080 : /usr/local/mysql/cluster-data
4 : 198.51.100.119 : 83886080 : /usr/local/mysql/cluster-data
```

In this example, we used the short options `-f` and `-r` for setting the field delimiter and row separator, respectively, as well as the short option `-q` to pass a list of parameters to be obtained.

- To exclude results from any host except one in particular, use the `--host` option:

```
$> ./ndb_config --host=198.51.100.176 -f : -r '\n' -q id,type
3:ndbd
5:ndb_mgmd
```

In this example, we also used the short form `-q` to determine the attributes to be queried.

Similarly, you can limit results to a node with a specific ID using the `--nodeid` option.

5.8 ndb_cpcd — Automate Testing for NDB Development

A utility having this name was formerly part of an internal automated test framework used in testing and debugging NDB Cluster. It is no longer included in NDB Cluster distributions provided by Oracle.

5.9 ndb_delete_all — Delete All Rows from an NDB Table

`ndb_delete_all` deletes all rows from the given NDB table. In some cases, this can be much faster than `DELETE` or even `TRUNCATE TABLE`.

Usage

```
ndb_delete_all -c connection_string tbl_name -d db_name
```

This deletes all rows from the table named `tbl_name` in the database named `db_name`. It is exactly equivalent to executing `TRUNCATE db_name.tbl_name` in MySQL.

Options that can be used with `ndb_delete_all` are shown in the following table. Additional descriptions follow the table.

Table 5.7 Command-line options used with the program `ndb_delete_all`

Format	Description	Added, Deprecated, or Removed
<code>--character-sets-dir=path</code>	Directory containing character sets	(Supported in all NDB releases based on MySQL 5.7)
<code>--connect-retries=#</code>	Number of times to retry connection before giving up	(Supported in all NDB releases based on MySQL 5.7)
<code>--connect-retry-delay=#</code>	Number of seconds to wait between attempts to contact management server	(Supported in all NDB releases based on MySQL 5.7)
<code>--connect-string=connection_string,</code> <code>-c connection_string</code>	Same as <code>--ndb-connectstring</code>	(Supported in all NDB releases based on MySQL 5.7)
<code>--core-file</code>	Write core file on error; used in debugging	(Supported in all NDB releases based on MySQL 5.7)
<code>--database=name,</code> <code>-d name</code>	Name of the database in which the table is found	(Supported in all NDB releases based on MySQL 5.7)
<code>--defaults-extra-file=path</code>	Read given file after global files are read	(Supported in all NDB releases based on MySQL 5.7)
<code>--defaults-file=path</code>	Read default options from given file only	(Supported in all NDB releases based on MySQL 5.7)
<code>--defaults-group-suffix=string</code>	Also read groups with <code>concat(group, suffix)</code>	(Supported in all NDB releases based on MySQL 5.7)
<code>--diskscan</code>	Perform disk scan	(Supported in all NDB releases based on MySQL 5.7)
<code>--help,</code> <code>-?</code>	Display help text and exit	(Supported in all NDB releases based on MySQL 5.7)
<code>--login-path=path</code>	Read given path from login file	(Supported in all NDB releases based on MySQL 5.7)
<code>--ndb-connectstring=connection_string,</code> <code>-c connection_string</code>	Set connect string for connecting to <code>ndb_mgmd</code> . Syntax: "[nodeid=id;][host=]hostname[:port]". Overrides entries in <code>NDB_CONNECTSTRING</code> and <code>my.cnf</code>	(Supported in all NDB releases based on MySQL 5.7)
<code>--ndb-mgmd-host=connection_string,</code> <code>-c connection_string</code>	Same as <code>--ndb-connectstring</code>	(Supported in all NDB releases based on MySQL 5.7)
<code>--ndb-nodeid=#</code>	Set node ID for this node, overriding any ID set by <code>--ndb-connectstring</code>	(Supported in all NDB releases based on MySQL 5.7)
<code>--ndb-optimized-node-selection</code>	Enable optimizations for selection of nodes for transactions. Enabled by default; use <code>--skip-ndb-optimized-node-selection</code> to disable	(Supported in all NDB releases based on MySQL 5.7)

Format	Description	Added, Deprecated, or Removed
<code>--no-defaults</code>	Do not read default options from any option file other than login file	(Supported in all NDB releases based on MySQL 5.7)
<code>--print-defaults</code>	Print program argument list and exit	(Supported in all NDB releases based on MySQL 5.7)
<code>--transactional,</code> <code>-t</code>	Perform delete in one single transaction; possible to run out of operations when used	(Supported in all NDB releases based on MySQL 5.7)
<code>--tupscan</code>	Perform tuple scan	(Supported in all NDB releases based on MySQL 5.7)
<code>--usage,</code> <code>-?</code>	Display help text and exit; same as <code>--help</code>	(Supported in all NDB releases based on MySQL 5.7)
<code>--version,</code> <code>-V</code>	Display version information and exit	(Supported in all NDB releases based on MySQL 5.7)

- `--character-sets-dir`

Command-Line Format	<code>--character-sets-dir=path</code>
---------------------	--

Directory containing character sets.

- `--connect-retries`

Command-Line Format	<code>--connect-retries=#</code>
Type	Integer
Default Value	12
Minimum Value	0
Maximum Value	12

Number of times to retry connection before giving up.

- `--connect-retry-delay`

Command-Line Format	<code>--connect-retry-delay=#</code>
Type	Integer
Default Value	5
Minimum Value	0
Maximum Value	5

Number of seconds to wait between attempts to contact management server.

- `--connect-string`

Command-Line Format	<code>--connect-string=connection_string</code>
Type	String
Default Value	[none]

Same as `--ndb-connectstring`.

- `--core-file`

Command-Line Format	<code>--core-file</code>
---------------------	--------------------------

Write core file on error; used in debugging.

- `--database, -d`

Command-Line Format	<code>--database=name</code>
Type	String
Default Value	<code>TEST_DB</code>

Name of the database containing the table to delete from.

- `--defaults-extra-file`

Command-Line Format	<code>--defaults-extra-file=path</code>
Type	String
Default Value	<code>[none]</code>

Read given file after global files are read.

- `--defaults-file`

Command-Line Format	<code>--defaults-file=path</code>
Type	String
Default Value	<code>[none]</code>

Read default options from given file only.

- `--defaults-group-suffix`

Command-Line Format	<code>--defaults-group-suffix=string</code>
Type	String
Default Value	<code>[none]</code>

Also read groups with `concat(group, suffix)`.

- `--diskscan`

Command-Line Format	<code>--diskscan</code>
---------------------	-------------------------

Run a disk scan.

- `--help`

Command-Line Format	<code>--help</code>
---------------------	---------------------

Display help text and exit.

- `--login-path`

Command-Line Format	<code>--login-path=path</code>
Type	String

Default Value	[none]
---------------	--------

Read given path from login file.

- `--ndb-connectstring`

Command-Line Format	<code>--ndb-connectstring=connection_string</code>
Type	String
Default Value	[none]

Set connect string for connecting to `ndb_mgmd`. Syntax: "[nodeid=id;][host=]hostname[:port]". Overrides entries in `NDB_CONNECTSTRING` and `my.cnf`.

- `--ndb-mgmd-host`

Command-Line Format	<code>--ndb-mgmd-host=connection_string</code>
Type	String
Default Value	[none]

Same as `--ndb-connectstring`.

- `--ndb-nodeid`

Command-Line Format	<code>--ndb-nodeid=#</code>
Type	Integer
Default Value	[none]

Set node ID for this node, overriding any ID set by `--ndb-connectstring`.

- `--ndb-optimized-node-selection`

Command-Line Format	<code>--ndb-optimized-node-selection</code>
---------------------	---

Enable optimizations for selection of nodes for transactions. Enabled by default; use `--skip-ndb-optimized-node-selection` to disable.

- `--no-defaults`

Command-Line Format	<code>--no-defaults</code>
---------------------	----------------------------

Do not read default options from any option file other than login file.

- `--print-defaults`

Command-Line Format	<code>--print-defaults</code>
---------------------	-------------------------------

Print program argument list and exit.

- `--transactional, -t`

Use of this option causes the delete operation to be performed as a single transaction.

Warning

With very large tables, using this option may cause the number of operations available to the cluster to be exceeded.

- `--tupscan`

Run a tuple scan.

- `--usage`

Command-Line Format	<code>--usage</code>
---------------------	----------------------

Display help text and exit; same as `--help`.

- `--version`

Command-Line Format	<code>--version</code>
---------------------	------------------------

Display version information and exit.

5.10 ndb_desc — Describe NDB Tables

`ndb_desc` provides a detailed description of one or more [NDB](#) tables.

Usage

```
ndb_desc -c connection_string tbl_name -d db_name [options]
```

```
ndb_desc -c connection_string index_name -d db_name -t tbl_name
```

Additional options that can be used with `ndb_desc` are listed later in this section.

Sample Output

MySQL table creation and population statements:

```
USE test;

CREATE TABLE fish (
  id INT(11) NOT NULL AUTO_INCREMENT,
  name VARCHAR(20) NOT NULL,
  length_mm INT(11) NOT NULL,
  weight_gm INT(11) NOT NULL,

  PRIMARY KEY pk (id),
  UNIQUE KEY uk (name)
) ENGINE=NDB;

INSERT INTO fish VALUES
  (NULL, 'guppy', 35, 2), (NULL, 'tuna', 2500, 150000),
  (NULL, 'shark', 3000, 110000), (NULL, 'manta ray', 1500, 50000),
  (NULL, 'grouper', 900, 125000), (NULL, 'puffer', 250, 2500);
```

Output from `ndb_desc`:

```
$> ./ndb_desc -c localhost fish -d test -p
-- fish --
Version: 2
Fragment type: HashMapPartition
K Value: 6
Min load factor: 78
Max load factor: 80
Temporary table: no
Number of attributes: 4
Number of primary keys: 1
Length of frm data: 337
Max Rows: 0
Row Checksum: 1
Row GCI: 1
SingleUserMode: 0
ForceVarPart: 1
```

```

PartitionCount: 2
FragmentCount: 2
PartitionBalance: FOR_RP_BY_LDM
ExtraRowGciBits: 0
ExtraRowAuthorBits: 0
TableStatus: Retrieved
Table options:
HashMap: DEFAULT-HASHMAP-3840-2
-- Attributes --
id Int PRIMARY KEY DISTRIBUTION KEY AT=FIXED ST=MEMORY AUTO_INCR
name Varchar(20;latin1_swedish_ci) NOT NULL AT=SHORT_VAR ST=MEMORY DYNAMIC
length_nm Int NOT NULL AT=FIXED ST=MEMORY DYNAMIC
weight_gm Int NOT NULL AT=FIXED ST=MEMORY DYNAMIC
-- Indexes --
PRIMARY KEY(id) - UniqueHashIndex
PRIMARY(id) - OrderedIndex
uk(name) - OrderedIndex
uk$unique(name) - UniqueHashIndex
-- Per partition info --
Partition      Row count      Commit count      Frag fixed memory      Frag var sized memory      Extent_
0              2              2                 32768                  32768                      0
1              4              4                 32768                  32768                      0

NDBT_ProgramExit: 0 - OK

```

Information about multiple tables can be obtained in a single invocation of `ndb_desc` by using their names, separated by spaces. All of the tables must be in the same database.

You can obtain additional information about a specific index using the `--table` (short form: `-t`) option and supplying the name of the index as the first argument to `ndb_desc`, as shown here:

```

$> ./ndb_desc uk -d test -t fish
-- uk --
Version: 2
Base table: fish
Number of attributes: 1
Logging: 0
Index type: OrderedIndex
Index status: Retrieved
-- Attributes --
name Varchar(20;latin1_swedish_ci) NOT NULL AT=SHORT_VAR ST=MEMORY
-- IndexTable 10/uk --
Version: 2
Fragment type: FragUndefined
K Value: 6
Min load factor: 78
Max load factor: 80
Temporary table: yes
Number of attributes: 2
Number of primary keys: 1
Length of frm data: 0
Max Rows: 0
Row Checksum: 1
Row GCI: 1
SingleUserMode: 2
ForceVarPart: 0
PartitionCount: 2
FragmentCount: 2
FragmentCountType: ONE_PER_LDM_PER_NODE
ExtraRowGciBits: 0
ExtraRowAuthorBits: 0
TableStatus: Retrieved
Table options:
-- Attributes --
name Varchar(20;latin1_swedish_ci) NOT NULL AT=SHORT_VAR ST=MEMORY
NDB$TNODE Unsigned [64] PRIMARY KEY DISTRIBUTION KEY AT=FIXED ST=MEMORY
-- Indexes --
PRIMARY KEY(NDB$TNODE) - UniqueHashIndex

NDBT_ProgramExit: 0 - OK

```

When an index is specified in this way, the `--extra-partition-info` and `--extra-node-info` options have no effect.

The `Version` column in the output contains the table's schema object version. For information about interpreting this value, see [NDB Schema Object Versions](#).

Three of the table properties that can be set using `NDB_TABLE` comments embedded in `CREATE TABLE` and `ALTER TABLE` statements are also visible in `ndb_desc` output. The table's `FRAGMENT_COUNT_TYPE` is always shown in the `FragmentCountType` column. `READ_ONLY` and `FULLY_REPLICATED`, if set to 1, are shown in the `Table options` column. You can see this after executing the following `ALTER TABLE` statement in the `mysql` client:

```
mysql> ALTER TABLE fish COMMENT='NDB_TABLE=READ_ONLY=1,FULLY_REPLICATED=1';
1 row in set, 1 warning (0.00 sec)

mysql> SHOW WARNINGS\G
+-----+-----+-----+
| Level   | Code | Message
+-----+-----+-----+
| Warning | 1296 | Got error 4503 'Table property is FRAGMENT_COUNT_TYPE=ONE_PER_LDM_PER_NODE but not in c
+-----+-----+-----+
1 row in set (0.00 sec)
```

The warning is issued because `READ_ONLY=1` requires that the table's fragment count type is (or be set to) `ONE_PER_LDM_PER_NODE_GROUP`; NDB sets this automatically in such cases. You can check that the `ALTER TABLE` statement has the desired effect using `SHOW CREATE TABLE`:

```
mysql> SHOW CREATE TABLE fish\G
***** 1. row *****
      Table: fish
Create Table: CREATE TABLE `fish` (
  `id` int(11) NOT NULL AUTO_INCREMENT,
  `name` varchar(20) NOT NULL,
  `length_mm` int(11) NOT NULL,
  `weight_gm` int(11) NOT NULL,
  PRIMARY KEY (`id`),
  UNIQUE KEY `uk` (`name`)
) ENGINE=ndbcluster DEFAULT CHARSET=latin1
COMMENT='NDB_TABLE=READ_BACKUP=1,FULLY_REPLICATED=1'
1 row in set (0.01 sec)
```

Because `FRAGMENT_COUNT_TYPE` was not set explicitly, its value is not shown in the comment text printed by `SHOW CREATE TABLE`. `ndb_desc`, however, displays the updated value for this attribute. The `Table options` column shows the binary properties just enabled. You can see this in the output shown here (emphasized text):

```
$> ./ndb_desc -c localhost fish -d test -p
-- fish --
Version: 4
Fragment type: HashMapPartition
K Value: 6
Min load factor: 78
Max load factor: 80
Temporary table: no
Number of attributes: 4
Number of primary keys: 1
Length of frm data: 380
Max Rows: 0
Row Checksum: 1
Row GCI: 1
SingleUserMode: 0
ForceVarPart: 1
PartitionCount: 1
FragmentCount: 1
FragmentCountType: ONE_PER_LDM_PER_NODE_GROUP
ExtraRowGciBits: 0
ExtraRowAuthorBits: 0
TableStatus: Retrieved
Table options: readbackup, fullyreplicated
```

```

HashMap: DEFAULT-HASHMAP-3840-1
-- Attributes --
id Int PRIMARY KEY DISTRIBUTION KEY AT=FIXED ST=MEMORY AUTO_INCR
name Varchar(20;latin1_swedish_ci) NOT NULL AT=SHORT_VAR ST=MEMORY DYNAMIC
length_mm Int NOT NULL AT=FIXED ST=MEMORY DYNAMIC
weight_gm Int NOT NULL AT=FIXED ST=MEMORY DYNAMIC
-- Indexes --
PRIMARY KEY(id) - UniqueHashIndex
PRIMARY(id) - OrderedIndex
uk(name) - OrderedIndex
uk$unique(name) - UniqueHashIndex
-- Per partition info --
Partition          Row count          Commit count          Frag fixed memory          Frag varsized memory          Extent_
NDBT_ProgramExit: 0 - OK

```

For more information about these table properties, see [Setting NDB_TABLE Options](#).

The `Extent_space` and `Free extent_space` columns are applicable only to NDB tables having columns on disk; for tables having only in-memory columns, these columns always contain the value 0.

To illustrate their use, we modify the previous example. First, we must create the necessary Disk Data objects, as shown here:

```

CREATE LOGFILE GROUP lg_1
  ADD UNDOFILE 'undo_1.log'
  INITIAL_SIZE 16M
  UNDO_BUFFER_SIZE 2M
  ENGINE NDB;

ALTER LOGFILE GROUP lg_1
  ADD UNDOFILE 'undo_2.log'
  INITIAL_SIZE 12M
  ENGINE NDB;

CREATE TABLESPACE ts_1
  ADD DATAFILE 'data_1.dat'
  USE LOGFILE GROUP lg_1
  INITIAL_SIZE 32M
  ENGINE NDB;

ALTER TABLESPACE ts_1
  ADD DATAFILE 'data_2.dat'
  INITIAL_SIZE 48M
  ENGINE NDB;

```

(For more information on the statements just shown and the objects created by them, see [Section 6.10.1, “NDB Cluster Disk Data Objects”](#), as well as [CREATE LOGFILE GROUP Statement](#), and [CREATE TABLESPACE Statement](#).)

Now we can create and populate a version of the `fish` table that stores 2 of its columns on disk (deleting the previous version of the table first, if it already exists):

```

CREATE TABLE fish (
  id INT(11) NOT NULL AUTO_INCREMENT,
  name VARCHAR(20) NOT NULL,
  length_mm INT(11) NOT NULL,
  weight_gm INT(11) NOT NULL,

  PRIMARY KEY pk (id),
  UNIQUE KEY uk (name)
) TABLESPACE ts_1 STORAGE DISK
ENGINE=NDB;

INSERT INTO fish VALUES
  (NULL, 'guppy', 35, 2), (NULL, 'tuna', 2500, 150000),
  (NULL, 'shark', 3000, 110000), (NULL, 'manta ray', 1500, 50000),
  (NULL, 'grouper', 900, 125000), (NULL, 'puffer', 250, 2500);

```

When run against this version of the table, `ndb_desc` displays the following output:

```

$> ./ndb_desc -c localhost fish -d test -p
-- fish --
Version: 1
Fragment type: HashMapPartition
K Value: 6
Min load factor: 78
Max load factor: 80
Temporary table: no
Number of attributes: 4
Number of primary keys: 1
Length of frm data: 346
Max Rows: 0
Row Checksum: 1
Row GCI: 1
SingleUserMode: 0
ForceVarPart: 1
PartitionCount: 2
FragmentCount: 2
FragmentCountType: ONE_PER_LDM_PER_NODE
ExtraRowGciBits: 0
ExtraRowAuthorBits: 0
TableStatus: Retrieved
Table options:
HashMap: DEFAULT-HASHMAP-3840-2
-- Attributes --
id Int PRIMARY KEY DISTRIBUTION KEY AT=FIXED ST=MEMORY AUTO_INCR
name Varchar(20;latin1_swedish_ci) NOT NULL AT=SHORT_VAR ST=MEMORY
length_mm Int NOT NULL AT=FIXED ST=DISK
weight_gm Int NOT NULL AT=FIXED ST=DISK
-- Indexes --
PRIMARY KEY(id) - UniqueHashIndex
PRIMARY(id) - OrderedIndex
uk(name) - OrderedIndex
uk$unique(name) - UniqueHashIndex
-- Per partition info --
Partition      Row count      Commit count      Frag fixed memory      Frag varsized memory      Extent_space
0              2              2                 32768                  32768                     1048576
1              4              4                 32768                  32768                     1048576

NDBT_ProgramExit: 0 - OK

```

This means that 1048576 bytes are allocated from the tablespace for this table on each partition, of which 1044440 bytes remain free for additional storage. In other words, $1048576 - 1044440 = 4136$ bytes per partition is currently being used to store the data from this table's disk-based columns. The number of bytes shown as `Free extent_space` is available for storing on-disk column data from the `fish` table only; for this reason, it is not visible when selecting from the `INFORMATION_SCHEMA.FILES` table.

For fully replicated tables, `ndb_desc` shows only the nodes holding primary partition fragment replicas; nodes with copy fragment replicas (only) are ignored. Beginning with NDB 7.5.4, you can obtain such information, using the `mysql` client, from the `table_distribution_status`, `table_fragments`, `table_info`, and `table_replicas` tables in the `ndbinfo` database.

Options that can be used with `ndb_desc` are shown in the following table. Additional descriptions follow the table.

Table 5.8 Command-line options used with the program `ndb_desc`

Format	Description	Added, Deprecated, or Removed
<code>--auto-inc</code> , <code>-a</code>	Show next value for <code>AUTO_INCREMENT</code> column if table has one	ADDED: NDB 7.6.14
<code>--blob-info</code> , <code>-b</code>	Include partition information for BLOB tables in output. Requires that the <code>-p</code> option also be used	(Supported in all NDB releases based on MySQL 5.7)

Format	Description	Added, Deprecated, or Removed
<code>--character-sets-dir=path</code>	Directory containing character sets	(Supported in all NDB releases based on MySQL 5.7)
<code>--connect-retries=#</code>	Number of times to retry connection before giving up	(Supported in all NDB releases based on MySQL 5.7)
<code>--connect-retry-delay=#</code>	Number of seconds to wait between attempts to contact management server	(Supported in all NDB releases based on MySQL 5.7)
<code>--connect-string=connection_string,</code>	Same as <code>--ndb-connectstring</code>	(Supported in all NDB releases based on MySQL 5.7)
<code>-c connection_string</code>		
<code>--context,</code>	Show extra information for table such as database, schema, name, and internal ID	ADDED: NDB 7.6.14
<code>-x</code>		
<code>--core-file</code>	Write core file on error; used in debugging	(Supported in all NDB releases based on MySQL 5.7)
<code>--database=name,</code>	Name of database containing table	(Supported in all NDB releases based on MySQL 5.7)
<code>-d name</code>		
<code>--defaults-extra-file=path</code>	Read given file after global files are read	(Supported in all NDB releases based on MySQL 5.7)
<code>--defaults-file=path</code>	Read default options from given file only	(Supported in all NDB releases based on MySQL 5.7)
<code>--defaults-group-suffix=string</code>	Also read groups with <code>concat(group, suffix)</code>	(Supported in all NDB releases based on MySQL 5.7)
<code>--extra-node-info,</code>	Include partition-to-data-node mappings in output; requires <code>--extra-partition-info</code>	(Supported in all NDB releases based on MySQL 5.7)
<code>-n</code>		
<code>--extra-partition-info,</code>	Display information about partitions	(Supported in all NDB releases based on MySQL 5.7)
<code>-p</code>		
<code>--help,</code>	Display help text and exit	(Supported in all NDB releases based on MySQL 5.7)
<code>-?</code>		
<code>--login-path=path</code>	Read given path from login file	(Supported in all NDB releases based on MySQL 5.7)
<code>--ndb-connectstring=connection_string</code>	Set connect string for connecting to <code>ndb_mgmd</code> . Syntax: "[nodeid=id;][host=]hostname[:port]". Overrides entries in <code>NDB_CONNECTSTRING</code> and <code>my.cnf</code>	(Supported in all NDB releases based on MySQL 5.7)
<code>-c connection_string</code>		
<code>--ndb-mgmd-host=connection_string,</code>	Same as <code>--ndb-connectstring</code>	(Supported in all NDB releases based on MySQL 5.7)
<code>-c connection_string</code>		
<code>--ndb-nodeid=#</code>	Set node ID for this node, overriding any ID set by <code>--ndb-connectstring</code>	(Supported in all NDB releases based on MySQL 5.7)

Format	Description	Added, Deprecated, or Removed
<code>--ndb-optimized-node-selection</code>	Enable optimizations for selection of nodes for transactions. Enabled by default; use <code>--skip-ndb-optimized-node-selection</code> to disable	(Supported in all NDB releases based on MySQL 5.7)
<code>--no-defaults</code>	Do not read default options from any option file other than login file	(Supported in all NDB releases based on MySQL 5.7)
<code>--print-defaults</code>	Print program argument list and exit	(Supported in all NDB releases based on MySQL 5.7)
<code>--retries=#,</code> <code>-r #</code>	Number of times to retry the connection (once per second)	(Supported in all NDB releases based on MySQL 5.7)
<code>--table=name,</code> <code>-t name</code>	Specify the table in which to find an index. When this option is used, <code>-p</code> and <code>-n</code> have no effect and are ignored	(Supported in all NDB releases based on MySQL 5.7)
<code>--unqualified,</code> <code>-u</code>	Use unqualified table names	(Supported in all NDB releases based on MySQL 5.7)
<code>--usage,</code> <code>-?</code>	Display help text and exit; same as <code>--help</code>	(Supported in all NDB releases based on MySQL 5.7)
<code>--version,</code> <code>-V</code>	Display version information and exit	(Supported in all NDB releases based on MySQL 5.7)

- `--auto-inc, -a`

Show the next value for a table's `AUTO_INCREMENT` column, if it has one.

- `--blob-info, -b`

Include information about subordinate `BLOB` and `TEXT` columns.

Use of this option also requires the use of the `--extra-partition-info (-p)` option.

- `--character-sets-dir`

Command-Line Format	<code>--character-sets-dir=path</code>
---------------------	--

Directory containing character sets.

- `--connect-retries`

Command-Line Format	<code>--connect-retries=#</code>
Type	Integer
Default Value	12
Minimum Value	0
Maximum Value	12

Number of times to retry connection before giving up.

- `--connect-retry-delay`

Command-Line Format	<code>--connect-retry-delay=#</code>
Type	Integer
Default Value	5
Minimum Value	0
Maximum Value	5

Number of seconds to wait between attempts to contact management server.

- `--connect-string`

Command-Line Format	<code>--connect-string=connection_string</code>
Type	String
Default Value	[none]

Same as `--ndb-connectstring`.

- `--context, -x`

Show additional contextual information for the table such as schema, database name, table name, and the table's internal ID.

- `--core-file`

Command-Line Format	<code>--core-file</code>
---------------------	--------------------------

Write core file on error; used in debugging.

- `--database=db_name, -d`

Specify the database in which the table should be found.

- `--defaults-extra-file`

Command-Line Format	<code>--defaults-extra-file=path</code>
Type	String
Default Value	[none]

Read given file after global files are read.

- `--defaults-file`

Command-Line Format	<code>--defaults-file=path</code>
Type	String
Default Value	[none]

Read default options from given file only.

- `--defaults-group-suffix`

Command-Line Format	<code>--defaults-group-suffix=string</code>
Type	String
Default Value	[none]

Also read groups with `concat(group, suffix)`.

- `--extra-node-info, -n`

Include information about the mappings between table partitions and the data nodes upon which they reside. This information can be useful for verifying distribution awareness mechanisms and supporting more efficient application access to the data stored in NDB Cluster.

Use of this option also requires the use of the `--extra-partition-info (-p)` option.

- `--extra-partition-info, -p`

Print additional information about the table's partitions.

- `--help`

Command-Line Format	<code>--help</code>
---------------------	---------------------

Display help text and exit.

- `--login-path`

Command-Line Format	<code>--login-path=path</code>
Type	String
Default Value	[none]

Read given path from login file.

- `--ndb-connectstring`

Command-Line Format	<code>--ndb-connectstring=connection_string</code>
Type	String
Default Value	[none]

Set connect string for connecting to `ndb_mgmd`. Syntax: "[nodeid=id;][host=]hostname[:port]". Overrides entries in `NDB_CONNECTSTRING` and `my.cnf`.

- `--ndb-mgmd-host`

Command-Line Format	<code>--ndb-mgmd-host=connection_string</code>
Type	String
Default Value	[none]

Same as `--ndb-connectstring`.

- `--ndb-nodeid`

Command-Line Format	<code>--ndb-nodeid=#</code>
Type	Integer
Default Value	[none]

Set node ID for this node, overriding any ID set by `--ndb-connectstring`.

- `--ndb-optimized-node-selection`

Command-Line Format	<code>--ndb-optimized-node-selection</code>
---------------------	---

Enable optimizations for selection of nodes for transactions. Enabled by default; use `--skip-ndb-optimized-node-selection` to disable.

- `--no-defaults`

Command-Line Format	<code>--no-defaults</code>
---------------------	----------------------------

Do not read default options from any option file other than login file.

- `--print-defaults`

Command-Line Format	<code>--print-defaults</code>
---------------------	-------------------------------

Print program argument list and exit.

- `--retries=#, -r`

Try to connect this many times before giving up. One connect attempt is made per second.

- `--table=tbl_name, -t`

Specify the table in which to look for an index.

- `--unqualified, -u`

Use unqualified table names.

- `--usage`

Command-Line Format	<code>--usage</code>
---------------------	----------------------

Display help text and exit; same as `--help`.

- `--version`

Command-Line Format	<code>--version</code>
---------------------	------------------------

Display version information and exit.

In NDB 7.5.3 and later, table indexes listed in the output are ordered by ID. Previously, this was not deterministic and could vary between platforms. (Bug #81763, Bug #23547742)

5.11 ndb_drop_index — Drop Index from an NDB Table

`ndb_drop_index` drops the specified index from an NDB table. *It is recommended that you use this utility only as an example for writing NDB API applications—see the Warning later in this section for details.*

Usage

```
ndb_drop_index -c connection_string table_name index -d db_name
```

The statement shown above drops the index named `index` from the `table` in the `database`.

Options that can be used with `ndb_drop_index` are shown in the following table. Additional descriptions follow the table.

Table 5.9 Command-line options used with the program `ndb_drop_index`

Format	Description	Added, Deprecated, or Removed
<code>--character-sets-dir=path</code>	Directory containing character sets	(Supported in all NDB releases based on MySQL 5.7)
<code>--connect-retries=#</code>	Number of times to retry connection before giving up	(Supported in all NDB releases based on MySQL 5.7)
<code>--connect-retry-delay=#</code>	Number of seconds to wait between attempts to contact management server	(Supported in all NDB releases based on MySQL 5.7)
<code>--connect-string=connection_string,</code> <code>-c connection_string</code>	Same as <code>--ndb-connectstring</code>	(Supported in all NDB releases based on MySQL 5.7)
<code>--core-file</code>	Write core file on error; used in debugging	(Supported in all NDB releases based on MySQL 5.7)
<code>--database=name,</code> <code>-d name</code>	Name of database in which table is found	(Supported in all NDB releases based on MySQL 5.7)
<code>--defaults-extra-file=path</code>	Read given file after global files are read	(Supported in all NDB releases based on MySQL 5.7)
<code>--defaults-file=path</code>	Read default options from given file only	(Supported in all NDB releases based on MySQL 5.7)
<code>--defaults-group-suffix=string</code>	Also read groups with <code>concat(group, suffix)</code>	(Supported in all NDB releases based on MySQL 5.7)
<code>--help,</code> <code>-?</code>	Display help text and exit	(Supported in all NDB releases based on MySQL 5.7)
<code>--login-path=path</code>	Read given path from login file	(Supported in all NDB releases based on MySQL 5.7)
<code>--ndb-connectstring=connection_string,</code> <code>-c connection_string</code>	Set connect string for connecting to <code>ndb_mgmd</code> . Syntax: "[nodeid=id;][host=]hostname[:port]". Overrides entries in <code>NDB_CONNECTSTRING</code> and <code>my.cnf</code>	(Supported in all NDB releases based on MySQL 5.7)
<code>--ndb-mgmd-host=connection_string,</code> <code>-c connection_string</code>	Same as <code>--ndb-connectstring</code>	(Supported in all NDB releases based on MySQL 5.7)
<code>--ndb-nodeid=#</code>	Set node ID for this node, overriding any ID set by <code>--ndb-connectstring</code>	(Supported in all NDB releases based on MySQL 5.7)
<code>--ndb-optimized-node-selection</code>	Enable optimizations for selection of nodes for transactions. Enabled by default; use <code>--skip-ndb-optimized-node-selection</code> to disable	(Supported in all NDB releases based on MySQL 5.7)
<code>--no-defaults</code>	Do not read default options from any option file other than login file	(Supported in all NDB releases based on MySQL 5.7)

Format	Description	Added, Deprecated, or Removed
<code>--print-defaults</code>	Print program argument list and exit	(Supported in all NDB releases based on MySQL 5.7)
<code>--usage</code> , <code>-?</code>	Display help text and exit; same as <code>--help</code>	(Supported in all NDB releases based on MySQL 5.7)
<code>--version</code> , <code>-V</code>	Display version information and exit	(Supported in all NDB releases based on MySQL 5.7)

- `--character-sets-dir`

Command-Line Format	<code>--character-sets-dir=path</code>
---------------------	--

Directory containing character sets.

- `--connect-retries`

Command-Line Format	<code>--connect-retries=#</code>
Type	Integer
Default Value	12
Minimum Value	0
Maximum Value	12

Number of times to retry connection before giving up.

- `--connect-retry-delay`

Command-Line Format	<code>--connect-retry-delay=#</code>
Type	Integer
Default Value	5
Minimum Value	0
Maximum Value	5

Number of seconds to wait between attempts to contact management server.

- `--connect-string`

Command-Line Format	<code>--connect-string=connection_string</code>
Type	String
Default Value	[none]

Same as `--ndb-connectstring`.

- `--core-file`

Command-Line Format	<code>--core-file</code>
---------------------	--------------------------

Write core file on error; used in debugging.

- `--database`, `-d`

Command-Line Format	<code>--database=name</code>
---------------------	------------------------------

Type	String
Default Value	TEST_DB

Name of the database in which the table resides.

- `--defaults-extra-file`

Command-Line Format	<code>--defaults-extra-file=path</code>
Type	String
Default Value	[none]

Read given file after global files are read.

- `--defaults-file`

Command-Line Format	<code>--defaults-file=path</code>
Type	String
Default Value	[none]

Read default options from given file only.

- `--defaults-group-suffix`

Command-Line Format	<code>--defaults-group-suffix=string</code>
Type	String
Default Value	[none]

Also read groups with `concat(group, suffix)`.

- `--help`

Command-Line Format	<code>--help</code>
---------------------	---------------------

Display help text and exit.

- `--login-path`

Command-Line Format	<code>--login-path=path</code>
Type	String
Default Value	[none]

Read given path from login file.

- `--ndb-connectstring`

Command-Line Format	<code>--ndb-connectstring=connection_string</code>
Type	String
Default Value	[none]

Set connect string for connecting to `ndb_mgmd`. Syntax: "[nodeid=id;][host=]hostname[:port]". Overrides entries in `NDB_CONNECTSTRING` and `my.cnf`.

- `--ndb-mgmd-host`

Command-Line Format	<code>--ndb-mgmd-host=connection_string</code>
Type	String
Default Value	[none]

Same as `--ndb-connectstring`.

- `--ndb-nodeid`

Command-Line Format	<code>--ndb-nodeid=#</code>
Type	Integer
Default Value	[none]

Set node ID for this node, overriding any ID set by `--ndb-connectstring`.

- `--ndb-optimized-node-selection`

Command-Line Format	<code>--ndb-optimized-node-selection</code>
---------------------	---

Enable optimizations for selection of nodes for transactions. Enabled by default; use `--skip-ndb-optimized-node-selection` to disable.

- `--no-defaults`

Command-Line Format	<code>--no-defaults</code>
---------------------	----------------------------

Do not read default options from any option file other than login file.

- `--print-defaults`

Command-Line Format	<code>--print-defaults</code>
---------------------	-------------------------------

Print program argument list and exit.

- `--usage`

Command-Line Format	<code>--usage</code>
---------------------	----------------------

Display help text and exit; same as `--help`.

- `--version`

Command-Line Format	<code>--version</code>
---------------------	------------------------

Display version information and exit.

Warning

Operations performed on Cluster table indexes using the NDB API are not visible to MySQL and make the table unusable by a MySQL server. If you use this program to drop an index, then try to access the table from an SQL node, an error results, as shown here:

```
$> ./ndb_drop_index -c localhost dogs ix -d ctest1
Dropping index dogs/idx...OK

NDBT_ProgramExit: 0 - OK
```

```
$> ./mysql -u jon -p ctest1
Enter password: *****
Reading table information for completion of table and column names
You can turn off this feature to get a quicker startup with -A

Welcome to the MySQL monitor.  Commands end with ; or \g.
Your MySQL connection id is 7 to server version: 5.7.36-ndb-7.5.25

Type 'help;' or '\h' for help. Type '\c' to clear the buffer.

mysql> SHOW TABLES;
+-----+
| Tables_in_ctest1 |
+-----+
| a                 |
| bt1               |
| bt2               |
| dogs              |
| employees         |
| fish              |
+-----+
6 rows in set (0.00 sec)

mysql> SELECT * FROM dogs;
ERROR 1296 (HY000): Got error 4243 'Index not found' from NDBCLUSTER
```

In such a case, your *only* option for making the table available to MySQL again is to drop the table and re-create it. You can use either the SQL statement `DROP TABLE` or the `ndb_drop_table` utility (see Section 5.12, “`ndb_drop_table` — Drop an NDB Table”) to drop the table.

5.12 `ndb_drop_table` — Drop an NDB Table

`ndb_drop_table` drops the specified NDB table. (If you try to use this on a table created with a storage engine other than NDB, the attempt fails with the error `723: No such table exists.`) This operation is extremely fast; in some cases, it can be an order of magnitude faster than using a MySQL `DROP TABLE` statement on an NDB table.

Usage

```
ndb_drop_table -c connection_string tbl_name -d db_name
```

Options that can be used with `ndb_drop_table` are shown in the following table. Additional descriptions follow the table.

Table 5.10 Command-line options used with the program `ndb_drop_table`

Format	Description	Added, Deprecated, or Removed
<code>--character-sets-dir=path</code>	Directory containing character sets	(Supported in all NDB releases based on MySQL 5.7)
<code>--connect-retries=#</code>	Number of times to retry connection before giving up	(Supported in all NDB releases based on MySQL 5.7)
<code>--connect-retry-delay=#</code>	Number of seconds to wait between attempts to contact management server	(Supported in all NDB releases based on MySQL 5.7)
<code>--connect-string=connection_string,</code> <code>-c connection_string</code>	Same as <code>--ndb-connectstring</code>	(Supported in all NDB releases based on MySQL 5.7)
<code>--core-file</code>	Write core file on error; used in debugging	(Supported in all NDB releases based on MySQL 5.7)
<code>--database=name,</code>	Name of database in which table is found	(Supported in all NDB releases based on MySQL 5.7)

Format	Description	Added, Deprecated, or Removed
<code>-d name</code>	Read given file after global files are read	(Supported in all NDB releases based on MySQL 5.7)
<code>--defaults-extra-file=path</code>	Read default options from given file only	(Supported in all NDB releases based on MySQL 5.7)
<code>--defaults-file=path</code>	Also read groups with <code>concat(group, suffix)</code>	(Supported in all NDB releases based on MySQL 5.7)
<code>--defaults-group-suffix=string</code>	Display help text and exit	(Supported in all NDB releases based on MySQL 5.7)
<code>--help,</code>		
<code>-?</code>		
<code>--login-path=path</code>	Read given path from login file	(Supported in all NDB releases based on MySQL 5.7)
<code>--ndb-connectstring=connection_string</code>	Set connect string for connecting to <code>ndb_mgmd</code> . Syntax: "[nodeid=id;][host=]hostname[:port]". Overrides entries in <code>NDB_CONNECTSTRING</code> and <code>my.cnf</code>	(Supported in all NDB releases based on MySQL 5.7)
<code>-c connection_string</code>		
<code>--ndb-mgmd-host=connection_string,</code>	Same as <code>--ndb-connectstring</code>	(Supported in all NDB releases based on MySQL 5.7)
<code>-c connection_string</code>		
<code>--ndb-nodeid=#</code>	Set node ID for this node, overriding any ID set by <code>--ndb-connectstring</code>	(Supported in all NDB releases based on MySQL 5.7)
<code>--ndb-optimized-node-selection</code>	Enable optimizations for selection of nodes for transactions. Enabled by default; use <code>--skip-ndb-optimized-node-selection</code> to disable	(Supported in all NDB releases based on MySQL 5.7)
<code>--no-defaults</code>	Do not read default options from any option file other than login file	(Supported in all NDB releases based on MySQL 5.7)
<code>--print-defaults</code>	Print program argument list and exit	(Supported in all NDB releases based on MySQL 5.7)
<code>--usage,</code>	Display help text and exit; same as <code>--help</code>	(Supported in all NDB releases based on MySQL 5.7)
<code>-?</code>		
<code>--version,</code>	Display version information and exit	(Supported in all NDB releases based on MySQL 5.7)
<code>-V</code>		

- `--character-sets-dir`

Command-Line Format	<code>--character-sets-dir=path</code>
---------------------	--

Directory containing character sets.

- `--connect-retries`

Command-Line Format	<code>--connect-retries=#</code>
---------------------	----------------------------------

Type	Integer
Default Value	12
Minimum Value	0
Maximum Value	12

Number of times to retry connection before giving up.

- `--connect-retry-delay`

Command-Line Format	<code>--connect-retry-delay=#</code>
Type	Integer
Default Value	5
Minimum Value	0
Maximum Value	5

Number of seconds to wait between attempts to contact management server.

- `--connect-string`

Command-Line Format	<code>--connect-string=connection_string</code>
Type	String
Default Value	[none]

Same as `--ndb-connectstring`.

- `--core-file`

Command-Line Format	<code>--core-file</code>
---------------------	--------------------------

Write core file on error; used in debugging.

- `--database, -d`

Command-Line Format	<code>--database=name</code>
Type	String
Default Value	TEST_DB

Name of the database in which the table resides.

- `--defaults-extra-file`

Command-Line Format	<code>--defaults-extra-file=path</code>
Type	String
Default Value	[none]

Read given file after global files are read.

- `--defaults-file`

Command-Line Format	<code>--defaults-file=path</code>
Type	String
Default Value	[none]

Read default options from given file only.

- `--defaults-group-suffix`

Command-Line Format	<code>--defaults-group-suffix=string</code>
Type	String
Default Value	[none]

Also read groups with `concat(group, suffix)`.

- `--help`

Command-Line Format	<code>--help</code>
---------------------	---------------------

Display help text and exit.

- `--login-path`

Command-Line Format	<code>--login-path=path</code>
Type	String
Default Value	[none]

Read given path from login file.

- `--ndb-connectstring`

Command-Line Format	<code>--ndb-connectstring=connection_string</code>
Type	String
Default Value	[none]

Set connect string for connecting to `ndb_mgmd`. Syntax: "[nodeid=id;][host=]hostname[:port]". Overrides entries in `NDB_CONNECTSTRING` and `my.cnf`.

- `--ndb-mgmd-host`

Command-Line Format	<code>--ndb-mgmd-host=connection_string</code>
Type	String
Default Value	[none]

Same as `--ndb-connectstring`.

- `--ndb-nodeid`

Command-Line Format	<code>--ndb-nodeid=#</code>
Type	Integer
Default Value	[none]

Set node ID for this node, overriding any ID set by `--ndb-connectstring`.

- `--ndb-optimized-node-selection`

Command-Line Format	<code>--ndb-optimized-node-selection</code>
---------------------	---

Enable optimizations for selection of nodes for transactions. Enabled by default; use `--skip-ndb-optimized-node-selection` to disable.

- `--no-defaults`

Command-Line Format	<code>--no-defaults</code>
---------------------	----------------------------

Do not read default options from any option file other than login file.

- `--print-defaults`

Command-Line Format	<code>--print-defaults</code>
---------------------	-------------------------------

Print program argument list and exit.

- `--usage`

Command-Line Format	<code>--usage</code>
---------------------	----------------------

Display help text and exit; same as `--help`.

- `--version`

Command-Line Format	<code>--version</code>
---------------------	------------------------

Display version information and exit.

5.13 ndb_error_reporter — NDB Error-Reporting Utility

`ndb_error_reporter` creates an archive from data node and management node log files that can be used to help diagnose bugs or other problems with a cluster. *It is highly recommended that you make use of this utility when filing reports of bugs in NDB Cluster.*

Options that can be used with `ndb_error_reporter` are shown in the following table. Additional descriptions follow the table.

Table 5.11 Command-line options used with the program `ndb_error_reporter`

Format	Description	Added, Deprecated, or Removed
<code>--connection-timeout=#</code>	Number of seconds to wait when connecting to nodes before timing out	(Supported in all NDB releases based on MySQL 5.7)
<code>--dry-scp</code>	Disable scp with remote hosts; used in testing only	(Supported in all NDB releases based on MySQL 5.7)
<code>--fs</code>	Include file system data in error report; can use a large amount of disk space	(Supported in all NDB releases based on MySQL 5.7)
<code>--help</code> , <code>-?</code>	Display help text and exit	(Supported in all NDB releases based on MySQL 5.7)
<code>--skip-nodegroup=#</code>	Skip all nodes in the node group having this ID	(Supported in all NDB releases based on MySQL 5.7)

Usage

```
ndb_error_reporter path/to/config-file [username] [options]
```

This utility is intended for use on a management node host, and requires the path to the management host configuration file (usually named `config.ini`). Optionally, you can supply the name of a user that is able to access the cluster's data nodes using SSH, to copy the data node log files. `ndb_error_reporter` then includes all of these files in archive that is created in the same directory

in which it is run. The archive is named `ndb_error_report_YYYYMMDDhhmmss.tar.bz2`, where `YYYYMMDDhhmmss` is a datetime string.

`ndb_error_reporter` also accepts the options listed here:

- `--connection-timeout=timeout`

Command-Line Format	<code>--connection-timeout=#</code>
Type	Integer
Default Value	0

Wait this many seconds when trying to connect to nodes before timing out.

- `--dry-scp`

Command-Line Format	<code>--dry-scp</code>
---------------------	------------------------

Run `ndb_error_reporter` without using `scp` from remote hosts. Used for testing only.

- `--fs`

Command-Line Format	<code>--fs</code>
---------------------	-------------------

Copy the data node file systems to the management host and include them in the archive.

Because data node file systems can be extremely large, even after being compressed, we ask that you please do *not* send archives created using this option to Oracle unless you are specifically requested to do so.

- `--help`

Command-Line Format	<code>--help</code>
---------------------	---------------------

Display help text and exit.

- `--skip-nodegroup=nodegroup_id`

Command-Line Format	<code>--connection-timeout=#</code>
Type	Integer
Default Value	0

Skip all nodes belong to the node group having the supplied node group ID.

5.14 ndb_import — Import CSV Data Into NDB

`ndb_import` imports CSV-formatted data, such as that produced by `mysqldump --tab`, directly into NDB using the NDB API. `ndb_import` requires a connection to an NDB management server (`ndb_mgmd`) to function; it does not require a connection to a MySQL Server.

Usage

```
ndb_import db_name file_name options
```

`ndb_import` requires two arguments. `db_name` is the name of the database where the table into which to import the data is found; `file_name` is the name of the CSV file from which to read the data; this must include the path to this file if it is not in the current directory. The name of the file must match that of the table; the file's extension, if any, is not taken into consideration. Options supported by `ndb_import` include those for specifying field separators, escapes, and line terminators, and are

described later in this section. `ndb_import` must be able to connect to an NDB Cluster management server; for this reason, there must be an unused `[api]` slot in the cluster `config.ini` file.

To duplicate an existing table that uses a different storage engine, such as InnoDB, as an NDB table, use the `mysql` client to perform a `SELECT INTO OUTFILE` statement to export the existing table to a CSV file, then to execute a `CREATE TABLE LIKE` statement to create a new table having the same structure as the existing table, then perform `ALTER TABLE ... ENGINE=NDB` on the new table; after this, from the system shell, invoke `ndb_import` to load the data into the new NDB table. For example, an existing InnoDB table named `myinnodb_table` in a database named `myinnodb` can be exported into an NDB table named `myndb_table` in a database named `myndb` as shown here, assuming that you are already logged in as a MySQL user with the appropriate privileges:

1. In the `mysql` client:

```
mysql> USE myinnodb;

mysql> SELECT * INTO OUTFILE '/tmp/myndb_table.csv'
>   FIELDS TERMINATED BY ',' OPTIONALLY ENCLOSED BY '"' ESCAPED BY '\\'
>   LINES TERMINATED BY '\n'
>   FROM myinnodbttable;

mysql> CREATE DATABASE myndb;

mysql> USE myndb;

mysql> CREATE TABLE myndb_table LIKE myinnodb.myinnodb_table;

mysql> ALTER TABLE myndb_table ENGINE=NDB;

mysql> EXIT;
Bye
$>
```

Once the target database and table have been created, a running `mysqld` is no longer required. You can stop it using `mysqladmin shutdown` or another method before proceeding, if you wish.

2. In the system shell:

```
# if you are not already in the MySQL bin directory:
$> cd path-to-mysql-bin-dir

$> ndb_import myndb /tmp/myndb_table.csv --fields-optionally-enclosed-by='"' \
--fields-terminated-by="," --fields-escaped-by='\\'
```

The output should resemble what is shown here:

```
job-1 import myndb.myndb_table from /tmp/myndb_table.csv
job-1 [running] import myndb.myndb_table from /tmp/myndb_table.csv
job-1 [success] import myndb.myndb_table from /tmp/myndb_table.csv
job-1 imported 19984 rows in 0h0m9s at 2277 rows/s
jobs summary: defined: 1 run: 1 with success: 1 with failure: 0
$>
```

Options that can be used with `ndb_import` are shown in the following table. Additional descriptions follow the table.

Table 5.12 Command-line options used with the program `ndb_import`

Format	Description	Added, Deprecated, or Removed
<code>--abort-on-error</code>	Dump core on any fatal error; used for debugging	ADDED: NDB 7.6.2
<code>--ai-increment=#</code>	For table with hidden PK, specify autoincrement increment. See <code>mysqld</code>	ADDED: NDB 7.6.2

Format	Description	Added, Deprecated, or Removed
<code>--ai-offset=#</code>	For table with hidden PK, specify autoincrement offset. See <code>mysqld</code>	ADDED: NDB 7.6.2
<code>--ai-prefetch-sz=#</code>	For table with hidden PK, specify number of autoincrement values that are prefetched. See <code>mysqld</code>	ADDED: NDB 7.6.2
<code>--character-sets-dir=path</code>	Directory containing character sets	ADDED: NDB 7.6.2
<code>--connect-retries=#</code>	Number of times to retry connection before giving up	(Supported in all NDB releases based on MySQL 5.7)
<code>--connect-retry-delay=#</code>	Number of seconds to wait between attempts to contact management server	ADDED: NDB 7.6.2
<code>--connect-string=connection_string,</code> <code>-c connection_string</code>	Same as <code>--ndb-connectstring</code>	ADDED: NDB 7.6.2
<code>--connections=#</code>	Number of cluster connections to create	ADDED: NDB 7.6.2
<code>--continue</code>	When job fails, continue to next job	ADDED: NDB 7.6.2
<code>--core-file</code>	Write core file on error; used in debugging	ADDED: NDB 7.6.2
<code>--csvopt=opts</code>	Shorthand option for setting typical CSV option values. See documentation for syntax and other information	ADDED: NDB 7.6.2
<code>--db-workers=#</code>	Number of threads, per data node, executing database operations	ADDED: NDB 7.6.2
<code>--defaults-extra-file=path</code>	Read given file after global files are read	ADDED: NDB 7.6.2
<code>--defaults-file=path</code>	Read default options from given file only	ADDED: NDB 7.6.2
<code>--defaults-group-suffix=string</code>	Also read groups with <code>concat(group, suffix)</code>	ADDED: NDB 7.6.2
<code>--errins-type=name</code>	Error insert type, for testing purposes; use "list" to obtain all possible values	ADDED: NDB 7.6.2
<code>--errins-delay=#</code>	Error insert delay in milliseconds; random variation is added	ADDED: NDB 7.6.2
<code>--fields-enclosed-by=char</code>	Same as <code>FIELDS ENCLOSED BY</code> option for <code>LOAD DATA</code> statements. For CSV input this is same as using <code>--fields-optionally-enclosed-by</code>	ADDED: NDB 7.6.2
<code>--fields-escaped-by=char</code>	Same as <code>FIELDS ESCAPED BY</code> option for <code>LOAD DATA</code> statements	ADDED: NDB 7.6.2

Format	Description	Added, Deprecated, or Removed
<code>--fields-optionally-enclosed-by=char</code>	Same as FIELDS OPTIONALLY ENCLOSED BY option for LOAD DATA statements	ADDED: NDB 7.6.2
<code>--fields-terminated-by=char</code>	Same as FIELDS TERMINATED BY option for LOAD DATA statements	ADDED: NDB 7.6.2
<code>--help,</code> <code>-?</code>	Display help text and exit	ADDED: NDB 7.6.2
<code>--idlesleep=#</code>	Number of milliseconds to sleep waiting for more to do	ADDED: NDB 7.6.2
<code>--idlespin=#</code>	Number of times to retry before idlesleep	ADDED: NDB 7.6.2
<code>--ignore-lines=#</code>	Ignore first # lines in input file. Used to skip a non-data header	ADDED: NDB 7.6.2
<code>--input-type=name</code>	Input type: random or csv	ADDED: NDB 7.6.2
<code>--input-workers=#</code>	Number of threads processing input. Must be 2 or more if --input-type is csv	ADDED: NDB 7.6.2
<code>--keep-state</code>	State files (except non-empty *.rej files) are normally removed on job completion. Using this option causes all state files to be preserved instead	ADDED: NDB 7.6.4
<code>--lines-terminated-by=char</code>	Same as LINES TERMINATED BY option for LOAD DATA statements	ADDED: NDB 7.6.2
<code>--login-path=path</code>	Read given path from login file	ADDED: NDB 7.6.2
<code>--max-rows=#</code>	Import only this number of input data rows; default is 0, which imports all rows	ADDED: NDB 7.6.2
<code>--monitor=#</code>	Periodically print status of running job if something has changed (status, rejected rows, temporary errors). Value 0 disables. Value 1 prints any change seen. Higher values reduce status printing exponentially up to some pre-defined limit	ADDED: NDB 7.6.2
<code>--ndb-connectstring=connection_string</code> <code>-c connection_string</code>	Set connect string for connecting to ndb_mgmd. Syntax: "[nodeid=id;][host=]hostname[:port]". Overrides entries in NDB_CONNECTSTRING and my.cnf	ADDED: NDB 7.6.2
<code>--ndb-mgmd-host=connection_string,</code> <code>-c connection_string</code>	Same as --ndb-connectstring	ADDED: NDB 7.6.2

Format	Description	Added, Deprecated, or Removed
<code>--ndb-nodeid=#</code>	Set node ID for this node, overriding any ID set by <code>--ndb-connectstring</code>	ADDED: NDB 7.6.2
<code>--ndb-optimized-node-selection</code>	Enable optimizations for selection of nodes for transactions. Enabled by default; use <code>--skip-ndb-optimized-node-selection</code> to disable	(Supported in all NDB releases based on MySQL 5.7)
<code>--no-asynch</code>	Run database operations as batches, in single transactions	ADDED: NDB 7.6.2
<code>--no-defaults</code>	Do not read default options from any option file other than login file	ADDED: NDB 7.6.2
<code>--no-hint</code>	Tells transaction coordinator not to use distribution key hint when selecting data node	ADDED: NDB 7.6.2
<code>--opbatch=#</code>	A db execution batch is a set of transactions and operations sent to NDB kernel. This option limits NDB operations (including blob operations) in a db execution batch. Therefore it also limits number of asynch transactions. Value 0 is not valid	ADDED: NDB 7.6.2
<code>--opbytes=#</code>	Limit bytes in execution batch (default 0 = no limit)	ADDED: NDB 7.6.2
<code>--output-type=name</code>	Output type: <code>ndb</code> is default, <code>null</code> used for testing	ADDED: NDB 7.6.2
<code>--output-workers=#</code>	Number of threads processing output or relaying database operations	ADDED: NDB 7.6.2
<code>--pagesize=#</code>	Align I/O buffers to given size	ADDED: NDB 7.6.2
<code>--pagecnt=#</code>	Size of I/O buffers as multiple of page size. CSV input worker allocates double-sized buffer	ADDED: NDB 7.6.2
<code>--polltimeout=#</code>	Timeout per poll for completed asynchronous transactions; polling continues until all polls are completed, or error occurs	ADDED: NDB 7.6.2
<code>--print-defaults</code>	Print program argument list and exit	ADDED: NDB 7.6.2
<code>--rejects=#</code>	Limit number of rejected rows (rows with permanent error) in data load. Default is 0 which means that any rejected row causes a fatal error. The row exceeding the limit is also added to <code>*.rej</code>	ADDED: NDB 7.6.2

Format	Description	Added, Deprecated, or Removed
<code>--resume</code>	If job aborted (temporary error, user interrupt), resume with rows not yet processed	ADDED: NDB 7.6.2
<code>--rowbatch=#</code>	Limit rows in row queues (default 0 = no limit); must be 1 or more if <code>--input-type</code> is random	ADDED: NDB 7.6.2
<code>--rowbytes=#</code>	Limit bytes in row queues (0 = no limit)	ADDED: NDB 7.6.2
<code>--state-dir=path</code>	Where to write state files; current directory is default	ADDED: NDB 7.6.2
<code>--stats</code>	Save performance related options and internal statistics in *.sto and *.stt files. These files are kept on successful completion even if <code>--keep-state</code> is not used	ADDED: NDB 7.6.4
<code>--tempdelay=#</code>	Number of milliseconds to sleep between temporary errors	ADDED: NDB 7.6.2
<code>--temperrors=#</code>	Number of times a transaction can fail due to a temporary error, per execution batch; 0 means any temporary error is fatal. Such errors do not cause any rows to be written to .rej file	ADDED: NDB 7.6.2
<code>--usage,</code> <code>-?</code>	Display help text and exit; same as <code>--help</code>	ADDED: NDB 7.6.2
<code>--verbose[=#],</code> <code>-v [#]</code>	Enable verbose output	ADDED: NDB 7.6.2
<code>--version,</code> <code>-V</code>	Display version information and exit	ADDED: NDB 7.6.2

- `--abort-on-error`

Command-Line Format	<code>--abort-on-error</code>
Introduced	5.7.18-ndb-7.6.2

Dump core on any fatal error; used for debugging only.

- `--ai-increment=#`

Command-Line Format	<code>--ai-increment=#</code>
Introduced	5.7.18-ndb-7.6.2
Type	Integer
Default Value	1
Minimum Value	1

Maximum Value	4294967295
---------------	------------

For a table with a hidden primary key, specify the autoincrement increment, like the `auto_increment_increment` system variable does in the MySQL Server.

- `--ai-offset=#`

Command-Line Format	<code>--ai-offset=#</code>
Introduced	5.7.18-ndb-7.6.2
Type	Integer
Default Value	1
Minimum Value	1
Maximum Value	4294967295

For a table with hidden primary key, specify the autoincrement offset. Similar to the `auto_increment_offset` system variable.

- `--ai-prefetch-sz=#`

Command-Line Format	<code>--ai-prefetch-sz=#</code>
Introduced	5.7.18-ndb-7.6.2
Type	Integer
Default Value	1024
Minimum Value	1
Maximum Value	4294967295

For a table with a hidden primary key, specify the number of autoincrement values that are prefetched. Behaves like the `ndb_autoincrement_prefetch_sz` system variable does in the MySQL Server.

- `--character-sets-dir`

Command-Line Format	<code>--character-sets-dir=path</code>
Introduced	5.7.18-ndb-7.6.2

Directory containing character sets.

- `--connect-retries`

Command-Line Format	<code>--connect-retries=#</code>
Type	Integer
Default Value	12
Minimum Value	0
Maximum Value	12

Number of times to retry connection before giving up.

- `--connect-retry-delay`

Command-Line Format	<code>--connect-retry-delay=#</code>	
Introduced	5.7.18-ndb-7.6.2	363
Type	Integer	

Default Value	5
Minimum Value	0
Maximum Value	5

Number of seconds to wait between attempts to contact management server.

- `--connections=#`

Command-Line Format	<code>--connections=#</code>
Introduced	5.7.18-ndb-7.6.2
Type	Integer
Default Value	1
Minimum Value	1
Maximum Value	4294967295

Number of cluster connections to create.

- `--connect-string`

Command-Line Format	<code>--connect-string=connection_string</code>
Introduced	5.7.18-ndb-7.6.2
Type	String
Default Value	[none]

Same as `--ndb-connectstring`.

- `--continue`

Command-Line Format	<code>--continue</code>
Introduced	5.7.18-ndb-7.6.2

When a job fails, continue to the next job.

- `--core-file`

Command-Line Format	<code>--core-file</code>
Introduced	5.7.18-ndb-7.6.2

Write core file on error; used in debugging.

- `--csvopt=string`

Command-Line Format	<code>--csvopt=opts</code>
Introduced	5.7.18-ndb-7.6.2
Type	String

Default Value	[none]
---------------	--------

Provides a shortcut method for setting typical CSV import options. The argument to this option is a string consisting of one or more of the following parameters:

- `c`: Fields terminated by comma
- `d`: Use defaults, except where overridden by another parameter
- `n`: Lines terminated by `\n`
- `q`: Fields optionally enclosed by double quote characters (")
- `r`: Line terminated by `\r`

The order of the parameters makes no difference, except that if both `n` and `r` are specified, the one occurring last is the parameter which takes effect.

This option is intended for use in testing under conditions in which it is difficult to transmit escapes or quotation marks.

- `--db-workers=#`

Command-Line Format	<code>--db-workers=#</code>
Introduced	5.7.18-ndb-7.6.2
Type	Integer
Default Value (\geq 5.7.20-ndb-7.6.4)	4
Default Value (\geq 5.7.18-ndb-7.6.2, \leq 5.7.18-ndb-7.6.3)	1
Minimum Value	1
Maximum Value	4294967295

Number of threads, per data node, executing database operations.

- `--defaults-extra-file`

Command-Line Format	<code>--defaults-extra-file=path</code>
Introduced	5.7.18-ndb-7.6.2
Type	String
Default Value	[none]

Read given file after global files are read.

- `--defaults-file`

Command-Line Format	<code>--defaults-file=path</code>
Introduced	5.7.18-ndb-7.6.2
Type	String
Default Value	[none]

Read default options from given file only.

- `--defaults-group-suffix`

Command-Line Format	<code>--defaults-group-suffix=string</code>
---------------------	---

Introduced	5.7.18-ndb-7.6.2
Type	String
Default Value	[none]

Also read groups with `concat(group, suffix)`.

- `--errins-type=name`

Command-Line Format	<code>--errins-type=name</code>
Introduced	5.7.18-ndb-7.6.2
Type	Enumeration
Default Value	[none]
Valid Values	<code>stopjob</code> <code>stopall</code> <code>sighup</code> <code>sigint</code> <code>list</code>

Error insert type; use `list` as the `name` value to obtain all possible values. This option is used for testing purposes only.

- `--errins-delay=#`

Command-Line Format	<code>--errins-delay=#</code>
Introduced	5.7.18-ndb-7.6.2
Type	Integer
Default Value	1000
Minimum Value	0
Maximum Value	4294967295
Unit	ms

Error insert delay in milliseconds; random variation is added. This option is used for testing purposes only.

- `--fields-enclosed-by=char`

Command-Line Format	<code>--fields-enclosed-by=char</code>
Introduced	5.7.18-ndb-7.6.2
Type	String
Default Value	[none]

This works in the same way as the `FIELDS ENCLOSED BY` option does for the `LOAD DATA` statement, specifying a character to be interpreted as quoting field values. For CSV input, this is the same as `--fields-optionally-enclosed-by`.

- `--fields-escaped-by=name`

Command-Line Format	<code>--fields-escaped-by=char</code>
Introduced	5.7.18-ndb-7.6.2

Type	String
Default Value	\

Specify an escape character in the same way as the `FIELDS ESCAPED BY` option does for the `SQL LOAD DATA` statement.

- `--fields-optionally-enclosed-by=char`

Command-Line Format	<code>--fields-optionally-enclosed-by=char</code>
Introduced	5.7.18-ndb-7.6.2
Type	String
Default Value	[none]

This works in the same way as the `FIELDS OPTIONALLY ENCLOSED BY` option does for the `LOAD DATA` statement, specifying a character to be interpreted as optionally quoting field values. For CSV input, this is the same as `--fields-enclosed-by`.

- `--fields-terminated-by=char`

Command-Line Format	<code>--fields-terminated-by=char</code>
Introduced	5.7.18-ndb-7.6.2
Type	String
Default Value	\t

This works in the same way as the `FIELDS TERMINATED BY` option does for the `LOAD DATA` statement, specifying a character to be interpreted as the field separator.

- `--help`

Command-Line Format	<code>--help</code>
Introduced	5.7.18-ndb-7.6.2

Display help text and exit.

- `--idlesleep=#`

Command-Line Format	<code>--idlesleep=#</code>
Introduced	5.7.18-ndb-7.6.2
Type	Integer
Default Value	1
Minimum Value	1
Maximum Value	4294967295
Unit	ms

Number of milliseconds to sleep waiting for more work to perform.

- `--idlespin=#`

Command-Line Format	<code>--idlespin=#</code>
Introduced	5.7.18-ndb-7.6.2
Type	Integer
Default Value	0

Minimum Value	0
Maximum Value	4294967295

Number of times to retry before sleeping.

- `--ignore-lines=#`

Command-Line Format	<code>--ignore-lines=#</code>
Introduced	5.7.18-ndb-7.6.2
Type	Integer
Default Value	0
Minimum Value	0
Maximum Value	4294967295

Cause `ndb_import` to ignore the first `#` lines of the input file. This can be employed to skip a file header that does not contain any data.

- `--input-type=name`

Command-Line Format	<code>--input-type=name</code>
Introduced	5.7.18-ndb-7.6.2
Type	Enumeration
Default Value	<code>csv</code>
Valid Values	<code>random</code> <code>csv</code>

Set the type of input type. The default is `csv`; `random` is intended for testing purposes only. .

- `--input-workers=#`

Command-Line Format	<code>--input-workers=#</code>
Introduced	5.7.18-ndb-7.6.2
Type	Integer
Default Value (\geq 5.7.20-ndb-7.6.4)	4
Default Value (\geq 5.7.18-ndb-7.6.2, \leq 5.7.18-ndb-7.6.3)	2
Minimum Value	1
Maximum Value	4294967295

Set the number of threads processing input.

- `--keep-state`

Command-Line Format	<code>--keep-state</code>
Introduced	5.7.20-ndb-7.6.4

By default, `ndb_import` removes all state files (except non-empty `*.rej` files) when it completes a job. Specify this option (nor argument is required) to force the program to retain all state files instead.

- `--lines-terminated-by=name`

Command-Line Format	<code>--lines-terminated-by=char</code>
---------------------	---

Introduced	5.7.18-ndb-7.6.2
Type	String
Default Value	\n

This works in the same way as the `LINES TERMINATED BY` option does for the `LOAD DATA` statement, specifying a character to be interpreted as end-of-line.

- `--login-path`

Command-Line Format	<code>--login-path=path</code>
Introduced	5.7.18-ndb-7.6.2
Type	String
Default Value	[none]

Read given path from login file.

- `--log-level=#`

Command-Line Format	<code>--log-level=#</code>
Type	Integer
Default Value	0
Minimum Value	0
Maximum Value	2

Performs internal logging at the given level. This option is intended primarily for internal and development use.

In debug builds of NDB only, the logging level can be set using this option to a maximum of 4.

- `--max-rows=#`

Command-Line Format	<code>--max-rows=#</code>
Introduced	5.7.18-ndb-7.6.2
Type	Integer
Default Value	0
Minimum Value	0
Maximum Value	4294967295
Unit	bytes

Import only this number of input data rows; the default is 0, which imports all rows.

- `--monitor=#`

Command-Line Format	<code>--monitor=#</code>
Introduced	5.7.18-ndb-7.6.2
Type	Integer
Default Value	2
Minimum Value	0
Maximum Value	4294967295

Unit	bytes
------	-------

Periodically print the status of a running job if something has changed (status, rejected rows, temporary errors). Set to 0 to disable this reporting. Setting to 1 prints any change that is seen. Higher values reduce the frequency of this status reporting.

- `--ndb-connectstring`

Command-Line Format	<code>--ndb-connectstring=connection_string</code>
Introduced	5.7.18-ndb-7.6.2
Type	String
Default Value	[none]

Set connect string for connecting to `ndb_mgmd`. Syntax: "[nodeid=id;][host=]hostname[:port]". Overrides entries in `NDB_CONNECTSTRING` and `my.cnf`.

- `--ndb-mgmd-host`

Command-Line Format	<code>--ndb-mgmd-host=connection_string</code>
Introduced	5.7.18-ndb-7.6.2
Type	String
Default Value	[none]

Same as `--ndb-connectstring`.

- `--ndb-nodeid`

Command-Line Format	<code>--ndb-nodeid=#</code>
Introduced	5.7.18-ndb-7.6.2
Type	Integer
Default Value	[none]

Set node ID for this node, overriding any ID set by `--ndb-connectstring`.

- `--ndb-optimized-node-selection`

Command-Line Format	<code>--ndb-optimized-node-selection</code>
---------------------	---

Enable optimizations for selection of nodes for transactions. Enabled by default; use `--skip-ndb-optimized-node-selection` to disable.

- `--no-asynch`

Command-Line Format	<code>--no-asynch</code>
Introduced	5.7.18-ndb-7.6.2

Run database operations as batches, in single transactions.

- `--no-defaults`

Command-Line Format	<code>--no-defaults</code>
Introduced	5.7.18-ndb-7.6.2

Do not read default options from any option file other than login file.

- `--no-hint`

Command-Line Format	<code>--no-hint</code>
Introduced	5.7.18-ndb-7.6.2

Do not use distribution key hinting to select a data node.

- `--opbatch=#`

Command-Line Format	<code>--opbatch=#</code>
Introduced	5.7.18-ndb-7.6.2
Type	Integer
Default Value	256
Minimum Value	1
Maximum Value	4294967295
Unit	bytes

Set a limit on the number of operations (including blob operations), and thus the number of asynchronous transactions, per execution batch.

- `--opbytes=#`

Command-Line Format	<code>--opbytes=#</code>
Introduced	5.7.18-ndb-7.6.2
Type	Integer
Default Value	0
Minimum Value	0
Maximum Value	4294967295
Unit	bytes

Set a limit on the number of bytes per execution batch. Use 0 for no limit.

- `--output-type=name`

Command-Line Format	<code>--output-type=name</code>
Introduced	5.7.18-ndb-7.6.2
Type	Enumeration
Default Value	ndb
Valid Values	null

Set the output type. `ndb` is the default. `null` is used only for testing.

- `--output-workers=#`

Command-Line Format	<code>--output-workers=#</code>
Introduced	5.7.18-ndb-7.6.2
Type	Integer
Default Value	2
Minimum Value	1

Maximum Value	4294967295
---------------	------------

Set the number of threads processing output or relaying database operations.

- `--pagesize=#`

Command-Line Format	<code>--pagesize=#</code>
Introduced	5.7.18-ndb-7.6.2
Type	Integer
Default Value	4096
Minimum Value	1
Maximum Value	4294967295
Unit	bytes

Align I/O buffers to the given size.

- `--pagecnt=#`

Command-Line Format	<code>--pagecnt=#</code>
Introduced	5.7.18-ndb-7.6.2
Type	Integer
Default Value	64
Minimum Value	1
Maximum Value	4294967295

Set the size of I/O buffers as multiple of page size. The CSV input worker allocates buffer that is doubled in size.

- `--polltimeout=#`

Command-Line Format	<code>--polltimeout=#</code>
Introduced	5.7.18-ndb-7.6.2
Type	Integer
Default Value	1000
Minimum Value	1
Maximum Value	4294967295
Unit	ms

Set a timeout per poll for completed asynchronous transactions; polling continues until all polls are completed, or until an error occurs.

- `--print-defaults`

Command-Line Format	<code>--print-defaults</code>
Introduced	5.7.18-ndb-7.6.2

Print program argument list and exit.

- `--rejects=#`

Command-Line Format	<code>--rejects=#</code>
Introduced	5.7.18-ndb-7.6.2

Type	Integer
Default Value	0
Minimum Value	0
Maximum Value	4294967295

Limit the number of rejected rows (rows with permanent errors) in the data load. The default is 0, which means that any rejected row causes a fatal error. Any rows causing the limit to be exceeded are added to the `.rej` file.

The limit imposed by this option is effective for the duration of the current run. A run restarted using `--resume` is considered a “new” run for this purpose.

- `--resume`

Command-Line Format	<code>--resume</code>
Introduced	5.7.18-ndb-7.6.2

If a job is aborted (due to a temporary db error or when interrupted by the user), resume with any rows not yet processed.

- `--rowbatch=#`

Command-Line Format	<code>--rowbatch=#</code>
Introduced	5.7.18-ndb-7.6.2
Type	Integer
Default Value	0
Minimum Value	0
Maximum Value	4294967295
Unit	rows

Set a limit on the number of rows per row queue. Use 0 for no limit.

- `--rowbytes=#`

Command-Line Format	<code>--rowbytes=#</code>
Introduced	5.7.18-ndb-7.6.2
Type	Integer
Default Value	262144
Minimum Value	0
Maximum Value	4294967295
Unit	bytes

Set a limit on the number of bytes per row queue. Use 0 for no limit.

- `--stats`

Command-Line Format	<code>--stats</code>
Introduced	5.7.20-ndb-7.6.4

Save information about options related to performance and other internal statistics in files named `*.sto` and `*.stt`. These files are always kept on successful completion (even if `--keep-state` is not also specified).

- `--state-dir=name`

Command-Line Format	<code>--state-dir=path</code>
Introduced	5.7.18-ndb-7.6.2
Type	String
Default Value	.

Where to write the state files (`tbl_name.map`, `tbl_name.rej`, `tbl_name.res`, and `tbl_name.stt`) produced by a run of the program; the default is the current directory.

- `--tempdelay=#`

Command-Line Format	<code>--tempdelay=#</code>
Introduced	5.7.18-ndb-7.6.2
Type	Integer
Default Value	10
Minimum Value	0
Maximum Value	4294967295
Unit	ms

Number of milliseconds to sleep between temporary errors.

- `--temperrors=#`

Command-Line Format	<code>--temperrors=#</code>
Introduced	5.7.18-ndb-7.6.2
Type	Integer
Default Value	0
Minimum Value	0
Maximum Value	4294967295

Number of times a transaction can fail due to a temporary error, per execution batch. The default is 0, which means that any temporary error is fatal. Temporary errors do not cause any rows to be added to the `.rej` file.

- `--usage`

Command-Line Format	<code>--usage</code>
Introduced	5.7.18-ndb-7.6.2

Display help text and exit; same as `--help`.

- `--verbose, -v`

Command-Line Format	<code>--verbose[=#]</code>
Introduced	5.7.18-ndb-7.6.2
Type (\geq 5.7.20-ndb-7.6.4)	Boolean
Type (\geq 5.7.18-ndb-7.6.2, \leq 5.7.18-ndb-7.6.3)	Integer
Default Value (\geq 5.7.20-ndb-7.6.4)	<code>false</code>
Default Value (\geq 5.7.18-ndb-7.6.2, \leq 5.7.18-ndb-7.6.3)	0

Minimum Value	0
Maximum Value	2

Enable verbose output.

Note

Previously, this option controlled the internal logging level for debugging messages. In NDB 7.6, use the `--log-level` option for this purpose instead.

- `--version`

Command-Line Format	<code>--version</code>
Introduced	5.7.18-ndb-7.6.2

Display version information and exit.

As with `LOAD DATA`, options for field and line formatting much match those used to create the CSV file, whether this was done using `SELECT INTO ... OUTFILE`, or by some other means. There is no equivalent to the `LOAD DATA` statement `STARTING WITH` option.

`ndb_import` was added in NDB 7.6.

5.15 ndb_index_stat — NDB Index Statistics Utility

`ndb_index_stat` provides per-fragment statistical information about indexes on NDB tables. This includes cache version and age, number of index entries per partition, and memory consumption by indexes.

Usage

To obtain basic index statistics about a given NDB table, invoke `ndb_index_stat` as shown here, with the name of the table as the first argument and the name of the database containing this table specified immediately following it, using the `--database (-d)` option:

```
ndb_index_stat table -d database
```

In this example, we use `ndb_index_stat` to obtain such information about an NDB table named `mytable` in the `test` database:

```
$> ndb_index_stat -d test mytable
table:City index:PRIMARY fragCount:2
sampleVersion:3 loadTime:1399585986 sampleCount:1994 keyBytes:7976
query cache: valid:1 sampleCount:1994 totalBytes:27916
times in ms: save: 7.133 sort: 1.974 sort per sample: 0.000

NDBT_ProgramExit: 0 - OK
```

`sampleVersion` is the version number of the cache from which the statistics data is taken. Running `ndb_index_stat` with the `--update` option causes `sampleVersion` to be incremented.

`loadTime` shows when the cache was last updated. This is expressed as seconds since the Unix Epoch.

`sampleCount` is the number of index entries found per partition. You can estimate the total number of entries by multiplying this by the number of fragments (shown as `fragCount`).

`sampleCount` can be compared with the cardinality of `SHOW INDEX` or `INFORMATION_SCHEMA.STATISTICS`, although the latter two provide a view of the table as a whole, while `ndb_index_stat` provides a per-fragment average.

`keyBytes` is the number of bytes used by the index. In this example, the primary key is an integer, which requires four bytes for each index, so `keyBytes` can be calculated in this case as shown here:

```
keyBytes = sampleCount * (4 bytes per index) = 1994 * 4 = 7976
```

This information can also be obtained using the corresponding column definitions from `INFORMATION_SCHEMA.COLUMNS` (this requires a MySQL Server and a MySQL client application).

`totalBytes` is the total memory consumed by all indexes on the table, in bytes.

Timings shown in the preceding examples are specific to each invocation of `ndb_index_stat`.

The `--verbose` option provides some additional output, as shown here:

```
$> ndb_index_stat -d test mytable --verbose
random seed 1337010518
connected
loop 1 of 1
table:mytable index:PRIMARY fragCount:4
sampleVersion:2 loadTime:1336751773 sampleCount:0 keyBytes:0
read stats
query cache created
query cache: valid:1 sampleCount:0 totalBytes:0
times in ms: save: 20.766 sort: 0.001
disconnected

NDBT_ProgramExit: 0 - OK

$>
```

If the only output from the program is `NDBT_ProgramExit: 0 - OK`, this may indicate that no statistics yet exist. To force them to be created (or updated if they already exist), invoke `ndb_index_stat` with the `--update` option, or execute `ANALYZE TABLE` on the table in the `mysql` client.

Options

The following table includes options that are specific to the NDB Cluster `ndb_index_stat` utility. Additional descriptions are listed following the table.

Table 5.13 Command-line options used with the program `ndb_index_stat`

Format	Description	Added, Deprecated, or Removed
<code>--character-sets-dir=path</code>	Directory containing character sets	(Supported in all NDB releases based on MySQL 5.7)
<code>--connect-retries=#</code>	Number of times to retry connection before giving up	(Supported in all NDB releases based on MySQL 5.7)
<code>--connect-retry-delay=#</code>	Number of seconds to wait between attempts to contact management server	(Supported in all NDB releases based on MySQL 5.7)
<code>--connect-string=connection_string,</code> <code>-c connection_string</code>	Same as <code>--ndb-connectstring</code>	(Supported in all NDB releases based on MySQL 5.7)
<code>--core-file</code>	Write core file on error; used in debugging	(Supported in all NDB releases based on MySQL 5.7)
<code>--database=name,</code> <code>-d name</code>	Name of database containing table	(Supported in all NDB releases based on MySQL 5.7)
<code>--defaults-extra-file=path</code>	Read given file after global files are read	(Supported in all NDB releases based on MySQL 5.7)

Format	Description	Added, Deprecated, or Removed
<code>--defaults-file=path</code>	Read default options from given file only	(Supported in all NDB releases based on MySQL 5.7)
<code>--defaults-group-suffix=string</code>	Also read groups with <code>concat(group, suffix)</code>	(Supported in all NDB releases based on MySQL 5.7)
<code>--delete</code>	Delete index statistics for table, stopping any auto-update previously configured	(Supported in all NDB releases based on MySQL 5.7)
<code>--dump</code>	Print query cache	(Supported in all NDB releases based on MySQL 5.7)
<code>--help,</code> <code>-?</code>	Display help text and exit	(Supported in all NDB releases based on MySQL 5.7)
<code>--login-path=path</code>	Read given path from login file	(Supported in all NDB releases based on MySQL 5.7)
<code>--loops=#</code>	Set the number of times to perform given command; default is 0	(Supported in all NDB releases based on MySQL 5.7)
<code>--ndb-connectstring=connection_string</code> <code>-c connection_string</code>	Set connect string for connecting to <code>ndb_mgmd</code> . Syntax: "[nodeid=id;][host=]hostname[:port]". Overrides entries in <code>NDB_CONNECTSTRING</code> and <code>my.cnf</code>	(Supported in all NDB releases based on MySQL 5.7)
<code>--ndb-mgmd-host=connection_string,</code> <code>-c connection_string</code>	Same as <code>--ndb-connectstring</code>	(Supported in all NDB releases based on MySQL 5.7)
<code>--ndb-nodeid=#</code>	Set node ID for this node, overriding any ID set by <code>--ndb-connectstring</code>	(Supported in all NDB releases based on MySQL 5.7)
<code>--ndb-optimized-node-selection</code>	Enable optimizations for selection of nodes for transactions. Enabled by default; use <code>--skip-ndb-optimized-node-selection</code> to disable	(Supported in all NDB releases based on MySQL 5.7)
<code>--no-defaults</code>	Do not read default options from any option file other than login file	(Supported in all NDB releases based on MySQL 5.7)
<code>--print-defaults</code>	Print program argument list and exit	(Supported in all NDB releases based on MySQL 5.7)
<code>--query=#</code>	Perform random range queries on first key attr (must be int unsigned)	(Supported in all NDB releases based on MySQL 5.7)
<code>--sys-drop</code>	Drop any statistics tables and events in NDB kernel (all statistics are lost)	(Supported in all NDB releases based on MySQL 5.7)
<code>--sys-create</code>	Create all statistics tables and events in NDB kernel, if none of them already exist	(Supported in all NDB releases based on MySQL 5.7)

Format	Description	Added, Deprecated, or Removed
<code>--sys-create-if-not-exist</code>	Create any statistics tables and events in NDB kernel that do not already exist	(Supported in all NDB releases based on MySQL 5.7)
<code>--sys-create-if-not-valid</code>	Create any statistics tables or events that do not already exist in the NDB kernel, after dropping any that are invalid	(Supported in all NDB releases based on MySQL 5.7)
<code>--sys-check</code>	Verify that NDB system index statistics and event tables exist	(Supported in all NDB releases based on MySQL 5.7)
<code>--sys-skip-tables</code>	Do not apply sys-* options to tables	(Supported in all NDB releases based on MySQL 5.7)
<code>--sys-skip-events</code>	Do not apply sys-* options to events	(Supported in all NDB releases based on MySQL 5.7)
<code>--update</code>	Update index statistics for table, restarting any auto-update previously configured	(Supported in all NDB releases based on MySQL 5.7)
<code>--usage,</code> <code>-?</code>	Display help text and exit; same as --help	(Supported in all NDB releases based on MySQL 5.7)
<code>--verbose,</code> <code>-v</code>	Turn on verbose output	(Supported in all NDB releases based on MySQL 5.7)
<code>--version,</code> <code>-V</code>	Display version information and exit	(Supported in all NDB releases based on MySQL 5.7)

- `--character-sets-dir`

Command-Line Format	<code>--character-sets-dir=path</code>
---------------------	--

Directory containing character sets.

- `--connect-retries`

Command-Line Format	<code>--connect-retries=#</code>
Type	Integer
Default Value	12
Minimum Value	0
Maximum Value	12

Number of times to retry connection before giving up.

- `--connect-retry-delay`

Command-Line Format	<code>--connect-retry-delay=#</code>
Type	Integer
Default Value	5
Minimum Value	0
Maximum Value	5

Number of seconds to wait between attempts to contact management server.

- `--connect-string`

Command-Line Format	<code>--connect-string=connection_string</code>
Type	String
Default Value	[none]

Same as `--ndb-connectstring`.

- `--core-file`

Command-Line Format	<code>--core-file</code>
---------------------	--------------------------

Write core file on error; used in debugging.

- `--database=name`, `-d name`

Command-Line Format	<code>--database=name</code>
Type	String
Default Value	[none]
Minimum Value	
Maximum Value	

The name of the database that contains the table being queried.

- `--defaults-extra-file`

Command-Line Format	<code>--defaults-extra-file=path</code>
Type	String
Default Value	[none]

Read given file after global files are read.

- `--defaults-file`

Command-Line Format	<code>--defaults-file=path</code>
Type	String
Default Value	[none]

Read default options from given file only.

- `--defaults-group-suffix`

Command-Line Format	<code>--defaults-group-suffix=string</code>
Type	String
Default Value	[none]

Also read groups with `concat(group, suffix)`.

- `--delete`

Command-Line Format	<code>--delete</code>
---------------------	-----------------------

Delete the index statistics for the given table, stopping any auto-update that was previously configured.

- `--dump`

Command-Line Format	<code>--dump</code>
---------------------	---------------------

Dump the contents of the query cache.

- `--help`

Command-Line Format	<code>--help</code>
---------------------	---------------------

Display help text and exit.

- `--login-path`

Command-Line Format	<code>--login-path=path</code>
Type	String
Default Value	[none]

Read given path from login file.

- `--loops=#`

Command-Line Format	<code>--loops=#</code>
Type	Numeric
Default Value	0
Minimum Value	0
Maximum Value	MAX_INT

Repeat commands this number of times (for use in testing).

- `--ndb-connectstring`

Command-Line Format	<code>--ndb-connectstring=connection_string</code>
Type	String
Default Value	[none]

Set connect string for connecting to `ndb_mgmd`. Syntax: "[nodeid=id;][host=]hostname[:port]". Overrides entries in `NDB_CONNECTSTRING` and `my.cnf`.

- `--ndb-mgmd-host`

Command-Line Format	<code>--ndb-mgmd-host=connection_string</code>
Type	String
Default Value	[none]

Same as `--ndb-connectstring`.

- `--ndb-nodeid`

Command-Line Format	<code>--ndb-nodeid=#</code>
Type	Integer
Default Value	[none]

Set node ID for this node, overriding any ID set by `--ndb-connectstring`.

- `--ndb-optimized-node-selection`

Command-Line Format	<code>--ndb-optimized-node-selection</code>
---------------------	---

Enable optimizations for selection of nodes for transactions. Enabled by default; use `--skip-ndb-optimized-node-selection` to disable.

- `--no-defaults`

Command-Line Format	<code>--no-defaults</code>
---------------------	----------------------------

Do not read default options from any option file other than login file.

- `--print-defaults`

Command-Line Format	<code>--print-defaults</code>
---------------------	-------------------------------

Print program argument list and exit.

- `--query=#`

Command-Line Format	<code>--query=#</code>
Type	Numeric
Default Value	0
Minimum Value	0
Maximum Value	MAX_INT

Perform random range queries on first key attribute (must be int unsigned).

- `--sys-drop`

Command-Line Format	<code>--sys-drop</code>
---------------------	-------------------------

Drop all statistics tables and events in the NDB kernel. *This causes all statistics to be lost.*

- `--sys-create`

Command-Line Format	<code>--sys-create</code>
---------------------	---------------------------

Create all statistics tables and events in the NDB kernel. This works only if none of them exist previously.

- `--sys-create-if-not-exist`

Command-Line Format	<code>--sys-create-if-not-exist</code>
---------------------	--

Create any NDB system statistics tables or events (or both) that do not already exist when the program is invoked.

- `--sys-create-if-not-valid`

Command-Line Format	<code>--sys-create-if-not-valid</code>
---------------------	--

Create any NDB system statistics tables or events that do not already exist, after dropping any that are invalid.

- `--sys-check`

Command-Line Format	<code>--sys-check</code>
---------------------	--------------------------

Verify that all required system statistics tables and events exist in the NDB kernel.

- `--sys-skip-tables`

Command-Line Format	<code>--sys-skip-tables</code>
---------------------	--------------------------------

Do not apply any `--sys-*` options to any statistics tables.

- `--sys-skip-events`

Command-Line Format	<code>--sys-skip-events</code>
---------------------	--------------------------------

Do not apply any `--sys-*` options to any events.

- `--update`

Command-Line Format	<code>--update</code>
---------------------	-----------------------

Update the index statistics for the given table, and restart any auto-update that was previously configured.

- `--usage`

Command-Line Format	<code>--usage</code>
---------------------	----------------------

Display help text and exit; same as `--help`.

- `--verbose`

Command-Line Format	<code>--verbose</code>
---------------------	------------------------

Turn on verbose output.

- `--version`

Command-Line Format	<code>--version</code>
---------------------	------------------------

Display version information and exit.

ndb_index_stat system options. The following options are used to generate and update the statistics tables in the NDB kernel. None of these options can be mixed with statistics options (see [ndb_index_stat statistics options](#)).

- `--sys-drop`
- `--sys-create`
- `--sys-create-if-not-exist`
- `--sys-create-if-not-valid`

- `--sys-check`
- `--sys-skip-tables`

ndb_index_stat statistics options. The options listed here are used to generate index statistics. They work with a given table and database. They cannot be mixed with system options (see [ndb_index_stat system options](#)).

- `--database`
- `--delete`
- `--update`
- `--dump`
- `--query`

5.16 ndb_move_data — NDB Data Copy Utility

`ndb_move_data` copies data from one NDB table to another.

Usage

The program is invoked with the names of the source and target tables; either or both of these may be qualified optionally with the database name. Both tables must use the NDB storage engine.

```
ndb_move_data options source target
```

Options that can be used with `ndb_move_data` are shown in the following table. Additional descriptions follow the table.

Table 5.14 Command-line options used with the program `ndb_move_data`

Format	Description	Added, Deprecated, or Removed
<code>--abort-on-error</code>	Dump core on permanent error (debug option)	(Supported in all NDB releases based on MySQL 5.7)
<code>--character-sets-dir=path</code>	Directory where character sets are	(Supported in all NDB releases based on MySQL 5.7)
<code>--connect-retries=#</code>	Number of times to retry connection before giving up	(Supported in all NDB releases based on MySQL 5.7)
<code>--connect-retry-delay=#</code>	Number of seconds to wait between attempts to contact management server	(Supported in all NDB releases based on MySQL 5.7)
<code>--connect-string=connection_string,</code> <code>-c connection_string</code>	Same as <code>--ndb-connectstring</code>	(Supported in all NDB releases based on MySQL 5.7)
<code>--core-file</code>	Write core file on error; used in debugging	(Supported in all NDB releases based on MySQL 5.7)
<code>--database=name,</code> <code>-d name</code>	Name of database in which table is found	(Supported in all NDB releases based on MySQL 5.7)
<code>--defaults-extra-file=path</code>	Read given file after global files are read	(Supported in all NDB releases based on MySQL 5.7)
<code>--defaults-file=path</code>	Read default options from given file only	(Supported in all NDB releases based on MySQL 5.7)
<code>--defaults-group-suffix=string</code>	Also read groups with <code>concat(group, suffix)</code>	(Supported in all NDB releases based on MySQL 5.7)
<code>--drop-source</code>	Drop source table after all rows have been moved	(Supported in all NDB releases based on MySQL 5.7)

Format	Description	Added, Deprecated, or Removed
<code>--error-insert</code>	Insert random temporary errors (used in testing)	(Supported in all NDB releases based on MySQL 5.7)
<code>--exclude-missing-columns</code>	Ignore extra columns in source or target table	(Supported in all NDB releases based on MySQL 5.7)
<code>--help,</code> <code>-?</code>	Display help text and exit	(Supported in all NDB releases based on MySQL 5.7)
<code>--login-path=path</code>	Read given path from login file	(Supported in all NDB releases based on MySQL 5.7)
<code>--lossy-conversions,</code> <code>-l</code>	Allow attribute data to be truncated when converted to smaller type	(Supported in all NDB releases based on MySQL 5.7)
<code>--ndb-connectstring=connection_string</code> <code>-c connection_string</code>	Set connect string for connecting to <code>ndb_mgmd</code> . Syntax: "[nodeid=id;][host=]hostname[:port]". Overrides entries in <code>NDB_CONNECTSTRING</code> and <code>my.cnf</code>	(Supported in all NDB releases based on MySQL 5.7)
<code>--ndb-mgmd-host=connection_string,</code> <code>-c connection_string</code>	Same as <code>--ndb-connectstring</code>	(Supported in all NDB releases based on MySQL 5.7)
<code>--ndb-nodeid=#</code>	Set node ID for this node, overriding any ID set by <code>--ndb-connectstring</code>	(Supported in all NDB releases based on MySQL 5.7)
<code>--ndb-optimized-node-selection</code>	Enable optimizations for selection of nodes for transactions. Enabled by default; use <code>--skip-ndb-optimized-node-selection</code> to disable	(Supported in all NDB releases based on MySQL 5.7)
<code>--no-defaults</code>	Do not read default options from any option file other than login file	(Supported in all NDB releases based on MySQL 5.7)
<code>--print-defaults</code>	Print program argument list and exit	(Supported in all NDB releases based on MySQL 5.7)
<code>--promote-attributes,</code> <code>-A</code>	Allow attribute data to be converted to larger type	(Supported in all NDB releases based on MySQL 5.7)
<code>--staging-tries=x[,y[,z]]</code>	Specify tries on temporary errors; format is <code>x[,y[,z]]</code> where <code>x</code> =max tries (0=no limit), <code>y</code> =min delay (ms), <code>z</code> =max delay (ms)	(Supported in all NDB releases based on MySQL 5.7)
<code>--usage,</code> <code>-?</code>	Display help text and exit; same as <code>--help</code>	(Supported in all NDB releases based on MySQL 5.7)
<code>--verbose</code>	Enable verbose messages	(Supported in all NDB releases based on MySQL 5.7)
<code>--version,</code> <code>-V</code>	Display version information and exit	(Supported in all NDB releases based on MySQL 5.7)

- `--abort-on-error`

Command-Line Format	<code>--abort-on-error</code>
---------------------	-------------------------------

Dump core on permanent error (debug option).

- `--character-sets-dir=name`

Command-Line Format	<code>--character-sets-dir=path</code>
Type	String
Default Value	[none]

Directory where character sets are.

- `--connect-retry-delay`

Command-Line Format	<code>--connect-retry-delay=#</code>
Type	Integer
Default Value	5
Minimum Value	0
Maximum Value	5

Number of seconds to wait between attempts to contact management server.

- `--connect-retries`

Command-Line Format	<code>--connect-retries=#</code>
Type	Integer
Default Value	12
Minimum Value	0
Maximum Value	12

Number of times to retry connection before giving up.

- `--connect-string`

Command-Line Format	<code>--connect-string=connection_string</code>
Type	String
Default Value	[none]

Same as `--ndb-connectstring`.

- `--core-file`

Command-Line Format	<code>--core-file</code>
---------------------	--------------------------

Write core file on error; used in debugging.

- `--database=dbname, -d`

Command-Line Format	<code>--database=name</code>	385
Type	String	

Default Value	TEST_DB
---------------	---------

Name of the database in which the table is found.

- `--defaults-extra-file`

Command-Line Format	<code>--defaults-extra-file=path</code>
Type	String
Default Value	[none]

Read given file after global files are read.

- `--defaults-file`

Command-Line Format	<code>--defaults-file=path</code>
Type	String
Default Value	[none]

Read default options from given file only.

- `--defaults-group-suffix`

Command-Line Format	<code>--defaults-group-suffix=string</code>
Type	String
Default Value	[none]

Also read groups with `concat(group, suffix)`.

- `--drop-source`

Command-Line Format	<code>--drop-source</code>
---------------------	----------------------------

Drop source table after all rows have been moved.

- `--error-insert`

Command-Line Format	<code>--error-insert</code>
---------------------	-----------------------------

Insert random temporary errors (testing option).

- `--exclude-missing-columns`

Command-Line Format	<code>--exclude-missing-columns</code>
---------------------	--

Ignore extra columns in source or target table.

- `--help`

Command-Line Format	<code>--help</code>
---------------------	---------------------

Display help text and exit.

- `--login-path`

Command-Line Format	<code>--login-path=path</code>
Type	String
Default Value	[none]

Read given path from login file.

- `--lossy-conversions, -l`

Command-Line Format	<code>--lossy-conversions</code>
---------------------	----------------------------------

Allow attribute data to be truncated when converted to a smaller type.

- `--ndb-connectstring`

Command-Line Format	<code>--ndb-connectstring=connection_string</code>
Type	String
Default Value	[none]

Set connect string for connecting to `ndb_mgmd`. Syntax: "[nodeid=id;][host=]hostname[:port]". Overrides entries in `NDB_CONNECTSTRING` and `my.cnf`.

- `--ndb-mgmd-host`

Command-Line Format	<code>--ndb-mgmd-host=connection_string</code>
Type	String
Default Value	[none]

Same as `--ndb-connectstring`.

- `--ndb-nodeid`

Command-Line Format	<code>--ndb-nodeid=#</code>
Type	Integer
Default Value	[none]

Set node ID for this node, overriding any ID set by `--ndb-connectstring`.

- `--ndb-optimized-node-selection`

Command-Line Format	<code>--ndb-optimized-node-selection</code>
---------------------	---

Enable optimizations for selection of nodes for transactions. Enabled by default; use `--skip-ndb-optimized-node-selection` to disable.

- `--no-defaults`

Command-Line Format	<code>--no-defaults</code>
---------------------	----------------------------

Do not read default options from any option file other than login file.

- `--print-defaults`

Command-Line Format	<code>--print-defaults</code>
---------------------	-------------------------------

Print program argument list and exit.

- `--promote-attributes, -A`

Command-Line Format	<code>--promote-attributes</code>
---------------------	-----------------------------------

Allow attribute data to be converted to a larger type.

- `--staging-tries=x[,y[,z]]`

Command-Line Format	<code>--staging-tries=x[,y[,z]]</code>
Type	String
Default Value	<code>0,1000,60000</code>

Specify tries on temporary errors. Format is x[,y[,z]] where x=max tries (0=no limit), y=min delay (ms), z=max delay (ms).

- `--usage`

Command-Line Format	<code>--usage</code>
---------------------	----------------------

Display help text and exit; same as `--help`.

- `--verbose`

Command-Line Format	<code>--verbose</code>
---------------------	------------------------

Enable verbose messages.

- `--version`

Command-Line Format	<code>--version</code>
---------------------	------------------------

Display version information and exit.

5.17 ndb_perror — Obtain NDB Error Message Information

`ndb_perror` shows information about an NDB error, given its error code. This includes the error message, the type of error, and whether the error is permanent or temporary. Added to the MySQL NDB Cluster distribution in NDB 7.6, it is intended as a drop-in replacement for `perror --ndb`.

Usage

```
ndb_perror [options] error_code
```

`ndb_perror` does not need to access a running NDB Cluster, or any nodes (including SQL nodes). To view information about a given NDB error, invoke the program, using the error code as an argument, like this:

```
$> ndb_perror 323
NDB error code 323: Invalid nodegroup id, nodegroup already existing: Permanent error: Application error
```

To display only the error message, invoke `ndb_perror` with the `--silent` option (short form `-s`), as shown here:

```
$> ndb_perror -s 323
Invalid nodegroup id, nodegroup already existing: Permanent error: Application error
```

Like `perror`, `ndb_perror` accepts multiple error codes:

```
$> ndb_perror 321 1001
NDB error code 321: Invalid nodegroup id: Permanent error: Application error
NDB error code 1001: Illegal connect string
```

Additional program options for `ndb_perror` are described later in this section.

`ndb_perror` replaces `pererror --ndb`, which is deprecated in NDB 7.6 and subject to removal in a future release of MySQL NDB Cluster. To make substitution easier in scripts and other applications that might depend on `pererror` for obtaining NDB error information, `ndb_perror` supports its own “dummy” `--ndb` option, which does nothing.

The following table includes all options that are specific to the NDB Cluster program `ndb_perror`. Additional descriptions follow the table.

Table 5.15 Command-line options used with the program `ndb_perror`

Format	Description	Added, Deprecated, or Removed
<code>--defaults-extra-file=path</code>	Read given file after global files are read	(Supported in all NDB releases based on MySQL 5.7)
<code>--defaults-file=path</code>	Read default options from given file only	(Supported in all NDB releases based on MySQL 5.7)
<code>--defaults-group-suffix=string</code>	Also read groups with <code>concat(group, suffix)</code>	(Supported in all NDB releases based on MySQL 5.7)
<code>--help,</code> <code>-?</code>	Display help text	ADDED: NDB 7.6.4
<code>--login-path=path</code>	Read given path from login file	(Supported in all NDB releases based on MySQL 5.7)
<code>--ndb</code>	For compatibility with applications depending on old versions of <code>pererror</code> ; does nothing	ADDED: NDB 7.6.4
<code>--no-defaults</code>	Do not read default options from any option file other than login file	(Supported in all NDB releases based on MySQL 5.7)
<code>--print-defaults</code>	Print program argument list and exit	(Supported in all NDB releases based on MySQL 5.7)
<code>--silent,</code> <code>-s</code>	Show error message only	ADDED: NDB 7.6.4
<code>--version,</code> <code>-V</code>	Print program version information and exit	ADDED: NDB 7.6.4
<code>--verbose,</code> <code>-v</code>	Verbose output; disable with <code>--silent</code>	ADDED: NDB 7.6.4

Additional Options

- `--help, -?`

Command-Line Format	<code>--help</code>
Introduced	5.7.19-ndb-7.6.4

Display program help text and exit.

- `--ndb`

Command-Line Format	<code>--ndb</code>
Introduced	5.7.19-ndb-7.6.4

For compatibility with applications depending on old versions of `percona-toolkit` that use that program's `--ndb` option. The option when used with `ndb_percona-toolkit` does nothing, and is ignored by it.

- `--silent, -s`

Command-Line Format	<code>--silent</code>
Introduced	5.7.19-ndb-7.6.4

Show error message only.

- `--version, -V`

Command-Line Format	<code>--version</code>
Introduced	5.7.19-ndb-7.6.4

Print program version information and exit.

- `--verbose, -v`

Command-Line Format	<code>--verbose</code>
Introduced	5.7.19-ndb-7.6.4

Verbose output; disable with `--silent`.

5.18 ndb_print_backup_file — Print NDB Backup File Contents

`ndb_print_backup_file` obtains diagnostic information from a cluster backup file.

Usage

```
ndb_print_backup_file file_name
```

file_name is the name of a cluster backup file. This can be any of the files (`.Data`, `.ctl`, or `.log` file) found in a cluster backup directory. These files are found in the data node's backup directory under the subdirectory `BACKUP-#`, where `#` is the sequence number for the backup. For more information about cluster backup files and their contents, see [Section 6.8.1, “NDB Cluster Backup Concepts”](#).

Like `ndb_print_schema_file` and `ndb_print_sys_file` (and unlike most of the other NDB utilities that are intended to be run on a management server host or to connect to a management server) `ndb_print_backup_file` must be run on a cluster data node, since it accesses the data node file system directly. Because it does not make use of the management server, this utility can be used when the management server is not running, and even when the cluster has been completely shut down.

Additional Options

None.

5.19 ndb_print_file — Print NDB Disk Data File Contents

`ndb_print_file` obtains information from an NDB Cluster Disk Data file.

Usage

```
ndb_print_file [-v] [-q] file_name+
```

`file_name` is the name of an NDB Cluster Disk Data file. Multiple filenames are accepted, separated by spaces.

Like `ndb_print_schema_file` and `ndb_print_sys_file` (and unlike most of the other NDB utilities that are intended to be run on a management server host or to connect to a management server) `ndb_print_file` must be run on an NDB Cluster data node, since it accesses the data node file system directly. Because it does not make use of the management server, this utility can be used when the management server is not running, and even when the cluster has been completely shut down.

Additional Options

`ndb_print_file` supports the following options:

- `-v`: Make output verbose.
- `-q`: Suppress output (quiet mode).
- `--help`, `-h`, `-?`: Print help message.

For more information, see [Section 6.10, “NDB Cluster Disk Data Tables”](#).

5.20 `ndb_print_frag_file` — Print NDB Fragment List File Contents

`ndb_print_frag_file` obtains information from a cluster fragment list file. It is intended for use in helping to diagnose issues with data node restarts.

Usage

```
ndb_print_frag_file file_name
```

`file_name` is the name of a cluster fragment list file, which matches the pattern `SX.FragList`, where `X` is a digit in the range 2-9 inclusive, and are found in the data node file system of the data node having the node ID `nodeid`, in directories named `ndb_nodeid_fs/DN/DBDIH/`, where `N` is 1 or 2. Each fragment file contains records of the fragments belonging to each NDB table. For more information about cluster fragment files, see [NDB Cluster Data Node File System Directory](#).

Like `ndb_print_backup_file`, `ndb_print_sys_file`, and `ndb_print_schema_file` (and unlike most of the other NDB utilities that are intended to be run on a management server host or to connect to a management server), `ndb_print_frag_file` must be run on a cluster data node, since it accesses the data node file system directly. Because it does not make use of the management server, this utility can be used when the management server is not running, and even when the cluster has been completely shut down.

Additional Options

None.

Sample Output

```
$> ndb_print_frag_file /usr/local/mysql/d/data/ndb_3_fs/D1/DBDIH/S2.FragList
Filename: /usr/local/mysql/d/data/ndb_3_fs/D1/DBDIH/S2.FragList with size 8192
noOfPages = 1 noOfWords = 182
Table Data
-----
Num Frags: 2 NoOfReplicas: 2 hashpointer: 4294967040
kvalue: 6 mask: 0x00000000 method: HashMap
Storage is on Logged and checkpointed, survives SR
----- Fragment with FragId: 0 -----
```

```
Preferred Primary: 2 numStoredReplicas: 2 numOldStoredReplicas: 0 distKey: 0 LogPartId: 0
-----Stored Replica-----
Replica node is: 2 initialGci: 2 numCrashedReplicas = 0 nextLcpNo = 1
LcpNo[0]: maxGciCompleted: 1 maxGciStarted: 2 lcpId: 1 lcpStatus: valid
LcpNo[1]: maxGciCompleted: 0 maxGciStarted: 0 lcpId: 0 lcpStatus: invalid
-----Stored Replica-----
Replica node is: 3 initialGci: 2 numCrashedReplicas = 0 nextLcpNo = 1
LcpNo[0]: maxGciCompleted: 1 maxGciStarted: 2 lcpId: 1 lcpStatus: valid
LcpNo[1]: maxGciCompleted: 0 maxGciStarted: 0 lcpId: 0 lcpStatus: invalid
----- Fragment with FragId: 1 -----
Preferred Primary: 3 numStoredReplicas: 2 numOldStoredReplicas: 0 distKey: 0 LogPartId: 1
-----Stored Replica-----
Replica node is: 3 initialGci: 2 numCrashedReplicas = 0 nextLcpNo = 1
LcpNo[0]: maxGciCompleted: 1 maxGciStarted: 2 lcpId: 1 lcpStatus: valid
LcpNo[1]: maxGciCompleted: 0 maxGciStarted: 0 lcpId: 0 lcpStatus: invalid
-----Stored Replica-----
Replica node is: 2 initialGci: 2 numCrashedReplicas = 0 nextLcpNo = 1
LcpNo[0]: maxGciCompleted: 1 maxGciStarted: 2 lcpId: 1 lcpStatus: valid
LcpNo[1]: maxGciCompleted: 0 maxGciStarted: 0 lcpId: 0 lcpStatus: invalid
```

5.21 ndb_print_schema_file — Print NDB Schema File Contents

`ndb_print_schema_file` obtains diagnostic information from a cluster schema file.

Usage

```
ndb_print_schema_file file_name
```

file_name is the name of a cluster schema file. For more information about cluster schema files, see [NDB Cluster Data Node File System Directory](#).

Like `ndb_print_backup_file` and `ndb_print_sys_file` (and unlike most of the other **NDB** utilities that are intended to be run on a management server host or to connect to a management server) `ndb_print_schema_file` must be run on a cluster data node, since it accesses the data node file system directly. Because it does not make use of the management server, this utility can be used when the management server is not running, and even when the cluster has been completely shut down.

Additional Options

None.

5.22 ndb_print_sys_file — Print NDB System File Contents

`ndb_print_sys_file` obtains diagnostic information from an NDB Cluster system file.

Usage

```
ndb_print_sys_file file_name
```

file_name is the name of a cluster system file (sysfile). Cluster system files are located in a data node's data directory (`DataDir`); the path under this directory to system files matches the pattern `ndb_#_fs/D#/DBDIH/P#.sysfile`. In each case, the `#` represents a number (not necessarily the same number). For more information, see [NDB Cluster Data Node File System Directory](#).

Like `ndb_print_backup_file` and `ndb_print_schema_file` (and unlike most of the other **NDB** utilities that are intended to be run on a management server host or to connect to a management server) `ndb_print_sys_file` must be run on a cluster data node, since it accesses the data node file system directly. Because it does not make use of the management server, this utility can be used when the management server is not running, and even when the cluster has been completely shut down.

Additional Options

None.

5.23 `ndb_redo_log_reader` — Check and Print Content of Cluster Redo Log

Reads a redo log file, checking it for errors, printing its contents in a human-readable format, or both. `ndb_redo_log_reader` is intended for use primarily by NDB Cluster developers and Support personnel in debugging and diagnosing problems.

This utility remains under development, and its syntax and behavior are subject to change in future NDB Cluster releases.

The C++ source files for `ndb_redo_log_reader` can be found in the directory `/storage/ndb/src/kernel/blocks/dblqh/redoLogReader`.

Options that can be used with `ndb_redo_log_reader` are shown in the following table. Additional descriptions follow the table.

Table 5.16 Command-line options used with the program `ndb_redo_log_reader`

Format	Description	Added, Deprecated, or Removed
<code>-dump</code>	Print dump info	(Supported in all NDB releases based on MySQL 5.7)
<code>-filedescriptors</code>	Print file descriptors only	(Supported in all NDB releases based on MySQL 5.7)
<code>--help</code>	Print usage information (has no short form)	(Supported in all NDB releases based on MySQL 5.7)
<code>-lap</code>	Provide lap info, with max GCI started and completed	(Supported in all NDB releases based on MySQL 5.7)
<code>-mbyte #</code>	Starting megabyte	(Supported in all NDB releases based on MySQL 5.7)
<code>-mbyteheaders</code>	Show only first page header of each megabyte in file	(Supported in all NDB releases based on MySQL 5.7)
<code>-nocheck</code>	Do not check records for errors	(Supported in all NDB releases based on MySQL 5.7)
<code>-noprint</code>	Do not print records	(Supported in all NDB releases based on MySQL 5.7)
<code>-page #</code>	Start with this page	(Supported in all NDB releases based on MySQL 5.7)
<code>-pageheaders</code>	Show page headers only	(Supported in all NDB releases based on MySQL 5.7)
<code>-pageindex #</code>	Start with this page index	(Supported in all NDB releases based on MySQL 5.7)
<code>-twiddle</code>	Bit-shifted dump	(Supported in all NDB releases based on MySQL 5.7)

Usage

```
ndb_redo_log_reader file_name [options]
```

file_name is the name of a cluster redo log file. redo log files are located in the numbered directories under the data node's data directory (*DataDir*); the path under this directory to the redo log files matches the pattern `ndb_nodeid_fs/D#/DBLQH/S#.FragLog`. *nodeid* is the data node's node ID. The two instances of # each represent a number (not necessarily the same number); the number following *D* is in the range 8-39 inclusive; the range of the number following *S* varies according to the value of the `NoOfFragmentLogFiles` configuration parameter, whose default value is 16; thus, the default range of the number in the file name is 0-15 inclusive. For more information, see [NDB Cluster Data Node File System Directory](#).

The name of the file to be read may be followed by one or more of the options listed here:

- `-dump`

Command-Line Format	<code>-dump</code>
---------------------	--------------------

Print dump info.

- | | |
|---------------------|-------------------------------|
| Command-Line Format | <code>-filedescriptors</code> |
|---------------------|-------------------------------|

`-filedescriptors`: Print file descriptors only.

- | | |
|---------------------|---------------------|
| Command-Line Format | <code>--help</code> |
|---------------------|---------------------|

`--help`: Print usage information.

- `-lap`

Command-Line Format	<code>-lap</code>
---------------------	-------------------

Provide lap info, with max GCI started and completed.

- | | |
|---------------------|-----------------------|
| Command-Line Format | <code>-mbyte #</code> |
| Type | Numeric |
| Default Value | 0 |
| Minimum Value | 0 |
| Maximum Value | 15 |

`-mbyte #`: Starting megabyte.

`#` is an integer in the range 0 to 15, inclusive.

- | | |
|---------------------|----------------------------|
| Command-Line Format | <code>-mbyteheaders</code> |
|---------------------|----------------------------|

`-mbyteheaders`: Show only the first page header of every megabyte in the file.

- | | |
|---------------------|-----------------------|
| Command-Line Format | <code>-noprint</code> |
|---------------------|-----------------------|

`-noprint`: Do not print the contents of the log file.

- | | |
|---------------------|-----------------------|
| Command-Line Format | <code>-nocheck</code> |
|---------------------|-----------------------|

`-nocheck`: Do not check the log file for errors.

- | | |
|---------------------|----------------------|
| Command-Line Format | <code>-page #</code> |
| Type | Integer |
| Default Value | 0 |
| Minimum Value | 0 |

Maximum Value	31
---------------	----

`-page #`: Start at this page.

`#` is an integer in the range 0 to 31, inclusive.

- | | |
|---------------------|---------------------------|
| Command-Line Format | <code>-pageheaders</code> |
|---------------------|---------------------------|

`-pageheaders`: Show page headers only.

- | | |
|---------------------|---------------------------|
| Command-Line Format | <code>-pageindex #</code> |
| Type | Integer |
| Default Value | 12 |
| Minimum Value | 12 |
| Maximum Value | 8191 |

`-pageindex #`: Start at this page index.

`#` is an integer between 12 and 8191, inclusive.

- `-twiddle`

Command-Line Format	<code>-twiddle</code>
---------------------	-----------------------

Bit-shifted dump.

Like `ndb_print_backup_file` and `ndb_print_schema_file` (and unlike most of the NDB utilities that are intended to be run on a management server host or to connect to a management server) `ndb_redo_log_reader` must be run on a cluster data node, since it accesses the data node file system directly. Because it does not make use of the management server, this utility can be used when the management server is not running, and even when the cluster has been completely shut down.

5.24 ndb_restore — Restore an NDB Cluster Backup

The NDB Cluster restoration program is implemented as a separate command-line utility `ndb_restore`, which can normally be found in the MySQL `bin` directory. This program reads the files created as a result of the backup and inserts the stored information into the database.

Note

Beginning with NDB 7.5.15 and 7.6.11, this program no longer prints `NDBT_ProgramExit: ...` when it finishes its run. Applications depending on this behavior should be modified accordingly when upgrading from earlier releases.

`ndb_restore` must be executed once for each of the backup files that were created by the `START BACKUP` command used to create the backup (see [Section 6.8.2, “Using The NDB Cluster Management Client to Create a Backup”](#)). This is equal to the number of data nodes in the cluster at the time that the backup was created.

Note

Before using `ndb_restore`, it is recommended that the cluster be running in single user mode, unless you are restoring multiple data nodes in parallel. See [Section 6.6, “NDB Cluster Single User Mode”](#), for more information.

Options that can be used with `ndb_restore` are shown in the following table. Additional descriptions follow the table.

Table 5.17 Command-line options used with the program ndb_restore

Format	Description	Added, Deprecated, or Removed
<code>--allow-pk-changes[=0 1]</code>	Allow changes to set of columns making up table's primary key	ADDED: NDB 7.6.14
<code>--append</code>	Append data to tab-delimited file	(Supported in all NDB releases based on MySQL 5.7)
<code>--backup-path=path</code>	Path to backup files directory	(Supported in all NDB releases based on MySQL 5.7)
<code>--backupid=#,</code> <code>-b #</code>	Restore from backup having this ID	(Supported in all NDB releases based on MySQL 5.7)
<code>--character-sets-dir=path</code>	Directory containing character sets	(Supported in all NDB releases based on MySQL 5.7)
<code>--connect=connection_string,</code> <code>-c connection_string</code>	Alias for <code>--connectstring</code>	(Supported in all NDB releases based on MySQL 5.7)
<code>--connect-retries=#</code>	Number of times to retry connection before giving up	(Supported in all NDB releases based on MySQL 5.7)
<code>--connect-retry-delay=#</code>	Number of seconds to wait between attempts to contact management server	(Supported in all NDB releases based on MySQL 5.7)
<code>--connect-string=connection_string,</code> <code>-c connection_string</code>	Same as <code>--ndb-connectstring</code>	(Supported in all NDB releases based on MySQL 5.7)
<code>--core-file</code>	Write core file on error; used in debugging	(Supported in all NDB releases based on MySQL 5.7)
<code>--defaults-extra-file=path</code>	Read given file after global files are read	(Supported in all NDB releases based on MySQL 5.7)
<code>--defaults-file=path</code>	Read default options from given file only	(Supported in all NDB releases based on MySQL 5.7)
<code>--defaults-group-suffix=string</code>	Also read groups with <code>concat(group, suffix)</code>	(Supported in all NDB releases based on MySQL 5.7)
<code>--disable-indexes</code>	Causes indexes from backup to be ignored; may decrease time needed to restore data	(Supported in all NDB releases based on MySQL 5.7)
<code>--dont-ignore-systab-0,</code> <code>-f</code>	Do not ignore system table during restore; experimental only; not for production use	(Supported in all NDB releases based on MySQL 5.7)
<code>--exclude-databases=list</code>	List of one or more databases to exclude (includes those not named)	(Supported in all NDB releases based on MySQL 5.7)
<code>--exclude-intermediate-sql-tables[=TRUE FALSE]</code>	Do not restore any intermediate tables (having names prefixed with '#sql-') that were left over from copying ALTER TABLE operations; specify FALSE to restore such tables	(Supported in all NDB releases based on MySQL 5.7)
<code>--exclude-missing-columns</code>	Causes columns from backup version of table that are missing	(Supported in all NDB releases based on MySQL 5.7)

Format	Description	Added, Deprecated, or Removed
	from version of table in database to be ignored	
<code>--exclude-missing-tables</code>	Causes tables from backup that are missing from database to be ignored	(Supported in all NDB releases based on MySQL 5.7)
<code>--exclude-tables=list</code>	List of one or more tables to exclude (includes those in same database that are not named); each table reference must include database name	(Supported in all NDB releases based on MySQL 5.7)
<code>--fields-enclosed-by=char</code>	Fields are enclosed by this character	(Supported in all NDB releases based on MySQL 5.7)
<code>--fields-optionally-enclosed-by</code>	Fields are optionally enclosed by this character	(Supported in all NDB releases based on MySQL 5.7)
<code>--fields-terminated-by=char</code>	Fields are terminated by this character	(Supported in all NDB releases based on MySQL 5.7)
<code>--help,</code> <code>-?</code>	Display help text and exit	(Supported in all NDB releases based on MySQL 5.7)
<code>--hex</code>	Print binary types in hexadecimal format	(Supported in all NDB releases based on MySQL 5.7)
<code>--ignore-extended-pk-updates[=0 1]</code>	Ignore log entries containing updates to columns now included in extended primary key	ADDED: NDB 7.6.14
<code>--include-databases=list</code>	List of one or more databases to restore (excludes those not named)	(Supported in all NDB releases based on MySQL 5.7)
<code>--include-tables=list</code>	List of one or more tables to restore (excludes those in same database that are not named); each table reference must include database name	(Supported in all NDB releases based on MySQL 5.7)
<code>--lines-terminated-by=char</code>	Lines are terminated by this character	(Supported in all NDB releases based on MySQL 5.7)
<code>--login-path=path</code>	Read given path from login file	(Supported in all NDB releases based on MySQL 5.7)
<code>--lossy-conversions,</code> <code>-L</code>	Allow lossy conversions of column values (type demotions or changes in sign) when restoring data from backup	(Supported in all NDB releases based on MySQL 5.7)
<code>--no-binlog</code>	If mysqld is connected and using binary logging, do not log restored data	(Supported in all NDB releases based on MySQL 5.7)
<code>--no-defaults</code>	Do not read default options from any option file other than login file	(Supported in all NDB releases based on MySQL 5.7)
<code>--no-restore-disk-objects,</code> <code>-d</code>	Do not restore objects relating to Disk Data	(Supported in all NDB releases based on MySQL 5.7)

Format	Description	Added, Deprecated, or Removed
<code>--no-upgrade,</code> <code>-u</code>	Do not upgrade array type for varsize attributes which do not already resize VAR data, and do not change column attributes	(Supported in all NDB releases based on MySQL 5.7)
<code>--ndb-connectstring=connection_string,</code> <code>-c connection_string</code>	Set connect string for connecting to ndb_mgmd. Syntax: "[nodeid=id;][host=]hostname[:port]". Overrides entries in NDB_CONNECTSTRING and my.cnf	(Supported in all NDB releases based on MySQL 5.7)
<code>--ndb-mgmd-host=connection_string,</code> <code>-c connection_string</code>	Same as <code>--ndb-connectstring</code>	(Supported in all NDB releases based on MySQL 5.7)
<code>--ndb-nodegroup-map=map,</code> <code>-z</code>	Specify node group map; unused, unsupported	(Supported in all NDB releases based on MySQL 5.7)
<code>--ndb-nodeid=#</code>	Set node ID for this node, overriding any ID set by <code>--ndb-connectstring</code>	(Supported in all NDB releases based on MySQL 5.7)
<code>--ndb-optimized-node-selection</code>	Enable optimizations for selection of nodes for transactions. Enabled by default; use <code>--skip-ndb-optimized-node-selection</code> to disable	(Supported in all NDB releases based on MySQL 5.7)
<code>--nodeid=#,</code> <code>-n #</code>	ID of node where backup was taken	(Supported in all NDB releases based on MySQL 5.7)
<code>--num-slices=#</code>	Number of slices to apply when restoring by slice	ADDED: NDB 7.6.13
<code>--parallelism=#,</code> <code>-p #</code>	Number of parallel transactions to use while restoring data	(Supported in all NDB releases based on MySQL 5.7)
<code>--preserve-trailing-spaces,</code> <code>-P</code>	Allow preservation of trailing spaces (including padding) when promoting fixed-width string types to variable-width types	(Supported in all NDB releases based on MySQL 5.7)
<code>--print</code>	Print metadata, data, and log to stdout (equivalent to <code>--print-meta --print-data --print-log</code>)	(Supported in all NDB releases based on MySQL 5.7)
<code>--print-data</code>	Print data to stdout	(Supported in all NDB releases based on MySQL 5.7)
<code>--print-defaults</code>	Print program argument list and exit	(Supported in all NDB releases based on MySQL 5.7)
<code>--print-log</code>	Print log to stdout	(Supported in all NDB releases based on MySQL 5.7)
<code>--print-meta</code>	Print metadata to stdout	(Supported in all NDB releases based on MySQL 5.7)
<code>--print-sql-log</code>	Write SQL log to stdout	ADDED: NDB 7.5.4

Format	Description	Added, Deprecated, or Removed
<code>--progress-frequency=#</code>	Print status of restore each given number of seconds	(Supported in all NDB releases based on MySQL 5.7)
<code>--promote-attributes,</code> <code>-A</code> <code>--rebuild-indexes</code>	Allow attributes to be promoted when restoring data from backup Causes multithreaded rebuilding of ordered indexes found in backup; number of threads used is determined by setting BuildIndexThreads	(Supported in all NDB releases based on MySQL 5.7)
<code>--remap-column=string</code>	Apply offset to value of specified column using indicated function and arguments. Format is [db].[tbl].[col]:[fn]:[args]; see documentation for details	ADDED: NDB 7.6.14
<code>--restore-data,</code> <code>-r</code> <code>--restore-epoch,</code> <code>-e</code>	Restore table data and logs into NDB Cluster using NDB API Restore epoch info into status table; useful on replica cluster for starting replication; updates or inserts row in mysql.ndb_apply_status with ID 0	(Supported in all NDB releases based on MySQL 5.7)
<code>--restore-meta,</code> <code>-m</code>	Restore metadata to NDB Cluster using NDB API	(Supported in all NDB releases based on MySQL 5.7)
<code>--restore-privilege-tables</code>	Restore MySQL privilege tables that were previously moved to NDB	(Supported in all NDB releases based on MySQL 5.7)
<code>--rewrite-database=string</code> <code>--skip-broken-objects</code>	Restore to differently named database; format is olddb,newdb Ignore missing blob tables in backup file	(Supported in all NDB releases based on MySQL 5.7)
<code>--skip-table-check,</code> <code>-s</code> <code>--skip-unknown-objects</code>	Skip table structure check during restore Causes schema objects not recognized by ndb_restore to be ignored when restoring backup made from newer NDB version to older version	(Supported in all NDB releases based on MySQL 5.7)
<code>--slice-id=#</code> <code>--tab=path,</code> <code>-T path</code> <code>--usage,</code> <code>-?</code> <code>--verbose=#</code>	Slice ID, when restoring by slices Creates a tab-separated .txt file for each table in path provided Display help text and exit; same as --help Level of verbosity in output	ADDED: NDB 7.6.13 (Supported in all NDB releases based on MySQL 5.7)

Format	Description	Added, Deprecated, or Removed
<code>--version,</code> <code>-V</code>	Display version information and exit	(Supported in all NDB releases based on MySQL 5.7)

- `--allow-pk-changes`

Command-Line Format	<code>--allow-pk-changes[=0 1]</code>
Introduced	5.7.29-ndb-7.6.14
Type	Integer
Default Value	0
Minimum Value	0
Maximum Value	1

When this option is set to `1`, `ndb_restore` allows the primary keys in a table definition to differ from that of the same table in the backup. This may be desirable when backing up and restoring between different schema versions with primary key changes on one or more tables, and it appears that performing the restore operation using `ndb_restore` is simpler or more efficient than issuing many `ALTER TABLE` statements after restoring table schemas and data.

The following changes in primary key definitions are supported by `--allow-pk-changes`:

- **Extending the primary key:** A non-nullable column that exists in the table schema in the backup becomes part of the table's primary key in the database.

Important

When extending a table's primary key, any columns which become part of primary key must not be updated while the backup is being taken; any such updates discovered by `ndb_restore` cause the restore operation to fail, even when no change in value takes place. In some cases, it may be possible to override this behavior using the `--ignore-extended-pk-updates` option; see the description of this option for more information.

- **Contracting the primary key (1):** A column that is already part of the table's primary key in the backup schema is no longer part of the primary key, but remains in the table.
- **Contracting the primary key (2):** A column that is already part of the table's primary key in the backup schema is removed from the table entirely.

These differences can be combined with other schema differences supported by `ndb_restore`, including changes to blob and text columns requiring the use of staging tables.

Basic steps in a typical scenario using primary key schema changes are listed here:

1. Restore table schemas using `ndb_restore --restore-meta`
2. Alter schema to that desired, or create it
3. Back up the desired schema
4. Run `ndb_restore --disable-indexes` using the backup from the previous step, to drop indexes and constraints
5. Run `ndb_restore --allow-pk-changes` (possibly along with `--ignore-extended-pk-updates`, `--disable-indexes`, and possibly other options as needed) to restore all data

- Run `ndb_restore --rebuild-indexes` using the backup made with the desired schema, to rebuild indexes and constraints

When extending the primary key, it may be necessary for `ndb_restore` to use a temporary secondary unique index during the restore operation to map from the old primary key to the new one. Such an index is created only when necessary to apply events from the backup log to a table which has an extended primary key. This index is named `NDB$RESTORE_PK_MAPPING`, and is created on each table requiring it; it can be shared, if necessary, by multiple instances of `ndb_restore` instances running in parallel. (Running `ndb_restore --rebuild-indexes` at the end of the restore process causes this index to be dropped.)

- `--append`

Command-Line Format	<code>--append</code>
---------------------	-----------------------

When used with the `--tab` and `--print-data` options, this causes the data to be appended to any existing files having the same names.

- `--backup-path=dir_name`

Command-Line Format	<code>--backup-path=path</code>
Type	Directory name
Default Value	<code>./</code>

The path to the backup directory is required; this is supplied to `ndb_restore` using the `--backup-path` option, and must include the subdirectory corresponding to the ID backup of the backup to be restored. For example, if the data node's `DataDir` is `/var/lib/mysql-cluster`, then the backup directory is `/var/lib/mysql-cluster/BACKUP`, and the backup files for the backup with the ID 3 can be found in `/var/lib/mysql-cluster/BACKUP/BACKUP-3`. The path may be absolute or relative to the directory in which the `ndb_restore` executable is located, and may be optionally prefixed with `backup-path=`.

It is possible to restore a backup to a database with a different configuration than it was created from. For example, suppose that a backup with backup ID 12, created in a cluster with two storage nodes having the node IDs 2 and 3, is to be restored to a cluster with four nodes. Then `ndb_restore` must be run twice—once for each storage node in the cluster where the backup was taken. However, `ndb_restore` cannot always restore backups made from a cluster running one version of MySQL to a cluster running a different MySQL version. See [Section 3.7, “Upgrading and Downgrading NDB Cluster”](#), for more information.

Important

It is not possible to restore a backup made from a newer version of NDB Cluster using an older version of `ndb_restore`. You can restore a backup made from a newer version of MySQL to an older cluster, but you must use a copy of `ndb_restore` from the newer NDB Cluster version to do so.

For example, to restore a cluster backup taken from a cluster running NDB Cluster 7.5.25 to a cluster running NDB Cluster 7.4.35, you must use the `ndb_restore` that comes with the NDB Cluster 7.5.25 distribution.

For more rapid restoration, the data may be restored in parallel, provided that there is a sufficient number of cluster connections available. That is, when restoring to multiple nodes in parallel, you must have an `[api]` or `[mysqld]` section in the cluster `config.ini` file available for each concurrent `ndb_restore` process. However, the data files must always be applied before the logs.

- `--backupid=#, -b`

Command-Line Format	<code>--backupid=#</code>
Type	Numeric
Default Value	<code>none</code>

This option is used to specify the ID or sequence number of the backup, and is the same number shown by the management client in the `Backup backup_id completed` message displayed upon completion of a backup. (See [Section 6.8.2, “Using The NDB Cluster Management Client to Create a Backup”](#).)

Important

When restoring cluster backups, you must be sure to restore all data nodes from backups having the same backup ID. Using files from different backups can at best result in restoring the cluster to an inconsistent state, and may fail altogether.

In NDB 7.5.13 and later, and in NDB 7.6.9 and later, this option is required.

- `--character-sets-dir`

Command-Line Format	<code>--character-sets-dir=path</code>
---------------------	--

Directory containing character sets.

- `--connect, -c`

Command-Line Format	<code>--connect=connection_string</code>
Type	String
Default Value	<code>localhost:1186</code>

Alias for `--ndb-connectstring`.

- `--connect-retries`

Command-Line Format	<code>--connect-retries=#</code>
Type	Integer
Default Value	<code>12</code>
Minimum Value	<code>0</code>
Maximum Value	<code>12</code>

Number of times to retry connection before giving up.

- `--connect-retry-delay`

Command-Line Format	<code>--connect-retry-delay=#</code>
Type	Integer
Default Value	<code>5</code>
Minimum Value	<code>0</code>
Maximum Value	<code>5</code>

Number of seconds to wait between attempts to contact management server.

- `--connect-string`

Command-Line Format	<code>--connect-string=connection_string</code>
Type	String
Default Value	[none]

Same as `--ndb-connectstring`.

- `--core-file`

Command-Line Format	<code>--core-file</code>
---------------------	--------------------------

Write core file on error; used in debugging.

- `--defaults-extra-file`

Command-Line Format	<code>--defaults-extra-file=path</code>
Type	String
Default Value	[none]

Read given file after global files are read.

- `--defaults-file`

Command-Line Format	<code>--defaults-file=path</code>
Type	String
Default Value	[none]

Read default options from given file only.

- `--defaults-group-suffix`

Command-Line Format	<code>--defaults-group-suffix=string</code>
Type	String
Default Value	[none]

Also read groups with `concat(group, suffix)`.

- `--disable-indexes`

Command-Line Format	<code>--disable-indexes</code>
---------------------	--------------------------------

Disable restoration of indexes during restoration of the data from a native NDB backup. Afterwards, you can restore indexes for all tables at once with multithreaded building of indexes using `--rebuild-indexes`, which should be faster than rebuilding indexes concurrently for very large tables.

Beginning with NDB 7.5.24 and NDB 7.6.20, this option also drops any foreign keys specified in the backup.

- `--dont-ignore-systab-0, -f`

Command-Line Format	<code>--dont-ignore-systab-0</code>
---------------------	-------------------------------------

Normally, when restoring table data and metadata, `ndb_restore` ignores the copy of the NDB system table that is present in the backup. `--dont-ignore-systab-0` causes the system table to be restored. *This option is intended for experimental and development use only, and is not recommended in a production environment.*

- `--exclude-databases=db-list`

Command-Line Format	<code>--exclude-databases=list</code>
Type	String
Default Value	

Comma-delimited list of one or more databases which should not be restored.

This option is often used in combination with `--exclude-tables`; see that option's description for further information and examples.

- `--exclude-intermediate-sql-tables[=TRUE|FALSE]`

Command-Line Format	<code>--exclude-intermediate-sql-tables[=TRUE FALSE]</code>
Type	Boolean
Default Value	TRUE

When performing copying `ALTER TABLE` operations, `mysqld` creates intermediate tables (whose names are prefixed with `#sql-`). When `TRUE`, the `--exclude-intermediate-sql-tables` option keeps `ndb_restore` from restoring such tables that may have been left over from these operations. This option is `TRUE` by default.

- `--exclude-missing-columns`

Command-Line Format	<code>--exclude-missing-columns</code>
---------------------	--

It is possible to restore only selected table columns using this option, which causes `ndb_restore` to ignore any columns missing from tables being restored as compared to the versions of those tables found in the backup. This option applies to all tables being restored. If you wish to apply this option only to selected tables or databases, you can use it in combination with one or more of the `--include-*` or `--exclude-*` options described elsewhere in this section to do so, then restore data to the remaining tables using a complementary set of these options.

- `--exclude-missing-tables`

Command-Line Format	<code>--exclude-missing-tables</code>
---------------------	---------------------------------------

It is possible to restore only selected tables using this option, which causes `ndb_restore` to ignore any tables from the backup that are not found in the target database.

- `--exclude-tables=table-list`

Command-Line Format	<code>--exclude-tables=list</code>
Type	String

Default Value	
---------------	--

List of one or more tables to exclude; each table reference must include the database name. Often used together with `--exclude-databases`.

When `--exclude-databases` or `--exclude-tables` is used, only those databases or tables named by the option are excluded; all other databases and tables are restored by `ndb_restore`.

This table shows several invocations of `ndb_restore` using `--exclude-*` options (other options possibly required have been omitted for clarity), and the effects these options have on restoring from an NDB Cluster backup:

Table 5.18 Several invocations of `ndb_restore` using `--exclude-*` options, and the effects these options have on restoring from an NDB Cluster backup.

Option	Result
<code>--exclude-databases=db1</code>	All tables in all databases except <code>db1</code> are restored; no tables in <code>db1</code> are restored
<code>--exclude-databases=db1,db2</code> (or <code>--exclude-databases=db1 --exclude-databases=db2</code>)	All tables in all databases except <code>db1</code> and <code>db2</code> are restored; no tables in <code>db1</code> or <code>db2</code> are restored
<code>--exclude-tables=db1.t1</code>	All tables except <code>t1</code> in database <code>db1</code> are restored; all other tables in <code>db1</code> are restored; all tables in all other databases are restored
<code>--exclude-tables=db1.t2,db2.t1</code> (or <code>--exclude-tables=db1.t2 --exclude-tables=db2.t1</code>)	All tables in database <code>db1</code> except for <code>t2</code> and all tables in database <code>db2</code> except for table <code>t1</code> are restored; no other tables in <code>db1</code> or <code>db2</code> are restored; all tables in all other databases are restored

You can use these two options together. For example, the following causes all tables in all databases *except for* databases `db1` and `db2`, and tables `t1` and `t2` in database `db3`, to be restored:

```
$> ndb_restore [...] --exclude-databases=db1,db2 --exclude-tables=db3.t1,db3.t2
```

(Again, we have omitted other possibly necessary options in the interest of clarity and brevity from the example just shown.)

You can use `--include-*` and `--exclude-*` options together, subject to the following rules:

- The actions of all `--include-*` and `--exclude-*` options are cumulative.
- All `--include-*` and `--exclude-*` options are evaluated in the order passed to `ndb_restore`, from right to left.
- In the event of conflicting options, the first (rightmost) option takes precedence. In other words, the first option (going from right to left) that matches against a given database or table “wins”.

For example, the following set of options causes `ndb_restore` to restore all tables from database `db1` except `db1.t1`, while restoring no other tables from any other databases:

```
--include-databases=db1 --exclude-tables=db1.t1
```

However, reversing the order of the options just given simply causes all tables from database `db1` to be restored (including `db1.t1`, but no tables from any other database), because the `--include-databases` option, being farthest to the right, is the first match against database `db1` and thus takes precedence over any other option that matches `db1` or any tables in `db1`:

```
--exclude-tables=db1.t1 --include-databases=db1
```

- `--fields-enclosed-by=char`

Command-Line Format	<code>--fields-enclosed-by=char</code>
Type	String
Default Value	

Each column value is enclosed by the string passed to this option (regardless of data type; see the description of `--fields-optionally-enclosed-by`).

- `--fields-optionally-enclosed-by`

Command-Line Format	<code>--fields-optionally-enclosed-by</code>
Type	String
Default Value	

The string passed to this option is used to enclose column values containing character data (such as `CHAR`, `VARCHAR`, `BINARY`, `TEXT`, or `ENUM`).

- `--fields-terminated-by=char`

Command-Line Format	<code>--fields-terminated-by=char</code>
Type	String
Default Value	<code>\t (tab)</code>

The string passed to this option is used to separate column values. The default value is a tab character (`\t`).

- `--help`

Command-Line Format	<code>--help</code>
---------------------	---------------------

Display help text and exit.

- `--hex`

Command-Line Format	<code>--hex</code>
---------------------	--------------------

If this option is used, all binary values are output in hexadecimal format.

- `--ignore-extended-pk-updates`

Command-Line Format	<code>--ignore-extended-pk-updates[=0 1]</code>
Introduced	5.7.29-ndb-7.6.14
Type	Integer
Default Value	0
Minimum Value	0
Maximum Value	1

When using the `--allow-pk-changes` option, columns which become part of a table's primary key must not be updated while the backup is being taken; such columns should keep the same values from the time values are inserted into them until the rows containing the values are deleted. If `ndb_restore` encounters updates to these columns when restoring a backup, the restore fails. Because some applications may set values for all columns when updating a row, even when some column values are not changed, the backup may include log events appearing to update columns

which are not in fact modified. In such cases you can set `--ignore-extended-pk-updates` to 1, forcing `ndb_restore` to ignore such updates.

Important

When causing these updates to be ignored, the user is responsible for ensuring that there are no updates to the values of any columns that become part of the primary key.

For more information, see the description of `--allow-pk-changes`.

- `--include-databases=db-list`

Command-Line Format	<code>--include-databases=list</code>
Type	String
Default Value	

Comma-delimited list of one or more databases to restore. Often used together with `--include-tables`; see the description of that option for further information and examples.

- `--include-tables=table-list`

Command-Line Format	<code>--include-tables=list</code>
Type	String
Default Value	

Comma-delimited list of tables to restore; each table reference must include the database name.

When `--include-databases` or `--include-tables` is used, only those databases or tables named by the option are restored; all other databases and tables are excluded by `ndb_restore`, and are not restored.

The following table shows several invocations of `ndb_restore` using `--include-*` options (other options possibly required have been omitted for clarity), and the effects these have on restoring from an NDB Cluster backup:

Table 5.19 Several invocations of `ndb_restore` using `--include-*` options, and their effects on restoring from an NDB Cluster backup.

Option	Result
<code>--include-databases=db1</code>	Only tables in database <code>db1</code> are restored; all tables in all other databases are ignored
<code>--include-databases=db1,db2</code> (or <code>--include-databases=db1 --include-databases=db2</code>)	Only tables in databases <code>db1</code> and <code>db2</code> are restored; all tables in all other databases are ignored
<code>--include-tables=db1.t1</code>	Only table <code>t1</code> in database <code>db1</code> is restored; no other tables in <code>db1</code> or in any other database are restored

Option	Result
<code>--include-tables=db1.t2,db2.t1</code> (or <code>--include-tables=db1.t2 --include-tables=db2.t1</code>)	Only the table <code>t2</code> in database <code>db1</code> and the table <code>t1</code> in database <code>db2</code> are restored; no other tables in <code>db1</code> , <code>db2</code> , or any other database are restored

You can also use these two options together. For example, the following causes all tables in databases `db1` and `db2`, together with the tables `t1` and `t2` in database `db3`, to be restored (and no other databases or tables):

```
$> ndb_restore [...] --include-databases=db1,db2 --include-tables=db3.t1,db3.t2
```

(Again we have omitted other, possibly required, options in the example just shown.)

It also possible to restore only selected databases, or selected tables from a single database, without any `--include-*` (or `--exclude-*`) options, using the syntax shown here:

```
ndb_restore other_options db_name,[db_name[,...]] | tbl_name[,tbl_name][,...]
```

In other words, you can specify either of the following to be restored:

- All tables from one or more databases
- One or more tables from a single database
- `--lines-terminated-by=char`

Command-Line Format	<code>--lines-terminated-by=char</code>
Type	String
Default Value	<code>\n</code> (linebreak)

Specifies the string used to end each line of output. The default is a linefeed character (`\n`).

- `--login-path`

Command-Line Format	<code>--login-path=path</code>
Type	String
Default Value	<code>[none]</code>

Read given path from login file.

- `--lossy-conversions, -L`

Command-Line Format	<code>--lossy-conversions</code>
---------------------	----------------------------------

This option is intended to complement the `--promote-attributes` option. Using `--lossy-conversions` allows lossy conversions of column values (type demotions or changes in sign) when restoring data from backup. With some exceptions, the rules governing demotion are the same as for MySQL replication; see [Replication of Columns Having Different Data Types](#), for information about specific type conversions currently supported by attribute demotion.

Beginning with NDB 7.5.23 and NDB 7.6.19, this option also makes it possible to restore a `NULL` column as `NOT NULL`. The column must not contain any `NULL` entries; otherwise `ndb_restore` stops with an error.

`ndb_restore` reports any truncation of data that it performs during lossy conversions once per attribute and column.

- `--ndb-connectstring`

Command-Line Format	<code>--ndb-connectstring=connection_string</code>
Type	String
Default Value	[none]

Set connect string for connecting to ndb_mgmd. Syntax: "[nodeid=id;][host=]hostname[:port]". Overrides entries in NDB_CONNECTSTRING and my.cnf.

- `--ndb-mgmd-host`

Command-Line Format	<code>--ndb-mgmd-host=connection_string</code>
Type	String
Default Value	[none]

Same as `--ndb-connectstring`.

- `--ndb-nodegroup-map=map, -z`

Command-Line Format	<code>--ndb-nodegroup-map=map</code>
---------------------	--------------------------------------

Intended for restoring a backup taken from one node group to a different node group, but never completely implemented; unsupported.

- `--ndb-nodeid`

Command-Line Format	<code>--ndb-nodeid=#</code>
Type	Integer
Default Value	[none]

Set node ID for this node, overriding any ID set by `--ndb-connectstring`.

- `--ndb-optimized-node-selection`

Command-Line Format	<code>--ndb-optimized-node-selection</code>
---------------------	---

Enable optimizations for selection of nodes for transactions. Enabled by default; use `--skip-ndb-optimized-node-selection` to disable.

- `--no-binlog`

Command-Line Format	<code>--no-binlog</code>
---------------------	--------------------------

This option prevents any connected SQL nodes from writing data restored by `ndb_restore` to their binary logs.

- `--no-defaults`

Command-Line Format	<code>--no-defaults</code>
---------------------	----------------------------

Do not read default options from any option file other than login file.

- `--no-restore-disk-objects, -d`

Command-Line Format	<code>--no-restore-disk-objects</code>
---------------------	--

This option stops `ndb_restore` from restoring any NDB Cluster Disk Data objects, such as tablespaces and log file groups; see [Section 6.10, “NDB Cluster Disk Data Tables”](#), for more information about these.

- `--no-upgrade, -u`

Command-Line Format	<code>--no-upgrade</code>
---------------------	---------------------------

When using `ndb_restore` to restore a backup, `VARCHAR` columns created using the old fixed format are resized and recreated using the variable-width format now employed. This behavior can be overridden by specifying `--no-upgrade`.

- `--nodeid=#, -n`

Command-Line Format	<code>--nodeid=#</code>
Type	Numeric
Default Value	<code>none</code>

Specify the node ID of the data node on which the backup was taken.

When restoring to a cluster with different number of data nodes from that where the backup was taken, this information helps identify the correct set or sets of files to be restored to a given node. (In such cases, multiple files usually need to be restored to a single data node.) See [Section 5.24.2, “Restoring to a different number of data nodes”](#), for additional information and examples.

In NDB 7.5.13 and later, and in NDB 7.6.9 and later, this option is required.

- `--num-slices=#`

Command-Line Format	<code>--num-slices=#</code>
Introduced	5.7.29-ndb-7.6.13
Type	Integer
Default Value	1
Minimum Value	1
Maximum Value	1024

When restoring a backup by slices, this option sets the number of slices into which to divide the backup. This allows multiple instances of `ndb_restore` to restore disjoint subsets in parallel, potentially reducing the amount of time required to perform the restore operation.

A *slice* is a subset of the data in a given backup; that is, it is a set of fragments having the same slice ID, specified using the `--slice-id` option. The two options must always be used together, and the value set by `--slice-id` must always be less than the number of slices.

`ndb_restore` encounters fragments and assigns each one a fragment counter. When restoring by slices, a slice ID is assigned to each fragment; this slice ID is in the range 0 to 1 less than the

number of slices. For a table that is not a `BLOB` table, the slice to which a given fragment belongs is determined using the formula shown here:

```
[slice_ID] = [fragment_counter] % [number_of_slices]
```

For a `BLOB` table, a fragment counter is not used; the fragment number is used instead, along with the ID of the main table for the `BLOB` table (recall that `NDB` stores `BLOB` values in a separate table internally). In this case, the slice ID for a given fragment is calculated as shown here:

```
[slice_ID] = ([main_table_ID] + [fragment_ID]) % [number_of_slices]
```

Thus, restoring by `N` slices means running `N` instances of `ndb_restore`, all with `--num-slices=N` (along with any other necessary options) and one each with `--slice-id=1`, `--slice-id=2`, `--slice-id=3`, and so on through `slice-id=N-1`.

- `--parallelism=#, -p`

Command-Line Format	<code>--parallelism=#</code>
Type	Numeric
Default Value	128
Minimum Value	1
Maximum Value	1024

`ndb_restore` uses single-row transactions to apply many rows concurrently. This parameter determines the number of parallel transactions (concurrent rows) that an instance of `ndb_restore` tries to use. By default, this is 128; the minimum is 1, and the maximum is 1024.

The work of performing the inserts is parallelized across the threads in the data nodes involved. This mechanism is employed for restoring bulk data from the `.Data` file—that is, the fuzzy snapshot of the data; it is not used for building or rebuilding indexes. The change log is applied serially; index drops and builds are DDL operations and handled separately. There is no thread-level parallelism on the client side of the restore.

- `--preserve-trailing-spaces, -P`

Command-Line Format	<code>--preserve-trailing-spaces</code>
---------------------	---

Cause trailing spaces to be preserved when promoting a fixed-width character data type to its variable-width equivalent—that is, when promoting a `CHAR` column value to `VARCHAR`, or a `BINARY` column value to `VARBINARY`. Otherwise, any trailing spaces are dropped from such column values when they are inserted into the new columns.

Note

Although you can promote `CHAR` columns to `VARCHAR` and `BINARY` columns to `VARBINARY`, you cannot promote `VARCHAR` columns to `CHAR` or `VARBINARY` columns to `BINARY`.

- `--print`

Command-Line Format	<code>--print</code>
---------------------	----------------------

Causes `ndb_restore` to print all data, metadata, and logs to `stdout`. Equivalent to using the `--print-data`, `--print-meta`, and `--print-log` options together.

Note

Use of `--print` or any of the `--print_*` options is in effect performing a dry run. Including one or more of these options causes any output to be redirected to `stdout`; in such cases, `ndb_restore` makes no attempt to restore data or metadata to an NDB Cluster.

- `--print-data`

Command-Line Format	<code>--print-data</code>
---------------------	---------------------------

Cause `ndb_restore` to direct its output to `stdout`. Often used together with one or more of `--tab`, `--fields-enclosed-by`, `--fields-optionally-enclosed-by`, `--fields-terminated-by`, `--hex`, and `--append`.

`TEXT` and `BLOB` column values are always truncated. Such values are truncated to the first 256 bytes in the output. This cannot currently be overridden when using `--print-data`.

- `--print-defaults`

Command-Line Format	<code>--print-defaults</code>
---------------------	-------------------------------

Print program argument list and exit.

- `--print-log`

Command-Line Format	<code>--print-log</code>
---------------------	--------------------------

Cause `ndb_restore` to output its log to `stdout`.

- `--print-meta`

Command-Line Format	<code>--print-meta</code>
---------------------	---------------------------

Print all metadata to `stdout`.

- `print-sql-log`

Command-Line Format	<code>--print-sql-log</code>
Introduced	5.7.16-ndb-7.5.4

Log SQL statements to `stdout`. Use the option to enable; normally this behavior is disabled. The option checks before attempting to log whether all the tables being restored have explicitly defined primary keys; queries on a table having only the hidden primary key implemented by `NDB` cannot be converted to valid SQL.

This option does not work with tables having `BLOB` columns.

The `--print-sql-log` option was added in NDB 7.5.4. (Bug #13511949)

- `--progress-frequency=N`

Command-Line Format	<code>--progress-frequency=#</code>
---------------------	-------------------------------------

Type	Numeric
Default Value	0
Minimum Value	0
Maximum Value	65535

Print a status report each *N* seconds while the backup is in progress. 0 (the default) causes no status reports to be printed. The maximum is 65535.

- `--promote-attributes, -A`

Command-Line Format	<code>--promote-attributes</code>
---------------------	-----------------------------------

`ndb_restore` supports limited *attribute promotion* in much the same way that it is supported by MySQL replication; that is, data backed up from a column of a given type can generally be restored to a column using a “larger, similar” type. For example, data from a `CHAR(20)` column can be restored to a column declared as `VARCHAR(20)`, `VARCHAR(30)`, or `CHAR(30)`; data from a `MEDIUMINT` column can be restored to a column of type `INT` or `BIGINT`. See [Replication of Columns Having Different Data Types](#), for a table of type conversions currently supported by attribute promotion.

Beginning with NDB 7.5.23 and NDB 7.6.19, this option also makes it possible to restore a `NOT NULL` column as `NULL`.

Attribute promotion by `ndb_restore` must be enabled explicitly, as follows:

1. Prepare the table to which the backup is to be restored. `ndb_restore` cannot be used to re-create the table with a different definition from the original; this means that you must either create the table manually, or alter the columns which you wish to promote using `ALTER TABLE` after restoring the table metadata but before restoring the data.
2. Invoke `ndb_restore` with the `--promote-attributes` option (short form `-A`) when restoring the table data. Attribute promotion does not occur if this option is not used; instead, the restore operation fails with an error.

When converting between character data types and `TEXT` or `BLOB`, only conversions between character types (`CHAR` and `VARCHAR`) and binary types (`BINARY` and `VARBINARY`) can be performed at the same time. For example, you cannot promote an `INT` column to `BIGINT` while promoting a `VARCHAR` column to `TEXT` in the same invocation of `ndb_restore`.

Converting between `TEXT` columns using different character sets is not supported, and is expressly disallowed.

When performing conversions of character or binary types to `TEXT` or `BLOB` with `ndb_restore`, you may notice that it creates and uses one or more staging tables named `table_name$Snode_id`. These tables are not needed afterwards, and are normally deleted by `ndb_restore` following a successful restoration.

- `--rebuild-indexes`

Command-Line Format	<code>--rebuild-indexes</code>
---------------------	--------------------------------

Enable multithreaded rebuilding of the ordered indexes while restoring a native NDB backup. The number of threads used for building ordered indexes by `ndb_restore` with this option is controlled by the `BuildIndexThreads` data node configuration parameter and the number of LDMs.

It is necessary to use this option only for the first run of `ndb_restore`; this causes all ordered indexes to be rebuilt without using `--rebuild-indexes` again when restoring subsequent nodes.

You should use this option prior to inserting new rows into the database; otherwise, it is possible for a row to be inserted that later causes a unique constraint violation when trying to rebuild the indexes.

Building of ordered indices is parallelized with the number of LDMS by default. Offline index builds performed during node and system restarts can be made faster using the `BuildIndexThreads` data node configuration parameter; this parameter has no effect on dropping and rebuilding of indexes by `ndb_restore`, which is performed online.

Rebuilding of unique indexes uses disk write bandwidth for redo logging and local checkpointing. An insufficient amount of this bandwidth can lead to redo buffer overload or log overload errors. In such cases you can run `ndb_restore --rebuild-indexes` again; the process resumes at the point where the error occurred. You can also do this when you have encountered temporary errors. You can repeat execution of `ndb_restore --rebuild-indexes` indefinitely; you may be able to stop such errors by reducing the value of `--parallelism`. If the problem is insufficient space, you can increase the size of the redo log (`FragmentLogFileSize` node configuration parameter), or you can increase the speed at which LCPs are performed (`MaxDiskWriteSpeed` and related parameters), in order to free space more quickly.

- `--remap-column=db.tbl.col:fn:args`

Command-Line Format	<code>--remap-column=string</code>
Introduced	5.7.29-ndb-7.6.14
Type	String
Default Value	[none]

When used together with `--restore-data`, this option applies a function to the value of the indicated column. Values in the argument string are listed here:

- `db`: Database name, following any renames performed by `--rewrite-database`.
- `tbl`: Table name.
- `col`: Name of the column to be updated. This column must be of type `INT` or `BIGINT`. The column can also be but is not required to be `UNSIGNED`.
- `fn`: Function name; currently, the only supported name is `offset`.
- `args`: Arguments supplied to the function. Currently, only a single argument, the size of the offset to be added by the `offset` function, is supported. Negative values are supported. The size of the argument cannot exceed that of the signed variant of the column's type; for example, if `col` is an `INT` column, then the allowed range of the argument passed to the `offset` function is `-2147483648` to `2147483647` (see [Integer Types \(Exact Value\) - INTEGER, INT, SMALLINT, TINYINT, MEDIUMINT, BIGINT](#)).

If applying the offset value to the column would cause an overflow or underflow, the restore operation fails. This could happen, for example, if the column is a `BIGINT`, and the option attempts to apply an offset value of 8 on a row in which the column value is 4294967291, since `4294967291 + 8 = 4294967299 > 4294967295`.

This option can be useful when you wish to merge data stored in multiple source instances of NDB Cluster (all using the same schema) into a single destination NDB Cluster, using NDB native backup (see [Section 6.8.2, "Using The NDB Cluster Management Client to Create a Backup"](#)) and `ndb_restore` to merge the data, where primary and unique key values are overlapping between source clusters, and it is necessary as part of the process to remap these values to ranges that do not overlap. It may also be necessary to preserve other relationships between tables. To fulfill such requirements, it is possible to use the option multiple times in the same invocation of `ndb_restore` to remap columns of different tables, as shown here:

```
$> ndb_restore --restore-data --remap-column=hr.employee.id:offset:1000 \
```

```
--remap-column=hr.manager.id:offset:1000 --remap-column=hr.firstaiders.id:offset:1000
```

(Other options not shown here may also be used.)

`--remap-column` can also be used to update multiple columns of the same table. Combinations of multiple tables and columns are possible. Different offset values can also be used for different columns of the same table, like this:

```
$> ndb_restore --restore-data --remap-column=hr.employee.salary:offset:10000 \
--remap-column=hr.employee.hours:offset:-10
```

When source backups contain duplicate tables which should not be merged, you can handle this by using `--exclude-tables`, `--exclude-databases`, or by some other means in your application.

Information about the structure and other characteristics of tables to be merged can be obtained using `SHOW CREATE TABLE`; the `ndb_desc` tool; and `MAX()`, `MIN()`, `LAST_INSERT_ID()`, and other MySQL functions.

Replication of changes from merged to unmerged tables, or from unmerged to merged tables, in separate instances of NDB Cluster is not supported.

- `--restore-data`, `-r`

Command-Line Format	<code>--restore-data</code>
---------------------	-----------------------------

Output NDB table data and logs.

- `--restore-epoch`, `-e`

Command-Line Format	<code>--restore-epoch</code>
---------------------	------------------------------

Add (or restore) epoch information to the cluster replication status table. This is useful for starting replication on an NDB replica cluster. When this option is used, the row in the `mysql.ndb_apply_status` having 0 in the `id` column is updated if it already exists; such a row is inserted if it does not already exist. (See [Section 7.9, “NDB Cluster Backups With NDB Cluster Replication”](#).)

- `--restore-meta`, `-m`

Command-Line Format	<code>--restore-meta</code>
---------------------	-----------------------------

This option causes `ndb_restore` to print NDB table metadata.

The first time you run the `ndb_restore` restoration program, you also need to restore the metadata. In other words, you must re-create the database tables—this can be done by running it with the `--restore-meta` (`-m`) option. Restoring the metadata need be done only on a single data node; this is sufficient to restore it to the entire cluster.

In older versions of NDB Cluster, tables whose schemas were restored using this option used the same number of partitions as they did on the original cluster, even if it had a differing number of data nodes from the new cluster. In NDB 7.5.2 and later, when restoring metadata, this is no longer an issue; `ndb_restore` now uses the default number of partitions for the target cluster, unless the number of local data manager threads is also changed from what it was for data nodes in the original cluster.

Note

The cluster should have an empty database when starting to restore a backup. (In other words, you should start the data nodes with `--initial` prior to performing the restore.)

- `--restore-privilege-tables`

Command-Line Format	<code>--restore-privilege-tables</code>
---------------------	---

`ndb_restore` does not by default restore distributed MySQL privilege tables. This option causes `ndb_restore` to restore the privilege tables.

This works only if the privilege tables were converted to `NDB` before the backup was taken. For more information, see [Section 6.12, “Distributed Privileges Using Shared Grant Tables”](#).

- `--rewrite-database=olddb,newdb`

Command-Line Format	<code>--rewrite-database=string</code>
Type	String
Default Value	<code>none</code>

This option makes it possible to restore to a database having a different name from that used in the backup. For example, if a backup is made of a database named `products`, you can restore the data it contains to a database named `inventory`, use this option as shown here (omitting any other options that might be required):

```
$> ndb_restore --rewrite-database=product,inventory
```

The option can be employed multiple times in a single invocation of `ndb_restore`. Thus it is possible to restore simultaneously from a database named `db1` to a database named `db2` and from a database named `db3` to one named `db4` using `--rewrite-database=db1,db2 --rewrite-database=db3,db4`. Other `ndb_restore` options may be used between multiple occurrences of `--rewrite-database`.

In the event of conflicts between multiple `--rewrite-database` options, the last `--rewrite-database` option used, reading from left to right, is the one that takes effect. For example, if `--rewrite-database=db1,db2 --rewrite-database=db1,db3` is used, only `--rewrite-database=db1,db3` is honored, and `--rewrite-database=db1,db2` is ignored. It is also possible to restore from multiple databases to a single database, so that `--rewrite-database=db1,db3 --rewrite-database=db2,db3` restores all tables and data from databases `db1` and `db2` into database `db3`.

Important

When restoring from multiple backup databases into a single target database using `--rewrite-database`, no check is made for collisions between table or other object names, and the order in which rows are restored is not guaranteed. This means that it is possible in such cases for rows to be overwritten and updates to be lost.

- `--skip-broken-objects`

Command-Line Format	<code>--skip-broken-objects</code>
---------------------	------------------------------------

This option causes `ndb_restore` to ignore corrupt tables while reading a native `NDB` backup, and to continue restoring any remaining tables (that are not also corrupted). Currently, the `--skip-broken-objects` option works only in the case of missing blob parts tables.

- `--skip-table-check, -s`

Command-Line Format	<code>--skip-table-check</code>
---------------------	---------------------------------

It is possible to restore data without restoring table metadata. By default when doing this, `ndb_restore` fails with an error if a mismatch is found between the table data and the table schema; this option overrides that behavior.

Some of the restrictions on mismatches in column definitions when restoring data using `ndb_restore` are relaxed; when one of these types of mismatches is encountered, `ndb_restore` does not stop with an error as it did previously, but rather accepts the data and inserts it into the target table while issuing a warning to the user that this is being done. This behavior occurs whether or not either of the options `--skip-table-check` or `--promote-attributes` is in use. These differences in column definitions are of the following types:

- Different `COLUMN_FORMAT` settings (`FIXED`, `DYNAMIC`, `DEFAULT`)
- Different `STORAGE` settings (`MEMORY`, `DISK`)
- Different default values
- Different distribution key settings
- `--skip-unknown-objects`

Command-Line Format	<code>--skip-unknown-objects</code>
---------------------	-------------------------------------

This option causes `ndb_restore` to ignore any schema objects it does not recognize while reading a native `NDB` backup. This can be used for restoring a backup made from a cluster running (for example) `NDB 7.6` to a cluster running `NDB Cluster 7.5`.

- `--slice-id=#`

Command-Line Format	<code>--slice-id=#</code>
Introduced	5.7.29-ndb-7.6.13
Type	Integer
Default Value	0
Minimum Value	0
Maximum Value	1023

When restoring by slices, this is the ID of the slice to restore. This option is always used together with `--num-slices`, and its value must be always less than that of `--num-slices`.

For more information, see the description of the `--num-slices` elsewhere in this section.

- `--tab=dir_name, -T dir_name`

Command-Line Format	<code>--tab=path</code>
Type	Directory name

Causes `--print-data` to create dump files, one per table, each named `tbl_name.txt`. It requires as its argument the path to the directory where the files should be saved; use `.` for the current directory.

- `--usage`

Command-Line Format	<code>--usage</code>
---------------------	----------------------

Display help text and exit; same as `--help`.

- `--verbose=#`

Command-Line Format	<code>--verbose=#</code>
Type	Numeric
Default Value	1
Minimum Value	0
Maximum Value	255

Sets the level for the verbosity of the output. The minimum is 0; the maximum is 255. The default value is 1.

- `--version`

Command-Line Format	<code>--version</code>
---------------------	------------------------

Display version information and exit.

Typical options for this utility are shown here:

```
ndb_restore [-c connection_string] -n node_id -b backup_id \
            [-m] -r --backup-path=/path/to/backup/files
```

Normally, when restoring from an NDB Cluster backup, `ndb_restore` requires at a minimum the `--nodeid` (short form: `-n`), `--backupid` (short form: `-b`), and `--backup-path` options. In addition, when `ndb_restore` is used to restore any tables containing unique indexes, you must include `--disable-indexes` or `--rebuild-indexes`. (Bug #57782, Bug #11764893)

The `-c` option is used to specify a connection string which tells `ndb_restore` where to locate the cluster management server (see Section 4.3.3, “NDB Cluster Connection Strings”). If this option is not used, then `ndb_restore` attempts to connect to a management server on `localhost:1186`. This utility acts as a cluster API node, and so requires a free connection “slot” to connect to the cluster management server. This means that there must be at least one `[api]` or `[mysqld]` section that can be used by it in the cluster `config.ini` file. It is a good idea to keep at least one empty `[api]` or `[mysqld]` section in `config.ini` that is not being used for a MySQL server or other application for this reason (see Section 4.3.7, “Defining SQL and Other API Nodes in an NDB Cluster”).

You can verify that `ndb_restore` is connected to the cluster by using the `SHOW` command in the `ndb_mgm` management client. You can also accomplish this from a system shell, as shown here:

```
$> ndb_mgm -e "SHOW"
```

Error reporting.

`ndb_restore` reports both temporary and permanent errors. In the case of temporary errors, it may be able to recover from them, and reports `Restore successful, but encountered temporary error, please look at configuration` in such cases.

Important

After using `ndb_restore` to initialize an NDB Cluster for use in circular replication, binary logs on the SQL node acting as the replica are not automatically created, and you must cause them to be created manually. To cause the binary logs to be created, issue a `SHOW TABLES` statement on that SQL node before running `START SLAVE`. This is a known issue in NDB Cluster.

5.24.1 Restoring an NDB Backup to a Different Version of NDB Cluster

The following two sections provide information about restoring a native NDB backup to a different version of NDB Cluster from the version in which the backup was taken.

In addition, you should consult [Section 3.7, “Upgrading and Downgrading NDB Cluster”](#), for other issues you may encounter when attempting to restore an NDB backup to a cluster running a different version of the NDB software.

It is also advisable to review [What is New in NDB Cluster 8.0](#), as well as [Changes in MySQL 5.7](#), for other changes between NDB 8.0 and previous versions of NDB Cluster that may be relevant to your particular circumstances.

5.24.1.1 Restoring an NDB backup to a previous version of NDB Cluster

You may encounter issues when restoring a backup taken from a later version of NDB Cluster to a previous one, due to the use of features which do not exist in the earlier version. Some of these issues are listed here:

- Tables created in NDB 8.0 by default use the `utf8mb4_ai_ci` character set, which is not available in NDB 7.6 and earlier, and so cannot be read by an `ndb_restore` binary from one of these earlier versions. In such cases, it is necessary to alter any tables using `utf8mb4_ai_ci` so that they use a character set supported in the older version prior to performing the backup.
- Due to changes in how the MySQL Server and NDB handle table metadata, tables created or altered using the included MySQL server binary from NDB 8.0.14 or later cannot be restored using `ndb_restore` to an earlier version of NDB Cluster. Such tables use `.sdi` files which are not understood by older versions of `mysqld`.

A backup taken in NDB 8.0.14 or later of tables which were created in NDB 8.0.13 or earlier, and which have not been altered since upgrading to NDB 8.0.14 or later, should be restorable to older versions of NDB Cluster.

Since it is possible to restore metadata and table data separately, you can in such cases restore the table schemas from a dump made using `mysqldump`, or by executing the necessary `CREATE TABLE` statements manually, then import only the table data using `ndb_restore` with the `--restore-data` option.

- Encrypted backups created in NDB 8.0.22 and later cannot be restored using `ndb_restore` from NDB 8.0.21 or earlier.
- The `NDB_STORED_USER` privilege is not supported prior to NDB 8.0.18.
- NDB Cluster 8.0.18 and later supports up to 144 data nodes, while earlier versions support a maximum of only 48 data nodes. See [Section 5.24.2.1, “Restoring to Fewer Nodes Than the Original”](#), for information with situations in which this incompatibility causes an issue.

5.24.1.2 Restoring an NDB backup to a later version of NDB Cluster

In general, it should be possible to restore a backup created using the `ndb_mgm` client `START BACKUP` command in an older version of NDB to a newer version, provided that you use the `ndb_restore` binary that comes with the newer version. (It may be possible to use the older version of `ndb_restore`, but this is not recommended.) Additional potential issues are listed here:

- When restoring the metadata from a backup (`--restore-meta` option), `ndb_restore` normally attempts to reproduce the captured table schema exactly as it was when the backup was taken.

Tables created in versions of NDB prior to 8.0.14 use `.frm` files for their metadata. These files can be read by the `mysqld` in NDB 8.0.14 and later, which can use the information contained therein to create the `.sdi` files used by the MySQL data dictionary in later versions.

- When restoring an older backup to a newer version of NDB, it may not be possible to take advantage of newer features such as hashmap partitioning, greater number of hashmap buckets, read backup, and different partitioning layouts. For this reason, it may be preferable to restore older schemas using `mysqldump` and the `mysql` client, which allows NDB to make use of the new schema features.
- Tables using the old temporal types which did not support fractional seconds (used prior to MySQL 5.6.4 and NDB 7.3.31) cannot be restored to NDB 8.0 using `ndb_restore`. You can check such tables using `CHECK TABLE`, and then upgrade them to the newer temporal column format, if necessary, using `REPAIR TABLE` in the `mysql` client; this must be done prior to taking the backup. See [Preparing Your Installation for Upgrade](#), for more information.

You also also restore such tables using a dump created with `mysqldump`.

- Distributed grant tables created in NDB 7.6 and earlier are not supported in NDB 8.0. Such tables can be restored to an NDB 8.0 cluster, but they have no effect on access control.

5.24.2 Restoring to a different number of data nodes

It is possible to restore from an NDB backup to a cluster having a different number of data nodes than the original from which the backup was taken. The following two sections discuss, respectively, the cases where the target cluster has a lesser or greater number of data nodes than the source of the backup.

5.24.2.1 Restoring to Fewer Nodes Than the Original

You can restore to a cluster having fewer data nodes than the original provided that the larger number of nodes is an even multiple of the smaller number. In the following example, we use a backup taken on a cluster having four data nodes to a cluster having two data nodes.

1. The management server for the original cluster is on host `host10`. The original cluster has four data nodes, with the node IDs and host names shown in the following extract from the management server's `config.ini` file:

```
[ndbd]
NodeId=2
HostName=host2

[ndbd]
NodeId=4
HostName=host4

[ndbd]
NodeId=6
HostName=host6

[ndbd]
NodeId=8
HostName=host8
```

We assume that each data node was originally started with `ndbmtid --ndb-connectstring=host10` or the equivalent.

2. Perform a backup in the normal manner. See [Section 6.8.2, “Using The NDB Cluster Management Client to Create a Backup”](#), for information about how to do this.
3. The files created by the backup on each data node are listed here, where *N* is the node ID and *B* is the backup ID.
 - `BACKUP-B-0.N.Data`
 - `BACKUP-B.N.ctl`
 - `BACKUP-B.N.log`

These files are found under `BackupDataDir/BACKUP/BACKUP-B`, on each data node. For the rest of this example, we assume that the backup ID is 1.

Have all of these files available for later copying to the new data nodes (where they can be accessed on the data node's local file system by `ndb_restore`). It is simplest to copy them all to a single location; we assume that this is what you have done.

- The management server for the target cluster is on host `host20`, and the target has two data nodes, with the node IDs and host names shown, from the management server `config.ini` file on `host20`:

```
[ndbd]
NodeId=3
hostname=host3

[ndbd]
NodeId=5
hostname=host5
```

Each of the data node processes on `host3` and `host5` should be started with `ndbmttd -c host20 --initial` or the equivalent, so that the new (target) cluster starts with clean data node file systems.

- Copy two different sets of two backup files to each of the target data nodes. For this example, copy the backup files from nodes 2 and 4 from the original cluster to node 3 in the target cluster. These files are listed here:

- `BACKUP-1-0.2.Data`
- `BACKUP-1.2ctl`
- `BACKUP-1.2.log`
- `BACKUP-1-0.4.Data`
- `BACKUP-1.4ctl`
- `BACKUP-1.4.log`

Then copy the backup files from nodes 6 and 8 to node 5; these files are shown in the following list:

- `BACKUP-1-0.6.Data`
- `BACKUP-1.6ctl`
- `BACKUP-1.6.log`
- `BACKUP-1-0.8.Data`
- `BACKUP-1.8ctl`
- `BACKUP-1.8.log`

For the remainder of this example, we assume that the respective backup files have been saved to the directory `/BACKUP-1` on each of nodes 3 and 5.

- On each of the two target data nodes, you must restore from both sets of backups. First, restore the backups from nodes 2 and 4 to node 3 by invoking `ndb_restore` on `host3` as shown here:

```
$> ndb_restore -c host20 --nodeid=2 --backupid=1 --restore-data --backup-path=/BACKUP-1
```

```
$> ndb_restore -c host20 --nodeid=4 --backupid=1 --restore-data --backup-path=/BACKUP-1
```

Then restore the backups from nodes 6 and 8 to node 5 by invoking `ndb_restore` on `host5`, like this:

```
$> ndb_restore -c host20 --nodeid=6 --backupid=1 --restore-data --backup-path=/BACKUP-1
```

```
$> ndb_restore -c host20 --nodeid=8 --backupid=1 --restore-data --backup-path=/BACKUP-1
```

5.24.2.2 Restoring to More Nodes Than the Original

The node ID specified for a given `ndb_restore` command is that of the node in the original backup and not that of the data node to restore it to. When performing a backup using the method described in this section, `ndb_restore` connects to the management server and obtains a list of data nodes in the cluster the backup is being restored to. The restored data is distributed accordingly, so that the number of nodes in the target cluster does not need to be known or calculated when performing the backup.

Note

When changing the total number of LCP threads or LQH threads per node group, you should recreate the schema from backup created using `mysqldump`.

1. *Create the backup of the data.* You can do this by invoking the `ndb_mgm` client `START BACKUP` command from the system shell, like this:

```
$> ndb_mgm -e "START BACKUP 1"
```

This assumes that the desired backup ID is 1.

2. *Create a backup of the schema.* In NDB 7.5.2 and later, this step is necessary only if the total number of LCP threads or LQH threads per node group is changed.

```
$> mysqldump --no-data --routines --events --triggers --databases > myschema.sql
```

Important

Once you have created the NDB native backup using `ndb_mgm`, you must not make any schema changes before creating the backup of the schema, if you do so.

3. *Copy the backup directory to the new cluster.* For example if the backup you want to restore has ID 1 and `BackupDataDir = /backups/node_nodeid`, then the path to the backup on this node is `/backups/node_1/BACKUP/BACKUP-1`. Inside this directory there are three files, listed here:

- `BACKUP-1-0.1.Data`
- `BACKUP-1.1.ctl`
- `BACKUP-1.1.log`

You should copy the entire directory to the new node.

If you needed to create a schema file, copy this to a location on an SQL node where it can be read by `mysqld`.

There is no requirement for the backup to be restored from a specific node or nodes.

To restore from the backup just created, perform the following steps:

1. *Restore the schema.*

- If you created a separate schema backup file using `mysqldump`, import this file using the `mysql` client, similar to what is shown here:

```
$> mysql < myschema.sql
```

When importing the schema file, you may need to specify the `--user` and `--password` options (and possibly others) in addition to what is shown, in order for the `mysql` client to be able to connect to the MySQL server.

- If you did *not* need to create a schema file, you can re-create the schema using `ndb_restore --restore-meta` (short form `-m`), similar to what is shown here:

```
$> ndb_restore --nodeid=1 --backupid=1 --restore-meta --backup-path=/backups/node_1/BACKUP/BACKUP-
```

`ndb_restore` must be able to contact the management server; add the `--ndb-connectstring` option if and as needed to make this possible.

2. *Restore the data.* This needs to be done once for each data node in the original cluster, each time using that data node's node ID. Assuming that there were 4 data nodes originally, the set of commands required would look something like this:

```
ndb_restore --nodeid=1 --backupid=1 --restore-data --backup-path=/backups/node_1/BACKUP/BACKUP-1 --c
ndb_restore --nodeid=2 --backupid=1 --restore-data --backup-path=/backups/node_2/BACKUP/BACKUP-1 --c
ndb_restore --nodeid=3 --backupid=1 --restore-data --backup-path=/backups/node_3/BACKUP/BACKUP-1 --c
ndb_restore --nodeid=4 --backupid=1 --restore-data --backup-path=/backups/node_4/BACKUP/BACKUP-1 --c
```

These can be run in parallel.

Be sure to add the `--ndb-connectstring` option as needed.

3. *Rebuild the indexes.* These were disabled by the `--disable-indexes` option used in the commands just shown. Recreating the indexes avoids errors due to the restore not being consistent at all points. Rebuilding the indexes can also improve performance in some cases. To rebuild the indexes, execute the following command once, on a single node:

```
$> ndb_restore --nodeid=1 --backupid=1 --backup-path=/backups/node_1/BACKUP/BACKUP-1 --rebuild-indexes
```

As mentioned previously, you may need to add the `--ndb-connectstring` option, so that `ndb_restore` can contact the management server.

5.25 ndb_select_all — Print Rows from an NDB Table

`ndb_select_all` prints all rows from an NDB table to `stdout`.

Usage

```
ndb_select_all -c connection_string tbl_name -d db_name [> file_name]
```

Options that can be used with `ndb_select_all` are shown in the following table. Additional descriptions follow the table.

Table 5.20 Command-line options used with the program `ndb_select_all`

Format	Description	Added, Deprecated, or Removed
<code>--character-sets-dir=path</code>	Directory containing character sets	(Supported in all NDB releases based on MySQL 5.7)
<code>--connect-retries=#</code>	Number of times to retry connection before giving up	(Supported in all NDB releases based on MySQL 5.7)
<code>--connect-retry-delay=#</code>	Number of seconds to wait between attempts to contact management server	(Supported in all NDB releases based on MySQL 5.7)
<code>--connect-string=connection_string,</code>	Same as <code>--ndb-connectstring</code>	(Supported in all NDB releases based on MySQL 5.7)

Format	Description	Added, Deprecated, or Removed
<code>-c connection_string</code>		
<code>--core-file</code>	Write core file on error; used in debugging	(Supported in all NDB releases based on MySQL 5.7)
<code>--database=name,</code>	Name of database in which table is found	(Supported in all NDB releases based on MySQL 5.7)
<code>-d name</code>		
<code>--defaults-extra-file=path</code>	Read given file after global files are read	(Supported in all NDB releases based on MySQL 5.7)
<code>--defaults-file=path</code>	Read default options from given file only	(Supported in all NDB releases based on MySQL 5.7)
<code>--defaults-group-suffix=string</code>	Also read groups with concat(group, suffix)	(Supported in all NDB releases based on MySQL 5.7)
<code>--delimiter=char,</code>	Set column delimiter	(Supported in all NDB releases based on MySQL 5.7)
<code>-D char</code>		
<code>--descending,</code>	Sort resultset in descending order (requires --order)	(Supported in all NDB releases based on MySQL 5.7)
<code>-z</code>		
<code>--disk</code>	Print disk references (useful only for Disk Data tables having unindexed columns)	(Supported in all NDB releases based on MySQL 5.7)
<code>--gci</code>	Include GCI in output	(Supported in all NDB releases based on MySQL 5.7)
<code>--gci64</code>	Include GCI and row epoch in output	(Supported in all NDB releases based on MySQL 5.7)
<code>--header[=value],</code>	Print header (set to 0 FALSE to disable headers in output)	(Supported in all NDB releases based on MySQL 5.7)
<code>-h</code>		
<code>--lock=#,</code>	Lock type	(Supported in all NDB releases based on MySQL 5.7)
<code>-l #</code>		
<code>--login-path=path</code>	Read given path from login file	(Supported in all NDB releases based on MySQL 5.7)
<code>--help,</code>	Display help text and exit	(Supported in all NDB releases based on MySQL 5.7)
<code>-?</code>		
<code>--ndb-connectstring=connection_string</code>	Set connect string for connecting to ndb_mgmd. Syntax: "[nodeid=id;] [host=]hostname[:port]". Overrides entries in NDB_CONNECTSTRING and my.cnf	(Supported in all NDB releases based on MySQL 5.7)
<code>-c connection_string</code>		
<code>--ndb-mgmd-host=connection_string,</code>	Same as --ndb-connectstring	(Supported in all NDB releases based on MySQL 5.7)
<code>-c connection_string</code>		
<code>--ndb-nodeid=#</code>	Set node ID for this node, overriding any ID set by --ndb-connectstring	(Supported in all NDB releases based on MySQL 5.7)

Format	Description	Added, Deprecated, or Removed
<code>--ndb-optimized-node-selection</code>	Enable optimizations for selection of nodes for transactions. Enabled by default; use <code>--skip-ndb-optimized-node-selection</code> to disable	(Supported in all NDB releases based on MySQL 5.7)
<code>--no-defaults</code>	Do not read default options from any option file other than login file	(Supported in all NDB releases based on MySQL 5.7)
<code>--nodata</code>	Do not print table column data	(Supported in all NDB releases based on MySQL 5.7)
<code>--order=index,</code> <code>-o index</code>	Sort resultset according to index having this name	(Supported in all NDB releases based on MySQL 5.7)
<code>--parallelism=#,</code> <code>-p #</code>	Degree of parallelism	(Supported in all NDB releases based on MySQL 5.7)
<code>--print-defaults</code>	Print program argument list and exit	(Supported in all NDB releases based on MySQL 5.7)
<code>--rowid</code>	Print row ID	(Supported in all NDB releases based on MySQL 5.7)
<code>--tupscan,</code> <code>-t</code>	Scan in tup order	(Supported in all NDB releases based on MySQL 5.7)
<code>--usage,</code> <code>-?</code>	Display help text and exit; same as <code>--help</code>	(Supported in all NDB releases based on MySQL 5.7)
<code>--useHexFormat,</code> <code>-x</code>	Output numbers in hexadecimal format	(Supported in all NDB releases based on MySQL 5.7)
<code>--version,</code> <code>-V</code>	Display version information and exit	(Supported in all NDB releases based on MySQL 5.7)

- `--character-sets-dir`

Command-Line Format	<code>--character-sets-dir=path</code>
---------------------	--

Directory containing character sets.

- `--connect-retries`

Command-Line Format	<code>--connect-retries=#</code>
Type	Integer
Default Value	12
Minimum Value	0
Maximum Value	12

Number of times to retry connection before giving up.

- `--connect-retry-delay`

Command-Line Format	<code>--connect-retry-delay=#</code>
---------------------	--------------------------------------

Type	Integer
Default Value	5
Minimum Value	0
Maximum Value	5

Number of seconds to wait between attempts to contact management server.

- `--connect-string`

Command-Line Format	<code>--connect-string=connection_string</code>
Type	String
Default Value	[none]

Same as `--ndb-connectstring`.

- `--core-file`

Command-Line Format	<code>--core-file</code>
---------------------	--------------------------

Write core file on error; used in debugging.

- `--database=dbname, -d dbname`

Name of the database in which the table is found. The default value is `TEST_DB`.

- `--descending, -z`

Sorts the output in descending order. This option can be used only in conjunction with the `-o (--order)` option.

- `--defaults-extra-file`

Command-Line Format	<code>--defaults-extra-file=path</code>
Type	String
Default Value	[none]

Read given file after global files are read.

- `--defaults-file`

Command-Line Format	<code>--defaults-file=path</code>
Type	String
Default Value	[none]

Read default options from given file only.

- `--defaults-group-suffix`

Command-Line Format	<code>--defaults-group-suffix=string</code>
Type	String
Default Value	[none]

- `--delimiter=character, -D character`

Causes the *character* to be used as a column delimiter. Only table data columns are separated by this delimiter.

The default delimiter is the tab character.

- `--disk`

Adds a disk reference column to the output. The column is nonempty only for Disk Data tables having nonindexed columns.

- `--gci`

Adds a `GCI` column to the output showing the global checkpoint at which each row was last updated. See [Chapter 2, NDB Cluster Overview](#), and [Section 6.3.2, “NDB Cluster Log Events”](#), for more information about checkpoints.

- `--gci64`

Adds a `ROW$GCI64` column to the output showing the global checkpoint at which each row was last updated, as well as the number of the epoch in which this update occurred.

- `--help`

Command-Line Format	<code>--help</code>
---------------------	---------------------

Display help text and exit.

- `--lock=lock_type, -l lock_type`

Employs a lock when reading the table. Possible values for *lock_type* are:

- `0`: Read lock
- `1`: Read lock with hold
- `2`: Exclusive read lock

There is no default value for this option.

- `--login-path`

Command-Line Format	<code>--login-path=path</code>
Type	String
Default Value	[none]

Read given path from login file.

- `--header=FALSE`

Excludes column headers from the output.

- `--nodata`

Causes any table data to be omitted.

- `--ndb-connectstring`

Command-Line Format	<code>--ndb-connectstring=connection_string</code>
---------------------	--

Type	String
Default Value	[none]

Set connect string for connecting to `ndb_mgmd`. Syntax: "[nodeid=id;][host=]hostname[:port]". Overrides entries in `NDB_CONNECTSTRING` and `my.cnf`.

- `--ndb-mgmd-host`

Command-Line Format	<code>--ndb-mgmd-host=connection_string</code>
Type	String
Default Value	[none]

Same as `--ndb-connectstring`.

- `--ndb-nodeid`

Command-Line Format	<code>--ndb-nodeid=#</code>
Type	Integer
Default Value	[none]

Set node ID for this node, overriding any ID set by `--ndb-connectstring`.

- `--ndb-optimized-node-selection`

Command-Line Format	<code>--ndb-optimized-node-selection</code>
---------------------	---

Enable optimizations for selection of nodes for transactions. Enabled by default; use `--skip-ndb-optimized-node-selection` to disable.

- `--no-defaults`

Command-Line Format	<code>--no-defaults</code>
---------------------	----------------------------

Do not read default options from any option file other than login file.

- `--order=index_name, -o index_name`

Orders the output according to the index named `index_name`.

Note

This is the name of an index, not of a column; the index must have been explicitly named when created.

- `parallelism=#, -p #`

Specifies the degree of parallelism.

- `--print-defaults`

Command-Line Format	<code>--print-defaults</code>
---------------------	-------------------------------

Print program argument list and exit.

- `--rowid`

Adds a `ROWID` column providing information about the fragments in which rows are stored.

- `--tupscan, -t`

Scan the table in the order of the tuples.

- `--usage`

Command-Line Format	<code>--usage</code>
---------------------	----------------------

Display help text and exit; same as `--help`.

- `--useHexFormat -x`

Causes all numeric values to be displayed in hexadecimal format. This does not affect the output of numerals contained in strings or datetime values.

- `--version`

Command-Line Format	<code>--version</code>
---------------------	------------------------

Display version information and exit.

Sample Output

Output from a MySQL `SELECT` statement:

```
mysql> SELECT * FROM ctest1.fish;
+-----+-----+
| id | name |
+-----+-----+
| 3 | shark |
| 6 | puffer |
| 2 | tuna |
| 4 | manta ray |
| 5 | grouper |
| 1 | guppy |
+-----+-----+
6 rows in set (0.04 sec)
```

Output from the equivalent invocation of `ndb_select_all`:

```
$> ./ndb_select_all -c localhost fish -d ctest1
id      name
3       [shark]
6       [puffer]
2       [tuna]
4       [manta ray]
5       [grouper]
1       [guppy]
6 rows returned

NDBT_ProgramExit: 0 - OK
```

All string values are enclosed by square brackets (`[...]`) in the output of `ndb_select_all`. For another example, consider the table created and populated as shown here:

```
CREATE TABLE dogs (
  id INT(11) NOT NULL AUTO_INCREMENT,
  name VARCHAR(25) NOT NULL,
  breed VARCHAR(50) NOT NULL,
  PRIMARY KEY pk (id),
  KEY ix (name)
)
TABLESPACE ts STORAGE DISK
ENGINE=NDBCLUSTER;

INSERT INTO dogs VALUES
  ('', 'Lassie', 'collie'),
```

```
('', 'Scooby-Doo', 'Great Dane'),
('', 'Rin-Tin-Tin', 'Alsatian'),
('', 'Rosscoe', 'Mutt');
```

This demonstrates the use of several additional `ndb_select_all` options:

```
$> ./ndb_select_all -d ctest1 dogs -o ix -z --gci --disk
GCI      id name          breed          DISK_REF
834461   2 [Scooby-Doo] [Great Dane] [ m_file_no: 0 m_page: 98 m_page_idx: 0 ]
834878   4 [Rosscoe] [Mutt] [ m_file_no: 0 m_page: 98 m_page_idx: 16 ]
834463   3 [Rin-Tin-Tin] [Alsatian] [ m_file_no: 0 m_page: 34 m_page_idx: 0 ]
835657   1 [Lassie] [Collie] [ m_file_no: 0 m_page: 66 m_page_idx: 0 ]
4 rows returned

NDBT_ProgramExit: 0 - OK
```

5.26 ndb_select_count — Print Row Counts for NDB Tables

`ndb_select_count` prints the number of rows in one or more NDB tables. With a single table, the result is equivalent to that obtained by using the MySQL statement `SELECT COUNT(*) FROM tbl_name`.

Usage

```
ndb_select_count [-c connection_string] -ddb_name tbl_name[, tbl_name2[, ...]]
```

Options that can be used with `ndb_select_count` are shown in the following table. Additional descriptions follow the table.

Table 5.21 Command-line options used with the program `ndb_select_count`

Format	Description	Added, Deprecated, or Removed
<code>--character-sets-dir=path</code>	Directory containing character sets	(Supported in all NDB releases based on MySQL 5.7)
<code>--connect-retries=#</code>	Number of times to retry connection before giving up	(Supported in all NDB releases based on MySQL 5.7)
<code>--connect-retry-delay=#</code>	Number of seconds to wait between attempts to contact management server	(Supported in all NDB releases based on MySQL 5.7)
<code>--connect-string=connection_string,</code> <code>-c connection_string</code>	Same as <code>--ndb-connectstring</code>	(Supported in all NDB releases based on MySQL 5.7)
<code>--core-file</code>	Write core file on error; used in debugging	(Supported in all NDB releases based on MySQL 5.7)
<code>--database=name,</code> <code>-d name</code>	Name of database in which table is found	(Supported in all NDB releases based on MySQL 5.7)
<code>--defaults-extra-file=path</code>	Read given file after global files are read	(Supported in all NDB releases based on MySQL 5.7)
<code>--defaults-file=path</code>	Read default options from given file only	(Supported in all NDB releases based on MySQL 5.7)
<code>--defaults-group-suffix=string</code>	Also read groups with <code>concat(group, suffix)</code>	(Supported in all NDB releases based on MySQL 5.7)
<code>--help,</code>	Display help text and exit	(Supported in all NDB releases based on MySQL 5.7)

Format	Description	Added, Deprecated, or Removed
-?		
--lock=#, -l #	Lock type	(Supported in all NDB releases based on MySQL 5.7)
--login-path=path	Read given path from login file	(Supported in all NDB releases based on MySQL 5.7)
--ndb-connectstring=connection_string -c connection_string	Set connect string for connecting to ndb_mgmd. Syntax: "[nodeid=id;][host=]hostname[:port]". Overrides entries in NDB_CONNECTSTRING and my.cnf	(Supported in all NDB releases based on MySQL 5.7)
--ndb-mgmd-host=connection_string, -c connection_string	Same as --ndb-connectstring	(Supported in all NDB releases based on MySQL 5.7)
--ndb-nodeid=#	Set node ID for this node, overriding any ID set by --ndb-connectstring	(Supported in all NDB releases based on MySQL 5.7)
--ndb-optimized-node-selection	Enable optimizations for selection of nodes for transactions. Enabled by default; use --skip-ndb-optimized-node-selection to disable	(Supported in all NDB releases based on MySQL 5.7)
--no-defaults	Do not read default options from any option file other than login file	(Supported in all NDB releases based on MySQL 5.7)
--parallelism=#, -p #	Degree of parallelism	(Supported in all NDB releases based on MySQL 5.7)
--print-defaults	Print program argument list and exit	(Supported in all NDB releases based on MySQL 5.7)
--usage, -?	Display help text and exit; same as --help	(Supported in all NDB releases based on MySQL 5.7)
--version, -V	Display version information and exit	(Supported in all NDB releases based on MySQL 5.7)

- `--character-sets-dir`

Command-Line Format	<code>--character-sets-dir=path</code>
---------------------	--

Directory containing character sets.

- `--connect-retries`

Command-Line Format	<code>--connect-retries=#</code>
Type	Integer
Default Value	12
Minimum Value	0

Maximum Value	12
---------------	----

Number of times to retry connection before giving up.

- `--connect-retry-delay`

Command-Line Format	<code>--connect-retry-delay=#</code>
Type	Integer
Default Value	5
Minimum Value	0
Maximum Value	5

Number of seconds to wait between attempts to contact management server.

- `--connect-string`

Command-Line Format	<code>--connect-string=connection_string</code>
Type	String
Default Value	[none]

Same as `--ndb-connectstring`.

- `--core-file`

Command-Line Format	<code>--core-file</code>
---------------------	--------------------------

Write core file on error; used in debugging.

- `--defaults-file`

Command-Line Format	<code>--defaults-file=path</code>
Type	String
Default Value	[none]

Read default options from given file only.

- `--defaults-extra-file`

Command-Line Format	<code>--defaults-extra-file=path</code>
Type	String
Default Value	[none]

Read given file after global files are read.

- `--defaults-group-suffix`

Command-Line Format	<code>--defaults-group-suffix=string</code>
Type	String
Default Value	[none]

Also read groups with `concat(group, suffix)`.

- `--login-path`

Command-Line Format	<code>--login-path=path</code>
---------------------	--------------------------------

Type	String
Default Value	[none]

Read given path from login file.

- `--help`

Command-Line Format	<code>--help</code>
---------------------	---------------------

Display help text and exit.

- `--ndb-connectstring`

Command-Line Format	<code>--ndb-connectstring=connection_string</code>
Type	String
Default Value	[none]

Set connect string for connecting to `ndb_mgmd`. Syntax: "[nodeid=id;][host=]hostname[:port]". Overrides entries in `NDB_CONNECTSTRING` and `my.cnf`.

- `--ndb-mgmd-host`

Command-Line Format	<code>--ndb-mgmd-host=connection_string</code>
Type	String
Default Value	[none]

Same as `--ndb-connectstring`.

- `--ndb-optimized-node-selection`

Command-Line Format	<code>--ndb-optimized-node-selection</code>
---------------------	---

Enable optimizations for selection of nodes for transactions. Enabled by default; use `--skip-ndb-optimized-node-selection` to disable.

- `--ndb-nodeid`

Command-Line Format	<code>--ndb-nodeid=#</code>
Type	Integer
Default Value	[none]

Set node ID for this node, overriding any ID set by `--ndb-connectstring`.

- `--no-defaults`

Command-Line Format	<code>--no-defaults</code>
---------------------	----------------------------

Do not read default options from any option file other than login file.

- `--print-defaults`

Command-Line Format	<code>--print-defaults</code>
---------------------	-------------------------------

Print program argument list and exit.

- `--usage`

Command-Line Format	<code>--usage</code>
---------------------	----------------------

Display help text and exit; same as `--help`.

- `--version`

Command-Line Format	<code>--version</code>
---------------------	------------------------

Display version information and exit.

You can obtain row counts from multiple tables in the same database by listing the table names separated by spaces when invoking this command, as shown under **Sample Output**.

Sample Output

```
$> ./ndb_select_count -c localhost -d ctest1 fish dogs
6 records in table fish
4 records in table dogs
NDBT_ProgramExit: 0 - OK
```

5.27 ndb_setup.py — Start browser-based Auto-Installer for NDB Cluster (DEPRECATED)

Note

This feature is deprecated and should be avoided. It is subject to removal in a future version of NDB Cluster.

`ndb_setup.py` starts the NDB Cluster Auto-Installer and opens the installer's Start page in the default Web browser.

Important

This program is intended to be invoked as a normal user, and not with the `mysql`, system `root` or other administrative account.

This section describes usage of and program options for the command-line tool only. For information about using the Auto-Installer GUI that is spawned when `ndb_setup.py` is invoked, see [Section 3.8](#), “The NDB Cluster Auto-Installer (NDB 7.5) (No longer supported)”.

Usage

All platforms:

```
ndb_setup.py [options]
```

Additionally, on Windows platforms only:

```
setup.bat [options]
```

The following table includes all options that are supported by the NDB Cluster installation and configuration program `ndb_setup.py`. Additional descriptions follow the table.

Table 5.22 Command-line options used with the program `ndb_setup.py`

Format	Description	Added, Deprecated, or Removed
<code>--browser-start-page=path,</code>	Page that web browser opens when starting	(Supported in all NDB releases based on MySQL 5.7)

Format	Description	Added, Deprecated, or Removed
<code>-s path</code>	File containing list of client certificates allowed to connect to server	(Supported in all NDB releases based on MySQL 5.7)
<code>--ca-certs-file=path,</code>		
<code>-a path</code>	File containing X509 certificate identifying server	(Supported in all NDB releases based on MySQL 5.7)
<code>--cert-file=path,</code>		
<code>-c path</code>	Python logging module debug level; one of DEBUG, INFO, WARNING (default), ERROR, or CRITICAL	(Supported in all NDB releases based on MySQL 5.7)
<code>--debug-level=level,</code>		
<code>-d level</code>	Print help message	(Supported in all NDB releases based on MySQL 5.7)
<code>--help,</code>		
<code>-h</code>	Specify file containing private key (if not included in <code>--cert-file</code>)	(Supported in all NDB releases based on MySQL 5.7)
<code>--key-file=path,</code>		
<code>-k path</code>	Do not open start page in browser, merely start tool	(Supported in all NDB releases based on MySQL 5.7)
<code>--no-browser,</code>		
<code>-n</code>	Specify port used by web server	(Supported in all NDB releases based on MySQL 5.7)
<code>--port=#,</code>		
<code>-p #</code>	Log requests to this file; use '-' to force logging to stderr instead	(Supported in all NDB releases based on MySQL 5.7)
<code>--server-log-file=path,</code>		
<code>-o path</code>	Name of server to connect to	(Supported in all NDB releases based on MySQL 5.7)
<code>--server-name=host,</code>		
<code>-N host</code>	Use unencrypted (HTTP) client/server connection	(Supported in all NDB releases based on MySQL 5.7)
<code>--use-http,</code>		
<code>-H</code>	Use encrypted (HTTPS) client/server connection	(Supported in all NDB releases based on MySQL 5.7)
<code>--use-https,</code>		
<code>-S</code>		

- `--browser-start-page=file, -s`

Command-Line Format	<code>--browser-start-page=path</code>
Type	String
Default Value	<code>index.html</code>

Specify the file to open in the browser as the installation and configuration Start page. The default is `index.html`.

- `--ca-certs-file=file, -a`

Command-Line Format	<code>--ca-certs-file=path</code>
Type	File name

Default Value	[none]
---------------	--------

Specify a file containing a list of client certificates which are allowed to connect to the server. The default is an empty string, which means that no client authentication is used.

- `--cert-file=file, -c`

Command-Line Format	<code>--cert-file=path</code>
Type	File name
Default Value	<code>/usr/share/mysql/mcc/cfg.pem</code>

Specify a file containing an X.509 certificate which identifies the server. It is possible for the certificate to be self-signed. The default is `cfg.pem`.

- `--debug-level=level, -d`

Command-Line Format	<code>--debug-level=level</code>
Type	Enumeration
Default Value	<code>WARNING</code>
Valid Values	<code>WARNING</code> <code>DEBUG</code> <code>INFO</code> <code>ERROR</code> <code>CRITICAL</code>

Set the Python logging module debug level. This is one of `DEBUG`, `INFO`, `WARNING`, `ERROR`, or `CRITICAL`. `WARNING` is the default.

- `--help, -h`

Command-Line Format	<code>--help</code>
---------------------	---------------------

Print a help message.

- `--key-file=file, -d`

Command-Line Format	<code>--key-file=path</code>
Type	File name
Default Value	[none]

Specify a file containing the private key if this is not included in the X. 509 certificate file (`--cert-file`). The default is an empty string, which means that no such file is used.

- `--no-browser, -n`

Command-Line Format	<code>--no-browser</code>
---------------------	---------------------------

Start the installation and configuration tool, but do not open the Start page in a browser.

- `--port=#, -p`

Command-Line Format	<code>--port=#</code>
Type	Numeric

Default Value	8081
Minimum Value	1
Maximum Value	65535

Set the port used by the web server. The default is 8081.

- `--server-log-file=file, -o`

Command-Line Format	<code>--server-log-file=path</code>
Type	File name
Default Value	<code>ndb_setup.log</code>
Valid Values	<code>ndb_setup.log</code> - (Log to stderr)

Log requests to this file. The default is `ndb_setup.log`. To specify logging to `stderr`, rather than to a file, use a - (dash character) for the file name.

- `--server-name=host, -N`

Command-Line Format	<code>--server-name=host</code>
Type	String
Default Value	<code>localhost</code>

Specify the host name or IP address for the browser to use when connecting. The default is `localhost`.

- `--use-http, -H`

Command-Line Format	<code>--use-http</code>
---------------------	-------------------------

Make the browser use HTTP to connect with the server. This means that the connection is unencrypted and not secured in any way.

This option was added in NDB 7.6.

- `--use-https, -S`

Command-Line Format	<code>--use-https</code>
---------------------	--------------------------

Make the browser use a secure (HTTPS) connection with the server.

5.28 ndb_show_tables — Display List of NDB Tables

`ndb_show_tables` displays a list of all NDB database objects in the cluster. By default, this includes not only both user-created tables and NDB system tables, but NDB-specific indexes, internal triggers, and NDB Cluster Disk Data objects as well.

Options that can be used with `ndb_show_tables` are shown in the following table. Additional descriptions follow the table.

Table 5.23 Command-line options used with the program `ndb_show_tables`

Format	Description	Added, Deprecated, or Removed
<code>--character-sets-dir=path</code>	Directory containing character sets	(Supported in all NDB releases based on MySQL 5.7)

Format	Description	Added, Deprecated, or Removed
<code>--connect-retries=#</code>	Number of times to retry connection before giving up	(Supported in all NDB releases based on MySQL 5.7)
<code>--connect-retry-delay=#</code>	Number of seconds to wait between attempts to contact management server	(Supported in all NDB releases based on MySQL 5.7)
<code>--connect-string=connection_string,</code> <code>-c connection_string</code>	Same as <code>--ndb-connectstring</code>	(Supported in all NDB releases based on MySQL 5.7)
<code>--core-file</code>	Write core file on error; used in debugging	(Supported in all NDB releases based on MySQL 5.7)
<code>--database=name,</code> <code>-d name</code>	Specifies database in which table is found; database name must be followed by table name	(Supported in all NDB releases based on MySQL 5.7)
<code>--defaults-extra-file=path</code>	Read given file after global files are read	(Supported in all NDB releases based on MySQL 5.7)
<code>--defaults-file=path</code>	Read default options from given file only	(Supported in all NDB releases based on MySQL 5.7)
<code>--defaults-group-suffix=string</code>	Also read groups with <code>concat(group, suffix)</code>	(Supported in all NDB releases based on MySQL 5.7)
<code>--login-path=path</code>	Read given path from login file	(Supported in all NDB releases based on MySQL 5.7)
<code>--loops=#,</code> <code>-l #</code>	Number of times to repeat output	(Supported in all NDB releases based on MySQL 5.7)
<code>--help,</code> <code>-?</code>	Display help text and exit	(Supported in all NDB releases based on MySQL 5.7)
<code>--ndb-connectstring=connection_string,</code> <code>-c connection_string</code>	Set connect string for connecting to <code>ndb_mgmd</code> . Syntax: "[nodeid=id;][host=]hostname[:port]". Overrides entries in <code>NDB_CONNECTSTRING</code> and <code>my.cnf</code>	(Supported in all NDB releases based on MySQL 5.7)
<code>--ndb-mgmd-host=connection_string,</code> <code>-c connection_string</code>	Same as <code>--ndb-connectstring</code>	(Supported in all NDB releases based on MySQL 5.7)
<code>--ndb-nodeid=#</code>	Set node ID for this node, overriding any ID set by <code>--ndb-connectstring</code>	(Supported in all NDB releases based on MySQL 5.7)
<code>--ndb-optimized-node-selection</code>	Enable optimizations for selection of nodes for transactions. Enabled by default; use <code>--skip-ndb-optimized-node-selection</code> to disable	(Supported in all NDB releases based on MySQL 5.7)
<code>--no-defaults</code>	Do not read default options from any option file other than login file	(Supported in all NDB releases based on MySQL 5.7)

Format	Description	Added, Deprecated, or Removed
<code>--parsable,</code> <code>-p</code>	Return output suitable for MySQL LOAD DATA statement	(Supported in all NDB releases based on MySQL 5.7)
<code>--print-defaults</code>	Print program argument list and exit	(Supported in all NDB releases based on MySQL 5.7)
<code>--show-temp-status</code>	Show table temporary flag	(Supported in all NDB releases based on MySQL 5.7)
<code>--type=#,</code> <code>-t #</code>	Limit output to objects of this type	(Supported in all NDB releases based on MySQL 5.7)
<code>--unqualified,</code> <code>-u</code>	Do not qualify table names	(Supported in all NDB releases based on MySQL 5.7)
<code>--usage,</code> <code>-?</code>	Display help text and exit; same as <code>--help</code>	(Supported in all NDB releases based on MySQL 5.7)
<code>--version,</code> <code>-V</code>	Display version information and exit	(Supported in all NDB releases based on MySQL 5.7)

Usage

```
ndb_show_tables [-c connection_string]
```

- `--character-sets-dir`

Command-Line Format	<code>--character-sets-dir=path</code>
---------------------	--

Directory containing character sets.

- `--connect-retries`

Command-Line Format	<code>--connect-retries=#</code>
Type	Integer
Default Value	12
Minimum Value	0
Maximum Value	12

Number of times to retry connection before giving up.

- `--connect-retry-delay`

Command-Line Format	<code>--connect-retry-delay=#</code>
Type	Integer
Default Value	5
Minimum Value	0
Maximum Value	5

Number of seconds to wait between attempts to contact management server.

- `--connect-string`

Command-Line Format	<code>--connect-string=connection_string</code>
Type	String
Default Value	[none]

Same as `--ndb-connectstring`.

- `--core-file`

Command-Line Format	<code>--core-file</code>
---------------------	--------------------------

Write core file on error; used in debugging.

- `--database, -d`

Specifies the name of the database in which the desired table is found. If this option is given, the name of a table must follow the database name.

If this option has not been specified, and no tables are found in the `TEST_DB` database, `ndb_show_tables` issues a warning.

- `--defaults-extra-file`

Command-Line Format	<code>--defaults-extra-file=path</code>
Type	String
Default Value	[none]

Read given file after global files are read.

- `--defaults-file`

Command-Line Format	<code>--defaults-file=path</code>
Type	String
Default Value	[none]

Read default options from given file only.

- `--defaults-group-suffix`

Command-Line Format	<code>--defaults-group-suffix=string</code>
Type	String
Default Value	[none]

Also read groups with `concat(group, suffix)`.

- `--help`

Command-Line Format	<code>--help</code>
---------------------	---------------------

Display help text and exit.

- `--login-path`

Command-Line Format	<code>--login-path=path</code>
Type	String
Default Value	[none]

Read given path from login file.

- `--loops, -l`

Specifies the number of times the utility should execute. This is 1 when this option is not specified, but if you do use the option, you must supply an integer argument for it.

- `--ndb-connectstring`

Command-Line Format	<code>--ndb-connectstring=connection_string</code>
Type	String
Default Value	[none]

Set connect string for connecting to `ndb_mgmd`. Syntax: "[nodeid=id;][host=]hostname[:port]". Overrides entries in `NDB_CONNECTSTRING` and `my.cnf`.

- `--ndb-mgmd-host`

Command-Line Format	<code>--ndb-mgmd-host=connection_string</code>
Type	String
Default Value	[none]

Same as `--ndb-connectstring`.

- `--ndb-nodeid`

Command-Line Format	<code>--ndb-nodeid=#</code>
Type	Integer
Default Value	[none]

Set node ID for this node, overriding any ID set by `--ndb-connectstring`.

- `--ndb-optimized-node-selection`

Command-Line Format	<code>--ndb-optimized-node-selection</code>
---------------------	---

Enable optimizations for selection of nodes for transactions. Enabled by default; use `--skip-ndb-optimized-node-selection` to disable.

- `--no-defaults`

Command-Line Format	<code>--no-defaults</code>
---------------------	----------------------------

Do not read default options from any option file other than login file.

- `--parsable, -p`

Using this option causes the output to be in a format suitable for use with `LOAD DATA`.

- `--print-defaults`

Command-Line Format	<code>--print-defaults</code>
---------------------	-------------------------------

Print program argument list and exit.

- `--show-temp-status`

If specified, this causes temporary tables to be displayed.

- `--type, -t`

Can be used to restrict the output to one type of object, specified by an integer type code as shown here:

- 1: System table
- 2: User-created table
- 3: Unique hash index

Any other value causes all NDB database objects to be listed (the default).

- `--unqualified, -u`

If specified, this causes unqualified object names to be displayed.

- `--usage`

Command-Line Format	<code>--usage</code>
---------------------	----------------------

Display help text and exit; same as `--help`.

- `--version`

Command-Line Format	<code>--version</code>
---------------------	------------------------

Display version information and exit.

Note

Only user-created NDB Cluster tables may be accessed from MySQL; system tables such as `SYSTAB_0` are not visible to `mysqld`. However, you can examine the contents of system tables using NDB API applications such as `ndb_select_all` (see Section 5.25, “`ndb_select_all` — Print Rows from an NDB Table”).

Prior to NDB 7.5.18 and 7.6.14, this program printed `NDBT_ProgramExit - status` upon completion of its run, due to an unnecessary dependency on the NDBT testing library. This dependency is has now been removed, eliminating the extraneous output.

5.29 ndb_size.pl — NDBCLUSTER Size Requirement Estimator

This is a Perl script that can be used to estimate the amount of space that would be required by a MySQL database if it were converted to use the NDBCLUSTER storage engine. Unlike the other utilities discussed in this section, it does not require access to an NDB Cluster (in fact, there is no reason for it to do so). However, it does need to access the MySQL server on which the database to be tested resides.

Requirements

- A running MySQL server. The server instance does not have to provide support for NDB Cluster.
- A working installation of Perl.
- The DBI module, which can be obtained from CPAN if it is not already part of your Perl installation. (Many Linux and other operating system distributions provide their own packages for this library.)

- A MySQL user account having the necessary privileges. If you do not wish to use an existing account, then creating one using `GRANT USAGE ON db_name.*`—where `db_name` is the name of the database to be examined—is sufficient for this purpose.

`ndb_size.pl` can also be found in the MySQL sources in `storage/ndb/tools`.

Options that can be used with `ndb_size.pl` are shown in the following table. Additional descriptions follow the table.

Table 5.24 Command-line options used with the program `ndb_size.pl`

Format	Description	Added, Deprecated, or Removed
<code>--database=string</code>	Database or databases to examine; a comma-delimited list; default is ALL (use all databases found on server)	(Supported in all NDB releases based on MySQL 5.7)
<code>--hostname=string</code>	Specify host and optional port in <code>host[:port]</code> format	(Supported in all NDB releases based on MySQL 5.7)
<code>--socket=path</code>	Specify socket to connect to	(Supported in all NDB releases based on MySQL 5.7)
<code>--user=string</code>	Specify MySQL user name	(Supported in all NDB releases based on MySQL 5.7)
<code>--password=password</code>	Specify MySQL user password	(Supported in all NDB releases based on MySQL 5.7)
<code>--format=string</code>	Set output format (text or HTML)	(Supported in all NDB releases based on MySQL 5.7)
<code>--excludetables=list</code>	Skip any tables in comma-separated list	(Supported in all NDB releases based on MySQL 5.7)
<code>--excludedbs=list</code>	Skip any databases in comma-separated list	(Supported in all NDB releases based on MySQL 5.7)
<code>--savequeries=path</code>	Saves all queries on database into file specified	(Supported in all NDB releases based on MySQL 5.7)
<code>--loadqueries=path</code>	Loads all queries from file specified; does not connect to database	(Supported in all NDB releases based on MySQL 5.7)
<code>--real_table_name=string</code>	Designates table to handle unique index size calculations	(Supported in all NDB releases based on MySQL 5.7)

Usage

```
perl ndb_size.pl [--database={db_name|ALL}] [--hostname=host[:port]] [--socket=socket] \
  [--user=user] [--password=password] \
  [--help|-h] [--format={html|text}] \
  [--loadqueries=file_name] [--savequeries=file_name]
```

By default, this utility attempts to analyze all databases on the server. You can specify a single database using the `--database` option; the default behavior can be made explicit by using `ALL` for the name of the database. You can also exclude one or more databases by using the `--excludedbs` option with a comma-separated list of the names of the databases to be skipped. Similarly, you can cause specific tables to be skipped by listing their names, separated by commas, following the optional `--excludetables` option. A host name can be specified using `--hostname`; the default is `localhost`. You can specify a port in addition to the host using `host:port` format for the value of `--hostname`. The default port number is 3306. If necessary, you can also specify a socket; the default is `/var/lib/mysql.sock`. A MySQL user name and password can be specified the corresponding options shown. It also possible to control the format of the output using the `--format` option; this can

take either of the values `html` or `text`, with `text` being the default. An example of the text output is shown here:

```
$> ndb_size.pl --database=test --socket=/tmp/mysql.sock
ndb_size.pl report for database: 'test' (1 tables)
-----
Connected to: DBI:mysql:host=localhost;mysql_socket=/tmp/mysql.sock

Including information for versions: 4.1, 5.0, 5.1

test.tl
-----

DataMemory for Columns (* means var sized DataMemory):
      Column Name      Type  Varsized  Key  4.1  5.0  5.1
      HIDDEN_NDB_PKEY  bigint  --      PRI  8    8    8
      c2               varchar(50)  Y      --  52   52  4*
      c1               int(11)      --      --  4    4    4
      --              --          --      --  --   --  --
Fixed Size Columns DM/Row                64   64  12
Varsize Columns DM/Row                  0    0   4

DataMemory for Indexes:
      Index Name      Type      4.1      5.0      5.1
      PRIMARY        BTREE     16       16       16
      --             --        --        --        --
      Total Index DM/Row                16       16       16

IndexMemory for Indexes:
      Index Name      4.1      5.0      5.1
      PRIMARY        33       16       16
      --             --        --        --
      Indexes IM/Row  33       16       16

Summary (for THIS table):
      4.1      5.0      5.1
      Fixed Overhead DM/Row  12       12       16
      NULL Bytes/Row        4         4         4
      DataMemory/Row        96        96        48
      (Includes overhead, bitmap and indexes)

      Varsize Overhead DM/Row  0         0         8
      Varsize NULL Bytes/Row  0         0         4
      Avg Varside DM/Row      0         0        16

      No. Rows                0         0         0

      Rows/32kb DM Page      340       340       680
Fixedsize DataMemory (KB)    0         0         0

      Rows/32kb Varsize DM Page  0         0       2040
      Varsize DataMemory (KB)  0         0         0

      Rows/8kb IM Page       248       512       512
      IndexMemory (KB)       0         0         0

Parameter Minimum Requirements
-----
* indicates greater than default

      Parameter      Default      4.1      5.0      5.1
      DataMemory (KB)  81920       0         0         0
      NoOfOrderedIndexes  128         1         1         1
      NoOfTables        128         1         1         1
      IndexMemory (KB)  18432       0         0         0
      NoOfUniqueHashIndexes  64          0         0         0
      NoOfAttributes    1000        3         3         3
      NoOfTriggers      768         5         5         5
```

For debugging purposes, the Perl arrays containing the queries run by this script can be read from the file specified using `--savequeries`; a file containing such arrays to be

read during script execution can be specified using `--loadqueries`. Neither of these options has a default value.

To produce output in HTML format, use the `--format` option and redirect the output to a file, as shown here:

```
$> ndb_size.pl --database=test --socket=/tmp/mysql.sock --format=html > ndb_size.html
```

(Without the redirection, the output is sent to `stdout`.)

The output from this script includes the following information:

- Minimum values for the `DataMemory`, `IndexMemory`, `MaxNoOfTables`, `MaxNoOfAttributes`, `MaxNoOfOrderedIndexes`, and `MaxNoOfTriggers` configuration parameters required to accommodate the tables analyzed.
- Memory requirements for all of the tables, attributes, ordered indexes, and unique hash indexes defined in the database.
- The `IndexMemory` and `DataMemory` required per table and table row.

5.30 ndb_top — View CPU usage information for NDB threads

`ndb_top` displays running information in the terminal about CPU usage by NDB threads on an NDB Cluster data node. Each thread is represented by two rows in the output, the first showing system statistics, the second showing the measured statistics for the thread.

`ndb_top` is available in MySQL NDB Cluster 7.6 (and later).

Usage

```
ndb_top [-h hostname] [-t port] [-u user] [-p pass] [-n node_id]
```

`ndb_top` connects to a MySQL Server running as an SQL node of the cluster. By default, it attempts to connect to a `mysqld` running on `localhost` and port 3306, as the MySQL `root` user with no password specified. You can override the default host and port using, respectively, `--host` (`-h`) and `--port` (`-t`). To specify a MySQL user and password, use the `--user` (`-u`) and `--passwd` (`-p`) options. This user must be able to read tables in the `ndbinfo` database (`ndb_top` uses information from `ndbinfo.cpustat` and related tables).

For more information about MySQL user accounts and passwords, see [Access Control and Account Management](#).

Output is available as plain text or an ASCII graph; you can specify this using the `--text` (`-x`) and `--graph` (`-g`) options, respectively. These two display modes provide the same information; they can be used concurrently. At least one display mode must be in use.

Color display of the graph is supported and enabled by default (`--color` or `-c` option). With color support enabled, the graph display shows OS user time in blue, OS system time in green, and idle time as blank. For measured load, blue is used for execution time, yellow for send time, red for time spent in send buffer full waits, and blank spaces for idle time. The percentage shown in the graph display is the sum of percentages for all threads which are not idle. Colors are not currently configurable; you can use grayscale instead by using `--skip-color`.

The sorted view (`--sort`, `-r`) is based on the maximum of the measured load and the load reported by the OS. Display of these can be enabled and disabled using the `--measured-load` (`-m`) and `--os-load` (`-o`) options. Display of at least one of these loads must be enabled.

The program tries to obtain statistics from a data node having the node ID given by the `--node-id` (`-n`) option; if unspecified, this is 1. `ndb_top` cannot provide information about other types of nodes.

The view adjusts itself to the height and width of the terminal window; the minimum supported width is 76 characters.

Once started, `ndb_top` runs continuously until forced to exit; you can quit the program using `Ctrl-C`. The display updates once per second; to set a different delay interval, use `--sleep-time (-s)`.

Note

`ndb_top` is available on macOS, Linux, and Solaris. It is not currently supported on Windows platforms.

The following table includes all options that are specific to the NDB Cluster program `ndb_top`. Additional descriptions follow the table.

Table 5.25 Command-line options used with the program `ndb_top`

Format	Description	Added, Deprecated, or Removed
<code>--color,</code> <code>-c</code>	Show ASCII graphs in color; use <code>--skip-colors</code> to disable	ADDED: NDB 7.6.3
<code>--defaults-extra-file=path</code> <code>--defaults-file=path</code>	Read given file after global files are read Read default options from given file only	(Supported in all NDB releases based on MySQL 5.7) (Supported in all NDB releases based on MySQL 5.7)
<code>--defaults-group-suffix=string</code> <code>--graph,</code> <code>-g</code>	Also read groups with <code>concat(group, suffix)</code> Display data using graphs; use <code>--skip-graphs</code> to disable	(Supported in all NDB releases based on MySQL 5.7) ADDED: NDB 7.6.3
<code>--help</code> <code>--host=string,</code> <code>-h string</code>	Show program usage information Host name or IP address of MySQL Server to connect to	ADDED: NDB 7.6.3 ADDED: NDB 7.6.3
<code>--login-path=path</code> <code>--measured-load,</code> <code>-m</code>	Read given path from login file Show measured load by thread	(Supported in all NDB releases based on MySQL 5.7) ADDED: NDB 7.6.3
<code>--no-defaults</code> <code>--node-id=#,</code> <code>-n #</code>	Do not read default options from any option file other than login file Watch node having this node ID	(Supported in all NDB releases based on MySQL 5.7) ADDED: NDB 7.6.3
<code>--os-load,</code> <code>-o</code>	Show load measured by operating system	ADDED: NDB 7.6.3
<code>--passwd=password,</code> <code>-p password</code>	Connect using this password (same as <code>--password</code> option)	ADDED: NDB 7.6.3 REMOVED: NDB 7.6.4
<code>--password=password,</code> <code>-p password</code>	Connect using this password	ADDED: NDB 7.6.6
<code>--port=#,</code>	Port number to use when connecting to MySQL Server	ADDED: NDB 7.6.3

Format	Description	Added, Deprecated, or Removed
<code>-t # (<=7.6.5),</code> <code>-P # (>=7.6.6)</code> <code>--print-defaults</code> <code>--sleep-time=#,</code> <code>-s #</code> <code>--socket=path,</code> <code>-S path</code> <code>--sort,</code> <code>-r</code> <code>--text,</code> <code>-x (<=7.6.5),</code> <code>-t (>=7.6.6)</code> <code>--usage</code> <code>--user=name,</code> <code>-u name</code>	Print program argument list and exit Time to wait between display refreshes, in seconds Socket file to use for connection Sort threads by usage; use <code>--skip-sort</code> to disable Display data using text Show program usage information; same as <code>--help</code> Connect as this MySQL user	(Supported in all NDB releases based on MySQL 5.7) ADDED: NDB 7.6.3 ADDED: NDB 7.6.6 ADDED: NDB 7.6.3 ADDED: NDB 7.6.3 ADDED: NDB 7.6.3 ADDED: NDB 7.6.3

Additional Options

- `--color, -c`

Command-Line Format	<code>--color</code>
Introduced	5.7.19-ndb-7.6.3

Show ASCII graphs in color; use `--skip-colors` to disable.

- `--defaults-extra-file`

Command-Line Format	<code>--defaults-extra-file=path</code>
Type	String
Default Value	[none]

Read given file after global files are read.

- `--defaults-file`

Command-Line Format	<code>--defaults-file=path</code>
Type	String
Default Value	[none]

Read default options from given file only.

- `--defaults-group-suffix`

Command-Line Format	<code>--defaults-group-suffix=string</code>
---------------------	---

Type	String
Default Value	[none]

Also read groups with `concat(group, suffix)`.

- `--graph, -g`

Command-Line Format	<code>--graph</code>
Introduced	5.7.19-ndb-7.6.3

Display data using graphs; use `--skip-graphs` to disable. This option or `--text` must be true; both options may be true.

- `--help, -?`

Command-Line Format	<code>--help</code>
Introduced	5.7.19-ndb-7.6.3

Show program usage information.

- `--host[=name], -h`

Command-Line Format	<code>--host=string</code>
Introduced	5.7.19-ndb-7.6.3
Type	String
Default Value	<code>localhost</code>

Host name or IP address of MySQL Server to connect to.

- `--login-path`

Command-Line Format	<code>--login-path=path</code>
Type	String
Default Value	[none]

Read given path from login file.

- `--measured-load, -m`

Command-Line Format	<code>--measured-load</code>
Introduced	5.7.19-ndb-7.6.3

Show measured load by thread. This option or `--os-load` must be true; both options may be true.

- `--no-defaults`

Command-Line Format	<code>--no-defaults</code>
---------------------	----------------------------

Do not read default options from any option file other than login file.

- `--node-id[=#], -n`

Command-Line Format	<code>--node-id=#</code>
Introduced	5.7.19-ndb-7.6.3
Type	Integer

Default Value	1
---------------	---

Watch the data node having this node ID.

- `--os-load, -o`

Command-Line Format	<code>--os-load</code>
Introduced	5.7.19-ndb-7.6.3

Show load measured by operating system. This option or `--measured-load` must be true; both options may be true.

- `--passwd[=password], -p`

Command-Line Format	<code>--passwd=<i>password</i></code>
Introduced	5.7.19-ndb-7.6.3
Removed	5.7.20-ndb-7.6.4
Type	String
Default Value	NULL

Connect to a MySQL Server using this password and the MySQL user specified by `--user`.
Synonym for `--password`.

This password is associated with a MySQL user account only, and is not related in any way to the password used with encrypted NDB backups.

- `--password[=password], -p`

Command-Line Format	<code>--password=<i>password</i></code>
Introduced	5.7.22-ndb-7.6.6
Type	String
Default Value	NULL

Connect to a MySQL Server using this password and the MySQL user specified by `--user`.

This password is associated with a MySQL user account only, and is not related in any way to the password used with encrypted NDB backups.

- `--port[=#], -P`

Command-Line Format	<code>--port=#</code>
Introduced	5.7.19-ndb-7.6.3
Type	Integer
Default Value	3306

Port number to use when connecting to MySQL Server.

(Formerly, the short form for this option was `-t`, which was repurposed as the short form of `--text`.)

- `--print-defaults`

Command-Line Format	<code>--print-defaults</code>
---------------------	-------------------------------

Print program argument list and exit.

- `--sleep-time[=seconds], -s`

Command-Line Format	<code>--sleep-time=#</code>
Introduced	5.7.19-ndb-7.6.3
Type	Integer
Default Value	1

Time to wait between display refreshes, in seconds.

- `--socket=path/to/file, -S`

Command-Line Format	<code>--socket=path</code>
Introduced	5.7.22-ndb-7.6.6
Type	Path name
Default Value	[none]

Use the specified socket file for the connection.

- `--sort, -r`

Command-Line Format	<code>--sort</code>
Introduced	5.7.19-ndb-7.6.3

Sort threads by usage; use `--skip-sort` to disable.

- `--text, -t`

Command-Line Format	<code>--text</code>
Introduced	5.7.19-ndb-7.6.3

Display data using text. This option or `--graph` must be true; both options may be true.

(The short form for this option was `-x` in previous versions of NDB Cluster, but this is no longer supported.)

- `--usage`

Command-Line Format	<code>--usage</code>
Introduced	5.7.19-ndb-7.6.3

Display help text and exit; same as `--help`.

- `--user[=name], -u`

Command-Line Format	<code>--user=name</code>
Introduced	5.7.19-ndb-7.6.3
Type	String
Default Value	root

Connect as this MySQL user. Normally requires a password supplied by the `--password` option.

Sample Output. The next figure shows `ndb_top` running in a terminal window on a Linux system with an `ndbmysqld` data node under a moderate load. Here, the program has been invoked using `ndb_top -n8 -x` to provide both text and graph output:

Figure 5.1 ndb_top Running in Terminal

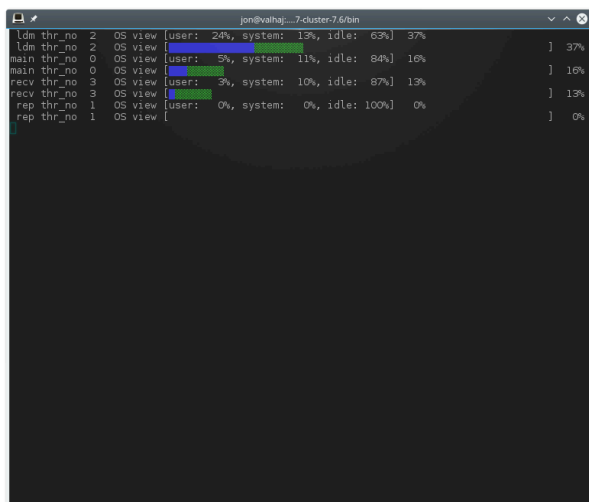

```

joni@valhaja:~$ ndb_top
ldm thr_no 2 OS view [user: 24%, system: 15%, idle: 63%] 37%
ldm thr_no 2 OS view [user: 24%, system: 15%, idle: 63%] 37%
main thr_no 0 OS view [user: 5%, system: 11%, idle: 84%] 16%
main thr_no 0 OS view [user: 5%, system: 11%, idle: 84%] 16%
recv thr_no 3 OS view [user: 3%, system: 10%, idle: 87%] 13%
recv thr_no 3 OS view [user: 3%, system: 10%, idle: 87%] 13%
rep thr_no 1 OS view [user: 0%, system: 0%, idle: 100%] 0%
rep thr_no 1 OS view [user: 0%, system: 0%, idle: 100%] 0%

```

5.31 ndb_waiter — Wait for NDB Cluster to Reach a Given Status

`ndb_waiter` repeatedly (each 100 milliseconds) prints out the status of all cluster data nodes until either the cluster reaches a given status or the `--timeout` limit is exceeded, then exits. By default, it waits for the cluster to achieve `STARTED` status, in which all nodes have started and connected to the cluster. This can be overridden using the `--no-contact` and `--not-started` options.

The node states reported by this utility are as follows:

- `NO_CONTACT`: The node cannot be contacted.
- `UNKNOWN`: The node can be contacted, but its status is not yet known. Usually, this means that the node has received a `START` or `RESTART` command from the management server, but has not yet acted on it.
- `NOT_STARTED`: The node has stopped, but remains in contact with the cluster. This is seen when restarting the node using the management client's `RESTART` command.
- `STARTING`: The node's `ndbd` process has started, but the node has not yet joined the cluster.
- `STARTED`: The node is operational, and has joined the cluster.
- `SHUTTING_DOWN`: The node is shutting down.
- `SINGLE USER MODE`: This is shown for all cluster data nodes when the cluster is in single user mode.

Options that can be used with `ndb_waiter` are shown in the following table. Additional descriptions follow the table.

Table 5.26 Command-line options used with the program `ndb_waiter`

Format	Description	Added, Deprecated, or Removed
<code>--character-sets-dir=path</code>	Directory containing character sets	(Supported in all NDB releases based on MySQL 5.7)
<code>--connect-retries=#</code>	Number of times to retry connection before giving up	(Supported in all NDB releases based on MySQL 5.7)
<code>--connect-retry-delay=#</code>	Number of seconds to wait between attempts to contact management server	(Supported in all NDB releases based on MySQL 5.7)

Format	Description	Added, Deprecated, or Removed
<code>--connect-string=connection_string,</code> <code>-c connection_string</code>	Same as <code>--ndb-connectstring</code>	(Supported in all NDB releases based on MySQL 5.7)
<code>--core-file</code>	Write core file on error; used in debugging	(Supported in all NDB releases based on MySQL 5.7)
<code>--defaults-extra-file=path</code>	Read given file after global files are read	(Supported in all NDB releases based on MySQL 5.7)
<code>--defaults-file=path</code>	Read default options from given file only	(Supported in all NDB releases based on MySQL 5.7)
<code>--defaults-group-suffix=string</code>	Also read groups with <code>concat(group, suffix)</code>	(Supported in all NDB releases based on MySQL 5.7)
<code>--help,</code> <code>-?</code>	Display help text and exit	(Supported in all NDB releases based on MySQL 5.7)
<code>--login-path=path</code>	Read given path from login file	(Supported in all NDB releases based on MySQL 5.7)
<code>--ndb-connectstring=connection_string,</code> <code>-c connection_string</code>	Set connect string for connecting to <code>ndb_mgmd</code> . Syntax: "[nodeid=id;][host=]hostname[:port]". Overrides entries in <code>NDB_CONNECTSTRING</code> and <code>my.cnf</code>	(Supported in all NDB releases based on MySQL 5.7)
<code>--ndb-mgmd-host=connection_string,</code> <code>-c connection_string</code>	Same as <code>--ndb-connectstring</code>	(Supported in all NDB releases based on MySQL 5.7)
<code>--ndb-nodeid=#</code>	Set node ID for this node, overriding any ID set by <code>--ndb-connectstring</code>	(Supported in all NDB releases based on MySQL 5.7)
<code>--ndb-optimized-node-selection</code>	Enable optimizations for selection of nodes for transactions. Enabled by default; use <code>--skip-ndb-optimized-node-selection</code> to disable	(Supported in all NDB releases based on MySQL 5.7)
<code>--no-contact,</code> <code>-n</code>	Wait for cluster to reach NO CONTACT state	(Supported in all NDB releases based on MySQL 5.7)
<code>--no-defaults</code>	Do not read default options from any option file other than login file	(Supported in all NDB releases based on MySQL 5.7)
<code>--not-started</code>	Wait for cluster to reach NOT STARTED state	(Supported in all NDB releases based on MySQL 5.7)
<code>--nowait-nodes=list</code>	List of nodes not to be waited for	(Supported in all NDB releases based on MySQL 5.7)
<code>--print-defaults</code>	Print program argument list and exit	(Supported in all NDB releases based on MySQL 5.7)
<code>--single-user</code>	Wait for cluster to enter single user mode	(Supported in all NDB releases based on MySQL 5.7)

Format	Description	Added, Deprecated, or Removed
<code>--timeout=#</code> , <code>-t #</code>	Wait this many seconds, then exit whether or not cluster has reached desired state	(Supported in all NDB releases based on MySQL 5.7)
<code>--usage</code> , <code>-?</code>	Display help text and exit; same as <code>--help</code>	(Supported in all NDB releases based on MySQL 5.7)
<code>--version</code> , <code>-V</code>	Display version information and exit	(Supported in all NDB releases based on MySQL 5.7)
<code>--wait-nodes=list</code> , <code>-w list</code>	List of nodes to be waited for	(Supported in all NDB releases based on MySQL 5.7)

Usage

```
ndb_waiter [-c connection_string]
```

Additional Options

- `--character-sets-dir`

Command-Line Format	<code>--character-sets-dir=path</code>
---------------------	--

Directory containing character sets.

- `--connect-retries`

Command-Line Format	<code>--connect-retries=#</code>
Type	Integer
Default Value	12
Minimum Value	0
Maximum Value	12

Number of times to retry connection before giving up.

- `--connect-retry-delay`

Command-Line Format	<code>--connect-retry-delay=#</code>
Type	Integer
Default Value	5
Minimum Value	0
Maximum Value	5

Number of seconds to wait between attempts to contact management server.

- `--connect-string`

Command-Line Format	<code>--connect-string=connection_string</code>
Type	String
Default Value	[none]

Same as `--ndb-connectstring`.

- `--core-file`

Command-Line Format	<code>--core-file</code>
---------------------	--------------------------

Write core file on error; used in debugging.

- `--defaults-extra-file`

Command-Line Format	<code>--defaults-extra-file=path</code>
Type	String
Default Value	[none]

Read given file after global files are read.

- `--defaults-file`

Command-Line Format	<code>--defaults-file=path</code>
Type	String
Default Value	[none]

Read default options from given file only.

- `--defaults-group-suffix`

Command-Line Format	<code>--defaults-group-suffix=string</code>
Type	String
Default Value	[none]

Also read groups with `concat(group, suffix)`.

- `--login-path`

Command-Line Format	<code>--login-path=path</code>
Type	String
Default Value	[none]

Read given path from login file.

- `--help`

Command-Line Format	<code>--help</code>
---------------------	---------------------

Display help text and exit.

- `--ndb-connectstring`

Command-Line Format	<code>--ndb-connectstring=connection_string</code>
Type	String
Default Value	[none]

Set connect string for connecting to `ndb_mgmd`. Syntax: "[nodeid=id;][host=]hostname[:port]". Overrides entries in `NDB_CONNECTSTRING` and `my.cnf`.

- `--ndb-mgmd-host`

Command-Line Format	<code>--ndb-mgmd-host=connection_string</code>
Type	String
Default Value	[none]

Same as `--ndb-connectstring`.

- `--ndb-nodeid`

Command-Line Format	<code>--ndb-nodeid=#</code>
Type	Integer
Default Value	[none]

Set node ID for this node, overriding any ID set by `--ndb-connectstring`.

- `--ndb-optimized-node-selection`

Command-Line Format	<code>--ndb-optimized-node-selection</code>
---------------------	---

Enable optimizations for selection of nodes for transactions. Enabled by default; use `--skip-ndb-optimized-node-selection` to disable.

- `--no-contact`, `-n`

Instead of waiting for the `STARTED` state, `ndb_waiter` continues running until the cluster reaches `NO_CONTACT` status before exiting.

- `--no-defaults`

Command-Line Format	<code>--no-defaults</code>
---------------------	----------------------------

Do not read default options from any option file other than login file.

- `--not-started`

Instead of waiting for the `STARTED` state, `ndb_waiter` continues running until the cluster reaches `NOT_STARTED` status before exiting.

- `--nowait-nodes=list`

When this option is used, `ndb_waiter` does not wait for the nodes whose IDs are listed. The list is comma-delimited; ranges can be indicated by dashes, as shown here:

```
$> ndb_waiter --nowait-nodes=1,3,7-9
```

Important

Do *not* use this option together with the `--wait-nodes` option.

- `--print-defaults`

Command-Line Format	<code>--print-defaults</code>
---------------------	-------------------------------

Print program argument list and exit.

- `--timeout=seconds`, `-t seconds`

Time to wait. The program exits if the desired state is not achieved within this number of seconds. The default is 120 seconds (1200 reporting cycles).

- `--single-user`

The program waits for the cluster to enter single user mode.

- `--usage`

Command-Line Format	<code>--usage</code>
---------------------	----------------------

Display help text and exit; same as `--help`.

- `--version`

Command-Line Format	<code>--version</code>
---------------------	------------------------

Display version information and exit.

- `--wait-nodes=list, -w list`

When this option is used, `ndb_waiter` waits only for the nodes whose IDs are listed. The list is comma-delimited; ranges can be indicated by dashes, as shown here:

```
$> ndb_waiter --wait-nodes=2,4-6,10
```

Important

Do *not* use this option together with the `--nowait-nodes` option.

Sample Output. Shown here is the output from `ndb_waiter` when run against a 4-node cluster in which two nodes have been shut down and then started again manually. Duplicate reports (indicated by `...`) are omitted.

```
$> ./ndb_waiter -c localhost

Connecting to mgmsrv at (localhost)
State node 1 STARTED
State node 2 NO_CONTACT
State node 3 STARTED
State node 4 NO_CONTACT
Waiting for cluster enter state STARTED

...

State node 1 STARTED
State node 2 UNKNOWN
State node 3 STARTED
State node 4 NO_CONTACT
Waiting for cluster enter state STARTED

...

State node 1 STARTED
State node 2 STARTING
State node 3 STARTED
State node 4 NO_CONTACT
Waiting for cluster enter state STARTED

...

State node 1 STARTED
State node 2 STARTING
State node 3 STARTED
State node 4 UNKNOWN
Waiting for cluster enter state STARTED

...

State node 1 STARTED
State node 2 STARTING
```



```
State node 3 STARTED
State node 4 STARTING
Waiting for cluster enter state STARTED

...

State node 1 STARTED
State node 2 STARTED
State node 3 STARTED
State node 4 STARTING
Waiting for cluster enter state STARTED

...

State node 1 STARTED
State node 2 STARTED
State node 3 STARTED
State node 4 STARTED
Waiting for cluster enter state STARTED
```

Note

If no connection string is specified, then `ndb_waiter` tries to connect to a management on `localhost`, and reports `Connecting to mgmsrv at (null)`.

Prior to NDB 7.5.18 and 7.6.14, this program printed `NDBT_ProgramExit - status` upon completion of its run, due to an unnecessary dependency on the NDBT testing library. This dependency is has now been removed, eliminating the extraneous output.

Chapter 6 Management of NDB Cluster

Table of Contents

6.1	Commands in the NDB Cluster Management Client	461
6.2	NDB Cluster Log Messages	466
6.2.1	NDB Cluster: Messages in the Cluster Log	466
6.2.2	NDB Cluster Log Startup Messages	482
6.2.3	Event Buffer Reporting in the Cluster Log	482
6.2.4	NDB Cluster: NDB Transporter Errors	484
6.3	Event Reports Generated in NDB Cluster	485
6.3.1	NDB Cluster Logging Management Commands	486
6.3.2	NDB Cluster Log Events	488
6.3.3	Using CLUSTERLOG STATISTICS in the NDB Cluster Management Client	494
6.4	Summary of NDB Cluster Start Phases	497
6.5	Performing a Rolling Restart of an NDB Cluster	498
6.6	NDB Cluster Single User Mode	500
6.7	Adding NDB Cluster Data Nodes Online	501
6.7.1	Adding NDB Cluster Data Nodes Online: General Issues	501
6.7.2	Adding NDB Cluster Data Nodes Online: Basic procedure	503
6.7.3	Adding NDB Cluster Data Nodes Online: Detailed Example	504
6.8	Online Backup of NDB Cluster	512
6.8.1	NDB Cluster Backup Concepts	512
6.8.2	Using The NDB Cluster Management Client to Create a Backup	512
6.8.3	Configuration for NDB Cluster Backups	515
6.8.4	NDB Cluster Backup Troubleshooting	516
6.9	MySQL Server Usage for NDB Cluster	516
6.10	NDB Cluster Disk Data Tables	517
6.10.1	NDB Cluster Disk Data Objects	518
6.10.2	Using Symbolic Links with Disk Data Objects	523
6.10.3	NDB Cluster Disk Data Storage Requirements	523
6.11	Online Operations with ALTER TABLE in NDB Cluster	523
6.12	Distributed Privileges Using Shared Grant Tables	526
6.13	NDB API Statistics Counters and Variables	529
6.14	ndbinfo: The NDB Cluster Information Database	540
6.14.1	The ndbinfo arbitrator_validity_detail Table	544
6.14.2	The ndbinfo arbitrator_validity_summary Table	545
6.14.3	The ndbinfo blocks Table	546
6.14.4	The ndbinfo cluster_locks Table	546
6.14.5	The ndbinfo cluster_operations Table	547
6.14.6	The ndbinfo cluster_transactions Table	549
6.14.7	The ndbinfo config_nodes Table	550
6.14.8	The ndbinfo config_params Table	551
6.14.9	The ndbinfo config_values Table	551
6.14.10	The ndbinfo counters Table	554
6.14.11	The ndbinfo cpustat Table	555
6.14.12	The ndbinfo cpustat_50ms Table	556
6.14.13	The ndbinfo cpustat_1sec Table	557
6.14.14	The ndbinfo cpustat_20sec Table	558
6.14.15	The ndbinfo dict_obj_info Table	559
6.14.16	The ndbinfo dict_obj_types Table	560
6.14.17	The ndbinfo disk_write_speed_base Table	560
6.14.18	The ndbinfo disk_write_speed_aggregate Table	561
6.14.19	The ndbinfo disk_write_speed_aggregate_node Table	562
6.14.20	The ndbinfo diskpagebuffer Table	562
6.14.21	The ndbinfo error_messages Table	564

6.14.22	The ndbinfo locks_per_fragment Table	565
6.14.23	The ndbinfo logbuffers Table	567
6.14.24	The ndbinfo logspaces Table	568
6.14.25	The ndbinfo membership Table	569
6.14.26	The ndbinfo memoryusage Table	571
6.14.27	The ndbinfo memory_per_fragment Table	572
6.14.28	The ndbinfo nodes Table	574
6.14.29	The ndbinfo operations_per_fragment Table	575
6.14.30	The ndbinfo processes Table	579
6.14.31	The ndbinfo resources Table	580
6.14.32	The ndbinfo restart_info Table	581
6.14.33	The ndbinfo server_locks Table	584
6.14.34	The ndbinfo server_operations Table	586
6.14.35	The ndbinfo server_transactions Table	587
6.14.36	The ndbinfo table_distribution_status Table	589
6.14.37	The ndbinfo table_fragments Table	590
6.14.38	The ndbinfo table_info Table	591
6.14.39	The ndbinfo table_replicas Table	592
6.14.40	The ndbinfo tc_time_track_stats Table	593
6.14.41	The ndbinfo threadblocks Table	594
6.14.42	The ndbinfo threads Table	595
6.14.43	The ndbinfo threadstat Table	596
6.14.44	The ndbinfo transporters Table	597
6.15	INFORMATION_SCHEMA Tables for NDB Cluster	599
6.16	Quick Reference: NDB Cluster SQL Statements	600
6.17	NDB Cluster Security Issues	608
6.17.1	NDB Cluster Security and Networking Issues	608
6.17.2	NDB Cluster and MySQL Privileges	612
6.17.3	NDB Cluster and MySQL Security Procedures	613

Managing an NDB Cluster involves a number of tasks, the first of which is to configure and start NDB Cluster. This is covered in [Chapter 4, Configuration of NDB Cluster](#), and [Chapter 5, NDB Cluster Programs](#).

The next few sections cover the management of a running NDB Cluster.

For information about security issues relating to management and deployment of an NDB Cluster, see [Section 6.17, “NDB Cluster Security Issues”](#).

There are essentially two methods of actively managing a running NDB Cluster. The first of these is through the use of commands entered into the management client whereby cluster status can be checked, log levels changed, backups started and stopped, and nodes stopped and started. The second method involves studying the contents of the cluster log `ndb_node_id_cluster.log`; this is usually found in the management server's `DataDir` directory, but this location can be overridden using the `LogDestination` option. (Recall that `node_id` represents the unique identifier of the node whose activity is being logged.) The cluster log contains event reports generated by `ndbd`. It is also possible to send cluster log entries to a Unix system log.

Some aspects of the cluster's operation can be also be monitored from an SQL node using the `SHOW ENGINE NDB STATUS` statement.

More detailed information about NDB Cluster operations is available in real time through an SQL interface using the `ndbinfo` database. For more information, see [Section 6.14, “ndbinfo: The NDB Cluster Information Database”](#).

NDB statistics counters provide improved monitoring using the `mysql` client. These counters, implemented in the NDB kernel, relate to operations performed by or affecting `Ndb` objects, such as starting, closing, and aborting transactions; primary key and unique key operations; table, range, and pruned scans; blocked threads waiting for various operations to complete; and data and events sent

and received by NDB Cluster. The counters are incremented by the NDB kernel whenever NDB API calls are made or data is sent to or received by the data nodes.

`mysqld` exposes the NDB API statistics counters as system status variables, which can be identified from the prefix common to all of their names (`Ndb_api_`). The values of these variables can be read in the `mysql` client from the output of a `SHOW STATUS` statement, or by querying either the `SESSION_STATUS` table or the `GLOBAL_STATUS` table (in the `INFORMATION_SCHEMA` database). By comparing the values of the status variables before and after the execution of an SQL statement that acts on NDB tables, you can observe the actions taken on the NDB API level that correspond to this statement, which can be beneficial for monitoring and performance tuning of NDB Cluster.

MySQL Cluster Manager provides an advanced command-line interface that simplifies many otherwise complex NDB Cluster management tasks, such as starting, stopping, or restarting an NDB Cluster with a large number of nodes. The MySQL Cluster Manager client also supports commands for getting and setting the values of most node configuration parameters as well as `mysqld` server options and variables relating to NDB Cluster. See [MySQL Cluster Manager 1.4.8 User Manual](#), for more information.

6.1 Commands in the NDB Cluster Management Client

In addition to the central configuration file, a cluster may also be controlled through a command-line interface available through the management client `ndb_mgm`. This is the primary administrative interface to a running cluster.

Commands for the event logs are given in [Section 6.3, “Event Reports Generated in NDB Cluster”](#); commands for creating backups and restoring from them are provided in [Section 6.8, “Online Backup of NDB Cluster”](#).

Using `ndb_mgm` with MySQL Cluster Manager. MySQL Cluster Manager handles starting and stopping processes and tracks their states internally, so it is not necessary to use `ndb_mgm` for these tasks for an NDB Cluster that is under MySQL Cluster Manager control. It is recommended *not* to use the `ndb_mgm` command-line client that comes with the NDB Cluster distribution to perform operations that involve starting or stopping nodes. These include but are not limited to the `START`, `STOP`, `RESTART`, and `SHUTDOWN` commands. For more information, see [MySQL Cluster Manager Process Commands](#).

The management client has the following basic commands. In the listing that follows, `node_id` denotes either a data node ID or the keyword `ALL`, which indicates that the command should be applied to all of the cluster’s data nodes.

- `CONNECT connection-string`

Connects to the management server indicated by the connection string. If the client is already connected to this server, the client reconnects.

- `CREATE NODEGROUP nodeid[, nodeid, ...]`

Creates a new NDB Cluster node group and causes data nodes to join it.

This command is used after adding new data nodes online to an NDB Cluster, and causes them to join a new node group and thus to begin participating fully in the cluster. The command takes as its sole parameter a comma-separated list of node IDs—these are the IDs of the nodes just added and started, and that are to join the new node group. The list must contain no duplicate IDs; beginning with NDB 7.5.23 and NDB 7.6.19, the presence of any duplicates causes the command to return an error. The number of nodes in the list must be the same as the number of nodes in each node group that is already part of the cluster (each NDB Cluster node group must have the same number of nodes). In other words, if the NDB Cluster consists of 2 node groups having 2 data nodes each, then the new node group must also have 2 data nodes.

The node group ID of the new node group created by this command is determined automatically, and always the next highest unused node group ID in the cluster; it is not possible to set it manually.

For more information, see [Section 6.7, “Adding NDB Cluster Data Nodes Online”](#).

- `DROP NODEGROUP nodegroup_id`

Drops the NDB Cluster node group with the given *nodegroup_id*.

This command can be used to drop a node group from an NDB Cluster. `DROP NODEGROUP` takes as its sole argument the node group ID of the node group to be dropped.

`DROP NODEGROUP` acts only to remove the data nodes in the effected node group from that node group. It does not stop data nodes, assign them to a different node group, or remove them from the cluster's configuration. A data node that does not belong to a node group is indicated in the output of the management client `SHOW` command with `no nodegroup` in place of the node group ID, like this (indicated using bold text):

```
id=3      @10.100.2.67  (5.7.36-ndb-7.5.25, no nodegroup)
```

`DROP NODEGROUP` works only when all data nodes in the node group to be dropped are completely empty of any table data and table definitions. Since there is currently no way using `ndb_mgm` or the `mysql` client to remove all data from a specific data node or node group, this means that the command succeeds only in the two following cases:

1. After issuing `CREATE NODEGROUP` in the `ndb_mgm` client, but before issuing any `ALTER TABLE ... REORGANIZE PARTITION` statements in the `mysql` client.
2. After dropping all `NDBCLUSTER` tables using `DROP TABLE`.

`TRUNCATE TABLE` does not work for this purpose because this removes only the table data; the data nodes continue to store an `NDBCLUSTER` table's definition until a `DROP TABLE` statement is issued that causes the table metadata to be dropped.

For more information about `DROP NODEGROUP`, see [Section 6.7, “Adding NDB Cluster Data Nodes Online”](#).

- `ENTER SINGLE USER MODE node_id`

Enters single user mode, whereby only the MySQL server identified by the node ID *node_id* is permitted to access the database.

- `EXIT SINGLE USER MODE`

Exits single user mode, enabling all SQL nodes (that is, all running `mysqld` processes) to access the database.

Note

It is possible to use `EXIT SINGLE USER MODE` even when not in single user mode, although the command has no effect in this case.

- `HELP`

Displays information on all available commands.

- `node_id NODELOG DEBUG {ON|OFF}`

Toggles debug logging in the node log, as though the effected data node or nodes had been started with the `--verbose` option. `NODELOG DEBUG ON` starts debug logging; `NODELOG DEBUG OFF` switches debug logging off.

This command was added in NDB 7.6.

- `PROMPT [prompt]`

Changes the prompt shown by `ndb_mgm` to the string literal `prompt`.

`prompt` should not be quoted (unless you want the prompt to include the quotation marks). Unlike the case with the `mysql` client, special character sequences and escapes are not recognized. If called without an argument, the command resets the prompt to the default value (`ndb_mgm>`).

Some examples are shown here:

```
ndb_mgm> PROMPT mgm#1:
mgm#1: SHOW
Cluster Configuration
...
mgm#1: PROMPT mymgm >
mymgm > PROMPT 'mymgm: '
'mymgm: ' PROMPT mymgm:
mymgm: PROMPT
ndb_mgm> EXIT
$>
```

Note that leading spaces and spaces within the `prompt` string are not trimmed. Trailing spaces are removed.

The `PROMPT` command was added in NDB 7.5.0.

- `QUIT, EXIT`

Terminates the management client.

This command does not affect any nodes connected to the cluster.

- `node_id REPORT report-type`

Displays a report of type `report-type` for the data node identified by `node_id`, or for all data nodes using `ALL`.

Currently, there are three accepted values for `report-type`:

- `BackupStatus` provides a status report on a cluster backup in progress
- `MemoryUsage` displays how much data memory and index memory is being used by each data node as shown in this example:

```
ndb_mgm> ALL REPORT MEMORY

Node 1: Data usage is 5%(177 32K pages of total 3200)
Node 1: Index usage is 0%(108 8K pages of total 12832)
Node 2: Data usage is 5%(177 32K pages of total 3200)
Node 2: Index usage is 0%(108 8K pages of total 12832)
```

This information is also available from the `ndbinfo.memoryusage` table.

- `EventLog` reports events from the event log buffers of one or more data nodes.

`report-type` is case-insensitive and “fuzzy”; for `MemoryUsage`, you can use `MEMORY` (as shown in the prior example), `memory`, or even simply `MEM` (or `mem`). You can abbreviate `BackupStatus` in a similar fashion.

- `node_id RESTART [-n] [-i] [-a] [-f]`

Restarts the data node identified by `node_id` (or all data nodes).

Using the `-i` option with `RESTART` causes the data node to perform an initial restart; that is, the node's file system is deleted and recreated. The effect is the same as that obtained from stopping the data node process and then starting it again using `ndbd --initial` from the system shell.

Note

Backup files and Disk Data files are not removed when this option is used.

Using the `-n` option causes the data node process to be restarted, but the data node is not actually brought online until the appropriate `START` command is issued. The effect of this option is the same as that obtained from stopping the data node and then starting it again using `ndbd --nostart` or `ndbd -n` from the system shell.

Using the `-a` causes all current transactions relying on this node to be aborted. No GCP check is done when the node rejoins the cluster.

Normally, `RESTART` fails if taking the node offline would result in an incomplete cluster. The `-f` option forces the node to restart without checking for this. If this option is used and the result is an incomplete cluster, the entire cluster is restarted.

- `SHOW`

Displays basic information about the cluster and cluster nodes. For all nodes, the output includes the node's ID, type, and NDB software version. If the node is connected, its IP address is also shown; otherwise the output shows `not connected`, `accepting connect from ip_address`, with `any host` used for nodes that are permitted to connect from any address.

In addition, for data nodes, the output includes `starting` if the node has not yet started, and shows the node group of which the node is a member. If the data node is acting as the master node, this is indicated with an asterisk (*).

Consider a cluster whose configuration file includes the information shown here (possible additional settings are omitted for clarity):

```
[ndbd default]
DataMemory= 128G
NoOfReplicas= 2

[ndb_mgmd]
NodeId=50
HostName=198.51.100.150

[ndbd]
NodeId=5
HostName=198.51.100.10
DataDir=/var/lib/mysql-cluster

[ndbd]
NodeId=6
HostName=198.51.100.20
DataDir=/var/lib/mysql-cluster

[ndbd]
NodeId=7
HostName=198.51.100.30
DataDir=/var/lib/mysql-cluster

[ndbd]
NodeId=8
HostName=198.51.100.40
DataDir=/var/lib/mysql-cluster

[mysqld]
NodeId=100
HostName=198.51.100.100

[api]
```

NodeId=101

After this cluster (including one SQL node) has been started, `SHOW` displays the following output:

```
ndb_mgm> SHOW
Connected to Management Server at: localhost:1186
Cluster Configuration
-----
[ndbd(NDB)] 4 node(s)
id=5 @198.51.100.10 (5.7.36-ndb-7.6.21, Nodegroup: 0, *)
id=6 @198.51.100.20 (5.7.36-ndb-7.6.21, Nodegroup: 0)
id=7 @198.51.100.30 (5.7.36-ndb-7.6.21, Nodegroup: 1)
id=8 @198.51.100.40 (5.7.36-ndb-7.6.21, Nodegroup: 1)

[ndb_mgmd(MGM)] 1 node(s)
id=50 @198.51.100.150 (5.7.36-ndb-7.6.21)

[mysqld(API)] 2 node(s)
id=100 @198.51.100.100 (5.7.36-ndb-7.6.21)
id=101 (not connected, accepting connect from any host)
```

The output from this command also indicates when the cluster is in single user mode (see the description of the `ENTER SINGLE USER MODE` command, as well as [Section 6.6, “NDB Cluster Single User Mode”](#)).

- `SHUTDOWN`

Shuts down all cluster data nodes and management nodes. To exit the management client after this has been done, use `EXIT` or `QUIT`.

This command does *not* shut down any SQL nodes or API nodes that are connected to the cluster.

- `node_id STATUS`

Displays status information for the data node identified by `node_id` (or for all data nodes).

Possible node status values include `UNKNOWN`, `NO_CONTACT`, `NOT_STARTED`, `STARTING`, `STARTED`, `SHUTTING_DOWN`, and `RESTARTING`.

The output from this command also indicates when the cluster is in single user mode (status `SINGLE USER MODE`).

- `node_id START`

Brings online the data node identified by `node_id` (or all data nodes).

`ALL START` works on all data nodes only, and does not affect management nodes.

Important

To use this command to bring a data node online, the data node must have been started using `--nostart` or `-n`.

- `node_id STOP [-a] [-f]`

Stops the data or management node identified by `node_id`.

Note

`ALL STOP` works to stop all data nodes only, and does not affect management nodes.

A node affected by this command disconnects from the cluster, and its associated `ndbd` or `ndb_mgmd` process terminates.

The `-a` option causes the node to be stopped immediately, without waiting for the completion of any pending transactions.

Normally, `STOP` fails if the result would cause an incomplete cluster. The `-f` option forces the node to shut down without checking for this. If this option is used and the result is an incomplete cluster, the cluster immediately shuts down.

Warning

Use of the `-a` option also disables the safety check otherwise performed when `STOP` is invoked to insure that stopping the node does not cause an incomplete cluster. In other words, you should exercise extreme care when using the `-a` option with the `STOP` command, due to the fact that this option makes it possible for the cluster to undergo a forced shutdown because it no longer has a complete copy of all data stored in `NDB`.

Additional commands. A number of other commands available in the `ndb_mgm` client are described elsewhere, as shown in the following list:

- `START BACKUP` is used to perform an online backup in the `ndb_mgm` client; the `ABORT BACKUP` command is used to cancel a backup already in progress. For more information, see [Section 6.8, “Online Backup of NDB Cluster”](#).
- The `CLUSTERLOG` command is used to perform various logging functions. See [Section 6.3, “Event Reports Generated in NDB Cluster”](#), for more information and examples. NDB 7.6 adds `NODELOG DEBUG` to activate or deactivate debug printouts in node logs, as described previously in this section.
- For testing and diagnostics work, the client supports a `DUMP` command which can be used to execute internal commands on the cluster. It should never be used in a production setting unless directed to do so by MySQL Support. For more information, see [NDB Cluster Management Client DUMP Commands](#).

6.2 NDB Cluster Log Messages

This section contains information about the messages written to the cluster log in response to different cluster log events. It provides additional, more specific information on `NDB` transporter errors.

6.2.1 NDB Cluster: Messages in the Cluster Log

The following table lists the most common `NDB` cluster log messages. For information about the cluster log, log events, and event types, see [Section 6.3, “Event Reports Generated in NDB Cluster”](#). These log messages also correspond to log event types in the MGM API; see [The Ndb_logevent_type Type](#), for related information of interest to Cluster API developers.

Table 6.1 Common NDB cluster log messages

Log Message	Description	Event Name	Event Type	Priority	Severity
<code>Node mgm_node_id:</code>	The data node having node	<code>Connected</code>	<code>Connection</code>	8	<code>INFO</code>

Log Message	Description	Event Name	Event Type	Priority	Severity
Node <i>data_node_id</i> Connected	ID <i>node_id</i> has connected to the management server (node <i>mgm_node_id</i>).				
Node <i>mgm_node_id</i> : Node <i>data_node_id</i> Disconnected	The data node having node ID <i>data_node_id</i> has disconnected from the management server (node <i>mgm_node_id</i>).	Disconnected	Connection	8	ALERT
Node <i>data_node_id</i> : Communication to Node <i>api_node_id</i> closed	The API node or SQL node having node ID <i>api_node_id</i> is no longer communicating with data node <i>data_node_id</i> .	Communication Closed	Connection	8	INFO
Node <i>data_node_id</i> : Communication to Node <i>api_node_id</i> opened	The API node or SQL node having node ID <i>api_node_id</i> is now communicating with data node <i>data_node_id</i> .	Communication Opened	Connection	8	INFO
Node <i>mgm_node_id</i> : Node <i>api_node_id</i> : API <i>version</i>	The API node having node ID <i>api_node_id</i> has connected to management node <i>mgm_node_id</i> using NDB API version <i>version</i> (generally the same as the MySQL version number).	Connected	API Connection	8	INFO
Node <i>node_id</i> : Global checkpoint <i>gci</i> started	A global checkpoint with the ID <i>gci</i> has been started; node <i>node_id</i> is the master responsible for this global checkpoint.	GlobalCheckpoint Started	Checkpoint	9	INFO

NDB Cluster: Messages in the Cluster Log

Log Message	Description	Event Name	Event Type	Priority	Severity
Node <i>node_id</i> : Global checkpoint <i>gci</i> completed	The global checkpoint having the ID <i>gci</i> has been completed; node <i>node_id</i> was the master responsible for this global checkpoint.	GlobalCheckpointCompleted	GlobalCheckpointCompleted	10	INFO
Node <i>node_id</i> : Local checkpoint <i>lcp</i> started. Keep GCI = <i>current_gci</i> oldest restorable GCI = <i>old_gci</i>	The local checkpoint having sequence ID <i>lcp</i> has been started on node <i>node_id</i> . The most recent GCI that can be used has the index <i>current_gci</i> , and the oldest GCI from which the cluster can be restored has the index <i>old_gci</i> .	LocalCheckpointStarted	LocalCheckpointStarted	7	INFO
Node <i>node_id</i> : Local checkpoint <i>lcp</i> completed	The local checkpoint having sequence ID <i>lcp</i> on node <i>node_id</i> has been completed.	LocalCheckpointCompleted	LocalCheckpointCompleted	8	INFO
Node <i>node_id</i> : Local Checkpoint stopped in CALCULATED_KEEP_GCI	The node was unable to determine the most recent usable GCI.	LCPStoppedInCalculatedGCI	LCPStoppedInCalculatedGCI	0	ALERT
Node <i>node_id</i> : Table ID = <i>table_id</i> , fragment ID = <i>fragment_id</i> has completed LCP on Node <i>node_id</i> maxGciStarted = <i>started_gci</i>	A table fragment has been checkpointed to disk on node <i>node_id</i> . The GCI in progress has the index <i>started_gci</i> , and the most recent GCI to have been completed	LCPFragmentCompleted	LCPFragmentCompleted	11	INFO

Log Message	Description	Event Name	Event Type	Priority	Severity
maxGciCompleted <i>completed_gci</i>	has the index <i>completed_gci</i> .				
Node <i>node_id</i> : ACC Blocked <i>num_1</i> and TUP Blocked <i>num_2</i> times last second	Undo logging is blocked because the log buffer is close to overflowing.	UndoLogBlocked	Checkpoint	7	INFO
Node <i>node_id</i> : Start initiated <i>version</i>	Data node <i>node_id</i> , running NDB version <i>version</i> , is beginning its startup process.	NDBStartStart	Startup	1	INFO
Node <i>node_id</i> : Started <i>version</i>	Data node <i>node_id</i> , running NDB version <i>version</i> , has started successfully.	NDBStartComplete	Startup	1	INFO
Node <i>node_id</i> : STTORRY received after restart finished	The node has received a signal indicating that a cluster restart has completed.	STTORRYReceived	Startup	15	INFO
Node <i>node_id</i> : Start phase <i>phase</i> completed (<i>type</i>)	The node has completed start phase <i>phase</i> of a <i>type</i> start. For a listing of start phases, see Section 6.4 , “Summary of NDB Cluster Start Phases”. (<i>type</i> is one of <i>initial</i> , <i>system</i> , <i>node</i> , <i>initial</i> <i>node</i> , or <Unknown>.)	StartPhaseComplete	Startup	4	INFO
Node <i>node_id</i> : CM_REGCONF president = <i>president_id</i> , own Node = <i>own_id</i> , our dynamic	Node <i>president_id</i> has been selected as “president”. <i>own_id</i> and <i>dynamic_id</i> should always	CM_REGCONF	Startup	3	INFO

NDB Cluster: Messages in the Cluster Log

Log Message	Description	Event Name	Event Type	Priority	Severity
<code>id = dynamic_id</code>	be the same as the ID (<code>node_id</code>) of the reporting node.				
<code>Node node_id: CM_REGREF from Node president_id to our Node node_id. Cause = cause</code>	The reporting node (ID <code>node_id</code>) was unable to accept node <code>president_id</code> as president. The <i>cause</i> of the problem is given as one of <code>Busy</code> , <code>Election with wait = false</code> , <code>Not president</code> , <code>Election without selecting new candidate</code> , or <code>No such cause</code> .	CM_REGREF	StartUp	8	INFO
<code>Node node_id: We are Node own_id with dynamic ID dynamic_id, our left neighbor is Node id_1, our right is Node id_2</code>	The node has discovered its neighboring nodes in the cluster (node <code>id_1</code> and node <code>id_2</code>). <code>node_id</code> , <code>own_id</code> , and <code>dynamic_id</code> should always be the same; if they are not, this indicates a serious misconfiguration of the cluster nodes.	FIND_NEIGHBOURS	StartUp	8	INFO
<code>Node node_id: type shutdown initiated</code>	The node has received a shutdown signal. The <i>type</i> of shutdown is either <code>Cluster</code> or <code>Node</code> .	NDBStopStarted	StartUp	1	INFO
<code>Node node_id:</code>	The node has been	NDBStopCompleted	StartUp	1	INFO

Log Message	Description	Event Name	Event Type	Priority	Severity
Node shutdown completed [, <i>action</i>] [Initiated by signal <i>signal</i> .]	shut down. This report may include an <i>action</i> , which if present is one of <i>restarting</i> , <i>no start</i> , or <i>initial</i> . The report may also include a reference to an NDB Protocol <i>signal</i> ; for possible signals, refer to Operations and Signals .				
Node <i>node_id</i> : Forced node shutdown completed [, <i>action</i>]. [Occurred during startphase <i>start_phase</i> .] [Initiated by <i>signal</i> .] [Caused by error <i>error_code</i> : ' <i>error_message</i> ' (report <i>classification</i>).] [<i>error_status</i> : ' <i>error_status</i> ' (extra info: [<i>extra_info</i>], <i>extra_code</i>)]	The node has been forcibly shut down. The <i>action</i> (one of <i>restarting</i> , <i>no start</i> , or <i>initial</i>) subsequently being taken, if any, is also reported. If the shutdown occurred while the node was starting, the report includes the <i>start_phase</i> during which the node failed. If this was a result of a <i>signal</i> sent to the node, this information is also provided (see Operations and Signals , for more information). If the error causing the failure is known, this is also included; for more information about NDB error	NDBStopForced	StartUp	1	ALERT

Log Message	Description	Event Name	Event Type	Priority	Severity
	messages and classifications, see NDB Cluster API Errors .				
Node <i>node_id</i> : Node shutdown aborted	The node shutdown process was aborted by the user.	NDBStopAborted	StartUp	1	INFO
Node <i>node_id</i> : StartLog: [GCI Keep: <i>keep_pos</i> LastCompleted <i>last_pos</i> NewestRestorable <i>restore_pos</i>]	This reports global checkpoints referenced during a node start. The redo log prior to <i>keep_pos</i> is dropped. <i>last_pos</i> is the last global checkpoint in which data node the participated; <i>restore_pos</i> is the global checkpoint which is actually used to restore all data nodes.	StartREDOLog	StartUp	4	INFO
<i>startup_message</i> [Listed separately; see below.]	There are a number of possible startup messages that can be logged under different circumstances. These are listed separately; see Section 6.2.2, "NDB Cluster Log Startup Messages" .	StartReport	StartUp	4	INFO
Node <i>node_id</i> : Node restart completed copy of dictionary information	Copying of data dictionary information to the restarted node has been completed.	NR_CopyDict	NodeRestart	8	INFO

Log Message	Description	Event Name	Event Type	Priority	Severity
Node <i>node_id</i> : Node restart completed copy of distribution information	Copying of data distribution information to the restarted node has been completed.	NR_CopyDistr	NodeRestart	8	INFO
Node <i>node_id</i> : Node restart starting to copy the fragments to Node <i>node_id</i>	Copy of fragments to starting data node <i>node_id</i> has begun	NR_CopyFragStart	NodeRestart	8	INFO
Node <i>node_id</i> : Table ID = <i>table_id</i> , fragment ID = <i>fragment_id</i> have been copied to Node <i>node_id</i>	Fragment <i>fragment_id</i> from table <i>table_id</i> has been copied to data node <i>node_id</i>	NR_CopyFragDone	NodeRestart	10	INFO
Node <i>node_id</i> : Node restart completed copying the fragments to Node <i>node_id</i>	Copying of all table fragments to restarting data node <i>node_id</i> has been completed	NR_CopyFragComplete	NodeRestart	8	INFO
Node <i>node_id</i> : Node <i>node1_id</i> completed failure of Node <i>node2_id</i>	Data node <i>node1_id</i> has detected the failure of data node <i>node2_id</i>	NodeFailComplete	NodeRestart	8	ALERT
All nodes completed failure of Node <i>node_id</i>	All (remaining) data nodes have detected the failure of data node <i>node_id</i>	NodeFailComplete	NodeRestart	8	ALERT
Node failure of	The failure of data node <i>node_id</i>	NodeFailComplete	NodeRestart	8	ALERT

Log Message	Description	Event Name	Event Type	Priority	Severity
<code>node_idblock</code> <code>completed</code>	has been detected in the <code>blockNDB</code> kernel block, where <code>block</code> is 1 of <code>DBTC</code> , <code>DBDICT</code> , <code>DBDIH</code> , or <code>DBLQH</code> ; for more information, see NDB Kernel Blocks				
<code>Node</code> <code>mgm_node_id:</code> <code>Node</code> <code>data_node_id</code> <code>has failed.</code> <code>The Node</code> <code>state at</code> <code>failure was</code> <code>state_code</code>	A data node has failed. Its state at the time of failure is described by an arbitration state code <code>state_code</code> : possible state code values can be found in the file <code>include/kernel/signaldata/ArbitSignalData.hpp</code> .	<code>NODE_FAILREP</code>	<code>NodeRestart</code>	8	ALERT
<code>President</code> <code>restarts</code> <code>arbitration</code> <code>thread</code> <code>[state=state_code</code> <code>or Prepare</code> <code>arbitrator</code> <code>node</code> <code>node_id</code> <code>[ticket=ticket_id</code> <code>or Receive</code> <code>arbitrator</code> <code>node</code> <code>node_id</code> <code>[ticket=ticket_id</code> <code>or Started</code> <code>arbitrator</code> <code>node</code> <code>node_id</code> <code>[ticket=ticket_id</code> <code>or Lost</code> <code>arbitrator</code> <code>node</code> <code>node_id</code> <code>- process</code> <code>failure</code> <code>[state=state_code</code>	This is a report on the current state and progress of arbitration in the cluster. <code>node_id</code> is the node ID of the management node or SQL node selected as the arbitrator. <code>state_code</code> is an arbitration state code, as found in <code>include/kernel/signaldata/ArbitSignalData.hpp</code> . When an error has occurred, an <code>error_message</code> , also defined in <code>ArbitSignalData.hpp</code> ,	<code>ArbitState</code>	<code>NodeRestart</code>	6	INFO

Log Message	Description	Event Name	Event Type	Priority	Severity
or Lost arbitrator node <i>node_id</i> - process exit [state= <i>state</i>] or Lost arbitrator node <i>node_id</i> - <i>error_message</i> [state= <i>state</i>]	is provided. <i>ticket_id</i> is a unique identifier handed out by the arbitrator when it is selected to all the nodes that participated in its selection; this is used to ensure that each node requesting arbitration was one of the nodes that took part in the selection process.				
Arbitration check lost - less than 1/2 nodes left or Arbitration check won - all node groups and more than 1/2 nodes left or Arbitration check won - node group majority or Arbitration check lost - missing node group or Network partitioning - arbitration required or Arbitration won - positive reply from node <i>node_id</i> or Arbitration lost - negative reply	This message reports on the result of arbitration. In the event of arbitration failure, an <i>error_message</i> and an arbitration <i>state_code</i> are provided; definitions for both of these are found in <code>include/kernel/signaldata/ArbitSignalData.hpp</code> .	ArbitResult	NodeRestart	2	ALERT

Log Message	Description	Event Name	Event Type	Priority	Severity
from node <i>node_id</i> Or Network partitioning - no arbitrator available Or Network partitioning - no arbitrator configured or Arbitration failure - <i>error_message</i> [<i>state=state_code</i>]					
Node <i>node_id</i> : GCP Take over started	This node is attempting to assume responsibility for the next global checkpoint (that is, it is becoming the master node)	GCP_Takeover	NodeRestart	7	INFO
Node <i>node_id</i> : GCP Take over completed	This node has become the master, and has assumed responsibility for the next global checkpoint	GCP_Takeover	NodeRestart	7	INFO
Node <i>node_id</i> : LCP Take over started	This node is attempting to assume responsibility for the next set of local checkpoints (that is, it is becoming the master node)	LCP_Takeover	NodeRestart	7	INFO
Node <i>node_id</i> : LCP Take over completed	This node has become the master, and has assumed responsibility for the next set of local checkpoints	LCP_Takeover	NodeRestart	7	INFO
Node <i>node_id</i> :	This report of transaction	TransReport	Statistic	8	INFO

Log Message	Description	Event Name	Event Type	Priority	Severity
Trans. Count = <i>transactions</i> , Commit Count = <i>commits</i> , Read Count = <i>reads</i> , Simple Read Count = <i>simple_reads</i> , Write Count = <i>writes</i> , AttrInfo Count = <i>AttrInfo_objects</i> , Concurrent Operations = <i>concurrent_operations</i> , Abort Count = <i>aborts</i> , Scans = <i>scans</i> , Range scans = <i>range_scans</i>	activity is given approximately once every 10 seconds				
Node <i>node_id</i> : Operations= <i>operations</i>	Number of operations performed by this node, provided approximately once every 10 seconds	OperationReportStatistics	Statistic	8	INFO
Node <i>node_id</i> : Table with ID = <i>table_id</i> created	A table having the table ID shown has been created	TableCreated	Statistic	7	INFO
Node <i>node_id</i> : Mean loop Counter in doJob last 8192 times = <i>count</i>		JobStatistic	Statistic	9	INFO
Mean send size to Node = <i>node_id</i> last 4096 sends = <i>bytes</i> bytes	This node is sending an average of <i>bytes</i> bytes per send to node <i>node_id</i>	SendBytesStatistic	Statistic	9	INFO

NDB Cluster: Messages in the Cluster Log

Log Message	Description	Event Name	Event Type	Priority	Severity
Mean receive size to Node = node_id last 4096 sends = bytes bytes	This node is receiving an average of <i>bytes</i> of data each time it receives data from node <i>node_id</i>	ReceiveBytesStatistic	Statistic	9	INFO
Node node_id: Data usage is data_memory_percentage% (data_pages_used 32K pages of total data_pages_total) /Node node_id: Index usage is index_memory_percentage% (index_pages_used 8K pages of total index_pages_total)	This report is generated when a DUMP 1000 command is issued in the cluster management client	MemoryUsage	Statistic	5	INFO
Node node1_id: Transporter to node node2_id reported error error_code: error_message	A transporter error occurred while communicating with node <i>node2_id</i> ; for a listing of transporter error codes and messages, see NDB Transporter Errors , in MySQL NDB Cluster Internals Manual	TransporterError	Error	2	ERROR
Node node1_id: Transporter to node node2_id reported error error_code: error_message	A warning of a potential transporter problem while communicating with node <i>node2_id</i> ; for a listing of transporter error codes and messages, see NDB	TransporterWarning	Warning	8	WARNING

Log Message	Description	Event Name	Event Type	Priority	Severity
	Transporter Errors , for more information				
Node <code>node1_id</code> : Node <code>node2_id</code> missed heartbeat <code>heartbeat_id</code>	This node missed a heartbeat from node <code>node2_id</code>	<code>MissedHeartbeat</code>	<code>Error</code>	8	WARNING
Node <code>node1_id</code> : Node <code>node2_id</code> declared dead due to missed heartbeat	This node has missed at least 3 heartbeats from node <code>node2_id</code> , and so has declared that node "dead"	<code>DeadDueToHeartbeat</code>	<code>Error</code>	8	ALERT
Node <code>node1_id</code> : Node Sent Heartbeat to node = <code>node2_id</code>	This node has sent a heartbeat to node <code>node2_id</code>	<code>SentHeartbeat</code>	<code>Info</code>	12	INFO
(NDB 7.5.0 and earlier.) Node <code>node_id</code> : Event buffer status: <code>used=bytes_used</code> (<code>percent_used</code>) <code>alloc=bytes_allocated</code> (<code>percent_available</code>) <code>max=bytes_available</code> <code>apply_epoch=latest_epoch</code> <code>latest_epoch=latest_epoch</code>	This report is seen during heavy event buffer usage, for example, when many updates are being applied in a relatively short period of time; the report shows the number of bytes and the percentage of event buffer memory used, the bytes allocated and percentage still available, and the latest and latest restorable epochs	<code>EventBufferStatus</code>	<code>Info</code>	7	INFO
(NDB 7.5.1 and later.) Node <code>node_id</code> : Event buffer status	This report is seen during heavy event buffer usage, for example, when many	<code>EventBufferStatus2</code>	<code>Info</code>	7	INFO

Log Message	Description	Event Name	Event Type	Priority	Severity
<pre>(object_id): updates are used=bytes_used being applied (percent_used) in a relatively of alloc) short period alloc=bytes_allocated of time; the max=bytes_available report shows latest_consumed_epoch the number of latest_consumed_epoch latest_buffered_epoch bytes and the latest_buffered_epoch report_reason percentage of</pre>	<p>event buffer memory used, the bytes allocated and percentage still available, and the latest buffered and consumed epochs; for more information, see Section 6.2.3, "Event Buffer Reporting in the Cluster Log"</p>				
<pre>Node node_id: Entering single user mode, Node node_id: Entered single user mode Node API_node_id has exclusive access, Node node_id: Entering single user mode</pre>	<p>These reports are written to the cluster log when entering and exiting single user mode; <i>API_node_id</i> is the node ID of the API or SQL having exclusive access to the cluster (for more information, see Section 6.6, "NDB Cluster Single User Mode"); the message <code>Unknown single user report</code> <i>API_node_id</i> indicates an error has taken place and should never be seen in normal operation</p>	SingleUser	Info	7	INFO

Log Message	Description	Event Name	Event Type	Priority	Severity
Node <i>node_id</i> : Backup <i>backup_id</i> started from node <i>mgm_node_id</i>	A backup has been started using the management node having <i>mgm_node_id</i> ; this message is also displayed in the cluster management client when the <code>START BACKUP</code> command is issued; for more information, see Section 6.8.2, “Using The NDB Cluster Management Client to Create a Backup”	BackupStarted	Backup	7	INFO
Node <i>node_id</i> : Backup <i>backup_id</i> started from node <i>mgm_node_id</i> completed. StartGCP: <i>start_gcp</i> StopGCP: <i>stop_gcp</i> #Records: <i>records</i> #LogRecords: <i>log_records</i> Data: <i>data_bytes</i> bytes Log: <i>log_bytes</i> bytes	The backup having the ID <i>backup_id</i> has been completed; for more information, see Section 6.8.2, “Using The NDB Cluster Management Client to Create a Backup”	BackupCompleted	Backup	7	INFO
Node <i>node_id</i> : Backup request from <i>mgm_node_id</i> failed to start. Error: <i>error_code</i>	The backup failed to start; for error codes, see MGM API Errors	BackupFailed	Backup	7	ALERT
Node <i>node_id</i> :	The backup was terminated	BackupAborted	Backup	7	ALERT

Log Message	Description	Event Name	Event Type	Priority	Severity
Backup <i>backup_id</i> started from <i>mgm_node_id</i> has been aborted. Error: <i>error_code</i>	after starting, possibly due to user intervention				

6.2.2 NDB Cluster Log Startup Messages

Possible startup messages with descriptions are provided in the following list:

- Initial start, waiting for %s to connect, nodes [all: %s connected: %s no-wait: %s]
- Waiting until nodes: %s connects, nodes [all: %s connected: %s no-wait: %s]
- Waiting %u sec for nodes %s to connect, nodes [all: %s connected: %s no-wait: %s]
- Waiting for non partitioned start, nodes [all: %s connected: %s missing: %s no-wait: %s]
- Waiting %u sec for non partitioned start, nodes [all: %s connected: %s missing: %s no-wait: %s]
- Initial start with nodes %s [missing: %s no-wait: %s]
- Start with all nodes %s
- Start with nodes %s [missing: %s no-wait: %s]
- Start potentially partitioned with nodes %s [missing: %s no-wait: %s]
- Unknown startreport: 0x%x [%s %s %s %s]

6.2.3 Event Buffer Reporting in the Cluster Log

NDB uses one or more memory buffers for events received from the data nodes. There is one such buffer for each Ndb object subscribing to table events, which means that there are usually two buffers for each mysqld performing binary logging (one buffer for schema events, and one for data events). Each buffer contains epochs made up of events. These events consist of operation types (insert, update, delete) and row data (before and after images plus metadata).

NDB generates messages in the cluster log to describe the state of these buffers. Although these reports appear in the cluster log, they refer to buffers on API nodes (unlike most other cluster log messages, which are generated by data nodes). These messages and the data structures underlying them were changed significantly in NDB 7.5.1, with the addition of the NDB_LE_EventBufferStatus2 event type and the ndb_logevent_EventBufferStatus2 data structure (see [The Ndb_logevent_type Type](#)). The remainder of this discussion focuses on the implementation based on NDB_LE_EventBufferStatus2.

Event buffer logging reports in the cluster log use the format shown here:

```
Node node_id: Event buffer status (object_id):
used=bytes_used (percent_used% of alloc)
alloc=bytes_allocated (percent_alloc% of max) max=bytes_available
latest_consumed_epoch=latest_consumed_epoch
```

```
latest_buffered_epoch=latest_buffered_epoch
report_reason=report_reason
```

The fields making up this report are listed here, with descriptions:

- *node_id*: ID of the node where the report originated.
- *object_id*: ID of the `Ndb` object where the report originated.
- *bytes_used*: Number of bytes used by the buffer.
- *percent_used*: Percentage of allocated bytes used.
- *bytes_allocated*: Number of bytes allocated to this buffer.
- *percent_alloc*: Percentage of available bytes used; not printed if `ndb_eventbuffer_max_alloc` is equal to 0 (unlimited).
- *bytes_available*: Number of bytes available; this is 0 if `ndb_eventbuffer_max_alloc` is 0 (unlimited).
- *latest_consumed_epoch*: The epoch most recently consumed to completion. (In NDB API applications, this is done by calling `nextEvent()`.)
- *latest_buffered_epoch*: The epoch most recently buffered (completely) in the event buffer.
- *report_reason*: The reason for making the report. Possible reasons are shown later in this section.

The `latest_consumed_epoch` and `latest_buffered_epoch` fields correspond, respectively, to the `apply_gci` and `latest_gci` fields of the old-style event buffer logging messages used prior to NDB 7.5.1.

Possible reasons for reporting are described in the following list:

- `ENOUGH_FREE_EVENTBUFFER`: The event buffer has sufficient space.
- `LOW_FREE_EVENTBUFFER`: The event buffer is running low on free space.
The threshold free percentage level triggering these reports can be adjusted by setting the `ndb_report_thresh_binlog_mem_usage` server variable.
- `BUFFERED_EPOCHS_OVER_THRESHOLD`: Whether the number of buffered epochs has exceeded the configured threshold. This number is the difference between the latest epoch that has been received in its entirety and the epoch that has most recently been consumed (in NDB API applications, this is done by calling `nextEvent()` or `nextEvent2()`). The report is generated every second until the number of buffered epochs goes below the threshold, which can be adjusted by setting the `ndb_report_thresh_binlog_epoch_slip` server variable. You can also adjust the threshold in NDB API applications by calling `setEventBufferQueueEmptyEpoch()`.
- `PARTIALLY_DISCARDING`: Event buffer memory is exhausted—that is, 100% of `ndb_eventbuffer_max_alloc` has been used. Any partially buffered epoch is buffered to completion even if usage exceeds 100%, but any new epochs received are discarded. This means that a gap has occurred in the event stream.
- `COMPLETELY_DISCARDING`: No epochs are buffered.
- `PARTIALLY_BUFFERING`: The buffer free percentage following the gap has risen to the threshold, which can be set in the `mysql` client using the `ndb_eventbuffer_free_percent` server system variable or in NDB API applications by calling `set_eventbuffer_free_percent()`. New epochs are buffered. Epochs that could not be completed due to the gap are discarded.
- `COMPLETELY_BUFFERING`: All epochs received are being buffered, which means that there is sufficient event buffer memory. The gap in the event stream has been closed.

6.2.4 NDB Cluster: NDB Transporter Errors

This section lists error codes, names, and messages that are written to the cluster log in the event of transporter errors.

0x00	TE_NO_ERROR	No error
0x01	TE_ERROR_CLOSING_SOCKET	Error found during closing of socket
0x02	TE_ERROR_IN_SELECT_BEFORE_ACCEPT	Error found before accept. The transporter will retry
0x03	TE_INVALID_MESSAGE_LENGTH	Error found in message (invalid message length)
0x04	TE_INVALID_CHECKSUM	Error found in message (checksum)
0x05	TE_COULD_NOT_CREATE_SOCKET	Error found while creating socket(can't create socket)
0x06	TE_COULD_NOT_BIND_SOCKET	Error found while binding server socket
0x07	TE_LISTEN_FAILED	Error found while listening to server socket
0x08	TE_ACCEPT_RETURN_ERROR	Error found during accept(accept return error)
0x0b	TE_SHM_DISCONNECT	The remote node has disconnected
0x0c	TE_SHM_IPC_STAT	Unable to check shm segment
0x0d	TE_SHM_UNABLE_TO_CREATE_SEGMENT	Unable to create shm segment
0x0e	TE_SHM_UNABLE_TO_ATTACH_SEGMENT	Unable to attach shm segment
0x0f	TE_SHM_UNABLE_TO_REMOVE_SEGMENT	Unable to remove shm segment
0x10	TE_TOO_SMALL_SIGID	

	Sig ID too small
0x11	TE_TOO_LARGE_SIGID
	Sig ID too large
0x12	TE_WAIT_STACK_FULL
	Wait stack was full
0x13	TE_RECEIVE_BUFFER_FULL
	Receive buffer was full
0x14	TE_SIGNAL_LOST_SEND_BUFFER_FULL
	Send buffer was full, and trying to force send fails
0x15	TE_SIGNAL_LOST
	Send failed for unknown reason(signal lost)
0x16	TE_SEND_BUFFER_FULL
	The send buffer was full, but sleeping for a while solved
0x21	TE_SHM_IPC_PERMANENT
	Shm ipc Permanent error

Note

Transporter error codes 0x17 through 0x20 and 0x22 are reserved for SCI connections, which are not supported in this version of NDB Cluster, and so are not included here.

6.3 Event Reports Generated in NDB Cluster

In this section, we discuss the types of event logs provided by NDB Cluster, and the types of events that are logged.

NDB Cluster provides two types of event log:

- The *cluster log*, which includes events generated by all cluster nodes. The cluster log is the log recommended for most uses because it provides logging information for an entire cluster in a single location.

By default, the cluster log is saved to a file named `ndb_node_id_cluster.log`, (where *node_id* is the node ID of the management server) in the management server's `DataDir`.

Cluster logging information can also be sent to `stdout` or a `syslog` facility in addition to or instead of being saved to a file, as determined by the values set for the `DataDir` and `LogDestination` configuration parameters. See [Section 4.3.5, “Defining an NDB Cluster Management Server”](#), for more information about these parameters.

- *Node logs* are local to each node.

Output generated by node event logging is written to the file `ndb_node_id_out.log` (where *node_id* is the node's node ID) in the node's `DataDir`. Node event logs are generated for both management nodes and data nodes.

Node logs are intended to be used only during application development, or for debugging application code.

Both types of event logs can be set to log different subsets of events.

Each reportable event can be distinguished according to three different criteria:

- *Category*: This can be any one of the following values: [STARTUP](#), [SHUTDOWN](#), [STATISTICS](#), [CHECKPOINT](#), [NODERESTART](#), [CONNECTION](#), [ERROR](#), or [INFO](#).
- *Priority*: This is represented by one of the numbers from 0 to 15 inclusive, where 0 indicates “most important” and 15 “least important.”
- *Severity Level*: This can be any one of the following values: [ALERT](#), [CRITICAL](#), [ERROR](#), [WARNING](#), [INFO](#), or [DEBUG](#).

Both the cluster log and the node log can be filtered on these properties.

The format used in the cluster log is as shown here:

```
2007-01-26 19:35:55 [MgmSrvr] INFO -- Node 1: Data usage is 2%(60 32K pages of total 2560)
2007-01-26 19:35:55 [MgmSrvr] INFO -- Node 1: Index usage is 1%(24 8K pages of total 2336)
2007-01-26 19:35:55 [MgmSrvr] INFO -- Node 1: Resource 0 min: 0 max: 639 curr: 0
2007-01-26 19:35:55 [MgmSrvr] INFO -- Node 2: Data usage is 2%(76 32K pages of total 2560)
2007-01-26 19:35:55 [MgmSrvr] INFO -- Node 2: Index usage is 1%(24 8K pages of total 2336)
2007-01-26 19:35:55 [MgmSrvr] INFO -- Node 2: Resource 0 min: 0 max: 639 curr: 0
2007-01-26 19:35:55 [MgmSrvr] INFO -- Node 3: Data usage is 2%(58 32K pages of total 2560)
2007-01-26 19:35:55 [MgmSrvr] INFO -- Node 3: Index usage is 1%(25 8K pages of total 2336)
2007-01-26 19:35:55 [MgmSrvr] INFO -- Node 3: Resource 0 min: 0 max: 639 curr: 0
2007-01-26 19:35:55 [MgmSrvr] INFO -- Node 4: Data usage is 2%(74 32K pages of total 2560)
2007-01-26 19:35:55 [MgmSrvr] INFO -- Node 4: Index usage is 1%(25 8K pages of total 2336)
2007-01-26 19:35:55 [MgmSrvr] INFO -- Node 4: Resource 0 min: 0 max: 639 curr: 0
2007-01-26 19:39:42 [MgmSrvr] INFO -- Node 4: Node 9 Connected
2007-01-26 19:39:42 [MgmSrvr] INFO -- Node 1: Node 9 Connected
2007-01-26 19:39:42 [MgmSrvr] INFO -- Node 1: Node 9: API 5.7.36-ndb-7.5.25
2007-01-26 19:39:42 [MgmSrvr] INFO -- Node 2: Node 9 Connected
2007-01-26 19:39:42 [MgmSrvr] INFO -- Node 2: Node 9: API 5.7.36-ndb-7.5.25
2007-01-26 19:39:42 [MgmSrvr] INFO -- Node 3: Node 9 Connected
2007-01-26 19:39:42 [MgmSrvr] INFO -- Node 3: Node 9: API 5.7.36-ndb-7.5.25
2007-01-26 19:39:42 [MgmSrvr] INFO -- Node 4: Node 9: API 5.7.36-ndb-7.5.25
2007-01-26 19:59:22 [MgmSrvr] ALERT -- Node 2: Node 7 Disconnected
2007-01-26 19:59:22 [MgmSrvr] ALERT -- Node 2: Node 7 Disconnected
```

Each line in the cluster log contains the following information:

- A timestamp in `YYYY-MM-DD HH:MM:SS` format.
- The type of node which is performing the logging. In the cluster log, this is always `[MgmSrvr]`.
- The severity of the event.
- The ID of the node reporting the event.
- A description of the event. The most common types of events to appear in the log are connections and disconnections between different nodes in the cluster, and when checkpoints occur. In some cases, the description may contain status information.

6.3.1 NDB Cluster Logging Management Commands

`ndb_mgm` supports a number of management commands related to the cluster log and node logs. In the listing that follows, `node_id` denotes either a storage node ID or the keyword `ALL`, which indicates that the command should be applied to all of the cluster's data nodes.

- `CLUSTERLOG ON`

Turns the cluster log on.

- `CLUSTERLOG OFF`
Turns the cluster log off.
- `CLUSTERLOG INFO`
Provides information about cluster log settings.
- `node_id CLUSTERLOG category=threshold`
Logs *category* events with priority less than or equal to *threshold* in the cluster log.
- `CLUSTERLOG FILTER severity_level`
Toggles cluster logging of events of the specified *severity_level*.

The following table describes the default setting (for all data nodes) of the cluster log category threshold. If an event has a priority with a value lower than or equal to the priority threshold, it is reported in the cluster log.

Note

Events are reported per data node, and that the threshold can be set to different values on different nodes.

Table 6.2 Cluster log categories, with default threshold setting

Category	Default threshold (All data nodes)
STARTUP	7
SHUTDOWN	7
STATISTICS	7
CHECKPOINT	7
NODERESTART	7
CONNECTION	7
ERROR	15
INFO	7

The `STATISTICS` category can provide a great deal of useful data. See [Section 6.3.3, “Using CLUSTERLOG STATISTICS in the NDB Cluster Management Client”](#), for more information.

Thresholds are used to filter events within each category. For example, a `STARTUP` event with a priority of 3 is not logged unless the threshold for `STARTUP` is set to 3 or higher. Only events with priority 3 or lower are sent if the threshold is 3.

The following table shows the event severity levels.

Note

These correspond to Unix `syslog` levels, except for `LOG_EMERG` and `LOG_NOTICE`, which are not used or mapped.

Table 6.3 Event severity levels

Severity Level Value	Severity	Description
1	ALERT	A condition that should be corrected immediately, such as a corrupted system database

Severity Level Value	Severity	Description
2	CRITICAL	Critical conditions, such as device errors or insufficient resources
3	ERROR	Conditions that should be corrected, such as configuration errors
4	WARNING	Conditions that are not errors, but that might require special handling
5	INFO	Informational messages
6	DEBUG	Debugging messages used for NDBCLUSTER development

Event severity levels can be turned on or off (using `CLUSTERLOG FILTER`—see above). If a severity level is turned on, then all events with a priority less than or equal to the category thresholds are logged. If the severity level is turned off then no events belonging to that severity level are logged.

Important

Cluster log levels are set on a per `ndb_mgmd`, per subscriber basis. This means that, in an NDB Cluster with multiple management servers, using a `CLUSTERLOG` command in an instance of `ndb_mgm` connected to one management server affects only logs generated by that management server but not by any of the others. This also means that, should one of the management servers be restarted, only logs generated by that management server are affected by the resetting of log levels caused by the restart.

6.3.2 NDB Cluster Log Events

An event report reported in the event logs has the following format:

```
datetime [string] severity -- message
```

For example:

```
09:19:30 2005-07-24 [NDB] INFO -- Node 4 Start phase 4 completed
```

This section discusses all reportable events, ordered by category and severity level within each category.

In the event descriptions, GCP and LCP mean “Global Checkpoint” and “Local Checkpoint”, respectively.

CONNECTION Events

These events are associated with connections between Cluster nodes.

Table 6.4 Events associated with connections between cluster nodes

Event	Priority	Severity Level	Description
Connected	8	INFO	Data nodes connected
Disconnected	8	ALERT	Data nodes disconnected
CommunicationClosed	8	INFO	SQL node or data node connection closed
CommunicationOpened	8	INFO	SQL node or data node connection open

Event	Priority	Severity Level	Description
ConnectedApiVersion8	8	INFO	Connection using API version

CHECKPOINT Events

The logging messages shown here are associated with checkpoints.

Table 6.5 Events associated with checkpoints

Event	Priority	Severity Level	Description
GlobalCheckpointStarted	9	INFO	Start of GCP: REDO log is written to disk
GlobalCheckpointCompleted	10	INFO	GCP finished
LocalCheckpointStarted	7	INFO	Start of LCP: data written to disk
LocalCheckpointCompleted	7	INFO	LCP completed normally
LCPStoppedInCalcKeepGci	0	ALERT	LCP stopped
LCPFragmentCompleted	11	INFO	LCP on a fragment has been completed
UndoLogBlocked	7	INFO	UNDO logging blocked; buffer near overflow
RedoStatus	7	INFO	Redo status

STARTUP Events

The following events are generated in response to the startup of a node or of the cluster and of its success or failure. They also provide information relating to the progress of the startup process, including information concerning logging activities.

Table 6.6 Events relating to the startup of a node or cluster

Event	Priority	Severity Level	Description
NDBStartStarted	1	INFO	Data node start phases initiated (all nodes starting)
NDBStartCompleted	1	INFO	Start phases completed, all data nodes
STTORRYRecieved	15	INFO	Blocks received after completion of restart
StartPhaseCompleted	4	INFO	Data node start phase X completed
CM_REGCONF	3	INFO	Node has been successfully included into the cluster; shows the node, managing node, and dynamic ID
CM_REGREF	8	INFO	Node has been refused for inclusion in the cluster; cannot be included in cluster due to misconfiguration, inability to establish

Event	Priority	Severity Level	Description
			communication, or other problem
FIND_NEIGHBOURS	8	INFO	Shows neighboring data nodes
NDBStopStarted	1	INFO	Data node shutdown initiated
NDBStopCompleted	1	INFO	Data node shutdown complete
NDBStopForced	1	ALERT	Forced shutdown of data node
NDBStopAborted	1	INFO	Unable to shut down data node normally
StartREDOLog	4	INFO	New redo log started; GCI keep <i>X</i> , newest restorable GCI <i>Y</i>
StartLog	10	INFO	New log started; log part <i>X</i> , start MB <i>Y</i> , stop MB <i>Z</i>
UNDORecordsExecuted	15	INFO	Undo records executed
StartReport	4	INFO	Report started
LogFileInitStatus	7	INFO	Log file initialization status
LogFileInitCompStatus	7	INFO	Log file completion status
StartReadLCP	10	INFO	Start read for local checkpoint
ReadLCPComplete	10	INFO	Read for local checkpoint completed
RunRedo	8	INFO	Running the redo log
RebuildIndex	10	INFO	Rebuilding indexes

NODERESTART Events

The following events are generated when restarting a node and relate to the success or failure of the node restart process.

Table 6.7 Events relating to restarting a node

Event	Priority	Severity Level	Description
NR_CopyDict	7	INFO	Completed copying of dictionary information
NR_CopyDistr	7	INFO	Completed copying distribution information
NR_CopyFragStarted	7	INFO	Starting to copy fragments
NR_CopyFragDone	10	INFO	Completed copying a fragment
NR_CopyFragCompleted	7	INFO	Completed copying all fragments
NodeFailCompleted	8	ALERT	Node failure phase completed

Event	Priority	Severity Level	Description
<code>NODE_FAILREP</code>	8	<code>ALERT</code>	Reports that a node has failed
<code>ArbitState</code>	6	<code>INFO</code>	<p>Report whether an arbitrator is found or not; there are seven different possible outcomes when seeking an arbitrator, listed here:</p> <ul style="list-style-type: none"> • Management server restarts arbitration thread [state=<code>X</code>] • Prepare arbitrator node <code>X</code> [ticket=<code>Y</code>] • Receive arbitrator node <code>X</code> [ticket=<code>Y</code>] • Started arbitrator node <code>X</code> [ticket=<code>Y</code>] • Lost arbitrator node <code>X</code> - process failure [state=<code>Y</code>] • Lost arbitrator node <code>X</code> - process exit [state=<code>Y</code>] • Lost arbitrator node <code>X</code> <error msg> [state=<code>Y</code>]
<code>ArbitResult</code>	2	<code>ALERT</code>	<p>Report arbitrator results; there are eight different possible results for arbitration attempts, listed here:</p> <ul style="list-style-type: none"> • Arbitration check failed: less than 1/2 nodes left • Arbitration check succeeded: node group majority • Arbitration check failed: missing node group • Network partitioning: arbitration required • Arbitration succeeded: affirmative response from node <code>X</code>

Event	Priority	Severity Level	Description
			<ul style="list-style-type: none"> Arbitration failed: negative response from node <i>x</i> Network partitioning: no arbitrator available Network partitioning: no arbitrator configured
GCP_TakeoverStarted	7	INFO	GCP takeover started
GCP_TakeoverCompleted	7d	INFO	GCP takeover complete
LCP_TakeoverStarted	7	INFO	LCP takeover started
LCP_TakeoverCompleted	7d	INFO	LCP takeover complete (state = <i>x</i>)
ConnectCheckStarted	6	INFO	Connection check started
ConnectCheckCompleted	6d	INFO	Connection check completed
NodeFailRejected	6	ALERT	Node failure phase failed

STATISTICS Events

The following events are of a statistical nature. They provide information such as numbers of transactions and other operations, amount of data sent or received by individual nodes, and memory usage.

Table 6.8 Events of a statistical nature

Event	Priority	Severity Level	Description
TransReportCounters	8	INFO	Report transaction statistics, including numbers of transactions, commits, reads, simple reads, writes, concurrent operations, attribute information, and aborts
OperationReportCounters	8	INFO	Number of operations
TableCreated	7	INFO	Report number of tables created
JobStatistic	9	INFO	Mean internal job scheduling statistics
ThreadConfigLoop	9	INFO	Number of thread configuration loops
SendBytesStatistic	9	INFO	Mean number of bytes sent to node <i>x</i>
ReceiveBytesStatistic	9c	INFO	Mean number of bytes received from node <i>x</i>
MemoryUsage	5	INFO	Data and index memory usage (80%, 90%, and 100%)

Event	Priority	Severity Level	Description
<code>MTSignalStatistics</code>	9	INFO	Multithreaded signals

SCHEMA Events

These events relate to NDB Cluster schema operations.

Table 6.9 Events relating to NDB Cluster schema operations

Event	Priority	Severity Level	Description
<code>CreateSchemaObject</code>	8	INFO	Schema object created
<code>AlterSchemaObject</code>	8	INFO	Schema object updated
<code>DropSchemaObject</code>	8	INFO	Schema object dropped

ERROR Events

These events relate to Cluster errors and warnings. The presence of one or more of these generally indicates that a major malfunction or failure has occurred.

Table 6.10 Events relating to cluster errors and warnings

Event	Priority	Severity Level	Description
<code>TransporterError</code>	2	ERROR	Transporter error
<code>TransporterWarning</code>	8	WARNING	Transporter warning
<code>MissedHeartbeat</code>	8	WARNING	Node <i>x</i> missed heartbeat number <i>y</i>
<code>DeadDueToHeartbeat</code>	8	ALERT	Node <i>x</i> declared “dead” due to missed heartbeat
<code>WarningEvent</code>	2	WARNING	General warning event
<code>SubscriptionStatus</code>	4	WARNING	Change in subscription status

INFO Events

These events provide general information about the state of the cluster and activities associated with Cluster maintenance, such as logging and heartbeat transmission.

Table 6.11 Information events

Event	Priority	Severity Level	Description
<code>SentHeartbeat</code>	12	INFO	Sent heartbeat
<code>CreateLogBytes</code>	11	INFO	Create log: Log part, log file, size in MB
<code>InfoEvent</code>	2	INFO	General informational event
<code>EventBufferStatus</code>	7	INFO	Event buffer status
<code>EventBufferStatus2</code>	7	INFO	Improved event buffer status information; added in NDB 7.5.1

Note

`SentHeartbeat` events are available only if NDB Cluster was compiled with `VM_TRACE` enabled.

SINGLEUSER Events

These events are associated with entering and exiting single user mode.

Table 6.12 Events relating to single user mode

Event	Priority	Severity Level	Description
SingleUser	7	INFO	Entering or exiting single user mode

BACKUP Events

These events provide information about backups being created or restored.

Table 6.13 Backup events

Event	Priority	Severity Level	Description
BackupStarted	7	INFO	Backup started
BackupStatus	7	INFO	Backup status
BackupCompleted	7	INFO	Backup completed
BackupFailedToStart	7	ALERT	Backup failed to start
BackupAborted	7	ALERT	Backup aborted by user
RestoreStarted	7	INFO	Started restoring from backup
RestoreMetaData	7	INFO	Restoring metadata
RestoreData	7	INFO	Restoring data
RestoreLog	7	INFO	Restoring log files
RestoreCompleted	7	INFO	Completed restoring from backup
SavedEvent	7	INFO	Event saved

6.3.3 Using CLUSTERLOG STATISTICS in the NDB Cluster Management Client

The NDB management client's `CLUSTERLOG STATISTICS` command can provide a number of useful statistics in its output. Counters providing information about the state of the cluster are updated at 5-second reporting intervals by the transaction coordinator (TC) and the local query handler (LQH), and written to the cluster log.

Transaction coordinator statistics. Each transaction has one transaction coordinator, which is chosen by one of the following methods:

- In a round-robin fashion
- By communication proximity
- By supplying a data placement hint when the transaction is started

Note

You can determine which TC selection method is used for transactions started from a given SQL node using the `ndb_optimized_node_selection` system variable.

All operations within the same transaction use the same transaction coordinator, which reports the following statistics:

- **Trans count.** This is the number transactions started in the last interval using this TC as the transaction coordinator. Any of these transactions may have committed, have been aborted, or remain uncommitted at the end of the reporting interval.

Note

Transactions do not migrate between TCs.

- **Commit count.** This is the number of transactions using this TC as the transaction coordinator that were committed in the last reporting interval. Because some transactions committed in this reporting interval may have started in a previous reporting interval, it is possible for `Commit count` to be greater than `Trans count`.
- **Read count.** This is the number of primary key read operations using this TC as the transaction coordinator that were started in the last reporting interval, including simple reads. This count also includes reads performed as part of unique index operations. A unique index read operation generates 2 primary key read operations—1 for the hidden unique index table, and 1 for the table on which the read takes place.
- **Simple read count.** This is the number of simple read operations using this TC as the transaction coordinator that were started in the last reporting interval.
- **Write count.** This is the number of primary key write operations using this TC as the transaction coordinator that were started in the last reporting interval. This includes all inserts, updates, writes and deletes, as well as writes performed as part of unique index operations.

Note

A unique index update operation can generate multiple PK read and write operations on the index table and on the base table.

- **AttrInfoCount.** This is the number of 32-bit data words received in the last reporting interval for primary key operations using this TC as the transaction coordinator. For reads, this is proportional to the number of columns requested. For inserts and updates, this is proportional to the number of columns written, and the size of their data. For delete operations, this is usually zero.

Unique index operations generate multiple PK operations and so increase this count. However, data words sent to describe the PK operation itself, and the key information sent, are *not* counted here. Attribute information sent to describe columns to read for scans, or to describe ScanFilters, is also not counted in `AttrInfoCount`.

- **Concurrent Operations.** This is the number of primary key or scan operations using this TC as the transaction coordinator that were started during the last reporting interval but that were not completed. Operations increment this counter when they are started and decrement it when they are completed; this occurs after the transaction commits. Dirty reads and writes—as well as failed operations—decrement this counter.

The maximum value that `Concurrent Operations` can have is the maximum number of operations that a TC block can support; currently, this is $(2 * \text{MaxNoOfConcurrentOperations}) + 16 + \text{MaxNoOfConcurrentTransactions}$. (For more information about these configuration parameters, see the *Transaction Parameters* section of [Section 4.3.6, “Defining NDB Cluster Data Nodes”](#).)

- **Abort count.** This is the number of transactions using this TC as the transaction coordinator that were aborted during the last reporting interval. Because some transactions that were aborted in the last reporting interval may have started in a previous reporting interval, `Abort count` can sometimes be greater than `Trans count`.
- **Scans.** This is the number of table scans using this TC as the transaction coordinator that were started during the last reporting interval. This does not include range scans (that is, ordered index scans).

- **Range scans.** This is the number of ordered index scans using this TC as the transaction coordinator that were started in the last reporting interval.
- **Local reads.** This is the number of primary-key read operations performed using a transaction coordinator on a node that also holds the primary fragment replica of the record. This count can also be obtained from the `LOCAL_READS` counter in the `ndbinfo.counters` table.
- **Local writes.** This contains the number of primary-key read operations that were performed using a transaction coordinator on a node that also holds the primary fragment replica of the record. This count can also be obtained from the `LOCAL_WRITES` counter in the `ndbinfo.counters` table.

Local query handler statistics (Operations). There is 1 cluster event per local query handler block (that is, 1 per data node process). Operations are recorded in the LQH where the data they are operating on resides.

Note

A single transaction may operate on data stored in multiple LQH blocks.

The `Operations` statistic provides the number of local operations performed by this LQH block in the last reporting interval, and includes all types of read and write operations (insert, update, write, and delete operations). This also includes operations used to replicate writes. For example, in a cluster having two fragment replicas, the write to the primary fragment replica is recorded in the primary LQH, and the write to the backup is recorded in the backup LQH. Unique key operations may result in multiple local operations; however, this does *not* include local operations generated as a result of a table scan or ordered index scan, which are not counted.

Process scheduler statistics. In addition to the statistics reported by the transaction coordinator and local query handler, each `ndbd` process has a scheduler which also provides useful metrics relating to the performance of an NDB Cluster. This scheduler runs in an infinite loop; during each loop the scheduler performs the following tasks:

1. Read any incoming messages from sockets into a job buffer.
2. Check whether there are any timed messages to be executed; if so, put these into the job buffer as well.
3. Execute (in a loop) any messages in the job buffer.
4. Send any distributed messages that were generated by executing the messages in the job buffer.
5. Wait for any new incoming messages.

Process scheduler statistics include the following:

- **Mean Loop Counter.** This is the number of loops executed in the third step from the preceding list. This statistic increases in size as the utilization of the TCP/IP buffer improves. You can use this to monitor changes in performance as you add new data node processes.
- **Mean send size and Mean receive size.** These statistics enable you to gauge the efficiency of, respectively writes and reads between nodes. The values are given in bytes. Higher values mean a lower cost per byte sent or received; the maximum value is 64K.

To cause all cluster log statistics to be logged, you can use the following command in the NDB management client:

```
ndb_mgm> ALL CLUSTERLOG STATISTICS=15
```

Note

Setting the threshold for `STATISTICS` to 15 causes the cluster log to become very verbose, and to grow quite rapidly in size, in direct proportion to the number of cluster nodes and the amount of activity in the NDB Cluster.

For more information about NDB Cluster management client commands relating to logging and reporting, see [Section 6.3.1, “NDB Cluster Logging Management Commands”](#).

6.4 Summary of NDB Cluster Start Phases

This section provides a simplified outline of the steps involved when NDB Cluster data nodes are started. More complete information can be found in [NDB Cluster Start Phases](#), in the *NDB Internals Guide*.

These phases are the same as those reported in the output from the `node_id STATUS` command in the management client (see [Section 6.1, “Commands in the NDB Cluster Management Client”](#)). These start phases are also reported in the `start_phase` column of the `ndbinfo.nodes` table.

Start types. There are several different startup types and modes, as shown in the following list:

- **Initial start.** The cluster starts with a clean file system on all data nodes. This occurs either when the cluster started for the very first time, or when all data nodes are restarted using the `--initial` option.

Note

Disk Data files are not removed when restarting a node using `--initial`.

- **System restart.** The cluster starts and reads data stored in the data nodes. This occurs when the cluster has been shut down after having been in use, when it is desired for the cluster to resume operations from the point where it left off.
- **Node restart.** This is the online restart of a cluster node while the cluster itself is running.
- **Initial node restart.** This is the same as a node restart, except that the node is reinitialized and started with a clean file system.

Setup and initialization (phase -1). Prior to startup, each data node (`ndbd` process) must be initialized. Initialization consists of the following steps:

1. Obtain a node ID
2. Fetch configuration data
3. Allocate ports to be used for inter-node communications
4. Allocate memory according to settings obtained from the configuration file

When a data node or SQL node first connects to the management node, it reserves a cluster node ID. To make sure that no other node allocates the same node ID, this ID is retained until the node has managed to connect to the cluster and at least one `ndbd` reports that this node is connected. This retention of the node ID is guarded by the connection between the node in question and `ndb_mgmd`.

After each data node has been initialized, the cluster startup process can proceed. The stages which the cluster goes through during this process are listed here:

- **Phase 0.** The `NDBFS` and `NDBCNTR` blocks start. Data node file systems are cleared on those data nodes that were started with `--initial` option.
- **Phase 1.** In this stage, all remaining `NDB` kernel blocks are started. NDB Cluster connections are set up, inter-block communications are established, and heartbeats are started. In the case of a node restart, API node connections are also checked.

Note

When one or more nodes hang in Phase 1 while the remaining node or nodes hang in Phase 2, this often indicates network problems. One possible cause of such issues is one or more cluster hosts having multiple network

interfaces. Another common source of problems causing this condition is the blocking of TCP/IP ports needed for communications between cluster nodes. In the latter case, this is often due to a misconfigured firewall.

- **Phase 2.** The `NDBCNTR` kernel block checks the states of all existing nodes. The master node is chosen, and the cluster schema file is initialized.
- **Phase 3.** The `DBLQH` and `DBTC` kernel blocks set up communications between them. The startup type is determined; if this is a restart, the `DBDIH` block obtains permission to perform the restart.
- **Phase 4.** For an initial start or initial node restart, the redo log files are created. The number of these files is equal to `NoOfFragmentLogFiles`.

For a system restart:

- Read schema or schemas.
- Read data from the local checkpoint.
- Apply all redo information until the latest restorable global checkpoint has been reached.

For a node restart, find the tail of the redo log.

- **Phase 5.** Most of the database-related portion of a data node start is performed during this phase. For an initial start or system restart, a local checkpoint is executed, followed by a global checkpoint. Periodic checks of memory usage begin during this phase, and any required node takeovers are performed.
- **Phase 6.** In this phase, node groups are defined and set up.
- **Phase 7.** The arbitrator node is selected and begins to function. The next backup ID is set, as is the backup disk write speed. Nodes reaching this start phase are marked as `Started`. It is now possible for API nodes (including SQL nodes) to connect to the cluster.
- **Phase 8.** If this is a system restart, all indexes are rebuilt (by `DBDIH`).
- **Phase 9.** The node internal startup variables are reset.
- **Phase 100 (OBSOLETE).** Formerly, it was at this point during a node restart or initial node restart that API nodes could connect to the node and begin to receive events. Currently, this phase is empty.
- **Phase 101.** At this point in a node restart or initial node restart, event delivery is handed over to the node joining the cluster. The newly-joined node takes over responsibility for delivering its primary data to subscribers. This phase is also referred to as *SUMA handover phase*.

After this process is completed for an initial start or system restart, transaction handling is enabled. For a node restart or initial node restart, completion of the startup process means that the node may now act as a transaction coordinator.

6.5 Performing a Rolling Restart of an NDB Cluster

This section discusses how to perform a *rolling restart* of an NDB Cluster installation, so called because it involves stopping and starting (or restarting) each node in turn, so that the cluster itself remains operational. This is often done as part of a *rolling upgrade* or *rolling downgrade*, where high availability of the cluster is mandatory and no downtime of the cluster as a whole is permissible. Where we refer to upgrades, the information provided here also generally applies to downgrades as well.

There are a number of reasons why a rolling restart might be desirable. These are described in the next few paragraphs.

Configuration change.

To make a change in the cluster's configuration, such as adding an SQL node to the cluster, or setting a configuration parameter to a new value.

NDB Cluster software upgrade or downgrade. To upgrade the cluster to a newer version of the NDB Cluster software (or to downgrade it to an older version). This is usually referred to as a “rolling upgrade” (or “rolling downgrade”, when reverting to an older version of NDB Cluster).

Change on node host. To make changes in the hardware or operating system on which one or more NDB Cluster node processes are running.

System reset (cluster reset).

To reset the cluster because it has reached an undesirable state. In such cases it is often desirable to reload the data and metadata of one or more data nodes. This can be done in any of three ways:

- Start each data node process (`ndbd` or possibly `ndbmttd`) with the `--initial` option, which forces the data node to clear its file system and to reload all NDB Cluster data and metadata from the other data nodes.
- Create a backup using the `ndb_mgm` client `START BACKUP` command prior to performing the restart. Following the upgrade, restore the node or nodes using `ndb_restore`.

See [Section 6.8, “Online Backup of NDB Cluster”](#), and [Section 5.24, “ndb_restore — Restore an NDB Cluster Backup”](#), for more information.

- Use `mysqldump` to create a backup prior to the upgrade; afterward, restore the dump using `LOAD DATA`.

Resource Recovery.

To free memory previously allocated to a table by successive `INSERT` and `DELETE` operations, for re-use by other NDB Cluster tables.

The process for performing a rolling restart may be generalized as follows:

1. Stop all cluster management nodes (`ndb_mgmd` processes), reconfigure them, then restart them. (See [Rolling restarts with multiple management servers](#).)
2. Stop, reconfigure, then restart each cluster data node (`ndbd` process) in turn.

Some node configuration parameters can be updated by issuing `RESTART` for each of the data nodes in the `ndb_mgm` client following the previous step. Other parameters require that the data node be stopped completely using the management client `STOP` command, then started again from a system shell by invoking the `ndbd` or `ndbmttd` executable as appropriate. (A shell command such as `kill` can also be used on most Unix systems to stop a data node process, but the `STOP` command is preferred and usually simpler.)

Note

On Windows, you can also use `SC STOP` and `SC START` commands, `NET STOP` and `NET START` commands, or the Windows Service Manager to stop and start nodes which have been installed as Windows services (see [Section 3.2.4, “Installing NDB Cluster Processes as Windows Services”](#)).

The type of restart required is indicated in the documentation for each node configuration parameter. See [Section 4.3, “NDB Cluster Configuration Files”](#).

3. Stop, reconfigure, then restart each cluster SQL node (`mysqld` process) in turn.

NDB Cluster supports a somewhat flexible order for upgrading nodes. When upgrading an NDB Cluster, you may upgrade API nodes (including SQL nodes) before upgrading the management nodes, data nodes, or both. In other words, you are permitted to upgrade the API and SQL nodes in any order. This is subject to the following provisions:

- This functionality is intended for use as part of an online upgrade only. A mix of node binaries from different NDB Cluster releases is neither intended nor supported for continuous, long-term use in a production setting.
- All management nodes must be upgraded before any data nodes are upgraded. This remains true regardless of the order in which you upgrade the cluster's API and SQL nodes.
- Features specific to the “new” version must not be used until all management nodes and data nodes have been upgraded.

This also applies to any MySQL Server version change that may apply, in addition to the NDB engine version change, so do not forget to take this into account when planning the upgrade. (This is true for online upgrades of NDB Cluster in general.)

It is not possible for any API node to perform schema operations (such as data definition statements) during a node restart. Due in part to this limitation, schema operations are also not supported during an online upgrade or downgrade.

Rolling restarts with multiple management servers. When performing a rolling restart of an NDB Cluster with multiple management nodes, you should keep in mind that `ndb_mgmd` checks to see if any other management node is running, and, if so, tries to use that node's configuration data. To keep this from occurring, and to force `ndb_mgmd` to re-read its configuration file, perform the following steps:

1. Stop all NDB Cluster `ndb_mgmd` processes.
2. Update all `config.ini` files.
3. Start a single `ndb_mgmd` with `--reload`, `--initial`, or both options as desired.
4. If you started the first `ndb_mgmd` with the `--initial` option, you must also start any remaining `ndb_mgmd` processes using `--initial`.

Regardless of any other options used when starting the first `ndb_mgmd`, you should not start any remaining `ndb_mgmd` processes after the first one using `--reload`.

5. Complete the rolling restarts of the data nodes and API nodes as normal.

When performing a rolling restart to update the cluster's configuration, you can use the `config_generation` column of the `ndbinfo.nodes` table to keep track of which data nodes have been successfully restarted with the new configuration. See [Section 6.14.28, “The ndbinfo nodes Table”](#).

6.6 NDB Cluster Single User Mode

Single user mode enables the database administrator to restrict access to the database system to a single API node, such as a MySQL server (SQL node) or an instance of `ndb_restore`. When entering single user mode, connections to all other API nodes are closed gracefully and all running transactions are aborted. No new transactions are permitted to start.

Once the cluster has entered single user mode, only the designated API node is granted access to the database.

You can use the `ALL STATUS` command in the `ndb_mgm` client to see when the cluster has entered single user mode. You can also check the `status` column of the `ndbinfo.nodes` table (see [Section 6.14.28, “The ndbinfo nodes Table”](#), for more information).

Example:

```
ndb_mgm> ENTER SINGLE USER MODE 5
```

After this command has executed and the cluster has entered single user mode, the API node whose node ID is 5 becomes the cluster's only permitted user.

The node specified in the preceding command must be an API node; attempting to specify any other type of node is rejected.

Note

When the preceding command is invoked, all transactions running on the designated node are aborted, the connection is closed, and the server must be restarted.

The command `EXIT SINGLE USER MODE` changes the state of the cluster's data nodes from single user mode to normal mode. API nodes—such as MySQL Servers—waiting for a connection (that is, waiting for the cluster to become ready and available), are again permitted to connect. The API node denoted as the single-user node continues to run (if still connected) during and after the state change.

Example:

```
ndb_mgm> EXIT SINGLE USER MODE
```

There are two recommended ways to handle a node failure when running in single user mode:

- Method 1:
 1. Finish all single user mode transactions
 2. Issue the `EXIT SINGLE USER MODE` command
 3. Restart the cluster's data nodes

- Method 2:

Restart storage nodes prior to entering single user mode.

6.7 Adding NDB Cluster Data Nodes Online

This section describes how to add NDB Cluster data nodes “online”—that is, without needing to shut down the cluster completely and restart it as part of the process.

Important

Currently, you must add new data nodes to an NDB Cluster as part of a new node group. In addition, it is not possible to change the number of fragment replicas (or the number of nodes per node group) online.

6.7.1 Adding NDB Cluster Data Nodes Online: General Issues

This section provides general information about the behavior of and current limitations in adding NDB Cluster nodes online.

Redistribution of Data. The ability to add new nodes online includes a means to reorganize `NDBCLUSTER` table data and indexes so that they are distributed across all data nodes, including the new ones, by means of the `ALTER TABLE ... REORGANIZE PARTITION` statement. Table reorganization of both in-memory and Disk Data tables is supported. This redistribution does not currently include unique indexes (only ordered indexes are redistributed).

The redistribution for `NDBCLUSTER` tables already existing before the new data nodes were added is not automatic, but can be accomplished using simple SQL statements in `mysql` or another MySQL client application. However, all data and indexes added to tables created after a new node group has been added are distributed automatically among all cluster data nodes, including those added as part of the new node group.

Partial starts. It is possible to add a new node group without all of the new data nodes being started. It is also possible to add a new node group to a degraded cluster—that is, a cluster that is only partially started, or where one or more data nodes are not running. In the latter case, the cluster must have enough nodes running to be viable before the new node group can be added.

Effects on ongoing operations. Normal DML operations using NDB Cluster data are not prevented by the creation or addition of a new node group, or by table reorganization. However, it is not possible to perform DDL concurrently with table reorganization—that is, no other DDL statements can be issued while an `ALTER TABLE ... REORGANIZE PARTITION` statement is executing. In addition, during the execution of `ALTER TABLE ... REORGANIZE PARTITION` (or the execution of any other DDL statement), it is not possible to restart cluster data nodes.

Failure handling. Failures of data nodes during node group creation and table reorganization are handled as shown in the following table:

Table 6.14 Data node failure handling during node group creation and table reorganization

Failure during	Failure in “Old” data node	Failure in “New” data node	System Failure
Node group creation	<ul style="list-style-type: none"> • If a node other than the master fails: The creation of the node group is always rolled forward. • If the master fails: <ul style="list-style-type: none"> • If the internal commit point has been reached: The creation of the node group is rolled forward. • If the internal commit point has not yet been reached. The creation of the node group is rolled back 	<ul style="list-style-type: none"> • If a node other than the master fails: The creation of the node group is always rolled forward. • If the master fails: <ul style="list-style-type: none"> • If the internal commit point has been reached: The creation of the node group is rolled forward. • If the internal commit point has not yet been reached. The creation of the node group is rolled back 	<ul style="list-style-type: none"> • If the execution of CREATE NODEGROUP has reached the internal commit point: When restarted, the cluster includes the new node group. Otherwise it without. • If the execution of CREATE NODEGROUP has not yet reached the internal commit point: When restarted, the cluster does not include the new node group.
Table reorganization	<ul style="list-style-type: none"> • If a node other than the master fails: The table reorganization is always rolled forward. • If the master fails: <ul style="list-style-type: none"> • If the internal commit point has been reached: The table reorganization is rolled forward. • If the internal commit point has not yet been reached. The 	<ul style="list-style-type: none"> • If a node other than the master fails: The table reorganization is always rolled forward. • If the master fails: <ul style="list-style-type: none"> • If the internal commit point has been reached: The table reorganization is rolled forward. • If the internal commit point has not yet been reached. The 	<ul style="list-style-type: none"> • If the execution of an ALTER TABLE ... REORGANIZE PARTITION statement has reached the internal commit point: When the cluster is restarted, the data and indexes belonging to <i>table</i> are distributed using the “new” data nodes. • If the execution of an ALTER TABLE ... REORGANIZE PARTITION statement has not

Failure during	Failure in “Old” data node	Failure in “New” data node	System Failure
	table reorganization is rolled back.	table reorganization is rolled back.	yet reached the internal commit point: When the cluster is restarted, the data and indexes belonging to <i>table</i> are distributed using only the “old” data nodes.

Dropping node groups. The `ndb_mgm` client supports a `DROP NODEGROUP` command, but it is possible to drop a node group only when no data nodes in the node group contain any data. Since there is currently no way to “empty” a specific data node or node group, this command works only the following two cases:

1. After issuing `CREATE NODEGROUP` in the `ndb_mgm` client, but before issuing any `ALTER TABLE ... REORGANIZE PARTITION` statements in the `mysql` client.
2. After dropping all `NDBCLUSTER` tables using `DROP TABLE`.

`TRUNCATE TABLE` does not work for this purpose because the data nodes continue to store the table definitions.

6.7.2 Adding NDB Cluster Data Nodes Online: Basic procedure

In this section, we list the basic steps required to add new data nodes to an NDB Cluster. This procedure applies whether you are using `ndbd` or `ndbmtbd` binaries for the data node processes. For a more detailed example, see [Section 6.7.3, “Adding NDB Cluster Data Nodes Online: Detailed Example”](#).

Assuming that you already have a running NDB Cluster, adding data nodes online requires the following steps:

1. Edit the cluster configuration `config.ini` file, adding new `[ndbd]` sections corresponding to the nodes to be added. In the case where the cluster uses multiple management servers, these changes need to be made to all `config.ini` files used by the management servers.

You must be careful that node IDs for any new data nodes added in the `config.ini` file do not overlap node IDs used by existing nodes. In the event that you have API nodes using dynamically allocated node IDs and these IDs match node IDs that you want to use for new data nodes, it is possible to force any such API nodes to “migrate”, as described later in this procedure.

2. Perform a rolling restart of all NDB Cluster management servers.

Important

All management servers must be restarted with the `--reload` or `--initial` option to force the reading of the new configuration.

3. Perform a rolling restart of all existing NDB Cluster data nodes. It is not necessary (or usually even desirable) to use `--initial` when restarting the existing data nodes.

If you are using API nodes with dynamically allocated IDs matching any node IDs that you wish to assign to new data nodes, you must restart all API nodes (including SQL nodes) before restarting any of the data nodes processes in this step. This causes any API nodes with node IDs that were previously not explicitly assigned to relinquish those node IDs and acquire new ones.

4. Perform a rolling restart of any SQL or API nodes connected to the NDB Cluster.

5. Start the new data nodes.

The new data nodes may be started in any order. They can also be started concurrently, as long as they are started after the rolling restarts of all existing data nodes have been completed, and before proceeding to the next step.

6. Execute one or more `CREATE NODEGROUP` commands in the NDB Cluster management client to create the new node group or node groups to which the new data nodes belong.
7. Redistribute the cluster's data among all data nodes, including the new ones. Normally this is done by issuing an `ALTER TABLE ... ALGORITHM=INPLACE, REORGANIZE PARTITION` statement in the `mysql` client for each `NDBCLUSTER` table.

Exception: For tables created using the `MAX_ROWS` option, this statement does not work; instead, use `ALTER TABLE ... ALGORITHM=INPLACE MAX_ROWS=...` to reorganize such tables. You should also bear in mind that using `MAX_ROWS` to set the number of partitions in this fashion is deprecated in NDB 7.5.4 and later, where you should use `PARTITION_BALANCE` instead; see [Setting NDB_TABLE Options](#), for more information.

Note

This needs to be done only for tables already existing at the time the new node group is added. Data in tables created after the new node group is added is distributed automatically; however, data added to any given table `tbl` that existed before the new nodes were added is not distributed using the new nodes until that table has been reorganized.

8. `ALTER TABLE ... REORGANIZE PARTITION ALGORITHM=INPLACE` reorganizes partitions but does not reclaim the space freed on the “old” nodes. You can do this by issuing, for each `NDBCLUSTER` table, an `OPTIMIZE TABLE` statement in the `mysql` client.

This works for space used by variable-width columns of in-memory NDB tables. `OPTIMIZE TABLE` is not supported for fixed-width columns of in-memory tables; it is also not supported for Disk Data tables.

You can add all the nodes desired, then issue several `CREATE NODEGROUP` commands in succession to add the new node groups to the cluster.

6.7.3 Adding NDB Cluster Data Nodes Online: Detailed Example

In this section we provide a detailed example illustrating how to add new NDB Cluster data nodes online, starting with an NDB Cluster having 2 data nodes in a single node group and concluding with a cluster having 4 data nodes in 2 node groups.

Starting configuration. For purposes of illustration, we assume a minimal configuration, and that the cluster uses a `config.ini` file containing only the following information:

```
[ndbd default]
DataMemory = 100M
IndexMemory = 100M
NoOfReplicas = 2
DataDir = /usr/local/mysql/var/mysql-cluster

[ndbd]
Id = 1
HostName = 198.51.100.1

[ndbd]
Id = 2
HostName = 198.51.100.2

[mgm]
HostName = 198.51.100.10
```



```

Id = 10

[api]
Id=20
HostName = 198.51.100.20

[api]
Id=21
HostName = 198.51.100.21

```

Note

We have left a gap in the sequence between data node IDs and other nodes. This makes it easier later to assign node IDs that are not already in use to data nodes which are newly added.

We also assume that you have already started the cluster using the appropriate command line or `my.cnf` options, and that running `SHOW` in the management client produces output similar to what is shown here:

```

-- NDB Cluster -- Management Client --
ndb_mgm> SHOW
Connected to Management Server at: 198.51.100.10:1186
Cluster Configuration
-----
[ndbd(NDB)]      2 node(s)
id=1   @198.51.100.1  (5.7.36-ndb-7.5.25, Nodegroup: 0,*)
id=2   @198.51.100.2  (5.7.36-ndb-7.5.25, Nodegroup: 0)

[ndb_mgmd(MGM)] 1 node(s)
id=10  @198.51.100.10 (5.7.36-ndb-7.5.25)

[mysqld(API)]   2 node(s)
id=20  @198.51.100.20 (5.7.36-ndb-7.5.25)
id=21  @198.51.100.21 (5.7.36-ndb-7.5.25)

```

Finally, we assume that the cluster contains a single `NDBCLUSTER` table created as shown here:

```

USE n;

CREATE TABLE ips (
  id BIGINT NOT NULL AUTO_INCREMENT PRIMARY KEY,
  country_code CHAR(2) NOT NULL,
  type CHAR(4) NOT NULL,
  ip_address VARCHAR(15) NOT NULL,
  addresses BIGINT UNSIGNED DEFAULT NULL,
  date BIGINT UNSIGNED DEFAULT NULL
) ENGINE NDBCLUSTER;

```

The memory usage and related information shown later in this section was generated after inserting approximately 50000 rows into this table.

Note

In this example, we show the single-threaded `ndbd` being used for the data node processes. You can also apply this example, if you are using the multithreaded `ndbmt` by substituting `ndbmt` for `ndbd` wherever it appears in the steps that follow.

Step 1: Update configuration file. Open the cluster global configuration file in a text editor and add `[ndbd]` sections corresponding to the 2 new data nodes. (We give these data nodes IDs 3 and 4, and assume that they are to be run on host machines at addresses 198.51.100.3 and 198.51.100.4, respectively.) After you have added the new sections, the contents of the `config.ini` file should look like what is shown here, where the additions to the file are shown in bold type:

```

[ndbd default]
DataMemory = 100M
IndexMemory = 100M

```

```

NoOfReplicas = 2
DataDir = /usr/local/mysql/var/mysql-cluster

[ndbd]
Id = 1
HostName = 198.51.100.1

[ndbd]
Id = 2
HostName = 198.51.100.2

[ndbd]
Id = 3
HostName = 198.51.100.3

[ndbd]
Id = 4
HostName = 198.51.100.4

[mgm]
HostName = 198.51.100.10
Id = 10

[api]
Id=20
HostName = 198.51.100.20

[api]
Id=21
HostName = 198.51.100.21

```

Once you have made the necessary changes, save the file.

Step 2: Restart the management server. Restarting the cluster management server requires that you issue separate commands to stop the management server and then to start it again, as follows:

1. Stop the management server using the management client `STOP` command, as shown here:

```

ndb_mgm> 10 STOP
Node 10 has shut down.
Disconnecting to allow Management Server to shutdown

$>

```

2. Because shutting down the management server causes the management client to terminate, you must start the management server from the system shell. For simplicity, we assume that `config.ini` is in the same directory as the management server binary, but in practice, you must supply the correct path to the configuration file. You must also supply the `--reload` or `--initial` option so that the management server reads the new configuration from the file rather than its configuration cache. If your shell's current directory is also the same as the directory where the management server binary is located, then you can invoke the management server as shown here:

```

$> ndb_mgmd -f config.ini --reload
2008-12-08 17:29:23 [MgmSrvr] INFO      -- NDB Cluster Management Server. 5.7.36-ndb-7.5.25
2008-12-08 17:29:23 [MgmSrvr] INFO      -- Reading cluster configuration from 'config.ini'

```

If you check the output of `SHOW` in the management client after restarting the `ndb_mgm` process, you should now see something like this:

```

-- NDB Cluster -- Management Client --
ndb_mgm> SHOW
Connected to Management Server at: 198.51.100.10:1186
Cluster Configuration
-----
[ndbd(NDB)]      2 node(s)
id=1      @198.51.100.1  (5.7.36-ndb-7.5.25, Nodegroup: 0, *)
id=2      @198.51.100.2  (5.7.36-ndb-7.5.25, Nodegroup: 0)
id=3 (not connected, accepting connect from 198.51.100.3)
id=4 (not connected, accepting connect from 198.51.100.4)

```

```
[ndb_mgmd(MGM)] 1 node(s)
id=10 @198.51.100.10 (5.7.36-ndb-7.5.25)

[mysqld(API)] 2 node(s)
id=20 @198.51.100.20 (5.7.36-ndb-7.5.25)
id=21 @198.51.100.21 (5.7.36-ndb-7.5.25)
```

Step 3: Perform a rolling restart of the existing data nodes. This step can be accomplished entirely within the cluster management client using the `RESTART` command, as shown here:

```
ndb_mgm> 1 RESTART
Node 1: Node shutdown initiated
Node 1: Node shutdown completed, restarting, no start.
Node 1 is being restarted

ndb_mgm> Node 1: Start initiated (version 7.5.25)
Node 1: Started (version 7.5.25)

ndb_mgm> 2 RESTART
Node 2: Node shutdown initiated
Node 2: Node shutdown completed, restarting, no start.
Node 2 is being restarted

ndb_mgm> Node 2: Start initiated (version 7.5.25)
ndb_mgm> Node 2: Started (version 7.5.25)
```

Important

After issuing each `X RESTART` command, wait until the management client reports `Node X: Started (version ...)` before proceeding any further.

You can verify that all existing data nodes were restarted using the updated configuration by checking the `ndbinfo.nodes` table in the `mysql` client.

Step 4: Perform a rolling restart of all cluster API nodes. Shut down and restart each MySQL server acting as an SQL node in the cluster using `mysqladmin shutdown` followed by `mysqld_safe` (or another startup script). This should be similar to what is shown here, where `password` is the MySQL `root` password for a given MySQL server instance:

```
$> mysqladmin -uroot -ppassword shutdown
081208 20:19:56 mysqld_safe mysqld from pid file
/usr/local/mysql/var/tonfisk.pid ended
$> mysqld_safe --ndbcluster --ndb-connectstring=198.51.100.10 &
081208 20:20:06 mysqld_safe Logging to '/usr/local/mysql/var/tonfisk.err'.
081208 20:20:06 mysqld_safe Starting mysqld daemon with databases
from /usr/local/mysql/var
```

Of course, the exact input and output depend on how and where MySQL is installed on the system, as well as which options you choose to start it (and whether or not some or all of these options are specified in a `my.cnf` file).

Step 5: Perform an initial start of the new data nodes. From a system shell on each of the hosts for the new data nodes, start the data nodes as shown here, using the `--initial` option:

```
$> ndbd -c 198.51.100.10 --initial
```

Note

Unlike the case with restarting the existing data nodes, you can start the new data nodes concurrently; you do not need to wait for one to finish starting before starting the other.

Wait until both of the new data nodes have started before proceeding with the next step. Once the new data nodes have started, you can see in the output of the management client `SHOW` command that they do not yet belong to any node group (as indicated with bold type here):

```

ndb_mgm> SHOW
Connected to Management Server at: 198.51.100.10:1186
Cluster Configuration
-----
[ndbd(NDB)]      2 node(s)
id=1      @198.51.100.1  (5.7.36-ndb-7.5.25, Nodegroup: 0, *)
id=2      @198.51.100.2  (5.7.36-ndb-7.5.25, Nodegroup: 0)
id=3      @198.51.100.3  (5.7.36-ndb-7.5.25, no nodegroup)
id=4      @198.51.100.4  (5.7.36-ndb-7.5.25, no nodegroup)

[ndb_mgmd(MGM)] 1 node(s)
id=10     @198.51.100.10 (5.7.36-ndb-7.5.25)

[mysqld(API)]   2 node(s)
id=20     @198.51.100.20 (5.7.36-ndb-7.5.25)
id=21     @198.51.100.21 (5.7.36-ndb-7.5.25)

```

Step 6: Create a new node group. You can do this by issuing a `CREATE NODEGROUP` command in the cluster management client. This command takes as its argument a comma-separated list of the node IDs of the data nodes to be included in the new node group, as shown here:

```

ndb_mgm> CREATE NODEGROUP 3,4
Nodegroup 1 created

```

By issuing `SHOW` again, you can verify that data nodes 3 and 4 have joined the new node group (again indicated in bold type):

```

ndb_mgm> SHOW
Connected to Management Server at: 198.51.100.10:1186
Cluster Configuration
-----
[ndbd(NDB)]      2 node(s)
id=1      @198.51.100.1  (5.7.36-ndb-7.5.25, Nodegroup: 0, *)
id=2      @198.51.100.2  (5.7.36-ndb-7.5.25, Nodegroup: 0)
id=3      @198.51.100.3  (5.7.36-ndb-7.5.25, Nodegroup: 1)
id=4      @198.51.100.4  (5.7.36-ndb-7.5.25, Nodegroup: 1)

[ndb_mgmd(MGM)] 1 node(s)
id=10     @198.51.100.10 (5.7.36-ndb-7.5.25)

[mysqld(API)]   2 node(s)
id=20     @198.51.100.20 (5.7.36-ndb-7.5.25)
id=21     @198.51.100.21 (5.7.36-ndb-7.5.25)

```

Step 7: Redistribute cluster data. When a node group is created, existing data and indexes are not automatically distributed to the new node group's data nodes, as you can see by issuing the appropriate `REPORT` command in the management client:

```

ndb_mgm> ALL REPORT MEMORY

Node 1: Data usage is 5%(177 32K pages of total 3200)
Node 1: Index usage is 0%(108 8K pages of total 12832)
Node 2: Data usage is 5%(177 32K pages of total 3200)
Node 2: Index usage is 0%(108 8K pages of total 12832)
Node 3: Data usage is 0%(0 32K pages of total 3200)
Node 3: Index usage is 0%(0 8K pages of total 12832)
Node 4: Data usage is 0%(0 32K pages of total 3200)
Node 4: Index usage is 0%(0 8K pages of total 12832)

```

By using `ndb_desc` with the `-p` option, which causes the output to include partitioning information, you can see that the table still uses only 2 partitions (in the `Per partition info` section of the output, shown here in bold text):

```

$> ndb_desc -c 198.51.100.10 -d n ips -p
-- ips --
Version: 1
Fragment type: 9
K Value: 6
Min load factor: 78

```

```

Max load factor: 80
Temporary table: no
Number of attributes: 6
Number of primary keys: 1
Length of frm data: 340
Row Checksum: 1
Row GCI: 1
SingleUserMode: 0
ForceVarPart: 1
FragmentCount: 2
TableStatus: Retrieved
-- Attributes --
id Bigint PRIMARY KEY DISTRIBUTION KEY AT=FIXED ST=MEMORY AUTO_INCR
country_code Char(2;latin1_swedish_ci) NOT NULL AT=FIXED ST=MEMORY
type Char(4;latin1_swedish_ci) NOT NULL AT=FIXED ST=MEMORY
ip_address Varchar(15;latin1_swedish_ci) NOT NULL AT=SHORT_VAR ST=MEMORY
addresses Bigunsigned NULL AT=FIXED ST=MEMORY
date Bigunsigned NULL AT=FIXED ST=MEMORY

-- Indexes --
PRIMARY KEY(id) - UniqueHashIndex
PRIMARY(id) - OrderedIndex

-- Per partition info --
Partition    Row count    Commit count    Frag fixed memory    Frag var sized memory
0            26086        26086           1572864              557056
1            26329        26329           1605632              557056

NDBT_ProgramExit: 0 - OK

```

You can cause the data to be redistributed among all of the data nodes by performing, for each [NDB table](#), an `ALTER TABLE ... ALGORITHM=INPLACE, REORGANIZE PARTITION` statement in the `mysql` client.

Important

`ALTER TABLE ... ALGORITHM=INPLACE, REORGANIZE PARTITION` does not work on tables that were created with the `MAX_ROWS` option. Instead, use `ALTER TABLE ... ALGORITHM=INPLACE, MAX_ROWS=...` to reorganize such tables.

Keep in mind that using `MAX_ROWS` to set the number of partitions per table is deprecated in NDB 7.5.4 and later, where you should use `PARTITION_BALANCE` instead; see [Setting NDB_TABLE Options](#), for more information.

After issuing the statement `ALTER TABLE ips ALGORITHM=INPLACE, REORGANIZE PARTITION`, you can see using `ndb_desc` that the data for this table is now stored using 4 partitions, as shown here (with the relevant portions of the output in bold type):

```

$> ndb_desc -c 198.51.100.10 -d n ips -p
-- ips --
Version: 16777217
Fragment type: 9
K Value: 6
Min load factor: 78
Max load factor: 80
Temporary table: no
Number of attributes: 6
Number of primary keys: 1
Length of frm data: 341
Row Checksum: 1
Row GCI: 1
SingleUserMode: 0
ForceVarPart: 1
FragmentCount: 4
TableStatus: Retrieved
-- Attributes --

```

```

id Bigint PRIMARY KEY DISTRIBUTION KEY AT=FIXED ST=MEMORY AUTO_INCR
country_code Char(2;latin1_swedish_ci) NOT NULL AT=FIXED ST=MEMORY
type Char(4;latin1_swedish_ci) NOT NULL AT=FIXED ST=MEMORY
ip_address Varchar(15;latin1_swedish_ci) NOT NULL AT=SHORT_VAR ST=MEMORY
addresses Bigunsigned NULL AT=FIXED ST=MEMORY
date Bigunsigned NULL AT=FIXED ST=MEMORY

-- Indexes --
PRIMARY KEY(id) - UniqueHashIndex
PRIMARY(id) - OrderedIndex

-- Per partition info --
Partition  Row count  Commit count  Frag fixed memory  Frag var sized memory
0          12981      52296        1572864            557056
1          13236      52515        1605632            557056
2          13105      13105        819200             294912
3          13093      13093        819200             294912

NDBT_ProgramExit: 0 - OK

```

Note

Normally, `ALTER TABLE table_name [ALGORITHM=INPLACE,] REORGANIZE PARTITION` is used with a list of partition identifiers and a set of partition definitions to create a new partitioning scheme for a table that has already been explicitly partitioned. Its use here to redistribute data onto a new NDB Cluster node group is an exception in this regard; when used in this way, no other keywords or identifiers follow `REORGANIZE PARTITION`.

For more information, see [ALTER TABLE Statement](#).

In addition, for each table, the `ALTER TABLE` statement should be followed by an `OPTIMIZE TABLE` to reclaim wasted space. You can obtain a list of all `NDBCLUSTER` tables using the following query against the `INFORMATION_SCHEMA.TABLES` table:

```

SELECT TABLE_SCHEMA, TABLE_NAME
FROM INFORMATION_SCHEMA.TABLES
WHERE ENGINE = 'NDBCLUSTER';

```

Note

The `INFORMATION_SCHEMA.TABLES.ENGINE` value for an NDB Cluster table is always `NDBCLUSTER`, regardless of whether the `CREATE TABLE` statement used to create the table (or `ALTER TABLE` statement used to convert an existing table from a different storage engine) used `NDB` or `NDBCLUSTER` in its `ENGINE` option.

You can see after performing these statements in the output of `ALL REPORT MEMORY` that the data and indexes are now redistributed between all cluster data nodes, as shown here:

```

ndb_mgm> ALL REPORT MEMORY

Node 1: Data usage is 5%(176 32K pages of total 3200)
Node 1: Index usage is 0%(76 8K pages of total 12832)
Node 2: Data usage is 5%(176 32K pages of total 3200)
Node 2: Index usage is 0%(76 8K pages of total 12832)
Node 3: Data usage is 2%(80 32K pages of total 3200)
Node 3: Index usage is 0%(51 8K pages of total 12832)
Node 4: Data usage is 2%(80 32K pages of total 3200)
Node 4: Index usage is 0%(50 8K pages of total 12832)

```

Note

Since only one DDL operation on `NDBCLUSTER` tables can be executed at a time, you must wait for each `ALTER TABLE ... REORGANIZE PARTITION` statement to finish before issuing the next one.

It is not necessary to issue `ALTER TABLE ... REORGANIZE PARTITION` statements for `NDBCLUSTER` tables created *after* the new data nodes have been added; data added to such tables is distributed among all data nodes automatically. However, in `NDBCLUSTER` tables that existed *prior to* the addition of the new nodes, neither existing nor new data is distributed using the new nodes until these tables have been reorganized using `ALTER TABLE ... REORGANIZE PARTITION`.

Alternative procedure, without rolling restart. It is possible to avoid the need for a rolling restart by configuring the extra data nodes, but not starting them, when first starting the cluster. We assume, as before, that you wish to start with two data nodes—nodes 1 and 2—in one node group and later to expand the cluster to four data nodes, by adding a second node group consisting of nodes 3 and 4:

```
[ndbd default]
DataMemory = 100M
IndexMemory = 100M
NoOfReplicas = 2
DataDir = /usr/local/mysql/var/mysql-cluster

[ndbd]
Id = 1
HostName = 198.51.100.1

[ndbd]
Id = 2
HostName = 198.51.100.2

[ndbd]
Id = 3
HostName = 198.51.100.3
Nodegroup = 65536

[ndbd]
Id = 4
HostName = 198.51.100.4
Nodegroup = 65536

[mgm]
HostName = 198.51.100.10
Id = 10

[api]
Id=20
HostName = 198.51.100.20

[api]
Id=21
HostName = 198.51.100.21
```

The data nodes to be brought online at a later time (nodes 3 and 4) can be configured with `NodeGroup = 65536`, in which case nodes 1 and 2 can each be started as shown here:

```
$> ndbd -c 198.51.100.10 --initial
```

The data nodes configured with `NodeGroup = 65536` are treated by the management server as though you had started nodes 1 and 2 using `--nowait-nodes=3,4` after waiting for a period of time determined by the setting for the `StartNoNodeGroupTimeout` data node configuration parameter. By default, this is 15 seconds (15000 milliseconds).

Note

`StartNoNodegroupTimeout` must be the same for all data nodes in the cluster; for this reason, you should always set it in the `[ndbd default]` section of the `config.ini` file, rather than for individual data nodes.

When you are ready to add the second node group, you need only perform the following additional steps:

1. Start data nodes 3 and 4, invoking the data node process once for each new node:

```
$> ndbd -c 198.51.100.10 --initial
```

2. Issue the appropriate `CREATE NODEGROUP` command in the management client:

```
ndb_mgm> CREATE NODEGROUP 3,4
```

3. In the `mysql` client, issue `ALTER TABLE ... REORGANIZE PARTITION` and `OPTIMIZE TABLE` statements for each existing `NDBCLUSTER` table. (As noted elsewhere in this section, existing NDB Cluster tables cannot use the new nodes for data distribution until this has been done.)

6.8 Online Backup of NDB Cluster

The next few sections describe how to prepare for and then to create an NDB Cluster backup using the functionality for this purpose found in the `ndb_mgm` management client. To distinguish this type of backup from a backup made using `mysqldump`, we sometimes refer to it as a “native” NDB Cluster backup. (For information about the creation of backups with `mysqldump`, see [mysqldump — A Database Backup Program](#).) Restoration of NDB Cluster backups is done using the `ndb_restore` utility provided with the NDB Cluster distribution; for information about `ndb_restore` and its use in restoring NDB Cluster backups, see [Section 5.24, “ndb_restore — Restore an NDB Cluster Backup”](#).

6.8.1 NDB Cluster Backup Concepts

A backup is a snapshot of the database at a given time. The backup consists of three main parts:

- **Metadata.** The names and definitions of all database tables
- **Table records.** The data actually stored in the database tables at the time that the backup was made
- **Transaction log.** A sequential record telling how and when data was stored in the database

Each of these parts is saved on all nodes participating in the backup. During backup, each node saves these three parts into three files on disk:

- `BACKUP-backup_id.node_idctl`

A control file containing control information and metadata. Each node saves the same table definitions (for all tables in the cluster) to its own version of this file.

- `BACKUP-backup_id-0.node_id.data`

A data file containing the table records, which are saved on a per-fragment basis. That is, different nodes save different fragments during the backup. The file saved by each node starts with a header that states the tables to which the records belong. Following the list of records there is a footer containing a checksum for all records.

- `BACKUP-backup_id.node_id.log`

A log file containing records of committed transactions. Only transactions on tables stored in the backup are stored in the log. Nodes involved in the backup save different records because different nodes host different database fragments.

In the listing just shown, `backup_id` stands for the backup identifier and `node_id` is the unique identifier for the node creating the file.

The location of the backup files is determined by the `BackupDataDir` parameter.

6.8.2 Using The NDB Cluster Management Client to Create a Backup

Before starting a backup, make sure that the cluster is properly configured for performing one. (See [Section 6.8.3, “Configuration for NDB Cluster Backups”](#).)

The `START BACKUP` command is used to create a backup:

```
START BACKUP [backup_id] [wait_option] [snapshot_option]

wait_option:
WAIT {STARTED | COMPLETED} | NOWAIT

snapshot_option:
SNAPSHOTSTART | SNAPSHOTEND
```

Successive backups are automatically identified sequentially, so the *backup_id*, an integer greater than or equal to 1, is optional; if it is omitted, the next available value is used. If an existing *backup_id* value is used, the backup fails with the error `Backup failed: file already exists`. If used, the *backup_id* must follow `START BACKUP` immediately, before any other options are used.

The *wait_option* can be used to determine when control is returned to the management client after a `START BACKUP` command is issued, as shown in the following list:

- If `NOWAIT` is specified, the management client displays a prompt immediately, as seen here:

```
ndb_mgm> START BACKUP NOWAIT
ndb_mgm>
```

In this case, the management client can be used even while it prints progress information from the backup process.

- With `WAIT STARTED` the management client waits until the backup has started before returning control to the user, as shown here:

```
ndb_mgm> START BACKUP WAIT STARTED
Waiting for started, this may take several minutes
Node 2: Backup 3 started from node 1
ndb_mgm>
```

- `WAIT COMPLETED` causes the management client to wait until the backup process is complete before returning control to the user.

`WAIT COMPLETED` is the default.

A *snapshot_option* can be used to determine whether the backup matches the state of the cluster when `START BACKUP` was issued, or when it was completed. `SNAPSHOTSTART` causes the backup to match the state of the cluster when the backup began; `SNAPSHOTEND` causes the backup to reflect the state of the cluster when the backup was finished. `SNAPSHOTEND` is the default, and matches the behavior found in previous NDB Cluster releases.

Note

If you use the `SNAPSHOTSTART` option with `START BACKUP`, and the `CompressedBackup` parameter is enabled, only the data and control files are compressed—the log file is not compressed.

If both a *wait_option* and a *snapshot_option* are used, they may be specified in either order. For example, all of the following commands are valid, assuming that there is no existing backup having 4 as its ID:

```
START BACKUP WAIT STARTED SNAPSHOTSTART
START BACKUP SNAPSHOTSTART WAIT STARTED
START BACKUP 4 WAIT COMPLETED SNAPSHOTSTART
START BACKUP SNAPSHOTEND WAIT COMPLETED
START BACKUP 4 NOWAIT SNAPSHOTSTART
```

The procedure for creating a backup consists of the following steps:

1. Start the management client (`ndb_mgm`), if it not running already.

- Execute the `START BACKUP` command. This produces several lines of output indicating the progress of the backup, as shown here:

```
ndb_mgm> START BACKUP
Waiting for completed, this may take several minutes
Node 2: Backup 1 started from node 1
Node 2: Backup 1 started from node 1 completed
StartGCP: 177 StopGCP: 180
#Records: 7362 #LogRecords: 0
Data: 453648 bytes Log: 0 bytes
ndb_mgm>
```

- When the backup has started the management client displays this message:

```
Backup backup_id started from node node_id
```

backup_id is the unique identifier for this particular backup. This identifier is saved in the cluster log, if it has not been configured otherwise. *node_id* is the identifier of the management server that is coordinating the backup with the data nodes. At this point in the backup process the cluster has received and processed the backup request. It does not mean that the backup has finished. An example of this statement is shown here:

```
Node 2: Backup 1 started from node 1
```

- The management client indicates with a message like this one that the backup has started:

```
Backup backup_id started from node node_id completed
```

As is the case for the notification that the backup has started, *backup_id* is the unique identifier for this particular backup, and *node_id* is the node ID of the management server that is coordinating the backup with the data nodes. This output is accompanied by additional information including relevant global checkpoints, the number of records backed up, and the size of the data, as shown here:

```
Node 2: Backup 1 started from node 1 completed
StartGCP: 177 StopGCP: 180
#Records: 7362 #LogRecords: 0
Data: 453648 bytes Log: 0 bytes
```

It is also possible to perform a backup from the system shell by invoking `ndb_mgm` with the `-e` or `--execute` option, as shown in this example:

```
$> ndb_mgm -e "START BACKUP 6 WAIT COMPLETED SNAPSHOTSTART"
```

When using `START BACKUP` in this way, you must specify the backup ID.

Cluster backups are created by default in the `BACKUP` subdirectory of the `DataDir` on each data node. This can be overridden for one or more data nodes individually, or for all cluster data nodes in the `config.ini` file using the `BackupDataDir` configuration parameter. The backup files created for a backup with a given *backup_id* are stored in a subdirectory named `BACKUP-backup_id` in the backup directory.

Cancelling backups. To cancel or abort a backup that is already in progress, perform the following steps:

- Start the management client.
- Execute this command:

```
ndb_mgm> ABORT BACKUP backup_id
```

The number *backup_id* is the identifier of the backup that was included in the response of the management client when the backup was started (in the message `Backup backup_id started from node management_node_id`).

- The management client acknowledges the abort request with `Abort of backup backup_id ordered`.

Note

At this point, the management client has not yet received a response from the cluster data nodes to this request, and the backup has not yet actually been aborted.

- After the backup has been aborted, the management client reports this fact in a manner similar to what is shown here:

```
Node 1: Backup 3 started from 5 has been aborted.
  Error: 1321 - Backup aborted by user request: Permanent error: User defined error
Node 3: Backup 3 started from 5 has been aborted.
  Error: 1323 - 1323: Permanent error: Internal error
Node 2: Backup 3 started from 5 has been aborted.
  Error: 1323 - 1323: Permanent error: Internal error
Node 4: Backup 3 started from 5 has been aborted.
  Error: 1323 - 1323: Permanent error: Internal error
```

In this example, we have shown sample output for a cluster with 4 data nodes, where the sequence number of the backup to be aborted is 3, and the management node to which the cluster management client is connected has the node ID 5. The first node to complete its part in aborting the backup reports that the reason for the abort was due to a request by the user. (The remaining nodes report that the backup was aborted due to an unspecified internal error.)

Note

There is no guarantee that the cluster nodes respond to an `ABORT BACKUP` command in any particular order.

The `Backup backup_id started from node management_node_id has been aborted` messages mean that the backup has been terminated and that all files relating to this backup have been removed from the cluster file system.

It is also possible to abort a backup in progress from a system shell using this command:

```
$> ndb_mgm -e "ABORT BACKUP backup_id"
```

Note

If there is no backup having the ID `backup_id` running when an `ABORT BACKUP` is issued, the management client makes no response, nor is it indicated in the cluster log that an invalid abort command was sent.

6.8.3 Configuration for NDB Cluster Backups

Five configuration parameters are essential for backup:

- `BackupDataBufferSize`

The amount of memory used to buffer data before it is written to disk.

- `BackupLogBufferSize`

The amount of memory used to buffer log records before these are written to disk.

- `BackupMemory`

The total memory allocated in a data node for backups. This should be the sum of the memory allocated for the backup data buffer and the backup log buffer.

- `BackupWriteSize`

The default size of blocks written to disk. This applies for both the backup data buffer and the backup log buffer.

- `BackupMaxWriteSize`

The maximum size of blocks written to disk. This applies for both the backup data buffer and the backup log buffer.

In addition, `CompressedBackup` causes NDB to use compression when creating and writing to backup files.

More detailed information about these parameters can be found in [Backup Parameters](#).

You can also set a location for the backup files using the `BackupDataDir` configuration parameter. The default is `FileSystemPath/BACKUP/BACKUP-backup_id`.

6.8.4 NDB Cluster Backup Troubleshooting

If an error code is returned when issuing a backup request, the most likely cause is insufficient memory or disk space. You should check that there is enough memory allocated for the backup.

Important

If you have set `BackupDataBufferSize` and `BackupLogBufferSize` and their sum is greater than 4MB, then you must also set `BackupMemory` as well.

You should also make sure that there is sufficient space on the hard drive partition of the backup target.

NDB does not support repeatable reads, which can cause problems with the restoration process. Although the backup process is “hot”, restoring an NDB Cluster from backup is not a 100% “hot” process. This is due to the fact that, for the duration of the restore process, running transactions get nonrepeatable reads from the restored data. This means that the state of the data is inconsistent while the restore is in progress.

6.9 MySQL Server Usage for NDB Cluster

`mysqld` is the traditional MySQL server process. To be used with NDB Cluster, `mysqld` needs to be built with support for the NDB storage engine, as it is in the precompiled binaries available from <https://dev.mysql.com/downloads/>. If you build MySQL from source, you must invoke `CMake` with the `-DWITH_NDBCLUSTER=1` option to include support for NDB.

For more information about compiling NDB Cluster from source, see [Section 3.1.4, “Building NDB Cluster from Source on Linux”](#), and [Section 3.2.2, “Compiling and Installing NDB Cluster from Source on Windows”](#).

(For information about `mysqld` options and variables, in addition to those discussed in this section, which are relevant to NDB Cluster, see [Section 4.3.9, “MySQL Server Options and Variables for NDB Cluster”](#).)

If the `mysqld` binary has been built with Cluster support, the `NDBCLUSTER` storage engine is still disabled by default. You can use either of two possible options to enable this engine:

- Use `--ndbcluster` as a startup option on the command line when starting `mysqld`.
- Insert a line containing `ndbcluster` in the `[mysqld]` section of your `my.cnf` file.

An easy way to verify that your server is running with the `NDBCLUSTER` storage engine enabled is to issue the `SHOW ENGINES` statement in the MySQL Monitor (`mysql`). You should see the value `YES`

as the `Support` value in the row for `NDBCLUSTER`. If you see `NO` in this row or if there is no such row displayed in the output, you are not running an NDB-enabled version of MySQL. If you see `DISABLED` in this row, you need to enable it in either one of the two ways just described.

To read cluster configuration data, the MySQL server requires at a minimum three pieces of information:

- The MySQL server's own cluster node ID
- The host name or IP address for the management server
- The number of the TCP/IP port on which it can connect to the management server

Node IDs can be allocated dynamically, so it is not strictly necessary to specify them explicitly.

The `mysqld` parameter `ndb-connectstring` is used to specify the connection string either on the command line when starting `mysqld` or in `my.cnf`. The connection string contains the host name or IP address where the management server can be found, as well as the TCP/IP port it uses.

In the following example, `ndb_mgmd.mysql.com` is the host where the management server resides, and the management server listens for cluster messages on port 1186:

```
$> mysqld --ndbcluster --ndb-connectstring=ndb_mgmd.mysql.com:1186
```

See [Section 4.3.3, “NDB Cluster Connection Strings”](#), for more information on connection strings.

Given this information, the MySQL server can act as a full participant in the cluster. (We often refer to a `mysqld` process running in this manner as an SQL node.) It is fully aware of all cluster data nodes as well as their status, and establishes connections to all data nodes. In this case, it is able to use any data node as a transaction coordinator and to read and update node data.

You can see in the `mysql` client whether a MySQL server is connected to the cluster using `SHOW PROCESSLIST`. If the MySQL server is connected to the cluster, and you have the `PROCESS` privilege, then the first row of the output is as shown here:

```
mysql> SHOW PROCESSLIST \G
***** 1. row *****
  Id: 1
  User: system user
  Host:
  db:
Command: Daemon
  Time: 1
  State: Waiting for event from ndbcluster
  Info: NULL
```

Important

To participate in an NDB Cluster, the `mysqld` process must be started with *both* the options `--ndbcluster` and `--ndb-connectstring` (or their equivalents in `my.cnf`). If `mysqld` is started with only the `--ndbcluster` option, or if it is unable to contact the cluster, it is not possible to work with NDB tables, *nor is it possible to create any new tables regardless of storage engine*. The latter restriction is a safety measure intended to prevent the creation of tables having the same names as NDB tables while the SQL node is not connected to the cluster. If you wish to create tables using a different storage engine while the `mysqld` process is not participating in an NDB Cluster, you must restart the server *without* the `--ndbcluster` option.

6.10 NDB Cluster Disk Data Tables

It is possible to store the nonindexed columns of NDB tables on disk, rather than in RAM.

As part of implementing NDB Cluster Disk Data work, a number of improvements were made in NDB Cluster for the efficient handling of very large amounts (terabytes) of data during node recovery and restart. These include a “no-steal” algorithm for synchronizing a starting node with very large data sets. For more information, see the paper [Recovery Principles of NDB Cluster 5.1](#), by NDB Cluster developers Mikael Ronström and Jonas Oreland.

NDB Cluster Disk Data performance can be influenced by a number of configuration parameters. For information about these parameters and their effects, see [NDB Cluster Disk Data configuration parameters](#) and [NDB Cluster Disk Data storage and GCP Stop errors](#)

The performance of an NDB Cluster that uses Disk Data storage can also be greatly improved by separating data node file systems from undo log files and tablespace data files, which can be done using symbolic links. For more information, see [Section 6.10.2, “Using Symbolic Links with Disk Data Objects”](#).

6.10.1 NDB Cluster Disk Data Objects

NDB Cluster Disk Data storage is implemented using a number of *Disk Data objects*. These include the following:

- *Tablespaces* act as containers for other Disk Data objects.
- *Undo log files* undo information required for rolling back transactions.
- One or more undo log files are assigned to a *log file group*, which is then assigned to a tablespace.
- *Data files* store Disk Data table data. A data file is assigned directly to a tablespace.

Undo log files and data files are actual files in the file system of each data node; by default they are placed in `ndb_node_id_fs` in the `DataDir` specified in the NDB Cluster `config.ini` file, and where `node_id` is the data node's node ID. It is possible to place these elsewhere by specifying either an absolute or relative path as part of the filename when creating the undo log or data file. Statements that create these files are shown later in this section.

NDB Cluster tablespaces and log file groups are not implemented as files.

Important

Although not all Disk Data objects are implemented as files, they all share the same namespace. This means that *each Disk Data object* must be uniquely named (and not merely each Disk Data object of a given type). For example, you cannot have a tablespace and a log file group both named `dd1`.

Assuming that you have already set up an NDB Cluster with all nodes (including management and SQL nodes), the basic steps for creating an NDB Cluster table on disk are as follows:

1. Create a log file group, and assign one or more undo log files to it (an undo log file is also sometimes referred to as an *undofile*).

Note

Undo log files are necessary only for Disk Data tables; they are not used for `NDBCLUSTER` tables that are stored only in memory.

2. Create a tablespace; assign the log file group, as well as one or more data files, to the tablespace.
3. Create a Disk Data table that uses this tablespace for data storage.

Each of these tasks can be accomplished using SQL statements in the `mysql` client or other MySQL client application, as shown in the example that follows.

1. We create a log file group named `lg_1` using `CREATE LOGFILE GROUP`. This log file group is to be made up of two undo log files, which we name `undo_1.log` and `undo_2.log`, whose initial sizes are 16 MB and 12 MB, respectively. (The default initial size for an undo log file is 128 MB.) Optionally, you can also specify a size for the log file group's undo buffer, or permit it to assume the default value of 8 MB. In this example, we set the UNDO buffer's size at 2 MB. A log file group must be created with an undo log file; so we add `undo_1.log` to `lg_1` in this `CREATE LOGFILE GROUP` statement:

```
CREATE LOGFILE GROUP lg_1
  ADD UNDOFILE 'undo_1.log'
  INITIAL_SIZE 16M
  UNDO_BUFFER_SIZE 2M
  ENGINE NDBCLUSTER;
```

To add `undo_2.log` to the log file group, use the following `ALTER LOGFILE GROUP` statement:

```
ALTER LOGFILE GROUP lg_1
  ADD UNDOFILE 'undo_2.log'
  INITIAL_SIZE 12M
  ENGINE NDBCLUSTER;
```

Some items of note:

- The `.log` file extension used here is not required. We use it merely to make the log files easily recognizable.
- Every `CREATE LOGFILE GROUP` and `ALTER LOGFILE GROUP` statement must include an `ENGINE` option. The only permitted values for this option are `NDBCLUSTER` and `NDB`.

Important

There can exist at most one log file group in the same NDB Cluster at any given time.

- When you add an undo log file to a log file group using `ADD UNDOFILE 'filename'`, a file with the name `filename` is created in the `ndb_node_id_fs` directory within the `DataDir` of each data node in the cluster, where `node_id` is the node ID of the data node. Each undo log file is of the size specified in the SQL statement. For example, if an NDB Cluster has 4 data nodes, then the `ALTER LOGFILE GROUP` statement just shown creates 4 undo log files, 1 each on in the data directory of each of the 4 data nodes; each of these files is named `undo_2.log` and each file is 12 MB in size.
 - `UNDO_BUFFER_SIZE` is limited by the amount of system memory available.
 - For more information about the `CREATE LOGFILE GROUP` statement, see [CREATE LOGFILE GROUP Statement](#). For more information about `ALTER LOGFILE GROUP`, see [ALTER LOGFILE GROUP Statement](#).
2. Now we can create a tablespace, which contains files to be used by NDB Cluster Disk Data tables for storing their data. A tablespace is also associated with a particular log file group. When creating a new tablespace, you must specify the log file group which it is to use for undo logging; you must also specify a data file. You can add more data files to the tablespace after the tablespace is created; it is also possible to drop data files from a tablespace (an example of dropping data files is provided later in this section).

Assume that we wish to create a tablespace named `ts_1` which uses `lg_1` as its log file group. This tablespace is to contain two data files named `data_1.dat` and `data_2.dat`, whose initial sizes are 32 MB and 48 MB, respectively. (The default value for `INITIAL_SIZE` is 128 MB.) We can do this using two SQL statements, as shown here:

```
CREATE TABLESPACE ts_1
  ADD DATAFILE 'data_1.dat'
  USE LOGFILE GROUP lg_1
```

```

INITIAL_SIZE 32M
ENGINE NDBCLUSTER;

ALTER TABLESPACE ts_1
  ADD DATAFILE 'data_2.dat'
  INITIAL_SIZE 48M
  ENGINE NDBCLUSTER;

```

The `CREATE TABLESPACE` statement creates a tablespace `ts_1` with the data file `data_1.dat`, and associates `ts_1` with log file group `lg_1`. The `ALTER TABLESPACE` adds the second data file (`data_2.dat`).

Some items of note:

- As is the case with the `.log` file extension used in this example for undo log files, there is no special significance for the `.dat` file extension; it is used merely for easy recognition of data files.
 - When you add a data file to a tablespace using `ADD DATAFILE 'filename'`, a file with the name `filename` is created in the `ndb_node_id_fs` directory within the `DataDir` of each data node in the cluster, where `node_id` is the node ID of the data node. Each data file is of the size specified in the SQL statement. For example, if an NDB Cluster has 4 data nodes, then the `ALTER TABLESPACE` statement just shown creates 4 data files, 1 each in the data directory of each of the 4 data nodes; each of these files is named `data_2.dat` and each file is 48 MB in size.
 - NDB 7.6 (and later) reserves 4% of each tablespace for use during data node restarts. This space is not available for storing data.
 - All `CREATE TABLESPACE` and `ALTER TABLESPACE` statements must contain an `ENGINE` clause; only tables using the same storage engine as the tablespace can be created in the tablespace. For NDB Cluster tablespaces, the only permitted values for this option are `NDBCLUSTER` and `NDB`.
 - For more information about the `CREATE TABLESPACE` and `ALTER TABLESPACE` statements, see [CREATE TABLESPACE Statement](#), and [ALTER TABLESPACE Statement](#).
3. Now it is possible to create a table whose nonindexed columns are stored on disk in the tablespace `ts_1`:

```

CREATE TABLE dt_1 (
  member_id INT UNSIGNED NOT NULL AUTO_INCREMENT PRIMARY KEY,
  last_name VARCHAR(50) NOT NULL,
  first_name VARCHAR(50) NOT NULL,
  dob DATE NOT NULL,
  joined DATE NOT NULL,
  INDEX(last_name, first_name)
)
TABLESPACE ts_1 STORAGE DISK
ENGINE NDBCLUSTER;

```

The `TABLESPACE ... STORAGE DISK` option tells the `NDBCLUSTER` storage engine to use tablespace `ts_1` for disk data storage.

Once table `ts_1` has been created as shown, you can perform `INSERT`, `SELECT`, `UPDATE`, and `DELETE` statements on it just as you would with any other MySQL table.

It is also possible to specify whether an individual column is stored on disk or in memory by using a `STORAGE` clause as part of the column's definition in a `CREATE TABLE` or `ALTER TABLE` statement. `STORAGE DISK` causes the column to be stored on disk, and `STORAGE MEMORY` causes in-memory storage to be used. See [CREATE TABLE Statement](#), for more information.

Indexing of columns implicitly stored on disk. For table `dt_1` as defined in the example just shown, only the `dob` and `joined` columns are stored on disk. This is because there are indexes on

the `id`, `last_name`, and `first_name` columns, and so data belonging to these columns is stored in RAM. Only nonindexed columns can be held on disk; indexes and indexed column data continue to be stored in memory. This tradeoff between the use of indexes and conservation of RAM is something you must keep in mind as you design Disk Data tables.

You cannot add an index to a column that has been explicitly declared `STORAGE DISK`, without first changing its storage type to `MEMORY`; any attempt to do so fails with an error. A column which *implicitly* uses disk storage can be indexed; when this is done, the column's storage type is changed to `MEMORY` automatically. By “implicitly”, we mean a column whose storage type is not declared, but which is which inherited from the parent table. In the following CREATE TABLE statement (using the tablespace `ts_1` defined previously), columns `c2` and `c3` use disk storage implicitly:

```
mysql> CREATE TABLE ti (
->   c1 INT PRIMARY KEY,
->   c2 INT,
->   c3 INT,
->   c4 INT
-> )
->   STORAGE DISK
->   TABLESPACE ts_1
->   ENGINE NDBCLUSTER;
Query OK, 0 rows affected (1.31 sec)
```

Because `c2`, `c3`, and `c4` are themselves not declared with `STORAGE DISK`, it is possible to index them. Here, we add indexes to `c2` and `c3`, using, respectively, `CREATE INDEX` and `ALTER TABLE`:

```
mysql> CREATE INDEX i1 ON ti(c2);
Query OK, 0 rows affected (2.72 sec)
Records: 0 Duplicates: 0 Warnings: 0

mysql> ALTER TABLE ti ADD INDEX i2(c3);
Query OK, 0 rows affected (0.92 sec)
Records: 0 Duplicates: 0 Warnings: 0
```

`SHOW CREATE TABLE` confirms that the indexes were added.

```
mysql> SHOW CREATE TABLE ti\G
***** 1. row *****
      Table: ti
Create Table: CREATE TABLE `ti` (
  `c1` int(11) NOT NULL,
  `c2` int(11) DEFAULT NULL,
  `c3` int(11) DEFAULT NULL,
  `c4` int(11) DEFAULT NULL,
  PRIMARY KEY (`c1`),
  KEY `i1` (`c2`),
  KEY `i2` (`c3`)
) /*!50100 TABLESPACE `ts_1` STORAGE DISK */ ENGINE=ndbcluster DEFAULT CHARSET=latin1
1 row in set (0.00 sec)
```

You can see using `ndb_desc` that the indexed columns (emphasized text) now use in-memory rather than on-disk storage:

```
$> ./ndb_desc -d test t1
-- t1 --
Version: 33554433
Fragment type: HashMapPartition
K Value: 6
Min load factor: 78
Max load factor: 80
Temporary table: no
Number of attributes: 4
Number of primary keys: 1
Length of frm data: 317
Max Rows: 0
Row Checksum: 1
Row GCI: 1
SingleUserMode: 0
ForceVarPart: 1
```

```

PartitionCount: 4
FragmentCount: 4
PartitionBalance: FOR_RP_BY_LDM
ExtraRowGciBits: 0
ExtraRowAuthorBits: 0
TableStatus: Retrieved
Table options:
HashMap: DEFAULT-HASHMAP-3840-4
-- Attributes --
c1 Int PRIMARY KEY DISTRIBUTION KEY AT=FIXED ST=MEMORY
c2 Int NULL AT=FIXED ST=MEMORY
c3 Int NULL AT=FIXED ST=MEMORY
c4 Int NULL AT=FIXED ST=DISK
-- Indexes --
PRIMARY KEY(c1) - UniqueHashIndex
i2(c3) - OrderedIndex
PRIMARY(c1) - OrderedIndex
i1(c2) - OrderedIndex

NDBT_ProgramExit: 0 - OK

```

Performance note. The performance of a cluster using Disk Data storage is greatly improved if Disk Data files are kept on a separate physical disk from the data node file system. This must be done for each data node in the cluster to derive any noticeable benefit.

You may use absolute and relative file system paths with [ADD UNDOFILE](#) and [ADD DATAFILE](#). Relative paths are calculated relative to the data node's data directory. You may also use symbolic links; see [Section 6.10.2, "Using Symbolic Links with Disk Data Objects"](#), for more information and examples.

A log file group, a tablespace, and any Disk Data tables using these must be created in a particular order. The same is true for dropping any of these objects:

- A log file group cannot be dropped as long as any tablespaces are using it.
- A tablespace cannot be dropped as long as it contains any data files.
- You cannot drop any data files from a tablespace as long as there remain any tables which are using the tablespace.
- It is not possible to drop files created in association with a different tablespace than the one with which the files were created. (Bug #20053)

For example, to drop all the objects created so far in this section, you would use the following statements:

```

mysql> DROP TABLE dt_1;

mysql> ALTER TABLESPACE ts_1
-> DROP DATAFILE 'data_2.dat'
-> ENGINE NDBCLUSTER;

mysql> ALTER TABLESPACE ts_1
-> DROP DATAFILE 'data_1.dat'
-> ENGINE NDBCLUSTER;

mysql> DROP TABLESPACE ts_1
-> ENGINE NDBCLUSTER;

mysql> DROP LOGFILE GROUP lg_1
-> ENGINE NDBCLUSTER;

```

These statements must be performed in the order shown, except that the two [ALTER TABLESPACE ... DROP DATAFILE](#) statements may be executed in either order.

You can obtain information about data files used by Disk Data tables by querying the [FILES](#) table in the [INFORMATION_SCHEMA](#) database. An extra "NULL row" provides additional information about undo log files. For more information and examples, see [The INFORMATION_SCHEMA FILES Table](#).

6.10.2 Using Symbolic Links with Disk Data Objects

The performance of an NDB Cluster that uses Disk Data storage can be greatly improved by separating the data node file system from any tablespace files (undo log files and data files), and placing these on different disks. In early versions of NDB Cluster, there was no direct support for this in NDB Cluster, and it was necessary to achieve this separation using symbolic links. NDB Cluster now supports the data node configuration parameters `FileSystemPathDD`, `FileSystemPathDataFiles`, and `FileSystemPathUndoFiles`, which make the use of symbolic links for this purpose unnecessary. For more information about these parameters, see [Disk Data file system parameters](#).

6.10.3 NDB Cluster Disk Data Storage Requirements

The following items apply to Disk Data storage requirements:

- Variable-length columns of Disk Data tables take up a fixed amount of space. For each row, this is equal to the space required to store the largest possible value for that column.

For general information about calculating these values, see [Data Type Storage Requirements](#).

You can obtain an estimate the amount of space available in data files and undo log files by querying the `INFORMATION_SCHEMA.FILES` table. For more information and examples, see [The INFORMATION_SCHEMA FILES Table](#).

Note

The `OPTIMIZE TABLE` statement does not have any effect on Disk Data tables.

- In a Disk Data table, the first 256 bytes of a `TEXT` or `BLOB` column are stored in memory; only the remainder is stored on disk.
- Each row in a Disk Data table uses 8 bytes in memory to point to the data stored on disk. This means that, in some cases, converting an in-memory column to the disk-based format can actually result in greater memory usage. For example, converting a `CHAR(4)` column from memory-based to disk-based format increases the amount of `DataMemory` used per row from 4 to 8 bytes.

Important

Starting the cluster with the `--initial` option does *not* remove Disk Data files. You must remove these manually prior to performing an initial restart of the cluster.

Performance of Disk Data tables can be improved by minimizing the number of disk seeks by making sure that `DiskPageBufferMemory` is of sufficient size. You can query the `diskpagebuffer` table to help determine whether the value for this parameter needs to be increased.

6.11 Online Operations with ALTER TABLE in NDB Cluster

MySQL NDB Cluster 7.5 supports online table schema changes using the standard `ALTER TABLE` syntax employed by the MySQL Server (`ALGORITHM=DEFAULT | INPLACE | COPY`), and described elsewhere.

Note

Some older releases of NDB Cluster used a syntax specific to `NDB` for online `ALTER TABLE` operations. That syntax has since been removed.

Operations that add and drop indexes on variable-width columns of `NDB` tables occur online. Online operations are noncopying; that is, they do not require that indexes be re-created. They do not lock

the table being altered from access by other API nodes in an NDB Cluster (but see [Limitations of NDB online operations](#), later in this section). Such operations do not require single user mode for NDB table alterations made in an NDB cluster with multiple API nodes; transactions can continue uninterrupted during online DDL operations.

`ALGORITHM=INPLACE` can be used to perform online `ADD COLUMN`, `ADD INDEX` (including `CREATE INDEX` statements), and `DROP INDEX` operations on NDB tables. Online renaming of NDB tables is also supported.

Currently you cannot add disk-based columns to NDB tables online. This means that, if you wish to add an in-memory column to an NDB table that uses a table-level `STORAGE DISK` option, you must declare the new column as using memory-based storage explicitly. For example—assuming that you have already created tablespace `ts1`—suppose that you create table `t1` as follows:

```
mysql> CREATE TABLE t1 (
>   c1 INT NOT NULL PRIMARY KEY,
>   c2 VARCHAR(30)
> )
> TABLESPACE ts1 STORAGE DISK
> ENGINE NDB;
Query OK, 0 rows affected (1.73 sec)
Records: 0 Duplicates: 0 Warnings: 0
```

You can add a new in-memory column to this table online as shown here:

```
mysql> ALTER TABLE t1
>   ADD COLUMN c3 INT COLUMN_FORMAT DYNAMIC STORAGE MEMORY,
>   ALGORITHM=INPLACE;
Query OK, 0 rows affected (1.25 sec)
Records: 0 Duplicates: 0 Warnings: 0
```

This statement fails if the `STORAGE MEMORY` option is omitted:

```
mysql> ALTER TABLE t1
>   ADD COLUMN c4 INT COLUMN_FORMAT DYNAMIC,
>   ALGORITHM=INPLACE;
ERROR 1846 (0A000): ALGORITHM=INPLACE is not supported. Reason:
Adding column(s) or add/reorganize partition not supported online. Try
ALGORITHM=COPY.
```

If you omit the `COLUMN_FORMAT DYNAMIC` option, the dynamic column format is employed automatically, but a warning is issued, as shown here:

```
mysql> ALTER ONLINE TABLE t1 ADD COLUMN c4 INT STORAGE MEMORY;
Query OK, 0 rows affected, 1 warning (1.17 sec)
Records: 0 Duplicates: 0 Warnings: 0

mysql> SHOW WARNINGS\G
***** 1. row *****
Level: Warning
Code: 1478
Message: DYNAMIC column c4 with STORAGE DISK is not supported, column will
become FIXED

mysql> SHOW CREATE TABLE t1\G
***** 1. row *****
Table: t1
Create Table: CREATE TABLE `t1` (
  `c1` int(11) NOT NULL,
  `c2` varchar(30) DEFAULT NULL,
  `c3` int(11) /*!50606 STORAGE MEMORY */ /*!50606 COLUMN_FORMAT DYNAMIC */ DEFAULT NULL,
  `c4` int(11) /*!50606 STORAGE MEMORY */ DEFAULT NULL,
  PRIMARY KEY (`c1`)
) /*!50606 TABLESPACE ts_1 STORAGE DISK */ ENGINE=ndbcluster DEFAULT CHARSET=latin1
1 row in set (0.03 sec)
```

Note

The `STORAGE` and `COLUMN_FORMAT` keywords are supported only in NDB Cluster; in any other version of MySQL, attempting to use either of these keywords in a `CREATE TABLE` or `ALTER TABLE` statement results in an error.

It is also possible to use the statement `ALTER TABLE ... REORGANIZE PARTITION, ALGORITHM=INPLACE` with no `partition_names INTO (partition_definitions)` option on NDB tables. This can be used to redistribute NDB Cluster data among new data nodes that have been added to the cluster online. This does *not* perform any defragmentation, which requires an `OPTIMIZE TABLE` or null `ALTER TABLE` statement. For more information, see [Section 6.7, “Adding NDB Cluster Data Nodes Online”](#).

Limitations of NDB online operations

Online `DROP COLUMN` operations are not supported.

Online `ALTER TABLE`, `CREATE INDEX`, or `DROP INDEX` statements that add columns or add or drop indexes are subject to the following limitations:

- A given online `ALTER TABLE` can use only one of `ADD COLUMN`, `ADD INDEX`, or `DROP INDEX`. One or more columns can be added online in a single statement; only one index may be created or dropped online in a single statement.
- The table being altered is not locked with respect to API nodes other than the one on which an online `ALTER TABLE ADD COLUMN`, `ADD INDEX`, or `DROP INDEX` operation (or `CREATE INDEX` or `DROP INDEX` statement) is run. However, the table is locked against any other operations originating on the *same* API node while the online operation is being executed.
- The table to be altered must have an explicit primary key; the hidden primary key created by the NDB storage engine is not sufficient for this purpose.
- The storage engine used by the table cannot be changed online.
- The tablespace used by the table cannot be changed online. (Bug #99269, Bug #31180526)
- When used with NDB Cluster Disk Data tables, it is not possible to change the storage type (`DISK` or `MEMORY`) of a column online. This means, that when you add or drop an index in such a way that the operation would be performed online, and you want the storage type of the column or columns to be changed, you must use `ALGORITHM=COPY` in the statement that adds or drops the index.

Columns to be added online cannot use the `BLOB` or `TEXT` type, and must meet the following criteria:

- The columns must be dynamic; that is, it must be possible to create them using `COLUMN_FORMAT DYNAMIC`. If you omit the `COLUMN_FORMAT DYNAMIC` option, the dynamic column format is employed automatically.
- The columns must permit `NULL` values and not have any explicit default value other than `NULL`. Columns added online are automatically created as `DEFAULT NULL`, as can be seen here:

```
mysql> CREATE TABLE t2 (
>   c1 INT NOT NULL AUTO_INCREMENT PRIMARY KEY
> ) ENGINE=NDB;
Query OK, 0 rows affected (1.44 sec)

mysql> ALTER TABLE t2
>   ADD COLUMN c2 INT,
>   ADD COLUMN c3 INT,
>   ALGORITHM=INPLACE;
Query OK, 0 rows affected, 2 warnings (0.93 sec)

mysql> SHOW CREATE TABLE t1\G
***** 1. row *****
Table: t1
```

```

Create Table: CREATE TABLE `t2` (
  `c1` int(11) NOT NULL AUTO_INCREMENT,
  `c2` int(11) DEFAULT NULL,
  `c3` int(11) DEFAULT NULL,
  PRIMARY KEY (`c1`)
) ENGINE=ndbcluster DEFAULT CHARSET=latin1
1 row in set (0.00 sec)

```

- The columns must be added following any existing columns. If you attempt to add a column online before any existing columns or using the `FIRST` keyword, the statement fails with an error.
- Existing table columns cannot be reordered online.

For online `ALTER TABLE` operations on NDB tables, fixed-format columns are converted to dynamic when they are added online, or when indexes are created or dropped online, as shown here (repeating the `CREATE TABLE` and `ALTER TABLE` statements just shown for the sake of clarity):

```

mysql> CREATE TABLE t2 (
>   c1 INT NOT NULL AUTO_INCREMENT PRIMARY KEY
>   ) ENGINE=NDB;
Query OK, 0 rows affected (1.44 sec)

mysql> ALTER TABLE t2
>   ADD COLUMN c2 INT,
>   ADD COLUMN c3 INT,
>   ALGORITHM=INPLACE;
Query OK, 0 rows affected, 2 warnings (0.93 sec)

mysql> SHOW WARNINGS;
***** 1. row *****
Level: Warning
Code: 1478
Message: Converted FIXED field 'c2' to DYNAMIC to enable online ADD COLUMN
***** 2. row *****
Level: Warning
Code: 1478
Message: Converted FIXED field 'c3' to DYNAMIC to enable online ADD COLUMN
2 rows in set (0.00 sec)

```

Only the column or columns to be added online must be dynamic. Existing columns need not be; this includes the table's primary key, which may also be `FIXED`, as shown here:

```

mysql> CREATE TABLE t3 (
>   c1 INT NOT NULL AUTO_INCREMENT PRIMARY KEY COLUMN_FORMAT FIXED
>   ) ENGINE=NDB;
Query OK, 0 rows affected (2.10 sec)

mysql> ALTER TABLE t3 ADD COLUMN c2 INT, ALGORITHM=INPLACE;
Query OK, 0 rows affected, 1 warning (0.78 sec)
Records: 0 Duplicates: 0 Warnings: 0

mysql> SHOW WARNINGS;
***** 1. row *****
Level: Warning
Code: 1478
Message: Converted FIXED field 'c2' to DYNAMIC to enable online ADD COLUMN
1 row in set (0.00 sec)

```

Columns are not converted from `FIXED` to `DYNAMIC` column format by renaming operations. For more information about `COLUMN_FORMAT`, see [CREATE TABLE Statement](#).

The `KEY`, `CONSTRAINT`, and `IGNORE` keywords are supported in `ALTER TABLE` statements using `ALGORITHM=INPLACE`.

Beginning with NDB Cluster 7.5.7, setting `MAX_ROWS` to 0 using an online `ALTER TABLE` statement is disallowed. You must use a copying `ALTER TABLE` to perform this operation. (Bug #21960004)

6.12 Distributed Privileges Using Shared Grant Tables

NDB Cluster supports distribution of MySQL users and privileges across all SQL nodes in an NDB Cluster. This support is not enabled by default; you should follow the procedure outlined in this section in order to do so.

Normally, each MySQL server's user privilege tables in the `mysql` database must use the `MyISAM` storage engine, which means that a user account and its associated privileges created on one SQL node are not available on the cluster's other SQL nodes. An SQL file `ndb_dist_priv.sql` provided with the NDB Cluster distribution can be found in the `share` directory in the MySQL installation directory.

The first step in enabling distributed privileges is to load this script into a MySQL Server that functions as an SQL node (which we refer to after this as the *target* SQL node or MySQL Server). You can do this by executing the following command from the system shell on the target SQL node after changing to its MySQL installation directory (where `options` stands for any additional options needed to connect to this SQL node):

```
$> mysql options -uroot < share/ndb_dist_priv.sql
```

Importing `ndb_dist_priv.sql` creates a number of stored routines (six stored procedures and one stored function) in the `mysql` database on the target SQL node. After connecting to the SQL node in the `mysql` client (as the MySQL `root` user), you can verify that these were created as shown here:

```
mysql> SELECT ROUTINE_NAME, ROUTINE_SCHEMA, ROUTINE_TYPE
-> FROM INFORMATION_SCHEMA.ROUTINES
-> WHERE ROUTINE_NAME LIKE 'mysql_cluster%'
-> ORDER BY ROUTINE_TYPE;
```

ROUTINE_NAME	ROUTINE_SCHEMA	ROUTINE_TYPE
mysql_cluster_privileges_are_distributed	mysql	FUNCTION
mysql_cluster_backup_privileges	mysql	PROCEDURE
mysql_cluster_move_grant_tables	mysql	PROCEDURE
mysql_cluster_move_privileges	mysql	PROCEDURE
mysql_cluster_restore_local_privileges	mysql	PROCEDURE
mysql_cluster_restore_privileges	mysql	PROCEDURE
mysql_cluster_restore_privileges_from_local	mysql	PROCEDURE

```
7 rows in set (0.01 sec)
```

The stored procedure named `mysql_cluster_move_privileges` creates backup copies of the existing privilege tables, then converts them to `NDB`.

`mysql_cluster_move_privileges` performs the backup and conversion in two steps. The first step is to call `mysql_cluster_backup_privileges`, which creates two sets of copies in the `mysql` database:

- A set of local copies that use the `MyISAM` storage engine. Their names are generated by adding the suffix `_backup` to the original privilege table names.
- A set of distributed copies that use the `NDBCLUSTER` storage engine. These tables are named by prefixing `ndb_` and appending `_backup` to the names of the original tables.

After the copies are created, `mysql_cluster_move_privileges` invokes `mysql_cluster_move_grant_tables`, which contains the `ALTER TABLE ... ENGINE = NDB` statements that convert the `mysql` system tables to `NDB`.

Normally, you should not invoke either `mysql_cluster_backup_privileges` or `mysql_cluster_move_grant_tables` manually; these stored procedures are intended only for use by `mysql_cluster_move_privileges`.

Although the original privilege tables are backed up automatically, it is always a good idea to create backups manually of the existing privilege tables on all affected SQL nodes before proceeding. You can do this using `mysqldump` in a manner similar to what is shown here:

```
$> mysqldump options -uroot \
mysql user db tables_priv columns_priv procs_priv proxies_priv > backup_file
```

To perform the conversion, you must be connected to the target SQL node using the `mysql` client (again, as the MySQL `root` user). Invoke the stored procedure like this:

```
mysql> CALL mysql.mysql_cluster_move_privileges();
Query OK, 0 rows affected (22.32 sec)
```

Depending on the number of rows in the privilege tables, this procedure may take some time to execute. If some of the privilege tables are empty, you may see one or more `No data - zero rows fetched, selected, or processed` warnings when `mysql_cluster_move_privileges` returns. In such cases, the warnings may be safely ignored. To verify that the conversion was successful, you can use the stored function `mysql_cluster_privileges_are_distributed` as shown here:

```
mysql> SELECT CONCAT(
-> 'Conversion ',
-> IF(mysql.mysql_cluster_privileges_are_distributed(), 'succeeded', 'failed'),
-> '.')
-> AS Result;
+-----+
| Result |
+-----+
| Conversion succeeded. |
+-----+
1 row in set (0.00 sec)
```

`mysql_cluster_privileges_are_distributed` checks for the existence of the distributed privilege tables and returns `1` if all of the privilege tables are distributed; otherwise, it returns `0`.

You can verify that the backups have been created using a query such as this one:

```
mysql> SELECT TABLE_NAME, ENGINE FROM INFORMATION_SCHEMA.TABLES
-> WHERE TABLE_SCHEMA = 'mysql' AND TABLE_NAME LIKE '%backup'
-> ORDER BY ENGINE;
+-----+-----+
| TABLE_NAME | ENGINE |
+-----+-----+
| db_backup | MyISAM |
| user_backup | MyISAM |
| columns_priv_backup | MyISAM |
| tables_priv_backup | MyISAM |
| proxies_priv_backup | MyISAM |
| procs_priv_backup | MyISAM |
| ndb_columns_priv_backup | ndbcluster |
| ndb_user_backup | ndbcluster |
| ndb_tables_priv_backup | ndbcluster |
| ndb_proxies_priv_backup | ndbcluster |
| ndb_procs_priv_backup | ndbcluster |
| ndb_db_backup | ndbcluster |
+-----+-----+
12 rows in set (0.00 sec)
```

Once the conversion to distributed privileges has been made, any time a MySQL user account is created, dropped, or has its privileges updated on any SQL node, the changes take effect immediately on all other MySQL servers attached to the cluster. Once privileges are distributed, any new MySQL Servers that connect to the cluster automatically participate in the distribution.

Note

For clients connected to SQL nodes at the time that `mysql_cluster_move_privileges` is executed, you may need to execute `FLUSH PRIVILEGES` on those SQL nodes, or to disconnect and then reconnect the clients, in order for those clients to be able to see the changes in privileges.

All MySQL user privileges are distributed across all connected MySQL Servers. This includes any privileges associated with views and stored routines, even though distribution of views and stored routines themselves is not currently supported.

In the event that an SQL node becomes disconnected from the cluster while `mysql_cluster_move_privileges` is running, you must drop its privilege tables after reconnecting to the cluster, using a statement such as `DROP TABLE IF EXISTS mysql.user mysql.db mysql.tables_priv mysql.columns_priv mysql.procs_priv`. This causes the SQL node to use the shared privilege tables rather than its own local versions of them. This is not needed when connecting a new SQL node to the cluster for the first time.

In the event of an initial restart of the entire cluster (all data nodes shut down, then started again with `--initial`), the shared privilege tables are lost. If this happens, you can restore them using the original target SQL node either from the backups made by `mysql_cluster_move_privileges` or from a dump file created with `mysqldump`. If you need to use a new MySQL Server to perform the restoration, you should start it with `--skip-grant-tables` when connecting to the cluster for the first time; after this, you can restore the privilege tables locally, then distribute them again using `mysql_cluster_move_privileges`. After restoring and distributing the tables, you should restart this MySQL Server without the `--skip-grant-tables` option.

You can also restore the distributed tables using `ndb_restore --restore-privilege-tables` from a backup made using `START BACKUP` in the `ndb_mgm` client. (The `MyISAM` tables created by `mysql_cluster_move_privileges` are not backed up by the `START BACKUP` command.) `ndb_restore` does not restore the privilege tables by default; the `--restore-privilege-tables` option causes it to do so.

You can restore the SQL node's local privileges using either of two procedures. `mysql_cluster_restore_privileges` works as follows:

1. If copies of the `mysql.ndb*_backup` tables are available, attempt to restore the system tables from these.
2. Otherwise, attempt to restore the system tables from the local backups named `*_backup` (without the `ndb_` prefix).

The other procedure, named `mysql_cluster_restore_local_privileges`, restores the system tables from the local backups only, without checking the `ndb_*` backups.

The system tables re-created by `mysql_cluster_restore_privileges` or `mysql_cluster_restore_local_privileges` use the MySQL server default storage engine; they are not shared or distributed in any way, and do not use NDB Cluster's `NDB` storage engine.

The additional stored procedure `mysql_cluster_restore_privileges_from_local` is intended for the use of `mysql_cluster_restore_privileges` and `mysql_cluster_restore_local_privileges`. It should not be invoked directly.

Important

Applications that access NDB Cluster data directly, including NDB API and ClusterJ applications, are not subject to the MySQL privilege system. This means that, once you have distributed the grant tables, they can be freely accessed by such applications, just as they can any other `NDB` tables. In particular, you should keep in mind that *NDB API and ClusterJ applications can read and write user names, host names, password hashes, and any other contents of the distributed grant tables without any restrictions.*

6.13 NDB API Statistics Counters and Variables

A number of types of statistical counters relating to actions performed by or affecting `Ndb` objects are available. Such actions include starting and closing (or aborting) transactions; primary key and unique key operations; table, range, and pruned scans; threads blocked while waiting for the completion

of various operations; and data and events sent and received by `NDBCLUSTER`. The counters are incremented inside the NDB kernel whenever NDB API calls are made or data is sent to or received by the data nodes. `mysqld` exposes these counters as system status variables; their values can be read in the output of `SHOW STATUS`, or by querying the `INFORMATION_SCHEMA.SESSION_STATUS` or `INFORMATION_SCHEMA.GLOBAL_STATUS` table. By comparing the values before and after statements operating on NDB tables, you can observe the corresponding actions taken on the API level, and thus the cost of performing the statement.

You can list all of these status variables using the following `SHOW STATUS` statement:

```
mysql> SHOW STATUS LIKE 'ndb_api%';
```

Variable_name	Value
Ndb_api_wait_exec_complete_count_session	0
Ndb_api_wait_scan_result_count_session	0
Ndb_api_wait_meta_request_count_session	0
Ndb_api_wait_nanos_count_session	0
Ndb_api_bytes_sent_count_session	0
Ndb_api_bytes_received_count_session	0
Ndb_api_trans_start_count_session	0
Ndb_api_trans_commit_count_session	0
Ndb_api_trans_abort_count_session	0
Ndb_api_trans_close_count_session	0
Ndb_api_pk_op_count_session	0
Ndb_api_uk_op_count_session	0
Ndb_api_table_scan_count_session	0
Ndb_api_range_scan_count_session	0
Ndb_api_pruned_scan_count_session	0
Ndb_api_scan_batch_count_session	0
Ndb_api_read_row_count_session	0
Ndb_api_trans_local_read_row_count_session	0
Ndb_api_event_data_count_injector	0
Ndb_api_event_nondata_count_injector	0
Ndb_api_event_bytes_count_injector	0
Ndb_api_wait_exec_complete_count_slave	0
Ndb_api_wait_scan_result_count_slave	0
Ndb_api_wait_meta_request_count_slave	0
Ndb_api_wait_nanos_count_slave	0
Ndb_api_bytes_sent_count_slave	0
Ndb_api_bytes_received_count_slave	0
Ndb_api_trans_start_count_slave	0
Ndb_api_trans_commit_count_slave	0
Ndb_api_trans_abort_count_slave	0
Ndb_api_trans_close_count_slave	0
Ndb_api_pk_op_count_slave	0
Ndb_api_uk_op_count_slave	0
Ndb_api_table_scan_count_slave	0
Ndb_api_range_scan_count_slave	0
Ndb_api_pruned_scan_count_slave	0
Ndb_api_scan_batch_count_slave	0
Ndb_api_read_row_count_slave	0
Ndb_api_trans_local_read_row_count_slave	0
Ndb_api_wait_exec_complete_count	2
Ndb_api_wait_scan_result_count	3
Ndb_api_wait_meta_request_count	27
Ndb_api_wait_nanos_count	45612023
Ndb_api_bytes_sent_count	992
Ndb_api_bytes_received_count	9640
Ndb_api_trans_start_count	2
Ndb_api_trans_commit_count	1
Ndb_api_trans_abort_count	0
Ndb_api_trans_close_count	2
Ndb_api_pk_op_count	1
Ndb_api_uk_op_count	0
Ndb_api_table_scan_count	1
Ndb_api_range_scan_count	0
Ndb_api_pruned_scan_count	0
Ndb_api_scan_batch_count	0
Ndb_api_read_row_count	1
Ndb_api_trans_local_read_row_count	1

Ndb_api_event_data_count	0
Ndb_api_event_nondata_count	0
Ndb_api_event_bytes_count	0

-----+-----

60 rows in set (0.02 sec)

These status variables are also available from the [SESSION_STATUS](#) and [GLOBAL_STATUS](#) tables of the [INFORMATION_SCHEMA](#) database, as shown here:

```
mysql> SELECT * FROM INFORMATION_SCHEMA.SESSION_STATUS
-> WHERE VARIABLE_NAME LIKE 'ndb_api%';
```

VARIABLE_NAME	VARIABLE_VALUE
NDB_API_WAIT_EXEC_COMPLETE_COUNT_SESSION	2
NDB_API_WAIT_SCAN_RESULT_COUNT_SESSION	0
NDB_API_WAIT_META_REQUEST_COUNT_SESSION	1
NDB_API_WAIT_NANOS_COUNT_SESSION	8144375
NDB_API_BYTES_SENT_COUNT_SESSION	68
NDB_API_BYTES_RECEIVED_COUNT_SESSION	84
NDB_API_TRANS_START_COUNT_SESSION	1
NDB_API_TRANS_COMMIT_COUNT_SESSION	1
NDB_API_TRANS_ABORT_COUNT_SESSION	0
NDB_API_TRANS_CLOSE_COUNT_SESSION	1
NDB_API_PK_OP_COUNT_SESSION	1
NDB_API_UK_OP_COUNT_SESSION	0
NDB_API_TABLE_SCAN_COUNT_SESSION	0
NDB_API_RANGE_SCAN_COUNT_SESSION	0
NDB_API_PRUNED_SCAN_COUNT_SESSION	0
NDB_API_SCAN_BATCH_COUNT_SESSION	0
NDB_API_READ_ROW_COUNT_SESSION	1
NDB_API_TRANS_LOCAL_READ_ROW_COUNT_SESSION	1
NDB_API_EVENT_DATA_COUNT_INJECTOR	0
NDB_API_EVENT_NONDATA_COUNT_INJECTOR	0
NDB_API_EVENT_BYTES_COUNT_INJECTOR	0
NDB_API_WAIT_EXEC_COMPLETE_COUNT_SLAVE	0
NDB_API_WAIT_SCAN_RESULT_COUNT_SLAVE	0
NDB_API_WAIT_META_REQUEST_COUNT_SLAVE	0
NDB_API_WAIT_NANOS_COUNT_SLAVE	0
NDB_API_BYTES_SENT_COUNT_SLAVE	0
NDB_API_BYTES_RECEIVED_COUNT_SLAVE	0
NDB_API_TRANS_START_COUNT_SLAVE	0
NDB_API_TRANS_COMMIT_COUNT_SLAVE	0
NDB_API_TRANS_ABORT_COUNT_SLAVE	0
NDB_API_TRANS_CLOSE_COUNT_SLAVE	0
NDB_API_PK_OP_COUNT_SLAVE	0
NDB_API_UK_OP_COUNT_SLAVE	0
NDB_API_TABLE_SCAN_COUNT_SLAVE	0
NDB_API_RANGE_SCAN_COUNT_SLAVE	0
NDB_API_PRUNED_SCAN_COUNT_SLAVE	0
NDB_API_SCAN_BATCH_COUNT_SLAVE	0
NDB_API_READ_ROW_COUNT_SLAVE	0
NDB_API_TRANS_LOCAL_READ_ROW_COUNT_SLAVE	0
NDB_API_WAIT_EXEC_COMPLETE_COUNT	4
NDB_API_WAIT_SCAN_RESULT_COUNT	3
NDB_API_WAIT_META_REQUEST_COUNT	28
NDB_API_WAIT_NANOS_COUNT	53756398
NDB_API_BYTES_SENT_COUNT	1060
NDB_API_BYTES_RECEIVED_COUNT	9724
NDB_API_TRANS_START_COUNT	3
NDB_API_TRANS_COMMIT_COUNT	2
NDB_API_TRANS_ABORT_COUNT	0
NDB_API_TRANS_CLOSE_COUNT	3
NDB_API_PK_OP_COUNT	2
NDB_API_UK_OP_COUNT	0
NDB_API_TABLE_SCAN_COUNT	1
NDB_API_RANGE_SCAN_COUNT	0
NDB_API_PRUNED_SCAN_COUNT	0
NDB_API_SCAN_BATCH_COUNT	0
NDB_API_READ_ROW_COUNT	2
NDB_API_TRANS_LOCAL_READ_ROW_COUNT	2
NDB_API_EVENT_DATA_COUNT	0

NDB API Statistics Counters and Variables

```

| NDB_API_EVENT_NONDATA_COUNT | 0 |
| NDB_API_EVENT_BYTES_COUNT | 0 |
+-----+-----+
60 rows in set (0.00 sec)

mysql> SELECT * FROM INFORMATION_SCHEMA.GLOBAL_STATUS
-> WHERE VARIABLE_NAME LIKE 'ndb_api%';
+-----+-----+
| VARIABLE_NAME | VARIABLE_VALUE |
+-----+-----+
| NDB_API_WAIT_EXEC_COMPLETE_COUNT_SESSION | 2 |
| NDB_API_WAIT_SCAN_RESULT_COUNT_SESSION | 0 |
| NDB_API_WAIT_META_REQUEST_COUNT_SESSION | 1 |
| NDB_API_WAIT_NANOS_COUNT_SESSION | 8144375 |
| NDB_API_BYTES_SENT_COUNT_SESSION | 68 |
| NDB_API_BYTES_RECEIVED_COUNT_SESSION | 84 |
| NDB_API_TRANS_START_COUNT_SESSION | 1 |
| NDB_API_TRANS_COMMIT_COUNT_SESSION | 1 |
| NDB_API_TRANS_ABORT_COUNT_SESSION | 0 |
| NDB_API_TRANS_CLOSE_COUNT_SESSION | 1 |
| NDB_API_PK_OP_COUNT_SESSION | 1 |
| NDB_API_UK_OP_COUNT_SESSION | 0 |
| NDB_API_TABLE_SCAN_COUNT_SESSION | 0 |
| NDB_API_RANGE_SCAN_COUNT_SESSION | 0 |
| NDB_API_PRUNED_SCAN_COUNT_SESSION | 0 |
| NDB_API_SCAN_BATCH_COUNT_SESSION | 0 |
| NDB_API_READ_ROW_COUNT_SESSION | 1 |
| NDB_API_TRANS_LOCAL_READ_ROW_COUNT_SESSION | 1 |
| NDB_API_EVENT_DATA_COUNT_INJECTOR | 0 |
| NDB_API_EVENT_NONDATA_COUNT_INJECTOR | 0 |
| NDB_API_EVENT_BYTES_COUNT_INJECTOR | 0 |
| NDB_API_WAIT_EXEC_COMPLETE_COUNT_SLAVE | 0 |
| NDB_API_WAIT_SCAN_RESULT_COUNT_SLAVE | 0 |
| NDB_API_WAIT_META_REQUEST_COUNT_SLAVE | 0 |
| NDB_API_WAIT_NANOS_COUNT_SLAVE | 0 |
| NDB_API_BYTES_SENT_COUNT_SLAVE | 0 |
| NDB_API_BYTES_RECEIVED_COUNT_SLAVE | 0 |
| NDB_API_TRANS_START_COUNT_SLAVE | 0 |
| NDB_API_TRANS_COMMIT_COUNT_SLAVE | 0 |
| NDB_API_TRANS_ABORT_COUNT_SLAVE | 0 |
| NDB_API_TRANS_CLOSE_COUNT_SLAVE | 0 |
| NDB_API_PK_OP_COUNT_SLAVE | 0 |
| NDB_API_UK_OP_COUNT_SLAVE | 0 |
| NDB_API_TABLE_SCAN_COUNT_SLAVE | 0 |
| NDB_API_RANGE_SCAN_COUNT_SLAVE | 0 |
| NDB_API_PRUNED_SCAN_COUNT_SLAVE | 0 |
| NDB_API_SCAN_BATCH_COUNT_SLAVE | 0 |
| NDB_API_READ_ROW_COUNT_SLAVE | 0 |
| NDB_API_TRANS_LOCAL_READ_ROW_COUNT_SLAVE | 0 |
| NDB_API_WAIT_EXEC_COMPLETE_COUNT | 4 |
| NDB_API_WAIT_SCAN_RESULT_COUNT | 3 |
| NDB_API_WAIT_META_REQUEST_COUNT | 28 |
| NDB_API_WAIT_NANOS_COUNT | 53756398 |
| NDB_API_BYTES_SENT_COUNT | 1060 |
| NDB_API_BYTES_RECEIVED_COUNT | 9724 |
| NDB_API_TRANS_START_COUNT | 3 |
| NDB_API_TRANS_COMMIT_COUNT | 2 |
| NDB_API_TRANS_ABORT_COUNT | 0 |
| NDB_API_TRANS_CLOSE_COUNT | 3 |
| NDB_API_PK_OP_COUNT | 2 |
| NDB_API_UK_OP_COUNT | 0 |
| NDB_API_TABLE_SCAN_COUNT | 1 |
| NDB_API_RANGE_SCAN_COUNT | 0 |
| NDB_API_PRUNED_SCAN_COUNT | 0 |
| NDB_API_SCAN_BATCH_COUNT | 0 |
| NDB_API_READ_ROW_COUNT | 2 |
| NDB_API_TRANS_LOCAL_READ_ROW_COUNT | 2 |
| NDB_API_EVENT_DATA_COUNT | 0 |
| NDB_API_EVENT_NONDATA_COUNT | 0 |
| NDB_API_EVENT_BYTES_COUNT | 0 |
+-----+-----+
60 rows in set (0.00 sec)

```

Each `Ndb` object has its own counters. NDB API applications can read the values of the counters for use in optimization or monitoring. For multithreaded clients which use more than one `Ndb` object concurrently, it is also possible to obtain a summed view of counters from all `Ndb` objects belonging to a given `Ndb_cluster_connection`.

Four sets of these counters are exposed. One set applies to the current session only; the other 3 are global. *This is in spite of the fact that their values can be obtained as either session or global status variables in the `mysql` client.* This means that specifying the `SESSION` or `GLOBAL` keyword with `SHOW STATUS` has no effect on the values reported for NDB API statistics status variables, and the value for each of these variables is the same whether the value is obtained from the equivalent column of the `SESSION_STATUS` or the `GLOBAL_STATUS` table.

- *Session counters (session specific)*

Session counters relate to the `Ndb` objects in use by (only) the current session. Use of such objects by other MySQL clients does not influence these counts.

In order to minimize confusion with standard MySQL session variables, we refer to the variables that correspond to these NDB API session counters as “`_session` variables”, with a leading underscore.

- *Replica counters (global)*

This set of counters relates to the `Ndb` objects used by the replicat SQL thread, if any. If this `mysqld` does not act as a replica, or does not use `NDB` tables, then all of these counts are 0.

We refer to the related status variables as “`_slave` variables” (with a leading underscore).

- *Injector counters (global)*

Injector counters relate to the `Ndb` object used to listen to cluster events by the binary log injector thread. Even when not writing a binary log, `mysqld` processes attached to an NDB Cluster continue to listen for some events, such as schema changes.

We refer to the status variables that correspond to NDB API injector counters as “`_injector` variables” (with a leading underscore).

- *Server (Global) counters (global)*

This set of counters relates to all `Ndb` objects currently used by this `mysqld`. This includes all MySQL client applications, the replica SQL thread (if any), the binlog injector, and the `NDB` utility thread.

We refer to the status variables that correspond to these counters as “global variables” or “`mysqld`-level variables”.

You can obtain values for a particular set of variables by additionally filtering for the substring `session`, `slave`, or `injector` in the variable name (along with the common prefix `Ndb_api`). For `_session` variables, this can be done as shown here:

```
mysql> SHOW STATUS LIKE 'ndb_api%session';
```

Variable_name	Value
Ndb_api_wait_exec_complete_count_session	2
Ndb_api_wait_scan_result_count_session	0
Ndb_api_wait_meta_request_count_session	1
Ndb_api_wait_nanos_count_session	8144375
Ndb_api_bytes_sent_count_session	68
Ndb_api_bytes_received_count_session	84
Ndb_api_trans_start_count_session	1
Ndb_api_trans_commit_count_session	1
Ndb_api_trans_abort_count_session	0
Ndb_api_trans_close_count_session	1

```

| Ndb_api_pk_op_count_session          | 1 |
| Ndb_api_uk_op_count_session          | 0 |
| Ndb_api_table_scan_count_session     | 0 |
| Ndb_api_range_scan_count_session     | 0 |
| Ndb_api_pruned_scan_count_session    | 0 |
| Ndb_api_scan_batch_count_session     | 0 |
| Ndb_api_read_row_count_session       | 1 |
| Ndb_api_trans_local_read_row_count_session | 1 |
+-----+-----+
18 rows in set (0.50 sec)

```

To obtain a listing of the NDB API `mysqld`-level status variables, filter for variable names beginning with `ndb_api` and ending in `_count`, like this:

```

mysql> SELECT * FROM INFORMATION_SCHEMA.SESSION_STATUS
-> WHERE VARIABLE_NAME LIKE 'ndb_api%count';
+-----+-----+
| VARIABLE_NAME                | VARIABLE_VALUE |
+-----+-----+
| NDB_API_WAIT_EXEC_COMPLETE_COUNT | 4              |
| NDB_API_WAIT_SCAN_RESULT_COUNT  | 3              |
| NDB_API_WAIT_META_REQUEST_COUNT | 28             |
| NDB_API_WAIT_NANOS_COUNT        | 53756398      |
| NDB_API_BYTES_SENT_COUNT        | 1060           |
| NDB_API_BYTES_RECEIVED_COUNT    | 9724           |
| NDB_API_TRANS_START_COUNT       | 3              |
| NDB_API_TRANS_COMMIT_COUNT      | 2              |
| NDB_API_TRANS_ABORT_COUNT       | 0              |
| NDB_API_TRANS_CLOSE_COUNT       | 3              |
| NDB_API_PK_OP_COUNT             | 2              |
| NDB_API_UK_OP_COUNT             | 0              |
| NDB_API_TABLE_SCAN_COUNT        | 1              |
| NDB_API_RANGE_SCAN_COUNT        | 0              |
| NDB_API_PRUNED_SCAN_COUNT       | 0              |
| NDB_API_SCAN_BATCH_COUNT        | 0              |
| NDB_API_READ_ROW_COUNT          | 2              |
| NDB_API_TRANS_LOCAL_READ_ROW_COUNT | 2              |
| NDB_API_EVENT_DATA_COUNT        | 0              |
| NDB_API_EVENT_NONDATA_COUNT     | 0              |
| NDB_API_EVENT_BYTES_COUNT       | 0              |
+-----+-----+
21 rows in set (0.09 sec)

```

Not all counters are reflected in all 4 sets of status variables. For the event counters `DataEventsRecvdCount`, `NondataEventsRecvdCount`, and `EventBytesRecvdCount`, only `_injector` and `mysqld`-level NDB API status variables are available:

```

mysql> SHOW STATUS LIKE 'ndb_api%event%';
+-----+-----+
| Variable_name                | Value |
+-----+-----+
| Ndb_api_event_data_count_injector | 0     |
| Ndb_api_event_nondata_count_injector | 0     |
| Ndb_api_event_bytes_count_injector | 0     |
| Ndb_api_event_data_count         | 0     |
| Ndb_api_event_nondata_count      | 0     |
| Ndb_api_event_bytes_count        | 0     |
+-----+-----+
6 rows in set (0.00 sec)

```

`_injector` status variables are not implemented for any other NDB API counters, as shown here:

```

mysql> SHOW STATUS LIKE 'ndb_api%injector%';
+-----+-----+
| Variable_name                | Value |
+-----+-----+
| Ndb_api_event_data_count_injector | 0     |
| Ndb_api_event_nondata_count_injector | 0     |
| Ndb_api_event_bytes_count_injector | 0     |
+-----+-----+
3 rows in set (0.00 sec)

```

The names of the status variables can easily be associated with the names of the corresponding counters. Each NDB API statistics counter is listed in the following table with a description as well as the names of any MySQL server status variables corresponding to this counter.

Table 6.15 NDB API statistics counters

Counter Name	Description	Status Variables (by statistic type):
<code>WaitExecCompleteCount</code>	Number of times thread has been blocked while waiting for execution of an operation to complete. Includes all <code>execute()</code> calls as well as implicit executes for blob operations and auto-increment not visible to clients.	<ul style="list-style-type: none"> • Session • Slave (replica) • Injector • Server <ul style="list-style-type: none"> • <code>Ndb_api_wait_exec_complete_count</code> • <code>Ndb_api_wait_exec_complete_count_slave</code> • [none] • <code>Ndb_api_wait_exec_complete_count_injector</code> • <code>Ndb_api_wait_exec_complete_count_server</code>
<code>WaitScanResultCount</code>	Number of times thread has been blocked while waiting for a scan-based signal, such waiting for additional results, or for a scan to close.	<ul style="list-style-type: none"> • <code>Ndb_api_wait_scan_result_count</code> • <code>Ndb_api_wait_scan_result_count_slave</code> • [none] • <code>Ndb_api_wait_scan_result_count_injector</code> • <code>Ndb_api_wait_scan_result_count_server</code>
<code>WaitMetaRequestCount</code>	Number of times thread has been blocked waiting for a metadata-based signal; this can occur when waiting for a DDL operation or for an epoch to be started (or ended).	<ul style="list-style-type: none"> • <code>Ndb_api_wait_meta_request_count</code> • <code>Ndb_api_wait_meta_request_count_slave</code> • [none] • <code>Ndb_api_wait_meta_request_count_injector</code> • <code>Ndb_api_wait_meta_request_count_server</code>
<code>WaitNanosCount</code>	Total time (in nanoseconds) spent waiting for some type of signal from the data nodes.	<ul style="list-style-type: none"> • <code>Ndb_api_wait_nanos_count_session</code> • <code>Ndb_api_wait_nanos_count_slave</code> • [none] • <code>Ndb_api_wait_nanos_count_injector</code> • <code>Ndb_api_wait_nanos_count_server</code>
<code>BytesSentCount</code>	Amount of data (in bytes) sent to the data nodes	<ul style="list-style-type: none"> • <code>Ndb_api_bytes_sent_count_session</code> • <code>Ndb_api_bytes_sent_count_slave</code> • [none] • <code>Ndb_api_bytes_sent_count_injector</code> • <code>Ndb_api_bytes_sent_count_server</code>
<code>BytesRecvdCount</code>	Amount of data (in bytes) received from the data nodes	<ul style="list-style-type: none"> • <code>Ndb_api_bytes_received_count_session</code> • <code>Ndb_api_bytes_received_count_slave</code> • [none] • <code>Ndb_api_bytes_received_count_injector</code> • <code>Ndb_api_bytes_received_count_server</code>

Counter Name	Description	Status Variables (by statistic type):
TransStartCount	Number of transactions started.	<ul style="list-style-type: none"> • Session • Slave (replica) • Injector • Server
TransCommitCount	Number of transactions committed.	<ul style="list-style-type: none"> • Ndb_api_trans_start_count_session • Ndb_api_trans_start_count_slave • [none] • Ndb_api_trans_start_count
TransAbortCount	Number of transactions aborted.	<ul style="list-style-type: none"> • Ndb_api_trans_commit_count_session • Ndb_api_trans_commit_count_slave • [none] • Ndb_api_trans_commit_count
TransCloseCount	Number of transactions aborted. (This value may be greater than the sum of TransCommitCount and TransAbortCount.)	<ul style="list-style-type: none"> • Ndb_api_trans_abort_count_session • Ndb_api_trans_abort_count_slave • [none] • Ndb_api_trans_abort_count
PkOpCount	Number of operations based on or using primary keys. This count includes blob-part table operations, implicit unlocking operations, and auto-increment operations, as well as primary key operations normally visible to MySQL clients.	<ul style="list-style-type: none"> • Ndb_api_trans_close_count_session • Ndb_api_trans_close_count_slave • [none] • Ndb_api_trans_close_count
UkOpCount	Number of operations based on or using unique keys.	<ul style="list-style-type: none"> • Ndb_api_pk_op_count_session • Ndb_api_pk_op_count_slave • [none] • Ndb_api_pk_op_count
TableScanCount	Number of table scans that have been started. This includes scans of internal tables.	<ul style="list-style-type: none"> • Ndb_api_uk_op_count_session • Ndb_api_uk_op_count_slave • [none] • Ndb_api_uk_op_count
		<ul style="list-style-type: none"> • Ndb_api_table_scan_count_session • Ndb_api_table_scan_count_slave • [none]

Counter Name	Description	Status Variables (by statistic type):
		<ul style="list-style-type: none"> • Session • Slave (replica) • Injector • Server
RangeScanCount	Number of range scans that have been started.	<ul style="list-style-type: none"> • Ndb_api_table_scan_count • Ndb_api_range_scan_count_session • Ndb_api_range_scan_count_slave • [none] • Ndb_api_range_scan_count
PrunedScanCount	Number of scans that have been pruned to a single partition.	<ul style="list-style-type: none"> • Ndb_api_pruned_scan_count_session • Ndb_api_pruned_scan_count_slave • [none] • Ndb_api_pruned_scan_count
ScanBatchCount	Number of batches of rows received. (A <i>batch</i> in this context is a set of scan results from a single fragment.)	<ul style="list-style-type: none"> • Ndb_api_scan_batch_count_session • Ndb_api_scan_batch_count_slave • [none] • Ndb_api_scan_batch_count
ReadRowCount	Total number of rows that have been read. Includes rows read using primary key, unique key, and scan operations.	<ul style="list-style-type: none"> • Ndb_api_read_row_count_session • Ndb_api_read_row_count_slave • [none] • Ndb_api_read_row_count
TransLocalReadRowCount	Number of rows read from the data same node on which the transaction was being run.	<ul style="list-style-type: none"> • Ndb_api_trans_local_read_row_count • Ndb_api_trans_local_read_row_count_slave • [none] • Ndb_api_trans_local_read_row_count
DataEventsRecvdCount	Number of row change events received.	<ul style="list-style-type: none"> • [none] • [none] • Ndb_api_event_data_count_injector • Ndb_api_event_data_count
NondataEventsRecvdCount	Number of events received, other than row change events.	<ul style="list-style-type: none"> • [none] • [none] • Ndb_api_event_nondata_count_injector

Counter Name	Description	Status Variables (by statistic type):
		<ul style="list-style-type: none"> • Session • Slave (replica) • Injector • Server
		<ul style="list-style-type: none"> • <code>Ndb_api_event_nondata_count</code>
<code>EventBytesRecvdCount</code>	Number of bytes of events received.	<ul style="list-style-type: none"> • [none] • [none] • <code>Ndb_api_event_bytes_count_injector</code> • <code>Ndb_api_event_bytes_count</code>

To see all counts of committed transactions—that is, all `TransCommitCount` counter status variables—you can filter the results of `SHOW STATUS` for the substring `trans_commit_count`, like this:

```
mysql> SHOW STATUS LIKE '%trans_commit_count%';
+-----+-----+
| Variable_name | Value |
+-----+-----+
| Ndb_api_trans_commit_count_session | 1 |
| Ndb_api_trans_commit_count_slave | 0 |
| Ndb_api_trans_commit_count | 2 |
+-----+-----+
3 rows in set (0.00 sec)
```

From this you can determine that 1 transaction has been committed in the current `mysql` client session, and 2 transactions have been committed on this `mysqld` since it was last restarted.

You can see how various NDB API counters are incremented by a given SQL statement by comparing the values of the corresponding `_session` status variables immediately before and after performing the statement. In this example, after getting the initial values from `SHOW STATUS`, we create in the `test` database an NDB table, named `t`, that has a single column:

```
mysql> SHOW STATUS LIKE 'ndb_api%session%';
+-----+-----+
| Variable_name | Value |
+-----+-----+
| Ndb_api_wait_exec_complete_count_session | 2 |
| Ndb_api_wait_scan_result_count_session | 0 |
| Ndb_api_wait_meta_request_count_session | 3 |
| Ndb_api_wait_nanos_count_session | 820705 |
| Ndb_api_bytes_sent_count_session | 132 |
| Ndb_api_bytes_received_count_session | 372 |
| Ndb_api_trans_start_count_session | 1 |
| Ndb_api_trans_commit_count_session | 1 |
| Ndb_api_trans_abort_count_session | 0 |
| Ndb_api_trans_close_count_session | 1 |
| Ndb_api_pk_op_count_session | 1 |
| Ndb_api_uk_op_count_session | 0 |
| Ndb_api_table_scan_count_session | 0 |
| Ndb_api_range_scan_count_session | 0 |
| Ndb_api_pruned_scan_count_session | 0 |
| Ndb_api_scan_batch_count_session | 0 |
| Ndb_api_read_row_count_session | 1 |
| Ndb_api_trans_local_read_row_count_session | 1 |
+-----+-----+
18 rows in set (0.00 sec)

mysql> USE test;
```

```
Database changed
mysql> CREATE TABLE t (c INT) ENGINE NDBCLUSTER;
Query OK, 0 rows affected (0.85 sec)
```

Now you can execute a new `SHOW STATUS` statement and observe the changes, as shown here (with the changed rows highlighted in the output):

```
mysql> SHOW STATUS LIKE 'ndb_api%session%';
+-----+-----+
| Variable_name | Value |
+-----+-----+
| Ndb_api_wait_exec_complete_count_session | 8 |
| Ndb_api_wait_scan_result_count_session | 0 |
| Ndb_api_wait_meta_request_count_session | 17 |
| Ndb_api_wait_nanos_count_session | 706871709 |
| Ndb_api_bytes_sent_count_session | 2376 |
| Ndb_api_bytes_received_count_session | 3844 |
| Ndb_api_trans_start_count_session | 4 |
| Ndb_api_trans_commit_count_session | 4 |
| Ndb_api_trans_abort_count_session | 0 |
| Ndb_api_trans_close_count_session | 4 |
| Ndb_api_pk_op_count_session | 6 |
| Ndb_api_uk_op_count_session | 0 |
| Ndb_api_table_scan_count_session | 0 |
| Ndb_api_range_scan_count_session | 0 |
| Ndb_api_pruned_scan_count_session | 0 |
| Ndb_api_scan_batch_count_session | 0 |
| Ndb_api_read_row_count_session | 2 |
| Ndb_api_trans_local_read_row_count_session | 1 |
+-----+-----+
18 rows in set (0.00 sec)
```

Similarly, you can see the changes in the NDB API statistics counters caused by inserting a row into `t`: Insert the row, then run the same `SHOW STATUS` statement used in the previous example, as shown here:

```
mysql> INSERT INTO t VALUES (100);
Query OK, 1 row affected (0.00 sec)

mysql> SHOW STATUS LIKE 'ndb_api%session%';
+-----+-----+
| Variable_name | Value |
+-----+-----+
| Ndb_api_wait_exec_complete_count_session | 11 |
| Ndb_api_wait_scan_result_count_session | 6 |
| Ndb_api_wait_meta_request_count_session | 20 |
| Ndb_api_wait_nanos_count_session | 707370418 |
| Ndb_api_bytes_sent_count_session | 2724 |
| Ndb_api_bytes_received_count_session | 4116 |
| Ndb_api_trans_start_count_session | 7 |
| Ndb_api_trans_commit_count_session | 6 |
| Ndb_api_trans_abort_count_session | 0 |
| Ndb_api_trans_close_count_session | 7 |
| Ndb_api_pk_op_count_session | 8 |
| Ndb_api_uk_op_count_session | 0 |
| Ndb_api_table_scan_count_session | 1 |
| Ndb_api_range_scan_count_session | 0 |
| Ndb_api_pruned_scan_count_session | 0 |
| Ndb_api_scan_batch_count_session | 0 |
| Ndb_api_read_row_count_session | 3 |
| Ndb_api_trans_local_read_row_count_session | 2 |
+-----+-----+
18 rows in set (0.00 sec)
```

We can make a number of observations from these results:

- Although we created `t` with no explicit primary key, 5 primary key operations were performed in doing so (the difference in the “before” and “after” values of `Ndb_api_pk_op_count_session`, or 6 minus 1). This reflects the creation of the hidden primary key that is a feature of all tables using the `NDB` storage engine.

- By comparing successive values for `Ndb_api_wait_nanos_count_session`, we can see that the NDB API operations implementing the `CREATE TABLE` statement waited much longer (706871709 - 820705 = 706051004 nanoseconds, or approximately 0.7 second) for responses from the data nodes than those executed by the `INSERT` (707370418 - 706871709 = 498709 ns or roughly .0005 second). The execution times reported for these statements in the `mysql` client correlate roughly with these figures.

On platforms without sufficient (nanosecond) time resolution, small changes in the value of the `WaitNanosCount` NDB API counter due to SQL statements that execute very quickly may not always be visible in the values of `Ndb_api_wait_nanos_count_session`, `Ndb_api_wait_nanos_count_slave`, or `Ndb_api_wait_nanos_count`.

- The `INSERT` statement incremented both the `ReadRowCount` and `TransLocalReadRowCount` NDB API statistics counters, as reflected by the increased values of `Ndb_api_read_row_count_session` and `Ndb_api_trans_local_read_row_count_session`.

6.14 ndbinfo: The NDB Cluster Information Database

`ndbinfo` is a database containing information specific to NDB Cluster.

This database contains a number of tables, each providing a different sort of data about NDB Cluster node status, resource usage, and operations. You can find more detailed information about each of these tables in the next several sections.

`ndbinfo` is included with NDB Cluster support in the MySQL Server; no special compilation or configuration steps are required; the tables are created by the MySQL Server when it connects to the cluster. You can verify that `ndbinfo` support is active in a given MySQL Server instance using `SHOW PLUGINS`; if `ndbinfo` support is enabled, you should see a row containing `ndbinfo` in the `Name` column and `ACTIVE` in the `Status` column, as shown here (emphasized text):

```
mysql> SHOW PLUGINS;
```

Name	Status	Type	Library	License
binlog	ACTIVE	STORAGE ENGINE	NULL	GPL
mysql_native_password	ACTIVE	AUTHENTICATION	NULL	GPL
sha256_password	ACTIVE	AUTHENTICATION	NULL	GPL
MRG_MYISAM	ACTIVE	STORAGE ENGINE	NULL	GPL
MEMORY	ACTIVE	STORAGE ENGINE	NULL	GPL
CSV	ACTIVE	STORAGE ENGINE	NULL	GPL
MyISAM	ACTIVE	STORAGE ENGINE	NULL	GPL
InnoDB	ACTIVE	STORAGE ENGINE	NULL	GPL
INNODB_TRX	ACTIVE	INFORMATION SCHEMA	NULL	GPL
INNODB_LOCKS	ACTIVE	INFORMATION SCHEMA	NULL	GPL
INNODB_LOCK_WAITS	ACTIVE	INFORMATION SCHEMA	NULL	GPL
INNODB_CMP	ACTIVE	INFORMATION SCHEMA	NULL	GPL
INNODB_CMP_RESET	ACTIVE	INFORMATION SCHEMA	NULL	GPL
INNODB_CMPMEM	ACTIVE	INFORMATION SCHEMA	NULL	GPL
INNODB_CMPMEM_RESET	ACTIVE	INFORMATION SCHEMA	NULL	GPL
INNODB_CMP_PER_INDEX	ACTIVE	INFORMATION SCHEMA	NULL	GPL
INNODB_CMP_PER_INDEX_RESET	ACTIVE	INFORMATION SCHEMA	NULL	GPL
INNODB_BUFFER_PAGE	ACTIVE	INFORMATION SCHEMA	NULL	GPL
INNODB_BUFFER_PAGE_LRU	ACTIVE	INFORMATION SCHEMA	NULL	GPL
INNODB_BUFFER_POOL_STATS	ACTIVE	INFORMATION SCHEMA	NULL	GPL
INNODB_TEMP_TABLE_INFO	ACTIVE	INFORMATION SCHEMA	NULL	GPL
INNODB_METRICS	ACTIVE	INFORMATION SCHEMA	NULL	GPL
INNODB_FT_DEFAULT_STOPWORD	ACTIVE	INFORMATION SCHEMA	NULL	GPL
INNODB_FT_DELETED	ACTIVE	INFORMATION SCHEMA	NULL	GPL
INNODB_FT_BEING_DELETED	ACTIVE	INFORMATION SCHEMA	NULL	GPL
INNODB_FT_CONFIG	ACTIVE	INFORMATION SCHEMA	NULL	GPL
INNODB_FT_INDEX_CACHE	ACTIVE	INFORMATION SCHEMA	NULL	GPL
INNODB_FT_INDEX_TABLE	ACTIVE	INFORMATION SCHEMA	NULL	GPL
INNODB_SYS_TABLES	ACTIVE	INFORMATION SCHEMA	NULL	GPL
INNODB_SYS_TABLESTATS	ACTIVE	INFORMATION SCHEMA	NULL	GPL
INNODB_SYS_INDEXES	ACTIVE	INFORMATION SCHEMA	NULL	GPL

```

    Engine: ndbinfo
    Support: YES
    Comment: NDB Cluster system information storage engine
Transactions: NO
    XA: NO
    Savepoints: NO
***** 9. row *****
    Engine: PERFORMANCE_SCHEMA
    Support: YES
    Comment: Performance Schema
Transactions: NO
    XA: NO
    Savepoints: NO
***** 10. row *****
    Engine: MEMORY
    Support: YES
    Comment: Hash based, stored in memory, useful for temporary tables
Transactions: NO
    XA: NO
    Savepoints: NO
10 rows in set (0.00 sec)

```

If `ndbinfo` support is enabled, then you can access `ndbinfo` using SQL statements in `mysql` or another MySQL client. For example, you can see `ndbinfo` listed in the output of `SHOW DATABASES`, as shown here (emphasized text):

```

mysql> SHOW DATABASES;
+-----+
| Database          |
+-----+
| information_schema |
| mysql             |
| ndbinfo          |
| performance_schema |
| sys               |
+-----+
5 rows in set (0.04 sec)

```

If the `mysqld` process was not started with the `--ndbcluster` option, `ndbinfo` is not available and is not displayed by `SHOW DATABASES`. If `mysqld` was formerly connected to an NDB Cluster but the cluster becomes unavailable (due to events such as cluster shutdown, loss of network connectivity, and so forth), `ndbinfo` and its tables remain visible, but an attempt to access any tables (other than `blocks` or `config_params`) fails with Got error 157 'Connection to NDB failed' from NDBINFO.

With the exception of the `blocks` and `config_params` tables, what we refer to as `ndbinfo` “tables” are actually views generated from internal NDB tables not normally visible to the MySQL Server. You can make these tables visible by setting the `ndbinfo_show_hidden` system variable to `ON` (or `1`), but this is normally not necessary.

All `ndbinfo` tables are read-only, and are generated on demand when queried. Because many of them are generated in parallel by the data nodes while other are specific to a given SQL node, they are not guaranteed to provide a consistent snapshot.

In addition, pushing down of joins is not supported on `ndbinfo` tables; so joining large `ndbinfo` tables can require transfer of a large amount of data to the requesting API node, even when the query makes use of a `WHERE` clause.

`ndbinfo` tables are not included in the query cache. (Bug #59831)

You can select the `ndbinfo` database with a `USE` statement, and then issue a `SHOW TABLES` statement to obtain a list of tables, just as for any other database, like this:

```

mysql> USE ndbinfo;
Database changed
mysql> SHOW TABLES;

```

```

+-----+
| Tables_in_ndbinfo
+-----+
| arbitrator_validity_detail
| arbitrator_validity_summary
| blocks
| cluster_locks
| cluster_operations
| cluster_transactions
| config_nodes
| config_params
| config_values
| counters
| cpustat
| cpustat_1sec
| cpustat_20sec
| cpustat_50ms
| dict_obj_info
| dict_obj_types
| disk_write_speed_aggregate
| disk_write_speed_aggregate_node
| disk_write_speed_base
| diskpagebuffer
| error_messages
| locks_per_fragment
| logbuffers
| logspaces
| membership
| memory_per_fragment
| memoryusage
| nodes
| operations_per_fragment
| processes
| resources
| restart_info
| server_locks
| server_operations
| server_transactions
| table_distribution_status
| table_fragments
| table_info
| table_replicas
| tc_time_track_stats
| threadblocks
| threads
| threadstat
| transporters
+-----+
44 rows in set (0.00 sec)

```

In NDB 7.5.0 (and later), all `ndbinfo` tables use the `NDB` storage engine; however, an `ndbinfo` entry still appears in the output of `SHOW ENGINES` and `SHOW PLUGINS` as described previously.

The `config_values` table was added in NDB 7.5.0.

The `cpustat`, `cpustat_50ms`, `cpustat_1sec`, `cpustat_20sec`, and `threads` tables were added in NDB 7.5.2.

The `cluster_locks`, `locks_per_fragment`, and `server_locks` tables were added in NDB 7.5.3.

The `dict_obj_info`, `table_distribution_status`, `table_fragments`, `table_info`, and `table_replicas` tables were added in NDB 7.5.4.

The `config_nodes` and `processes` tables were added in NDB 7.5.7.

The `error_messages` table was added in NDB 7.6.

You can execute `SELECT` statements against these tables, just as you would normally expect:

```
mysql> SELECT * FROM memoryusage;
```

The ndbinfo arbitrator_validity_detail Table

node_id	memory_type	used	used_pages	total	total_pages
5	Data memory	753664	23	1073741824	32768
5	Index memory	163840	20	1074003968	131104
5	Long message buffer	2304	9	67108864	262144
6	Data memory	753664	23	1073741824	32768
6	Index memory	163840	20	1074003968	131104
6	Long message buffer	2304	9	67108864	262144

6 rows in set (0.02 sec)

More complex queries, such as the two following `SELECT` statements using the `memoryusage` table, are possible:

```
mysql> SELECT SUM(used) as 'Data Memory Used, All Nodes'
> FROM memoryusage
> WHERE memory_type = 'Data memory';
+-----+
| Data Memory Used, All Nodes |
+-----+
| 6460 |
+-----+
1 row in set (0.37 sec)

mysql> SELECT SUM(max) as 'Total IndexMemory Available'
> FROM memoryusage
> WHERE memory_type = 'Index memory';
+-----+
| Total IndexMemory Available |
+-----+
| 25664 |
+-----+
1 row in set (0.33 sec)
```

`ndbinfo` table and column names are case-sensitive (as is the name of the `ndbinfo` database itself). These identifiers are in lowercase. Trying to use the wrong lettercase results in an error, as shown in this example:

```
mysql> SELECT * FROM nodes;
+-----+
| node_id | uptime | status | start_phase |
+-----+
| 1 | 13602 | STARTED | 0 |
| 2 | 16 | STARTED | 0 |
+-----+
2 rows in set (0.04 sec)

mysql> SELECT * FROM Nodes;
ERROR 1146 (42S02): Table 'ndbinfo.Nodes' doesn't exist
```

`mysqldump` ignores the `ndbinfo` database entirely, and excludes it from any output. This is true even when using the `--databases` or `--all-databases` option.

NDB Cluster also maintains tables in the `INFORMATION_SCHEMA` information database, including the `FILES` table which contains information about files used for NDB Cluster Disk Data storage, and the `ndb_transid_mysql_connection_map` table, which shows the relationships between transactions, transaction coordinators, and NDB Cluster API nodes. For more information, see the descriptions of the tables or [Section 6.15, "INFORMATION_SCHEMA Tables for NDB Cluster"](#).

6.14.1 The ndbinfo arbitrator_validity_detail Table

The `arbitrator_validity_detail` table shows the view that each data node in the cluster has of the arbitrator. It is a subset of the `membership` table.

The `arbitrator_validity_detail` table contains the following columns:

- `node_id`

This node's node ID

- `arbitrator`

Node ID of arbitrator

- `arb_ticket`

Internal identifier used to track arbitration

- `arb_connected`

Whether this node is connected to the arbitrator; either of `Yes` or `No`

- `arb_state`

Arbitration state

Notes

The node ID is the same as that reported by `ndb_mgm -e "SHOW"`.

All nodes should show the same `arbitrator` and `arb_ticket` values as well as the same `arb_state` value. Possible `arb_state` values are `ARBIT_NULL`, `ARBIT_INIT`, `ARBIT_FIND`, `ARBIT_PREP1`, `ARBIT_PREP2`, `ARBIT_START`, `ARBIT_RUN`, `ARBIT_CHOOSE`, `ARBIT_CRASH`, and `UNKNOWN`.

`arb_connected` shows whether the current node is connected to the `arbitrator`.

6.14.2 The ndbinfo arbitrator_validity_summary Table

The `arbitrator_validity_summary` table provides a composite view of the arbitrator with regard to the cluster's data nodes.

The `arbitrator_validity_summary` table contains the following columns:

- `arbitrator`

Node ID of arbitrator

- `arb_ticket`

Internal identifier used to track arbitration

- `arb_connected`

Whether this arbitrator is connected to the cluster; either of `Yes` or `No`

- `consensus_count`

Number of data nodes that see this node as arbitrator

Notes

In normal operations, this table should have only 1 row for any appreciable length of time. If it has more than 1 row for longer than a few moments, then either not all nodes are connected to the arbitrator, or all nodes are connected, but do not agree on the same arbitrator.

The `arbitrator` column shows the arbitrator's node ID.

`arb_ticket` is the internal identifier used by this arbitrator.

`arb_connected` shows whether this node is connected to the cluster as an arbitrator.

6.14.3 The ndbinfo blocks Table

The `blocks` table is a static table which simply contains the names and internal IDs of all NDB kernel blocks (see [NDB Kernel Blocks](#)). It is for use by the other `ndbinfo` tables (most of which are actually views) in mapping block numbers to block names for producing human-readable output.

The `blocks` table contains the following columns:

- `block_number`
Block number
- `block_name`
Block name

Notes

To obtain a list of all block names, simply execute `SELECT block_name FROM ndbinfo.blocks`. Although this is a static table, its content can vary between different NDB Cluster releases.

6.14.4 The ndbinfo cluster_locks Table

The `cluster_locks` table provides information about current lock requests holding and waiting for locks on `NDB` tables in an NDB Cluster, and is intended as a companion table to `cluster_operations`. Information obtain from the `cluster_locks` table may be useful in investigating stalls and deadlocks.

The `cluster_locks` table contains the following columns:

- `node_id`
ID of reporting node
- `block_instance`
ID of reporting LDM instance
- `tableid`
ID of table containing this row
- `fragmentid`
ID of fragment containing locked row
- `rowid`
ID of locked row
- `transid`
Transaction ID
- `mode`
Lock request mode
- `state`
Lock state

- `detail`
Whether this is first holding lock in row lock queue
- `op`
Operation type
- `duration_millis`
Milliseconds spent waiting or holding lock
- `lock_num`
ID of lock object
- `waiting_for`
Waiting for lock with this ID

Notes

The table ID (`tableid` column) is assigned internally, and is the same as that used in other `ndbinfo` tables. It is also shown in the output of `ndb_show_tables`.

The transaction ID (`transid` column) is the identifier generated by the NDB API for the transaction requesting or holding the current lock.

The `mode` column shows the lock mode; this is always one of `S` (indicating a shared lock) or `X` (an exclusive lock). If a transaction holds an exclusive lock on a given row, all other locks on that row have the same transaction ID.

The `state` column shows the lock state. Its value is always one of `H` (holding) or `W` (waiting). A waiting lock request waits for a lock held by a different transaction.

When the `detail` column contains a `*` (asterisk character), this means that this lock is the first holding lock in the affected row's lock queue; otherwise, this column is empty. This information can be used to help identify the unique entries in a list of lock requests.

The `op` column shows the type of operation requesting the lock. This is always one of the values `READ`, `INSERT`, `UPDATE`, `DELETE`, `SCAN`, or `REFRESH`.

The `duration_millis` column shows the number of milliseconds for which this lock request has been waiting or holding the lock. This is reset to 0 when a lock is granted for a waiting request.

The lock ID (`lockid` column) is unique to this node and block instance.

The lock state is shown in the `lock_state` column; if this is `W`, the lock is waiting to be granted, and the `waiting_for` column shows the lock ID of the lock object this request is waiting for. Otherwise, the `waiting_for` column is empty. `waiting_for` can refer only to locks on the same row, as identified by `node_id`, `block_instance`, `tableid`, `fragmentid`, and `rowid`.

The `cluster_locks` table was added in NDB 7.5.3.

6.14.5 The ndbinfo cluster_operations Table

The `cluster_operations` table provides a per-operation (stateful primary key op) view of all activity in the NDB Cluster from the point of view of the local data management (LQH) blocks (see [The DBLQH Block](#)).

The `cluster_operations` table contains the following columns:

- `node_id`
Node ID of reporting LQH block
- `block_instance`
LQH block instance
- `transid`
Transaction ID
- `operation_type`
Operation type (see text for possible values)
- `state`
Operation state (see text for possible values)
- `tableid`
Table ID
- `fragmentid`
Fragment ID
- `client_node_id`
Client node ID
- `client_block_ref`
Client block reference
- `tc_node_id`
Transaction coordinator node ID
- `tc_block_no`
Transaction coordinator block number
- `tc_block_instance`
Transaction coordinator block instance

Notes

The transaction ID is a unique 64-bit number which can be obtained using the NDB API's `getTransactionId()` method. (Currently, the MySQL Server does not expose the NDB API transaction ID of an ongoing transaction.)

The `operation_type` column can take any one of the values `READ`, `READ-SH`, `READ-EX`, `INSERT`, `UPDATE`, `DELETE`, `WRITE`, `UNLOCK`, `REFRESH`, `SCAN`, `SCAN-SH`, `SCAN-EX`, or `<unknown>`.

The `state` column can have any one of the values `ABORT_QUEUED`, `ABORT_STOPPED`, `COMMITTED`, `COMMIT_QUEUED`, `COMMIT_STOPPED`, `COPY_CLOSE_STOPPED`, `COPY_FIRST_STOPPED`, `COPY_STOPPED`, `COPY_TUPKEY`, `IDLE`, `LOG_ABORT_QUEUED`, `LOG_COMMIT_QUEUED`, `LOG_COMMIT_QUEUED_WAIT_SIGNAL`, `LOG_COMMIT_WRITTEN`, `LOG_COMMIT_WRITTEN_WAIT_SIGNAL`, `LOG_QUEUED`, `PREPARED`, `PREPARED_RECEIVED_COMMIT`, `SCAN_CHECK_STOPPED`, `SCAN_CLOSE_STOPPED`, `SCAN_FIRST_STOPPED`,

SCAN_RELEASE_STOPPED, SCAN_STATE_USED, SCAN_STOPPED, SCAN_TUPKEY, STOPPED, TC_NOT_CONNECTED, WAIT_ACC, WAIT_ACC_ABORT, WAIT_AI_AFTER_ABORT, WAIT_ATTR, WAIT_SCAN_AI, WAIT_TUP, WAIT_TUPKEYINFO, WAIT_TUP_COMMIT, or WAIT_TUP_TO_ABORT. (If the MySQL Server is running with `ndbinfo_show_hidden` enabled, you can view this list of states by selecting from the `ndb$dblqh_tcconnect_state` table, which is normally hidden.)

You can obtain the name of an NDB table from its table ID by checking the output of `ndb_show_tables`.

The `fragid` is the same as the partition number seen in the output of `ndb_desc --extra-partition-info` (short form `-p`).

In `client_node_id` and `client_block_ref`, `client` refers to an NDB Cluster API or SQL node (that is, an NDB API client or a MySQL Server attached to the cluster).

The `block_instance` and `tc_block_instance` column provide, respectively, the `DBLQH` and `DBTC` block instance numbers. You can use these along with the block names to obtain information about specific threads from the `threadblocks` table.

6.14.6 The ndbinfo cluster_transactions Table

The `cluster_transactions` table shows information about all ongoing transactions in an NDB Cluster.

The `cluster_transactions` table contains the following columns:

- `node_id`
Node ID of transaction coordinator
- `block_instance`
TC block instance
- `transid`
Transaction ID
- `state`
Operation state (see text for possible values)
- `count_operations`
Number of stateful primary key operations in transaction (includes reads with locks, as well as DML operations)
- `outstanding_operations`
Operations still being executed in local data management blocks
- `inactive_seconds`
Time spent waiting for API
- `client_node_id`
Client node ID
- `client_block_ref`
Client block reference

Notes

The transaction ID is a unique 64-bit number which can be obtained using the NDB API's `getTransactionId()` method. (Currently, the MySQL Server does not expose the NDB API transaction ID of an ongoing transaction.)

`block_instance` refers to an instance of a kernel block. Together with the block name, this number can be used to look up a given instance in the `threadblocks` table.

The `state` column can have any one of the values `CS_ABORTING`, `CS_COMMITTING`, `CS_COMMIT_SENT`, `CS_COMPLETE_SENT`, `CS_COMPLETING`, `CS_CONNECTED`, `CS_DISCONNECTED`, `CS_FAIL_ABORTED`, `CS_FAIL_ABORTING`, `CS_FAIL_COMMITTED`, `CS_FAIL_COMMITTING`, `CS_FAIL_COMPLETED`, `CS_FAIL_PREPARED`, `CS_PREPARE_TO_COMMIT`, `CS_RECEIVING`, `CS_REC_COMMITTING`, `CS_RESTART`, `CS_SEND_FIRE_TRIG_REQ`, `CS_STARTED`, `CS_START_COMMITTING`, `CS_START_SCAN`, `CS_WAIT_ABORT_CONF`, `CS_WAIT_COMMIT_CONF`, `CS_WAIT_COMPLETE_CONF`, `CS_WAIT_FIRE_TRIG_REQ`. (If the MySQL Server is running with `ndbinfo_show_hidden` enabled, you can view this list of states by selecting from the `ndb $dbtc_apiconnect_state` table, which is normally hidden.)

In `client_node_id` and `client_block_ref`, `client` refers to an NDB Cluster API or SQL node (that is, an NDB API client or a MySQL Server attached to the cluster).

The `tc_block_instance` column provides the `DBTC` block instance number. You can use this along with the block name to obtain information about specific threads from the `threadblocks` table.

6.14.7 The ndbinfo config_nodes Table

The `config_nodes` table shows nodes configured in an NDB Cluster `config.ini` file. For each node, the table displays a row containing the node ID, the type of node (management node, data node, or API node), and the name or IP address of the host on which the node is configured to run.

This table does not indicate whether a given node is actually running, or whether it is currently connected to the cluster. Information about nodes connected to an NDB Cluster can be obtained from the `nodes` and `processes` table.

The `config_nodes` table contains the following columns:

- `node_id`
The node's ID
- `node_type`
The type of node
- `node_hostname`
The name or IP address of the host on which the node resides

Notes

The `node_id` column shows the node ID used in the `config.ini` file for this node; if none is specified, the node ID that would be assigned automatically to this node is displayed.

The `node_type` column displays one of the following three values:

- `MGM`: Management node.
- `NDB`: Data node.
- `API`: API node; this includes SQL nodes.

The `node_hostname` column shows the node host as specified in the `config.ini` file. This can be empty for an API node, if `HostName` has not been set in the cluster configuration file. If `HostName` has not been set for a data node in the configuration file, `localhost` is used here. `localhost` is also used if `HostName` has not been specified for a management node.

The `config_nodes` table was added in NDB 7.5.7.

6.14.8 The ndbinfo config_params Table

The `config_params` table is a static table which provides the names and internal ID numbers of and other information about NDB Cluster configuration parameters.

The `config_params` table contains the following columns:

- `param_number`
The parameter's internal ID number
- `param_name`
The name of the parameter
- `param_description`
A brief description of the parameter
- `param_type`
The parameter's data type
- `param_default`
The parameter's default value, if any
- `param_min`
The parameter's maximum value, if any
- `param_max`
The parameter's minimum value, if any
- `param_mandatory`
This is 1 if the parameter is required, otherwise 0
- `param_status`
Currently unused

Notes

In NDB Cluster 7.5 (and later), this table is read-only. The `param_description`, `param_type`, `param_default`, `param_min`, `param_max`, `param_mandatory`, and `param_status` columns were all added in NDB 7.5.0.

Although this is a static table, its content can vary between NDB Cluster installations, since supported parameters can vary due to differences between software releases, cluster hardware configurations, and other factors.

6.14.9 The ndbinfo config_values Table

The `config_values` table, implemented in NDB 7.5.0, provides information about the current state of node configuration parameter values. Each row in the table corresponds to the current value of a parameter on a given node.

- `node_id`
ID of the node in the cluster
- `config_param`
The parameter's internal ID number
- `config_value`
Current value of the parameter

Notes

This table's `config_param` column and the `config_params` table's `param_number` column use the same parameter identifiers. By joining the two tables on these columns, you can obtain detailed information about desired node configuration parameters. The query shown here provides the current values for all parameters on each data node in the cluster, ordered by node ID and parameter name:

```
SELECT v.node_id AS 'Node Id',
       p.param_name AS 'Parameter',
       v.config_value AS 'Value'
FROM   config_values v
JOIN   config_params p
ON     v.config_param=p.param_number
WHERE  p.param_name NOT LIKE '\_\_%'
ORDER BY v.node_id, p.param_name;
```

Partial output from the previous query when run on a small example cluster used for simple testing:

```
+-----+-----+-----+
| Node Id | Parameter                               | Value          |
+-----+-----+-----+
| 2       | Arbitration                             | 1              |
| 2       | ArbitrationTimeout                      | 7500           |
| 2       | BackupDataBufferSize                    | 16777216       |
| 2       | BackupDataDir                           | /home/jon/data |
| 2       | BackupDiskWriteSpeedPct                 | 50             |
| 2       | BackupLogBufferSize                     | 16777216       |
| ...     | ...                                     | ...            |
| 3       | TotalSendBufferMemory                   | 0              |
| 3       | TransactionBufferMemory                  | 1048576        |
| 3       | TransactionDeadlockDetectionTimeout      | 1200           |
| 3       | TransactionInactiveTimeout              | 4294967039    |
| 3       | TwoPassInitialNodeRestartCopy          | 0              |
| 3       | UndoDataBuffer                          | 16777216       |
| 3       | UndoIndexBuffer                         | 2097152        |
+-----+-----+-----+
248 rows in set (0.02 sec)
```

The `WHERE` clause filters out parameters whose names begin with a double underscore (`__`); these parameters are reserved for testing and other internal uses by the NDB developers, and are not intended for use in a production NDB Cluster.

You can obtain output that is more specific, more detailed, or both by issuing the proper queries. This example provides all types of available information about the `NodeId`, `NoOfReplicas`, `HostName`, `DataMemory`, `IndexMemory`, and `TotalSendBufferMemory` parameters as currently set for all data nodes in the cluster:

```
SELECT p.param_name AS Name,
       v.node_id AS Node,
```

The ndbinfo config_values Table

```
        p.param_type AS Type,
        p.param_default AS 'Default',
        p.param_min AS Minimum,
        p.param_max AS Maximum,
        CASE p.param_mandatory WHEN 1 THEN 'Y' ELSE 'N' END AS 'Required',
        v.config_value AS Current
FROM    config_params p
JOIN    config_values v
ON      p.param_number = v.config_param
WHERE   p.param_name
        IN ('NodeId', 'NoOfReplicas', 'HostName',
            'DataMemory', 'IndexMemory', 'TotalSendBufferMemory')\G
```

The output from this query when run on a small NDB Cluster with 2 data nodes used for simple testing is shown here:

```
***** 1. row *****
      Name: NodeId
      Node: 2
      Type: unsigned
      Default:
      Minimum: 1
      Maximum: 48
      Required: Y
      Current: 2
***** 2. row *****
      Name: HostName
      Node: 2
      Type: string
      Default: localhost
      Minimum:
      Maximum:
      Required: N
      Current: 127.0.0.1
***** 3. row *****
      Name: TotalSendBufferMemory
      Node: 2
      Type: unsigned
      Default: 0
      Minimum: 262144
      Maximum: 4294967039
      Required: N
      Current: 0
***** 4. row *****
      Name: NoOfReplicas
      Node: 2
      Type: unsigned
      Default: 2
      Minimum: 1
      Maximum: 4
      Required: N
      Current: 2
***** 5. row *****
      Name: DataMemory
      Node: 2
      Type: unsigned
      Default: 102760448
      Minimum: 1048576
      Maximum: 109951162776
      Required: N
      Current: 524288000
***** 6. row *****
      Name: NodeId
      Node: 3
      Type: unsigned
      Default:
      Minimum: 1
      Maximum: 48
      Required: Y
      Current: 3
***** 7. row *****
      Name: HostName
```

```

Node: 3
Type: string
Default: localhost
Minimum:
Maximum:
Required: N
Current: 127.0.0.1
***** 8. row *****
Name: TotalSendBufferMemory
Node: 3
Type: unsigned
Default: 0
Minimum: 262144
Maximum: 4294967039
Required: N
Current: 0
***** 9. row *****
Name: NoOfReplicas
Node: 3
Type: unsigned
Default: 2
Minimum: 1
Maximum: 4
Required: N
Current: 2
***** 10. row *****
Name: DataMemory
Node: 3
Type: unsigned
Default: 102760448
Minimum: 1048576
Maximum: 1099511627776
Required: N
Current: 524288000
10 rows in set (0.01 sec)

```

6.14.10 The ndbinfo counters Table

The `counters` table provides running totals of events such as reads and writes for specific kernel blocks and data nodes. Counts are kept from the most recent node start or restart; a node start or restart resets all counters on that node. Not all kernel blocks have all types of counters.

The `counters` table contains the following columns:

- `node_id`
The data node ID
- `block_name`
Name of the associated NDB kernel block (see [NDB Kernel Blocks](#)).
- `block_instance`
Block instance
- `counter_id`
The counter's internal ID number; normally an integer between 1 and 10, inclusive.
- `counter_name`
The name of the counter. See text for names of individual counters and the NDB kernel block with which each counter is associated.
- `val`
The counter's value

Notes

Each counter is associated with a particular NDB kernel block.

The `OPERATIONS` counter is associated with the `DBLQH` (local query handler) kernel block (see [The DBLQH Block](#)). A primary-key read counts as one operation, as does a primary-key update. For reads, there is one operation in `DBLQH` per operation in `DBTC`. For writes, there is one operation counted per fragment replica.

The `ATTRINFO`, `TRANSACTIONS`, `COMMITTS`, `READS`, `LOCAL_READS`, `SIMPLE_READS`, `WRITES`, `LOCAL_WRITES`, `ABORTS`, `TABLE_SCANS`, and `RANGE_SCANS` counters are associated with the `DBTC` (transaction co-ordinator) kernel block (see [The DBTC Block](#)).

`LOCAL_WRITES` and `LOCAL_READS` are primary-key operations using a transaction coordinator in a node that also holds the primary fragment replica of the record.

The `READS` counter includes all reads. `LOCAL_READS` includes only those reads of the primary fragment replica on the same node as this transaction coordinator. `SIMPLE_READS` includes only those reads in which the read operation is the beginning and ending operation for a given transaction. Simple reads do not hold locks but are part of a transaction, in that they observe uncommitted changes made by the transaction containing them but not of any other uncommitted transactions. Such reads are “simple” from the point of view of the TC block; since they hold no locks they are not durable, and once `DBTC` has routed them to the relevant LQH block, it holds no state for them.

`ATTRINFO` keeps a count of the number of times an interpreted program is sent to the data node. See [NDB Protocol Messages](#), for more information about `ATTRINFO` messages in the `NDB` kernel.

The `LOCAL_TABLE_SCANS_SENT`, `READS_RECEIVED`, `PRUNED_RANGE_SCANS_RECEIVED`, `RANGE_SCANS_RECEIVED`, `LOCAL_READS_SENT`, `CONST_PRUNED_RANGE_SCANS_RECEIVED`, `LOCAL_RANGE_SCANS_SENT`, `REMOTE_READS_SENT`, `REMOTE_RANGE_SCANS_SENT`, `READS_NOT_FOUND`, `SCAN_BATCHES_RETURNED`, `TABLE_SCANS_RECEIVED`, and `SCAN_ROWS_RETURNED` counters are associated with the `DBSPJ` (select push-down join) kernel block (see [The DBSPJ Block](#)).

The `block_name` and `block_instance` columns provide, respectively, the applicable NDB kernel block name and instance number. You can use these to obtain information about specific threads from the `threadblocks` table.

A number of counters provide information about transporter overload and send buffer sizing when troubleshooting such issues. For each LQH instance, there is one instance of each counter in the following list:

- `LQHKEY_OVERLOAD`: Number of primary key requests rejected at the LQH block instance due to transporter overload
- `LQHKEY_OVERLOAD_TC`: Count of instances of `LQHKEY_OVERLOAD` where the TC node transporter was overloaded
- `LQHKEY_OVERLOAD_READER`: Count of instances of `LQHKEY_OVERLOAD` where the API reader (reads only) node was overloaded.
- `LQHKEY_OVERLOAD_NODE_PEER`: Count of instances of `LQHKEY_OVERLOAD` where the next backup data node (writes only) was overloaded
- `LQHKEY_OVERLOAD_SUBSCRIBER`: Count of instances of `LQHKEY_OVERLOAD` where a event subscriber (writes only) was overloaded.
- `LQHSCAN_SLOWDOWNS`: Count of instances where a fragment scan batch size was reduced due to scanning API transporter overload.

6.14.11 The ndbinfo cpustat Table

The `cpustat` table provides per-thread CPU statistics gathered each second, for each thread running in the `NDB` kernel.

The `cpustat` table contains the following columns:

- `node_id`
ID of the node where the thread is running
- `thr_no`
Thread ID (specific to this node)
- `OS_user`
OS user time
- `OS_system`
OS system time
- `OS_idle`
OS idle time
- `thread_exec`
Thread execution time
- `thread_sleeping`
Thread sleep time
- `thread_spinning`
Thread spin time
- `thread_send`
Thread send time
- `thread_buffer_full`
Thread buffer full time
- `elapsed_time`
Elapsed time

Notes

This table was added in `NDB 7.5.2`.

6.14.12 The ndbinfo cpustat_50ms Table

The `cpustat_50ms` table provides raw, per-thread CPU data obtained each 50 milliseconds for each thread running in the `NDB` kernel.

Like `cpustat_1sec` and `cpustat_20sec`, this table shows 20 measurement sets per thread, each referencing a period of the named duration. Thus, `cpustat_50ms` provides 1 second of history.

The `cpustat_50ms` table contains the following columns:

- `node_id`

ID of the node where the thread is running

- `thr_no`

Thread ID (specific to this node)

- `OS_user_time`

OS user time

- `OS_system_time`

OS system time

- `OS_idle_time`

OS idle time

- `exec_time`

Thread execution time

- `sleep_time`

Thread sleep time

- `spin_time`

Thread spin time

- `send_time`

Thread send time

- `buffer_full_time`

Thread buffer full time

- `elapsed_time`

Elapsed time

Notes

This table was added in NDB 7.5.2.

6.14.13 The ndbinfo cpustat_1sec Table

The `cpustat_1sec` table provides raw, per-thread CPU data obtained each second for each thread running in the NDB kernel.

Like `cpustat_50ms` and `cpustat_20sec`, this table shows 20 measurement sets per thread, each referencing a period of the named duration. Thus, `cpustat_1sec` provides 20 seconds of history.

The `cpustat_1sec` table contains the following columns:

- `node_id`

ID of the node where the thread is running

- `thr_no`

Thread ID (specific to this node)

- `OS_user_time`
OS user time
- `OS_system_time`
OS system time
- `OS_idle_time`
OS idle time
- `exec_time`
Thread execution time
- `sleep_time`
Thread sleep time
- `spin_time`
Thread spin time
- `send_time`
Thread send time
- `buffer_full_time`
Thread buffer full time
- `elapsed_time`
Elapsed time

Notes

This table was added in NDB 7.5.2.

6.14.14 The ndbinfo cpustat_20sec Table

The `cpustat_20sec` table provides raw, per-thread CPU data obtained each 20 seconds, for each thread running in the NDB kernel.

Like `cpustat_50ms` and `cpustat_1sec`, this table shows 20 measurement sets per thread, each referencing a period of the named duration. Thus, `cpustat_20sec` provides 400 seconds of history.

The `cpustat_20sec` table contains the following columns:

- `node_id`
ID of the node where the thread is running
- `thr_no`
Thread ID (specific to this node)
- `OS_user_time`
OS user time
- `OS_system_time`

OS system time

- `OS_idle_time`

OS idle time

- `exec_time`

Thread execution time

- `sleep_time`

Thread sleep time

- `spin_time`

Thread spin time

- `send_time`

Thread send time

- `buffer_full_time`

Thread buffer full time

- `elapsed_time`

Elapsed time

Notes

This table was added in NDB 7.5.2.

6.14.15 The ndbinfo dict_obj_info Table

The `dict_obj_info` table provides information about NDB data dictionary (`DICT`) objects such as tables and indexes. (The `dict_obj_types` table can be queried for a list of all the types.) This information includes the object's type, state, parent object (if any), and fully qualified name.

The `dict_obj_info` table contains the following columns:

- `type`

Type of `DICT` object; join on `dict_obj_types` to obtain the name

- `id`

Object identifier; for Disk Data undo log files and data files, this is the same as the value shown in the `LOGFILE_GROUP_NUMBER` column of the `INFORMATION_SCHEMA.FILES` table

- `version`

Object version

- `state`

Object state

- `parent_obj_type`

Parent object's type (a `dict_obj_types` type ID); 0 indicates that the object has no parent

- `parent_obj_id`

Parent object ID (such as a base table); 0 indicates that the object has no parent

- `fq_name`

Fully qualified object name; for a table, this has the form `database_name/def/table_name`, for a primary key, the form is `sys/def/table_id/PRIMARY`, and for a unique key it is `sys/def/table_id/uk_name$unique`

Notes

This table was added in NDB 7.5.4.

6.14.16 The ndbinfo dict_obj_types Table

The `dict_obj_types` table is a static table listing possible dictionary object types used in the NDB kernel. These are the same types defined by `Object::Type` in the NDB API.

The `dict_obj_types` table contains the following columns:

- `type_id`

The type ID for this type

- `type_name`

The name of this type

6.14.17 The ndbinfo disk_write_speed_base Table

The `disk_write_speed_base` table provides base information about the speed of disk writes during LCP, backup, and restore operations.

The `disk_write_speed_base` table contains the following columns:

- `node_id`

Node ID of this node

- `thr_no`

Thread ID of this LDM thread

- `millis_ago`

Milliseconds since this reporting period ended

- `millis_passed`

Milliseconds elapsed in this reporting period

- `backup_lcp_bytes_written`

Number of bytes written to disk by local checkpoints and backup processes during this period

- `redo_bytes_written`

Number of bytes written to REDO log during this period

- `target_disk_write_speed`

Actual speed of disk writes per LDM thread (base data)

6.14.18 The ndbinfo disk_write_speed_aggregate Table

The `disk_write_speed_aggregate` table provides aggregated information about the speed of disk writes during LCP, backup, and restore operations.

The `disk_write_speed_aggregate` table contains the following columns:

- `node_id`
Node ID of this node
- `thr_no`
Thread ID of this LDM thread
- `backup_lcp_speed_last_sec`
Number of bytes written to disk by backup and LCP processes in the last second
- `redo_speed_last_sec`
Number of bytes written to REDO log in the last second
- `backup_lcp_speed_last_10sec`
Number of bytes written to disk by backup and LCP processes per second, averaged over the last 10 seconds
- `redo_speed_last_10sec`
Number of bytes written to REDO log per second, averaged over the last 10 seconds
- `std_dev_backup_lcp_speed_last_10sec`
Standard deviation in number of bytes written to disk by backup and LCP processes per second, averaged over the last 10 seconds
- `std_dev_redo_speed_last_10sec`
Standard deviation in number of bytes written to REDO log per second, averaged over the last 10 seconds
- `backup_lcp_speed_last_60sec`
Number of bytes written to disk by backup and LCP processes per second, averaged over the last 60 seconds
- `redo_speed_last_60sec`
Number of bytes written to REDO log per second, averaged over the last 10 seconds
- `std_dev_backup_lcp_speed_last_60sec`
Standard deviation in number of bytes written to disk by backup and LCP processes per second, averaged over the last 60 seconds
- `std_dev_redo_speed_last_60sec`
Standard deviation in number of bytes written to REDO log per second, averaged over the last 60 seconds
- `slowdowns_due_to_io_lag`
Number of seconds since last node start that disk writes were slowed due to REDO log I/O lag

- `slowdowns_due_to_high_cpu`
Number of seconds since last node start that disk writes were slowed due to high CPU usage
- `disk_write_speed_set_to_min`
Number of seconds since last node start that disk write speed was set to minimum
- `current_target_disk_write_speed`
Actual speed of disk writes per LDM thread (aggregated)

6.14.19 The ndbinfo disk_write_speed_aggregate_node Table

The `disk_write_speed_aggregate_node` table provides aggregated information per node about the speed of disk writes during LCP, backup, and restore operations.

The `disk_write_speed_aggregate_node` table contains the following columns:

- `node_id`
Node ID of this node
- `backup_lcp_speed_last_sec`
Number of bytes written to disk by backup and LCP processes in the last second
- `redo_speed_last_sec`
Number of bytes written to REDO log in the last second
- `backup_lcp_speed_last_10sec`
Number of bytes written to disk by backup and LCP processes per second, averaged over the last 10 seconds
- `redo_speed_last_10sec`
Number of bytes written to REDO log per second, averaged over the last 10 seconds
- `backup_lcp_speed_last_60sec`
Number of bytes written to disk by backup and LCP processes per second, averaged over the last 60 seconds
- `redo_speed_last_60sec`
Number of bytes written to disk by backup and LCP processes per second, averaged over the last 60 seconds

6.14.20 The ndbinfo diskpagebuffer Table

The `diskpagebuffer` table provides statistics about disk page buffer usage by NDB Cluster Disk Data tables.

The `diskpagebuffer` table contains the following columns:

- `node_id`
The data node ID
- `block_instance`

Block instance

- [pages_written](#)

Number of pages written to disk.

- [pages_written_lcp](#)

Number of pages written by local checkpoints.

- [pages_read](#)

Number of pages read from disk

- [log_waits](#)

Number of page writes waiting for log to be written to disk

- [page_requests_direct_return](#)

Number of requests for pages that were available in buffer

- [page_requests_wait_queue](#)

Number of requests that had to wait for pages to become available in buffer

- [page_requests_wait_io](#)

Number of requests that had to be read from pages on disk (pages were unavailable in buffer)

Notes

You can use this table with NDB Cluster Disk Data tables to determine whether [DiskPageBufferMemory](#) is sufficiently large to allow data to be read from the buffer rather than from disk; minimizing disk seeks can help improve performance of such tables.

You can determine the proportion of reads from [DiskPageBufferMemory](#) to the total number of reads using a query such as this one, which obtains this ratio as a percentage:

```
SELECT
  node_id,
  100 * page_requests_direct_return /
    (page_requests_direct_return + page_requests_wait_io)
  AS hit_ratio
FROM ndbinfo.diskpagebuffer;
```

The result from this query should be similar to what is shown here, with one row for each data node in the cluster (in this example, the cluster has 4 data nodes):

```
+-----+-----+
| node_id | hit_ratio |
+-----+-----+
|      5 | 97.6744 |
|      6 | 97.6879 |
|      7 | 98.1776 |
|      8 | 98.1343 |
+-----+-----+
4 rows in set (0.00 sec)
```

[hit_ratio](#) values approaching 100% indicate that only a very small number of reads are being made from disk rather than from the buffer, which means that Disk Data read performance is approaching an optimum level. If any of these values are less than 95%, this is a strong indicator that the setting for [DiskPageBufferMemory](#) needs to be increased in the [config.ini](#) file.

Note

A change in [DiskPageBufferMemory](#) requires a rolling restart of all of the cluster's data nodes before it takes effect.

[block_instance](#) refers to an instance of a kernel block. Together with the block name, this number can be used to look up a given instance in the [threadblocks](#) table. Using this information, you can obtain information about disk page buffer metrics relating to individual threads; an example query using `LIMIT 1` to limit the output to a single thread is shown here:

```
mysql> SELECT
>   node_id, thr_no, block_name, thread_name, pages_written,
>   pages_written_lcp, pages_read, log_waits,
>   page_requests_direct_return, page_requests_wait_queue,
>   page_requests_wait_io
> FROM ndbinfo.diskpagebuffer
> INNER JOIN ndbinfo.threadblocks USING (node_id, block_instance)
> INNER JOIN ndbinfo.threads USING (node_id, thr_no)
> WHERE block_name = 'PGMAN' LIMIT 1\G
***** 1. row *****
          node_id: 1
          thr_no: 1
          block_name: PGMAN
          thread_name: rep
          pages_written: 0
          pages_written_lcp: 0
          pages_read: 1
          log_waits: 0
          page_requests_direct_return: 4
          page_requests_wait_queue: 0
          page_requests_wait_io: 1
1 row in set (0.01 sec)
```

6.14.21 The ndbinfo error_messages Table

The [error_messages](#) table provides information about

The [error_messages](#) table contains the following columns:

- [error_code](#)
Numeric error code
- [error_description](#)
Description of error
- [error_status](#)
Error status code
- [error_classification](#)
Error classification code

Notes

[error_code](#) is a numeric NDB error code. This is the same error code that can be supplied to `ndb_perror` or `perror --ndb`.

[error_description](#) provides a basic description of the condition causing the error.

The [error_status](#) column provides status information relating to the error. Possible values for this column are listed here:

- No error

- Illegal connect string
- Illegal server handle
- Illegal reply from server
- Illegal number of nodes
- Illegal node status
- Out of memory
- Management server not connected
- Could not connect to socket
- Start failed
- Stop failed
- Restart failed
- Could not start backup
- Could not abort backup
- Could not enter single user mode
- Could not exit single user mode
- Failed to complete configuration change
- Failed to get configuration
- Usage error
- Success
- Permanent error
- Temporary error
- Unknown result
- Temporary error, restart node
- Permanent error, external action needed
- Ndbd file system error, restart node initial
- Unknown

The `error_classification` column shows the error classification. See [NDB Error Classifications](#), for information about classification codes and their meanings.

The `error_messages` table was added in NDB 7.6.

6.14.22 The ndbinfo locks_per_fragment Table

The `locks_per_fragment` table provides information about counts of lock claim requests, and the outcomes of these requests on a per-fragment basis, serving as a companion table to `operations_per_fragment` and `memory_per_fragment`. This table also shows the total time spent waiting for locks successfully and unsuccessfully since fragment or table creation, or since the most recent restart.

The `locks_per_fragment` table contains the following columns:

- `fq_name`
Fully qualified table name
- `parent_fq_name`
Fully qualified name of parent object
- `type`
Table type; see text for possible values
- `table_id`
Table ID
- `node_id`
Reporting node ID
- `block_instance`
LDM instance ID
- `fragment_num`
Fragment identifier
- `ex_req`
Exclusive lock requests started
- `ex_imm_ok`
Exclusive lock requests immediately granted
- `ex_wait_ok`
Exclusive lock requests granted following wait
- `ex_wait_fail`
Exclusive lock requests not granted
- `sh_req`
Shared lock requests started
- `sh_imm_ok`
Shared lock requests immediately granted
- `sh_wait_ok`
Shared lock requests granted following wait
- `sh_wait_fail`
Shared lock requests not granted
- `wait_ok_millis`
Time spent waiting for lock requests that were granted, in milliseconds

- `wait_fail_millis`

Time spent waiting for lock requests that failed, in milliseconds

Notes

`block_instance` refers to an instance of a kernel block. Together with the block name, this number can be used to look up a given instance in the `threadblocks` table.

`fq_name` is a fully qualified database object name in `database/schema/name` format, such as `test/def/t1` or `sys/def/10/b$unique`.

`parent_fq_name` is the fully qualified name of this object's parent object (table).

`table_id` is the table's internal ID generated by NDB. This is the same internal table ID shown in other `ndbinfo` tables; it is also visible in the output of `ndb_show_tables`.

The `type` column shows the type of table. This is always one of `System table`, `User table`, `Unique hash index`, `Hash index`, `Unique ordered index`, `Ordered index`, `Hash index trigger`, `Subscription trigger`, `Read only constraint`, `Index trigger`, `Reorganize trigger`, `Tablespace`, `Log file group`, `Data file`, `Undo file`, `Hash map`, `Foreign key definition`, `Foreign key parent trigger`, `Foreign key child trigger`, or `Schema transaction`.

The values shown in all of the columns `ex_req`, `ex_req_imm_ok`, `ex_wait_ok`, `ex_wait_fail`, `sh_req`, `sh_req_imm_ok`, `sh_wait_ok`, and `sh_wait_fail` represent cumulative numbers of requests since the table or fragment was created, or since the last restart of this node, whichever of these occurred later. This is also true for the time values shown in the `wait_ok_millis` and `wait_fail_millis` columns.

Every lock request is considered either to be in progress, or to have completed in some way (that is, to have succeeded or failed). This means that the following relationships are true:

```
ex_req >= (ex_req_imm_ok + ex_wait_ok + ex_wait_fail)
sh_req >= (sh_req_imm_ok + sh_wait_ok + sh_wait_fail)
```

The number of requests currently in progress is the current number of incomplete requests, which can be found as shown here:

```
[exclusive lock requests in progress] =
  ex_req - (ex_req_imm_ok + ex_wait_ok + ex_wait_fail)
[shared lock requests in progress] =
  sh_req - (sh_req_imm_ok + sh_wait_ok + sh_wait_fail)
```

A failed wait indicates an aborted transaction, but the abort may or may not be caused by a lock wait timeout. You can obtain the total number of aborts while waiting for locks as shown here:

```
[aborts while waiting for locks] = ex_wait_fail + sh_wait_fail
```

The `locks_per_fragment` table was added in NDB 7.5.3.

6.14.23 The ndbinfo logbuffers Table

The `logbuffer` table provides information on NDB Cluster log buffer usage.

The `logbuffers` table contains the following columns:

- `node_id`

The ID of this data node.

- `log_type`

Type of log. In NDB 7.5, one of: [REDO](#) or [DD-UNDO](#). In NDB 7.6, one of: [REDO](#), [DD-UNDO](#), [BACKUP-DATA](#), or [BACKUP-LOG](#).

- [log_id](#)

The log ID; for Disk Data undo log files, this is the same as the value shown in the [LOGFILE_GROUP_NUMBER](#) column of the [INFORMATION_SCHEMA.FILES](#) table as well as the value shown for the [log_id](#) column of the [ndbinfo logspaces](#) table

- [log_part](#)

The log part number

- [total](#)

Total space available for this log

- [used](#)

Space used by this log

Notes

NDB 7.6.6 makes available [logbuffers](#) table rows reflecting two additional log types when performing an NDB backup. One of these rows has the log type [BACKUP-DATA](#), which shows the amount of data buffer used during backup to copy fragments to backup files. The other row has the log type [BACKUP-LOG](#), which displays the amount of log buffer used during the backup to record changes made after the backup has started. One each of these [log_type](#) rows is shown in the [logbuffers](#) table for each data node in the cluster. These rows are not present unless an NDB backup is currently being performed. (Bug #25822988)

6.14.24 The ndbinfo logspaces Table

This table provides information about NDB Cluster log space usage.

The [logspaces](#) table contains the following columns:

- [node_id](#)

The ID of this data node.

- [log_type](#)

Type of log; one of: [REDO](#) or [DD-UNDO](#).

- [log_id](#)

The log ID; for Disk Data undo log files, this is the same as the value shown in the [LOGFILE_GROUP_NUMBER](#) column of the [INFORMATION_SCHEMA.FILES](#) table as well as the value shown for the [log_id](#) column of the [ndbinfo logbuffers](#) table

- [log_part](#)

The log part number.

- [total](#)

Total space available for this log.

- [used](#)

Space used by this log.

6.14.25 The ndbinfo membership Table

The `membership` table describes the view that each data node has of all the others in the cluster, including node group membership, president node, arbitrator, arbitrator successor, arbitrator connection states, and other information.

The `membership` table contains the following columns:

- `node_id`
This node's node ID
- `group_id`
Node group to which this node belongs
- `left_node`
Node ID of the previous node
- `right_node`
Node ID of the next node
- `president`
President's node ID
- `successor`
Node ID of successor to president
- `succession_order`
Order in which this node succeeds to presidency
- `Conf_HB_order`
-
- `arbitrator`
Node ID of arbitrator
- `arb_ticket`
Internal identifier used to track arbitration
- `arb_state`
Arbitration state
- `arb_connected`
Whether this node is connected to the arbitrator; either of `Yes` or `No`
- `connected_rank1_arbs`
Connected arbitrators of rank 1
- `connected_rank2_arbs`
Connected arbitrators of rank 1

Notes

The node ID and node group ID are the same as reported by `ndb_mgm -e "SHOW"`.

`left_node` and `right_node` are defined in terms of a model that connects all data nodes in a circle, in order of their node IDs, similar to the ordering of the numbers on a clock dial, as shown here:

Figure 6.1 Circular Arrangement of NDB Cluster Nodes

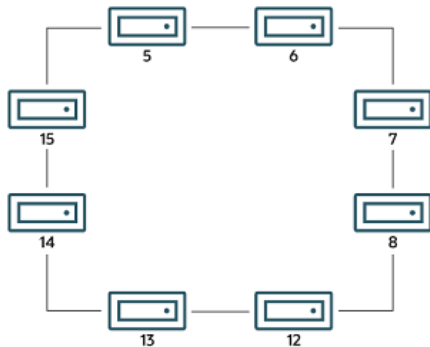

In this example, we have 8 data nodes, numbered 5, 6, 7, 8, 12, 13, 14, and 15, ordered clockwise in a circle. We determine “left” and “right” from the interior of the circle. The node to the left of node 5 is node 15, and the node to the right of node 5 is node 6. You can see all these relationships by running the following query and observing the output:

```
mysql> SELECT node_id, left_node, right_node
-> FROM ndbinfo.membership;
+-----+-----+-----+
| node_id | left_node | right_node |
+-----+-----+-----+
|      5 |        15 |          6 |
|      6 |          5 |          7 |
|      7 |          6 |          8 |
|      8 |          7 |         12 |
|     12 |          8 |         13 |
|     13 |         12 |         14 |
|     14 |         13 |         15 |
|     15 |         14 |          5 |
+-----+-----+-----+
8 rows in set (0.00 sec)
```

The designations “left” and “right” are used in the event log in the same way.

The `president` node is the node viewed by the current node as responsible for setting an arbitrator (see [NDB Cluster Start Phases](#)). If the president fails or becomes disconnected, the current node expects the node whose ID is shown in the `successor` column to become the new president. The `succession_order` column shows the place in the succession queue that the current node views itself as having.

In a normal NDB Cluster, all data nodes should see the same node as `president`, and the same node (other than the president) as its `successor`. In addition, the current president should see itself as `1` in the order of succession, the `successor` node should see itself as `2`, and so on.

All nodes should show the same `arb_ticket` values as well as the same `arb_state` values. Possible `arb_state` values are `ARBIT_NULL`, `ARBIT_INIT`, `ARBIT_FIND`, `ARBIT_PREP1`, `ARBIT_PREP2`, `ARBIT_START`, `ARBIT_RUN`, `ARBIT_CHOOSE`, `ARBIT_CRASH`, and `UNKNOWN`.

`arb_connected` shows whether this node is connected to the node shown as this node's arbitrator.

The `connected_rank1_arbs` and `connected_rank2_arbs` columns each display a list of 0 or more arbitrators having an `ArbitrationRank` equal to 1, or to 2, respectively.

Note

Both management nodes and API nodes are eligible to become arbitrators.

6.14.26 The ndbinfo memoryusage Table

Querying this table provides information similar to that provided by the `ALL REPORT MemoryUsage` command in the `ndb_mgm` client, or logged by `ALL DUMP 1000`.

The `memoryusage` table contains the following columns:

- `node_id`

The node ID of this data node.

- `memory_type`

One of `Data memory`, `Index memory`, or `Long message buffer`.

- `used`

Number of bytes currently used for data memory or index memory by this data node.

- `used_pages`

Number of pages currently used for data memory or index memory by this data node; see text.

- `total`

Total number of bytes of data memory or index memory available for this data node; see text.

- `total_pages`

Total number of memory pages available for data memory or index memory on this data node; see text.

Notes

The `total` column represents the total amount of memory in bytes available for the given resource (data memory or index memory) on a particular data node. This number should be approximately equal to the setting of the corresponding configuration parameter in the `config.ini` file.

Suppose that the cluster has 2 data nodes having node IDs 5 and 6, and the `config.ini` file contains the following:

```
[ndbd default]
DataMemory = 1G
IndexMemory = 1G
```

Suppose also that the value of the `LongMessageBuffer` configuration parameter is allowed to assume its default (64 MB).

The following query shows approximately the same values:

```
mysql> SELECT node_id, memory_type, total
> FROM ndbinfo.memoryusage;
```

node_id	memory_type	total
5	Data memory	1073741824
5	Index memory	1074003968
5	Long message buffer	67108864
6	Data memory	1073741824
6	Index memory	1074003968
6	Long message buffer	67108864

```
+-----+-----+-----+
6 rows in set (0.00 sec)
```

In this case, the `total` column values for index memory are slightly higher than the value set of `IndexMemory` due to internal rounding.

For the `used_pages` and `total_pages` columns, resources are measured in pages, which are 32K in size for `DataMemory` and 8K for `IndexMemory`. For long message buffer memory, the page size is 256 bytes.

6.14.27 The ndbinfo memory_per_fragment Table

The `memory_per_fragment` table provides information about the usage of memory by individual fragments.

The `memory_per_fragment` table contains the following columns:

- `fq_name`
Name of this fragment
- `parent_fq_name`
Name of this fragment's parent
- `type`
Type of object; see text for possible values
- `table_id`
Table ID for this table
- `node_id`
Node ID for this node
- `block_instance`
Kernel block instance ID
- `fragment_num`
Fragment ID (number)
- `fixed_elem_alloc_bytes`
Number of bytes allocated for fixed-sized elements
- `fixed_elem_free_bytes`
Free bytes remaining in pages allocated to fixed-size elements
- `fixed_elem_size_bytes`
Length of each fixed-size element in bytes
- `fixed_elem_count`
Number of fixed-size elements
- `fixed_elem_free_count`
Number of free rows for fixed-size elements

- `var_elem_alloc_bytes`
Number of bytes allocated for variable-size elements
- `var_elem_free_bytes`
Free bytes remaining in pages allocated to variable-size elements
- `var_elem_count`
Number of variable-size elements
- `hash_index_alloc_bytes`
Number of bytes allocated to hash indexes

Notes

The `type` column from this table shows the dictionary object type used for this fragment (`Object::Type`, in the NDB API), and can take any one of the values shown in the following list:

- System table
- User table
- Unique hash index
- Hash index
- Unique ordered index
- Ordered index
- Hash index trigger
- Subscription trigger
- Read only constraint
- Index trigger
- Reorganize trigger
- Tablespace
- Log file group
- Data file
- Undo file
- Hash map
- Foreign key definition
- Foreign key parent trigger
- Foreign key child trigger
- Schema transaction

You can also obtain this list by executing `SELECT * FROM ndbinfo.dict_obj_types` in the `mysql` client.

The `block_instance` column provides the NDB kernel block instance number. You can use this to obtain information about specific threads from the `threadblocks` table.

6.14.28 The ndbinfo nodes Table

This table contains information on the status of data nodes. For each data node that is running in the cluster, a corresponding row in this table provides the node's node ID, status, and uptime. For nodes that are starting, it also shows the current start phase.

The `nodes` table contains the following columns:

- `node_id`

The data node's unique node ID in the cluster.

- `uptime`

Time since the node was last started, in seconds.

- `status`

Current status of the data node; see text for possible values.

- `start_phase`

If the data node is starting, the current start phase.

- `config_generation`

The version of the cluster configuration file in use on this data node.

Notes

The `uptime` column shows the time in seconds that this node has been running since it was last started or restarted. This is a `BIGINT` value. This figure includes the time actually needed to start the node; in other words, this counter starts running the moment that `ndbd` or `ndbmtid` is first invoked; thus, even for a node that has not yet finished starting, `uptime` may show a nonzero value.

The `status` column shows the node's current status. This is one of: `NOTHING`, `CMVMI`, `STARTING`, `STARTED`, `SINGLEUSER`, `STOPPING_1`, `STOPPING_2`, `STOPPING_3`, or `STOPPING_4`. When the status is `STARTING`, you can see the current start phase in the `start_phase` column (see later in this section). `SINGLEUSER` is displayed in the `status` column for all data nodes when the cluster is in single user mode (see [Section 6.6, "NDB Cluster Single User Mode"](#)). Seeing one of the `STOPPING` states does not necessarily mean that the node is shutting down but can mean rather that it is entering a new state. For example, if you put the cluster in single user mode, you can sometimes see data nodes report their state briefly as `STOPPING_2` before the status changes to `SINGLEUSER`.

The `start_phase` column uses the same range of values as those used in the output of the `ndb_mgm` client `node_id STATUS` command (see [Section 6.1, "Commands in the NDB Cluster Management Client"](#)). If the node is not currently starting, then this column shows `0`. For a listing of NDB Cluster start phases with descriptions, see [Section 6.4, "Summary of NDB Cluster Start Phases"](#).

The `config_generation` column shows which version of the cluster configuration is in effect on each data node. This can be useful when performing a rolling restart of the cluster in order to make changes in configuration parameters. For example, from the output of the following `SELECT` statement, you can see that node 3 is not yet using the latest version of the cluster configuration (`6`) although nodes 1, 2, and 4 are doing so:

```
mysql> USE ndbinfo;
Database changed
mysql> SELECT * FROM nodes;
```

node_id	uptime	status	start_phase	config_generation
1	10462	STARTED	0	6
2	10460	STARTED	0	6

```

|      3 | 10457 | STARTED |      0 |      5 |
|      4 | 10455 | STARTED |      0 |      6 |
+-----+-----+-----+-----+-----+
2 rows in set (0.04 sec)

```

Therefore, for the case just shown, you should restart node 3 to complete the rolling restart of the cluster.

Nodes that are stopped are not accounted for in this table. Suppose that you have an NDB Cluster with 4 data nodes (node IDs 1, 2, 3 and 4), and all nodes are running normally, then this table contains 4 rows, 1 for each data node:

```

mysql> USE ndbinfo;
Database changed
mysql> SELECT * FROM nodes;
+-----+-----+-----+-----+-----+
| node_id | uptime | status | start_phase | config_generation |
+-----+-----+-----+-----+-----+
|      1 | 11776 | STARTED |      0 |      6 |
|      2 | 11774 | STARTED |      0 |      6 |
|      3 | 11771 | STARTED |      0 |      6 |
|      4 | 11769 | STARTED |      0 |      6 |
+-----+-----+-----+-----+-----+
4 rows in set (0.04 sec)

```

If you shut down one of the nodes, only the nodes that are still running are represented in the output of this `SELECT` statement, as shown here:

```

ndb_mgm> 2 STOP
Node 2: Node shutdown initiated
Node 2: Node shutdown completed.
Node 2 has shutdown.

mysql> SELECT * FROM nodes;
+-----+-----+-----+-----+-----+
| node_id | uptime | status | start_phase | config_generation |
+-----+-----+-----+-----+-----+
|      1 | 11807 | STARTED |      0 |      6 |
|      3 | 11802 | STARTED |      0 |      6 |
|      4 | 11800 | STARTED |      0 |      6 |
+-----+-----+-----+-----+-----+
3 rows in set (0.02 sec)

```

6.14.29 The ndbinfo operations_per_fragment Table

The `operations_per_fragment` table provides information about the operations performed on individual fragments and fragment replicas, as well as about some of the results from these operations.

The `operations_per_fragment` table contains the following columns:

- `fq_name`
Name of this fragment
- `parent_fq_name`
Name of this fragment's parent
- `type`
Type of object; see text for possible values
- `table_id`
Table ID for this table
- `node_id`

Node ID for this node

- `block_instance`

Kernel block instance ID

- `fragment_num`

Fragment ID (number)

- `tot_key_reads`

Total number of key reads for this fragment replica

- `tot_key_inserts`

Total number of key inserts for this fragment replica

- `tot_key_updates`

total number of key updates for this fragment replica

- `tot_key_writes`

Total number of key writes for this fragment replica

- `tot_key_deletes`

Total number of key deletes for this fragment replica

- `tot_key_refs`

Number of key operations refused

- `tot_key_attrinfo_bytes`

Total size of all `attrinfo` attributes

- `tot_key_keyinfo_bytes`

Total size of all `keyinfo` attributes

- `tot_key_prog_bytes`

Total size of all interpreted programs carried by `attrinfo` attributes

- `tot_key_inst_exec`

Total number of instructions executed by interpreted programs for key operations

- `tot_key_bytes_returned`

Total size of all data and metadata returned from key read operations

- `tot_frag_scans`

Total number of scans performed on this fragment replica

- `tot_scan_rows_examined`

Total number of rows examined by scans

- `tot_scan_rows_returned`

Total number of rows returned to client

- `tot_scan_bytes_returned`

Total size of data and metadata returned to the client

- `tot_scan_prog_bytes`

Total size of interpreted programs for scan operations

- `tot_scan_bound_bytes`

Total size of all bounds used in ordered index scans

- `tot_scan_inst_exec`

Total number of instructions executed for scans

- `tot_qd_frag_scans`

Number of times that scans of this fragment replica have been queued

- `conc_frag_scans`

Number of scans currently active on this fragment replica (excluding queued scans)

- `conc_qd_frag_scans`

Number of scans currently queued for this fragment replica

- `tot_commits`

Total number of row changes committed to this fragment replica

Notes

The `fq_name` contains the fully qualified name of the schema object to which this fragment replica belongs. This currently has the following formats:

- Base table: `DbName/def/TblName`
- BLOB table: `DbName/def/NDB$BLOB_BaseTblId_ColNo`
- Ordered index: `sys/def/BaseTblId/IndexName`
- Unique index: `sys/def/BaseTblId/IndexName$unique`

The `$unique` suffix shown for unique indexes is added by `mysqld`; for an index created by a different NDB API client application, this may differ, or not be present.

The syntax just shown for fully qualified object names is an internal interface which is subject to change in future releases.

Consider a table `t1` created and modified by the following SQL statements:

```
CREATE DATABASE mydb;

USE mydb;

CREATE TABLE t1 (
  a INT NOT NULL,
  b INT NOT NULL,
  t TEXT NOT NULL,
  PRIMARY KEY (b)
) ENGINE=ndbcluster;
```

```
CREATE UNIQUE INDEX ix1 ON t1(b) USING HASH;
```

If `t1` is assigned table ID 11, this yields the `fq_name` values shown here:

- Base table: `mydb/def/t1`
- BLOB table: `mydb/def/NDB$BLOB_11_2`
- Ordered index (primary key): `sys/def/11/PRIMARY`
- Unique index: `sys/def/11/ix1$unique`

For indexes or BLOB tables, the `parent_fq_name` column contains the `fq_name` of the corresponding base table. For base tables, this column is always `NULL`.

The `type` column shows the schema object type used for this fragment, which can take any one of the values `System table`, `User table`, `Unique hash index`, or `Ordered index`. BLOB tables are shown as `User table`.

The `table_id` column value is unique at any given time, but can be reused if the corresponding object has been deleted. The same ID can be seen using the `ndb_show_tables` utility.

The `block_instance` column shows which LDM instance this fragment replica belongs to. You can use this to obtain information about specific threads from the `threadblocks` table. The first such instance is always numbered 0.

Since there are typically two replicas, and assuming that this is so, each `fragment_num` value should appear twice in the table, on two different data nodes from the same node group.

Since NDB does not use single-key access for ordered indexes, the counts for `tot_key_reads`, `tot_key_inserts`, `tot_key_updates`, `tot_key_writes`, and `tot_key_deletes` are not incremented by ordered index operations.

Note

When using `tot_key_writes`, you should keep in mind that a write operation in this context updates the row if the key exists, and inserts a new row otherwise. (One use of this is in the NDB implementation of the `REPLACE SQL` statement.)

The `tot_key_refs` column shows the number of key operations refused by the LDM. Generally, such a refusal is due to duplicate keys (inserts), `Key not found` errors (updates, deletes, and reads), or the operation was rejected by an interpreted program used as a predicate on the row matching the key.

The `attrinfo` and `keyinfo` attributes counted by the `tot_key_attrinfo_bytes` and `tot_key_keyinfo_bytes` columns are attributes of an `LQHKEYREQ` signal (see [The NDB Communication Protocol](#)) used to initiate a key operation by the LDM. An `attrinfo` typically contains tuple field values (inserts and updates) or projection specifications (for reads); `keyinfo` contains the primary or unique key needed to locate a given tuple in this schema object.

The value shown by `tot_frag_scans` includes both full scans (that examine every row) and scans of subsets. Unique indexes and BLOB tables are never scanned, so this value, like other scan-related counts, is 0 for fragment replicas of these.

`tot_scan_rows_examined` may display less than the total number of rows in a given fragment replica, since ordered index scans can be limited by bounds. In addition, a client may choose to end a scan before all potentially matching rows have been examined; this occurs when using an SQL statement containing a `LIMIT` or `EXISTS` clause, for example. `tot_scan_rows_returned` is always less than or equal to `tot_scan_rows_examined`.

`tot_scan_bytes_returned` includes, in the case of pushed joins, projections returned to the `DBSPJ` block in the NDB kernel.

`tot_qd_frag_scans` can be effected by the setting for the `MaxParallelScansPerFragment` data node configuration parameter, which limits the number of scans that may execute concurrently on a single fragment replica.

6.14.30 The ndbinfo processes Table

This table contains information about NDB Cluster node processes; each node is represented by the row in the table. Only nodes that are connected to the cluster are shown in this table. You can obtain information about nodes that are configured but not connected to the cluster from the `nodes` and `config_nodes` tables.

The `processes` table contains the following columns:

- `node_id`
The node's unique node ID in the cluster
- `node_type`
Type of node (management, data, or API node; see text)
- `node_version`
Version of the NDB software program running on this node.
- `process_id`
This node's process ID
- `angel_process_id`
Process ID of this node's angel process
- `process_name`
Name of the executable
- `service_URI`
Service URI of this node (see text)

Notes

`node_id` is the ID assigned to this node in the cluster.

The `node_type` column displays one of the following three values:

- `MGM`: Management node.
- `NDB`: Data node.
- `API`: API or SQL node.

For an executable shipped with the NDB Cluster distribution, `node_version` shows the two-part MySQL NDB Cluster version string, such as `5.7.36-ndb-7.5.25` or `5.7.36-ndb-7.6.21`, that it was compiled with. See [Version strings used in NDB Cluster software](#), for more information.

`process_id` is the node executable's process ID as shown by the host operating system using a process display application such as `top` on Linux, or the Task Manager on Windows platforms.

`angel_process_id` is the system process ID for the node's angel process, which ensures that a data node or SQL is automatically restarted in cases of failures. For management nodes and API nodes other than SQL nodes, the value of this column is `NULL`.

The `process_name` column shows the name of the running executable. For management nodes, this is `ndb_mgmd`. For data nodes, this is `ndbd` (single-threaded) or `ndbmt` (multithreaded). For SQL nodes, this is `mysqld`. For other types of API nodes, it is the name of the executable program connected to the cluster; NDB API applications can set a custom value for this using `Ndb_cluster_connection::set_name()`.

`service_URI` shows the service network address. For management nodes and data nodes, the scheme used is `ndb://`. For SQL nodes, this is `mysql://`. By default, API nodes other than SQL nodes use `ndb://` for the scheme; NDB API applications can set this to a custom value using `Ndb_cluster_connection::set_service_uri()`. regardless of the node type, the scheme is followed by the IP address used by the NDB transporter for the node in question. For management nodes and SQL nodes, this address includes the port number (usually 1186 for management nodes and 3306 for SQL nodes). If the SQL node was started with the `bind_address` system variable set, this address is used instead of the transporter address, unless the bind address is set to `*`, `0.0.0.0`, or `::`.

Additional path information may be included in the `service_URI` value for an SQL node reflecting various configuration options. For example, `mysql://198.51.100.3/tmp/mysql.sock` indicates that the SQL node was started with the `skip_networking` system variable enabled, and `mysql://198.51.100.3:3306/?server-id=1` shows that replication is enabled for this SQL node.

The `processes` table was added in NDB 7.5.7.

6.14.31 The ndbinfo resources Table

This table provides information about data node resource availability and usage.

These resources are sometimes known as *super-pools*.

The `resources` table contains the following columns:

- `node_id`

The unique node ID of this data node.

- `resource_name`

Name of the resource; see text.

- `reserved`

The amount reserved for this resource.

- `used`

The amount actually used by this resource.

- `max`

The maximum amount of this resource used, since the node was last started.

Notes

The `resource_name` can be any one of the names shown in the following table:

- **RESERVED**: Reserved by the system; cannot be overridden.
- **DISK_OPERATIONS**: If a log file group is allocated, the size of the undo log buffer is used to set the size of this resource. This resource is used only to allocate the undo log buffer for an undo log file group; there can only be one such group. Overallocation occurs as needed by `CREATE LOGFILE GROUP`.

- **DISK_RECORDS**: Records allocated for Disk Data operations.
- **DATA_MEMORY**: Used for main memory tuples, indexes, and hash indexes. Sum of DataMemory and IndexMemory, plus 8 pages of 32 KB each if IndexMemory has been set. Cannot be overallocated.
- **JOBBUFFER**: Used for allocating job buffers by the NDB scheduler; cannot be overallocated. This is approximately 2 MB per thread plus a 1 MB buffer in both directions for all threads that can communicate. For large configurations this consume several GB.
- **FILE_BUFFERS**: Used by the redo log handler in the **DBLQH** kernel block; cannot be overallocated. Size is `NoOfFragmentLogParts * RedoBuffer`, plus 1 MB per log file part.
- **TRANSPORTER_BUFFERS**: Used for send buffers by `ndbmt`; the sum of `TotalSendBufferMemory` and `ExtraSendBufferMemory`. This resource that can be overallocated by up to 25 percent. `TotalSendBufferMemory` is calculated by summing the send buffer memory per node, the default value of which is 2 MB. Thus, in a system having four data nodes and eight API nodes, the data nodes have $12 * 2$ MB send buffer memory. `ExtraSendBufferMemory` is used by `ndbmt` and amounts to 2 MB extra memory per thread. Thus, with 4 LDM threads, 2 TC threads, 1 main thread, 1 replication thread, and 2 receive threads, `ExtraSendBufferMemory` is $10 * 2$ MB. Overallocation of this resource can be performed by setting the `SharedGlobalMemory` data node configuration parameter.
- **DISK_PAGE_BUFFER**: Used for the disk page buffer; determined by the `DiskPageBufferMemory` configuration parameter. Cannot be overallocated.
- **QUERY_MEMORY**: Used by the `DBSPJ` kernel block.
- **SCHEMA_TRANS_MEMORY**: Minimum is 2 MB; can be overallocated to use any remaining available memory.

6.14.32 The ndbinfo restart_info Table

The `restart_info` table contains information about node restart operations. Each entry in the table corresponds to a node restart status report in real time from a data node with the given node ID. Only the most recent report for any given node is shown.

The `restart_info` table contains the following columns:

- `node_id`
Node ID in the cluster
- `node_restart_status`
Node status; see text for values. Each of these corresponds to a possible value of `node_restart_status_int`.
- `node_restart_status_int`
Node status code; see text for values.
- `secs_to_complete_node_failure`
Time in seconds to complete node failure handling
- `secs_to_allocate_node_id`
Time in seconds from node failure completion to allocation of node ID
- `secs_to_include_in_heartbeat_protocol`
Time in seconds from allocation of node ID to inclusion in heartbeat protocol

The ndbinfo restart_info Table

- `secs_until_wait_for_ndbcntr_master`
Time in seconds from being included in heartbeat protocol until waiting for `NDBCNTR` master began
- `secs_wait_for_ndbcntr_master`
Time in seconds spent waiting to be accepted by `NDBCNTR` master for starting
- `secs_to_get_start_permitted`
Time in seconds elapsed from receiving of permission for start from master until all nodes have accepted start of this node
- `secs_to_wait_for_lcp_for_copy_meta_data`
Time in seconds spent waiting for LCP completion before copying metadata
- `secs_to_copy_meta_data`
Time in seconds required to copy metadata from master to newly starting node
- `secs_to_include_node`
Time in seconds waited for GCP and inclusion of all nodes into protocols
- `secs_starting_node_to_request_local_recovery`
Time in seconds that the node just starting spent waiting to request local recovery
- `secs_for_local_recovery`
Time in seconds required for local recovery by node just starting
- `secs_restore_fragments`
Time in seconds required to restore fragments from LCP files
- `secs_undo_disk_data`
Time in seconds required to execute undo log on disk data part of records
- `secs_exec_redo_log`
Time in seconds required to execute redo log on all restored fragments
- `secs_index_rebuild`
Time in seconds required to rebuild indexes on restored fragments
- `secs_to_synchronize_starting_node`
Time in seconds required to synchronize starting node from live nodes
- `secs_wait_lcp_for_restart`
Time in seconds required for LCP start and completion before restart was completed
- `secs_wait_subscription_handover`
Time in seconds spent waiting for handover of replication subscriptions
- `total_restart_secs`
Total number of seconds from node failure until node is started again

Notes

The following list contains values defined for the `node_restart_status_int` column with their internal status names (in parentheses), and the corresponding messages shown in the `node_restart_status` column:

- 0 (ALLOCATED_NODE_ID)
Allocated node id
- 1 (INCLUDED_IN_HB_PROTOCOL)
Included in heartbeat protocol
- 2 (NDBCNTR_START_WAIT)
Wait for NDBCNTR master to permit us to start
- 3 (NDBCNTR_STARTED)
NDBCNTR master permitted us to start
- 4 (START_PERMITTED)
All nodes permitted us to start
- 5 (WAIT_LCP_TO_COPY_DICT)
Wait for LCP completion to start copying metadata
- 6 (COPY_DICT_TO_STARTING_NODE)
Copying metadata to starting node
- 7 (INCLUDE_NODE_IN_LCP_AND_GCP)
Include node in LCP and GCP protocols
- 8 (LOCAL_RECOVERY_STARTED)
Restore fragments ongoing
- 9 (COPY_FRAGMENTS_STARTED)
Synchronizing starting node with live nodes
- 10 (WAIT_LCP_FOR_RESTART)
Wait for LCP to ensure durability
- 11 (WAIT_SUMA_HANDOVER)
Wait for handover of subscriptions
- 12 (RESTART_COMPLETED)
Restart completed
- 13 (NODE_FAILED)
Node failed, failure handling in progress
- 14 (NODE_FAILURE_COMPLETED)

- Node failure handling completed
- 15 (NODE_GETTING_PERMIT)
All nodes permitted us to start
- 16 (NODE_GETTING_INCLUDED)
Include node in LCP and GCP protocols
- 17 (NODE_GETTING_SYNCED)
Synchronizing starting node with live nodes
- 18 (NODE_GETTING_LCP_WAITED)
[none]
- 19 (NODE_ACTIVE)
Restart completed
- 20 (NOT_DEFINED_IN_CLUSTER)
[none]
- 21 (NODE_NOT_RESTARTED_YET)
Initial state

Status numbers 0 through 12 apply on master nodes only; the remainder of those shown in the table apply to all restarting data nodes. Status numbers 13 and 14 define node failure states; 20 and 21 occur when no information about the restart of a given node is available.

See also [Section 6.4, “Summary of NDB Cluster Start Phases”](#).

6.14.33 The ndbinfo server_locks Table

The `server_locks` table is similar in structure to the `cluster_locks` table, and provides a subset of the information found in the latter table, but which is specific to the SQL node (MySQL server) where it resides. (The `cluster_locks` table provides information about all locks in the cluster.) More precisely, `server_locks` contains information about locks requested by threads belonging to the current `mysqld` instance, and serves as a companion table to `server_operations`. This may be useful for correlating locking patterns with specific MySQL user sessions, queries, or use cases.

The `server_locks` table contains the following columns:

- `mysql_connection_id`
MySQL connection ID
- `node_id`
ID of reporting node
- `block_instance`
ID of reporting LDM instance
- `tableid`
ID of table containing this row

- `fragmentid`
ID of fragment containing locked row
- `rowid`
ID of locked row
- `transid`
Transaction ID
- `mode`
Lock request mode
- `state`
Lock state
- `detail`
Whether this is first holding lock in row lock queue
- `op`
Operation type
- `duration_millis`
Milliseconds spent waiting or holding lock
- `lock_num`
ID of lock object
- `waiting_for`
Waiting for lock with this ID

Notes

The `mysql_connection_id` column shows the MySQL connection or thread ID as shown by `SHOW PROCESSLIST`.

`block_instance` refers to an instance of a kernel block. Together with the block name, this number can be used to look up a given instance in the `threadblocks` table.

The `tableid` is assigned to the table by NDB; the same ID is used for this table in other `ndbinfo` tables, as well as in the output of `ndb_show_tables`.

The transaction ID shown in the `transid` column is the identifier generated by the NDB API for the transaction requesting or holding the current lock.

The `mode` column shows the lock mode, which is always one of `S` (shared lock) or `X` (exclusive lock). If a transaction has an exclusive lock on a given row, all other locks on that row have the same transaction ID.

The `state` column shows the lock state. Its value is always one of `H` (holding) or `W` (waiting). A waiting lock request waits for a lock held by a different transaction.

The `detail` column indicates whether this lock is the first holding lock in the affected row's lock queue, in which case it contains a `*` (asterisk character); otherwise, this column is empty. This information can be used to help identify the unique entries in a list of lock requests.

The `op` column shows the type of operation requesting the lock. This is always one of the values `READ`, `INSERT`, `UPDATE`, `DELETE`, `SCAN`, or `REFRESH`.

The `duration_millis` column shows the number of milliseconds for which this lock request has been waiting or holding the lock. This is reset to 0 when a lock is granted for a waiting request.

The lock ID (`lockid` column) is unique to this node and block instance.

If the `lock_state` column's value is `W`, this lock is waiting to be granted, and the `waiting_for` column shows the lock ID of the lock object this request is waiting for. Otherwise, `waiting_for` is empty. `waiting_for` can refer only to locks on the same row (as identified by `node_id`, `block_instance`, `tableid`, `fragmentid`, and `rowid`).

The `server_locks` table was added in NDB 7.5.3.

6.14.34 The ndbinfo server_operations Table

The `server_operations` table contains entries for all ongoing `NDB` operations that the current SQL node (MySQL Server) is currently involved in. It effectively is a subset of the `cluster_operations` table, in which operations for other SQL and API nodes are not shown.

The `server_operations` table contains the following columns:

- `mysql_connection_id`
MySQL Server connection ID
- `node_id`
Node ID
- `block_instance`
Block instance
- `transid`
Transaction ID
- `operation_type`
Operation type (see text for possible values)
- `state`
Operation state (see text for possible values)
- `tableid`
Table ID
- `fragmentid`
Fragment ID
- `client_node_id`
Client node ID
- `client_block_ref`
Client block reference

- `tc_node_id`
Transaction coordinator node ID
- `tc_block_no`
Transaction coordinator block number
- `tc_block_instance`
Transaction coordinator block instance

Notes

The `mysql_connection_id` is the same as the connection or session ID shown in the output of `SHOW PROCESSLIST`. It is obtained from the `INFORMATION_SCHEMA` table `NDB_TRANSID_MYSQL_CONNECTION_MAP`.

`block_instance` refers to an instance of a kernel block. Together with the block name, this number can be used to look up a given instance in the `threadblocks` table.

The transaction ID (`transid`) is a unique 64-bit number which can be obtained using the NDB API's `getTransactionId()` method. (Currently, the MySQL Server does not expose the NDB API transaction ID of an ongoing transaction.)

The `operation_type` column can take any one of the values `READ`, `READ-SH`, `READ-EX`, `INSERT`, `UPDATE`, `DELETE`, `WRITE`, `UNLOCK`, `REFRESH`, `SCAN`, `SCAN-SH`, `SCAN-EX`, or `<unknown>`.

The `state` column can have any one of the values `ABORT_QUEUED`, `ABORT_STOPPED`, `COMMITTED`, `COMMIT_QUEUED`, `COMMIT_STOPPED`, `COPY_CLOSE_STOPPED`, `COPY_FIRST_STOPPED`, `COPY_STOPPED`, `COPY_TUPKEY`, `IDLE`, `LOG_ABORT_QUEUED`, `LOG_COMMIT_QUEUED`, `LOG_COMMIT_QUEUED_WAIT_SIGNAL`, `LOG_COMMIT_WRITTEN`, `LOG_COMMIT_WRITTEN_WAIT_SIGNAL`, `LOG_QUEUED`, `PREPARED`, `PREPARED_RECEIVED_COMMIT`, `SCAN_CHECK_STOPPED`, `SCAN_CLOSE_STOPPED`, `SCAN_FIRST_STOPPED`, `SCAN_RELEASE_STOPPED`, `SCAN_STATE_USED`, `SCAN_STOPPED`, `SCAN_TUPKEY`, `STOPPED`, `TC_NOT_CONNECTED`, `WAIT_ACC`, `WAIT_ACC_ABORT`, `WAIT_AI_AFTER_ABORT`, `WAIT_ATTR`, `WAIT_SCAN_AI`, `WAIT_TUP`, `WAIT_TUPKEYINFO`, `WAIT_TUP_COMMIT`, or `WAIT_TUP_TO_ABORT`. (If the MySQL Server is running with `ndbinfo_show_hidden` enabled, you can view this list of states by selecting from the `ndb$tblqh_tcconnect_state` table, which is normally hidden.)

You can obtain the name of an NDB table from its table ID by checking the output of `ndb_show_tables`.

The `fragid` is the same as the partition number seen in the output of `ndb_desc --extra-partition-info` (short form `-p`).

In `client_node_id` and `client_block_ref`, `client` refers to an NDB Cluster API or SQL node (that is, an NDB API client or a MySQL Server attached to the cluster).

The `block_instance` and `tc_block_instance` column provide NDB kernel block instance numbers. You can use these to obtain information about specific threads from the `threadblocks` table.

6.14.35 The ndbinfo server_transactions Table

The `server_transactions` table is subset of the `cluster_transactions` table, but includes only those transactions in which the current SQL node (MySQL Server) is a participant, while including the relevant connection IDs.

The `server_transactions` table contains the following columns:

- `mysql_connection_id`
MySQL Server connection ID
- `node_id`
Transaction coordinator node ID
- `block_instance`
Transaction coordinator block instance
- `transid`
Transaction ID
- `state`
Operation state (see text for possible values)
- `count_operations`
Number of stateful operations in the transaction
- `outstanding_operations`
Operations still being executed by local data management layer (LQH blocks)
- `inactive_seconds`
Time spent waiting for API
- `client_node_id`
Client node ID
- `client_block_ref`
Client block reference

Notes

The `mysql_connection_id` is the same as the connection or session ID shown in the output of `SHOW PROCESSLIST`. It is obtained from the `INFORMATION_SCHEMA` table `NDB_TRANSID_MYSQL_CONNECTION_MAP`.

`block_instance` refers to an instance of a kernel block. Together with the block name, this number can be used to look up a given instance in the `threadblocks` table.

The transaction ID (`transid`) is a unique 64-bit number which can be obtained using the NDB API's `getTransactionId()` method. (Currently, the MySQL Server does not expose the NDB API transaction ID of an ongoing transaction.)

The `state` column can have any one of the values `CS_ABORTING`, `CS_COMMITTING`, `CS_COMMIT_SENT`, `CS_COMPLETE_SENT`, `CS_COMPLETING`, `CS_CONNECTED`, `CS_DISCONNECTED`, `CS_FAIL_ABORTED`, `CS_FAIL_ABORTING`, `CS_FAIL_COMMITTED`, `CS_FAIL_COMMITTING`, `CS_FAIL_COMPLETED`, `CS_FAIL_PREPARED`, `CS_PREPARE_TO_COMMIT`, `CS_RECEIVING`, `CS_REC_COMMITTING`, `CS_RESTART`, `CS_SEND_FIRE_TRIG_REQ`, `CS_STARTED`, `CS_START_COMMITTING`, `CS_START_SCAN`, `CS_WAIT_ABORT_CONF`, `CS_WAIT_COMMIT_CONF`, `CS_WAIT_COMPLETE_CONF`, `CS_WAIT_FIRE_TRIG_REQ`. (If the MySQL Server is running with `ndbinfo_show_hidden` enabled, you can view this list of states by selecting from the `ndb $dbtc_apiconnect_state` table, which is normally hidden.)

In `client_node_id` and `client_block_ref`, `client` refers to an NDB Cluster API or SQL node (that is, an NDB API client or a MySQL Server attached to the cluster).

The `block_instance` column provides the `DBTC` kernel block instance number. You can use this to obtain information about specific threads from the `threadblocks` table.

6.14.36 The ndbinfo table_distribution_status Table

The `table_distribution_status` table provides information about the progress of table distribution for `NDB` tables.

The `table_distribution_status` table contains the following columns:

- `node_id`

Node id

- `table_id`

Table ID

- `tab_copy_status`

Status of copying of table distribution data to disk; one of `IDLE`, `SR_PHASE1_READ_PAGES`, `SR_PHASE2_READ_TABLE`, `SR_PHASE3_COPY_TABLE`, `REMOVE_NODE`, `LCP_READ_TABLE`, `COPY_TAB_REQ`, `COPY_NODE_STATE`, `ADD_TABLE_MASTER`, `ADD_TABLE_SLAVE`, `INVALIDATE_NODE_LCP`, `ALTER_TABLE`, `COPY_TO_SAVE`, or `GET_TABINFO`

- `tab_update_status`

Status of updating of table distribution data; one of `IDLE`, `LOCAL_CHECKPOINT`, `LOCAL_CHECKPOINT_QUEUED`, `REMOVE_NODE`, `COPY_TAB_REQ`, `ADD_TABLE_MASTER`, `ADD_TABLE_SLAVE`, `INVALIDATE_NODE_LCP`, or `CALLBACK`

- `tab_lcp_status`

Status of table LCP; one of `ACTIVE` (waiting for local checkpoint to be performed), `WRITING_TO_FILE` (checkpoint performed but not yet written to disk), or `COMPLETED` (checkpoint performed and persisted to disk)

- `tab_status`

Table internal status; one of `ACTIVE` (table exists), `CREATING` (table is being created), or `DROPPING` (table is being dropped)

- `tab_storage`

Table recoverability; one of `NORMAL` (fully recoverable with redo logging and checkpointing), `NOLOGGING` (recoverable from node crash, empty following cluster crash), or `TEMPORARY` (not recoverable)

- `tab_partitions`

Number of partitions in table

- `tab_fragments`

Number of fragments in table; normally same as `tab_partitions`; for fully replicated tables equal to `tab_partitions * [number of node groups]`

- `current_scan_count`

Current number of active scans

- `scan_count_wait`

Current number of scans waiting to be performed before `ALTER TABLE` can complete.

- `is_reorg_ongoing`

Whether table is currently being reorganized (1 if true)

Notes

The `table_distribution_status` table was added in NDB 7.5.4.

6.14.37 The ndbinfo table_fragments Table

The `table_fragments` table provides information about the fragmentation, partitioning, distribution, and (internal) replication of NDB tables.

The `table_fragments` table contains the following columns:

- `node_id`

Node ID (DIH master)

- `table_id`

Table ID

- `partition_id`

Partition ID

- `fragment_id`

Fragment ID (same as partition ID unless table is fully replicated)

- `partition_order`

Order of fragment in partition

- `log_part_id`

Log part ID of fragment

- `no_of_replicas`

Number of fragment replicas

- `current_primary`

Current primary node ID

- `preferred_primary`

Preferred primary node ID

- `current_first_backup`

Current first backup node ID

- `current_second_backup`

Current second backup node ID

- `current_third_backup`

Current third backup node ID

- `num_alive_replicas`

Current number of live fragment replicas

- `num_dead_replicas`

Current number of dead fragment replicas

- `num_lcp_replicas`

Number of fragment replicas remaining to be checkpointed

Notes

The `table_fragments` table was added in NDB 7.5.4.

6.14.38 The ndbinfo table_info Table

The `table_info` table provides information about logging, checkpointing, distribution, and storage options in effect for individual `NDB` tables.

The `table_info` table contains the following columns:

- `table_id`

Table ID

- `logged_table`

Whether table is logged (1) or not (0)

- `row_contains_gci`

Whether table rows contain GCI (1 true, 0 false)

- `row_contains_checksum`

Whether table rows contain checksum (1 true, 0 false)

- `read_backup`

If backup fragment replicas are read this is 1, otherwise 0

- `fully_replicated`

If table is fully replicated this is 1, otherwise 0

- `storage_type`

Table storage type; one of `MEMORY` or `DISK`

- `hashmap_id`

Hashmap ID

- `partition_balance`

Partition balance (fragment count type) used for table; one of `FOR_RP_BY_NODE`, `FOR_RA_BY_NODE`, `FOR_RP_BY_LDM`, or `FOR_RA_BY_LDM`

- `create_gci`

GCI in which table was created

Notes

The `table_info` table was added in NDB 7.5.4.

6.14.39 The ndbinfo table_replicas Table

The `table_replicas` table provides information about the copying, distribution, and checkpointing of NDB table fragments and fragment replicas.

The `table_replicas` table contains the following columns:

- `node_id`
ID of the node from which data is fetched (DIH master)
- `table_id`
Table ID
- `fragment_id`
Fragment ID
- `initial_gci`
Initial GCI for table
- `replica_node_id`
ID of node where fragment replica is stored
- `is_lcp_ongoing`
Is 1 if LCP is ongoing on this fragment, 0 otherwise
- `num_crashed_replicas`
Number of crashed fragment replica instances
- `last_max_gci_started`
Highest GCI started in most recent LCP
- `last_max_gci_completed`
Highest GCI completed in most recent LCP
- `last_lcp_id`
ID of most recent LCP
- `prev_lcp_id`
ID of previous LCP
- `prev_max_gci_started`
Highest GCI started in previous LCP
- `prev_max_gci_completed`

Highest GCI completed in previous LCP

- `last_create_gci`

Last Create GCI of last crashed fragment replica instance

- `last_replica_gci`

Last GCI of last crashed fragment replica instance

- `is_replica_alive`

1 if this fragment replica is alive, 0 otherwise

Notes

The `table_replicas` table was added in NDB 7.5.4.

6.14.40 The ndbinfo tc_time_track_stats Table

The `tc_time_track_stats` table provides time-tracking information obtained from the `DBTC` block (TC) instances in the data nodes, through API nodes access `NDB`. Each TC instance tracks latencies for a set of activities it undertakes on behalf of API nodes or other data nodes; these activities include transactions, transaction errors, key reads, key writes, unique index operations, failed key operations of any type, scans, failed scans, fragment scans, and failed fragment scans.

A set of counters is maintained for each activity, each counter covering a range of latencies less than or equal to an upper bound. At the conclusion of each activity, its latency is determined and the appropriate counter incremented. `tc_time_track_stats` presents this information as rows, with a row for each instance of the following:

- Data node, using its ID
- TC block instance
- Other communicating data node or API node, using its ID
- Upper bound value

Notes

Each row contains a value for each activity type. This is the number of times that this activity occurred with a latency within the range specified by the row (that is, where the latency does not exceed the upper bound).

The `tc_time_track_stats` table contains the following columns:

- `node_id`

Requesting node ID

- `block_number`

TC block number

- `block_instance`

TC block instance number

- `comm_node_id`

Node ID of communicating API or data node

- [upper_bound](#)

Upper bound of interval (in microseconds)

- [scans](#)

Based on duration of successful scans from opening to closing, tracked against the API or data nodes requesting them.

- [scan_errors](#)

Based on duration of failed scans from opening to closing, tracked against the API or data nodes requesting them.

- [scan_fragments](#)

Based on duration of successful fragment scans from opening to closing, tracked against the data nodes executing them

- [scan_fragment_errors](#)

Based on duration of failed fragment scans from opening to closing, tracked against the data nodes executing them

- [transactions](#)

Based on duration of successful transactions from beginning until sending of commit [ACK](#), tracked against the API or data nodes requesting them. Stateless transactions are not included.

- [transaction_errors](#)

Based on duration of failing transactions from start to point of failure, tracked against the API or data nodes requesting them.

- [read_key_ops](#)

Based on duration of successful primary key reads with locks. Tracked against both the API or data node requesting them and the data node executing them.

- [write_key_ops](#)

Based on duration of successful primary key writes, tracked against both the API or data node requesting them and the data node executing them.

- [index_key_ops](#)

Based on duration of successful unique index key operations, tracked against both the API or data node requesting them and the data node executing reads of base tables.

- [key_op_errors](#)

Based on duration of all unsuccessful key read or write operations, tracked against both the API or data node requesting them and the data node executing them.

The [block_instance](#) column provides the [DBTC](#) kernel block instance number. You can use this together with the block name to obtain information about specific threads from the [threadblocks](#) table.

6.14.41 The ndbinfo threadblocks Table

The `threadblocks` table associates data nodes, threads, and instances of NDB kernel blocks.

The `threadblocks` table contains the following columns:

- `node_id`
Node ID
- `thr_no`
Thread ID
- `block_name`
Block name
- `block_instance`
Block instance number

Notes

The value of the `block_name` in this table is one of the values found in the `block_name` column when selecting from the `ndbinfo.blocks` table. Although the list of possible values is static for a given NDB Cluster release, the list may vary between releases.

The `block_instance` column provides the kernel block instance number.

6.14.42 The ndbinfo threads Table

The `threads` table provides information about threads running in the NDB kernel.

The `threads` table contains the following columns:

- `node_id`
ID of the node where the thread is running
- `thr_no`
Thread ID (specific to this node)
- `thread_name`
Thread name (type of thread)
- `thread_description`
Thread (type) description

Notes

Sample output from a 2-node example cluster, including thread descriptions, is shown here:

```
mysql> SELECT * FROM threads;
```

node_id	thr_no	thread_name	thread_description
5	0	main	main thread, schema and distribution handling
5	1	rep	rep thread, asynch replication and proxy block handling
5	2	ldm	ldm thread, handling a set of data partitions
5	3	recv	receive thread, performing receive and polling for new receives
6	0	main	main thread, schema and distribution handling
6	1	rep	rep thread, asynch replication and proxy block handling

The ndbinfo threadstat Table

6	2	ldm	ldm thread, handling a set of data partitions
6	3	recv	receive thread, performing receive and polling for new receives

8 rows in set (0.01 sec)

This table was added in NDB 7.5.2.

6.14.43 The ndbinfo threadstat Table

The `threadstat` table provides a rough snapshot of statistics for threads running in the NDB kernel.

The `threadstat` table contains the following columns:

- `node_id`
Node ID
- `thr_no`
Thread ID
- `thr_nm`
Thread name
- `c_loop`
Number of loops in main loop
- `c_exec`
Number of signals executed
- `c_wait`
Number of times waiting for additional input
- `c_l_sent_prioa`
Number of priority A signals sent to own node
- `c_l_sent_priob`
Number of priority B signals sent to own node
- `c_r_sent_prioa`
Number of priority A signals sent to remote node
- `c_r_sent_priob`
Number of priority B signals sent to remote node
- `os_tid`
OS thread ID
- `os_now`
OS time (ms)
- `os_ru_utime`
OS user CPU time (μ s)

- `os_ru_stime`
OS system CPU time (μ s)
- `os_ru_minflt`
OS page reclaims (soft page faults)
- `os_ru_majflt`
OS page faults (hard page faults)
- `os_ru_nvcsw`
OS voluntary context switches
- `os_ru_nivcsw`
OS involuntary context switches

Notes

`os_time` uses the system `gettimeofday()` call.

The values of the `os_ru_utime`, `os_ru_stime`, `os_ru_minflt`, `os_ru_majflt`, `os_ru_nvcsw`, and `os_ru_nivcsw` columns are obtained using the system `getrusage()` call, or the equivalent.

Since this table contains counts taken at a given point in time, for best results it is necessary to query this table periodically and store the results in an intermediate table or tables. The MySQL Server's Event Scheduler can be employed to automate such monitoring. For more information, see [Using the Event Scheduler](#).

6.14.44 The ndbinfo transporters Table

This table contains information about NDB transporters.

The `transporters` table contains the following columns:

- `node_id`
This data node's unique node ID in the cluster
- `remote_node_id`
The remote data node's node ID
- `status`
Status of the connection
- `remote_address`
Name or IP address of the remote host
- `bytes_sent`
Number of bytes sent using this connection
- `bytes_received`
Number of bytes received using this connection
- `connect_count`

Number of times connection established on this transporter

- `overloaded`

1 if this transporter is currently overloaded, otherwise 0

- `overload_count`

Number of times this transporter has entered overload state since connecting

- `slowdown`

1 if this transporter is in slowdown state, otherwise 0

- `slowdown_count`

Number of times this transporter has entered slowdown state since connecting

Notes

For each running data node in the cluster, the `transporters` table displays a row showing the status of each of that node's connections with all nodes in the cluster, *including itself*. This information is shown in the table's `status` column, which can have any one of the following values: `CONNECTING`, `CONNECTED`, `DISCONNECTING`, or `DISCONNECTED`.

Connections to API and management nodes which are configured but not currently connected to the cluster are shown with status `DISCONNECTED`. Rows where the `node_id` is that of a data node which is not currently connected are not shown in this table. (This is similar omission of disconnected nodes in the `ndbinfo.nodes` table.

The `remote_address` is the host name or address for the node whose ID is shown in the `remote_node_id` column. The `bytes_sent` from this node and `bytes_received` by this node are the numbers, respectively, of bytes sent and received by the node using this connection since it was established. For nodes whose status is `CONNECTING` or `DISCONNECTED`, these columns always display 0.

Assume you have a 5-node cluster consisting of 2 data nodes, 2 SQL nodes, and 1 management node, as shown in the output of the `SHOW` command in the `ndb_mgm` client:

```
ndb_mgm> SHOW
Connected to Management Server at: localhost:1186
Cluster Configuration
-----
[ndbd(NDB)]      2 node(s)
id=1   @10.100.10.1 (5.7.36-ndb-7.6.21, Nodegroup: 0, *)
id=2   @10.100.10.2 (5.7.36-ndb-7.6.21, Nodegroup: 0)

[ndb_mgmd(MGM)]  1 node(s)
id=10  @10.100.10.10 (5.7.36-ndb-7.6.21)

[mysqld(API)]   2 node(s)
id=20  @10.100.10.20 (5.7.36-ndb-7.6.21)
id=21  @10.100.10.21 (5.7.36-ndb-7.6.21)
```

There are 10 rows in the `transporters` table—5 for the first data node, and 5 for the second—assuming that all data nodes are running, as shown here:

```
mysql> SELECT node_id, remote_node_id, status
-> FROM ndbinfo.transporters;
+-----+-----+-----+
| node_id | remote_node_id | status      |
+-----+-----+-----+
| 1       | 1               | DISCONNECTED |
| 1       | 2               | CONNECTED    |
| 1       | 10              | CONNECTED    |
```

```

+-----+-----+-----+-----+
| 1 | 20 | CONNECTED |
| 1 | 21 | CONNECTED |
| 2 | 1 | CONNECTED |
| 2 | 2 | DISCONNECTED |
| 2 | 10 | CONNECTED |
| 2 | 20 | CONNECTED |
| 2 | 21 | CONNECTED |
+-----+-----+-----+
10 rows in set (0.04 sec)
    
```

If you shut down one of the data nodes in this cluster using the command `2 STOP` in the `ndb_mgm` client, then repeat the previous query (again using the `mysql` client), this table now shows only 5 rows—1 row for each connection from the remaining management node to another node, including both itself and the data node that is currently offline—and displays `CONNECTING` for the status of each remaining connection to the data node that is currently offline, as shown here:

```

mysql> SELECT node_id, remote_node_id, status
-> FROM ndbinfo.transporters;
+-----+-----+-----+-----+
| node_id | remote_node_id | status |
+-----+-----+-----+-----+
| 1 | 1 | DISCONNECTED |
| 1 | 2 | CONNECTING |
| 1 | 10 | CONNECTED |
| 1 | 20 | CONNECTED |
| 1 | 21 | CONNECTED |
+-----+-----+-----+-----+
5 rows in set (0.02 sec)
    
```

The `connect_count`, `overloaded`, `overload_count`, `slowdown`, and `slowdown_count` counters are reset on connection, and retain their values after the remote node disconnects. The `bytes_sent` and `bytes_received` counters are also reset on connection, and so retain their values following disconnection (until the next connection resets them).

The *overload* state referred to by the `overloaded` and `overload_count` columns occurs when this transporter's send buffer contains more than `OVERloadLimit` bytes (default is 80% of `SendBufferMemory`, that is, $0.8 * 2097152 = 1677721$ bytes). When a given transporter is in a state of overload, any new transaction that tries to use this transporter fails with Error 1218 (`Send Buffers overloaded in NDB kernel`). This affects both scans and primary key operations.

The *slowdown* state referenced by the `slowdown` and `slowdown_count` columns of this table occurs when the transporter's send buffer contains more than 60% of the overload limit (equal to $0.6 * 2097152 = 1258291$ bytes by default). In this state, any new scan using this transporter has its batch size reduced to minimize the load on the transporter.

Common causes of send buffer slowdown or overloading include the following:

- Data size, in particular the quantity of data stored in `TEXT` columns or `BLOB` columns (or both types of columns)
- Having a data node (`ndbd` or `ndbmt`) on the same host as an SQL node that is engaged in binary logging
- Large number of rows per transaction or transaction batch
- Configuration issues such as insufficient `SendBufferMemory`
- Hardware issues such as insufficient RAM or poor network connectivity

See also [Section 4.3.13, “Configuring NDB Cluster Send Buffer Parameters”](#).

6.15 INFORMATION_SCHEMA Tables for NDB Cluster

Two `INFORMATION_SCHEMA` tables provide information that is of particular use when managing an NDB Cluster. The `FILES` table provides information about NDB Cluster Disk Data files. The

`ndb_transid_mysql_connection_map` table provides a mapping between transactions, transaction coordinators, and API nodes.

Additional statistical and other data about NDB Cluster transactions, operations, threads, blocks, and other aspects of performance can be obtained from the tables in the `ndbinfo` database. For information about these tables, see [Section 6.14, “ndbinfo: The NDB Cluster Information Database”](#).

6.16 Quick Reference: NDB Cluster SQL Statements

This section discusses several SQL statements that can prove useful in managing and monitoring a MySQL server that is connected to an NDB Cluster, and in some cases provide information about the cluster itself.

- `SHOW ENGINE NDB STATUS, SHOW ENGINE NDBCLUSTER STATUS`

The output of this statement contains information about the server's connection to the cluster, creation and usage of NDB Cluster objects, and binary logging for NDB Cluster replication.

See [SHOW ENGINE Statement](#), for a usage example and more detailed information.

- `SHOW ENGINES`

This statement can be used to determine whether or not clustering support is enabled in the MySQL server, and if so, whether it is active.

See [SHOW ENGINES Statement](#), for more detailed information.

Note

This statement does not support a `LIKE` clause. However, you can use `LIKE` to filter queries against the `INFORMATION_SCHEMA.ENGINES` table, as discussed in the next item.

- `SELECT * FROM INFORMATION_SCHEMA.ENGINES [WHERE ENGINE LIKE 'NDB%']`

This is the equivalent of `SHOW ENGINES`, but uses the `ENGINES` table of the `INFORMATION_SCHEMA` database. Unlike the case with the `SHOW ENGINES` statement, it is possible to filter the results using a `LIKE` clause, and to select specific columns to obtain information that may be of use in scripts. For example, the following query shows whether the server was built with `NDB` support and, if so, whether it is enabled:

```
mysql> SELECT SUPPORT FROM INFORMATION_SCHEMA.ENGINES
-> WHERE ENGINE LIKE 'NDB%';
+-----+
| support |
+-----+
| ENABLED |
+-----+
```

See [The INFORMATION_SCHEMA ENGINES Table](#), for more information.

- `SHOW VARIABLES LIKE 'NDB%'`

This statement provides a list of most server system variables relating to the `NDB` storage engine, and their values, as shown here, using `NDB 7.6`:

```
mysql> SHOW VARIABLES LIKE 'NDB%';
+-----+-----+
| Variable_name | Value |
+-----+-----+
| ndb_allow_copying_alter_table | ON |
| ndb_autoincrement_prefetch_sz | 1 |
| ndb_batch_size | 32768 |
| ndb_blob_read_batch_bytes | 65536 |
+-----+-----+
```

equivalent to the `SHOW VARIABLES` statement described in the previous item, and provides almost identical output, as shown here:

```
mysql> SET @@global.show_compatibility_56=ON;
Query OK, 0 rows affected (0.00 sec)

mysql> SELECT * FROM INFORMATION_SCHEMA.GLOBAL_VARIABLES
-> WHERE VARIABLE_NAME LIKE 'NDB%';

mysql> SELECT * FROM INFORMATION_SCHEMA.GLOBAL_VARIABLES WHERE VARIABLE_NAME LIKE 'NDB%';
+-----+-----+
| VARIABLE_NAME | VARIABLE_VALUE |
+-----+-----+
| NDB_CLUSTER_CONNECTION_POOL_NODEIDS | ON |
| NDB_LOG_BINLOG_INDEX | 30 |
| NDB_WAIT_SETUP | 1 |
| NDB_ROW_CHECKSUM | 30 |
| NDB_WAIT_CONNECTED | OFF |
| NDB_USE_EXACT_COUNT | 8 |
| NDB_RECV_THREAD_ACTIVATION_THRESHOLD | OFF |
| NDB_READ_BACKUP | 0 |
| NDB_EVENTBUFFER_MAX_ALLOC | ndbinfo |
| NDBINFO_DATABASE | OFF |
| NDB_LOG_APPLY_STATUS | ON |
| NDB_JOIN_PUSHDOWN | 460301 |
| NDB_RECV_THREAD_CPU_MASK | 127.0.0.1 |
| NDBINFO_VERSION | OFF |
| NDB_CONNECTSTRING | ON |
| NDB_TABLE_NO_LOGGING | 460301 |
| NDB_LOG_UPDATED_ONLY | OFF |
| NDB_VERSION | 10 |
| NDB_LOG_UPDATE_MINIMAL | FIXED |
| NDB_OPTIMIZATION_DELAY | ON |
| NDB_DEFAULT_COLUMN_FORMAT | OFF |
| NDB_LOG_UPDATE_AS_WRITE | OFF |
| NDB_SHOW_FOREIGN_KEY_MOCK_TABLES | ndb-7.6.21 |
| NDB_VERSION_STRING | OFF |
| NDBINDEXSTAT_OPTION | loop_enable=1000ms,loop_idle=1000ms, |
| NDBINFO_MAX_ROWS | check_delay=10m,delete_batch=8,clean_delay=1m,error_batch=4,error_delay=1m, |
| NDB_BATCH_SIZE | evict_batch=8,evict_delay=1m,cache_limit=32M,cache_lowpct=90,zero_total=0 |
| NDB_USE_TRANSACTIONS | 10 |
| NDB_NODEID | 32768 |
| NDB_ALLOW_COPYING_ALTER_TABLE | ON |
| NDB_SLAVE_CONFLICT_ROLE | NONE |
| NDB_REPORT_THRESH_BINLOG_MEM_USAGE | 0 |
| NDB_FULLY_REPLICATED | ON |
| NDB_MGMD_HOST | 127.0.0.1 |
| NDB_REPORT_THRESH_BINLOG_EPOCH_SLIP | 10 |
| NDBINFO_MAX_BYTES | 0 |
| NDB_LOG_BIN | ON |
| NDBINFO_TABLE_PREFIX | ndb$ |
| NDB_LOG_EMPTY_EPOCHS | OFF |
| NDB_LOG_ORIG | OFF |
| NDB_LOG_EXCLUSIVE_READS | OFF |
| NDB_LOG_TRANSACTION_ID | OFF |
| NDB_DATA_NODE_NEIGHBOUR | 0 |
| NDB_CLEAR_APPLY_STATUS | ON |
| NDBINFO_SHOW_HIDDEN | OFF |
| NDB_INDEX_STAT_ENABLE | ON |
| NDB_DISTRIBUTION | KEYHASH |
| NDB_BLOB_WRITE_BATCH_BYTES | 65536 |
| NDB_DEFERRED_CONSTRAINTS | 0 |
| NDB_TABLE_TEMPORARY | OFF |
| NDB_EXTRA_LOGGING | 1 |
| NDB_AUTOINCREMENT_PREFETCH_SZ | 1 |
| NDB_FORCE_SEND | ON |
| NDB_OPTIMIZED_NODE_SELECTION | 3 |
| NDB_CLUSTER_CONNECTION_POOL | 1 |
```

```

| NDB_EVENTBUFFER_FREE_PERCENT | 20 |
| NDB_USE_COPYING_ALTER_TABLE | OFF |
| NDB_CACHE_CHECK_TIME | 0 |
| NDB_BLOB_READ_BATCH_BYTES | 65536 |
| NDB_LOG_EMPTY_UPDATE | OFF |
+-----+-----+
61 rows in set, 1 warning (0.00 sec)

mysql> SHOW WARNINGS;
+-----+-----+-----+
| Level | Code | Message |
+-----+-----+-----+
| Warning | 1287 | 'INFORMATION_SCHEMA.GLOBAL_VARIABLES' is deprecated and will be removed in a future release. Please use performance_schema.global_variables instead |
+-----+-----+-----+

```

Unlike the case with the `SHOW VARIABLES` statement, it is possible to select individual columns. For example:

```

mysql> SELECT VARIABLE_VALUE
-> FROM INFORMATION_SCHEMA.GLOBAL_VARIABLES
-> WHERE VARIABLE_NAME = 'ndb_force_send';
+-----+
| VARIABLE_VALUE |
+-----+
| ON |
+-----+

```

See [The INFORMATION_SCHEMA GLOBAL_VARIABLES and SESSION_VARIABLES Tables](#), and [Server System Variables](#), for more information. See also [Migrating to Performance Schema System and Status Variable Tables](#).

- `SELECT * FROM performance_schema.global_variables WHERE VARIABLE_NAME LIKE 'NDB%'`

This statement is the equivalent of the `SHOW VARIABLES` statement described in the previous item, and is preferred in NDB 7.5 and NDB 7.6 to querying the `INFORMATION_SCHEMA.GLOBAL_VARIABLES` table (now deprecated; see previous item). It provides output almost identical to that produced by `SHOW VARIABLES`, as shown here:

```

mysql> SELECT * FROM performance_schema.global_variables
-> WHERE VARIABLE_NAME LIKE 'NDB%';
+-----+-----+
| VARIABLE_NAME | VARIABLE_VALUE |
+-----+-----+
| ndb_allow_copying_alter_table | ON |
| ndb_autoincrement_prefetch_sz | 1 |
| ndb_batch_size | 32768 |
| ndb_blob_read_batch_bytes | 65536 |
| ndb_blob_write_batch_bytes | 65536 |
| ndb_cache_check_time | 0 |
| ndb_clear_apply_status | ON |
| ndb_cluster_connection_pool | 1 |
| ndb_cluster_connection_pool_nodeids | |
| ndb_connectstring | 127.0.0.1 |
| ndb_data_node_neighbour | 0 |
| ndb_default_column_format | FIXED |
| ndb_deferred_constraints | 0 |
| ndb_distribution | KEYHASH |
| ndb_eventbuffer_free_percent | 20 |
| ndb_eventbuffer_max_alloc | 0 |
| ndb_extra_logging | 1 |
| ndb_force_send | ON |
| ndb_fully_replicated | OFF |
| ndb_index_stat_enable | ON |
| ndb_index_stat_option | loop_enable=1000ms,loop_idle=1000ms, |
| loop_busy=100ms,update_batch=1,read_batch=4,idle_batch=32,check_batch=8, |
| check_delay=10m,delete_batch=8,clean_delay=1m,error_batch=4,error_delay=1m, |
+-----+-----+

```

```

evict_batch=8,evict_delay=1m,cache_limit=32M,cache_lowpct=90,zero_total=0
|
| ndb_join_pushdown | ON
| ndb_log_apply_status | OFF
| ndb_log_bin | ON
| ndb_log_binlog_index | ON
| ndb_log_empty_epochs | OFF
| ndb_log_empty_update | OFF
| ndb_log_exclusive_reads | OFF
| ndb_log_orig | OFF
| ndb_log_transaction_id | OFF
| ndb_log_update_as_write | ON
| ndb_log_update_minimal | OFF
| ndb_log_updated_only | ON
| ndb_mgmd_host | 127.0.0.1
| ndb_nodeid | 0
| ndb_optimization_delay | 10
| ndb_optimized_node_selection | 3
| ndb_read_backup | OFF
| ndb_recv_thread_activation_threshold | 8
| ndb_recv_thread_cpu_mask |
| ndb_report_thresh_binlog_epoch_slip | 10
| ndb_report_thresh_binlog_mem_usage | 10
| ndb_row_checksum | 1
| ndb_show_foreign_key_mock_tables | OFF
| ndb_slave_conflict_role | NONE
| ndb_table_no_logging | OFF
| ndb_table_temporary | OFF
| ndb_use_copying_alter_table | OFF
| ndb_use_exact_count | OFF
| ndb_use_transactions | ON
| ndb_version | 460301
| ndb_version_string | ndb-7.6.21
| ndb_wait_connected | 30
| ndb_wait_setup | 30
| ndbinfo_database | ndbinfo
| ndbinfo_max_bytes | 0
| ndbinfo_max_rows | 10
| ndbinfo_offline | OFF
| ndbinfo_show_hidden | OFF
| ndbinfo_table_prefix | ndb$
| ndbinfo_version | 460301
+-----+-----+

```

Unlike the case with the `SHOW VARIABLES` statement, it is possible to select individual columns. For example:

```

mysql> SELECT VARIABLE_VALUE
-> FROM performance_schema.global_variables
-> WHERE VARIABLE_NAME = 'ndb_force_send';
+-----+
| VARIABLE_VALUE |
+-----+
| ON              |
+-----+

```

A more useful query is shown here:

```

mysql> SELECT VARIABLE_NAME AS Name, VARIABLE_VALUE AS Value
> FROM performance_schema.global_variables
> WHERE VARIABLE_NAME
> IN ('version', 'ndb_version',
> 'ndb_version_string', 'ndbinfo_version');
+-----+-----+
| Name          | Value          |
+-----+-----+
| ndb_version   | 460301         |
| ndb_version_string | ndb-7.6.21    |
| ndbinfo_version | 460301         |
| version       | 5.7.36-ndb-7.6.21 |
+-----+-----+

```

See [Performance Schema System Variable Tables](#), and [Server System Variables](#), for more information.

- `SHOW STATUS LIKE 'NDB%'`

This statement shows at a glance whether or not the MySQL server is acting as a cluster SQL node, and if so, it provides the MySQL server's cluster node ID, the host name and port for the cluster management server to which it is connected, and the number of data nodes in the cluster, as shown here:

```
mysql> SHOW STATUS LIKE 'NDB%';
```

Variable_name	Value
Ndb_api_wait_exec_complete_count	2
Ndb_api_wait_scan_result_count	5
Ndb_api_wait_meta_request_count	54
Ndb_api_wait_nanos_count	1849442202547
Ndb_api_bytes_sent_count	2044
Ndb_api_bytes_received_count	81384
Ndb_api_trans_start_count	2
Ndb_api_trans_commit_count	1
Ndb_api_trans_abort_count	0
Ndb_api_trans_close_count	2
Ndb_api_pk_op_count	1
Ndb_api_uk_op_count	0
Ndb_api_table_scan_count	1
Ndb_api_range_scan_count	0
Ndb_api_pruned_scan_count	0
Ndb_api_scan_batch_count	2
Ndb_api_read_row_count	4
Ndb_api_trans_local_read_row_count	2
Ndb_api_adaptive_send_forced_count	0
Ndb_api_adaptive_send_unforced_count	3
Ndb_api_adaptive_send_deferred_count	0
Ndb_api_event_data_count	0
Ndb_api_event_nondata_count	0
Ndb_api_event_bytes_count	0
Ndb_api_wait_exec_complete_count_slave	0
Ndb_api_wait_scan_result_count_slave	0
Ndb_api_wait_meta_request_count_slave	0
Ndb_api_wait_nanos_count_slave	0
Ndb_api_bytes_sent_count_slave	0
Ndb_api_bytes_received_count_slave	0
Ndb_api_trans_start_count_slave	0
Ndb_api_trans_commit_count_slave	0
Ndb_api_trans_abort_count_slave	0
Ndb_api_trans_close_count_slave	0
Ndb_api_pk_op_count_slave	0
Ndb_api_uk_op_count_slave	0
Ndb_api_table_scan_count_slave	0
Ndb_api_range_scan_count_slave	0
Ndb_api_pruned_scan_count_slave	0
Ndb_api_scan_batch_count_slave	0
Ndb_api_read_row_count_slave	0
Ndb_api_trans_local_read_row_count_slave	0
Ndb_api_adaptive_send_forced_count_slave	0
Ndb_api_adaptive_send_unforced_count_slave	0
Ndb_api_adaptive_send_deferred_count_slave	0
Ndb_slave_max_replicated_epoch	0
Ndb_api_event_data_count_injector	0
Ndb_api_event_nondata_count_injector	0
Ndb_api_event_bytes_count_injector	0
Ndb_cluster_node_id	100
Ndb_config_from_host	127.0.0.1
Ndb_config_from_port	1186
Ndb_number_of_data_nodes	2
Ndb_number_of_ready_data_nodes	2

Quick Reference: NDB Cluster SQL Statements

Ndb_connect_count	0
Ndb_execute_count	0
Ndb_scan_count	0
Ndb_pruned_scan_count	0
Ndb_schema_locks_count	0
Ndb_api_wait_exec_complete_count_session	0
Ndb_api_wait_scan_result_count_session	0
Ndb_api_wait_meta_request_count_session	0
Ndb_api_wait_nanos_count_session	0
Ndb_api_bytes_sent_count_session	0
Ndb_api_bytes_received_count_session	0
Ndb_api_trans_start_count_session	0
Ndb_api_trans_commit_count_session	0
Ndb_api_trans_abort_count_session	0
Ndb_api_trans_close_count_session	0
Ndb_api_pk_op_count_session	0
Ndb_api_uk_op_count_session	0
Ndb_api_table_scan_count_session	0
Ndb_api_range_scan_count_session	0
Ndb_api_pruned_scan_count_session	0
Ndb_api_scan_batch_count_session	0
Ndb_api_read_row_count_session	0
Ndb_api_trans_local_read_row_count_session	0
Ndb_api_adaptive_send_forced_count_session	0
Ndb_api_adaptive_send_unforced_count_session	0
Ndb_api_adaptive_send_deferred_count_session	0
Ndb_sorted_scan_count	0
Ndb_pushed_queries_defined	0
Ndb_pushed_queries_dropped	0
Ndb_pushed_queries_executed	0
Ndb_pushed_reads	0
Ndb_last_commit_epoch_server	29347511533580
Ndb_last_commit_epoch_session	0
Ndb_system_name	MC_20191209172820
Ndb_conflict_fn_max	0
Ndb_conflict_fn_old	0
Ndb_conflict_fn_max_del_win	0
Ndb_conflict_fn_epoch	0
Ndb_conflict_fn_epoch_trans	0
Ndb_conflict_fn_epoch2	0
Ndb_conflict_fn_epoch2_trans	0
Ndb_conflict_trans_row_conflict_count	0
Ndb_conflict_trans_row_reject_count	0
Ndb_conflict_trans_reject_count	0
Ndb_conflict_trans_detect_iter_count	0
Ndb_conflict_trans_conflict_commit_count	0
Ndb_conflict_epoch_delete_delete_count	0
Ndb_conflict_reflected_op_prepare_count	0
Ndb_conflict_reflected_op_discard_count	0
Ndb_conflict_refresh_op_count	0
Ndb_conflict_last_conflict_epoch	0
Ndb_conflict_last_stable_epoch	0
Ndb_index_stat_status	allow:1,enable:1,busy:0, loop:1000,list:(new:0,update:0,read:0,idle:0,check:0,delete:0,error:0,total:0), analyze:(queue:0,wait:0),stats:(nostats:0,wait:0),total:(analyze:(all:0,error:0), query:(all:0,nostats:0,error:0),event:(act:0,skip:0,miss:0), cache:(refresh:0,clear:0,pinned:0,drop:0,evict:0)), cache:(query:0,clear:0,drop:0,evict:0,usedpct:0.00,highpct:0.00)
Ndb_index_stat_cache_query	0
Ndb_index_stat_cache_clean	0

If the MySQL server was built with clustering support, but it is not connected to a cluster, all rows in the output of this statement contain a zero or an empty string.

See also [SHOW STATUS Statement](#).

- `SELECT * FROM INFORMATION_SCHEMA.GLOBAL_STATUS WHERE VARIABLE_NAME LIKE 'NDB%';`

This statement, although deprecated in NDB 7.5 and NDB 7.6, can be used if `show_compatibility_56` is enabled to obtain similar output to the `SHOW STATUS` statement discussed in the previous item; the preferred method is to query the `performance_schema.global_status` table (see next item). Unlike the case with `SHOW STATUS`, it is possible using the `SELECT` to extract values in SQL for use in scripts for monitoring and automation purposes.

See [The INFORMATION_SCHEMA GLOBAL_STATUS and SESSION_STATUS Tables](#), as well as [Migrating to Performance Schema System and Status Variable Tables](#), for more information.

- `SELECT * FROM performance_schema.global_status WHERE VARIABLE_NAME LIKE 'NDB%'`

This statement provides similar output to the `SHOW STATUS` statement discussed previously. Unlike the case with `SHOW STATUS`, it is possible using `SELECT` statements to extract values in SQL for use in scripts for monitoring and automation purposes.

See [Performance Schema Status Variable Tables](#), for more information.

- `SELECT * FROM INFORMATION_SCHEMA.PLUGINS WHERE PLUGIN_NAME LIKE 'NDB%'`

This statement displays information from the `INFORMATION_SCHEMA.PLUGINS` table about plugins associated with NDB Cluster, such as version, author, and license, as shown here:

```
mysql> SELECT * FROM INFORMATION_SCHEMA.PLUGINS
> WHERE PLUGIN_NAME LIKE 'NDB%'\G
***** 1. row *****
      PLUGIN_NAME: ndbcluster
      PLUGIN_VERSION: 1.0
      PLUGIN_STATUS: ACTIVE
      PLUGIN_TYPE: STORAGE ENGINE
      PLUGIN_TYPE_VERSION: 50729.0
      PLUGIN_LIBRARY: NULL
      PLUGIN_LIBRARY_VERSION: NULL
      PLUGIN_AUTHOR: MySQL AB
      PLUGIN_DESCRIPTION: Clustered, fault-tolerant tables
      PLUGIN_LICENSE: GPL
      LOAD_OPTION: ON
***** 2. row *****
      PLUGIN_NAME: ndbinfo
      PLUGIN_VERSION: 0.1
      PLUGIN_STATUS: ACTIVE
      PLUGIN_TYPE: STORAGE ENGINE
      PLUGIN_TYPE_VERSION: 50736.0
      PLUGIN_LIBRARY: NULL
      PLUGIN_LIBRARY_VERSION: NULL
      PLUGIN_AUTHOR: Sun Microsystems Inc.
      PLUGIN_DESCRIPTION: MySQL Cluster system information storage engine
      PLUGIN_LICENSE: GPL
      LOAD_OPTION: ON
***** 3. row *****
      PLUGIN_NAME: ndb_transid_mysql_connection_map
      PLUGIN_VERSION: 0.1
      PLUGIN_STATUS: ACTIVE
      PLUGIN_TYPE: INFORMATION SCHEMA
      PLUGIN_TYPE_VERSION: 50736.0
      PLUGIN_LIBRARY: NULL
      PLUGIN_LIBRARY_VERSION: NULL
      PLUGIN_AUTHOR: Oracle Corporation
      PLUGIN_DESCRIPTION: Map between mysql connection id and ndb transaction id
      PLUGIN_LICENSE: GPL
```

```
LOAD_OPTION: ON
```

You can also use the `SHOW PLUGINS` statement to display this information, but the output from that statement cannot easily be filtered. See also [The MySQL Plugin API](#), which describes where and how the information in the `PLUGINS` table is obtained.

You can also query the tables in the `ndbinfo` information database for real-time data about many NDB Cluster operations. See [Section 6.14, “ndbinfo: The NDB Cluster Information Database”](#).

6.17 NDB Cluster Security Issues

This section discusses security considerations to take into account when setting up and running NDB Cluster.

Topics covered in this section include the following:

- NDB Cluster and network security issues
- Configuration issues relating to running NDB Cluster securely
- NDB Cluster and the MySQL privilege system
- MySQL standard security procedures as applicable to NDB Cluster

6.17.1 NDB Cluster Security and Networking Issues

In this section, we discuss basic network security issues as they relate to NDB Cluster. It is extremely important to remember that NDB Cluster “out of the box” is not secure; you or your network administrator must take the proper steps to ensure that your cluster cannot be compromised over the network.

Cluster communication protocols are inherently insecure, and no encryption or similar security measures are used in communications between nodes in the cluster. Because network speed and latency have a direct impact on the cluster's efficiency, it is also not advisable to employ SSL or other encryption to network connections between nodes, as such schemes effectively slow communications.

It is also true that no authentication is used for controlling API node access to an NDB Cluster. As with encryption, the overhead of imposing authentication requirements would have an adverse impact on Cluster performance.

In addition, there is no checking of the source IP address for either of the following when accessing the cluster:

- SQL or API nodes using “free slots” created by empty `[mysqld]` or `[api]` sections in the `config.ini` file

This means that, if there are any empty `[mysqld]` or `[api]` sections in the `config.ini` file, then any API nodes (including SQL nodes) that know the management server's host name (or IP address) and port can connect to the cluster and access its data without restriction. (See [Section 6.17.2, “NDB Cluster and MySQL Privileges”](#), for more information about this and related issues.)

Note

You can exercise some control over SQL and API node access to the cluster by specifying a `HostName` parameter for all `[mysqld]` and `[api]` sections in the `config.ini` file. However, this also means that, should you wish to connect an API node to the cluster from a previously unused host, you need to add an `[api]` section containing its host name to the `config.ini` file.

More information is available [elsewhere in this chapter](#) about the `HostName` parameter. Also see [Section 4.1, “Quick Test Setup of NDB Cluster”](#), for configuration examples using `HostName` with API nodes.

- Any `ndb_mgm` client

This means that any cluster management client that is given the management server's host name (or IP address) and port (if not the standard port) can connect to the cluster and execute any management client command. This includes commands such as `ALL STOP` and `SHUTDOWN`.

For these reasons, it is necessary to protect the cluster on the network level. The safest network configuration for Cluster is one which isolates connections between Cluster nodes from any other network communications. This can be accomplished by any of the following methods:

1. Keeping Cluster nodes on a network that is physically separate from any public networks. This option is the most dependable; however, it is the most expensive to implement.

We show an example of an NDB Cluster setup using such a physically segregated network here:

Figure 6.2 NDB Cluster with Hardware Firewall

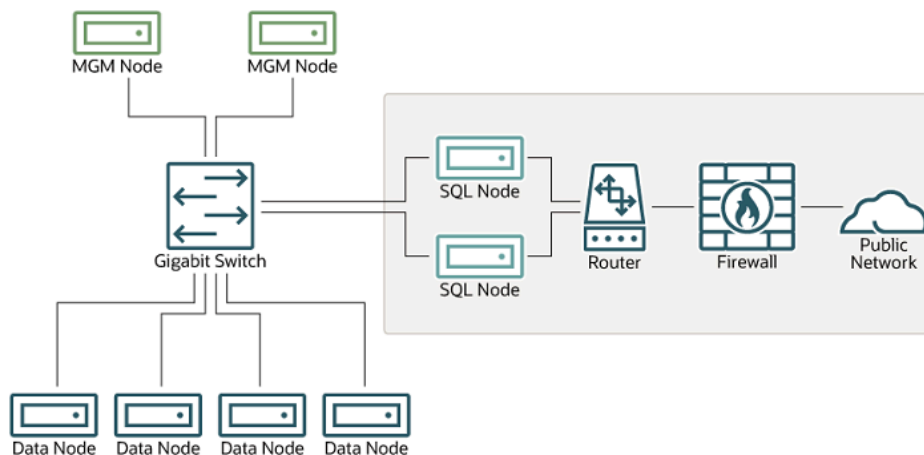

This setup has two networks, one private (solid box) for the Cluster management servers and data nodes, and one public (dotted box) where the SQL nodes reside. (We show the management and data nodes connected using a gigabit switch since this provides the best performance.) Both networks are protected from the outside by a hardware firewall, sometimes also known as a *network-based firewall*.

This network setup is safest because no packets can reach the cluster's management or data nodes from outside the network—and none of the cluster's internal communications can reach the outside—without going through the SQL nodes, as long as the SQL nodes do not permit any packets to be forwarded. This means, of course, that all SQL nodes must be secured against hacking attempts.

Important

With regard to potential security vulnerabilities, an SQL node is no different from any other MySQL server. See [Making MySQL Secure Against Attackers](#), for a description of techniques you can use to secure MySQL servers.

2. Using one or more software firewalls (also known as *host-based firewalls*) to control which packets pass through to the cluster from portions of the network that do not require access to it. In this type of setup, a software firewall must be installed on every host in the cluster which might otherwise be accessible from outside the local network.

The host-based option is the least expensive to implement, but relies purely on software to provide protection and so is the most difficult to keep secure.

This type of network setup for NDB Cluster is illustrated here:

Figure 6.3 NDB Cluster with Software Firewalls

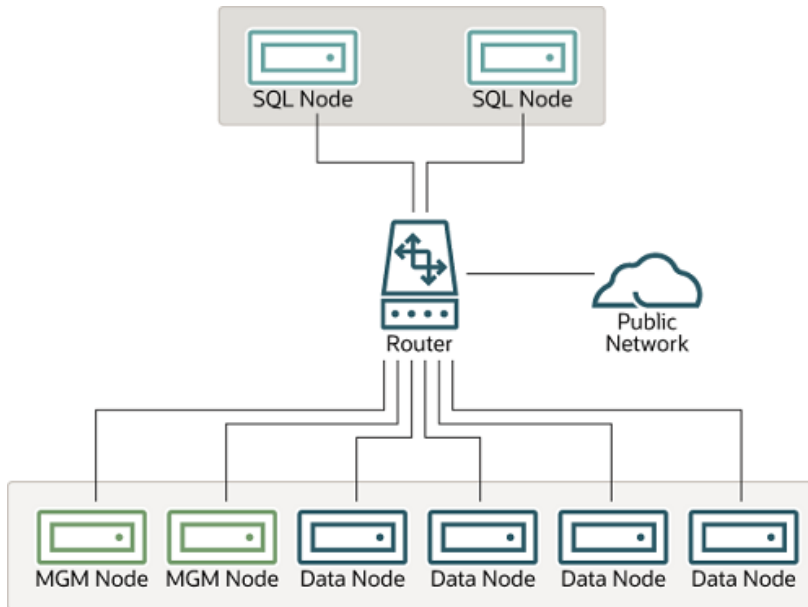

Using this type of network setup means that there are two zones of NDB Cluster hosts. Each cluster host must be able to communicate with all of the other machines in the cluster, but only those hosting SQL nodes (dotted box) can be permitted to have any contact with the outside, while those in the zone containing the data nodes and management nodes (solid box) must be isolated from any machines that are not part of the cluster. Applications using the cluster and user of those applications must *not* be permitted to have direct access to the management and data node hosts.

To accomplish this, you must set up software firewalls that limit the traffic to the type or types shown in the following table, according to the type of node that is running on each cluster host computer:

Table 6.16 Node types in a host-based firewall cluster configuration

Node Type	Permitted Traffic
SQL or API node	<ul style="list-style-type: none"> It originates from the IP address of a management or data node (using any TCP or UDP port). It originates from within the network in which the cluster resides and is on the port that your application is using.
Data node or Management node	<ul style="list-style-type: none"> It originates from the IP address of a management or data node (using any TCP or UDP port).

Node Type	Permitted Traffic
	<ul style="list-style-type: none"> It originates from the IP address of an SQL or API node.

Any traffic other than that shown in the table for a given node type should be denied.

The specifics of configuring a firewall vary from firewall application to firewall application, and are beyond the scope of this Manual. `iptables` is a very common and reliable firewall application, which is often used with `APF` as a front end to make configuration easier. You can (and should) consult the documentation for the software firewall that you employ, should you choose to implement an NDB Cluster network setup of this type, or of a “mixed” type as discussed under the next item.

- It is also possible to employ a combination of the first two methods, using both hardware and software to secure the cluster—that is, using both network-based and host-based firewalls. This is between the first two schemes in terms of both security level and cost. This type of network setup keeps the cluster behind the hardware firewall, but permits incoming packets to travel beyond the router connecting all cluster hosts to reach the SQL nodes.

One possible network deployment of an NDB Cluster using hardware and software firewalls in combination is shown here:

Figure 6.4 NDB Cluster with a Combination of Hardware and Software Firewalls

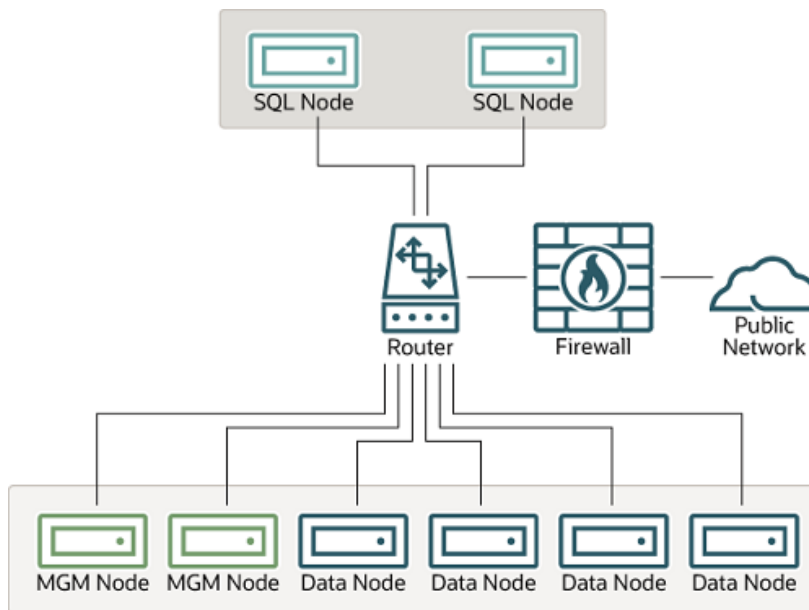

In this case, you can set the rules in the hardware firewall to deny any external traffic except to SQL nodes and API nodes, and then permit traffic to them only on the ports required by your application.

Whatever network configuration you use, remember that your objective from the viewpoint of keeping the cluster secure remains the same—to prevent any unessential traffic from reaching the cluster while ensuring the most efficient communication between the nodes in the cluster.

Because NDB Cluster requires large numbers of ports to be open for communications between nodes, the recommended option is to use a segregated network. This represents the simplest way to prevent unwanted traffic from reaching the cluster.

Note

If you wish to administer an NDB Cluster remotely (that is, from outside the local network), the recommended way to do this is to use `ssh` or another secure

login shell to access an SQL node host. From this host, you can then run the management client to access the management server safely, from within the cluster's own local network.

Even though it is possible to do so in theory, it is *not* recommended to use `ndb_mgm` to manage a Cluster directly from outside the local network on which the Cluster is running. Since neither authentication nor encryption takes place between the management client and the management server, this represents an extremely insecure means of managing the cluster, and is almost certain to be compromised sooner or later.

6.17.2 NDB Cluster and MySQL Privileges

In this section, we discuss how the MySQL privilege system works in relation to NDB Cluster and the implications of this for keeping an NDB Cluster secure.

Standard MySQL privileges apply to NDB Cluster tables. This includes all MySQL privilege types (`SELECT` privilege, `UPDATE` privilege, `DELETE` privilege, and so on) granted on the database, table, and column level. As with any other MySQL Server, user and privilege information is stored in the `mysql` system database. The SQL statements used to grant and revoke privileges on NDB tables, databases containing such tables, and columns within such tables are identical in all respects with the `GRANT` and `REVOKE` statements used in connection with database objects involving any (other) MySQL storage engine. The same thing is true with respect to the `CREATE USER` and `DROP USER` statements.

It is important to keep in mind that, by default, the MySQL grant tables use the `MyISAM` storage engine. Because of this, those tables are not normally duplicated or shared among MySQL servers acting as SQL nodes in an NDB Cluster. In other words, changes in users and their privileges do not automatically propagate between SQL nodes by default. If you wish, you can enable automatic distribution of MySQL users and privileges across NDB Cluster SQL nodes; see [Section 6.12](#), “Distributed Privileges Using Shared Grant Tables”, for details.

Conversely, because there is no way in MySQL to deny privileges (privileges can either be revoked or not granted in the first place, but not denied as such), there is no special protection for NDB tables on one SQL node from users that have privileges on another SQL node; (This is true even if you are not using automatic distribution of user privileges. The definitive example of this is the MySQL `root` account, which can perform any action on any database object. In combination with empty `[mysqld]` or `[api]` sections of the `config.ini` file, this account can be especially dangerous. To understand why, consider the following scenario:

- The `config.ini` file contains at least one empty `[mysqld]` or `[api]` section. This means that the NDB Cluster management server performs no checking of the host from which a MySQL Server (or other API node) accesses the NDB Cluster.
- There is no firewall, or the firewall fails to protect against access to the NDB Cluster from hosts external to the network.
- The host name or IP address of the NDB Cluster management server is known or can be determined from outside the network.

If these conditions are true, then anyone, anywhere can start a MySQL Server with `--ndbcluster --ndb-connectstring=management_host` and access this NDB Cluster. Using the MySQL `root` account, this person can then perform the following actions:

- Execute metadata statements such as `SHOW DATABASES` statement (to obtain a list of all NDB databases on the server) or `SHOW TABLES FROM some_ndb_database` statement to obtain a list of all NDB tables in a given database
- Run any legal MySQL statements on any of the discovered tables, such as:
 - `SELECT * FROM some_table` to read all the data from any table

- `DELETE FROM some_table` to delete all the data from a table
- `DESCRIBE some_table` or `SHOW CREATE TABLE some_table` to determine the table schema
- `UPDATE some_table SET column1 = some_value` to fill a table column with “garbage” data; this could actually cause much greater damage than simply deleting all the data

More insidious variations might include statements like these:

```
UPDATE some_table SET an_int_column = an_int_column + 1
```

or

```
UPDATE some_table SET a_varchar_column = REVERSE(a_varchar_column)
```

Such malicious statements are limited only by the imagination of the attacker.

The only tables that would be safe from this sort of mayhem would be those tables that were created using storage engines other than `NDB`, and so not visible to a “rogue” SQL node.

A user who can log in as `root` can also access the `INFORMATION_SCHEMA` database and its tables, and so obtain information about databases, tables, stored routines, scheduled events, and any other database objects for which metadata is stored in `INFORMATION_SCHEMA`.

It is also a very good idea to use different passwords for the `root` accounts on different NDB Cluster SQL nodes unless you are using distributed privileges.

In sum, you cannot have a safe NDB Cluster if it is directly accessible from outside your local network.

Important

Never leave the MySQL root account password empty. This is just as true when running MySQL as an NDB Cluster SQL node as it is when running it as a standalone (non-Cluster) MySQL Server, and should be done as part of the MySQL installation process before configuring the MySQL Server as an SQL node in an NDB Cluster.

If you wish to employ NDB Cluster's distributed privilege capabilities, you should not simply convert the system tables in the `mysql` database to use the `NDB` storage engine manually. Use the stored procedure provided for this purpose instead; see [Section 6.12, “Distributed Privileges Using Shared Grant Tables”](#).

Otherwise, if you need to synchronize `mysql` system tables between SQL nodes, you can use standard MySQL replication to do so, or employ a script to copy table entries between the MySQL servers.

Summary. The most important points to remember regarding the MySQL privilege system with regard to NDB Cluster are listed here:

1. Users and privileges established on one SQL node do not automatically exist or take effect on other SQL nodes in the cluster. Conversely, removing a user or privilege on one SQL node in the cluster does not remove the user or privilege from any other SQL nodes.
2. You can distribute MySQL users and privileges among SQL nodes using the SQL script, and the stored procedures it contains, that are supplied for this purpose in the NDB Cluster distribution.
3. Once a MySQL user is granted privileges on an `NDB` table from one SQL node in an NDB Cluster, that user can “see” any data in that table regardless of the SQL node from which the data originated, even if you are not using privilege distribution.

6.17.3 NDB Cluster and MySQL Security Procedures

In this section, we discuss MySQL standard security procedures as they apply to running NDB Cluster.

In general, any standard procedure for running MySQL securely also applies to running a MySQL Server as part of an NDB Cluster. First and foremost, you should always run a MySQL Server as the `mysql` operating system user; this is no different from running MySQL in a standard (non-Cluster) environment. The `mysql` system account should be uniquely and clearly defined. Fortunately, this is the default behavior for a new MySQL installation. You can verify that the `mysqld` process is running as the `mysql` operating system user by using the system command such as the one shown here:

```
$> ps aux | grep mysql
root      10467  0.0  0.1   3616  1380 pts/3    S   11:53   0:00 \
/bin/sh ./mysqld_safe --ndbcluster --ndb-connectstring=localhost:1186
mysql     10512  0.2  2.5  58528 26636 pts/3    Sl  11:53   0:00 \
/usr/local/mysql/libexec/mysqld --basedir=/usr/local/mysql \
--datadir=/usr/local/mysql/var --user=mysql --ndbcluster \
--ndb-connectstring=localhost:1186 --pid-file=/usr/local/mysql/var/mothra.pid \
--log-error=/usr/local/mysql/var/mothra.err
jon       10579  0.0  0.0   2736   688 pts/0    S+  11:54   0:00 grep mysql
```

If the `mysqld` process is running as any other user than `mysql`, you should immediately shut it down and restart it as the `mysql` user. If this user does not exist on the system, the `mysql` user account should be created, and this user should be part of the `mysql` user group; in this case, you should also make sure that the MySQL data directory on this system (as set using the `--datadir` option for `mysqld`) is owned by the `mysql` user, and that the SQL node's `my.cnf` file includes `user=mysql` in the `[mysqld]` section. Alternatively, you can start the MySQL server process with `--user=mysql` on the command line, but it is preferable to use the `my.cnf` option, since you might forget to use the command-line option and so have `mysqld` running as another user unintentionally. The `mysqld_safe` startup script forces MySQL to run as the `mysql` user.

Important

Never run `mysqld` as the system root user. Doing so means that potentially any file on the system can be read by MySQL, and thus—should MySQL be compromised—by an attacker.

As mentioned in the previous section (see [Section 6.17.2, “NDB Cluster and MySQL Privileges”](#)), you should always set a root password for the MySQL Server as soon as you have it running. You should also delete the anonymous user account that is installed by default. You can accomplish these tasks using the following statements:

```
$> mysql -u root

mysql> UPDATE mysql.user
->   SET Password=PASSWORD('secure_password')
->   WHERE User='root';

mysql> DELETE FROM mysql.user
->   WHERE User='';

mysql> FLUSH PRIVILEGES;
```

Be very careful when executing the `DELETE` statement not to omit the `WHERE` clause, or you risk deleting *all* MySQL users. Be sure to run the `FLUSH PRIVILEGES` statement as soon as you have modified the `mysql.user` table, so that the changes take immediate effect. Without `FLUSH PRIVILEGES`, the changes do not take effect until the next time that the server is restarted.

Note

Many of the NDB Cluster utilities such as `ndb_show_tables`, `ndb_desc`, and `ndb_select_all` also work without authentication and can reveal table names, schemas, and data. By default these are installed on Unix-style systems with the permissions `wxr-xr-x` (755), which means they can be executed by any user that can access the `mysql/bin` directory.

See [Chapter 5, *NDB Cluster Programs*](#), for more information about these utilities.

Chapter 7 NDB Cluster Replication

Table of Contents

7.1 NDB Cluster Replication: Abbreviations and Symbols	618
7.2 General Requirements for NDB Cluster Replication	619
7.3 Known Issues in NDB Cluster Replication	620
7.4 NDB Cluster Replication Schema and Tables	627
7.5 Preparing the NDB Cluster for Replication	632
7.6 Starting NDB Cluster Replication (Single Replication Channel)	634
7.7 Using Two Replication Channels for NDB Cluster Replication	635
7.8 Implementing Failover with NDB Cluster Replication	636
7.9 NDB Cluster Backups With NDB Cluster Replication	638
7.9.1 NDB Cluster Replication: Automating Synchronization of the Replica to the Source Binary Log	640
7.9.2 Point-In-Time Recovery Using NDB Cluster Replication	643
7.10 NDB Cluster Replication: Bidirectional and Circular Replication	644
7.11 NDB Cluster Replication Conflict Resolution	648

NDB Cluster supports *asynchronous replication*, more usually referred to simply as “replication”. This section explains how to set up and manage a configuration in which one group of computers operating as an NDB Cluster replicates to a second computer or group of computers. We assume some familiarity on the part of the reader with standard MySQL replication as discussed elsewhere in this Manual. (See [Replication](#)).

Note

NDB Cluster does not support replication using GTIDs; semisynchronous replication and group replication are also not supported by the [NDB](#) storage engine.

Normal (non-clustered) replication involves a source server (formerly called a “master”) and a replica server (formerly referred to as a “slave”), the source being so named because operations and data to be replicated originate with it, and the replica being the recipient of these. In NDB Cluster, replication is conceptually very similar but can be more complex in practice, as it may be extended to cover a number of different configurations including replicating between two complete clusters. Although an NDB Cluster itself depends on the [NDB](#) storage engine for clustering functionality, it is not necessary to use [NDB](#) as the storage engine for the replica's copies of the replicated tables (see [Replication from NDB to other storage engines](#)). However, for maximum availability, it is possible (and preferable) to replicate from one NDB Cluster to another, and it is this scenario that we discuss, as shown in the following figure:

Figure 7.1 NDB Cluster-to-Cluster Replication Layout

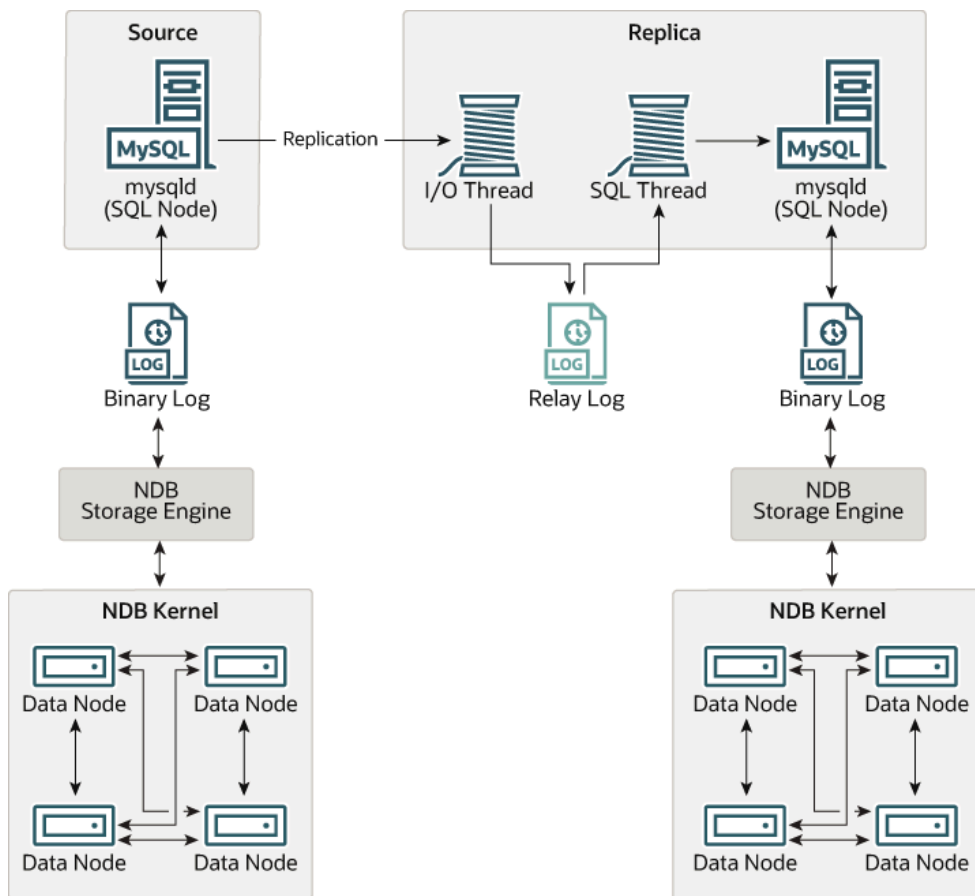

In this scenario, the replication process is one in which successive states of a source cluster are logged and saved to a replica cluster. This process is accomplished by a special thread known as the NDB binary log injector thread, which runs on each MySQL server and produces a binary log (*binlog*). This thread ensures that all changes in the cluster producing the binary log—and not just those changes that are effected through the MySQL Server—are inserted into the binary log with the correct serialization order. We refer to the MySQL source and replica servers as replication servers or replication nodes, and the data flow or line of communication between them as a *replication channel*.

For information about performing point-in-time recovery with NDB Cluster and NDB Cluster Replication, see [Section 7.9.2, “Point-In-Time Recovery Using NDB Cluster Replication”](#).

NDB API replica status variables. NDB API counters can provide enhanced monitoring capabilities on replica clusters. These counters are implemented as NDB statistics `_slave` status variables, as seen in the output of `SHOW STATUS`, or in the results of queries against the `SESSION_STATUS` or `GLOBAL_STATUS` table in a `mysql` client session connected to a MySQL Server that is acting as a replica in NDB Cluster Replication. By comparing the values of these status variables before and after the execution of statements affecting replicated NDB tables, you can observe the corresponding actions taken on the NDB API level by the replica, which can be useful when monitoring or troubleshooting NDB Cluster Replication. [Section 6.13, “NDB API Statistics Counters and Variables”](#), provides additional information.

Replication from NDB to non-NDB tables. It is possible to replicate NDB tables from an NDB Cluster acting as the replication source to tables using other MySQL storage engines such as `InnoDB` or `MyISAM` on a replica `mysqld`. This is subject to a number of conditions; see [Replication from NDB to other storage engines](#), and [Replication from NDB to a nontransactional storage engine](#), for more information.

7.1 NDB Cluster Replication: Abbreviations and Symbols

Throughout this section, we use the following abbreviations or symbols for referring to the source and replica clusters, and to processes and commands run on the clusters or cluster nodes:

Table 7.1 Abbreviations used throughout this section referring to source and replica clusters, and to processes and commands run on cluster nodes

Symbol or Abbreviation	Description (Refers to...)
<i>S</i>	The cluster serving as the (primary) replication source
<i>R</i>	The cluster acting as the (primary) replica
<code>shellS></code>	Shell command to be issued on the source cluster
<code>mysqlS></code>	MySQL client command issued on a single MySQL server running as an SQL node on the source cluster
<code>mysqlS*></code>	MySQL client command to be issued on all SQL nodes participating in the replication source cluster
<code>shellR></code>	Shell command to be issued on the replica cluster
<code>mysqlR></code>	MySQL client command issued on a single MySQL server running as an SQL node on the replica cluster
<code>mysqlR*></code>	MySQL client command to be issued on all SQL nodes participating in the replica cluster
<i>C</i>	Primary replication channel
<i>C'</i>	Secondary replication channel
<i>S'</i>	Secondary replication source
<i>R'</i>	Secondary replica

7.2 General Requirements for NDB Cluster Replication

A replication channel requires two MySQL servers acting as replication servers (one each for the source and replica). For example, this means that in the case of a replication setup with two replication channels (to provide an extra channel for redundancy), there should be a total of four replication nodes, two per cluster.

Replication of an NDB Cluster as described in this section and those following is dependent on row-based replication. This means that the replication source MySQL server must be running with `--binlog-format=ROW` or `--binlog-format=MIXED`, as described in [Section 7.6, “Starting NDB Cluster Replication \(Single Replication Channel\)”](#). For general information about row-based replication, see [Replication Formats](#).

Important

If you attempt to use NDB Cluster Replication with `--binlog-format=STATEMENT`, replication fails to work properly because the `ndb_binlog_index` table on the source cluster and the `epoch` column of the `ndb_apply_status` table on the replica cluster are not updated (see [Section 7.4, “NDB Cluster Replication Schema and Tables”](#)). Instead, only updates on the MySQL server acting as the replication source propagate to the replica, and no updates from any other SQL nodes in the source cluster are replicated.

The default value for the `--binlog-format` option is `MIXED`.

Each MySQL server used for replication in either cluster must be uniquely identified among all the MySQL replication servers participating in either cluster (you cannot have replication servers on both the source and replica clusters sharing the same ID). This can be done by starting each SQL node using the `--server-id=id` option, where `id` is a unique integer. Although it is not strictly necessary, we assume for purposes of this discussion that all NDB Cluster binaries are of the same release version.

It is generally true in MySQL Replication that both MySQL servers (`mysqld` processes) involved must be compatible with one another with respect to both the version of the replication protocol used and the SQL feature sets which they support (see [Replication Compatibility Between MySQL Versions](#)). It is due to such differences between the binaries in the NDB Cluster and MySQL Server 5.7 distributions that NDB Cluster Replication has the additional requirement that both `mysqld` binaries come from an NDB Cluster distribution. The simplest and easiest way to assure that the `mysqld` servers are compatible is to use the same NDB Cluster distribution for all source and replica `mysqld` binaries.

We assume that the replica server or cluster is dedicated to replication of the source cluster, and that no other data is being stored on it.

All NDB tables being replicated must be created using a MySQL server and client. Tables and other database objects created using the NDB API (with, for example, `Dictionary::createTable()`) are not visible to a MySQL server and so are not replicated. Updates by NDB API applications to existing tables that were created using a MySQL server can be replicated.

Note

It is possible to replicate an NDB Cluster using statement-based replication. However, in this case, the following restrictions apply:

- All updates to data rows on the cluster acting as the source must be directed to a single MySQL server.
- It is not possible to replicate a cluster using multiple simultaneous MySQL replication processes.
- Only changes made at the SQL level are replicated.

These are in addition to the other limitations of statement-based replication as opposed to row-based replication; see [Advantages and Disadvantages of Statement-Based and Row-Based Replication](#), for more specific information concerning the differences between the two replication formats.

7.3 Known Issues in NDB Cluster Replication

This section discusses known problems or issues when using replication with NDB Cluster.

Loss of connection between source and replica. A loss of connection can occur either between the source cluster SQL node and the replica cluster SQL node, or between the source SQL node and the data nodes of the source cluster. In the latter case, this can occur not only as a result of loss of physical connection (for example, a broken network cable), but due to the overflow of data node event buffers; if the SQL node is too slow to respond, it may be dropped by the cluster (this is controllable to some degree by adjusting the `MaxBufferedEpochs` and `TimeBetweenEpochs` configuration parameters). If this occurs, *it is entirely possible for new data to be inserted into the source cluster without being recorded in the source SQL node's binary log*. For this reason, to guarantee high availability, it is extremely important to maintain a backup replication channel, to monitor the primary channel, and to fail over to the secondary replication channel when necessary to keep the replica cluster synchronized with the source. NDB Cluster is not designed to perform such monitoring on its own; for this, an external application is required.

The source SQL node issues a “gap” event when connecting or reconnecting to the source cluster. (A gap event is a type of “incident event,” which indicates an incident that occurs that affects the contents

of the database but that cannot easily be represented as a set of changes. Examples of incidents are server failures, database resynchronization, some software updates, and some hardware changes.) When the replica encounters a gap in the replication log, it stops with an error message. This message is available in the output of `SHOW SLAVE STATUS`, and indicates that the SQL thread has stopped due to an incident registered in the replication stream, and that manual intervention is required. See [Section 7.8, “Implementing Failover with NDB Cluster Replication”](#), for more information about what to do in such circumstances.

Important

Because NDB Cluster is not designed on its own to monitor replication status or provide failover, if high availability is a requirement for the replica server or cluster, then you must set up multiple replication lines, monitor the source `mysqld` on the primary replication line, and be prepared fail over to a secondary line if and as necessary. This must be done manually, or possibly by means of a third-party application. For information about implementing this type of setup, see [Section 7.7, “Using Two Replication Channels for NDB Cluster Replication”](#), and [Section 7.8, “Implementing Failover with NDB Cluster Replication”](#).

If you are replicating from a standalone MySQL server to an NDB Cluster, one channel is usually sufficient.

Circular replication. NDB Cluster Replication supports circular replication, as shown in the next example. The replication setup involves three NDB Clusters numbered 1, 2, and 3, in which Cluster 1 acts as the replication source for Cluster 2, Cluster 2 acts as the source for Cluster 3, and Cluster 3 acts as the source for Cluster 1, thus completing the circle. Each NDB Cluster has two SQL nodes, with SQL nodes A and B belonging to Cluster 1, SQL nodes C and D belonging to Cluster 2, and SQL nodes E and F belonging to Cluster 3.

Circular replication using these clusters is supported as long as the following conditions are met:

- The SQL nodes on all source and replica clusters are the same.
- All SQL nodes acting as sources and replicas are started with the `log_slave_updates` system variable enabled.

This type of circular replication setup is shown in the following diagram:

Figure 7.2 NDB Cluster Circular Replication With All Sources As Replicas

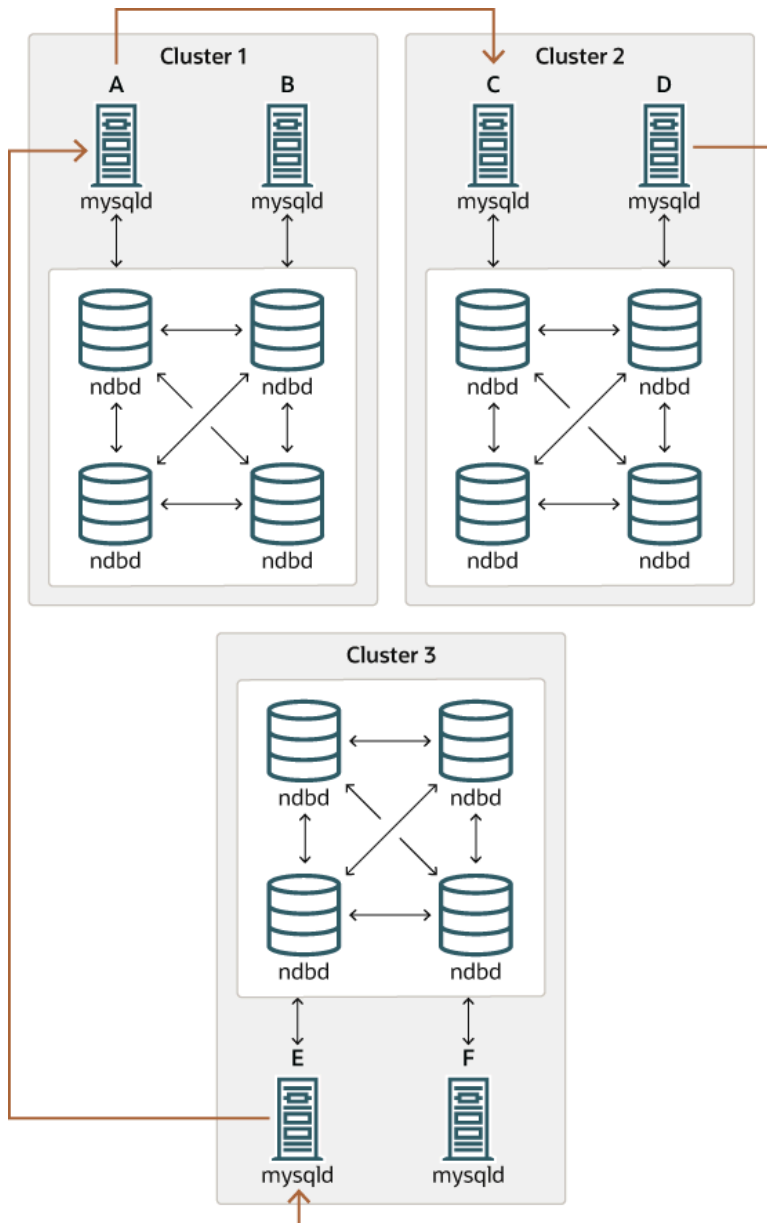

In this scenario, SQL node A in Cluster 1 replicates to SQL node C in Cluster 2; SQL node C replicates to SQL node E in Cluster 3; SQL node E replicates to SQL node A. In other words, the replication line (indicated by the curved arrows in the diagram) directly connects all SQL nodes used as sources and replicas.

It should also be possible to set up circular replication in which not all source SQL nodes are also replicas, as shown here:

Figure 7.3 NDB Cluster Circular Replication Where Not All Sources Are Replicas

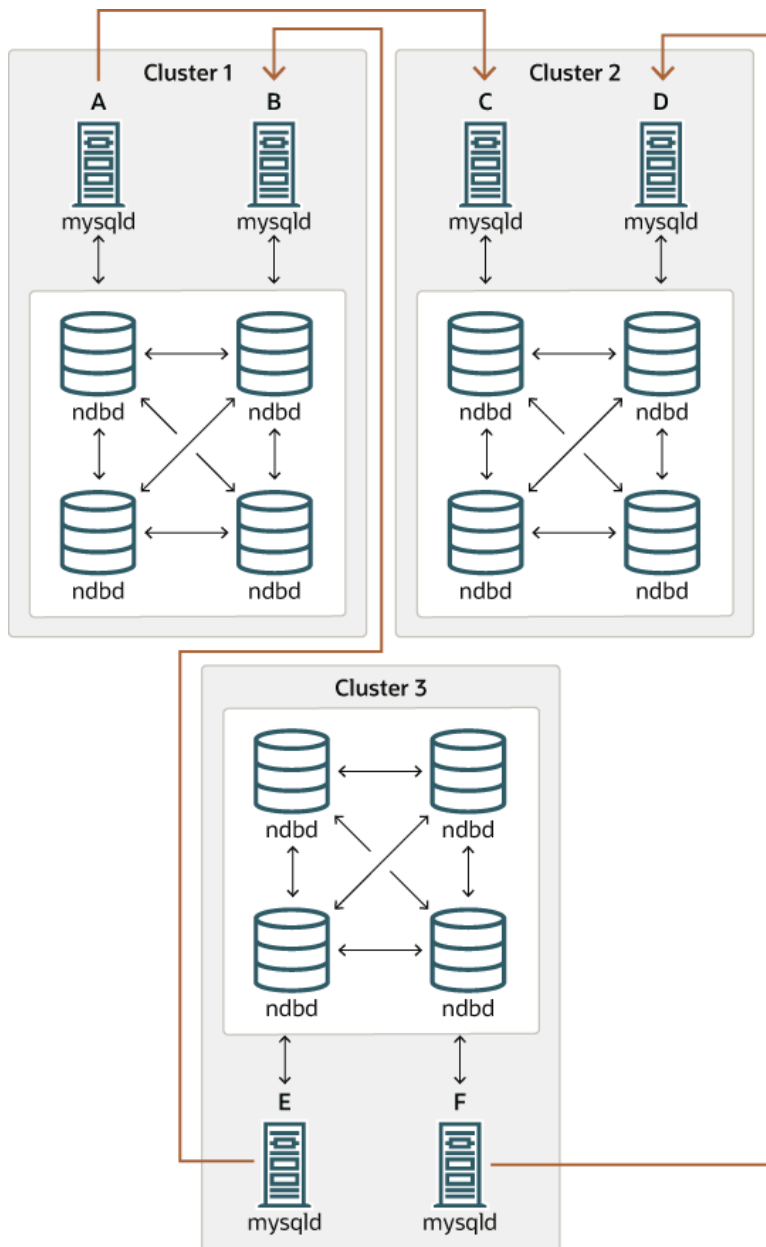

In this case, different SQL nodes in each cluster are used as sources and replicas. However, you must *not* start any of the SQL nodes with the `log_slave_updates` system variable enabled. This type of circular replication scheme for NDB Cluster, in which the line of replication (again indicated by the curved arrows in the diagram) is discontinuous, should be possible, but it should be noted that it has not yet been thoroughly tested and must therefore still be considered experimental.

Note

The NDB storage engine uses *idempotent execution mode*, which suppresses duplicate-key and other errors that otherwise break circular replication of NDB Cluster. This is equivalent to setting the global `slave_exec_mode` system variable to `IDEMPOTENT`, although this is not necessary in NDB Cluster replication, since NDB Cluster sets this variable automatically and ignores any attempts to set it explicitly.

NDB Cluster replication and primary keys. In the event of a node failure, errors in replication of NDB tables without primary keys can still occur, due to the possibility of duplicate rows being inserted in

such cases. For this reason, it is highly recommended that all [NDB](#) tables being replicated have explicit primary keys.

NDB Cluster Replication and Unique Keys. In older versions of NDB Cluster, operations that updated values of unique key columns of [NDB](#) tables could result in duplicate-key errors when replicated. This issue is solved for replication between [NDB](#) tables by deferring unique key checks until after all table row updates have been performed.

Deferring constraints in this way is currently supported only by [NDB](#). Thus, updates of unique keys when replicating from [NDB](#) to a different storage engine such as [InnoDB](#) or [MyISAM](#) are still not supported.

The problem encountered when replicating without deferred checking of unique key updates can be illustrated using [NDB](#) table such as `t`, is created and populated on the source (and transmitted to a replica that does not support deferred unique key updates) as shown here:

```
CREATE TABLE t (
  p INT PRIMARY KEY,
  c INT,
  UNIQUE KEY u (c)
) ENGINE NDB;

INSERT INTO t
VALUES (1,1), (2,2), (3,3), (4,4), (5,5);
```

The following `UPDATE` statement on `t` succeeds on the source, since the rows affected are processed in the order determined by the `ORDER BY` option, performed over the entire table:

```
UPDATE t SET c = c - 1 ORDER BY p;
```

The same statement fails with a duplicate key error or other constraint violation on the replica, because the ordering of the row updates is performed for one partition at a time, rather than for the table as a whole.

Note

Every [NDB](#) table is implicitly partitioned by key when it is created. See [KEY Partitioning](#), for more information.

GTIDs not supported. Replication using global transaction IDs is not compatible with the [NDB](#) storage engine, and is not supported. Enabling GTIDs is likely to cause NDB Cluster Replication to fail.

Multithreaded replicas not supported. NDB Cluster does not support multithreaded replicas, and setting related system variables such as `slave_parallel_workers`, `slave_checkpoint_group`, and `slave_checkpoint_group` (or the equivalent `mysqld` startup options) has no effect.

This is because the replica may not be able to separate transactions occurring in one database from those in another if they are written within the same epoch. In addition, every transaction handled by the [NDB](#) storage engine involves at least two databases—the target database and the `mysql` system database—due to the requirement for updating the `mysql.ndb_apply_status` table (see [Section 7.4, “NDB Cluster Replication Schema and Tables”](#)). This in turn breaks the requirement for multithreading that the transaction is specific to a given database.

Restarting with `--initial`. Restarting the cluster with the `--initial` option causes the sequence of GCI and epoch numbers to start over from 0. (This is generally true of NDB Cluster and not limited to replication scenarios involving Cluster.) The MySQL servers involved in replication should in this case be restarted. After this, you should use the `RESET MASTER` and `RESET SLAVE` statements to clear the invalid `ndb_binlog_index` and `ndb_apply_status` tables, respectively.

Replication from NDB to other storage engines. It is possible to replicate an [NDB](#) table on the source to a table using a different storage engine on the replica, taking into account the restrictions listed here:

- Multi-source and circular replication are not supported (tables on both the source and the replica must use the [NDB](#) storage engine for this to work).
- Using a storage engine which does not perform binary logging for tables on the replica requires special handling.
- Use of a nontransactional storage engine for tables on the replica also requires special handling.
- The source `mysqld` must be started with `--ndb-log-update-as-write=0` or `--ndb-log-update-as-write=OFF`.

The next few paragraphs provide additional information about each of the issues just described.

Multiple sources not supported when replicating NDB to other storage engines. For replication from [NDB](#) to a different storage engine, the relationship between the two databases must be one-to-one. This means that bidirectional or circular replication is not supported between NDB Cluster and other storage engines.

In addition, it is not possible to configure more than one replication channel when replicating between [NDB](#) and a different storage engine. (An NDB Cluster database *can* simultaneously replicate to multiple NDB Cluster databases.) If the source uses [NDB](#) tables, it is still possible to have more than one MySQL Server maintain a binary log of all changes, but for the replica to change sources (fail over), the new source-replica relationship must be explicitly defined on the replica.

Replicating NDB tables to a storage engine that does not perform binary logging. If you attempt to replicate from an NDB Cluster to a replica that uses a storage engine that does not handle its own binary logging, the replication process aborts with the error `Binary logging not possible ... Statement cannot be written atomically since more than one engine involved and at least one engine is self-logging` (Error 1595). It is possible to work around this issue in one of the following ways:

- **Turn off binary logging on the replica.** This can be accomplished by setting `sql_log_bin = 0`.
- **Change the storage engine used for the `mysql.ndb_apply_status` table.** Causing this table to use an engine that does not handle its own binary logging can also eliminate the conflict. This can be done by issuing a statement such as `ALTER TABLE mysql.ndb_apply_status ENGINE=MyISAM` on the replica. It is safe to do this when using a storage engine other than [NDB](#) on the replica, since you do not need to worry about keeping multiple replicas synchronized.
- **Filter out changes to the `mysql.ndb_apply_status` table on the replica.** This can be done by starting the replica with `--replicate-ignore-table=mysql.ndb_apply_status`. If you need for other tables to be ignored by replication, you might wish to use an appropriate `--replicate-wild-ignore-table` option instead.

Important

You should *not* disable replication or binary logging of `mysql.ndb_apply_status` or change the storage engine used for this table when replicating from one NDB Cluster to another. See [Replication and binary log filtering rules with replication between NDB Clusters](#), for details.

Replication from NDB to a nontransactional storage engine. When replicating from [NDB](#) to a nontransactional storage engine such as [MyISAM](#), you may encounter unnecessary duplicate key errors when replicating `INSERT ... ON DUPLICATE KEY UPDATE` statements. You can suppress these by using `--ndb-log-update-as-write=0`, which forces updates to be logged as writes, rather than as updates.

Replication and binary log filtering rules with replication between NDB Clusters. If you are using any of the options `--replicate-do-*`, `--replicate-ignore-*`, `--binlog-do-db`, or `--`

`binlog-ignore-db` to filter databases or tables being replicated, you must take care not to block replication or binary logging of the `mysql.ndb_apply_status`, which is required for replication between NDB Clusters to operate properly. In particular, you must keep in mind the following:

1. Using `--replicate-do-db=db_name` (and no other `--replicate-do-*` or `--replicate-ignore-*` options) means that *only* tables in database `db_name` are replicated. In this case, you should also use `--replicate-do-db=mysql`, `--binlog-do-db=mysql`, or `--replicate-do-table=mysql.ndb_apply_status` to ensure that `mysql.ndb_apply_status` is populated on replicas.

Using `--binlog-do-db=db_name` (and no other `--binlog-do-db` options) means that changes *only* to tables in database `db_name` are written to the binary log. In this case, you should also use `--replicate-do-db=mysql`, `--binlog-do-db=mysql`, or `--replicate-do-table=mysql.ndb_apply_status` to ensure that `mysql.ndb_apply_status` is populated on replicas.

2. Using `--replicate-ignore-db=mysql` means that no tables in the `mysql` database are replicated. In this case, you should also use `--replicate-do-table=mysql.ndb_apply_status` to ensure that `mysql.ndb_apply_status` is replicated.

Using `--binlog-ignore-db=mysql` means that no changes to tables in the `mysql` database are written to the binary log. In this case, you should also use `--replicate-do-table=mysql.ndb_apply_status` to ensure that `mysql.ndb_apply_status` is replicated.

You should also remember that each replication rule requires the following:

1. Its own `--replicate-do-*` or `--replicate-ignore-*` option, and that multiple rules cannot be expressed in a single replication filtering option. For information about these rules, see [Replication and Binary Logging Options and Variables](#).
2. Its own `--binlog-do-db` or `--binlog-ignore-db` option, and that multiple rules cannot be expressed in a single binary log filtering option. For information about these rules, see [The Binary Log](#).

If you are replicating an NDB Cluster to a replica that uses a storage engine other than `NDB`, the considerations just given previously may not apply, as discussed elsewhere in this section.

NDB Cluster Replication and IPv6. While the NDB API and MGM API (and thus data nodes and management nodes) do not support IPv6 in NDB 7.5 and 7.6, MySQL Servers—including those acting as SQL nodes in an NDB Cluster—can use IPv6 to contact other MySQL Servers. This means that you can replicate between NDB Clusters using IPv6 to connect the source and replica SQL nodes as shown by the dotted arrow in the following diagram:

Figure 7.4 Replication Between SQL Nodes Connected Using IPv6

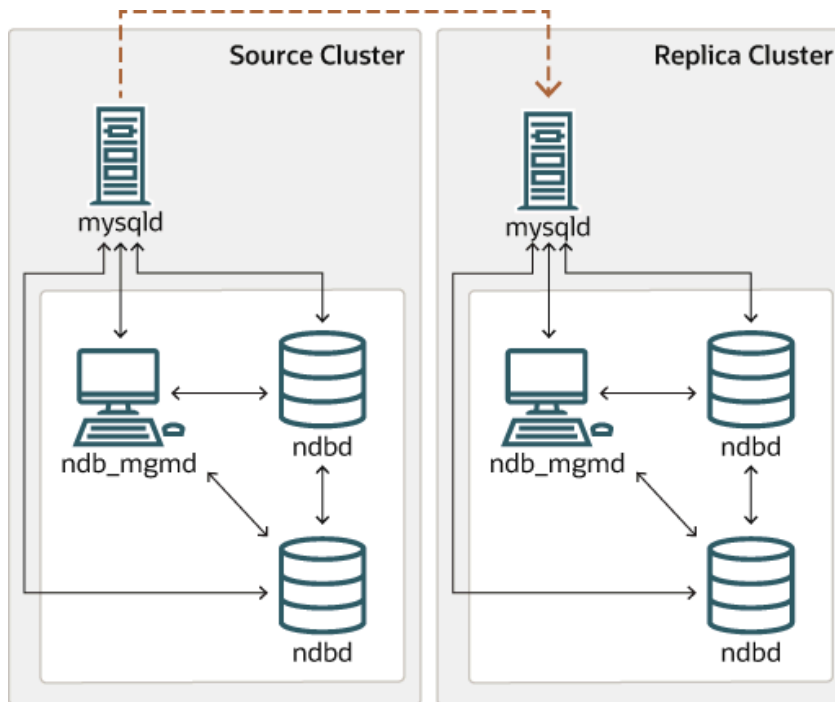

All connections originating *within* the NDB Cluster —represented in the preceding diagram by solid arrows—must use IPv4. In other words, all NDB Cluster data nodes, management servers, and management clients must be accessible from one another using IPv4. In addition, SQL nodes must use IPv4 to communicate with the cluster.

Since there is currently no support in the NDB and MGM APIs for IPv6, any applications written using these APIs must also make all connections using IPv4.

Attribute promotion and demotion. NDB Cluster Replication includes support for attribute promotion and demotion. The implementation of the latter distinguishes between lossy and non-lossy type conversions, and their use on the replica can be controlled by setting the `slave_type_conversions` global server system variable.

For more information about attribute promotion and demotion in NDB Cluster, see [Row-based replication: attribute promotion and demotion](#).

NDB, unlike InnoDB or MyISAM, does not write changes to virtual columns to the binary log; however, this has no detrimental effects on NDB Cluster Replication or replication between NDB and other storage engines. Changes to stored generated columns are logged.

7.4 NDB Cluster Replication Schema and Tables

- [ndb_apply_status Table](#)
- [ndb_binlog_index Table](#)
- [ndb_replication Table](#)

Replication in NDB Cluster makes use of a number of dedicated tables in the `mysql` database on each MySQL Server instance acting as an SQL node in both the cluster being replicated and in the replica. This is true regardless of whether the replica is a single server or a cluster.

The `ndb_binlog_index` and `ndb_apply_status` tables are created in the `mysql` database. They should not be explicitly replicated by the user. User intervention is normally not required to create or maintain either of these tables, since both are maintained by the NDB binary log (binlog) injector thread. This keeps the source `mysqld` process updated to changes performed by the NDB storage engine.

The *NDB binlog injector thread* receives events directly from the *NDB* storage engine. The *NDB* injector is responsible for capturing all the data events within the cluster, and ensures that all events which change, insert, or delete data are recorded in the `ndb_binlog_index` table. The replica I/O thread transfers the events from the source's binary log to the replica's relay log.

The `ndb_replication` table must be created manually. This table can be updated by the user to perform filtering by database or table. See [ndb_replication Table](#), for more information. `ndb_replication` is also used in NDB Replication conflict detection and resolution for conflict resolution control; see [Conflict Resolution Control](#).

Even though `ndb_binlog_index` and `ndb_apply_status` are created and maintained automatically, it is advisable to check for the existence and integrity of these tables as an initial step in preparing an NDB Cluster for replication. It is possible to view event data recorded in the binary log by querying the `mysql.ndb_binlog_index` table directly on the source. This can be also be accomplished using the `SHOW BINLOG EVENTS` statement on either the source or replica SQL node. (See [SHOW BINLOG EVENTS Statement](#).)

You can also obtain useful information from the output of `SHOW ENGINE NDB STATUS`.

Note

When performing schema changes on *NDB* tables, applications should wait until the `ALTER TABLE` statement has returned in the MySQL client connection that issued the statement before attempting to use the updated definition of the table.

ndb_apply_status Table

`ndb_apply_status` is used to keep a record of the operations that have been replicated from the source to the replica. If the `ndb_apply_status` table does not exist on the replica, `ndb_restore` re-creates it.

Unlike the case with `ndb_binlog_index`, the data in this table is not specific to any one SQL node in the (replica) cluster, and so `ndb_apply_status` can use the *NDBCLUSTER* storage engine, as shown here:

```
CREATE TABLE `ndb_apply_status` (
  `server_id` INT(10) UNSIGNED NOT NULL,
  `epoch` BIGINT(20) UNSIGNED NOT NULL,
  `log_name` VARCHAR(255) CHARACTER SET latin1 COLLATE latin1_bin NOT NULL,
  `start_pos` BIGINT(20) UNSIGNED NOT NULL,
  `end_pos` BIGINT(20) UNSIGNED NOT NULL,
  PRIMARY KEY (`server_id`) USING HASH
) ENGINE=NDBCLUSTER DEFAULT CHARSET=latin1;
```

The `ndb_apply_status` table is populated only on replicas, which means that, on the source, this table never contains any rows; thus, there is no need to allot any *DataMemory* to `ndb_apply_status` there.

Because this table is populated from data originating on the source, it should be allowed to replicate; any replication filtering or binary log filtering rules that inadvertently prevent the replica from updating `ndb_apply_status`, or that prevent the source from writing into the binary log may prevent replication between clusters from operating properly. For more information about potential problems arising from such filtering rules, see [Replication and binary log filtering rules with replication between NDB Clusters](#).

ndb_binlog_index Table

NDB Cluster Replication uses the `ndb_binlog_index` table for storing the binary log's indexing data. Since this table is local to each MySQL server and does not participate in clustering, it uses the *InnoDB* storage engine. This means that it must be created separately on each `mysqld` participating in the source cluster. (The binary log itself contains updates from all MySQL servers in the cluster.) This table is defined as follows:

```
CREATE TABLE `ndb_binlog_index` (
  `Position` BIGINT(20) UNSIGNED NOT NULL,
  `File` VARCHAR(255) NOT NULL,
  `epoch` BIGINT(20) UNSIGNED NOT NULL,
  `inserts` INT(10) UNSIGNED NOT NULL,
  `updates` INT(10) UNSIGNED NOT NULL,
  `deletes` INT(10) UNSIGNED NOT NULL,
  `schemaops` INT(10) UNSIGNED NOT NULL,
  `orig_server_id` INT(10) UNSIGNED NOT NULL,
  `orig_epoch` BIGINT(20) UNSIGNED NOT NULL,
  `gci` INT(10) UNSIGNED NOT NULL,
  `next_position` bigint(20) unsigned NOT NULL,
  `next_file` varchar(255) NOT NULL,
  PRIMARY KEY (`epoch`,`orig_server_id`,`orig_epoch`)
) ENGINE=InnoDB DEFAULT CHARSET=latin1;
```

Note

Prior to NDB 7.5.2, this table always used the [MyISAM](#) storage engine. If you are upgrading from an earlier release, you can use `mysql_upgrade` with the `--force` and `--upgrade-system-tables` options after starting the server.) The system table upgrade causes an `ALTER TABLE ... ENGINE=INNODB` statement to be executed for this table. Use of the [MyISAM](#) storage engine for this table continues to be supported for backward compatibility.

`ndb_binlog_index` may require additional disk space after being converted to [InnoDB](#). If this becomes an issue, you may be able to conserve space by using an [InnoDB](#) tablespace for this table, changing its `ROW_FORMAT` to `COMPRESSED`, or both. For more information, see [CREATE TABLESPACE Statement](#), and [CREATE TABLE Statement](#), as well as [Tablespaces](#).

The size of the `ndb_binlog_index` table is dependent on the number of epochs per binary log file and the number of binary log files. The number of epochs per binary log file normally depends on the amount of binary log generated per epoch and the size of the binary log file, with smaller epochs resulting in more epochs per file. You should be aware that empty epochs produce inserts to the `ndb_binlog_index` table, even when the `--ndb-log-empty-epochs` option is `OFF`, meaning that the number of entries per file depends on the length of time that the file is in use; this relationship can be represented by the formula shown here:

```
[number of epochs per file] = [time spent per file] / TimeBetweenEpochs
```

A busy NDB Cluster writes to the binary log regularly and presumably rotates binary log files more quickly than a quiet one. This means that a “quiet” NDB Cluster with `--ndb-log-empty-epochs=ON` can actually have a much higher number of `ndb_binlog_index` rows per file than one with a great deal of activity.

When `mysqld` is started with the `--ndb-log-orig` option, the `orig_server_id` and `orig_epoch` columns store, respectively, the ID of the server on which the event originated and the epoch in which the event took place on the originating server, which is useful in NDB Cluster replication setups employing multiple sources. The `SELECT` statement used to find the closest binary log position to the highest applied epoch on the replica in a multi-source setup (see [Section 7.10, “NDB Cluster Replication: Bidirectional and Circular Replication”](#)) employs these two columns, which are not indexed. This can lead to performance issues when trying to fail over, since the query must perform a table scan, especially when the source has been running with `--ndb-log-empty-epochs=ON`. You can improve multi-source failover times by adding an index to these columns, as shown here:

```
ALTER TABLE mysql.ndb_binlog_index
  ADD INDEX orig_lookup USING BTREE (orig_server_id, orig_epoch);
```

Adding this index provides no benefit when replicating from a single source to a single replica, since the query used to get the binary log position in such cases makes no use of `orig_server_id` or `orig_epoch`.

See [Section 7.8, “Implementing Failover with NDB Cluster Replication”](#), for more information about using the `next_position` and `next_file` columns.

The following figure shows the relationship of the NDB Cluster replication source server, its binary log injector thread, and the `mysql.ndb_binlog_index` table.

Figure 7.5 The Replication Source Cluster

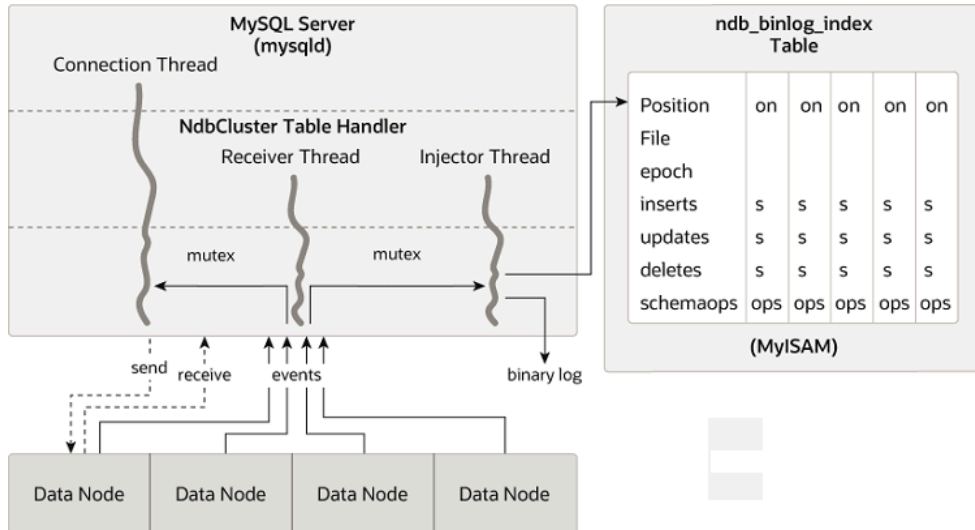

ndb_replication Table

The `ndb_replication` table is used to control binary logging and conflict resolution, and acts on a per-table basis. Each row in this table corresponds to a table being replicated, determines how to log changes to the table and, if a conflict resolution function is specified, and determines how to resolve conflicts for that table.

Unlike the `ndb_apply_status` and `ndb_replication` tables, the `ndb_replication` table must be created manually. You can do this by using the SQL statement shown here:

```
CREATE TABLE mysql.ndb_replication (
  db VARBINARY(63),
  table_name VARBINARY(63),
  server_id INT UNSIGNED,
  binlog_type INT UNSIGNED,
  conflict_fn VARBINARY(128),
  PRIMARY KEY USING HASH (db, table_name, server_id)
) ENGINE=NDB
PARTITION BY KEY(db,table_name);
```

The columns of this table are listed here, with descriptions:

- `db` column

The name of the database containing the table to be replicated. You may employ either or both of the wildcards `_` and `%` as part of the database name. Matching is similar to what is implemented for the [LIKE](#) operator.

- `table_name` column

The name of the table to be replicated. The table name may include either or both of the wildcards `_` and `%`. Matching is similar to what is implemented for the [LIKE](#) operator.

- `server_id` column

The unique server ID of the MySQL instance (SQL node) where the table resides.

- `binlog_type` column

The type of binary logging to be employed. See text for values and descriptions.

- `conflict_fn` column

The conflict resolution function to be applied; one of `NDB$OLD(column_name)`, `NDB$MAX(column_name)`, `NDB$MAX_DELETE_WIN()`, `NDB$EPOCH()`, `NDB$EPOCH_TRANS()`, `NDB$EPOCH2()`, `NDB$EPOCH2_TRANS()`; `NULL` indicates that conflict resolution is not used for this table.

See [Conflict Resolution Functions](#), for more information about these functions and their uses in NDB Replication conflict resolution.

Some conflict resolution functions (`NDB$OLD()`, `NDB$EPOCH()`, `NDB$EPOCH_TRANS()`) require the use of one or more user-created exceptions tables. See [Conflict Resolution Exceptions Table](#).

To enable conflict resolution with NDB Replication, it is necessary to create and populate this table with control information on the SQL node or nodes on which the conflict should be resolved. Depending on the conflict resolution type and method to be employed, this may be the source, the replica, or both servers. In a simple source-replica setup where data can also be changed locally on the replica this is typically the replica. In a more complex replication scheme, such as bidirectional replication, this is usually all of the sources involved. See [Section 7.11, “NDB Cluster Replication Conflict Resolution”](#), for more information.

The `ndb_replication` table allows table-level control over binary logging outside the scope of conflict resolution, in which case `conflict_fn` is specified as `NULL`, while the remaining column values are used to control binary logging for a given table or set of tables matching a wildcard expression. By setting the proper value for the `binlog_type` column, you can make logging for a given table or tables use a desired binary log format, or disabling binary logging altogether. Possible values for this column, with internal values and descriptions, are shown in the following table:

Table 7.2 binlog_type values, with internal values and descriptions

Value	Internal Value	Description
0	<code>NBT_DEFAULT</code>	Use server default
1	<code>NBT_NO_LOGGING</code>	Do not log this table in the binary log
2	<code>NBT_UPDATED_ONLY</code>	Only updated attributes are logged
3	<code>NBT_FULL</code>	Log full row, even if not updated (MySQL server default behavior)
4	<code>NBT_USE_UPDATE</code>	(For generating <code>NBT_UPDATED_ONLY_USE_UPDATE</code> and <code>NBT_FULL_USE_UPDATE</code> values only—not intended for separate use)
5	<i>[Not used]</i>	---
6	<code>NBT_UPDATED_ONLY_USE_UPDATE</code> (equal to <code>NBT_UPDATED_ONLY</code> <code>NBT_USE_UPDATE</code>)	Use updated attributes, even if values are unchanged
7	<code>NBT_FULL_USE_UPDATE</code> (equal to <code>NBT_FULL</code> <code>NBT_USE_UPDATE</code>)	Use full row, even if values are unchanged
8	<code>NBT_UPDATED_ONLY_MINIMAL</code>	Log update as <code>UPDATE_ROW</code> ; log only primary key columns in before image, and only updated columns in after image

Value	Internal Value	Description
9	NBT_UPDATED_FULL_MINIMAL	Log update as <code>UPDATE_ROW</code> ; log only primary key columns in before image, and all columns other than primary key columns in after image

Binary logging can be set to different formats for different tables by inserting rows into the `ndb_replication` table using the appropriate `db`, `table_name`, and `binlog_type` column values. The internal integer value shown in the preceding table should be used when setting the binary logging format. The following two statements set binary logging to logging of full rows (`NBT_FULL`, internal value 3) for table `test.a`, and to logging of updates only (`NBT_UPDATED_ONLY`, internal value 2) for table `test.b`:

```
# Table test.a: Log full rows
INSERT INTO mysql.ndb_replication VALUES("test", "a", 0, 3, NULL);

# Table test.b: log updates only
INSERT INTO mysql.ndb_replication VALUES("test", "b", 0, 2, NULL);
```

To disable logging for one or more tables, use 1 (`NBT_NO_LOGGING`) for `binlog_type`, as shown here:

```
# Disable binary logging for table test.t1
INSERT INTO mysql.ndb_replication VALUES("test", "t1", 0, 1, NULL);

# Disable binary logging for any table in 'test' whose name begins with 't'
INSERT INTO mysql.ndb_replication VALUES("test", "t%", 0, 1, NULL);
```

7.5 Preparing the NDB Cluster for Replication

Preparing the NDB Cluster for replication consists of the following steps:

1. Check all MySQL servers for version compatibility (see [Section 7.2, “General Requirements for NDB Cluster Replication”](#)).
2. Create a replication account on the source Cluster with the appropriate privileges, using the following two SQL statements:

```
mysqlS> CREATE USER 'replica_user'@'replica_host'
-> IDENTIFIED BY 'replica_password';

mysqlS> GRANT REPLICATION SLAVE ON *.*
-> TO 'replica_user'@'replica_host';
```

In the previous statement, `replica_user` is the replication account user name, `replica_host` is the host name or IP address of the replica, and `replica_password` is the password to assign to this account.

For example, to create a replica user account with the name `myreplica`, logging in from the host named `replica-host`, and using the password `53cr37`, use the following `CREATE USER` and `GRANT` statements:

```
mysqlS> CREATE USER 'myreplica'@'replica-host'
-> IDENTIFIED BY '53cr37';

mysqlS> GRANT REPLICATION SLAVE ON *.*
-> TO 'myreplica'@'replica-host';
```

For security reasons, it is preferable to use a unique user account—not employed for any other purpose—for the replication account.

3. Set up the replica to use the source. Using the `mysql` client, this can be accomplished with the the following `CHANGE MASTER TO` statement:

```
mysqlR> CHANGE MASTER TO
-> MASTER_HOST='source_host',
-> MASTER_PORT=source_port,
-> MASTER_USER='replica_user',
-> MASTER_PASSWORD='replica_password';
```

In the previous statement, `source_host` is the host name or IP address of the replication source, `source_port` is the port for the replica to use when connecting to the source, `replica_user` is the user name set up for the replica on the source, and `replica_password` is the password set for that user account in the previous step.

For example, to tell the replica to use the MySQL server whose host name is `rep-source` with the replication account created in the previous step, use the following statement:

```
mysqlR> CHANGE MASTER TO
-> MASTER_HOST='rep-source',
-> MASTER_PORT=3306,
-> MASTER_USER='myreplica',
-> MASTER_PASSWORD='53cr37';
```

For a complete list of options that can be used with this statement, see [CHANGE MASTER TO Statement](#).

To provide replication backup capability, you also need to add an `--ndb-connectstring` option to the replica's `my.cnf` file prior to starting the replication process. See [Section 7.9, “NDB Cluster Backups With NDB Cluster Replication”](#), for details.

For additional options that can be set in `my.cnf` for replicas, see [Replication and Binary Logging Options and Variables](#).

4. If the source cluster is already in use, you can create a backup of the source and load this onto the replica to cut down on the amount of time required for the replica to synchronize itself with the source. If the replica is also running NDB Cluster, this can be accomplished using the backup and restore procedure described in [Section 7.9, “NDB Cluster Backups With NDB Cluster Replication”](#).

```
ndb-connectstring=management_host[:port]
```

In the event that you are *not* using NDB Cluster on the replica, you can create a backup with this command on the source:

```
shellS> mysqldump --master-data=1
```

Then import the resulting data dump onto the replica by copying the dump file over to it. After this, you can use the `mysql` client to import the data from the dumpfile into the replica database as shown here, where `dump_file` is the name of the file that was generated using `mysqldump` on the source, and `db_name` is the name of the database to be replicated:

```
shellR> mysql -u root -p db_name < dump_file
```

For a complete list of options to use with `mysqldump`, see [mysqldump — A Database Backup Program](#).

Note

If you copy the data to the replica in this fashion, you should make sure that the replica is started with the `--skip-slave-start` option on the command line, or else include `skip-slave-start` in the replica's `my.cnf` file to keep it from trying to connect to the source to begin replicating before all the data has been loaded. Once the data loading has completed, follow the additional steps outlined in the next two sections.

5. Ensure that each MySQL server acting as a replication source is assigned a unique server ID, and has binary logging enabled, using the row-based format. (See [Replication Formats](#).) In addition, we recommend enabling the `slave_allow_batching` system variable, and possibly increasing the values used with the `--ndb-batch-size` and `--ndb-blob-write-batch-bytes` options as well. All of these options can be set either in the source server's `my.cnf` file, or on the command line when starting the source `mysqld` process. See [Section 7.6, "Starting NDB Cluster Replication \(Single Replication Channel\)"](#), for more information.

7.6 Starting NDB Cluster Replication (Single Replication Channel)

This section outlines the procedure for starting NDB Cluster replication using a single replication channel.

1. Start the MySQL replication source server by issuing this command, where `id` is this server's unique ID (see [Section 7.2, "General Requirements for NDB Cluster Replication"](#)):

```
shellS> mysqld --ndbcluster --server-id=id \
--log-bin --ndb-log-bin &
```

This starts the server's `mysqld` process with binary logging enabled using the proper logging format.

Note

You can also start the source with `--binlog-format=MIXED`, in which case row-based replication is used automatically when replicating between clusters. Statement-based binary logging is not supported for NDB Cluster Replication (see [Section 7.2, "General Requirements for NDB Cluster Replication"](#)).

2. Start the MySQL replica server as shown here:

```
shellR> mysqld --ndbcluster --server-id=id &
```

In the command just shown, `id` is the replica server's unique ID. It is not necessary to enable logging on the replica.

Note

You should use the `--skip-slave-start` option with this command or else you should include `skip-slave-start` in the replica server's `my.cnf` file, unless you want replication to begin immediately. With the use of this option, the start of replication is delayed until the appropriate `START SLAVE` statement has been issued, as explained in Step 4 below.

3. It is necessary to synchronize the replica server with the source server's replication binary log. If binary logging has not previously been running on the source, run the following statement on the replica:

```
mysqlR> CHANGE MASTER TO
-> MASTER_LOG_FILE='',
-> MASTER_LOG_POS=4;
```

This instructs the replica to begin reading the source server's binary log from the log's starting point. Otherwise—that is, if you are loading data from the source using a backup—see [Section 7.8, "Implementing Failover with NDB Cluster Replication"](#), for information on how to obtain the correct values to use for `MASTER_LOG_FILE` and `MASTER_LOG_POS` in such cases.

4. Finally, instruct the replica to begin applying replication by issuing this command from the `mysql` client on the replica:

```
mysqlR> START SLAVE;
```

This also initiates the transmission of data and changes from the source to the replica.

It is also possible to use two replication channels, in a manner similar to the procedure described in the next section; the differences between this and using a single replication channel are covered in [Section 7.7, “Using Two Replication Channels for NDB Cluster Replication”](#).

It is also possible to improve cluster replication performance by enabling *batched updates*. This can be accomplished by setting the `slave_allow_batching` system variable on the replicas' `mysqld` processes. Normally, updates are applied as soon as they are received. However, the use of batching causes updates to be applied in batches of 32 KB each; this can result in higher throughput and less CPU usage, particularly where individual updates are relatively small.

Note

Batching works on a per-epoch basis; updates belonging to more than one transaction can be sent as part of the same batch.

All outstanding updates are applied when the end of an epoch is reached, even if the updates total less than 32 KB.

Batching can be turned on and off at runtime. To activate it at runtime, you can use either of these two statements:

```
SET GLOBAL slave_allow_batching = 1;
SET GLOBAL slave_allow_batching = ON;
```

If a particular batch causes problems (such as a statement whose effects do not appear to be replicated correctly), batching can be deactivated using either of the following statements:

```
SET GLOBAL slave_allow_batching = 0;
SET GLOBAL slave_allow_batching = OFF;
```

You can check whether batching is currently being used by means of an appropriate `SHOW VARIABLES` statement, like this one:

```
mysql> SHOW VARIABLES LIKE 'slave%';
+-----+-----+
| Variable_name | Value |
+-----+-----+
| slave_allow_batching | ON |
| slave_compressed_protocol | OFF |
| slave_load_tmpdir | /tmp |
| slave_net_timeout | 3600 |
| slave_skip_errors | OFF |
| slave_transaction_retries | 10 |
+-----+-----+
6 rows in set (0.00 sec)
```

7.7 Using Two Replication Channels for NDB Cluster Replication

In a more complete example scenario, we envision two replication channels to provide redundancy and thereby guard against possible failure of a single replication channel. This requires a total of four replication servers, two source servers on the source cluster and two replica servers on the replica cluster. For purposes of the discussion that follows, we assume that unique identifiers are assigned as shown here:

Table 7.3 NDB Cluster replication servers described in the text

Server ID	Description
1	Source - primary replication channel (S)
2	Source - secondary replication channel (S')

Server ID	Description
3	Replica - primary replication channel (R)
4	replica - secondary replication channel (R)

Setting up replication with two channels is not radically different from setting up a single replication channel. First, the `mysqld` processes for the primary and secondary replication source servers must be started, followed by those for the primary and secondary replicas. The replication processes can be initiated by issuing the `START SLAVE` statement on each of the replicas. The commands and the order in which they need to be issued are shown here:

1. Start the primary replication source:

```
shellS> mysqld --ndbcluster --server-id=1 \
            --log-bin &
```

2. Start the secondary replication source:

```
shellS'> mysqld --ndbcluster --server-id=2 \
            --log-bin &
```

3. Start the primary replica server:

```
shellR> mysqld --ndbcluster --server-id=3 \
            --skip-slave-start &
```

4. Start the secondary replica server:

```
shellR'> mysqld --ndbcluster --server-id=4 \
            --skip-slave-start &
```

5. Finally, initiate replication on the primary channel by executing the `START SLAVE` statement on the primary replica as shown here:

```
mysqlR> START SLAVE;
```

Warning

Only the primary channel must be started at this point. The secondary replication channel needs to be started only in the event that the primary replication channel fails, as described in [Section 7.8, “Implementing Failover with NDB Cluster Replication”](#). Running multiple replication channels simultaneously can result in unwanted duplicate records being created on the replicas.

As mentioned previously, it is not necessary to enable binary logging on the replicas.

7.8 Implementing Failover with NDB Cluster Replication

In the event that the primary Cluster replication process fails, it is possible to switch over to the secondary replication channel. The following procedure describes the steps required to accomplish this.

1. Obtain the time of the most recent global checkpoint (GCP). That is, you need to determine the most recent epoch from the `ndb_apply_status` table on the replica cluster, which can be found using the following query:

```
mysqlR'> SELECT @latest:=MAX(epoch)
            -> FROM mysql.ndb_apply_status;
```

In a circular replication topology, with a source and a replica running on each host, when you are using `ndb_log_apply_status=1`, NDB Cluster epochs are written in the replicas' binary logs. This means that the `ndb_apply_status` table contains information for the replica on this host as

well as for any other host which acts as a replica of the replication source server running on this host.

In this case, you need to determine the latest epoch on this replica to the exclusion of any epochs from any other replicas in this replica's binary log that were not listed in the `IGNORE_SERVER_IDS` options of the `CHANGE MASTER TO` statement used to set up this replica. The reason for excluding such epochs is that rows in the `mysql.ndb_apply_status` table whose server IDs have a match in the `IGNORE_SERVER_IDS` list from the `CHANGE MASTER TO` statement used to prepare this replica's source are also considered to be from local servers, in addition to those having the replica's own server ID. You can retrieve this list as `Replicate_Ignore_Server_Ids` from the output of `SHOW SLAVE STATUS`. We assume that you have obtained this list and are substituting it for `ignore_server_ids` in the query shown here, which like the previous version of the query, selects the greatest epoch into a variable named `@latest`:

```
mysqlR'> SELECT @latest:=MAX(epoch)
->         FROM mysql.ndb_apply_status
->         WHERE server_id NOT IN (ignore_server_ids);
```

In some cases, it may be simpler or more efficient (or both) to use a list of the server IDs to be included and `server_id IN server_id_list` in the `WHERE` condition of the preceding query.

- Using the information obtained from the query shown in Step 1, obtain the corresponding records from the `ndb_binlog_index` table on the source cluster.

You can use the following query to obtain the needed records from the `ndb_binlog_index` table on the source:

```
mysqlS'> SELECT
->         @file:=SUBSTRING_INDEX(next_file, '/', -1),
->         @pos:=next_position
-> FROM mysql.ndb_binlog_index
-> WHERE epoch >= @latest
-> ORDER BY epoch ASC LIMIT 1;
```

These are the records saved on the source since the failure of the primary replication channel. We have employed a user variable `@latest` here to represent the value obtained in Step 1. Of course, it is not possible for one `mysqld` instance to access user variables set on another server instance directly. These values must be “plugged in” to the second query manually or by an application.

Important

You must ensure that the replica `mysqld` is started with `--slave-skip-errors=ddl_exist_errors` before executing `START SLAVE`. Otherwise, replication may stop with duplicate DDL errors.

- Now it is possible to synchronize the secondary channel by running the following query on the secondary replica server:

```
mysqlR'> CHANGE MASTER TO
->         MASTER_LOG_FILE='@file',
->         MASTER_LOG_POS=@pos;
```

Again we have employed user variables (in this case `@file` and `@pos`) to represent the values obtained in Step 2 and applied in Step 3; in practice these values must be inserted manually or using an application that can access both of the servers involved.

Note

`@file` is a string value such as `'/var/log/mysql/replication-source-bin.00001'`, and so must be quoted when used in SQL or application code. However, the value represented by `@pos` must *not* be quoted. Although MySQL normally attempts to convert strings to numbers, this case is an exception.

4. You can now initiate replication on the secondary channel by issuing the appropriate statement on the secondary replica `mysqlR'`:

```
mysqlR' > START SLAVE;
```

Once the secondary replication channel is active, you can investigate the failure of the primary and effect repairs. The precise actions required to do this depend upon the reasons for which the primary channel failed.

Warning

The secondary replication channel is to be started only if and when the primary replication channel has failed. Running multiple replication channels simultaneously can result in unwanted duplicate records being created on the replicas.

If the failure is limited to a single server, it should in theory be possible to replicate from *S* to *R'*, or from *S'* to *R*.

7.9 NDB Cluster Backups With NDB Cluster Replication

This section discusses making backups and restoring from them using NDB Cluster replication. We assume that the replication servers have already been configured as covered previously (see [Section 7.5, “Preparing the NDB Cluster for Replication”](#), and the sections immediately following). This having been done, the procedure for making a backup and then restoring from it is as follows:

1. There are two different methods by which the backup may be started.
 - **Method A.** This method requires that the cluster backup process was previously enabled on the source server, prior to starting the replication process. This can be done by including the following line in a `[mysql_cluster]` section in the `my.cnf` file, where `management_host` is the IP address or host name of the NDB management server for the source cluster, and `port` is the management server's port number:

```
ndb-connectstring=management_host[:port]
```

Note

The port number needs to be specified only if the default port (1186) is not being used. See [Section 3.3, “Initial Configuration of NDB Cluster”](#), for more information about ports and port allocation in NDB Cluster.

In this case, the backup can be started by executing this statement on the replication source:

```
shellS> ndb_mgm -e "START BACKUP"
```

- **Method B.** If the `my.cnf` file does not specify where to find the management host, you can start the backup process by passing this information to the NDB management client as part of the `START BACKUP` command. This can be done as shown here, where `management_host` and `port` are the host name and port number of the management server:

```
shellS> ndb_mgm management_host:port -e "START BACKUP"
```

In our scenario as outlined earlier (see [Section 7.5, “Preparing the NDB Cluster for Replication”](#)), this would be executed as follows:

```
shellS> ndb_mgm rep-source:1186 -e "START BACKUP"
```

2. Copy the cluster backup files to the replica that is being brought on line. Each system running an `ndbd` process for the source cluster has cluster backup files located on it, and *all* of these files must be copied to the replica to ensure a successful restore. The backup files can be copied into any

directory on the computer where the replica's management host resides, as long as the MySQL and NDB binaries have read permissions in that directory. In this case, we assume that these files have been copied into the directory `/var/BACKUPS/BACKUP-1`.

While it is not necessary that the replica cluster have the same number of `ndbd` processes (data nodes) as the source, it is highly recommended this number be the same. It is necessary that the replica be started with the `--skip-slave-start` option, to prevent premature startup of the replication process.

3. Create any databases on the replica cluster that are present on the source cluster and that are to be replicated.

Important

A `CREATE DATABASE` (or `CREATE SCHEMA`) statement corresponding to each database to be replicated must be executed on each SQL node in the replica cluster.

4. Reset the replica cluster using this statement in the `mysql` client:

```
mysqlR> RESET SLAVE;
```

5. You can now start the cluster restoration process on the replica using the `ndb_restore` command for each backup file in turn. For the first of these, it is necessary to include the `-m` option to restore the cluster metadata, as shown here:

```
shellR> ndb_restore -c replica_host:port -n node-id \
        -b backup-id -m -r dir
```

`dir` is the path to the directory where the backup files have been placed on the replica. For the `ndb_restore` commands corresponding to the remaining backup files, the `-m` option should *not* be used.

For restoring from a source cluster with four data nodes (as shown in the figure in [Chapter 7, NDB Cluster Replication](#)) where the backup files have been copied to the directory `/var/BACKUPS/BACKUP-1`, the proper sequence of commands to be executed on the replica might look like this:

```
shellR> ndb_restore -c replica-host:1186 -n 2 -b 1 -m \
        -r ./var/BACKUPS/BACKUP-1
shellR> ndb_restore -c replica-host:1186 -n 3 -b 1 \
        -r ./var/BACKUPS/BACKUP-1
shellR> ndb_restore -c replica-host:1186 -n 4 -b 1 \
        -r ./var/BACKUPS/BACKUP-1
shellR> ndb_restore -c replica-host:1186 -n 5 -b 1 -e \
        -r ./var/BACKUPS/BACKUP-1
```

Important

The `-e` (or `--restore-epoch`) option in the final invocation of `ndb_restore` in this example is required to make sure that the epoch is written to the replica's `mysql.ndb_apply_status` table. Without this information, the replica cannot synchronize properly with the source. (See [Section 5.24, "ndb_restore — Restore an NDB Cluster Backup"](#).)

6. Now you need to obtain the most recent epoch from the `ndb_apply_status` table on the replica (as discussed in [Section 7.8, "Implementing Failover with NDB Cluster Replication"](#)):

```
mysqlR> SELECT @latest:=MAX(epoch)
        FROM mysql.ndb_apply_status;
```

7. Using `@latest` as the epoch value obtained in the previous step, you can obtain the correct starting position `@pos` in the correct binary log file `@file` from the `mysql.ndb_binlog_index` table on the source. The query shown here gets these from the `next_position` and `next_file` columns from the last epoch applied before the logical restore position:

```
mysqlS> SELECT
->   @file:=SUBSTRING_INDEX(next_file, '/', -1),
->   @pos:=next_position
-> FROM mysql.ndb_binlog_index
-> WHERE epoch > @latest
-> ORDER BY epoch ASC LIMIT 1;
```

In the event that there is currently no replication traffic, you can get similar information by running `SHOW MASTER STATUS` on the source and using the value shown in the `Position` column of the output for the file whose name has the suffix with the greatest value for all files shown in the `File` column. In this case, you must determine which file this is and supply the name in the next step manually or by parsing the output with a script.

- Using the values obtained in the previous step, you can now issue the appropriate `CHANGE MASTER TO` statement in the replica's `mysql` client:

```
mysqlR> CHANGE MASTER TO
->   MASTER_LOG_FILE='@file',
->   MASTER_LOG_POS=@pos;
```

- Now that the replica knows from what point in which binary log file to start reading data from the source, you can cause the replica to begin replicating with this statement:

```
mysqlR> START SLAVE;
```

To perform a backup and restore on a second replication channel, it is necessary only to repeat these steps, substituting the host names and IDs of the secondary source and replica for those of the primary source and replica servers where appropriate, and running the preceding statements on them.

For additional information on performing Cluster backups and restoring Cluster from backups, see [Section 6.8, "Online Backup of NDB Cluster"](#).

7.9.1 NDB Cluster Replication: Automating Synchronization of the Replica to the Source Binary Log

It is possible to automate much of the process described in the previous section (see [Section 7.9, "NDB Cluster Backups With NDB Cluster Replication"](#)). The following Perl script `reset-replica.pl` serves as an example of how you can do this.

```
#!/user/bin/perl -w

# file: reset-replica.pl

# Copyright (c) 2005, 2020, Oracle and/or its affiliates. All rights reserved.

# This program is free software; you can redistribute it and/or modify
# it under the terms of the GNU General Public License as published by
# the Free Software Foundation; either version 2 of the License, or
# (at your option) any later version.

# This program is distributed in the hope that it will be useful,
# but WITHOUT ANY WARRANTY; without even the implied warranty of
# MERCHANTABILITY or FITNESS FOR A PARTICULAR PURPOSE. See the
# GNU General Public License for more details.

# You should have received a copy of the GNU General Public License
# along with this program; if not, write to:
# Free Software Foundation, Inc.
# 59 Temple Place, Suite 330
# Boston, MA 02111-1307 USA
#
# Version 1.1

##### Includes #####

use DBI;
```



```

##### Globals #####

my $m_host='';
my $m_port='';
my $m_user='';
my $m_pass='';
my $s_host='';
my $s_port='';
my $s_user='';
my $s_pass='';
my $dbhM='';
my $dbhS='';

##### Sub Prototypes #####

sub CollectCommandPromptInfo;
sub ConnectToDatabases;
sub DisconnectFromDatabases;
sub GetReplicaEpoch;
sub GetSourceInfo;
sub UpdateReplica;

##### Program Main #####

CollectCommandPromptInfo;
ConnectToDatabases;
GetReplicaEpoch;
GetSourceInfo;
UpdateReplica;
DisconnectFromDatabases;

##### Collect Command Prompt Info #####

sub CollectCommandPromptInfo
{
  ### Check that user has supplied correct number of command line args
  die "Usage:\n
      reset-replica >source MySQL host< >source MySQL port< \n
          >source user< >source pass< >replica MySQL host< \n
          >replica MySQL port< >replica user< >replica pass< \n
      All 8 arguments must be passed. Use BLANK for NULL passwords\n"
      unless @ARGV == 8;

  $m_host = $ARGV[0];
  $m_port = $ARGV[1];
  $m_user = $ARGV[2];
  $m_pass = $ARGV[3];
  $s_host = $ARGV[4];
  $s_port = $ARGV[5];
  $s_user = $ARGV[6];
  $s_pass = $ARGV[7];

  if ($m_pass eq "BLANK") { $m_pass = '';}
  if ($s_pass eq "BLANK") { $s_pass = '';}
}

##### Make connections to both databases #####

sub ConnectToDatabases
{
  ### Connect to both source and replica cluster databases

  ### Connect to source
  $dbhM
  = DBI->connect(
    "dbi:mysql:database=mysql;host=$m_host;port=$m_port",
    "$m_user", "$m_pass")
    or die "Can't connect to source cluster MySQL process!
          Error: $DBI::errstr\n";

  ### Connect to replica

```

```

$dbhS
= DBI->connect(
    "dbi:mysql:database=mysql;host=$s_host",
    "$s_user", "$s_pass")
or die "Can't connect to replica cluster MySQL process!
      Error: $DBI::errstr\n";
}

##### Disconnect from both databases #####

sub DisconnectFromDatabases
{
    ### Disconnect from source

    $dbhM->disconnect
    or warn " Disconnection failed: $DBI::errstr\n";

    ### Disconnect from replica

    $dbhS->disconnect
    or warn " Disconnection failed: $DBI::errstr\n";
}

##### Find the last good GCI #####

sub GetReplicaEpoch
{
    $sth = $dbhS->prepare("SELECT MAX(epoch)
                          FROM mysql.ndb_apply_status;")
    or die "Error while preparing to select epoch from replica: ",
          $dbhS->errstr;

    $sth->execute
    or die "Selecting epoch from replica error: ", $sth->errstr;

    $sth->bind_col (1, \ $epoch);
    $sth->fetch;
    print "\tReplica epoch = $epoch\n";
    $sth->finish;
}

##### Find the position of the last GCI in the binary log #####

sub GetSourceInfo
{
    $sth = $dbhM->prepare("SELECT
                          SUBSTRING_INDEX(File, '/', -1), Position
                          FROM mysql.ndb_binlog_index
                          WHERE epoch > $epoch
                          ORDER BY epoch ASC LIMIT 1;")
    or die "Prepare to select from source error: ", $dbhM->errstr;

    $sth->execute
    or die "Selecting from source error: ", $sth->errstr;

    $sth->bind_col (1, \ $binlog);
    $sth->bind_col (2, \ $binpos);
    $sth->fetch;
    print "\tSource binary log file = $binlog\n";
    print "\tSource binary log position = $binpos\n";
    $sth->finish;
}

##### Set the replica to process from that location #####

sub UpdateReplica
{
    $sth = $dbhS->prepare("CHANGE MASTER TO
                          MASTER_LOG_FILE='$binlog',
                          MASTER_LOG_POS=$binpos;")
    or die "Prepare to CHANGE MASTER error: ", $dbhS->errstr;
}

```

```

$sth->execute
    or die "CHANGE MASTER on replica error: ", $sth->errstr;
$sth->finish;
print "\tReplica has been updated. You may now start the replica.\n";
}
# end reset-replica.pl

```

7.9.2 Point-In-Time Recovery Using NDB Cluster Replication

Point-in-time recovery—that is, recovery of data changes made since a given point in time—is performed after restoring a full backup that returns the server to its state when the backup was made. Performing point-in-time recovery of NDB Cluster tables with NDB Cluster and NDB Cluster Replication can be accomplished using a native NDB data backup (taken by issuing `CREATE BACKUP` in the `ndb_mgm` client) and restoring the `ndb_binlog_index` table (from a dump made using `mysqldump`).

To perform point-in-time recovery of NDB Cluster, it is necessary to follow the steps shown here:

1. Back up all NDB databases in the cluster, using the `START BACKUP` command in the `ndb_mgm` client (see [Section 6.8, “Online Backup of NDB Cluster”](#)).
2. At some later point, prior to restoring the cluster, make a backup of the `mysql.ndb_binlog_index` table. It is probably simplest to use `mysqldump` for this task. Also back up the binary log files at this time.

This backup should be updated regularly—perhaps even hourly—depending on your needs.

3. (*Catastrophic failure or error occurs.*)
4. Locate the last known good backup.
5. Clear the data node file systems (using `ndbd --initial` or `ndbmtid --initial`).

Note

NDB Cluster Disk Data tablespace and log files are not removed by `--initial`. You must delete these manually.

6. Use `DROP TABLE` or `TRUNCATE TABLE` with the `mysql.ndb_binlog_index` table.
7. Execute `ndb_restore`, restoring all data. You must include the `--restore-epoch` option when you run `ndb_restore`, so that the `ndb_apply_status` table is populated correctly. (See [Section 5.24, “ndb_restore — Restore an NDB Cluster Backup”](#), for more information.)
8. Restore the `ndb_binlog_index` table from the output of `mysqldump` and restore the binary log files from backup, if necessary.
9. Find the epoch applied most recently—that is, the maximum `epoch` column value in the `ndb_apply_status` table—as the user variable `@LATEST_EPOCH` (emphasized):

```

SELECT @LATEST_EPOCH:=MAX(epoch)
FROM mysql.ndb_apply_status;

```

10. Find the latest binary log file (`@FIRST_FILE`) and position (`Position` column value) within this file that correspond to `@LATEST_EPOCH` in the `ndb_binlog_index` table:

```

SELECT Position, @FIRST_FILE:=File
FROM mysql.ndb_binlog_index
WHERE epoch > @LATEST_EPOCH ORDER BY epoch ASC LIMIT 1;

```

11. Using `mysqlbinlog`, replay the binary log events from the given file and position up to the point of the failure. (See [mysqlbinlog — Utility for Processing Binary Log Files](#).)

See also [Point-in-Time \(Incremental\) Recovery](#), for more information about the binary log, replication, and incremental recovery.

7.10 NDB Cluster Replication: Bidirectional and Circular Replication

It is possible to use NDB Cluster for bidirectional replication between two clusters, as well as for circular replication between any number of clusters.

Circular replication example. In the next few paragraphs we consider the example of a replication setup involving three NDB Clusters numbered 1, 2, and 3, in which Cluster 1 acts as the replication source for Cluster 2, Cluster 2 acts as the source for Cluster 3, and Cluster 3 acts as the source for Cluster 1. Each cluster has two SQL nodes, with SQL nodes A and B belonging to Cluster 1, SQL nodes C and D belonging to Cluster 2, and SQL nodes E and F belonging to Cluster 3.

Circular replication using these clusters is supported as long as the following conditions are met:

- The SQL nodes on all sources and replicas are the same.
- All SQL nodes acting as sources and replicas are started with the `log_slave_updates` system variable enabled.

This type of circular replication setup is shown in the following diagram:

Figure 7.6 NDB Cluster Circular Replication with All Sources As Replicas

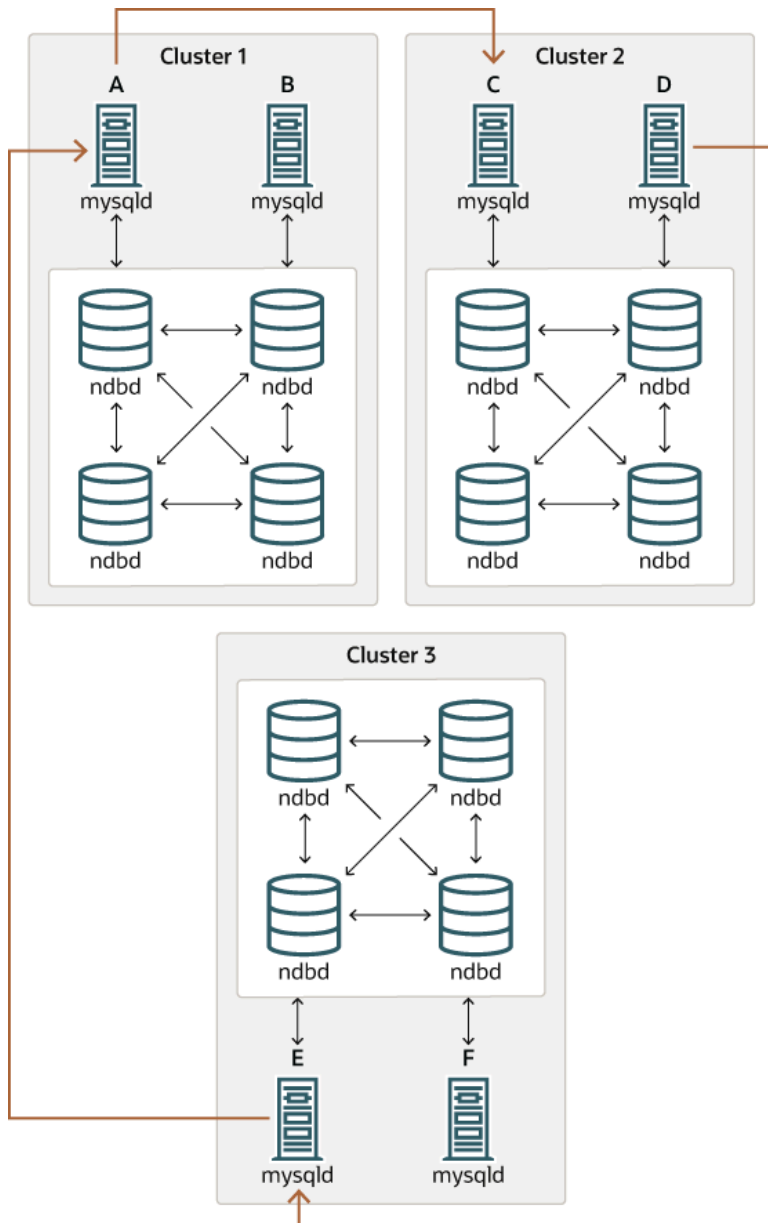

In this scenario, SQL node A in Cluster 1 replicates to SQL node C in Cluster 2; SQL node C replicates to SQL node E in Cluster 3; SQL node E replicates to SQL node A. In other words, the replication line (indicated by the curved arrows in the diagram) directly connects all SQL nodes used as replication sources and replicas.

It is also possible to set up circular replication in such a way that not all source SQL nodes are also replicas, as shown here:

Figure 7.7 NDB Cluster Circular Replication Where Not All Sources Are Replicas

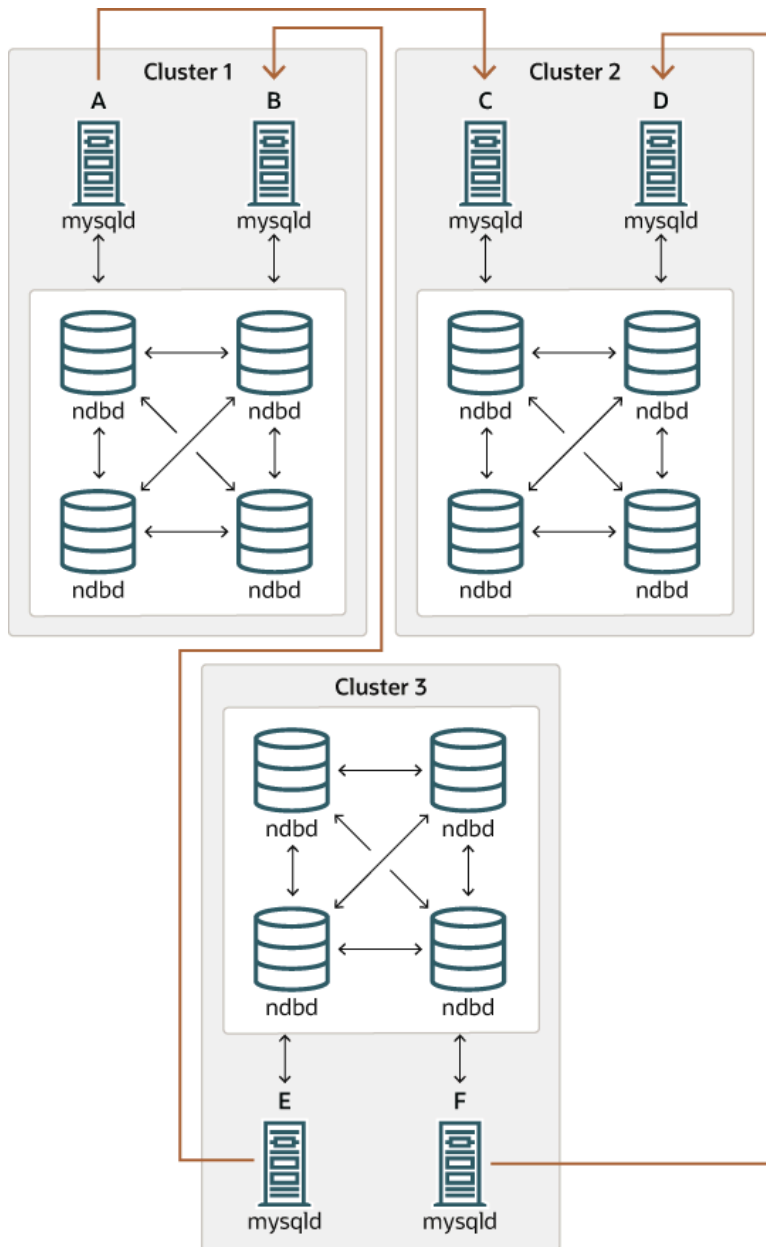

In this case, different SQL nodes in each cluster are used as replication sources and replicas. You must *not* start any of the SQL nodes with the `log_slave_updates` system variable enabled. This type of circular replication scheme for NDB Cluster, in which the line of replication (again indicated by the curved arrows in the diagram) is discontinuous, should be possible, but it should be noted that it has not yet been thoroughly tested and must therefore still be considered experimental.

Using NDB-native backup and restore to initialize a replica cluster. When setting up circular replication, it is possible to initialize the replica cluster by using the management client `START BACKUP` command on one NDB Cluster to create a backup and then applying this backup on another NDB Cluster using `ndb_restore`. This does not automatically create binary logs on the second NDB Cluster's SQL node acting as the replica; in order to cause the binary logs to be created, you must issue a `SHOW TABLES` statement on that SQL node; this should be done prior to running `START SLAVE`. This is a known issue.

Multi-source failover example. In this section, we discuss failover in a multi-source NDB Cluster replication setup with three NDB Clusters having server IDs 1, 2, and 3. In this scenario, Cluster 1 replicates to Clusters 2 and 3; Cluster 2 also replicates to Cluster 3. This relationship is shown here:

Figure 7.8 NDB Cluster Multi-Master Replication With 3 Sources

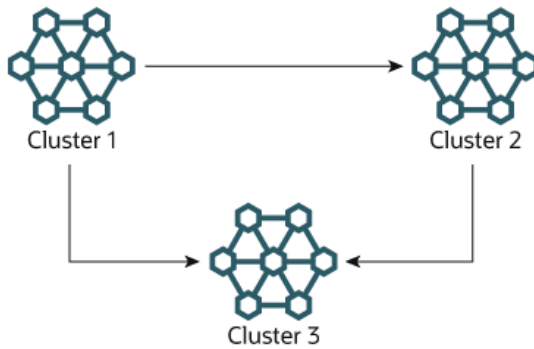

In other words, data replicates from Cluster 1 to Cluster 3 through 2 different routes: directly, and by way of Cluster 2.

Not all MySQL servers taking part in multi-source replication must act as both source and replica, and a given NDB Cluster might use different SQL nodes for different replication channels. Such a case is shown here:

Figure 7.9 NDB Cluster Multi-Source Replication, With MySQL Servers

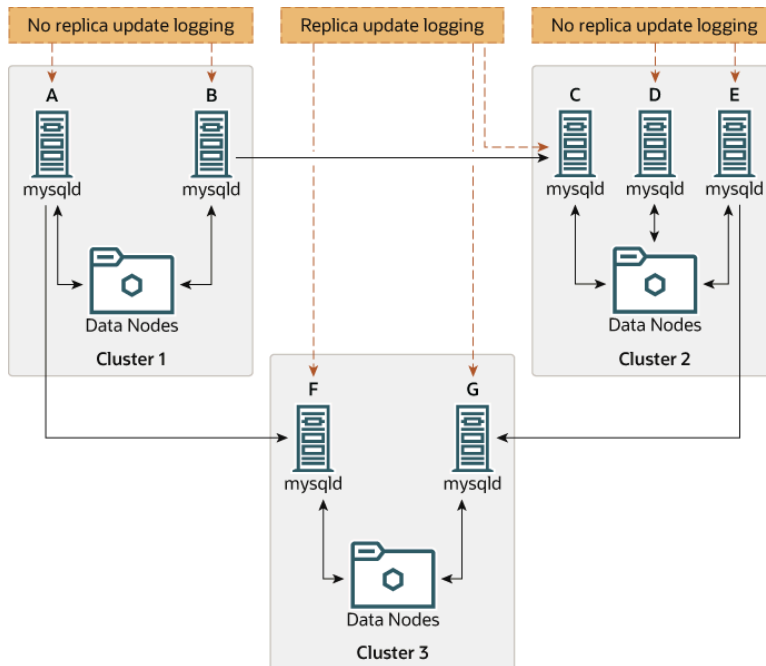

MySQL servers acting as replicas must be run with the `log_slave_updates` system variable enabled. Which `mysqld` processes require this option is also shown in the preceding diagram.

Note

Using the `log_slave_updates` system variable has no effect on servers not being run as replicas.

The need for failover arises when one of the replicating clusters goes down. In this example, we consider the case where Cluster 1 is lost to service, and so Cluster 3 loses 2 sources of updates from Cluster 1. Because replication between NDB Clusters is asynchronous, there is no guarantee that Cluster 3's updates originating directly from Cluster 1 are more recent than those received through Cluster 2. You can handle this by ensuring that Cluster 3 catches up to Cluster 2 with regard to updates from Cluster 1. In terms of MySQL servers, this means that you need to replicate any outstanding updates from MySQL server C to server F.

On server C, perform the following queries:

```
mysqlC> SELECT @latest:=MAX(epoch)
-> FROM mysql.ndb_apply_status
-> WHERE server_id=1;

mysqlC> SELECT
-> @file:=SUBSTRING_INDEX(File, '/', -1),
-> @pos:=Position
-> FROM mysql.ndb_binlog_index
-> WHERE orig_epoch >= @latest
-> AND orig_server_id = 1
-> ORDER BY epoch ASC LIMIT 1;
```

Note

You can improve the performance of this query, and thus likely speed up failover times significantly, by adding the appropriate index to the `ndb_binlog_index` table. See [Section 7.4, “NDB Cluster Replication Schema and Tables”](#), for more information.

Copy over the values for `@file` and `@pos` manually from server C to server F (or have your application perform the equivalent). Then, on server F, execute the following `CHANGE MASTER TO` statement:

```
mysqlF> CHANGE MASTER TO
-> MASTER_HOST = 'serverC'
-> MASTER_LOG_FILE=@file,
-> MASTER_LOG_POS=@pos;
```

Once this has been done, you can issue a `START SLAVE` statement on MySQL server F; this causes any missing updates originating from server B to be replicated to server F.

The `CHANGE MASTER TO` statement also supports an `IGNORE_SERVER_IDS` option which takes a comma-separated list of server IDs and causes events originating from the corresponding servers to be ignored. For more information, see [CHANGE MASTER TO Statement](#), and [SHOW SLAVE STATUS Statement](#). For information about how this option interacts with the `ndb_log_apply_status` variable, see [Section 7.8, “Implementing Failover with NDB Cluster Replication”](#).

7.11 NDB Cluster Replication Conflict Resolution

- [Requirements](#)
- [Source Column Control](#)
- [Conflict Resolution Control](#)
- [Conflict Resolution Functions](#)
- [Conflict Resolution Exceptions Table](#)
- [Conflict Detection Status Variables](#)
- [Examples](#)

When using a replication setup involving multiple sources (including circular replication), it is possible that different sources may try to update the same row on the replica with different data. Conflict resolution in NDB Cluster Replication provides a means of resolving such conflicts by permitting a user-defined resolution column to be used to determine whether or not an update on a given source should be applied on the replica.

Some types of conflict resolution supported by NDB Cluster (`NDB$OLD()`, `NDB$MAX()`, `NDB$MAX_DELETE_WIN()`) implement this user-defined column as a “timestamp” column (although its type

cannot be `TIMESTAMP`, as explained later in this section). These types of conflict resolution are always applied on a row-by-row basis rather than a transactional basis. The epoch-based conflict resolution functions `NDB$EPOCH()` and `NDB$EPOCH_TRANS()` compare the order in which epochs are replicated (and thus these functions are transactional). Different methods can be used to compare resolution column values on the replica when conflicts occur, as explained later in this section; the method used can be set on a per-table basis.

You should also keep in mind that it is the application's responsibility to ensure that the resolution column is correctly populated with relevant values, so that the resolution function can make the appropriate choice when determining whether to apply an update.

Requirements

Preparations for conflict resolution must be made on both the source and the replica. These tasks are described in the following list:

- On the source writing the binary logs, you must determine which columns are sent (all columns or only those that have been updated). This is done for the MySQL Server as a whole by applying the `mysqld` startup option `--ndb-log-updated-only` (described later in this section) or on a per-table basis by entries in the `mysql.ndb_replication` table (see [ndb_replication Table](#)).

Note

If you are replicating tables with very large columns (such as `TEXT` or `BLOB` columns), `--ndb-log-updated-only` can also be useful for reducing the size of the binary logs and avoiding possible replication failures due to exceeding `max_allowed_packet`.

See [Replication and max_allowed_packet](#), for more information about this issue.

- On the replica, you must determine which type of conflict resolution to apply (“latest timestamp wins”, “same timestamp wins”, “primary wins”, “primary wins, complete transaction”, or none). This is done using the `mysql.ndb_replication` system table, on a per-table basis (see [ndb_replication Table](#)).
- NDB Cluster also supports read conflict detection, that is, detecting conflicts between reads of a given row in one cluster and updates or deletes of the same row in another cluster. This requires exclusive read locks obtained by setting `ndb_log_exclusive_reads` equal to 1 on the replica. All rows read by a conflicting read are logged in the exceptions table. For more information, see [Read conflict detection and resolution](#).

When using the functions `NDB$OLD()`, `NDB$MAX()`, and `NDB$MAX_DELETE_WIN()` for timestamp-based conflict resolution, we often refer to the column used for determining updates as a “timestamp” column. However, the data type of this column is never `TIMESTAMP`; instead, its data type should be `INT` (`INTEGER`) or `BIGINT`. The “timestamp” column should also be `UNSIGNED` and `NOT NULL`.

The `NDB$EPOCH()` and `NDB$EPOCH_TRANS()` functions discussed later in this section work by comparing the relative order of replication epochs applied on a primary and secondary NDB Cluster, and do not make use of timestamps.

Source Column Control

We can see update operations in terms of “before” and “after” images—that is, the states of the table before and after the update is applied. Normally, when updating a table with a primary key, the “before” image is not of great interest; however, when we need to determine on a per-update basis whether or not to use the updated values on a replica, we need to make sure that both images are written to the source's binary log. This is done with the `--ndb-log-update-as-write` option for `mysqld`, as described later in this section.

Important

Whether logging of complete rows or of updated columns only is done is decided when the MySQL server is started, and cannot be changed online; you must either restart `mysqld`, or start a new `mysqld` instance with different logging options.

Logging Full or Partial Rows. For purposes of conflict resolution, there are two basic methods of logging rows, as determined by the setting of the `--ndb-log-updated-only` option for `mysqld`:

- Log complete rows (option set to `ON`)
- Log only column data that has been updated—that is, column data whose value has been set, regardless of whether or not this value was actually changed. This is the default behavior (option set to `OFF`).

It is usually sufficient—and more efficient—to log updated columns only; however, if you need to log full rows, you can do so by setting `--ndb-log-updated-only` to `0` or `OFF`.

Logging Changed Data as Updates. The setting of the MySQL Server's `--ndb-log-update-as-write` option determines whether logging is performed with or without the “before” image. Because conflict resolution is done in the MySQL Server's update handler, it is necessary to control logging performed by the replication source such that updates are updates and not writes; that is, such that updates are treated as changes in existing rows rather than the writing of new rows, even though these replace existing rows. This option is turned on by default; in other words, updates are treated as writes. That is, updates are by default written as `write_row` events in the binary log, rather than as `update_row` events.

To disable the option, start the source `mysqld` with `--ndb-log-update-as-write=0` or `--ndb-log-update-as-write=OFF`. You must do this when replicating from NDB tables to tables using a different storage engine; see [Replication from NDB to other storage engines](#), and [Replication from NDB to a nontransactional storage engine](#), for more information.

Conflict Resolution Control

Conflict resolution is usually enabled on the server where conflicts can occur. Like logging method selection, it is enabled by entries in the `mysql.ndb_replication` table.

`NBT_UPDATED_ONLY_MINIMAL` and `NBT_UPDATED_FULL_MINIMAL` can be used with `NDB$EPOCH()`, `NDB$EPOCH2()`, and `NDB$EPOCH_TRANS()`, because these do not require “before” values of columns which are not primary keys. Conflict resolution algorithms requiring the old values, such as `NDB$MAX()` and `NDB$OLD()`, do not work correctly with these `binlog_type` values.

Conflict Resolution Functions

The next few paragraphs provide detailed information about the functions which can be used for conflict detection and resolution with NDB Replication.

NDB\$OLD(column_name). If the value of `column_name` is the same on both the source and the replica, then the update is applied; otherwise, the update is not applied on the replica and an exception is written to the log. This is illustrated by the following pseudocode:

```
if (source_old_column_value == replica_current_column_value)
    apply_update();
else
    log_exception();
```

This function can be used for “same value wins” conflict resolution. This type of conflict resolution ensures that updates are not applied on the replica from the wrong source.

Important

The column value from the source's “before” image is used by this function.

NDB\$MAX(column_name). If the “timestamp” column value for a given row coming from the source is higher than that on the replica, it is applied; otherwise it is not applied on the replica. This is illustrated by the following pseudocode:

```
if (source_new_column_value > replica_current_column_value)
    apply_update();
```

This function can be used for “greatest timestamp wins” conflict resolution. This type of conflict resolution ensures that, in the event of a conflict, the version of the row that was most recently updated is the version that persists.

Important

The column value from the sources's “after” image is used by this function.

NDB\$MAX_DELETE_WIN(). This is a variation on `NDB$MAX()`. Due to the fact that no timestamp is available for a delete operation, a delete using `NDB$MAX()` is in fact processed as `NDB$OLD`, but for some use cases, this is not optimal. For `NDB$MAX_DELETE_WIN()`, if the “timestamp” column value for a given row adding or updating an existing row coming from the source is higher than that on the replica, it is applied. However, delete operations are treated as always having the higher value. This is illustrated by the following pseudocode:

```
if ( (source_new_column_value > replica_current_column_value)
    ||
    operation.type == "delete")
    apply_update();
```

This function can be used for “greatest timestamp, delete wins” conflict resolution. This type of conflict resolution ensures that, in the event of a conflict, the version of the row that was deleted or (otherwise) most recently updated is the version that persists.

Note

As with `NDB$MAX()`, the column value from the source's “after” image is the value used by this function.

NDB\$EPOCH(). The `NDB$EPOCH()` function tracks the order in which replicated epochs are applied on a replica cluster relative to changes originating on the replica. This relative ordering is used to determine whether changes originating on the replica are concurrent with any changes that originate locally, and are therefore potentially in conflict.

Most of what follows in the description of `NDB$EPOCH()` also applies to `NDB$EPOCH_TRANS()`. Any exceptions are noted in the text.

`NDB$EPOCH()` is asymmetric, operating on one NDB Cluster in a bidirectional replication configuration (sometimes referred to as “active-active” replication). We refer here to cluster on which it operates as the primary, and the other as the secondary. The replica on the primary is responsible for detecting and handling conflicts, while the replica on the secondary is not involved in any conflict detection or handling.

When the replica on the primary detects conflicts, it injects events into its own binary log to compensate for these; this ensures that the secondary NDB Cluster eventually realigns itself with the primary and so keeps the primary and secondary from diverging. This compensation and realignment mechanism requires that the primary NDB Cluster always wins any conflicts with the secondary—that is, that the primary's changes are always used rather than those from the secondary in event of a conflict. This “primary always wins” rule has the following implications:

- Operations that change data, once committed on the primary, are fully persistent and are not undone or rolled back by conflict detection and resolution.

- Data read from the primary is fully consistent. Any changes committed on the Primary (locally or from the replica) are not reverted later.
- Operations that change data on the secondary may later be reverted if the primary determines that they are in conflict.
- Individual rows read on the secondary are self-consistent at all times, each row always reflecting either a state committed by the secondary, or one committed by the primary.
- Sets of rows read on the secondary may not necessarily be consistent at a given single point in time. For `NDB$EPOCH_TRANS()`, this is a transient state; for `NDB$EPOCH()`, it can be a persistent state.
- Assuming a period of sufficient length without any conflicts, all data on the secondary NDB Cluster (eventually) becomes consistent with the primary's data.

`NDB$EPOCH()` and `NDB$EPOCH_TRANS()` do not require any user schema modifications, or application changes to provide conflict detection. However, careful thought must be given to the schema used, and the access patterns used, to verify that the complete system behaves within specified limits.

Each of the `NDB$EPOCH()` and `NDB$EPOCH_TRANS()` functions can take an optional parameter; this is the number of bits to use to represent the lower 32 bits of the epoch, and should be set to no less than the value calculated as shown here:

```
CEIL( LOG2( TimeBetweenGlobalCheckpoints / TimeBetweenEpochs ), 1)
```

For the default values of these configuration parameters (2000 and 100 milliseconds, respectively), this gives a value of 5 bits, so the default value (6) should be sufficient, unless other values are used for `TimeBetweenGlobalCheckpoints`, `TimeBetweenEpochs`, or both. A value that is too small can result in false positives, while one that is too large could lead to excessive wasted space in the database.

Both `NDB$EPOCH()` and `NDB$EPOCH_TRANS()` insert entries for conflicting rows into the relevant exceptions tables, provided that these tables have been defined according to the same exceptions table schema rules as described elsewhere in this section (see `NDB$OLD(column_name)`). You must create any exceptions table before creating the data table with which it is to be used.

As with the other conflict detection functions discussed in this section, `NDB$EPOCH()` and `NDB$EPOCH_TRANS()` are activated by including relevant entries in the `mysql.ndb_replication` table (see `ndb_replication Table`). The roles of the primary and secondary NDB Clusters in this scenario are fully determined by `mysql.ndb_replication` table entries.

Because the conflict detection algorithms employed by `NDB$EPOCH()` and `NDB$EPOCH_TRANS()` are asymmetric, you must use different values for the `server_id` entries of the primary and secondary replicas.

A conflict between `DELETE` operations alone is not sufficient to trigger a conflict using `NDB$EPOCH()` or `NDB$EPOCH_TRANS()`, and the relative placement within epochs does not matter. (Bug #18459944)

For more information, see [Limitations on NDB\\$EPOCH\(\)](#).

NDB\$EPOCH_TRANS(). `NDB$EPOCH_TRANS()` extends the `NDB$EPOCH()` function. Conflicts are detected and handled in the same way using the “primary wins all” rule (see `NDB$EPOCH()`) but with the extra condition that any other rows updated in the same transaction in which the conflict occurred are also regarded as being in conflict. In other words, where `NDB$EPOCH()` realigns individual conflicting rows on the secondary, `NDB$EPOCH_TRANS()` realigns conflicting transactions.

In addition, any transactions which are detectably dependent on a conflicting transaction are also regarded as being in conflict, these dependencies being determined by the contents of the secondary cluster's binary log. Since the binary log contains only data modification operations (inserts, updates, and deletes), only overlapping data modifications are used to determine dependencies between transactions.

`NDB$EPOCH_TRANS()` is subject to the same conditions and limitations as `NDB$EPOCH()`, and in addition requires that Version 2 binary log row events are used (`log_bin_use_v1_row_events` equal to 0), which adds a storage overhead of 2 bytes per event in the binary log. In addition, all transaction IDs must be recorded in the secondary's binary log (`--ndb-log-transaction-id` option), which adds a further variable overhead (up to 13 bytes per row).

See `NDB$EPOCH()`.

NDB\$EPOCH2(). The `NDB$EPOCH2()` function is similar to `NDB$EPOCH()`, except that `NDB$EPOCH2()` provides for delete-delete handling with a bidirectional replication topology. In this scenario, primary and secondary roles are assigned to the two sources by setting the `ndb_slave_conflict_role` system variable to the appropriate value on each source (usually one each of `PRIMARY`, `SECONDARY`). When this is done, modifications made by the secondary are reflected by the primary back to the secondary which then conditionally applies them.

NDB\$EPOCH2_TRANS(). `NDB$EPOCH2_TRANS()` extends the `NDB$EPOCH2()` function. Conflicts are detected and handled in the same way, and assigning primary and secondary roles to the replicating clusters, but with the extra condition that any other rows updated in the same transaction in which the conflict occurred are also regarded as being in conflict. That is, `NDB$EPOCH2()` realigns individual conflicting rows on the secondary, while `NDB$EPOCH_TRANS()` realigns conflicting transactions.

Where `NDB$EPOCH()` and `NDB$EPOCH_TRANS()` use metadata that is specified per row, per last modified epoch, to determine on the primary whether an incoming replicated row change from the secondary is concurrent with a locally committed change; concurrent changes are regarded as conflicting, with subsequent exceptions table updates and realignment of the secondary. A problem arises when a row is deleted on the primary so there is no longer any last-modified epoch available to determine whether any replicated operations conflict, which means that conflicting delete operations are not detected. This can result in divergence, an example being a delete on one cluster which is concurrent with a delete and insert on the other; this why delete operations can be routed to only one cluster when using `NDB$EPOCH()` and `NDB$EPOCH_TRANS()`.

`NDB$EPOCH2()` bypasses the issue just described—storing information about deleted rows on the `PRIMARY`—by ignoring any delete-delete conflict, and by avoiding any potential resultant divergence as well. This is accomplished by reflecting any operation successfully applied on and replicated from the secondary back to the secondary. On its return to the secondary, it can be used to reapply an operation on the secondary which was deleted by an operation originating from the primary.

When using `NDB$EPOCH2()`, you should keep in mind that the secondary applies the delete from the primary, removing the new row until it is restored by a reflected operation. In theory, the subsequent insert or update on the secondary conflicts with the delete from the primary, but in this case, we choose to ignore this and allow the secondary to “win”, in the interest of preventing divergence between the clusters. In other words, after a delete, the primary does not detect conflicts, and instead adopts the secondary's following changes immediately. Because of this, the secondary's state can revisit multiple previous committed states as it progresses to a final (stable) state, and some of these may be visible.

You should also be aware that reflecting all operations from the secondary back to the primary increases the size of the primary's logbinary log, as well as demands on bandwidth, CPU usage, and disk I/O.

Application of reflected operations on the secondary depends on the state of the target row on the secondary. Whether or not reflected changes are applied on the secondary can be tracked by checking the `Ndb_conflict_reflected_op_prepare_count` and `Ndb_conflict_reflected_op_discard_count` status variables. The number of changes applied is simply the difference between these two values (note that `Ndb_conflict_reflected_op_prepare_count` is always greater than or equal to `Ndb_conflict_reflected_op_discard_count`).

Events are applied if and only if both of the following conditions are true:

- The existence of the row—that is, whether or not it exists—is in accordance with the type of event. For delete and update operations, the row must already exist. For insert operations, the row must *not* exist.
- The row was last modified by the primary. It is possible that the modification was accomplished through the execution of a reflected operation.

If both of these conditions are not met, the reflected operation is discarded by the secondary.

Limitations on NDB\$EPOCH(). The following limitations currently apply when using `NDB$EPOCH()` to perform conflict detection:

- Conflicts are detected using NDB Cluster epoch boundaries, with granularity proportional to `TimeBetweenEpochs` (default: 100 milliseconds). The minimum conflict window is the minimum time during which concurrent updates to the same data on both clusters always report a conflict. This is always a nonzero length of time, and is roughly proportional to $2 * (\text{latency} + \text{queueing} + \text{TimeBetweenEpochs})$. This implies that—assuming the default for `TimeBetweenEpochs` and ignoring any latency between clusters (as well as any queuing delays)—the minimum conflict window size is approximately 200 milliseconds. This minimum window should be considered when looking at expected application “race” patterns.
- Additional storage is required for tables using the `NDB$EPOCH()` and `NDB$EPOCH_TRANS()` functions; from 1 to 32 bits extra space per row is required, depending on the value passed to the function.
- Conflicts between delete operations may result in divergence between the primary and secondary. When a row is deleted on both clusters concurrently, the conflict can be detected, but is not recorded, since the row is deleted. This means that further conflicts during the propagation of any subsequent realignment operations are not detected, which can lead to divergence.

Deletes should be externally serialized, or routed to one cluster only. Alternatively, a separate row should be updated transactionally with such deletes and any inserts that follow them, so that conflicts can be tracked across row deletes. This may require changes in applications.

- Only two NDB Clusters in a bidirectional “active-active” configuration are currently supported when using `NDB$EPOCH()` or `NDB$EPOCH_TRANS()` for conflict detection.
- Tables having `BLOB` or `TEXT` columns are not currently supported with `NDB$EPOCH()` or `NDB$EPOCH_TRANS()`.

Conflict Resolution Exceptions Table

To use the `NDB$OLD()` conflict resolution function, it is also necessary to create an exceptions table corresponding to each NDB table for which this type of conflict resolution is to be employed. This is also true when using `NDB$EPOCH()` or `NDB$EPOCH_TRANS()`. The name of this table is that of the table for which conflict resolution is to be applied, with the string `$EX` appended. (For example, if the name of the original table is `mytable`, the name of the corresponding exceptions table name should be `mytable$EX`.) The syntax for creating the exceptions table is as shown here:

```
CREATE TABLE original_table$EX (
  [NDB$]server_id INT UNSIGNED,
  [NDB$]source_server_id INT UNSIGNED,
  [NDB$]source_epoch BIGINT UNSIGNED,
  [NDB$]count INT UNSIGNED,

  [NDB$OP_TYPE ENUM('WRITE_ROW', 'UPDATE_ROW', 'DELETE_ROW',
    'REFRESH_ROW', 'READ_ROW') NOT NULL,]
  [NDB$CAUSE ENUM('ROW_DOES_NOT_EXIST', 'ROW_ALREADY_EXISTS',
    'DATA_IN_CONFLICT', 'TRANS_IN_CONFLICT') NOT NULL,]
  [NDB$ORIG_TRANSID BIGINT UNSIGNED NOT NULL,]

  original_table_pk_columns,
```

```
[orig_table_column|orig_table_column$OLD|orig_table_column$NEW,]
[additional_columns,]
PRIMARY KEY([NDB$]server_id, [NDB$]source_server_id, [NDB$]source_epoch, [NDB$]count)
) ENGINE=NDB;
```

The first four columns are required. The names of the first four columns and the columns matching the original table's primary key columns are not critical; however, we suggest for reasons of clarity and consistency, that you use the names shown here for the `server_id`, `source_server_id`, `source_epoch`, and `count` columns, and that you use the same names as in the original table for the columns matching those in the original table's primary key.

If the exceptions table uses one or more of the optional columns `NDB$OP_TYPE`, `NDB$CFT_CAUSE`, or `NDB$ORIG_TRANSID` discussed later in this section, then each of the required columns must also be named using the prefix `NDB$`. If desired, you can use the `NDB$` prefix to name the required columns even if you do not define any optional columns, but in this case, all four of the required columns must be named using the prefix.

Following these columns, the columns making up the original table's primary key should be copied in the order in which they are used to define the primary key of the original table. The data types for the columns duplicating the primary key columns of the original table should be the same as (or larger than) those of the original columns. A subset of the primary key columns may be used.

The exceptions table must use the `NDB` storage engine. (An example that uses `NDB$OLD()` with an exceptions table is shown later in this section.)

Additional columns may optionally be defined following the copied primary key columns, but not before any of them; any such extra columns cannot be `NOT NULL`. `NDB` Cluster supports three additional, predefined optional columns `NDB$OP_TYPE`, `NDB$CFT_CAUSE`, and `NDB$ORIG_TRANSID`, which are described in the next few paragraphs.

`NDB$OP_TYPE`: This column can be used to obtain the type of operation causing the conflict. If you use this column, define it as shown here:

```
NDB$OP_TYPE ENUM('WRITE_ROW', 'UPDATE_ROW', 'DELETE_ROW',
'REFRESH_ROW', 'READ_ROW') NOT NULL
```

The `WRITE_ROW`, `UPDATE_ROW`, and `DELETE_ROW` operation types represent user-initiated operations. `REFRESH_ROW` operations are operations generated by conflict resolution in compensating transactions sent back to the originating cluster from the cluster that detected the conflict. `READ_ROW` operations are user-initiated read tracking operations defined with exclusive row locks.

`NDB$CFT_CAUSE`: You can define an optional column `NDB$CFT_CAUSE` which provides the cause of the registered conflict. This column, if used, is defined as shown here:

```
NDB$CFT_CAUSE ENUM('ROW_DOES_NOT_EXIST', 'ROW_ALREADY_EXISTS',
'DATA_IN_CONFLICT', 'TRANS_IN_CONFLICT') NOT NULL
```

`ROW_DOES_NOT_EXIST` can be reported as the cause for `UPDATE_ROW` and `WRITE_ROW` operations; `ROW_ALREADY_EXISTS` can be reported for `WRITE_ROW` events. `DATA_IN_CONFLICT` is reported when a row-based conflict function detects a conflict; `TRANS_IN_CONFLICT` is reported when a transactional conflict function rejects all of the operations belonging to a complete transaction.

`NDB$ORIG_TRANSID`: The `NDB$ORIG_TRANSID` column, if used, contains the ID of the originating transaction. This column should be defined as follows:

```
NDB$ORIG_TRANSID BIGINT UNSIGNED NOT NULL
```

`NDB$ORIG_TRANSID` is a 64-bit value generated by `NDB`. This value can be used to correlate multiple exceptions table entries belonging to the same conflicting transaction from the same or different exceptions tables.

Additional reference columns which are not part of the original table's primary key can be named `colname$OLD` or `colname$NEW`. `colname$OLD` references old values in update and delete operations—that is, operations containing `DELETE_ROW` events. `colname$NEW` can be used to reference new values in insert and update operations—in other words, operations using `WRITE_ROW` events, `UPDATE_ROW` events, or both types of events. Where a conflicting operation does not supply a value for a given reference column that is not a primary key, the exceptions table row contains either `NULL`, or a defined default value for that column.

Important

The `mysql.ndb_replication` table is read when a data table is set up for replication, so the row corresponding to a table to be replicated must be inserted into `mysql.ndb_replication` before the table to be replicated is created.

Conflict Detection Status Variables

Several status variables can be used to monitor conflict detection. You can see how many rows have been found in conflict by `NDB$EPOCH()` since this replica was last restarted from the current value of the `Ndb_conflict_fn_epoch` system status variable.

`Ndb_conflict_fn_epoch_trans` provides the number of rows that have been found directly in conflict by `NDB$EPOCH_TRANS()`. `Ndb_conflict_fn_epoch2` and `Ndb_conflict_fn_epoch2_trans` show the number of rows found in conflict by `NDB$EPOCH2()` and `NDB$EPOCH2_TRANS()`, respectively. The number of rows actually realigned, including those affected due to their membership in or dependency on the same transactions as other conflicting rows, is given by `Ndb_conflict_trans_row_reject_count`.

Another server status variable `Ndb_conflict_fn_max` provides a count of the number of times that a row was not applied on the current SQL node due to “greatest timestamp wins” conflict resolution since the last time that `mysqld` was started.

The number of times that a row was not applied as the result of “same timestamp wins” conflict resolution on a given `mysqld` since the last time it was restarted is given by the global status variable `Ndb_conflict_fn_old`. In addition to incrementing `Ndb_conflict_fn_old`, the primary key of the row that was not used is inserted into an *exceptions table*, as explained elsewhere in this section.

See also [Section 4.3.9.3, “NDB Cluster Status Variables”](#).

Examples

The following examples assume that you have already a working NDB Cluster replication setup, as described in [Section 7.5, “Preparing the NDB Cluster for Replication”](#), and [Section 7.6, “Starting NDB Cluster Replication \(Single Replication Channel\)”](#).

NDB\$MAX() example. Suppose you wish to enable “greatest timestamp wins” conflict resolution on table `test.t1`, using column `mycol` as the “timestamp”. This can be done using the following steps:

1. Make sure that you have started the source `mysqld` with `--ndb-log-update-as-write=OFF`.
2. On the source, perform this `INSERT` statement:

```
INSERT INTO mysql.ndb_replication
VALUES ('test', 't1', 0, NULL, 'NDB$MAX(mycol)');
```

Inserting a 0 into the `server_id` indicates that all SQL nodes accessing this table should use conflict resolution. If you want to use conflict resolution on a specific `mysqld` only, use the actual server ID.

Inserting `NULL` into the `binlog_type` column has the same effect as inserting 0 (`NBT_DEFAULT`); the server default is used.

3. Create the `test.t1` table:

```
CREATE TABLE test.t1 (
  columns
  mycol INT UNSIGNED,
  columns
) ENGINE=NDB;
```

Now, when updates are performed on this table, conflict resolution is applied, and the version of the row having the greatest value for `mycol` is written to the replica.

Note

Other `binlog_type` options—such as `NBT_UPDATED_ONLY_USE_UPDATE`—should be used to control logging on the source using the `ndb_replication` table rather than by using command-line options.

NDB\$OLD() example. Suppose an `NDB` table such as the one defined here is being replicated, and you wish to enable “same timestamp wins” conflict resolution for updates to this table:

```
CREATE TABLE test.t2 (
  a INT UNSIGNED NOT NULL,
  b CHAR(25) NOT NULL,
  columns,
  mycol INT UNSIGNED NOT NULL,
  columns,
  PRIMARY KEY pk (a, b)
) ENGINE=NDB;
```

The following steps are required, in the order shown:

1. First—and *prior* to creating `test.t2`—you must insert a row into the `mysql.ndb_replication` table, as shown here:

```
INSERT INTO mysql.ndb_replication
VALUES ('test', 't2', 0, NULL, 'NDB$OLD(mycol)');
```

Possible values for the `binlog_type` column are shown earlier in this section. The value `'NDB$OLD(mycol)'` should be inserted into the `conflict_fn` column.

2. Create an appropriate exceptions table for `test.t2`. The table creation statement shown here includes all required columns; any additional columns must be declared following these columns, and before the definition of the table's primary key.

```
CREATE TABLE test.t2$EX (
  server_id INT UNSIGNED,
  source_server_id INT UNSIGNED,
  source_epoch BIGINT UNSIGNED,
  count INT UNSIGNED,
  a INT UNSIGNED NOT NULL,
  b CHAR(25) NOT NULL,

  [additional_columns,]

  PRIMARY KEY(server_id, source_server_id, source_epoch, count)
) ENGINE=NDB;
```

We can include additional columns for information about the type, cause, and originating transaction ID for a given conflict. We are also not required to supply matching columns for all primary key columns in the original table. This means you can create the exceptions table like this:

```
CREATE TABLE test.t2$EX (
  NDB$server_id INT UNSIGNED,
  NDB$source_server_id INT UNSIGNED,
  NDB$source_epoch BIGINT UNSIGNED,
  NDB$count INT UNSIGNED,
  a INT UNSIGNED NOT NULL,
```

```

NDB$OP_TYPE ENUM('WRITE_ROW', 'UPDATE_ROW', 'DELETE_ROW',
  'REFRESH_ROW', 'READ_ROW') NOT NULL,
NDB$CFT_CAUSE ENUM('ROW_DOES_NOT_EXIST', 'ROW_ALREADY_EXISTS',
  'DATA_IN_CONFLICT', 'TRANS_IN_CONFLICT') NOT NULL,
NDB$ORIG_TRANSID BIGINT UNSIGNED NOT NULL,

[additional_columns,]

PRIMARY KEY(NDB$server_id, NDB$source_server_id, NDB$source_epoch, NDB$count)
) ENGINE=NDB;

```

Note

The `NDB$` prefix is required for the four required columns since we included at least one of the columns `NDB$OP_TYPE`, `NDB$CFT_CAUSE`, or `NDB$ORIG_TRANSID` in the table definition.

3. Create the table `test.t2` as shown previously.

These steps must be followed for every table for which you wish to perform conflict resolution using `NDB$OLD()`. For each such table, there must be a corresponding row in `mysql.ndb_replication`, and there must be an exceptions table in the same database as the table being replicated.

Read conflict detection and resolution. NDB Cluster also supports tracking of read operations, which makes it possible in circular replication setups to manage conflicts between reads of a given row in one cluster and updates or deletes of the same row in another. This example uses `employee` and `department` tables to model a scenario in which an employee is moved from one department to another on the source cluster (which we refer to hereafter as cluster *A*) while the replica cluster (hereafter *B*) updates the employee count of the employee's former department in an interleaved transaction.

The data tables have been created using the following SQL statements:

```

# Employee table
CREATE TABLE employee (
  id INT PRIMARY KEY,
  name VARCHAR(2000),
  dept INT NOT NULL
) ENGINE=NDB;

# Department table
CREATE TABLE department (
  id INT PRIMARY KEY,
  name VARCHAR(2000),
  members INT
) ENGINE=NDB;

```

The contents of the two tables include the rows shown in the (partial) output of the following `SELECT` statements:

```

mysql> SELECT id, name, dept FROM employee;
+-----+-----+-----+
| id   | name  | dept |
+-----+-----+-----+
...
| 998  | Mike  | 3    |
| 999  | Joe   | 3    |
| 1000 | Mary  | 3    |
...
+-----+-----+-----+

mysql> SELECT id, name, members FROM department;
+-----+-----+-----+
| id   | name          | members |
+-----+-----+-----+
...
| 3    | Old project  | 24      |

```

```
...
+-----+-----+-----+

```

We assume that we are already using an exceptions table that includes the four required columns (and these are used for this table's primary key), the optional columns for operation type and cause, and the original table's primary key column, created using the SQL statement shown here:

```
CREATE TABLE employee$EX (
  NDB$server_id INT UNSIGNED,
  NDB$source_server_id INT UNSIGNED,
  NDB$source_epoch BIGINT UNSIGNED,
  NDB$count INT UNSIGNED,

  NDB$OP_TYPE ENUM( 'WRITE_ROW', 'UPDATE_ROW', 'DELETE_ROW',
                   'REFRESH_ROW', 'READ_ROW' ) NOT NULL,
  NDB$CFT_CAUSE ENUM( 'ROW_DOES_NOT_EXIST',
                    'ROW_ALREADY_EXISTS',
                    'DATA_IN_CONFLICT',
                    'TRANS_IN_CONFLICT' ) NOT NULL,

  id INT NOT NULL,

  PRIMARY KEY(NDB$server_id, NDB$source_server_id, NDB$source_epoch, NDB$count)
) ENGINE=NDB;
```

Suppose there occur the two simultaneous transactions on the two clusters. On cluster *A*, we create a new department, then move employee number 999 into that department, using the following SQL statements:

```
BEGIN;
  INSERT INTO department VALUES (4, "New project", 1);
  UPDATE employee SET dept = 4 WHERE id = 999;
COMMIT;
```

At the same time, on cluster *B*, another transaction reads from `employee`, as shown here:

```
BEGIN;
  SELECT name FROM employee WHERE id = 999;
  UPDATE department SET members = members - 1 WHERE id = 3;
commit;
```

The conflicting transactions are not normally detected by the conflict resolution mechanism, since the conflict is between a read (`SELECT`) and an update operation. You can circumvent this issue by executing `SET ndb_log_exclusive_reads = 1` on the replica cluster. Acquiring exclusive read locks in this way causes any rows read on the source to be flagged as needing conflict resolution on the replica cluster. If we enable exclusive reads in this way prior to the logging of these transactions, the read on cluster *B* is tracked and sent to cluster *A* for resolution; the conflict on the employee row is subsequently detected and the transaction on cluster *B* is aborted.

The conflict is registered in the exceptions table (on cluster *A*) as a `READ_ROW` operation (see [Conflict Resolution Exceptions Table](#), for a description of operation types), as shown here:

```
mysql> SELECT id, NDB$OP_TYPE, NDB$CFT_CAUSE FROM employee$EX;
+-----+-----+-----+
| id    | NDB$OP_TYPE | NDB$CFT_CAUSE |
+-----+-----+-----+
...
| 999   | READ_ROW    | TRANS_IN_CONFLICT |
+-----+-----+-----+
```

Any existing rows found in the read operation are flagged. This means that multiple rows resulting from the same conflict may be logged in the exception table, as shown by examining the effects a conflict between an update on cluster *A* and a read of multiple rows on cluster *B* from the same table in simultaneous transactions. The transaction executed on cluster *A* is shown here:

```
BEGIN;
```

```
INSERT INTO department VALUES (4, "New project", 0);
UPDATE employee SET dept = 4 WHERE dept = 3;
SELECT COUNT(*) INTO @count FROM employee WHERE dept = 4;
UPDATE department SET members = @count WHERE id = 4;
COMMIT;
```

Concurrently a transaction containing the statements shown here runs on cluster *B*:

```
SET ndb_log_exclusive_reads = 1; # Must be set if not already enabled
...
BEGIN;
  SELECT COUNT(*) INTO @count FROM employee WHERE dept = 3 FOR UPDATE;
  UPDATE department SET members = @count WHERE id = 3;
COMMIT;
```

In this case, all three rows matching the `WHERE` condition in the second transaction's `SELECT` are read, and are thus flagged in the exceptions table, as shown here:

```
mysql> SELECT id, NDB$OP_TYPE, NDB$CFT_CAUSE FROM employee$EX;
+-----+-----+-----+
| id    | NDB$OP_TYPE | NDB$CFT_CAUSE |
+-----+-----+-----+
...
| 998   | READ_ROW    | TRANS_IN_CONFLICT |
| 999   | READ_ROW    | TRANS_IN_CONFLICT |
| 1000  | READ_ROW    | TRANS_IN_CONFLICT |
...
+-----+-----+-----+
```

Read tracking is performed on the basis of existing rows only. A read based on a given condition track conflicts only of any rows that are *found* and not of any rows that are inserted in an interleaved transaction. This is similar to how exclusive row locking is performed in a single instance of NDB Cluster.

Appendix A NDB Cluster FAQ

In the following section, we answer questions that are frequently asked about NDB Cluster and the [NDB](#) storage engine.

Questions

- [A.1](#): Which versions of the MySQL software support NDB Cluster? Do I have to compile from source?
- [A.2](#): What do “NDB” and “NDBCLUSTER” mean?
- [A.3](#): What is the difference between using NDB Cluster versus using MySQL Replication?
- [A.4](#): Do I need any special networking to run NDB Cluster? How do computers in a cluster communicate?
- [A.5](#): How many computers do I need to run an NDB Cluster, and why?
- [A.6](#): What do the different computers do in an NDB Cluster?
- [A.7](#): When I run the [SHOW](#) command in the NDB Cluster management client, I see a line of output that looks like this:

```
id=2 @10.100.10.32 (Version: 8.0.28-ndb-8.0.28 Nodegroup: 0, *)
```

What does the `*` mean? How is this node different from the others?

- [A.8](#): With which operating systems can I use NDB Cluster?
- [A.9](#): What are the hardware requirements for running NDB Cluster?
- [A.10](#): How much RAM do I need to use NDB Cluster? Is it possible to use disk memory at all?
- [A.11](#): What file systems can I use with NDB Cluster? What about network file systems or network shares?
- [A.12](#): Can I run NDB Cluster nodes inside virtual machines (such as those created by VMWare, VirtualBox, Parallels, or Xen)?
- [A.13](#): I am trying to populate an NDB Cluster database. The loading process terminates prematurely and I get an error message like this one: `ERROR 1114: The table 'my_cluster_table' is full` Why is this happening?
- [A.14](#): NDB Cluster uses TCP/IP. Does this mean that I can run it over the Internet, with one or more nodes in remote locations?
- [A.15](#): Do I have to learn a new programming or query language to use NDB Cluster?
- [A.16](#): What programming languages and APIs are supported by NDB Cluster?
- [A.17](#): Does NDB Cluster include any management tools?
- [A.18](#): How do I find out what an error or warning message means when using NDB Cluster?
- [A.19](#): Is NDB Cluster transaction-safe? What isolation levels are supported?
- [A.20](#): What storage engines are supported by NDB Cluster?
- [A.21](#): In the event of a catastrophic failure—for example, the whole city loses power *and* my UPS fails—would I lose all my data?
- [A.22](#): Is it possible to use [FULLTEXT](#) indexes with NDB Cluster?

-
- [A.23](#): Can I run multiple nodes on a single computer?
 - [A.24](#): Can I add data nodes to an NDB Cluster without restarting it?
 - [A.25](#): Are there any limitations that I should be aware of when using NDB Cluster?
 - [A.26](#): Does NDB Cluster support foreign keys?
 - [A.27](#): How do I import an existing MySQL database into an NDB Cluster?
 - [A.28](#): How do NDB Cluster nodes communicate with one another?
 - [A.29](#): What is an *arbiter*?
 - [A.30](#): What data types are supported by NDB Cluster?
 - [A.31](#): How do I start and stop NDB Cluster?
 - [A.32](#): What happens to NDB Cluster data when the NDB Cluster is shut down?
 - [A.33](#): Is it a good idea to have more than one management node for an NDB Cluster?
 - [A.34](#): Can I mix different kinds of hardware and operating systems in one NDB Cluster?
 - [A.35](#): Can I run two data nodes on a single host? Two SQL nodes?
 - [A.36](#): Can I use host names with NDB Cluster?
 - [A.37](#): Does NDB Cluster support IPv6?
 - [A.38](#): How do I handle MySQL users in an NDB Cluster having multiple MySQL servers?
 - [A.39](#): How do I continue to send queries in the event that one of the SQL nodes fails?
 - [A.40](#): How do I back up and restore an NDB Cluster?
 - [A.41](#): What is an “angel process”?

Questions and Answers

A.1: Which versions of the MySQL software support NDB Cluster? Do I have to compile from source?

NDB Cluster is not supported in standard MySQL Server 5.7 releases. Instead, MySQL NDB Cluster is provided as a separate product. Available NDB Cluster release series include the following:

- **NDB Cluster 7.2.** This series is no longer supported for new deployments or maintained. Users of NDB Cluster 7.2 should upgrade to a newer release series as soon as possible. We recommend that new deployments use the latest NDB Cluster 8.0 release.
- **NDB Cluster 7.3.** This series is a previous General Availability (GA) version of NDB Cluster, still available for production use, although we recommend that new deployments use the latest NDB Cluster 8.0 release. The most recent NDB Cluster 7.3 release can be obtained from <https://dev.mysql.com/downloads/cluster/>.
- **NDB Cluster 7.4.** This series is a previous General Availability (GA) version of NDB Cluster, still available for production use, although we recommend that new deployments use the latest NDB Cluster 8.0 release. The most recent NDB Cluster 7.4 release can be obtained from <https://dev.mysql.com/downloads/cluster/>.
- **NDB Cluster 7.5.** This series is a previous General Availability (GA) version of NDB Cluster, still available for production use, although we recommend that new deployments use the latest NDB Cluster 7.6 release. The latest NDB Cluster 7.5 releases can be obtained from <https://dev.mysql.com/downloads/cluster/>.

-
- **NDB Cluster 7.6.** This series is a previous General Availability (GA) version of NDB Cluster, still available for production use, although we recommend that new deployments use the latest NDB Cluster 8.0 release. The latest NDB Cluster 7.6 releases can be obtained from <https://dev.mysql.com/downloads/cluster/>.
 - **NDB Cluster 8.0.** This series is the most recent General Availability (GA) version of NDB Cluster, based on version 8.0 of the [NDB](#) storage engine and MySQL Server 8.0. NDB Cluster 8.0 is available for production use; new deployments intended for production should use the latest GA release in this series, which is currently NDB Cluster 8.0.28. You can obtain the most recent NDB Cluster 8.0 release from <https://dev.mysql.com/downloads/cluster/>. For information about new features and other important changes in this series, see [What is New in NDB Cluster](#).

You can obtain and compile NDB Cluster from source (see [Section 3.1.4, “Building NDB Cluster from Source on Linux”](#), and [Section 3.2.2, “Compiling and Installing NDB Cluster from Source on Windows”](#)), but for all but the most specialized cases, we recommend using one of the following installers provided by Oracle that is appropriate to your operating platform and circumstances:

- The web-based [NDB Cluster Auto-Installer](#) (works on all platforms supported by [NDB](#))
- Linux [binary release](#) (`tar.gz` file)
- Linux [RPM package](#)
- Linux [.deb file](#)
- Windows [binary “no-install” release](#)
- Windows [MSI Installer](#)

Installation packages may also be available from your platform's package management system.

You can determine whether your MySQL Server has [NDB](#) support using one of the statements `SHOW VARIABLES LIKE 'have_%'`, `SHOW ENGINES`, or `SHOW PLUGINS`.

A.2: What do “NDB” and “NDBCLUSTER” mean?

“NDB” stands for “**N**etwork **D**atabase”. [NDB](#) and [NDBCLUSTER](#) are both names for the storage engine that enables clustering support with MySQL. [NDB](#) is preferred, but either name is correct.

A.3: What is the difference between using NDB Cluster versus using MySQL Replication?

In traditional MySQL replication, a source MySQL server updates one or more replicas. Transactions are committed sequentially, and a slow transaction can cause the replica to lag behind the source. This means that if the source fails, it is possible that the replica might not have recorded the last few transactions. If a transaction-safe engine such as [InnoDB](#) is being used, a transaction is either completed on the replica or not applied at all, but replication does not guarantee that all data on the source and the replica remains consistent at all times. In NDB Cluster, all data nodes are kept in synchrony, and a transaction committed by any one data node is committed for all data nodes. In the event of a data node failure, all remaining data nodes remain in a consistent state.

In short, whereas standard MySQL replication is *asynchronous*, NDB Cluster is *synchronous*.

Asynchronous replication is also available in NDB Cluster. *NDB Cluster Replication* (also sometimes known as “geo-replication”) includes the capability to replicate both between two NDB Clusters, and from an NDB Cluster to a non-Cluster MySQL server. See [Chapter 7, NDB Cluster Replication](#).

A.4: Do I need any special networking to run NDB Cluster? How do computers in a cluster communicate?

NDB Cluster is intended to be used in a high-bandwidth environment, with computers connecting using TCP/IP. Its performance depends directly upon the connection speed between the cluster's computers. The minimum connectivity requirements for NDB Cluster include a typical 100-megabit Ethernet network or the equivalent. We recommend you use gigabit Ethernet whenever available.

A.5: How many computers do I need to run an NDB Cluster, and why?

A minimum of three computers is required to run a viable cluster. However, the minimum *recommended* number of computers in an NDB Cluster is four: one each to run the management and SQL nodes, and two computers to serve as data nodes. The purpose of the two data nodes is to provide redundancy; the management node must run on a separate machine to guarantee continued arbitration services in the event that one of the data nodes fails.

To provide increased throughput and high availability, you should use multiple SQL nodes (MySQL Servers connected to the cluster). It is also possible (although not strictly necessary) to run multiple management servers.

A.6: What do the different computers do in an NDB Cluster?

An NDB Cluster has both a physical and logical organization, with computers being the physical elements. The logical or functional elements of a cluster are referred to as *nodes*, and a computer housing a cluster node is sometimes referred to as a *cluster host*. There are three types of nodes, each corresponding to a specific role within the cluster. These are:

- **Management node.** This node provides management services for the cluster as a whole, including startup, shutdown, backups, and configuration data for the other nodes. The management node server is implemented as the application `ndb_mgmd`; the management client used to control NDB Cluster is `ndb_mgm`. See [Section 5.4, “ndb_mgmd — The NDB Cluster Management Server Daemon”](#), and [Section 5.5, “ndb_mgm — The NDB Cluster Management Client”](#), for information about these programs.
- **Data node.** This type of node stores and replicates data. Data node functionality is handled by instances of the NDB data node process `ndbd`. For more information, see [Section 5.1, “ndbd — The NDB Cluster Data Node Daemon”](#).
- **SQL node.** This is simply an instance of MySQL Server (`mysqld`) that is built with support for the `NDBCLUSTER` storage engine and started with the `--ndb-cluster` option to enable the engine and the `--ndb-connectstring` option to enable it to connect to an NDB Cluster management server. For more about these options, see [Section 4.3.9.1, “MySQL Server Options for NDB Cluster”](#).

Note

An *API node* is any application that makes direct use of Cluster data nodes for data storage and retrieval. An SQL node can thus be considered a type of API node that uses a MySQL Server to provide an SQL interface to the Cluster. You can write such applications (that do not depend on a MySQL Server) using the NDB API, which supplies a direct, object-oriented transaction and scanning interface to NDB Cluster data; see [NDB Cluster API Overview: The NDB API](#), for more information.

A.7: When I run the `SHOW` command in the NDB Cluster management client, I see a line of output that looks like this:

```
id=2 @10.100.10.32 (Version: 8.0.28-ndb-8.0.28 Nodegroup: 0, *)
```

What does the `*` mean? How is this node different from the others?

The simplest answer is, “It’s not something you can control, and it’s nothing that you need to worry about in any case, unless you’re a software engineer writing or analyzing the NDB Cluster source code”.

If you don’t find that answer satisfactory, here’s a longer and more technical version:

A number of mechanisms in NDB Cluster require distributed coordination among the data nodes. These distributed algorithms and protocols include global checkpointing, DDL (schema) changes, and node restart handling. To make this coordination simpler, the data nodes “elect” one of their number

to act as leader. There is no user-facing mechanism for influencing this selection, which is completely automatic; the fact that it *is* automatic is a key part of NDB Cluster's internal architecture.

When a node acts as the “leader” for any of these mechanisms, it is usually the point of coordination for the activity, and the other nodes act as “followers”, carrying out their parts of the activity as directed by the leader. If the node acting as leader fails, then the remaining nodes elect a new leader. Tasks in progress that were being coordinated by the old leader may either fail or be continued by the new leader, depending on the actual mechanism involved.

It is possible for some of these different mechanisms and protocols to have different leader nodes, but in general the same leader is chosen for all of them. The node indicated as the leader in the output of `SHOW` in the management client is known internally as the `DICT` manager, responsible for coordinating DDL and metadata activity.

NDB Cluster is designed in such a way that the choice of leader has no discernible effect outside the cluster itself. For example, the current leader does not have significantly higher CPU or resource usage than the other data nodes, and failure of the leader should not have a significantly different impact on the cluster than the failure of any other data node.

A.8: With which operating systems can I use NDB Cluster?

NDB Cluster is supported on most Unix-like operating systems. NDB Cluster is also supported in production settings on Microsoft Windows operating systems.

For more detailed information concerning the level of support which is offered for NDB Cluster on various operating system versions, operating system distributions, and hardware platforms, please refer to <https://www.mysql.com/support/supportedplatforms/cluster.html>.

A.9: What are the hardware requirements for running NDB Cluster?

NDB Cluster should run on any platform for which `NDB`-enabled binaries are available. For data nodes and API nodes, faster CPUs and more memory are likely to improve performance, and 64-bit CPUs are likely to be more effective than 32-bit processors. There must be sufficient memory on machines used for data nodes to hold each node's share of the database (see *How much RAM do I Need?* for more information). For a computer which is used only for running the NDB Cluster management server, the requirements are minimal; a common desktop PC (or the equivalent) is generally sufficient for this task. Nodes can communicate through the standard TCP/IP network and hardware. They can also use the high-speed SCI protocol; however, special networking hardware and software are required to use SCI (see [Section 4.4, “Using High-Speed Interconnects with NDB Cluster”](#)).

A.10: How much RAM do I need to use NDB Cluster? Is it possible to use disk memory at all?

NDB Cluster was originally implemented as in-memory only, but all versions currently available also provide the ability to store NDB Cluster on disk. See [Section 6.10, “NDB Cluster Disk Data Tables”](#), for more information.

For in-memory `NDB` tables, you can use the following formula for obtaining a rough estimate of how much RAM is needed for each data node in the cluster:

```
(SizeofDatabase × NumberOfReplicas × 1.1 ) / NumberOfDataNodes
```

To calculate the memory requirements more exactly requires determining, for each table in the cluster database, the storage space required per row (see [Data Type Storage Requirements](#), for details), and multiplying this by the number of rows. You must also remember to account for any column indexes as follows:

- Each primary key or hash index created for an `NDBCLUSTER` table requires 21–25 bytes per record. These indexes use `IndexMemory`.
- Each ordered index requires 10 bytes storage per record, using `DataMemory`.

-
- Creating a primary key or unique index also creates an ordered index, unless this index is created with `USING HASH`. In other words:
 - A primary key or unique index on a Cluster table normally takes up 31 to 35 bytes per record.
 - However, if the primary key or unique index is created with `USING HASH`, then it requires only 21 to 25 bytes per record.

Creating NDB Cluster tables with `USING HASH` for all primary keys and unique indexes generally causes table updates to run more quickly—in some cases by as much as 20 to 30 percent faster than updates on tables where `USING HASH` was not used in creating primary and unique keys. This is due to the fact that less memory is required (because no ordered indexes are created), and that less CPU must be utilized (because fewer indexes must be read and possibly updated). However, it also means that queries that could otherwise use range scans must be satisfied by other means, which can result in slower selects.

When calculating Cluster memory requirements, you may find useful the `ndb_size.pl` utility which is available in recent MySQL 5.7 releases. This Perl script connects to a current (non-Cluster) MySQL database and creates a report on how much space that database would require if it used the `NDBCLUSTER` storage engine. For more information, see [Section 5.29, “ndb_size.pl — NDBCLUSTER Size Requirement Estimator”](#).

It is especially important to keep in mind that *every NDB Cluster table must have a primary key*. The `NDB` storage engine creates a primary key automatically if none is defined; this primary key is created without `USING HASH`.

You can determine how much memory is being used for storage of NDB Cluster data and indexes at any given time using the `REPORT MEMORYUSAGE` command in the `ndb_mgm` client; see [Section 6.1, “Commands in the NDB Cluster Management Client”](#), for more information. In addition, warnings are written to the cluster log when 80% of available `DataMemory` or (prior to NDB 7.6) `IndexMemory` is in use, and again when usage reaches 90%, 99%, and 100%.

A.11: What file systems can I use with NDB Cluster? What about network file systems or network shares?

Generally, any file system that is native to the host operating system should work well with NDB Cluster. If you find that a given file system works particularly well (or not so especially well) with NDB Cluster, we invite you to discuss your findings in the [NDB Cluster Forums](#).

For Windows, we recommend that you use `NTFS` file systems for NDB Cluster, just as we do for standard MySQL. We do not test NDB Cluster with `FAT` or `VFAT` file systems. Because of this, we do not recommend their use with MySQL or NDB Cluster.

NDB Cluster is implemented as a shared-nothing solution; the idea behind this is that the failure of a single piece of hardware should not cause the failure of multiple cluster nodes, or possibly even the failure of the cluster as a whole. For this reason, the use of network shares or network file systems is not supported for NDB Cluster. This also applies to shared storage devices such as SANs.

A.12: Can I run NDB Cluster nodes inside virtual machines (such as those created by VMWare, VirtualBox, Parallels, or Xen)?

NDB Cluster is supported for use in virtual machines. We currently support and test using [Oracle VM](#).

Some NDB Cluster users have successfully deployed NDB Cluster using other virtualization products; in such cases, Oracle can provide NDB Cluster support, but issues specific to the virtual environment must be referred to that product's vendor.

A.13: I am trying to populate an NDB Cluster database. The loading process terminates prematurely and I get an error message like this one: `ERROR 1114: The table 'my_cluster_table' is full` Why is this happening?

The cause is very likely to be that your setup does not provide sufficient RAM for all table data and all indexes, *including the primary key required by the NDB storage engine and automatically created in the event that the table definition does not include the definition of a primary key.*

It is also worth noting that all data nodes should have the same amount of RAM, since no data node in a cluster can use more memory than the least amount available to any individual data node. For example, if there are four computers hosting Cluster data nodes, and three of these have 3GB of RAM available to store Cluster data while the remaining data node has only 1GB RAM, then each data node can devote at most 1GB to NDB Cluster data and indexes.

In some cases it is possible to get `Table is full` errors in MySQL client applications even when `ndb_mgm -e "ALL REPORT MEMORYUSAGE"` shows significant free `DataMemory`. You can force NDB to create extra partitions for NDB Cluster tables and thus have more memory available for hash indexes by using the `MAX_ROWS` option for `CREATE TABLE`. In general, setting `MAX_ROWS` to twice the number of rows that you expect to store in the table should be sufficient.

For similar reasons, you can also sometimes encounter problems with data node restarts on nodes that are heavily loaded with data. The `MinFreePct` parameter can help with this issue by reserving a portion (5% by default) of `DataMemory` and (prior to NDB 7.6) `IndexMemory` for use in restarts. This reserved memory is not available for storing NDB tables or data.

A.14: NDB Cluster uses TCP/IP. Does this mean that I can run it over the Internet, with one or more nodes in remote locations?

It is *very* unlikely that a cluster would perform reliably under such conditions, as NDB Cluster was designed and implemented with the assumption that it would be run under conditions guaranteeing dedicated high-speed connectivity such as that found in a LAN setting using 100 Mbps or gigabit Ethernet—preferably the latter. We neither test nor warrant its performance using anything slower than this.

Also, it is extremely important to keep in mind that communications between the nodes in an NDB Cluster are not secure; they are neither encrypted nor safeguarded by any other protective mechanism. The most secure configuration for a cluster is in a private network behind a firewall, with no direct access to any Cluster data or management nodes from outside. (For SQL nodes, you should take the same precautions as you would with any other instance of the MySQL server.) For more information, see [Section 6.17, “NDB Cluster Security Issues”](#).

A.15: Do I have to learn a new programming or query language to use NDB Cluster?

No. Although some specialized commands are used to manage and configure the cluster itself, only standard (My)SQL statements are required for the following operations:

- Creating, altering, and dropping tables
- Inserting, updating, and deleting table data
- Creating, changing, and dropping primary and unique indexes

Some specialized configuration parameters and files are required to set up an NDB Cluster—see [Section 4.3, “NDB Cluster Configuration Files”](#), for information about these.

A few simple commands are used in the NDB Cluster management client (`ndb_mgm`) for tasks such as starting and stopping cluster nodes. See [Section 6.1, “Commands in the NDB Cluster Management Client”](#).

A.16: What programming languages and APIs are supported by NDB Cluster?

NDB Cluster supports the same programming APIs and languages as the standard MySQL Server, including ODBC, .Net, the MySQL C API, and numerous drivers for popular scripting languages such as PHP, Perl, and Python. NDB Cluster applications written using these APIs behave similarly to other MySQL applications; they transmit SQL statements to a MySQL Server (in the case of NDB Cluster,

an SQL node), and receive responses containing rows of data. For more information about these APIs, see [Connectors and APIs](#).

NDB Cluster also supports application programming using the NDB API, which provides a low-level C++ interface to NDB Cluster data without needing to go through a MySQL Server. See [The NDB API](#). In addition, many `NDBCLUSTER` management functions are exposed by the C-language MGM API; see [The MGM API](#), for more information.

NDB Cluster also supports Java application programming using ClusterJ, which supports a domain object model of data using sessions and transactions. See [Java and NDB Cluster](#), for more information.

In addition, NDB Cluster provides support for `memcached`, allowing developers to access data stored in NDB Cluster using the `memcached` interface; for more information, see [ndbmemcache—Memcache API for NDB Cluster \(NO LONGER SUPPORTED\)](#).

NDB Cluster also includes adapters supporting NoSQL applications written against `Node.js`, with NDB Cluster as the data store. See [MySQL NoSQL Connector for JavaScript](#), for more information.

A.17: Does NDB Cluster include any management tools?

NDB Cluster includes a command line client for performing basic management functions. See [Section 5.5, “ndb_mgm — The NDB Cluster Management Client”](#), and [Section 6.1, “Commands in the NDB Cluster Management Client”](#).

NDB Cluster 7.6 and earlier are also supported by MySQL Cluster Manager, a separate product providing an advanced command line interface that can automate many NDB Cluster management tasks such as rolling restarts and configuration changes. Beginning with version 1.4.8, MySQL Cluster Manager also provides experimental support for NDB Cluster 8.0. For more information about MySQL Cluster Manager, see [MySQL Cluster Manager 1.4.8 User Manual](#).

NDB Cluster also provides a graphical, browser-based Auto-Installer for setting up and deploying NDB Cluster, as part of the NDB Cluster software distribution. For more information, see [Section 3.8, “The NDB Cluster Auto-Installer \(NDB 7.5\) \(No longer supported\)”](#).

A.18: How do I find out what an error or warning message means when using NDB Cluster?

There are two ways in which this can be done:

- From within the `mysql` client, use `SHOW ERRORS` or `SHOW WARNINGS` immediately upon being notified of the error or warning condition.
- From a system shell prompt, use `pererror --ndb error_code`.

A.19: Is NDB Cluster transaction-safe? What isolation levels are supported?

Yes. For tables created with the `NDB` storage engine, transactions are supported. Currently, NDB Cluster supports only the `READ COMMITTED` transaction isolation level.

A.20: What storage engines are supported by NDB Cluster?

NDB Cluster requires the `NDB` storage engine. That is, in order for a table to be shared between nodes in an NDB Cluster, the table must be created using `ENGINE=NDB` (or the equivalent option `ENGINE=NDBCLUSTER`).

It is possible to create tables using other storage engines (such as `InnoDB` or `MyISAM`) on a MySQL server being used with NDB Cluster, but since these tables do not use `NDB`, they do not participate in clustering; each such table is strictly local to the individual MySQL server instance on which it is created.

NDB Cluster is quite different from `InnoDB` clustering with regard to architecture, requirements, and implementation; despite any similarity in their names, the two are not compatible. For more information

about [InnoDB](#) clustering, see [MySQL AdminAPI](#). See also [Section 2.6, “MySQL Server Using InnoDB Compared with NDB Cluster”](#), for information about the differences between the [NDB](#) and [InnoDB](#) storage engines.

A.21: In the event of a catastrophic failure—for example, the whole city loses power *and* my UPS fails—would I lose all my data?

All committed transactions are logged. Therefore, although it is possible that some data could be lost in the event of a catastrophe, this should be quite limited. Data loss can be further reduced by minimizing the number of operations per transaction. (It is not a good idea to perform large numbers of operations per transaction in any case.)

A.22: Is it possible to use `FULLTEXT` indexes with NDB Cluster?

`FULLTEXT` indexing is currently supported only by the [InnoDB](#) and [MyISAM](#) storage engines. See [Full-Text Search Functions](#), for more information.

A.23: Can I run multiple nodes on a single computer?

It is possible but not always advisable. One of the chief reasons to run a cluster is to provide redundancy. To obtain the full benefits of this redundancy, each node should reside on a separate machine. If you place multiple nodes on a single machine and that machine fails, you lose all of those nodes. For this reason, if you do run multiple data nodes on a single machine, it is *extremely* important that they be set up in such a way that the failure of this machine does not cause the loss of all the data nodes in a given node group.

Given that NDB Cluster can be run on commodity hardware loaded with a low-cost (or even no-cost) operating system, the expense of an extra machine or two is well worth it to safeguard mission-critical data. It also worth noting that the requirements for a cluster host running a management node are minimal. This task can be accomplished with a 300 MHz Pentium or equivalent CPU and sufficient RAM for the operating system, plus a small amount of overhead for the `ndb_mgmd` and `ndb_mgm` processes.

It is acceptable to run multiple cluster data nodes on a single host that has multiple CPUs, cores, or both. The NDB Cluster distribution also provides a multithreaded version of the data node binary intended for use on such systems. For more information, see [Section 5.3, “ndbmtl — The NDB Cluster Data Node Daemon \(Multi-Threaded\)”](#).

It is also possible in some cases to run data nodes and SQL nodes concurrently on the same machine; how well such an arrangement performs is dependent on a number of factors such as number of cores and CPUs as well as the amount of disk and memory available to the data node and SQL node processes, and you must take these factors into account when planning such a configuration.

A.24: Can I add data nodes to an NDB Cluster without restarting it?

It is possible to add new data nodes to a running NDB Cluster without taking the cluster offline. For more information, see [Section 6.7, “Adding NDB Cluster Data Nodes Online”](#).

For other types of NDB Cluster nodes, a rolling restart is all that is required (see [Section 6.5, “Performing a Rolling Restart of an NDB Cluster”](#)).

A.25: Are there any limitations that I should be aware of when using NDB Cluster?

Limitations on [NDB](#) tables in MySQL NDB Cluster include the following:

- Temporary tables are not supported; a `CREATE TEMPORARY TABLE` statement using `ENGINE=NDB` or `ENGINE=NDBCLUSTER` fails with an error.
- The only types of user-defined partitioning supported for `NDBCLUSTER` tables are `KEY` and `LINEAR KEY`. Trying to create an `NDB` table using any other partitioning type fails with an error.

-
- `FULLTEXT` indexes are not supported.
 - Index prefixes are not supported. Only complete columns may be indexed.
 - Spatial indexes are not supported (although spatial columns can be used). See [Spatial Data Types](#).
 - Support for partial transactions and partial rollbacks is comparable to that of other transactional storage engines such as `InnoDB` that can roll back individual statements.
 - The maximum number of attributes allowed per table is 512. Attribute names cannot be any longer than 31 characters. For each table, the maximum combined length of the table and database names is 122 characters.
 - Prior to NDB 8.0, the maximum size for a table row is 14 kilobytes, not counting `BLOB` values. In NDB 8.0, this maximum is increased to 30000 bytes. See [Section 2.7.5, “Limits Associated with Database Objects in NDB Cluster”](#), for more information.

There is no set limit for the number of rows per `NDB` table. Limits on table size depend on a number of factors, in particular on the amount of RAM available to each data node.

For a complete listing of limitations in NDB Cluster, see [Section 2.7, “Known Limitations of NDB Cluster”](#). See also [Previous NDB Cluster Issues Resolved in NDB Cluster 8.0](#).

A.26: Does NDB Cluster support foreign keys?

NDB Cluster provides support for foreign key constraints which is comparable to that found in the `InnoDB` storage engine; see [FOREIGN KEY Constraints](#), for more detailed information, as well as [FOREIGN KEY Constraints](#). Applications requiring foreign key support should use NDB Cluster 7.3, 7.4, 7.5, or later.

A.27: How do I import an existing MySQL database into an NDB Cluster?

You can import databases into NDB Cluster much as you would with any other version of MySQL. Other than the limitations mentioned elsewhere in this FAQ, the only other special requirement is that any tables to be included in the cluster must use the `NDB` storage engine. This means that the tables must be created with `ENGINE=NDB` or `ENGINE=NDBCLUSTER`.

It is also possible to convert existing tables that use other storage engines to `NDBCLUSTER` using one or more `ALTER TABLE` statement. However, the definition of the table must be compatible with the `NDBCLUSTER` storage engine prior to making the conversion. In MySQL 5.7, an additional workaround is also required; see [Section 2.7, “Known Limitations of NDB Cluster”](#), for details.

A.28: How do NDB Cluster nodes communicate with one another?

Cluster nodes can communicate through any of three different transport mechanisms: TCP/IP, SHM (shared memory), and SCI (Scalable Coherent Interface). Where available, SHM is used by default between nodes residing on the same cluster host; however, this is considered experimental. SCI is a high-speed (1 gigabit per second and higher), high-availability protocol used in building scalable multi-processor systems; it requires special hardware and drivers. See [Section 4.4, “Using High-Speed Interconnects with NDB Cluster”](#), for more about using SCI as a transport mechanism for NDB Cluster.

A.29: What is an *arbiter*?

If one or more data nodes in a cluster fail, it is possible that not all cluster data nodes are able to “see” one another. In fact, it is possible that two sets of data nodes might become isolated from one another in a network partitioning, also known as a “split-brain” scenario. This type of situation is undesirable because each set of data nodes tries to behave as though it is the entire cluster. An arbiter is required to decide between the competing sets of data nodes.

When all data nodes in at least one node group are alive, network partitioning is not an issue, because no single subset of the cluster can form a functional cluster on its own. The real problem arises when no single node group has all its nodes alive, in which case network partitioning (the “split-brain”

scenario) becomes possible. Then an arbitrator is required. All cluster nodes recognize the same node as the arbitrator, which is normally the management server; however, it is possible to configure any of the MySQL Servers in the cluster to act as the arbitrator instead. The arbitrator accepts the first set of cluster nodes to contact it, and tells the remaining set to shut down. Arbitrator selection is controlled by the `ArbitrationRank` configuration parameter for MySQL Server and management server nodes. You can also use the `ArbitrationRank` configuration parameter to control the arbitrator selection process. For more information about these parameters, see [Section 4.3.5, “Defining an NDB Cluster Management Server”](#).

The role of arbitrator does not in and of itself impose any heavy demands upon the host so designated, and thus the arbitrator host does not need to be particularly fast or to have extra memory especially for this purpose.

A.30: What data types are supported by NDB Cluster?

NDB Cluster supports all of the usual MySQL data types, including those associated with MySQL's spatial extensions; however, the NDB storage engine does not support spatial indexes. (Spatial indexes are supported only by `MyISAM`; see [Spatial Data Types](#), for more information.) In addition, there are some differences with regard to indexes when used with NDB tables.

Note

NDB Cluster Disk Data tables (that is, tables created with `TABLESPACE ... STORAGE DISK ENGINE=NDB` or `TABLESPACE ... STORAGE DISK ENGINE=NDBCLUSTER`) have only fixed-width rows. This means that (for example) each Disk Data table record containing a `VARCHAR(255)` column requires space for 255 characters (as required for the character set and collation being used for the table), regardless of the actual number of characters stored therein.

See [Section 2.7, “Known Limitations of NDB Cluster”](#), for more information about these issues.

A.31: How do I start and stop NDB Cluster?

It is necessary to start each node in the cluster separately, in the following order:

1. Start the management node, using the `ndb_mgmd` command.

You must include the `-f` or `--config-file` option to tell the management node where its configuration file can be found.

2. Start each data node with the `ndbd` command.

Each data node must be started with the `-c` or `--ndb-connectstring` option so that the data node knows how to connect to the management server.

3. Start each MySQL Server (SQL node) using your preferred startup script, such as `mysqld_safe`.

Each MySQL Server must be started with the `--ndbcluster` and `--ndb-connectstring` options. These options cause `mysqld` to enable `NDBCLUSTER` storage engine support and how to connect to the management server.

Each of these commands must be run from a system shell on the machine housing the affected node. (You do not have to be physically present at the machine—a remote login shell can be used for this purpose.) You can verify that the cluster is running by starting the NDB management client `ndb_mgm` on the machine housing the management node and issuing the `SHOW` or `ALL STATUS` command.

To shut down a running cluster, issue the command `SHUTDOWN` in the management client. Alternatively, you may enter the following command in a system shell:

```
$> ndb_mgm -e "SHUTDOWN"
```

(The quotation marks in this example are optional, since there are no spaces in the command string following the `-e` option; in addition, the `SHUTDOWN` command, like other management client commands, is not case-sensitive.)

Either of these commands causes the `ndb_mgm`, `ndb_mgm`, and any `ndbd` processes to terminate gracefully. MySQL servers running as SQL nodes can be stopped using `mysqladmin shutdown`.

For more information, see [Section 6.1, “Commands in the NDB Cluster Management Client”](#), and [Section 3.6, “Safe Shutdown and Restart of NDB Cluster”](#).

MySQL Cluster Manager and the NDB Cluster Auto-Installer provide additional ways to handle starting and stopping of NDB Cluster nodes. See [MySQL Cluster Manager 1.4.8 User Manual](#), and [Section 3.9, “The NDB Cluster Auto-Installer \(NDB 7.6\) \(No longer supported\)”](#), for more information about these tools.

A.32: What happens to NDB Cluster data when the NDB Cluster is shut down?

The data that was held in memory by the cluster's data nodes is written to disk, and is reloaded into memory the next time that the cluster is started.

A.33: Is it a good idea to have more than one management node for an NDB Cluster?

It can be helpful as a fail-safe. Only one management node controls the cluster at any given time, but it is possible to configure one management node as primary, and one or more additional management nodes to take over in the event that the primary management node fails.

See [Section 4.3, “NDB Cluster Configuration Files”](#), for information on how to configure NDB Cluster management nodes.

A.34: Can I mix different kinds of hardware and operating systems in one NDB Cluster?

Yes, as long as all machines and operating systems have the same “endianness” (all big-endian or all little-endian).

It is also possible to use software from different NDB Cluster releases on different nodes. However, we support such use only as part of a rolling upgrade procedure (see [Section 6.5, “Performing a Rolling Restart of an NDB Cluster”](#)).

A.35: Can I run two data nodes on a single host? Two SQL nodes?

Yes, it is possible to do this. In the case of multiple data nodes, it is advisable (but not required) for each node to use a different data directory. If you want to run multiple SQL nodes on one machine, each instance of `mysqld` must use a different TCP/IP port.

Running data nodes and SQL nodes together on the same host is possible, but you should be aware that the `ndbd` or `ndbmt` processes may compete for memory with `mysqld`.

A.36: Can I use host names with NDB Cluster?

Yes, it is possible to use DNS and DHCP for cluster hosts. However, if your application requires “five nines” availability, you should use fixed (numeric) IP addresses, since making communication between Cluster hosts dependent on services such as DNS and DHCP introduces additional potential points of failure.

A.37: Does NDB Cluster support IPv6?

IPv6 is supported for connections between SQL nodes (MySQL servers), but connections between all other types of NDB Cluster nodes must use IPv4.

In practical terms, this means that you can use IPv6 for replication between NDB Clusters, but connections between nodes in the same NDB Cluster must use IPv4. For more information, see [Section 7.3, “Known Issues in NDB Cluster Replication”](#).

A.38: How do I handle MySQL users in an NDB Cluster having multiple MySQL servers?

MySQL user accounts and privileges are normally not automatically propagated between different MySQL servers accessing the same NDB Cluster. MySQL NDB Cluster provides support for distributed privileges, which you can enable by following a procedure provided in the documentation; see [Section 6.12, “Distributed Privileges Using Shared Grant Tables”](#), for more information.

Important

The mechanism for handling users distributed or shared between NDB Cluster SQL nodes has changed significantly in NDB 8.0; this implementation is not compatible with that in NDB 7.6 and earlier. See [Distributed MySQL Privileges with NDB_STORED_USER](#), for details.

A.39: How do I continue to send queries in the event that one of the SQL nodes fails?

MySQL NDB Cluster does not provide any sort of automatic failover between SQL nodes. Your application must be prepared to handle the loss of SQL nodes and to fail over between them.

A.40: How do I back up and restore an NDB Cluster?

You can use the NDB Cluster native backup and restore functionality in the NDB management client and the `ndb_restore` program. See [Section 6.8, “Online Backup of NDB Cluster”](#), and [Section 5.24, “ndb_restore — Restore an NDB Cluster Backup”](#).

You can also use the traditional functionality provided for this purpose in `mysqldump` and the MySQL server. See [mysqldump — A Database Backup Program](#), for more information.

A.41: What is an “angel process”?

This process monitors and, if necessary, attempts to restart the data node process. If you check the list of active processes on your system after starting `ndbd`, you can see that there are actually 2 processes running by that name, as shown here (we omit the output from `ndb_mgmd` and `ndbd` for brevity):

```
$> ./ndb_mgmd

$> ps aux | grep ndb
me      23002  0.0  0.0 122948  3104 ?        Ssl  14:14   0:00 ./ndb_mgmd
me      23025  0.0  0.0   5284    820 pts/2    S+   14:14   0:00 grep ndb

$> ./ndbd -c 127.0.0.1 --initial

$> ps aux | grep ndb
me      23002  0.0  0.0 123080  3356 ?        Ssl  14:14   0:00 ./ndb_mgmd
me      23096  0.0  0.0   35876   2036 ?        Ss   14:14   0:00 ./ndbmttd -c 127.0.0.1 --initial
me      23097  1.0  2.4 524116  91096 ?        Sl   14:14   0:00 ./ndbmttd -c 127.0.0.1 --initial
me      23168  0.0  0.0   5284    812 pts/2    R+   14:15   0:00 grep ndb
```

The `ndbd` process showing `0.0` for both memory and CPU usage is the angel process (although it actually does use a very small amount of each). This process merely checks to see if the main `ndbd` or `ndbmttd` process (the primary data node process which actually handles the data) is running. If permitted to do so (for example, if the `StopOnError` configuration parameter is set to `false`), the angel process tries to restart the primary data node process.

