

Cost effectiveness of measles eradication

Final Report

August 12, 2010

**David Bishai, MD, MPH, PhD
Benjamin Johns
Amnesty Lefevre
Divya Nair**

Johns Hopkins Bloomberg School of Public Health

Acknowledgments

This project was funded through the generous support of WHO and the Bill and Melinda Gates Foundation. The funding source had no role in the decision to publish or in determining the content of the findings. Helpful comments were received from Derek Cummings and Justin Lessler courtesy of the Vaccine Modeling Initiative. Sunmin Lee provided valuable technical assistance to data collection and manuscript preparation. The standard disclaimer applies.

Table of Contents

Section	Page
Executive Summary	2
Final Report	8
Appendix 1 Epidemiological Methods	36
Appendix 2 Costing Methods	51
Appendix 3 Detailed country reports for six focal countries	
Bangladesh	87
Brazil	101
Colombia	115
Ethiopia	130
Tajikistan	150
Uganda	165
Appendix 4 Comparing cost effectiveness to other interventions	181

Executive Summary

Since 2000, measles mortality has been reduced by 90% or more in all countries in the world except India. Strategic decisions on next steps to take in measles control can weigh the costs of control against the deaths and disability adjusted life years (DALYs) averted. Detailed dynamic models to forecast how measles will respond to alternative control strategies were constructed for six representative low and middle income countries: Bangladesh, Brazil, Colombia, Ethiopia, Tajikistan, and Uganda. In each of the six countries the models depict the outcomes from six different strategies as follows: 1) **Baseline** Achieve or maintain 90% reduction of measles mortality from year 2000 baseline and continue that same level of routine coverage and that same frequency of SIAs¹; 2) **Stop SIAs**: Donors withdraw funding for supplemental immunization activities (SIAs) in 2010 in GAVI eligible countries; 3) **95% Mortality Reduction by 2015** relative to year 2000 baseline achieved by scaling up routine coverage and maintaining SIAs; 4) **98% Mortality Reduction by 2020** relative to year 2000 baseline achieved by scaling up routine coverage and maintaining SIAs; 5) **Eradicate 2020**: All countries eliminate by 2020; 6) **Eradicate 2025**: All countries eliminate by 2025; These strategies are each examined with and without a decision to add rubella antigen after a country has achieved adequate coverage with measles. The eradication strategies are examined with and without a decision to stop a second dose of measles vaccine (MCV2).

A strength of the project was the use of dual methods: a dynamic age-tiered measles transmission model for 6 countries and a linear model that could be applied to every country in the world. It is no surprise that the different methods lead to different estimates of the cost effectiveness of measles control. The range over which the estimates diverge helps give planners more confidence that their decisions are not hinging on the thin support of a single point estimate of cost-effectiveness. Although the precise numerical estimates are slightly divergent, both approaches converge to give policy makers a consistent set of conclusions. Key conclusions that are robust across both models and extensive sensitivity tests are as follows:

- If one wanted to conserve scarce resources by stopping SIAs in GAVI eligible countries in 2010, restarting SIAs immediately would be a more cost-effective use of these resources than almost any other investment in health.
- By all metrics for cost-effectiveness, scaling up routine measles coverage while maintaining SIAs in countries that have not yet achieved 90% coverage is a very cost-effective investment in health, even if the benefits from being able to control rubella are not included.
- When measles coverage becomes high enough to justify the addition of rubella antigen, the societal savings from prevented cases of congenital rubella syndrome can be from 50 to 100% as large as a country's expenditure on measles immunization.

¹ The 90% mortality reduction baseline has already been achieved in every country except India World Health Organization (2009). "Global reductions in measles mortality 2000–2008 and the risk of measles resurgence." *Weekly Epidemiological Record* **84**: 505-516.

- Countries that have already eliminated measles achieve financial savings if measles is eradicated globally. The financial savings amount to 9-10% of the global incremental costs of measles control.
- Uncertainty about the degree of population overlap in MCV2 and MCV1 coverage as well as uncertainty about epidemiological mixing of age groups and communities have the largest impact on estimates of immunization effectiveness. Measuring these factors better would be priorities for future empirical epidemiological research.

The principal limitation of the project extends to any attempt to project a human-controlled social endeavor into the future. The estimates assume the ability to implement plans that are based on a stable social environment. It is almost certain that among 190 countries attempting to improve measles control in the next two decades that contingent events will arise whose costs and epidemiological consequences cannot be predicted by a model. Among these predictably unpredictable contingencies are: war, climate change, anti-immunization social movements, and mass-migrations. In addition, our uncertainty about how each country will actually go about implementing scale up of measles control and sustaining political will is so large that it defies quantification.

To counter these limitations the strategy used to estimate the costs of measles control is overtly conservative. We assumed that even though low income countries have been able to achieve their current levels of MCV1 coverage at \$1.00 per child (Brenzel, Wolfson et al. 2006), efforts to expand coverage would require new and recurring investments in supervision, outreach, logistics, and cold chain. Following the template of the “Reaching Every District” (Ryman, Macauley et al. 2009) strategy, our ingredients based model implied that reaching new and heretofore uncovered populations of children on a permanent basis would cost \$18 to \$28 per newly covered child per year in core areas of low income countries and \$27 to \$38 per newly covered child in outlying satellite areas (Table 2)². These costs exceed the average annual per child costs of all government health spending in many low income countries. Health planners who believe that they can increase MCV coverage for lower costs should thus conclude that increasing measles coverage is even more cost-effective than claimed by our model.

Covering heretofore uncovered populations of children in high income countries where there is social resistance to vaccines could be even more financially costly. Nobody has been able to estimate the costs of improving coverage with these affluent populations, although elements of the strategy include strong surveillance, political commitment, societal support, and outreach (WHO 2010). Our approach has been to say “What if it costs \$200 per newly covered child”, in these affluent populations. Such an expenditure would be approximately 20% of the annual cost of all medical care for a child in many affluent countries. Health planners who believe that they can increase MCV coverage in affluent populations more cheaply would also be supported in thinking that scaling up measles control in high income countries is more cost-effective than claimed by our model.

The Cost Effectiveness of SIAs

² Our model involves hiring a new full time auxiliary worker whose job is to visit every household to identify unvaccinated children and refer them to the local venue for vaccination. This new worker requires minimal training and is not drawn from the ordinary cadres of health workers.

The model's clearest results are on the consequences of withdrawing support for SIAs in GAVI eligible countries. The global model (Table 4) shows that Africa could save \$26 million over the next 40 years if it stopped SIAs. The direct savings from stopping SIAs are undermined because of a rise in the costs of measles cases. Furthermore, the cost effectiveness ratios show that there is probably no better use of \$26 million than to spend it on SIAs that can avert DALYS at \$35 per DALY in Africa in the linear model (Table 4). The estimated cost effectiveness ratios of SIAs were even more favorable in the dynamic transmission models: \$19.2, \$2.5, and \$1.5 per DALY averted in Bangladesh, Ethiopia, and Uganda respectively (Table 3).

The estimated ICERS for all of Africa in the linear model are higher than those estimated for Ethiopia and Uganda with the dynamic model. The principal reason is that the dynamic transmission model of measles in Ethiopia and Uganda could capture the impact of stopping SIAs on the number of susceptible children in these countries. One can observe how the percent of toddlers immune due to vaccines erodes in the 4 years after SIAs are stopped and how this translates into more frequent measles outbreaks in Figure 1. When a large number of susceptible children accumulate, the epidemiological consequences of an outbreak are more severe. Linear models cannot capture these dynamic effects of accumulated susceptibility. Nevertheless, the cost-effectiveness ratios emerging from both linear and dynamic models indicate that SIAs fall within a benchmark of $< 1/3$ GDP capita that would merit their status as highly cost-effective.

The Cost Effectiveness of Mortality Reduction, Elimination, and Eradication

Measles mortality reduction, measles elimination, and measles eradication are interdependent decisions. A country must first decide whether to increase measles control beyond the current levels. If control is to be scaled up, one could choose whether to continue to scale up control efforts to the point where endogenous measles transmission is “eliminated”. On a global level, if a plurality of countries has decided to eliminate measles, global coordination could be contemplated where 100% of countries share a goal of measles elimination—a goal, which if achieved, would constitute measles eradication.

The key message of the modeling project is that for low income countries, the cost-effectiveness ratios of mortality reduction, elimination, and eradication are all similar. For low income countries there is no compelling statistically significant difference in the cost effectiveness ratios of any of these three strategies. The models do indicate that if eradication is achieved it permits some cost saving options for every country like the discontinuation of MCV2. For high income countries that have already eliminated measles, in particular the Americas, a decision to eradicate measles would lead to large financial savings from reductions in MCV2, outbreak control, and surveillance. There is a \$1 to 1.3 billion dollar financial difference for the Americas between measles eradication and measles mortality reduction, mostly savings realized if MCV2 is discontinued. In contrast, there is a much smaller difference to Africa between mortality reduction scenarios and measles elimination. In the linear models for Africa, 98% mortality reduction by 2020 would cost an additional \$10 billion, whereas eradication by 2020 would cost \$9.2 billion or \$7.4 billion depending on whether MCV2 is retained or abandoned after 2023 respectively (Table 4). The dynamic models reinforce this result showing that a 98% mortality reduction strategy would cost \$9.5 million and \$4.7 million in Ethiopia and Uganda respectively whereas comparable numbers for Eradication by 2020 would be \$12 million and \$ 6.6 million for the respective countries. In each country the 95% confidence intervals for the cost estimates overlap so there is no grounds to conclude that mortality reduction strategies are statistically significantly less expensive (Table 3). One reason

for the similarity in costs is that a country that chooses a mortality reduction might not achieve routine coverage levels that are high enough to warrant discontinuation of costly SIAs. In contrast the measles eradication scenarios that we modeled incurred higher costs to attain MCV coverage well above a 90% threshold and were able to discontinue SIAs (See Figure 3).

The conclusion that measles mortality reduction strategies are not economically superior to eradication strategies echoes result seen in economic models of polio control (Thompson and Tebbens 2007). Our results extend this insight because the dynamic transmission models underlying it were applied to 6 different countries and accompanied by extensive sensitivity analysis to assess the robustness of the conclusion to variations in the epidemiological and cost parameters. The result also emerges independently from the linear model. Furthermore, the result emerges despite a cost model that assumes that the per child cost of increasing immunization coverage escalates as coverage is increased among heretofore unvaccinated populations and in remote satellite populations of difficult to reach children.

Note that our cost model assumes that the low demand and refusal to accept measles vaccine in low income and high income populations respectively can be overcome by quite substantial financial investments in outreach. Although the Americas were able to create and sustain demand for vaccination to the point at which measles could be eliminated (Pan American Health Organization 2005), it remains to be seen whether social obstacles can be overcome in other countries. An influential paper by Geoffard and Philipson indicated that infectious disease eradication was always less cost-effective than disease control if the demand for vaccination were entirely based on an individual's rational self-interest (Geoffard and Philipson 1997). In this theory, as the herd immunity threshold is reached in a population the individual benefit from a single vaccination becomes asymptotically small and for a rational parent it becomes economically more efficient to free-ride on herd immunity rather than to invest even a few cents of time and travel costs to vaccinate their children. It is possible that Geoffard and Philipson type economic calculations lie at the core of vaccine refusal in high income countries. However as is evident from the Americas, individual rational calculation by parents may also play a negligible role in reducing the demand for vaccination even after a disease is eliminated. Future uncertainty about the magnitude and cost of overcoming demand side resistance to vaccination scale up in other parts of the world is destined to play a role in the debate over the social feasibility of measles eradication.

The Cost Effectiveness of Rubella Control

According to WHO guidelines, countries that are working to eliminate measles should consider taking the opportunity to eliminate rubella by adding rubella antigen to their routine measles immunization program after having achieved a reliable measles coverage rate of 80% (WHO 2000). Our dynamic models of rubella control in Bangladesh, Ethiopia and Uganda found that adding rubella antigen was highly cost effective. This result echoes prior literature (Hinman, Irons et al. 2002)³. Assuming that each case of congenital rubella syndrome cost a society \$25,000 in lost wages, medical care, and care-giving, the burden of CRS is sufficiently high that the savings can offset 50-100% of the costs of measles control.

The good news about the savings from rubella control should be a reason to encourage immunization programs everywhere to advance their routine MCV coverage above 80% so they

³ Our model of rubella costs was more conservative than prior models. We assumed that the lifetime costs to society of a case of CRS would be \$25,000 in a low income country. Prior studies assumed higher costs ranging from \$50,000 to \$64,000 in Barbados and Guyana respectively.

can realize the health and financial benefits of eliminating rubella and CRS. In most low income countries CRS cases impose costs for care-giving on families and households rather than on the medical sector, but the benefits exceed the costs (Hinman, Irons et al. 2002). Whether or not rubella is included in the model has little bearing on the debate over measles mortality reduction or measles elimination/ eradication. It turns out that a country would exceed the 80% coverage threshold for the addition of rubella whether or not mortality reduction or measles elimination is chosen.

International Benefits from Measles Eradication

The global models of measles eradication locate the largest financial gains from eradication among the high income countries which stand to save \$2.3 to 2.6 billion if measles is eradicated and \$3.1 to \$3.7 billion if after eradication they decide to drop MCV2 coverage (Table 4). The largest financial requirements will be in low and middle income countries which can be classified into 2 groups. The countries with very low coverage will require additional spending of \$5.3 to \$6.5 billion to eradicate measles. Other low and middle income countries will require \$6.8 to \$10.3 billion to eradicate measles. Countries that currently have very low coverage are assumed to face higher financial obstacles to increase coverage, hence they are assumed to need to spend much more to bring their coverage up to eradication thresholds and this spending makes the cost effectiveness less attractive ranging from \$106 to \$126 per DALY averted. Other low and middle income countries that have not yet eliminated measles are projected to require from \$6.9 to 10.3 billion over the next 40 years, but measles eradication in these countries is a very cost effective health investment at \$17 to \$24 per DALY averted.

In the global picture, measles eradication ranges from being cost saving to being very cost effective. For low income countries the total financial requirements from measles eradication are similar to those for mortality reduction scenarios. For high income countries the financial savings are only realized if measles is eradicated. The amount of money saved by the countries that do realize net savings from measles eradication is sufficient to offset 10% of the incremental global costs of measles eradication.

Future Priorities in Measles Research for Decision-Making

Although the point estimates of deaths, DALYs, and costs shift somewhat as parameters are altered, the fundamental conclusions discussed above do not change during sensitivity analysis for a wide range of assumptions about the behavior of measles dynamics and the nature of the costs of measles control. The sensitivity analysis can inform investment priorities in research on measles. Based on the experience with other disease eradication efforts, the key unknowns are the magnitude and location of social and political obstacles to measles control. Greater understanding about the factors that support the politics of measles control and population demand for these programs would be of immense value to decision-making.

Basic research on measles epidemiology has offered important lessons for biology and ecology. Our project has allowed us to identify those epidemiological factors that have the greatest impact on the cost-effectiveness ratios of various measles control options. As shown in Figure 4, uncertainty about population mixing patterns emerges as the single factor tested that can alter cost-effectiveness ratios the most. Overlap between MCV1 and MCV2 can alter cost effectiveness ratios by 10-20%. Despite the sensitivity of the cost-effectiveness ratios to the model parameters, the range across which ICERs vary does not alter any of the conclusions discussed above. Better measurement is unlikely to reverse any of the above conclusions. ICERs

are varying, but they remain less than \$200 per DALY across the range of parameters. Decision-makers in the health sector do not generally have the luxury of league tables for other health interventions that are defined with precisions smaller than +/- \$100 per DALY. Furthermore few, if any decision-makers possess a cleanly defined threshold about how much they would be willing to pay for a DALY averted that would discriminate between multiple options priced less than \$200 per DALY averted.

The project can be summarized as follows. For countries that do not yet have high routine measles coverage it would be a cost-effective investment to spend up to \$20 to \$30 per newly covered child to improve measles coverage. The reaching every district (RED) strategy which involves new and recurrent investments in outreach, supervision, and logistics forms a good starting template for these efforts to scale up. Whether or not low income countries sustain these increases all the way into the mid 90% coverage rate required for measles elimination, the investments in better measles coverage have similar cost effectiveness ratios from the perspective of low income countries. In contrast, the high income countries of the world achieve dramatically higher financial gains if measles is eradicated (i.e. eliminated in 100% of countries.)

High income countries may choose to invest more in measles control efforts in low income countries than their direct financial savings, particularly if they perceive altruistic gains from eradicating an historical scourge of mankind. The high income countries that gain the most from measles eradication may choose to “equitably” diffuse their support for measles efforts among all low income countries. However, it is likely that global progress towards measles eradication will reveal the existence of “weakest link” countries facing obstacles that they truly cannot overcome without external support. Predicting where these weakest links will occur and the best policy to strengthen their efforts is a high priority in the future of measles control.

Final Report

Introduction

Measles is estimated to have caused between 117,000 and 164,000 child deaths in 2008 (Black, Cousens et al.) (WHO 2010). Because most measles deaths can be prevented by vaccination, control strategies are designed to raise the prevalence of vaccine-related immunity. A key component of WHO and UNICEF strategy to combat measles is the use of a 2nd vaccine opportunity which countries can offer during campaigns and supplemental immunization activities (SIAs) or through a second routine vaccination (MCV2) (WHO and UNICEF 2005). Countries typically phase in MCV2 after having achieved consistently high coverage with the initial routine dose (MCV1) for three consecutive years.

How high to raise vaccine coverage is an economic issue, because the health resources used to push vaccine coverage higher have other potential uses. In theory, there is a threshold of vaccine coverage that is so high that raising coverage 1% further offers negligible public health benefit and could waste resources. This “elimination threshold” is defined as the level of coverage at which indigenous chains of transmission no longer occur and all new cases can be traced to imported cases. Increments to vaccine coverage above the elimination threshold only serve to limit the spread of secondary cases after an imported case arrives (Dowdle 1998).

Measles has been eliminated in the Americas, demonstrating feasibility. The primary rationale to achieve measles elimination is to achieve improved population health, as well as to save the costs that ensue from a preventable disease. However, countries in the Americas also illustrate an economic dilemma. Countries that eliminate measles still incur substantial costs from surveillance and outbreak control following the importation of cases. If all countries were to achieve elimination of measles—if there were global eradication—spending on surveillance and outbreak control could stop forever. Measles eradication would not necessarily imply stopping routine immunization given concerns over bioterrorism, but an end to outbreak control would generate permanent financial savings for future generations. Additional savings could accrue if the second dose of measles vaccine was discontinued after global eradication of measles. The economic question is which strategies for measles control can save the most lives and money over the next decades.

Unfortunately, the economic question may have a different answer for a decision maker in a single nation vs. the collective best interest of the global population. Decision-makers in national immunization programs want to save the most lives per dollar available to their country’s health sector. However, for global public goods like contagious disease control, what is best for a single country may not be best for all countries. The tragic math of global public goods is that although the collective global long run benefit ($B_1+B_2+\dots+B_N$) is greater than collective global long run cost ($C_1+C_2+\dots+C_N$), there may be one or more countries in which the individual country’s cost, C_i may be perceived as greater than the individual country’s benefit, B_i (Barrett 2007). According to Barrett, countries that perceive their own cost C_i as greater than their benefit B_i become “weakest link” countries and require external incentives to comply with global

decisions to supply a public good (Barrett 2007). Solutions to the policy dilemma lie in identifying the costs and benefits and improving the incentives to cooperate. Economic analysis can define the costs and benefits from the perspective of each nation as well as globally.

This paper strikes a balance between depth and breadth in serving both national and global policy decisions in estimating the costs and benefits of measles control policies using mathematical models of disease burden. The heavy data requirements of dynamic disease models rule out producing detailed models of measles for every country. Instead the analysis will offer in depth models of measles dynamics and costs in a subset of 6 low and middle income countries to generate cost and disease forecasts from 2010 to 2050. Breadth is achieved by applying lessons learned from the 6 focal countries to inform linearly extrapolated estimates of vaccination costs, deaths averted, and life years saved for the globe.

The focal countries were chosen in consultation with WHO's quantitative immunization and vaccines related research expert advisory group (QUIVER) and WHO regional offices to represent three that were at or near measles elimination (Brazil, Colombia, Tajikistan) and three that were actively scaling up coverage (Bangladesh, Ethiopia, and Uganda). In each of the six countries the models depict the outcomes from six different strategies as follows: 1) **Baseline** Achieve or maintain 90% reduction of measles mortality from year 2000 baseline by maintaining the exact same level of routine coverage and SIA coverage that was required to achieve that goal from 2010 onwards⁴; 2) **Stop SIAs**: SIAs cease in 2010 in GAVI eligible countries because of reduction of support from donor community and reprioritization of national resources; 3) **95% mortality reduction by 2015**: Increase routine coverage enough to achieve 95% reduction of measles mortality by 2015; 4) **98% mortality reduction by 2020**: Increase routine coverage enough to achieve 98% reduction of measles mortality by 2020. 5) **Eradicate 2020**: All countries eliminate by 2020; 6) **Eradicate 2025**: All countries eliminate by 2025; These strategies are each examined with and without a decision to add rubella antigen after a country has achieved adequate coverage with measles. The model also examined the option of dropping the second dose of measles vaccine (MCV2) after global eradication was achieved.

Methods

In Depth Dynamic Model of Measles Transmission in Six Focal Countries

For each of the 6 focal countries the future trajectory of measles is simulated as a discrete time, Markov chain, susceptible, immune, recovered, vaccinated (SIRV) model with a time step of 2 weeks. The population is broken into five age groups: 6-12 months, 1-4 years, 5-14 years, 15-45 years, and 45+. The first two groups allow the model to depict alterations in coverage by first dose (MCV1) and second dose (MCV2) of vaccine as well as supplementary immunization activities (SIAs) which occur at different ages. The adult population is differentiated into fertile and non-fertile ages to ease the depiction of congenital rubella syndrome. Because there are physical limitations on how many people can have epidemiological contact with each other, the model assumed that mixing of the population occurred in populations of 1 million people as of 2010 and case counts were rescaled to the country's total population. Age proportions in each scale model were based on country data for 2008 and projected to 2050 (United Nations 2008). Population heterogeneity was modeled by distributing the 1 million people into a core population with higher vaccine coverage and a smaller satellite population where coverage is 20 percentage

⁴ The 90% mortality reduction baseline has already been achieved in every country except India

points lower. Mixing rates between the core and satellite populations are varied in sensitivity analysis. Each country's birth and death rates were based on the medium projection of the United Nations for each age group out to 2050 (United Nations 2008).

For Bangladesh, Ethiopia, and Uganda the strategies that increased measles coverage were modeled as a linear ramp of routine vaccine coverage fractions starting in 2010 (Table 1). An analysis of increases in estimated MCV1 coverage in low income countries that were above 60% coverage revealed that the 75th percentile of the annual increase was around 3% and thus no country was allowed to increase coverage faster than 3% points per year in any scenario. In sensitivity analysis the linear ramp was replaced by a spline with one knot to depict eventual slowing of coverage increases over the next 10 years. All country's vaccine coverage fractions were initialized based on UNICEF/WHO's database of MCV1 and MCV2 coverage (WHO/UNICEF, 2010). MCV1 administered prior to 12 months of age was assumed to produce complete immunity in 85% of infants. MCV2 administered in the 2nd year of life was assumed to produce immunity in 95%. Receipt of MCV1 and MCV2 was arbitrarily set to have a covariance of 5-12% implying that children who missed MCV1 were more likely than average to miss MCV2 as well. The covariance of MCV1 and MCV2 coverage was varied in sensitivity analysis. It was assumed that countries that had not yet adopted MCV2 would do so three years after having consistently achieved MCV1 coverage above 80%. Countries that used SIAs in their measles control efforts were assumed to continue these on schedule until MCV1 and MCV2 reached $\geq 90\%$ coverage for three consecutive years, or eradication was declared.

Separate equations for each country, age group, and compartment modeled the force of infection as $\lambda_t = \beta_M (S_t I_t^\alpha)$ where β_M is a set of monthly infectiousness parameters that impose seasonality. S_t is the number of susceptibles in biweek t , I_t is the number infected in biweek t , and α is a parameter that adjusts for the heterogeneity in contact and the discretization of the continuous time transmission process. Until eradication was achieved, the population was exposed to a regular influx of 2 immigrant infection rate cases per week. Global measles eradication was modeled as a logistic S-shaped reduction in the number of immigrant cases timed to occur at either 2020 or 2025 depending on the scenario. The number of new infections was stochastically updated every two weeks using a negative binomial function according to $I_{t+1} \sim \text{NegBin}(I_t, \lambda_t)$ (Finkenstadt and Grenfell 2000; Bjornstad, Finkenstadt et al. 2002). The negative binomial was replaced by a Poisson function whenever the number of endogenous cases was less than the number of imported cases⁵. These basic equations were modified slightly in order to depict mixing patterns (See Appendix). The infectiousness parameters, β_M , for Uganda were estimated from monthly district data accounting for vaccination coverage using the method of susceptible reconstruction (Finkenstadt and Grenfell 2000; Bjornstad, Finkenstadt et al. 2002). Bangladesh's β_M parameters were extrapolated from a prior published monthly case series in Matlab district (D'Souza, Bhuiya et al. 1988).

The epidemiological model was programmed in Stata 11 and then validated according to its ability to approximate WHO's estimates of annual measles deaths for 2005-2010 within 5%, its ability to match historical age distributions of incident cases in unvaccinated populations, and its

⁵ When the number of infected cases was small, the negative binomial created too much overdispersion leading to overestimates of outbreak size that did not match recent data from Latin America.

ability to replicate the observed negative correlation between vaccine coverage and deaths within 5%. The demographics in the model were required to replicate UN population estimates within 10%. The underlying measles dynamics were examined in a natural history scenario with all vaccinations turned off and the model for each country was assessed for its ability to match the 2-3 year periodicity seen in the canonical pre-vaccine data from UK (Finkenstadt and Grenfell 2000; Bjornstad, Finkenstadt et al. 2002). The natural history models predicted measles cycles every 2-3 years, which is consistent with historical populations in Africa (O'Donovan 1971) (Cliff, Hagget et al. 1993), Asia (Chin 1983) (D'Souza, Bhuiya et al. 1988) (Cliff, Hagget et al. 1993), and Latin America (Cliff, Hagget et al. 1993). The models can also exhibit annual dynamics observed in developing country settings with higher birth rates (Cummings, Moss et al. 2006).

Costs

Costs were based on a societal perspective with time horizon of 40 years with discounting at 3% of both costs and DALYs. Sensitivity analysis varied the horizon to 20 years and varied the discount rate to 0% or 6%. Total costs include costs of scaling up routine vaccination, conducting SIAs, outbreak control, routine surveillance, health sector costs of treating measles cases, and societal costs of lost productivity for adults whose children were sick. The incremental costs of the various vaccination strategies were compared to the baseline reference point--a strategy that kept coverage fixed at 2010 levels. Elimination strategies are nested in the sense that all have to maintain the baseline 2010 coverage levels. Cost comparisons between strategies will not be related to the costs of maintaining the baseline because these maintenance costs are the same in all scenarios.

The cost model did not include the costs of global coordination of activities. It was unclear how or why global coordination costs would differ between mortality reduction scenarios and eradication scenarios. Although the polio eradication strategy includes spending on global coordination, the structure of these costs and why they are imposed by eradication but not improved control has not been well documented.

We assumed that increasing routine coverage higher will require new activities in new places. To encompass heterogeneity, the cost model used an ingredients based approach that segmented the population of unreached children into six categories based on (urban/rural/remote) × (core/satellite) area. After stratifying the population of children not yet reached by routine MCV the coverage increments in each compartment were multiplied by an estimate of the corresponding unit costs to scale up in each location.

Estimates of the quantity of resources needed for ramping up coverage in each of the 6 compartments were based on interviews that WHO sponsored with country EPI managers in Bangladesh, Brazil, Colombia, Ethiopia, and Uganda (See cost appendix for details on interviews). The interviews disclosed that the most likely investments to scale up coverage would echo the “reaching every district” RED strategy (Ryman, Macauley et al. 2009). Scaling up routine coverage with MCV1 will require more human resources for clinic-based outreach, better supervision, as well as more transport, supplies, and antigen. Most of the costs of the RED strategy are recurrent labor costs to hire more staff to conduct the outreach and supervision as well as an increase in recurrent costs of vaccine acquisition and transport. Scale up decisions

thus lead to permanently higher unit costs per increment in the number of children covered above baseline. Furthermore these increased labor costs are distributed over a small number of incremental children who are not yet routinely reached. The cost of reaching a new unreached child in easier to reach areas of Bangladesh, Ethiopia, and Uganda is estimated at \$28, \$19, \$27 respectively with higher costs assumed for children in hard to reach areas (See Cost Appendix for derivation of these estimates). Sensitivity analysis tested models with lower and higher unit costs of scale up. In models of the cost of changing from measles to measles-rubella vaccine there were virtually no recurrent costs and just a few negligible fixed costs of policy implementation.

The cost per child reached by supplementary immunization activities (SIAs) was estimated based on literature review and then extrapolated based on GDP per capita (Fiedler and Chuko 2008) (Dabral 2009) (See Appendix).

There is very little documented on practice patterns or the medical costs for acute measles in children in low and middle income countries. To account for both uncertainty and variability in the cost of measles cases there is a base model and models with 20% higher and 20% lower variants of the cost model. In the base model, for every 100 measles cases there are 50 primary care visits, 200 lost parent productivity days, and 10 hospital bed days. Because there are no published estimates on the costs of measles in low and middle income countries these are ad hoc assumptions that are varied in sensitivity analysis. Costs of measles related encephalitis were estimated based on an incidence of 1.5 per 10,000 cases, 14 inpatient hospital days per case and 10 years of lost GDP per capita per case.

Measles disability adjusted life years (DALYs) were estimated as life years lost relative to each countries estimate life expectancy for decedents at each age. Because of the brevity of acute measles cases, disease burden due to the acute disability of measles was ignored. Case fatality rates for each country and age group were based on literature (Wolfson, Grais et al. 2009). Recent reports indicate dramatic improvements in measles CFR (Sudfeld and Halsey 2009) and so the model for the 6 focal countries projected future CFR reductions at the same rate as UN's projections of under five mortality reductions for the next 40 years (United Nations 2008).

In univariate sensitivity analysis parameters in Table 2 were altered to 20% lower and higher and the results were compared to baseline. In multivariate sensitivity analysis of the transmission models, each scenario was run 100 times to establish the range of expected values.

Rubella

A separate model of rubella was constructed to explore whether the expected future switch to combination measles rubella (MR) vaccine would alter the cost-effectiveness of the various vaccination scenarios. The model of rubella retained the same negative binomial SIRV architecture as measles, but the force of infection for rubella was scaled back to 1/3 of measles following literature suggesting that rubella is one third less infectious (Anderson and May 1991). Estimates of congenital rubella syndrome were based on counts of incident cases in women age 15 to 45. The probability that a woman would be pregnant during any two week period was forecast for each country based on UN world population prospects for that country (United Nations 2008). The probability, that if pregnant, a woman was in her vulnerable first 16 weeks of

pregnancy was assumed to be 0.40 and the probability that if the mother were infected with rubella during the vulnerable part of pregnancy, the fetus would acquire congenital rubella syndrome was assumed to be 0.65 (Cutts and Vynnycky 1999). To estimate CRS DALYs a disability weight of 0.5 was assumed and applied for the full life expectancy of an infant in that country. The baseline lifetime cost of one case of CRS was arbitrarily assumed to be roughly 50 times the GDP per capita in each country, which led to estimates of about \$25,000 per case in Bangladesh, Ethiopia, and Uganda.

Global Model of Measles Eradication

The global models use a simple linear decrease from current measles deaths downward to the policy targets set for 2015, 2020, and 2025. The deaths averted are readily estimated for each country as the difference in the area under these straight lines. The imposition of discounting tends to front load the mortality reductions so that earlier reductions count more. The costs in the global model were estimated by estimating the population in low coverage and high coverage compartments in each country based on their reports to UNICEF and WHO (UNICEF and WHO 2010). The ingredients based model of the costs of scaling up routine coverage discussed above was applied to each country with two exceptions. There is a subset of high income countries where coverage is below elimination levels (see list in Appendix). Unfortunately, there is no empirical basis to make any estimate of what it would cost to increase coverage among the affluent vaccine-refusers. The model applies an ad hoc “what if” value of \$200 per incremental child per year. Policy makers from these affluent countries will have to determine what it would actually cost to improve coverage for affluent populations that are resistant to vaccinate their children. A second assumption was made for countries with routine measles coverage less than 60% or with large areas where supply chains were not yet functional and where it seemed unlikely that routine coverage could eliminate measles by 2020. In these countries the model of costs is based on a strategy of holding annual SIA campaigns.

Results for Six Focal Countries: Bangladesh, Brazil, Colombia, Ethiopia, Uganda, Tajikistan

Figure 1 shows an example of the dynamic epidemic curves with cases per year overlain with a plot of the prevalence of children age 1 to 4 who are immune to measles from vaccination for the case of Uganda. (See Appendix 3 for additional countries). The scenarios with SIAs show the presence of SIAs as rectangular upticks in immunity occurring every 3 years in Uganda. The scenario of stopping SIAs after 2010 leads to more frequent epidemics than would occur in the baseline situation where routine coverage and SIA policies are frozen in place.

Figure 2 plots the 40 year sums of discounted costs against the 40 year sum of discounted DALYs for the six focal countries. There are 100 iterations of each policy shown. Decision makers are assumed to prefer points that are lower on the vertical axis because these have lower cost and to prefer points that are more to the left on the horizontal axis because these have fewer DALYs. One can see from the three upper panels of Figure 2, that the baseline scenario (Δ s) of not increasing routine coverage while continuing SIAs imposes higher costs but has fewer

DALYs than stopping SIAs (Xs). For a decision maker at the baseline position (Δ) in Bangladesh, Ethiopia, Uganda or Tajikistan all choices that improve health lead to higher costs. In contrast, in Brazil and Colombia, the eradication scenarios result in both better health and lower costs.

If one were to plot trajectories from baseline points (Δ s) to the health improving strategies at the upper left of figure 2 the lines would have similar slopes going upward and to the left. These slopes are the incremental cost effectiveness ratios (ICERS) and are listed in Table 3. ICERS were estimated by drawing 200 line segments joining a randomly selected point from each alternative scenario to a randomly selected point in the baseline reference scenario. For all three low income countries in Table 3, each measles control option other than stopping SIAs offers a chance to avert DALYs for less than \$200 per DALY. In particular, the eradication scenarios lead to similar \$ per DALY averted when compared to either the 95% or 98% reduction scenarios. The substantial overlap between ICER's interquartile ranges for the scenarios given in Table 3 prevent the conclusion that scenarios that are less than eradication represent a statistically significantly better opportunity to avert more DALYs per dollar.

For the two Latin American countries, the scenarios of 95 and 98% mortality reduction were not modeled because measles has already been eliminated. In the Latin American countries, the eradication scenarios involved only the opportunity to both save money and have improved health. For Latin America, eradication involves an intensification of efforts in other countries and the costs of this intensification is borne by other countries. The numbers in the far right column of Table 3 for Colombia and Brazil are not ICERS and do not represent money spent per DALY averted, they merely display the ratio in which the dual benefits of financial savings and DALYS averted will accrue if eradication is achieved. For Brazil and Colombia the high ratio of financial gain to health gain indicates that Brazil and Colombia's gains are more weighted to financial gains than health gains. The DALY gains are less than 1000 DALYS in either country over the next 40 years, but the financial savings are between \$9 and \$68 million depending on the scenario.

Figure 3 shows the components of costs in each scenario in each country. For Bangladesh, Ethiopia, and Uganda the figure includes a comparison to the costs of measles if these countries had never adopted measles vaccine (top red bar labeled "Natural"). The analysis confirms that measles vaccination as currently practiced in the baseline is indeed cost saving—the costs of the program are less than half what the medical and social costs of measles would be if no vaccination occurred. In all scenarios that improve measles control the largest cost component is the cost of expanding and maintaining more routine measles coverage. As noted above, the model of scaling up routine coverage assumes that scale up will require permanent increases in recurrent costs of the vaccine program. The sooner scale up is implemented the longer these higher costs are incurred.

The study also computed the benefits of adding rubella antigen to the routine measles vaccine program in Bangladesh, Ethiopia, and Uganda. Details on the results of the rubella models are given in the country appendices. Highlights are summarized here. For Uganda, the model estimates that there would be 44,963 cases of congenital rubella syndrome (CRS) over 40 years if MR vaccine were not adopted. All strategies that switched from MCV to MR antigen

following WHO guidelines for appropriate switching brought cumulative caseloads to under 6000 cases over the next 40 years and averted over 350,000 DALYS as well as saving CRS costs. For Uganda, the inclusion of the cost consequences of CRS would offset 51%, 47%, 62% and 50% respectively of the total costs of scaling up immunization under the 95% reduction by 2015, 98% reduction by 2020, Eradicate 2020, or Eradicate 2025 scenarios. In Bangladesh and Ethiopia, the financial savings from rubella control are enough to fully offset all of the costs of the measles control program regardless of the measles control scenario.

Figure 4 shows the results of univariate sensitivity analysis in the form of tornado diagrams which were calculated for Uganda. These results show that assumptions about population mixing have the largest impact on cost effectiveness. Other factors that had a large impact on ICERS were assumptions on the force of infection and the degree of overlap between MCV1 and MCV2.

Incorporating the cost offsets from rubella control for the low income countries would improve all scenario's ICERS by a similar amount and have little impact on making any particular measles control strategy more attractive than the others. Because the CRS costs in low income countries are mostly borne by households, the medical sector would not easily recover the financial savings from rubella control. For these reasons we have omitted the cost-offsets of rubella control from the subsequent analysis of global measles control

Results of Global Model

Table 4 shows the results for the cost-effectiveness analysis on the global level. Depending on the scenario adopted, it is estimated that eradicating measles will cost between \$7.7 and \$13.9 billion additional US\$ and avert between 465 and 488 million discounted DALYs (or roughly 8 to 8.7 million undiscounted deaths) between 2010 and 2050. The most costly scenario was eradication by 2020, costing an additional \$13.9 billion more than the \$23 billion projected if baseline status quo of 2010 is maintained unchanged for the next 40 years. With eradication in 2020, The Americas, Europe, and Western Pacific regions are projected to make net savings of \$305, \$370, and \$730 million respectively (total \$1.4 billion savings). On the global level the \$1.4 billion in savings can partially offset the \$15.3 billion in costs required in Africa, Eastern Mediterranean, and Southeast Asia where costs are projected at \$9.2, \$1.3 and \$4.7 billion respectively.

Figure 6 shows the cost by category of expenditure for the six WHO regions. Scenarios where coverage is expanded but eradication is not achieved are still costly, at an additional US\$6 to 12 billion. Mortality reduction strategies would avert between 210 and 410 million discounted DALYs. Stopping SIAs in GAVI eligible countries would lower costs by about 2.1 billion US\$, and unfortunately result in 63 million more DALYs.

At the global level, the incremental cost-effectiveness of the eradication scenarios ranged around 27 dollars per DALY averted (dropping under \$20 per DALY averted if the MCV2 vaccination is stopped after eradication), while the expanding coverage without eradication scenarios are around 30 dollars per DALY averted. The closeness of these ICERS indicates that the cost-effectiveness of the different scenarios cannot be distinguished, but all demonstrate that investing

in expanding the coverage of measles vaccination is good value for money. The stop SIA in GAVI eligible scenario shows that SIAs are also good value for money; moving from a hypothetical situation without SIAs in these countries to a situation where there are SIAs (the current situation) has an ICER of only US\$34 per DALY averted.

Within this global picture there is considerable heterogeneity. Regionally, the ICERs for elimination tend to be around US\$100 per DALY averted in the WHO Africa region, \$29 in the Eastern Mediterranean region, under \$15 in the Southeast Asia region, and cost saving in the America, European, and Western Pacific regions. Removing MCV2 after elimination moves the ICER lower in all areas to under \$100 per DALY averted. When the ICER is stratified by income and coverage levels, expansion in measles vaccination is cost-savings where measles has already been eradicated, under the assumption that these countries will not expand coverage. The highest ICER is found for countries with the lowest levels of current coverage, where the ICER is found to be slightly over \$100 per DALY averted.

Figure 5 shows the estimated ICERs for different scenarios for all countries, sorted into four classes based on whether the scenario is cost-saving and with less disability compared to the current situation (“Cost saving”), the ICER is less than the country’s GDP per capita (“Less than 1x GDP”), the ICER is greater than the country’s GDP per capita but less than 3 times the GDP per capita (“Btw 1&3x GDP”), or the ICER is greater than three times the country’s GDP per capita (“Over 3x GDP”). For the majority of countries, any expansion in the global measles vaccination results in cost savings. These tend to be countries either where measles is currently eradicated (the Americas) or countries which already have high coverage. Further, assuming MCV2 will no longer be needed after eradication indicates that measles eradication will be cost saving in almost every high income country. Countries where expansion of measles vaccination would not be considered cost-effective are European countries with few or no measles deaths.

Discussion (Repeats Executive Summary)

The goal of this project was to estimate cost and epidemiological consequences of various options in measles control. A strength of the project was the use of dual methods: a dynamic age-tiered measles transmission model for 6 countries and a linear model that could be applied to every country in the world. It is no surprise that the different methods lead to different estimates of the cost effectiveness of measles control. The range over which the estimates diverge helps gives planners more confidence that their decisions are not hinging on the thin support of a single point estimate of cost-effectiveness. Although the precise numerical estimates are slightly divergent, both approaches converge to give policy makers a consistent set of conclusions. Key conclusions that are robust across both models and extensive sensitivity tests are as follows:

- If one wanted to conserve scarce resources by stopping SIAs in GAVI eligible countries in 2010, restarting SIAs immediately would be a more cost-effective use of these resources than almost any other investment in health.
- By all metrics for cost-effectiveness, scaling up routine measles coverage while maintaining SIAs in countries that have not yet achieved 90% coverage is a very cost-effective investment in health, even if the benefits from being able to control rubella are not included.

- When measles coverage becomes high enough to justify the addition of rubella antigen, the societal savings from prevented cases of congenital rubella syndrome can be from 50 to 100% as large as a country's expenditure on measles immunization.
- Countries that have already eliminated measles achieve financial savings if measles is eradicated globally. The financial savings amount to 9-10% of the global incremental costs of measles control.
- Uncertainty about the degree of population overlap in MCV2 and MCV1 coverage as well as uncertainty about epidemiological mixing of age groups and communities have the largest impact on estimates of immunization effectiveness. Measuring these factors better would be priorities for future empirical epidemiological research.

The principal limitation of the project extends to any attempt to project a human-controlled social endeavor into the future. The estimates assume the ability to implement plans that are based on a stable social environment. It is almost certain that among 190 countries attempting to improve measles control in the next two decades that contingent events will arise whose costs and epidemiological consequences cannot be predicted by a model. Among these predictably unpredictable contingencies are: war, climate change, anti-immunization social movements, and mass-migrations. In addition, our uncertainty about how each country will actually go about implementing scale up of measles control and sustaining political will is so large that it defies quantification.

To counter these limitations the strategy used to estimate the costs of measles control is overtly conservative. We assumed that even though low income countries have been able to achieve their current levels of MCV1 coverage at \$1.00 per child (Brenzel, Wolfson et al. 2006), efforts to expand coverage would require new and recurring investments in supervision, outreach, logistics, and cold chain. Following the template of the "Reaching Every District" (Ryman, Macauley et al. 2009) strategy, our ingredients based model implied that reaching new and heretofore uncovered populations of children on a permanent basis would cost \$18 to \$28 per newly covered child per year in core areas of low income countries and \$27 to \$38 per newly covered child in outlying satellite areas (Table 2)⁶. These costs exceed the average annual per child costs of all government health spending in many low income countries. Health planners who believe that they can increase MCV coverage for lower costs should thus conclude that increasing measles coverage is even more cost-effective than claimed by our model.

Covering heretofore uncovered populations of children in high income countries where there is social resistance to vaccines could be even more financially costly. Nobody has been able to estimate the costs of improving coverage with these affluent populations, although elements of the strategy include strong surveillance, political commitment, societal support, and outreach (WHO 2010). Our approach has been to say "What if it costs \$200 per newly covered child", in these affluent populations. Such an expenditure would be approximately 20% of the annual cost of all medical care for a child in many affluent countries. Health planners who believe that they can increase MCV coverage in affluent populations more cheaply would also be supported in

⁶ Our model involves hiring a new full time auxiliary worker whose job is to visit every household to identify unvaccinated children and refer them to the local venue for vaccination. This new worker requires minimal training and is not drawn from the ordinary cadres of health workers.

thinking that scaling up measles control in high income countries is more cost-effective than claimed by our model.

The Cost Effectiveness of SIAs

The model's clearest results are on the consequences of withdrawing support for SIAs in GAVI eligible countries. The global model (Table 4) shows that Africa could save \$26 million over the next 40 years if it stopped SIAs. The direct savings from stopping SIAs are undermined because of a rise in the costs of measles cases. Furthermore, the cost effectiveness ratios show that there is probably no better use of \$26 million than to spend it on SIAs that can avert DALYS at \$35 per DALY in Africa in the linear model (Table 4). The estimated cost effectiveness ratios of SIAs were even more favorable in the dynamic transmission models: \$19.2, \$2.5, and \$1.5 per DALY averted in Bangladesh, Ethiopia, and Uganda respectively (Table 3).

The estimated ICERS for all of Africa in the linear model are higher than those estimated for Ethiopia and Uganda with the dynamic model. The principal reason is that the dynamic transmission model of measles in Ethiopia and Uganda could capture the impact of stopping SIAs on the number of susceptible children in these countries. One can observe how the percent of toddlers immune due to vaccines erodes in the 4 years after SIAs are stopped and how this translates into more frequent measles outbreaks in Figure 1. When a large number of susceptible children accumulate, the epidemiological consequences of an outbreak are more severe. Linear models cannot capture these dynamic effects of accumulated susceptibility. Nevertheless, the cost-effectiveness ratios emerging from both linear and dynamic models indicate that SIAs fall within a benchmark of $< 1/3$ GDP capita that would merit their status as highly cost-effective.

The Cost Effectiveness of Mortality Reduction, Elimination, and Eradication

Measles mortality reduction, measles elimination, and measles eradication are interdependent decisions. A country must first decide whether to increase measles control beyond the current levels. If control is to be scaled up, one could choose whether to continue to scale up control efforts to the point where endogenous measles transmission is "eliminated". On a global level, if a plurality of countries has decided to eliminate measles, global coordination could be contemplated where 100% of countries share a goal of measles elimination—a goal, which if achieved, would constitute measles eradication.

The key message of the modeling project is that for low income countries, the cost-effectiveness ratios of mortality reduction, elimination, and eradication are all similar. For low income countries there is no compelling statistically significant difference in the cost effectiveness ratios of any of these three strategies. The models do indicate that if eradication is achieved it permits some cost saving options for every country like the discontinuation of MCV2. For high income countries that have already eliminated measles, in particular the Americas, a decision to eradicate measles would lead to large financial savings from reductions in MCV2, outbreak control, and surveillance. There is a \$1 to 1.3 billion dollar financial difference for the Americas between measles eradication and measles mortality reduction, mostly savings realized if MCV2 is discontinued. In contrast, there is a much smaller difference to Africa between mortality reduction scenarios and measles elimination. In the linear models for Africa, 98% mortality reduction by 2020 would cost an additional \$10 billion, whereas eradication by 2020 would cost \$9.2 billion or \$7.4 billion depending on whether MCV2 is retained or abandoned after 2023 respectively (Table 4). The dynamic models reinforce this result showing that a 98% mortality reduction strategy would cost \$9.5 million and \$4.7 million

in Ethiopia and Uganda respectively whereas comparable numbers for Eradication by 2020 would be \$12 million and \$ 6.6 million for the respective countries. In each country the 95% confidence intervals for the cost estimates overlap so there is no grounds to conclude that mortality reduction strategies are statistically significantly less expensive (Table 3). One reason for the similarity in costs is that a country that chooses a mortality reduction might not achieve routine coverage levels that are high enough to warrant discontinuation of costly SIAs. In contrast the measles eradication scenarios that we modeled incurred higher costs to attain MCV coverage well above a 90% threshold and were able to discontinue SIAs (See Figure 3).

The conclusion that measles mortality reduction strategies are not economically superior to eradication strategies echoes result seen in economic models of polio control (Thompson and Tebbens 2007). Our results extend this insight because the dynamic transmission models underlying it were applied to 6 different countries and accompanied by extensive sensitivity analysis to assess the robustness of the conclusion to variations in the epidemiological and cost parameters. The result also emerges independently from the linear model. Furthermore, the result emerges despite a cost model that assumes that the per child cost of increasing immunization coverage escalates as coverage is increased among heretofore unvaccinated populations and in remote satellite populations of difficult to reach children.

Note that our cost model assumes that the low demand and refusal to accept measles vaccine in low income and high income populations respectively can be overcome by quite substantial financial investments in outreach. Although the Americas were able to create and sustain demand for vaccination to the point at which measles could be eliminated (Pan American Health Organization 2005), it remains to be seen whether social obstacles can be overcome in other countries. An influential paper by Geoffard and Philipson indicated that infectious disease eradication was always less cost-effective than disease control if the demand for vaccination were entirely based on an individual's rational self-interest (Geoffard and Philipson 1997). In this theory, as the herd immunity threshold is reached in a population the individual benefit from a single vaccination becomes asymptotically small and for a rational parent it becomes economically more efficient to free-ride on herd immunity rather than to invest even a few cents of time and travel costs to vaccinate their children. It is possible that Geoffard and Philipson type economic calculations lie at the core of vaccine refusal in high income countries. However as is evident from the Americas, individual rational calculation by parents may also play a negligible role in reducing the demand for vaccination even after a disease is eliminated. Future uncertainty about the magnitude and cost of overcoming demand side resistance to vaccination scale up in other parts of the world is destined to play a role in the debate over the social feasibility of measles eradication.

The Cost Effectiveness of Rubella Control

According to WHO guidelines, countries that are working to eliminate measles should consider taking the opportunity to eliminate rubella by adding rubella antigen to their routine measles immunization program after having achieved a reliable measles coverage rate of 80% (WHO 2000). Our dynamic models of rubella control in Bangladesh, Ethiopia and Uganda found that adding rubella antigen was highly cost effective. This result echoes prior literature (Hinman, Irons et al. 2002)⁷. Assuming that each case of congenital rubella syndrome cost a

⁷ Our model of rubella costs was more conservative than prior models. We assumed that the lifetime costs to society of a case of CRS would be \$25,000 in a low income country. Prior studies assumed higher costs ranging from \$50,000 to \$64,000 in Barbados and Guyana respectively.

society \$25,000 in lost wages, medical care, and care-giving, the burden of CRS is sufficiently high that the savings can offset 50-100% of the costs of measles control.

The good news about the savings from rubella control should be a reason to encourage immunization programs everywhere to advance their routine MCV coverage above 80% so they can realize the health and financial benefits of eliminating rubella and CRS. In most low income countries CRS cases impose costs for care-giving on families and households rather than on the medical sector, but the benefits exceed the costs (Hinman, Irons et al. 2002). Whether or not rubella is included in the model has little bearing on the debate over measles mortality reduction or measles elimination/ eradication. It turns out that a country would exceed the 80% coverage threshold for the addition of rubella whether or not mortality reduction or measles elimination is chosen.

International Benefits from Measles Eradication

The global models of measles eradication locate the largest financial gains from eradication among the high income countries which stand to save \$2.3 to 2.6 billion if measles is eradicated and \$3.1 to \$3.7 billion if after eradication they decide to drop MCV2 coverage (Table 4). The largest financial requirements will be in low and middle income countries which can be classified into 2 groups. The countries with very low coverage will require additional spending of \$5.3 to \$6.5 billion to eradicate measles. Other low and middle income countries will require \$6.8 to \$10.3 billion to eradicate measles. Countries that currently have very low coverage are assumed to face higher financial obstacles to increase coverage, hence they are assumed to need to spend much more to bring their coverage up to eradication thresholds and this spending makes the cost effectiveness less attractive ranging from \$106 to \$126 per DALY averted. Other low and middle income countries that have not yet eliminated measles are projected to require from \$6.9 to 10.3 billion over the next 40 years, but measles eradication in these countries is a very cost effective health investment at \$17 to \$24 per DALY averted.

In the global picture, measles eradication ranges from being cost saving to being very cost effective. For low income countries the total financial requirements from measles eradication are similar to those for mortality reduction scenarios. For high income countries the financial savings are only realized if measles is eradicated. The amount of money saved by the countries that do realize net savings from measles eradication is sufficient to offset 10% of the incremental global costs of measles eradication.

Future Priorities in Measles Research for Decision-Making

Although the point estimates of deaths, DALYs, and costs shift somewhat as parameters are altered, the fundamental conclusions discussed above do not change during sensitivity analysis for a wide range of assumptions about the behavior of measles dynamics and the nature of the costs of measles control. The sensitivity analysis can inform investment priorities in research on measles. Based on the experience with other disease eradication efforts, the key unknowns are the magnitude and location of social and political obstacles to measles control. Greater understanding about the factors that support the politics of measles control and population demand for these programs would be of immense value to decision-making.

Basic research on measles epidemiology has offered important lessons for biology and ecology. Our project has allowed us to identify those epidemiological factors that have the greatest impact on the cost-effectiveness ratios of various measles control options. \$19.2, \$2.5, and \$1.5 per Despite the sensitivity of the cost-effectiveness ratios to the model parameters, the

range across which ICERs vary does not alter any of the conclusions discussed above. Better measurement is unlikely to reverse any of the above conclusions. ICERs are varying, but they remain less than \$100 per DALY across the range of parameters. Decision-makers in the health sector do not generally have the luxury of league tables for other health interventions that are defined with precisions smaller than +/- \$100 per DALY. Furthermore few, if any decision-makers possess a cleanly defined threshold about how much they would be willing to pay for a DALY averted that would discriminate between multiple options priced less than \$100 per DALY.

The project can be summarized as follows. For countries that do not yet have high routine measles coverage it would be a cost-effective investment to spend up to \$20 to \$30 per newly covered child to improve measles coverage. The reaching every district (RED) strategy which involves new and recurrent investments in outreach, supervision, and logistics forms a good starting template for these efforts to scale up. Whether or not low income countries sustain these increases all the way into the mid 90% coverage rate required for measles elimination, the investments in better measles coverage have similar cost effectiveness ratios from the perspective of low income countries. In contrast, the high income countries of the world achieve dramatically higher financial gains if measles is eradicated (i.e. eliminated in 100% of countries.)

High income countries may choose to invest more in measles control efforts in low income countries than their direct financial savings, particularly if they perceive altruistic gains from eradicating an historical scourge of mankind. The high income countries that gain the most from measles eradication may choose to “equitably” diffuse their support for measles efforts among all low income countries. However, it is likely that global progress towards measles eradication will reveal the existence of “weakest link” countries facing obstacles that they truly cannot overcome without external support. Predicting where these weakest links will occur and the best policy to strengthen their efforts is a high priority in the future of measles control.

Tables

Table 1 Scenarios tested

Strategy	Description of Strategy
Baseline (B) :	Freeze routine coverage at the 2010 levels that achieved a 90% reduction in mortality relative to 2000*
Stop SIAs (SS):	Freeze routine coverage at 2010. No more SIAs after 2010.
95% Mortality reduction by 2015	Maintain SIAs and increase routine coverage by 3 percentage points per year from 2010 to 2015
98% Mortality reduction by 2020	Maintain SIAs and increase routine coverage by 2 percentage points per year from 2010 to 2020
Eradication 2020 (Erad2020):	Eliminate endogenous transmission measles in every country by 2020. For countries above 70% coverage this is achieved by increasing coverage by 3 percentage points per year until 2020. For failed states and countries below 60% this implies best efforts at improving routine coverage and annual SIAs.
Eradication 2025 (Erad2025):	Eliminate endogenous transmission measles in the country by 2025 by increasing routine measles coverage by 3 percentage points per year till 2025

*India has not yet achieved the 90% mortality reduction and it is an exception. India's baseline scenario would be to advance coverage to 90% mortality reduction levels by around 2013 and then to freeze routine coverage there.

Table 2. Typical parameters for low income countries. Parameters for high income countries in appendix

Parameter	Bangladesh	Ethiopia	Uganda	Source
Baseline average cost per child vaccinated prior to scale up	\$1.04	\$1.00	\$1.00	(Brenzel, Wolfson et al. 2006)
Scale up cost per child for core areas	\$27.83	\$18.82	\$26.93	(See appendix)
Scale up cost per child for satellite areas	\$37.93	\$27.4	\$35.83	
Scale up cost per child for MCV2 in core areas	\$8.79	\$11.04	\$8.79	
Scale up cost per child for MCV2 in satellite	\$27.11	\$13.99	\$27.10	
SIA cost per child	\$0.58	\$0.58	\$0.58	
Monthly force of infection parameters (x 10 ⁻⁵)	Jan 7.75 Feb 8.88 Mar 1.01 Apr 8.43 May 7.55 Jun 7.37 Jul 7.19 Aug 6.98 Sep 6.89 Oct 6.83 Nov 6.77 Dec 6.87	6.392 7.325 8.090 8.57 7.162 10.455 7.821 7.61 7.831 8.567 7.201 8.348	6.392 7.325 8.090 8.57 7.162 10.455 7.821 7.61 7.831 8.567 7.201 8.348	(See appendix)
Initialization of proportion vaccinated	0.65-0.88*	0.12-0.77*	0.59-0.77 *	(WHO/UNICEF 2010)
Initial measles case fatality rate**	Infant: 0.034 Toddler: 0.017 Child: 0.0085 Adult: 0.0085	0.06 0.03 0.015 0.015	0.06 0.03 0.015 0.015	(Wolfson, Grais et al. 2009)
Life expectancy (additional years)	Infant: 67.3 Toddler: 65.3 Child: 57.9 Fertile: 39.9 Post Fertile: 20	62.2 60.2 54.9 37.2 20	54.8 52.8 47.9 31.4 20	(World Health Organization 2007)
Fraction of population in hard to reach (satellite) compartment	17%	32%	25%	(UNICEF and WHO 2010)
Initial population sizes (Millions)	Infant: 3.3 Toddler: 10.6 Child: 29.1 Fertile: 73.9 Post Fertile: 47.7	2.9 9.5 21.1 31.5 9.4	1.29 4.12 8.49 11.60 10.49	(United Nations 2008)

*For the first 20 years of the model, the proportion of adults vaccinated tracks historical coverage rates as they were reported to WHO from 1990 to 2009. After 2025, the model tracks the coverage rates that were depicted in the model's earlier years. The historical coverage of children and toddlers is similarly tracked, but for only 5 and 2 years respectively.

**From 2011 to 2050 CFR declines in parallel with the improvements in U5MR that the UN has projected for each country (United Nations 2008).

Table 3 Δ DALYs Δ Costs ICERS under 6 scenarios

	Δ Discounted DALYs relative to baseline		Δ Discounted Costs (\$ millions) relative to baseline		Incremental Cost Effectiveness Ratio (ICER) \$ per DALY averted			
Bangladesh	Mean SD		Mean SD		Median	Interquartile Range		Notes
Stop SIAs (SS)	2,336,191	(909,451)	-44	(7)	-\$19.2	(13.5; 28.9)		[1]
95% Reduction by 2015	-1,875,481	(471,422)	61	(4)	\$33.6	(26; 44)		
98% Reduction by 2020	-1,776,571	(495,278)	74	(5)	\$41.9	(33; 54)		
Eradication 2020 (E2020)	-1,960,814	(450,491)	156	(4)	\$81.2	(67; 102)		
Eradication 2025 (E2025)	-1,957,643	(452,312)	164	(4)	\$85.3	(70; 108)		
Eradication 2020 & Stop MCV2	-1,970,462	(449,259)	71	(4)	\$36.5	(29; 48)		
Eradication 2025 & Stop MCV2	-1,936,774	(445,737)	102	(4)	\$54.5	(43; 68)		
Ethiopia								
Stop SIAs (SS)	10,500,000	(1,689,198)	-26	(5)	-\$2.5	(2.0; 3.1)		[1]
95% Reduction by 2015	-4,376,613	(1,137,958)	197	(4)	\$43.5	(38; 56)		
98% Reduction by 2020	-4,632,074	(1,170,513)	394	(4)	\$85.6	(72; 107)		
Eradication 2020 (E2020)	-6,032,890	(1,008,378)	534	(3)	\$90.6	(78; 101)		
Eradication 2025 (E2025)	-5,743,865	(1,196,262)	644	(4)	\$111.7	(96; 132)		
Eradication 2020 & Stop MCV2	-6,072,661	(1,073,303)	376	(4)	\$63.7	(54; 71)		
Eradication 2025 & Stop MCV2	-5,942,791	(981,697)	506	(3)	\$86.1	(76; 97)		
Uganda								
Stop SIAs (SS)	5,090,410	(900,440)	-7	(4)	-\$1.5	(-2.2; -.8)		[1]
95% Reduction by 2015	-2,151,080	(647,752)	154	(3)	\$71.9	(58.6; 90.5)		
98% Reduction by 2020	-2,366,737	(649,053)	281	(3)	\$119.2	(100.0; 147.4)		
Eradication 2020 (E2020)	-3,339,213	(563,099)	393	(3)	\$117.9	(106.2; 135.5)		
Eradication 2025 (E2025)	-3,257,160	(539,862)	478	(3)	\$147.0	(133.4; 166.8)		
Eradication 2020 & Stop MCV2	-3,285,990	(608,428)	293	(3)	\$89.3	(78.2; 103.0)		
Eradication 2025 & Stop MCV2	-3,250,320	(568,643)	383	(3)	\$119.1	(106.1; 134.4)		
Brazil								
Eradication 2020 (E2020)	-93	(68)	-41	(.6)	-\$432,374	(-279,823.4; -630,151)		[2]
Eradication 2025 (E2025)	-68	(71)	-31	(.6)	-\$393,988	(-226,747.1; -658,491)		
Eradication 2020 & Stop MCV2	-100	(55)	-68	(.6)	-\$748,232	(-509,957.1; -1,042,652)		
Eradication 2025 & Stop MCV2	-75	(65)	-52	(.6)	-\$645,887	(-390,613.6; -1,175,064)		
Colombia								
Eradication 2020 (E2020)	-330	(541)	-12	(3)	-\$70,327.3	(-36,992; -92,640)		[2]
Eradication 2025 (E2025)	-297	(546)	-9	(3)	-\$58,088.2	(-27,131; -87,128)		
Eradication 2020 & Stop MCV2	-328	(542)	-21	(3)	-\$122,372.0	(-62,848; -169,652)		
Eradication 2025 & Stop MCV2	-305	(546)	-16	(3)	-\$102,784.0	(-43,483; -146,024)		
Tajikistan								
Eradication 2020 (E2020)	-9,632	(3,152)	14	(1)	\$1,496.7	(1,867.8; 1,183.8)		[2]
Eradication 2025 (E2025)	-6,449	(3,004)	12	(1)	\$1,822.2	(2,756.1; 1,370.8)		
Eradication 2020 & Stop MCV2	-9,736	(2,714)	9	(1)	\$954.5	(1,275.9; 782.3)		
Eradication 2025 & Stop MCV2	-7,064	(2,780)	9	(1)	\$1,286.0	(1,774.4; 910.1)		

[1] Stop SIAs option is cost saving, but increases the DALY burden

[2] Eradication options in Brazil, Colombia, and Tajikistan save money and lower DALY burden. ICER column gives ratio in which these benefits accumulate

Baseline Levels	Bangladesh	Ethiopia	Uganda	Brazil	Colombia	Tajikistan
Discounted DALYs	1.9 M	6.3 M	3.5 M	131	325	11.4K
Discounted Costs	\$170M	\$157M	\$94M	\$192M	\$55M	\$15M

Table 4: Costs, effects, and cost effectiveness of different scenarios at the global level

Region	Baseline			Eradication 2020			Eradication 2025			Eradication 2020 with no MCV2 after elimination			Eradication 2025 with no MCV2 after elimination		
	Cost (Billions)	DALYs (Billions)	IC (M\$)	IC (M\$)	IDA (M)	ICER	IC (M\$)	IDA (M)	ICER	IC (M\$)	IDA (M)	ICER	IC (M\$)	IDA (M)	ICER
Global	23	0.5	13,872	488	28		12,712	465	27	7,753	488	16	8,002	465	17
WHO Region															
Africa	2	0.1	9,237	92	101		8,596	88	98	7,447	92	81	7,170	88	81
America	4	0.0	(305)	0	C/S		(222)	0	C/S	(1,316)	0	C/S	(1,000)	0	C/S
Eastern Mediterranean	1	0.0	1,298	44	29		1,165	42	28	767	44	17	757	42	18
Europe	5	0.0	(370)	0	C/S		(316)	0	C/S	(1,285)	0	C/S	(1,013)	0	C/S
Southeast Asia	4	0.4	4,743	333	14		4,175	317	13	3,460	333	10	3,216	317	10
Western Pacific	5	0.0	(730)	19	C/S		(687)	18	C/S	(1,320)	19	C/S	(1,128)	18	C/S
By Income and Coverage															
Current Very Low Coverage	1	0.1	6,506	52	126		6,080	50	122	5,505	52	106	5,284	50	106
Low-Middle Income, Not Yet Eliminated	9	0.5	10,289	435	24		9,158	415	22	7,285	435	17	6,865	415	17
Low-Middle Income, Eliminated	1	0.0	(266)	0	C/S		(193)	0	C/S	(329)	0	C/S	(240)	0	C/S
High Income, Not Yet Eliminated	9	0.0	(2,617)	1	C/S		(2,304)	1	C/S	(3,721)	1	C/S	(3,147)	1	C/S
High Income, Eliminated	3	0.0	(39)	0	C/S		(30)	0	C/S	(987)	0	C/S	(760)	0	C/S

(Table 4 Continued)

Region	Maintain current coverage without SIAs in GAVI countries				95% Mortality Reduction				98% Mortality Reduction			
	IC (M\$)	IDA (M)	ICER		IC (M\$)	IDA (M)	ICER		IC (M\$)	IDA (M)	ICER	
Global	(2,124)	(63)	34		6,380	209	31		12,243	411	30	
WHO Region												
Africa	(898)	(26)	35		4,396	39	112		9,993	77	129	
America	(38)	0	N/A		(13)	0	N/A		(6)	0	N/A	
Eastern Mediterranean	(273)	(6)	43		556	19	29		1,073	37	29	
Europe	(8)	(0)	748		(740)	0	C/S		(652)	0	C/S	
Southeast Asia	(884)	(30)	30		3,217	143	23		3,658	280	13	
Western Pacific	(22)	(1)	29		(1,056)	8	C/S		(1,839)	16	C/S	
By Income and Coverage												
Current Very Low Coverage	(567)	(15)	38		3,557	22	161		7,294	44	167	
Low-Middle Income, Not Yet Eliminated	(1,518)	(48)	32		4,615	186	25		7,514	367	20	
Low-Middle Income, Eliminated	(38)	0	N/A		(13)	0	N/A		(7)	0	N/A	
High Income, Not Yet Eliminated	0	0	N/A		(1,799)	0	C/S		(2,576)	1	C/S	
High Income, Eliminated	0	0	N/A		0	0	N/A		1	0	N/A	

IC: Incremental costs

M: Millions

N/A: Not applicable

Very Low Coverage: Current MCV1 coverage under 65% and/or the presence of armed conflict within a country

High Income: GDP greater than US\$11,906

Low-Middle Income: GDP less than US\$11,906

All costs reported in 2010 US\$

M\$: Millions of dollars

ICER: Incremental cost effectiveness ratio

IDA: Incremental DALYs averted

C/S: Cost saving

Figure 1 Epidemic curves for natural history and six scenarios for the example of Uganda

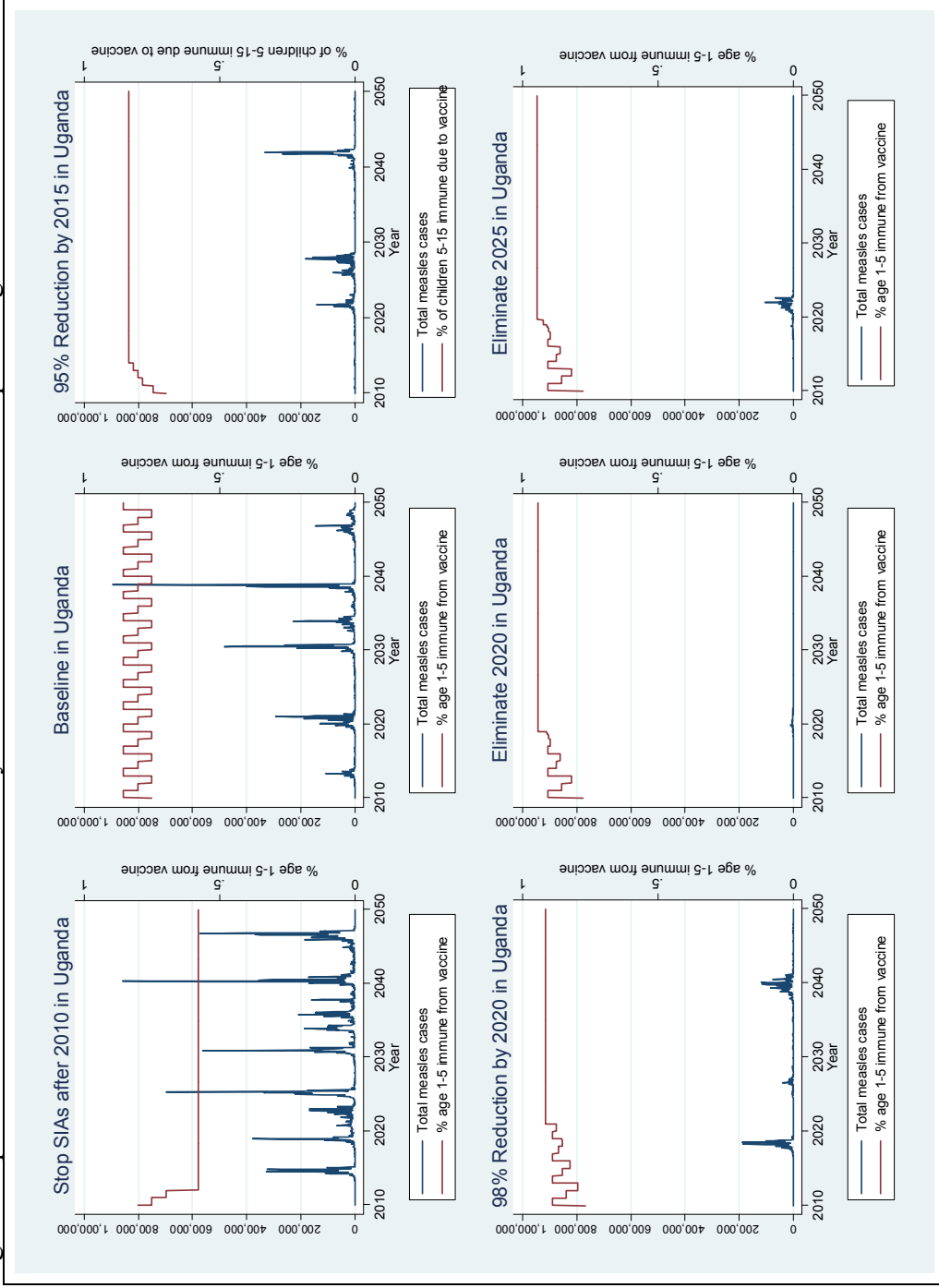

Figure 2 Costs vs. measles DALYs and Costs vs. measles deaths for 6 scenarios.

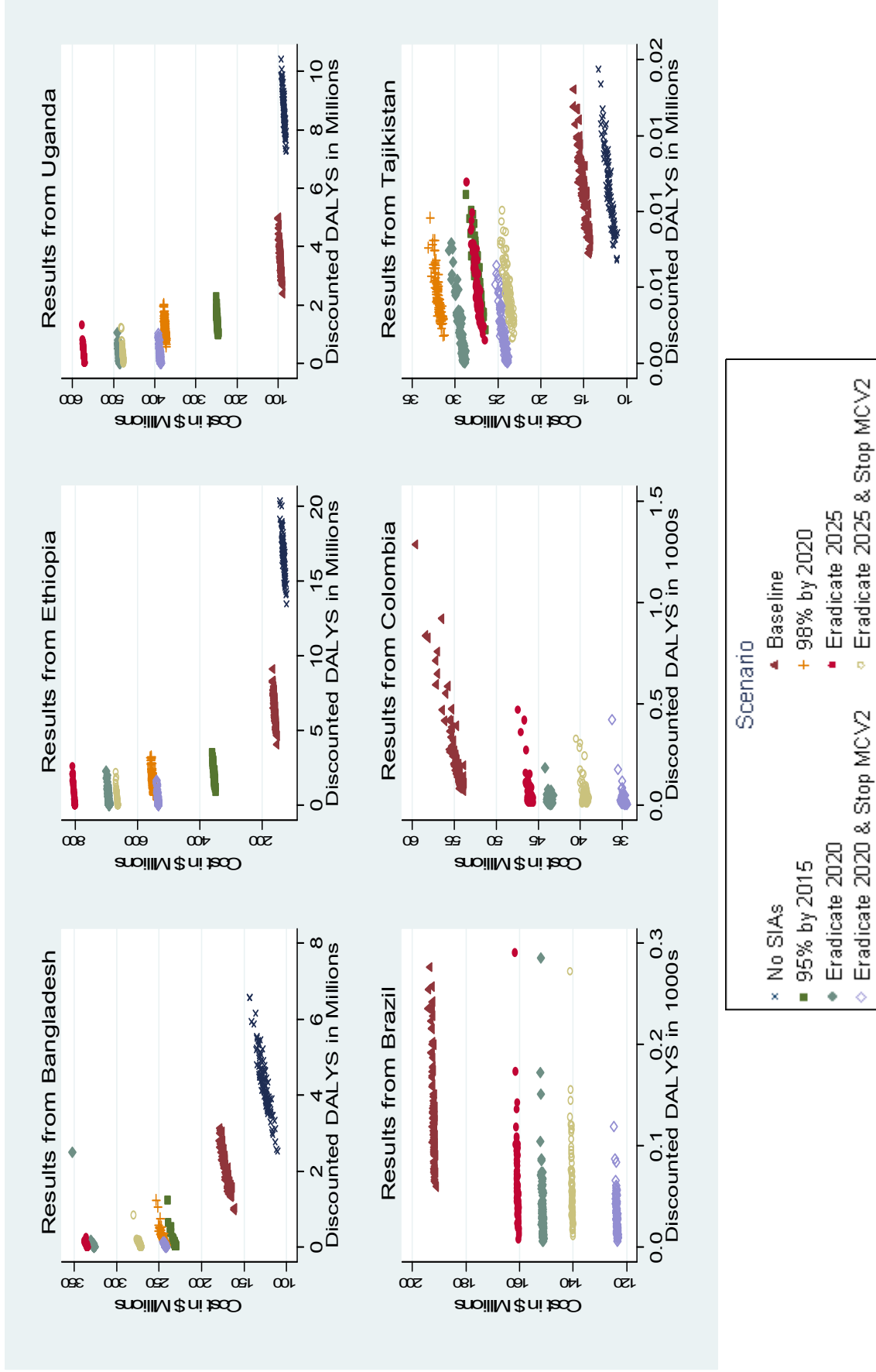

Figure 3. Components of costs in each scenario

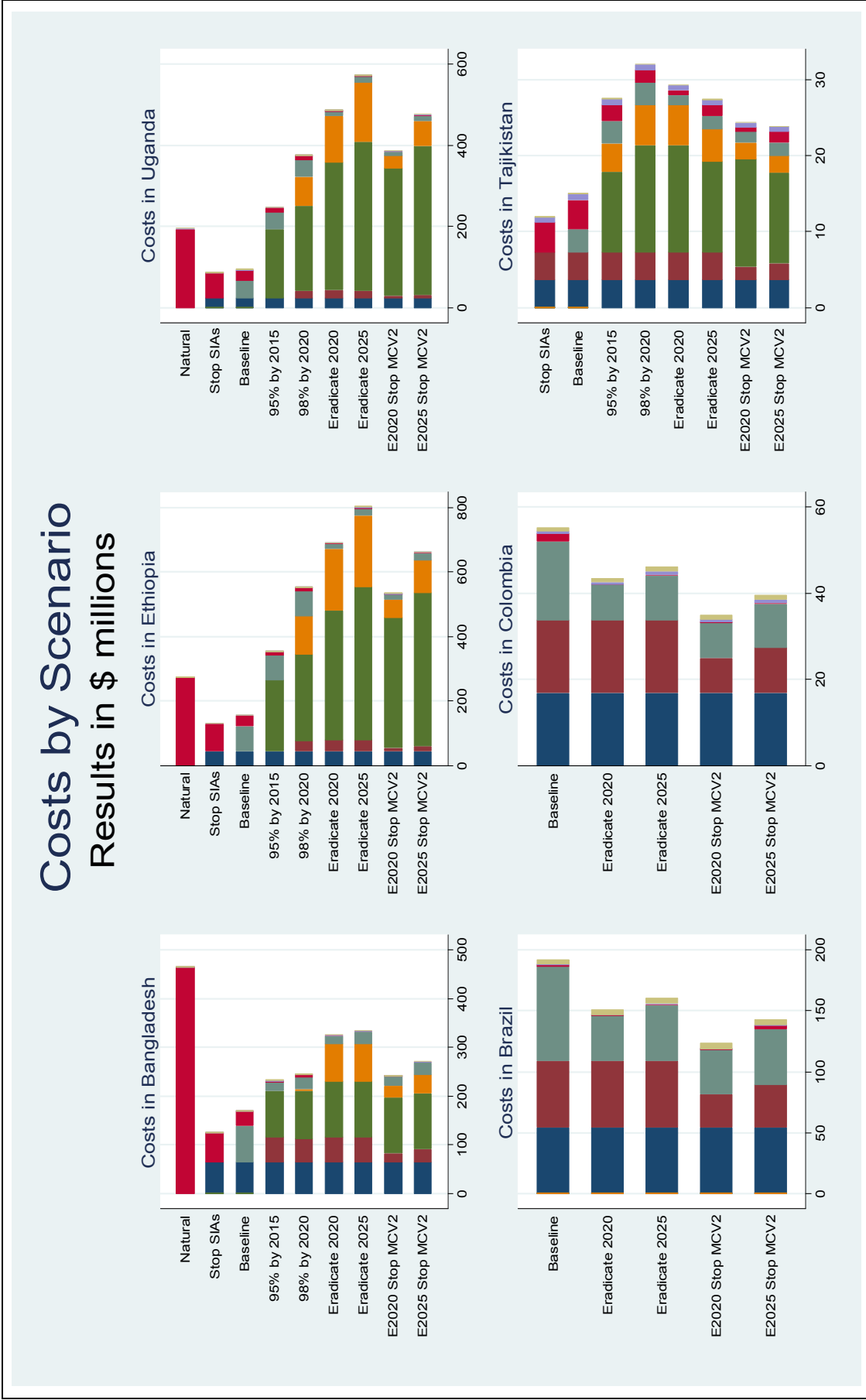

Figure 4 Sensitivity analysis. Tornado diagrams showing impact of parameter changes on ICERs for Uganda.

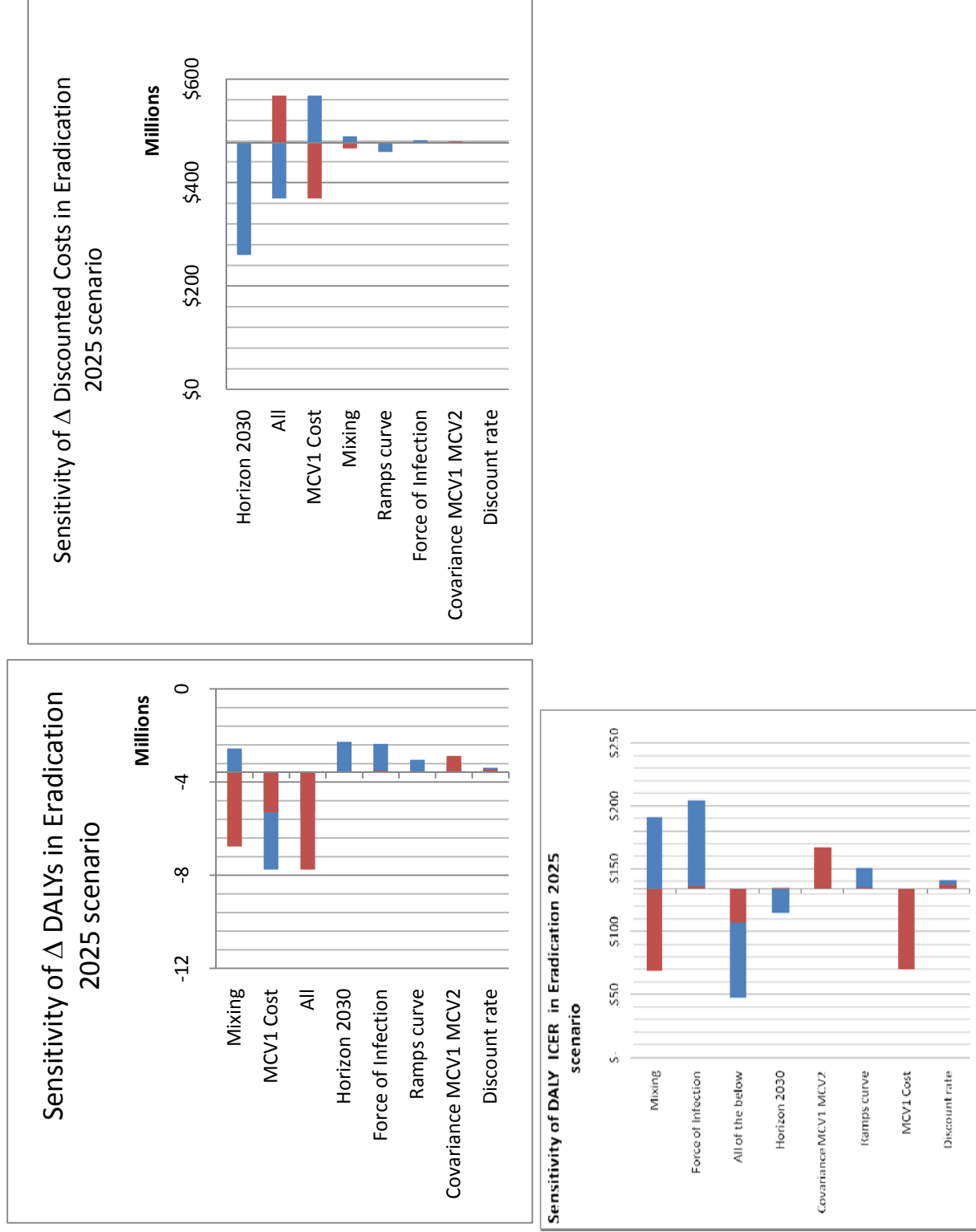

Figure 5: ICERs for individual countries, by scenario and classification

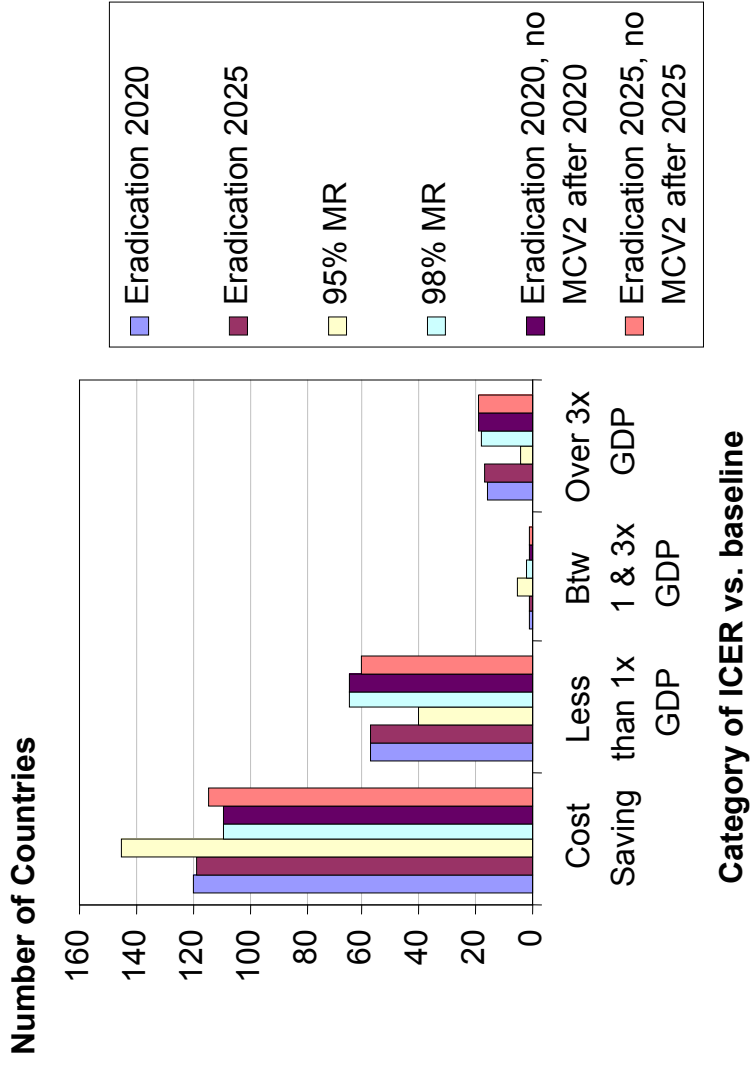
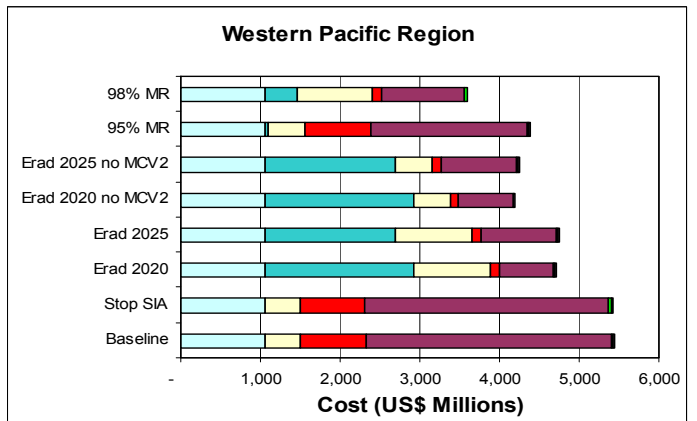
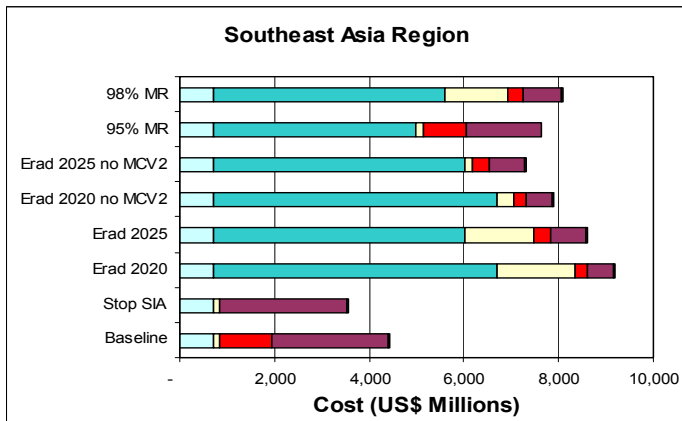
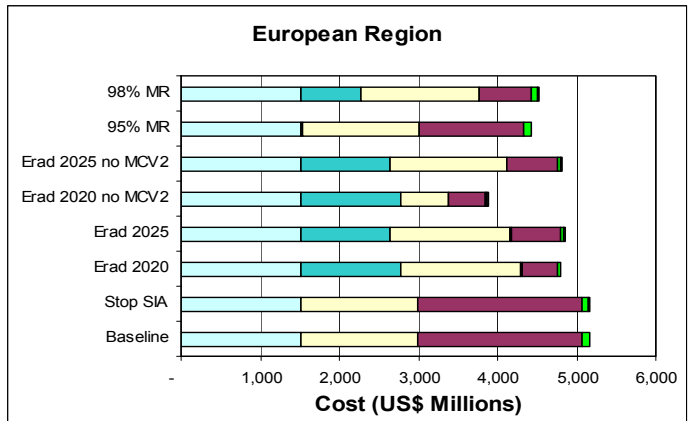
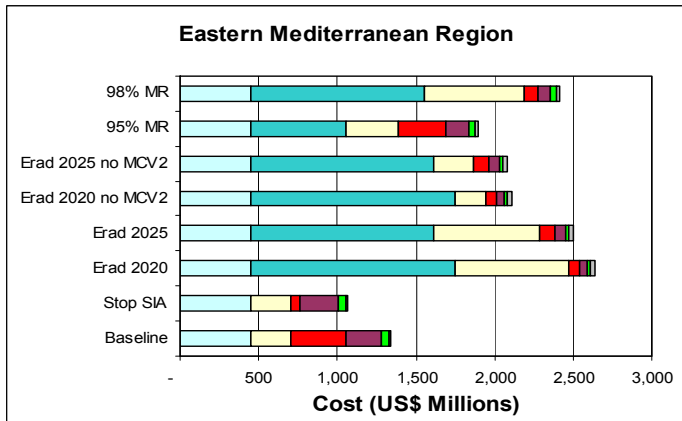
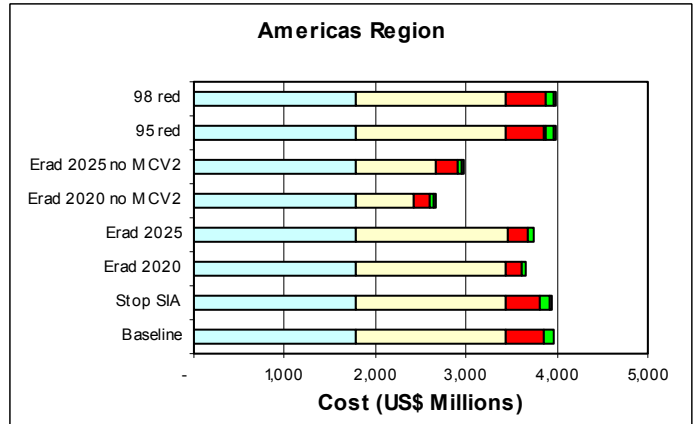
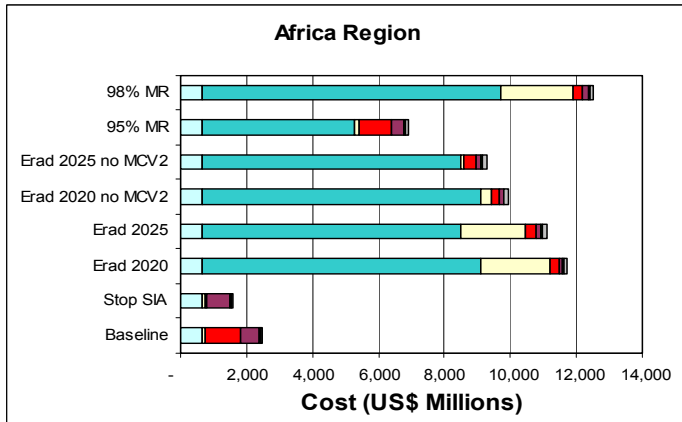

Figure 6: Cost breakdown of different scenarios by global region



BIBLIOGRAPHY

1. Anderson, R. and R. May (1991). Infectious Diseases of Humans. Oxford, Oxford Press.
2. Barrett, S. (2007). Why Cooperate? The Incentive to Supply Global Public Goods. Oxford, Oxford University Press.
3. Bjornstad, O. N., B. F. Finkenstadt, et al. (2002). "Dynamics of Measles Epidemics: Estimating Scaling of Transmission Rates Using a Time Series SIR Model." Ecological Monographs **72**(2): 169-184.
4. Black, R. E., S. Cousens, et al. "Global, regional, and national causes of child mortality in 2008: a systematic analysis." Lancet.
5. Brenzel, L., L. Wolfson, et al., Eds. (2006). Vaccine-Preventable Disease. Disease Control Priorities in Developing Countries. New York, Oxford University press.
6. Chin, J. (1983). An Evaluation of the Public Health Importance of Measles in Burma. Geneva, WHO.
7. Cliff, A., P. Hagget, et al. (1993). Measles: An Historical Geography. Cambridge, MA, Blackwell Publishers.
8. Cummings, D. A., W. J. Moss, et al. (2006). "Improved measles surveillance in Cameroon reveals two major dynamic patterns of incidence." Int J Infect Dis **10**(2): 148-55.
9. Cutts, F. T. and E. Vynnycky (1999). "Modelling the incidence of congenital rubella syndrome in developing countries." Int J Epidemiol **28**(6): 1176-84.
10. D'Souza, S., A. Bhuiya, et al. (1988). Mortality and morbidity: The Matlab Experience. Ottawa, International Development Research Centre.
11. Dabral, M. (2009). "Cost-effectiveness of supplementary immunization for measles in India." Indian Pediatr **46**(11): 957-62.
12. Dowdle, W. R. (1998). "The principles of disease elimination and eradication." Bull World Health Organ **76 Suppl 2**: 22-5.
13. Fiedler, J. L. and T. Chuko (2008). "The cost of Child Health Days: a case study of Ethiopia's Enhanced Outreach Strategy (EOS)." Health Policy Plan **23**(4): 222-33.
14. Finkenstadt, B. F. and B. T. Grenfell (2000). "Time series modelling of childhood diseases: a dynamical systems approach." Applied Statistics **49**(part 2): 187-205.
15. Geoffard, P. and T. Philipson (1997). "Disease Eradication: Private versus Public Vaccination." American Economic Review **87**(1): 222-30.

16. Hinman, A. R., B. Irons, et al. (2002). "Economic analyses of rubella and rubella vaccines: a global review." Bull World Health Organ **80**(4): 264-70.
17. O'Donovan, C. (1971). "Measles in Kenyan Children." East Afr Med J **48**(10): 526-532.
18. Pan American Health Organization (2005). Measles elimination: field guide. Washington, DC, PAHO.
19. Ryman, T., R. Macauley, et al. (2009). "Reaching every district (RED) approach to strengthen routine immunization services: evaluation in African region, 2005." Journal of Public Health **32**(1): 18-25.
20. Sudfeld, C. R. and N. A. Halsey (2009). "Measles case fatality ratio in India a review of community based studies." Indian Pediatr **46**(11): 983-9.
21. Thompson, K. M. and R. J. Tebbens (2007). "Eradication versus control for poliomyelitis: an economic analysis." Lancet **369**(9570): 1363-71.
22. UNICEF and WHO (2010). Immunization Summary: A Statistical Reference Containing Data Through 2008 (2010 Edition). New York and Geneva, UNICEF and WHO.
23. United Nations (2008). World Population Prospects Data. New York, United Nations.
24. WHO (2000). "Rubella Vaccines: WHO Position Paper." Weekly Epidemiological Record **75**: 161-172.
25. WHO. (2010). "Measles Surveillance Data." Retrieved March 26, 2010, 2010, from http://www.who.int/immunization_monitoring/diseases/measles_monthlydata/en/index.html.
26. WHO (2010). Programmatic Feasibility of Measles Elimination in WHO European Region. Geneva, WHO.
27. WHO/UNICEF. (2010). "WHO/UNICEF estimates of immunization coverage." Retrieved July 3, 2010, 2010, from http://www.who.int/immunization_monitoring/routine/immunization_coverage/en/index4.html.
28. Wolfson, L. J., R. F. Grais, et al. (2009). "Estimates of measles case fatality ratios: a comprehensive review of community-based studies." Int J Epidemiol **38**(1): 192-205.
29. World Health Organization (2007). Life Tables for WHO Member States, India 2006, World Health Organization.
30. World Health Organization (2009). "Global reductions in measles mortality 2000–2008 and the risk of measles resurgence." Weekly Epidemiological Record **84**: 505-516.

Appendix 1: Methodological Details for Epidemiological Models in the Six Country Study

1.0 Central model features

Because vaccination coverage is heterogeneous across districts, a model of a core (main) and a satellite (accessory) population can be regarded as more conservative. The project is not intended to focus on strategic choices between covering the core and satellite regions, but ignoring heterogeneity might overstate the cost-effectiveness of immunization.

The model features required for this task are thus the following:

- A population age structure that can exhibit immunity as a function of MCV1, SIA, and MCV2 schedules over time. Because these strategies differentially affect the immune status at different ages.
- A model scale of 1 million to “N” where “N” is the total population of the focal country.
- A population age structure that includes a fertile age cohort susceptible to CRS
- Age pyramid is proportional to the age pyramid of the focal country
- A core and a satellite compartment for the population
- Programmed in Stata 11 in code that is available from authors upon request. Program name is myxogogo.ado

For purposes of this exercise, all MCV1 recipient children can be regarded to receive vaccine during the middle of the month they become eligible. All SIA’s of 95% coverage can be regarded to uniformly cover 95% of the SIA-eligible target group.

2.0 Discrete stochastic dynamic model-architecture

2.1 States and Notation

The model’s disease forecast has a starting date of January, 2010 with a 2 week time step conforming to the natural time scale of the disease (Bjornstad, Finkenstadt et al. 2002).

The following state variables are updated every 2 weeks:

S_{hit}	Susceptible individuals
V_{hit}	Individuals effectively immune through vaccination
I_{hit}	Infectious
R_{hit}	Recovered

Reported “vaccinated individuals” are not the same as V , because vaccine efficacy is less than 1, and because vaccination coverage reports often include in the numerator counts of re-vaccinated children who had already sero-converted and of vaccinated children who already had immunity from prior measles infection.

The subscript “h” \in {Core, Satellite} denotes which population compartment is being described. The term “compartment” is not meant to convey any geo-spatial information—no assumptions are being made about the locations of the core and satellite population, but mixing rates between compartments are introduced to depict heterogeneity. This feature of the model is simply to

honor the intuition that coverage rates in a country are non-uniform. By modeling 2 parallel compartments, a core with higher coverage at the mean reported for the country, and a satellite with lower coverage this non-uniformity is depicted in the simplest possible way. The two compartments were initialized by setting the fraction in the satellite equal to the reported fraction of districts with coverage less than 80% as reported to WHO and UNICEF (UNICEF and WHO 2010)

Subscript “ i ” \in {Infant, Toddler, Children, Fertile, Post-fertile} denotes which age group. Infants are age 6 to 11 months, Toddlers age 1-4, Children 5-14, Fertile 15-45, and Post-fertile 45+. Both men and women are included in this group. Infants under 6 months are not included because they do not contribute a sufficient number of cases due to maternal antibodies. This age breakdown is motivated by the need to divide the population receiving MCV1—infants, from the population receiving 2nd doses—toddlers.

Children of school age have been implicated in driving much of the seasonality of measles via school year cycles (Schenzle 1984). Fertile women are necessarily broken out in order to model the impact of congenital rubella, and post-fertile is a residual population of low importance for either measles or rubella. The model

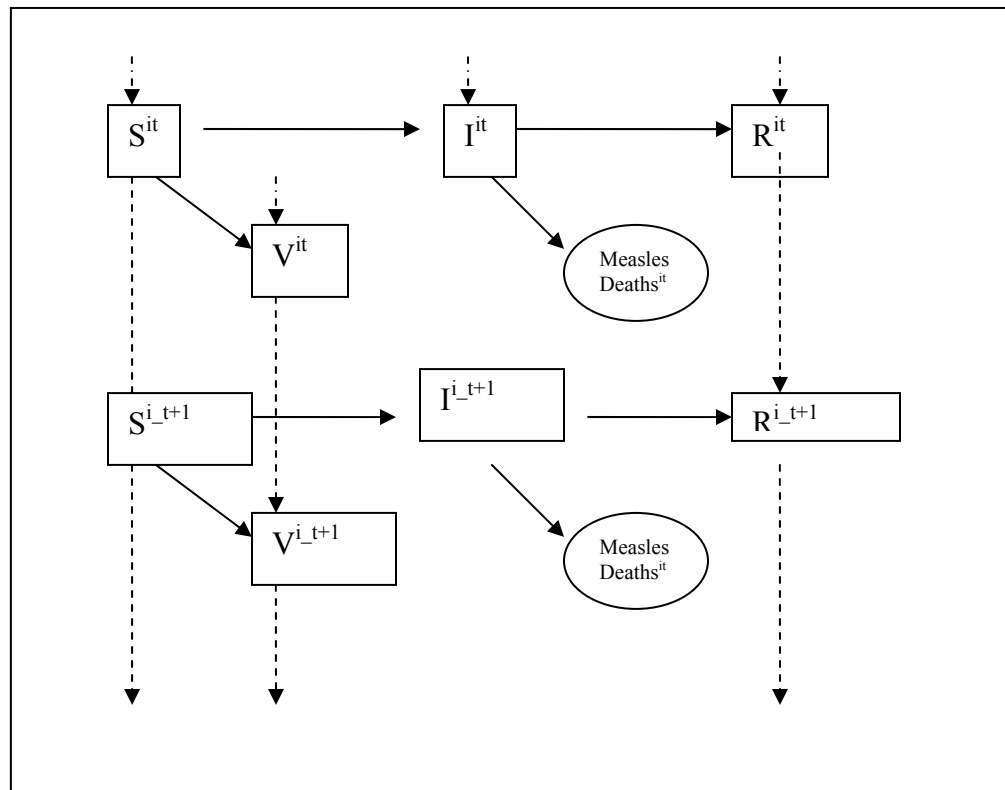

projects these populations to 2050 based on UN projections.

Subscript “ t ” \in {0...960} enables the model to run for 40 years ($40 \times 24 = 960$) from 2010 to 2050. The model imposes measles coverage ramps that lead to measles elimination dates of 2020 or 2025.

2.2 Demography

For each of the 6 countries the UN projections of births and age specific deaths are available in a quinquennial series from 2010 to 2050. These births and age-specific deaths have been interpolated down to a bi-weekly time scale that is linear between each 5 year update of the UN forecast from 2010, 2015, 2020, ...2045.

In order to model maternal immunity, infants are ignored until they are 6 months. In order to implement this, each birth count is adjusted by subtracting 92% of the infant deaths for that cohort. Infant deaths are not uniform over the first 12 months, most occur in the first month of life. We could not find a citation for the proportion of infant mortality that has accrued by 6 months, so we downloaded DHS data that has the month of infant death from parent self report. If the model had retained infants in the first half of infancy, it would have been necessary to arbitrarily accommodate a lower infectivity for all infants due to maternal antibodies retained by younger infants. Shortening effective infancy to its last 6 months makes infants more homogeneous. For each age cohort there will be an entry term, \hat{B} which denotes the number surviving from the previous age cohort. The term \hat{B} , conforms to the notation, B_{t-d} introduced by Finkenstadt and Grenfell (Finkenstadt and Grenfell 2000).

Each biweekly birth cohort can only enter the group of susceptibles, S_{INFANT} , but secular deaths and survival to next age cohort brings fresh entrants to S, V, I, and R states in proportion to their population fraction in the immediately preceding biweek. This implies that the model is ignoring heterogeneous population frailty that may be correlated with vaccination coverage rates. In other words, the model ignores the possibility that generic mortality hazards are higher in children who are least likely to present for vaccination. It also assumes that measles is not a significant cause of overall mortality.

Our experience in imposing the model on the entire population of large countries where population size was tens or hundreds of millions led to very inappropriate behavior with larger than normal outbreaks. Indeed the assumption of any SIR model is that the population counts in the S and I compartments are in epidemiological contact. This assumption is inappropriate for most national populations and for this reason all populations were first scaled to equal 1 million and then estimates of measles case counts and death counts were rescaled back to represent the national population. In essence, the scaling process makes our model of a country where there are N million people into a set of N separate non-communicating compartments of 1 million people. The computing demands of modeling contact rates between these N compartments would have exceeded the capacity of our present hardware.

2.3 Force of Infection

The system is governed by the difference equations [1-4]. The homogeneous case is presented on the left, however the model on the right is actually used for forecasting. Readers should peruse the model on the left first to understand the basic architecture before turning to the heterogeneous case on the right.

Homogenous Population	Heterogeneous Population “i” for age groups and “h” for core/satellite
[1a] $\lambda_t = \beta_s S_{t-1} (I_{t-1})^\alpha$	[1a'] $\lambda_{hit} = \beta_s S_{hi-1t-1} (I_{t-1} + \theta_{t-1})^\alpha$ <i>alternatively</i>
[1b] $I_t \sim \text{NB}(\lambda_t, I_{t-1})$	[1a''] $\lambda_{hit} = \beta_s S_{hi-1t-1} ((\sum_{j \in G} \rho_{ij} I_{hj-1t-1} + \rho_{-h} I_{-ht-1}) + \theta_{t-1})^\alpha$ [1b'] $I_{hit} \sim \text{NB}(\lambda_{hit}, I_{hit-1})$
[2] $S_t = S_{t-1} + \hat{B}_{t-1} - I_{t-1} - V_{t-1} - D_{t-1}$	[2'] $S_{hit} = S_{hi-1t-1} - I_{hi-1t-1} - V_{hi-1t-1} - D_{hi-1t-1}$
[3] $V_t = \kappa_t \varepsilon S_{t-1}$	[3'] $V_{hit} = \kappa_{hit} \varepsilon_i S_{hi-1t-1}$
[4] $R_t = R_{t-1} + \gamma I_{t-1}$	[4'] $R_{hit} = R_{hit-1} + \gamma I_{hit-1}$

Stochasticity enters the model by stipulating that I_t is updated from I_{t-1} as a series of draws from a negative binomial distribution. Parameter λ_t is a measure of epidemic intensity related to I_t through a negative binomial distribution with scale parameter I and dispersion parameter λ (Bjornstad, Finkenstadt et al. 2002). Each of the I_{t-1} infectious cases has a discrete probability of creating a new infection during the time step and the negative binomial allows for overdispersion in the distribution of these I_{t-1} independent trials. In our experience with the negative binomial, the overdispersion was inappropriately excessive for populations at the verge of measles elimination when the principal source of new infections was immigrant cases. We found unrealistically large outbreaks would occur under the binomial and improved model behavior by stipulating a Poisson distribution when measles incidence was less than 1 per 100,000 per year.

The model uses the “ μ ” parameterization of the negative binomial in which the scale parameter is $\mu_t = I_{t-1} / (I_{t-1} + \lambda_t)$ and the size parameter is I_{t-1} . Because Stata 11’s negative binomial program only accepts size parameters less than 10^5 , it was necessary to write to extension programs to enable estimates with up to 10^8 infected individuals. The negative binomial distribution would occasionally nominate a forecast of infection counts that was greater than the number of susceptible individuals. This happened during epidemic peaks only and was an unfortunate property of overdispersion that was corrected by reverting to a Poisson distribution whenever the negative binomial nominated more infections than there were susceptibles.

Other notation is as follows:

β_s is a vector of monthly infectiousness parameters with $s \in \{1 \dots 12\}$

α is a parameter between 0 and 1

ρ_{ij} are mixing parameters for age cohorts i and j

ρ_{-h} is a mixing parameter for core and satellite compartments

κ_{hit} is the incremental coverage fraction denoting the change in the vaccinated fraction of susceptibles of cohort “ i ” in compartment h during period t

E_i is vaccine efficacy assumed to be 85% for infants, 95% for toddlers {Moss, 2009 #6070}

γ is the recovered fraction assumed to be (1-case fatality rate).

θ_{hi} is the number of infected immigrants

A more general specification of [1] found in the literature is $S^{\alpha_1}(I+\theta)^{\alpha_2}$ where the exponential terms α_1 and α_2 permit the dominant eigenvalue to take on values other than 1 and θ can estimate immigrant infections. In an estimate based on UK measles data that assumed $\alpha_1=1$, the estimated value of α_2 was found to be very close to unity and independent of community size as well as robust to a 10 day time step (Bjornstad, Finkenstadt et al. 2002). External importations were assumed to be constant in each age group and in both core and satellite compartments until the year of global eradication which was set at 2020 and 2025 in the Erad2020 and Erad2025 scenarios respectively. In equation [1'] mixing parameters are introduced to enable the model to accommodate vaccine strategies that differentially cover infants and toddlers.

The inclusion of both equation 1a' and 1a'' stems from the challenge of absent data on age-specific case data from the 6 focal countries. Equation 1a' does not attempt to parameterize mixing and will simply adopt the homogeneous parameters and then apply them to 5 separate age strata. Equation 1a'' imposes a set of mixing parameters and these are varied in sensitivity analysis as shown in Appendix 1. Comparing estimates from 1a'' to 1a' allows readers to check the robustness of the model to variation in assumptions on mixing and assess the future importance of collecting further data on mixing patterns to inform measles eradication strategies.

When used for forecasting, each of equations 1' through 4' had demographic entry and exit terms that are suppressed for ease of exposition. All of the survival fractions (or births for $i=1$) and deaths were apportioned across age groups into the various model states (S,I,V, and R) in proportion to the frequency of these states in the preceding age group (superscript $i-1$) during the prior period (superscript $t-1$). Infants are not allowed to enter infancy as infected, recovered, or vaccinated infants. All entering infants are apportioned to the susceptible state.

2.4 Modeling Immunity due to Vaccines

2.4.1 Modeling the rate of increase of routine coverage

The scale up of MCV1 coverage was modeled as a linear ramp scheduled to occur more rapidly in the satellite area than the core. Satellite areas were initialized to have vaccine coverage that was 80% as large as core areas. For mortality reduction goals and eradication goals to be met at the target date, it was necessary for coverage to meet target goals in both satellite and core areas at about the same year.

Clearly there is a speed limit for vaccine coverage increments. In order to identify a feasible rate of increase of vaccine coverage we analyzed the WHO/UNICEF historical record of estimated vaccine coverage increases for countries with low GDP/capita who like Bangladesh, Ethiopia, and Uganda, had already exceeded 60% MCV1 coverage. We determined that the 75th percentile rate of coverage increase for low income countries was around 3 percentage points per year. (Results available from authors upon request.) We set this as the maximum speed limit for coverage increases.

We also realized that the data on estimated vaccination coverage was not a linear ramp. Rates of increase tend to be steeper before 80% coverage than afterward. To accommodate the potential slow down after 80% we programmed a variant of coverage increases as a spline with a knot at 80%. Coverage could be as large as 3 points per year until 80% coverage and then it had

to reduce to 1.5 points per year. The sensitivity of the ICERS to this non-linear scale up model was tested to determine how important the linear ramp up assumption was.

2.4.2 Modeling SIAs

Except for the scenario of stopping SIAs in 2010 all countries were required to continue conducting SIAs until either there was global eradication of measles. This model feature was prompted by our discovery that Brazil and Colombia were still conducting SIAs despite having eliminated measles. SIAs were programmed to occur every 3 years for countries with less than 90% coverage and every 4 years for countries above 90% coverage. The population covered by SIAs and the degree of coverage of each country's SIAs varied by country and is listed in the country appendices. Most SIAs targeted populations between 12 and 59 months of age.

For an SIA that covered 90% of children 12 to 59 months of age. The immunological impact of SIAs was to induce immune responses in 95% of the 90% of SIA-covered children. SIAs were assumed to achieve this effect all at once—e.g. within one time step from January 1 to January 15 of the SIA year. Immediately thereafter the SIA effect on the immunity of children age 12 to 59 months would begin to decay as the 59.5 month-olds aged out of the compartment and were replaced by 11.5 month olds aging in. The 11.5 months olds would have a lower probability of being immune because they had been covered at age 9 months at which time vaccination would only have been 85% effective and they would have been subject to a routine vaccine coverage rate that was typically lower than the SIA coverage. The SIA effects on toddler immunity were programmed to decay due to aging for the entire interval between SIAs. Symmetrical to the decay of SIA effects on the immunity of toddlers was an enrichment of the immunity of children over 5 as more heavily immunized children entered that compartment. SIA coverage was assumed to be independent of MCV1 and MCV2 coverage because the process delivering SIAs is not the same as that delivering routine vaccines.

2.4.3 Covariance of MCV1 and MCV2

Models included a strategy to parameterize the dependence of 2nd on 1st dose and resulting population immunity". The distribution of routine MCV vaccine with one dose can be well described with a binomial distribution for the probability of k successes in n trials. Here k would be the measurement of "coverage" and n would be the number of children in the target population.

Health systems that deliver both MCV1 and MCV2 to children use the same process of outreach and catchment to find the same child at both events. Because the social processes in the household and the health systems processes are unchanged for both events, one has reason to believe the probabilities will be correlated. Hence an appropriate model would be a model of two *correlated* binomial distributions. These models have been explored in detail in toxicology when the outcome is the occurrence of malformed fetuses in a litter (Kupper and Haseman 1978). Programmatic data from measles programs generates estimates of "MCV1 coverage" and "MCV2 coverage" which are single event probabilities-Pr(MCV1) and Pr(MCV2). Our goal is to provide an estimate of the following 4 joint probabilities.

1. **Pr(MCV1,MCV2)** The probability of receiving both doses. In which case probability of achieving immunity would be 0.9925 which is based on [1- Pr (not immune after MCV1)*Pr(not immune after MCV2)] which is 1-(0.15*0.05)

2. **Pr(MCV1, ~MCV2)** The probability of getting MCV1 and not MCV2. In which case the probability of achieving immunity would be 0.85 if immunized at 9 months.
3. **Pr(~MCV1, MCV2)** The probability of getting MCV2 and not MCV1. Which gives immunity at Pr=0.95.
4. **Pr(~MCV1, ~MCV2)** The probability of getting neither. Which gives no immunity from vaccines.

As shown by Kupper and Haseman, the closed form expression for these joint probabilities is quite complex and depends on pairwise correlations in the event probabilities for individual children {Kupper, 1978 #5897}. We will make an extreme simplification of this process by appending a single term to correct for the covariance.

- [1] $\Pr(\text{MCV1}, \text{MCV2}) = \Pr(\text{MCV1}) * \Pr(\text{MCV2}) + \text{Cov}(\text{MCV1}, \text{MCV2})$
- [2] $\Pr(\text{MCV1}, \sim \text{MCV2}) = \Pr(\text{MCV1}) * \Pr(\sim \text{MCV2}) + \text{Cov}(\text{MCV1}, \sim \text{MCV2})$
- [3] $\Pr(\sim \text{MCV1}, \text{MCV2}) = \Pr(\sim \text{MCV1}) * \Pr(\text{MCV2}) + \text{Cov}(\sim \text{MCV1}, \text{MCV2})$
- [4] $\Pr(\sim \text{MCV1}, \sim \text{MCV2}) = \Pr(\sim \text{MCV1}) * \Pr(\sim \text{MCV2}) + \text{Cov}(\sim \text{MCV1}, \sim \text{MCV2})$

The “Cov()” terms in this model express the covariance between the events. If we impose the fact that $\Pr(\text{MCV}) + \Pr(\sim \text{MCV}) = 1$ we derive the following equations.

- [1'] $\Pr(\text{MCV1}, \text{MCV2}) = \Pr(\text{MCV1}) * \Pr(\text{MCV2}) + \text{Cov}(\text{MCV1}, \text{MCV2})$
- [2'] $\Pr(\text{MCV1}, \sim \text{MCV2}) = \Pr(\text{MCV1}) * (1 - \Pr(\text{MCV2})) + \text{Cov}(\text{MCV1}, \sim \text{MCV2})$
- [3'] $\Pr(\sim \text{MCV1}, \text{MCV2}) = (1 - \Pr(\text{MCV1})) * \Pr(\text{MCV2}) + \text{Cov}(\sim \text{MCV1}, \text{MCV2})$
- [4'] $\Pr(\sim \text{MCV1}, \sim \text{MCV2}) = (1 - \Pr(\text{MCV1})) * (1 - \Pr(\text{MCV2})) + \text{Cov}(\sim \text{MCV1}, \sim \text{MCV2})$

Finally we make the simplifying assumption that

$$\text{Cov}(\text{MCV1}, \text{MCV2}) = \text{Cov}(\sim \text{MCV1}, \sim \text{MCV2}) = -\text{Cov}(\sim \text{MCV1}, \text{MCV2})$$

Which implies that we can model all of the joint probabilities we need based on programmatic data on coverage with each vaccine dose and one assumed parameter—the covariance of MCV1 and MCV2.

- [1''] $\Pr(\text{MCV1}, \text{MCV2}) = \Pr(\text{MCV1}) * \Pr(\text{MCV2}) + \text{Cov}(\text{MCV1}, \text{MCV2})$
- [2''] $\Pr(\text{MCV1}, \sim \text{MCV2}) = \Pr(\text{MCV1}) * (1 - \Pr(\text{MCV2})) - \text{Cov}(\text{MCV1}, \text{MCV2})$
- [3''] $\Pr(\sim \text{MCV1}, \text{MCV2}) = (1 - \Pr(\text{MCV1})) * \Pr(\text{MCV2}) - \text{Cov}(\text{MCV1}, \text{MCV2})$
- [4''] $\Pr(\sim \text{MCV1}, \sim \text{MCV2}) = (1 - \Pr(\text{MCV1})) * (1 - \Pr(\text{MCV2})) + \text{Cov}(\text{MCV1}, \text{MCV2})$

If covariance is zero the model reverts back to the model of independent binomial processes.

The model also imposes limits on the magnitude of covariance. Because probabilities cannot be negative, equations [2''] and [3''] imply that $\text{Cov}(\text{MCV1}, \text{MCV2}) < \Pr(\text{MCV1}) * (1 - \Pr(\text{MCV2}))$ and $\text{Cov}(\text{MCV1}, \text{MCV2}) < (1 - \Pr(\text{MCV1})) * \Pr(\text{MCV2})$

What does this model imply in practice

The measles transmission model’s baseline assumption is that $\text{Cov}(\text{MCV1}, \text{MCV2}) = 0.05$. The following tables illustrate what this assumption would imply by comparing the weighted average immunity of 100 children immunized in a model of independent MCV1 MCV2 to a model where covariance is 0.05. The table below conducts this exercise when MCV1 coverage is 80% and MCV2 has just been introduced with a coverage of 40%.

Table 1 shows that the assumption of covariance at 5% reduces the expected population immunity from 80% to 76%.

Table 1. When MCV1 is 0.8 and MCV2 is 0.4			
Covariance=0		MCV2	
		Yes	No
MCV1	Yes	0.32	0.48
	No	0.08	0.12
Weighted average immunity			0.8016
Covariance=0.05		MCV2	
		Yes	No
MCV1	Yes	0.37	0.43
	No	0.03	0.17
Weighted average immunity			0.761225

Table 2 below shows that at higher coverage when MCV1 is 90% and MCV2 is 81% (90% of 90%) the assumption of covariance reduces population average immunity from 94.6% to 90.5%.

In part because MCV2 costs a substantial amount of money to conduct, the model's results on cost effectiveness are sensitive to the covariance parameter. We conducted experiments in which the covariance parameter was varied between 0.04 at the low end and 0.06 at the high end. The tornado diagram in Figure 4 (p. 30) shows that with lower covariance (0.04), the ICER for eradication is \$8.50 DALY averted. With higher covariance, the ICER is \$45 per DALY averted. In the scheme of things, both ICERs are far less than GDP per capita in any country and would be extremely cost-effective. Because the MCV2 policies in the 6 scenarios modeled are extremely similar, the relative comparison between the strategies is not affected dramatically by the model's sensitivity to the covariance term. The model emphasizes that a fourfold change in cost-effectiveness of measles control can be achieved by small efforts to reach unreached children with MCV2. Countries on the verge of adopting an MCV2 strategy need to recognize that the programs must emphasize efforts to bring the 2nd dose to previously unreached children.

Table 2. When MCV1 is 0.9 and MCV2 is 0.81

Covariance=0		MCV2	
		Yes	No
MCV1	Yes	0.729	0.171
	No	0.081	0.019
Weighted average immunity			0.945833
Covariance=0.05		MCV2	
		Yes	No
MCV1	Yes	0.779	0.121
	No	0.031	0.069
Weighted average immunity			0.905458

low
per

3.0 From Data to Parameters

Var	Interpretation	How many	How estimated
β_s	Seasonal forcing terms	12 monthly	After susceptible reconstruction, can derive β_s as coefficients on 12 seasonal dummies in a regression. See section 3.2
α	Discrete-continuous conversion factor	1	Regression or ML estimate of [1]
ρ_{ij}	Mixing parameters for age group i and j	5 x 5 = 25	After fitting homogeneous model, initialize as fraction of household members of each age group. Use rejection algorithm MCMC model to minimize squared error between homogeneous and mixing model
ρ_h	Mixing parameter for core and satellite metapopulations	1	Initialize as fraction of household who lived away in last 30 days. Fit with MCMC method as above
κ_{hit}	Incremental coverage fraction	One for every time step	Set by user to model ramps of increasing routine, SIA, and MCV2
E_i	Vaccine efficacy	2	85% for infants 95% for toddlers
γ	Recovery rate	40 values--one for every year from 2010 to 2050	2010 value drawn from MSP tool Subsequent values will track reductions in U5MR
B	Effective birth rate	One for every time	Interpolated from annual UN

		step	demographic forecasts adjusted for 6 month survival by subtracting 92% of IMR. (The 92% comes from original examination of infant survival rates in DHS data.)
D_{it}	Death rate	One for every time step for every age group.	Interpolated from annual UN demographic forecasts
S_0, I_0, V_0	Initial values of each compartment	One for every time step	Set based on historical vaccine coverage data and a burn in from 2005 to 2010
θ	Infected immigrants	Set at constant =2 until date of eradication, then 0 until 2050.	Count of subsequent infections is insensitive to any non-zero number of immigrant infections. A low number is preferable to avoid distorting the demography of the model.

The 13 parameters that need to be estimated in the homogeneous model for each country are the 12 monthly β_s parameters and the α parameter. Parameters to be taken by assumption are

- ϵ the efficacy of measles vaccine, taken to be 0.85 for those vaccinated prior to age 1 and 0.95 for those vaccinated after age 1.
- κ the per period increment in the fraction of the population covered by vaccine will be input as a user-defined time series in the forecasting exercise.

We defer a discussion of strategies to estimate the ρ_{ij} and ρ_h parameters and turn immediately to strategies for estimating β_s and α . The strategies will depend on data available from the 6 target countries. An important limitation of the project is that WHO has asked for models of 6 specific countries chosen without there being attention to the quality or availability of the data.

3.1 Data Availability

The data to be used for estimates are time series of births, cases and measles vaccine coverage. Data availability by country are as follows:

Country	Variable	Yearly Data from ¹	Monthly Data	District data
Uganda	Births	1980-2050	-	2002
	Cases	1980-2008	Jan 01-May 09	Jan 07-May 09
	Coverage	MCV1: 81-08	MCV1: 06-08 MCV2: 06-09	MCV1: 06-08 MCV2: 06-09
Ethiopia	Births	1980-2050	-	-
	Cases	1980-2008	Jan 07- Apr 09	Jan 07- Apr 09
	Coverage	MCV1: 80-08	-	Dec 08 Mar 09

¹ Yearly data for Coverage for MCV1 and MCV2 are available for all countries from 1980-2002; this column represents start-end point data for years when countries actually implemented vaccination

Bangladesh	Births	1980-2050	-	-
	Cases	1980-2008	Jan 07-May 09 For Matlab only: 1980-1984	-
	Coverage	MCV1: 82-08	-	-

3.2 Susceptible Reconstruction

The method of susceptible reconstruction has been applied to time series data on pre-vaccine era measles from UK (Finkenstadt and Grenfell 2000; Bjornstad, Finkenstadt et al. 2002; Finkenstadt, Bjornstad et al. 2002). This section describes an extension of this method to reconstruct data on susceptibles in the populations receiving vaccinations. The general procedure is to model the stochastic data generating process for births, cases, and coverage thereby linking it to the transmission model above. Simply stated the problem is to bridge from data on reported new cases, C_t and reported children vaccinated, K_t , to estimates for true cases I_t and truly immune through vaccination, V_t . The key parameter to link true cases and reported cases is the reporting fraction:

$$[5] \text{ Reporting fraction} = r_t^C$$

One can relate the number of new true cases, I_t to the number of reported new cases C_t

$$[6] I_t = r_t^C C_t$$

Similarly the number of new truly immune through vaccination, V_t , is related to the number of reported covered children as

$$[7] V_t = r_t^K K_t$$

Where r_t^C and r_t^K are the reporting fractions for the number of cases or covered children respectively reported at time t under a binomial reporting process. These reporting fractions may or may not be relatively constant over time.

Joining equation [7] and [6] with equation [2] produces

$$[8] \Delta S_t = (\hat{B}_{t-1} - D_{t-1}) - r_t^C C_{t-1} - r_t^K K_{t-1}$$

Then decomposing S_t into its mean and temporal deviations as

$$[9] S_t = \bar{S} + Z_t$$

Where $E(S_t) = \bar{S}$ and $E(Z_t) = 0$. Thus $\Delta S_t = Z_t$ where Z_t are the transient deviations in the number of susceptibles.

One can impose T successive iterations of [9] to derive

$$[10] \sum_{t=1}^T Z_t = \sum_{t=1}^T (\hat{B}_{t-1} - D_{t-1}) - \sum_{t=1}^T r_t^C C_{t-1} - \sum_{t=1}^T r_t^K K_{t-1}$$

If one rearranges and assumes that the reporting fractions are constant over time one derives:

$$[10'] \sum_{t=1}^T (\hat{B}_{t-1} - D_{t-1}) = r^C \sum_{t=1}^T C_{t-1} + r_t^K \sum_{t=1}^T K_{t-1} - \sum_{t=1}^T Z_t$$

Prior studies applied equation [10'] to time series data on births and cases using splines or locally weighted least squares. One first computes cumulative estimates of the 3 observable terms that are based on births, cases, and coverage in [10'] by setting T=1, 2, 3 for as many periods as one has data and then applying regression to the cumulative terms.

This method produces an estimate of a vector of ΣZ_t estimates emerging as the residual. From these, Z_t can be estimated and hence [9] can be used to reconstruct S_t . Estimates of r_t^C and r_t^K emerge as regression coefficients and they can be used to reconstruct I_t and V_t .

We applied this model to panel data from districts, using a fixed effects and/or random effects model to recover the ΣZ_{jt} terms for each district as $\mu_j + \varepsilon_{jt}$.

$$[10''] \sum_{t=1}^T (\hat{B}_{jt-1} - D_{jt-1}) = r^C \sum_{t=1}^T C_{jt-1} + r_t^K \sum_{t=1}^T K_{jt-1} + \mu_j + \varepsilon_{jt}$$

The regression model from Uganda uses the data are shown at the end of this Appendix. The fixed effects and random effects model results are also shown at the end of the appendix. The predicted values of the case series for Uganda for each district are plotted below. The figure compares a locally weighted least squares (LOWESS) model and a linear model showing no major change in the reporting fraction over time and confirming the adequacy of a linear model here.

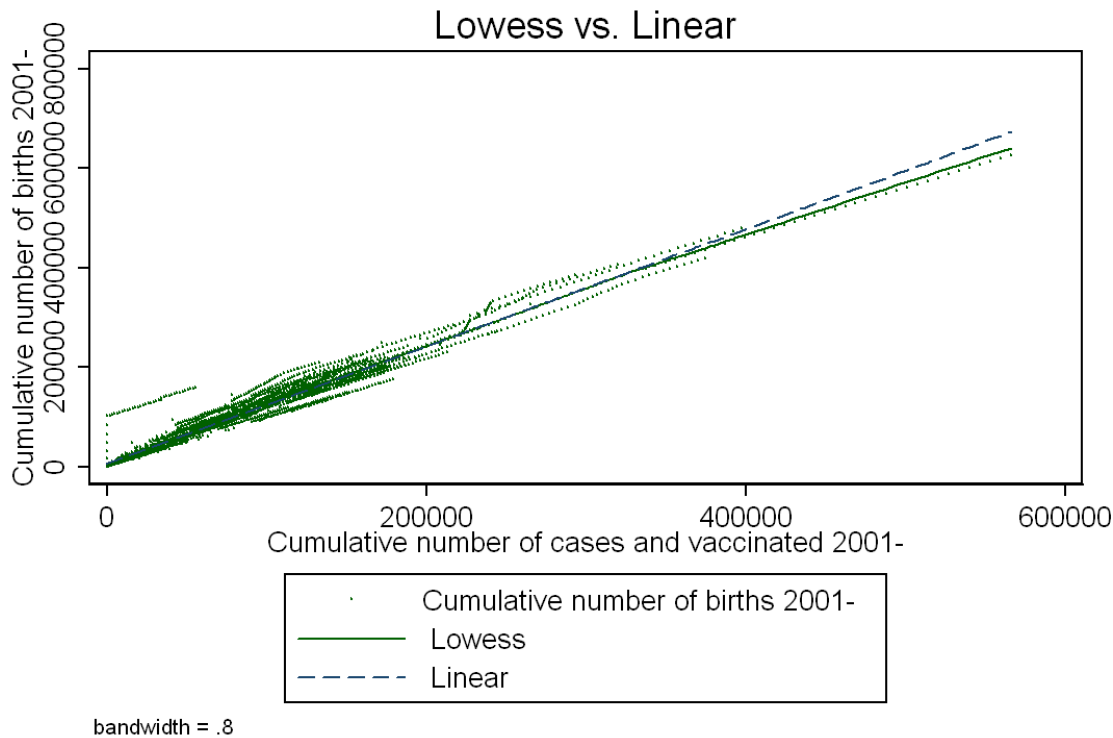

3.3 Modeling the Force of Infection

Having reconstructed a time series of S_t and I_t as shown in the LOWESS plot above, we used these data in a log transformed version of equation [1]. This allowed us to estimate the following equation:

$$[11] E(\log(I_t)) = E(\log(\beta_s) + \log(S_{t-1}) + \alpha \log(I_{t-1}))$$

The exponentiated constant term and exponentiated (constant + coefficient on each of the 11 monthly dummy variables β_s) recovered β_s , and the coefficient on the $\log(I_{t-1})$ term recovered α . We used a generalized linear model with a log link function to improve retransformation and to recapture

$$I_t \text{ as } \exp[(\log(\beta_s) + \log(S_{t-1}) + \alpha \log(I_{t-1})) \times \exp(SD)].$$

We used our estimates of α and β for Uganda in equations [1]-[4]. The validity of this model was checked by observing the ability of the model to approximate death reports and annual case reports from 2005 to 2010.

3.4 Heterogeneity: adding in ages and compartments

None of the countries has extensive data on incidence by age, nor on mixing patterns between geographical areas. Thus, a statistical approach to estimating ρ_{ij} and ρ_h is not an option. These parameters reflect differential rates of contact across the various age groups and compartments.

The motivation for having age and core/satellite compartments is to model heterogeneous vaccine coverage due to differential deployment of MCV1, SIA, and MCV2; social contact rates were not the driving consideration. We used the different vaccine coverage rates from equation [2'] to partition the susceptible population into 5 different age groups times 2 metapopulations. Initial vaccination coverage rates for children and adults were set for 2010 by referring to historical reports of coverage in each country. As shown in the sensitivity analysis obtaining precise estimates of mixing coefficients in the WAIFW matrix did not impact the cost-effectiveness properties of the various strategies. The baseline mixing matrix used for the model is shown below.

	Infant	Toddler	Child	Fertile	PostFertile	OtherCompartment
Infant	0.2	0.5	0.3	0	0	0
Toddler	0.2	0.5	0.3	0	0	0
Child	0.2	0.2	0.6	0	0	0
Fertile	0.25	0.25	0.25	0.25	0	0
PostFertile	0.02	0.02	0.02	0.44	0.5	0

This mixing matrix implies that toddlers are the primary reservoir of infection for both infants and children and that children are the primary infectors of other children.

3.4.1 Initializing the values and calibrating the heterogeneous model

The initial values for age specific numbers of infected were set by applying data on the age profile during recent outbreaks. The initial values for age specific numbers of vaccinated individuals were estimated based on historical data on coverage of prior cohorts. The age-specific number of susceptibles was derived using equation [2].

3.5 Rubella

After immunization programs have reached routine coverage of 80% with MCV1, many countries are expected to add rubella antigen to their routine measles programs. The addition of rubella antigen will offer additional health benefits in the form of DALYs averted from congenital rubella syndrome. Many more details would be needed in models designed to inform rubella control strategies, the goal of this project was limited to acquiring an estimate of DALYS from a switch to MR vaccine. Several rubella control options exist with permutations of routine immunization of infants or prepubertal girls and catch-up campaigns among adult women or women and men. Our model assumed no catch-up campaigns are used and that there is a simple switch from MCV to MR vaccine after countries have attained at least 80% coverage with MCV1 for three years.

The lack of monthly or weekly data on rubella cases from the focal countries left us with a simple procedure of assuming that the force of infection for rubella was one third that of measles as follows:

$$\lambda_{\text{rubella}} = 0.3 \times \lambda_{\text{measles}} \text{ (Edmunds, Gay et al. 2000).}$$

It emerged that the estimated CRS burden averted for any switch from no rubella vaccine to MR vaccine had a large benefit of averted DALYs. But there was little difference in rubella DALYS

averted between the various measles control strategies. It was deemed unwise to devote extensive research time to precise a characterization of the rubella burden.

The incidence of rubella in women age 15-45 was converted to an estimate of CRS cases using the model of Cutts and Vynnycky (Cutts and Vynnycky 1999). Each rubella case in a fertile woman is discounted by 1) The probability that the woman was pregnant at the time of the infection, modeled as the UN projected total fertility rate for that country in that year. 2) The probability that she was at less than 16 weeks gestation, modeled as 16/40; 3) The probability that the fetus acquired CRS conditional on exposure prior to 16 weeks—assumed to be 65% (Cutts and Vynnycky 1999).

Bibliography

- Bjornstad, O. N., B. F. Finkenstadt, et al. (2002). "Dynamics of Measles Epidemics: Estimating Scaling of Transmission Rates Using a Time Series SIR Model." Ecological Monographs **72**(2): 169-184.
- Cutts, F. T. and E. Vynnycky (1999). "Modelling the incidence of congenital rubella syndrome in developing countries." Int J Epidemiol **28**(6): 1176-84.
- Edmunds, W. J., N. J. Gay, et al. (2000). "The pre-vaccination epidemiology of measles, mumps and rubella in Europe: implications for modelling studies." Epidemiol Infect **125**(3): 635-50.
- Finkenstadt, B. F., O. N. Bjornstad, et al. (2002). "A stochastic model for extinction and recurrence of epidemics: estimation and inference for measles outbreaks." Biostatistics **3**(4): 493-510.
- Finkenstadt, B. F. and B. T. Grenfell (2000). "Time series modelling of childhood diseases: a dynamical systems approach." Applied Statistics **49**(part 2): 187-205.
- Kupper, L. L. and J. K. Haseman (1978). "The Use of a Correlated Binomial Model for the Analysis of Certain Toxicological Experiments." Biometrics **34**(1): 69-76.
- O'Donovan, C. (1971). "Measles in Kenyan Children." East Afr Med J **48**(10): 526-532.
- Schenzle, D. (1984). "An age-structured model of pre- and post-vaccination measles transmission." IMA J Math Appl Med Biol **1**(2): 169-91.
- UNICEF and WHO (2010). Immunization Summary: A Statistical Reference Containing Data Through 2008 (2010 Edition). New York and Geneva, UNICEF and WHO.

Figure 1 Example of measles data from Uganda used in the model.

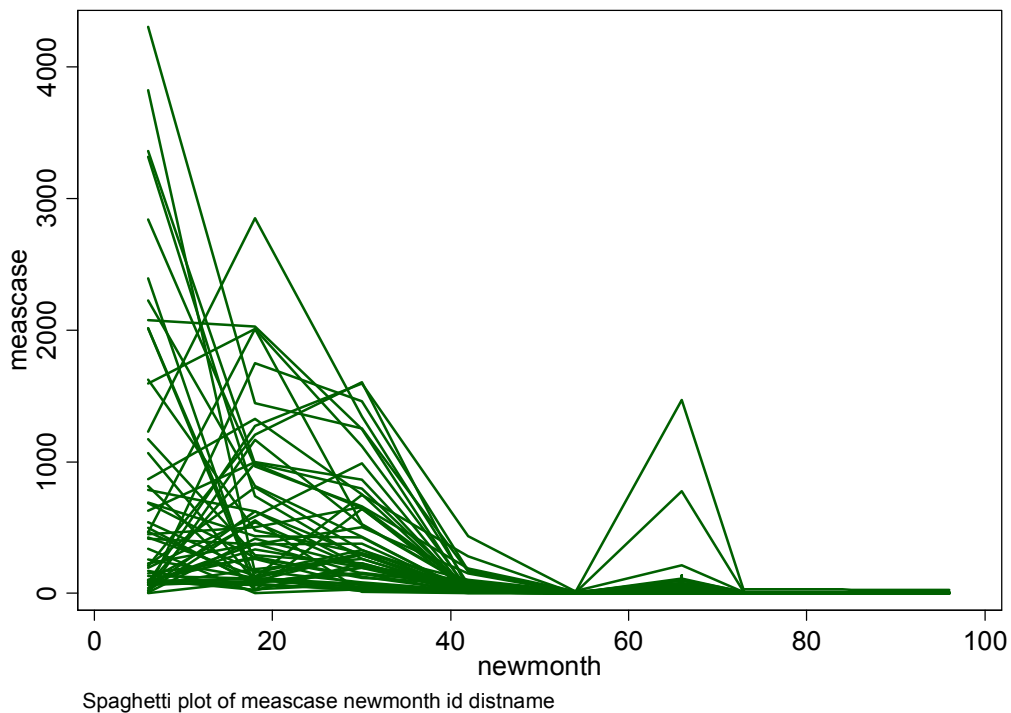

Cases by district over time. The case series is annual from 1/2001 to 12/2006 then monthly to 5/2009. This figure holds the case definition constant over time.

Table 1

Results of Susceptible Reconstruction Exercise for Uganda

Random Effects Model (Cases and MCV1 covered)

```
. xtreg cummonthlybirthsx01 cummeascase01 cumcovered01, i(distnum)
```

```
Random-effects GLS regression                Number of obs   =    1894
Group variable (i): distnum                 Number of groups =     80

R-sq:  within = 0.9781                      Obs per group:  min =     8
        between = 0.9646                      avg =    23.7
        overall = 0.9562                      max =     32

Random effects u_i ~ Gaussian                Wald chi2(2)    =  82874.06
corr(u_i, X) = 0 (assumed)                   Prob > chi2     =   0.0000
```

-----	-----	-----	-----	-----	-----	-----
cummonthl~01	Coef.	Std. Err.	z	P> z	[105% Conf. Interval]	
-----	-----	-----	-----	-----	-----	-----
cummeasca~01	2.767417	.5315382	5.21	0.000	1.725621	3.809212
cumcovered01	1.15999	.0052379	221.46	0.000	1.149723	1.170256
_cons	6042.956	1850.953	3.26	0.001	2415.155	9670.756
-----	-----	-----	-----	-----	-----	-----
sigma_u	15681.8					
sigma_e	5956.4454					
rho	.87391798	(fraction of variance due to u_i)				
-----	-----	-----	-----	-----	-----	-----

Fixed Effects Model (Cases and MCV1 covered)

```
. xtreg cummonthlybirthsx01 cummeascase01 cumcovered01, i(distnum) fe
```

```
Fixed-effects (within) regression      Number of obs      =      1894
Group variable (i): distnum           Number of groups   =        80

R-sq:  within = 0.9781                Obs per group: min =         8
      between = 0.9640                  avg =              23.7
      overall = 0.9554                  max =              32

corr(u_i, Xb) = -0.1176                F(2,1812)          = 40402.85
                                           Prob > F            =   0.0000
```

-----+-----	-----+-----	-----+-----	-----+-----	-----+-----	-----+-----	-----+-----
cummonthl~01	Coef.	Std. Err.	t	P> t	[105% Conf. Interval]	
-----+-----	-----+-----	-----+-----	-----+-----	-----+-----	-----+-----	-----+-----
cummeasca~01	3.242168	.5840266	5.55	0.000	2.096732	4.387604
cumcovered01	1.157067	.0053849	214.87	0.000	1.146506	1.167628
_cons	7082.517	792.5455	8.94	0.000	5528.118	8636.916
-----+-----	-----+-----	-----+-----	-----+-----	-----+-----	-----+-----	-----+-----
sigma_u	16153.927					
sigma_e	5956.4454					
rho	.880311	(fraction of variance due to u_i)				
-----+-----	-----+-----	-----+-----	-----+-----	-----+-----	-----+-----	-----+-----
F test that all u_i=0:	F(79, 1812) =	192.10			Prob > F =	0.0000

Appendix 2: Methods for estimating the costs of the elimination of measles

August 12, 2010

Benjamin Johns, David Bishai

1.0 Introduction

Economic theory predicts that there will be a non-linear relationship between the average cost of immunizing a child and coverage in both the short-run and the long-run. Given the timeframe of this study, we are interested in the long-run. Economic theory posits that in the long-run, firms in perfectly competitive markets will operate at the lowest point on a long-run average cost curve that is typically U-shaped. The initial drop in average cost as coverage goes from zero to the middle range of coverage occurs because there is a fixed cost to setting up and running a cold chain system, and initially these fixed costs are defrayed over more children (1;2)¹. As coverage expands and as vaccination efforts penetrate into the last percentages of unvaccinated children, they may incur increasingly higher costs to work in areas where children are not easy to reach due to civil disruption, geography, homelessness, and dysfunctional health systems. Alternative delivery strategies, such as regular outreach or campaigns, may be needed to reach and sustain high coverage levels (3), while at low coverage levels fixed-site facilities may be employed. The use of different technologies may have an influence on the average cost (4-8).

Some literature corroborates a non-linear relationship between coverage and costs (1;2;9;10). There is also evidence of differences in average cost for different districts or provinces (11-14), especially as relating to SIAs. Thus using linear projections to estimate the costs of increasing routine vaccine coverage to very high levels would ignore the more costly processes required to bring more children into primary care for routine vaccination (10;15).

Vaccine program managers know that there is heterogeneity by district or sub-district in the ease of increasing coverage of routine measles vaccine using fixed site strategies. However, few studies have parameterized the variability in the productivity of resources spent to increase coverage (3;7;16). Both supply and demand side interventions have been associated with increases in coverage in the short-run (3;7;17-19). The long-run impact and costs of maintaining these programs has not been well studied. Nor are there any available criteria for selecting which scale-up strategy is most appropriate for a given situation. Finally, much of the literature on potential economies of scale related to immunizations looks at potential scale effects at the individual facility level (cf., (1), which lists a number of studies at the facility level).

¹ Note also that delivery of vaccines only on-site at fixed facilities has implications for the costs to patients to access care and their opportunity costs of accessing care. These issues are not well represented in the literature, but their inclusion would affect the shape of the long-run average cost curve.

Determining when and where non-fixed site strategies (including outreach from fixed-site facilities) are needed in order to obtain the increased coverage necessary for measles elimination is also not clear. We have found 24 reports that list costs for SIAs on a cross-sectional basis (3;6;7;12-14;20-37), and one study that reported costs and coverage for multiple years (38). Data indicate that in some areas the average cost of an SIA-immunized child is higher than in other areas.

2.0 Theoretical considerations

A vaccine program seeking to minimize cost would prioritize the children that are cheapest to immunize, and then move upwards along the long-run average cost curve as coverage expands, as shown in Figure 1. At current coverage (assumed to be 70% in the diagram), the cost per additional child immunized is low, but as coverage increases over time, the vaccine program will incur increasingly high costs to reach additional children. The additional costs needed to reach 95% coverage in Figure 1 could be calculated as:

$$[1] \quad \Delta TC = \int_0^{T_{Erad}} (Cov(t) \times P(t) \times AC(t) \times e^{-rt}) dt$$

Where ΔTC is the incremental cost (above the cost to achieve current coverage) in net present value; t represents time; r represents the discount rate²; $Cov(t)$ represents the measles vaccine coverage rate as a function of time; $P(t)$ represents the total number of children eligible for vaccination; and $AC(t)$ is the average cost of vaccinating a child. This can be seen (without discounting) as the area under curve ABD in Figure 1.

In Figure 1, the vaccine program would move from current coverage (point A) along the solid line to 95% coverage at point B. Simultaneously the average cost per vaccinated child is expected to grow (dotted line) as harder to reach children are added to the annual workload of the vaccination team. Subsequent to reaching elimination, at point B, coverage levels stay flat (solid line) but average cost per vaccinated child may continue to rise (Point C) if real health worker salaries rise or infrastructure becomes more costly to maintain. An alternative scenario is that after elimination, there are efficiency gains from learning by doing that make it less costly to maintain high coverage (point D).

² We will employ discrete time (i.e., yearly) discounting in our model rather than continuous discounting, but the concept remains the same.

Figure 1: Average cost and coverage under assumptions of cost minimization

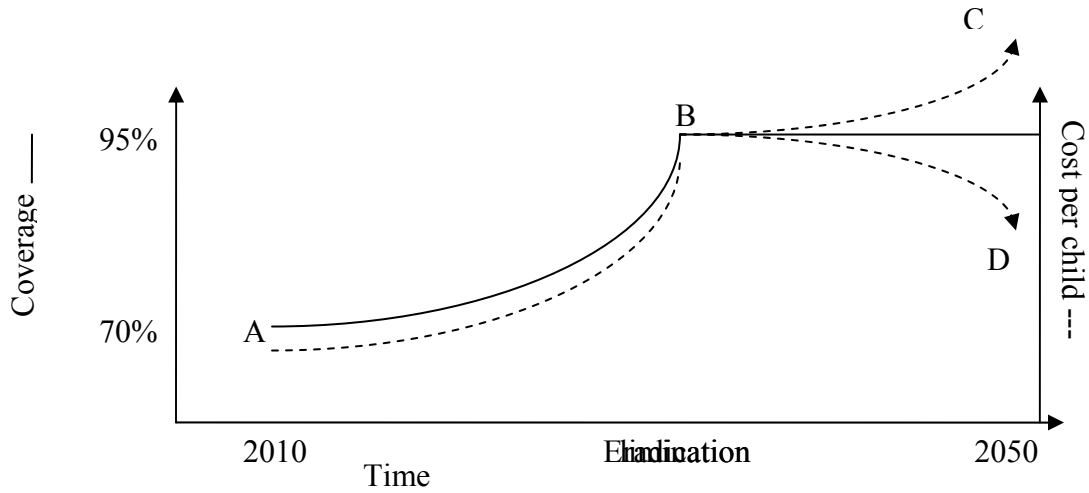

A more disaggregated account for why the average cost curve rises non-linearly comes from expanding our initial theory into one where there are multiple heterogeneous regions numbered 1 through N. In this situation Equation 1 would be modified to Equation 2

$$[2] \Delta TC = \int_0^{T_{Erad}} \sum_{i=1}^N [(Coverage_i(t) \times P_i(t) \times AC_i(t) \times e^{-rt})] dt$$

Where subscript “i” pertains to each of N geographical or socially distinct subpopulations with differing coverage rates, population sizes, and average costs per vaccinated child.

The addition of heterogeneity imposes financial considerations on the expected rise in average cost of immunizing children. Although achieving elimination implies *eventual* expansion of vaccinations to over 95% of children, deferring expansion of immunization of highest cost children can lower the net present budgetary impact. Later costs are discounted more because they are further in the future. However, it is unlikely that a country would actually be able to identify and arrange in order of cost the individual children needing vaccination. There are both logistical obstacles and moral obstacles that make it unlikely for vaccine scale up to be implemented in strict order based on ascending marginal cost of each child. However, a vaccine program might engage in incremental scale up on the basis of geography, prioritizing the cheapest areas to reach, and then moving sequentially to more expensive areas (39). While there may be some variation in the cost of reaching children within a targeted area, the metric of relevance is the average cost per child reached. The fact that a program only needs to reach only 95% of children in a given area likely ameliorates, at least to some extent, the need to

vaccinate those children that are the most challenging to reach. For the cost-minimizing vaccine program, heterogeneity in average cost implies savings from deferring the costs of the more expensive children until closer to 2020 (or the year selected for elimination).

Figure 2: Average cost and coverage under assumptions of cost minimization and targeting areas

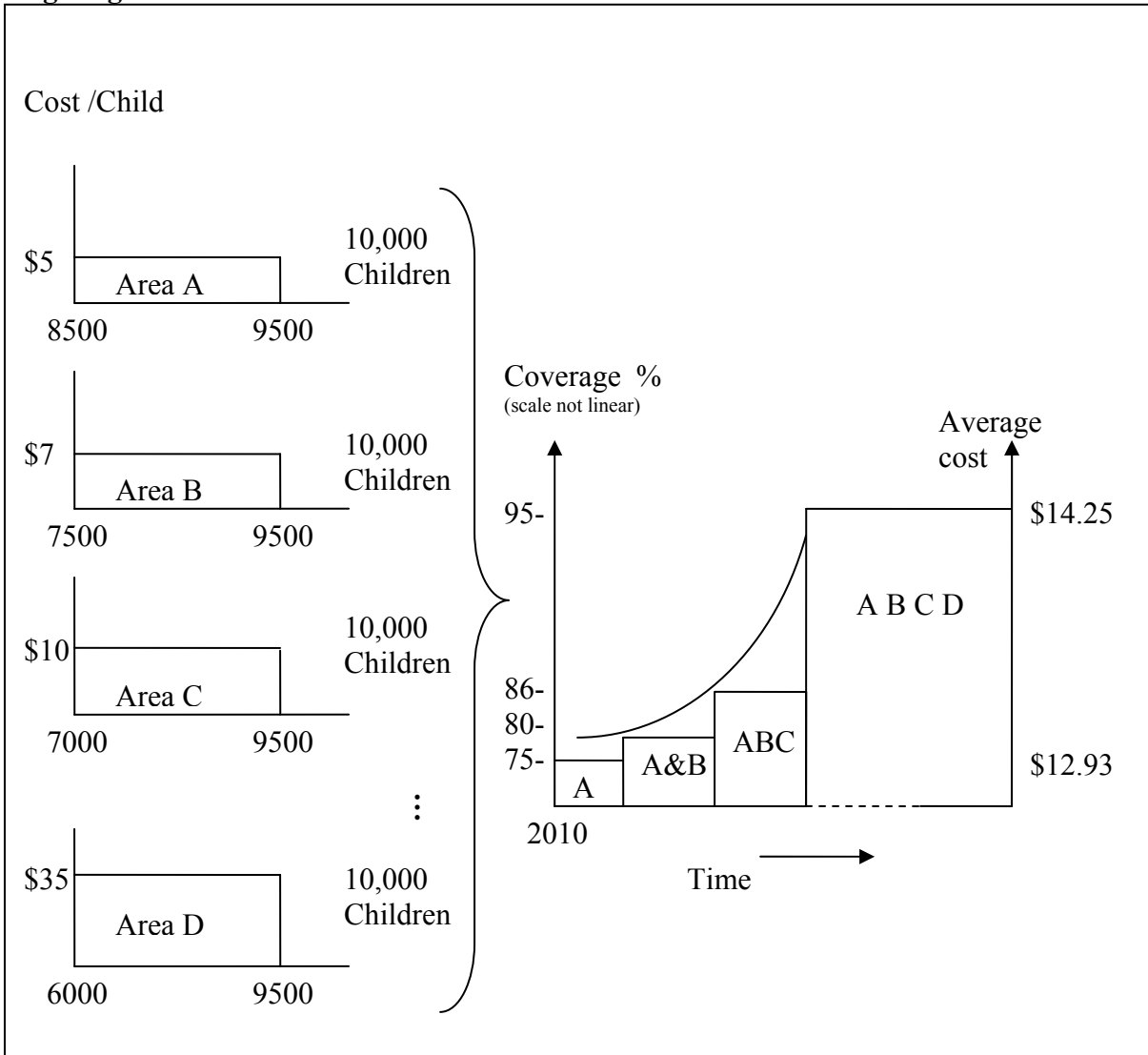

A stylized version of this is depicted in Figure 2. This diagram depicts a region composed of 4 areas of 10,000 children each. Each region labeled from A to D has a different average cost of vaccinating children ranging from \$5 in Area A to \$35 in Area D. Each region enters the year 2010 with a different initial rate of coverage from 85% in Area A, 75% in B, 70% in C and 60% in Area D. Overall coverage is thus the overall average which equals 72.5%.

The cost minimizing approach would start with Area A at the beginning and spend the initial period reaching 95% coverage in this area. After reaching 95% coverage in this

one area, the overall coverage in the country will increase to 75%. This increment from 72.5% to 75% is achieved at an average cost of \$5.00 per covered child. After Area B achieved coverage of 95% the country average will move to 80%, and the average cost would rise.

Table 1. Schematic table of costs before and after elimination in Areas A-D.

Areas Covered Each with 10,000 children	Average Cost in That Area	Baseline Children	Baseline Costs	Post Elimination Children Covered	Undiscounted Post Elimination Costs
A	5	8500	\$42,500	9500	\$47,500
B	7	7500	\$52,500	9500	\$66,500
C	10	7000	\$70,000	9500	\$95,000
D	35	6000	\$210,000	9500	\$332,500
TOTAL		30,000	\$380,000	38,000	\$541,500
Average Coverage		75%		95%	
Average Cost			\$9.5		\$13.375
Average Incremental Cost to Increase Coverage			\$4.375 per incremental child added to annual workload		
Incremental Number of Children Covered			8000 added to annual immunization workload		

In this scenario, additional costs needed to attain 95% coverage in a country would be calculated as a weighted average of local average costs where the weights are the relative sizes of the newly vaccinated population in each area.

Note that the way Figure 2 is drawn assumes that the country tries to tackle its lowest cost areas first in order to defer having to finance the higher burden that it will inevitably face to achieve elimination. Ultimately, the country must increase coverage from 30,000 to 38,000 children per year before elimination is achieved. They all have to be covered sometime, but Figure 2 assumes that for the sake of financial savings, the first of the additional 8000 children to be added would be in lowest cost Area A and the last 3500 to be added to the annual workload would be those in high cost Area D.

Given that most vaccination programs are government operated, there will be many other considerations besides cost-minimization that influence decisions about when, where, and to what extent to increase vaccine coverage. Thus the scale-up plan that is much more likely to occur in practice is one where the new additions to the annual vaccination workload will come from each of the 4 regions in balanced proportion every year. Conceptually this means that in Area D where average cost is \$35 per child would not be deferred till later. Since area D leaves 3500 children unvaccinated each year, the plan may be to increase coverage by 350 additional children every year for 10 years to achieve

elimination in 10 years. Similarly Area A may be given funds to increase coverage by 100 children every year. These equitable scale-up pathways are more linear, with an equal rise in coverage in every area for every year.

This ‘programmatically approach’ is depicted in figure 3. Figure 3 assumes that decision makers know the average cost for each area, and that each area gets an allocation of funds that allows them to achieve the same percentage increment in coverage as every other area. The main difference between the approach graphed in Figure 2 and that in Figure 3 arises under discounting. The programmatic approach to scaling up shown in Figure 3 will have a discounted present value that is slightly more than the stepped approach in Figure 2.

Figure 3: Average cost and coverage under the assumptions of the programmatic approach

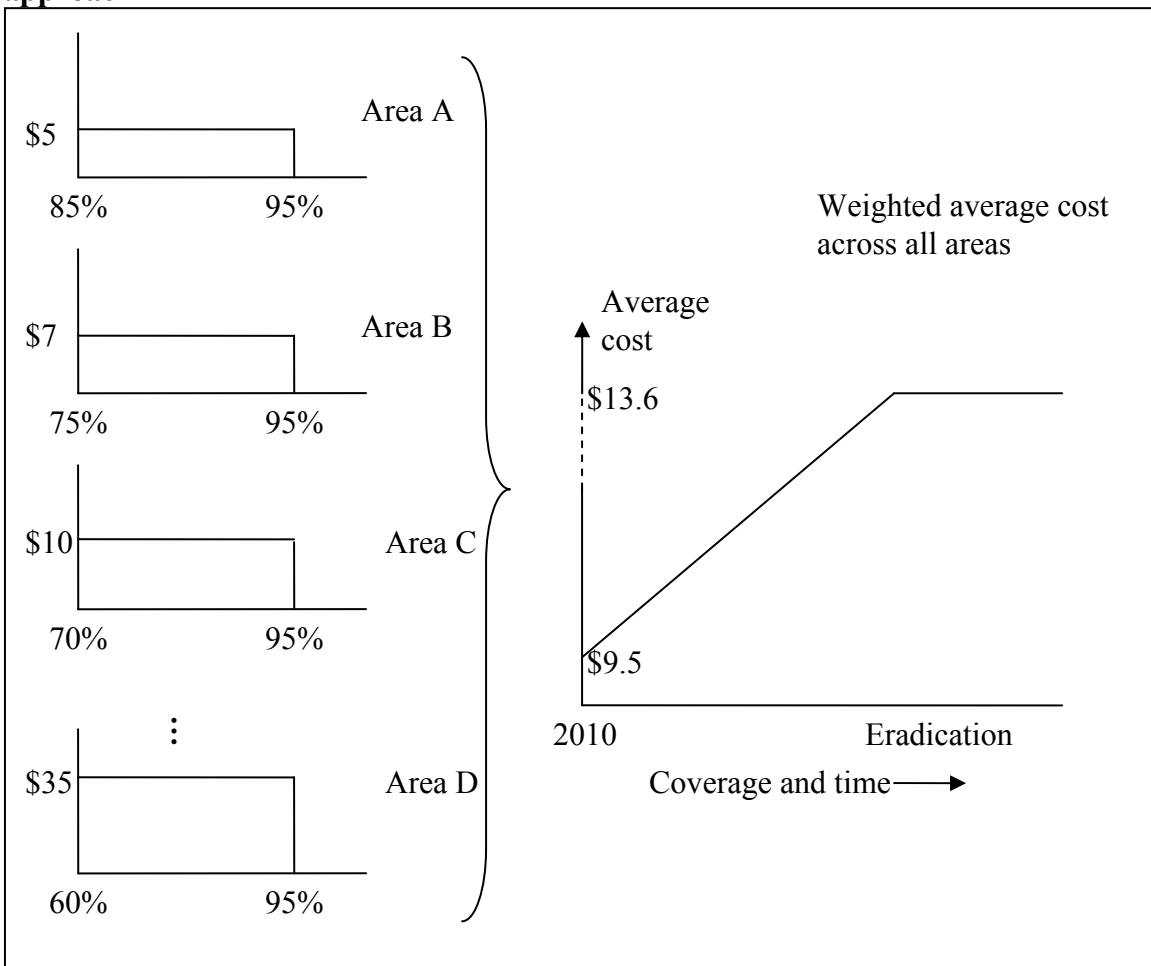

While acknowledging that linear scale up can potentially bias the cost estimate upwards, we think that the programmatic approach is more likely to reflect the true behavior of measles elimination programs than the cost-minimizing, stepped approach. The data that are needed in equation 2 to determine the cost of measles elimination is the average cost of vaccinating children in each region of a country as well as the relative population size.

3.0 Methods for estimating costs

In the absence of concrete data projecting the rises in average cost as coverage increases, and in light of the need to extrapolate costs across many countries, we have adopted a modeling approach to estimate the costs of measles elimination. The models are informed by data collection and interviews in the countries where in-depth modeling has been done (Uganda, Ethiopia, Brazil, Colombia, Tajikistan, and Bangladesh). We estimate costs for six categories: (1.) Delivery of MCV1 (2) MCV2; (3.) Cost of SIAs; (4.) Cost of treating measles infections; (5.) Cost of outbreak control, and (6) Cost of disease surveillance. Note that these categories exclude certain programmatic costs that may be used in the measles elimination effort, such as the costs of national and international coordination that may be needed to direct funds to needed areas.

The sections that follow provide details of the modeling approach employed for each of these cost categories. When appropriate, results are given for Uganda in order to further explicate the methods employed. We selected Uganda because we have data on both costs and coverage for multiple years from Uganda, and it can serve not only to demonstrate our models, but show the difficulties we encountered when trying to adapt other modeling approaches.

In order to complete this study, we have adapted a long-run, economic horizon. Specifically, we annualize capital costs over the 40 year period from 2010 to 2030 or 2050. Thus, we are reporting on the volume of resources needed under a variety of measles control options over decades, not the direct budgetary outlays needed in a particular year. The perspective is a societal perspective because we include costs of lost productivity due to disease³. Finally, we have assumed that incremental costs will be incurred in the public sector, or, alternatively, that there is no difference in the cost of providing vaccines between the public and private sector.

3.1 MCV1 and MCV2

Overview

Allocating the share of primary care visit costs to measles vaccination

Currently, the main site of delivery for MCV1, and MCV2 where applicable, in most countries is through the primary health care system. That is, children receive the vaccination when visiting a health centre or similar health care delivery site. Due to the multi-purpose nature of the primary care visit, the entire costs of the visit may not be

³Lost time and travel for parents due to receiving measles vaccine is a consideration in the societal perspective. There is no systematic data on the specific parental costs of having their children vaccinated. Accessing routine MCV1 imposes negligible costs to parents because the child is vaccinated as part of routine well child care, and only a small portion of parental time should be allocated to the vaccination services received. Furthermore many SIA campaigns take pains to minimize parental time and travel costs to access vaccines by conducting outreach to bring services closer to parents. These considerations suggest that the parental time costs of vaccinations would be a small fraction of the medical care costs of supplying the services, well within the +/- 20% cost bounds tested for sensitivity analysis.

attributable to MCV1 or MCV2. An undetermined fraction of the total cost of the visit should be attributed to measles vaccination.

Allocating the share of vaccine supply chain to measles vaccination

Attribution of costs to MCV1 / MCV2 is also complicated by resource sharing when delivering multiple vaccines and supplies to clinics (40). Thus, the costs of the vaccination delivery support system need to be allocated amongst the various vaccines to reflect the true costs attributable to MCV1 / MCV2.

Only five studies from developing countries report empirical results for the costs per MCV1 vaccine (6;31;41-48). Rule of thumb allocation methods of overhead costs to measles vaccines are usually applied. Given the difficulties, most studies present their results in terms of cost per fully immunized child rather than cost of delivering any single antigen.

The costs of demand creation

It is unlikely that passive reliance on fixed-site primary health care facilities to accelerate coverage of MCV1 and MCV2 will increase coverage sufficiently to achieve elimination (49). Resources need to be spent to ramp up. For example, many countries in Latin America have used targeted outreach or national immunization weeks to achieve high levels of coverage (63). Thus, simply applying costs of MCV1 and MCV2 delivery at fixed-site facilities to the number of additional children required for elimination will omit the costs of demand creation.

We assume that extra efforts are needed to achieve *any* increases in coverage (7;50). We have made the simplifying assumption that increased routine coverage will be achieved by some version of targeted outreach from fixed-facilities. Our version of targeted outreach may differ from other possible scale-up strategies. Thus it is important for readers to attend to the strategies we lay out to assess whether they conform to what they would deploy in their own context.

To develop our resource list for MCV1 scale up, we benefited from a series of interviews with EPI program managers, NGO fieldworkers and supervisors, and high level policymakers. (See complete list in acknowledgments.) The experience in PAHO, where this level scale up actually occurred, has provided an important benchmark (63). Although PAHO's resource list is partially documented, we expect that every country will vary slightly due to local contextual factors. Our sensitivity analysis assumes these local deviations will fall within +/- 20% of the baseline cost estimates, and readers who believe their case deviates more than this can use the sensitivity analysis as a guide to extend our results.

Incremental costs

Elimination will be achieved by creating an incremental change in the number of covered children. Decision makers need to compare the opportunity cost of creating this increment to the next best use of these resources. Past investments that have yielded current coverage levels and one assumes these can be maintained at current levels by

maintaining resource flows at current levels. We thus assume that current activities related to MCV1 and MCV2 will continue into the future, and we focus on *increments*. For completeness' sake, we have drawn estimates for the cost of current coverage from literature (31;41;43;46;51) for high income countries (average = US\$13.64 per vaccine delivered). Due to the paucity of data available in the published literature from developing countries, we have used the regional estimates provided by Brenzel, et al (2006) for developing countries for the costs of routine MCV1 and MCV 2 delivery at fixed facilities (2).

Ingredients based-recipe for routine targeted outreach (RTO)

Routine targeted outreach (RTO) has been the primary tool for increasing coverage for populations around the world where not every child makes regular visits to a primary care clinic. Two types of staff are the main ingredients in this approach. There are outreach vaccinators and mobilizers. We define outreach vaccinators as staff from primary health centers who make trips to outlying areas in order to deliver MCV1 / MCV2 to children that did not receive their vaccines by coming into the primary clinic. In order for staff to be able to identify unvaccinated children, workers in the community ('mobilizers') will be trained and compensated to track births and vaccinations in each village. This serves to reduce repetition of vaccination and to allow health center staff to make optimal use of their outreach visits. This outreach has to be routine – that is, every village needs to be visited at least once a year.

Ingredients based costing for routine targeted outreach (RTO)

In order to estimate the costs of routine, targeted outreach, we constructed a line-item unit cost and quantity model. The items populating this model were drawn first from interviews with health facility, district, and national level officials in Uganda, Brazil, Ethiopia, Bangladesh, and Colombia. These officials were interviewed using a structured questionnaire related to the cost and quantity of items needed in order to increase the coverage of measles immunization, and data related to the resources needed to conduct outreach. Data were recorded on-site at the interview in Microsoft Excel (52). Researchers were able to clarify items with follow up interviews. Most of the unit costs and quantities needed for outreach were based primarily on country level interviews. Other data were supplied using census data, routine reporting data from the EPI program, or filled in with assumptions, as noted below.

The initial design of the ingredients based model and some of the calculations were derived from the measles component of Global Immunization Vision and Strategy (GIVS) costing model (53) (Specifically, GIVS formulas for estimating the costs of cold chain, supervision, and outreach were used). This model was modified to incorporate inputs identified during the in-country interviews especially to account for heterogeneity between easy to vaccinate and hard to vaccinate regions. We defined six discrete regional types for which average costs have been calculated: urban, rural, and remote areas in each of the high and low coverage districts. The heterogeneity helps the model encompass the non-linearity of expected diminishing returns to scale in increasing vaccine coverage. The table below schematizes how the 6 types break out. The cost elements in the first two columns are the incremental cost per child vaccinated on the extensive margin as

routine coverage in each cell type is expanded. A weighted average of incremental costs is computed by using the population weights in the far right columns.

District Type	Core (Easier to reach)	Satellite (Hard to reach)		Core (Easier to reach)	Satellite (Hard to reach)
	COSTS			POPULATION WEIGHTS	
Urban	C _{UC}	C _{US}		P _{UC}	P _{US}
Rural	C _{RurC}	C _{RurS}		P _{RurC}	P _{RurS}
Remote	C _{RemC}	C _{RemS}		P _{RemC}	P _{RemS}

Costs for vaccines and vaccine disposal

Costs for vaccines were derived from antigens used for each country, and priced based on Table 2, syringes and needles were assumed to cost \$0.069, and safe disposal was assumed to cost \$0.01 per vaccination. The number of children vaccinated was calculated in the epidemiological model. A uniform wastage rate of 33% was assumed for vaccines given at fixed facilities and 15% was assumed during SIAs and outreach activities.

Table 2: Prices for antigens

Presentation	Cost per dose
Measles	\$0.02
MMR	\$0.09
MR	\$0.05
multiple	\$0.05

Source: (54)

Costs for cold chain

Cold chain costs were estimated based on an ingredients-based approach. Table 3 lists the costs included, and the source of data. Capital items were assumed to have a useful life of 10 years, excepting vehicles, cold boxes, and icepacks which were assumed to have a useful life of 5 years. Since we assume long-run, average costs, the cost per vaccine delivered does not change with the number of vaccines; that is, we apply a constant average cost for cold chain to the cost per child vaccinated.

The following formulas are used to estimate the quantity and price of storage needed:

Cost for storage at the national level:

Equation	Example calculation for Uganda
1. Percentage of freezer room space needed per vaccine = $\{[(\text{packed volume of measles vaccine in cubic centimeters}) / 1000000] / \text{Frequency of shipments}\} / \text{Size of the freezer room.}$	$= [(3 * 1.33) / 1000000] / 4 / 20 = 0.000005\%$

2. Cost of storage at the national level = Percentage of freezer room space needed per vaccine * [(Annual cost of freezer room + average annual maintenance cost + annual average running costs) + (annual cost of thermorecorder + annual cost of dial thermometers + annual cost of standby generator + annual cost of voltage stabilizer)]	= 0.000005% * [(2,469 + 527 + 1,422) + (161 + 5 + 1,104 + 58)] = 0.0003
---	---

Formulas at the district and health centre level mimic those at the national level, except replace some parameters (frequency of shipments, size of freezers, annual cost of freezers, and average annual maintenance cost and average annual running costs of freezers) with numbers that reflect sizes or prices for the particular level of interest. In all cases, it is assumed that only the amount of space needed for measles vaccines is the relevant cost; all other freezer space is expected to be allocated to other activities.

Cost of shipment from the national level to the district level:

Equation	Example calculation for Uganda
1. Proportion of van used per dose = (Storage volume per dose / capacity of van)	= [(3*1.33)/1000000] / 3 = 0.000001
2. Days of delivery needed per dose = [(Average travel time per district / 10 hours per day) * 2 for round trip] * Proportion of van used per dose	= [(19 / 10) * 2] * 0.000001 = 0.00005
3. Cost of vehicle = Days of delivery needed per dose / 220 * (Annual cost of vehicle + Annual salary of driver)	= 0.00005 / 220 * (4,009 + 1,509) = 0.0001
4. Cost of vehicle maintenance = Days of delivery needed per dose / 220 * Cost of vehicle * 15%	= (0.00005 / 220) * 18,360 * 15% = 0.0001
5. Cost of fuel = Days needed for delivery of measles vaccine * cost of fuel per liter * 20 liters of fuel per day	= 0.00005 * 1.45 * 20 = 0.0002
6. Cost of iceboxes = Days of delivery needed per dose / 220 * 1/0.02 icebox capacity * Number of boxes per trip * Annual cost of an icebox	= 0.00005 / 220 * 50 * 9 * 54 = 0.0006
7. Cost of icepacks = Days of delivery needed per dose / 220 * 1/0.02 icebox capacity * Number of boxes per trip * 24 icepacks per box * annual cost of icepacks	= 0.00005 / 220 * 50 * 9 * 24 * 0.12 = 0.00003
8. Total cost of transport = Cost of vehicle + Cost of vehicle maintenance + Cost of fuel + Cost of iceboxes + Cost of icepacks	= 0.0001 + 0.0002 + 0.0006 + 0.00003 = 0.001

Again, these formulae are repeated for distribution of measles vaccines from the district level to the health centre level.

To extrapolate the data from the six countries to all low- and middle-income countries, the base formulas were employed for all countries, but country specific values were placed in the formulas.

Costs for supervision

The costs for supervision were based primarily on country level interviews. Supervision visits to the district level and from the district level to the health facility level were included. The numbers of supervision visits, the number of staff, per diem and travel rates were collected in each of the countries. We assumed that the rates observed in high and low coverage districts surveyed would apply to other districts of the same classification. Table 4 lists parameters, sources, and sample values from Uganda. After calculating the total number of additional supervision visits required for the unvaccinated remnant, the model can compute the total required supervision days and full time equivalents which can be multiplied by the salary to estimate the economic costs associated with supervision. Travel costs were also included.

The following formulas are used to estimate the quantity and price of additional supervision needed.

For supervision from the national to the district level:

Equation	Example calculation for Uganda Core area
1. Percentage of children needing additional supervision = 95% - average current coverage for each of the 2 types of districts (high coverage and low coverage districts). Thus, the gap in coverage is used as an indicator of how much more supervision effort is needed.	= (95% - 82%) = 13%
2. Number of districts or subdistricts requiring additional supportive supervision = District in core area * percentage of children needing additional supervision	= 60 * 13% = 8
a. It is assumed that 60 is the number of districts and subdistricts needing supervision per 100,000 * 80% of the population in core areas * 13% uncovered children. This means that 8 supervision trips are needed for every 10,280 children to be incrementally covered.	
3. Number of supervisor trips = Number of districts requiring additional supportive supervision * Number of supervisors per trip * Number of supervision trips per year	= 8*2*2 = 31 (due to rounding)
4. Number of supervision days = Number of	= 31 * 2

supervisor trips * average length of supervision visit (days)	= 62
5. Cost for supervisors = (Number of supervision days / 230 working days per year) * (Salary of a supervisor + Cost of stationery, etc. per staff per year)	= (62 / 230) * (3,664 + 600) = 1,144
6. Cost for support staff = [(Number of supervisor trips * Number of support staff per trip) / 230 working days per year] * Salary for support staff	= ((62 * 2) / 230) * (1,509) = 810
7. Cost of per diems = Number of supervision days * Daily per diem rate (overnight trip) + Total number of support staff days * Daily per diem rate (overnight trip)	= 62 * 37.6 + 279 * 37.6 = 6,964
8. Travel costs = Number of supervisor trips * Travel costs (overnight trip)	= 62 * 107 = 6,632
9. Total costs of supervision = Cost for supervisors + Cost for support staff + Cost of per diems + Travel costs	= 1,144 + 810 + 6,964 + 6,632 = 15,550 15,550 / 10,280 children covered = 1.51 per child.

The same formulae are used to determine costs for supervision from the district level to the health center level with the following modifications:

1. Number of supervision trips = Number of districts requiring additional supportive supervision * Number of supervisors per trip * Number of supervision trips per year * Average number of health center per district for each of the 2 types of districts (high coverage and low coverage districts)
2. Daily per diem rate = Per diem (day trip) * (Percentage of the population living in urban and rural areas) + Per diem (overnight) * (Percentage of the population living in remote areas) for each of the 2 types of districts (high coverage and low coverage districts)
3. Travel costs = Travel costs (day trip) * (Percentage of the population living in urban and rural areas) + Travel costs (overnight) * (Percentage of the population living in remote areas) for each of the 2 types of districts (high coverage and low coverage districts)

Costs for routine targeted outreach

We estimated the percentage of children living in urban and rural areas from national census data when available (e.g., (55)), or from global databases when not available (56). In order to estimate the number of children living in remote areas, we determined the population of unvaccinated children living in districts classified as remote as a percentage of all unvaccinated children for the six countries where in-depth interviews were conducted. We then made the assumption that this national percentage was likely to apply within districts as well; this percentage was taken out of the category 'rural' and counted as 'remote'. These percentages were applied on a regional basis as well when estimating the global costs.

The average number of contacts possible in a single day outreach was determined for each of the three areas (urban, rural, and remote) based on in country interviews. We assumed that unvaccinated children were evenly dispersed across the three areas in proportion to their overall population, and calculated the number of days of outreach needed by dividing the number of children in each area by the number of contacts an outreach team can make in one day.

Distances traveled for each type of outreach were collected during the country interviews. From this, we calculated the number of vehicles needed by assuming 230 working days in a year, and we calculated the amount of petrol consumed based on average distances traveled and petrol mileage (53). Vehicle costs were annualized over 5 years, and annual maintenance was assumed to be 15% of purchase price (53).

The number of staff going on an outreach trip and per diems were collected during the country interviews for trips that can be completed in one day and for trips that need overnight stays. It was assumed that all trips in urban and rural areas could be completed

Table 3: Inputs used to estimate the costs of cold chain equipment

Item	Input	Source
Discount rate	3%	Guidelines (57)
Packed volume of measles per dose	3 cm ³	GIVs model (53)
Frequency of shipments		
to nation	2	Country interviews / GIVs model (53)
to district	4	
to health centre	4	
Type of storage		
central level	Freezer room, 20 m ³	GIVs model (53)
district	-200°C freezer, 111 L	GIVs model (53)
health centre	-200°C freezers, 111 L	GIVs model (53)
Price of storage		
Unit cost	Freezer room, 20 m ³	\$ 21,061
	Maintenance Cost	\$ 527
	Running Cost	\$ 1,422
	-200C freezers, 111 L	\$ 498 / \$4,000 for solar panel in selected countries
	Maintenance Cost, district per year	[\$ 81 in Uganda]
	Running Cost, district per year	[\$ 269 in Uganda]
	Maintenance Cost, health centre /year	\$ 28
	Running Cost, health centre / year	\$ 200
Thermorecorder		\$ 1,373

Dial thermometers	\$ 41	
Standby generator	\$ 9,420	
Voltage stabilizer	\$ 497	
Vaccine distribution		
National to district	Small van with 3m ³ loading capacity	GIVs model (53)
District to health centre	Motorcycle Motorcycle, off road	
Costs for vaccine distribution		
Small van with 3m ³ loading capacity	\$ 18,360	
Motorcycle	\$ 1,416	
Motorcycle, off road	\$ 1,682	GIVs model (53)
Large cold box 20 liters, long range	\$ 247	
Icepacks	\$ 0.57	
	Icepacks /cold box	24
Cost of gas, per liter	[\$1.45 in Uganda]	Country interviews / WHO-CHOICE (17)
Average travel time to district	[\$19 in Uganda]	GIVs model (53)

in one day, while trips to remote areas would require an overnight stay. Salaries for professional staff, support staff, and drivers were collected during country interviews or taken from publicly available databases (17). Salaries and per diems for staff in remote areas were adjusted upwards to compensate staff for hardship, based on country interviews and personal communication.

Table 4: Inputs used to estimate costs for additional supervision

Supervision: National to district		
Number of districts	[80 in Uganda]	WHO Country interviews
Percentage requiring additional supervision		
High coverage districts	[15% in Uganda]	
Low coverage districts	[30% in Uganda]	Country interviews (regionally applied)
Number of supervisors per trip	[2 in Uganda] (R)	
Visits per year	[2 in Uganda] (R)	Country interviews (regionally applied)
Length of supervision visits (days)	[2 in Uganda] (R)	
Salaries of supervisors	[\$3664 in Uganda]	Country interviews / WHO-CHOICE (17)
Cost of stationery, etc. per staff /yr	[\$600 in Uganda]	Assumption
# support staff per trip	[2 in Uganda] (R)	Country interviews
Salaries of support staff	[\$1509 in Uganda]	Country interviews / WHO-CHOICE (17)
Per diems		
Day trip	[\$6.45 in Uganda]	
Overnight Trip	[\$37.6 in Uganda]	Country interviews / WHO-CHOICE (17)
Travel costs		[updated using 2008 GDP in regression models]
Day trip	[\$54 in Uganda]	
Overnight Trip	[\$107 in Uganda]	
Supervision: District to health centre		

Number of health facilities per district	urban/rural remote	[53 in Uganda] (R) [9 in Uganda] (R)	Country interviews (regionally applied)
District coverage breakdown	% of districts with high coverage %of districts with low coverage	[75% in Uganda] [25% in Uganda]	WHO/UNICEF measles coverage data with adjustments based on 6 country interviews
Number of supervisors per trip		[2 in Uganda] (R)	
Visits per year		[2 in Uganda] (R)	
Length of supervision visits (days)		[2 in Uganda] (R)	Country interviews
# support staff per trip		[2 in Uganda] (R)	
Length of supervision visits (days)		[2 in Uganda] (R)	

(R) denotes region specific estimates

The quantity of mobilizers needed was taken from in-country interviews for each of the three regions, as were the length of training. The cost of training was calculated using per diems, arbitrarily increased by 20% to include room rental and materials. It was assumed that training has a useful life of three years (due to high turnover rates commonly found

Table 5: Inputs used in determining the costs for MCV1 RTO in Uganda

Item / Area	Value	Source
<i>Current coverage MCV1</i>		
High coverage districts	Country-specific estimate	WHO/UNICEF measles coverage data
Low coverage districts		
<i>Current coverage MCV2</i>		
High coverage districts	Country-specific estimate	WHO/UNICEF measles coverage data
Low coverage districts		
<i>% population living in urban areas</i>		
High coverage districts	Country-specific estimate	World development indicators (56) and extrapolation from 6 base countries (55)
Low coverage districts		
<i>% population living in rural areas</i>		
High coverage districts	Country-specific estimate	World development indicators (56) and extrapolation from 6 base countries (55)
Low coverage districts		
<i>% population living in remote areas</i>		
High coverage districts	Region-specific estimate	Extrapolation from 6 base countries (55)
Low coverage districts		
<i>Percentage of the population in each type of district</i>		
High coverage districts	Country-specific estimate	World development indicators (56) and extrapolation from 6 base countries (55)
Low coverage districts		
<i># contacts per day</i>		
in urban areas	[25 in Uganda](R)	Country interviews
in rural area	[10.5 in Uganda](R)	
in remote areas	[4 in Uganda](R)	
<i>Cost of vehicle (useful life 5 years; maintenance 15% of purchase costs)</i>		
KMs per liter	\$19,935 14.5	The GIVS model (53)

<i>Average distance to travel within district</i>		
Urban areas	[30 in Uganda]	Country interviews / The GIVS model (53)
Rural areas	[47 in Uganda]	
Remote areas	[100 in Uganda]	
<i>Staff per outreach trip</i>		
High coverage districts	[2 in Uganda]](R)	Country interviews
Low coverage districts	[4 in Uganda]](R)	
<i>Staff per diems</i>		
One day trip	[\$6.45 in Uganda]	Country interviews / WHO-CHOICE (17)
Overnight trip	[\$37.6 in Uganda]	
Salary multiplier, remote districts	1.2	email communication with A. Mutebi, 23 November 2009
Number of children covered by 1 mobilizer		
Urban areas	437.00	Country interviews
Rural Areas	69.92	
Remote areas	38.76	
Incentives paid to mobilizers	1/12 salary of driver	Country interviews / assumption

(R) region specific model

among village volunteers and the need for retraining), and costs were calculated as annual equivalents. Three day training was also included for health center staff. Costs for mobilizers and health center staff training were not included for MCV2, since it was assumed they could take on the additional duties of MCV1 without further numbers or training.

Data inputs are summarized in table 5, with specific examples supplied for Uganda. The majority of data come from country interviews and census data/international databases, while the price of vehicles is derived from the GIVS model. Additionally, the salaries of workers were derived as described under supervision. In Uganda, districts with higher coverage rates also had a higher urban population than low coverage districts (14% versus 6%). Further, low coverage districts were estimated to have a higher percentage of unvaccinated children living in remote areas than high coverage districts (10% versus 2%).

The following formulas are used to estimate the quantity and price of additional targeted outreach needed.

Equation	Example calculation for Uganda – MCV1 Core areas
1. Average number of days needed per outreach contacts = (Proportion of children living in urban areas / number contacts made per day during outreach in urban areas) + (Proportion of children living in rural areas / number contacts made per day during outreach in rural areas) +	= (14% / 25) + (84% / 10.5) + (2% / 4) = 0.09

<p>(Proportion of children living in remote areas / number contacts made per day during outreach in remote areas) for each of the 2 types of districts (high coverage [core] and low coverage districts [satellite])</p>	
<p>2. Cost of vehicles for outreach per contact = [(Average number of days needed per outreach contacts) / 230 working days in a year] * Annual cost of vehicle</p>	<p>= [(0.09)/230] * 3,987 = 1.62</p>
<p>3. Cost of fuel for vehicles per contact = [(Average number of days needed per outreach contacts) * Average distance traveled in a district (in kilometers) * Fuel consumption per kilometer] * Cost of fuel per liter.</p>	<p>= (0.09) * 47 * 0.07 * 1.45 = 0.44</p>
<p>a. Each of the 2 types of districts (high coverage and low coverage districts) has a different “Average distance to travel within district”, based on country interviews or the GIVs model.</p>	
<p>4. Cost of vehicle maintenance per contact = [(Average number of days needed per outreach contacts) / 230 working days in a year] * Purchase cost of vehicle * 15%</p>	<p>= [(0.09)/230] * 19,935 * 15% = 1.22</p>
<p>5. Per diem costs per contact = [(Average number of days needed per outreach contacts) * (Proportion of children living in urban areas + Proportion of children living in rural areas * Per diem for day trip) + (Average number of days needed per outreach contacts) * (Proportion of children living in remote areas * Per diem for overnight trip)] * Staff per outreach trip * Average number of days needed per outreach contacts / 230 working days, for each of the 2 types of districts (high coverage and low coverage districts)</p>	<p>= [(0.09) * (14% + 84%) * 6.45 + (0.09) * 2% * 45.14] * 2 * 0.09/230 = 1.81</p>
<p>6. Cost for staff salary per contact = [(Average number of days needed per outreach contacts)/230 working days in a year * (Staff per outreach trip * Annual salary of staff) * (Salary multiplier, remote districts * Proportion of outreach days to remote areas)] + [(Average number of days needed per outreach contacts)/230 working days in a year * (Staff per outreach trip * Annual salary of staff) * Proportion of outreach days to non-remote areas)], for each of the 2 types of districts (high</p>	<p>= [(0.09/230 * 2 * 3,664 * 1.2 * 8%) + [(0.09/230 * 2 * 3,664) * 92%] = 3.03 (due to rounding error) → 8% = (2%/4) / [(14% / 25) + (84% / 10.5) + (2% / 4)]</p>

coverage and low coverage districts)	
7. Cost for drivers per contact = [(Average number of days needed per outreach contacts) / 230 working days in a year * (Annual salary of a driver) * (Proportion of children living in remote district * Salary multiplier, remote districts)] + [(Average number of days needed per outreach contacts) / 230 working days in a year * (Annual salary of a driver) * (Proportion of children not living in remote district)], for each of the 2 types of districts (high coverage and low coverage districts)	= [(0.09/230 * 2 * 1,509 * 1.2 * 8%) + [(0.09/230 * 2 * 1,509) * 92%] = 0.62 (due to rounding error)
8. Average number of mobilizers needed per contact = [(Proportion of children living in urban areas / Number of children covered by 1 mobilizer in urban areas) + (Proportion of children living in rural areas / Number of children covered by 1 mobilizer in rural areas) + (Proportion of children living in remote areas / Number of children covered by 1 mobilizer in remote areas)], for each of the 2 types of districts (high coverage and low coverage districts)	= [(14% / 437) + (84% / 69.9) + (2% / 38.8)] = 0.013
a. If current coverage is above 85% in either of the 2 types of districts, then the multiplier [1/(1 - current coverage for MCV1)] is set equal to 1.	
9. Cost of mobilizers per contact = [Average number of mobilizers needed per contact * Annual cost of training + Average number of mobilizers needed per contact * (Annual salary of a driver / 12)] / Proportion of children newly covered (It is assumed that all children need enumeration, not just children newly covered)	= [0.013 * 32.48 + 0.013 * (1,518 / 12)] / (95%- 82%) = 15.81 (due to rounding error)
a. Annual cost of training = (Proportion of children living in urban areas + Proportion of children living in rural areas * Per diem for day trip *12 days of training) + (Proportion of children living in remote areas + * Per diem for overnight trip *12 days of training); it is assumed that training has a useful life of 2 years.	= [(14% / 437) + (84% / 69.9)] / [(14% / 437) + (84% / 69.9) + (2% / 38.8)] * 27.36 + [(2% / 38.8)] / [(14% / 437) + (84% / 69.9) + (2% / 38.8)] * 191.49 = 32.48
b. It is assumed that mobilizers make the same salary as drivers, but that only 1 month of their time will be needed for enumeration activities.	= [(14% / 437) + (84% / 69.9)] / [(14% / 437) + (84% / 69.9) + (2% / 38.8)] * 1,509+ [(2% / 38.8)] / [(14%

	$/ 437) + (84\% / 69.9) + (2\% / 38.8)] * 1,509 * 1.2$ $= 1,518$
10. Cost of training outreach staff per contact = [(Average number of days needed per outreach contacts) / 230 working days in a year] * 6 * 2 days training * per diem * 1.5	$= (0.09/230) * 6 * 2 * 6.45 * 1.5$ $= 0.034 \text{ (due to rounding error)}$
a. It is assumed that multiple staff will conduct outreach visits, with an average of 6 per area	
b. The per diems are multiplied upward by 1.5 in order to account for the costs associated for training, such as materials, room rental, etc.	
11. Total cost per contact = Cost of vehicles for outreach per contact + Cost of fuel for vehicles per contact + Cost of vehicle maintenance per contact + Per diem costs per contact + Cost for staff salary per contact + Cost for drivers per contact + Cost of mobilizers per contact + Cost of training outreach staff per contact	$= 1.62 + 0.44 + 1.22 + 1.81 + 3.03 + 0.62 + 15.81 + 0.034$ $= 24.59$

These are calculated separately for low and high coverage districts, as noted above.

High income countries

For high income countries where coverage is below elimination levels there is no credible basis to make any estimate of what it would cost to increase coverage among affluent vaccine-refusers. The model applies an *ad hoc* “what if” value of \$200 per incremental child.

3.2 SIAs

As mentioned in the introduction, the exact data needed to estimate the costs of SIAs needed for elimination has not been observed since many SIAs do not achieve 95% coverage, or do not achieve 95% coverage uniformly across the entire country. We have, to the extent possible, used retrospectively collected data reflecting the actual costs and number of children reached as presented in the literature to estimate the costs of SIAs since projections are likely to be optimistic in regards to the actual coverage that can be achieved.

Previous studies have used a mixture of data sources to estimate the cost of SIAs including budgets, expenditures from external donors, and published studies to estimate the costs of SIAs for additional countries (20;53;58). The extrapolation of data has been

done either by using regional averages (58), purchasing power parity adjustments (53), or regression techniques (20).

Table 6: Cost Estimates for SIAs from Selected Sources

Country	Year	Estimated cost per child 2008 US\$	Antigen	Cost include antigen	Target population	Coverage	Coverage derivation	Source
Argentina	1999	0.79	measles	Yes	Children < 5	95%	Projected	(20)
Brazil	1999	2.32	measles	Yes	Children < 5	95%	Projected	(20)
India	2008	0.69	measles	No	Children < 5	75%	Projected	(23)
Zambia	2000	1.47	measles	No	Birth cohort (< 15)	80%	Estimated	(6)
Kazakhstan	2001	1.26	measles	No	School age children	N/A	Target	(32)
Kyrgyz Republic	2001	0.38	measles	No	7 to 25 year olds	N/A	Target	(32)
Ethiopia	2006	0.64	measles	Yes	Children < 5	N/A	Observed	(25)
Ghana	2002	0.78	measles	No	Children < 15	93%	Estimated	(26)
Pakistan	2000	0.07	measles	No	Children < 5	N/A	Estimated	(30)
Lao PDR	2000	0.54	measles	No	Children < 5	82%	Observed	(12)
Canada	1995	10.52	measles	No	Children < 18	95%	Projected	(31)
South Africa	1996	0.69	measles	No	Children < 15	94%	Estimated	(38)
South Africa	1996	0.75	measles	No	Children < 15	N/A		(38)
China	1994	0.58	Polio	No	Children < 4	94%	Estimated	(13)
Uganda	2003	0.37	measles	No	Children < 5	105%	Observed	WHO
Uganda	2006	0.56	measles	No	Children < 5	101%	Observed	WHO
Uganda	2009	0.51	measles	No	Children < 5	104%	Observed	WHO

N/A: Not available

Our concern with taking averages or using purchasing power adjustments is that the costs observed are not from a random selection of countries and it is unlikely that the countries for which cost data have been found are representative of their regions/income classes (e.g., it is unlikely that Argentina, Brazil, and South Africa are representative of upper middle-income countries as a whole). Ideally, for measles SIAs, regression techniques would be used since different campaigns target different age groups, achieve different coverage levels, and employ different methodologies for estimating costs, which regression could handle to the extent that these differences are quantifiable and meaningful. Additionally, small area coverage and potential environmental confounders, such as population density and ease of transport, would also be included in this regression. However, this latter approach would require a larger sample of countries and districts in order to predict the costs of all the local areas in all countries of interest. We found only 17 observations of SIA costs at the national level in the literature. This small sample does not provide enough degrees of freedom to permit controlling for coverage levels achieved, methods of cost estimation, and differences in the target population. Therefore, we have employed a generalized linear model where costs are assumed to be solely a function of GDP per capita using a natural log link. A dummy variable was included to control for whether antigen costs were included in a cost measurement.

Table 6 summarizes the data found in the SIA cost literature. The cost per child reached ranged from \$0.07 in Pakistan to \$10.52 in Canada (in constant 2008 US dollars). Data from two studies (28;37) were excluded due to exclusion of certain categories of costs from their final calculations. Table 7 shows the results from the regression by income class compared to the average drawn directly from the data in table 5; it should be born in mind that the averages reported in Table 7 from the data are based on very small sample sizes. The regression smoothes the relationship between GDP and unit costs, such that unit costs monotonically increase with GDP, as would be expected. These results show a slightly higher cost per child in low income countries than has been previously reported for polio vaccines; but are lower for middle income countries (58). However, the results are not directly comparable since we report in 2008 dollars, and measles campaigns often have a different target population and mode of vaccine delivery than polio vaccines.

Table 7: Comparison of results from regression to averages observed in the data

	Low-Income countries		Lower middle income countries		Upper middle income countries	
	Observed in data	Results from regression	Observed in data	Results from regression	Observed in data	Results from regression
Cost per child reached (range)	\$0.58 (0.37 to 1.47)	\$0.58 (0.57 to 0.60)	\$0.45 (0.07 to 0.69)	\$0.65 (0.60 to 0.72)	\$1.16 (0.69 to 2.32)	\$0.88 (0.73 to 1.21)

Frequencies of SIAs are based on WHO guidelines, and are detailed in Table 8. Table 8 also includes data on the target population of SIAs based on SIA frequency.

Table 8: Frequency of SIAs

MCV1 Coverage	Age MIN	Age MAX	Frequency
> 80%	9 mo	59 mo	4 yr
60% - 79%	9 mo	47 mo	3 yr
< 60%	9 mo	35 mo	2 yr

3.3 Outbreak control

Outbreak control may involve disbursement of vaccines, contact tracing, quarantining of exposed people, laboratory testing, mass media messages, and treatment of ill people on an out-patient and in-patient basis (59-62); the exact categories of costs included in the studies we found were not consistent across studies. The exact amount of costs and resources employed in an outbreak control situation is determined by the speed, quality,

and scope of the response, as well as the amount of access the population has to health services.

Methods for low and middle income countries with endemic measles

Based on WHO recommendations for outbreak control in countries where measles is still endemic, we assume a large-scale vaccination campaign to follow initial outbreaks (63;64). Table 9 summarized this data; we adopt an approach which excludes the campaigns in the Darfur area of Sudan, and assume an outbreak will have, on average, 2,000 cases and require a large scale vaccination campaign where 100,000 people are vaccinated at the same cost as an SIA. Additionally, the equivalent of one full-time epidemiologist was assumed to be needed; the salary was assumed to be 5 times the average GDP of the country. In the detailed models of the 6 country models, outbreaks were detected by the computer on the basis of the observation of a change in the slope of the attack rate that was sustained for 2 biweekly periods in any cell of the model⁴. In the global linear model outbreaks are assumed to occur every year in low-coverage countries (as observed in Ethiopia) and every two years in higher coverage countries, until the time of global measles elimination.

Table 9: Outbreak response in low and middle income countries

Place and date	# Cases	# Vaccinees	# Vaccinees per case	Source
Papua New Guinea, 1999 - 2000	314	126	0.4	(65)
Papua New Guinea, 2001	492	5558	11.3	(66)
Guam, 1994	228	12000	52.6	(67)
Marshall Islands, 2003	826	33508	40.6	(68)
Fiji, 2006	132	89747	679.9	(69)
Sudan, 2004	725	2008202	2769.9	(70)
Bolivia, 1998 - 2000	2567	30983	12.1	(71)
Peru, 1993	150	159	1.1	(72)
Kenya, 2005 - 2006	2544	670016	263.4	(73)
Niger, 2003 - 2004	10880	84563	7.8	(74)
Average	1,886	293,486	156	
Average without Sudan	2,015	102,962	51	

Methods for countries without endemic measles

Literature on public health responses in Canada and the United States indicate that substantial, but variable, public health efforts are used in response to measles outbreaks. The following table summarizes the data that has been found:

⁴ Visual inspection confirmed that the computer’s outbreak detection algorithm successfully flagged all spikes as outbreaks and did not flag non-spikes.

Table 10: Data on measles outbreak control in developed countries

Place and date	# Cases	# Vaccinees	# Vaccinees per case	Source
Middlesex/London, Ontario 1994	43	28	0.65	Pelletier 1998 (31)
Calgary, Alberta 1994	9	130	14.44	
Toronto, Ontario 1995	177	326	1.84	
Chicago, Illinois 1995	119	820	6.89	
York Region, Ontario 1990	49	1509	30.80	
Montana, 1985	137	1731	12.64	
Pert County, Ontario 1992	172	2691	15.65	
Sudbury, Ontario 1991	147	5023	34.17	
Kitchener-Waterloo. Ontario 1991	1184	22777	19.24	
Indiana 2005	34	675	19.85	Parker 2006 (60)
Iowa 2004	3	2000	666.67	Dayan 2005 (59)
San Diego 2008	12	5	0.42	Sugerman 2010 (75)
Total	2086	37715		
Average (Mean)	174	3143	18.1	

Based on this data, we assume that an average outbreak will have 174 cases, and 3143 children vaccinated; the cost of vaccination is assumed to be the same as at health facilities. In addition, we assume 5 times GDP per capita (US\$238,000 in the United States) in overhead costs for each outbreak. Outbreaks are assumed to occur every 3 years until global elimination. Treatment costs for 174 cases were included for each outbreak.

Methods for high income countries with endemic measles

Limited literature from Europe reports only the costs for treating measles in an outbreak and do not report the costs of the public health response. There does not appear to be the same level of vaccination outreach as in North America. We therefore assume the same level of overhead costs for epidemiology and social marketing for outbreak control as in North America, but half of the number of vaccinations actually delivered (i.e., 1,572).

3.4 Measles surveillance

Based on data from PAHO surveillance, we estimate that a country that has eradicated measles will need about 2 tests per 1,000 surviving infants (76). We further assume that coverage of surveillance is reflected by MCV1 coverage – that is, that expanded

surveillance will be needed the closer a country gets to elimination. Test cost is assumed to be \$5.17 for reagents and one laboratory “full time equivalent worker” (FTE) required to perform 1000 tests per year. This lab FTE would be an amalgam of a technician conducting the tests, ($\frac{1}{2}$ FTE or 1000 hours per year), a supervisor ($\frac{1}{4}$ FTE), and other administrators worth an additional $\frac{1}{4}$ FTE. The assumptions about labor costs for surveillance have minimal impact on the model in sensitivity analysis because surveillance makes up only a small fraction of the total costs of measles control.

Methods for countries with endemic measles

We assume further laboratory development will be needed as countries approach elimination; we assume these costs will be 5 times the usual costs in the 5 years before elimination, and 1.5 times the usual costs in the 5 years following elimination. Surveillance is assumed to continue to be necessary until 2050 in all scenarios. We further assumed that current coverage of MCV1 also reflects current surveillance levels, and that as vaccination coverage rates increase, surveillance also increases. Costs are arbitrarily marked up 10x in countries classified as having very low coverage, based on data collected in Ethiopia.

Methods countries without endemic measles

It is assumed that sufficient laboratory facilities exist in these countries and that the current levels of surveillance (2 tests per 1000 surviving infants) match those necessary for monitoring elimination.

3.5 Cost of treating measles cases

We found only 8 studies that provided estimates of the costs of treating measles cases in 10 countries (43;45;51;61;62;77-79); 8 of these data points were from developed countries (43;51;61;62;77;78). It is likely that treatment quality, practices, and possibly classifications of disease severity differ between developed and developing countries making the use of regression to predict costs for missing countries from this data likely to be biased (in addition to being based on a small sample). One study from Bangladesh which looked at the treatment seeking behavior of members of a community estimated the average cost per measles case was \$0.90 (\$1.10 in 2008 inflation adjusted dollars).

In lieu of detailed data, we have made the assumption that given good access to care, for every 100 measles cases there would be 50 primary care visits (50% utilization rate), 200 lost parent productivity days, and 10 hospital bed days. Every primary care visit includes, in addition to labor costs, the provision of one Vitamin A supplement, assumed to cost \$0.05 (including delivery). However, access rates to primary care are likely to be dependent on the country where one lives; we have assumed that outpatient access rates in South Asia and Africa are different than elsewhere. Thus, in low coverage Africa, we assume that for every 100 measles cases there are only 7 outpatient visits and 6 hospital bed days; in high coverage Africa we assume there are 20 outpatient visits and 8 inpatient days, and; in South Asia we assume that there are 40 outpatient visits and 10 inpatient days. For Bangladesh, this results in a cost of US\$ 1.11, conforming to previous literature.

Unit costs for inpatient days and outpatient visits are taken from WHO-CHOICE and adapted to each country based on current GDP (17).

The estimated incidence and costs of long-term sequelae from measles cases is not well studied, although a few papers from developed countries allow for estimation of the incidence (46;51;61;77;78). Based on this literature, we estimate that about 1.5 cases out of 10,000 measles cases will have long-term sequelae such as sub-sclerosing pan-encephalitis. Lacking concrete data on costs for these cases in developing countries, we assume an average of 14 hospital days per case, and 10 years of lost income. Premature deaths in these cases are subsumed in the case fatality assumptions. Years lost due to disability (YLD) are assumed to be driven by a disability weight of 0.2 for a duration of 10 years. Altering the cost and burden assumptions of long term sequelae had almost no discernible impact in sensitivity analysis.

For countries with a high GDP, treatment costs were taken from the literature. Based on eight observations, the cost of treatment per case was US\$463 in 2008 dollars (43;51;61;62;77;78). These figures include estimates of treating long-term sequelae.

3.6 Estimating global resource needs

Estimating MCV1 coverage

Eradication scenarios: Baseline coverage rates were ramped up at a speed needed to achieve 100% coverage by the target year of elimination or by 3% per year, whichever was smaller. The coverage rate is then applied to the projected number of surviving infants for that year and the coverage achieved in the year of elimination is carried through to 2050. Some countries may not achieve a coverage rate high enough for elimination (assumed to be 95%) using this algorithm, and these countries are assumed to need yearly SIAs for the 5 years before elimination. Coverage in the Americas is assumed to remain constant for all years, with the exception of Haiti, where increased coverage is assumed to be needed to prevent re-introduction of measles.

Mortality reduction scenarios: The same algorithm is applied as for the elimination scenarios, except that the target coverage was set at 98% in 2020 (for the 98% reduction in mortality scenario) and 83% in 2015 (for the 95% reduction in mortality scenario). Countries that currently have coverage above these levels were assumed not to need expansion in coverage. SIAs are implemented as described in section 3.2, and below.

Baseline and stop SIA scenario: Coverage was frozen at current levels; for the stop SIA scenario, cost for SIAs was not included for any GAVI eligible country.

Estimating MCV2 coverage

MCV2 is introduced after 3 years of achieving 80% coverage with MCV1; coverage is introduced at 50% and achieves 90% of MCV1 coverage after 3 years. However, MCV2 is not introduced in countries only achieving 83% coverage in the 95% reduction in

mortality scenario. The costs for MCV2 after elimination are excluded in sensitivity analysis.

Estimating SIA coverage

Coverage of SIAs at baseline is assumed to be 90% or current MCV1 coverage, whichever is higher. Coverage is assumed to reach 95% in the eradication scenarios and 93% in the 98% reduction in mortality scenario; coverage is scaled up linearly.

Estimating number of deaths due to measles

The number of deaths from measles is drawn from WHO figures or recent literature (80). Deaths decrease linearly to zero in the year of elimination or the percentage reduction in mortality for the mortality reduction scenarios. The extra deaths for the stop SIA scenario are based on the percentage jump in deaths observed in the six countries where in-depth modeling was done.

Estimating number of measles cases

The number of measles cases is calculated by dividing the number of deaths by the case fatality rate (assumed to be 1.5% in low and middle income countries and 0.019% in high income countries). For high income countries and countries in the Americas, the number of cases from outbreaks is added to this figure, but elsewhere it is assumed the deaths estimation includes deaths in outbreaks, and, therefore, cases due to outbreaks.

4.0 Results

Table 1 presents the results of the micro-model for the six countries where in-depth modeling was performed. The figures presented are the average of urban, rural, and remote areas within high or low coverage districts. Costs for MCV2 are lower, as expected, since it is assumed that mobilizers paid for in the costs of MCV1 can assumed responsibility for MCV2. Table 12 shows the results for the cost of treating measles per measles case for the six countries. Results are presented as medical costs only (in the first column) and including productivity losses. Productivity losses include costs to access care and cost of lost productivity due to long term sequelae, and constitute a substantial part of the total costs of treating measles cases.

Finally, Table 13 presents a breakdown of the costs of RTO for Uganda, separating core and satellite areas. In core areas with high coverage, enumeration of the population constitutes the majority of costs, while in lower coverage areas, more costs are needed for outreach workers and transport. In both cases, overhead costs for cold chain and supervision are about 11% to 14% of costs.

Table 11: Results of the micro-costing model for targeted outreach

Country / Group	Type of area / district	Average cost per new child reached – MCV1*	Average cost per new child reached – MCV2*
Uganda	High coverage district	\$15.15	\$8.79
	Low coverage district	\$33.83	\$27.11
Brazil	High coverage district	N/A	\$4.42
	Low coverage district	\$121.16	\$5.46
Tajikistan	High coverage district	\$9.45	\$7.26
	Low coverage district	\$11.72	\$8.22
Ethiopia	High coverage district	\$18.82	\$11.04
	Low coverage district	\$27.43	\$13.99
Bangladesh	High coverage district	\$10.63	\$9.10
	Low coverage district	\$13.40	\$10.25
Colombia	High coverage district	\$18.80	\$4.20
	Low coverage district	\$21.04	\$4.51

*Excluding costs of vaccines, syringes, and waste disposal; presented in 2009 US\$

Table 12: Estimated cost of treatment per measles case*

Country	Cost for treatment per measles case (in year 2009 US\$)	
	Without parent productivity costs	Including parent productivity costs
Uganda	0.66	3.73
Ethiopia	0.30	2.56
Tajikistan	1.81	7.18
Bangladesh	1.12	4.63
Colombia	9.03	42.75
Brazil	14.45	70.51

*The denominator is all measles cases, including mild cases in which no care is sought.

Table 14: Breakdown of costs for Uganda

Item	Percentage of total cost for MCV1 Targeted Outreach*	
	Core districts (currently with high coverage)	Satellite districts (currently with low coverage)
Transportation of outreach staff	18%	46%
Outreach staff	13%	27%
Cost for community mobilizers & communication	56%	15%
Costs for training	0.1%	0.2%
Cost for cold chain	2%	0.3%
Costs for supervision	11%	11%

*Excluding costs of vaccines, syringes, and waste disposal

Acknowledgements

The authors of this paper are extremely grateful to all the people who informed this study, gave information to interviewers, helped collect data, or commented on earlier drafts of this paper. Emily Simons, Kyla Hayford, Maya Vijayaraghavan, Ann Levin, and Amnesty Lefevre helped to collect data. The following people deserve special mention.
 Uganda: A. Mutebi, William Mbabazi
 Ethiopia: Valeria Oliveira Cruz, Pascal Mkanda, Gavin Grant
 Bangladesh: Kyla Hayford, Jasim Udin

Any mistakes or errors in the content and results of this paper remain the responsibility of the authors.

Reference List

- (1) Brenzel, L. Note on Returns to Scale for Immunization Services. Washington, DC: The World Bank; 2005. Report No.: 32800.
- (2) Brenzel L, Wolfson LJ, Fox-Rushby J, Miller M, Halsey NA. Vaccine-Preventable Diseases. In: Jamison DT, Breman JG, Measham AR, Alleyne G, Claeson M, Evans DB et al., editors. *Disease Control Priorities in Developing Countries Second Edition*. Washington DC: The World Bank; 2006. p. 389-411.
- (3) Pegurri E, Fox-Rushby JA, Damian W. The effects and costs of expanding the coverage of immunisation services in developing countries: a systematic literature review. *Vaccine* 2005 February 18;23(13):1624-35.
- (4) Shepard DS, Robertson RL, Cameron CS, III, Saturno P, Pollack M, Manceau J et al. Cost-effectiveness of routine and campaign vaccination strategies in Ecuador. *Bull World Health Organ* 1989;67(6):649-62.
- (5) Walker D, Mosqueira NR, Penny ME, Lanata CF, Clark AD, Sanderson CF et al. Variation in the costs of delivering routine immunization services in Peru. *Bull World Health Organ* 2004 September;82(9):676-82.
- (6) Dayan GH, Cairns L, Sangruejee N, Mtonga A, Nguyen V, Strebel P. Cost-effectiveness of three different vaccination strategies against measles in Zambian children. *Vaccine* 2004 January 2;22(3-4):475-84.
- (7) Batt K, Fox-Rushby JA, Castillo-Riquelme M. The costs, effects and cost-effectiveness of strategies to increase coverage of routine immunizations in low- and middle-income countries: systematic review of the grey literature. *Bull World Health Organ* 2004 September;82(9):689-96.
- (8) Morgan, C., Hinton, R., Pongua, G., Clements, C. J., Sweeney, R., Reeder, J., and Duke, T. Better use of public health campaigns for child survival: The impact and operations of Papua New Guinea's supplementary immunisation activity 2003-05. Melbourne, Australia: Child Health and Nutrition Research Initiative; 2006.
- (9) Chee, G., Hsi, N., Carlson, K., Chankova, S., and Taylor, P. Evaluation of the First Five Years of GAVI Immunization Services Support Funding. Bethesda, MD: Abt Associates Inc.; 2007.
- (10) Valdmanis V, Walker D, Fox-Rushby J. Are vaccination sites in Bangladesh scale efficient? *Int J Technol Assess Health Care* 2003;19(4):692-7.
- (11) Robertson RL, Davis JH, Jobe K. Service volume and other factors affecting the costs of immunizations in the Gambia. *Bull World Health Organ* 1984;62(5):729-36.

- (12) Lydon, P. Costing of Measles Campaigns West Pacific Region: The Lao PDR Measles Campaigns 2000-2001. Geneva, Switzerland: World Health Organization; 2002.
- (13) Zhang J, Yu JJ, Zhang RZ, Zhang XL, Zhou J, Wing JS et al. Costs of polio immunization days in China: implications for mass immunization campaign strategies. *Int J Health Plann Manage* 1998 January;13(1):5-25.
- (14) Stevenson, S., Lydon, P., and Dalantai, H. Asian vaccination initiative: Mongolia national immunization program financing assessment. Manila, Philippines: Asian Development Bank; 2001.
- (15) Walker DG, Beutels P, Hutubessy R. Economic evaluation of childhood vaccines. In: Unger WJ, editor. *Economic evaluation in child health*. Oxford, UK: Oxford University Press; 2010. p. 211-24.
- (16) Hutchinson P, Lance P, Guilkey DK, Shahjahan M, Haque S. Measuring the cost-effectiveness of a national health communication program in rural Bangladesh. *J Health Commun* 2006;11 Suppl 2:91-121.
- (17) WHO-CHOICE. Tables of costs and prices used in WHO-CHOICE analysis. <http://www.who.int/choice/costs/en/> 2009;
- (18) Uddin MJ, Larson CP, Oliveras E, Khan AI, Quaiyum MA, Chandra SN. Child immunization coverage in rural hard-to-reach Haor areas of Bangladesh: possible alternative strategies. *Asia Pac J Public Health* 2009 January;21(1):8-18.
- (19) Uddin MJ, Larson CP, Oliveras E, Khan AI, Quaiyum MA, Saha NC. Child immunization coverage in urban slums of Bangladesh: impact of an intervention package. *Health Policy Plan* 2010 January;25(1):50-60.
- (20) Acharya A, az-Ortega JL, Tambini G, de QC, Arita I. Cost-effectiveness of measles elimination in Latin America and the Caribbean: a prospective analysis. *Vaccine* 2002 September 10;20(27-28):3332-41.
- (21) Attanyake, N. and Stevenson, S. Asian vaccination initiative: Sri Lanka national immunization program financing assessment. Manila, Philippines: Asian Development Bank; 2001.
- (22) Brenzel L, Claquin P. Immunization programs and their costs. *Soc Sci Med* 1994 August;39(4):527-36.
- (23) Dabral M. Cost effectiveness of Supplementary Immunization for Measles in India. *Indian Pediatr* 2009 May 20.
- (24) Fairbrother G, DuMont KA. New York City's 1993 child immunization day: planning, costs, and results. *Am J Public Health* 1995 December;85(12):1662-5.

- (25) Fiedler JL, Chuko T. The cost of Child Health Days: a case study of Ethiopia's Enhanced Outreach Strategy (EOS). *Health Policy Plan* 2008 July;23(4):222-33.
- (26) Grabowsky M, Nobiya T, Ahun M, Donna R, Lengor M, Zimmerman D et al. Distributing insecticide-treated bednets during measles vaccination: a low-cost means of achieving high and equitable coverage. *Bull World Health Organ* 2005 March;83(3):195-201.
- (27) Hsi, C. N. Etude sur le cout, cout-efficacite, et la viabilite financiere du programme elargi de vaccination du Senegal. World Bank; 2003.
- (28) Levin, A., Howlader, S., Ram, S., Siddiqui, I. R., and Routh, S. Case Study on the Costs and Financing of Immunization Services in Bangladesh. Bethesda, MD: Partnerships for Health Reform Project, Abt Associates Inc.; 1999.
- (29) Levin, A., England, S., Jorissen, J., Garshong, B., and Teprey, J. Case Study on the Costs and Financing of Immunization Services in Ghana. Bethesda, MD: Partnerships for Health Reform Project, Abt Associates Inc.; 2001.
- (30) Loevinsohn, B. Immunization Financing in Pakistan. Health, Population and Nutrition, The World Bank, South Asia Region; 2000.
- (31) Pelletier L, Chung P, Duclos P, Manga P, Scott J. A benefit-cost analysis of two-dose measles immunization in Canada. *Vaccine* 1998 May;16(9-10):989-96.
- (32) Sam, G. Asian vaccination initiative: Kazakhstan and Kyrgyz Republic national immunization program financing assessment. Manila, Philippines: Asian Development Bank; 2002.
- (33) Souleymane, S. Etude sur le coût et la viabilité financière du Programme National d'Immunisation. Mauritania: Ministère de la Santé et des Affaires Sociales, World Bank; 2005.
- (34) Stevenson, S. and Makhamova, S. Asian vaccination initiative: Uzbekistan national immunization program financing assessment. Manila, Philippines: Asian Development Bank; 2001.
- (35) Stevenson, S. and Candries, B. Ethiopia national immunization program costing and financing assessment. World Bank; 2002.
- (36) The World Bank. Immunization Financing in Nepal. Health, Population and Nutrition, The World Bank, South Asia Region; 2001.
- (37) Vijayaraghavan M, Lievano F, Cairns L, Wolfson L, Nandy R, Ansari A et al. Economic evaluation of measles catch-up and follow-up campaigns in Afghanistan in 2002 and 2003. *Disasters* 2006 June;30(2):256-69.

- (38) Uzicanin A, Zhou F, Eggers R, Webb E, Strebel P. Economic analysis of the 1996-1997 mass measles immunization campaigns in South Africa. *Vaccine* 2004 September 3;22(25-26):3419-26.
- (39) Johns B, Baltussen R. Accounting for the cost of scaling-up health interventions. *Health Econ* 2004 November;13(11):1117-24.
- (40) Edmunds WJ, Dejene A, Mekonnen Y, Haile M, Alemnu W, Nokes DJ. The cost of integrating hepatitis B vaccine into national immunization programmes: A case study from Addis Ababa. *Health Policy and Planning* 2000;15(4):408-16.
- (41) Carabin H, Edmunds WJ, Gyldmark M, Beutels P, Levy-Bruhl D, Salo H et al. The cost of measles in industrialised countries. *Vaccine* 2003 October 1;21(27-30):4167-77.
- (42) Hoang MV, Nguyen TB, Kim BG, Dao LH, Nguyen TH, Wright P. Cost of providing the expanded programme on immunization: findings from a facility-based study in Viet Nam, 2005. *Bull World Health Organ* 2008 June;86(6):429-34.
- (43) Miller MA, Redd S, Hadler S, Hinman A. A model to estimate the potential economic benefits of measles eradication for the United States. *Vaccine* 1998 December;16(20):1917-22.
- (44) Shepard DS, Sanoh L, Coffi E. Cost-effectiveness of the expanded programme on immunization in the Ivory Coast: a preliminary assessment. *Soc Sci Med* 1986;22(3):369-77.
- (45) Walker, D., Khan, S., Akramuzzaman, S. M., Khan, M., Fox-Rushby, J., and Cutts, F. Final report: Cost-effectiveness analysis of measles control in Dhaka, Bangladesh. Geneva, Switzerland: World Health Organization; 2000. Report No.: WHO HQ/98/454419 011638.
- (46) Zhou F, Reef S, Massoudi M, Papania MJ, Yusuf HR, Bardenheier B et al. An economic analysis of the current universal 2-dose measles-mumps-rubella vaccination program in the United States. *J Infect Dis* 2004 May 1;189 Suppl 1:S131-S145.
- (47) Van DW, Van LW. Strengthening health services to control epidemics: empirical evidence from Guinea on its cost-effectiveness. *Trop Med Int Health* 2004 February;9(2):281-91.
- (48) Watson JC, Pearson JA, Markowitz LE, Baughman AL, Erdman DD, Bellini WJ et al. An evaluation of measles revaccination among school-entry-aged children. *Pediatrics* 1996 May;97(5):613-8.
- (49) Ryman T, Macauley R, Nshimirimana D, Taylor P, Shimp L, Wilkins K. Reaching every district (RED) approach to strengthen routine immunization

- services: evaluation in the African region, 2005. *J Public Health (Oxf)* 2010 March;32(1):18-25.
- (50) Ryman TK, Dietz V, Cairns KL. Too little but not too late: results of a literature review to improve routine immunization programs in developing countries. *BMC Health Serv Res* 2008;8:134.
 - (51) Beutels P, VAN DP, Van C, V, Gay NJ, De SK, Meheus A. The difficult quest for data on "vanishing" vaccine-preventable infections in Europe: the case of measles in Flanders (Belgium). *Vaccine* 2002 October 4;20(29-30):3551-9.
 - (52) Microsoft Excel [computer program]. Seattle, Washington: Microsoft Corporation; 2003.
 - (53) Wolfson LJ, Gasse F, Lee-Martin SP, Lydon P, Magan A, Tibouti A et al. Estimating the costs of achieving the WHO-UNICEF Global Immunization Vision and Strategy, 2006-2015. *Bull World Health Organ* 2008 January;86(1):27-39.
 - (54) Pan American Health Organization. PAHO revolving fund: Vaccine and syringe prices for 2009. *Immunization Newsletter* 2009;XXXI(1):4-5.
 - (55) Uganda Bureau of Statistics (2002). The 2002 Uganda population and housing census, population size and distribution. Kampala, Uganda; 2006.
 - (56) International Bank for Reconstruction and Development / The World Bank. World development indicators 2005. Washington, DC: The World Bank; 2005.
 - (57) Walker DG, Hutubessy R, Beutels P. WHO Guide for standardisation of economic evaluations of immunization programmes. *Vaccine* 2009 June 27.
 - (58) Tebbens RJ, Sangrujee N, Thompson KM. The costs of future polio risk management policies. *Risk Anal* 2006 December;26(6):1507-31.
 - (59) Dayan GH, Ortega-Sanchez IR, LeBaron CW, Quinlisk MP. The cost of containing one case of measles: the economic impact on the public health infrastructure--Iowa, 2004. *Pediatrics* 2005 July;116(1):e1-e4.
 - (60) Parker AA, Staggs W, Dayan GH, Ortega-Sanchez IR, Rota PA, Lowe L et al. Implications of a 2005 measles outbreak in Indiana for sustained elimination of measles in the United States. *N Engl J Med* 2006 August 3;355(5):447-55.
 - (61) Shiell A, Jorm LR, Carruthers R, Fitzsimmons GJ. Cost-effectiveness of measles outbreak intervention strategies. *Aust N Z J Public Health* 1998 February;22(1):126-32.

- (62) Wichmann O, Siedler A, Sagebiel D, Hellenbrand W, Santibanez S, Mankertz A et al. Further efforts needed to achieve measles elimination in Germany: results of an outbreak investigation. *Bull World Health Organ* 2009 February;87(2):108-15.
- (63) Pan American Health Organization. Measles elimination field guide: Second edition. Washington, D.C.: Pan American Health Organization, Pan American Sanitary Bureau, Regional Office of the World Health Organization; 2005. Report No.: Scientific and Technical Publication No. 605.
- (64) World Health Organization: Regional Office for the Western Pacific. Field guidelines for measles elimination. Geneva, Switzerland: World Health Organization; 2004.
- (65) Mgone JM, Mgone CS, Duke T, Frank D, Yeka W. Control measures and the outcome of the measles epidemic of 1999 in the Eastern Highlands Province. *P N G Med J* 2000 March;43(1-2):91-7.
- (66) Benjamin AL, Dramoi V. Outbreak of measles in the National Capital District, Papua New Guinea in 2001. *P N G Med J* 2002 September;45(3-4):178-84.
- (67) Measles outbreak--Guam, 1994. *MMWR Morb Mortal Wkly Rep* 1995 September 15;44(36):657-60.
- (68) Hyde TB, Dayan GH, Langidrik JR, Nandy R, Edwards R, Briand K et al. Measles outbreak in the Republic of the Marshall Islands, 2003. *Int J Epidemiol* 2006 April;35(2):299-306.
- (69) Measles outbreak and response--Fiji, February-May 2006. *MMWR Morb Mortal Wkly Rep* 2006 September 8;55(35):963-6.
- (70) Emergency measles control activities--Darfur, Sudan, 2004. *MMWR Morb Mortal Wkly Rep* 2004 October 1;53(38):897-9.
- (71) Quiroga R, Barrezueta O, Venczel L, Halkyer P, Gil F, Machicao E et al. Interruption of indigenous measles transmission in Bolivia since October 2000. *J Infect Dis* 2003 May 15;187 Suppl 1:S121-S126.
- (72) Sniadack DH, Moscoso B, Aguilar R, Heath J, Bellini W, Chiu MC. Measles epidemiology and outbreak response immunization in a rural community in Peru. *Bull World Health Organ* 1999;77(7):545-52.
- (73) Progress in measles control--Kenya 2002-2007. *MMWR Morb Mortal Wkly Rep* 2007 September 21;56(37):969-72.
- (74) Grais RF, Conlan AJ, Ferrari MJ, Djibo A, Le MA, Bjornstad ON et al. Time is of the essence: exploring a measles outbreak response vaccination in Niamey, Niger. *J R Soc Interface* 2008 January 6;5(18):67-74.

- (75) Sugerma DE, Barskey AE, Delea MG, Ortega-Sanchez IR, Bi D, Ralston KJ et al. Measles outbreak in a highly vaccinated population, San Diego, 2008: role of the intentionally undervaccinated. *Pediatrics* 2010 April;125(4):747-55.
- (76) Pan American Health Organization. Measles and rubella surveillance in the Americas. *Measles/Rubella Weekly Bulletin* 2009;15(31):1-2.
- (77) Carabin H, Edmunds WJ, Kou U, van den HS, Nguyen VH. The average cost of measles cases and adverse events following vaccination in industrialised countries. *BMC Public Health* 2002 September 19;2:22.
- (78) Ginsberg GM, Tulchinsky TH. Costs and benefits of a second measles inoculation of children in Israel, the West Bank, and Gaza. *J Epidemiol Community Health* 1990 December;44(4):274-80.
- (79) Jha P, Bangoura O, Ranson K. The cost-effectiveness of forty health interventions in Guinea. *Health Policy Plan* 1998 September;13(3):249-62.
- (80) Black RE, Cousens S, Johnson HL, Lawn JE, Rudan I, Bassani DG et al. Global, regional, and national causes of child mortality in 2008: a systematic analysis. *Lancet* 2010 May 11.

COUNTRY MEASLES PROFILE: BANGLADESH

With contributions on Bangladesh background from Kyla Hayford

Bangladesh stands out among its neighbors because it achieves high vaccination coverage rates at a relatively low cost per capita. Despite maintaining measles vaccination coverage rates over 80% since 2006, the WHO and UNICEF estimate that 500,000 children were missed by routine measles vaccination in 2007.ⁱ Consequently, Bangladesh is one of 47 priority countries in the WHO-UNICEF accelerated strategy for reducing measles mortality.

The last major measles outbreak occurred in 2005 with nearly 26,000 reported cases. Cases dropped drastically thereafter with 6,180 cases in 2006, 2,924 in 2007 and 2,660 in 2008. Laboratory testing of every suspected outbreak began in 2008 and results revealed that only 1-2% of reported cases in 2007-2009 were true measles.ⁱⁱ As of 2009, the lab-confirmed incidence of measles is 0.015 per 100,000 population, which is 5 times lower than Sri Lanka and over 10 times lower than Nepal.ⁱⁱⁱ

WHO/UNICEF reported that Bangladesh achieved 89% coverage for MCV1 in 2008 and 2007 (Figure 1).^{iv} Only 20% of the 64 districts in Bangladesh had MCV1 coverage rates below 80% and no districts fell below 50%. Urban Dhaka and several remote areas reported the lowest coverage.

Bangladesh provides a single measles vaccine at age 9 months through routine immunization, and opportunities for a second dose are achieved through supplementary immunization activities (SIAs). In 2006, the measles SIA reached 87% of the eligible 35 million children ages 9 months to 10 years. A second measles SIA (with polio vaccination) in 2010 targeted over 20 million children, ages 9 months to 5 years.

Reported measles cases and measles vaccination coverage, 1990-2008, Bangladesh

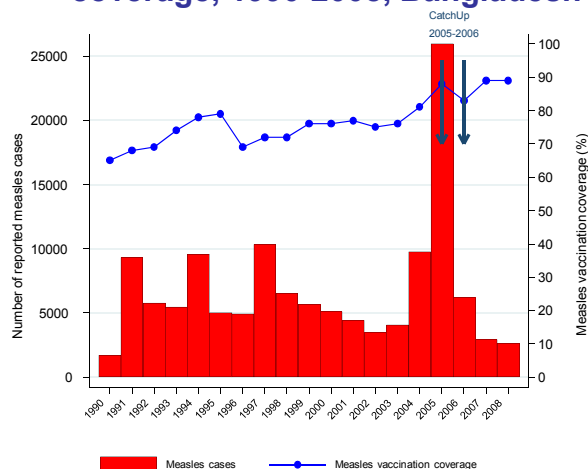

Data source:
 Measles cases- reported by national authorities to WHO annually
 Measles vaccination coverage- WHO/UNICEF immunization coverage estimates, as of August 2009
 Measles vaccination coverage 2nd dose- reported by national authorities to WHO annually
 SIA activities: WHO/EPI supplementary immunization activities database
 Date of slide: 27-08-2008

Figure 1. MCV1 Coverage and Measles Cases, 1990-2008

The government of Bangladesh has shown a strong commitment to measles control, aiming to reduce measles morbidity by 90% and mortality by 95% by 2010 compared with pre-vaccination levels.^v The government finances 77% of immunization costs, including 63% of the routine vaccine supply, with the remaining financed by GAVI, donor agencies, and foundations.^{viii} The vast majority of EPI vaccines are administered by government-run or government-supported clinics through routine vaccination. The vaccine supply is reportedly consistent and secure according to GAVI, with no interruptions in the vaccine supply or syringe stockouts in any district in 2008.^{viii} There are 1.1 health service providers per 1,000 population, which may put a strain on immunization services in Bangladesh. UNICEF is working with the government through the “Reaching Every District” strategy to improve vaccination coverage in hard-to-reach areas, such as the Chittagong Hill Tracts, and urban slums.^{ix} Although Bangladesh has achieved high coverage, improvements in the proper administration of the vaccine are still needed (e.g., on-time, invalid doses)

MODEL RESULTS

MODEL VALIDATION

Figure BGD1 shows the natural history of measles epidemics in Bangladesh. Although Bangladeshi epidemiological statistics do not permit a direct comparison of the model to historical case reports of an unimmunized population the cycle with a frequency of measles spikes every 3 years fits historical data. Between epidemics the model differs from data that would be seen in national statistics. The model can exhibit zero endogenous cases between cycles, whereas national data on measles in an unimmunized population would not do this. The reason is that national statistics on measles epidemiology can pool together data from multiple regions that have epidemiological isolation. Due to limitations in computing power, the mathematical model only has the ability to depict two epidemiological linked populations¹. In this microcosm, a measles epidemic has the potential to eliminate all susceptible from the population. The next wave can occur only after new infants arrive.

Figure BGD2 shows the cumulative number of measles case by age for various scenarios. The figure shows the age distribution for the natural history model which shows that in the model 31% and 80% of cases have occurred by 12 months and 60 months respectively. Bhaskaram published cumulative seroincidence of measles and found comparable numbers of 21% by age 12 months and 92% by 60 months {Bhaskaram, 1986 #5899}.

Figure BGD3 shows the epidemic curves for toddlers age 1 to 4 with cases per year overlain with a plot of the prevalence of children age 1 to 4 who are immune to measles from vaccination for the case of Bangladesh. The scenarios with SIAs show the presence of SIAs as rectangular upticks in immunity occurring every 3 years in Bangladesh. The scenario of stopping SIAs after 2010 leads to more frequent epidemics than would occur in the baseline situation where routine coverage and SIA policies are frozen in place.

Figure BGD4 plots the 40 year sum of discounted costs against the 40 year sum of discounted DALYs. Decision makers are assumed to prefer points that are lower on the vertical axis because these have lower cost and to prefer points that are more to the left on the horizontal axis because these have fewer DALYs. One can see from Figure BGD4, that the baseline scenario (Δ s) of not increasing routine coverage while continuing SIAs imposes higher costs but has 5.2 million fewer DALYs than stopping

¹ Running 100 iterations of 8 policy scenarios for a single country required 30 hours of computing time on a high performance computing cluster with AMD Opteron, 8-CPU cores and 16GB of memory.

SIA. In the baseline scenario of holding MCV1 coverage fixed at 2010 levels and continuing SIAs the model projects a total of 69,020 (SD 16,255) discounted measles deaths and 1.9 million (SD 485,000) discounted measles DALYs from 2010 to 2050. The baseline scenario incurs a total cost of \$ 171 million (SD 4.1 million). SIAs account for 44% of this cost. Terminating SIAs in 2010 in Bangladesh would lower costs to \$126 million (SD 6.6 million). Roughly \$75 million in SIA costs are averted, but replaced by \$31.4 million in additional health care costs for the additional measles cases.

For a decision maker at the baseline position (Δ), all choices that improve health lead to higher costs. Examining Figure BGD4 reveals that trajectories from the baseline to these health improving strategies at the left of the figure would have very similar slopes. These slopes i.e. “ICERS” (Table BGD3) were estimated by drawing 200 random line segments joining each scenario to the baseline scenario. The ICERS range from \$34 (IQR 26-44) per DALY averted in the 95% reduction scenario to \$85 per DALY averted in the Eradication by 2025 scenario (IQR 70-108).

Figure BGD5 shows the components of costs in each scenario and includes a comparison to the costs of measles if Bangladesh had never adopted measles vaccine (top bar “Natural”). The analysis confirms that measles vaccination as currently practiced in the baseline is indeed cost saving—the costs of the program are less than half what the medical and social costs of measles would be. In all scenarios that improve measles control the largest cost component is the cost of expanding and maintaining more routine measles coverage. As noted above, the model of scaling up routine coverage assumes that scale up will require permanent increases in recurrent costs of the vaccine program. The sooner scale up is implemented the longer these higher costs are incurred.

For Bangladesh, the model estimates (Table BGD4) that there would be 53,597 cases of congenital rubella syndrome (CRS) over 40 years if MR vaccine were not adopted. All strategies that switched from MCV to MR antigen following WHO guidelines for appropriate switching brought cumulative caseloads to under 500 cases over the next 40 years and averted over 1 million DALYS as well as saving CRS costs. The inclusion of the cost consequences of CRS would more than offset the total costs of scaling up immunization. This would improve all ICERs by a similar amount and have little impact on making any particular strategy more attractive than the others. Because the CRS costs in low income countries are mostly borne by households, the medical sector would not easily recover the financial savings from rubella control.

FIGURES

FIGURE BGD1. NATURAL HISTORY OF MEASLES DICTATED BY PARAMETERS CHOSEN FOR ASSUMING NO VACCINATION.

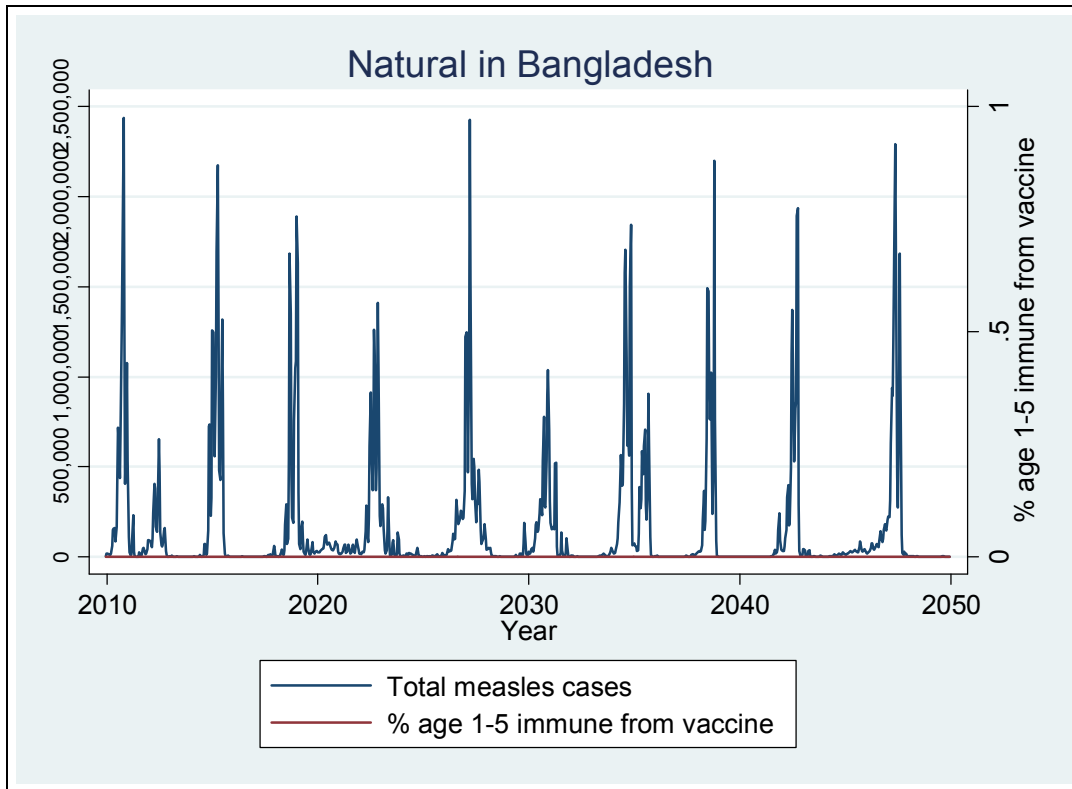
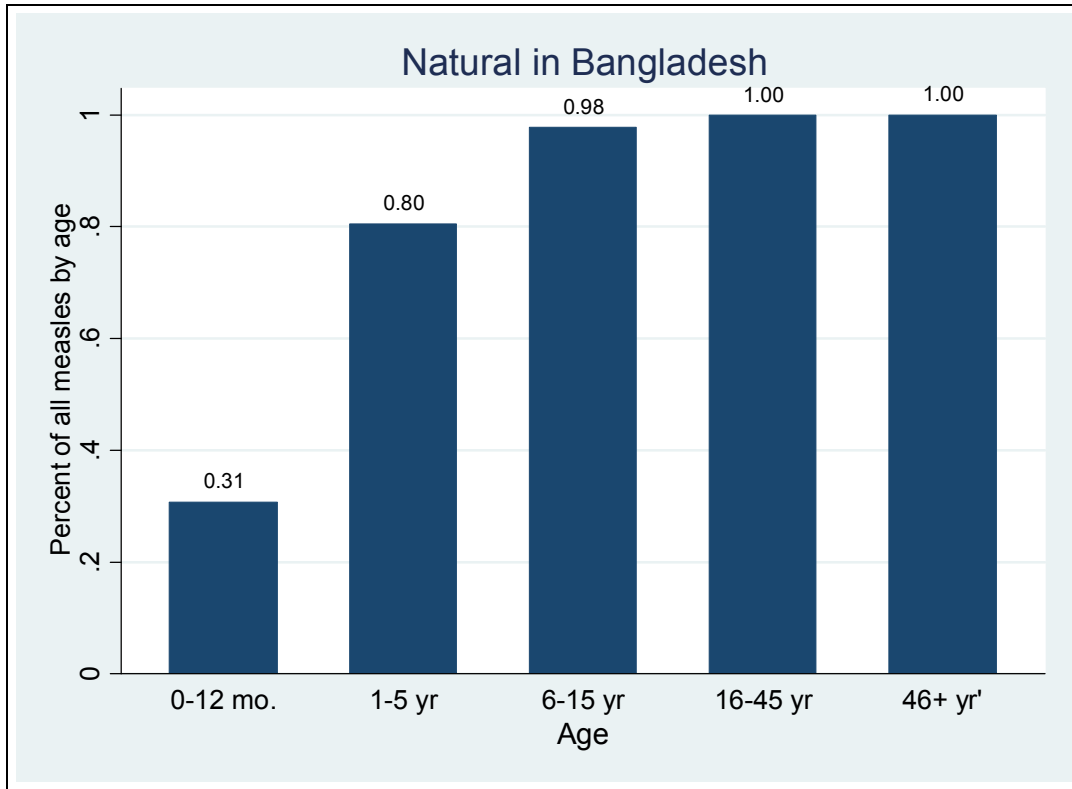

FIGURE BGD2. CUMULATIVE MEASLES INFECTIONS BY AGE GROUP IN BANGLADESH PREDICTED BY MODEL



Country Profile: Bangladesh

FIGURE BGD3. EPIDEMIC CURVES FOR THE 6 SCENARIOS IN BANGLADESH. LEFT AXIS SHOWS NUMBER OF MEASLES CASES IN BLUE. RIGHT AXIS SHOWS THE PROPORTION OF CHILDREN AGE 1-5 WHO ARE IMMUNE DUE TO VACCINE RECEIPT.

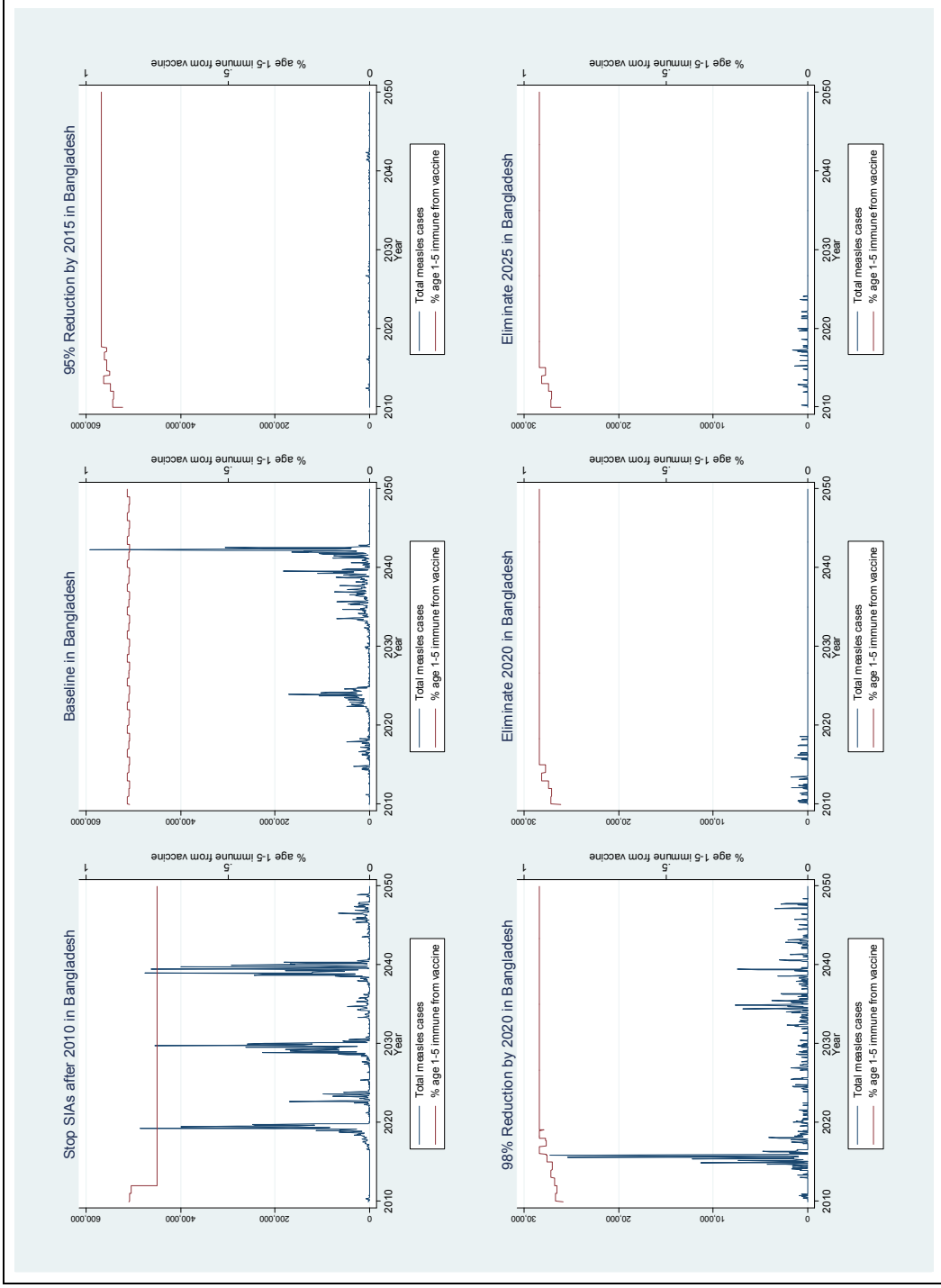

FIGURE BGD 4. COSTS VS. DALYS IN BANGLADESH FOR THE 6 SCENARIOS. SLOPES FROM BASELINE TO THE OTHER POINTS ARE “INCREMENTAL COST EFFECTIVENESS RATIO’S” (ICERs) AND ARE INTERPRETED AS \$ PER DALY AVERTED.

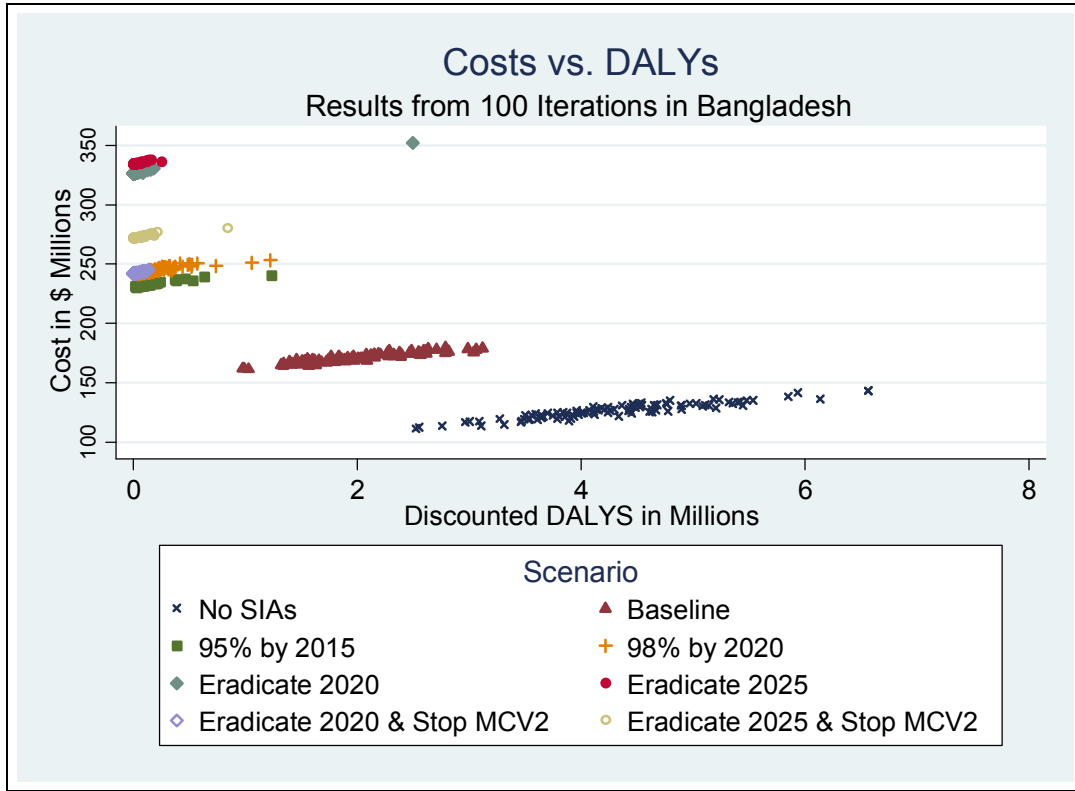
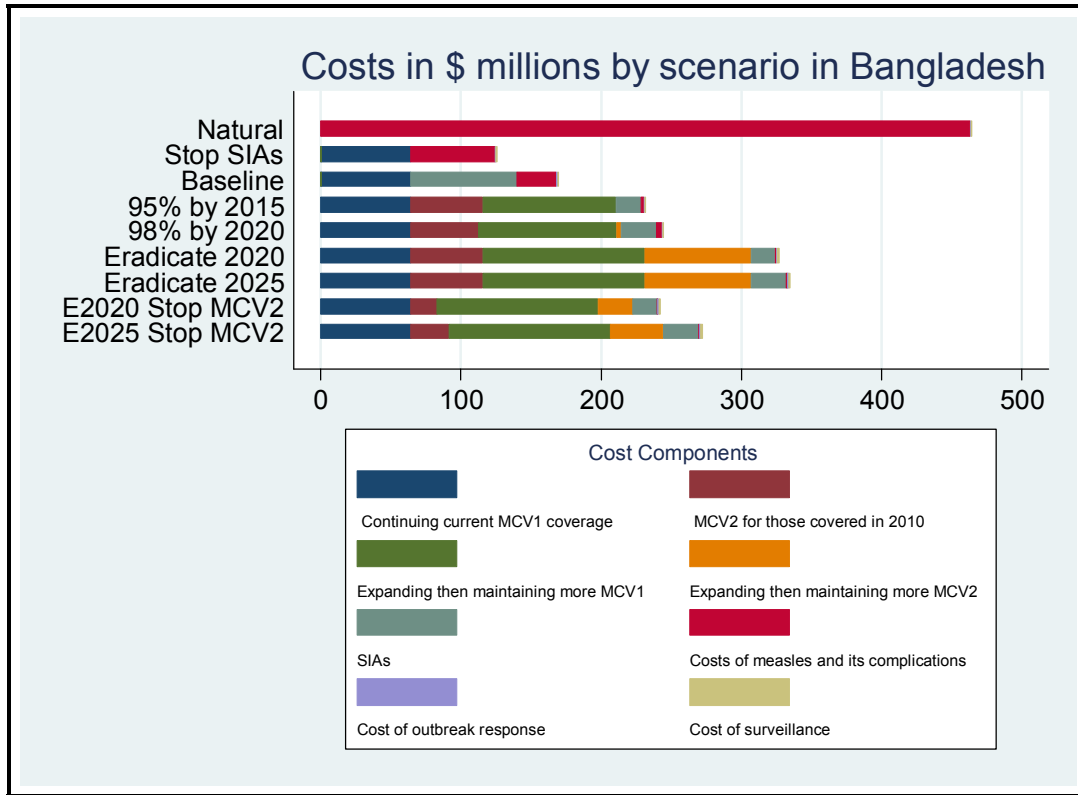

FIGURE BGD5. COST STRUCTURE AMONG VARIOUS MEASLES CONTROL SCENARIOS IN BANGLADESH COMPARED TO WHAT IT WOULD BE IN THE NATURAL HISTORY SCENARIO. COSTS ARE CUMULATIVE DISCOUNTED COSTS FROM 2010 TO 2050.



TABLES

TABLE BGD 1 DESCRIPTION OF MEASLES CONTROL SCENARIOS USED FOR BANGLADESH

Scenario:			1	2	3	4	5	6	
			Baseline	Current level of activities but no SIAs in GAVI eligible countries after 2010	95% Mortality Reduction Compared to 2000	98% Mortality Reduction Compared to 2000	Eradication 2020	Eradication 2025	
Status in 2010	MCV1	Covg	0.88						
		Age	9 mo						
	MCV2	Covg	0						
		Age	NA						
	SIA	Covg	0.9						
		Age	9 mo - 5 yr						
Freq		3 yrs							
Status after 2010 till target year	MCV1	Ramp up rate [1]	N/A	0.03	0.02	0.03	0.03		
		Age		[2]	[3]				
	MCV2	Ramp up rate		0	[4]	[4]			
		Age		N/A	36 mo				
		Yr Intro		N/A	2018	2016	2017		
	SIA every 3 years	Covg		0.95	N/A	0.95			
		Age		9 mo - 5 yr	N/A	9 mo - 5 yr			
		Year stopped		3 yrs	N/A	2014	2017	2014	2017
	Status after target year	MCV1		Covg	0.88	0.88	0.99	0.99	0.99
Age			9 mo	9 mo	9 mo	12 mo	12 mo		
MCV2		Covg	0				0.88	0.99	0.99
		Age					18mo	36 mo	
SIA		Covg	0.9	N/A	N/A	N/A	0		
		Age	9 mo - 5 yr	N/A	N/A			N/A	
	Freq	3 yrs	N/A	N/A					
Target Year			2010	2010	2015	2020	2020	2025	
Notes									
[1] Ramp up rates expressed as percentage points of coverage gained per year									
[2] MCV1 age not raised because MCV1 coverage never gets to 80% by target year in these scenarios.									
[3] MCV1 age can be lifted to 12 mos. after 3 yrs of MCV1>80%, but model waits until measles incidence drops below 1/100,000									
[4] MCV2 coverage starts at 50% of MCV1 in year introduced increases to 90% of MCV1 by 3rd year after introduction									

TABLE BGD 2. PARAMETERS FOR BANGLADESH

Parameter	Value	Range	Source
Average cost per child vaccinated prior to scale up via routine services	\$1.04	+/- 20%	(Brenzel, et al. 2006)
Scale up cost per child for core areas	\$27.83		(See costing appendix)
Scale up cost per child for satellite areas	\$37.93		
Scale up cost per child for MCV2 in core areas	\$8.79		
Scale up cost per child for MCV2 in satellite	\$27.11		
SIA cost per child	\$0.58		Interviews in Bangladesh
Monthly force of infection parameters	Jan: 0.0000775 Feb: 0.0000888 Mar: 0.0000101 Apr: 0.0000843 May: 0.0000755 Jun: 0.0000737 Jul: 0.0000719 Aug: 0.0000698 Sep: 0.0000689 Oct: 0.0000683 Nov: 0.0000677 Dec: 0.0000687	+/- 20%	Analysis of Bangladesh district case reports 2002-2008
Initialization of proportion vaccinated among adults, children, toddlers	0.65-0.88 depending on the age and year*		WHO coverage database
Initial measles case fatality rate**	Infant: 0.034 Toddler: 0.017 Child: 0.0085 Adult: 0.0085		(Wolfson, Grais et al. 2009)
Life expectancy (years)	Infant: 67.3 Toddler: 65.3 Child: 57.9 Fertile: 39.9 Post Fertile: 20		WHO
Fraction In satellite compartment	17%		(UNICEF and WHO 2010)
Initial population sizes	Infant: 3.3 million Toddler: 10.6 mil Child: 29.1 million Fertile: 73.9 mil Post Fert: 47.7 mil		(United Nations 2008)

TABLE BGD3. TABLE OF COSTS, DEATHS, DALYS AND ICERS FOR BANGLADESH WITH 3% DISCOUNTING AND HORIZON TO 2050.

	Discounted Deaths		Δ Discounted Deaths relative to baseline		Discounted DALYS relative to baseline of 1,974,312		Discounted Costs in \$ millions		Δ Discounted Costs relative to baseline	
	Mean	SD	Mean	SD	Mean	SD	Mean	SD	Mean	SD
Natural (N)	1,379,239	(54,183)	-	-	-	-	\$463	(13.4)	-	-
Stop SIAs (SS)	149,333	(26,742)	79,959	(30,313)	2,336,191	(909,451)	\$126	(6.6)	-\$45	(7.4)
Baseline (B)	69,020	(16,255)	-	-	-	-	\$171	(4.1)	-	-
95% Reduction by 2015	4,341	(5,239)	-65,361	(15,872)	-1,875,481	(471,422)	\$232	(1.8)	\$61	(4.5)
98% Reduction by 2020	7,745	(6,647)	-61,805	(16,679)	-1,776,571	(495,278)	\$245	(2.5)	\$74	(4.7)
Eradication 2020 (E2020)	1,886	(8,610)	-68,477	(15,121)	-1,960,814	(450,491)	\$327	(2.7)	\$156	(4.1)
Eradication 2025 (E2025)	1,198	(1,495)	-68,381	(15,187)	-1,957,643	(452,312)	\$335	(.8)	\$164	(4.1)
Eradication 2020 & Stop MCV2	800	(1,066)	-68,849	(15,063)	-1,970,462	(449,259)	\$242	(.6)	\$71	(4.0)
Eradication 2025 & Stop MCV2	1,705	(3,329)	-67,654	(14,964)	-1,936,774	(445,737)	\$272	(1.3)	\$102	(4.1)

	Incremental Cost Effectiveness Ratio (ICER) \$ per Death averted			Incremental Cost Effectiveness Ratio (ICER) \$ per DALY averted		
	Median	Interquartile Range	Notes	Median	Interquartile Range	Notes
Stop SIAs (SS)	-\$560	(399: 831)	[1]	-\$19.2	(13.5: 28.9)	[1]
Baseline (B)	-	-	-	-	-	-
95% Reduction by 2015	\$967	(734: 1,242)	-	\$34	(26: 44)	-
98% Reduction by 2020	\$1,196	(962: 1,531)	-	\$42	(33: 54)	-
Eradication 2020 (E2020)	\$2,318	(1,917: 2,885)	-	\$81	(67: 102)	-
Eradication 2025 (E2025)	\$2,433	(2,010: 3,045)	-	\$85	(70: 108)	-
Eradication 2020 & Stop MCV2	\$1,041	(844: 1,362)	-	\$36	(29: 48)	-
Eradication 2025 & Stop MCV2	\$1,556	(1,232: 1,909)	-	\$55	(43: 68)	-

[1] Stopping SIAs saves money, but one incurs additional deaths and DALYS which arrive in the ratios shown on this row. E.g. \$560 saved for every death incurred, \$19.2 saved for every DALY incurred.

TABLE BGD4. RUBELLA ADDITIONAL COSTS AND ADDITIONAL DALYS IF RUBELLA ANTIGEN IS ADDED AFTER COVERAGE REACHES 80% FOR 3 YEARS. THE MODEL ESTIMATES THAT BETWEEN 2010 AND 2050 IN THE ABSENCE OF IMMUNIZATION THERE WOULD BE 53,597 CASES OF CONGENITAL RUBELLA SYNDROME (32,370 DISCOUNTED CASES). THESE WOULD GENERATE 1,803,527 AND 1,089,262 DALYS AND DISCOUNTED DALYS RESPECTIVELY. UNDER IMMUNIZATION SCENARIOS THE NUMBER OF CRS CASES FOR THE SAME PERIOD DROPS TO BETWEEN 26 AND 204 CRS CASES. THIS AVERTS 99% OF THE DALYS AND SAVES MONEY DUE TO LOST ECONOMIC PRODUCTIVITY AND MEDICAL CARE COSTS OF CRS PATIENTS. THE COST OF A CASE OF CRS IS ASSUMED TO BE 50 YEARS OF GDP PER CAPITA. (FOR BANGLADESH THIS WOULD BE APPROXIMATELY \$25,000 PER CASE.) THE DALYS ARE CALCULATED BASED ON A DALY WEIGHT OF 0.5 FOR A CONDITION THAT LASTS AS LONG AS LIFE EXPECTANCY AT BIRTH.

	Δ Discounted Money Saved	Δ Discounted DALYS Averted	Dollars saved per DALY averted		Notes
Natural (N)	\$0	0			[1]
95% Reduction by 2015	\$856,000,000	1,086,493	\$788		
98% Reduction by 2020	\$880,000,000	1,086,247	\$810		
Eradication 2020 (E2020)	\$864,000,000	1,088,498	\$794		
Eradication 2025 (E2025)	\$849,000,000	1,082,830	\$784		

[1] The estimated cost savings from rubella control is enough to entirely offset the cost of each of the measles/rubella control strategies. Thus if one were to add the net costs of combined measles rubella control for these scenarios there would be net savings and the “ICER” would just express the ratio of money saved to DALYS saved for a set of strategies that all dominate not controlling rubella. However, the rubella costs are borne by families as lost income and costs of personal care and the disease control costs are borne by the health sector.

[1] All scenarios for adding rubella antigen save both money and avert DALYS. The ratio between dollars saved and DALYS averted is as shown.

BIBLIOGRAPHY

ⁱ WHO. 2009. Global elimination of measles. http://apps.who.int/gb/ebwha/pdf_files/EB125/B125_4-en.pdf

ⁱⁱ WHO, 2009. Immunization Profile: Bangladesh. http://apps.who.int/immunization_monitoring/en/globalsummary/countryprofileresult.cfm

ⁱⁱⁱ WHO. Measles surveillance in South East Asia Region. http://www.measlesinitiative.org/mi-files/Tools/Presentations/Global%20Measles%20Management%20Meeting/SEARO_Measles_surveillance.pdf

^{iv} WHO. 2009. Immunization Profile: Bangladesh.

^v WHO, Bangladesh: EPI. n.d. <http://www.whoban.org/EPI-No-08.html>

^{vi} GAVI, 2008. Bangladesh Fact Sheet

^{vii} GAVI. GAVI Alliance: Immunization Support Services. n.d. <http://www.gavialliance.org/performance/commitments/iss/index.php?theyear=2000>

^{viii} Ibid.

^{ix} UNICEF. 2010. Child Survival in Bangladesh. http://www.unicef.org/bangladesh/Child_Surviva_in_Bangladesh.pdf

MEASLES CONTROL PROFILE: BRAZIL

By Emily Simons and David Bishai

Prior to large scale vaccination against measles, up to 25% of child deaths were attributed to measles infection in Brazil. In the 1980's, small-scale vaccination campaigns began in high risk areas and fragmented local health services provided routine immunization to around 60% of children [Prevots 2003]. In reaction to a large outbreak in 1990 with over 60,000 reported cases, national authorities created a measles elimination plan that commenced with the first national vaccination campaign in 1992. Measles vaccination campaigns continue to be conducted every 3-6 years (see figure below.) With the aid of a newly formed national health system and expanded access to primary care in the 1990's, routine immunization coverage rose to over 95% by 1997 and has continued at or above that level since [Sistema de informações do Programa Nacional de Imunização, December 2009.] The last endemic transmission of measles virus was detected in 2000 and elimination of the virus was certified in 2002.

With substantial geographical challenges to routine health service delivery and diverse hard-to-reach populations, Brazil's national immunization program and disease surveillance program developed innovative mechanisms to reach the high level of population immunity (>90%) that is necessary for measles elimination. Building on the systems developed by the polio eradication activities, these mechanisms included: mobile outreach services for high risk and rural populations, support from the military to reach remote areas in the Amazon basin, and case-based surveillance. New activities developed specifically for measles elimination were national vaccination campaigns with trained health workers, high levels of monitoring and supervision by a national measles elimination task force, the establishment of laboratories in every state with one or two staff dedicated to measles surveillance, and aggressive outbreak investigation and vaccination of contacts of confirmed cases.

The achievement of measles elimination was aided by a number of external factors. One of the most salient of the concurrent health reforms was the formation of the Unified health care system (SUS), which began in 1988. SUS developed a national decentralized

health system from a previously fragmented network of vertical programs implemented through a conglomeration of community health care providers that were largely locally funded and operated. Such an ambitious reform measure led to comprehensive national health policies and numerous initiatives that directly impacted immunization services, including mandated federal, state and local funding for health; training programs that dramatically increased the number of health workers; federal grants to improve chain equipment; primary health mobile outreach teams for remote and high risk populations; and the formation of the Family Health Program, which was serving more than half of Brazil's families by 2009 through monthly household visits to follow-up on routine health issues such as vaccination status. A long-standing health care program for indigenous populations ensured that indigenous groups continued to have high levels of access to services and high routine immunization coverage throughout the course of these developments.

Maintaining measles elimination in Brazil, likewise, has been aided by the evolution of measles activities into other initiatives--a rubella elimination plan and dengue control program. Vaccination of women of child-bearing age with MR or MMR vaccine halved the number of susceptible adults, which is frequently problematic population group for measles control in advanced immunization programmes. The large-scale surveillance activities of the dengue control program have enabled continual monitoring for the re-establishment of endemic measles transmission through the testing of suspected dengue cases for wild measles virus. To date, no endemic cases have been detected.

Reported measles cases and measles vaccination coverage, 1990-2008, Brazil

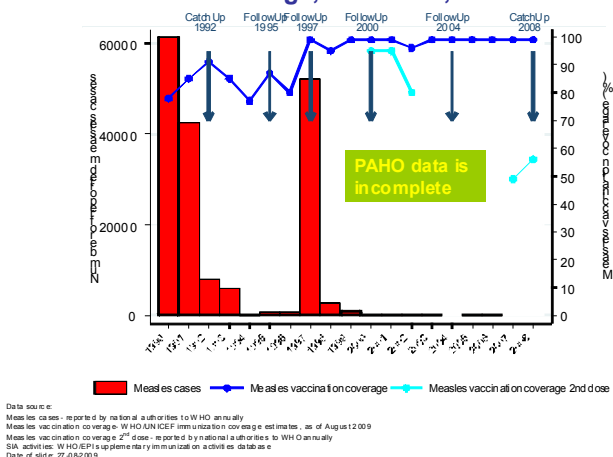

MODEL RESULTS

MODEL VALIDATION

Figure BRA1 shows the natural history of measles epidemics in Brazil. We were unable to locate epidemiological statistics to permit a direct comparison of the model to historical case reports of an unimmunized population. A case series from Mexico from 1940 to 1955 published in Cliff et al.(1993) confirms that Latin American natural history is consistent with a cycle with a frequency of measles spikes every 3 years fits historical data for many other countries¹.

Figure BRA2 shows the cumulative number of measles case by age and reveals the canonical pattern.

¹ Between epidemics the model differs from data that would be seen in national statistics. The model can exhibit zero endogenous cases between cycles, whereas national data on measles in an unimmunized population would not do this. The reason is that national statistics on measles epidemiology can pool together data from multiple regions that have epidemiological isolation. Due to limitations in computing power, the mathematical model only has the ability to depict two epidemiological linked populations¹. In this microcosm, a measles epidemic has the potential to eliminate all susceptible from the population. The next wave can occur only after new infants arrive.

MODEL RESULTS ON COSTS, DEATHS, DALYS, AND COST STRUCTURE

Figure BRA3 shows the epidemic curves for toddlers age 1 to 4 with cases per year overlain with a plot of the prevalence of children age 1 to 4 who are immune to measles from vaccination for the case of Brazil. These curves are flat, because it is assumed that Brazil maintains its already superb coverage into the future. This figure shows one possible stochastic realization of the model. It includes the prediction of scattered outbreaks, mostly less than 750 people are involved in any year. The model “scales” from observations in 1 million simulated people to the entire Brazilian population of 186 million. This 1:186 scale factor means that every person in the simulation represents 186 Brazilians. Thus when the simulation predicts an outbreak of 1 simulated case, that case gets scaled up to represent 186 cases for the whole country. Thus the smallest possible outbreak in the model is 186. In reality, the population of Brazil may experience outbreaks smaller than 186 people. There is no easy way to fix the problem of scale. The SIR model cannot be applied to all 186 million people simultaneously, because the entire population of Brazil is not in epidemiological contact with one another in any given year. The option of making an ad hoc adjustment to change the 186 scaling factor to some smaller number, though more realistic, would lack an empirical foundation.

The scaling factor is probably leading to overestimates of the size of the outbreaks. The frequency of outbreaks is being driven by the model’s assumption that there are 2 silent importations of measles every month. When there are only imported measles cases in the population, the probability that each imported case is able to infect others is distributed as a Poisson process depending on the number of susceptibles. If Brazil enacts border control policies to lower the number of importations then the predicted frequency of outbreaks will be lower than that predicted by the model. For these reasons the dynamic transmission model may be overstating the future burden of measles in the baseline scenario for Brazil. Despite its potential over-estimate of the number of measles cases, the baseline model still predicts a total of only 5 measles deaths in Brazil over the next 40 years.

Figure BRA4 plots the 40 year sum of discounted costs against the 40 year sum of discounted DALYs. Decision makers are assumed to prefer points that are lower on the vertical axis because these have lower cost and they prefer points that are more to the left on the horizontal axis because these have fewer DALYs. One can see from Figure BRA4, that the eradication scenarios shift the burden of Brazilian DALYs closer to zero. The scenarios that allow Brazil to discontinue MCV2 shift the costs downwards as well.

Referring to Table BRA3, in the baseline scenario of holding MCV1 coverage fixed at 2010 levels and continuing SIAs the model projects a total of 5 (SD 2) discounted measles deaths and 131 discounted measles DALYs in Brazil from 2010 to 2050. The baseline scenario incurs a total cost of \$ 192 million (SD 0.5).

For a decision maker at the baseline position (Δ) in Figure BRA4, all eradication scenarios improve health and lead to lower costs. Examining Figure BRA 4 reveals that trajectories from the baseline to these health improving strategies at the left of the figure would have very similar slopes. These slopes are not really “ICERS” in the conventional sense. The slopes tell decision makers how many dollars are saved at the same time one is saving a DALY. The slopes in Table BRA3 were estimated by drawing 200 random line segments joining each scenario to the baseline scenario. The slopes range from \$394,000 (IQR 226K-658K) saved per DALY averted in the Eradicate 2025 scenario to \$748,000 (IQR 510K-1,042K) saved per DALY averted in the Eradicate 2020 and Stop MCV2 Scenario.

Figure BRA5 shows the components of costs in each scenario The figure shows that the greatest cost saving comes from Brazil’s being able to stop SIAs after eradication is achieved. There are further savings from not having to finance MCV2 if Brazil also decides to stop MCV2.

FIGURES

FIGURE BRA1. NATURAL HISTORY OF MEASLES DICTATED BY PARAMETERS CHOSEN FOR BRAZIL ASSUMING NO VACCINATION.

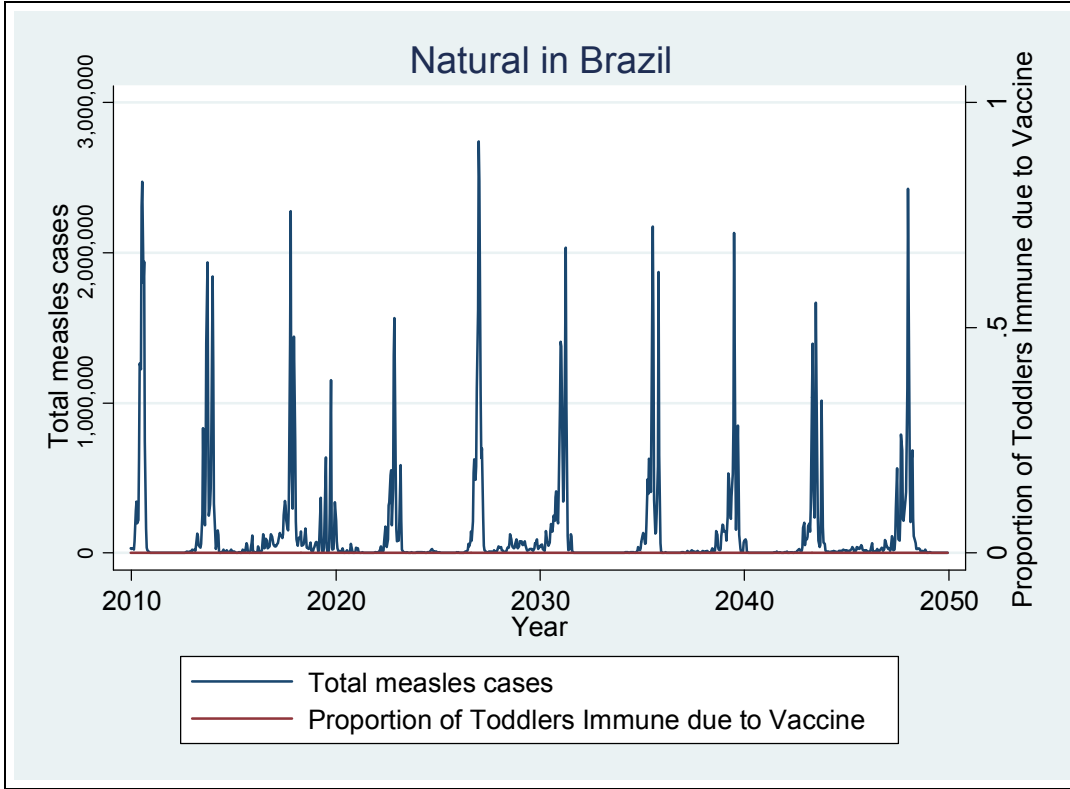

FIGURE BRA2. CUMULATIVE MEASLES INFECTIONS BY AGE GROUP IN BRAZIL PREDICTED BY MODEL IN THE ABSENCE OF IMMUNIZATION

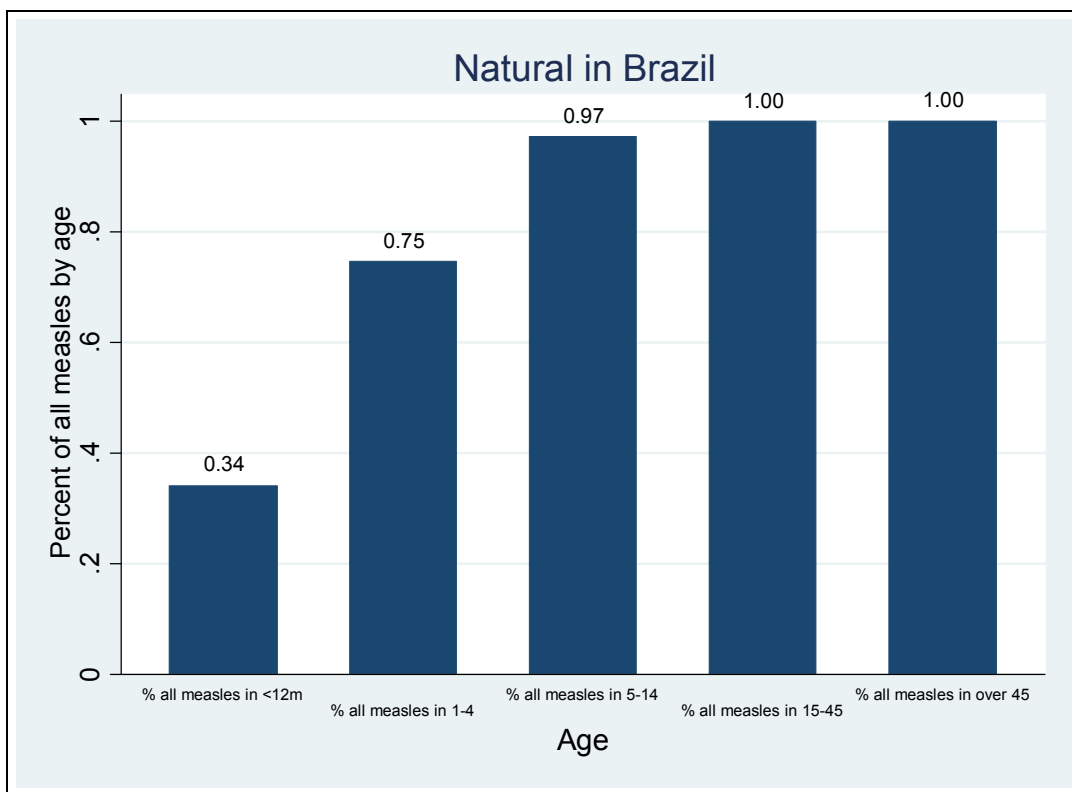

FIGURE BRA3. EPIDEMIC CURVES FOR THE 6 SCENARIOS IN BRAZIL. LEFT AXIS SHOWS NUMBER OF MEASLES CASES IN BLUE. RIGHT AXIS SHOWS THE PROPORTION OF CHILDREN AGE 1-5 WHO ARE IMMUNE DUE TO VACCINE RECEIPT.

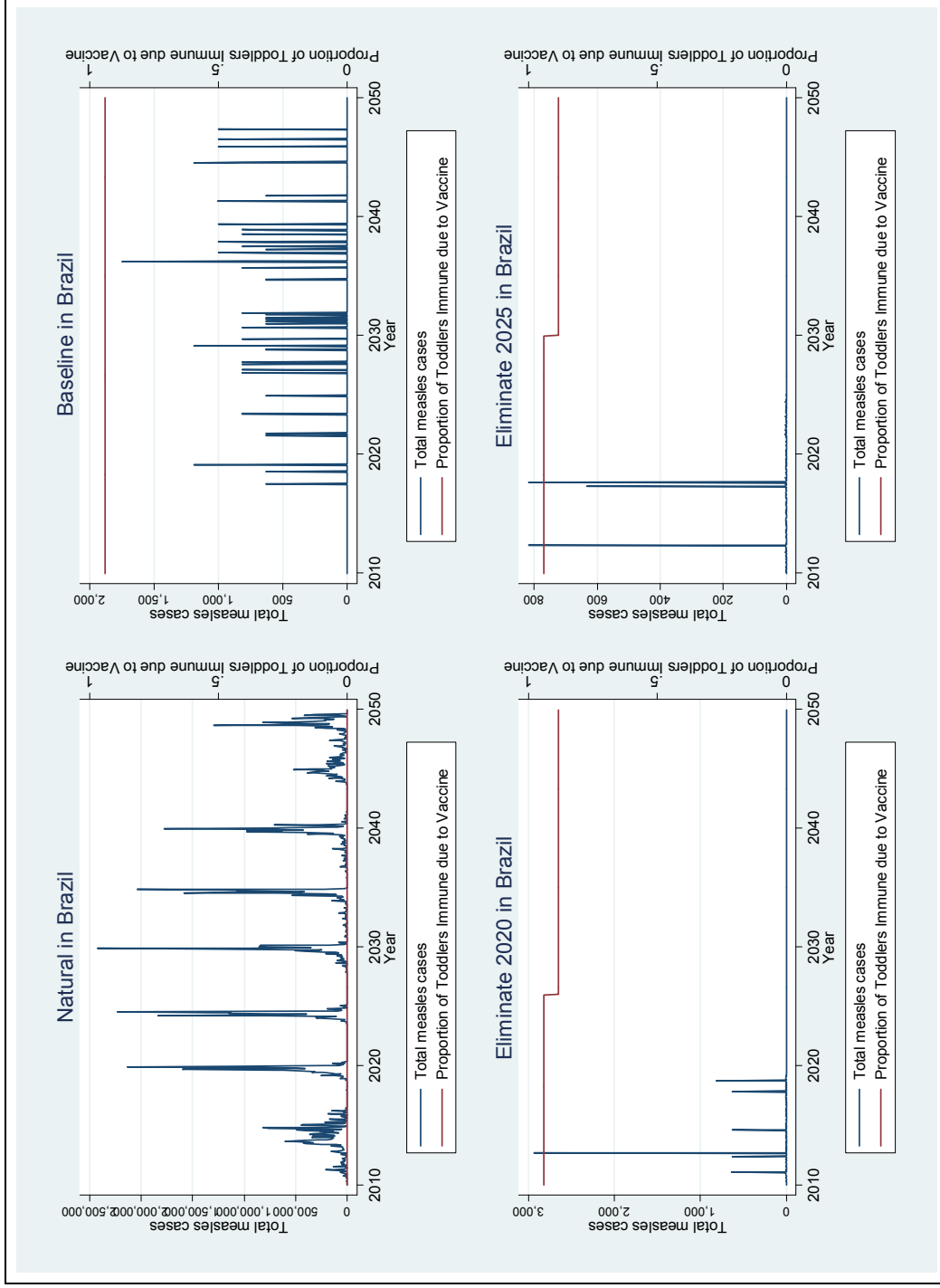

FIGURE BRA 4. COSTS VS. DALYS IN BRAZIL FOR THE 6 SCENARIOS. SLOPES FROM BASELINE (B) TO THE OTHER POINTS ARE “INCREMENTAL COST EFFECTIVENESS RATIO’S” (ICERs) AND ARE INTERPRETED AS \$ PER DALY AVERTED.

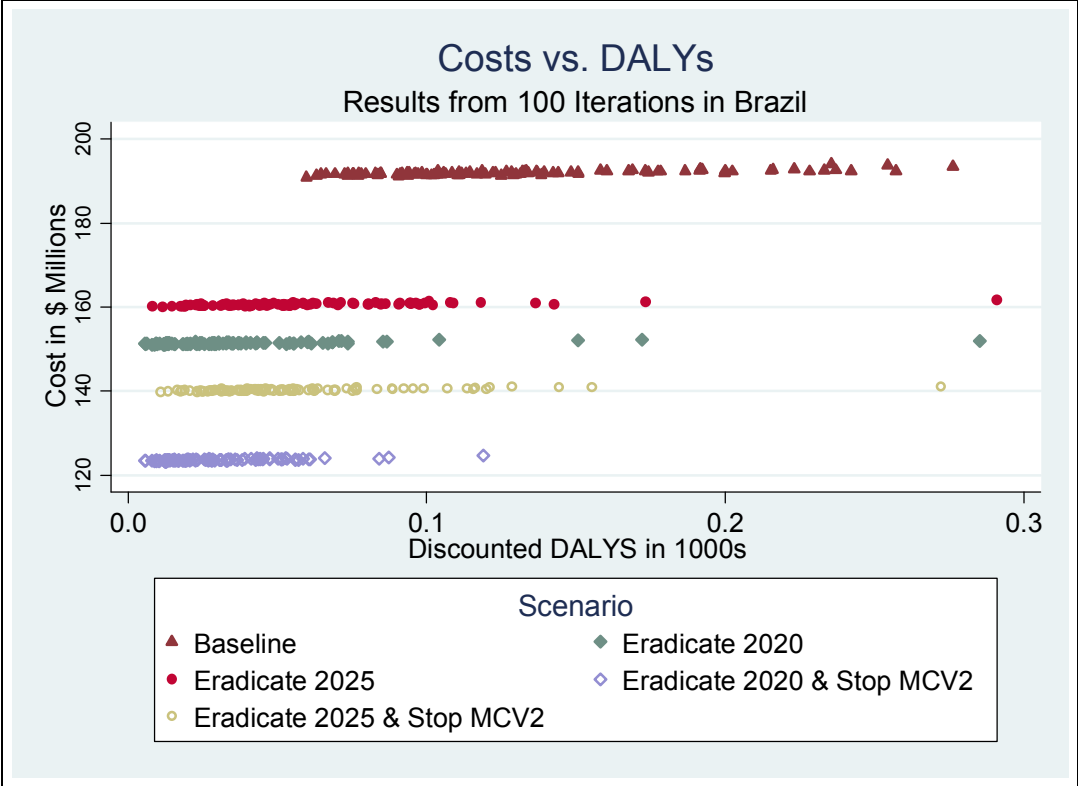
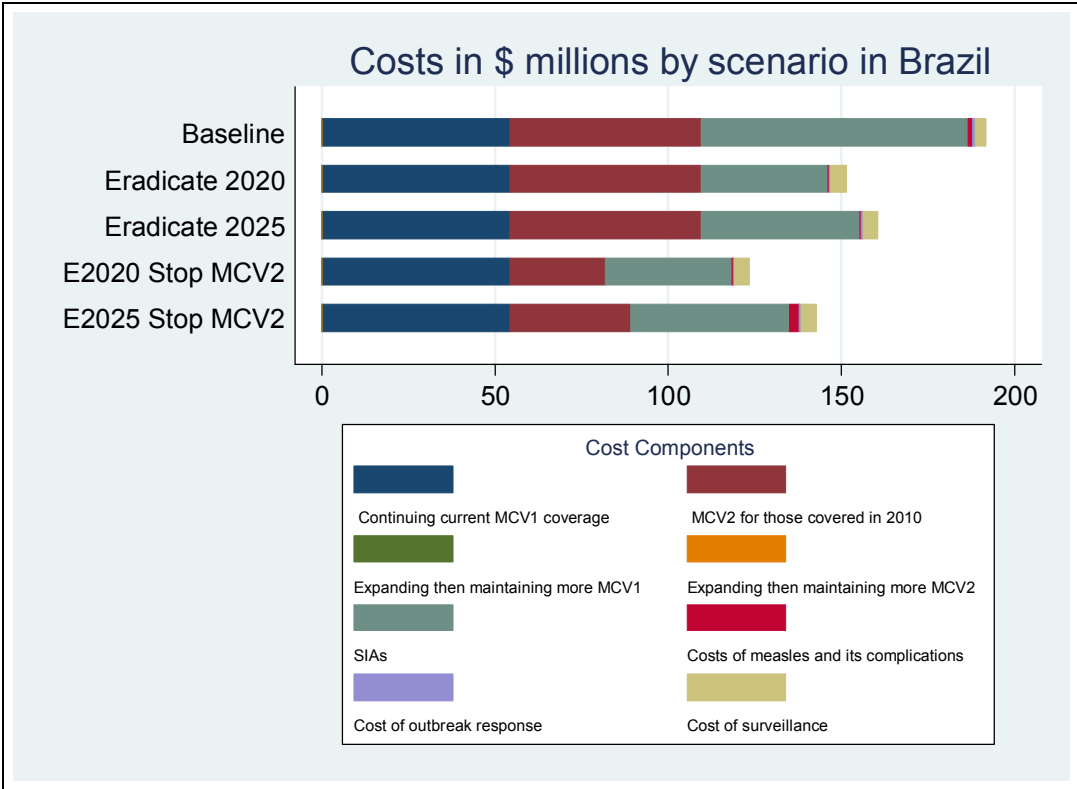

FIGURE BRA5. COST STRUCTURE AMONG VARIOUS MEASLES CONTROL SCENARIOS IN BRAZIL COMPARED TO WHAT IT WOULD BE IN THE NATURAL HISTORY SCENARIO. COSTS ARE CUMULATIVE DISCOUNTED COSTS FROM 2010 TO 2050.



TABLES

TABLE BRA 1 DESCRIPTION OF MEASLES CONTROL SCENARIOS USED FOR BRAZIL

Scenario:			1					
			Baseline	Eradication 2020	Eradication 2025	Eradication 2020 and stop MCV2 after 2023	Eradication 2025 and stop MCV2 after 2028	
Status in 2010	MCV1	Covg	0.99					
		Age	12 mo					
	MCV2	Covg	0.99					
		Age	48 mo					
	SIA	Covg	99%					
		Age	1-5 years					
		Freq	Every 4 years					
	Status after 2010 till target year	MCV1	Ramp up rate [1]	0				
			Age	12 mo				
MCV2		Ramp up rate	0					
		Age	48 mo					
		Yr Intro	1992					
SIA		Covg	99%					
		Age	1-5 years					
		Freq	Every 4 years					
Status after target year		MCV1	Covg	0.99				
	Age		12 mo					
	MCV2	Covg	0.99			0		
		Age	48 mo			N/A		
	SIA	Covg	N/A					
		Age						
		Freq						
	Target Year			2010	2020	2025	2020	2025
	Notes							
[1] Ramp up rates expressed as percentage points of coverage gained per year								
[2] MCV1 age not raised because MCV1 coverage never gets to 80% by target year in these scenarios.								
[3] MCV1 age can be lifted to 12 mos. after 3 yrs of MCV1>80%, but model waits until measles incidence drops below 1/100,000								
[4] MCV2 coverage starts at 50% of MCV1 in year introduced increases to 90% of MCV1 by 3rd year after introduction								

TABLE BRA 2. PARAMETERS FOR BRAZIL

Parameter	Value	Range	Source
Average cost per child vaccinated prior to scale up via routine services	\$1	+/- 20%	(Brenzel, et al. 2006)
Scale up cost per child for core areas	N/A		
Scale up cost per child for satellite areas	N/A		
Scale up cost per child for MCV2 in core areas	N/A		
Scale up cost per child for MCV2 in satellite	N/A		
SIA cost per child	N/A		
Monthly force of infection parameters	Jan: 0.00006392 Feb: 0.00007325 Mar: 0.0000809 Apr: 0.0000857 May:0.00007162 Jun: 0.00010455 Jul: 0.00007821 Aug: 0.0000761 Sep: 0.00007831 Oct: 0.00008567 Nov:0.00007201 Dec: 0.00008348	+/- 20%	Analysis of Brazil district case reports 2002-2008
Initialization of proportion vaccinated among adults, children, toddlers	0.78-0.99 depending on the age and year*		WHO estimated coverage database
Initial measles case fatality rate**	Infant: 0.001 Toddler: 0.0005 Child: 0.00025 Adult: 0.00025		(Wolfson, Grais et al. 2009)
Life expectancy (years)	Infant: 74 Toddler: 72 Child: 63.2 Fertile: 44.6 Post Fertile: 20		WHO
Fraction In satellite compartment	11%		(UNICEF and WHO 2010)
Initial population sizes	Infant:3.7 E6 Toddler:13.7 E6 Child: 33.9 E6 Fertile:91.9 E6 Post Fert: 42.4 E6		(United Nations 2008)

TABLE BRA 3. TABLE OF COSTS, DEATHS, DALYS AND ICERS FOR BRAZIL WITH 3% DISCOUNTING AND HORIZON TO 2050.

	Discounted Deaths		Δ Discounted Deaths relative to baseline		Δ Discounted DALYS relative to baseline of 131		Discounted Costs in \$ millions		Δ Discounted Costs relative to baseline	
	Mean	SD	Mean	SD	Mean	SD	Mean	SD	Mean	SD
Natural (N)	27,686	(1,611)	-	-	-	-	\$4,520	(205.0)	-	-
Baseline (B)	5	(2)	-	-	-	-	\$192	(.5)	-	-
Eradication 2020 (E2020)	1	(1)	-3	(2)	-93	(68)	\$151	(.2)	-\$41	(.6)
Eradication 2025 (E2025)	2	(1)	-2	(2)	-68	(71)	\$161	(.3)	-\$31	(.6)
Eradication 2020 & Stop MCV2	1	(1)	-3	(2)	-100	(55)	\$124	(.2)	-\$68	(.6)
Eradication 2025 & Stop MCV2	11	(92)	-3	(2)	-75	(65)	\$143	(24.1)	-\$52	(.6)

	Ratio of dollars saved per death averted		Ratio of dollars saved per DALY averted	
	Median	Interquartile Range	Median	Interquartile Range
Baseline (B)	-	-	-	-
Eradication 2020 (E2020)	-\$12,300,000	-(8,176,443: -18,200,000)	-\$432,374	-(279,823: -630,151)
Eradication 2025 (E2025)	-\$11,700,000	-(19,900,000: -6,917,953)	-\$393,988	-(226,747: -658,491)
Eradication 2020 & Stop MCV2	-\$22,200,000	-(31,200,000: -15,100,000)	-\$748,232	-(509,957: -1,042,652)
Eradication 2025 & Stop MCV2	-\$19,400,000	-(33,700,000: -11,800,000)	-\$645,887	-(390,614: -1,175,064)

BIBLIOGRAPHY

Prevots DR, Parise MS, Segatto TC, et al. Interruption of measles transmission in Brazil, 2000-2001. J Infect Dis. 2003 May 15;187 Suppl 1:S111-20. Review.

Sistema de informações do Programa Nacional de Imunização. Accessed December 2009. Available at: <http://pni.datasus.gov.br/>.

Interviews with: Márcia Sakai (National Human Resources Coordinator, Ministry of Health), Sônia Brito (National Planning and Budget Coordinator, Ministry of Health), Maria Arendelita (National Immunization Program Manager), Cristina Segatto (National Epidemiological Surveillance Coordinator), João Risi (National Secretary of Primary Health Activities from 1968 to 1989, Ministry of Health)

COUNTRY PROFILE: COLOMBIA

Amnesty Lefevre and David Bishai

MEASLES IN THE WESTERN HEMISPHERE

In 1994 the member countries of the Pan American Health Organization (PAHO) made a commitment to eradicate measles from the Western Hemisphere by 2000 [1]. In an effort to achieve this goal, one-time-only "catch-up" measles vaccination campaigns were carried out among children aged 9 months to 14 years of age [1]. To ensure sustained levels of high population immunity, catch-up campaigns were followed by vaccination campaigns every 4 years among children under 5 (i.e. pre-school age) [1]. Campaign activities were complemented by additional work aimed at strengthening routine immunization services to specifically reach a minimum of 95% of emerging newborn cohorts at 12 months of age [1]. Finally, beyond the strengthening of preventative services, measles surveillance activities were enhanced, including the laboratory testing of suspected cases [1].

Sixteen years after establishing a regional goal of measles eradication, PAHO member countries have made dramatic improvements in country specific and overall coverage rates; reduced the annual frequency and scope of outbreaks; and reduced measles related mortality. However, the eradication goal remains elusive. In 2008, 203 cases were identified in the region of the Americas – a figure which is but a fraction of that reported in other WHO regions (Africa 37,010; South East Asia 75,770; Europe 8,883, Eastern Mediterranean 12,120; Western Pacific 147,986) [1, 2]. With eradication goals nearing realization, efforts are needed to at once understand the factors contributing to the emergence of cases and bolster the financial support and political will necessary to address them.

MEASLES IN COLOMBIA

With a total population of over 46 million Colombia is one of the most populous countries in the Western Hemisphere [3]. Efforts to eradicate measles in Colombia have emphasized the strengthening of routine immunization services, improvement of

Country Profile Colombia

surveillance and case management, and conduct of catch-up and follow-up campaigns. Since 1990, Colombia has conducted a catch-up campaign in 1993, and follow-up campaigns in 1995, 2004, 2005 and 2006. Collectively these efforts have corresponded to an increase in MCV1 coverage from 82% in 1990 to 92% in 2008 [2]. Despite these improvements in coverage of a first dose, MCV2 coverage has declined from over 90% in 2007 to ~70% in 2008 (Figure 2).

Regionally, in 2009, Colombia had the third highest number of suspected cases with 1,105; however, none of these were confirmed following testing. Colombia's last confirmed outbreak occurred in 2002 when 68 cases were identified among children under 9 and among adults 25-29 years of age in 19 municipalities in 10 (30%) of the 33 departments [4]. An estimated 17 of the 19 affected municipalities were located on the Atlantic coast and/or bordered Venezuela [4]. In response to this, Colombian officials worked with Venezuela to enhance surveillance using active case searches in both countries. In total, 2,198 suspected cases were detected (5.4 per 100,000 population) in Colombia and 6,380 (26.5) in Venezuela [4]. Beyond surveillance, measles control activities were strengthened with emphasis placed upon the (a) initiation of a door-to-door measles vaccination campaign in high-risk municipalities; (b) house to house monitoring of vaccination coverage in high risk areas; (c) increasing training in case investigation and control [4]. As a result of these activities, a total of 2,587,408 (73%) children in the target group had been vaccinated [4].

In the years since this outbreak in 2002, no measles cases have been confirmed. However, if this trend is to be sustained immunization activities will need not only to be sustained but enhanced. Collaboration with neighboring countries – too prone to outbreaks – should continue, and measles surveillance activities further strengthened particularly in high risk areas.

Country Profile Colombia

Figure 1. Measles immunization coverage in PAHO Region from 1990 to 2008. [Source: PAHO]

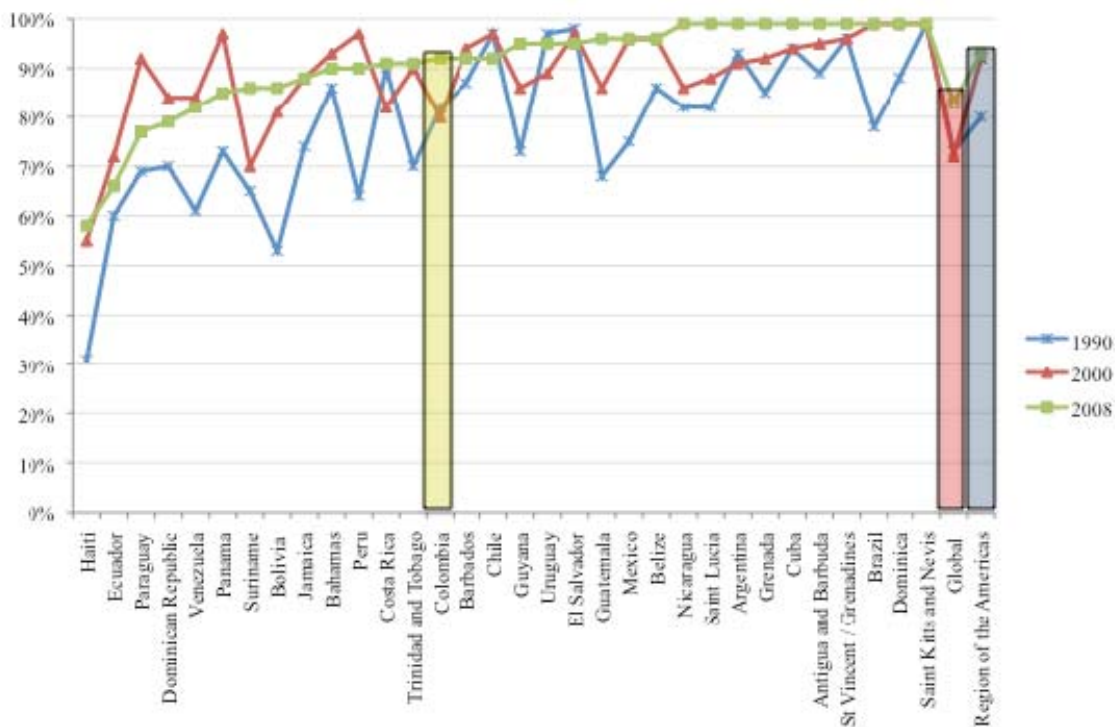
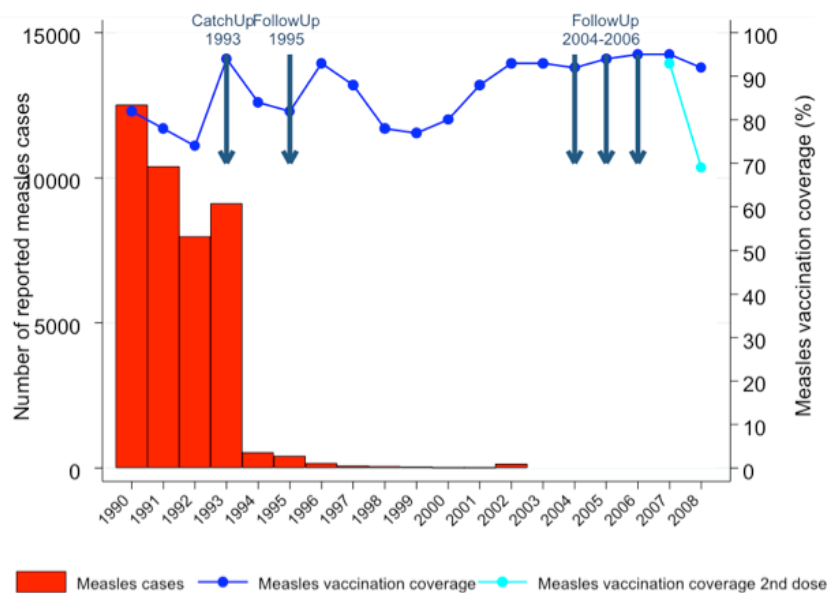

Figure 2. Reported measles cases and vaccination coverage in Colombia 1990-2008. [Source WHO]



Data source:
 Measles cases- reported by national authorities to WHO annually
 Measles vaccination coverage- WHO/UNICEF immunization coverage estimates, as of August 2009
 Measles vaccination coverage 2nd dose- reported by national authorities to WHO annually
 SIA activities: WHO/EPI supplementary immunization activities database
 Date of slide: 27-08-2009

MODEL RESULTS

MODEL VALIDATION

Figure COL1 shows the natural history of measles epidemics in Colombia. We were unable to locate epidemiological statistics to permit a direct comparison of the model to historical case reports of an unimmunized population. Cliff et al. (1993) published a case series from Mexico from 1940 to 1955 which confirms that Latin America's natural history is consistent with a cycle with a frequency of measles spikes every 3 years; thus fitting historical data for many other countries¹.

Figure COL2 shows the cumulative number of measles case by age and reveals the canonical pattern.

MODEL RESULTS ON COSTS, DEATHS, DALYS, AND COST STRUCTURE

Figure COL3 shows the epidemic curves for Colombian children age 1 to 4 with cases per year overlain with a plot of the prevalence of children age 1 to 4 who are immune to measles from vaccination. These curves are flat, because it is assumed that Colombia maintains its already superb coverage into the future. This figure shows one possible stochastic realization of the model. It includes the prediction of scattered outbreaks involving less than 100 people on any given year. The model "scales" from observations in 1 million simulated people to the entire Colombian population of 43 million. This 1:43 scale factor means that every person in the simulation represents 43 Colombians. Thus when the simulation predicts an outbreak of 1 simulated case, that case gets scaled up to represent 43 cases for the whole country. Therefore, the smallest possible outbreak in the model is 43. In reality, the population of Colombia may experience outbreaks smaller than 43 people; however, there is no easy way to fix the problem of scale. The SIR model cannot be applied to all 43 million people simultaneously, because the entire population of Colombia is not in epidemiological contact with one another in any given year. The option of making an ad hoc adjustment to change the 43 scaling factor to some smaller number, though more realistic, would lack an empirical foundation.

¹ Between epidemics the model differs from data that would be seen in national statistics. The model can exhibit zero endogenous cases between cycles, whereas national data on measles in an unimmunized population would not do this. The reason is that national statistics on measles epidemiology can pool together data from multiple regions that have epidemiological isolation. Due to limitations in computing power, the mathematical model only has the ability to depict two epidemiological linked populations¹. In this microcosm, a measles epidemic has the potential to eliminate all susceptible from the population. The next wave can occur only after new infants arrive.

As a result of this scaling factor, the sizes of outbreaks are likely overestimated. The frequency of outbreaks is being driven by the model's assumption that there are 2 silent importations of measles every month. When there are only imported measles cases in the population, the probability that each imported case is able to infect others are distributed as a Poisson process depending on the number of susceptibles. If Colombia enacts border control policies to lower the number of importations then the predicted frequency of outbreaks will be lower than that predicted by the model. For these reasons the dynamic transmission model may be overstating the future burden of measles in the baseline scenario for Colombia. Despite its potential over-estimate of the number of measles cases, the baseline model still predicts a total of only 11 measles deaths in Colombia over the next 40 years in the baseline model—one death every four years. Estimates of the number of deaths averted due to eradication, although they range around 11 deaths over 40 years, are not statistically different from 0 (Table COL3). Correcting the potential overestimate of Colombia's future caseload would have minimal impact on the estimates of how eradication would affect the DALY burden of measles in Colombia. Furthermore since the costs of illness and outbreaks account for a negligible fraction of the costs of measles in Colombia, the overestimate of cases has negligible impact on estimates of costs. Most cost savings from measles eradication come from stopping MCV2 and SIAs.

Figure COL4 plots the 40-year sum of discounted costs against the 40 year sum of discounted DALYs. Decision makers are assumed to prefer points that are lower on the vertical axis because these have lower cost and they prefer points that are more to the left on the horizontal axis because these have fewer DALYs. One can see from Figure COL4, that the eradication scenarios shift the burden of Colombian DALYs closer to zero. The scenarios that allow Colombia to discontinue MCV2 shift the costs downwards as well.

Referring to Table COL3, in the baseline scenario of holding MCV1 coverage fixed at 2010 levels and continuing SIAs the model projects a total of 11 (SD 15) discounted measles deaths and 325 discounted measles DALYs in Colombia from 2010 to 2050. The baseline scenario incurs a total cost of \$ 55 million (SD 2.1 million).

For a decision maker at the baseline position (D) in Figure COL4, all eradication scenarios improve health and lead to lower costs. Examining Figure COL 4 reveals that trajectories from the baseline to health improving strategies at the left of the figure would have very similar slopes. These slopes are not really "ICERS" in the conventional sense. The slopes tell decision makers how many dollars are saved at the same time one is saving a DALY. The slopes in Table COL3 were estimated by drawing 200 random line segments joining each scenario to the baseline scenario. The slopes range from \$58,000

(IQR 27K-87K) saved per DALY averted in the Eradicate 2025 scenario to \$122,000 (IQR 63K-170K) saved per DALY averted in the Eradicate 2020 and Stop MCV2 Scenario.

Figure COL5 shows the components of costs in each scenario. Findings indicate that the greatest cost saving comes from Colombia's being able to stop SIAs after eradication is achieved. There are further savings from not having to finance MCV2 if Colombia also decides to stop MCV2.

FIGURES

FIGURE COL1. NATURAL HISTORY OF MEASLES DICTATED BY PARAMETERS CHOSEN FOR COLOMBIA ASSUMING NO VACCINATION.

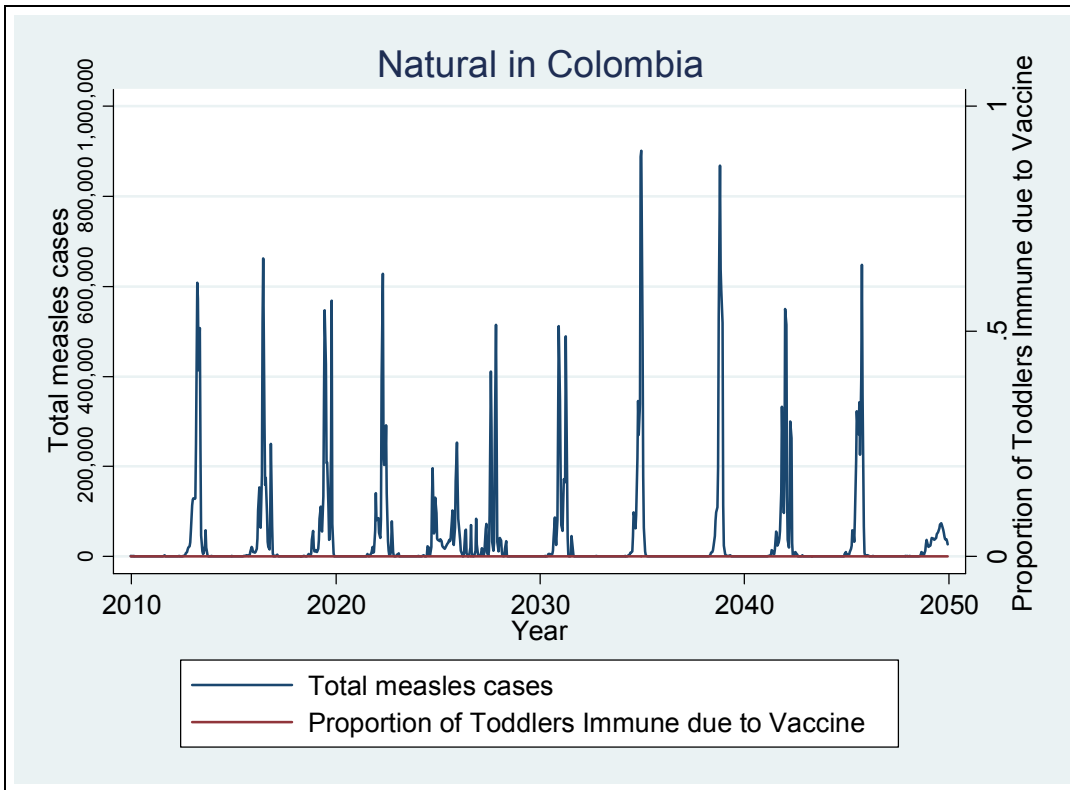

FIGURE COL2. CUMULATIVE MEASLES INFECTIONS BY AGE GROUP IN COLOMBIA PREDICTED BY MODEL IN THE ABSENCE OF IMMUNIZATION

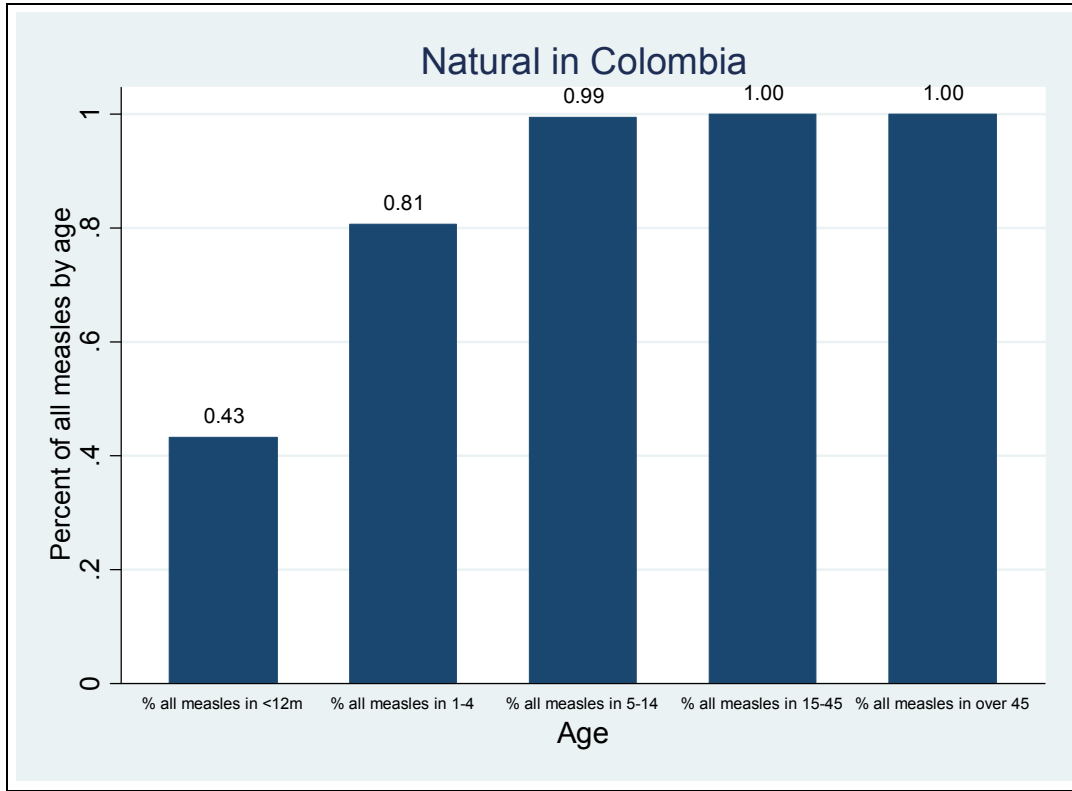

FIGURE COL3. EPIDEMIC CURVES FOR THE 6 SCENARIOS IN COLOMBIA. LEFT AXIS SHOWS NUMBER OF MEASLES CASES IN BLUE. RIGHT AXIS SHOWS THE PROPORTION OF CHILDREN AGE 1-5 WHO ARE IMMUNE DUE TO VACCINE RECEIPT. VERTICAL SCALE IS NOT THE SAME IN ALL PANELS.

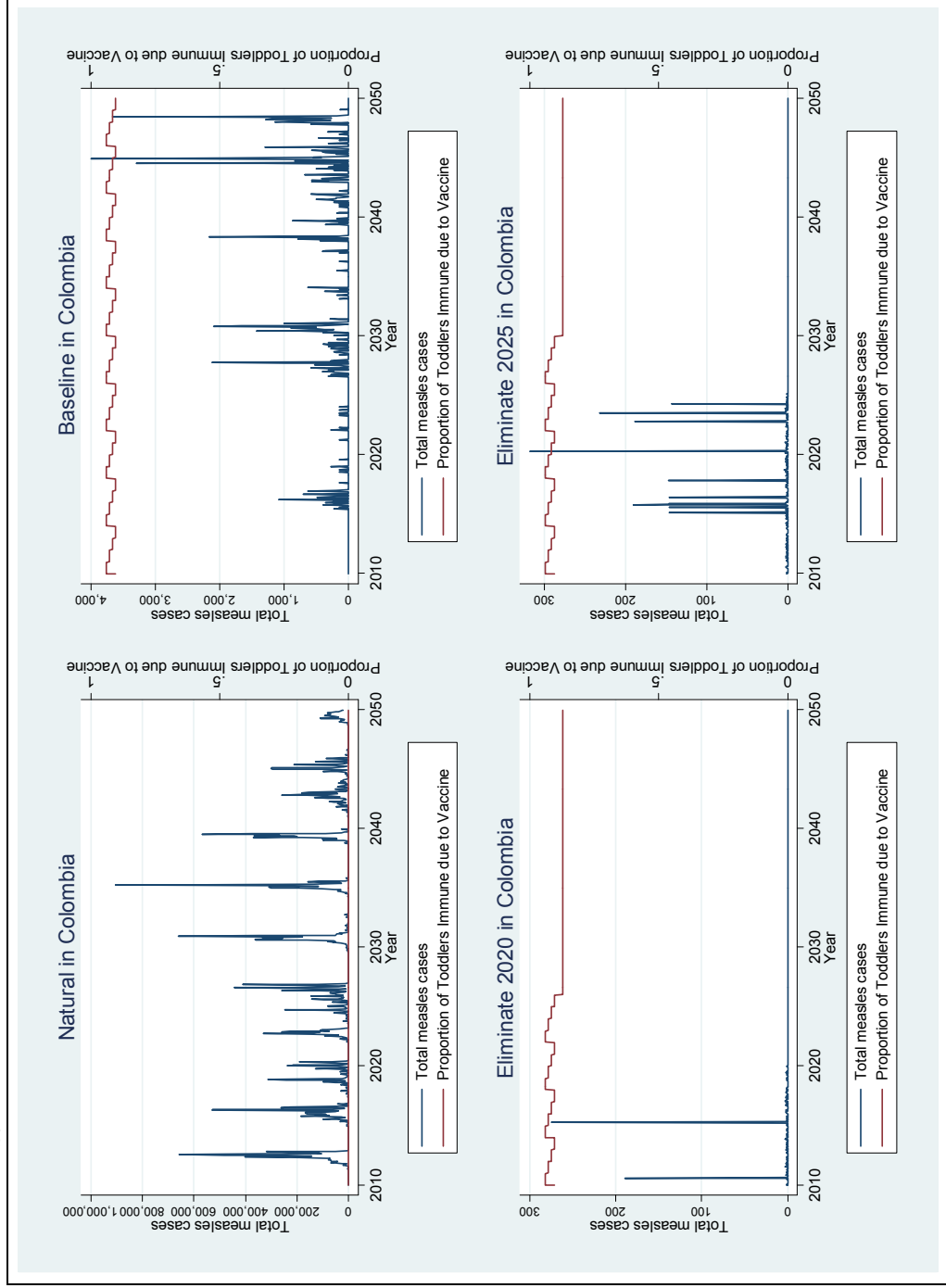

FIGURE COL 4. COSTS VS. DALYS IN COLOMBIA FOR THE 6 SCENARIOS. SLOPES FROM BASELINE (B) TO THE OTHER POINTS ARE “INCREMENTAL COST EFFECTIVENESS RATIO’S” (ICERs) AND ARE INTERPRETED AS \$ PER DEATH AVERTED.

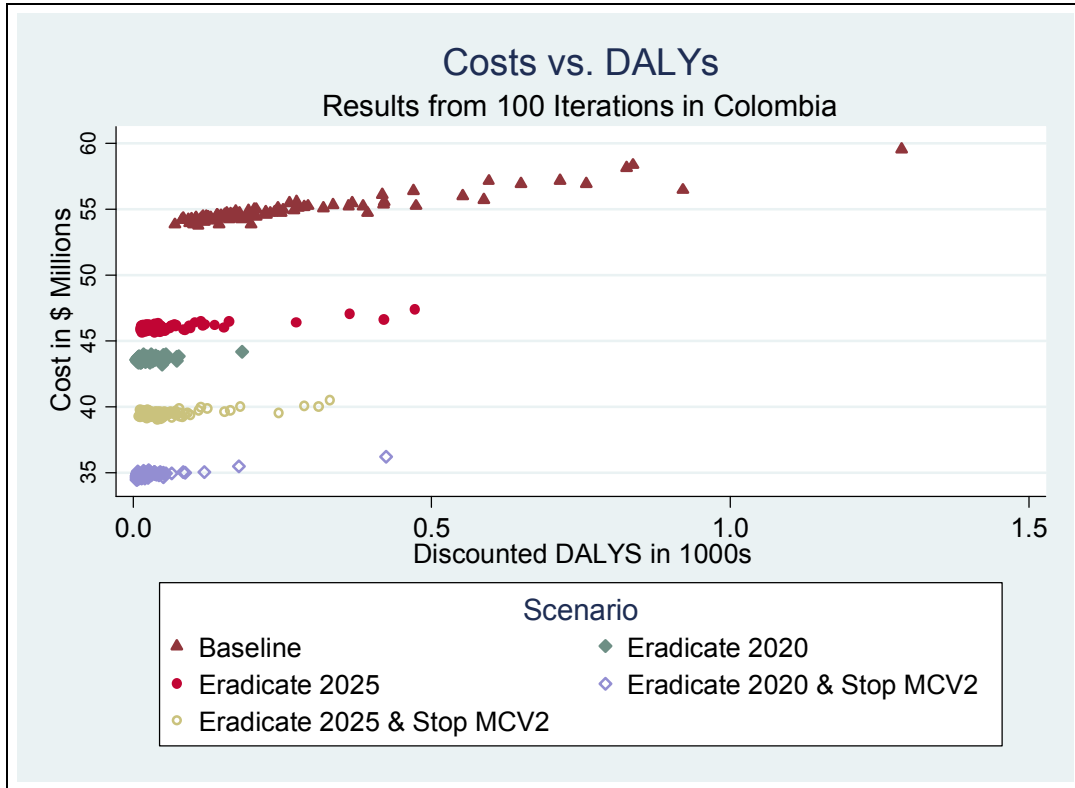
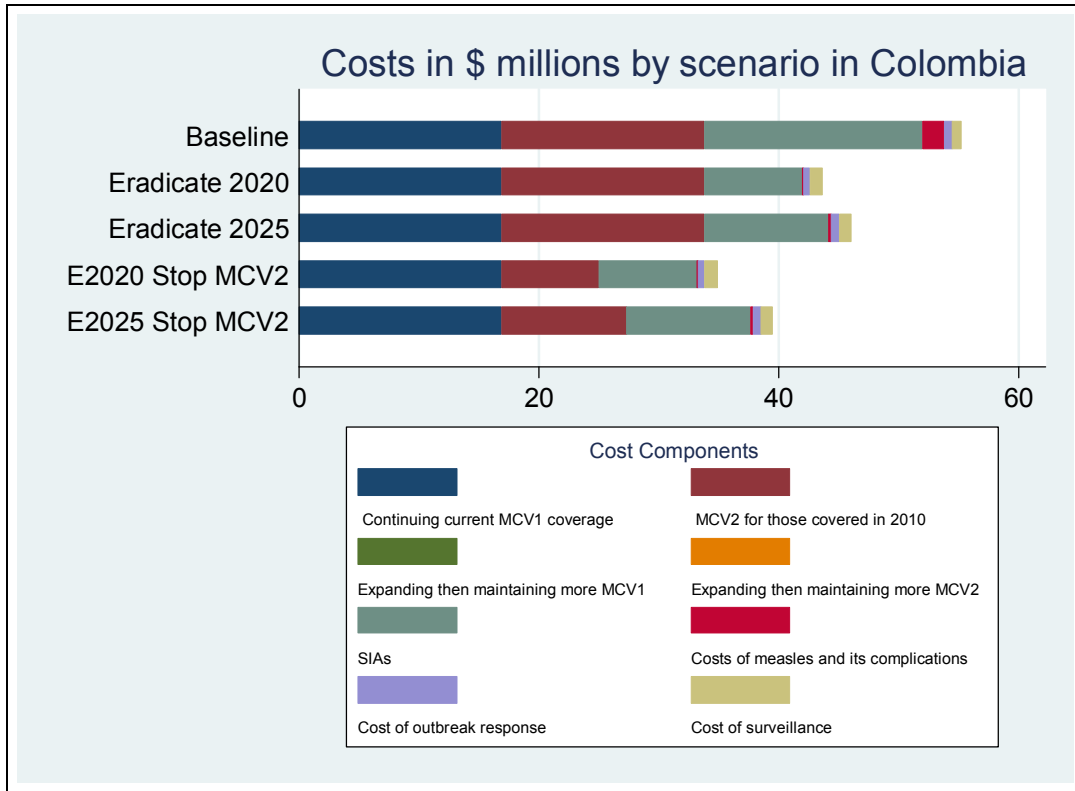

FIGURE COL5. COST STRUCTURE AMONG VARIOUS MEASLES CONTROL SCENARIOS IN COLOMBIA COMPARED TO WHAT IT WOULD BE IN THE NATURAL HISTORY SCENARIO. COSTS ARE CUMULATIVE DISCOUNTED COSTS FROM 2010 TO 2050.



TABLES

TABLE COL 1 DESCRIPTION OF MEASLES CONTROL SCENARIOS USED FOR COLOMBIA

Scenario:			1				
			Baseline	Eradication 2020	Eradication 2025	Eradication 2020 and stop MCV2 after 2023	Eradication 2025 and stop MCV2 after 2028
Status in 2010	MCV1	Covg	0.94				
		Age	12 mo				
	MCV2	Covg	0.94				
		Age	48 mo				
	SIA	Covg	99%				
		Age	Age 1-5				
Freq		Every 4 years					
Status after 2010 till target year	MCV1	Ramp up rate [1]	0				
		Age	12 mo				
	MCV2	Ramp up rate	0				
		Age	48 mo				
		Yr Intro	1997				
	SIA	Covg	99%				
Age		Age 1-5					
Freq		Every 4 years					
Status after target year	MCV1	Covg	0.94				
		Age	12 mo				
	MCV2	Covg	0.94		0		
		Age	48 mo		N/A		
	SIA	Covg	N/A				
		Age					
Freq							
Target Year			2010	2020	2025	2020	2025
Notes							
[1] Ramp up rates expressed as percentage points of coverage gained per year							
[2] MCV1 age not raised because MCV1 coverage never gets to 80% by target year in these scenarios.							
[3] MCV1 age can be lifted to 12 mos. after 3 yrs of MCV1>80%, but model waits until measles incidence drops below 1/100,000							
[4] MCV2 coverage starts at 50% of MCV1 in year introduced increases to 90% of MCV1 by 3rd year after introduction							

TABLE COL 2. PARAMETERS FOR COLOMBIA

Parameter	Value	Range	Source
Average cost per child vaccinated prior to scale up via routine services	\$1.00	+/- 20%	(Brenzel, et al. 2006)
Scale up cost per child for core areas	N/A no scale up		
Scale up cost per child for satellite areas	N/A no scale up		
Scale up cost per child for MCV2 in core areas	N/A no scale up		
Scale up cost per child for MCV2 in satellite	N/A no scale up		
SIA cost per child	N/A no SIAs		
Monthly force of infection parameters	Jan: 0.00006392 Feb: 0.00007325 Mar: 0.0000809 Apr: 0.0000857 May:0.00007162 Jun: 0.00010455 Jul: 0.00007821 Aug: 0.0000761 Sep: 0.00007831 Oct: 0.00008567 Nov:0.00007201 Dec: 0.00008348	+/- 20%	Ugandan parameters used and subjected to sensitivity analysis
Initialization of proportion vaccinated among adults, children, toddlers	0.82-0.94 depending on the age and year*		WHO coverage database
Initial measles case fatality rate**	Infant: 0.001 Toddler: 0.0005 Child: 0.00025 Adult: 0.00025		(Wolfson, Grais et al. 2009)
Life expectancy (years)	Infant: 74 Toddler: 72 Child: 63.3 Fertile: 44.2 Post Fertile: 20		WHO
Fraction In satellite compartment	3%		(UNICEF and WHO 2010)
Initial population sizes	Infant:0.9 E6 Toddler:3.5 E6 Child: 8.8 E6 Fertile:20.9 E6 Post Fert: 8.8E6		(United Nations 2008)

TABLE COL 3. TABLE OF COSTS, DEATHS, DALYS AND ICERS FOR COLOMBIA WITH 3% DISCOUNTING AND HORIZON TO 2050.

	Discounted Deaths		Δ Discounted Deaths relative to baseline		Δ Discounted DALYS relative to baseline of 325		Discounted Costs in \$ millions		Δ Discounted Costs relative to baseline	
	Mean	SD	Mean	SD	Mean	SD	Mean	SD	Mean	SD
Natural (N)	10,299	(449)	-	-	-	-	\$1,000	(34.7)	-	-
Baseline (B)	10.9	(15)	-	-	-	-	\$55	(2.1)	-	-
Eradication 2020 (E2020)	0.8	(1)	-11.0	(17.8)	-330	(541)	\$44	(.2)	-\$12	(2.6)
Eradication 2025 (E2025)	1.8	(2)	-10.0	(18.0)	-297	(546)	\$46	(.3)	-\$9	(2.6)
Eradication 2020 & Stop MCV2	0.9	(1)	-11.0	(17.8)	-328	(542)	\$35	(.2)	-\$21	(2.6)
Eradication 2025 & Stop MCV2	1.8	(2)	-10.2	(18.0)	-305	(546)	\$40	(.2)	-\$16	(2.6)

	Ratio of dollars saved per death averted			Ratio of dollars saved per DALY averted		
	Median	Interquartile Range	Notes	Median	Interquartile Range	Notes
Baseline (B)	-	-	-	-	-	-
Eradication 2020 (E2020)	-\$2,075,796	-(1,105,035: -2,731,305)		-\$70,327	-(36,992: -92,640)	
Eradication 2025 (E2025)	-\$1,719,276	-(2,451,623: -836,537)		-\$58,088	-(27,131: -87,128)	
Eradication 2020 & Stop MCV2	-\$3,612,034	-(4,925,235: -1,887,208)		-\$122,372	-(62,848: -169,652)	
Eradication 2025 & Stop MCV2	-\$3,025,495	-(4,161,963: -1,282,770)		-\$102,784	-(43,483: -146,024)	

[1] All eradication scenarios save money and save additional deaths and DALYS which arrive in the ratios shown.

BIBLIOGRAPHY

1. de Quadros, C.A., et al., *Measles Eradication: Experience in the Americas*. MMWR, 1999. **48**(SU01): p. 57-64.
2. WHO, *World Health Statistics*. 2010, World Health Organization: Geneva
3. WHO, *Colombia: Health Profile*. 2010, World Health Organization: Geneva.
4. CDC, *Outbreak of Measles --- Venezuela and Colombia, 2001--2002*. MMWR, 2002. **51**(34): p. 757-760.

COUNTRY MEASLES PROFILE: ETHIOPIA

Amnesty LeFevre and David Bishai

MEASLES IN AFRICA

Measles is the leading cause of mortality among vaccine preventable childhood diseases, accounting for an estimated 40% of the 1.4 million annual deaths [1]. Increases in vaccination have been associated with sharp declines in global deaths attributed to measles from 873,000 in 1999, 345,000 in 2005 to 164,000 in 2008 [2]. In Africa, reductions in mortality have exceeded global achievements as measles deaths have fallen by an estimated 75% from 506,000 in 1999 to 143,000 in 2005 [2, 3]. Despite these achievements, much work remains if present reductions are not only to be maintained but accelerated, and efforts to attain the Millennium Development Goal for child survival are to be realized.

Ethiopia is one of the 47 WHO/ UNICEF priority countries, which collectively account for 98% of measles deaths [1, 4]. Home to over 83 million people across 9 regions (9 administrative regions and 2 city-urban administrations; 80 zones; 756 woredas), Ethiopia is Africa's second most populous country and among its poorest. Despite improvements in MCV1 coverage from 42% in 2002 to 74% (Figure 1), Ethiopia continues to have annual measles outbreaks. In 2008, with over 3,000 confirmed measles cases¹ (Figure 2), Ethiopia reported the tenth highest number of cases globally and the highest in Sub-Saharan Africa, after Nigeria [5].

MEASLES INTERVENTION AND PROGRAMMATIC ACTIVITIES

Measles activities in Ethiopia fall within four distinct categories: (1) vaccine procurement, distribution, and storage; (2) routine immunization activities; (3) supplementary immunization activities; (4) case identification and management, including outbreak control and case treatment. Critical activities required to facilitate the execution of these are also discussed and include vaccine procurement and distribution; quality control including cold chain support; and supervision from both donor and government authorities at all levels.

Vaccine procurement, distribution and storage: In Ethiopia, UNICEF coordinates vaccine procurement with support from the World Bank and Ministry of Health's pharmaceutical storage facility (PSFA). From 2002-2009 a total of 16 shipments were received corresponding to an average of 2 shipments received annually of varying quantity. Once received by the PSFA,

¹ According to WHO, there were total of 74 outbreaks in 56 woredas reported in 2008. An estimated 57% of the total confirmed cases were less than 5 years of age; and only 36% of the confirmed cases had received at least 1 dose of MCV1.

Country Profile: Ethiopia

vaccines remain in the central procurement and storage facility in Ethiopia's capital of Addis Ababa until they are collected by representatives from each of the 11 regional hubs. While there are plans to expand the number of regional hubs by an additional 14, at present the 11 hubs serve as the storage facilities for measles and other vaccines. Distribution occurs in response to regional requests from the PSFA to the hub; an average of once every four months. From these regional hubs, each zonal authority (98 in total) submits requisitions for the facilities within their catchment area. Vaccines, including measles are typically collected every 3 months for distribution to the facilities in their catchment area. Once at the zonal level health authority, vaccines are collected on a monthly basis by either a health care professional or in most instances a community health volunteer.² Distribution only occurs between ~ 50% of health facilities and zonal authorities or those facilities which are classified as "Type A" (2,857 in total) and thus inclusive of cold chain storage capabilities. "Type B" facilities (6,704 in total) are typically clustered around Type A facilities and do not have cold chain capacity. As a result, they obtain vaccines with the aid of a CHV an average of twice monthly from the Type A facility in their cluster. These logistical challenges not only of geographic terrain but of not having cold chain storage capacity in all facilities has hampered efforts to expand RIAs. In the absence of a refrigerator in a given facility, providers must depend upon a CHV to retrieve the vaccine – a process which in remote areas may exceed a day and entail the use of a donkey as the mode of transportation— and utilize the received supply in a timely fashion before it succumbs to heat and other elements.

Routine Immunizations: As part of the Expanded Program for Immunization, Ethiopia introduced measles vaccination (MCV1) in 1980 [7]. Through a one dose vaccination schedule, children 9 months of age and older are targeted through the public health system by health officers, nurses, sanitarians (primarily serve as supervisors), and health extension workers (HEWs). With upwards of 32,000 deployed throughout the country, this latter category of provider– HEWs– reflects a new cadre of community-based health worker tasked with providing EPI services among other activities which is anticipated to greatly improve overall immunization coverage. Additional growth among the numbers of other cadres of staff, including nurses and an estimated 2,518 health officers who graduated in 2009, are anticipated to further strengthen MCV1 coverage, measles surveillance, and disease management. However, the ability to realize marginal increases in coverage will depend considerably upon the assurance of adequate supervision, continued and sustained support to HEWs (including attention to ensure that their scope of work is manageable, compensation sufficient, etc.), as well as the strengthening of cold chain, transportation, and other critical components of the health infrastructure.

² While the latter are typically referred to as volunteers, this terminology is decidedly misleading in light of the financial compensation they receive for their involvement in any and all health related activities including vaccine procurement; assistance with the EPI campaigns, etc.

Country Profile: Ethiopia

Supplementary Immunization Activities (SIAs) were initiated in 1998 to bolster coverage of key immunization services including MCV1, polio, DTP, and BCG. To date, measles SIAs have been carried out in phases across all regions and woredas: (1) 1998-2001; (2) Catch-up campaigns; (3) Follow-up SIA I; and (4) Follow-up SIA II. The first campaign was initiated in 1998 in 9 urban zones and by 2001 had led to the inoculation of over 12 million children under 5. Upward trends in the age of measles cases, coupled with droughts and high rates of malnutrition in some regions of the country, led to the conduct of a follow-up campaign from 2000-2003 targeting 31.8 million children 6 months to 15 years³ of age [7]. Improvements in health infrastructure coupled with increases in the number and capacity of health personnel, including the deployment of HEWs, have decreased the total time required to implement national SIAs (Map 2) from roughly 4 to 2 years. This time is anticipated to further narrow, with forthcoming campaigns slated to eventually span for no more than a single year. The time interval between national campaigns will depend upon trends in SIA and routine immunization coverage as well as the emergence of outbreaks, however, are anticipated to be roughly 2 years.

Case identification: Suspected cases of measles are identified through three probable mechanisms: (1) health care professionals; (2) “rumor report” identification through the Ethiopian Health and Nutrition Research Initiative’s Public Health Emergency and Surveillance office (EHNRI- PHES) in Addis Ababa; or (3) direct reporting to WHO. Measles is one of four “immediately reportable” infectious diseases along with yellow fever, avian influenza, and polio, which are tracked in all public health facilities throughout the country and monitored through a database and surveillance system established and maintained by WHO. In the event a suspected case is identified by a public health sector staff member, five samples are collected from the woreda from which suspected case stems and these are subsequently transported directly to the EHNRI’s Laboratory in Addis by the identifying health care provider. If 3 of the 5 samples are confirmed as measles cases, an outbreak is declared and appropriate linkages made with WHO and other donors to mobilize a response. The health care provider responsible for identifying the initially suspected case and collecting 4 additional specimens is reimbursed for travel and other expenses incurred and thus compensated financially for transporting the specimens for testing confirmation to Addis. Given the challenges associated with physical movement across and within regions, health care providers are able to bypass traditional regional reporting requirements and thus woreda and zonal level personnel interact directly with officials in Addis as needed to verify whether or not an outbreak has indeed occurred. Once tested, findings are conveyed by EHRNI laboratory officials to WHO to ensure continued communication and ongoing maintenance of their electronic surveillance system.

In parallel to this reporting system of health care personnel identifying and transporting suspected cases to Addis, the PHES branch of the EHNRI maintains telephone contact with each region on

³ Between 2002 and 2003 children 6 months to 14 years of age were targeted. However, from January 2003 to September 2004, the age range was expanded to 15 years.

Country Profile: Ethiopia

a daily basis. Once-daily telephone calls to each regional office are made with the explicit intent of identifying any “rumors” regarding the emergence of measles cases within and across regions. If a rumor is reported, WHO is contacted and surveillance personnel deployed to obtain samples for case confirmation.

The final mechanism through which cases may be identified is through WHO officials directly. WHO-Ethiopia has been engaged in active measles surveillance since 1998 as part of its STOP Campaign. While polio-specific, this plan has allowed WHO to provide critical technical support to government staff. The purpose of the STOP campaign is to fill gaps between cases not identified and reported in government health sector. To this end, a national level team has been employed by WHO to travel around regions and identify reportable diseases including neonatal tetanus, polio, and measles. Beyond these individuals, WHO employs 29 regional surveillance officers and as well provide incentives to zonal and woreda focal persons for disease surveillance and monitoring. Regional surveillance officers work to identify cases via the “immediately reportable” system and through visits to private health facilities. Overall this surveillance system has led to an increase in the number of cases identified (Figure 2); improvements in information flow (with regard to the speed and content of communication on suspected and confirmed cases); and improvements in the response and management of suspected outbreaks. While trends in the number of outbreaks have increased over time (Figure 2), this is likely due in part to improvements in monitoring and thus the identification of cases which otherwise would have gone undetected.

Case management and outbreak response: In the event a suspected measles case is identified, the responding health worker is tasked with collecting specimens from the presenting child and 4 additional children from the same woreda. If 3 of 5 specimens are tested and identified as being confirmed measles cases, EHRNI laboratory officials notify WHO, the MOH and the National Inter-agency Coordinating Committee (ICC). The latter is an inter-agency advisory body inclusive of representatives from multi- and bi-lateral agencies, which provides technical support to the MOH (through the Family Health Department and Disease Control Department) and facilitates resource identification and mobilization. Beyond the national level representatives, the ICC additionally has regional level committees and a technical advisory committee. In the event of an outbreak, the response is coordinated by the ICC and typically carried out with support from WHO, UNICEF, the MOH and other partners.

Treatment of measles cases: In the absence of a method to kill the measles virus, identified cases are clinically managed based on emerging symptoms. Given the large proportion of cases, which remain undetected and/or treated outside the formal government health sector, determination of approximate treatment practices and associated costs are difficult. However, in an effort to determine a proxy estimate of treatment practices and costs, measles cases were reviewed at Ethiopia’s largest tertiary care facility – the Black Lion hospital in Addis Ababa. In-depth interviews were carried out with all provider types involved in the identification and management of treatment cases. In addition, a review of patient facility logs were utilized to explore the

Country Profile: Ethiopia

reported treatment of the 11 total cases seen between August 2009 and March of 2010. All patients were administered a general course of antibiotics (ampicillin / getamicin; likely administered to treat secondary bacteria infection), rehydrated with intravenous solution, treated for identified fever or pain, and provided with a dose of Vitamin A. Of the 11 cases seen, 3 were admitted for a period of time ranging from 2 to 3 days, while the remaining were treated as outpatients and discharged following disease management.

NEXT STEPS FOR MEASLES IN ETHIOPIA

Despite the progress Ethiopia has made in improving routine MCV1 coverage from 55% in 2004 to 75% in 2009, disparities among regions in coverage rates persist and infection outbreaks remain an annual occurrence. Integrated SIAs continue to improve coverage among children under 5 and remarkable strides have been made in the execution of these activities corresponding to a decrease in the total time required to cover the entire country from 4 to 2 years. It is anticipated that the forthcoming SIAs in 2010 will cover all regions within a 1-year period.

Complementing efforts to improve the timeliness of SIA execution are slated plans to construct additional health facilities and continue strengthening the cold chain and transportation deficiencies. Further plans exist to enhance RIA through a more systematic implementation of the RED approach. RED activities are anticipated to enhance measles prevention and control activities in the pastoralist districts and emerging regions – areas which are presently characterized by low coverage due to a wide array of factors including poor health worker density, difficult physical terrain, a dry arid environment, and a nomadic population. Finally, continued emphasis upon the strengthening of surveillance systems, case management and outbreak control are anticipated to further accelerate under the ICC's leadership.

Country Profile: Ethiopia

Map 1. Measles Immunization Coverage by Region, 2008

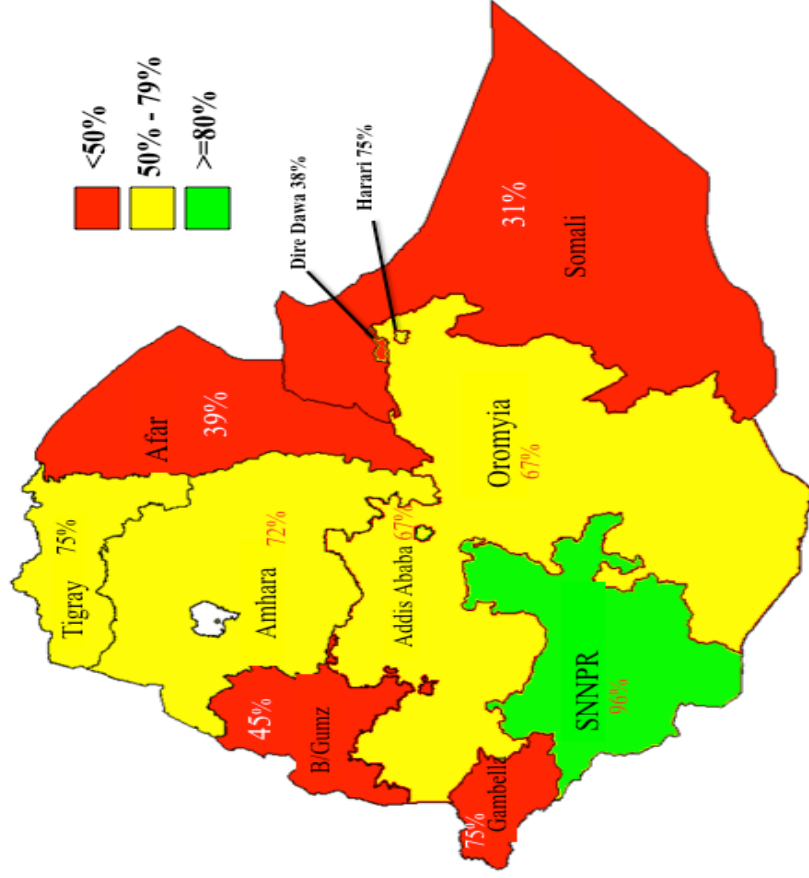

Map 2. SIA Campaign Implementation 2007-2009

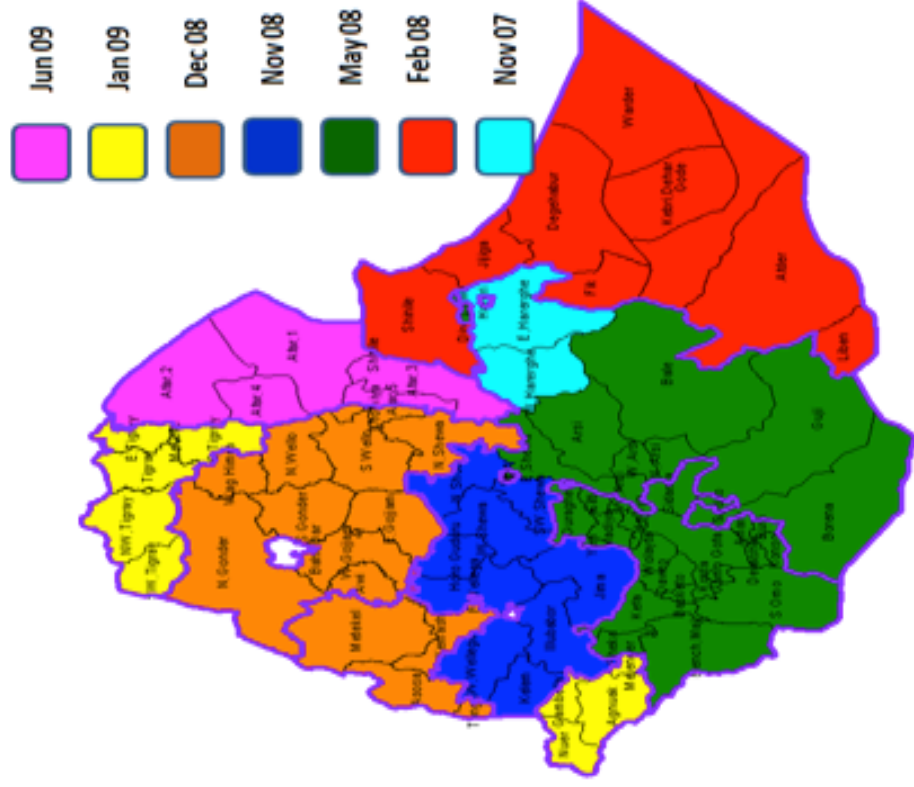

Source: World Health Organization, 2010

Country Profile: Ethiopia

Figure 1. MCV1 Coverage 2002-2009: Estimates for Africa Region, Ethiopia and by Region Within Ethiopia

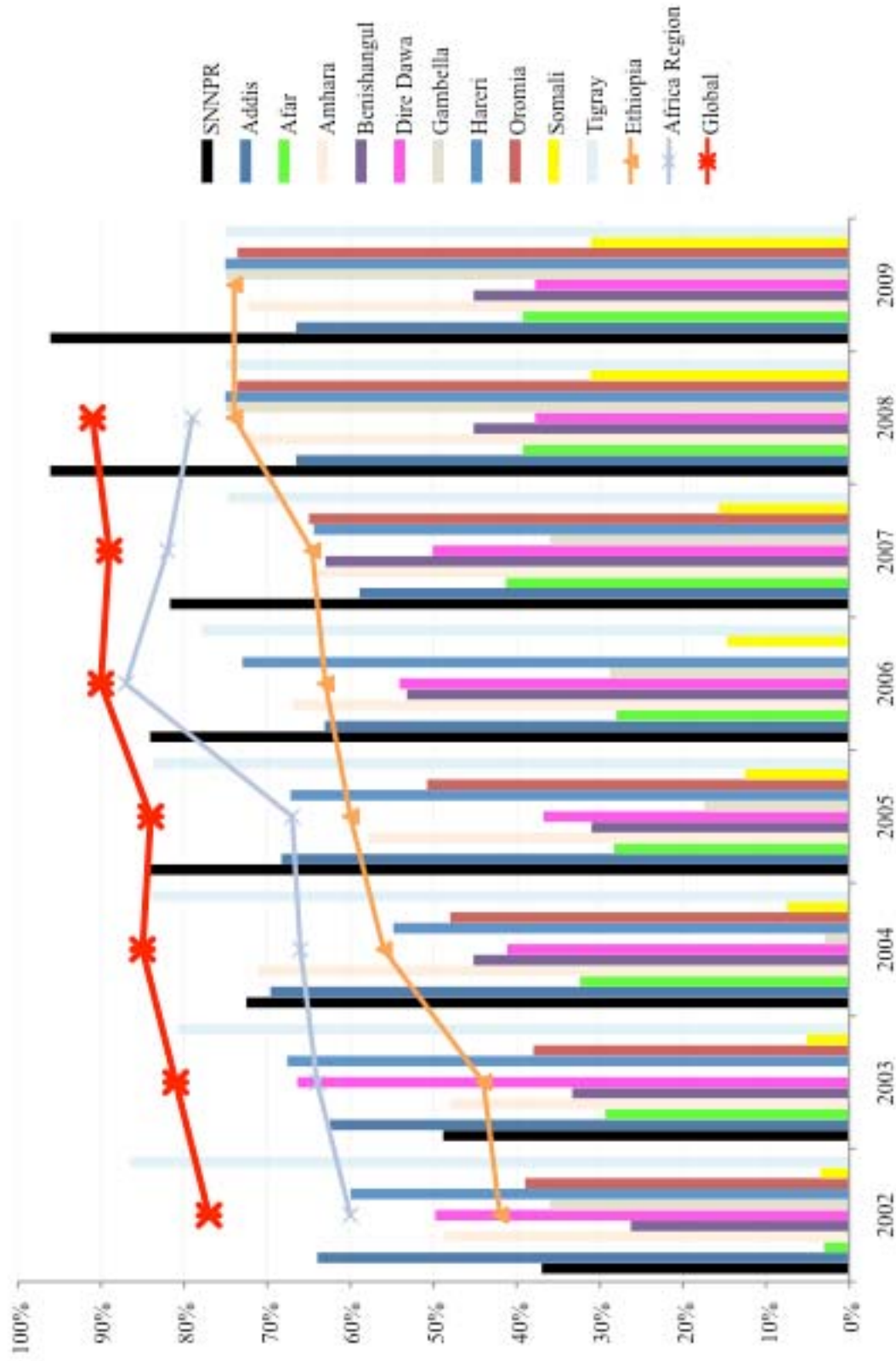

Country Profile: Ethiopia

Figure 2. Confirmed Measles Cases 2004-2009

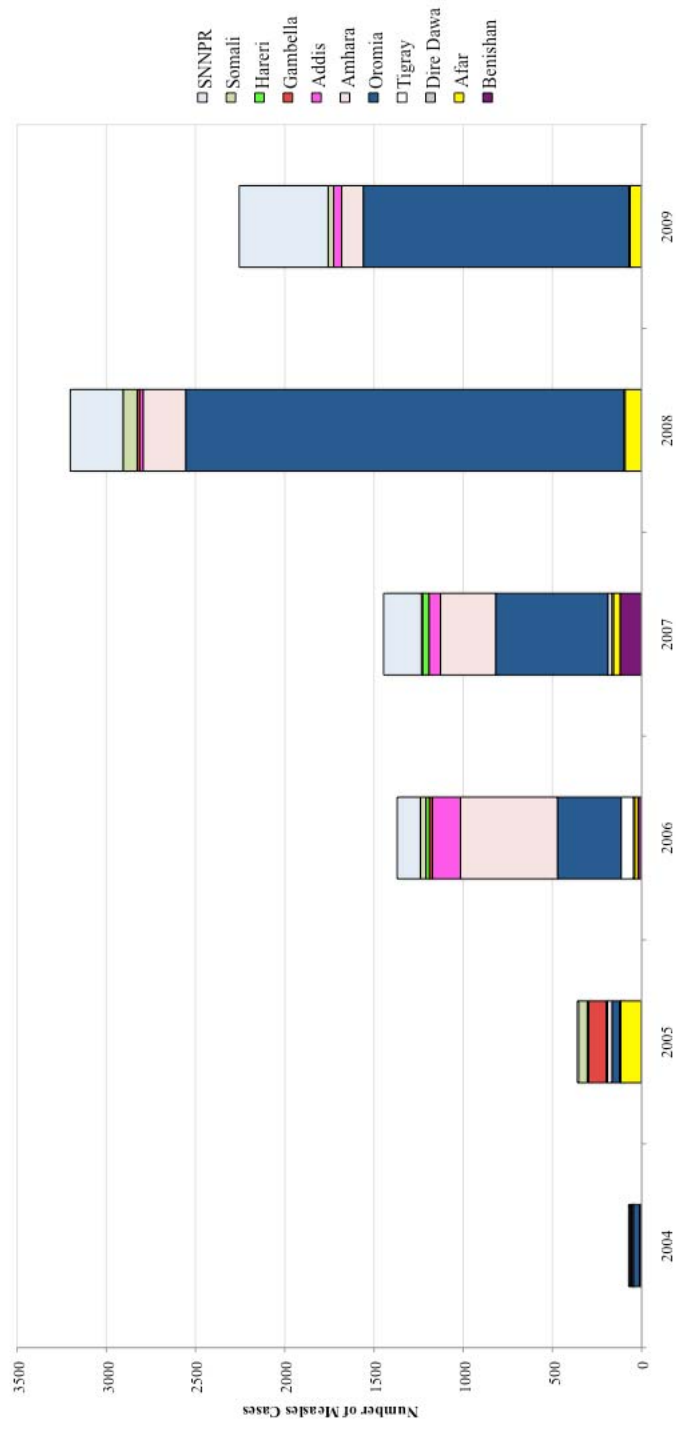

MODEL RESULTS

MODEL VALIDATION

Figure ETH1 shows the natural history of measles epidemics in Ethiopia. Although Ethiopian epidemiological statistics do not permit a direct comparison of the model to historical case reports of an unimmunized population, the cycle with a frequency of measles spikes every 3 years fits historical data. Between epidemics the model differs from data that would be seen in national statistics. The model can exhibit zero endogenous cases between cycles, whereas national data on measles in an unimmunized population would not do this. The reason is that national statistics on measles epidemiology can pool together data from multiple regions that have epidemiological isolation. Due to limitations in computing power, the mathematical model only has the ability to depict two epidemiological linked populations⁴. In this microcosm, a measles epidemic has the potential to eliminate all susceptible from the population. The next wave can occur only after new infants arrive.

Figure ETH2 shows the cumulative number of measles cases by age for various scenarios. The figure shows the age distribution for the natural history model which shows that in the model 22% and 70% of cases have occurred by 12 months and 60 months respectively. O'Donovan published cumulative incidence of hospital admissions for measles and found comparable numbers of 47% by age 12 months and 90% by 60 months {O'Donovan, 1971 #5767}.

Figure ETH3 shows the epidemic curves for toddlers age 1 to 4 with cases per year overlain with a plot of the prevalence of children age 1 to 4 who are immune to measles from vaccination for the case of Ethiopia. The scenarios with SIAs show the presence of SIAs as rectangular upticks in immunity occurring every 3 years in Ethiopia. The scenario of stopping SIAs after 2010 leads to more frequent epidemics than would occur in the baseline situation where routine coverage and SIA policies are frozen in place.

Figure ETH4 plots the 40-year sum of discounted costs against the 40 year sum of discounted DALYs. Decision makers are assumed to prefer points that are lower on the vertical axis because these have lower cost and to prefer points that are more to the left on the horizontal axis because these have fewer DALYs. One can see from Figure ETH4, that the baseline scenario (Ds) of not increasing routine coverage while continuing SIAs imposes similar costs but has 10.5 million fewer DALYs than stopping SIAs. In the baseline scenario of holding MCV1 coverage fixed at 2010 levels and continuing SIAs the model projects a total of 228,193 (SD 35,058) discounted measles deaths and 6,324,605 million discounted measles DALYs from 2010 to 2050. The baseline scenario incurs a total cost of \$ 158 million (SD 3.3). Terminating SIAs in 2010 in Ethiopia would lower costs to \$131 million (SD 4.3). Roughly \$77 million in SIA costs are averted (not shown in table), but replaced by \$51 million in health care costs for the additional measles cases. The net result is that stopping SIAs saves \$25 million at the expense of 373,185 additional deaths.

⁴ Running 100 iterations of 8 policy scenarios for a single country required 30 hours of computing time on a high performance computing cluster with AMD Opteron, 8-CPU cores and 16GB of memory.

For a decision maker at the baseline position (D), all choices that improve health lead to higher costs. Examining Figure ETH4 reveals that trajectories from the baseline to these health improving strategies at the left of the figure would have very similar slopes. These slopes i.e. “ICERS” (Table ETH3) were estimated by drawing 200 random line segments joining each scenario to the baseline scenario. The ICERS range from \$43 (IQR 38:56) per DALY averted in the 95% reduction scenario to \$112 per DALY averted in the Eradication by 2025 scenario (IQR 96-132).

Figure ETH5 shows the components of costs in each scenario and includes a comparison to the costs of measles if Ethiopia had never adopted measles vaccine (top bar “Natural”). The analysis confirms that measles vaccination as currently practiced in the baseline is indeed cost saving—the costs of the program are less than half what the medical and social costs of measles would be. In all scenarios that improve measles control the largest cost component is the cost of expanding and maintaining more routine measles coverage. As noted above, the model of scaling up routine coverage assumes that scale up will require permanent increases in recurrent costs of the vaccine program. The sooner scale up is implemented the longer these higher costs are incurred.

For Ethiopia, the model estimates (Table ETH4) that there would be 84,090 cases of congenital rubella syndrome (CRS) over 40 years if MR vaccine were not adopted. All strategies that switched from MCV to MR antigen following WHO guidelines for appropriate switching brought cumulative caseloads to under 500 cases over the next 40 years and averted over 1 million DALYS as well as saving CRS costs. The inclusion of the cost consequences of CRS would more than offset the total costs of scaling up immunization. This would improve all ICERs by a similar amount and have little impact on making any particular strategy more attractive than the others. Because the CRS costs in low income countries are mostly borne by households, the medical sector would not easily recover the financial savings from rubella control.

FIGURES

FIGURE ETH1. NATURAL HISTORY OF MEASLES DICTATED BY PARAMETERS CHOSEN FOR ETHIOPIA ASSUMING NO VACCINATION.

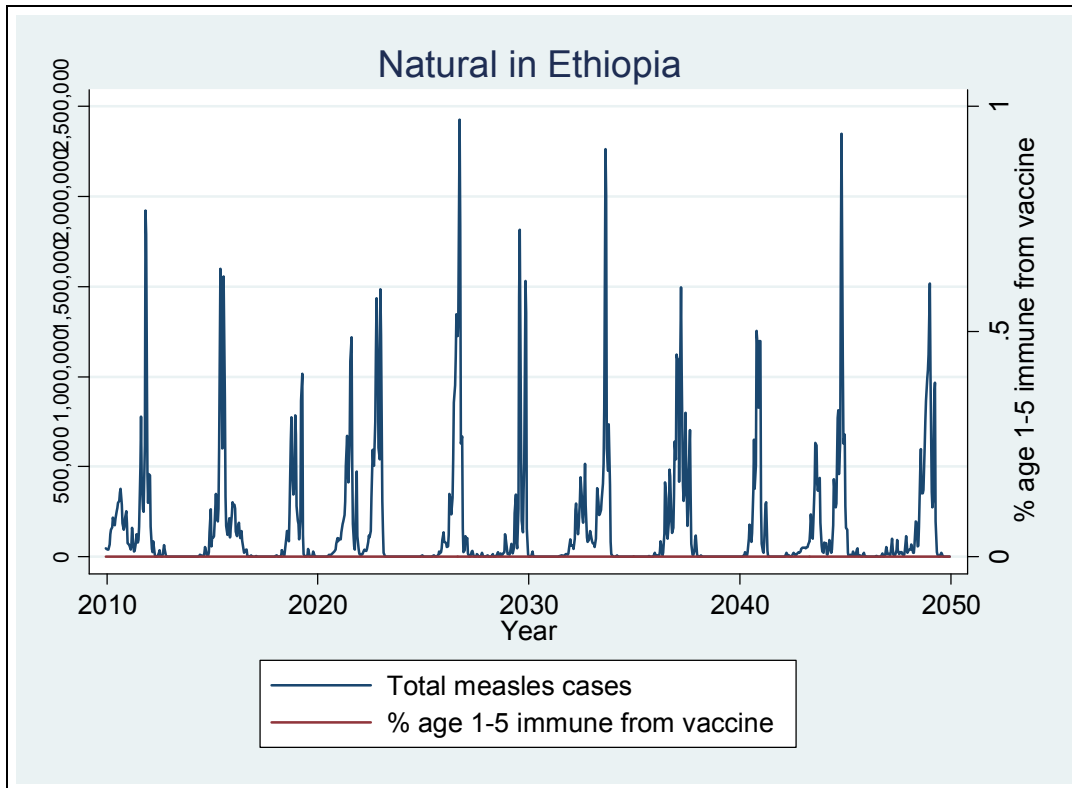

Figure ETH2. Cumulative measles infections by Age Group in Ethiopia Predicted by Model in the Absence of Immunization

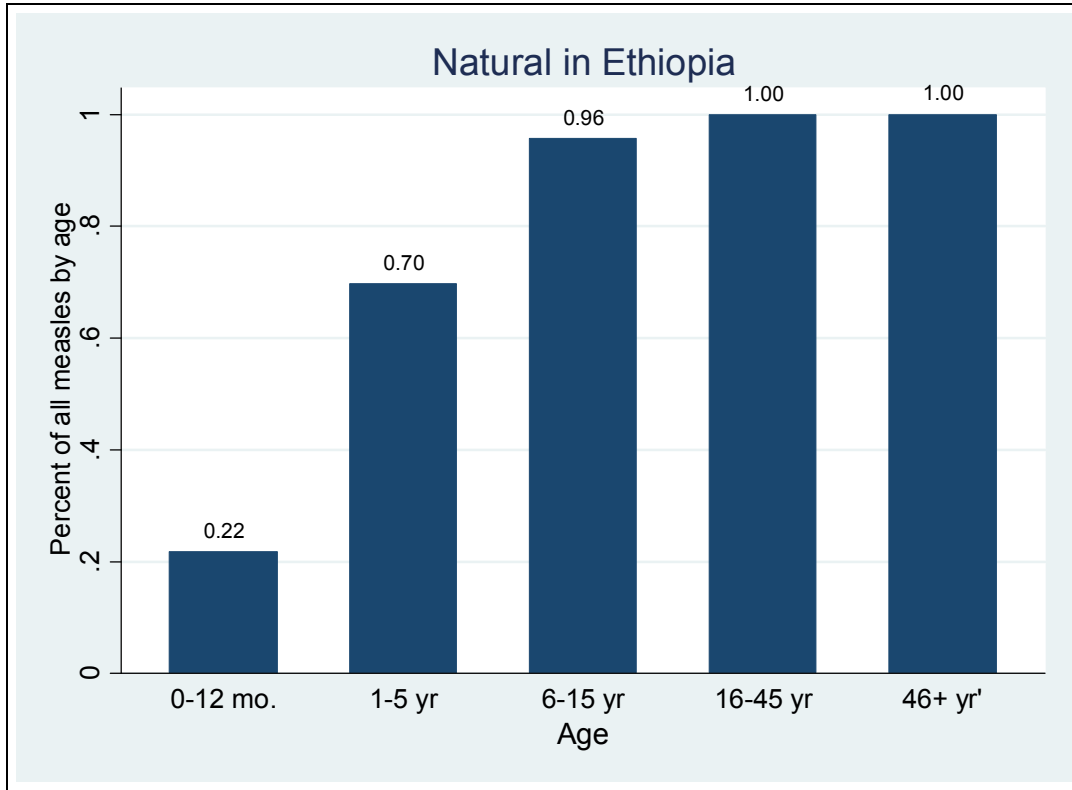

FIGURE ETH3. EPIDEMIC CURVES FOR THE 6 SCENARIOS IN ETHIOPIA. LEFT AXIS SHOWS NUMBER OF MEASLES CASES IN BLUE. RIGHT AXIS SHOWS THE PROPORTION OF CHILDREN AGE 1-5 WHO ARE IMMUNE DUE TO VACCINE RECEIPT.

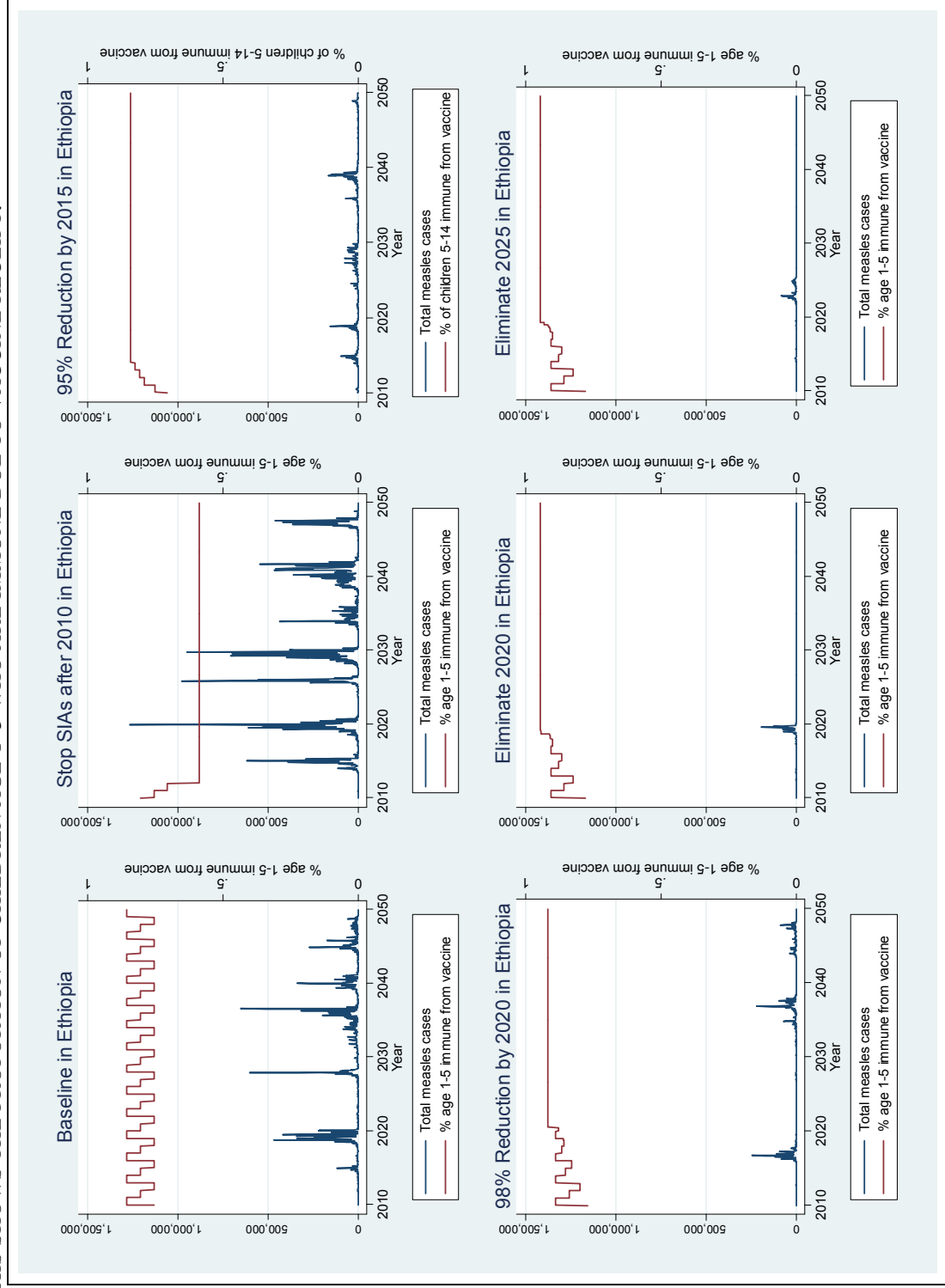

FIGURE ETH 4. COSTS vs. DALYS IN ETHIOPIA FOR THE 6 SCENARIOS. SLOPES FROM BASELINE (B) TO THE OTHER POINTS ARE “INCREMENTAL COST EFFECTIVENESS RATIO’S” (ICERs) AND ARE INTERPRETED AS \$ PER DALY AVERTED.

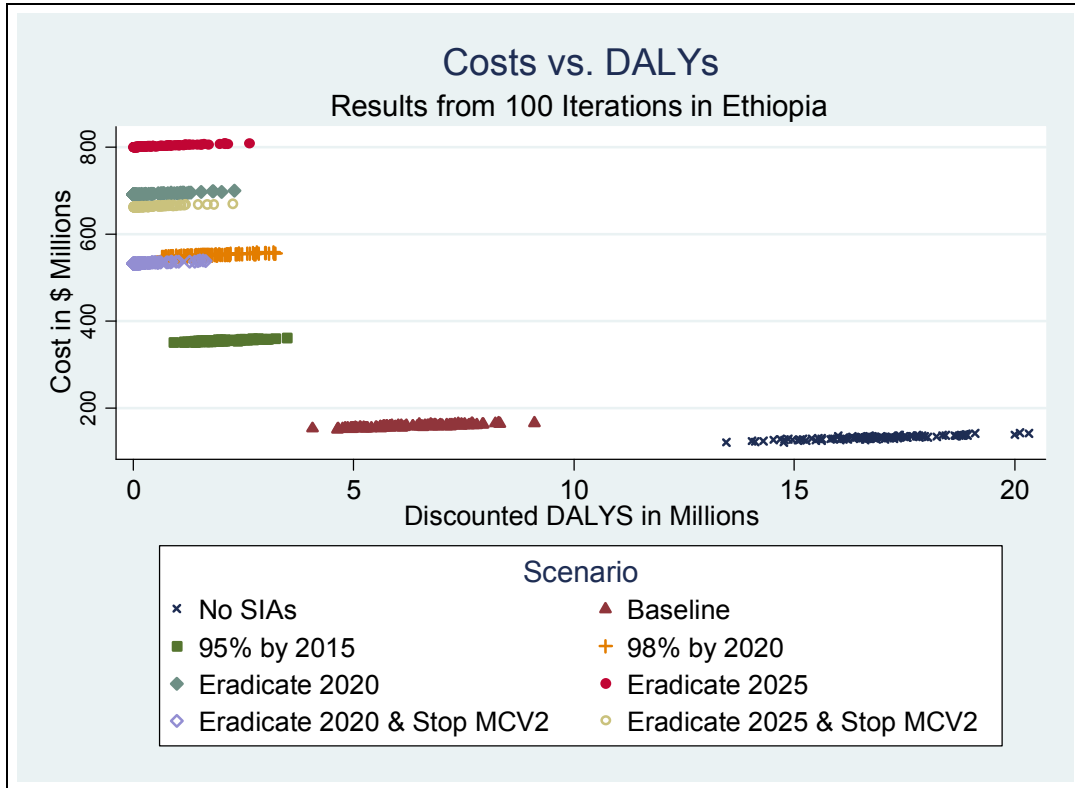
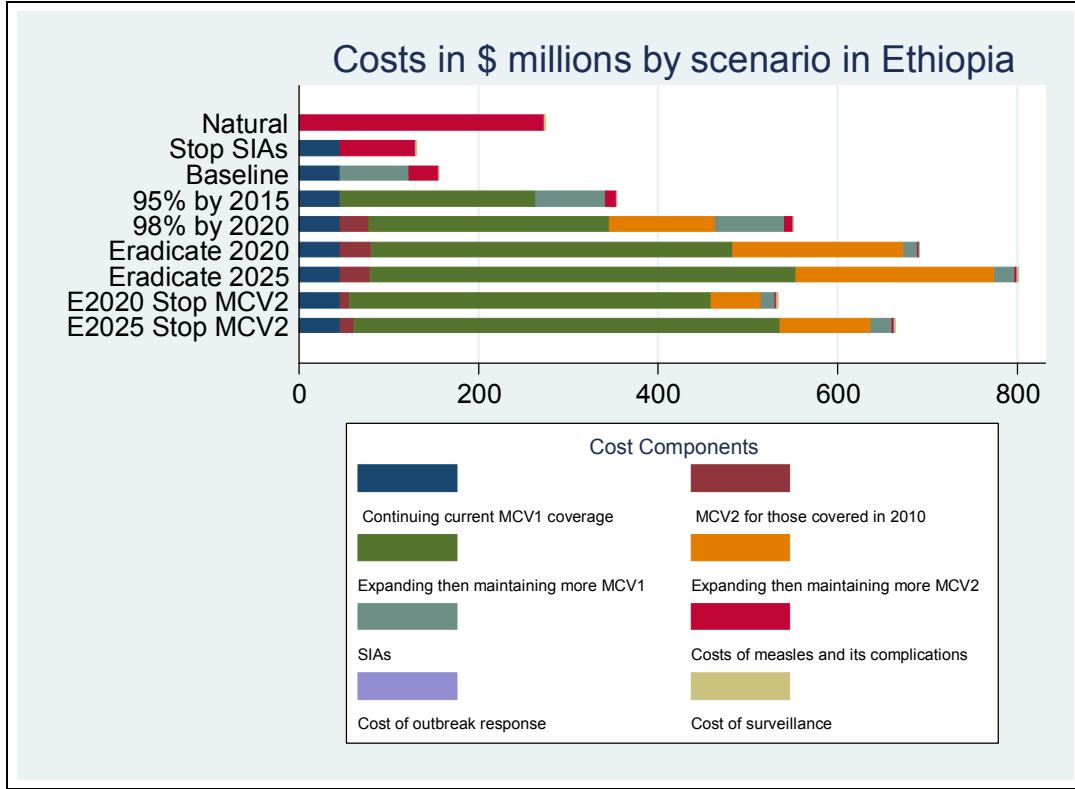

FIGURE ETH5. COST STRUCTURE AMONG VARIOUS MEASLES CONTROL SCENARIOS IN ETHIOPIA COMPARED TO WHAT IT WOULD BE IN THE NATURAL HISTORY SCENARIO. COSTS ARE CUMULATIVE DISCOUNTED COSTS FROM 2010 TO 2050.



TABLES

TABLE ETH 1 DESCRIPTION OF MEASLES CONTROL SCENARIOS USED FOR ETHIOPIA

Scenario:			1	2	3	4	5	6
			Baseline	Current level of activities but no SIAs in GAVI eligible countries after 2010	95% Mortality Reduction Compared to 2000	98% Mortality Reduction Compared to 2000	Eradication 2020	Eradication 2025
Status in 2010	MCV1	Covg	0.69					
		Age	9 mo					
	MCV2	Covg	0					
		Age	NA					
	SIA	Covg	0.9					
		Age	9 mo - 5 yr					
Freq		3 yrs						
Status after 2010 till target year	MCV1	Ramp up rate [1]	N/A	0.03	0.2	0.03	0.03	
		Age		[2]	[3]			
	MCV2	Ramp up rate		0	[4]			
		Age		N/A	36 mo			
	SIA	Yr Intro	N/A	2017	2014	2016		
		Covg	0.95	N/A	0.95			
		Age	9 mo - 5 yr	N/A	9 mo - 5 yr			
		Year Stopped [6]	3 yrs	N/A	2014	2017	2014	2017
Status after target year	MCV1	Covg	0.69	0.69	0.84	0.89	0.99	0.99
		Age	9 mo	9 mo	9 mo	9 mo	12 mo	
	MCV2	Covg	0			0.88	.99 or 0 [6]	.99 or 0 [6]
		Age				18 mos	36 mo	
	SIA	Covg	0.9	N/A	N/A	N/A	0	
		Age	9 mo - 5 yr	N/A	N/A		N/A	
		Freq	3 yrs	N/A	N/A			
	Target Year		2010	2010	2015	2020	2020	2025

Notes

[1] Ramp up rates expressed as percentage points of coverage gained per year

[2] MCV1 age not raised because MCV1 coverage never gets to 80% by target year in these scenarios.

[3] MCV1 age can be lifted to 12 mos. after 3 yrs of MCV1>80%, but model waits until measles incidence drops below 1/100,000

[4] MCV2 coverage starts at 50% of MCV1 in year introduced increases to 90% of MCV1 by 3rd year after introduction

[5] SIAs are stopped in these years because MCV1 coverage has exceeded 80% for 36 months.

[6] Options 7 and 8 correspond to 5 and 6 respectively except MCV2 coverage is stopped 3 years after eradication.

TABLE ETH 2. PARAMETERS FOR ETHIOPIA

Parameter	Value	Range	Source
Average cost per child vaccinated prior to scale up via routine services	\$1.00	+/- 20%	(Brenzel, et al. 2006)
Scale up cost per child for core areas	\$18.82		(See costing appendix)
Scale up cost per child for satellite areas	\$27.4		
Scale up cost per child for MCV2 in core areas	\$11.04		
Scale up cost per child for MCV2 in satellite	\$13.99		
SIA cost per child	\$0.58		Interviews in Ethiopia
Monthly force of infection parameters	Jan: 0.00006392 Feb: 0.00007325 Mar: 0.0000809 Apr: 0.0000857 May:0.00007162 Jun: 0.00010455 Jul: 0.00007821 Aug: 0.0000761 Sep: 0.00007831 Oct: 0.00008567 Nov:0.00007201 Dec: 0.00008348	+/- 20%	Analysis of Uganda district case reports 2002-2008
Initialization of proportion vaccinated among adults, children, toddlers	0.12-0.77 depending on the age and year*		WHO coverage database
Initial measles case fatality rate**	Infant: 0.06 Toddler: 0.03 Child: 0.015 Adult: 0.015		(Wolfson, Grais et al. 2009)
Life expectancy (years)	Infant: 62.2 Toddler: 60.2 Child: 54.9 Fertile: 37.2 Post Fertile: 20		WHO
Fraction In satellite compartment	32%		(UNICEF and WHO 2010)
Initial population sizes	Infant:2.9 E6 Toddler:9.5 E6 Child: 2.1 E6 Fertile:31.3 E6 Post Fert: 9.9 E6		(United Nations 2008)

TABLE ETH3. TABLE OF COSTS, DEATHS, DALYS AND ICERS FOR ETHIOPIA WITH 3% DISCOUNTING AND HORIZON TO 2050.

	Discounted Deaths		Δ Discounted Deaths relative to baseline		Δ Discounted DALYs relative to baseline of 6,324,605		Discounted Costs in \$ millions		Δ Discounted Costs relative to baseline	
	Mean	SD	Mean	SD	Mean	SD	Mean	SD	Mean	SD
Natural (N)	2,241,900	(87,421)	-		-		\$273	(9.5)	-	
Stop SIAs (SS)	601,841	(46,993)	373,185	(58,994)	10,500,000	(1,689,198)	\$131	(4.3)	-\$26	(5.3)
Baseline (B)	228,193	(35,058)	-		-		\$158	(3.3)	-	
95% Reduction by 2015	71,563	(17,539)	-156,744	(39,915)	-4,376,613	(1,137,958)	\$354	(1.9)	\$197	(3.9)
98% Reduction by 2020	62,976	(22,663)	-166,254	(41,082)	-4,632,074	(1,170,513)	\$552	(2.4)	\$394	(4.0)
Eradication 2020 (E2020)	13,385	(18,228)	-217,714	(35,350)	-6,032,890	(1,008,378)	\$692	(1.9)	\$534	(3.3)
Eradication 2025 (E2025)	20,130	(21,701)	-207,189	(42,163)	-5,743,865	(1,196,262)	\$802	(2.3)	\$644	(4.2)
Eradication 2020 & Stop MCV2	9,923	(14,208)	-219,112	(37,661)	-6,072,661	(1,073,303)	\$533	(1.6)	\$376	(3.5)
Eradication 2025 & Stop MCV2	16,060	(15,257)	-214,320	(34,411)	-5,942,791	(981,697)	\$664	(1.7)	\$506	(3.3)

	Incremental Cost Effectiveness Ratio (ICER) \$ per Death averted			Incremental Cost Effectiveness Ratio (ICER) \$ per DALY averted		
	Median	Interquartile Range	Notes	Median	Interquartile Range	Notes
Stop SIAs (SS)	-\$70	(55: 87)	[1]	-\$2.5	(1.95: 3.1)	[1]
Baseline (B)	-			-		
95% Reduction by 2015	\$1,213	(1,051: 1,543)		\$43	(38: 56)	
98% Reduction by 2020	\$2,381	(2,013: 2,954)		\$86	(72: 107)	
Eradication 2020 (E2020)	\$2,500	(2,165: 2,808)		\$91	(78: 101)	
Eradication 2025 (E2025)	\$3,085	(2,676: 3,654)		\$112	(96: 132)	
Eradication 2020 & Stop MCV2	\$1,763	(1,503: 1,948)		\$64	(54: 71)	
Eradication 2025 & Stop MCV2	\$2,380	(2,109: 2,684)		\$86	(76: 97)	

[1] Stopping SIAs saves money, but one incurs additional deaths and DALYs which arrive in the ratios shown on this row. E.g. \$70 saved for every death incurred, \$2.5 saved for every DALY incurred.

Table ETH4. Rubella Additional costs and additional DALYS if rubella antigen is added after coverage reaches 80% for 3 years. The model estimates that between 2010 and 2050, in the absence of immunization, there would be 84,090 cases of congenital rubella syndrome (52,766 discounted cases). These would generate 2.6 DALYS (1.641 million discounted DALYS), respectively. Under immunization scenarios the number of CRS cases for the same period drops to around 80. Except for 95% reduction, all scenarios can eliminate 99% of the DALYS from CRS and save money due to lost economic productivity and medical care costs of CRS patients. The cost of a case of CRS is assumed to be 50 years of GDP per Capita. (For a GDP per capita of \$500 this would be approximately \$25,000 per case.) The DALYs are calculated based on a DALY weight of 0.5 for a condition that lasts as long as life expectancy at birth.

	Δ Discounted Money Saved	Δ Discounted DALYS Averted	Dollars saved per DALY averted		Notes
Natural (N)	\$0	0			[1]
95% Reduction by 2015	\$1,204,000,000	1,421,712	\$847		
98% Reduction by 2020	\$1,260,000,000	1,626,655	\$775		
Eradication 2020 (E2020)	\$910,000,000	1,635,843	\$556		
Eradication 2025 (E2025)	\$700,000,000	1,638,542	\$427		

The estimated cost savings from rubella control is enough to entirely offset the cost of each of the measles/rubella control strategies. Thus if one were to add the net costs of combined measles rubella control for these scenarios there would be net savings and the “ICER” would just express the ratio of money saved to DALYS saved for a set of strategies that all dominate not controlling rubella. However, the rubella costs are borne by families as lost income and costs of personal care and the disease control costs are borne by the health sector.

[1] All scenarios for adding rubella antigen save both money and avert DALYS. The ratio between dollars saved and DALYS averted is as shown.

BIBLIOGRAPHY

1. WHO and UNICEF, *WHO/UNICEF Joint Statement Global Plan for Reducing Measles Mortality 2006-2010*. 2005, WHO/ UNICEF: Geneva.
2. UNICEF and WHO, *Joint Press Release: Global goal to reduce measles deaths in children surpassed*. 2007.
3. Wolfson, L., et al., *Has the 2005 measles mortality reduction goal been achieved? A natural history modelling study*. *Lancet*, 2007. **369**(9557): p. 191-200.
4. Biellik, R. and D. Brown, *Measles mortality reduction in Africa*. *Lancet*, 2009. **9668**(98).
5. WHO, *World Health Statistics*. 2010, World Health Organization: Geneva.
6. WHO and MOH, *Ethiopia measles control follow-up SIAs plan for 2010*. 2009, World Health Organization and Ministry of Health: Addis Ababa.

COUNTRY MEASLES PROFILE: TAJIKISTAN

Divya Nair and David Bishai

PART 1. RECENT STATUS OF MEASLES CONTROL EFFORTS IN TAJIKISTAN

Tajikistan reported less than five measles cases per year between 2005 and 2008.ⁱ In 2003, however, it reported 2,144 cases. Reflecting numerous fluctuations, prior to that, between 1990 and 2000 it reported an average of 200 cases per year (with just 56 and 42 cases reported in 1995 and 1996 respectively).ⁱⁱ With measles immunization scheduled at one and six years of age, as per WHO-UNICEF estimates, Tajikistan achieved national coverage of 86% for MCV in 2008 (and an average of 86% between 2005-2008).ⁱⁱⁱ Also see **figure 1** at the end of this section for trends. Only 20% of its districts have achieved coverage of over 90%, and MCV2 routine coverage was introduced in 2008.^{iv} As per UNICEF Multiple Indicator Cluster Survey 2005 data, immunization varies by Oblast; only 57.7% of Dushanbe residents reported that their child had received the measles vaccine compared to 77% in Sogd and only 41% in Raiony Respublikanskogo Podchineniya.^v

In 2004, Tajikistan conducted its most recent national campaign, a catch-up supplementary immunization activity among 1-19 year olds. Subsequently, in October 2009, as part of a follow-up campaign, nearly 2.3 million children between 1-14 years were vaccinated against measles and rubella within the framework of the national strategic plan for elimination; the campaign achieved a weighted national coverage of 96.6%.^{vi} Rubella subsequently has been introduced into the routine immunization program.^{vii}

As per the comprehensive multi-year costing and financing tool submitted by the Government of Tajikistan,^{viii} the national immunization program in 2009 cost \$5.8 million, at a cost of \$0.8 per capita. This program was financed mainly by donors, including GAVI (53%), JICA (13%), UNICEF (11%) and WHO and IFRC (7%); the national and sub-national government provided 14% and 2% respectively of the financing. As per government projections for the baseline scenario for 2011-2015, with SIAs planned in 2011 and 2014 and sustained current activities with no changes to the current immunization calendar, a total of \$30.8 million will be required, at \$0.5 per capita. Of this projection for 2011-15, 60% of the spending will be for vaccine supply and logistics, 22% for supplemental immunization activities, 11% for shared health systems costs, 4% for service delivery and about 1.2% for advocacy and communication. However, a funding gap of \$7.8 million is projected over 2011-2015, an almost 30% gap is projected in 2011 and a 58% funding gap is estimated for 2014. This gap does not affect routine immunization activities, which are to be covered by JICA and state resources; the major contributor to this funding gap is projected to be the cost of campaigns, with an estimated shortfall of \$6.8 million over 2011-15.

Country Profile: Tajikistan

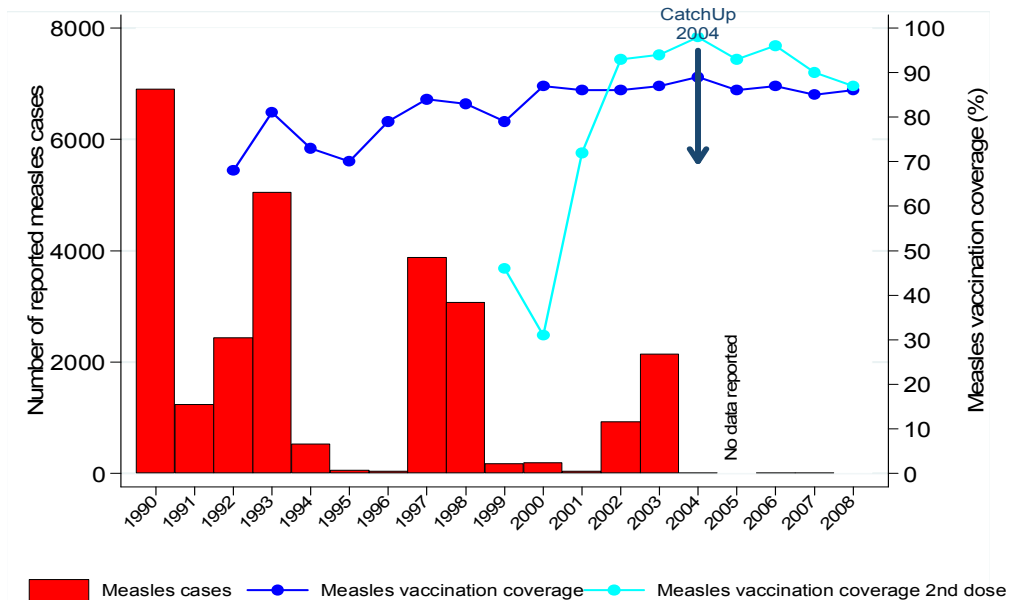

Source: World Health Organization, 27-08-2009

PART2: MODEL RESULTS

MODEL VALIDATION

Figure TJK1 shows the natural history of measles epidemics in Tajikistan. We attribute the 10-fold difference in the height of case reports vs. model-based estimates of cases to differences in the reporting fraction. There are no data from Tajikistan that would permit estimating the reporting fraction. We were unable to locate epidemiological statistics to permit a direct comparison of the model to historical case reports of an unimmunized population. Nevertheless the cycle with a frequency of measles spikes every 3 years fits historical data for many other countries¹.

Figure TJK2 shows the cumulative number of measles case by age and reveals the canonical pattern.

MODEL RESULTS ON COSTS, DEATHS, DALYs, AND COST STRUCTURE

Figure TJK3 shows the epidemic curves for toddlers age 1 to 4 with cases per year overlain with a plot of the prevalence of children age 1 to 4 who are immune to measles from vaccination for the case of Tajikistan. This figure shows one possible stochastic realization of the model, so the prediction of a large outbreak affecting 20,000 people in 2040 should not be taken literally. The outbreaks occurring in the baseline scenario are occurring despite the maintenance of SIAs. Figure TJK3's depiction of the baseline scenario is pointing to a very likely situation that does occur in many trials of the baseline scenario. If Tajikistan does not decide to improve its routine coverage it can build up a sufficient population of susceptible over the course of a decade to fuel extremely large epidemics of sustained transmission.

Figure TJK4 plots the 40 year sum of discounted costs against the 40 year sum of discounted DALYs. Decision makers are assumed to prefer points that are lower on the vertical axis because these have lower cost and to prefer points that are more to the left on the horizontal axis because these have fewer DALYs. One can see from Figure TJK4, that the baseline scenario (Δ s) of not increasing routine coverage while continuing SIAs

¹ Between epidemics the model differs from data that would be seen in national statistics. The model can exhibit zero endogenous cases between cycles, whereas national data on measles in an unimmunized population would not do this. The reason is that national statistics on measles epidemiology can pool together data from multiple regions that have epidemiological isolation. Due to limitations in computing power, the mathematical model only has the ability to depict two epidemiological linked populations¹. In this microcosm, a measles epidemic has the potential to eliminate all susceptible from the population. The next wave can occur only after new infants arrive.

imposes higher costs and generates a not too dissimilar DALY burden than stopping SIAs. Although the model projects an estimated excess of only 9 additional deaths over the next 40 years from stopping SIAs—this estimate is not statistically significant as the standard deviation is 108 deaths. Recall that the model assumes that routine coverage for most of Tajikistan with both MCV1 and MCV2 is 86% in 2010. This coverage applies to the “core” of the country assumed to be 95% of the population. The other 5% of the country has routine coverage of 69%. With these assumptions the benefits of SIAs every 3 years covering 99% of the population are small.

Referring to Table TJK3, in the baseline scenario of holding MCV1 coverage fixed at 2010 levels and continuing SIAs the model projects a total of 381 (SD 77) discounted measles deaths and 11,457 discounted measles DALYs from 2010 to 2050. The baseline scenario incurs a total cost of \$ 15 million (SD 0.47 million). Terminating SIAs in 2010 in Tajikistan would lower costs to \$12 million (SD 0.5). An estimated \$3.03 million in SIA costs are averted, and there is only a \$66,525 increase in health care costs without SIAs because the model predicts few additional measles cases in Tajikistan if SIAs are terminated.

For a decision maker at the baseline position (Δ) in Figure TJK4, all choices that improve health lead to higher costs. Examining Figure TJK 4 reveals that trajectories from the baseline to these health improving strategies at the left of the figure would have very similar slopes. These slopes i.e. “ICERS” (Table TJK3) were estimated by drawing 200 random line segments joining each scenario to the baseline scenario. The ICERS range from \$955 (IQR 782-1,276) per DALY averted in the Eradicate 2020 and Stop MCV2 scenario to \$1822 per DALY averted in the 98% Mortality Reduction Scenario (IQR 1371-2756).

Figure TJK5 shows the components of costs in each scenario. In all scenarios that improve measles control the largest cost component is the cost of expanding and maintaining more routine measles coverage. As noted above, the model of scaling up routine coverage assumes that scale up will require permanent increases in recurrent costs of the vaccine program. The sooner scale up is implemented the longer these higher costs are incurred.

FIGURES

FIGURE TJK1. NATURAL HISTORY OF MEASLES DICTATED BY PARAMETERS CHOSEN FOR TAJIKISTAN ASSUMING NO VACCINATION.

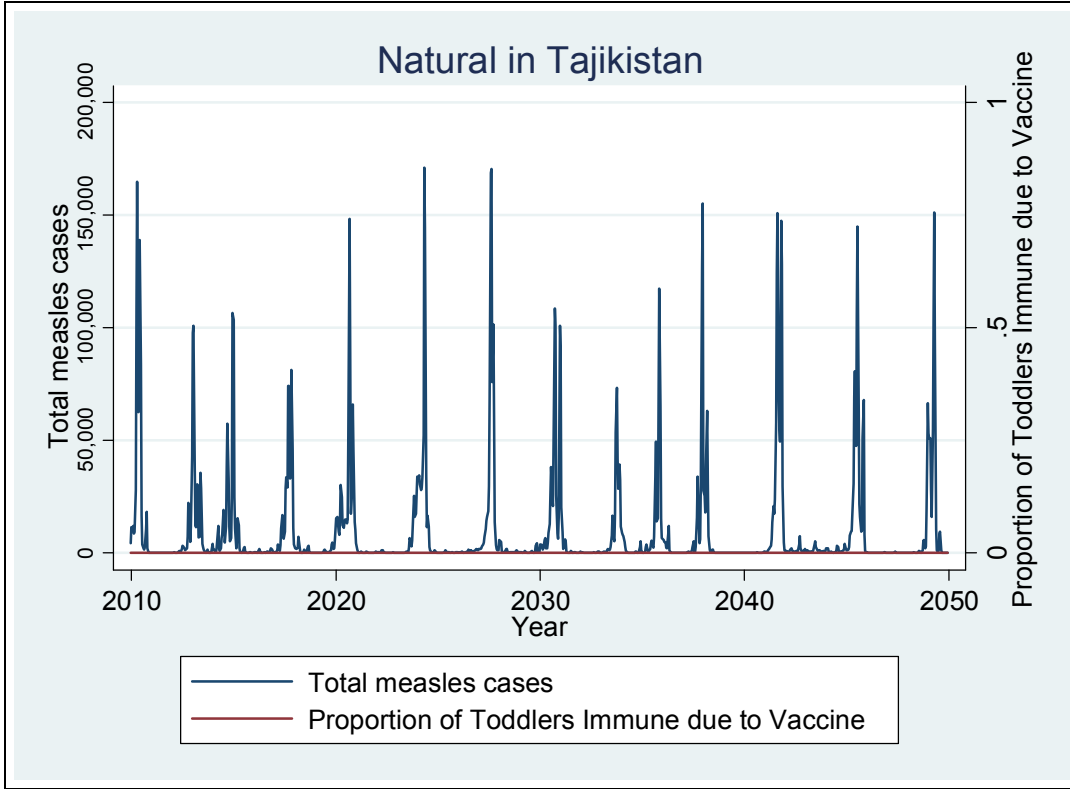

FIGURE TJK2. CUMULATIVE MEASLES INFECTIONS BY AGE GROUP IN TAJIKISTAN PREDICTED BY MODEL IN THE ABSENCE OF IMMUNIZATION

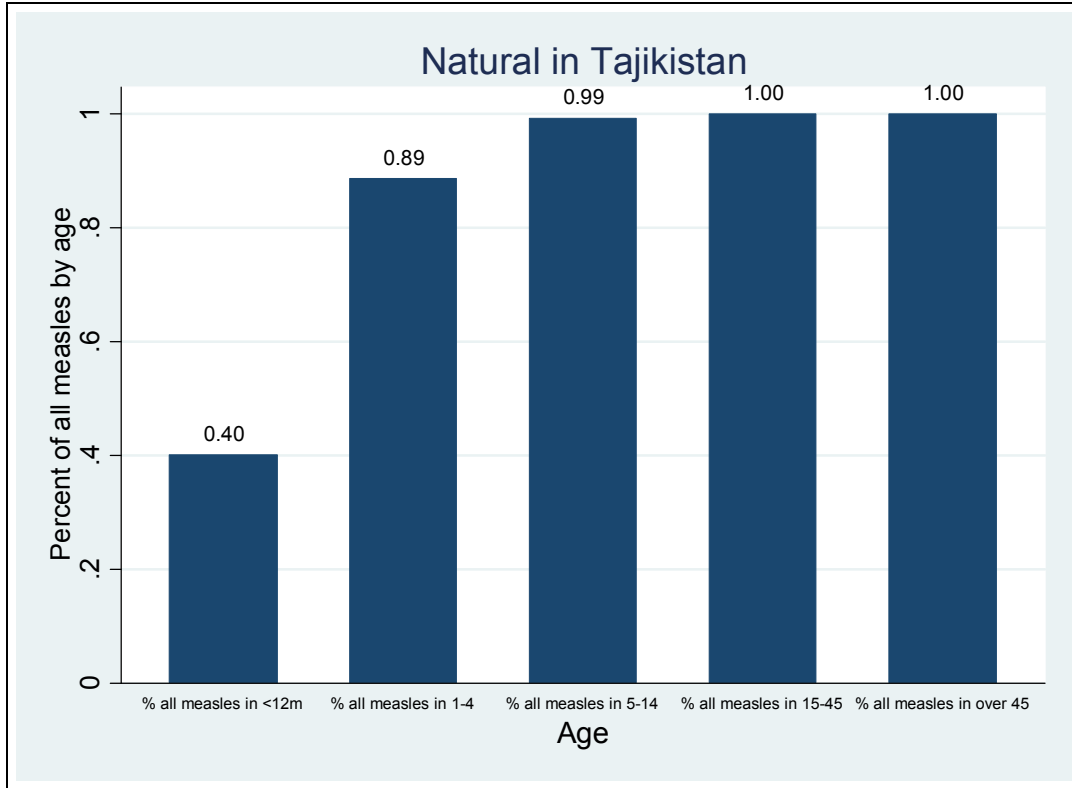

FIGURE TJK3. EPIDEMIC CURVES FOR THE 6 SCENARIOS IN TAJIKISTAN. LEFT AXIS SHOWS NUMBER OF MEASLES CASES IN BLUE. RIGHT AXIS SHOWS THE PROPORTION OF CHILDREN AGE 1-5 WHO ARE IMMUNE DUE TO VACCINE RECEIPT.

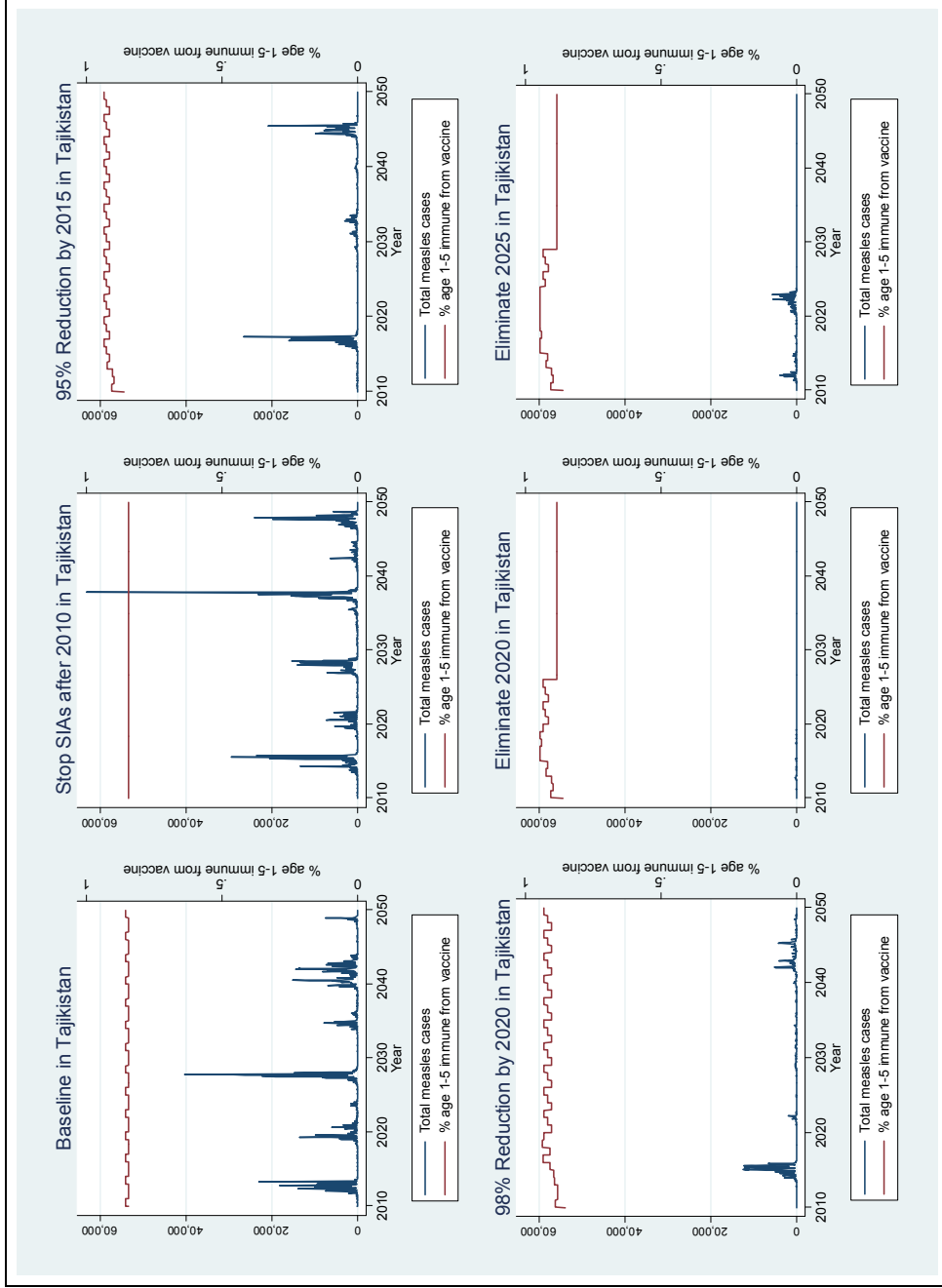

FIGURE TJK 4. COSTS VS. DEATHS IN TAJIKISTAN FOR THE 6 SCENARIOS. SLOPES FROM BASELINE (B) TO THE OTHER POINTS ARE “INCREMENTAL COST EFFECTIVENESS RATIO’S” (ICERs) AND ARE INTERPRETED AS \$ PER DEATH AVERTED.

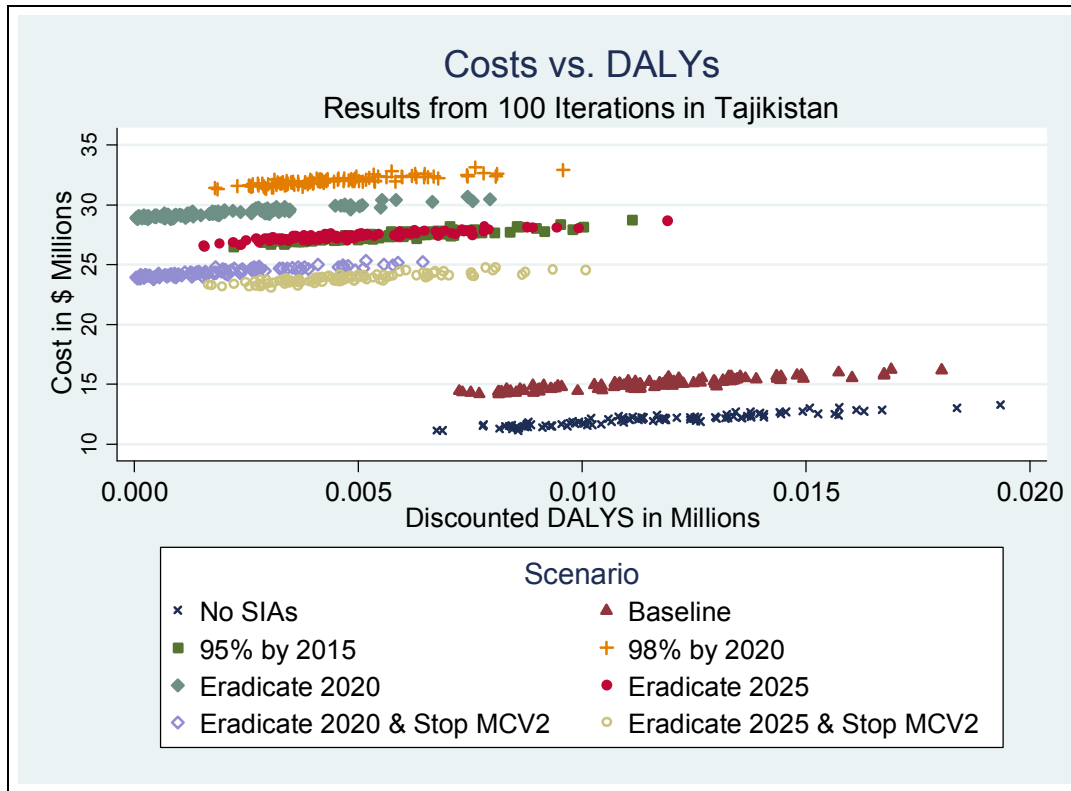
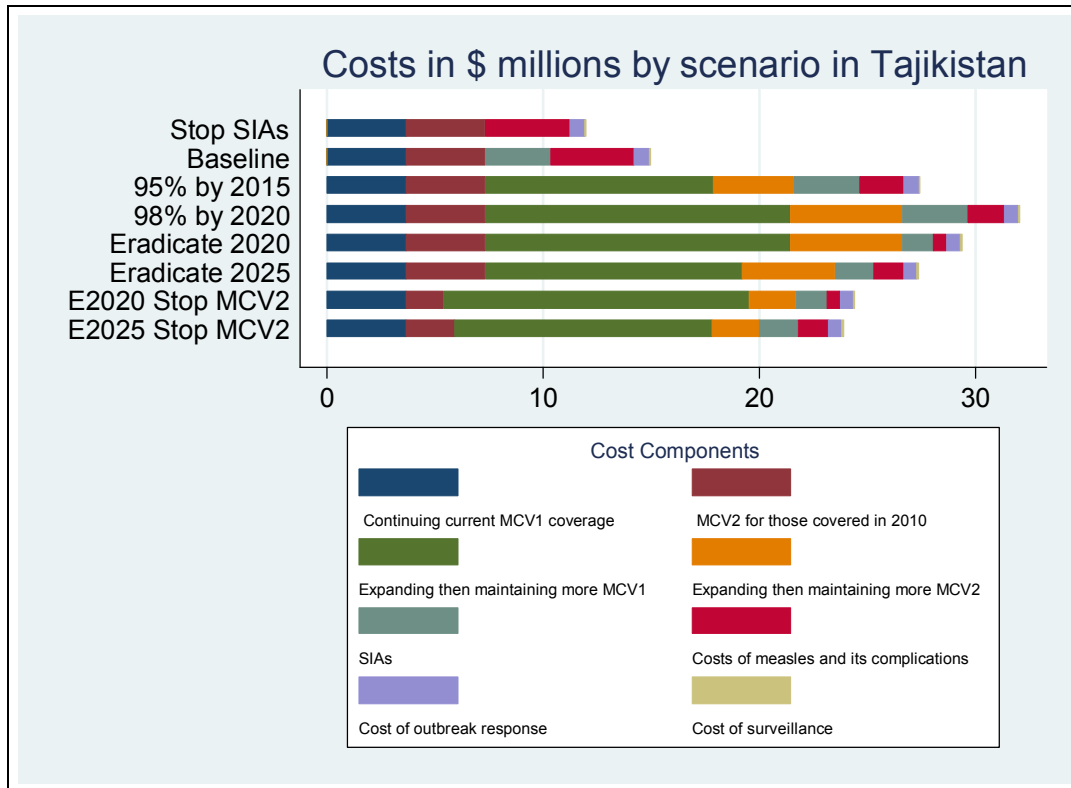

FIGURE TJK5. COST STRUCTURE AMONG VARIOUS MEASLES CONTROL SCENARIOS IN TAJIKISTAN COMPARED TO WHAT IT WOULD BE IN THE NATURAL HISTORY SCENARIO. COSTS ARE CUMULATIVE DISCOUNTED COSTS FROM 2010 TO 2050.



TABLES

TABLE TJK 1 DESCRIPTION OF MEASLES CONTROL SCENARIOS USED FOR TAJIKISTAN

Scenario:			1				
			Baseline	Eradication 2020	Eradication 2025	Eradication 2020 and stop MCV2 after 2023	Eradication 2025 and stop MCV2 after 2028
Status in 2010	MCV1	Covg	0.86				
		Age	12 mo				
	MCV2	Covg	0.86				
		Age	48 mo				
	SIA	Covg	99%				
		Age	Age 1-5				
Freq		Every 3 years					
Status after 2010 till target year	MCV1	Ramp up rate [1]	0	0.01	0.02	0.01	0.02
		Age	12 mo				
	MCV2	Ramp up rate	0				
		Age	6 years				
		Yr Intro	1986				
	SIA	Covg	99%				
		Age	Age 1-5				
		Freq	Every 3 years				
	Status after target year	MCV1	Covg	0.96			
Age			12 mo				
MCV2		Covg	0.96			0	
		Age	6 years			N/A	
SIA		Covg	N/A				
		Age					
	Freq						
Target Year			2010	2020	2025	2020	2025
Notes							
[1] Ramp up rates expressed as percentage points of coverage gained per year							
[2] MCV1 age not raised because MCV1 coverage never gets to 80% by target year in these scenarios.							
[3] MCV1 age can be lifted to 12 mos. after 3 yrs of MCV1>80%, but model waits until measles incidence drops below 1/100,000							
[4] MCV2 coverage starts at 50% of MCV1 in year introduced increases to 90% of MCV1 by 3rd year after introduction							

TABLE TJK 2. PARAMETERS FOR TAJIKISTAN

Parameter	Value	Range	Source
Average cost per child vaccinated prior to scale up via routine services	\$1.05	+/- 20%	(Brenzel, et al. 2006)
Scale up cost per child for core areas	\$26.93		(See costing appendix)
Scale up cost per child for satellite areas	\$35.83		
Scale up cost per child for MCV2 in core areas	\$8.79		
Scale up cost per child for MCV2 in satellite	\$27.10		
SIA cost per child	\$0.59		Interviews in Tajikistan
Monthly force of infection parameters	Jan: 0.00006392 Feb: 0.00007325 Mar: 0.0000809 Apr: 0.0000857 May: 0.00007162 Jun: 0.00010455 Jul: 0.00007821 Aug: 0.0000761 Sep: 0.00007831 Oct: 0.00008567 Nov: 0.00007201 Dec: 0.00008348	+/- 20%	Analysis of Tajikistan district case reports 2002-2008
Initialization of proportion vaccinated among adults, children, toddlers	0.86 depending on the age and year*		WHO coverage database
Initial measles case fatality rate**	Infant: 0.002 Toddler: 0.001 Child: 0.0005 Adult: 0.0005		(Wolfson, Grais et al. 2009)
Life expectancy (years)	Infant: 69.2 Toddler: 67.2 Child: 59.2 Fertile: 40.1 Post Fertile: 20		WHO
Fraction In satellite compartment	5%		(UNICEF and WHO 2010)
Initial population sizes	Infant: 195,000 Toddler: 665,000 Child: 1,718,000 Fertile: 3,056,000 Post Fert: 901,000		(United Nations 2008)

TABLE TJK 3. TABLE OF COSTS, MEASLES DEATHS, MEASLES DALYS AND ICERS FOR TAJIKISTAN WITH 3% DISCOUNTING AND HORIZON TO 2050.

	Discounted Deaths		Δ Discounted Deaths relative to baseline		Δ Discounted DALYS relative to baseline of 11,457		Discounted Costs in \$ millions		Δ Discounted Costs relative to baseline	
	Mean	SD	Mean	SD	Mean	SD	Mean	SD	Mean	SD
Natural (N)	4,406	(240)	-		-		\$39	(1.63)	-	
Baseline (B)	381	(77)	-		-		\$15	(0.47)	-	
Eradication 2020 (E2020)	71	(62)	-320	(103)	-9,632	(3,152)	\$29	(0.42)	\$14	(0.64)
Eradication 2025 (E2025)	165	(62)	-214	(98)	-6,449	(3,004)	\$27	(0.36)	\$12	(0.58)
Eradication 2020 & Stop MCV2	67	(53)	-323	(89)	-9,736	(2,714)	\$24	(0.34)	\$9	(0.57)
Eradication 2025 & Stop MCV2	158	(57)	-234	(90)	-7,064	(2,780)	\$24	(0.38)	\$9	(0.56)
	Ratio of dollars saved per death averted		Ratio of dollars saved per DALY averted				Ratio of dollars saved per DALY averted			
	Median	Interquartile Range	Notes	Median	Interquartile Range	Notes	Median	Interquartile Range	Notes	
Baseline (B)	-			-			-			
Eradication 2020 (E2020)	\$45,178	(56,207: 35,688)		\$1,497	(1,868: 1,184)		\$1,497	(1,868: 1,184)		
Eradication 2025 (E2025)	\$54,966	(41,563: 82,416)		\$1,822	(2,756: 1,371)		\$1,822	(2,756: 1,371)		
Eradication 2020 & Stop MCV2	\$28,806	(23,613: 38,317)		\$955	(1,276: 782)		\$955	(1,276: 782)		
Eradication 2025 & Stop MCV2	\$39,023	(27,559: 52,927)		\$1,286	(1,774: 910)		\$1,286	(1,774: 910)		

[1] All eradication scenarios save money and save additional deaths and DALYS which arrive in the ratios shown.

BIBLIOGRAPHY

World Health Organization (2008). *“Immunization surveillance, assessment and monitoring. Measles Reported Cases”*. Geneva.

http://www.who.int/immunization_monitoring/en/globalsummary/timeseries/tsincidence <accessed 25 May, 2010>

UNICEF and WHO. (2010). *“Immunization Summary. A statistical reference containing data through 2008: the 2010 Edition”*. New York and Geneva.

http://www.childinfo.org/files/Immunization_Summary_2008_r6.pdf, <accessed 25 May, 2010>

World Health Organization, Republic of Tajikistan. (2009). *“Multisectoral Determinants of Child Mortality in Tajikistan”* Human Development Sector, Central Asia Country Unit, Europe and Central Asia Region

World Health Organization, EURO Immunization Monitor.(2009). *“Successful measles and rubella immunization activities in Tajikistan,”* Issue 11, October 2009. Geneva.

http://www.measlesinitiative.org/mi-files/Reports/Surveillance/EURO/euro_immun_mon_oct_2009.pdf <accessed 25 May, 2010>

FOOTNOTES:

ⁱ World Health Organization. 2008. *Immunization surveillance, assessment and monitoring. Measles Reported Cases*. Geneva. http://www.who.int/immunization_monitoring/en/globalsummary/timeseries/tsincidence <accessed 25 May, 2010>

ⁱⁱ Ibid.

ⁱⁱⁱ UNICEF and WHO. *Immunization Summary. A statistical reference containing data through 2008: the 2010 Edition*. http://www.childinfo.org/files/Immunization_Summary_2008_r6.pdf, <accessed 25 May, 2010>

^{iv} Ibid.

^v World Health Organization, Republic of Tajikistan *“Multisectoral Determinants of Child Mortality in Tajikistan”* Human Development Sector, Central Asia Country Unit, Europe and Central Asia Region

May 2009

^{vi} World Health Organization, EURO Immunization Monitor, “Successful measles and rubella immunization activities in Tajikistan,” Issue 11, October 2009. Geneva. http://www.measlesinitiative.org/mi-files/Reports/Surveillance/EURO/euro_immun_mon_oct_2009.pdf < accessed 25 May, 2010>

^{vii} Ibid.

^{viii} See for background: <http://www.who.int/vaccines-documents/DocsPDF07/848.pdf>

COUNTRY MEASLES PROFILE: UGANDA

Divya Nair and David Bishai

PART 1. RECENT STATUS OF MEASLES CONTROL EFFORTS IN UGANDA

The WHO-UNICEF accelerated strategy for reducing measles mortality focuses on 47 priority countries that have the highest measles disease burden. Uganda is one of these priority countries.ⁱ As of December 2009, with a population of 30.6 million under surveillance, Uganda reported a total 1,216 cases in 2009.ⁱⁱ The current number of reported cases represents a steady decline, with 1,319 cases reported in 2008, 3,776 cases in 2007 and 5,736 cases in 2006.ⁱⁱⁱ Moreover, prior to 2004, Uganda reported an average of 28,000 cases a year, representing a dramatic decline in measles-related cases and deaths.^{iv} See also **Figure 1** at the end. While for Africa, the average incidence of confirmed measles is 1.9 per 100,000 of the population in 2009, Uganda had a confirmed measles incidence rate of 0.2 per 100,000, which is also lower than regional rates in East and Southern Africa.^v

In 2003, Uganda conducted its “catch-up campaign” when it achieved average coverage of 105% among its target population of 6 month to 14 year olds^{vi}. A supplemental measles immunization campaign (along with polio immunization) was carried out in 15 northern districts in 2005; that campaign achieved 100% coverage among 9-23 month children who may not have been covered during the catch-up campaign. A follow-up

campaign was subsequently carried out in 2006, targeted at 6-59 month year old children, resulting in national coverage of 99.5%.^{vii} The government also conducted a Stop Transmission of Measles and Polio missions in 16 poorly performing districts in 2009^{viii}.

Uganda is one of six African countries reporting more than 100 confirmed lab cases of rubella in 2009. As per WHO-UNICEF estimates, Uganda achieved vaccination of 68% of its MCV target population in 2008.^{ix} There is considerable temporal fluctuation and spatial variation across the country. While in 2008 24% of Uganda's districts reported coverage of more than 90% of the target population, in 2007 35% districts had reported this coverage target, up from 14% in 2001.^{x,xi} Similarly, during the 2003 catch-up campaign, district coverage ranged from 52% in Kalangala to 130% in Mayuge districts^{xii}.

As per official reporting, the government of Uganda currently provides 100% funding for the procurement of measles vaccines^{xiii}. The government acknowledges a number of challenges for the provision of vaccines at central, district and lower levels. A large funding gap exists, with recurrent costs for the transportation of vaccines, provision of data collection tools, technical support to health workers, being particularly vulnerable. Irregularity of vaccine supplies and stock-management is a concern at district and lower levels, and there is a shortage of cold and dry space even at the central level^{xiv}. The quality of immunization data continues to be a challenge at all levels. Staff training at central and district levels is required in vaccine management and inventory updating.

More fundamentally, the demand for, and valuation of, vaccinations among the target population continues to be low.

FIGURE 1 RECENT TRENDS IN MEASLES CONTROL IN UGANDA

Reported measles cases and measles vaccination coverage, 1990-2008, Uganda

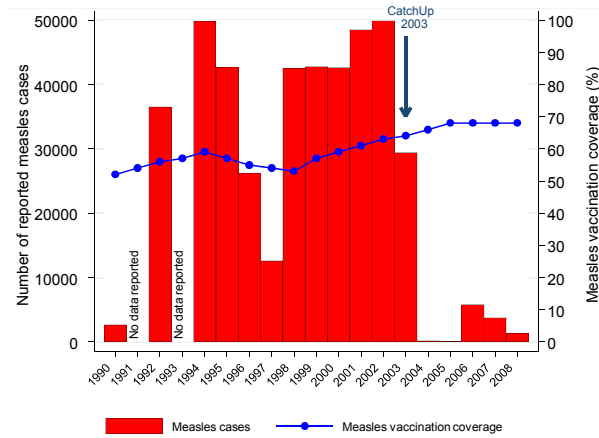

Data source:
 Measles cases- reported by national authorities to WHO annually
 Measles vaccination coverage- WHO/UNICEF immunization coverage estimates, as of August 2009
 Measles vaccination coverage 2nd dose- reported by national authorities to WHO annually
 SIA activities: WHO/EPI supplementary immunization activities database
 Date of slide: 27-08-2009

PART 2: MODEL RESULTS

MODEL VALIDATION

Figure UGA1 shows the natural history of measles epidemics in Uganda. Although Ugandan epidemiological statistics do not permit a direct comparison of the model to historical case reports of an unimmunized population the cycle with a frequency of measles spikes every 3 years fits historical data. Between epidemics, the model differs from data that would be seen in national statistics. The model can exhibit zero endogenous cases between cycles, whereas national data on measles in an unimmunized population would not do this. The reason is that national statistics on measles epidemiology can pool together data from multiple regions that have epidemiological isolation. Due to limitations in computing power, the mathematical model only has the ability to depict two epidemiological linked populations¹. In this microcosm, a measles epidemic has the potential to eliminate all susceptible from the population. The next wave can occur only after new infants arrive.

Another way to validate the model would be to compare it to case report data from Uganda. Uganda has historical data on measles case reports by district from 2002 to 2008. These reports are monthly in 2007 and 2008. Using the method of susceptible reconstruction, the reporting fraction for Uganda was estimated at 32% and this factor was used to correct the case reports and make them comparable to those that would come from the computer model where all cases are detected. The case report dataset leads to an estimate of 1.97 (IQR: 0.51 to 7.89) measles cases per 1000 births for 2002 to 2008 in Uganda. The computer model estimates of measles incidence from a population that would have the same vaccination coverage as the case report data had a median of 5.3 (IQR: 0.02 to 76.6). This shows that the computer model leads to estimates of measles incidence centered in a range similar to case report data. The model showed higher spikes than the monthly case report data.

Figure UGA2 shows the cumulative number

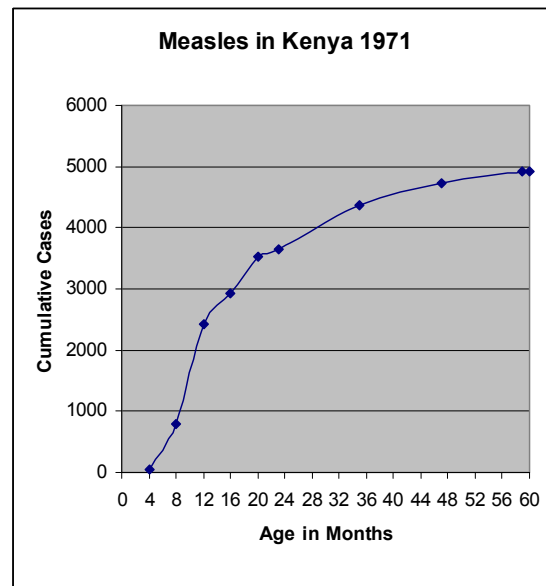

¹ Running 100 iterations of 8 policy scenarios for a single country required 30 hours of computing time on a high performance computing cluster with AMD Opteron, 8-CPU cores and 16GB of memory.

of measles case by age for various scenarios. The top left panel shows the age distribution for the natural history model which shows that in the model 30% and 76% of cases have occurred by 12 months and 60 months respectively. O'Donovan published cumulative incidence of hospital admissions for measles and found comparable numbers of 47% by age 12 months and 90% by 60 months (O'Donovan 1971). Since O'Donovan was observing admitted cases his data would naturally be skewed towards younger children where measles morbidity is known to be more severe. A more appropriate comparison might be a cross-country examination of cumulative seropositivity for measles where the cumulative incidence in the most severely affected pre-vaccine population was 18% and 80% in 12 month olds and 60 month olds respectively (Black 1962). The model is also able to replicate the well known phenomenon that vaccination increases the age of incidence. The eradication scenarios show that the percent of all cases that occur after age 5 would increase to 42-48% compared to 24% in the natural history scenario. Stopping SIAs leads to a heightened risk of measles in adults over the long run because larger cohorts of susceptible adults can be assembled when SIAs are stopped.

Figure UGA3 shows the epidemic curves for toddlers age 1 to 4 with cases per year overlain with a plot of the prevalence of children age 1 to 4 who are immune to measles from vaccination for the case of Uganda. The scenarios with SIAs show the presence of SIAs as rectangular upticks in immunity occurring every 3 years in Uganda. The scenario of stopping SIAs after 2010 leads to more frequent epidemics than would occur in the baseline situation where routine coverage and SIA policies are frozen in place.

Figure UGA4 plots the 40 year sum of discounted costs against the 40 year sum of discounted DALYs. Decision makers are assumed to prefer points that are lower on the vertical axis because these have lower cost and to prefer points that are more to the left on the horizontal axis because these have fewer DALYs. One can see from Figure UGA4, that the baseline scenario (Δ s) of not increasing routine coverage while continuing SIAs imposes similar costs but has 10 million fewer DALYs than stopping SIAs. In the baseline scenario of holding MCV1 coverage fixed at 2010 levels and continuing SIAs the model projects a total of 136,120 (SD 19,815) discounted measles deaths and 7.1 million (SD 1.2 million) discounted measles DALYs from 2010 to 2050. The baseline scenario incurs a total cost of \$ 94 million (SD 2.4). The cost of holding SIAs at \$42 million accounts for 45% of this cost. Terminating SIAs in 2010 in Uganda only lowers costs to \$87 million (SD 2.4), instead of the full amount. Roughly \$42 million in SIA direct costs are averted, but replaced by \$35 million in health care costs for the additional measles cases. So the net saving is only \$7 million

For a decision maker at the baseline position (Δ), all choices that improve health lead to higher costs. Examining Figure UGA4 reveals that trajectories from the baseline to these health improving strategies at the left of the figure would have very similar slopes. These

slopes i.e. “ICERS” (Table UGA3) were estimated by drawing 200 random line segments joining each scenario to the baseline scenario. The ICERS range from \$72 (IQR 59-90) per DALY averted in the 95% reduction scenario to \$147 per DALY averted in the Eradication by 2025 scenario (IQR 133-167).

Figure UGA5 shows the components of costs in each scenario and includes a comparison to the costs of measles if Uganda had never adopted measles vaccine (top bar “Natural”). The analysis confirms that measles vaccination as currently practiced in the baseline is indeed cost saving—the costs of the program are less than half what the medical and social costs of measles would be. In all scenarios that improve measles control the largest cost component is the cost of expanding and maintaining more routine measles coverage. As noted above, the model of scaling up routine coverage assumes that scale up will require permanent increases in recurrent costs of the vaccine program. The sooner scale up is implemented the longer these higher costs are incurred.

For Uganda, the model estimates (Table UGA4) that there would be 44,963 cases of congenital rubella syndrome (CRS) over 40 years if MR vaccine were not adopted. All strategies that switched from MCV to MR antigen following WHO guidelines for appropriate switching brought cumulative caseloads to under 6000 cases over the next 40 years and averted over 350,000 DALYS as well as saving CRS costs. The inclusion of the cost consequences of CRS would offset 51%, 47%, 62% and 50% respectively of the total costs of scaling up immunization under the 95% reduction by 2015, 98% reduction by 2020, Eradicate 2020, or Eradicate 2025 scenarios. This would improve all ICERs by a similar amount and have little impact on making any particular strategy more attractive than the others. Because the CRS costs in low income countries are mostly borne by households, the medical sector would not easily recover the financial savings from rubella control.

FIGURES

FIGURE UGA1. NATURAL HISTORY OF MEASLES DICTATED BY PARAMETERS CHOSEN FOR UGANDA ASSUMING NO VACCINATION.

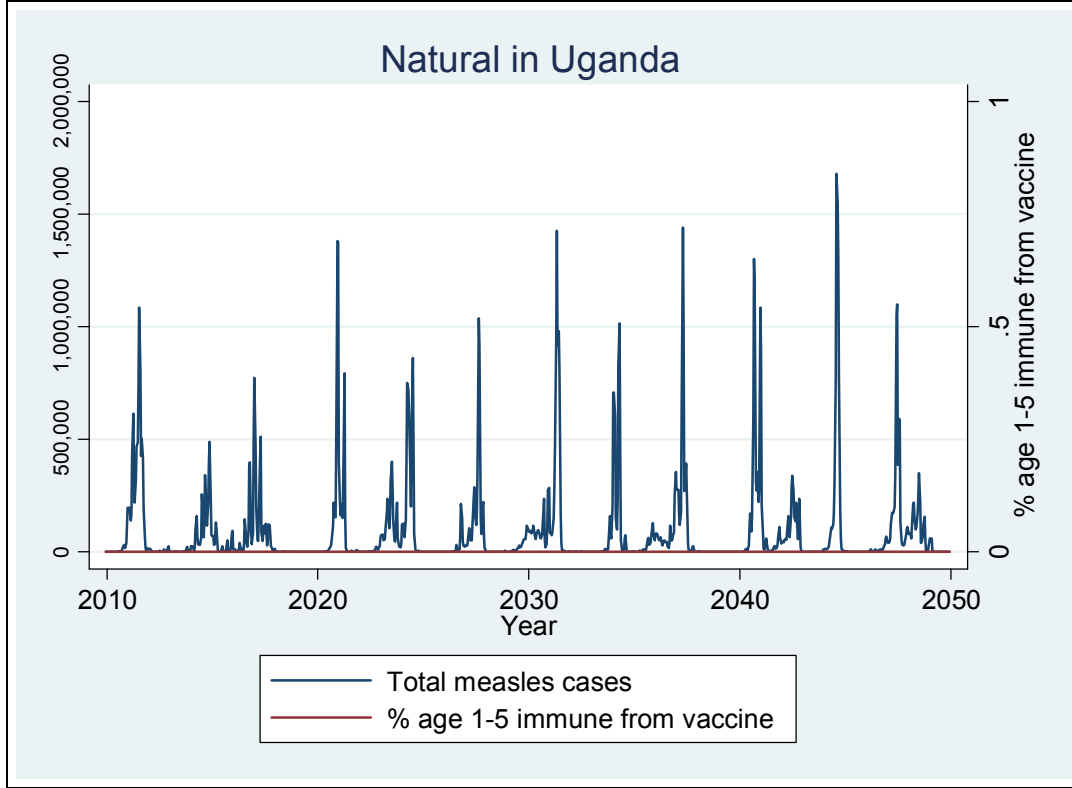

FIGURE UGA2. CUMULATIVE MEASLES INFECTIONS BY AGE GROUP IN UGANDA

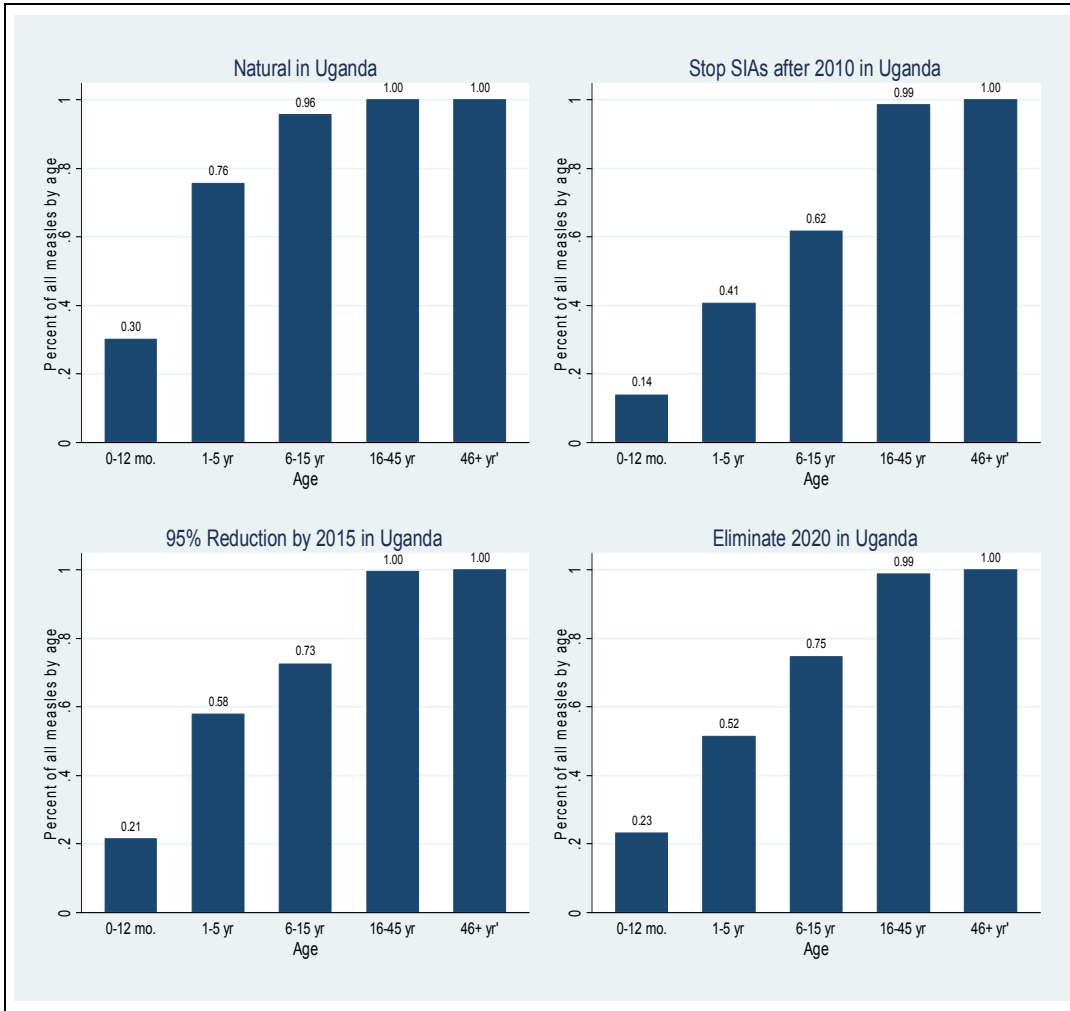

FIGURE UGA3. EPIDEMIC CURVES FOR THE 6 SCENARIOS IN UGANDA. LEFT AXIS SHOWS NUMBER OF MEASLES CASES IN BLUE. RIGHT AXIS SHOWS THE PROPORTION OF CHILDREN AGE 1-5 WHO ARE IMMUNE DUE TO VACCINE RECEIPT.

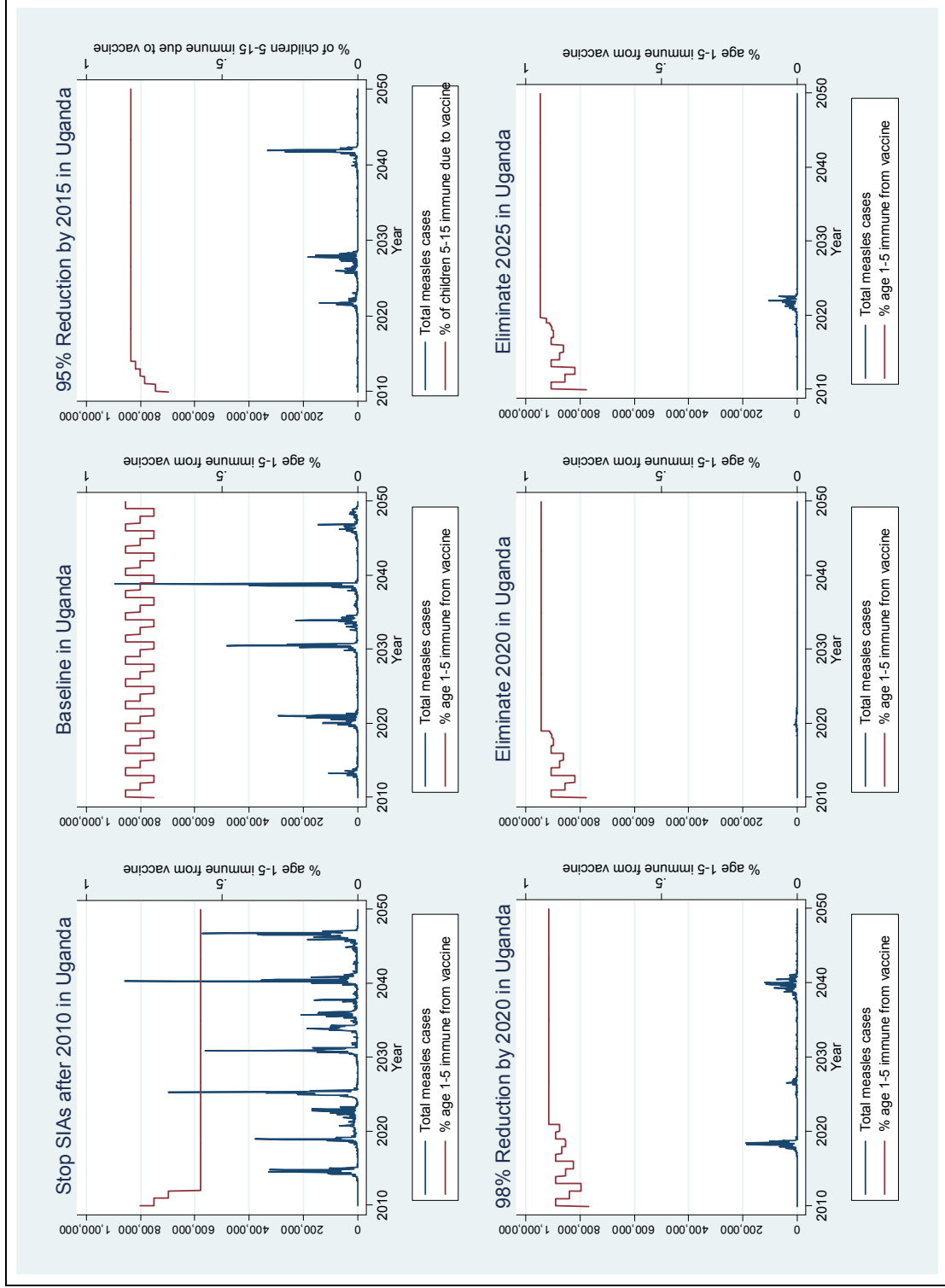

FIGURE UGA 4. COSTS VS. MEASLES DALYs IN UGANDA FOR THE 6 SCENARIOS. SLOPES FROM BASELINE (B) TO THE OTHER POINTS ARE “INCREMENTAL COST EFFECTIVENESS RATIO’S” (ICERs) AND ARE INTERPRETED AS \$ PER DALY AVERTED.

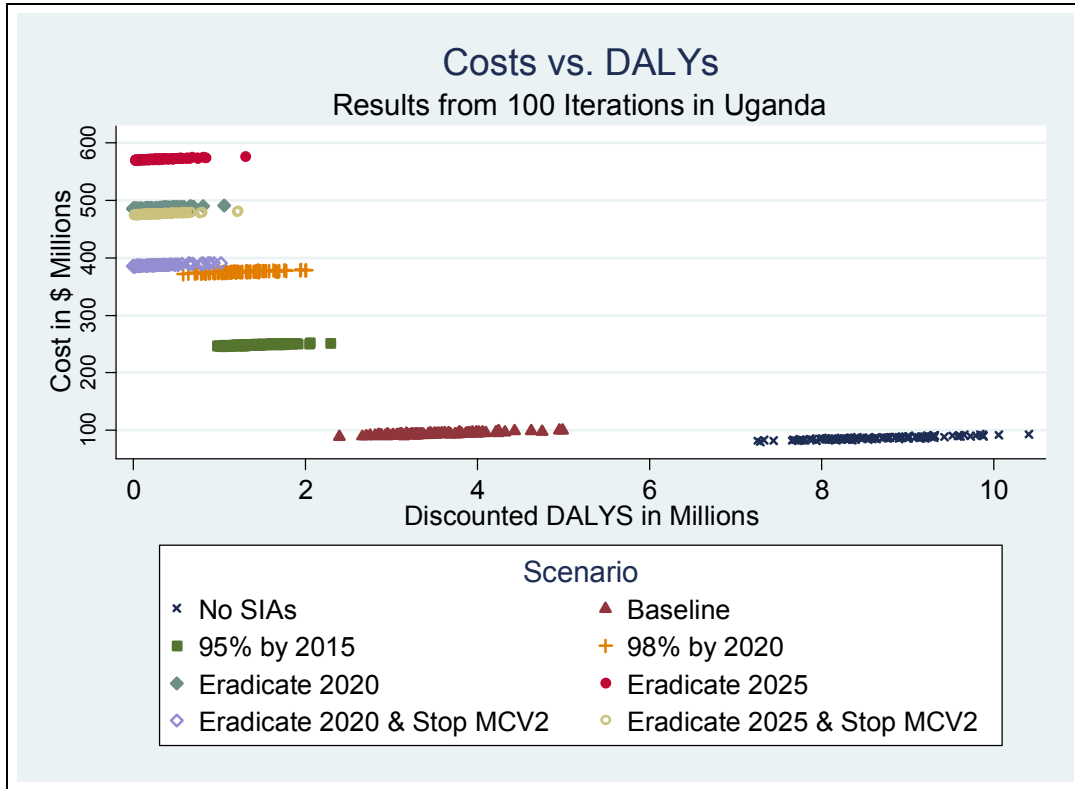
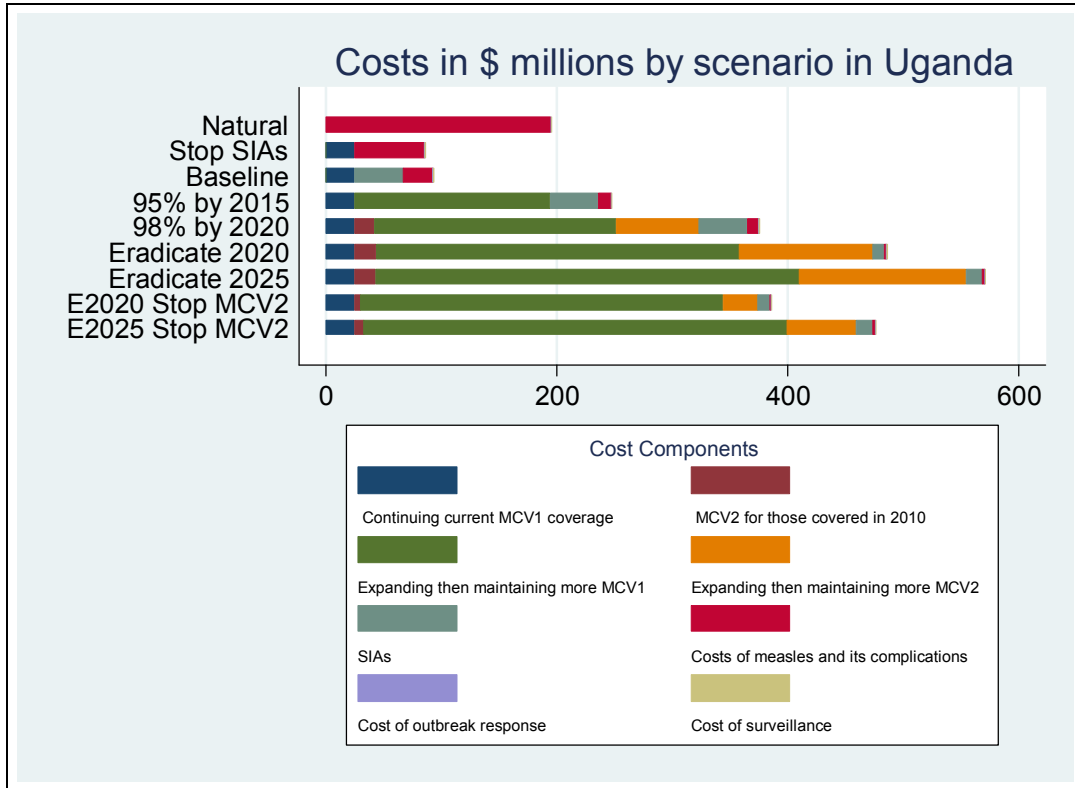

Figure UGA5. Cost structure among various measles control scenarios in Uganda compared to what it would be in the natural history scenario. Costs are cumulative discounted costs from 2010 to 2050, calculated as the average of 100 iterations of each scenario



TABLES

TABLE UGA 1 DESCRIPTION OF MEASLES CONTROL SCENARIOS USED FOR UGANDA

Scenario:			1	2	3	4	5	6		
			Baseline	Current level of activities but no SIAs in GAVI eligible countries after 2010	95% Mortality Reduction Compared to 2000	98% Mortality Reduction Compared to 2000	Eradiation 2020	Eradiation 2025		
Status in 2010	MCV1	Covg	0.68							
		Age	9 mo							
	MCV2	Covg	0							
		Age	NA							
	SIA	Covg	0.9							
		Age	9 mo - 5 yr							
		Freq	3 yrs							
	Status after 2010 till target year	MCV1	Ramp up rate [1]	N/A	0.03	0.2	0.03	0.03		
			Age		[2]		[3]			
MCV2		Ramp up rate	0		[4]					
		Age	N/A		36 mo	36 mo	36 mo			
		Yr Intro	N/A		2018	2016	2017			
SIA		Covg	0.95		N/A	0.95				
		Age	9 mo - 5 yr		N/A	9 mo - 5 yr				
		Year Stopped [6]	3 yrs		N/A	2014	2017	2014	2017	
Status after target year		MCV1	Covg		0.68	0.68	0.83	0.88	0.98	0.98
			Age		9 mo	9 mo	9 mo	9 mo	12 mo	
	MCV2	Covg	0			0.88	.98 or 0 [6]	.98 or 0 [6]		
		Age				36 mo	36 mo			
	SIA	Covg	0.9	N/A	N/A	N/A	0			
		Age	9 mo - 5 yr	N/A	N/A		N/A			
		Freq	3 yrs	N/A	N/A					
Target Year		2010	2010	2015	2020	2020	2025			

Notes

[1] Ramp up rates expressed as percentage points of coverage gained per year

[2] MCV1 age not raised because MCV1 coverage never gets to 80% by target year in these scenarios.

[3] MCV1 age can be lifted to 12 mos. after 3 yrs of MCV1>80%, but model waits until measles incidence drops below 1/100,000

[4] MCV2 coverage starts at 50% of MCV1 in year introduced increases to 90% of MCV1 by 3rd year after introduction

[5] SIAs are stopped in these years because MCV1 coverage has exceeded 80% for 36 months.

[6] Options 7 and 8 correspond to 5 and 6 respectively except MCV2 coverage is stopped 3 years after eradication.

TABLE UGA 2. PARAMETERS FOR UGANDA

Parameter	Value	Range	Source
Average cost per child vaccinated prior to scale up via routine services	\$1.00	+/- 20%	(Brenzel, Wolfson et al. 2006)
Scale up cost per child for core areas	\$26.93		(See costing appendix)
Scale up cost per child for satellite areas	\$35.83		
Scale up cost per child for MCV2 in core areas	\$8.79		
Scale up cost per child for MCV2 in satellite	\$27.10		
SIA cost per child	\$0.58		Interviews in Uganda
Monthly force of infection parameters	Jan: 0.00006392 Feb: 0.00007325 Mar: 0.0000809 Apr: 0.0000857 May: 0.00007162 Jun: 0.00010455 Jul: 0.00007821 Aug: 0.0000761 Sep: 0.00007831 Oct: 0.00008567 Nov: 0.00007201 Dec: 0.00008348	+/- 20%	Analysis of Uganda district case reports 2002-2008
Initialization of proportion vaccinated among adults, children, toddlers	0.59-0.77 depending on the age and year*		WHO coverage database
Initial measles case fatality rate**	Infant: 0.06 Toddler: 0.03 Child: 0.015 Adult: 0.015		(Wolfson, Grais et al. 2009)
Life expectancy (years)	Infant: 54.8 Toddler: 52.8 Child: 47.9 Fertile: 31.4 Post Fertile: 20		WHO
Fraction In satellite compartment	25%		(UNICEF and WHO 2010)
Initial population sizes	Infant: 1.29 E6 Toddler: 4.12 E6 Child: 8.49 E6 Fertile: 11.60 E6 Post Fert: 10.49 E6		(United Nations 2008)

TABLE UGA 3. TABLE OF COSTS, DEATHS, DALYS AND ICERS FOR UGANDA WITH 3% DISCOUNTING AND HORIZON TO 2050.

	Discounted Deaths	Δ Discounted Deaths relative to baseline Mean SD	Δ Discounted DALYS relative to baseline of 3,522,587 Mean SD	Discounted Costs in \$ millions	Δ Discounted Costs relative to baseline Mean SD
	Mean SD			Mean SD	
Natural (N)	1,206,143 (33,778)	-	-	\$196 (4.3)	-
Stop SIAs (SS)	331,729 (25,165)	194,539 (33,841)	5,090,410 (900,440)	\$87 (2.8)	-\$7 (3.9)
Baseline (B)	135,990 (19,026)	-	-	\$94 (2.3)	-
95% Reduction by 2015	55,785 (10,763)	-82,547 (24,343)	-2,151,080 (647,752)	\$249 (1.4)	\$154 (3.0)
98% Reduction by 2020	47,285 (11,708)	-90,794 (24,365)	-2,366,737 (649,053)	\$376 (1.5)	\$281 (2.9)
Eradication 2020 (E2020)	8,593 (8,935)	-128,802 (21,285)	-3,339,213 (563,099)	\$487 (1.3)	\$393 (2.7)
Eradication 2025 (E2025)	12,127 (8,418)	-125,537 (20,366)	-3,257,160 (539,862)	\$572 (1.2)	\$478 (2.6)
Eradication 2020 & Stop MCV2	10,372 (10,177)	-126,763 (23,036)	-3,285,990 (608,428)	\$387 (1.5)	\$293 (3.0)
Eradication 2025 & Stop MCV2	12,249 (8,499)	-125,244 (21,467)	-3,250,320 (568,643)	\$477 (1.2)	\$383 (2.7)

	Incremental Cost Effectiveness Ratio (ICER) \$ per <u>Death</u> averted				Incremental Cost Effectiveness Ratio (ICER) \$ per <u>DALY</u> averted		
	Median	Interquartile Range	Notes		Median	Interquartile Range	Notes
Stop SIAs (SS)	\$39	-(58: -20)	[1]		-\$1.5	-(2.2: -.8)	[1]
Baseline (B)	-				-		
95% Reduction by 2015	\$1,866	(1,533: 2,352)			\$72	(59: 90)	
98% Reduction by 2020	\$3,103	(2,616: 3,826)			\$119	(100: 147)	
Eradication 2020 (E2020)	\$3,055	(2,764: 3,506)			\$118	(106: 135)	
Eradication 2025 (E2025)	\$3,810	(3,463: 4,305)			\$147	(133: 167)	
Eradication 2020 & Stop MCV2	\$2,316	(2,033: 2,652)			\$89	(78: 103)	
Eradication 2025 & Stop MCV2	\$3,090	(2,759: 3,474)			\$119	(106: 134)	

[1] Stopping SIAs saves money but causes additional deaths and DALYS which arrive in the ratios shown on this row. One saves \$39 for every death and saves \$1.50 for every DALY caused by this strategy.

TABLE UGA4. RUBELLA. ADDITIONAL COSTS AND ADDITIONAL DALYS IF RUBELLA ANTIGEN IS ADDED AFTER COVERAGE REACHES 80% FOR 3 YEARS. THE MODEL ESTIMATES THAT OVER BETWEEN 2010 AND 2050 IN THE ABSENCE OF IMMUNIZATION THERE WOULD BE 44,963 CASES OF CONGENITAL RUBELLA SYNDROME (26,880 DISCOUNTED CASES). THESE WOULD GENERATE 726,101 DALYS (429,719 DISCOUNTED DALYS). UNDER IMMUNIZATION SCENARIOS THE NUMBER OF CRS CASES FOR THE SAME PERIOD DROPS TO BETWEEN 1003 AND 5742 CRS CASES. THIS AVERTS 99% OF THE DALYS AND SAVES MONEY DUE TO LOST ECONOMIC PRODUCTIVITY AND MEDICAL CARE COSTS OF CRS PATIENTS. THE COST OF A CASE OF CRS IS ASSUMED TO BE 50 YEARS OF GDP PER CAPITA. (AT A GDP OF \$500 PER CAPITA THIS WOULD BE APPROXIMATELY \$25,000 PER CASE.) THE DALYS ARE CALCULATED BASED ON A DALY WEIGHT OF 0.5 FOR A CONDITION THAT LASTS AS LONG AS LIFE EXPECTANCY AT BIRTH.

	Δ Discounted Money Saved	Δ Discounted DALYS Averted		Dollars saved per DALY averted	Notes
Natural (N)	\$0	0			[1]
95% Reduction by 2015	\$126,000,000	381,633		\$330	
98% Reduction by 2020	\$175,000,000	352,257		\$497	
Eradication 2020 (E2020)	\$301,000,000	383,508		\$785	
Eradication 2025 (E2025)	\$286,000,000	365,819		\$782	

The estimated cost savings from rubella control is enough to entirely offset the cost of each of the measles/rubella control strategies. Thus if one were to add the net costs of combined measles rubella control for these scenarios there would be net savings and the “ICER” would just express the ratio of money saved to DALYS saved for a set of strategies that all dominate not controlling rubella. However, the rubella costs are borne by families as lost income and costs of personal care and the disease control costs are borne by the health sector.

BIBLIOGRAPHY

- Black, F. L. (1962). "Measles antibody prevalence in diverse populations." *Am J Dis Child* **103**: 242-9.
- Brenzel, L., L. Wolfson, et al., Eds. (2006). *Vaccine-Preventable Disease*. Disease Control Priorities in Developing Countries. New York, Oxford University press.
- O'Donovan, C. (1971). "Measles in Kenyan Children." *East Afr Med J* **48**(10): 526-532.
- UNICEF and WHO (2010). *Immunization Summary: A Statistical Reference Containing Data Through 2008 (2010 Edition)*. New York and Geneva, UNICEF and WHO.
- United Nations (2008). *World Population Prospects Data*. New York, United Nations.
- Wolfson, L. J., R. F. Grais, et al. (2009). "Estimates of measles case fatality ratios: a comprehensive review of community-based studies." *Int J Epidemiol* **38**(1): 192-205.

ⁱ World Health Organization and UNICEF. 2001. *Measles mortality reduction and regional elimination strategic plan 2001–2005*. Geneva.

ⁱⁱ World Health Organization. 2009. *AFRO Measles Surveillance Feedback Bulletin* December 2009. Geneva.

ⁱⁱⁱ Ibid. WHO(2009)

^{iv} World Health Organization. 2008. *Immunization surveillance, assessment and monitoring. Measles Reported Cases*. Geneva.

http://www.who.int/immunization_monitoring/en/globalsummary/timeseries/tsincidencemea.htm, <accessed April 19, 2010>

^v World Health Organization. 2009. *AFRO Measles Surveillance Feedback Bulletin* December 2009. Geneva.

^{vi} UNICEF and WHO. *Immunization Summary A statistical reference containing data through 2008: the 2010 Edition*. <http://www.childinfo.org/files/Immunization_Summary_2008_r6.pdf, accessed April 22, 2010>

^{vii} Mbabazi, W. B., M. Nanyunja, et al. (2009). "Achieving measles control: lessons from the 2002-06 measles control strategy for Uganda." *Health Policy Plan* **24**(4): 261-9

^{viii} Government of Uganda. 2009. Annual Progress Report 2008, GAVI Alliance. 15 May, 2009.

^{ix} World Health Organization. 2009. WHO Vaccine-Preventable Diseases: Monitoring System - 2009 Global Summary. Geneva. <HTTP://WHQLIBDOC.WHO.INT/HQ/2009/WHO_IVB_2009_ENG_PART2.PDF, ACCESSED APRIL 22, 2010>

^x Op cit. UNICEF (2010)

^{xi} Op cit. Mbabazi et al (2009)

^{xii} Ibid.

^{xiii} Op cit. Government of Uganda (2009)

^{xiv} Ibid.

Appendix 4: Comparing the Cost Effectiveness of Measles Eradication to Other Interventions

The table below compares the incremental cost effectiveness ratio of measles eradication by 2020 to seven other interventions that were reported to be highly cost effective in Disease Control Priorities 2 (DCP2) (Laxminarayan 2006). The results of the present study shown in the top row are from Table 4 (p. 25) and are in \$US 2010 converted at exchange rates. The DCP2 numbers are expressed in 2006 US dollars and would be about 20% higher if inflated to 2010 prices.

	\$ US per DALY averted	Range
Measles Eradication	\$28.00	\$14.00-\$126
HIV/AIDS	\$67.50	\$9.00-\$126.00
Surgical Services and Emergency Care	\$109.00	\$6.00-\$212.00
TB	\$135.50	\$8.00-\$263.00
ALRIs in Children < 5 years	\$146.00	\$28.00-\$264.00
Cardiovascular Disease	\$156.50	\$9.00-\$304.00
Tobacco Use and Addiction	\$194.00	\$14.00-\$374.00
Maternal and Neonatal Care	\$260.50	\$127.00-\$394.00

The description of each of the comparator interventions as per DCP 2 is given below:

-HIV / AIDS prevention interventions = Voluntary counseling and testing + Peer outreach +School based interventions + ARVs to prevent MTCT

Surgical services and emergency care = Surgery in a district hospital mainly for obstetrics, trauma, and injury + community ambulance +paramedic training

-TB = BCG + DOTS + Isoniazid treatment of epidemic + Management of drug resistance

-Lower acute ARI = Community or facility based management of non-severe cases, hospital based care for severe cases

-CVD = MI management with aspirin and beta blocker + legislation to substitute 2% of trans fat with polyunsaturated fat + secondary prevention of congestive heart failure, secondary prevention of MI

-Tobacco use = 33% tax increase + advertising bans + information dissemination + tobacco supply reductions + smoking restrictions + nicotine replacement therapy

-Maternal and neonatal care = Increased primary care coverage +improved emergency obstetric care + improved overall quality and coverage of care + neonatal packages targeted to families +communities and clinics.

REFERENCES

Laxminarayan, R. (2006). Intervention Cost-Effectiveness: Overview of Main Messages. Disease Control Priorities in Developing Countries (2nd Edition). D. T. Jamison, D. B. Evans, G. Alleyne et al. Oxford, Oxford University Press.