

STANDARD HORIZON

Nothing takes to water like Standard Horizon

HX280E

VHF FM Marine Transceiver

Owner's Manual



TABLE OF CONTENTS

1. GENERAL INFORMATION	4
1.1 INTRODUCTION	4
2. ABOUT THIS RADIO	4
2.1 ABOUT THE VHF MARINE BAND	4
3. ACCESSORIES	5
2.1 PACKING LIST	5
2.2 OPTIONS	5
4. GETTING STARTED	6
4.1 RADIO CARE	6
4.2 BATTERIES AND CHARGERS	6
4.2.1 BATTERY SAFETY	6
4.2.2 BATTERY INSTALLATION / REMOVAL	8
4.2.3 BATTERY CHARGING	8
4.3 INSTALLATION OF OPTION	9
4.3.1 FBA-40 ALKALINE BATTERY CASE	9
5. CONTROLS AND INDICATORS	10
5.1 CONTROLS AND SWITCHES	10
5.2 INDICATORS	13
6. BASIC OPERATION	14
6.1 PROHIBITED COMMUNICATIONS	14
6.2 INITIAL SETUP	14
6.3 RECEPTION	14
6.4 TRANSMISSION	15
6.4.1 TRANSMIT TIME-OUT TIMER (TOT)	15
6.5 USA, CANADIAN, AND INTERNATIONAL CHANNELS	16
6.6 SIMPLEX/DUPLEX CHANNEL USE	16
6.7 KEYPAD LOCKING	16
6.8 PRESET CHANNELS (0 ~ 9): INSTANT ACCESS	17
6.8.1 PROGRAMMING	17
6.8.2 OPERATION	17
6.9 SCANNING	18
6.9.1 SELECTING THE SCAN TYPE	18
6.9.2 MEMORY SCANNING (M-SCAN)	18
6.9.3 PRIORITY SCANNING (P-SCAN)	19
6.10 DUAL WATCH	20
6.11 EMERGENCY (CHANNEL 16 USE)	20
6.12 CALLING ANOTHER VESSEL (CHANNEL 16 OR 9)	21
6.13 OPERATING ON CHANNEL 13	22
6.14 OPERATING ON CHANNEL 67	22
7. MENU ("SET") MODE	23
8. MAINTENANCE	24
8.1 GENERAL	24
8.2 REPLACEMENT PARTS	24
8.3 TROUBLESHOOTING CHART	25
9. VHF MARINE CHANNEL ASSIGNMENT	26
10. SPECIFICATIONS	30
10.1 GENERAL	30
10.2 TRANSMITTER	30
10.3 RECEIVER	30

Congratulations on your purchase of the **HX280E**! Whether this is your first portable marine VHF transceiver, or if you have other STANDARD HORIZON equipment, the STANDARD HORIZON organization is committed to ensuring your enjoyment of this high performance transceiver, which should provide you with many years of satisfying communications even in the harshest of environments. STANDARD HORIZON technical support personnel stands behind every product sold, and we invite you to contact us should you require technical advice or assistance.

We appreciate your purchase of the **HX280E**, and encourage you to read this manual thoroughly, so as to learn and fully understand the capabilities of the **HX280E**.

Disposal of your Electronic and Electric Equipment

Products with the symbol (crossed-out wheeled bin) cannot be disposed as household waste.

Electronic and Electric Equipment should be recycled at a facility capable of handling these items and their waste byproducts.

In EU countries, please contact your local equipment supplier representative or service center for information about the waste collection system in your country.



Attention in Case of Use

This transceiver works on frequencies which are not generally permitted. For frequency allocation, apply for a licence at your local spectrum management authority. For actual usage contact your dealer or sales shop in order to get your transceiver adjusted to the allocated frequency range.

List of the practicable area						
AUT	BEL	BGR	CYP	CZE	DEU	DNK
ESP	EST	FIN	FRA	GBR	GRC	HUN
IRL	ITA	LTU	LUX	LVA	MLT	NLD
POL	PRT	ROM	SVK	SVN	SWE	CHE
ISL	LIE	NOR				

1. GENERAL INFORMATION

1.1 INTRODUCTION

The **HX280E** is a Submersible 5-Watt portable two way marine transceiver. The transceiver has all allocated USA, International, or Canadian channels. It has emergency channel 16 which can be immediately selected from any channel by pressing the [16/9] key.

The **HX280E** includes the following features: Memory Scanning, Priority Scanning, easy-to-read large LCD display, EEPROM memory back-up, Battery Life displayed on LCD, and a transmit Time-Out Timer (TOT).

The **HX280E** transmitter provides a full 5 Watt of transmit power and also is selectable to 1 Watt to assist the user in ensuring maximum battery life.

2. ABOUT THIS RADIO

2.1 ABOUT THE VHF MARINE BAND

WARNING

The radio frequencies used in the VHF marine band lie between 156 and 158 MHz. The marine VHF band provides communications over distances that are essentially "Line of sight" Actual transmission range depends much more on antenna type, gain and height than on the power output of the transmitter. On a fixed mount 25 W radio transmission expected distances can be greater than 15 miles, for a portable 5 W radio transmission the expected distance can be greater than 5 miles in "Line of sight".

The user of a Marine VHF radio is subject to severe fines if the radio is used on land. The reasoning for this is you may be near an inland waterway, or propagation anomalies may cause your transmission to be heard in a waterway. If this occurs, depending upon the marine VHF channel on which you are transmitting, you could interfere with a search and rescue case, or contribute to a collision between passing ships. For VHF Marine channel assignments refer to page 32 section 10.

3. ACCESSORIES

3.1 PACKING LIST

When the package containing the transceiver is first opened, please check it for the following contents:

- **HX280E** Transceiver
- **CAT460** Antenna
- **FNB-V105LI** 7.4 V, 1650 mAh Li-Ion Battery Pack
- **CD-46** Charger Cradle for **HX280E**
- **PA-48C/U*** AC AC Adapter for **CD-46**
- **CLIP-920** Belt Clip
- Owner's Manual

3.2 OPTIONS

- ① **CN-3** Radio-to-Ship's-Antenna Adapter
- ② **CD-46** Charger Cradle
- ③ **FNB-V105LI** 7.4 V, 1650 mAh Li-Ion Battery Pack
- ④ **FBA-40** Alkaline Battery Case
- ⑤ **E-DC-19A***1 DC Cable with 12 V Cigarette Lighter Plug
- ⑥ **PA-48B/C/U***2 AC Adapter for the **CD-46**

※1: **E-DC-19A** supply voltage 10.4 V ~ 14.4 VDC only. Fuse rating of 3A only to be used.

※2: "B" suffix is for use with 120 VAC (Type-A plug), "C" suffix is for use with 230 VAC (Type-C plug), and "U" suffix is for use with 230 VAC (Type-BF plug).

Note: Before operating the **HX280E** for the first time, it is recommended that the battery be charged. Please see section "4.2.3 BATTERY CHARGING" for details.

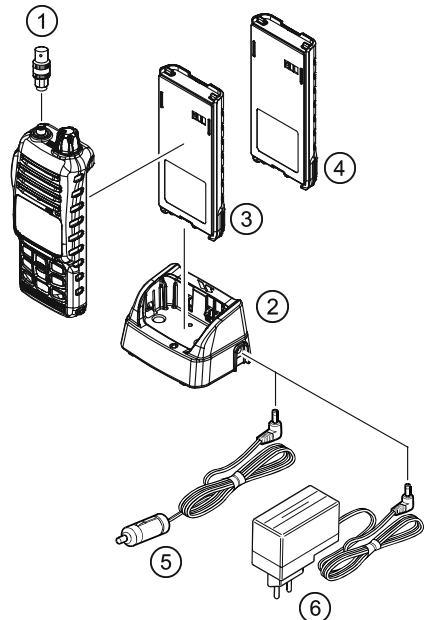

4. GETTING STARTED

4.1 RADIO CARE

CAUTION

Before following the instructions below, insure the battery pack is in place and firmly tightened. Care must be taken if the radio was dropped and a close inspection may be needed to insure the radio case and gaskets are in adequate condition.

Clean the radio with fresh water after exposure to salt water by rinsing the radio under a sink faucet or by dunking the radio in a bucket of fresh water. After washing, use a soft cloth and thoroughly dry all parts of the radio. This is to keep the rubber switches and speaker grill clean and in top operating condition.

CAUTION

There is rare case that water is in between the radio and battery pack. In this case, the radio and battery pack keep the submersible performance individually. However, remove the battery pack from the radio, then clean the radio and battery pack individually by a procedures described above.

4.2 BATTERIES AND CHARGERS

If the radio has never been used, or its charge is depleted, it may be charged by connecting the **CD-46** Charger Cradle with the **PA-48C/U** AC Adapter, as shown in the illustration on page 8. The **PA-48C/U** will charge a completely discharged **FNB-V105LI** battery pack in about 6 hours.

The **FNB-V105LI** is a high performance Li-Ion battery providing high capacity in a compact package.

CAUTION

To avoid risk of explosion and injury, **FNB-V105LI** battery pack should only be removed, charged or recharged in non-hazardous environments.

4.2.1 BATTERY SAFETY

Battery packs for your transceiver contain Li-Ion batteries. This type of battery stores a charge powerful enough to be dangerous if misused or abused, especially when removed from the transceiver. Please observe the following precautions:

DO NOT SHORT BATTERY PACK TERMINALS: Shorting the terminals that power the transceiver can cause sparks, severe overheating, burns, and battery cell damage. If the short is of sufficient duration, it is possible to melt battery components. Do not place a loose battery pack on or near metal surfaces or objects such as paper clips, keys, tools, etc. When the battery pack is installed on the transceiver, the terminals that transfer current to the transceiver are not exposed. The terminals that are exposed on the battery pack when it is mounted on the transceiver are charging terminals only and do not constitute a hazard.

DO NOT INCINERATE: Do not dispose of any battery in a fire or incinerator. The heat of fire may cause battery cells to explode and/or release dangerous gases.

Battery Maintenance

For safe and proper battery use, please observe the following:

- Battery packs should be charged only in non-hazardous environments;
- Use only STANDARD HORIZON-approved batteries;
- Use only a STANDARD HORIZON approved charger. The use of any other charger may cause permanent damage to the battery.
- Follow charging instructions provided with the chargers.
- Keep the battery contacts clean.

Battery Storage

Store the batteries in a cool place to maximize storage life. Since batteries are subject to self-discharge, avoid high storage temperatures that cause large self-discharge rates. After extended storage, a full recharge is recommended.

Battery Recycling

**DO NOT PLACE USED BATTERIES IN YOUR REGULAR TRASH!
LI-ION BATTERIES MUST BE COLLECTED, RECYCLED OR DISPOSED
OF IN AN ENVIRONMENTALLY SOUND MANNER.**

The incineration, land filling or mixing of Li-Ion batteries with the municipal solid waste stream is PROHIBITED BY LAW in most areas.

Return batteries to an approved Li-Ion battery recycler. This may be where you purchased the battery.

Contact your local waste management officials for other information regarding the environmentally sound collection, recycling and disposal of Li-Ion batteries.

4.2.2 BATTERY INSTALLATION/REMOVAL

- To install the battery pack, hold the transceiver with your left hand, so your palm is over the speaker and your thumb is on the top of the belt clip. Insert the battery pack into the battery compartment on the back of the radio while tilting the Belt Clip outward, then push the bottom side of the battery pack until the battery pack locks with the Battery Pack Latch.

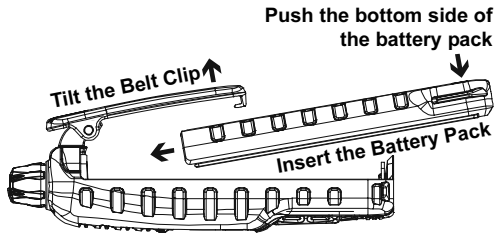

- To remove the battery, turn the radio off. Slide the Battery Pack Latch on the bottom of the radio, then slide the battery downward and out from the radio while holding the Belt Clip.

4.2.3 BATTERY CHARGING

1. Turn the transceiver off.
2. **PA-48C/U**: Insert the DC plug from the **PA-48C/U** into the DC jack on the **CD-46** side panel, then plug the **PA-48C/U** into the AC line outlet.

E-DC-19A: Insert the DC plug from the **E-DC-19A** into the DC jack on the **CD-46** side panel, then insert the 12 V DC connector into a suitable DC supply (10 - 14 VDC).

3. Insert the **HX280E** (with the battery pack) into the **CD-46**; the antenna should be at the left side when viewing the charger from the front.
4. If the **HX280E** is inserted correctly, the Red "**CHARGING**" indicator will glow. A fully-discharged pack will be charged completely in approximately 6 hours.
5. When charging is completed, the red LED indicator will change to green. Remove the transceiver from the **CD-46**, and unplug the **NC-90C/U** from the AC line outlet (**PA-48C/U**) or unplug the **E-DC-19A** from the DC supply (**E-DC-19A**).

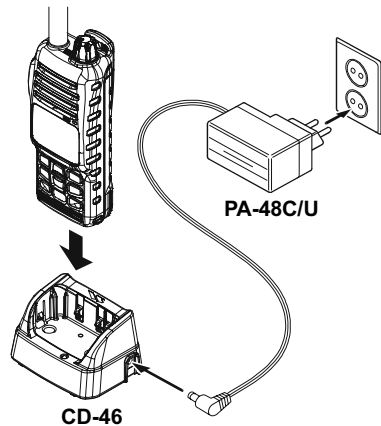

CAUTION

The **CD-46** is NOT designed to be waterproof. Do not attempt to charge in water hazardous locations.

NOTE

The **CD-46** is only designed for the charging of the **HX280E**'s battery, and is not suitable for other purposes. The **CD-46** may contribute noise to TV and radio reception in the immediate vicinity, so we do not recommend its use adjacent to such device.

4.3 INSTALLATION OF OPTION

4.3.1 FBA-40 ALKALINE BATTERY CASE

FBA-40 is a battery case that holds six LR6 size Alkaline batteries and is used with the **HX280E** transceiver. When the **FBA-40** is installed into the **HX280E** the radio can withstand immersion in water up to 3.3ft for 30 minutes.

1. On the **FBA-40**, remove the battery case cover (☞).
2. Slide the six LR6 size Alkaline batteries into the **FBA-40** Battery Case with the Negative (-) side of the batteries touching the spring connections inside the **FBA-40** Battery Case.
3. Attach the battery cover to the **FBA-40** Battery Case while being careful so that o-ring is not twisted.
4. Insert the **FBA-40** Battery Case into the battery compartment on the back of the **HX280E** transceiver while tilting the Belt Clip outward, then push the bottom side of the **FBA-40** Battery Case until the Battery Case locks with the Battery Pack Latch.

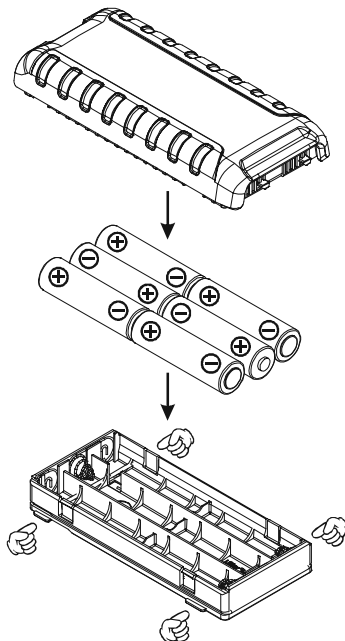

5. CONTROLS AND INDICATORS

5.1 CONTROLS AND SWITCHES

NOTE

This section defines each control of the transceiver. For detailed operating instructions, refer to section 6 “**BASIC OPERATION**”. Refer to illustrations for the location of the following controls, switches, and connections.

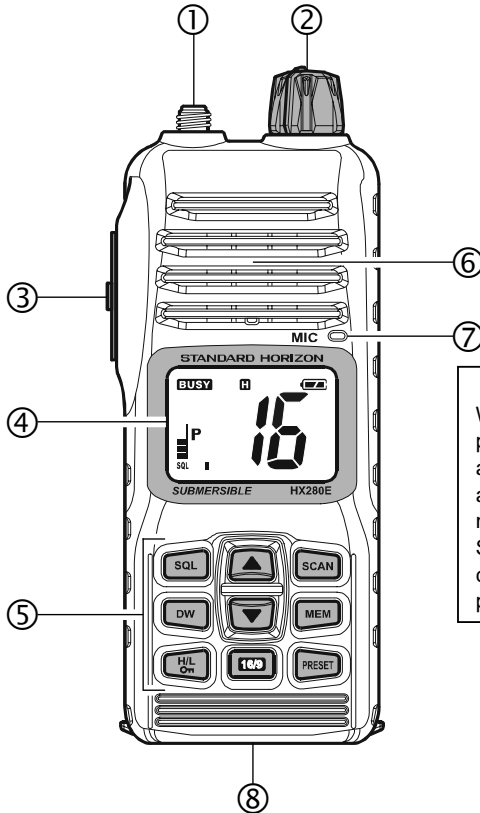

NOTE

When transmitting, position your mouth about 1.0 ~ 2.5 cm away from the small mic hole. Speak slowly and clearly into the microphone.

① **ANT** Jack (Top Panel)

The supplied **CAT460** flexible antenna is attached here.

② **POWER** Switch/**VOLUME** Control (**VOL**)

Turns the transceiver on and off as well as adjusts the speakers audio volume.

Turn this knob clockwise to turn the radio on and increase the speakers audio volume.

Turn fully counter-clockwise to turn the radio off.

- ③ **PTT (PUSH-TO-TALK) Switch**
When pushed activates the transmitter.
- ④ **LCD Display**
This display shows current operating conditions, as indicated on the page 13.
- ⑤ **Keypad**
- [SQL] Key**
Press this key to activate the squelch adjusting mode. Press the [▼] or [▲] key to adjust the squelch threshold level.
Press and hold this key for 3 seconds to open the squelch, allowing you to monitor the operating channel. Release the key to resume normal (quiet) monitoring.
- [SCAN] Key**
Starts scanning and priority scanning of programmed channels.
- [▲(UP)] Key**
Press the key momentarily to increase the channel one step. Hold the key down to increase the channel continuously.
Secondary use:
Used to adjust the squelch threshold level up after the [SQL] key is pressed.
- [▼(DOWN)] Key**
Press the key momentarily to decrease the channel one step. Hold the key down to decrease the channel continuously.
Secondary use:
Used to adjust the squelch threshold level down after the [SQL] key is pressed.
- [DW] Key**
Press this key to activate the Dual Watch feature. A “**DW**” icon will appear on the upper left of the display when the Dual Watch feature is activated.
Secondary use:
When the [16/9] key is held and the [DW] key is pressed, the radio will change the marine band between the International, Canadian, and USA channels.

[MEM] Key



Press this key to memorize the selected channel for scanning. When pressed a “MEM” icon will be shown on the LCD display indicating the channel has been saved to scan memory.

To delete the channel from scan memory, select the channel and press this key until “MEM” is removed from the display.

[H/L()] Key

Press this key to toggle the transmitter output power between “High” (5 Watts) and “Low” (1 Watt) power. This key does not function on the “Transmission Inhibited” and “Low power only” channels.

Secondary use:

Hold down this key to lock the keypad (except the [SQL], [H/L()], and PTT keys) so that they are not accidentally changed. The “” icon will appear at the bottom right corner on the display, to indicate that the functions are locked. Hold down this key until the “” icon disappears to unlock the radio.

[16/9] Key

Pressing this key immediately recalls channel 16 from any channel location. Holding down this key recalls channel 9. Pressing this key again reverts to the previous selected working channel.

[PRESET] Key

Immediately recalls one of up to 10 user preset memories for each band (shown as “0” - “9” on the LCD). Pressing this key repeatedly scrolls through the preset memory channels.

⑥ Speaker

The internal speaker is located here.

⑦ Microphone





The internal microphone is located here.

When transmitting, position your mouth about 1.0 ~ 2.5 cm away from the small mic hole. Speak slowly and clearly into the microphone.

⑧ Battery Pack Lock (Bottom side)

Slide the Battery Pack Lock to the “◀” position for battery removal.

5.2 LCD INDICATORS

- ① **“BUSY”** Indicator
This indicator appears when a signal is being received.
- ② **“TX”** Indicator
This indicator appears during transmission.
- ③ **“H/L”** Indicators
This indicator shows the TX output power.
“H”: High power (5 Watts)
“L”: Low power (1 Watt).
- ④ **“Om”** Indicator
When the “Om” icon is shown on the LCD, all keys are disabled except for the **PTT**, **[SQL]**, and **[H/L(Om)]** keys.
- ⑤ **“”** Battery Indicator
“”: Full battery
“”: Lower battery
“”: Battery is very low
“” (Blinking): Prepare to charge the battery
- ⑥ **“DW”** Indicator
This indicator appears when the Dual Watch is activated.
- ⑦ **“MEM”** Indicator
This indicator shows the channel is in the transceiver’s “Scan Memory”.
- ⑧ **SQL** Indicator
This indicator shows the squelch level.

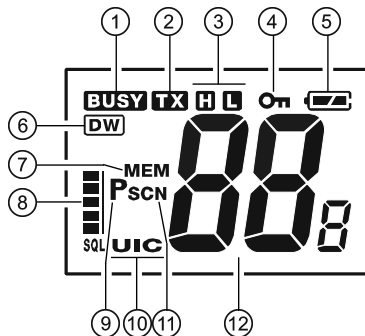

- ⑨ **“P”** Indicator
This indicator shows the channel is in the “Priority Channel”.
- ⑩ **“U/I/C”** Indicator
These indicators show the “band” of operation for the particular channel. “U” indicates the USA band; “I” indicates the International band; and “C” indicates the Canadian band.
- ⑪ **“SCN”** Indicator
This indicator appears when the Scan is activated.
- ⑫ **Channel Display**
The operating channel is shown on the LCD in both the transmission and reception modes.

6. BASIC OPERATION





6.1 PROHIBITED COMMUNICATIONS

- False distress or emergency messages:
- Messages to “any boat” except in emergencies and radio tests;
- Messages to or from a vessel on land;
- Transmission while on land;
- Obscene, indecent, or profane language.

6.2 INITIAL SETUP

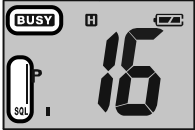
1. Install the battery pack on the transceiver (see section “4.2.2 BATTERY INSTALLATION/REMOVAL”).
2. Install the antenna onto the transceiver; hold the bottom end of the antenna, then screw it onto the mating connector on the transceiver until it is snug. Do not over-tighten.

6.3 RECEPTION

1. Turn the **VOL** knob clockwise to turn the transceiver on.
2. Press the [**SQL**] key to activate the squelch adjusting mode (The “**SQL**” indicator will blink). Press the [**▼**] key until the “**BUSY**” indicator will appear on the display, then press the [**SQL**] key again.
3. Turn up the **VOL** knob until the noise or audio from the speaker is at a comfortable level.
4. Press the [**SQL**] key, then press the [**▲**] key until the random noise disappears. This state is known as the “Squelch Threshold”.
5. Press the [**▼**] or [**▲**] key to select the desired channel. Refer to the channel chart on page 27 for available channels.
6. When a signal is received, adjust the **VOL** knob to the desired listening level. The “**BUSY**” indicator in the LCD is displayed indicating that the channel is being used.

6.4 TRANSMISSION

1. Perform “**6.3 RECEPTION**” discussion above.
2. Before transmitting, monitor the channel and make sure it is clear.
3. For communications over short distances, press the [H/L(**Low**)] key to select the Low power (1 watt: “**L**” icon appears).



- Note:** Transmitting on Low power prolongs battery life. Low power should be selected whenever possible.
4. If using Low power is not effective, select High power (5 watts: “**H**” icon appears) by pressing the [H/L(**High**)] key.
 5. When receiving a signal, wait until the incoming signal stops before transmitting. The transceiver cannot transmit and receive simultaneously.
 6. Press the **PTT** (Push-To-Talk) switch to transmit. During transmission, the “**TX**” indicator will appear on the display.
 7. Position your mouth about 1.0 ~ 2.5 cm away from the mic hole. Speak slowly and clearly into the microphone.
 8. When the transmission is finished, release the **PTT** switch.

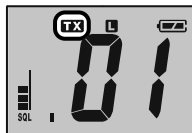
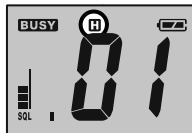

6.4.1 TRANSMIT TIME - OUT TIMER (TOT)

While the **PTT** switch is held down, transmission time is limited to 5 minutes. This prevents prolonged (unintentional) transmissions. About 10 seconds before automatic transmitter shutdown, a warning beep will sound from the speaker. The transceiver automatically switches to the receiving mode, even if the **PTT** switch is held down. Before transmitting again, the **PTT** switch must first be released, then wait 10 seconds and then pressed again. This Time-Out-Timer (TOT) prevents a continuous transmission that would result from an accidentally stuck **PTT** switch.

NOTE

The **PTT** switch is ignored for 10 seconds after the transceiver automatically switches to the receiving mode by the TOT feature.

6.5 USA, CANADIAN, AND INTERNATIONAL CHANNELS

1. To change from International to Canadian or US Marine Channels, hold down the [16/9] key and press the [DW] key. The band will change from International, to Canadian, and to US with each press.
2. “U” appears on the LCD for the USA band, “I” appears for the International band, and “C” appears for the Canadian band
3. Refer to the marine channel charts in section 9 “VHF MARINE CHANNEL ASSIGNMENTS” for allocated channels.

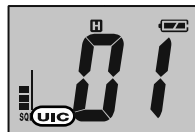

6.6 SIMPLEX/DUPLEX CHANNEL USE

Refer to the VHF MARINE CHANNEL CHART (page 27) for instructions on use of simplex and duplex channels.

NOTE

All channels are factory-programmed in accordance with FCC (USA), Industry Canada and International regulations. The mode of operation cannot be altered from simplex to duplex or vice-versa. Simplex (ship to ship) or duplex (marine operator) mode is automatically activated, depending on the channel and whether the USA, International or Canadian operating band is selected.

6.7 KEYPAD LOCKING

In order to prevent accidental channel change, the HX280E's keypad may be locked out.

Hold down the [H/L] key to lock the keypad (except the PTT, [SQL], and [H/L] keys) so that they are not accidentally changed. The “**L**” icon will appear on the channel number of the display, to indicate that the functions are locked.

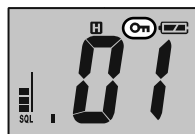

Hold down the [H/L] key until the “**L**” icon disappears to unlock the radio.

6.8 PRESET CHANNELS (0 ~ 9): INSTANT ACCESS

Ten user assigned channels can be programmed for instant access. Pressing the [PRESET] key activates the user assigned channel bank. If the [PRESET] key is pressed and no channels have been assigned, an alert beep will be emitted from the speaker.

6.8.1 PROGRAMMING

1. Select the desired channel to be assigned into the Preset Channel Bank using the [▼] or [▲] key.
2. Press and hold the [PRESET] key until the Preset Channel Number “0” is shown at the right of the channel number on the display.
3. Repeat steps 1 and 2 to program the desired channels into Preset Channels “1” ~ “9”.
4. To delete a Preset Channel, select the Preset Channel Number to be deleted using the [▼] or [▲] key, then press and hold the [PRESET] key until the Preset Channel Number is removed from the display.



6.8.2 OPERATION

Pressing the [PRESET] key will toggle between Preset Channels “0” through “9” and the last selected “regular” channel. Preset Channel “0” is represented by “0” to the right of the channel number on the display for one second, and preset channel “1” is represented by “1” and so forth. The preset channel number will disappear after one second.



6.9 SCANNING

The **HX280E** allows the user to select the scan type from “Memory Scan” or “Priority Scan”. “Memory Scan” scans the channels that were programmed into memory. “Priority Scan” scans the channels that were programmed into memory with the priority channel (Channel 16). When an incoming signal is detected on one of the channels during scan, the radio will pause on that channel, allowing you to listen to the incoming transmission.

6.9.1 SELECTING THE SCAN TYPE

1. Turn the transceiver off by rotating the **VOL** knob fully counter-clockwise.
2. Hold down the [**SQL**] key, and then turn on the transceiver while still holding down the [**SQL**] key.
3. “SET” will appear on the display, indicating the Menu (“Set”) Mode has been activated.
4. Press the [**SQL**] key, repeatedly if necessary to select the Menu item “SC”.
5. Press the [▼] or [▲] key to select “PS (Priority Scan)” or “MS (Memory Scan)”. The factory default is “PS (Priority Scan)”.
6. After completing your selection, turn the transceiver off and on by rotating the **VOL** knob.

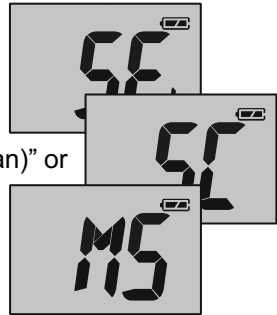

6.9.2 MEMORY SCANNING (M-SCAN)

1. Select the desired channel to be included in the scan memory using the [▼] or [▲] key.
2. Press the [**MEM**] key to store the channel into the transceiver’s scan memory. “MEM” will be displayed on the LCD.
3. Repeat steps 1 and 2 for all the channels to be scanned.
4. To delete a channel from the transceiver’s scan memory, select the memorized channel, then press the [**MEM**] key to delete the channel from scan memory.
5. All channels programmed remain in the transceiver’s scan memory even if the power is turned off.
6. Adjust the SQL level until background noise is eliminated by pressing the [**SQL**] key followed by the [▼] / [▲] key.
7. To start scanning, press the [**SCAN**] key. The scan proceeds from the lowest to the highest programmed channel and stops scanning when a transmission is received. Scanning will resume when the incoming signal disappears at the end of the transmission. The “MEM” and “SCN” icon will ap-

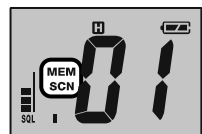
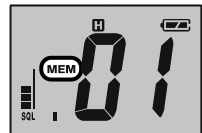

- pear at the left of the channel number on the display during scanning.
- To stop the scan, press the [**SCAN**] key.

6.9.3 PRIORITY SCANNING (P-SCAN)

- Select the desired channel to be included in the scan memory using the [**▼**] or [**▲**] key.
- Press the [**MEM**] key to store the channel into the transceiver's scan memory. "**MEM**" will be displayed on the LCD.
- Repeat steps 1 and 2 for all the channels to be scanned.
- To delete a channel from the transceiver's scan memory, select the memorized channel, then press the [**MEM**] key to delete the channel from scan memory.
- All channels programmed remain in the transceiver's scan memory even if the power is turned off.
- Adjust the Squelch Level until background noise is eliminated by pressing the [**SQL**] key followed by the [**▼**] / [**▲**] key.
- To start scanning, press the [**SCAN**] key. A "**SCN**" icon and blinking "**P**" and "**MEM**" icons will appear at the left of the channel number on the display during scanning. The scan proceeds between the memorized channels and the Priority Channel (Channel 16). As an example of priority scanning, let us say that marine channels "06", "07", and "08" are memorized in the transceiver's scan memory. Priority scanning will proceed in the following sequence:

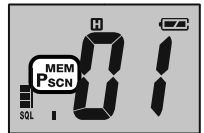
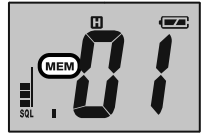

[CH06] → (CH16)* → [CH07] → (CH16)* →
[CH08] → (CH16)* → [CH06] → (CH16)* → [CH07]
 *: Priority Channel

- Even when the transceiver stops and listens to the signal of a programmed channel, the transceiver will "dual watch" between this channel and the priority channel. This allows the radio to be able to receive calls on channel 16 (priority channel) even when the radio is receiving on another channel.
- To stop the Priority Scanning, press the [**SCAN**] key.

6.10 DUAL WATCH

The Dual Watch feature allows the radio watch the Priority Channel “Channel 16” and one other channel.

1. Select the desired channel using the [▼] or [▲] key.
2. Press the [DW] key to activate the Dual Watch feature. A “DW” icon will appear on the upper left of the display when the Dual Watch feature is activated.
3. When a transmission is received on the “Priority Channel”, the radio receives the “Priority Channel” until the incoming signal disappears.
4. When a transmission is received on the “Priority Channel”, the radio receives the “Priority Channel” until the incoming signal disappears.
5. The Dual Watch feature will resume when the incoming signal disappears at the end of the transmission.
6. To stop the Dual Watch feature and return to normal operation, press and hold the [SCAN(DW)] key for two seconds again.

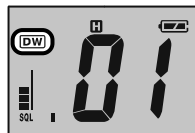

6.11 EMERGENCY (CHANNEL 16 USE)

Channel 16 is known as the Hail and Distress Channel. An emergency may be defined as a threat to life or property. In such instances, be sure the transceiver is on and set to “Channel 16”. Then use the following procedure:

1. Press the **PTT** (Push-To-Talk) switch and say “**Mayday, Mayday, Mayday**. This is _____, _____, _____” (your vessel’s name).
2. Then repeat once: “**Mayday**, _____” (your vessel’s name).
3. Now report your position in latitude/longitude, or by giving a true or magnetic bearing (state which) to a well-known landmark such as a navigation aid or geographic feature such as an island or harbor entry.
4. Explain the nature of your distress (sinking, collision, aground, fire, heart attack, life-threatening injury, etc.).
5. State the kind of assistance your desire (pumps, medical aid, etc.).
6. Report the number of persons aboard and condition of any injured.
7. Estimate the present seaworthiness and condition of your vessel.
8. Give your vessel’s description: length, design (power or sail), color and other distinguishing marks. The total transmission should not exceed 1 minute.
9. End the message by saying “**OVER**”. Release the **PTT** switch and listen.
10. If there is no answer, repeat the above procedure. If there is still no response, try another channel.

6.12 CALLING ANOTHER VESSEL (CHANNEL 16 OR 9)

Channel 16 may be used for initial contact (hailing) with another vessel.

However, its most important use is for emergency messages. This channel must be monitored at all times except when actually using another channel.

It is monitored by the U.S. and Canadian Coast Guards and by other vessels. Use of channel 16 for hailing must be limited to initial contact only. Calling should not exceed 30 seconds, but may be repeated 3 times at 2-minute intervals. In areas of heavy radio traffic, congestion on channel 16 resulting from its use as a hailing channel can be reduced significantly in U.S. waters by using Channel 9 as the initial contact (hailing) channel for non-emergency communications. Here, also, calling time should not exceed 30 seconds but may be repeated 3 times at 2-minute intervals.

Prior to making contact with another vessel, refer to the channel charts in this manual, and select an appropriate channel for communications after initial contact. For example, Channels 68 and 69 of the U.S. VHF Charts are some of the channels available to non-commercial (recreational) boaters. Monitor your desired channel in advance to make sure you will not be interrupting other traffic, and then go back to either channel 16 or 9 for your initial contact.

When the hailing channel (16 or 9) is clear, state the name of the other vessel you wish to call and then “**this is**” followed by the name of your vessel and your Station License (Call Sign). When the other vessel returns your call, immediately request another channel by saying “**go to**”, the number of the other channel, and “**over**”. Then switch to the new channel. When the new channel is not busy, call the other vessel.

After a transmission, say “**over**”, and release the **PTT** (Push-To-Talk) switch. When all communication with the other vessel is completed, end the last transmission by stating your Call Sign and the word “**out**”. Note that it is not necessary to state your Call Sign with each transmission, only at the beginning and end of the contact.

Remember to return to Channel 16 when not using another channel. Some radios automatically monitor Channel 16 even when set to other channels or when scanning.

6.13 OPERATING ON CHANNEL 13

Channel 13 is used at docks, bridges and for maneuvering in port. Messages on this channel must concern navigation only, such as meeting and passing in restricted waters. In emergencies and when approaching blind river bends, High power is allowed. Pressing the [H/L(☉)] key will change the power output from Low Power (1 Watt) to High (5 Watts). When you change from this channel then return to it, low power will be automatically selected.

6.14 OPERATING ON CHANNEL 67

When channel 67 is used for navigational bridge-to-bridge traffic between ships, Normal, High or Medium power may be used temporarily (in the USA band) by pressing the [H/L(☉)] key. When you select this channel again, the transceiver will revert to low power.

7. MENU (“SET”) MODE

The **HX280E**'s Menu Mode allows a number of the **HX280E** operating parameters to be custom-configured for your operating requirements.

The Menu Mode is easy to activate and set, using the following procedure:

1. Turn the transceiver off by rotating the **VOL** knob fully counter-clockwise.
2. Hold down the [**SQL**] key, and then turn on the transceiver while still holding down the [**SQL**] key.
3. “SEt” will appear on the display, indicating the Menu (“Set”) Mode has been activated.
4. Press the [**SQL**] key to select the Menu item to be adjusted.
5. Press the [**▼**] or [**▲**] key to enable adjustment of the selected Menu item. The menu item will blink.
6. Press the [**SQL**] key to select the status or value of the Menu item.
7. After completing your adjustment, turn the transceiver off and on by rotating the **VOL** knob.



LP (LAMP MODE)

Function: Selects the Lamp illumination method for the LCD/Keypad.

Available Values: on / KEY / oFF

Default: KEY

on: Illuminates the LCD/Keypad continuously.

KEY: Illuminates the LCD/Keypad for 5 seconds when any key is pressed.

oFF: Turns off the backlight for the LCD and keys.



bP (BEEP)

Function: Enable/Disable the Keypad beeper.

Available Values: HI / Lo / oFF

Default: HI



SC (SCAN TYPE)

Function: Selects the Scan mode.

Available Values: PS (Priority Scan) / MS (Memory Scan)

Default: PS (Priority Scan)



8. MAINTENANCE

8.1 GENERAL

The inherent quality of the solid-state components in STANDARD HORIZON radios will provide many years of continuous use. Take the following precautions to prevent damage to the radio.

- To prevent corrosion of electrical contacts and keep the water resistance, keep the microphone connected or the jack covered at all times.
- Never key the transmitter unless an antenna or suitable dummy load is connected to the antenna receptacle.
- Ensure that the input voltage does not exceed the value specified in your Owner's Manual.
- Use only STANDARD HORIZON-approved accessories and replacement parts.

In the unlikely event of serious problems, please contact your Dealer.

8.2 REPLACEMENT PARTS

Occasionally an owner needs a replacement part. These can be ordered from STANDARD HORIZON authorized dealers.

Commonly requested parts, and their part numbers are listed below.

- **VOL** Knob: RA1078700
- **CD-46** Charger Cradle: CB4777001
- **CAT460** Antenna: Q3000176
- **CLIP-920** Belt Clip: AAE51X001

11.2 FACTORY SERVICE

In the unlikely event that the radio fails to perform or needs servicing, please contact your Dealer or STANDARD HORIZON authorized dealers.

8.3 TROUBLESHOOTING CHART

SYMPTOM	PROBABLE CAUSE	REMEDY
The [SCAN(DW)] key does not start the scan.	No channels memorized.	Use the [MEM] key to enter desired channels into the transceiver's memory.
	Squelch is not adjusted.	Adjust the squelch to threshold or to the point where noise just disappears. Further adjustment of the squelch control may eliminate incoming signals.
Cannot select between USA, INTL, or Canadian bands.	Proper operation not followed.	HOLD down the [16/9] key and press the [DW] key.
Speaker audio is not heard when the [SQL] key is press and held.	Low battery.	Charge battery. Refer to section 4.2.3 of this manual.
	Audio volume level is too low.	Turn the VOL knob clockwise.
Some keys do not operate.	Key Lock is on.	Turn Key Lock off. Refer to section 5.1 of this manual ([H/L(On)] key).
Cannot select keylock function.	Proper operation not followed.	Hold down the [H/L(On)] key for 2 seconds.
Charging indicator on CD-46 does not illuminate.	Defective battery FNB-V105LI .	Contact your Standard Horizon dealer.

9. VHF MARINE CHANNEL ASSIGNMENTS

Tables on the following pages list the VHF Marine Channel assignments for U.S.A. and International use. Below are listed some data about the charts.

1. VTS. Where indicated, these channels are part of the U.S. Coast Guard's Vessel Traffic System.
2. Alpha channel numbers, that is, channel numbers followed by the letter A (such as Channel 07**A**) are **simplex** channels on the U.S.A. or Canadian channel assignments whose counterparts in the International assignments are **duplex** channels. International channels do not use "alpha" numbers. If you call the Coast Guard on Channel 16, they will sometimes ask you to "**go to channel 22 Alpha**." This is a channel assigned to U.S.A., and Canadian Coast Guards for handling distress and other calls. If your radio is set for **International** operation you will go to Channel 22 instead of 22**A**, and will not be able to communicate with the Coast Guard. To use Channel 22**A**, your radio must be set for **USA** or **Canada** operation, usually by a U/I/C (USA/International/Canada) control or combination of controls. Channel 22 (without an "A") is an **International** duplex channel for port operations. Some radios indicate an "A" adjacent to the alpha channels on the display; on others "alpha" is not indicated but the proper channel is selected based on the U/I/C setting.
3. Bridge-to-Bridge channels (for example, Channel 13) are for use by bridge operators on inter-coastal waterways and rivers. It is also used by marine vessels in the vicinity of these bridges for navigation and for communicating with the bridge operators. Note that a limit of 1 Watt is specified for these channels.
4. The **S/D** column on the chart indicates either S (simplex) or D (duplex). **Simplex** means transmitting and receiving on the same frequency. Only one party at a time can talk, unlike a telephone. Be sure to say "**over**" and release your microphone push-to-talk switch at the end of each transmission. **Duplex** operation involves the use of one frequency for transmitting and a separate frequency for receiving. On channels specified as duplex on the charts, correct mode of operation is established automatically by your radio when you select a channel; you cannot change the mode. And you still must release the push-to-talk switch after each transmission in order to listen to the radio.
5. Channels normally used by recreational boaters are those that include the term "non-commercial" in the **Channel Use** column of the chart. Some of these are shared with other users and some are used only in certain geographic regions.
6. Marine vessels equipped with VHF radios are required to monitor Channel 16.

VHF MARINE CHANNEL CHART							
CH	U	C	I	S/D	TX	RX	CHANNEL USE
01		X	X	D	156.050	160.650	Public Correspondence (Marine Operator)
01A	X			S	156.050		Port Operation and Commercial. VTS in selected areas
02		X	X	D	156.100	160.700	Public Correspondence (Marine Operator)
03		X	X	D	156.150	160.750	Public Correspondence (Marine Operator)
03A	X			S	156.150		U.S. Government Only, Coast Guard
04			X	D	156.200	160.800	Public Correspondence (Marine Operator), Port operation, ship movement
04A		X		S	156.200		Pacific coast: Coast Guard, East Coast: Commercial fishing
05			X	D	156.250	160.850	Public Correspondence (Marine Operator), Port operation, ship movement
05A	X	X		S	156.250		Port operation. VTS in Seattle
06	X	X	X	S	156.300		Inter-ship Safety
07			X	D	156.350	160.950	Public Correspondence (Marine Operator), Port operation, ship movement
07A	X	X		S	156.350		Commercial
08	X	X	X	S	156.400		Commercial (Inter-ship only)
09	X	X	X	S	156.450		Boater Calling channel, Commercial & Non-commercial (Recreational)
10	X	X	X	S	156.500		Commercial
11	X	X	X	S	156.550		Commercial. VTS in selected areas.
12	X	X	X	S	156.600		Port operation. VTS in selected areas.
13	X	X	X	S	156.650		Inter-ship Navigation Safety (Bridge-to-bridge)
14	X	X	X	S	156.700		Port operation. VTS in selected areas.
15	X			S	---	156.750	Environmental (Receive only)
15		X	X	S	156.750		Commercial, non-commercial, ship movement (1 W)
16	X	X	X	S	156.800		International Distress, Safety and Calling
17	X	X	X	S	156.850		State Controlled (1 W)
18			X	D	156.900	161.500	Port operation, ship movement
18A	X	X		S	156.900		Commercial
19			X	D	156.950	161.550	Port operation, ship movement
19A	X			S	156.950		US: Commercial
19A		X		S	156.950		Coast Guard
20	X	X	X	D	157.000	161.600	Canadian Coast Guard Only, International: port operations and shipment
20A	X			S	157.000		Port operation
21			X	D	157.050	161.650	Port operation, ship movement
21A	X	X		S	157.050		U.S. Government Only, Canadian Coast Guard
22			X	D	157.100	161.700	Port operation, ship movement
22A	X	X		S	157.100		US and Canadian Coast Guard Liaison and Maritime Safety Information Broadcasts announced on channel 16
23		X	X	D	157.150	161.750	Public Correspondence (Marine Operator)
23A	X			S	157.150		U.S. Government Only
24	X	X	X	D	157.200	161.800	Public Correspondence (Marine Operator)
25	X	X	X	D	157.250	161.850	Public Correspondence (Marine Operator)
26	X	X	X	D	157.300	161.900	Public Correspondence (Marine Operator)
27	X	X	X	D	157.350	161.950	Public Correspondence (Marine Operator)
28	X	X	X	D	157.400	162.000	Public Correspondence (Marine Operator)

VHF MARINE CHANNEL CHART							
CH	U	C	I	S/D	TX	RX	CHANNEL USE
60		X	X	D	156.025	160.625	Public Correspondence (Marine Operator)
61			X	D	156.075	160.675	Public Correspondence (Marine Operator), Port operation, ship movement
61A	X	X		S	156.075		Public Coast: Coast Guard; East Coast: commercial fishing only
62			X	D	156.125	160.725	Public Correspondence (Marine Operator), Port operation, ship movement
62A		X		S	156.125		Public Coast: Coast Guard; East Coast: commercial fishing only
63			X	D	156.175	160.775	Public Correspondence (Marine Operator), Port operation, ship movement
63A	X	X		S	156.175		Port Operation and Commercial. VTS in selected areas.
64		X	X	D	156.225	160.825	Public Correspondence (Marine Operator), Port operation, ship movement
64A	X	X		S	156.225		Public Correspondence (Marine Operator), Port operation, ship movement
65			X	D	156.275	160.875	Public Correspondence (Marine Operator), Port operation, ship movement
65A	X	X		S	156.275		Port Operations
66			X	D	156.325	160.925	Public Correspondence (Marine Operator), Port operation, ship movement
66A	X	X		S	156.325		Port Operations
67	X	X	X	S	156.375		US: Commercial. Used for Bridge-to-bridge com- muni-cations in lower Mississippi River. Inter-ship only, Canada: Commercial fishing, S&R
68	X	X	X	S	156.425		Non-commercial (Recreational)
69	X	X	X	S	156.475		US: Non-commercial (Recreational), Canada: Commercial fishing only, International: Inter-ship, Port operations and Ship movement
70	X	X	X	S	156.525		Digital selective calling (voice communications not allowed)
71	X	X	X	S	156.575		US, Canada: Non-commercial (Recreational), International: Port operations and Ship movement
72	X	X	X	S	156.625		Non-commercial (Inter-ship only)
73	X	X	X	S	156.675		US: Port Operations, Canada: Commercial fish ing only, International: Inter-ship, Port operations and Ship movement
74	X	X	X	S	156.725		US: Port Operations, Canada: Commercial fishing only, International: Inter-ship, Port operations and Ship movement
75	X	X	X	S	156.775		Port Operations (Inter-ship only) (1W)
76	X	X	X	S	156.825		Port Operations (Inter-ship only) (1W)
77	X	X		S	156.875		Port Operations (Inter-ship only) (1W)
77			X	S	156.875		Port Operations (Inter-ship only)
78			X	D	156.925	161.525	Public Correspondence (Marine Operator), Port operation, ship-movement
78A	X	X		S	156.925		Non-commercial (Recreational)
79			X	D	156.975	161.575	Port operation and Ship movement
79A	X	X		S	156.975		Commercial

VHF MARINE CHANNEL CHART							
CH	U	C	I	S/D	TX	RX	CHANNEL USE
80			X	D	157.025	161.625	Port operation, ship movement
80A	X	X		S	157.025		Commercial
81			X	D	157.075	161.675	Port operation, ship movement
81A	X			S	157.075		U.S. Government Only - Environmental protection operations.
81A		X		S	157.075		Canadian Coast Guard Only
82			X	D	157.125	161.725	Public Correspondence (Marine Operator), Port operation, ship movement
82A	X	X		S	157.125		U.S. Government Only, Canadian Coast Guard Only
83		X		D	157.175	161.775	Canadian Coast Guard Only
83			X	D	157.175	161.775	Public Correspondence (Marine Operator)
83A	X	X		S	157.175		U.S. Government Only, Canadian Coast Guard Only
84	X	X	X	D	157.225	161.825	Public Correspondence (Marine Operator)
85	X	X	X	D	157.275	161.875	Public Correspondence (Marine Operator)
86	X	X	X	D	157.325	161.925	Public Correspondence (Marine Operator)
87		X	X	S	157.375		Port operation, ship movement
87A	X			S	157.375		Public Correspondence (Marine Operator)
88		X	X	S	157.425		Port operation, ship movement
88A	X			S	157.425		Commercial, Inter-ship Only

NOTE: Simplex channels, 3A, 21A, 23A, 61A, 64A, 81A, 82A and 83A CANNOT be lawfully used by the general public in U.S.A. waters.

10. SPECIFICATIONS

Performance specifications are nominal, unless otherwise indicated, and are subject to change without notice.

10.1 GENERAL

Frequency Ranges:	156.025 MHz - 162.000 MHz
Channel Spacing:	25 kHz
Frequency Stability:	±5 ppm (-20 °C to +60 °C)
Emission Type:	16K0G3E
Antenna Impedance:	50 Ω
Supply Voltage:	7.4V DC, Negative Ground (Battery Terminal)
Current Consumption:	320 mA (Receive, Typical at AF MAX.) 50 mA (Standby) 1.6 A / 0.7 A (TX: 5 W / 1W)
Operating Temperature:	-20 °C to +60 °C
Case Size (W x H x D):	56 x 133 x 27.5 mm (w/o knob & antenna)
Weight (Approx.):	310 g (w/FNB-V105LI, Belt Clip, & Antenna)

10.2 TRANSMITTER

RF Power Output:	5 W / 1 W (@7.4 V)
Modulation Type:	Variable Reactance
Maximum Deviation:	±5 kHz
Spurious Emission:	Less than 0.25 μW
Microphone Impedance:	2 kΩ

10.3 RECEIVER

Circuit Type:	Double-Conversion Superheterodyne
Intermediate Frequencies:	1st: 21.7 MHz, 2nd: 450 kHz
Adjacent Channel Selectivity:	70 dB
Intermodulation:	68 dB
Hum & Noise Ratio:	40 dB
Sensitivity:	1 μV for 20 dB SINAD
Selectivity:	25 kHz (-70 dB)
AF Output (Internal SP):	700 mW @16 Ω for 10 % THD (@7.4 V)

Measured in accordance with EN301 178-2, EN300 698-3, EN301 843-2, EN60950-1

Declaration of Conformity

We, Yaesu UK Ltd. declare under our sole responsibility that the following equipment complies with the essential requirements of the Directive 1999/5/EC.

Type of Equipment:	VHF Transceiver
Brand Name:	STANDARD HORIZON
Model Number:	HX280E
Manufacturer:	Vertex Standard Co., Ltd.
Address of Manufacturer:	4-8-8 Nakameguro Meguro-Ku, Tokyo 153-8644, Japan

Applicable Standards:

This equipment is tested and conforms to the essential requirements of directive, as included in following standards.

Radio Standard:	EN 301 178-2
	EN 300 698-3
EMC Standard:	EN 301 843-2
Safety Standard:	EN 60950-1

The technical documentation as required by the Conformity Assessment procedures is kept at the following address:

Company: Yaesu UK Ltd.
Address: Unit 12, Sun Valley Business Park, Winnall Close
Winchester, Hampshire, SO23 0LB, U.K.

STANDARD HORIZON

Nothing takes to water like Standard Horizon

YAESU MUSEN CO., LTD.

Tennozu Parkside Building
2-5-8 Higashi-Shinagawa, Shinagawa-ku, Tokyo 140-0002 Japan

YAESU USA, INC.

6125 Phyllis Drive, Cypress, CA 90630

YAESU UK LTD.

Unit 12, Sun Valley Business Park, Winnall Close
Winchester, Hampshire, SO23 0LB, U.K.

YAESU HK LTD.

Unit 1306-1308, 13F., Millennium City 2, 378 Kwun Tong Road,
Kwun Tong, Kowloon, Hong Kong

Copyright 2012

YAESU MUSEN CO., LTD.

All rights reserved.

No portion of this manual
may be reproduced
without the permission of
YAESU MUSEN CO., LTD.



E M 0 3 8 N 2 0 6

Printed in China.