

Squatting guide

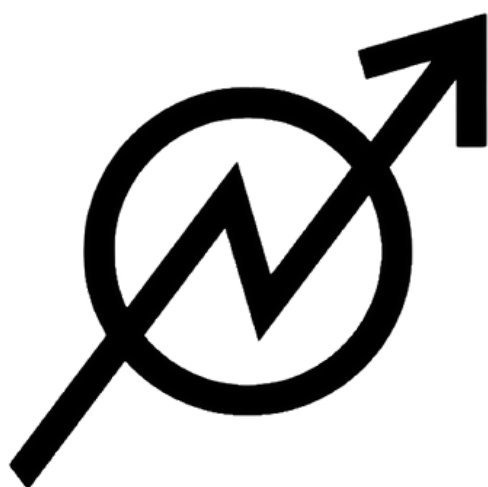

This guide is a short introduction to the different steps you can take when you want to squat a building in the Netherlands.

We decided to make a guide that does not go too much into detail. We want to keep it as straight to the point as possible. If you want more information you can go to your local Kraakspreekuur (squatting advice hour, more info on page 4) or look at the links that are at the end of the document.

This is just a compilation of how some people squat and have squatted (in Amsterdam) over the past few years. Now it is up to you to see what you want to take from this. You can always decide to do things differently. Squatting is a lot about trying, being flexible and finding creative solutions.

Good luck and have fun squatting your house !!!

A. Chose your house

1

- 1. Find an empty house**
- 2. Tag the building**
- 3. Go during the day**

B. Find our more information about the building

- 1. Who is the owner?**
- 2. How long has it been empty?**
- 3. Are there any plans with the building?**

C. Entering the building

- 1. Take a close look at the house and its surroundings**
- 2. Get your crew together**
- 3. Chose one method**
- 4. Action day**

D. Securing the house

- 1. House peace**
- 2. Barricading**

E. Reveal

- 1. What to have with you**
- 2. Important tasks**
- 3. The different things that can happen**

F. After the reveal

- 1. Occupying**
- 2. What happens legally?**

G. Annex

A. Choose your house



1. Find an empty house

Bike or walk around the city and look around to see if anything looks empty. Look out for broken or boarded up windows, places where lights are off, trash on or in front of the door.

2. Tag the building



This means that you slide a piece of paper between the door.

This allows you to know if someone entered the building. If someone opens the door, the tag will fall. Go several times during the next days, weeks, months in order to check if the tag is still there.

3. Go during the day

In order to be sure it is empty, you can go during the day. This allows you to see better inside, you can ring the bell and see if anyone opens the door.

B. Find out more information about the building

Once you found your empty house you will want to find as much information as you can about it.

To complete these steps you can go to your local Kraakspreekuur (KSU). They can help you to find, pay for and understand the information you will encounter.

In Amsterdam:

- KSU at Joe's Garage: Pretoriusstraat 43, 1092 EZ, Amsterdam Every Tuesday 19h to 20h30
- SKSU at Vrankrijk: Spuistraat 216: Every Thursday from 19h to 20h30

Check radar.squat.net to find a KSU in your city

When doing your research there are three main questions you need to keep in mind.

1. Who is the owner?

Eigendomsinformatie

ALGEMEEN

1 Kadastrele aanduiding: Apeldoorn A 1234

2 Locatie: Langelaan 49, 7311 LX APELDOORN

3 Grootte: 130 m²

4 Meest recent verschuldigd: Ja

5 Coördinaten: 594319 - 469446

6 Omgeving: Wonen

7 Koopprijs: € 310.000

8 Ontstaan uit: Apeldoorn A 1192

AANTEKENINGEN

9 Publiekrechtelijke beperking: Er zijn geen beperkingen bekend in de Basisregistratie Kadaster.

RECHTEN

10 Eigendom belast met Erfpacht (1.1)

11 Aandeel: 1/2

12 Aankomst uit stuk: Ingeachreven op 16-06-2007

13 Naam gerechtigde: De heer Jan Piet Hendriks

14 Burgerlijke staat: Getrouwd (ten tijde van verkrijging)

Where to find this information?

Check on kadaster.nl

What are you looking for?

The document you need is the Eigendomsinformatie. It costs 2,80 euros. You can buy it online and will receive it online.

Why do you need this information?

It is useful to know whether the owner is a person or a company. Maybe other people already know about this owner, have already squatted a house from this owner in the past.

The name of the owner and the date on which he bought the building

2. How long has it been empty?

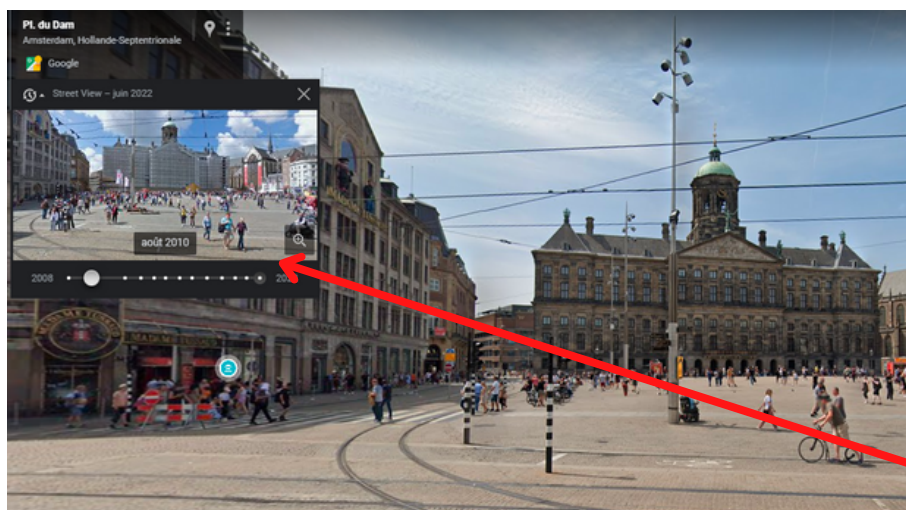

On your laptop, you can go on google maps, use the street view function and scroll back in time in order to see how building has changed. This can allow you to estimate how long it has been empty.

Here you can scroll back in time

3. Are there any plans with the building?

A building can be empty but maybe there are plans with it. Maybe the owner has permits in order to renovate it, demolish it etc.

You can find some of this information online :

- officielebekendmakingen.nl
- oozo.nl



C. Entering the building

1. Take a close look at the house and its surroundings

Questions to ask yourself, things to look out for

How many locks are on the door?	
What type of lock is it ?	<div style="display: flex; justify-content: space-around;">   </div> <div style="display: flex; justify-content: space-around; margin-top: 10px;"> rim lock mortice lock </div>
Are the locks actually locked?	Push the door in order to feel it or try feeling it with a door latch opening card that you slide between the door and the door frame..
Is there a lockbox?	<div style="display: flex; align-items: center;">  <div style="margin-left: 20px;"> <p>Example of a master lockbox. Sometimes keys are stored inside. This is the easiest way in.</p> </div> </div>
Is there a backdoor, are there windows accessible, is there a garden ?	The front door is not always the easiest way in.
Are there alarms or cameras around?	In this case you might want to be more careful, cover your face, or reconsider.

2. Choose one method

6

You can take pictures of the lock and all the other elements you consider as interesting or important.

Here is an overview and explanation of some of the techniques to break into the house. Some of them have been copied, inspired or translated from zines made by other groups. Of course, there are many more techniques! A more complete zine about breaking and lockpicking is in the making. Once it will be finished you will probably be able to find it at the same place where you found this zine :)

You can also go to the KSU. They can look at the pictures with you and give you advice, lend you tools.

Lockbox picking

How to open: Lockboxes with number wheels!
-the can technique-

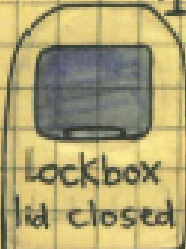

1. Lockbox lid closed

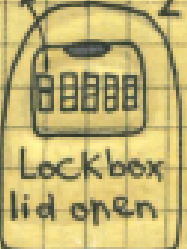

2. Lockbox lid open

a lockbox looks like this and often has 3-5 wheels with numbers that you can turn. There are a lot of different brands and they come in all shapes and sizes!



3.



4.

So, underneath the wheel with numbers there's another wheel that has a dent you can feel from the outside of the box with a tool. The dent corresponds with the right number of the code...!

5. Round off the tip.

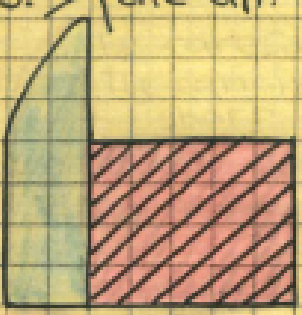

6.

for the tool: cut out a piece from a soda/beer can like in drawing #5. Wrap the straight, striped part around the coloured part to create a more secure handle. This is a guideline, see what works for you!

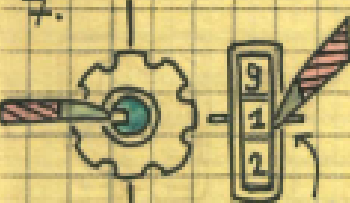

7.

you need to feel the dent in the middle

you need to insert the tip of the tool on the right side of the lockbox wheel and move it back and forth. Turn the number wheel one by one until you feel the dent. Do this for all the wheels. If you think you got it, push down the handle and tada! you just picked a lockbox.

1. Check the door

- What kind of door? *Wood or metal? Opens to inside or outside?*
- Is it a strong or weak door? *Push the door and feel if it moves in the base. Is there a big enough gap to fit a crowbar?*
- How many locks does it have and are they locked? *You can try feeling it with a door latch opening card that you slide between the door and the door frame.*
- Check for 3 point lock.
- Does it have an anti crowbar strip? *Lookout for a metal strip on the side of the door, on the side where it opens.*

2. Tools you need

You will need at least two people and two crowbars. Decide who uses which crowbar, and which one puts it first.

3. The technique

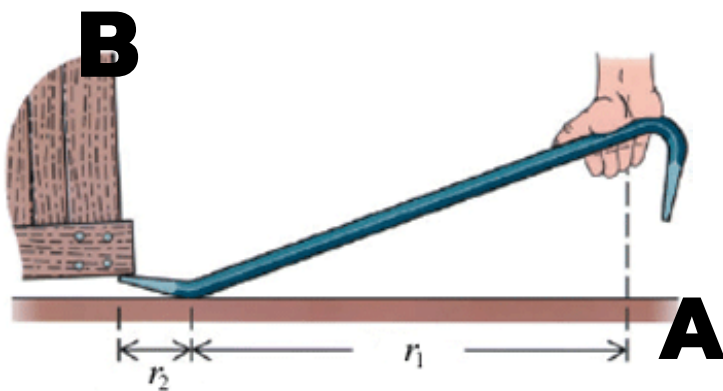

1. Push against the door with your foot to create a gap at the bottom.
2. Put the first crowbar like shown on the drawing. A is the door, B is the door frame. Press towards the door.
3. The gap will widen so that the second person can put the second crowbar above the first one.
4. Repeat this action and work your way up until you are as close as possible to the lock.
5. Use force until the door opens.

Cylinder breaking

1. Check the door

This technique can be used in the case where the lock is sticking out at least 1 or 2 cm.

2. Tools you need

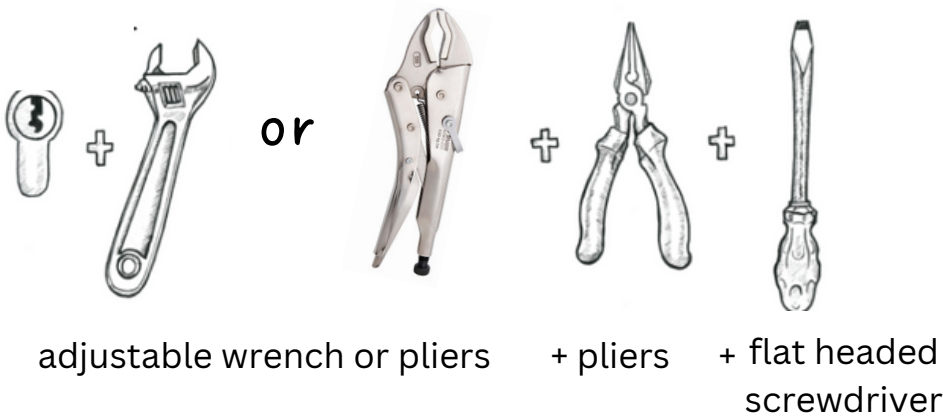

3. The technique

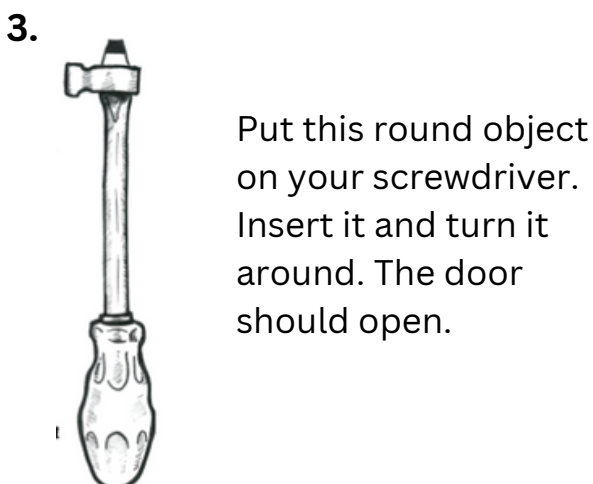
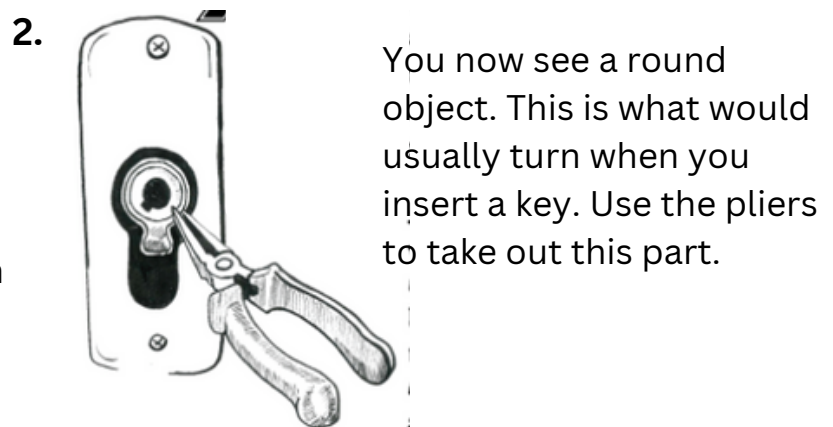
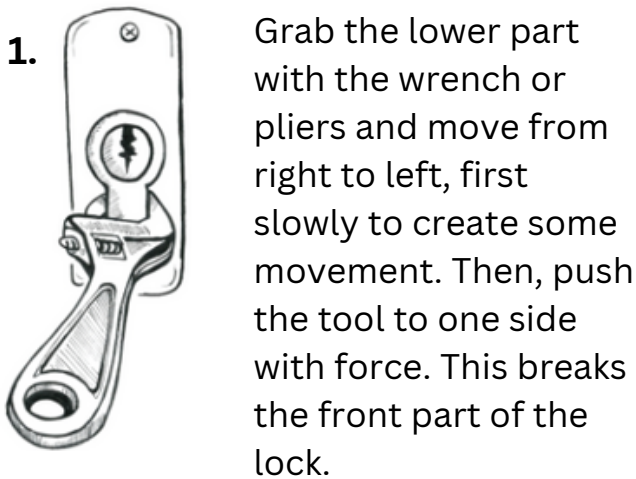

4. If it's a rim lock

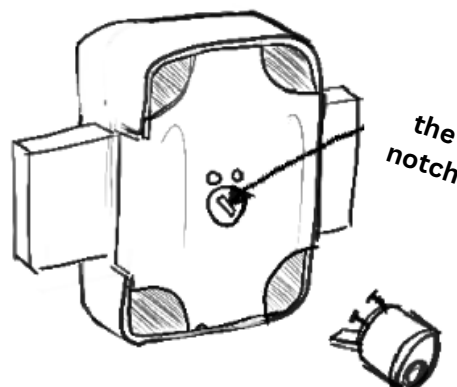

If it's a rim lock the last two steps are different. After breaking off the cylinder you will find a small notch. Put a flat headed screwdriver in the notch and turn it around. The door should open.

Cylinder pulling: Method 1

1. Check the door

This method works if the lock is not sticking out of the door.

2. Tools you need

The first method we are going to talk about requires a cylinder puller. This tool can only be owned by locksmiths so it can be a bit hard to access it. Sometimes they have it at the KSU so you can ask there. On the next page we will talk about an alternative method that does not require a cylinder puller.

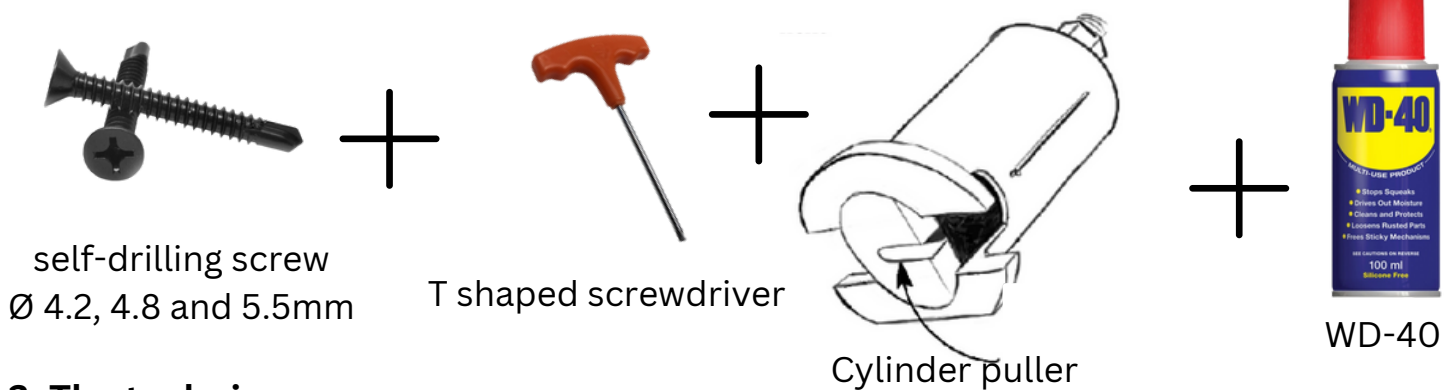

3. The technique

1. First, spray some WD-40 into the lock to reduce the amount of noise .

2. Then, insert a self drilling screw into the lock. Use the T shaped screwdriver to insert a few centimetres inside of the lock. The T shaped screwdriver gives you more force to do so. During this step you need to be careful. If you put the screw in too deep, the screw might break. If it is not deep enough, the lock might not break when you try pulling it.



Insert the screw here

3. Put the cylinder puller against the screw. The head of the screw needs to be in the notch of the cylinder puller.



Notch

4. Turn on the part that is sticking out of the cylinder puller (the part in black on the drawing). Turn it until you hear a cracking or until you see the lock falling on the floor.

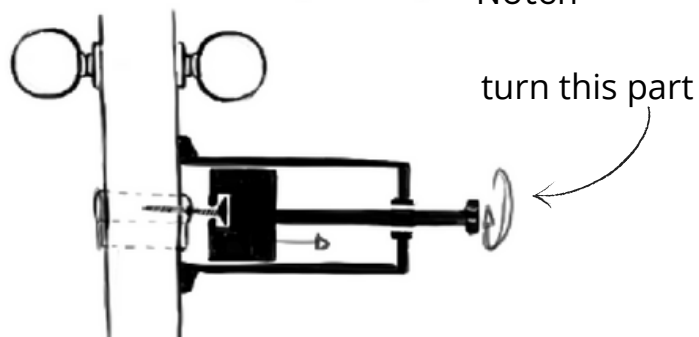

5. This is the same as part 2/3/4 from the previous technique.

Cylinder pulling: Method 2

1. Tools you need



WD-40

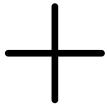

T shaped screwdriver

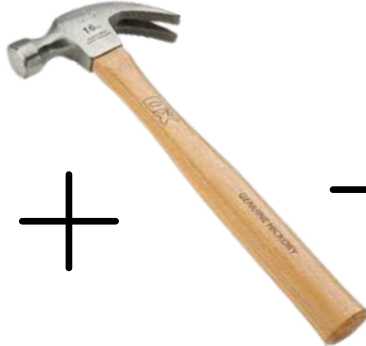
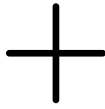

Hammer

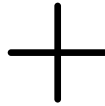
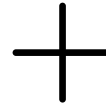
flat headed
screwdriver

Screw with red tip

2 The technique

1. First, spray WD-40 into the lock to reduce the amount of noise.

2. Then, insert a screw into the lock. Use either a self drilling screw or one of the screws with a red tip. Use the T shaped screwdriver to insert a few centimetres inside of the lock, until the end of the red tip. The T shaped screwdriver gives you more force to do so. During this step you need to be careful. If you put the screw in too deep, the screw might break. If it is not deep enough, the lock might not break when you try pulling it.



Insert the screw here

3. Once the screw is in deep enough, put the head of the screw in the notch on the back of the hammer.

put the screw here



4. Pull out the screw while trying to keep it as straight as possible. So do not pull down but towards yourself. What can help is to put a piece of wood between the door and the hammer so that the it stays straighter.

5. The lock should eventually break. Use methods 2/3/4 from the part "cylinder breaking" to open the door.

3. Get your crew together

You can always squat alone but it is safer, less stressful and more fun to do it together with people. Get in touch with other people who want to squat. This is something you can already have done before, it is always nicer to do all the research and work together with someone.

Once you got your crew together it is nice to divide the tasks for the action day. You will need:



1 or 2 breaker(s)	This is the person breaking open the door
Lookouts	1 or more people who check if no one is seeing the breaking happening. Look out for neighbours in the houses next door or in front, people passing in the street, cops.
A person going away with the tool bag	You don't want to be found with the tools. So once you finished opening the door it is important to have someone who can walk away with the tool bag and either put it back in a safe place or hide it.



4. Action day

A few points to keep in mind

At what time do you want to do the action?	It's nice to go by the street at different times of the night before the action day to check. Maybe there is a restaurant that closes late, or neighbours that never sleep. This is all important information to have in order to adapt your action.
Do you want to start occupying immediately?	If you suspect that there might be an alarm you might want to decide to enter, walk through the house once and then come back later. Or if the breaking made a lot of noise, and you're scared someone saw you, you can also wait for one or two hours, or come back the next day.

D. Securing the house

1. House peace

Some important information about how the Dutch law works around squatting. You can not just enter a building and the next day show to everyone that you squatted it. First you need to live there secretly for 24h to 3 days (or longer). After this period of time you get what is called “house peace”. This means that cops can not just suddenly come and kick you out. They need to start a court case in order to evict you.

<p>How do you get house peace?</p>	<p>In order to prove that you did actually live there for a few days, you need to take pictures of you doing “homely things”. You then post these pictures on a twitter account every two or three hours. Create a public twitter account especially for this purpose, and use a fake name. After the three days, when you reveal the house (see part 5 about the reveal) you can show the twitter pictures to the cops as a proof that you have been living in the house for a few days.</p>
<p>What do I post on twitter?</p> 	<p>Pictures of you cooking, cleaning, sleeping, reading. Make sure the street is visible and there are some elements showing that you are indeed inside of this particular house. Take a picture where you can see the open door and the number of the house. Don't forget to remove the metadata (there are apps for that that you can download in the app store) and don't forget to blur faces.</p>

2. Barricading







It is important to secure your house as soon as you enter it and start living in it. The way you barricade will depend on what you want to achieve.

A few questions to ask yourself in order to decide on your barricading technique:

- Who do I want to keep out? *Cops? Angry neighbours? An angry owner?*
- Do I want to get away if the cops say they are going to evict? *Then you just need barricading that is strong enough to keep them away while you escape.*

Here we are going to talk about the quick and easy barricades you can do.

Basic tools and stuff you need to have in order to get at least some protection. You can always do way more, by adding beams, wooden planks, metal or whatever else you find. Be creative and have fun!

Drill		
Screws		
Sliding bolts	To put on the doors. This will offer you additional strength or it can be the only barricade if there is one door you want to be able to open, in case that only door is your escape route!	
Long screws	To put diagonally between the door and the door frame	
Metal corners	To attach between the door and the ground or ceiling, or between the door and door frame.	
A lock	To change the lock. You can do that before, during, or after the action.	
Glue	To glue the lock you don't want to change	
Metal bits	To put between the door and door frame of doors you will not want to open. Or in the middle of double windows. Or just in general it's good to have with you in case you discover something you did not think of but need to barricade.	

E. Reveal

The day of the reveal marks the moment where you stop hiding and make public the fact that this house has been squatted. This happens after you stayed there for 24h to 3 days.

You could also decide not to reveal that you are a squatter. Either you find a building where you can live without anyone noticing that you live there, or you move in somewhere and pretend like you are renting. In this case there is no reveal. This might allow you to stay longer if no one finds out you live there, but you also have the constant risk that someone (owner, someone coming to check on the house) might show up at your door.

1. What to have with you

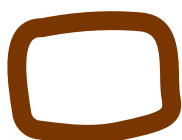

An **action bag** with tools and barricading material. You can also put the material inside of the house before the day of the reveal.

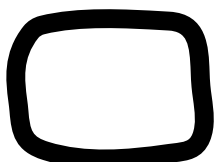

Kadaster: one copy inside, one copy with the police speaker outside



Police letter: one copy inside, one copy with the police speaker outside (see model for the letter on page 20)

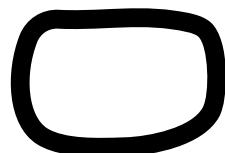

Printed twitter pictures: one copy inside, one copy with the police speaker outside

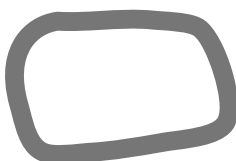

Bustcards: In case of arrest. Little cards with people's rights + name and number of the lawyer. See model on page 18

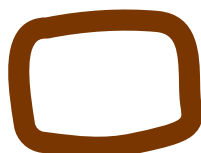

Banner: and neighbourhood letter: you can write a slogan or any message you want to share. This is a way to communicate that this house has been squatted. You can also write a letter where you introduce yourself to the neighbours/

2. People needed for the reveal

15

Inside crew	At least 2 people. They will be inside during the reveal. Their task is to barricade and drop the banner.
Police speaker	1 person. Their task is to ensure the communication with cops. They will provide them with the documents (kadaster, police letter, twitter pictures).
Arrest group	1 or more people. They are in touch with the lawyers and, in case of arrests, they keep track of the people who got arrested.
Outside contact	1 person. They are in constant communication with the people inside, the police speaker, the other people outside. They distribute the bustcards.
Lawyer	You can ask at the KSU if they know a lawyer whose number you can give to cops + that is on standby and could assist you in case of arrest. This lawyer could also represent you in a later stage.

3. The different things that can happen

During the reveal different scenarios can happen. Here is an overview of the possible outcomes:

Speed eviction: This means that cops evict you immediately, on the day itself, without starting a court case. They can use three reasons in order to speed evict:

- Heterdaad: "caught in the act". This means that they do not recognize your house peace and consider that they caught you in the act of breaking in
- Safety reasons: This means that they consider that the house is unsafe to live in (because of holes in the floor, walls etc.).
- The house is in use: This is used if they consider that the house is not empty but in use by someone.

Approval of the house peace: Cops approve your house peace and leave. This means that now the owner has to start a court case in order to evict you. Careful! It has already happened in the past that cops come back 24h after the reveal and still speed evict.

F. After the reveal

The reveal has happened, everything went well, cops left, what now ?

1. Occupying

During the first days we would advise you to have one or more people in the house by all times for at least the first 3 days.

- Why is that? *During the first days a lot of things can and will happen. Cops can come back, journalists can come by, neighbours, other squatters, people who are curious or want to help out, etc. It is nice to have someone who can deal with the people showing up and who is in touch with other people who are close by and could show up in case there is an emergency.*

2. After a few days

After a few days you can start moving in, fixing stuff, just start living. You can ask at the KSU or go by at other squats to ask for help if there are some things you need to fix. They can help you with it, lend you tools, teach you skills.

In order to find furniture you can look up online when the trash day of the neighbourhood is. Trash day is the day where people put the bulky waste in the street, for it to be picked up the next morning. This is a really good way to find nice furniture!

If you enter your postcode in this website you can find out about the trash day of your neighbourhood:

<https://www.amsterdam.nl/afval-en-hergebruik/afvalinformatie/afvalwijzer/>

2. Communicating

After the reveal you can post a statement on indymedia.nl to let other people know you squatted the building. Mention the date on which you squatted the place, the address, the name of the owner or company. This is useful for other people doing research in case they want to squat a building from the same owner.



3. What happens legally?

Getting arrested for squatting

Squatting is a Criminal act for which you can get arrested and go to court. Usually convictions result in fines, but the maximum sentence for squatting is one year of imprisonment, more if violence was involved.

Read about your rights in the bustcards that you can find on page 19 or in the "know your rights" flyer of the AFGA website (link on page 18).

The legal procedure in case you are threatened with eviction

If no speed eviction takes place, squats can get evicted either through a criminal procedure or a civil procedure.

- Civil procedure: This means that the owner starts a lawsuit. You will be informed of the court case through a letter.
- Criminal procedure: This happens after the owner pressed charges against the squatters. If the Public Prosecutor decides that he wants to evict the squat he needs to submit a request to a Judge Commissioner (Rechter Commissaris) who takes the final decision.
 - Temporality: From the moment when the Public Prosecutor submits the request to the Rechter Commissaris the court case can take place within three days.
 - Chances of winning: Squatting court cases are only rarely won
 - What happens when losing the court case: Eviction can be immediate or a few days can be given to leave the building
 - Appeal: Appeal is only possible after the eviction. There haven't been any cases where the squatters can return to the building but, if the appeal is won, it can still be helpful for future court cases.
 - Costs: Whether squatters win or lose the court cases there are no costs for the procedure. You will only need to pay your lawyer.

Annex

Important links

<https://radar.squat.net/en>

To find all about the events organized in the city. There you can find out about the time and place of the KSU for example

<https://planet.squat.net/>

Autonomous media platform

<https://joesgarage.nl/>

Website of the squatted social space Joe's Garage. On their website you can find squatting manuals, news and events.

<https://www.indymedia.nl>

Autonomous media platform where everyone can publish their statements or other news. Open publication.

<https://astudentstruggle.noblogs.org/files/2023/02/How-to-live-for-free-zinemade8.pdf>

A zine on how to live for little money. You will find tips specific to Amsterdam but also just in general.

<https://afga.noblogs.org/>

Website of Anarcha-feminist Group Amsterdam. There you can find, among other things, the template of the bustcard and flyers with your rights

<https://joesgarage.nl/wp-content/uploads/joe2/2020/11/kraakhandleiding2015.pdf>

Squatting manual written in 2015. In Dutch!

<https://joesgarage.nl/wp-content/uploads/joe2/2020/11/rotterdamse-kraakhandleiding-2020.pdf>

Squatting manual written by the KSU Rotterdam. In Dutch !

Know your rights if you get arrested

Always say **NO COMMENT**. You do not need to answer questions.

DO NOT sign anything.

DO NOT accept a caution or fine. This is an admission of guilt.

You have the **right** to:

- Stay anonymous.
- Medication.
- Vegan/vegetarian/halal/kosher food.
- Have an interpreter present.
- Be searched by a police officer of the same sex stated in your passport.
- Talk to your own lawyer, tell the police you want to speak to your lawyer. We advise:

Number of your lawyer

Met het verzoek deze brief te verstrekken naar de Officier van Justitie.

Bewoners **ADRESS (STREETNAME + NUMBER)**

FULL ADDRESS (STREETNAME + NUMBER + POSTAL CODE + CITY)

Openbaar Ministerie

Arrondissementsparket Amsterdam

tav de (Hoofd) Officier van Justitie

IJdok 163, 1013 MM, Amsterdam

Betreft: heringebruikname **FULL ADDRESS**

Geachte Officier van Justitie,

Door middel van deze brief willen wij u op de hoogte stellen van de heringebruikname van het leegstaande pand op de **ADRESS + CITY** Het pand is ongebruikt, staat al geruime tijd leeg, en is onderhevig aan gebrekkig onderhoud. Wij hebben huisvrede, en daarmee huisrecht, gevestigd in het pand, door hier sinds **DATE SINCE WHICH YOU OCCUPY THE BUILDING** te wonen. Deze twitter timeline met foto's en tijdsindicaties zal dit ook bevestigen:

LINK TO THE TWITTER

Zoals u ongetwijfeld niet ontgaan zal zijn, zit Amsterdam in het heetst van de landelijke wooncrisis. Sociale huurwoningen worden verkocht, bestaande wijken gesloopt of gerenoveerd, en de wachtlijsten lopen alleen maar op. Tijdelijke huisvestingscomplexen worden jaren langer gebruikt dan ooit bedoeld, met gevaarlijke situaties zoals het instorten van het dak op startblok Riekerhaven als gevolg. In deze omstandigheden willen wij onszelf genoodzaakt huisrecht zelf te vestigen, als het alternatief thuisloosheid is. Nu het pand op de **ADRESS** al lange tijd leeg staat, en niet binnen afzienbare tijd gebruikt zal worden voor bewoning, hebben wij ervoor gekozen ons hier te vestigen, en zonderdeel te zijn van de oplossing voor het huisvestingsprobleem.

Bij het vestigen van het huisrecht in dit pand hebben wij geen schade toegebracht aan het huis en/of toebehoren. Voorts hebben wij geen strafbare feiten gepleegd, en is ook geen gevaar ontstaan door bewoning voor onszelf en/of derden. Het pand is brandveilig en voldoet reeds, of na minimale inspanning, aan de geldende eisen voor brandveiligheid bij bewoning. Wij maken van dit pand ons thuis, en zullen het dus ook als goed huisvader gebruiken en onderhouden waardoor geen waardevermindering kan optreden voor de eigenaar. Wij nemen graag kennis van alle handelingen van de eigenaar om langdurige leegstand tegen te gaan en zullen hier te goeder trouw aan meewerken.

Indien u, de Officier van Justitie, voornemens bent tot een strafrechtelijke ontruiming over te gaan, delen wij u mede dat de bevoegdheid tot ontruiming naar het oordeel van de Hoge Raad (LJN: BQ9880), in navolging van het Hof 's Gravenhage (LJN: B03682), met de 'Wet Kraken en Leegstand' van 1 oktober 2010 niet gegeven is. Wij gaan er derhalve dan ook van uit dat u, conform kenbaar gemaakt beleid van het landelijk parket (Staatscourant 2010 nr. 19500) niet tot ontruiming over zal gaan alvorens dit voornemen schriftelijk aan ons kenbaar te maken, en ons de mogelijkheid is geboden deze maatregel te laten toetsen op proportionaliteit door de rechtspraak. Wij verzoeken u, tot een eventuele uitspraak van de rechter, ons huisrecht te eerbiedigen, met inachtneming van de toepasselijke wet- en regelgeving, waaronder het Wetboek van Strafvordering en de Algemene Wet op Binnentreden.

In afwachting van uw spoedige reactie,

De nieuwe bewoners van **ADRESS**