

# Is a Back Radiation Greenhouse Effect of 33 Kelvin Possible?

Ross McLeod  
7 February 2019

PRINCIPIA  
SCIENTIFIC



International

This was published as a PROM paper in 2017  
See [Principia-scientific.org](http://Principia-scientific.org) under  
'SUPPORT/NEWS' 'HOW THE PROM PROCESSWORKS'

## **Is a Back Radiation Greenhouse Effect of 33 Kelvin Possible?**

Ross McLeod, Assoc. Diploma Health Surveying, B. Tech. (Engineering)

May 29 2013

Rewritten May 31 2017

### **ABSTRACT**

This paper seeks to establish if the claim for a “back radiative greenhouse effect” resulting from an arithmetic sum of the power of 2 discrete sources of radiation can be demonstrated by simple experiment.

This principle is fundamental to the claims made about the back radiative “greenhouse effect”.

This paper uses a simple experiment which is based on a model from the University of Washington online lecture notes. This model is quoted widely as the scientific basis for the greenhouse effect.

The results lead to the obvious conclusion that the arithmetic sum of 2 discrete sources of radiant energy cannot be used to calculate a valid temperature using the Stefan- Boltzmann equation in the manner claimed by climate science introductory lectures as taught in University.

Obviously this has important ramifications for many of the claims about future temperature increases, the ability to even make such predictions and the relevance of any computer program where this untested hypothesis is used in the source code.

To the author’s knowledge the affirmation of the claim has not been performed before. Extensive internet searching failed to locate any reference to this experiment having been undertaken previously.

As the claim is fundamental to contemporary climate science the fact it has never been verified is simply astounding.

This paper is not disputing any of the well-established scientific laws of radiative physics.

It is simply questioning a previously untested hypothesis that cannot be claimed as a fundamental truth stemming from the work of the physicists that established these scientific laws.

I believe it is demonstrated as invalid.

# **Is a Back Radiation Greenhouse Effect of 33 Kelvin Possible?**

## CONTENTS

1. The basic claim for the Greenhouse Effect.
2. Experimental Procedures.
3. Experimental Results.
4. Criticisms of the experiment.
5. What is a reasonable approximation for the value of the radiation incident on the thermometer?
6. What about conduction and convection?
7. References.
8. Appendix of photographs.

## Is a Back Radiation Greenhouse Effect of 33 Kelvin Possible?

### 1. The basic claim for the Greenhouse Effect.

The “greenhouse effect” is credited with raising the Earth’s theoretical temperature of about 255 Kelvin or about minus 18 degrees C to the “observed average” of about 288 K or about plus 15 degrees C.

Here is Wikipedia’s definition of the “greenhouse effect”:-

*“The **greenhouse effect** is a process by which thermal radiation from a planetary surface is absorbed by atmospheric greenhouse gases, and is re-radiated in all directions. Since part of this re-radiation is back towards the surface and the lower atmosphere, it results in an elevation of the average surface temperature above what it would be in the absence of the gases.”*

Below is just **one of numerous examples** of how the basic “physics” of the “greenhouse effect” is taught in Universities - [http://www.atmos.washington.edu/2002Q4/211/notes\\_greenhouse.html](http://www.atmos.washington.edu/2002Q4/211/notes_greenhouse.html).

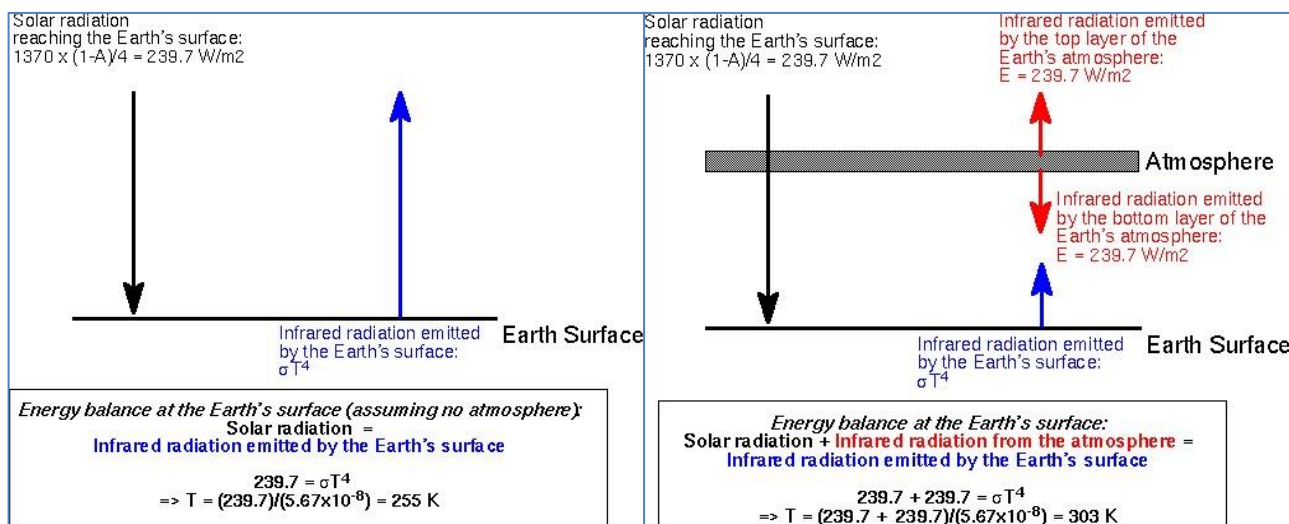

Figure 1.

The “greenhouse effect” is claimed to be caused by radiation absorbed by greenhouse gases. This heats the gases so that they radiate a portion of this energy back to the Earth’s surfaces causing additional heating of the surfaces instead of the circumstances established where this energy simply escapes to space.

Another claim as illustrated in the diagrams is that it is valid to sum various individual irradiative fluxes arithmetically and use that result to calculate a temperature from the Stefan-Boltzmann equation.

The Stefan-Boltzmann equation is accepted as a scientific law of physics and is widely used in climate science.

The simple model illustrated by the diagrams and the text of the lecture unambiguously makes the following assertions:-

- The atmospheric “back radiation” has the equivalent heating power as the solar radiation !

**This is obviously not true !**

If this were true then it would be possible to induce a higher temperature in an object by collecting and focusing the “back radiation” as is obviously possible with the solar radiation.

## Is a Back Radiation Greenhouse Effect of 33 Kelvin Possible?

b. Spectral considerations do not matter !

**This is obviously not true !**

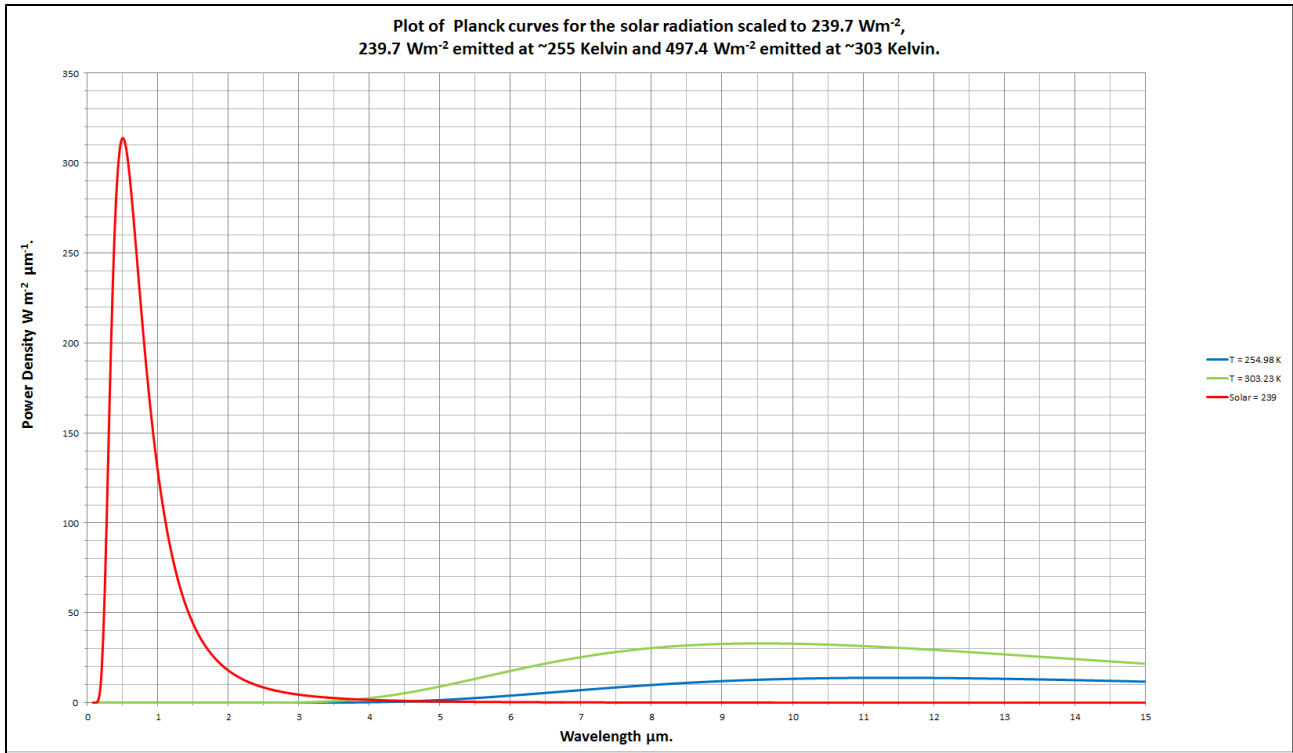

Figure 2

I cannot even imagine just how one would add up such dissimilar quantities as the red curve and the blue curve.

The red curve is a Planck curve for 5778 Kelvin – the Sun - scaled by the inverse square law to give the resulting  $P = 239.7 \text{ Wm}^{-2}$ .

The blue curve is  $239.7 \text{ Wm}^{-2}$  for the equivalent temperature  $\sqrt[4]{\frac{239.7}{\sigma}} = \sim 255 \text{ Kelvin}$ .

The green curve is  $479.4 \text{ Wm}^{-2}$  for the equivalent temperature  $\sqrt[4]{\frac{479.4}{\sigma}} = \sim 303 \text{ Kelvin}$ .

The University lecture is claiming that the green curve is the result of the sum of the red curve and the blue curve.

I am uncertain how one would verify this claim either theoretically or experimentally.

However, the claim that one can sum up discrete radiative fluxes and calculate the resulting temperature is widely accepted. Therefore according to this assertion **any** radiative emissions can be summed algebraically and the resultant temperature can be calculated !

Therefore it is possible to compare Planck curves and perform proper mathematical transformations on them provided the spectral range is similar and, as integrals are involved, one applies the rules of calculus. Every curve plotted in this paper uses the notation from “Spectralcalc” as listed in the references except that  $\pi$  is introduced in the equations used. This equates the area under the curve to  $\sigma T^4$ .

## Is a Back Radiation Greenhouse Effect of 33 Kelvin Possible?

- c. IT is valid to algebraically sum radiant emissions using basic algebra as taught in this University lecture. But is it and has it been demonstrated ?

Does  $239.7 + 239.7$  really equal  $\sigma T^4$  where  $T = \sim 303$  Kelvin ?

Is the Stefan-Boltzmann equation even the appropriate equation to attempt to perform such mathematical operations ?

Thermal radiant emission was a major challenge during the 19<sup>th</sup> century. The empirically derived Stefan-Boltzmann equation relates the total power emitted from a blackbody at the temperature of the body. The result was also derived theoretically.

The other empirically derived law was Wien's law which described the shift in wavelength, frequency etc. of the peak emissions with temperature.

However the only successful description of the spectral emission from a blackbody was derived by Planck.

**Only Planck's equation describes any radiant emission totally.**

Planck's Blackbody formula for spectral radiance in terms of wavelength in  $\mu\text{m}$  (using the nomenclature used in the reference from Spectralcalc) is:

$$L_{\lambda} = \frac{2 \times 10^{24} hc^2}{\lambda^5} \cdot \frac{1}{e^{10^6 hc/\lambda kT} - 1} \text{ Wm}^{-2}\text{sr}^{-1}\mu\text{m}^{-1} \quad (L_{\lambda} = \frac{2\pi \times 10^{24} hc^2}{\lambda^5} \cdot \frac{1}{e^{10^6 hc/\lambda kT} - 1} \text{ Wm}^{-2}\mu\text{m}^{-1}).$$

Wien's Displacement law is related to Planck's Blackbody formula where the derivative of  $L_{\lambda} = 0$ .

The Stefan-Boltzmann equation is related to Planck's Blackbody formula as pi times the integral of  $L_{\lambda}$ .

$$P_1 = \pi \int_0^{\infty} L_{\lambda} d\lambda = \frac{2\pi^5 k^4}{15 h^3 c^2} T^4 = \sigma T^4.$$

All of the plots shown use the value  $\pi \cdot L_{\lambda}$ . **Thus the area under each curve is numerically equal to  $\sigma T^4$ .**

The rules of calculus for integrals state:

- i.  $\int_a^b c \cdot f(x) dx = c \cdot \int_a^b f(x) dx$
- ii.  $\int_a^b f(x) \pm g(x) dx = \int_a^b f(x) dx \pm \int_a^b g(x) dx$

If  $P_1 (= 239.7\text{W/m}^2) + P_2 (= 239.7\text{W/m}^2) = 479.4 \text{ W/m}^2 = \sigma T^4$  is true, then the following is also equivalent and therefore true:

$$\pi \int_0^{\infty} L_{\lambda(T=254.98K)} d\lambda + \pi \int_0^{\infty} L_{\lambda(T=254.98K)} d\lambda = \int_0^{\infty} 2\pi \cdot L_{\lambda(T=254.98K)} d\lambda = 479.4 \text{ Wm}^{-2}$$

which of course is  $\sigma T^4$ .

The red curve is  $479.4 \text{ Wm}^{-2}$  for the equivalent temperature  $\sqrt[4]{\frac{479.4}{\sigma}} = \sim 303$  Kelvin.

## Is a Back Radiation Greenhouse Effect of 33 Kelvin Possible?

The blue curve is  $239.7 \text{ Wm}^{-2}$  for the equivalent temperature  $\sqrt[4]{\frac{239.7}{\sigma}} = \sim 255 \text{ Kelvin}$ .

The green curve is  $479.4 \text{ Wm}^{-2}$  which is the sum of  $239.7 \text{ Wm}^{-2} + 239.7 \text{ Wm}^{-2}$ .

The following graph shows the relationship.

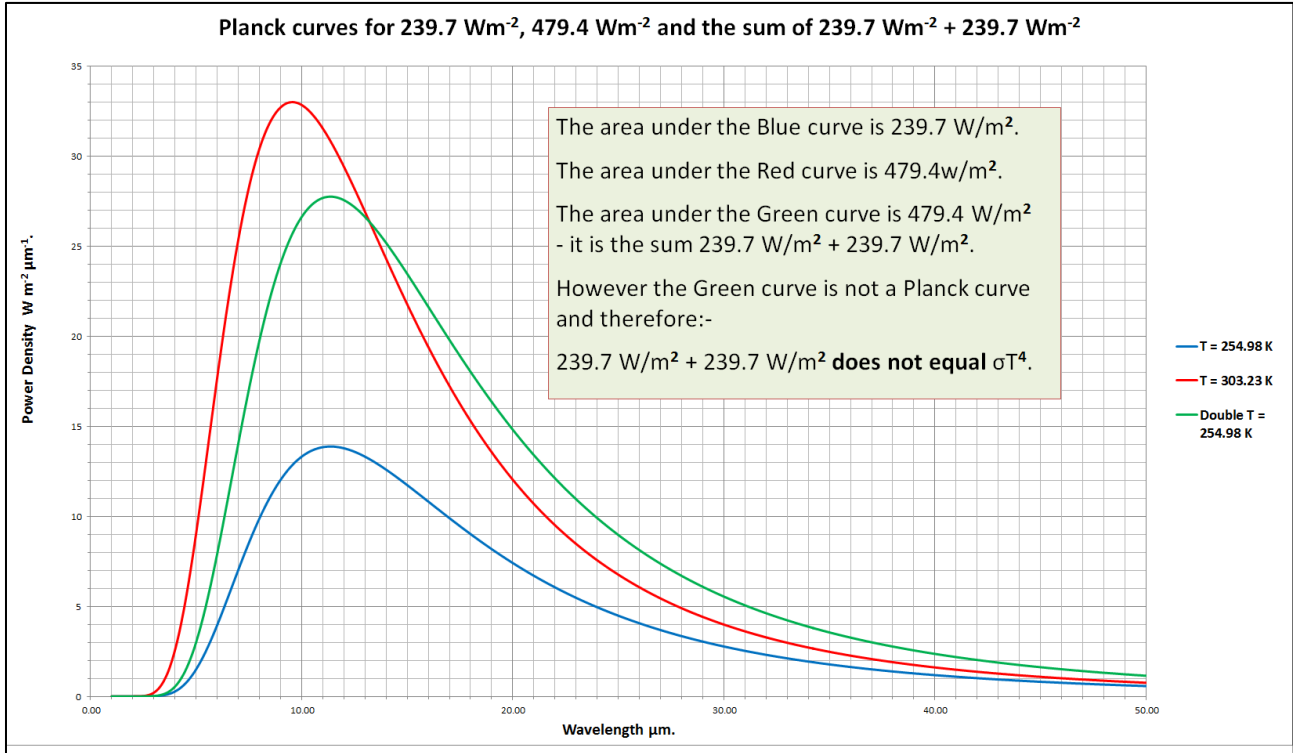

Figure 3

Every temperature used was calculated by the spreadsheet using this relationship. The value of a graphic is that in some circumstances it clearly demonstrates what a numeric equation cannot.

The expression  $P_1 + P_2 = 479.4 \text{ Wm}^{-2} = \sigma T^4$  completely fails to account for the other fundamental relationship inherent in radiation thermodynamics – **Wien's law** !

I make no claim as to what the sum represents but it clearly does not equate to any Planck curve. Unless there is some other relationship between the laws of radiant emission then a simple algebraic sum such as this does not equal  $\sigma T^4$ .

To further verify this it is possible to extract an expression for temperature from Planck's equation and use this to check the veracity of the relationship.

The expression for calculating temperature using the plotted Planck curves is

$$T_{\lambda} = \frac{10^6 hc}{\lambda k} \times \frac{1}{\ln\left(\frac{2\pi \times 10^{24} hc^2}{\lambda^5 L_{\lambda}} + 1\right)}$$

This may seem to be redundant, even ridiculous, but it demonstrates the fundamental flaw inherent in using simple algebra involving the Stefan-Boltzmann equation. The graphs produced by this are mathematically correct and illustrative !

## Is a Back Radiation Greenhouse Effect of 33 Kelvin Possible?

As is eloquently demonstrated the curves generated using a single temperature re-produce a curve with that temperature value at all values of wavelength (or frequency etc.) !

The curves for any algebraic sum do not – simple algebraic sums produce curves sweeping up whilst differences produce curves sweeping downwards.

However using the equation  $P_{\text{(net)}} = \epsilon A \sigma (T_o^4 - T_b^4)$  produces correct values as will be demonstrated in the analysis of the experimental data.

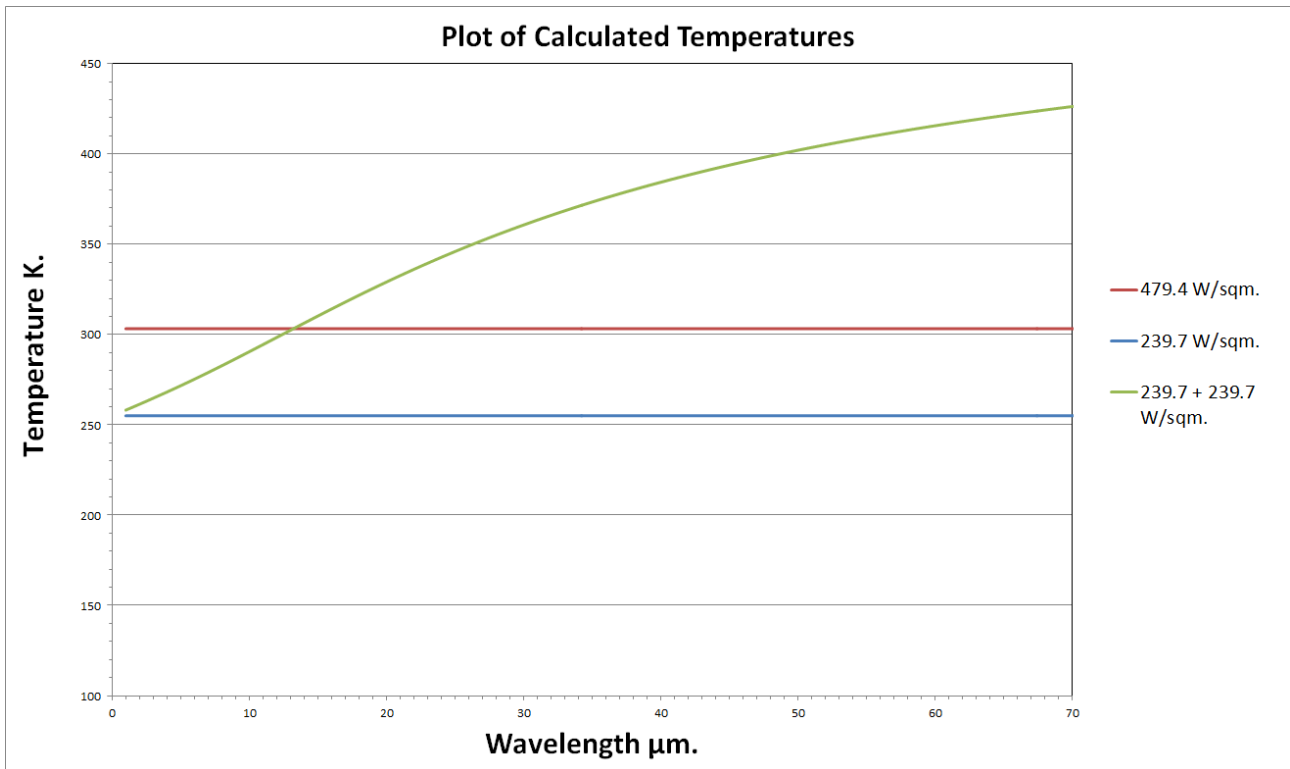

Figure 4

The “Blue” curve from Figure 3 calculated using the value of  $T = \sqrt[4]{\frac{239.7}{\sigma}} = \sim 255$  Kelvin produces a straight line at the value of  $\sim 255$  Kelvin in Figure 4.

The “Red” curve from Figure 3 calculated using the value of  $T = \sqrt[4]{\frac{479.4}{\sigma}} = \sim 303$  Kelvin produces a straight line at the value of  $\sim 303$  Kelvin in Figure 4.

Clearly the algebraic sum fails again – it cannot reproduce the correct curve for a temperature of 303 Kelvin in Figure 3 and it fails to reproduce this value when graphed in Figure 4.



## Is a Back Radiation Greenhouse Effect of 33 Kelvin Possible?

This graph shows the **real** relationship between radiative emissions for different temperatures. It is simply  $P_{\text{(net)}} = \sigma (T_o^4 - T_b^4)$ :-

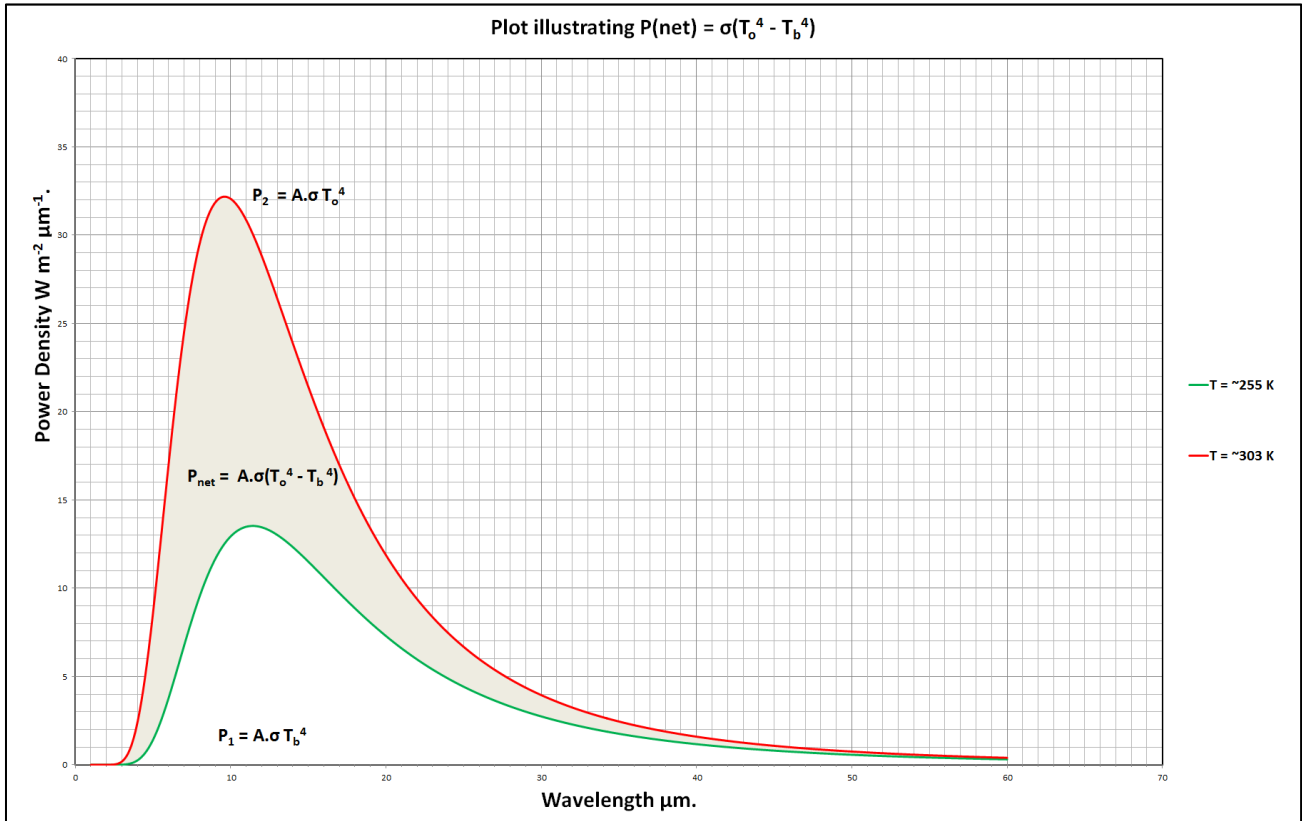

Figure 5

As is obvious the shaded area,  $P_{\text{(net)}}$ , is what is required to add to  $239.7 W m^{-2}$ , 255 Kelvin, to produce  $479.4 W m^{-2}$  at a temperature of 303 Kelvin.

The areas under the Planck curves,  $P = \pi \int_0^{\infty} L_{\lambda(T)} d\lambda = \sigma T^4$  extend from the wavelength axis to the curve while the shaded area is clearly the difference between the 2 curves for 255 and 303 Kelvin.

While this area has a value of 239 it has **no  $\sigma T^4$  value**, it is obviously the difference between 2 temperature curves, and using it as if it does, as is done in numerous "thermodynamic" analyses quoted to support the greenhouse effect, is simply incorrect.

This establishes the methods used to analyse the data I recorded during the experiment.

## Is a Back Radiation Greenhouse Effect of 33 Kelvin Possible?

### 2. Experimental Procedures.

The purpose of this experiment was to attempt to verify the claims made in the University lecture.

The experimental procedure could not be simpler. Anyone can replicate this experiment for themselves cheaply. The total cost was less than \$30 AU. I would have preferred more sophisticated equipment but the principle being tested does not demand it. The experiment took place on Friday 24 May 2014.

Spotlight 1 is positioned so it is capable of inducing a certain temperature in an object – the black tape on the thermometer. Spotlight 2 is positioned so it is capable of inducing a certain temperature in an object – the black tape on the thermometer.

Using the data produced – the temperatures – I calculate the black body emissions of the tape.

Analysis is performed using both the Stefan-Boltzmann equation and the technique shown above employing Planck curves.



Figure 6.

The results are unequivocal and contradict the claim shown in the University lecture and all of the simple models of the “greenhouse effect” !

I placed a simple thermometer on a simple stand. I placed some black tape over the bulb of the thermometer.

I used the thermometer to record the temperature each light could induce on its own. I placed a clock next to the thermometer to record time.

I placed each light individually in various positions until I was able to achieve a temperature response as shown by the thermometer. I allowed significant time until it appeared no further increase in temperature occurred.

Obviously I claim no real precision in measurements, my equipment is simple and not of the same standard as laboratory equipment, **but I do claim a fundamental principle is demonstrated.**

## Is a Back Radiation Greenhouse Effect of 33 Kelvin Possible?

I performed several experiments over a period of a week and the fundamental principle is verified every time.

I invite anyone to try this.

Whilst not as dramatic as heating a light bulb with mirrors or other similar flawed experiments it provides a real effect that is verifiable, provides real data and is based on simple sound scientific principles.

I used 2 spotlights with a rated electrical power of 150 W.

### 3. Experimental Results.

The experimental results are:

- a) The ambient air temperature was approximately 18° C or ~291.15 Kelvin.
- b) The heating effect of spotlight 1 on its own induces 30 °C or ~303.15 Kelvin.
- c) The heating effect of spotlight 2 on its own induces 36° C or ~309.15 Kelvin.
- d) The heating effect of spotlight 1 plus spotlight 2 induces 46° C or ~319.15 Kelvin.

The question is how to analyse these results.

The Stefan-Boltzmann equation calculates the total power of the radiant emission from an object at an observed temperature. It is an empirically derived equation confirmed by theoretical analysis. It has practical application in devices such as infra-red thermometers and is accepted science.

I did not know the values of the radiation emitted from the spotlights inducing the heating effect on the tape on the thermometer and I had no equipment to measure this.

But I could **calculate the emission from the tape** on the thermometer using the Stefan-Boltzmann equation and assume that the spotlights must be supplying this power.

The Stefan-Boltzmann equation is quoted in two forms:

$$P = \epsilon A \sigma T_o^4; \text{ and,}$$

$$P_{(\text{net})} = \epsilon A \sigma (T_o^4 - T_b^4).$$

Let  $T_o$  be the temperature of the object in question,  $T_b$  is the temperature of the “background”,  $A$  is the area of the object and  $\epsilon$  is the emissivity of the object. Temperature readings are simple as the thermometer is irradiated by the spotlights.

The calculated values are initially expressed in Watts.

Using this reasonable hypothesis I calculated:

- (i) At 291.15 Kelvin (18° C ambient air temperature) the tape is emitting ~407.5  $\epsilon A$  Watts.
- (ii) At 303.15 Kelvin (30° C temperature) the tape is emitting ~ 478.9  $\epsilon A$  Watts.
- (iii) At 309.15 Kelvin (36° C temperature) the tape is emitting ~517.9  $\epsilon A$  Watts.
- (iv) At 319.15 Kelvin (46° C temperature) the tape is emitting ~588.3  $\epsilon A$  Watts.

## Is a Back Radiation Greenhouse Effect of 33 Kelvin Possible?

### Emissivity – $\epsilon$ – is irrelevant.

This should be obvious as the object is the same in every case and hence any algebraic fraction is the same and cancels in all calculations. Further proof of this is evident by simple inspection of the graphs.

For example an  $\epsilon$  of 0.9, 0.8, 0.5 or whatever will simply reduce the value of each curve by that fraction and not change the net calculation relationships.

Back calculating T provides a challenge though.

If  $P = \epsilon A \sigma T^4$  then  $T^4 = P / \epsilon A \sigma$ , yet T curves plotted for simple algebraic sums or differences (multiplication or division) produce curves where T varies with wavelength, frequency etc.

### Area is irrelevant.

Again this is obvious as the object is the same in every case and hence any algebraic fraction is the same and cancels in all calculations.

Hence it is valid to use units of  $\text{Wm}^{-2}$  based on unit area in my analysis of the experimental results.

Applying the “net” form of the Stefan-Boltzmann equation:-

$$P_{(\text{net})} = \epsilon A \sigma (T_o^4 - T_b^4).$$

$$(i) \quad \text{At 303 Kelvin} - P_{(\text{net})} = \epsilon A \sigma (T_o^4 - T_b^4) = \epsilon A \sigma (303.15^4 - 291.15^4) = \sim 71.4 \epsilon A \text{ Watts.}$$

$$(ii) \quad \text{At 309 Kelvin} - P_{(\text{net})} = \epsilon A \sigma (T_o^4 - T_b^4) = \epsilon A \sigma (309.15^4 - 291.15^4) = \sim 110.5 \epsilon A \text{ Watts.}$$

$$(iii) \quad \text{At 319 Kelvin} - P_{(\text{net})} = \epsilon A \sigma (T_o^4 - T_b^4) = \epsilon A \sigma (319.15^4 - 291.15^4) = \sim 181.9 \epsilon A \text{ Watts.}$$

It surely cannot be coincidence that the final temperature measured, which was 319.15 Kelvin or  $\sim 46^\circ\text{C}$ , is able to be predicted by calculating the “net” emission at each initial temperature of  $\sim 30^\circ\text{C}$  and  $\sim 36^\circ\text{C}$  and adding these values to the background radiation emission due to ambient conditions!

Note this gives the correct result -  $\sim 407.5 + \sim 71.4 + \sim 110.5 = \sim 589.3$  which is equivalent to a temperature of  $\sim 319.28$  Kelvin or  $\sim 46^\circ\text{C}$  – a tiny fraction of a Kelvin difference !

To verify my calculations presented above I plotted the temperatures against wavelength to produce the Planck curves shown. Similar frequency and wavenumber Planck curves yield the same fundamental results.

I also plotted the value of  $\sim 407 \text{ Wm}^{-2}$  plus  $71.4 \text{ Wm}^{-2}$  plus  $110.5 \text{ Wm}^{-2}$ .

This expression represents, using the Stefan-Boltzmann equation and eliminating emissivity and area.

$$P = \sigma T_o^4 \text{ for } 18^\circ \text{ C } (\sim 407.5 \epsilon A).$$

$$\text{plus } P_{(\text{net})} = \sigma (T_o^4 - T_b^4) (\sim 71.4 \epsilon A).$$

$$\text{plus } P_{(\text{net})} = \sigma (T_o^4 - T_b^4) (\sim 110.5 \epsilon A).$$

That is:-

$$P_{(\text{sum})} = \sigma T_{291.15\text{K}}^4 + \sigma (T_{303.15\text{K}}^4 - T_{291.15\text{K}}^4) + \sigma (T_{309.15\text{K}}^4 - T_{291.15\text{K}}^4) = \sim 589.3 \text{ Wm}^{-2} \text{ at } \sim 46^\circ\text{C}.$$

# Is a Back Radiation Greenhouse Effect of 33 Kelvin Possible?

Planck Curves for Each Temperature and the Net Sum using  $P_{(net)} = \epsilon \sigma (T_o^4 - T_b^4)$

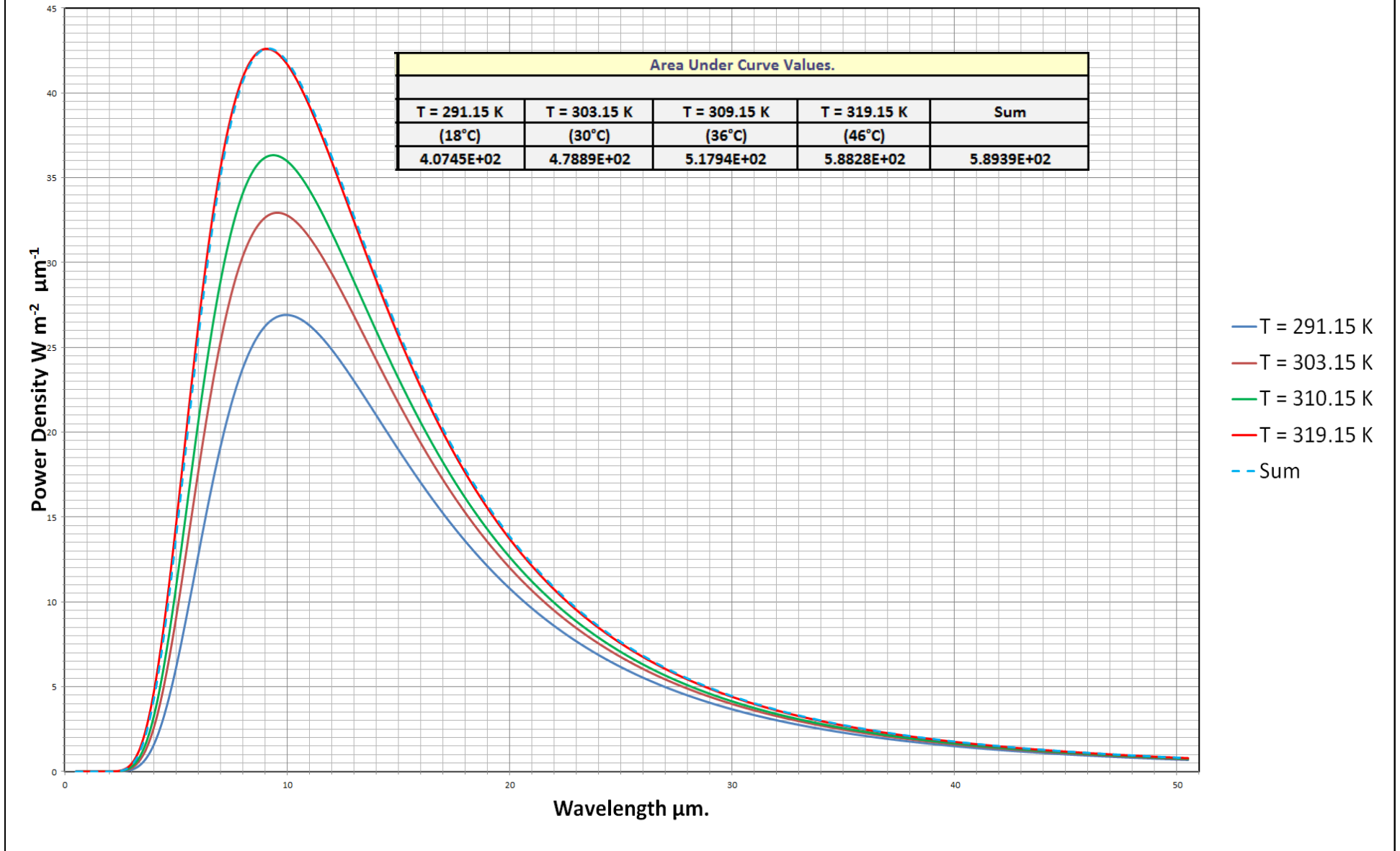
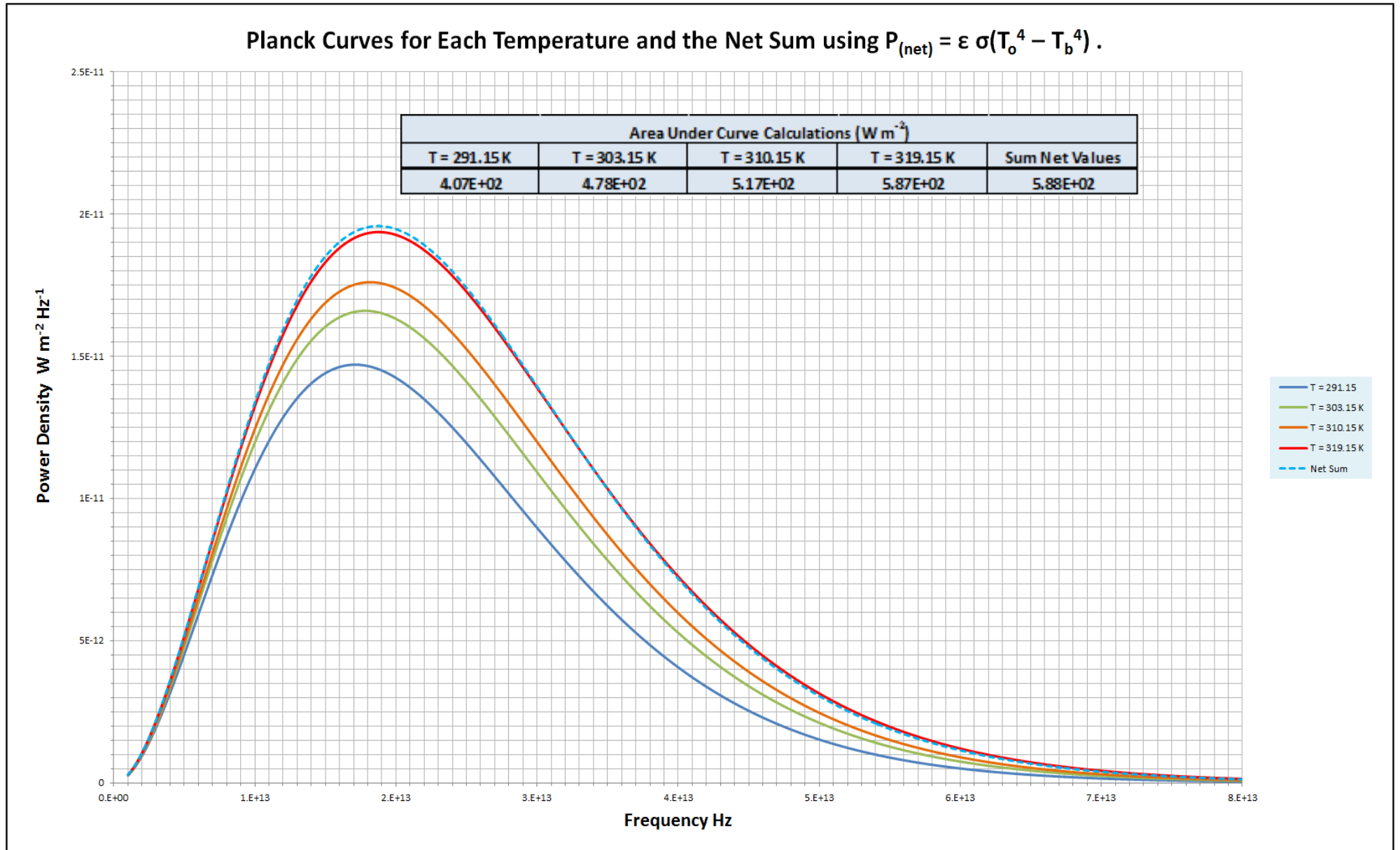
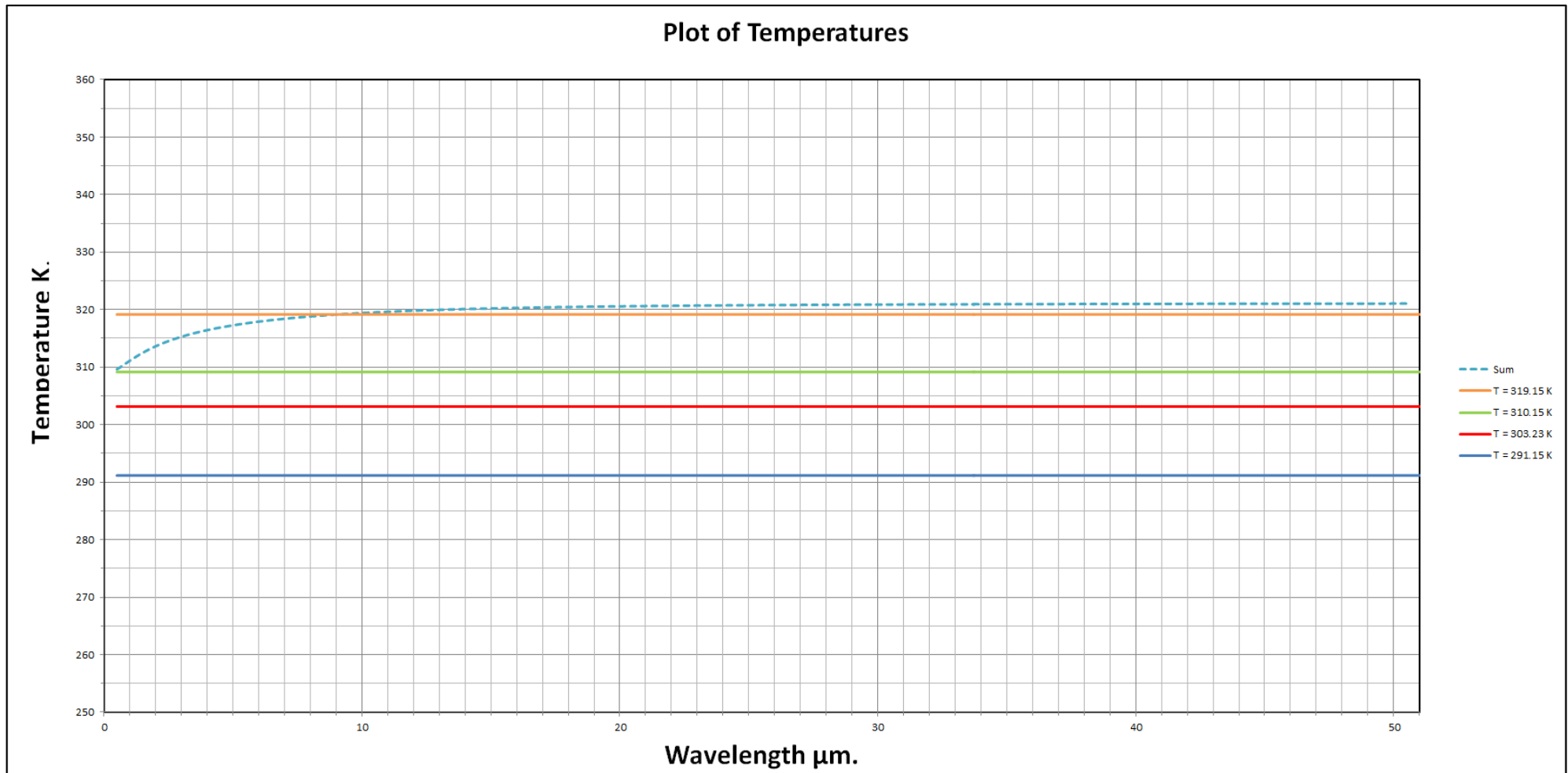

Figure 7

## Is a Back Radiation Greenhouse Effect of 33 Kelvin Possible?



## Is a Back Radiation Greenhouse Effect of 33 Kelvin Possible?



**Figure 9**

Figure 7 is a plot of  $\pi L_\lambda$  For the values of 18°C, 30°C, 36°C, 46°C and the sum of net values. Figure 8 is the same plot using frequency as the variable. Figure 9 is the plot of  $T_\lambda = \frac{10^6 hc}{\lambda k} \times \frac{1}{\ln\left(\frac{2\pi \times 10^{24} hc^2}{\lambda^5 L_\lambda} + 1\right)}$  for the various temperatures and the sum of net values. Compare the values in figure 9 with figure 4. Each plot in figure 9 shows a constant temperature. **The net sum value curve is revealing.** At low wavelength **only** the 309.15 K values are significant. As wavelength increases the 303.15K values increase and the dotted curve begins at 309.15 K and initially “climbs”.

## Is a Back Radiation Greenhouse Effect of 33 Kelvin Possible?

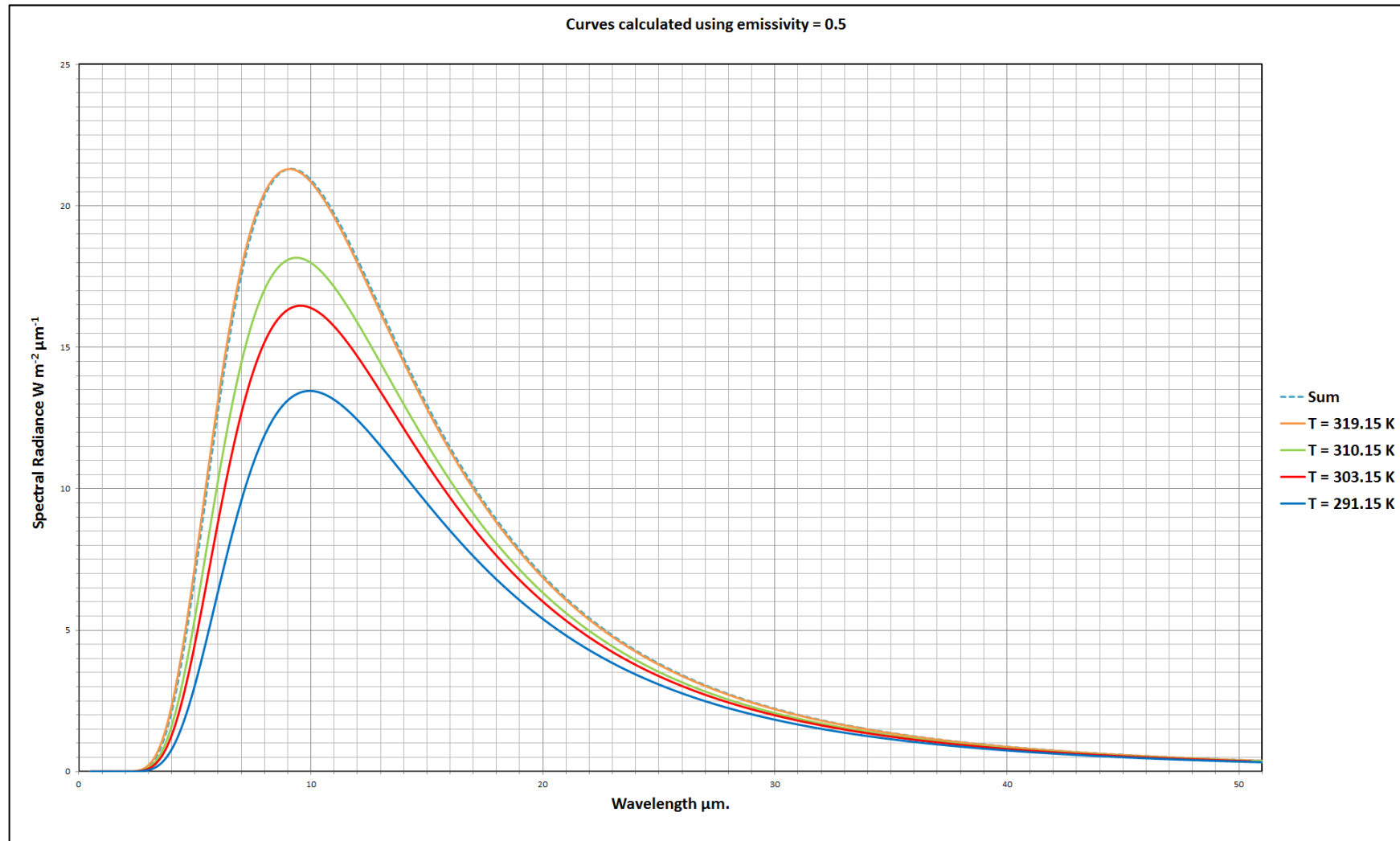

Figure 10

As is readily observable the relationship between each temperature curve **does not depend on emissivity**. Calculating the temperature using the Stefan-Boltzmann equation involves dividing the power by emissivity thus preserving the relationship as if one simply ignored emissivity.



## Is a Back Radiation Greenhouse Effect of 33 Kelvin Possible?

However, while applying emissivity of 0.5 to the Planck equation does not alter the ratios between the various temperatures and does not affect Stefan-Boltzmann equation calculations for temperature, calculating the temperature using the expression derived for temperature from Planck's equation produces strange results even though it obviously works for black body temperatures. What this means is debatable.

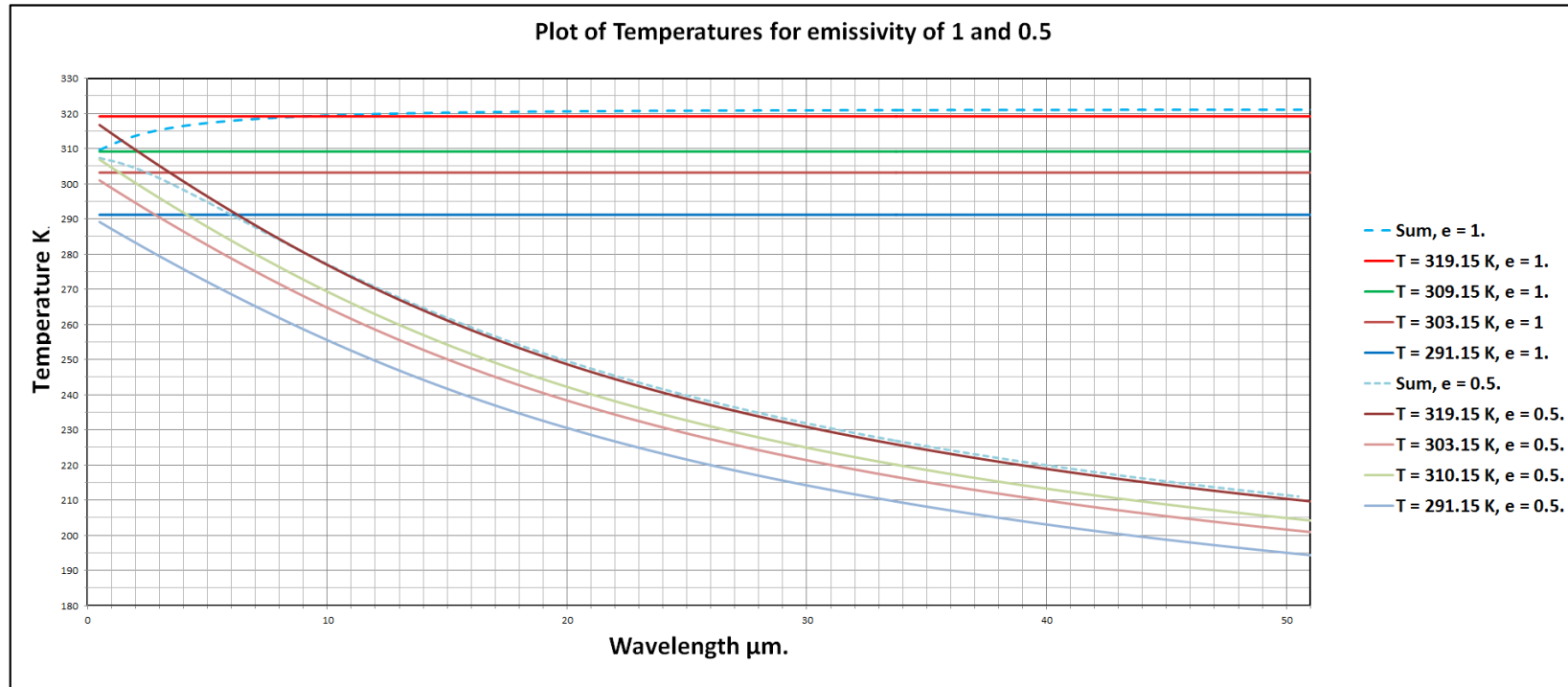

Figure 11

The graph shows, as has been shown previously, that algebraic sums, differences, multiples and quotients do not produce a constant temperature result. In the  $e = 1$  curves above the divisor is “corrected” to become the expression  $T_{\lambda} = \frac{10^6 hc}{\lambda k} \times \frac{1}{\ln\left(\frac{2\pi \times 10^{24} hc^2}{\lambda^5 2L_{\lambda}} + 1\right)}$ . Notice the “2” in the denominator which **transforms the  $e = 0.5$  to the  $e = 1$  curves shown at the top of the graph**. Calculating temperature using the Stefan-Boltzmann equation for emissivity of 0.5 requires that  $P = 0.5 \sigma T^4$  and  $T^4 = 2P / \sigma$ . Note that the factor of 2 **must go into the  $\ln()$  expression** – this is unequivocal - suggesting that treating emissivity as a simple algebraic manipulation **may** be incorrect.

## Is a Back Radiation Greenhouse Effect of 33 Kelvin Possible?

There is one further interesting point to this analysis that directly refutes the claim shown in the University lecture.

The data is:-

- |   |                   |
|---|-------------------|
| (1) $T_1$ = ambient air temperature         | = 18°C = 291.15 K |
| (2) $T_2$ = Spotlight 1 induced temperature | = 30°C = 303.15 K |
| (3) $T_3$ = Spotlight 2 induced temperature | = 36°C = 309.15 K |
| (4) $T_4$ = Combined Spotlights temperature | = 46°C = 319.15 K |

The analysis presented here **clearly** shows that (Figures 7 and 8):-

$$\sigma T_{(1)}^4 + \sigma(T_{(2)}^4 - T_{(1)}^4) + \sigma(T_{(3)}^4 - T_{(1)}^4) = \sigma T_{(4)}^4.$$

And we can write this in terms of radiation power per unit area - in  $\text{Wm}^{-2}$  as :-

$$P_{(1)} = \sigma T_{(T=291.15\text{ K})}^4 = \sim 407.5 \text{ Wm}^{-2}; \text{ and,}$$

$$P_{(2)} = \sigma T_{(T=303.15\text{ K})}^4 = \sim 478.9 \text{ Wm}^{-2}; \text{ and,}$$

$$P_{(3)} = \sigma T_{(T=309.15\text{ K})}^4 = \sim 517.9 \text{ Wm}^{-2}.$$

Therefore the expression above, which is equivalent to:-

$$P_{(1)} + (P_{(2)} - P_{(1)}) + (P_{(3)} - P_{(1)}) = P_{(4)}$$

which the experiment confirms **is true**.

Obviously this reduces to:-

$$P_{(2)} + P_{(3)} - P_{(1)} = P_{(4)} !$$

This result is clearly different to the claims made by people whose false “thermodynamics” result in higher temperatures because they misapply the Stefan-Boltzmann equation, to the assertions contained in the 2004 University lecture notes and is also “at odds” with the 2001 University lecture notes which clearly states:-

[http://www.atmos.washington.edu/2001Q1/211/notes\\_for\\_011001\\_lecture.html](http://www.atmos.washington.edu/2001Q1/211/notes_for_011001_lecture.html)

### ***“A multi-layer atmosphere***

*Suppose that we pile on another perfectly absorbing layer on top of the one that we've already considered. Using the short cut we infer that the radiation emitted from the top layer of the atmosphere must still be E; the radiation emitted upward from the bottom layer of the atmosphere must be equal to 2E and the radiation emitted from the surface must be 3E. It's not difficult to extend this simple analysis to additional layers.”*

**There you have it. Just add up any numbers you like in the wrong manner and teach that as science !**

## Is a Back Radiation Greenhouse Effect of 33 Kelvin Possible?

### 4. Criticisms of the experiment.

Many people have criticised this experiment and my analysis on many grounds.

- (i) Radiation calculations such as this are invalid except in a vacuum. (?)

This is ridiculous - for example Infra-Red thermometers work !

- (ii) Radiation calculations such as this are invalid except when observing a “cavity”.

Again, this is ridiculous.

- (iii) The spotlights are only 150 Watt and are incapable of supplying the power required for my analysis to be correct. Critics have asserted that each spotlight supplies only ~71 and ~110 “gross” flux not “net” and the University lecture is actually validated.

The only mechanism whereby this assertion could possibly be true is if the power emitted by the Spotlights is diminished by the Inverse square law.

Using 3000 Kelvin as the temperature of the spotlight filament it is emitting ~4.6 million  $\text{Wm}^{-2}$ . True, the emitting area of a filament is tiny.

I had always simply assumed if you heat something to a certain temperature you need to supply the energy necessary to force it past its initial temperature – i.e. supply sufficient energy to equal the value of the radiation it is already emitting plus the extra necessary to continue to heat it further.

Calculations to examine this possibility are shown later.

- (iv) It has no allowance for conduction and convection.

This is irrelevant.

- a. Firstly, the difference in either of these over the small range of temperatures is likely to have little variation and is therefore a “constant”; and,
- b. It is well accepted science that an object at temperature  $T_o$  emits  $P = \epsilon A \sigma T_o^4$  !

### 5. What is a reasonable approximation for the value of the radiation incident on the thermometer?

First I needed to establish some approximate distances and to do this I needed to find clues from the photographic record of the experiment. Reasonable approximations will suffice.

In the photo the thermometer is supported on a metal stand. The diameter of the base is ~12 cm.

The tape on the thermometer is therefore slightly less than 6 cm from the end of the plastic ruler and slightly less than 5 cm from the end of the metal tape.

The plastic ruler is 38 cm long. The end under the light is placed approximately where the filament is located. This distance – front of glass to filament - is approximately 5 cm.

## Is a Back Radiation Greenhouse Effect of 33 Kelvin Possible?



Figure 12

Thus the glass of the spotlight bulb in the background is approximately  $38 + 6 - 5 = \sim 39$  cm from the tape on the thermometer. Height adjustments in the distance calculations are clearly not an issue as any angle from the horizontal is tiny. Let's call it 40 cm.

The calculation for the spotlight in the foreground is more challenging. But there are some distinctive features on the tape.

First is the kink in the left hand side about halfway between the light and the stand. The second is the sequence of digits on the right hand side. If you zoom in you can identify single digits, two double digits and a red mark then another double digit.

These are 8, 9, 10, 11, 12(red mark) and 13 inch marks. The kink is at approximately 19 cm or about 7.5 inches.

This means this light is actually closer than the other but it is the light which heated to 30 degrees C.

So 40 cm is a reasonable estimate also.

Note that in the calculations that follow I use 45 cm, not 40 cm, to err of the side of being conservative.

The next piece of information we can gain is approximate angle of incidence.

The spotlight in the foreground is at about 45 degrees to the lines of the table while the spotlight in the background is at about 30 degrees to these lines – a view from another angle suggests these are reasonable.

## Is a Back Radiation Greenhouse Effect of 33 Kelvin Possible?

The final information comes from the manufacturer of the spotlight globes.

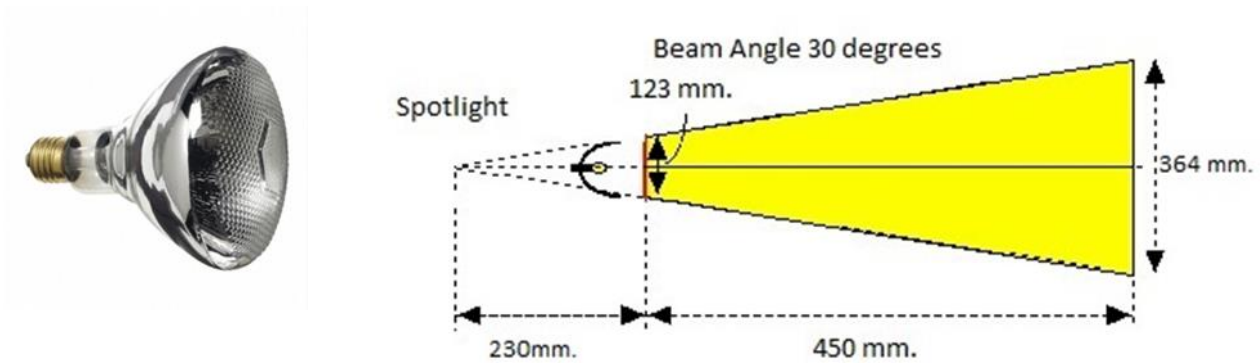

Figure 13

From the data sheet of the spotlight we have the following:-

Beam angle is 30 degrees.

Gross dimensions are 136 mm long x 123 mm lens diameter.

We solve for the distance from apparent point of origin to globe by "x" =  $61.5 / \tan 15 = 229.5$  mm - or ~230 mm.

We can calculate the solid angle of a cone with plane angle  $\theta$  using:-

$$\Omega = 2 \pi (1 - \cos \theta) \text{ sr.}$$

Beam angle is 30 degrees therefore  $\theta = 15$  degrees or  $\pi / 12$ .

$$\Omega = 2 \pi (1 - \cos 15) \text{ sr.}$$

$$\Omega = 0.214 \text{ sr.}$$

The radiant intensity  $I = P / \Omega = 150 / 0.214 = \sim 701$  Watts per steradian.

Note that 150 Watt over 1 steradian of **unit** area is 150 Watts per steradian equivalent to  $150 \text{ W/m}^2$ .

*("A steradian can be defined as the solid angle subtended at the centre of a unit sphere by a unit area on its surface. For a general sphere of radius  $r$ , any portion of its surface with area  $A = r^2$  subtends one steradian.*

*At 1 m radius the area of the sphere of 1 steradian is  $r^2 = 1 \text{ m}^2/\text{sr.}$ ")*

By definition at 68 cm ( $\sim 23 + \sim 45$ ) the area of the part of the sphere of 1 steradian is  $r^2$ .

$$A = 0.4624 \text{ m}^2/\text{sr.}$$

Therefore the power in  $\text{W/m}^2 = I/A = 701 \text{ (W/sr)} / 0.4624 \text{ (m}^2/\text{sr)}$

Therefore the power equals  $1516 \text{ W/m}^2$ .

This seems staggering but the mathematics and geometry do not lie. Of course it is the geometry which requires this result.

Alternatively, at 0.68 m the radius of the flat plane illuminated spot is approximately equal to  $0.68 \tan \theta$ .

## Is a Back Radiation Greenhouse Effect of 33 Kelvin Possible?

With  $\theta = 15$  degrees we have  $r = 0.182$  m.

Thus  $A = \pi r^2 = \pi (0.182)^2 = \sim 0.1041$  m<sup>2</sup>.

A sphere with radius 0.68 m has an area of  $4 \pi r^2 = 5.81$  m<sup>2</sup>.

Solid angle  $\Omega = (4 \pi) 0.1041$  m<sup>2</sup> /  $5.81$  m<sup>2</sup> = 0.225 sr.

$I = P / \Omega = 150 / 0.225 = 667$  W/sr.

And  $P/A = 150 / 0.1041 = 1441$  W/m<sup>2</sup>

(Of course this analysis isn't quite the same as the calculation immediately above but it is more intuitive. The calculation employing steradians should be more accurate.)

So let's analyse the values choosing to be conservative again.

At 30 C P emitted is  $\sim 478$  W/m<sup>2</sup>.

The angle of incidence of spotlight 1 to the tape on the thermometer is approximately 45 degrees. To supply 478 W/m<sup>2</sup> at an incident angle of 45 degrees requires 676 W/m<sup>2</sup> from spotlight 1 –  $478 / \cos 45$ .

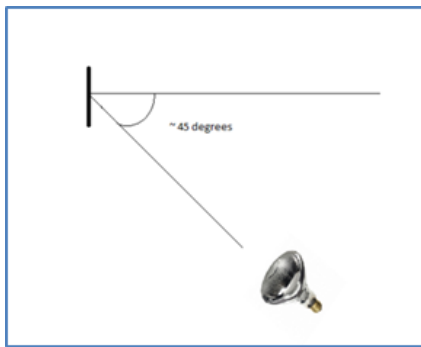

At approximately 45 degrees with power equal to 1440 W/m<sup>2</sup> the power **normal to the tape area** is approximately equal to  $1440 \times \cos 45 = 1018$  W/m<sup>2</sup>.

This is approximately 1.5 times 676 W/m<sup>2</sup>.

Critics have claimed this spotlight supplies a mere  $\sim 71$  W/m<sup>2</sup> and this validates their belief that the University lecture teaches the correct method for summing radiation and calculating temperatures.

Figure 14

I say that the claim the spotlight can provide a mere  $\sim 71$  W/m<sup>2</sup> is simply unbelievable!

Similarly for spotlight 2 we have similar power from the light of approximately 1440 W/m<sup>2</sup> at about 45 cm from the thermometer.

At 36 C P emitted is  $\sim 517$  W/m<sup>2</sup>.

Incident angle of spotlight 1 to the tape on the thermometer is approximately 30 degrees. To supply 517 W/m<sup>2</sup> at an incident angle of 30 degrees requires  $\sim 600$  W/m<sup>2</sup> from spotlight 2.

With angle of incidence approximately 30 degrees with power equal to 1440 W/m<sup>2</sup> the power normal to the tape area is approximately equal to  $1440 \times \cos 30 = 1247$  W/m<sup>2</sup> - more than double the requirement.

Critics have claimed this spotlight supplies a mere  $\sim 110$  W/m<sup>2</sup> and this validates their belief that the University lecture teaches the correct method for summing radiation and calculating temperatures.

I say that the claim this spotlight can provide a mere  $\sim 110$  W/m<sup>2</sup> is simply unbelievable!

## Is a Back Radiation Greenhouse Effect of 33 Kelvin Possible?

I only need to show there is sufficient power to support my theoretical analysis. Thus far it seems to be supportable.

### 6. What about conduction and convection?

This leaves the question of conduction/convection of the air in the room.

Obviously the tape is losing energy in this manner. It is also impossible for me to measure during the experiment.

So again I choose a reasonable approximation.

An experiment involving radiation cooling in a vacuum versus cooling in air suggests radiation alone is responsible for ~64% of the energy loss in “normal” air – i.e. still air with minimal forced convection.

<http://www.physics.ucc.ie/staff/Didfyz%20paper.pdf>

This means that at the temperatures in the experiment I conducted:-

$P_{e-s1}$  therefore equals approximately  $478 \text{ W/m}^2/0.64 = \sim 747 \text{ W/m}^2$  ( $\ll$  available  $1018 \text{ W/m}^2$ ); and,

$P_{e-s2}$  therefore equals approximately  $517 \text{ W/m}^2/0.64 = \sim 808 \text{ W/m}^2$  ( $\ll$  available  $1247 \text{ W/m}^2$ ).

We have already calculated there is ample power available to supply this power “demand”.

Also note that  $747/1018 \text{ W/m}^2$  represents ~73 % absorption and  $808/1247 \text{ W/m}^2$  represents ~65 % absorption of the potential available power from the spotlights.

The tape is black cloth tape and as such would probably have a high absorption co-efficient.

The percentages also allow for a significant “wastage” of power through “spread” of the beam – the light produces a circle of illumination with a central bright spot with a much larger circle of significantly lower illumination levels surrounding it.

There is more than enough power available to support my claim that calculating a temperature using the Stefan-Boltzmann equation by a simple sum of “gross” discrete fluxes does not represent reality.

Simple experiment falsifies this claim!

Calculating the “net” power is not only correct theoretically but gives realistic results which are supportable by simple experiment.

The only variable measured is the temperature and the only power calculated is radiation emitted at that temperature using standard accepted science.

### 7. References.

- (1) <http://www.spectralcalc.com/blackbody/CalculatingBlackbodyRadianceV2.pdf>
- (2) [http://www.atmos.washington.edu/2002Q4/211/notes\\_greenhouse.html](http://www.atmos.washington.edu/2002Q4/211/notes_greenhouse.html)
- (3) [http://www.atmos.washington.edu/2001Q1/211/notes\\_for\\_011001\\_lecture.html](http://www.atmos.washington.edu/2001Q1/211/notes_for_011001_lecture.html)
- (4) <http://en.wikipedia.org/wiki/Steradian>

## Is a Back Radiation Greenhouse Effect of 33 Kelvin Possible?

- (5) <http://www.physics.ucc.ie/staff/Didfyz%20paper.pdf>
- (6) <http://www.crompton.com.au/catalog/trade/lamps/incandescent-lamps/p/products/soft-glass-par38-lamp>
- (7) [http://omlc.org/classroom/ece532/class1/intensity\\_flashlight.html](http://omlc.org/classroom/ece532/class1/intensity_flashlight.html)
- (8) [https://en.wikipedia.org/wiki/Stefan–Boltzmann\\_law](https://en.wikipedia.org/wiki/Stefan–Boltzmann_law)



## Is a Back Radiation Greenhouse Effect of 33 Kelvin Possible?

### 8. Appendix of photographs.



Figure 15

This photo above was taken at the conclusion of the experiment and illustrates the procedure.



Figure 16

These photos show spotlight 1 heating the thermometer to 30 degrees C or about 303 Kelvin. As can be clearly seen the time is 10:17 am and the thermometer is reading 30 degrees C.

## Is a Back Radiation Greenhouse Effect of 33 Kelvin Possible?

The fact that it is the light on the left is demonstrated by the illumination on the left hand side of the tape on the thermometer although the whole of the tape is obviously illuminated.

The position to achieve this temperature had already been carefully determined.

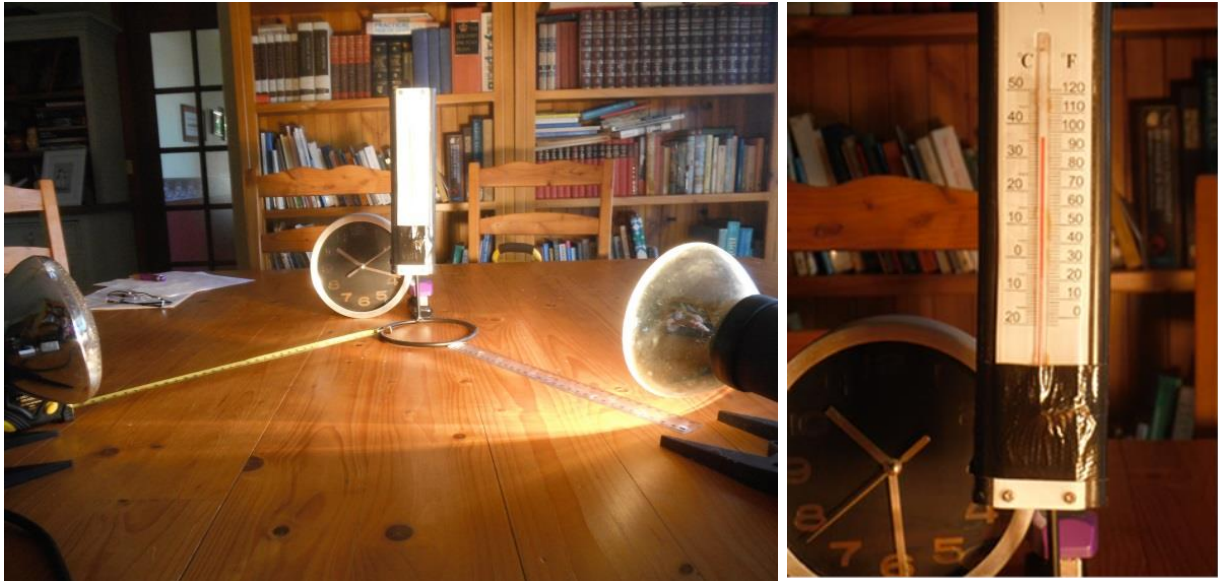

Figure 17

Then I turn off light 1 and turn on light 2. The time is approximately 10:19 am.

This series shows spotlight 2 heating the thermometer to 36 degrees C - ~309 Kelvin.

As can be clearly seen the time is 10:29 am and the thermometer is reading 36 degrees C.

The fact that it is the light on the right is demonstrated by the illumination on the right hand side of the tape on the thermometer although the whole of the tape is obviously illuminated.



Figure 18

I then turned both lights on. The time is clearly 10:33 am.



## Is a Back Radiation Greenhouse Effect of 33 Kelvin Possible?

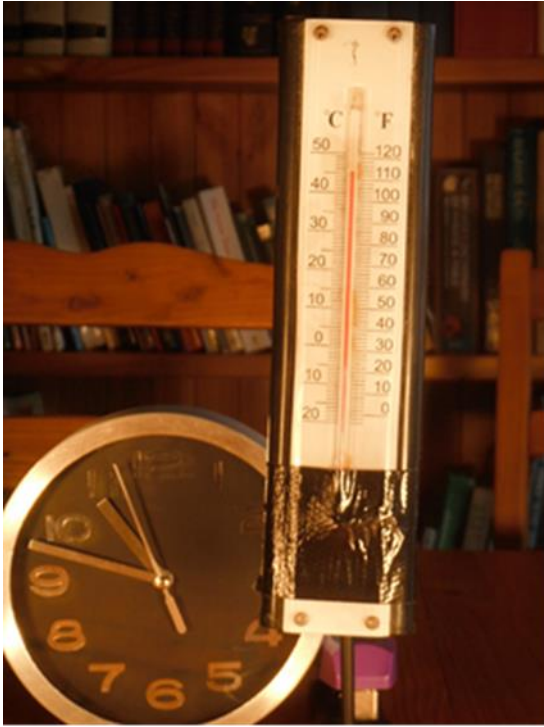

Figure 19

The clock clearly shows 10:48 am.

After 15 minutes the temperature has increased to a little above 45 degrees C or ~318 Kelvin.



Figure 20

The Clock now clearly shows 11:25 am.

The thermometer clearly shows ~46 degrees C or ~319 Kelvin.

This represents a rise in temperature of less than 1 degree in more than 37 minutes.

## Is a Back Radiation Greenhouse Effect of 33 Kelvin Possible?



Figure 21

The clock now clearly shows 11: 50 am.  
The thermometer clearly still shows ~46 degrees C – 319 K.

No increase in temperature in a period of 25 minutes.

I had to go out at this time and left the experiment in a closed room for another 55 minutes.



Figure 22

Upon my return the clock clearly shows 12: 45 pm.

The thermometer clearly still shows 46 degrees C – 319 K.

I decided to finish it at this time having recorded less than one degree increase in temperature in almost 2 hours after the initial reading of 45 degrees C – 318 K recorded at 10:48 am.