



FUCK THE POLICE





ARCHITECTURE OF APPROPRIATION
On squatting as spatial practice

Edited by René Boer, Marina Otero Verzier and
Katía Truijen

Acknowledgements

This publication is based on and inspired by the work of all those involved in the squatting movement across the Netherlands and beyond, from active collectives to dedicated lawyers, and from committed researchers to those maintaining its legacy.

Places (among others)

Aan Lager Wal, ADM, Antarctica, Bajesdorp, Bike Wars, De Fabriek, De Grote Broek, Eureka, Het Domijn, Jeltje, Landbouwbelang, Luikhuis, Ontspoord, ORKZ, Plantage Dok, Poortgebouw, Vluchtkerk, Vluchtmaat, Wijde Heisteeg 7, and all their inhabitants.

Individuals and collectives

Aart, Adeola Enigbokan, Adrian Lahoud, Amal Alhaag, Amr Abotawila, Andrea Lanzoni, Aymeric Mansoux, Berk, Carla Caffè, Coreen, Daan, Dave Carr-Smith, Davide, Deanna Dadusc, Delphine Bedel, Dubravka Sekulic, Eduardo Penalver, Eef Vermeij, Elke Uitentuis, ETC Dee, Felicity Scott, Franc Gonzales, Gallows, Giulia Giovanelli, Godofredo Pereira, Gosse de Kort, Hans Foto, Hay, Hessel Dokkum, Ippolito Pestellini, Ivo Stumpe, Jacob Voorthuis, Jere Kuzmanic, Joppe Schaaper, Kevin, Kinderen van Mokum, Klaas Kuitenbrouwer, Mark Minkjan, Masfen, Max Franklin, Merel, Nancy, Nieke Koek, Ocupação 9 de Julho, Pedro Rivera, Petra, Piet Zwart Institute: MA Media Design/Experimental Publishing, Platon Issaias, Rahul Uppal, Reinder, Rianne de Beer, Rosemary Grennan, SKSU (Student Squatting Information Center)

and all other active KSUs (Squatting Information Centers), Sonia Katyal, SPOK (Speculation Research Collective), SqEK (Squatting Everywhere Kollektive), Studio-X Rio, Suwanne, Tashina Blom, Tim Verlaan, Tobias Meierdierks, We Are Here/Wij Zijn Hier, Willem Jebbink, Yonas.

Archives

International Institute for Social History, Maagdenhuis Archive Group, MayDay Rooms, Staatsarchief, State Archive for Dutch Architecture and Urban Planning, The Autonomous Archive of Vereniging Poortgebouw, The Black Archives, This Is Not A Gateway Archive.

Special thanks to Behrang Mousavi (General Manager Heritage Department, Het Nieuwe Instituut) for his support.

Graham Foundation

This publication is generously supported by the Graham Foundation for Advanced Studies in the Fine Arts.

Contents

5	Acknowledgements
9	Architecture of appropriation
15	Squatting as spatial practice
33	Methodology
49	Plantage Dok
97	Tracing the impact of squatting on the Dutch urban landscape – a conversation with Mark Minkjan
121	Wijde Heisteeg 7
153	A conversation with three generations of the Student Squatting Information Center (SKSU)
165	Landbouwbelang
205	Whose urban appropriation is it? – a conversation with Amal Alhaag
221	A note on gezelligheid – an essay by Adeola Enigbokan
225	Poortgebouw
273	A conversation with lawyers Rahul Uppal and Willem Jebbink

285	Vluchtmaat
317	ADM
373	A quest for non-normative spaces
387	Archive inventory
390	List of illustrations
393	Colophon

Architecture of appropriation

The cultural free-haven ADM was one of Amsterdam's largest self-organized communities with about 100 inhabitants of all ages and nationalities until its eviction on 7 January 2019. The property, a neglected shipyard, was first squatted in 1987 and again in 1997. It gave rise to an alternative social organization and an ever-growing spatial arrangement of diverse habitats, with dozens of self-built structures that served as places to work and live, and sites for permaculture practices and myriad cultural events.

Squatting, or the occupation of a property without the permission of the owner, was popularized in the 1970s. In the Netherlands squatting has been characterized by a high degree of institutionalization, and although the Dutch squatting ban came into effect in 2010, the phenomenon has continued across the country, albeit on a limited scale. The community of ADM had been fighting their eviction since 2015, but despite the efforts of their seven lawyers, and all the individuals and organizations who supported their struggle through more than 20 court cases, a final verdict in the summer of 2018 led to the eviction that winter.

With the closing of ADM the Netherlands also lost one of the architectures that epitomized its once radical and visionary housing

projects. Long under fierce real estate speculation, the majority of people living in cities such as Amsterdam now struggle to find affordable housing options, the initiatives of cooperatives and some public agencies notwithstanding. In this context, the spatial practices of the squatting movement still unleash strategies of subversion against market-oriented housing policies that overwhelmingly lead the development of cities.

Since the 1970s the squatting movement has played a major role in the design of the urban fabric and the domestic interior. Using unscripted and collective spatial tactics, rather than master plans or conventional design strategies, squatters have proposed alternatives to these dominant policies, arguing that the people's right to a home supersedes the right to property ownership. Through the appropriation and maintenance of abandoned buildings, these communities have been able to set up autonomous domestic infrastructures, free-zones, or spaces to house newcomers, while in some cases even contributing to the conservation of historic city centers.

Despite the evictions, a considerable number of squats in cities across the Netherlands have acquired legal status and, accordingly, survived as collective housing, workspaces, and cultural venues. Together with existing squats and buildings that have been spared demolition thanks to the efforts of squatters, these communal spaces constitute the spatial heritage of the squatting movement. The ideals cultivated and propagated by squatters, such as the transformation of vacant

premises, reuse of construction materials, and collective live-work spaces at a building or neighborhood level, have greatly influenced our thinking about the city.

Architecture of Appropriation recognizes the role of squatters in the transformation of cities and their systems of inhabitation.¹ While squatting is mainly understood as a social movement and approached as a historical phenomenon, this publication presents squatting through the language of architecture and spatial activism. It includes the voices of representatives and collectives of squats, architects, urbanists, researchers, lawyers, curators, activists and archivists in order to inspire alternative models to the policies currently driving the development of cities. An analysis of the architecture and design methods of the squatting movement are mobilized here to study their resulting confluence of informal practices, legal frameworks, and sociopolitical and economic conditions, as evidence of the possibility of alternative futures for the development of cities.

The main squats and their legalized counterparts analyzed in this publication are ADM, Plantage Dok, Vluchtmaat and Wijde Heisteeg 7 in Amsterdam, Poortgebouw in Rotterdam, and Landbouwbelang in Maastricht. These six examples illustrate the different spatial and legal strategies used by squatters to appropriate urban fabric and alter existing architectures to accommodate new programs. Alongside the project research methodology and documentation of the contemporary architecture of the squats, the publication includes conversations with cultural

1. Some of the notions and formulations included here have been previously published and presented in different media and forums. This publication is the culmination of a long-term research project developed since 2016.

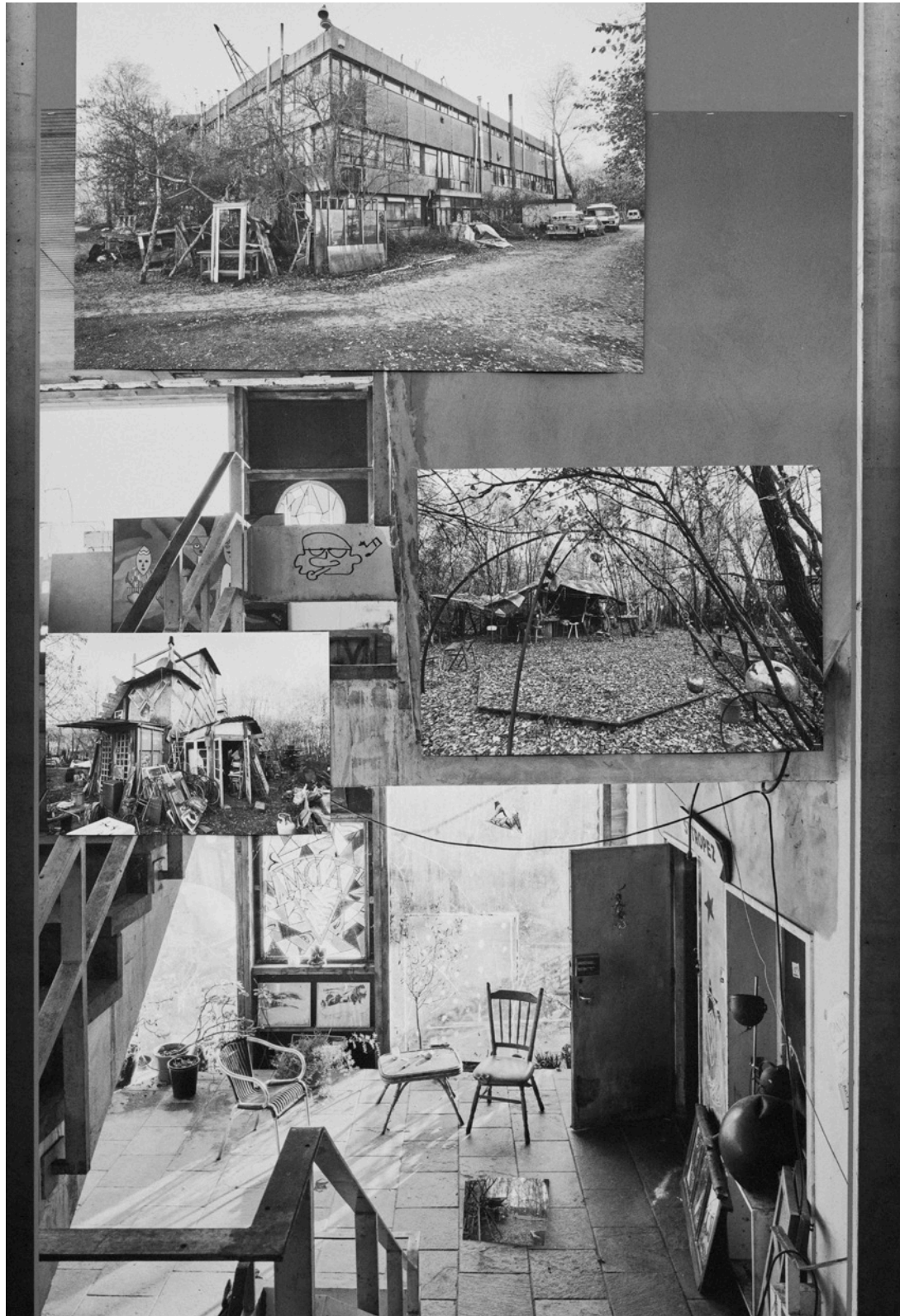

Architecture of Appropriation exhibition at Het Nieuwe Instituut, 2017.

activists, urban geographers, different generations of representatives from squatting information centers, and the lawyers who have been defending the squatting community over the last decade.

Some of the squats presented here have unfortunately been evicted, even demolished, during the research process, evidencing the continuous threats to which these communities are exposed. This publication nevertheless argues the ongoing relevance of this spatial and political knowledge, stimulating debate on the inclusion of non-normative spatial practices in architectural archives, platforms and debates. Architectural representations of the participating squats have been developed by architects and students in collaboration with the respective communities, alongside a spatial and material analysis of the practices of squatting, its architectural strategies, typologies, design and construction details, and its legacy.

Architecture of Appropriation has formed the basis for new acquisition policies at the State Archive for Dutch Architecture and Urban Planning, acknowledging forms of practice beyond the classic notions of authorship in the production of spaces, using squatting as a paradigm. The methodology developed for this project was also designed for resisting and altering processes inside the archive that are often exclusionary and opaque.

This call to recognize the spatial practices of the squatting movement aims to demonstrate how architectural projects can mediate between vacancy, ownership, and the right to housing. This appeal was launched

by acknowledging the precariousness of these communities, as well as the need to counter the general archival methods of acquiring objects and narrating history in a way which could lead to the separation of the spatial practice of squatting from the political, economic, and cultural contexts out of which it arose. Yet, in celebrating and protecting forms of spatial practice and the cultural and political knowledge that is generally precarious, non-author-based and often criminalized, we are also inviting architects to fight for, and design, the future terrain for other political possibilities.

Squatting as spatial practice

A ubiquitous phenomenon

Squatting is a phenomenon that has occurred throughout history, and still occurs in every place around the world where the need for space coexists with vacancy. Sometimes it is individuals looking to satisfy their most immediate needs, while elsewhere sizeable movements emerge to address these issues together. In 17th century England the 'Diggers' started to occupy land for the construction of their own cottages, while marginalized groups in Cairo continue to squat abandoned social housing projects on the city's outskirts today, often out of pure necessity. In the Netherlands squatting is likely to have taken place throughout its history, although almost no documentation from before World War II has survived. In the second half of the 20th century it became a substantial social movement which, by applying its very own 'spatial practice', has considerably influenced the development of Dutch cities.

After the war the extreme housing shortage in the Netherlands led to incidental squatting in the major cities, yet the actions lacked coordination. Only when, in the course of the 60s, an articulate post-war generation needed places of their own to inhabit, squatting became a more cohesive movement.

In Amsterdam's dilapidated Kattenburg neighborhood, a large group of young people started to occupy vacant dwellings and in 1966 the countercultural Provo movement launched their White Houses Plan, calling for white paint to be splashed on the doors of empty properties to notify prospective squatters (fig. 1).

Some haphazard occupations followed which showed a growing need to help people squatting and coordinate actions. Soon, *Woningburo de Kraker* (Squatter Housing Agency)



Figure 1: White Houses Plan pamphlet by Provo movement, April 1966.



Figure 2: The Squatter Housing Agency opens its Squatting Information Center at the entrance to the Office for Housing Relocation, Amsterdam, December 1970.



Figure 3: A squatting manual with the slogan 'Save a building, occupy a building' by the Squatter Housing Agency, May 1969.

opened their information center in Amsterdam (fig. 2) and the first *Kraakhandleiding* (Squatting manual) was published (fig. 3). Both initiatives were important in the further development of the movement.

Squatted communities were often still quickly evicted by the authorities until, in 1971, a squatting group from the city of Nijmegen started a legal procedure. Their actions confirmed the early 20th century legal ruling which determined that those residing in a property with a bed, table and a chair could not be suddenly deprived of the 'peace of one's home'.¹ This event marked the beginning of the squatting movement's attempts to find legislative confirmation of their rights, and began the complicated, still ongoing legal balancing act between the right to property and the right to housing. It also prompted a rise in squatting which in turn triggered the authorities to draft a preventive law in support of property owners, who at that time had to resort to civil procedures to reclaim their buildings. Yet, it was a critical report from the Dutch Council of Churches that influenced the Christian Democrats to block the procedure in a 1978 parliamentary vote. Seemingly unstoppable and with broad societal support, the squatting movement reached its zenith in the first half of the 80s.

A spatial practice

In this period, squatting in the Netherlands developed from improvised urban interventions to an institutionalized spatial practice that allowed squatters to operate effectively

1. *Huisvredebreuk*, meaning that trespassing robs one of the peace of one's home.

in urban space. A network of autonomous *Kraakspreekuren* (Squatting Information Centers), inspired by the Squatter Housing Agency, opened in almost all major cities. New squatting manuals were published regularly, including protocols for thorough research on the building and neighborhood level. At the same time new legal, media and research collectives emerged, while nationwide meetings were organized. Even the choreography of a typical squatting action was protocolized and became a fundamental 'squatting institution'. This ritual can be seen as a collaborative political act organized around its own rules, rhythms and expectations, which structures the way the occupation manifests itself in the urban environment, and even squatters' interaction with the authorities. All these institutions turned squatting into a practice that enables anyone to intervene in the urban environment according to their needs and desires, and transform the city after their hearts' desires.

Over time, this new, 'open source' tool allowed many people to appropriate spaces for their inhabitation, and all kinds of purposes. In some cities the network of squatted spaces started to amount to what can be described as a parallel society, consisting of alternative housing arrangements, subcultural venues, food distribution systems, people's kitchens, legal support, media, and medical services. Besides creating alternatives to the market-oriented city development, the practice of squatting opened up the possibility of defending strategic positions in debates surrounding vacancy, housing shortage, urban development and heritage preservation.

Overall, this new, widely applied spatial practice represented a radical new approach to urban development, especially compared to the then still dominant tenets of modernism. Squatting became a movement experimenting with all kinds of bottom-up, small-scale and incremental urbanism with a collective, diverse, but also antagonistic character, and with new ideas around self-organization, autonomy and 'the commons'.

Legal complications

In the early 80s the rising influence and conflictual nature of the movement soon resulted in multiple confrontations with the authorities, among others, during the coronation of Queen Beatrix and after the eviction of several major squats. As a result the movement lost some of the broad support it had enjoyed earlier. However, the movement's decline from the mid 80s onwards could probably be attributed to other factors as well, including the diminishing housing shortage, the changing zeitgeist, and increasing repression from the authorities. While there was not yet enough societal and parliamentary support to fully criminalize squatting, a new law introduced in the early 90s stipulated that only properties empty for more than one year could be squatted. Despite the gradual decrease in the number of squatters, their practice retained a considerable presence in most Dutch cities and continued to function as a spatial practice, one still handed over from generation to generation.

Coinciding with the wave of conservative politics that emerged in the early 2000s, a renewed campaign against squatting was initiated by right-wing politicians. Even though the mayors of the four largest cities argued against a new law, from 1 October 2010 all forms of squatting became a criminal offense punishable with up to two years and seven months in jail. A turbulent period ensued, characterized by numerous protests and evictions, as well as various legal procedures by the movement against the ban. Following article eight of the European Treaty for Human Rights, which protects, among other things, the right to the privacy of one's home, a higher court concluded that a sudden eviction of a squat constitutes an infraction of this right. The final ruling stated that squatters should be notified about an upcoming eviction and be given the opportunity to challenge the eviction in court. In that case, a judge still has to decide, despite the ban, whether the need of a property owner to use their building outweighs the infraction on the private life of a squatter.

In practice, this meant that the police were not requested to immediately intervene when a new place was squatted and, therefore, that squatters retained the possibility to sustain their occupation. Yet, there is a myriad of reasons why squatters don't immediately get evicted. In some cases squatters made use of the new timeframe to start a negotiation with the owner, aiming for some kind of agreement. In others, owners do not file a police report in order to not draw attention to questionable business arrangements. If a report is filed and an eviction notice handed out,

squatters could still argue in court that, in the case that an owner has no plans to do anything with the building, the protection of their new living environment is more important than leaving the property empty. While this new situation means that squatting is not fully eradicated, as the proponents of the ban were hoping for, it is increasingly harder to sustain a squat in the long term. As it became a criminal offense, squatting a building became less attractive for prospective squatters. As a result of the ban the movement has shrunk, maintaining active groups and information centers in only a handful of cities in the Netherlands.

Architecture of appropriation

A successful squatting action, whether in 1979 or 2019, always results in the immediate control and responsibility over a certain property. If the squatters manage to stay, they have the freedom to use and repurpose it according to planned or spontaneous intervention. As the selected buildings are often neglected and in poor shape or constructed for other purposes, this often requires intensive work. Therefore a typical kind of architecture starts to emerge which is the result of a combination of the immediate need and desire to transform the space, the ideology of collaboratively shaping and living in shared spaces, the lack of budget to make actual investments, the ease of adapting to the found typology, and the uncertainty of being evicted. Hence, this specific 'architecture of appropriation' can be seen as the immediate result of the

collaborative application of the spatial practice of squatting.

The self-made, often unplanned, low-budget, and spontaneous character of the architecture, often built using recycled materials (found on the street or donated by other squats), make it easily recognizable and give it many qualities not often found in normative architecture, such as a certain authenticity, material diversity, and a raw and immediate expression of creativity. After an eviction the interventions are often quickly demolished, making it a kind of architecture that is ephemeral and precarious, often existing temporarily and quickly disappearing or transforming again. Over half a century of squatting, thousands of squats have been opened and closed, but some have chosen to be legalized, whereby the property is bought or rented from the owner, or given in loan under certain conditions for a particular time frame. The 'architecture of appropriation' is often kept, altered to respond to official regulations, or revamped with structural interventions.

The possibility of legalizing a squat has been dismissed by a large, generally speaking more radical, part of the squatting movement who regard the state of conflict with the owner and the authorities as a preferable end goal. The various legalization options, however, have allowed hundreds of squats across the Netherlands to retain their space for collective aims, even though the buildings are in a legal sense not 'squatted' any more. Generally these places still remain closely connected to the actual squatting movement which continues to focus on opening new squats.

Over time, these practices resulted in a constantly changing archipelago of stable legalized squats, and more precarious, but arguably also more urgent, actually squatted buildings. These communities still have a visible presence in the Dutch urban landscape, and remain an important site for alternative housing arrangements, subculture and radical politics (fig.4-6).

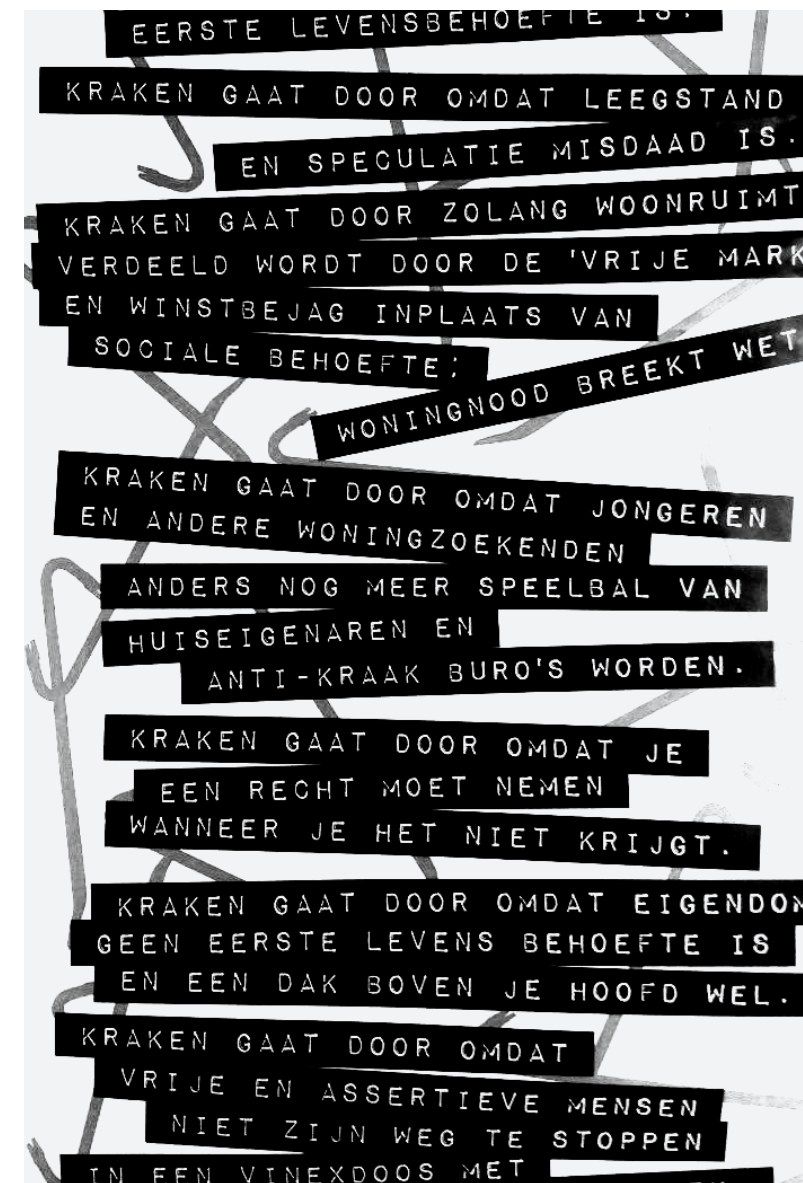

Figure 4: Poster (detail) created in 2010 in response to the upcoming squatting ban.



Figure 5: Students squatting empty apartments in Amsterdam West, 2009.



Figure 6: Squatting action in central Amsterdam, late 2018.

The spatial practice of squatting in seven steps

In the Netherlands, squatting a building is a complicated and now criminalized intervention in the built environment, yet one that requires an organized structure of solidarity and support as well as specific knowledge and experience. Successive generations of squatters have pursued their ideals using diverse methods, although most of them have largely adhered to the following protocol, even after the squatting ban.

1) Finding vacant buildings

Carry out a survey of unoccupied buildings in a city or region either by cycling, walking or asking around. Determine whether the resulting list of unoccupied properties corresponds with the intended objectives, such as establishing a living group, making a political statement, or creating subcultural infrastructure (p.25).

When does urban transformation lead to high levels of unoccupied buildings? Is there a neighborhood conflict in need of support? What is a suitable place to live in? In what type of space can the group's objectives be achieved?

2) Researching vacant buildings

Carry out an investigation into a selection of buildings. Examine their structural condition and legal status, and chart the social context. Put together the 'life story' of the building, and the resulting reasons for a possible squatting action (p.25).

Is the space in question truly vacant? For how long? Who owns it? Why is the property

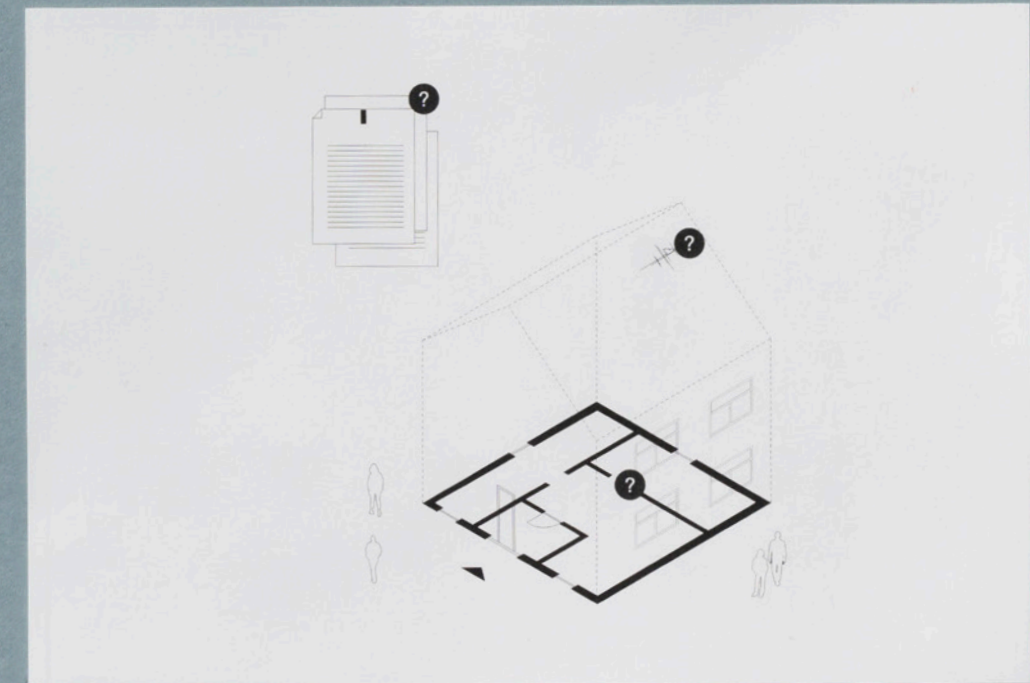
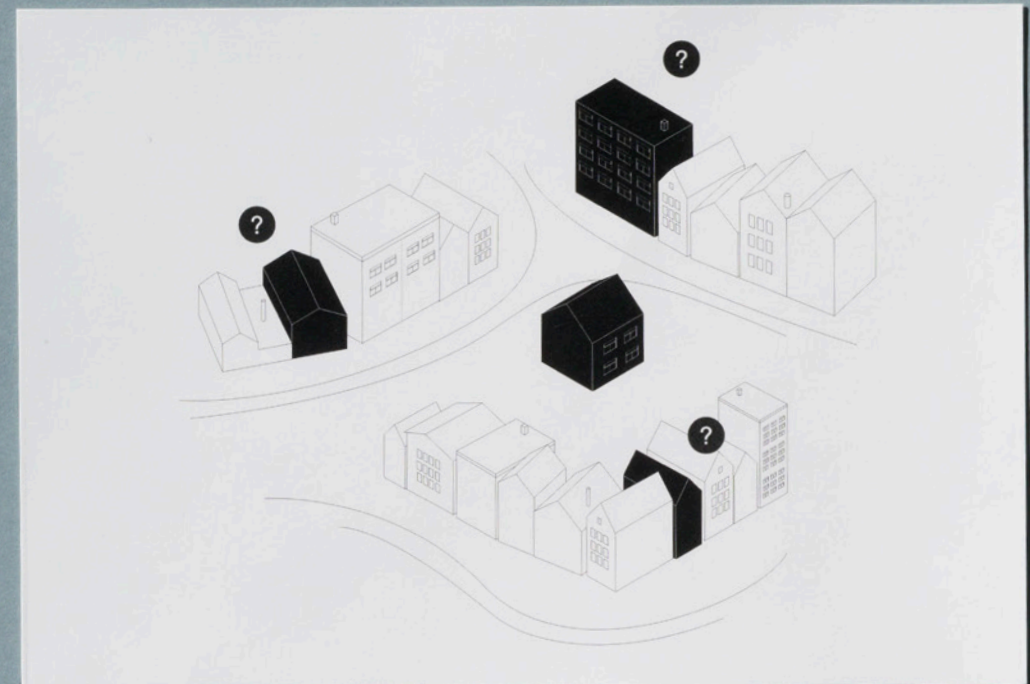

1) Finding vacant buildings
2) Researching vacant buildings

not being used? Speculation, dilapidation, negligence? Are there plans for its future? What is the structure and condition of the building? Is it safe to occupy?

3) Mobilizing supporters

Squatting is a complex action that requires experience and insight to be carried out effectively. Seek collaboration with a Squatting Information Center, which usually meets once a week in a neighborhood, city, or region. Use the center as a base to discuss and review plans, establish a network of experienced members (p.27).

With whom can the proposed plans best be realized? Are there other parties that have interests in the selected site? What skills are needed to occupy the site and establish the squat? Where are people with those skills found?

4) Preparing the squatting action

Select an assembly point near the intended squat. Appoint a breaking crew, indoor crew, and police liaisons. As a group, write and distribute letters for mobilization among collaborators. Prepare a press release and letter addressed to the neighbors. Gather materials and tools for barricades and initial renovation work, and prepare an occupation schedule for the first two weeks (p.27).

How many people are needed to set up the squat? Is it possible to go from the assembly point to the selected location without being noticed? Who does what? What communication channels are used during the squatting action? What action is to be taken if the situation with the police, security guards, neighbors, or others escalates?

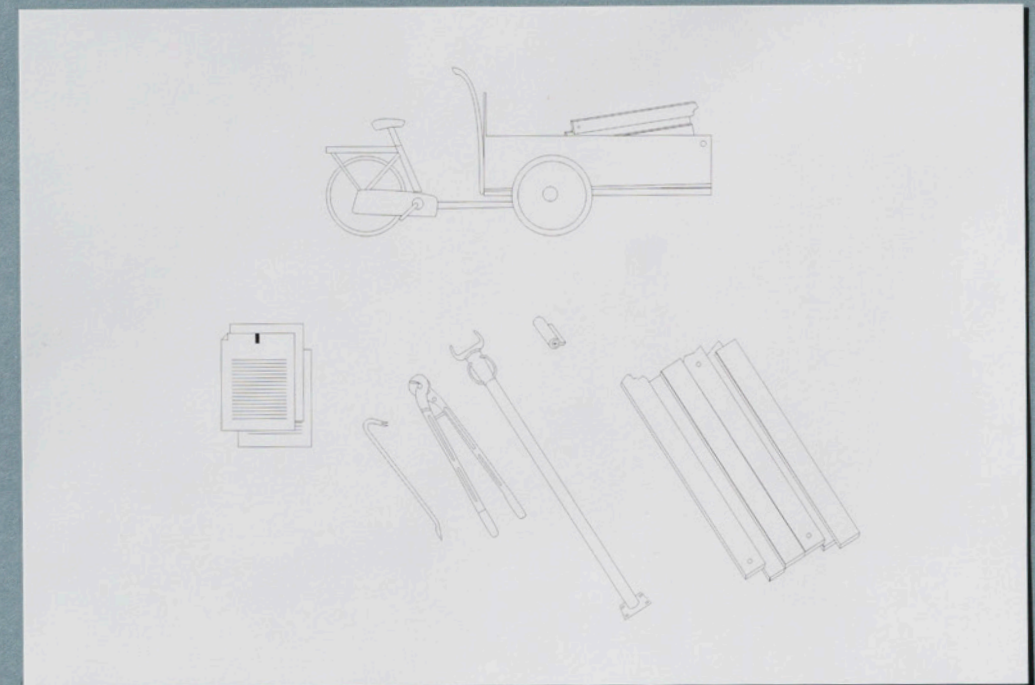

3) Mobilizing supporters

4) Preparing the squatting action

5) Carrying out the squatting action
Gather the team at the agreed time and place, normally on a Sunday. In a group of at least 30 squatters, set off for the site on a pre-determined route. The breaking crew opens the door while the others shield them. The indoor crew inspects the interior for any unexpected situations. Replace the lock. Await the arrival of the police while informing a lawyer, neighbors and the media (p.29-30).

In most cases, the police acknowledge the situation and leave. Create a space where meetings can be held to discuss the next steps, and to coordinate any urgent repairs that are needed.

Is the situation inside as expected? Is the building habitable and safe? How do the police and neighbors react? Which space can be made fit for habitation first? What renovation work must be carried out first?

6) Maintaining the occupation
The continued occupation of a squatted site is the spatial embodiment of a form of political action and a punishable offense. Make the building suitable for habitation and occupation through rudimentary renovation work. Set up lines of communication with the owner, police and judicial authorities through a lawyer in order to ensure the continuation of the squat. For the same purpose, seek publicity or conduct a political campaign (p.30).

How can a building be made suitable for the intended inhabitation program? Is the position of the squat strong or weak? How can a site be held for as long as possible? How can the solidarity be acknowledged and compensated?

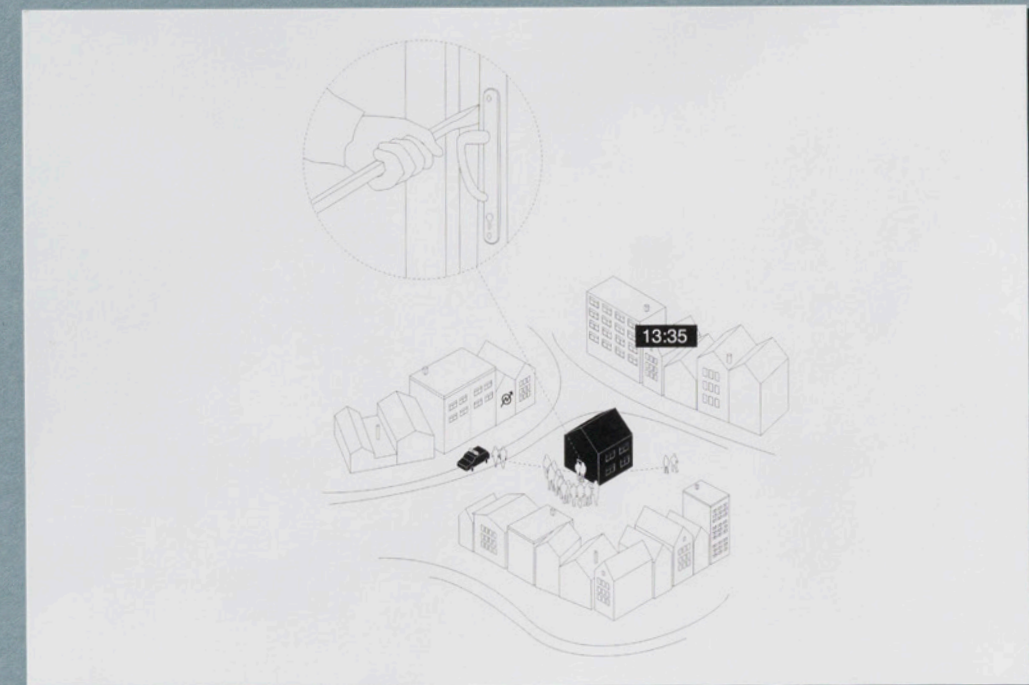
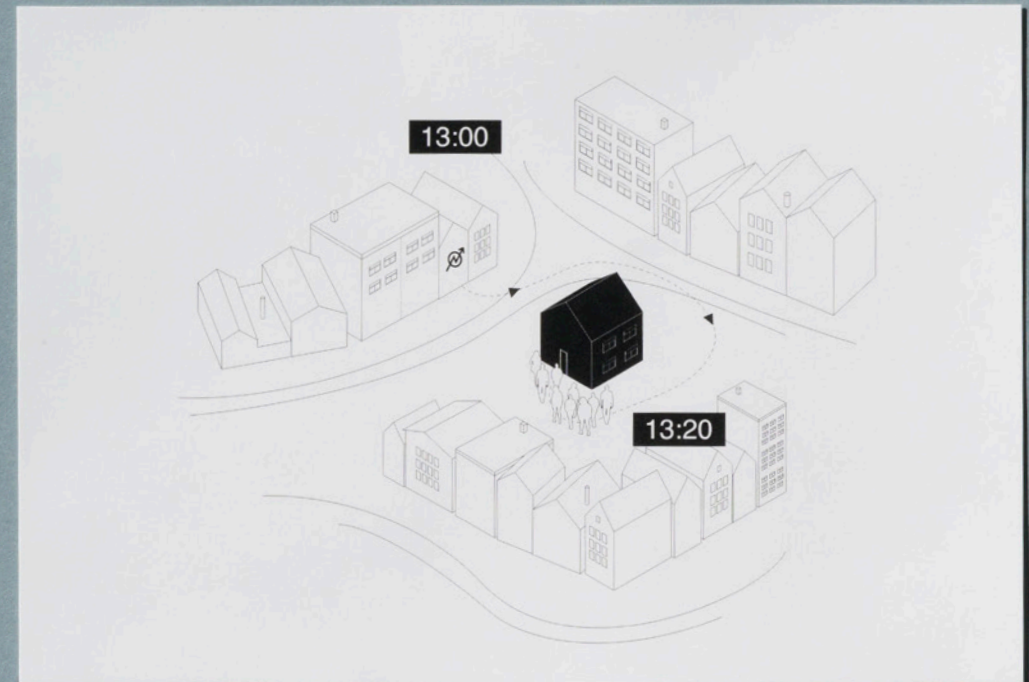

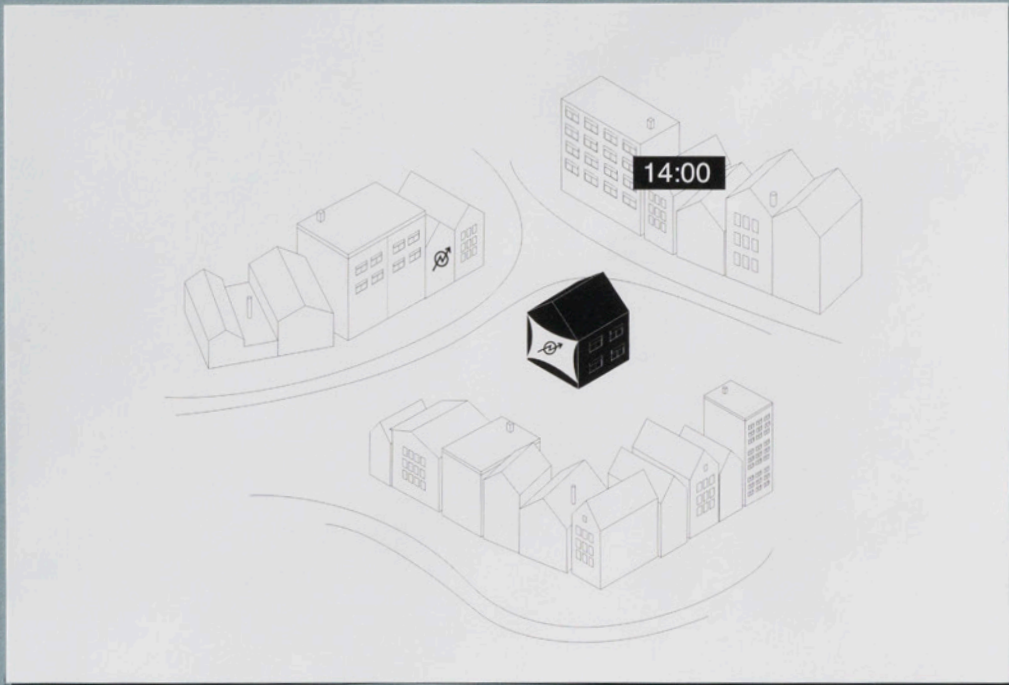

30

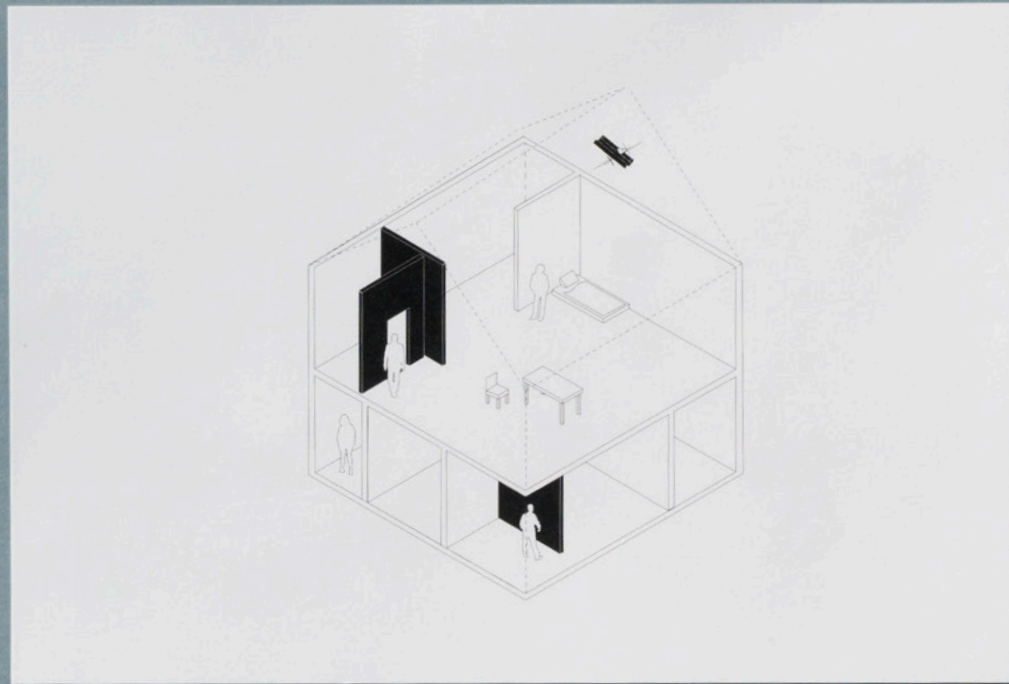

5) Carrying out the squatting action
6) Maintaining the occupation

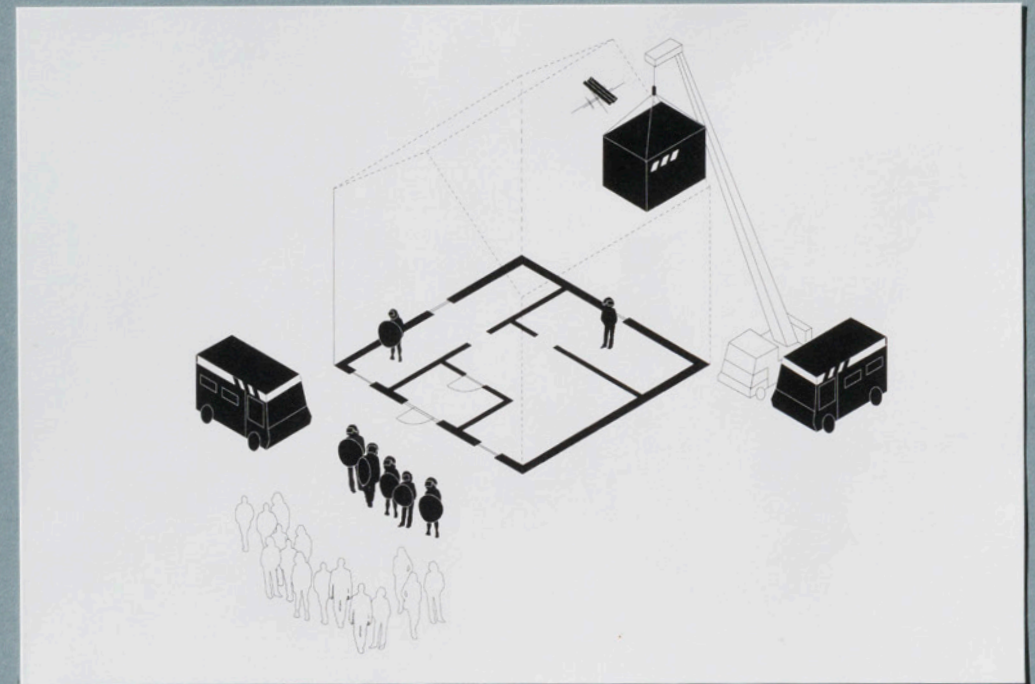

31

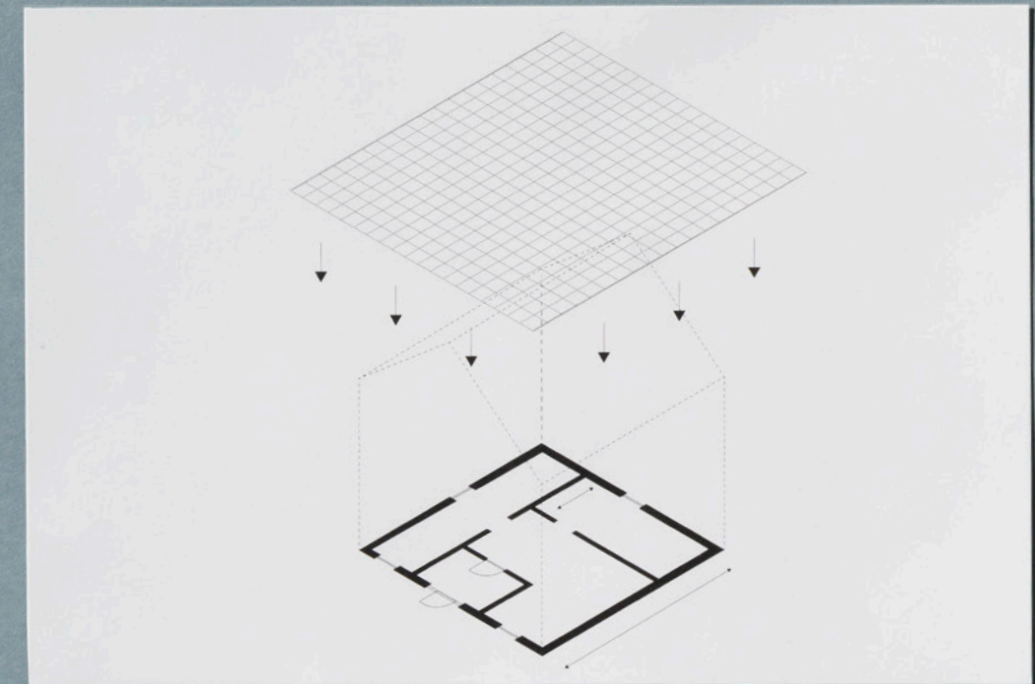

7) Beyond squatting: eviction or legalization

7) Beyond squatting: eviction or legalization

Owners often instigate legal proceedings, after which a judge could demand the departure of the squatters. Either depart voluntarily or prepare for the upcoming eviction by riot police. Otherwise, try to come to a user, rental or sale agreement with the owner, after which the squat would acquire a legal status. In that case, comply with the structural and financial requirements of such an agreement (p.31).

What are the owner's plans for the building? Is the owner open to the idea of legalization? What defense is put forward in any legal proceedings? Is opposition to the eviction possible and appropriate?

Methodology

Opening the archive

Since 2016 Het Nieuwe Instituut has opened up the State Archive for Dutch Architecture and Urban Planning through a series of archive explorations. This endeavor not only works to reframe acquisition policies to include new documents, subjects and media, but also acknowledges the thematic and methodological gaps in the official historiography. These include feminisms in architecture, queer perspectives, and the architectural legacy of former Dutch colonies with their different forms of heritage and afterlives.

Currently 97% of the collection is composed of documents authored by white male architects, with only 26 of 835 archives attributed to female architects. Yet, the architecture of the Netherlands is a result of many other agents involved in important transformations of the built environment. Het Nieuwe Instituut is bringing overlooked actors, unacknowledged agents, and forgotten stories into the discussion by examining the role that archives play in the construction of the history of cities and their inhabitants, as well as to contest institutional memory and the dominant historiography.

The *Architecture of Appropriation* project epitomizes this effort by conducting research into the spatial practices of the squatting movement, recognizing the contribution of informal, non-author-based, precarious, or even

criminalized practices in the construction of the Dutch urban landscape. While acknowledging the precariousness of the communities involved as well as the need to carefully limit the processes of institutional appropriation, the initiative aims to open up a discussion on the inclusion of these spatial practices in architectural platforms, archives and debates. As a pilot project, it also seeks to develop a process that would allow the state archive, and others, to collect in a different manner.

One of the aims of the project, exhibition, and publication was therefore to analyze a series of squats through architectural drawings, interviews, and archival material, to build up a record of these struggles, spaces, and oral histories. This material carries the possibility and intelligence of alternative modes of domesticity and housing for current and future generations of architects, researchers, policy-makers, and the general public, both in the Netherlands and abroad.

In 2016 the institute's research department, led by Marina Otero Verzier, set up a collective to develop a methodology and carry out exploratory research to be presented in an open-ended exhibition at Het Nieuwe Instituut. The collective consisted of Katia Truijen, Marten Kuijpers, Maria Fernanda Duarte and Roos van Strien of the institute's research department, curator, researcher and activist René Boer, photographer Johannes Schwartz, and students from the MA Architecture, Urban Design and Engineering at Eindhoven University of Technology.

The first phase of the project, from August to December 2016, focused on how to document the architecture of appropriation. As the squatting movement is often presented as a historical social movement, there is a lack of clearly defined methodologies for researching and documenting their non-normative and criminalized architectures. This attempt, however, follows other initiatives to document informal, temporary, and precarious spaces around the world, serving as inspiration for the development of a methodology for documenting squats and their legalized counterparts across the Netherlands.

While this national focus does not align with the internationalist character and ideologies of the movement, it was maintained for the unique urban, legal and political conditions that have shaped the practice of squatting in this territory. The character and focus of the State Archive for Dutch Architecture and Urban Planning, where the resulting research documents would be included, conditioned the scope of the research as well. Initially, five squats were selected and their communities approached to conduct the research collaboratively. These sites show the diversity of the architecture of appropriation in the Netherlands, in terms of typology (monumental canal houses or industrial complexes), community size (small living groups or entire micro-societies), age (squatted for a few years or a few decades) and status (still squatted or legalized in different ways).



Figure 1: Poortgebouw, axonometric drawing of the first floor with mezzanines.

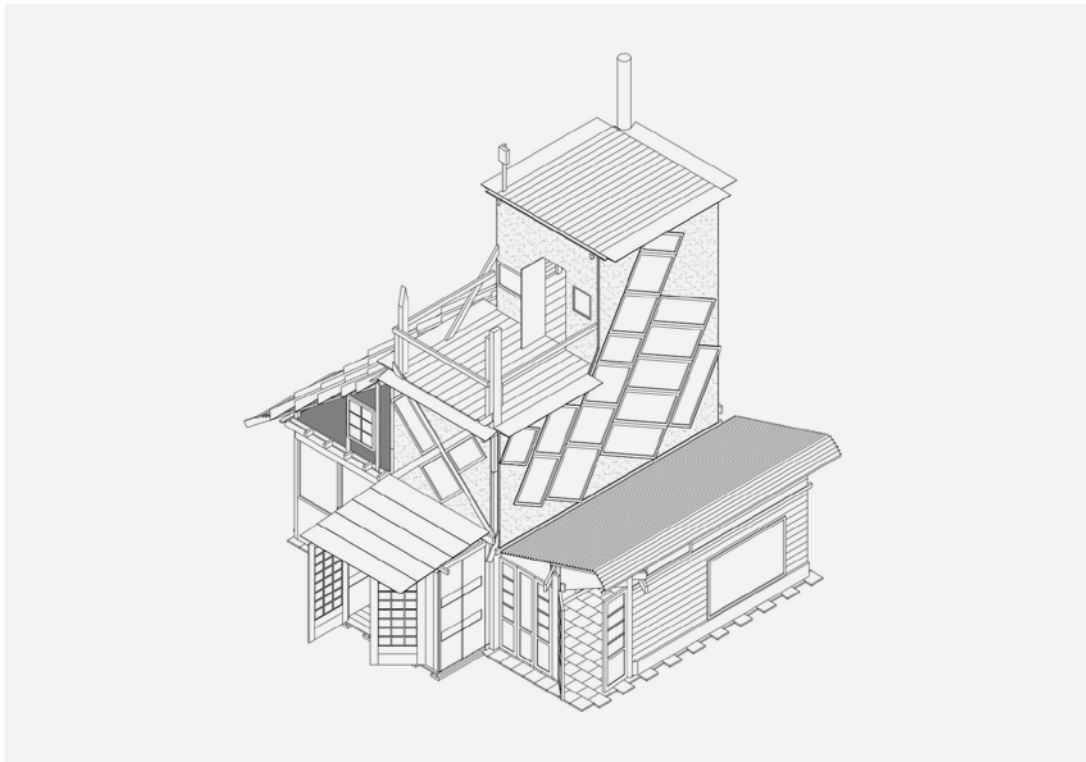

Figure 2: ADM, axonometric drawing of the Pizza Tower.

Forms of representation

The initial conversations with the squats' inhabitants shed light on how the evolution of the space, its origins and major social, political or legal 'life events', are crucial to understanding its current architectural arrangements. A timeline based on interviews, email correspondence, and archival research served to map the history of each location before its occupation, its often volatile developments following the first squatting action, and its plans for the near future. Historical documents from Het Nieuwe Instituut's archive, city archives, the Amsterdam-based International Institute for Social History, and the squats' own archives were all included in these time-based overviews. In addition to the accounts of the squats' histories and the researched archival material, the collective explicitly decided to use drawings to present these architectural practices not generally included in the histories of architecture, its operating platforms and archives, by appropriating the tools, methodologies and forms of representation generally used by the discipline. In collaboration with architecture students from TU Eindhoven and the squats' inhabitants and users, the collective developed a set of floor plans and axonometric drawings of all the squats, with an emphasis on the spatial and material strategies for the occupation of the space and its transformation into a communal space for living (fig. 1,2).

These drawings were accompanied by a photographic series of each squat, aiming to transcend the rather romanticized approach

of other attempts to visualize squats, instead focusing specifically on the architecture that shapes them.

Yet representation is neither an innocent or neutral task. It forms the basis of the discipline of architecture, but it is not exclusive to it. Architectural representations such as plans and models are fundamental tools in the institutions of power – including the financial, security and scientific realms – to establish systems of governance and control over the distribution of rights, borders, and belongings. Representation, therefore, makes visible the relationships between architecture, power and politics. To represent is to select, to put emphasis on certain aspects of reality, and obviate others. With this, we build new realities and make them plausible, measurable, and of course we also determine who or what is represented, highlighting our prejudices, interests, and value judgements. With this in mind the collective questioned whether normative representation techniques should be used to represent non-normative spatial practices.

The choice of the type of architectural representations employed was motivated by forms of political representation. Using technical drawings allowed these documents to infiltrate both architectural and legal discourses, and even be used as evidence in court cases. The research collective was composed primarily of architects, designers and media theorists, yet there was a consensus around the idea that the architects and designers involved in the development of the drawings were mediators, with the focus instead on the voices and positions of those who inhabit the squats.

Exhibiting appropriation, appropriating the exhibition

The first phase of the research was presented at Het Nieuwe Instituut from January to August 2017 in the exhibition *Architecture of Appropriation*. Architects Elma van Boxel, Kristian Koreman, Thomas Steigema and Anja Verdonk of ZUS (Zones Urbaines Sensibles) designed an installation in which they ‘appropriated’ the third floor of the institute. They opened up a prominent new entrance to the side of the building allowing visitors to bypass the normal entrance and its protocols (fig.3). Inside they created a domestic environment filled with reused materials and furniture, acknowledging the themes of gathering and the exchange of ideas that prompted the preliminary research. The exhibition space was used for meetings, public events, as well as a working space. It was also ‘squatted’ twice by unsolicited interventions. First, artist Reinier Kranendonk moved *Todopia*, a semi-mobile living and work-space installation promoting autarkic lifestyles, into the exhibition. Later, the art collective Architecture of Control started to build a construction next to the entrance, which developed over time.

From the end of March 2017 the installation *Fight, Squat, Resist: Housing Alternatives of Social Movements* by Studio-X Rio, which addressed squatting as an alternative for communal living in response to the housing problem in Brazil, joined the Netherlands-based case studies inside the exhibition space. Alongside the stories of the National Struggle for Housing movement, fighting



Figure 3: *Architecture of Appropriation* staircase, designed by ZUS (Zones Urbaines Sensibles).

for the right to the city, the project presents the objectives, strategies, victories and urban visions of the movement, illustrating the daily life of the residents of the Manuel Congo squat in the center of Rio de Janeiro. This squat is regarded as an example of participatory architectural design in which residents and architects collaborate to realize a community housing project with public facilities. By presenting examples of squats, the installation sheds light on how access to affordable housing is a pressing and ongoing struggle around the world.

Archiving appropriation, appropriating the archive

Following the exhibition the research collective invited Het Nieuwe Instituut's Behrang Moussavi (General Manager, Heritage department) and Hetty Berens (Conservator, Heritage Department) to explore how the *Architecture of Appropriation* project could relate to the archive's ambition to challenge the policies that shaped the collection by, for instance, collecting non-author-based and temporary forms of architecture. These forms of architecture often lack the type of documents historically collected by the archive such as plans, models and drawings, and in the case of the five squats, almost no such material has ever been produced by the squatters themselves, with the exception of some sketches, meeting notes, and photographs.

The first research phase had provided a set of drawings for each squat, yet the evaluations conducted by the collective acknowledged

that the architectural methodologies used to document the squats might have flattened the intricate stories, collective practices, and detailed qualities of their appropriations. The voices of those who actually designed and built these unique spaces are fundamental to describing and understanding them.

Around the same time, a meeting with a wide range of activists and archival professionals was organized in order to discuss the research methodologies and open up a public conversation about their relevance, conflictual stances, as well as other possible approaches to documenting non-normative spatial practices. The meeting *Constructing institutional memory: archiving non-author-based, precarious and criminalized urban practices* was held on 12 September 2017 at Het Nieuwe Instituut, in collaboration with Poortgebouw and Piet Zwart Institute's MA in Experimental Publishing, and explored alternative approaches to the representation and collection of precarious and often criminalized urban practices within the institutional framework of archives and museums. By comparing different methodologies and case studies, the group examined the role of museums and autonomous archives in the construction of the history of cities and their inhabitants. The group concluded that it would be necessary to find a way to include the voices of those who created the architectures. As a response to these conversations, a series of annotation sessions with all the squats were arranged during the second phase of the project.

The respective communities could annotate the architectural representations by

adding their own stories, reflections and comments directly onto the drawings or by using tracing paper, illustrating layers of personal and collective narratives.

A first test-run of an annotation session was organized in collaboration with Poortgebouw in Rotterdam (fig. 4, 5, 7). After a brief discussion, all 12 participants started to add their thoughts, memories and comments. The outcome was a rich collection of notes, yet almost impossible to decipher even by the current members of the squat. The next annotation session started with an hour-long group conversation on the most important reflections, which were then added by one of the members. These documents were still the outcome of a process of collective discussion, yet also comprehensible to the community and to future inhabitants and readers. By including the voice of the communities with the architectural representations, hybrid documents emerged, which could also comply with the archive's policy of collecting originals rather than representations made by others. Having these documents and practices in the archive of the state that rendered them illegal is a political act, one that preserves the event of the occupation as a political message, and not just as a cultural event. Archives, this project argues, could be a catalyst for activism in the present, its documents being mobilized in court cases and political decision-making.

Another relevant point of discussion centered on where and under what classification the documents would enter the archive. The aim was to include them as stand-alone architectural projects at the same level as buildings by well-known architects.



Figure 4: The first annotation session at Poortgebouw in Rotterdam, September 2017.



Figure 5: Group discussion after the first annotation session at Poortgebouw in Rotterdam, September 2017.



Figure 6: Landbouwbelang annotation session in Maastricht, November 2018.

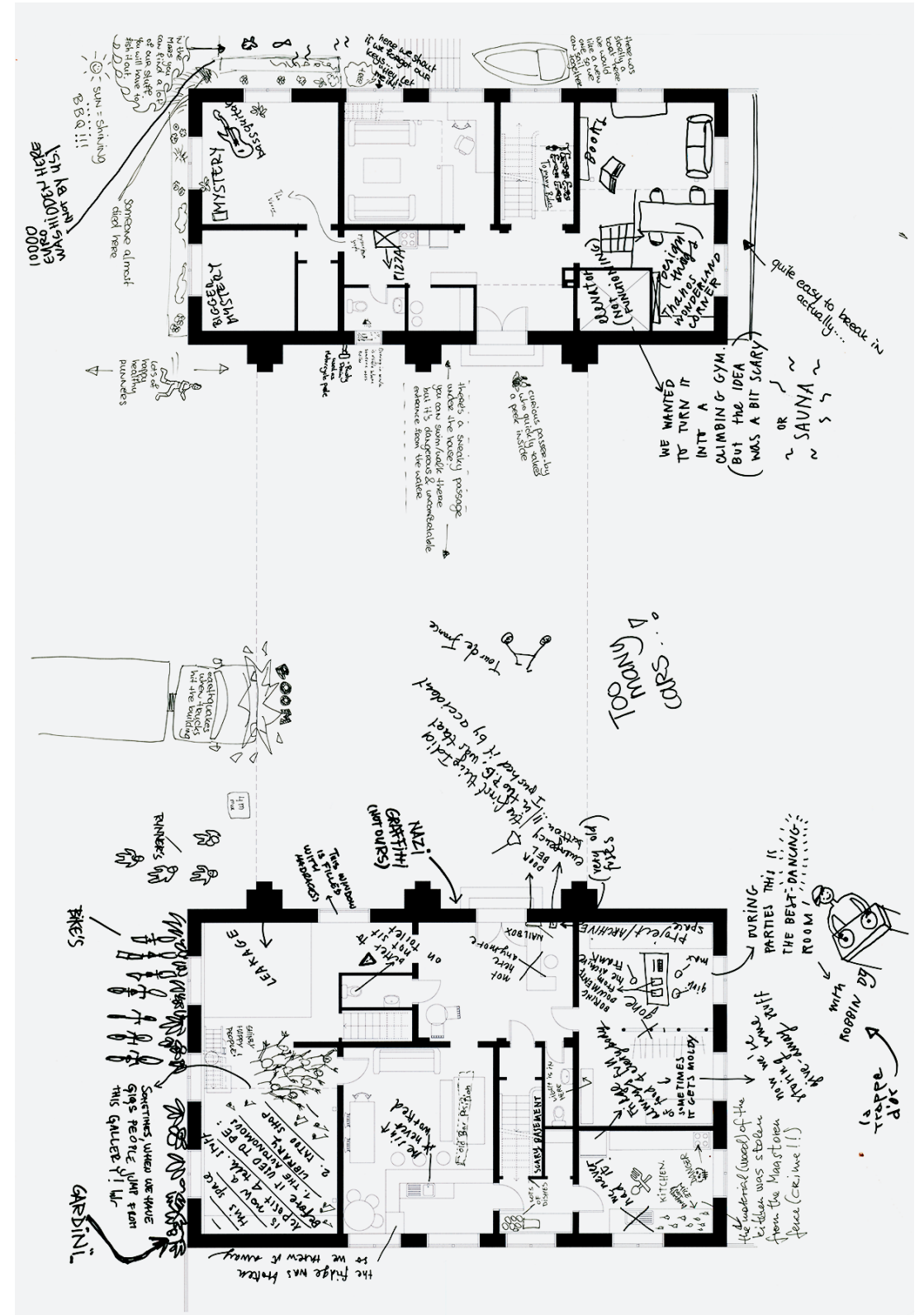

Figure 7: The outcome of the first annotation session at Poortgebouw in Rotterdam.

The respective building dossiers would then mention the squatting community as ‘authors’ and the *Architecture of Appropriation* research collective as the ‘archive former’. Every box would also get an information sheet where the group could self-identify and describe their squat. This could also function as a ‘meta archive’ by referring to documents related to a specific squat in other archives, including the squatting community’s personal archives, via the archive’s Adlib database and its search portal.

Expanding the project

During the conversations held at the exhibition, it was noted that only squats from the two major Dutch cities (Amsterdam and Rotterdam) were part of the project, while the squatting movement has been and still is a nationwide phenomenon. In particular, cities outside the country’s major metropolitan core known as the *Randstad* have seen active and productive squatting movements. A conversation with the community of Landbouwbelang, a squatted grain silo in Maastricht, was established, and Landbouwbelang was included as part of the research, archive and publication (fig.6).

Simultaneously, the *Architecture of Appropriation* exhibition was updated and presented at the 11th São Paulo Architecture Biennial held in Brazil’s largest city with themes related to collaborative, ongoing construction. *Architecture of Appropriation* was installed in the Ocupação 9 de Julho, a squatted skyscraper in the city center, which was slowly being transformed by its



Figure 8: *Architecture of Appropriation* was installed in the Ocupação 9 de Julho, a squatted skyscraper in the city center.



Figure 9: *Architecture of Appropriation* at the 11th São Paulo Architecture Biennial in Brazil.

1. Drukkerij Raddraaier is a printing office that started in Amsterdam in 1979. They printed posters on behalf of groups busy with squatting, anti-nuclear energy, the environment, anti-militarism and anti-racism. The presses in the printing department ran at full speed in the service of these ideologies. Drukkerij Raddraaier has evolved into a professional printing company, yet it always kept its distinct nature.

inhabitants (fig.8,9). This squat is part of a larger network organized and supported by the city's active housing movements. During the exhibition at 9 de Julho various public discussions were organized with representatives of the housing movement, community members, and international guests.

One of the outcomes of the project's second phase is also the present publication, for which Aimée Albers, Anastasia Kubrak, Flora Bello Milanez and Fiona Herrod joined the research team, while Jere Kuzmanić and Maria Fernanda Duarte worked on the architectural drawings, and Maud Vervenne on the graphic design. This publication presents the annotated drawings and photographs as they have been included in the archive. It is designed to be able to circulate freely. Therefore, in addition to the version printed at Raddraaier in Amsterdam, it is also available to download as a PDF.¹ The revenues will be used to contribute to the legal costs of squatting communities who are threatened with eviction.

With this publication, the project comes to a provisional end. Yet it also celebrates the project's afterlives in different initiatives, actions, collaborations, and in the methodology that we hope could be appropriated, improved, and used in current and future archiving of both still-existing and legalized squats.



PLANTAGE DOK – This large industrial complex in the middle of Amsterdam has been squatted on two occasions and is now legalized as a major subcultural center.

In the early 1980s a group of squatters briefly occupied a large former printing office built around a 19th century church in Amsterdam's Plantage district. After their eviction, the complex was temporarily used as a school before becoming vacant again for several years. In 1998 squatters took possession of the site again. As many squats in Amsterdam were threatened with eviction at the time, the new inhabitants started a campaign to legalize their premises and living conditions in order to secure the building in the long term.

After a period of negotiations, the group purchased the complex in collaboration with the municipality's newly established office for creative spaces and took it off the market by means of a leasehold. Following the legalization the occupants started to renovate and transform the building, fostering social interaction among its users, for instance by adding internal windows that created spatial relations and connections. They also constructed affordable studios, workshops and a café-restaurant. The enclosed church was restored to its original condition and used as a cultural venue. Plantage Dok has since developed into an important meeting place within Amsterdam's subcultural scene.

Program – A *woonwerkpand* (a building for living and working) with a cultural venue inside a former church, multifunctional spaces, a café with a stage, artist residency and 30 studios and workspaces for artists, collectives and social initiatives.

1872

Construction of the Plantagekerk church on the Plantage Doklaan in Amsterdam (fig. 1, 2).



Figure 1, 2: Plantagekerk around 1928.

1929–1932

The printing company Kampert en Helm acquires the church and adds a building to it.

1954–1956

Kampert en Helm constructs a building across the full width of the site at Plantage Doklaan (fig. 3). Presses are placed in the former church.



Figure 3: Kampert and Helm printing firm.

Early 1980s

Kampert en Helm relocates to Lelystad.

April 1981

The Artis Squatter Group squats the buildings at Plantage Doklaan 8-12 and Henri Polaklaan 11, naming the whole complex Huize Lukraak.

(p. 54: Press release to announce a new squat / p. 55: Alarm system of Artis Squatter Groups / p. 56: Neighborhood map and list of buildings squatted by Artis Squatter Groups).

1984–1994

The entire complex is in use as a school for vocational training. The former church serves as a gym.

1994–1998

Periods of vacancy are followed by periods of temporary use by anti-squatters.

January 1998

The building is squatted by a group from the evicted Graansilo and Houtkopersburgwal squats. The premises are opened with an emergency key found in a small safe on the façade. Immediately after it is occupied, walls are erected around the anti-squatters who remain in the furthest corners of the building.

(p. 57: Press release to announce a new squat).

Early 1998

The building is made suitable for occupation. Provisional walls made of scrap wood and canvas are constructed to transform the large classrooms into living spaces and workshops. The rooms are heated by wood-burning stoves, for which chimneys are installed.

1998–1999

Out of concern for a number of planned evictions, various squatting groups launch a joint campaign to highlight the disappearance of free space in the city. In response, the city sets up *Broedplaats Amsterdam* (now *Bureau Broedplaatsen*), an initiative that aims to provide space for young creative people in the city.

Early 2000

As part of the new *Broedplaats* program, a feasibility study is carried out into the legalization of Plantage Dok.

Early 2001

The squatters of Plantage Dok set up the foundation Stichting TOK in anticipation of the upcoming legalization. The municipality buys the building from the owner for three million guilders (€1.7 million).

June 2001

Stichting TOK acquires the building from the municipality for one guilder and signs a lease contract for 50 years, to be extended automatically afterwards. To prevent speculation, the building may only ever be sold back to the municipality.

July 2002

Stichting TOK receives approval for an extensive renovation, to be carried out largely by the occupants themselves. They propose a radical transformation of the interior with the aim of fostering social interaction among its different user groups.

2002–2005

During the renovation many studios are created, one of which is intended for temporary use by international guests. Balconies are inserted into the church nave which will host exhibitions, performances and lectures. In the future café space, a hole is cut out of the concrete floor, balustraded with fencing from the squatted ADM terrain.

2006–2018

Supported by donations, the community organizes a series of recurring public events in the building's largest space inside the former church, the 'Dokzaal', and the café space.

(p. 58: 20th anniversary poster / pp. 60-61: Monthly activity posters).

2010

As rental revenue from the Dokzaal proves to be below expectation, the inhabitants decide to restore it to its original condition in an attempt to maximize its use.

Early 2014

The roof is renovated and 200 solar panels are installed.

Early 2019

Rental revenues are above expectations, making it possible to renovate further and make the building more sustainable and comfortable.

PERSVERKLARING KONINGINNE-DAG ! ! 1981 !

Het is feest vandaag ! Omdat Kraakgroep ARTIS deze koningin-
dag ook feestelijk willen maken voor 25 woningzoekenden heb-
ben we vanochtend de leegstaande drukkerij van Kampert &
Helm B.V. (Henri Polaklaan 11 en 11a, Plantage Doklaan 8,
10 en 12) gekraakt. Twee jaar geleden is de drukkerij naar
Lelystad verhuisd en sindsdien heeft het pand leeggestaan.

Met het bewoonbaar maken van dit pand willen we onderstrepen
dat het huisvestingsbeleid in deze stad niet klopt. De leeg-
standswet zal hierin geen verbetering brengen.

We hebben woninginnedag extra feestelijk willen maken voor
de Plantage- en weesperbuurt door met een grote groep mensen
de zo kale Weesperstraat en omgeving op te fleuren met leuke
tekst en spannende affiches. Bij deze aktie zijn helaas 6
mensen opgepakt die nu (16.00 u s'middags) nog steeds vast
zitten. De politie was wederom schijnbaar niet in feeststem-
ming. Wij wel, en KRAKEN GAAT DOOR !!!!!!!!!!!!!!!!!!!!!!!!!!!!!

Kraakgroep ARTIS (Weesper/Plantagebuurt)

ALARMLIJST ARTIS

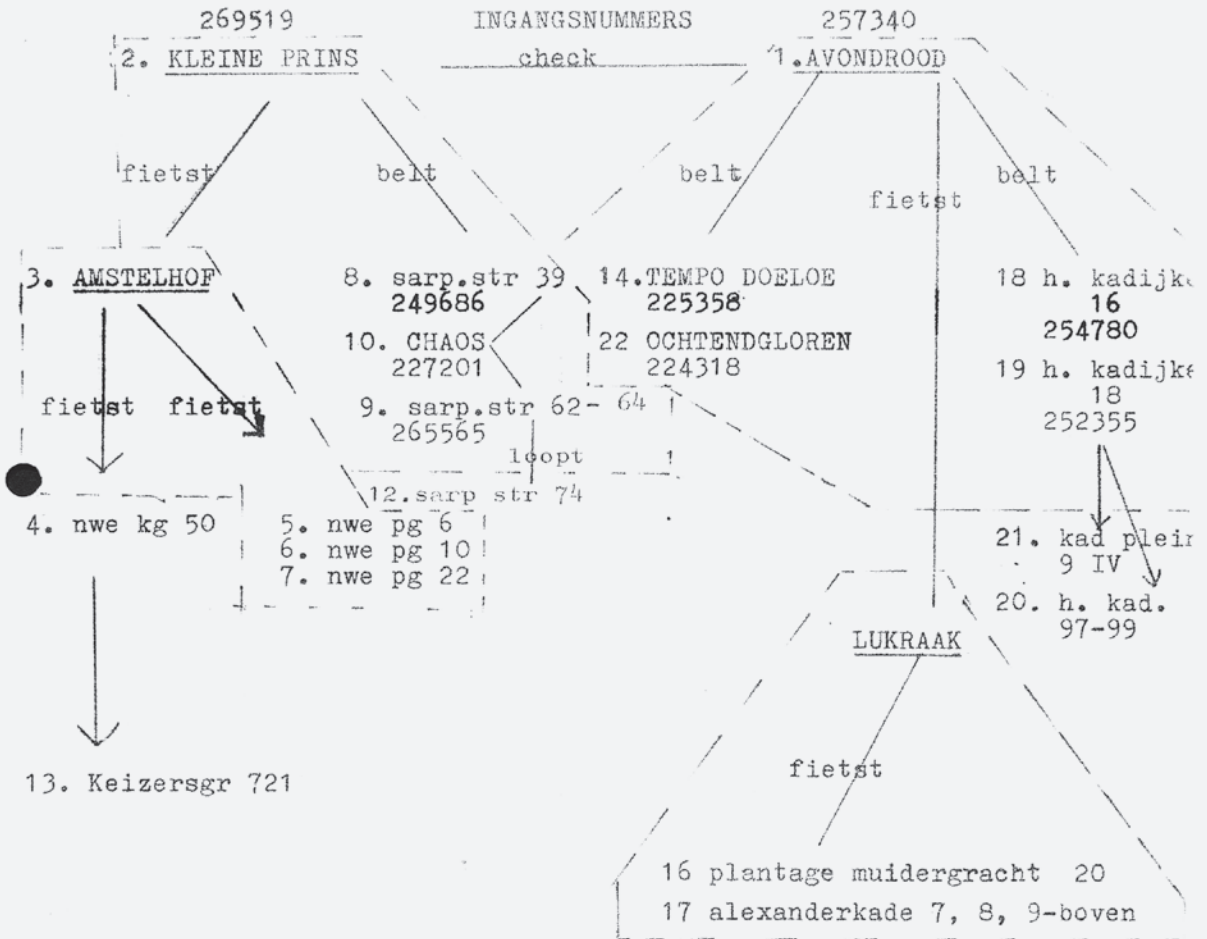

INGANGSNUMMERS AANGRENZENDE BUURTEN:
DAPPERBUURT 936251
NIEUWMARKT 256768
GRACHTENGORDEL 246069 / 233839 / 259243

OPMERKINGEN BIJ DEZE FANTASTISCHE ALARMLIJST

1. Als er alarm binnenkomt op een ander nummer dan de ingangsnummers moeten eerst deze ingangsnummers worden gebeld.
2. Wanneer het niet tegelĳktĳdig kan moet de KLEINE PRINS eĳerst fietsen en dan bellen.
3. Bij knokploegen of andere plotselinge narigheid is het zinnig om naast alarm in ARTIS ook de dichtstbijzijnde omliggende buurt te waarschuwen
4. HOUDT DE BUURTKAART MET PANDENLIJST EN DEZE ALARMLIJST BIJ ELKAAR. HANG ZE BIJ DE TELEFOON OF OP EEN ANDER CENTRAAL PUNT IN HUIS.



- | | | |
|-----------------|----------------------------------|-------------------------------|
| 1. AVONDROOD | Nieuwe Herengracht 143 | tel. 257340 |
| 2. KLEINE PRINS | Utrechtsedwardsstraat/Prinsengr. | 269519 |
| 3. AMSTELHOF | Nieuwe Keizersgracht 1A | |
| 4. | Nieuwe Keizersgracht 50 | |
| 5. | Nieuwe Prinsengracht 6 | |
| 6. | Nieuwe Prinsengracht 10 | |
| 7. | Nieuwe Prinsengracht 22 | |
| 8. | Saphatistraat 39 | tel. 249686 |
| 9. | Saphatistraat 62-64 | tel. 265565 - 277266 - 232743 |
| 10. | CHAOS Saphatistraat | tel. 227201 |
| 11. | Saphatistraat 91 hs | |
| 12. | Saphatistraat 74 | |
| 13. | Keizersgracht 721 | |
| 14. | TEMPO DOELOE Prinsengracht | |
| 15. | HUIZE LUKRAAK Henry Polaklaan 11 | |
| 16. | Plantage Muidergracht 20 | |
| 17. | Alexanderkade 7, 8, 9 boven | |
| 18. | Hoogte Kadijk 16 | tel. 254780 |
| 19. | Hoogte Kadijk 18 | tel. 252355 |
| 20. | Hoogte Kadijk 97, 99 | |
| 21. | Kadijksp. 9 IV | |
| 22. | OCHTENDGLOREN (reclassering) | tel. 224318 |

*fax Vh 70
6025672*

PERSBERICHT

Op 3 januari 1998 is de voormalige streekschool aan de Plantage Doklaan gekraakt door een groep kunstenaars, ambachtslieden en studenten. Mensen die ervoor kiezen in een breder sociaal verband te wonen en te werken, en hun kennis en ervaring bundelen. Ondanks het aantoonbaar culturele en economische succes van woon/werkpanden in Amsterdam worden ze keer op keer in hun voortbestaan bedreigd of weggedrukt door kapitaalintensievere projecten. Dit dreigt op korte termijn te gebeuren met o.a. de Graansilo, het Vrieshuis Amerika, Ruigoord, de Houtkorpersburgwal en het Doklaantje achter Artis. Plekken die broodnodig zijn voor de leefbaarheid in een stad als Amsterdam.

Wat hebben woon/werkpanden nog meer te bieden:

- atelier-ruimte.
- makkelijke start beginnende bedrijven.
- natuurlijke sociale controle.
- opvang en stimulering van sociaal minder bedeelden.
- armoedebstrijding door gedeelde en lagere woonlasten.
- mogelijke samenwerking tussen kunstenaars van verschillende disciplines
- vernieuwende experimenten op het gebied van theater en dans hebben door de lage huur kans zich te ontwikkelen.

Wij komen uit andere woon/werkpanden die momenteel bedreigd worden. We hebben de streekschool op de Plantage Doklaan in gebruik genomen omdat we door willen gaan met onze initiatieven. We willen laten zien dat er plek is in de stad voor deze initiatieven, betaalbare woon- en werkruimte, een broedplaats voor kunst en cultuur, en te zijner tijd een levendige uitwisseling met de buurt en de stad.

Met vriendelijke groeten,
De bewoners en gebruikers van de Plantage Doklaan ...

20 JAAR JUBILEUM

PLANTAGE DOKLAAN

ZAT 21 APRIL

JA HOOR...
WE HEBBEN HET PAND
NET GEKRAAKT,
KOMEN JULLIE
LANGS?



La Banda
Fantástica

HOEMPA
TRASH

AANVANG 20.00

EN... DJ'S! OPEN ATELIERS!
EXPOSITIES! THEATER & DANS
VOORSTELLINGEN!

ENTREE OP DONATIE

WWW.PLANTAGEDOK.NL



PLANTAGE DOKLAAN 8-12 AMSTERDAM

58



Naam van de gekraakte-
gelegaliseerde locatie

Plantage Dok

Adres

Plantage doklaan 8-12

Grootte (m² van het gebouw
en/of terrein)

2900 m²

VOOR DE KRAAKACTIE

Originele functie(s)
van het gebouw

Kerk, drukkerij, ambachtsschool,
Vrijd 12010, mogelijkheden plaats

Oorspronkelijke eigenaar(s)
van het gebouw

Geleefde kerk,
drukkerij, ambachtsschool

Geschatte periode
van leegstand voor
de kraakactie

0 jaar

DE GEKRAAKTE PERIODE

Datum van de kraak

03 | 01 | 1998

Aantal
en/of gebruikers

10

Functies van de gekraakte locatie

Kunst, ambacht, actieve, publieke functies

Motivatie of redenen
voor de kraakactie

Ontmiming van de kwaliteit
Belangrijkste ruimtelijke
transformaties na de
kraakactie

Extreme make over

LEGALISATIE / ONTRUWING

Datum
of legalisatie

2002

Nieuwe eigenaar
sinds legalisatie

STICHTINGA TOK

Nieuw aantal
sinds legalisatie

45

Nieuwe functies
sinds legalisatie

ALLES

Belangrijkste ruimtelijke
transformaties sinds
legalisatie

Volledige renovatie, herindeling,
opdelen kerk ruimte, creatie publieke
ruimte / dak vervangen, zone panden 202

59

DOKHUIS GALERIE

GET IT ON!
EVERY THURSDAY!

RE-OPENING
25 AUG

Live Music

FOOD SERVED AT 19.00 / SHOW STARTS AT 21.30
CHECK FULL PROGRAMME ON RADAR.SQUAT.NET
OR AMSTERDAM ALTERNATIVE!

FREE ENTRANCE

Vegan Food & Art expo

Plantage 8/12
Doklaan
Adam xxx

YEAH NEE

IK HEB GEEN TWIJFELS!

MASH-UP DRAWING BY MAIA MATCHES & EWAN CAMERON

DOKHUIS GALERIE

April 2013

LET'S GET IT ON!

THURS. 4
Nomak! LIVE! JAPANESE SOUNDSCAPES
19% FOOD 21% SHOW

SAT. 6
Cerga! HUNGARIAN DANCE & LIVE BAND!
16% SHOW 19% FOOD & MORE

THURS. 17
Bad Kitten!
WARPED HILLBILLY & ROCK N' ROLL!
19% FOOD 21% SHOW

THURS. 18
Delicate Project
PSYCHROCK BAND!
19% FOOD 21% SHOW
PLUS! ART OPENING

THURS. 25
Kiss Me Kill Me!
UTAH SPACE ROCK! 21% SHOW
19% FOOD BY COCO SAUVAGE!

VEGAN DINNER
FOREF
TRAMS
9&14

PLANTAGE
DOKLAAN
& AMSTERDAM

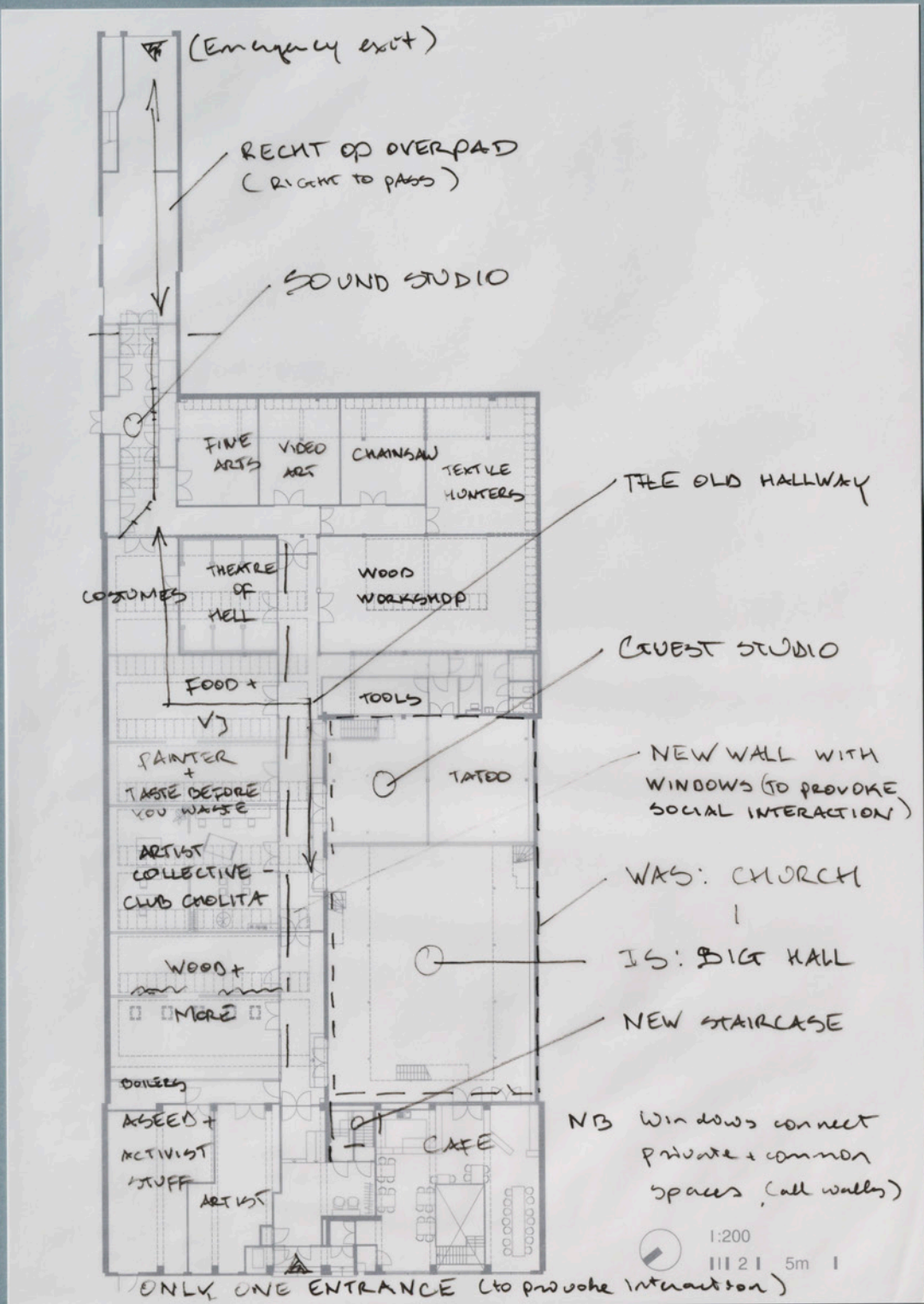

Ground floor



Entrance – To enhance social interaction, the number of entrances was reduced to two doors located next to each other on the front side.









WAS:

IS:

BICYCLE STORAGE

CAFE / LOUNGE /
VENUE

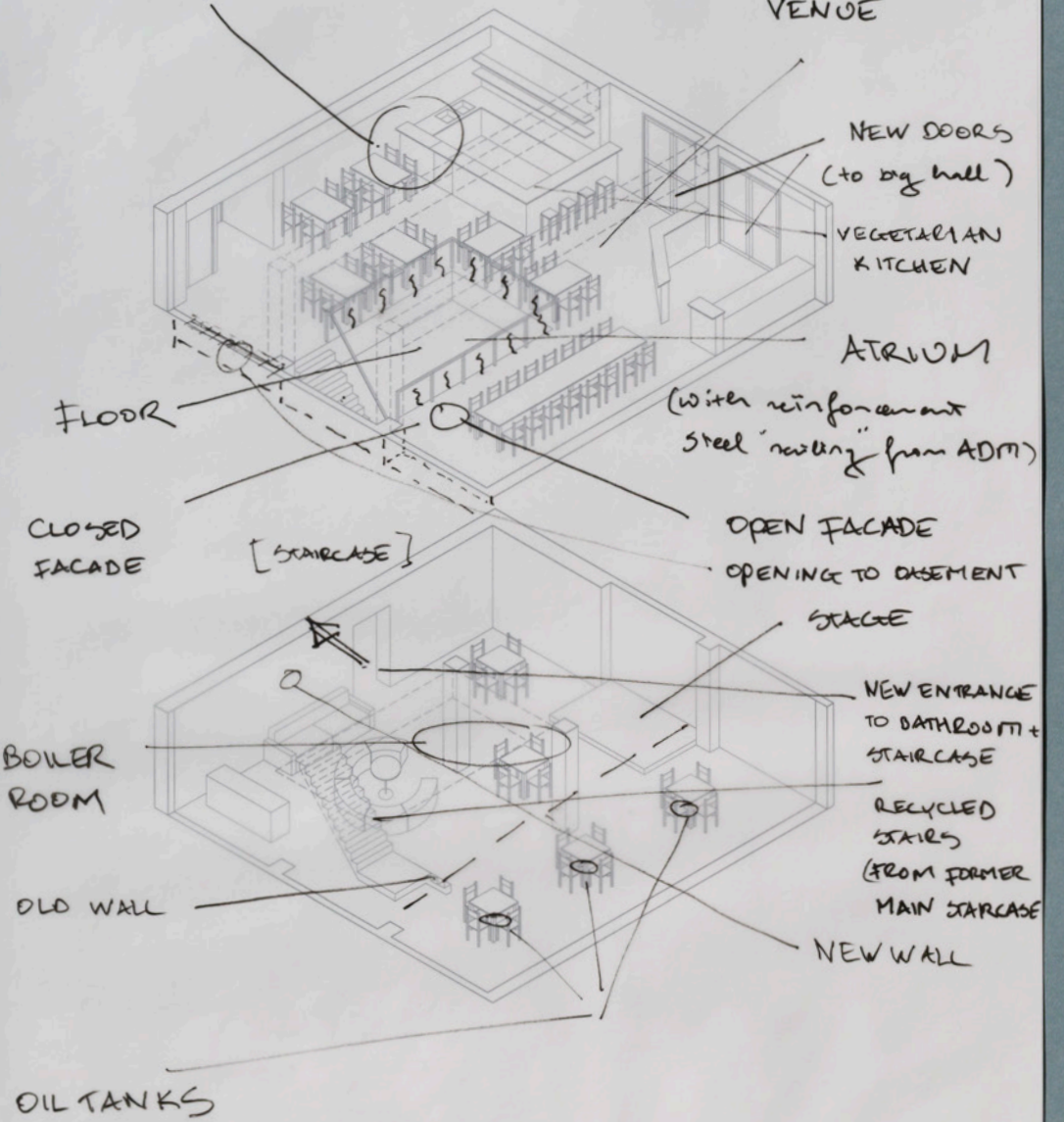

Ground floor – Café







Ground floor – Dokzaal

Church space – The former church is used as a multifunctional space and cultural venue, the Dokzaal.

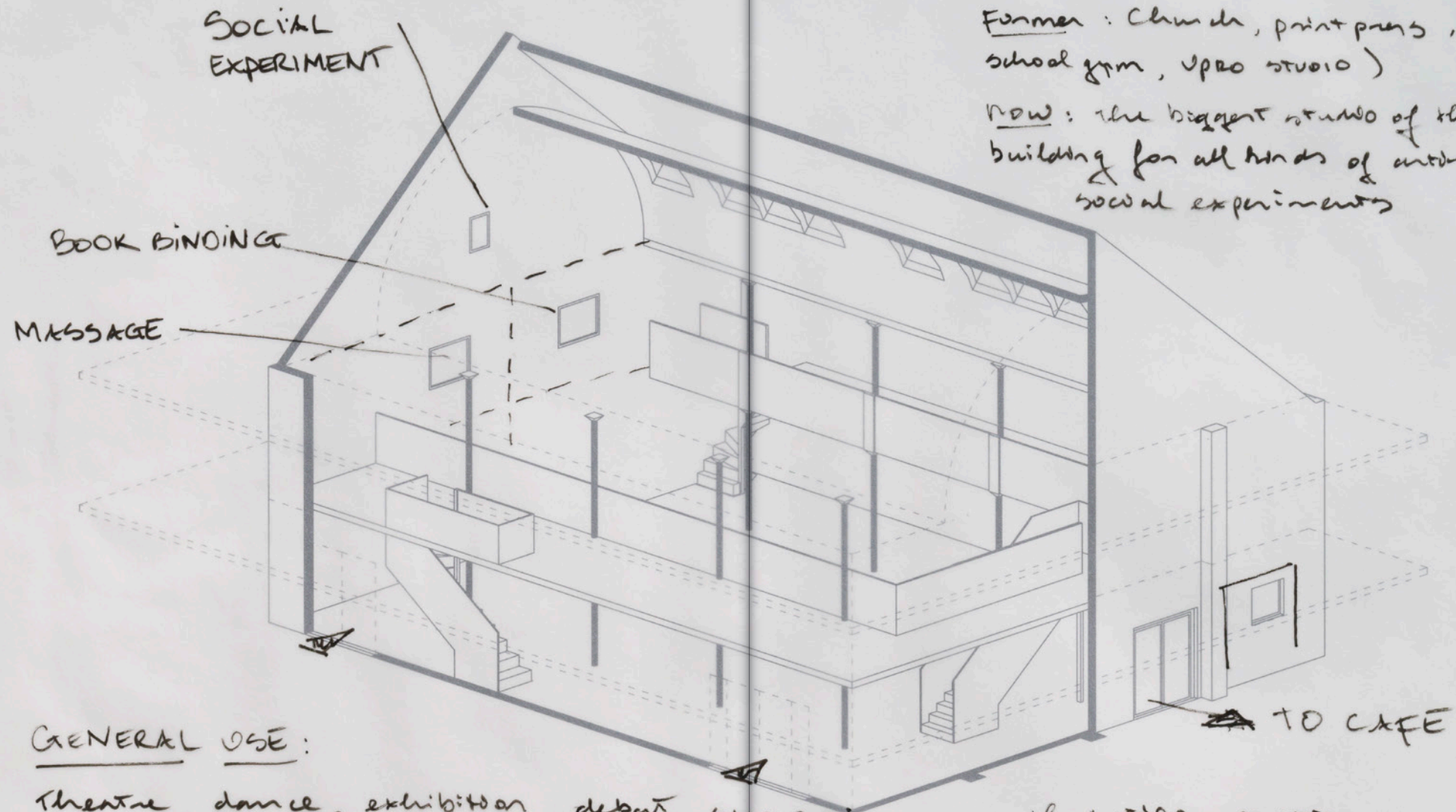

GENERAL USE:

Theatre, dance, exhibition, debat, symposium, manifestation, music, vohomoham, rituals, experiment, play ground (Dokkers), rehearsals

BIG HALL

Former: Church, print press, school gym, vpro studio)

now: the biggest studio of the building for all kinds of artistic social experiments

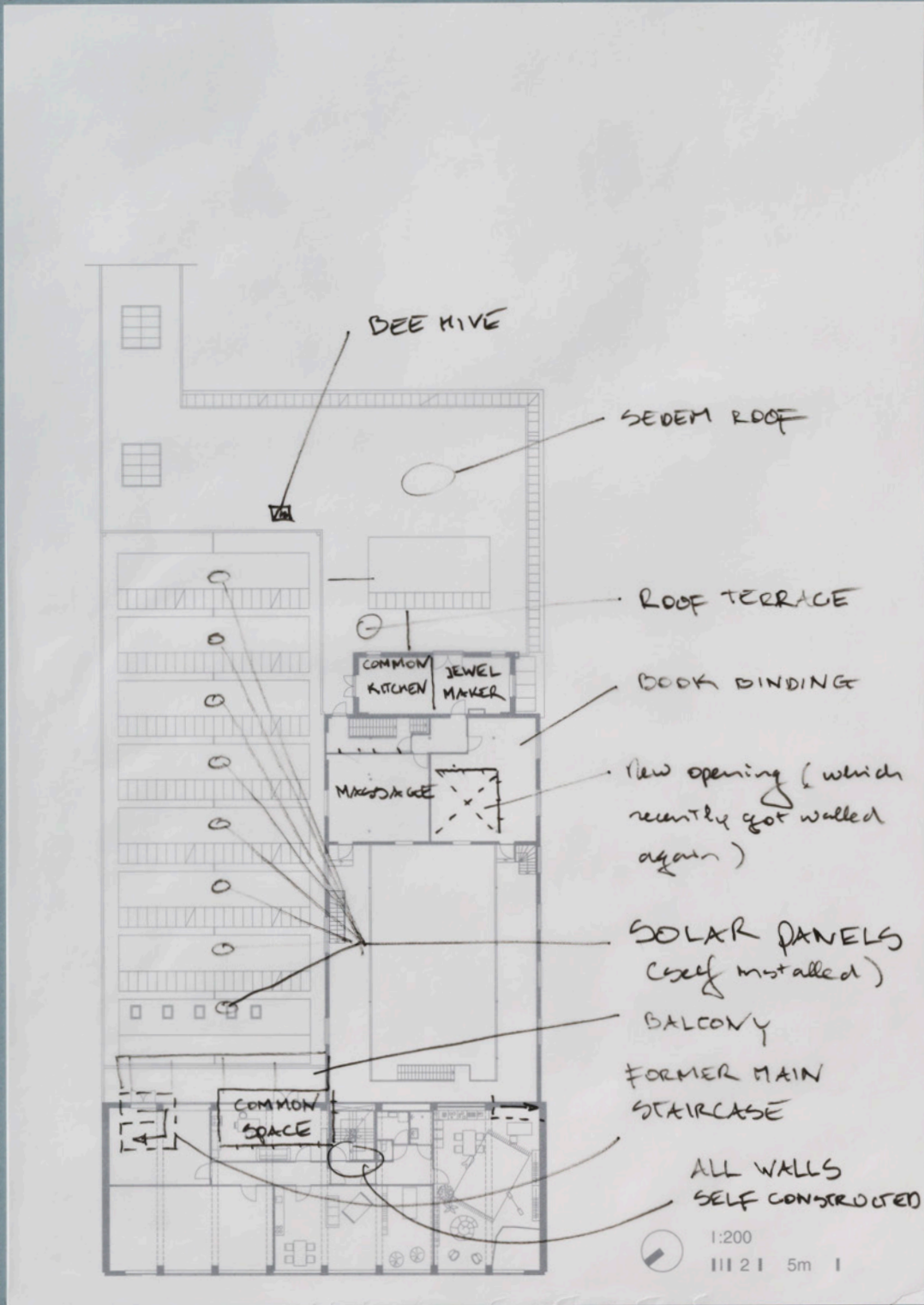

First floor







First floor – Kitchen

Each floor has a shared kitchen.





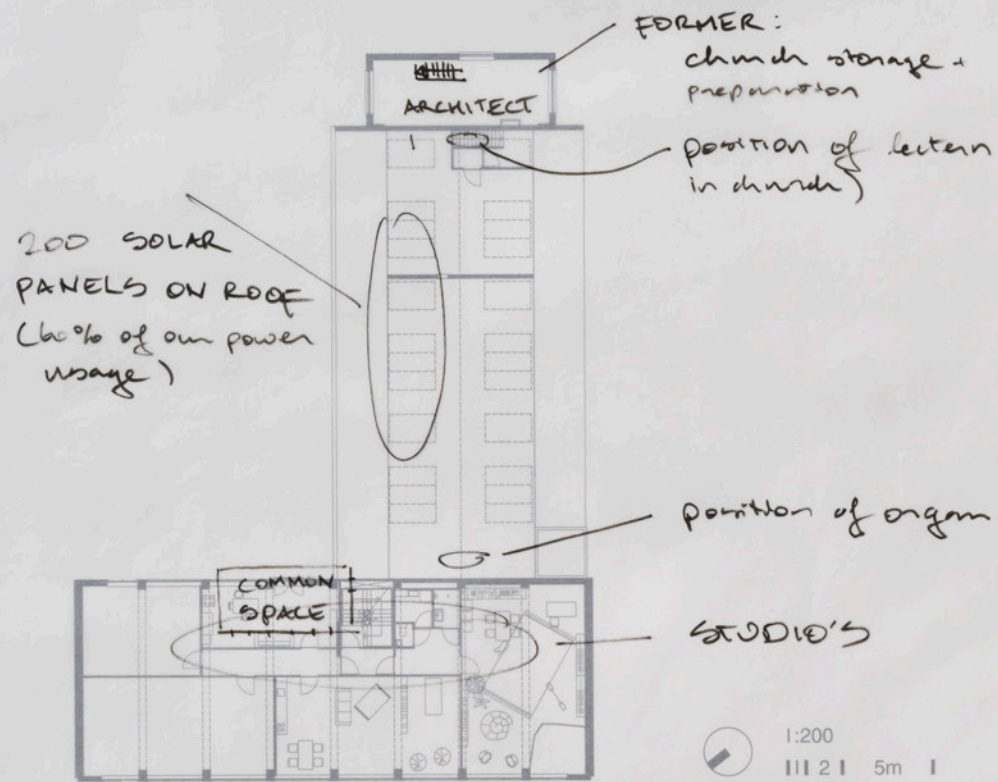

Second floor

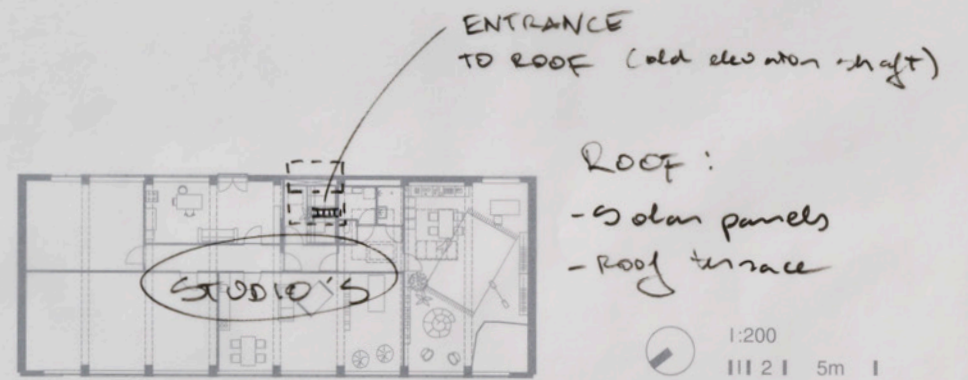

Third floor



Second floor – Kitchen





Tracing the impact of squatting on the Dutch urban landscape – a conversation with Mark Minkjan

René Boer, Marina Otero Verzier, Katía Truijen (Eds.): Mark, your work focuses on the social, political and economic implications of architecture and planning, and in particular contemporary urban dynamics. Where do you notice the impact of the squatting movement on the Dutch urban landscape?

Mark Minkjan (MM): In Dutch cities squatting has been a significant institutional force in politics and spatial development since the 1960s. Its official criminalization in 2010, when the squatting ban became law, is often seen as the end of an era in which squatting was allowed under certain circumstances, if a building had been vacant for at least one year. The ban wiped out this legal maneuvering space.

Yet despite happening in smaller numbers today, squatting is not dead. We should therefore avoid historicizing the movement if that means considering it a thing of the past. However, right now is a good occasion to take an associative look at the ways in which Dutch cities today have been influenced by squatting.

Due to stigmatizing media coverage and spectacularized historical events, common understanding of squatting in the Netherlands is superficial, with a handful of violent clashes between protestors and authorities often referred to – most of which happened over 35 years ago. Common associations with squatters are frequently derogatory, and this dominant stigma was gratefully used by the political parties campaigning for the criminalization of squatting. Framing it as a criminal activity makes it easier to ignore the structural societal problems addressed by the squatting movement, such as housing shortages and real estate speculation, which have far from disappeared. The movement has been an important political factor by researching and calling attention to vacancy, real estate crime, and other social ills.

Moreover, experimental spatial and social practices originating from or strongly related to squatting have had a significant influence on architecture, urban culture, policy, and real estate. Its practices have been adopted, inspired spin-offs, and even been turned against the movement's own agenda through appropriation and commodification.

Eds.: Could you elaborate on how these practices have evolved in the Netherlands over

time, and the motivations that were behind them?

MM: Squatting blossomed in the decades when inner-city living was out of vogue and those who could afford it moved to villages and suburbs, leaving parts of the housing stock empty. The post-World War II era saw a general disdain for the old, dilapidated, unhygienic and congested inner cities. Amsterdam, for example, saw its population decrease from 870,000 to 675,000 between 1960 and 1985. By appropriating many of the vacant, often deteriorated and unloved buildings, the squatting movement contributed to preserving and renovating architectural heritage which was about to fall into complete disrepair, or be demolished in favor of property development. Amsterdam's Nieuwmarkt area owes it to the squatting movement for its part in preventing the entire area being wiped out for a modernist renewal project in the 1970s.

The appropriation of architecture made issues of vacancy, speculation and preservation politically visible, both in the streets as well as through media attention. Squats have also regularly forged coalitions with local residents and organizations to establish social provisions and orchestrate political action.

Whatever society's least favored building type or urban environment at a certain moment in time, it can still provide space for the reimagination and reuse of human environments. Forsaken buildings and urban wastelands that became blind spots on the general population and investors' mental maps – houses, apartment buildings, schools, factories,

warehouses, churches and offices – have been fruitful grounds for the emergence of new domestic compositions, architectural typologies, cultural spaces, and places for work. In many ways, the squatting movement has been an example for practices and policies for the greater social good, but unluckily also for exclusionary developments.

Eds.: The difficulty that large parts of the population experience in accessing housing is a very pressing issue affecting many cities around the world, making them very exclusive places to live. What kind of alternatives to market housing strategies have emerged from the squatting movement?

MM: Housing has been the initial and primary focus of the squatting movement which has resulted in famous squats, unique architectures and policy innovations. Not only have all cities in the Netherlands had vacant buildings squatted by and for people in need of a place to live, many of them still house squats or squatted buildings that have since been legalized as formal social housing options. The squatting movement has paved the way for the repurposing of architecture. An important result of this has been the emergence of innovative living arrangements. With the conversion of warehouses, schools, office buildings and other structures into non-traditional homes, both architecture and domestic structures have been reinterpreted, resulting in novel spatial and social expressions. *Woongroep* (co-living) is such an expression. Although not exclusive to

squatting, many squats were set up as a communal housing arrangement. Many of these cohabitations still exist in the Netherlands today, with around 150 in Amsterdam alone, with famous ones including the former Wilhelmina Gasthuis hospital and several early 20th century school buildings. Here, groups consist of four to 10 people who individually have a private room and share most amenities such as kitchens and bathrooms. Demographic changes in household composition, housing shortages, and a social, economic and environmental preference for sharing make co-living a sensible option for many urbanites today.

The combined home-workspace arrangement is another domestic architecture that has proliferated in squats and was later adopted in formal project developments. Sometimes these innovative housing projects were realized in collaboration with architects, often also without them. ORKZ in Groningen (fig.1-11) is a repurposed former hospital with combined living and work spaces, housing around 250 people. The squatted Landbouwbelaag in Maastricht is an enormous repurposed granary offering an experimental space where living, creating, and cultural activities are interwoven. Various new developments mixing housing and workspace such as Amsterdam's Vrijburcht and Nautilus projects are direct spin-offs of the squatting movement.

New additions to the urban housing market today still mostly consist of traditional apartments. The alternative strategies of the squatting movement have not scaled up considerably, at least not in not-for-profit ways. In recent years however, commercial

1. As explained in 'A conversation between three generations of the Student Squatting Information Center (SKSU)', pp. 153-164.

urban developments in Dutch cities have also shown less conventional housing setups, such as micro apartments or cohabitation developments like The Student Hotel. These developments rent out small private rooms with other spaces and facilities shared, promising a flexible, affordable way of living and a sense of community. The Student Hotel is probably the most misleading example, selling a luxury version of communal living for almost €1,000 per month for a 14 to 18 square meter private room, with shared kitchens and 'play areas' with video games and ping pong.

In contrast, the Student Squatting Information Center has been working for years on entirely different housing solutions for students in a more affordable and political way.¹ Similarly, the legalized squats in formerly abandoned school buildings or other cohabitation arrangements in the social housing sector have rents between €250 and €400 for a similarly sized private room with shared facilities. In another recent and more uplifting example, the city of Amsterdam has built housing for students as well as refugees of similar ages, where 23 m² studios with private bathrooms and kitchens come at €511 (rooms in shared apartments at €387). One lesson here is that when the provision of housing is not left to the market, more affordable options can be offered to a more diverse population. The Student Hotel is only accessible to the more well-off, and because it operates on a hotel license, students have no tenants' rights and can only stay for a maximum of 12 months. That makes for a very exclusive and temporary community.



Figure 1, 2: ORKZ in Groningen is a repurposed former hospital with combined living and work spaces, housing around 250 people.



Figure 3: ORKZ in Groningen.

Eds.: Would you argue that the communal, collective living ethos and conditions present in squatting practices have been commodified? What other influences of the squatting movement on urban development models or urban culture have you observed?

MM: Self-organization is a key feature of squatting collectives, and making and sustaining a community demands time, joint effort and conflict resolution. But it also has the power to generate an increasingly rare sense of social and local belonging. More pragmatically, it lowers the cost of construction and living since much of the required work is done in-kind, materials are reused, and no middlemen take a cut of the pie.

This century, the bottom-up social practice and mantra have interestingly created a middle class resurgence in Dutch cities. Most clearly, individual self-build projects and cooperative housing developments have dotted urban expansions of virtually all of the larger cities in the past decade or two, including Amsterdam's Zeeburgereiland, Rotterdam's Katendrecht, Homerus-kwartier in Almere, and Leiden's Nieuw-Leyden. Here, end-users have thrown developers out of the equation, commissioning architects and contractors, or taking care of the construction themselves. Still, it generally requires above-average mortgages to play this game of buying land and building according to regulations, making it a rather privileged undertaking. Moreover, it seems to have mostly been a crisis reflex of local governments to provide space for self-builds; recently they

have mostly reverted to selling large swathes of land to single developers again.

Other local community-driven projects with little or no monetary exchange involved have recently popped up, including community land trusts, meeting places, food growing initiatives, collective childcare, cultural venues, libraries, public space maintenance, alternative local currencies, local waste processing, energy production, repair cafés, and workshops. These have received attention in the media, in professional spatial practices and in academic circles, as well as from local governments. The growing interest in 'the commons' (commonly owned, governed and operated spaces and services) is encouraging, but it also leaves a bitter taste when you consider that the squatting movement, which has demonstrated various forms of commoning, has now been criminalized. Yet further, if you consider the dismantling of the welfare state and governments calling for citizens' self-reliance, while some of the best self-organized, balanced and sustainable examples of 'the commons' have now disappeared. All the while, local and national governments in the Netherlands have been researching and subsidizing numerous commoning projects starting from scratch. Many of today's projects hailed for bottom-up growth also show a rather middle-class membership, which leaves one wondering how people without the right amounts of time, connections and cultural baggage end up after governments have torn down public provisions.

Cynically, the restaurants in The Student Hotel branches are called The Commons. Pumpkin enchiladas come at €17 and you pay €6.50 for

some watermelon with mint. Another ironic way in which squatting culture has been appropriated to facilitate a more exclusive city is in aesthetics, what I have called 'trashthetics'. The look and feel of squatting is generally associated with recycled materials and (seemingly) makeshift, accidental constructions. The past decade has seen a wealth of places of consumption propped up with reused pallet wood, scavenged objects, commissioned street art, and second-hand furniture in an edgy and seemingly spontaneous fashion, yet designed recognizably enough for the urban middle classes. Temporary and bottom-up aesthetics have interestingly made it from thrifty counterculture pragmatism to being a pretentiously unassuming décor for the manifestation of a mainstream creative urban lifestyle.

Eds.: Has squatting culture survived in other ways that could still be seen as an asset?

MM: The many cultural venues in Dutch cities still functioning today are perhaps the most visible remnants of the squatting movement, even though most people are not aware of their genesis. The well-known ones generally operate in a more commercial form than they used to, but all of them only exist because these locations started out as squats. Concert venues such as Paradiso, Tivoli and Melkweg are among the most legendary, the NDSM wharf is world famous for its reclaimed industrial landscape and as a festival grounds, and Pakhuis de Zwijger is one of the country's main platforms for international debate.

Het Domijn in Weesp is an artist and

craftspeople cooperative providing space for creation. Together with the many other music halls, galleries, cafés, people's kitchens, food co-ops, no-charge shops, book stores, cinemas, rehearsal spaces, artist studios and free-zones, they constitute an indispensable share of the cultural and social DNA of Dutch cities. Their independent, affordable and unconventional nature has contributed to the emergence and preservation of subcultures, experimental arts, critical debate, and inexpensive places to eat, drink and meet.

However, since cities have experienced an influx of more affluent residents and businesses, and development pressures have risen in the past two decades – certainly since the squatting ban – fewer of these spaces have come into being. More still have disappeared. For a healthy, open, and innovative cultural scene, cities need places and subcultures where mainstream norms, tastes and habits can be challenged and complemented. Artistic production is part of this endeavor. For many artists, makers, and other independents doing labor with little, uncertain, or no economic return, affordable workspace – just as affordable housing – is essential for the development of their practice. Many squatted buildings have contributed to this infrastructure over the past decades, providing a crucial stock of temporary and unofficial, as well as later on formalized, studios and other spaces for work. However, with increasing development pressure on Dutch cities (ironically lubricated by creative industries policies) inexpensive workspace has become scarcer.



Figure 4, 5: The ORKZ hospital was transformed into a little village within the city of Groningen with the long corridors serving as bike lanes, and the reception hall as a central square.



Figure 6: ORKZ in Groningen.

In Amsterdam, the local government acknowledged this scarcity in 1998 after a collective of some 700 of the city's squatters called attention to the importance of their own existence, as well as that of the many buildings housing artist studios, workshops, cultural venues and homes that were in danger of being evicted. The assembly demanded a constructive policy for the settlement and growth of young cultural-economic actors in the city. A policy document actually followed, recognizing the importance of a system of alternative live-work setups. It stressed the value of fostering and sustaining the city's arts, design, media and other cultural economies to the city's economy as a whole. Because many artists have a small income and the cost of most workspaces exceeds their budget, the document concluded that the government should intervene. The resulting policy plan was notably titled 'No culture without subculture' and took the practices of several former squats as a blueprint for supporting – through subsidies and guidance – the creation of new incubator places (*broedplaatsen*) as they have been called since. The initial aim was to provide space to work for some 1,400 to 2,000 artists and cultural entrepreneurs in Amsterdam. In 2016, some 170,000 m² was in use as a result of this policy, ranging from artist studios, workshops, small offices and galleries to shops, cafés and restaurants. Perhaps the most notable of these is the 7,500 m² ACTA building, housing nightclub Radion, and De Ceugel, a cluster of recycled houseboats used as offices and a trendy Berlinesque café. Over the past decade, multiple Dutch cities have adopted a

version of the policy including Rotterdam, Groningen, Alkmaar, and Tilburg.

Since the policy was inaugurated almost two decades ago, the spatial focus has roughly moved from inner-city industrial and harbor spaces to disadvantaged neighborhoods such as Noord and Nieuw-West in Amsterdam. Another interesting shift is one in perception and purpose – subsidizing incubator places were initially seen as state support for struggling artists, whereas currently the temporary creative projects are regarded as stimulants for – and symbols of – the social, cultural and economic upgrading of neighborhoods. With many of them only existing for a few years, disproportionate amounts of energy, time and money are wasted on the build-up and dismantling of these places. This also makes it difficult for the communities in these incubator places to have their practices come to fruition, let alone establish valuable relations with their urban surroundings.

A recent example of this phenomenon is Lola Lik, an 8,000 square meter ‘creative hub’ in Amsterdam’s former Bijlmer Bajes prison which only existed for one year, took a huge toll on the people involved, and yet a lot of potential was left unfulfilled. The city council recently sold the area for it to be developed into an upscale neighborhood. Moreover, at least in Amsterdam, the artists and entrepreneurs that the incubator policy provides space for increasingly need to have been earmarked as ‘top talent’, and the amount of artist studios provided is steadily dropping. Although still providing highly necessary space for many, mostly young independents,

the policy that started from an idea of inclusiveness and preservation is turning into a state-sponsored tool for gentrification, both for urban areas as well as for the cultural scene it is supposed to care for.

Eds.: We should also talk about one of the most dramatic ways in which squatting was absorbed by the market and deployed into neo-liberal real estate policies – the anti-squat.

MM: Squatting largely originated as a response to a combination of housing shortages, vacancy, and real estate speculation, with speculation making it impossible for the demand for space, and the oversupply of it, to equal each other out. Over the past half century articulations of vacancy and housing scarcity have taken on new shapes. If the collective desire were there, the equation could have been solved through policy and action leading to a more accessible and affordable housing market.

Yet for the suppliers of space, including real estate investors, property developers, homeowners, landlords, and also governments and the politics representing them, preserving or even producing scarcity is preferable in order to keep demand and thus prices high. With every appropriated vacant building, squatting has contributed to a balancing out of the need for a place to live and the oversupply of space that could not be solved by the market because of property speculation and artificial shortages. Some squats have held out and others have been formalized, but many have been evicted and the buildings handed

back to the market in the widespread belief that this is where societal issues should be solved. The market has even used appropriation tactics to expand speculation. Before criminalization in 2010, occupying a building through appropriation was tolerated after the space had been vacant for at least a year and until the property owner could show a relevant and feasible plan for reuse. The practice and possibility of squatting has functioned as a counter-speculation force in the housing system because it encouraged owners to make sure space was used and maintained.

However, a market response against squatting has been the emergence of an entire industry of anti-squat (*antikraak*) or property guardianship since the 1980s. The essence of anti-squat is that a small group of people or a single individual 'guards' a building, thereby neutralizing the owner's risk of having their property squatted. It is a considerably cheaper option than using traditional security guarding, and it can help owners dodge vacancy taxes and drive down maintenance costs.

These initiatives are often presented as a win-win situation as it still provides space to people looking for an affordable home, office or studio. The anti-squat industry is large, and the concept is a successful Dutch export product. Currently, one in 1,000 people in the Netherlands lives in an anti-squat situation, compared to one in 10,000 in the UK. Yet anti-squat fits the general trend of socioeconomic flexibilization and precarization with things like zero-hour contracts and the gig economy.



Figure 7, 8: The ORKZ is an autonomously managed experiment of collective living with socio-cultural activities like a cinema, an eatery, a bar and a second-hand shop.



Figure 9-11: ORKZ in Groningen.

Despite being called ‘guardians’, the temporary angels are not paid for their services; instead they pay the property guardian company a utility fee, usually increased by administrative costs, making the actual costs not as low as generally thought. Instead of a normal rental contract, a kind of lend-lease is set up between the property guardian company and the guardians, who are explicitly never called tenants or dwellers. This formality makes it so that the guardians do not have any tenants’ rights. Property guardian companies make unannounced visits to inspect the property and single rooms usually cannot be locked. The absence of tenants’ rights not only makes trespassing possible and privacy minimal, it also implies the ever-impending threat of eviction, often with a few weeks’ notice – sometimes a few days. Sometimes guardians cannot be absent from the premise for more than two nights – this is the precariat’s house arrest.

Though it is sometimes presented as a lifestyle decision to live as a property guardian (adorned with adjectives such as cheap, spacious, adventurous and flexible), anti-squat is often the only option for people to live affordably in popular cities. It alleviates immediate pain for some, but it does nothing to address structural housing market failures. Whereas squatting could be seen as a contribution to the housing solution and the debate surrounding it, anti-squatting is no more than a security service for property owners. While squatting weighs in to counter speculation and other unjust forms of spatial distribution, anti-squatting widens the

opportunities for speculation, muffles the discussion about housing as a human right, and makes it more attractive not to invest in the long-term functioning of spaces. Moreover, squatting in the Netherlands historically has a strong connection to neighborhood activism, but due to their precarious position, property guardians – not unlike AirBnB tourists – have less of an incentive to connect to their urban surroundings. The lack of tenants’ rights also makes it easy to get rid of people with non-conformist political views.

Eds.: What do you think is the importance of the squatting movement today?

MM: In the first decades of the squatting movement, the fight for housing was not only in numbers but also in quality, to relieve people from coal stoves, shared toilets and moldy multiple-family apartments. Currently, unhygienic living experiences aren’t as widespread as 50 years ago, but a crisis exists – one in availability, accessibility and affordability. The Dutch market, mostly in cities, is not meeting the numerical demand for homes, but a look at the housing quota also shows that housing costs, as a percentage of income, have risen considerably over the last 25 years. For tenants, as the Central Bureau for Statistics showed in their 2015 ‘WoOn’ research, this share has gone up more than 10% between 1990 and 2015 (from 28.3% to 38.8%). Housing for ownership has only risen from 24% to 27.2% during the same period, not even considering the fact that most housing costs can be seen as an investment. Some 20% of

lower income echelons paid more than 50% of their income on rent in 2015. In academic literature a consensus exists that when household spending on housing is more than 30%, there is a housing cost burden. This increasing burden is limiting people in their freedom to live, work, and contribute to society. Given that over 25 years a large percentage of the housing system has been left to the market, and that the market is not delivering inclusivity, alternative housing strategies are much needed today.

Yet squatting is not a historical phenomenon. During the past five years, a group of asylum seekers whose asylum application has been rejected and who have no right to housing or work, has appropriated dozens of buildings, aided by the squatting movement. Some of these buildings are iconic, which has drawn attention to an invisible and neglected part of Dutch society. Just like 50 years ago, squatting still helps to address highly problematic and inhumane situations. Similar maneuvers would be welcome today to call on antisocial and austere circumstances in the fields of housing, cultural life, and public provisions. These could contribute to political debate, social good, and spatial experiments which are all crucial elements of an inclusive, productive and sustainable society.



WIJDE HEISTEEG 7 – This typical 17th century Amsterdam-style house was neglected by its owner and squatted twice for long periods of time.

Wijde Heisteeg 7 is a small house in Amsterdam's historic center. Despite being listed as a national heritage site, it has been in a particularly poor condition for years. The owner's neglect of the building forced the original tenants to leave, and has created tensions with the city authorities and heritage preservation groups alike. These groups repeatedly lodged objections against planning applications by the owner, arguing that the heritage status of the building was not adequately considered. Their claims have prevented a full-blown renovation, and the conversion of the building into luxury apartments.

In an effort to counter its persistent vacancy, the building was squatted from 2007 until the 2011 enforcement of the squatting ban, and later again for almost the entire year of 2016. On both occasions the squatters carried out renovation work to prevent further deterioration, including repairing leaks and mending the roof structure. Coinciding with the most recent occupation, a group of collaborating squatters published the 2015/2016 squatting manual, prompting questions amongst both the city council and national parliament about the legality of circulating such documents. Meanwhile, the occupants of Wijde Heisteeg 7 were evicted in late 2016 and it has since been transformed into a pop-up store, while the upper floors remain empty.

Program – Housing for up to five people, a guest room, workshop and give-away store.

Early 17th century

The building was constructed on a site that was part of a minor urban expansion scheme.

Early 19th century

A new façade is built.

May 1970

The building is registered as a national heritage site.

Around 2000

Separate tenants rent each of the small apartments on the first to fourth floors, while the ground floor houses a small fashion boutique.

2003

The occupants complain about overdue maintenance. The city authorities call on the owner to carry out renovations, yet no actions are taken.

February 2007

After lying vacant for over two years, the second and third floors are squatted. The squatters claim the owner wilfully neglecting the building in order to force the tenants to depart and to eventually be able to construct luxury apartments.

Late 2007

The fourth floor and attic are squatted after they are vacated by the previous tenants. The attic, and in particular the roof, are in poor

condition, for which the squatters carry out provisional repairs.

2007–2011

The three squatted floors are occupied by three individuals, each with a household of their own.

March 2011

In one of the first rounds of evictions carried out on the basis of the squatting ban (in effect since 1 October 2010), the occupants are evicted without the owner having submitted concrete proposals for its future use. A number of anti-squat residents are stationed in the property.

(p. 126: Statement about an upcoming eviction).

October 2011

The anti-squat residents are removed, and the owner has the building's interior stripped.

2011–2016

The building lies vacant.

January 2015

The owner seeks permission to renovate the property, and to reposition the 17th century rear elevation in order to enlarge the building.

February–September 2015

The Association of Friends of the Amsterdam City Center (VVAB), a foundation that advocates the preservation of monuments,

gets involved in the case and submits objections to the renovation plans.

September 2015

A board of appeal concludes that the entire approval procedure must be conducted again.

Early January 2016

After being vacant for almost five years, the whole building is squatted by a group of approximately 100 squatters who gather in the nearby Vrankrijk squat. During the occupation, the owner's son climbs into the building through the adjoining premises but is ousted by the squatters. This squatting action was also used as an occasion to present the newly published squatting manual (fig. 1).

(p. 127: Press release about the 2016 squatting action).



Figure 1: 'What is not allowed is still possible', 2015/2016 squatting manual.

Late January 2016

Five squatters immediately form a community to fit windows found on the street into the ruined building, with the aim of preventing further deterioration and make its occupation possible. Later, the community creates a workshop and give-away store on the ground floor, a shared kitchen on the first floor, and bedrooms on the other floors.

(p. 128: Poster for a give-away store).

January–February 2016

The right-wing political party VVD condemns this squatting action in a meeting of the Amsterdam city council as well as in the national parliament.

March 2016

The owner once more seeks permission to redevelop the building. The VVAB opposes the project and lodges an objection.

November 2016

While approval for the complete renovation is pending, the owner requests the eviction of the inhabitants, citing the intention of putting an anti-squat resident in the building. The squatters instigate legal proceedings as they suspect that the eviction will be followed by a lengthy period of vacancy and further deterioration of the building.

8 December 2016

The court case takes place.

At the request of the squatters, Het Nieuwe Instituut submits a letter concerning the cultural and urban value of squatting as an architectural practice, and its role in preserving historic buildings, citing Wijde Heisteeg 7 as a key example.

22 December 2016

The court determines that the building must be evicted by 13 January 2017.

23 December 2016

The police evict the residents in the early morning without warning. Four inhabitants are arrested but released on the same day. After almost a year, this building is one of the longest running squats since the ban came into effect.

Early 2017

A pop-up store opens on the ground floor under an anti-squat contract, while other floors remain empty.

November 2017

Two of the former squatters are charged with a €500 fine and the two others with four and six week prison sentences. All have been requested to give DNA samples.

Early 2019

The appeal procedure hasn't come to an end yet, while the building remains empty.

Amsterdam: Buurtbrief Wijde Heisteeg 7

maart 22nd, 2011



Beste burens,

Na vier jaar met veel plezier op Wijde Heisteeg 7/II/III/IV gewoond te hebben, worden wij morgen (22 maart) helaas ontruimd door de politie. Eigenaar P.W. Hagendoorn heeft, na het pand jarenlang te hebben verwaarloosd, aangegeven dat hij plannen heeft om het pand te gaan verbouwen. Hij poogt daarmee boetes, die de gemeente hem dreigt op te leggen, te ontlopen. Op basis van dit afgedwongen

voornemen van de eigenaar, heeft justitie, met de nieuwe anti-kraakwet in de hand, ons bevolen het pand te verlaten.

Wijde Heisteeg 7 is een rijksmonument, dus voordat daar verbouwd kan worden heeft de eigenaar een aantal vergunningen nodig, welke hij nog niet heeft aangevraagd. Navraag bij de gemeente leert dat, zelfs al de eigenaar de vergunningen nu aanvraagt, het minstens zes maanden tot misschien wel negen maanden kan duren voordat daadwerkelijk met de verbouwing begonnen kan worden. Wij hebben de eigenaar een aanbod gedaan om op het moment dat de bouwplannen en vergunningen rond zijn en de verbouwing kan beginnen het pand vrijwillig te verlaten. Dat aanbod heeft hij afgewezen. Nu zullen de woningen voorlopig leeg blijven of zal er anti-kraak in worden gezet.

Toen wij de etages in februari 2007 kraakten waren zij in zeer slechte staat. Het dak lekte op verschillende plaatsen, een aantal ramen waren stuk en de ruimtes waren vochtig en vies. Wij hebben de woningen weer bewoonbaar gemaakt. De laatste dagen zijn wij bezig geweest om al onze spullen uit het pand verhuizen, wat een pijnlijk moment is voor ons. Het is zuur om te zien dat de eigenaar uiteindelijk door justitie and politie wordt beloond voor zijn wangedrag, en er strakt wellicht kraakwachten zullen wonen op de plek waar wij zoveel energie in hebben gestoken, terwijl wij moeten proberen om in een stad met woningnood een nieuw onderkomen te vinden.

Groeten,
bewoners Wijde Heisteeg 7-II/III/IV

Amsterdam: Krakers presenteren nieuwe kraakhandleiding. Wijde Heisteeg 7 gekraakt!

januari 9th, 2016



Vandaag is als presentatie van de nieuwe kraakhandleiding het pand Wijde Heisteeg 7 in Amsterdam na jarenlange leegstand en verkrotting gekraakt. De kraakhandleiding is een handig boekje voor woningzoekers en andere geïnteresseerden waarin alles wordt uitgelegd over het kraken van een pand. Kraken is dan zogenaamd wel bij wet verboden maar ook deze kraak van Wijde Heisteeg 7 laat duidelijk zien: Wat niet mag... kan nog steeds!

Burgemeester Van der Laan opperde ooit in de media dat alle panden die op basis van kraakverbod ontruimd zijn niet meer leegstaan en opnieuw in gebruik zijn. Naast dat de krakers vinden dat de grootschalige inzet van anti-kraak en andere leegstandbeheerders in ontruimde panden geen duurzaam en structureel gebruik is, laten de ontruiming en

herkraak van Wijde Heisteeg 7 goed zien dat de uitspraken van Van der Laan en het bijhorende ontruimingsbeleid niet kloppen.

De ME ontruimde in 2011 op basis van het kraakverbod omdat eigenaar Hagedoorn belang zou hebben bij en plannen zou hebben met het pand. Na de ontruiming heeft Hagedoorn de staat van het pand moedwillig verslechterd door de laatste huurster uit te plaatsen, het pand uit te slopen, ramen uit de kozijnen te slaan en gaten in het dak te slaan. Hagedoorn had nog meer plannen met het pand: hij wilde namelijk het rijksmonumentale pand nog verder slopen en zo onherstelbaar beschadigen om er vervolgens dure appartementen in te realiseren. Door inzet van monumentenclub 'Vrienden van de Amsterdamse Binnenstad' werd dit gelukkig voorkomen.

Nu anno 2016 staat het pand nog steeds leeg. Hierdoor is de kraak van de Wijde Heisteeg 7 een perfect voorbeeld hoe een eigenaar en gemeente, in de persoon van Burgemeester Van der Laan, de boel verkloten. Terwijl krakers juist wel een positieve draai geven aan de leegstand en verkrotting door deze te kraken en bewoonbaar te maken.

In de namiddag en de avond van de kraakactie wordt er een divers swingend programma met muziek, theater etc in en rond Wijde Heisteeg 7 georganiseerd om te vieren dat kraken doorgaat met een nieuwe kraakhandleiding en om een positief tegengeluid te geven aan een steeds maar saaier en duurder wordend Amsterdam.

De nieuwe kraakhandleiding is oa te koop bij Fort van Sjakoo
Jodenbreestraat 24 te Amsterdam

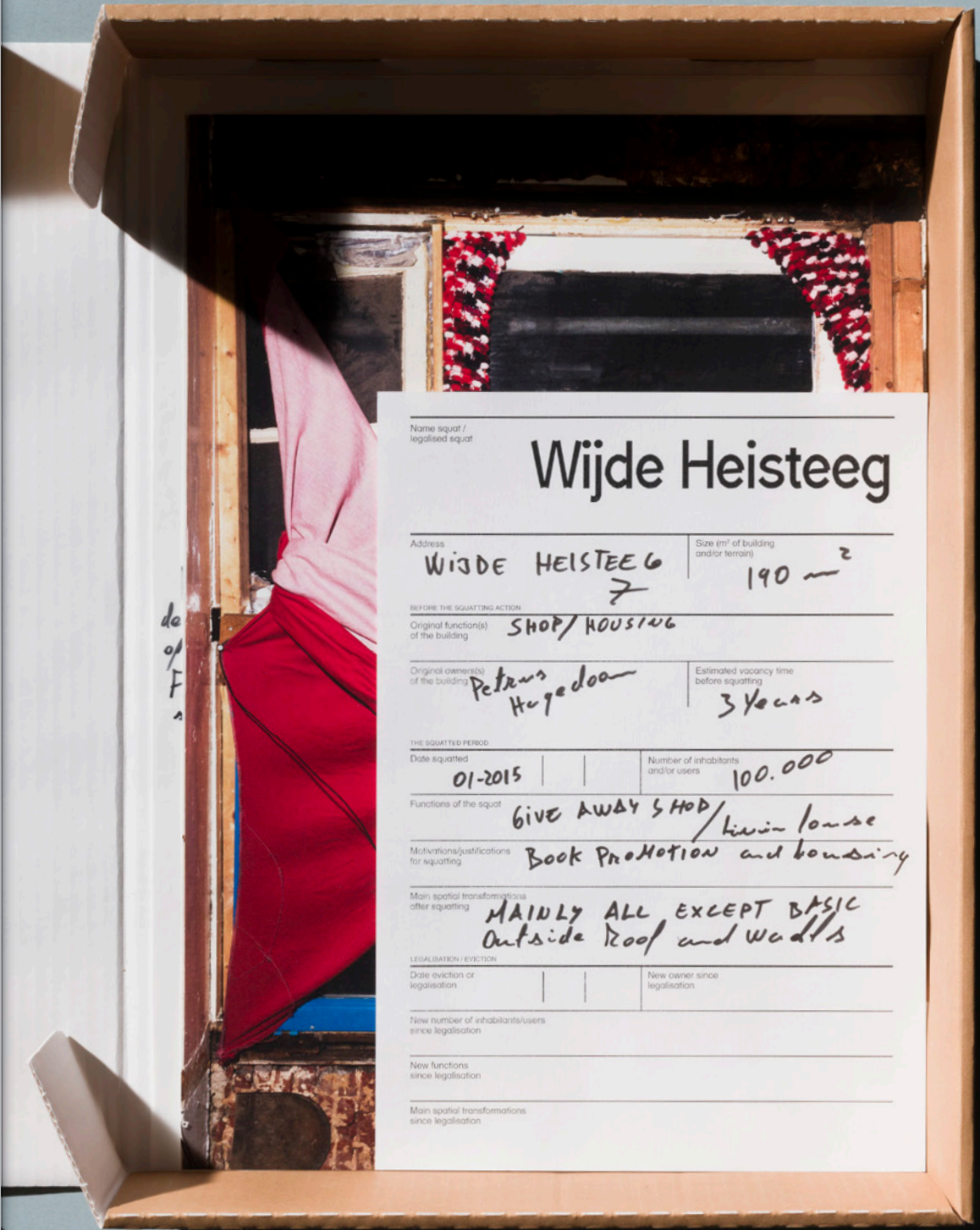
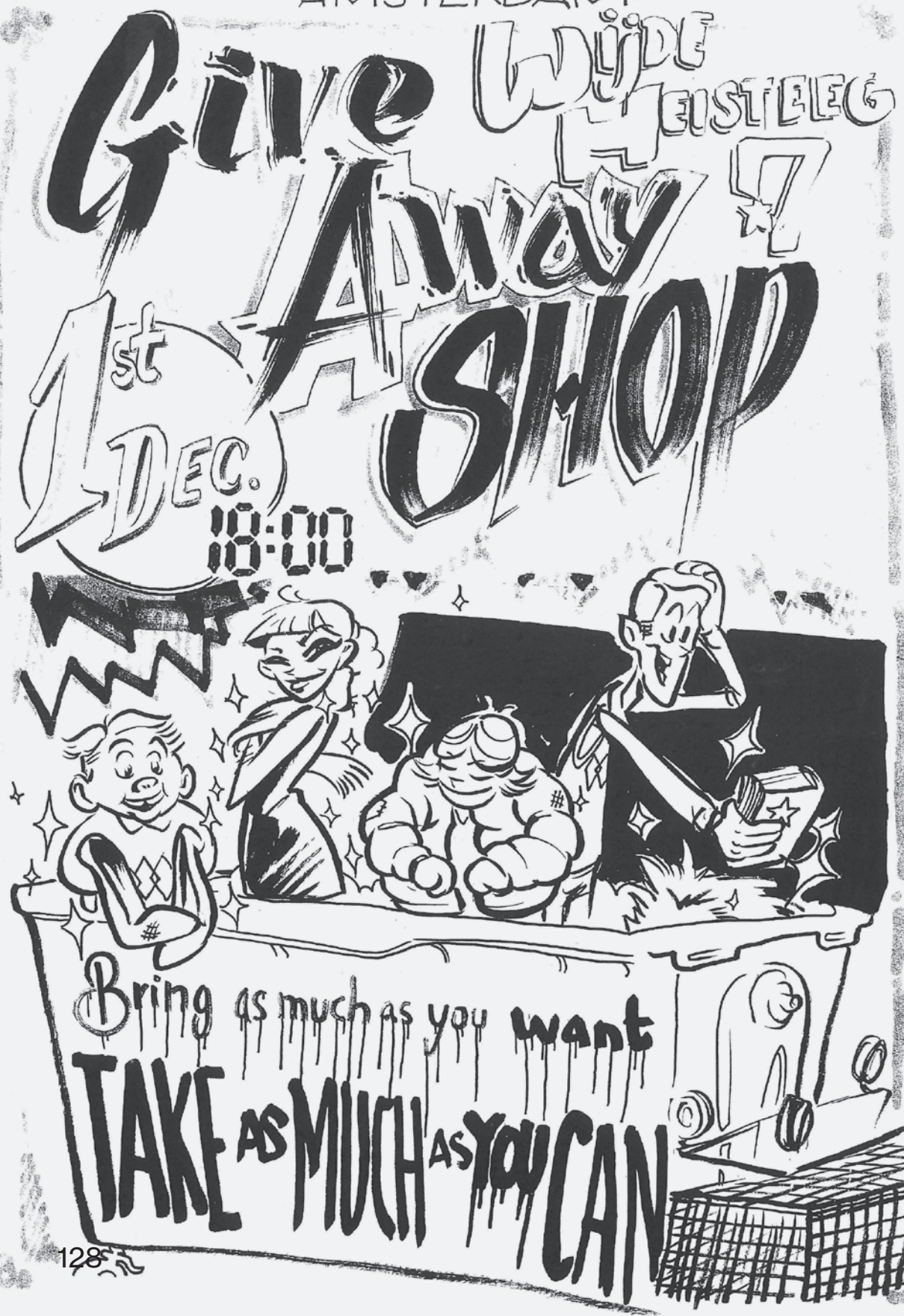

Name squat / legalised squat
Wijde Heisteeg

Address
WIJDE HEISTEEG 7

Size (m²) of building and/or terrain
190 m²

BEFORE THE SQUATTING ACTION

Original function(s) of the building
SHOP/ HOUSING

Original owner(s) of the building
Peters Hagedoorn

Estimated vacancy time before squatting
3 Years

THE SQUATTED PERIOD

Date squatted
01-2015

Number of inhabitants and/or users
100.000

Functions of the squat
GIVE AWAY SHOP / living lounge

Motivations/justifications for squatting
Book Promotion and housing

Main spatial transformations after squatting
MAINLY ALL EXCEPT BASIC Outside Roof and walls

LEGALISATION / EJECTION

Date eviction or legalisation

New owner since legalisation

New number of inhabitants/users since legalisation

New functions since legalisation

Main spatial transformations since legalisation

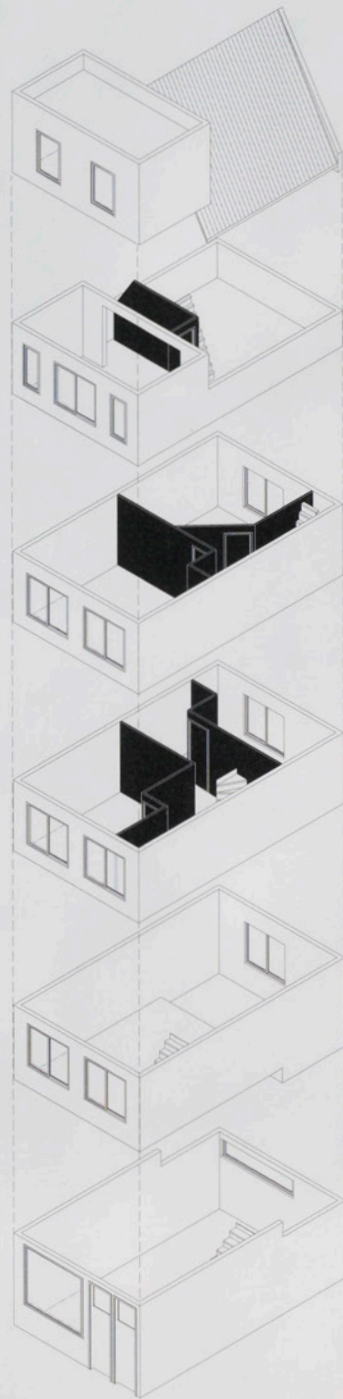

After the first squatting period the owner completely destroyed the interior walls. Directly after it was squatted again in 2016, the new inhabitants started renovations to construct new interior walls.

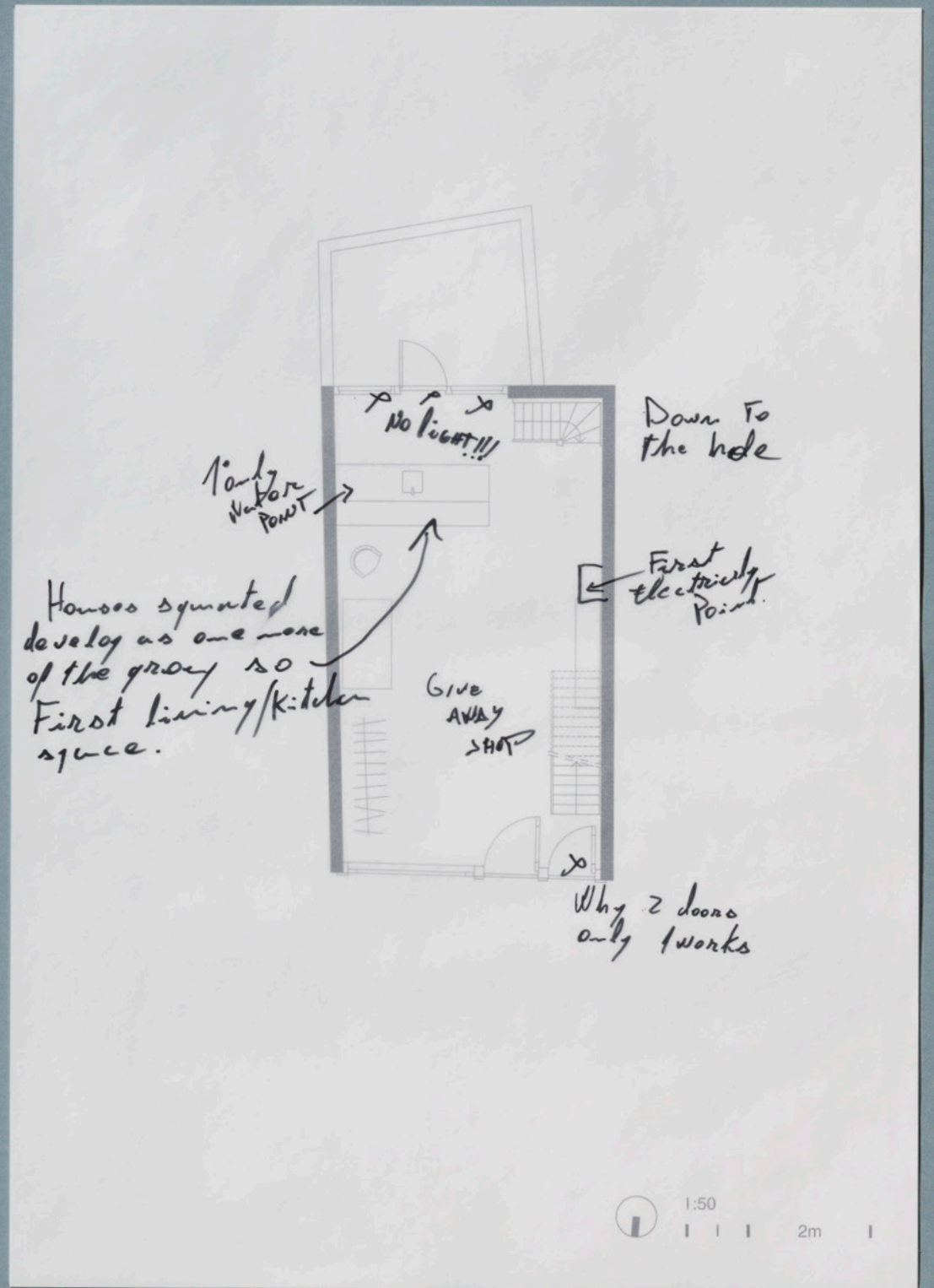

Ground floor

132



Ground floor – Give-away store

133



The ground floor, originally a retail space, was turned into a give-away store where people could bring and pick up goods for free.



Windows – Many windows were taken out by the owner, accelerating the building's dilapidation, so the inhabitants replaced them with window frames found in the street and given by other squats.

136



137

First floor

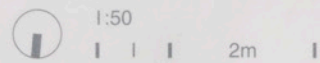
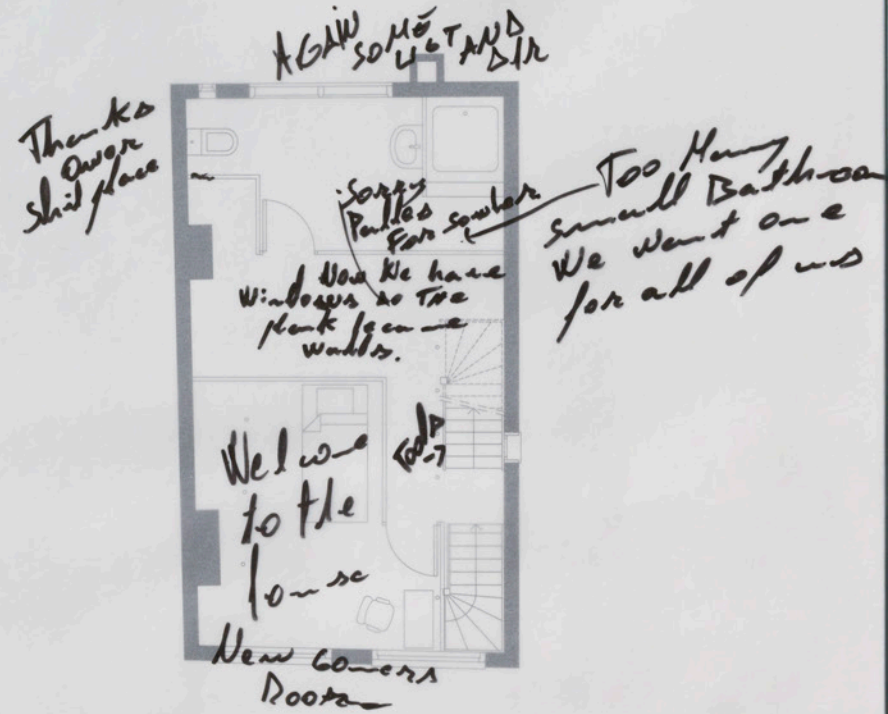

Second floor – Bathroom



The second floor includes an improvised bathroom.



Renovation – As the owner tore down all the internal walls, the squatters had to improvise and rebuild the entire interior by themselves.

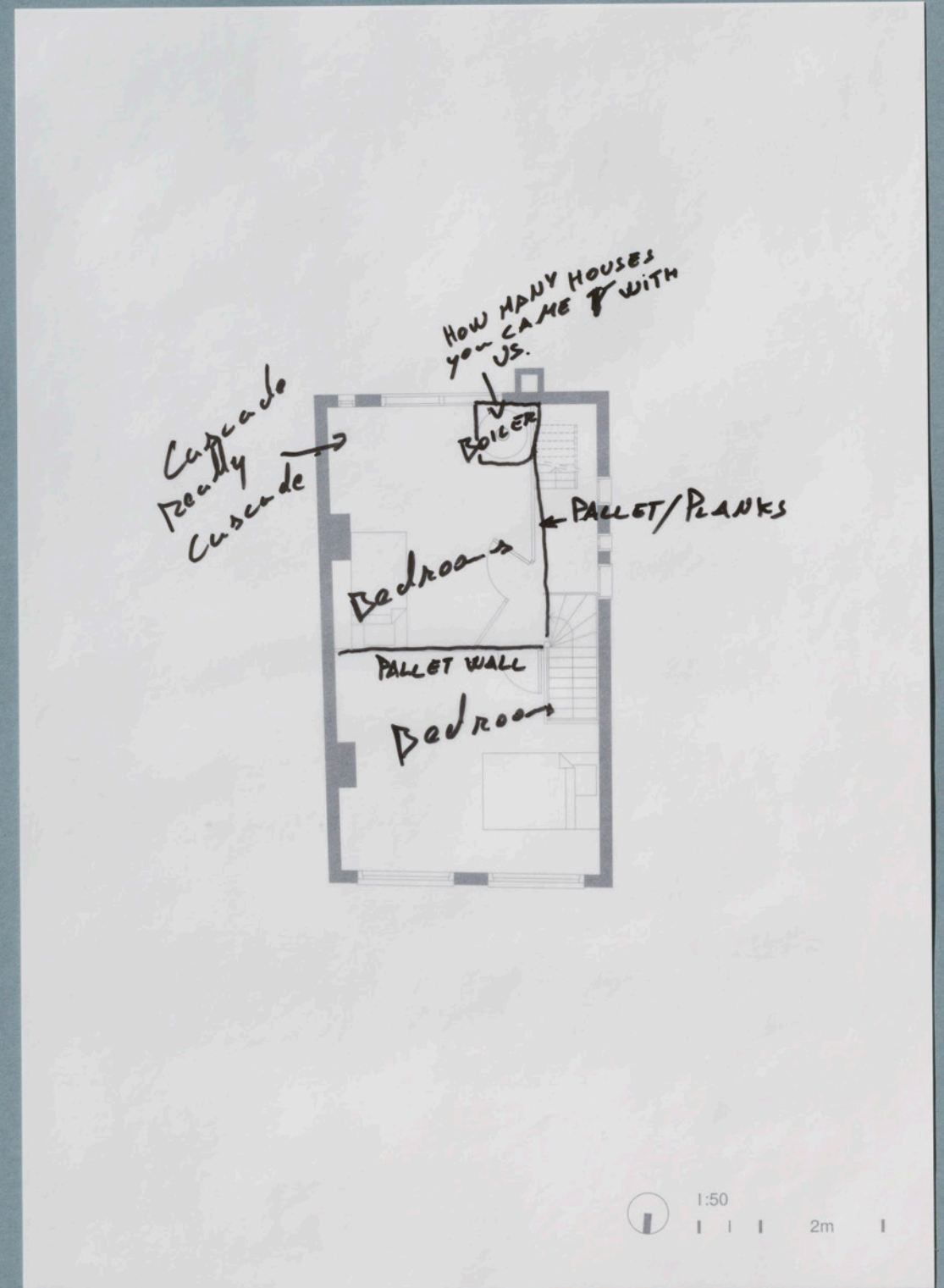

Third floor



144



145

Third floor

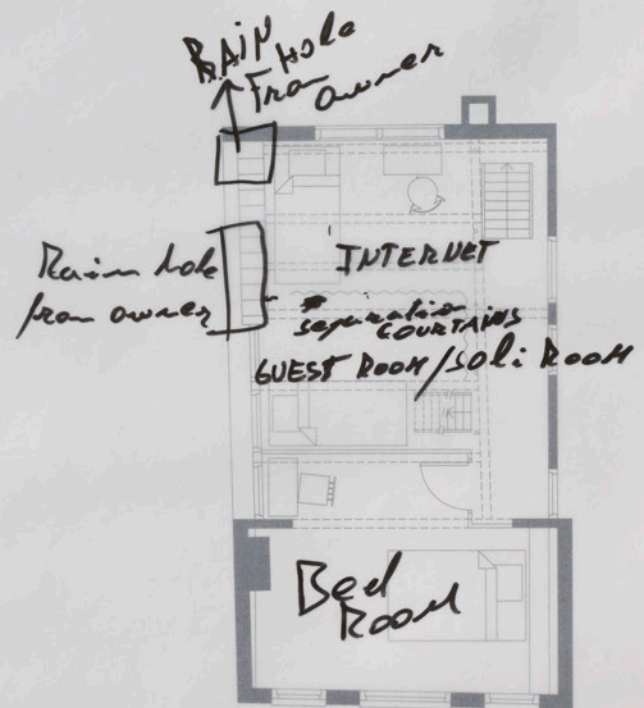

146

Fourth floor

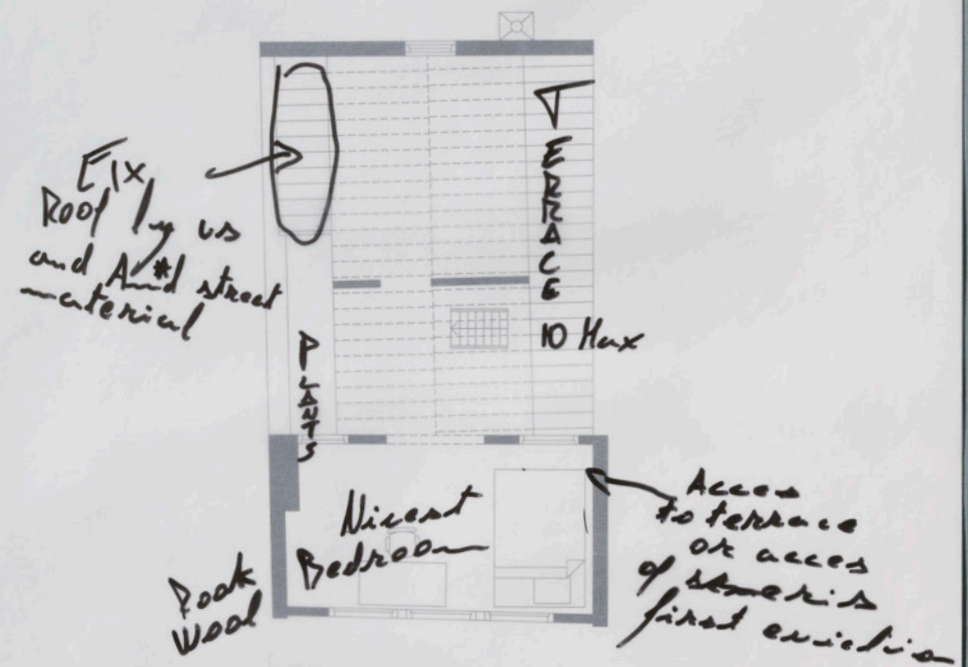

147

Fifth floor

148



Fourth floor

149

Privacy – Throughout the building, bare walls are covered with sheets of fabric, also used as space dividers, thus providing degrees of privacy.

150



151

Fifth floor

A conversation between three generations of the Student Squatting Infor- mation Center (SKSU)

René Boer (RB): Can you introduce yourselves, and tell us when you were active for the SKSU and what was a highlight for you at the time?

Petra (P): It's quite a long time ago. I think we started around 2005 when I was also doing squatting assistance in the De Pijp neighborhood in Amsterdam. Along with a few people we noticed that there were a lot of people squatting, but no students. There was a certain reluctance to come to the regular squatting information centers. Students have the same problems though, and a lot of them took anti-squat contracts. Instead of creating a conflict around that, we wanted to give them another

1. The Vondelbunker is a Cold War bomb shelter hidden under a bridge in Amsterdam's Vondelpark, hosting a variety of activities and events.

option. That's why we started the SKSU with a few other people. We started in neighborhood centers, not in squat bars, to make it more accessible. We hoped this would attract students, and it worked, although it wasn't as big as it later became.

Kevin (K): At some point the SKSU closed, and a few years later, when we felt the squatting ban was coming up, we said to each other that we had to start SKSU again, as a counter-attack for a possible ban. That was in 2010, with some new people. We started doing it in the Vondelbunker for a similar reason as in 2005, to have the bar as low as possible for the not so radical people to get into this way of life.¹ We ran it for a couple a years; one of the highlights was definitely squatting with the refugees, which was never done before and up till today has a resonance.

Another highlight was the attempt to start a political center in a neighborhood in Amsterdam Noord, with which we wanted to empower the residents to fight their landlord, a housing corporation, who wanted to demolish the entire neighborhood of 1,500 houses. The residents were fighting this and were becoming a little more successful. Our political center, looking back at it now, was the drop that made the bucket flow over. Not long after, the corporation pulled its plans. Up till today the residents have a stronger voice in the way in which their neighborhood is developing. We also had one of the first squatting actions after the ban, trying to work with new rules and regulations (fig.1).

Gallows (G): I've been active in the SKSU since 2014. I got in touch after the evictions of the student occupations.² I joined at that point and have ever since tried to reach out to more students. Working with the refugees was a part of the information center since the beginning — it was always just part of the work, it wasn't

2. The University of Amsterdam witnessed a series of student protests and occupations in 2014/2015.

Studenten, brekers en een voor de twee

De kraak van 'Villa Valentijn' in Amsterdam

► De politie mag kraakpanden niet meer zomaar ontruimen.

► De eerste kraak sinds de nieuwe jurisprudentie was zaterdag. *nrc.next* ging mee.

Door FREET SCHRAVESANDE
AMSTERDAM. In een woning ergens in Amsterdam zat meer dan een jaar op kniehoogte een houtje klem in de deurpost. Het houtje viel niet. En dus hebben zich op Valentijnsdag zo'n vijftig man, veel studenten, verzameld op het hoofdkwartier van het Studenten Kraak Spreekuur (SKSU) in de Schoolstraat in Amsterdam-West. Omdat de valentijnskraak niet mag 'stuklopen' weet de meute, opgetrommeld via vrienden en de kraakbeweging, nog niet waar de woning is en wie er gaat wonen.

Kraken is altijd spannend, en zeker vandaag, vertelt SKSU-lid Esther Tienstra (27). „Dit is de eerste keer dat er sinds de nieuwe jurisprudentie in Amsterdam wordt gekraakt.“ Dat zit zo: in een aantal recente rechterlijke uitspraken is bepaald dat ook krakers woonrecht hebben. Ze mogen daarom, net als ieder ander, niet meer dubbel gestraft worden: én een boete plus gevangenisstraf én hun woning kwijt door ontruiming. Gevolg: krakers kunnen nog slechts de straf krijgen die staat voor huisvredebreuk en de politie mag kraakpanden dus niet meer zomaar ontruimen. „Maar we weten nog niet hoe de politie op deze nieuwe situatie gaat reageren.“

Als iedereen rond 16.30 uur binnen is, worden de walkietalkies getest voor degenen die op de uitkijk staan en spreekt iemand de groep toe: „We kraken vandaag het souterrain van Saxenburgerdwarstraat 9, hier om de hoek. Dat doen we voor twee woningzoekende zusjes: ik noem ze Roos en Rosa. Het is hun eerste kraak. We doen dat met zo'n grote groep omdat we dan sterker staan mochten er problemen met politie ontstaan.“

Wat is het voor pand, vraag iemand. „De bovenste etages zijn verbouwd en het lijkt erop dat het souterrain als bouwkeet is gebruikt. Boven wonen een ouder echtpaar en de achterneef van de eigenaar. Omdat het onderste gedeelte al meer dan een jaar leeg staat, is dit een compleet legale kraak. Het pand is van een parti-



Voorbereidingen voor de kraak in de Saxenburgerdwarstraat 9 in Amsterdam. Foto Kim de Kroon

culier, een man van 71. Verwacht van de eigenaar weinig problemen, want bij eerdere kraken van zijn panden bleek hij best welwillend.“

En dan de taakomschrijving: „Julie kunnen helpen door een tafel, bed en stoel naar binnen te dragen, de

manier waarop de zusjes laten zien dat ze er willen wonen. Daarna wachten we samen met hen totdat de politie is gearriveerd om leegstand te constateren. Een aantal van ons zal ondertussen met bloemen ongeruste buurtbewoners op hun gemak stel-

steld. De telefoon gaat over. „Goedag, u spreekt met Victor. Ik lieg juist langs het pand aan de Saxen gerdwarstraat 9 en heb het idee hier iets gekraakt wordt. Kunt u komen? Mijn telefoonnummer? houd ik graag privé. Anders kon

Figure 1: The NRC newspaper reporting on a squatting action, February 2009. The action was supported by the SKSU.

STUDENTEN KRAAK SPREEKuur

STUDENT SQUATTING ASSISTANCE

Every
Thursday
19.00-20.30
Vrankrijk
Spuistraat 21b



that exceptional for us anymore. These days it has become the largest part of the work that we do. It's now quite rare that we do something for students.

In terms of highlights, I guess squatting the second Spinhuis would be one of them.³ It was a pirate dungeon under an old bridge in the city center, and it was one of the first actions that I planned, and where most of the planning and arranging was on me.

K: Emotionally that can be a lot right! It's suddenly all on you.

RB: The idea of squatting as a 'spatial practice', does that resonate with you?

P: Sure. It's the story that we explain to people. By the way, when I hear all these stories, it seems that the SKSU grew much bigger later on. When we started, we just gave information. When people really wanted to squat, they would be forwarded to a regular squatting information center, of which there were still four in Amsterdam. The current SKSU seems to be a full squatting information center, in which I recognize the seven steps.⁴

K: In our time, we did indeed do it this way. I could add a few details — the working groups such as the breaking team, the barricading team, the press team, and so on.

G: The police spokesperson, the neighborhood people.

P: With SKSU we always did press releases,

3. The Spinhuis is a student-squatted social center in Amsterdam underneath a bridge over one of its main canals.

4. See 'Squatting as spatial practice', pp. 15-32.

explaining why it was important for students.

RB: It's interesting you mention that because there were different practices among sections of the movement, right? Some groups would not talk to the press; in Rotterdam, for example, people don't follow these procedures anymore, they just sneak in at night.

P: Every city always had its own way of squatting. In Utrecht it was quite different from Amsterdam. Many squatting actions were DIY, getting yourself your own place to live.

RB: Gallows, do you feel it's still valid nowadays, these seven steps?

G: To a degree, yes. Mobilization works a bit differently now, mainly because of the shrinking number of information centers operating. Maintaining mobilization lists is less necessary, everybody just knows each other. But for the rest, that's the model. There are two sides to this; you could say there are two spatial practices — doing these things yourself, or running an information center and telling people how to do it. If people need a mobilization list, it needs to be up to date, so making that happen is another spatial practice in itself. The breakers going around the city, investigating different doors, developing their own relationship to the city and sharing their knowledge, is a spatial practice as well.

RB: So you are saying that for the actual groups, squatting is as much a spatial practice

as it is running a squatting information center?

G: Yes, there is a whole different layer of information involved. Also in terms of remembering all the squats that have been evicted, or all the owners of different places. If someone comes in, you need to be able to tell what happened. Having that relationship to addresses, and being able to map them in your brain is important.

RB: Kevin, you were also active during the introduction of the ban. Did the practice of squatting change a lot at that time?

K: I think so yes, because of the effect of the ban during and right after its introduction. Within the movement at that time there was quite a lot of cohesion and energy to fight the ban, and to find a new way to keep on being able to squat. Everybody felt it as a task to search for new ways.

Before the ban the squatting movement was bigger and more plural. There were outcasts interested in partying, but also people simply focusing on the living function, and you had groups more active in the housing struggle, or people focusing on free-zones. There were a lot of reasons why people were still squatting, but squatting for the purpose of housing has been made impossible. At some point everything was quite turbulent, but when the clouds settled, we saw that squatting was still very relevant for political actions and establishing free-zones, but for housing it became almost impossible.

The mayor decided that the city of

Amsterdam would replace squatters with anti-squatters, so a lot of normal apartments that were squatted were evicted much sooner. This made it really complicated for people who really needed housing because it became much more unstable. As we all know squatting takes a lot of time and energy, and to do that every three or four months is not nothing. At the same time, the housing function is still the root of the movement. When people live in squats they have such a strong interaction, which makes the social cohesion of a community very strong. Since the ban on squatting, the ability of the movement to grow has been severely damaged. It has become very hard to attract new squatters.

RB: How is that right now, Gallows?

G: That's how it is. I have only squatted two houses for myself and both lasted for three weeks. And when people come in to the SKSU, especially if they're just individuals, you don't want to lie to them and tell them it's all rosy. I never had a stable housing group myself because we were getting evicted constantly. When you don't live together for long you don't form that bond. If you want to keep it up it's a full-time job. It's only sustainable for a while if you fully commit to it.

RB: Kevin, you say it was quite turbulent right after the ban, but do you think the spatial practice changed much?

K: Before the ban the state kind of supported you when a place was empty for a year and you

would show it to the police. After the squatting ban, this didn't apply anymore because it was illegal anyway, so we decided not to let them in. So that changed, but for the rest not so much I think.

G: In a sense it is still quite similar, you still have an argument with a cop outside about the law. And eventually they call their chief, and because it's too much work to get rid of the entire group they just write it down and leave. The only difference is that they can 'speed evict' you after three days. So that's different, but the action procedure is still more or less the same. A bit more stressful, maybe.

P: It was also stressful before the ban because you could get caught in the act, for example, and it was always tricky to find enough people to support you in the action.

RB: Petra, when you look back at your squatting career, what do you think your impact on the city has been?

P: In our times, we were the ones shouting in the desert and now suddenly people realize all the social housing is gone. At the time, we already fought against selling social housing with various big actions. The first action I participated in was the famous 1920s Dageraad social housing complex where we occupied 10 to 12 social housing apartments to prevent them being sold off.⁵ We collaborated with the local neighborhood center, so it was a collective housing struggle, but we weren't as many as in the 80s, saving one social housing block after

5. Located in Amsterdam's De Pijp neighborhood, and partly occupied in the fall of 2005.

6. Located in Amsterdam's De Pijp neighborhood, and the site of a long-standing struggle featuring multiple squatting actions.

the other. But we did some large projects as well, such as the well known struggle for the Bakkerblokken social housing, together with the inhabitants.⁶ In the end, we managed to keep 30% of the social housing. It wasn't a full victory, but also not a full loss.

RB: Kevin, you already mentioned the successes of the struggle in Amsterdam Noord, but are there any other things that have made an impact?

K: Of course, the start of squatting with refugees, which continues up till today, is quite something. The struggle we all fought at the time was the fight to continue squatting after the ban, and by now it's not completely impossible, fortunately, and we made a small contribution to that. Our impact is also indirect, to a large extent. For example, Petra founded the SKSU again, and we could not have existed without the Petras before us.

P: And we were again standing on the shoulders of a lot of other people.

K: The most concrete thing is that we made it possible for a new generation to continue squatting.

P: There are still people who are taking action and saying that they have the right to live in their own way, in their own houses. And everybody has the right to do so, not just those with money or power. It's great this practice continues today.

RB: By now the urban landscape has changed

completely from when you were active. What role can the application of this practice play today?

G: Although it's a spatial practice, it's largely dependent on social relations. As long as people are willing to open up spaces it allows people to meet each other and create a certain momentum. What the actual effects are, the material gains, also depend on how it plays out and how the state or the owners respond. In terms of architecture or planning there is little result I can point to.

There is one house in Amsterdam West which we prevented from succumbing to unregulated rent, and with that a new action group against selling social housing called *Niet Te Koop* (Not For Sale) started. With many of the spaces we opened, new collectives were formed which still exist and where people were politicized.

RB: If you look from here into the near future, will squatting continue to play a role?

P: It has to. For me, besides getting a place to live, it's a political action at the core of the housing struggle. It's DIY. Not asking other people to make it happen for you, but doing it yourself. We also see that in the social center that was squatted recently in Amsterdam. They don't beg the city council, but see an empty place and just create their own space. I hope it keeps on going everywhere in the Netherlands.

K: For me it's the same. As long as people like Gallows preserve the legacy, such as the way

people work, the knowledge, the structures and so forth, then things such as the new social center are still possible. Gallows probably knows better whether this can be handed over to a new generation.

G: Any movement needs a form of memory next to tactics and expertise. These institutions are one way to preserve it, but there are other ways to preserve collective memory. In such a defused and decentralized practice, to put it nicely, to trace and maintain the history of an organization is quite difficult. But I agree, if new people aren't coming in to squat, there is no reason to do a squatting information center. And then the knowledge would die.

P: With the squatting with refugees we see that the struggles are the same, and in that sense squatting continues to exist. They use the same tools, and make use of the knowledge produced by generations before them.

G: It's also good to point out that there was never a unified squatting movement. There was just a lot of people using the same tactics. It was a movement of squatters.



LANDBOUWBELANG – This large, pre-war industrial complex located in Maastricht was squatted in 2002. Since then, it has been transformed into a unique cultural free-zone inside the Belvédère urban redevelopment area.

Nothing remains of the 13th century monastery that once stood a short distance from the old city center of Maastricht, along the river Maas. The industrial expansion of the area led to the construction of new infrastructures and the consequent destruction of the sacred buildings. Just before World War II an influential agricultural cooperative erected a large industrial complex on the site, yet this was already abandoned by the 70s. After a long period of vacancy, the industrial complex was partially squatted in 2002.

The squat, called Landbouwbelang after the former agricultural cooperative, used the sizeable industrial spaces for the development of public events, exhibitions, and parties. Over time various private spaces were created in the main building's concrete grid through the construction of walls. While Landbouwbelang continued to grow as one of the most important hubs for alternative culture in Maastricht, the city council initiated the Belvédère project, which aims to redevelop the squat and its immediate surrounding area into a cultural quarter.

Program – Around 10 living spaces of different dimensions, a communal kitchen, various artist studios and working spaces, a yoga/meditation space with 360 degree views, creative working zones, a community restaurant, martial arts studio, sauna, large club space, large event hall, and basement bar.

1209

The monastery of the Order of St. Anthony is founded along the Maas river in Maastricht, on the site of the current Landbouwbelang.

1793

The monastery is partially destroyed during a siege by French troops.

1848

The monastery is demolished in its entirety.

1914

Vereeniging Landbouwbelang, an association for collective agricultural sales and purchases, was founded in Roermond.

1921–1937

The Landbouwbelang association builds a series of warehouse complexes on another location along the Maas.



Figure 1: Landbouwbelang's main hall in use.

1939

The association needs a warehouse for grain storage and the

processing of cereals, and orders the construction of an industrial complex with a silo on the location of the former monastery. The building process was completed after World War II (fig. 1, 2).

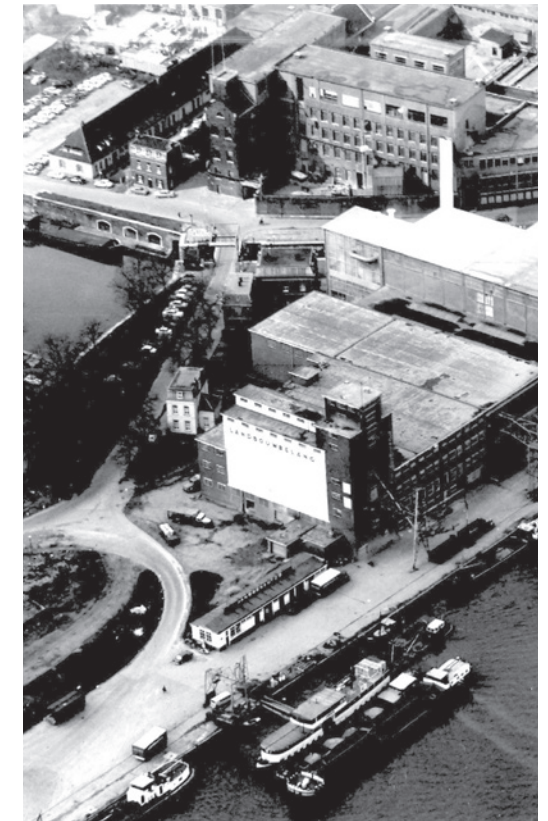

Figure 2: Landbouwbelang in operation.

1970s

The association closes the warehouse due to limited opportunities for expansion within the city. The building is acquired by the nearby paper mill.

1990s

The vacant premises are used by several cultural groups such as Intro

in Situ and Toneelgroep Maastricht, for occasional activities and events.

April 2002

A group of squatters, some of whom come from the nearby Vendex squat, decide to occupy the building. The first living spaces and artist studios are constructed on the river side of the rough industrial building.

June 2004

The municipality of Maastricht agrees on the Masterplan Belvédère, which foresees the redevelopment of the semi-industrial area around the squat into a dynamic new cultural quarter.

August 2004

The communal restaurant Volkskeuken Kometen moves into the Landbouwbelang, using scrap material from the nearby Vendex squat as a construction material. By now the squat has become a cultural free-zone where many activities and parties are organized.

2005

A large party is shut down by the police, causing uncertainty on the need for permits for future events at Landbouwbelang. The squatters ask for clarity from the mayor and the councillors of Maastricht, who commission a report to explain what changes have to be made to

the building in order to continue the activities.

2006

The squatters decide to make the necessary adjustments themselves and set up a foundation to organize the process. In the meantime the building is bought for €46 million by Belvédère Wijkontwikkelingsmaatschappij BV, a public-private partnership set up by the municipality to redevelop the area around Landbouwbelang.

2007

The confusion over the need for event permits in squats ends when a covenant is signed between the municipality of Maastricht and the squatters, which contains regulations for large events. The covenant is not a rental agreement, and does not influence the squatted nature of the property.

2009

The owner announces a plan to evict the squatters and transform the building into luxury apartments. In the meantime, the squatters open the first give-away store in Maastricht, and construction work starts on the Landhuis, an abandoned structure in front of the complex.

2012

Negotiations for a new covenant are started.

January 2013

A new vision on the redevelopment of the area is published by the municipality. Landbouwbelang is described as a 'provisional zone for art experiments and the creative industry', which 'will have to be redeveloped in the long term' but with no provision for immediate actions.

Mid 2013

Maastricht starts its application for the 2018 European Capital of Culture. Squats and other alternative venues launch the Cultural Freezone Collective in order to respond collectively.

2014

Then-mayor of Maastricht Onno Hoes visits Landbouwbelang. Activities in the squat continue to expand with initiatives such as a food bank and Maastricht Goes Vegan.

2015

The municipality insist on regular inspections of the club space, the big hall, and the living spaces. As the reports reveal the need to carry out works, the inhabitants move temporarily to the ground floor of the building.

2016

Many spaces are renovated. Talks with the municipality are started to research the possible legalization, which isn't supported by the entire community.

April 2017

Landbouwbelang celebrates its 15th birthday.
(p. 172: 15th anniversary poster).

June 2017

Despite the criminalization of squatting in 2010, the Maastricht city council adopts a proposal to acknowledge the importance of Landbouwbelang and invites them to develop a plan for the future regularization of the squat.

July 2018

While Landbouwbelang struggles to bring all the different opinions on the building's users together, right-wing political parties in the city council demand the eviction of Landbouwbelang. A majority votes against the demand. At the same time, the covenant is extended with a paragraph stating that the squat's inhabitants can only be evicted if a suitable alternative for the project has been found.

Early 2019

The inhabitants have developed a vision paper including a proposal for the future of the project.
(p. 170: Page four of Landbouwbelang's vision document, which outlines some of the most important points of the debate).

1. What went before

In 2016, agreements were made between the municipality of Maastricht and the Landbouwbelang to legalize the location step by step. This idea was not supported by everyone within the Landbouwbelang and led to a long and difficult process over a period of two years. It was a period of great differences of opinion, in which people regularly stood opposed to each other.

(of the direction to be followed, with the necessary pain and sorrow as a result.)

At the same time, this kind of step by step process is in keeping with the history of the Landbouwbelang. Over the years, there have been many separate initiatives that have found their way to the Biesenwal 3 and blossomed within the walls of the Landbouwbelang. That was an organic process, initiatives came and went and were fed with ambitions and (clashing) temperaments, underpinned by principles of autonomy, formalization and legalization.

Meanwhile, the community has existed for more than 16 years and it is still the hub for subculture where hundreds of regular events take place every year, visited by more than ten thousand visitors.

During this period the community worked internally on a vision document in which seven strategic issues for the further development were discussed.

Issue #	Issue - current state	Issue - proposed change
1	LBB should never be legalized	LBB should get legalized
2	Community should stay to operate within the current LBB model	Community operations should transform into a more transparently organized LBB 2.0 model
3	LBB should continue to decline state funding assistance and subsidies	LBB should perceive and accept state funding and subsidies as a helpful tool
4	LBB should continue relying on fluid flock of volunteers	LBB should introduce LBB membership club or some other formal incentive which would improve the commitment and longevity of volunteers with LBB
5	Living in LBB - keeping rent as low as possible is essential	The rent for living in LBB should be increased, but housemates' work input should be better valued (if you work more, you pay less)
6	Work for LBB is for free of charge and fully voluntary	It should be possible to create paid jobs in LBB and/or LBB should offer financial reimbursements for work
7	LBB should stay financially independent	LBB should search for financial investors and be prepared to work with them

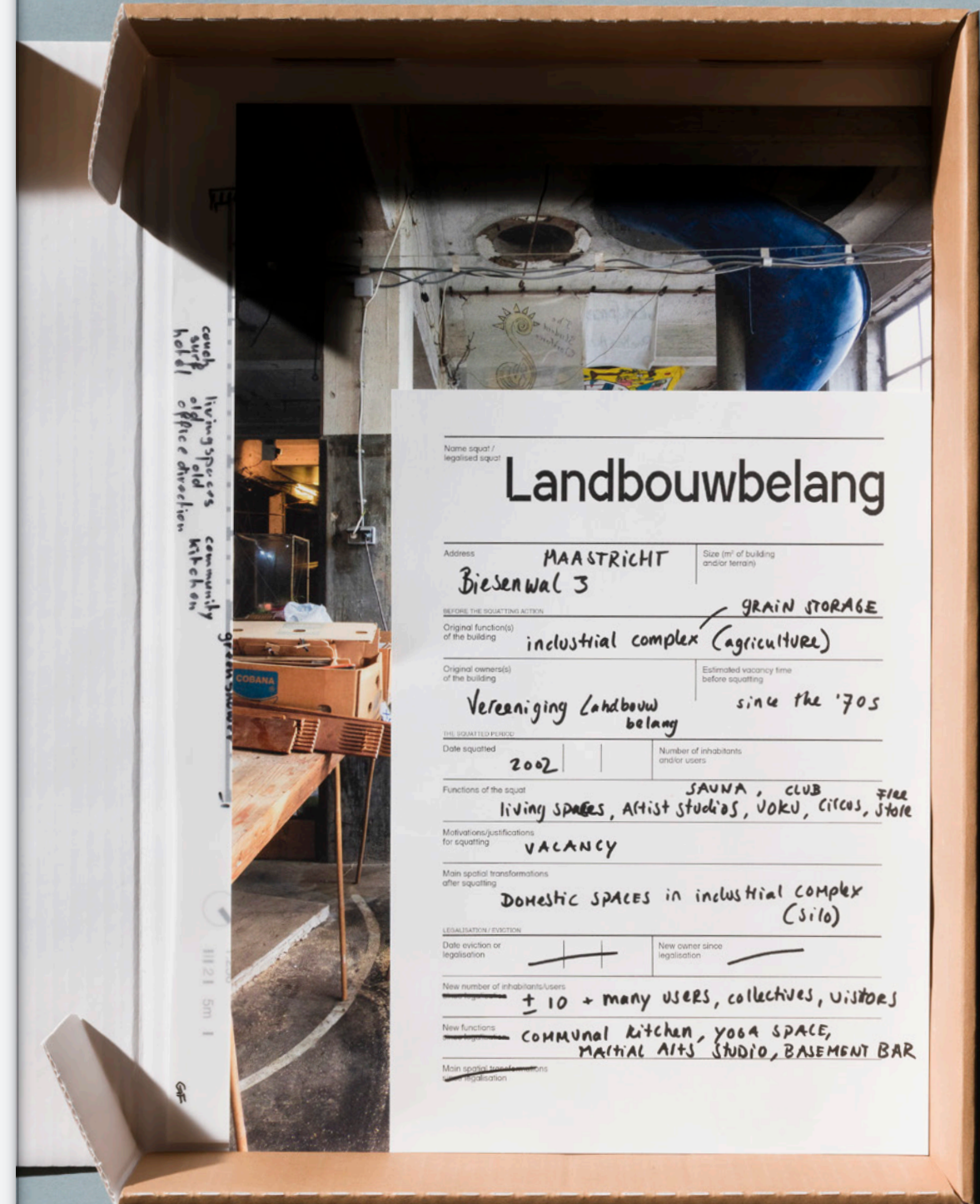

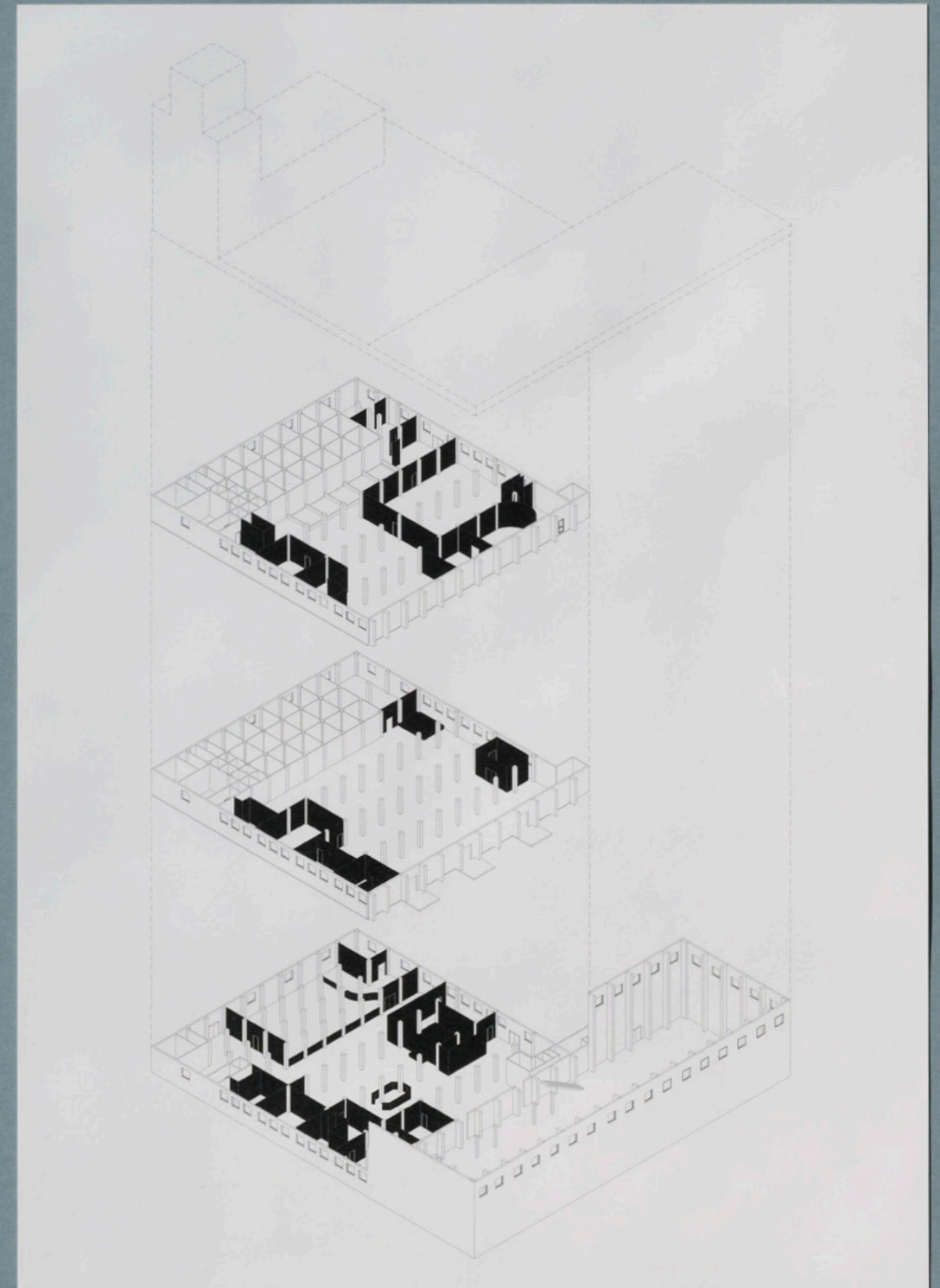

Domesticating concrete – The concrete grid in the middle section of the building has been domesticated through the construction of walls made of found and scrap materials.

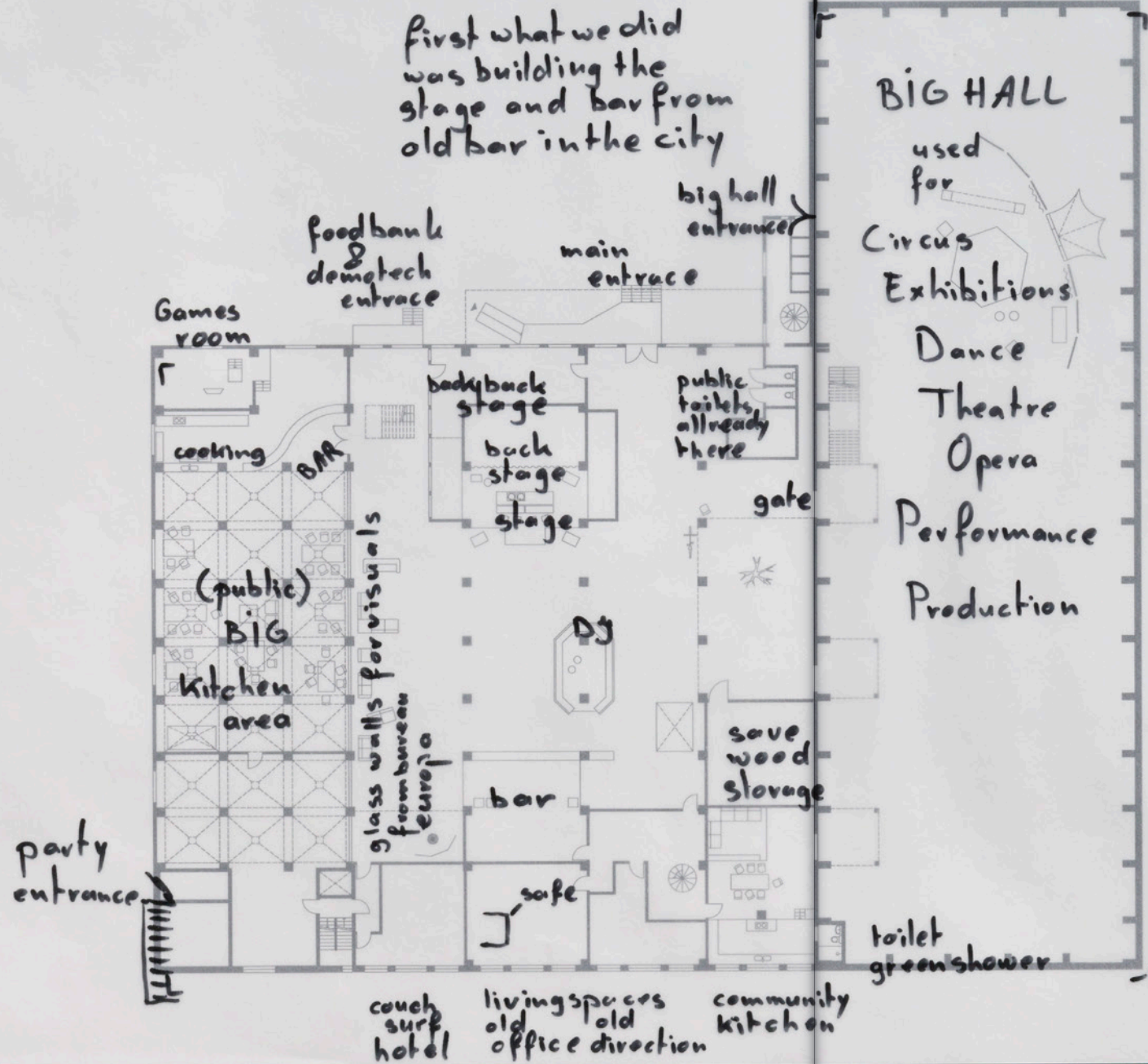

Ground floor

Spread-out living – The individual rooms, the communal kitchen, the bathrooms and toilets are constructed in people’s preferred places throughout the building, spreading the community throughout the entire complex.

Organizational structure – Landbouwbelang is organized through the monthly *Frietjes* meeting, which is open to all and attended by representatives of the inhabitants and the various collectives that operate in the building. Decisions are made on a one-person, one-vote basis. An official foundation has been set up in order to be able to operate as a legal entity.



Ground floor – Communal kitchen

178



Ground floor – Big hall

179

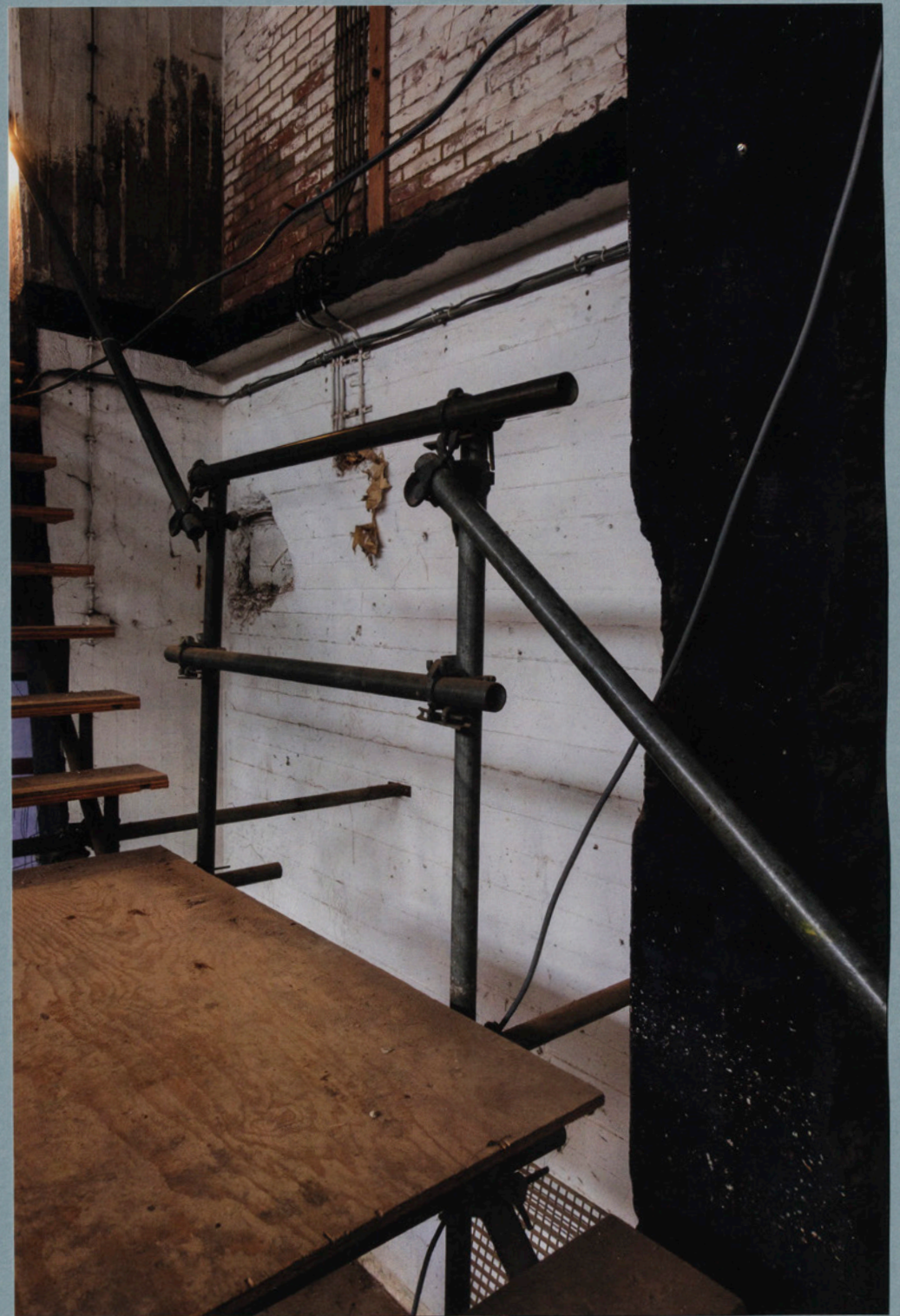

180



181

Ground floor – Stage



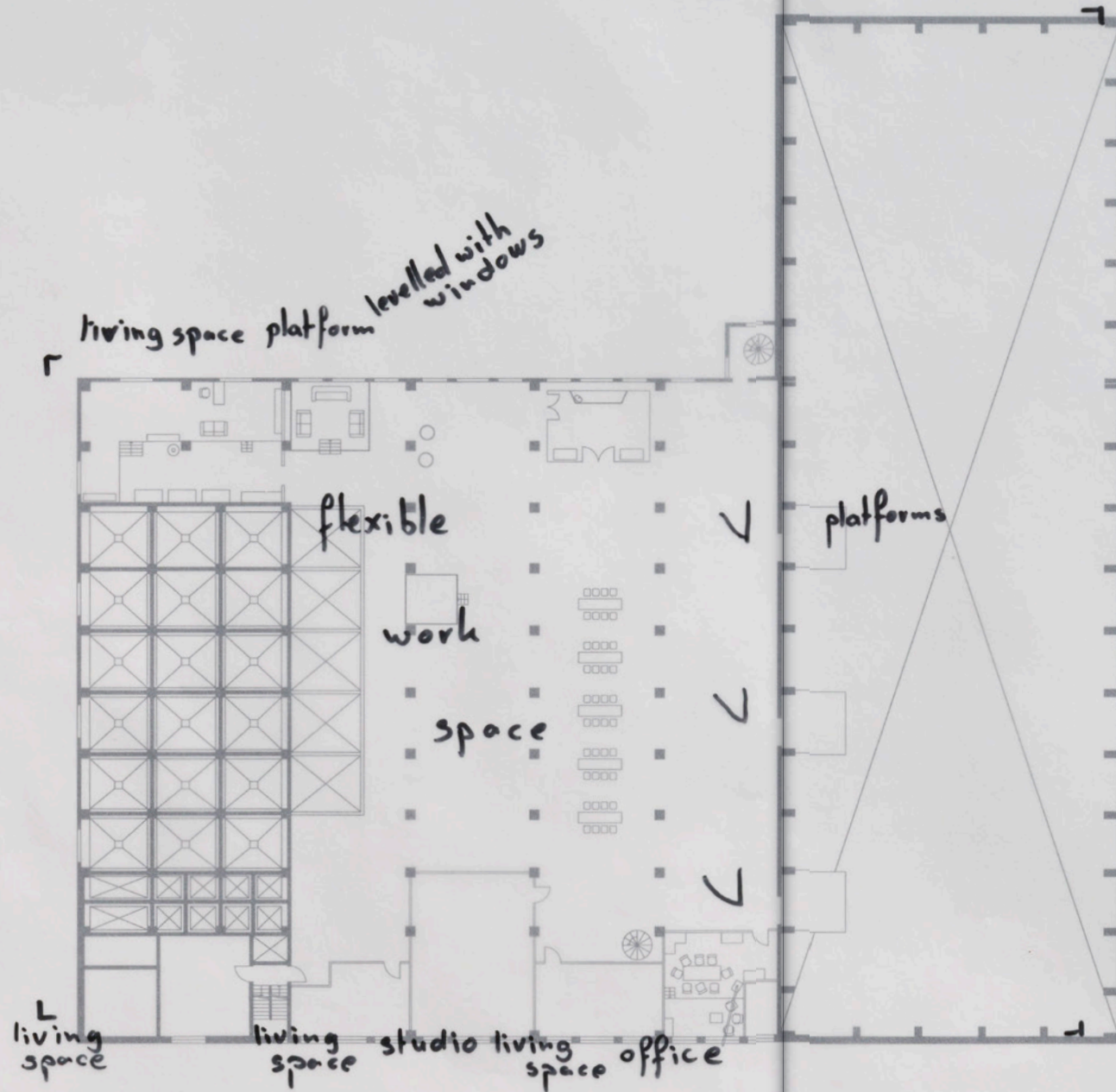

1:250
 III 2 | 5m |

TF

186



First floor



187



New Rooms – The spatial and material transformation resulted in a series of rooms and studios with more intimate corners for specific activities, and rough separations within the building.

188



First floor

189

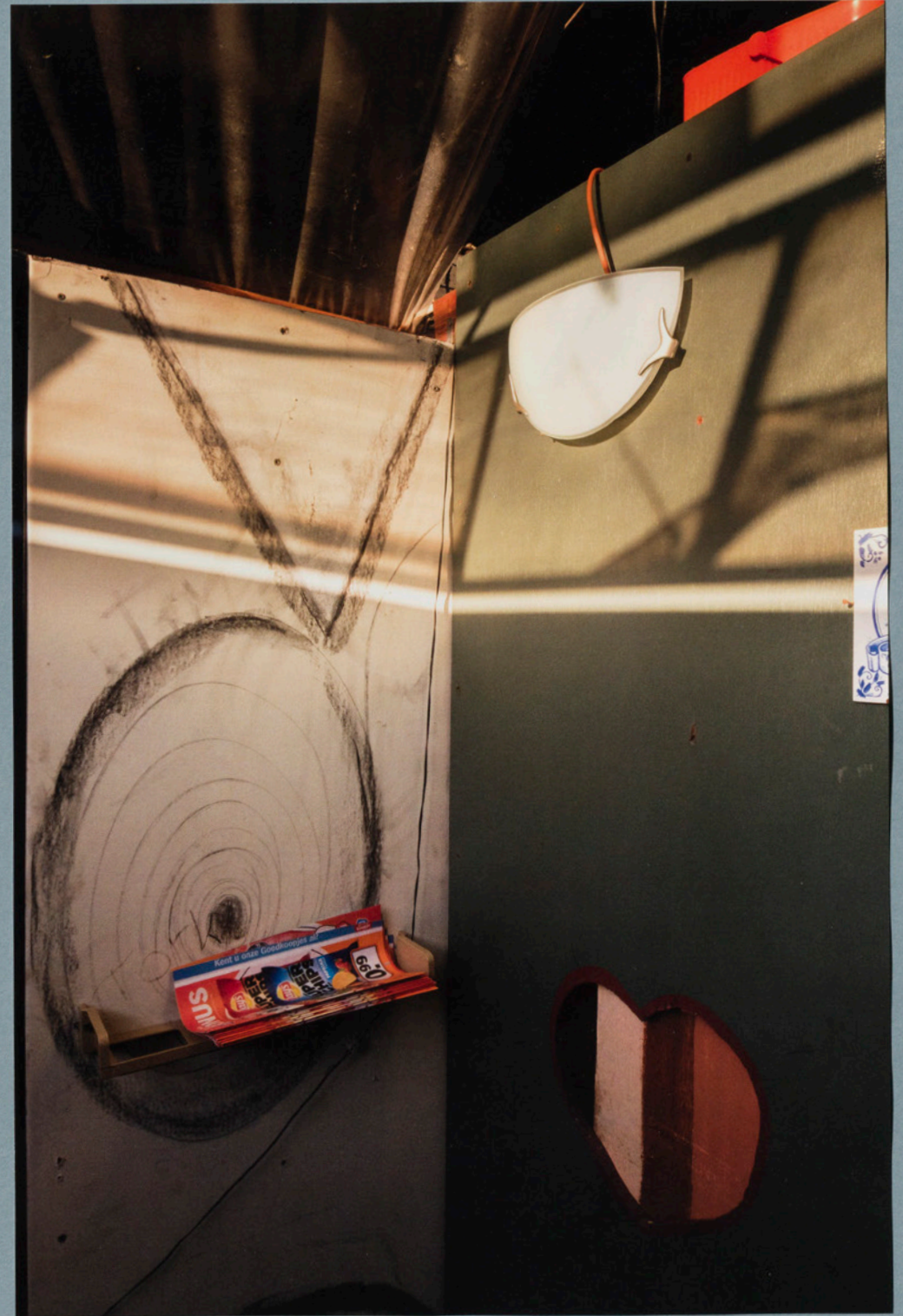



First floor



Platforms – Platforms of about a meter high have been erected to make sure people can look through the high windows.

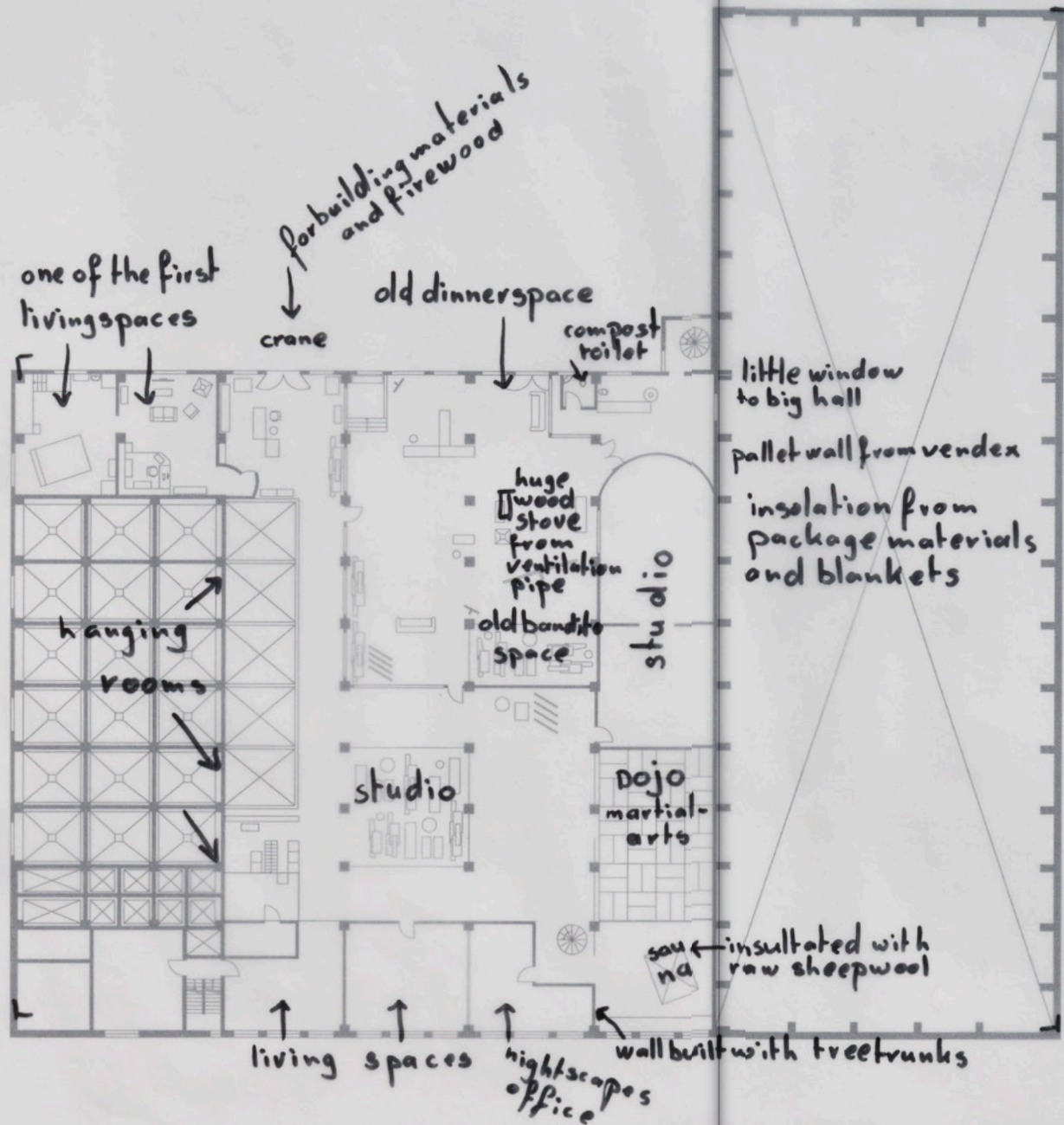

1:250
 III 2 | 5m |

ZF



196



Second floor

197



Artistic zones – Large parts have not been walled off but divided into zones with invisible borders, often used by artists or collectives.

198



Second floor – Hanging rooms

199



200



201

Roof

4G – In exchange for high-speed internet in the entire building, Landbouwbelang has allowed the installation of a 4G mobile internet antenna on its roof by a private company.





Whose urban appropriation is it?

— a conversation with Amal Alhaag

René Boer (RB): We are representing an institution that is collaborating with activist spaces that hold an ideology that is often anti-state. Het Nieuwe Instituut is, in fact, a state-run organization, the same state which criminalized squatting eight years ago. There is a tension between a state institution and activist practices that permeate the entire project of *Architecture of Appropriation*. We'd like to reflect on these tensions.

Amal Alhaag (AA): There is indeed a conflict in the fact that these documents and practices are entering a state archive and, simultaneously, are produced outside that system, are deviant from how the state wants its citizens to perform citizenship, whether by building or by living.

RB: Soon after the *Architecture of Appropriation* exhibition opened at Het Nieuwe Instituut you

1. In 2017 the Metro54 collective presented *BLUEPRINT: Whose Urban Appropriation Is This?*, a multi-disciplinary group exhibition and public program at TENT, a platform for contemporary art in Rotterdam, focusing on the relationship between street culture and architecture. Metro54 invited architects, designers, rappers, producers, and artists to show new and existing work that explores and articulates the complex relationship between architecture and street culture.

also inaugurated the exhibition *Whose Urban Appropriation Is This?* at TENT.¹ Both projects reflected on the notion of appropriation and explored the same tension, namely the collaboration between cultural institutions and collectives from different backgrounds dealing with street culture (fig. 1).

AA: I could not have done that project if I had not done certain projects previously, and engaged with the networks and people I collaborated with. TENT was a stage, but the project wasn't about the institution; we were interested in the site and location that they could offer us.

It took us two years to build networks and relationships in Rotterdam, to build the language that is local, embedded and co-owned by people who live there, before we even entered TENT. I think that Rotterdam was the



Figure 1: *Whose Urban Appropriation Is This?* exhibition at TENT in Rotterdam, 2017.

right place to have conversations about questions of ownership, and the way appropriation was seeded, also in popular culture. It had a lot to do with the city's urban planning, how people live there, and to whom the city center belongs.

Ten years ago we could not have this conversation about street culture; street culture had a negative connotation. It is still criminalized, but at the same time it dominates popular culture and, simultaneously, is as much counter-culture as it is a form of refusal. Whether it's pop culture, mainstream, or not, it refuses what is the norm.

Marina Otero Verzier (MOV): A refusal of the norm. Could you elaborate on that?

AA: You see it in the mentality of people. It is needed to create a setting from which to refuse the norm in which we find ourselves. I've been thinking for a very long time about this because people talk a lot about decolonial practices and projects, but it is actually not that easy to refuse that which is given to you.

In the case of working with or within an institution, this is particularly relevant. It is about power relations. In the exhibition at TENT we were co-owners and had our own resources, which allowed us to negotiate. That's a different type of departure point than when you are hosted, you are invited to work inside an institution and have to perform within a particular protocol you are given. I find that institutions often don't want to collaborate with you if you have an

equal amount of resources and decision-making power, when you are in an equal power relationship.

RB: Could or should an institution decorate itself with the culture that actually emerges on the street, and would the people participating benefit from presenting their own work in that context?

AA: You could bring a different working methodology. The public program could help to create a space that can be activated. That is a combination, a formula that took me many years to fully develop. But as a formula, you can set that space up, and then people could choose whether to work with it or not. At the same time, a large part of the program could be a takeover, done by others. So people saw this methodology in TENT and thought, "If they can do it, then I can do it too," and approached the institution asking for space. Institutions should be a space for this to happen.

RB: So you basically opened up the institution?

AA: Yes, for me it's always an urgent aspect to really open up space; you allow different forms of being present, and accept that whoever wants to use the space can use it. And I think that is allowing people to appropriate, to change the language, but then someone else comes in and they reappropriate, then someone else comes in and they critique. What we didn't do was tell people what to do, we were not being paternalistic, in a sense, teaching people how to look, because in street culture

the refusal means that you can't tell anyone anything.

Katía Truijen (KT): Allowing for autonomy?

AA: Yes in that sense, I think it's urgent. Because it's one of the pillars of counter-culture and street culture, that everything can be potentially dismantled, but at the same time it is about how we can use the space and transform it, to make use of where it is located, socially, that it is a place where people can say, "I already walked on that street, I grew up on that street." There is a particular relationship between people on that street, and for a long time it hasn't been their's anymore, or that's at least what people told me in the case of this exhibition. What does it mean when you are spatially alienated; when you don't feel that some places are for you? The whole neighborhood near TENT, in the center of Rotterdam, is coded like that, but then it is of course to exclude the people we are trying to invite. Sometimes you don't need a 'door bitch', the way the cafés are decorated is a code, where a Dutch-Turkish person would say, "Ah – this isn't a place for me." There are informal tools and ways that design can communicate that people are not invited. What does it mean when you enter these spaces?

MOV: You are arguing that we can appropriate existing institutions and bring different discourses into them. In that sense, the main idea of the *Architecture of Appropriation* project is to acknowledge that there is an archive of Dutch architecture and that it's

mainly white men in there. So if we want to acknowledge unrepresented voices, and also think about what it is that we want to pass to future generations, we have to discuss who and what should be included at this point.

Yet, you could also claim that these institutions are, perhaps, obsolete. They are rooted in principles that are not based on diversity, they are not open to certain types of practices. That's why we are always wondering – should we appropriate these institutions and try to change them, or should we just let them collapse, and instead try to create new ones?

AA: What does it actually mean to build institutions for yourself? Is it not arrogant to think that you don't fall into the same immediate traps? There's the thing about authorship – how do you break the rules of institutions when they have existed for thousands of years? We have to go around the world and look for different formulas, and remix them, and create a mixture of them.

And then another option is to side-step all of that, and disregard the rules and the history and what the institution actually is. Almost repackaging it, temporarily. That doesn't mean that there's no space for critique or re-thinking, but to see it as a potential moment in time where you use it in the way you think is necessary, and then you disregard it. Like a temporary package, or home. What if institutions are a site that can be used for staging?

I think about the Tropenmuseum, where I work, because of the heaviness of the history

of the building, the violence attached to the building and the collection, which is largely stolen.² Originally you were never allowed to say that but now it is mentioned in some of the texts, especially in the Indonesian section. I think it's really okay if people remain angry and upset at the institution, and at the same time there is still potentially a space that can be used as a site of gathering, as a stage for whatever political goals. That's how the museum was a really good exercise for me. How can the museum be a stage where I can connect with people who have historical relationships with this place, which they haven't activated yet? Some people tell me they are still angry. "I hate this place, the violence; there can't be any good about this building." I think it's a waste of time to be obsessed by the fact that the history of the place can be transformed, it cannot be transformed! How do we live with the heaviness of that history, or the violence of that history? And at the same time, what do people need, what do people desire, what discussions can happen? How do we talk about the violence that is attached? Whether it's the violence of keeping women out of the archive, or queer people out of the archive? I always wonder that we know it's white men, but there are so many other ways of being, where are all the people who are hidden in this archive?

MOV: We are now working on initiatives such as 'Queering the Archive' and 'Feminisms in the Archive'. The squatting project was, in fact, an attempt to create a new acquisition policy that would include collective, and

2. The Tropenmuseum (*Museum of the Tropics*) is an ethnographic museum in Amsterdam, founded in 1864.

often criminalized, practices inside the archive and recognize their legacy in the construction of the city. We had everything against us to make it happen, but repeating this possibility over and over again creates a public discussion to begin with. Sometimes people ask, “How come you are using public funding to do a project with squatters?” but others think its a very relevant endeavor. Even if surrounded by disagreement, the project allows us to imagine a different archive, and plant a seed of change inside the institutions and its different constituents.

RB: I think this complicated position is very interesting. On the one hand there is the violence from the state, attacking these appropriated and squatted spaces, but at the same time an institution of the state is being used as a Trojan horse to open up these practices. To occupy space within these state institutions. It’s not a clear-cut thing.

MOV: In Amal’s project, she was saying something more, if I understood correctly. That the type of space and language she aims to facilitate inside the institution operates as a street, at street level. In our case, even though we are not only acknowledging gaps (both thematic and methodological) in the official historiography – such as feminism in architecture, queer perspectives, and collective and radically improvisational spatial practices – we are also working to reframe acquisition policies and include new documents, subjects, and media, but our archive is nevertheless on top of pillars.

It’s not even connected to the street. In order to get into the archive you have to ask for permission. There are many layers in which this information is not accessible.

AA: I’ve said before that archives are places where collections and objects go to die. There is a disconnected relationship to the objects, whether it’s documents or something else. A lot of the things in public space, in the street, are not as valuable as the archive. The archive in that sense is an illusionary space of value creation, and the street is actually a simultaneously illusionary space, but for culture-making there is a friction in the street, the street cannot be controlled but, equally, the archive is uncontrollable.

There is a performance of containing the archive, and that I am very fascinated with – the desire to contain it, where there is all the time holes and silences and mess. If I think about some of the rooms in the museum where I work, there are whole collections of objects about Indonesia just gathering dust. But you can really smell the archive, it’s not as if it’s not living if it’s not amongst you. But what I find very difficult sometimes is how we undo the performance of keeping up the guard. It’s like keeping up appearances. You know this inaccessibility, this performance of inaccessibility to recreate value over decades and centuries. At one point the objects become toxic, and you cannot touch them with your fingers.

RB: I like this idea that things die within an archive, but they can also be reactivated,

maybe in 150 years from now. When somebody looks into architecture in the Netherlands in 2019 they will see that somebody thought it was interesting to look at these kind of spatial practices. It dies, and it's inaccessible, but it's also part of the historic cycle.

MOV: I found the argument that Adeola Enigbokan defended in one of the workshops very interesting.³ She said maybe drawings like this should not be kept in the archive, maybe you have the archive for *Architecture of Appropriation*, or squatting in the Netherlands, but when you go to find the documents they are not there, you have to go to the places themselves. A networked, dispersed archive.

RB: That's an interesting idea, but the archive at Het Nieuwe Instituut is an extremely well protected, fortified space.

AA: It does look that way! But I wonder, do we not overestimate who wants to see this in 150 years; do we not overestimate the work we are doing now? Some things will be seen, but equally some things will be forgotten. But the percentage of what will be seen will be very small, and of course depends on the interest of people. These things are locked up in forts, but why are the forts not transparent? Why can I not see it from the outside and know it's the fort, and that the fort opens once a month? You know that there is something happening, of course it is for the future, but not for those that live in the present. It is contained forever, but the containment

means that we, who are here now, cannot touch it or contaminate it.

This is a concern of mine – who is it we are saving it for? The national archives, and in particular the colonial archives, were as much about administration as anything else. Mostly to verify that no one was stealing from the empire or the system. It's so well documented, but I wonder sometimes to what extent it laid the model for how we archive today. It almost feels like archives were built not to preserve artifacts, but to preserve value.

RB: There is a certain value system which has been put in place, full of biases and ideologies. But what we try to do is drag alternative values into this current value system.

AA: To me, you are trying to experiment, to almost side-step what the normative archive is. How one deals with it by already making these undesired connections. It can really be considered as a contamination of the archive! I think it's quite interesting that it's the unwanted, but it's equally important that it is a mapping of how people live together. What is erased or invisible.

It is not only criminalized now but this act of living together in this way, against a normative nuclear family, is also considered criminal. There are so much politics and morals attached to squatting practices that are refused by those who want to keep up the appearances of the architecture archive.

MOV: We were willing and able to open up a

4. ADM was a large squatted shipyard with an alternative micro-society in Amsterdam's western port area. It was squatted 1987-1993 and 1997-2019. See pp. 313-368.

more political discussion by bringing this conversation to a national institute. What does it mean for cities like Amsterdam or Rotterdam to dismantle these kind of spaces of communality and solidarity?

AA: I think it is collectively accepted that it is improper citizenship to squat. It went so fast from a practice which was considered as a way to reclaim your city and tolerated, to being criminal. Even if houses and communities are legalized, or become more formal places for cohabitation, the role they play is still very undervalued. People don't remember how important it was for Amsterdam or Rotterdam. I am concerned because I don't think the topic fits in the algorithm of media sales in the Netherlands right now. It is trying to bring two worlds together, and use the value of the other to rethink how we value squatting practices. In that sense, I think an institution could be the right place for staging, but we also live in a moment when developers and city planners are really in a state of "We do not care because we know we can make money."

RB: The work also has an impact on the conversations about heritage. At the moment there is a new focus on post-1975 heritage, while the first post-modernist buildings are being classified. We had interesting discussions about ADM, and all these self-built houses there, which could also be seen as heritage.⁴ The only documentation of these buildings is the work we have been doing.

AA: I think the impact takes a long time

sometimes. You know it disappears, the urgency is there, you know the impact might not be in the media, but it will be in the archive for people, for researchers. The actual documented correspondence work you have been doing will be present for people to actually work with. So far there hasn't been any material for people to work with to say, "This is what it is, this is how we can perhaps look at it," or be critical. It's like laying a blueprint.

RB: The question of gatekeeping is also interesting; for example in the exhibition you have been making you are selecting who is going to be part of it. Same with us. We have made an arbitrary selection of places we found interesting for specific reasons. It's interesting, the role of the mediator between the activists or the street – we are mediating between the archive and the exhibition space. How do you see this role? How can it be democratized?

AA: I often don't see it as a selection, but I see it as a way of being in relation with people. Because I don't work *with* people I collaborate with people through relationships. But I try to erase myself from it, I try to minimally reproduce authorship. For example, for the project you didn't see my name. It's irrelevant, it's not about me. It is collaboratively run, we don't want to see our names. Undo the rules of authorship and play the mediator.

RB: You are still making a selection of how the street is presented to the outside.

AA: I invite people, I don't edit what people decide. I am really only extending the invitation. There was complete freedom, I really didn't interfere with such a major intervention; I didn't do the programming myself, and I didn't edit it.

There is a layout to the invitation, what the parameters are of the invitation, and to a degree I am responsible for this but I can't take the credit fully because it is also based on other collective thinking. You are in conversation and on the shoulders of others in a way. What I find complicated is the question "What is a democratic way of doing this?" Then there is the anarchistic ways of doing things, or democracy in the sense of having everyone vote. Then there is also the question of how to pay people properly. The financial model, how to move forward in an ethical way, so that people are not giving their time for free, and you are not benefitting from their knowledge.

Everyone wants their name out there, and of course that's fine, it's about taking space and ownership. Thinking about what you are doing with power, allowing other people to take ownership.

RB: We have created a blueprint which enables these spaces to enter the archive because it also needs to enter the archive in a specific way. But the gesture is already quite radical, so it needs to be structured to some extent. It's also a blueprint or a methodology that can be replicated for the future, and future practices. Allowing people in the future to also 'extend this invitation'.

AA: The question is whether you are willing to step into the position of non-authorship. I think about this at the museum, how we work with new things entering the collection, because that's almost impossible.

Recently I've been thinking how we can surpass the commissions. There is the center, there is the activation, the discourse, the dislike, the critique, and you attach it to the object. So in this case the objects become like flowers, they are no longer single entities which can be classified through a story of a missionary road in 1905.

It's something we are thinking about, but then you have to work with a collection, and sometimes it's difficult working with people. We are obsessed with the present and ephemeral things, sometimes things can be dismantled and taken away, but they are preservers. So you are not always on their side, you are a troublemaker in a way. How do you collaborate with people who don't necessarily see the benefit of rethinking objects?

It takes time – I mean three years ago I was talking about this idea of the flowers, but only now can I actually propose it, and test if it could potentially work, because yes, you can attach things to the object, but you can't attach other objects to the object. It can't be new work, as new work cannot enter. That's why your archive is a step further, as there is space for new things to enter. Perhaps under certain conditions, but there is a blueprint for this, it could be interesting for museums who work around heritage to see what possibilities there are for rethinking what goes in, and who the gatekeepers are for that.

RB: The question is how we can open the doors.

AA: If you want to change the basis of how the collection of an archive is seen, this could be a way, while potentially feeding it with new things. It doesn't even matter whether it will be used 150 years later, it already changes the structure that is built-in, and that's already an interesting proposition.

A NOTE ON GEZELLIGHEID

By Adeola Enigbokan

We flowed, laughing, out of the Stedelijk's heavy glass revolving doors, manned by black-clad security guards, and into the Amsterdam damp. It was midnight, not quite yet Christmas, and no one was ready to let the night end. So we wandered into the winding streets around the Concertgebouw, and settled upon Café Welling. The small, classic café is a neighborhood fixture, with its worn leather and wood seats and its older, well-heeled clientele. My first time in Welling was at the invitation of a Russian acquaintance who had lived in the neighborhood for years, and wanted to show me something special. She presented it as a kind of hidden jewel, a ticket into that very exclusive Dutch notion of *gezelligheid*, often translated as "cozy," but meaning so much more: family, belonging, togetherness, comfort, home, friendship. On that first visit my Russian companion ordered us two jenevers, another Dutch treat: a kind of protoypical gin, distilled from juniper berries, which could be clear and strong, like vodka, but without that liquor's brightness. The drink arrived still in the bottle, along with two tiny glasses, each shaped like a miniature champagne flute, but with a curiously curved lip. The barman poured the liquor at the table, as per Dutch tradition, filling each flute to the lip, so that the clear liquid pulsed into a slight curve at the tip, held in place by the magic of surface tension. We bent over and sipped, my companion reminding me to be careful not to spill a single drop. I was almost entirely successful.

Now, almost a year since that first visit, the dignified café was transformed into a delirious Christmas diorama, with tinsel and lights covering the windows and the ceiling and the walls. It was as though we were packed inside a holiday gift box prepared by someone's faraway and slightly barmy grandmother. It was lovely. The crowd from the Stedelijk party, a who's-who of Amsterdam's art, architecture and curatorial scene, and their admirers, crammed in amongst the regulars, gentlemen and women of Amsterdam Zuid, already drinking for some hours. The space charged and friendly, all very *gezellig*. A well-groomed older man, with shoulder-length silver hair, pushed back from his forehead into a thick wave gathering at the back of his neck, caught my eye and smiled at me immediately as we entered. I smiled back. We sat at a table in the only free seats we could find, and the silver-haired man stood with his friends, hovering over us. I fingered a pen and paper placed on the table, especially for customers to gather drink orders and submit them to the bartender all at one time. I started to doodle a bit and soon the silver-haired gentleman leaned down, and in heavily-accented English, asked me for a poem. How delightful! I thought.

What is your name?

Simon.

Well alright Simon, one poem for you, coming up!

I set about writing a note about friendliness and love, being strange in the city, and finding it hard to be in the right place, with the right people, and how tonight, with Christmas coming,

I could feel a miracle was happening: Here, in this tinsel box, I was finally welcome, and asked to share my gift, my way with words, and my warmth.

Dear Simon...

I wrote slowly. I introduced myself to my new table companions, two lively middle-aged women, one Dutch and the other Venezuelan, both long-time residents of the neighborhood. I fell in and out of conversation with my Stedelijk acquaintances, finding it hard to follow their conversation about the details of life in the Dutch architecture world. I bought a round of drinks for the table. Periodically, Simon leaned in to ask how his poem was coming along and to give increasingly demanding direction.

Make it long, not short, many lines, and funny too!

Each time he did so, curiously, he and his friends broke into laughter, exchanging comments in Dutch, and slapping Simon's back and shoulders. I smiled along with them, a bit confused, but assuring him that his poem was turning into something rather lovely. On the third interruption, just as I was starting to feel a bit harassed, the Venezuelan woman intervened. Speaking in Dutch with a somewhat drunker Simon, she asked him what he wanted with me. A heated conversation ensued, in which I heard something about "*Zwarte Piet*," some gesturing in my direction and more laughter from Simon's friends. A great coldness overtook me, as the warmth of the tinsel box faded, irretrievably. The Venezuelan woman looked at me, her anger with Simon, changing to silent pity and protectiveness.

Don't give him the poem. He doesn't deserve it. He is not a good man.

I crumpled the half-written poem in my hand, and let it drop to the floor. I turned to my Dutch architecture companions to ask for an explanation of what had happened. Apparently, it seems, I reminded Simon and his friends of the Dutch blackface character, *Zwarte Piet*.

* * * * *

When I enter Café Welling, I feel simply that I am a surprise, a bit unexpected, and in the silver-haired gentleman's first glance I do not perceive malice. Within Simon's universe his request that I write him a poem is entirely appropriate. In some strands of Dutch culture—apparently those strands tucked away across the street from the Stedelijk Museum, just behind the Concertgebouw, and maybe elsewhere as well—it is socially acceptable to associate my dark skin with a racist "children's" caricature, and to ask me to play this role, publicly, and for the entertainment of all who get the joke. In that environment, only the Venezuelan woman, a fellow foreigner, questions this behavior, does not accept the joke, and highlights it as inappropriate. Soon after this interaction, I leave the café, suddenly exhausted, and with a deep sense of my inappropriateness for that place. What had previously been introduced to me by my Russian acquaintance as a site of *gezelligheid*, now becomes a site of shame and humiliation.

Dutch lives unfold in the space between what is *normaal* (normal, standard, correct) and what is *toegestaan* (allowed, permitted, as by law). Both categories, *normaal* and *toegestaan*, indicate different forms of "appropriateness" and "appropriation," what is natural and acceptable, on one hand, and what is proper to oneself and one's group on the other. These forms of appropriateness and appropriation describe the boundaries of what is properly "us", spaces and behaviors that belong to us, and not to "them," the outsiders who cannot decipher what is "*toegestaan*," and in their bodies and behaviors are too far out of the ordinary. There is, within these boundaries, very little room for serious difference, for excess. Staying within these boundaries, like jenever poured into a curve at the lip of the glass, without spilling over, is the key to "appropriateness," to fitting in, in urban spaces coded "Dutch." My very presence in Café Welling this December night represents a kind of spilling over. For Simon and his friends, it may be "allowed" (*toegestaan*) for me to be there, but it is not normal (*niet normaal*). Within this logic, the elaborate poetry game, associating me with Black Piet, is actually a way of making me "homey," recognizable, *gezellig*. Through writing the poem, participating in the game, I who am not Dutch, not white, can be made familiar and comfortable, *normaal*. I am a foreign territory that can be appropriated and make myself appropriate at the same time, by association with a blackface character that is as Dutch as apple pie. Who is more *gezellig* in grandma's tinsel-wrapped gift box, than the beloved *Zwarte Piet*? In a matter of minutes, I go from woman to caricature, a figment of a Dutch imagination, a part of the holiday decoration, an amusement. My voice, my poem, my expression, my gift, is limited, shaped into a form I cannot choose. This is my narrow opportunity to "integrate" into Café Welling, to become a part of the surroundings, to "fit in." In order to become appropriate for this space, I must let my body, and my poetic expression, be appropriated by those who arrived before me by accident of birth and color. That is the price of admission into *gezelligheid*.

The moment I realize I am the joke, I retreat. I physically recoil. My hand crumples the paper into a tiny ball.

There is a dull pain in my chest, in reaction to the Venezuelan woman's piteous glance. I ask her what Simon is saying.

I won't repeat it. It's nothing good.

Her refusal to translate his words provides me no relief. I need more, an acknowledgement that something is happening to me, to the space around me: I am shrinking. Simon and his friends are too close. My body is taking up less space. I can't breathe. I am no longer appropriate for the café, and I can no longer appropriate space within it. I must tell this story immediately, and I do, to those nearest me. Soon, my architect-friend says he is leaving. He has to drive to Belgium early in the morning. I gather my things and begin to get up. He says:

Don't worry. You can stay here if you want.

I don't want to stay here. I can't.

I understand in this moment that he has not perceived my shrinking, my smallness. Has he not noticed my body being possessed by *Zwarte Piet*? Has he not noticed the glass wall of silence that has formed around me, isolating me, distancing me from my surroundings, exposing me to further attack? How could an architect not sense this change in space? I am no longer filled with warmth, and all this tinsel is claustrophobic. I am suddenly cold, and very tired. This is not only a change in mood. This is a change in physiology. This is a change in the very quality of the space.

Later I write to my architect-friend:

Hey was great to synchronize in the city last night. You were right when you said I am waiting. I am in a holding pattern here, which I am not used to. I love cities, and finding their flow, their creamy centers, even or especially when those creamy centers are actually the peripheries. I usually never have to wait for this, because I have a way of being, always open and ready to go inside. Also, I move towards my fears, and am rarely paralyzed by them. And I have a funny bone, and find a lot of humor in the everyday. Why am I telling you my city-lover's CV? Well, because here, I have reached a limit—a brick wall. At first I felt it was to keep me out of the creamy center. Since Dutch brick is so famously hard, I was worried by this: how could I get to the cream? But then, I got a glimpse, in the face of the Black Petes which seem to follow me around these days, and in some other interactions, that makes me feel that there is no cream at the center, that there is really just a kind of emptiness, a monstrous horror, hidden away behind the wall, while we are all directed to "doe normaal" and ride our bikes in spirals around the canals. This vision fills me with sadness, and a new kind of fear that paralyzes me. This is maybe why it appears to you I am waiting. I am afraid there might be more horror behind the doors.

I am writing to ask for your help. I would like your help in really looking at the monster hidden behind the wall of normaal. I would like you to help me with this because I get the impression that you understand what I am talking about, and that you sense the horrors under the old churches, and the new high rises, and in the way people imagine their pasts and futures.

Could we please find a way to do this together? I am asking about more than a book or an exhibition or some art-architecture thing, though it could be all that or something more. I will leave this place, and there will be much I won't want to remember. But I would like to be able to say that I did not leave before I found the hidden monster, and that I did not run from it, and that with the help of a capable friend, we were able to face it. Together.



POORTGEBOUW – This late 19th century office building on Rotterdam's waterfront was squatted in the early 80s, legalized soon after that, and is still home to a thriving alternative community.

Poortgebouw was built in Rotterdam in 1879 as the headquarters of a new trading company founded by the notorious entrepreneur Lodewijk Pincoffs. The imposing building was constructed over a main road along the south bank of the Maas river, and later acquired national heritage status. When its last tenant, Rotterdam's port authority, moved out in 1977, immediate plans to transform the building into a brothel were met with local resistance. After lying vacant for three years, the building was squatted in 1980. The squatters kept the name of the building, carried out much-needed maintenance, and made it fit for living.

The newly established community added living spaces, shared kitchens and bathrooms, a wood workshop, a photographic darkroom, a rehearsal space and a stage. Poortgebouw soon became a renowned venue in the city's underground scene. In 1984 the squat was legalized, and the residents started to rent the building from the municipality, who later sold it to private owners. Today Poortgebouw is home to about 30 residents, as well as a give-away store, a weekly café and a bimonthly performance night.

Program – Housing for 30 to 35 residents, a give-away store, a people's kitchen, an event space for concerts, films or parties, various workshops, a large assembly space and a multifunctional attic.

1879

The administrative office of the Rotterdamsche Handelsvereniging, a company set up by entrepreneur Lodewijk Pincoffs, is built in the Kop van Zuid district to a design by architect JSC van de Wall (fig. 1).

1882

All property belonging to the company is acquired by the city of Rotterdam. The municipal port authority and the Holland-America Line move into the building.



Figure 1: Poortgebouw, 1900.

1932

The newly established Port of Rotterdam makes the building its headquarters.

1977

The Port of Rotterdam moves out of Poortgebouw, and the municipality plans to turn the building into a brothel. After protests the plans are abandoned and the building remains empty.

October 1980

The Rotterdam Association of Squatter Groups squats Poortgebouw in protest against the high level of vacancy in the city, and against a new law concerning unoccupied buildings. The aim of the squatters is to make the building suitable for living, and to use it as a youth center.

(p. 230: Letter circulated to inform the neighborhood about a new squatting action).

November 1980

The squatters engage in a discussion with the municipality about the legalization of the building's occupation. The squatting group considers a proposal by the municipality to transform the building into independent one and two-person household units, yet this is too expensive for the residents. The group is convinced that if they renovate the building as a community and on their own, lower rent can be offered. As a result, the plan by the municipality is abandoned.

1981

Poortgebouw starts to provide space for squatters to meet, a basement rehearsal space for musicians, and a venue in the attic.

1982

The Poortgebouw Association is set up as a formal organization to represent the residents.

(p. 231: Announcement for the Squatter Café).

1983–1984

Poortgebouw is legalized as the municipality and the association draw up an official rental contract. The contract specifies that the association pays a reduced rate on the condition that they take responsibility for the management of the building. The municipality retains responsibility for the building exterior. Despite the legalization, Poortgebouw remains a central hub for the squatting community.

(p. 232: Rental contract between the city and the Poortgebouw Association).

October 1986

Poortgebouw is officially registered as a national heritage site.

1993–1997

A campaign is conducted to preserve the garden next to Poortgebouw, but this is eventually reclaimed by the municipality in a court case.

July 2001

The Rotterdam Housing Association, who acquired the building from the municipality, sells Poortgebouw to De Groene Groep, an investor and developer specializing in the management of historical buildings. The sale agreement specifies that the new owner can not evict the residents during the next three years.



Figure 2: Monthly activity program, 2003.

2004–2010

Extended period of conflict between the Poortgebouw Association and De Groene Groep. The building is in poor condition, and De Groene Groep argues that it must first be vacated to allow for a proper renovation. The Poortgebouw Association appeals, and emphasizes that in order to evict them De Groene

Groep must provide accommodation with similar facilities for the residents as a group, not as individuals. The court decides in favor of the Poortgebouw Association.



Figure 3: 24th anniversary poster, 2004.

Early 2016

Poortgebouw is sold to a private owner. Residents contact the owner, and their situation remains unchanged.

May 2016

The SqEK (Squatting Everywhere Collective) conference takes place, where international participants present research projects and discuss squatting issues.

(p. 234: Flyer for the SqEK conference).

2017

In collaboration with Stad in de Maak (SidM), the association employs an expert on real estate mediation to conduct extensive social, economic and structural research on the building and the continuation of Poortgebouw.

2018

A small group of community members starts to reach out to the neighborhood to demystify – and grow support for – the living community of Poortgebouw. The venue is insulated and the guest room renovated. The research by SidM is completed and the Poortgebouw Association establishes a foundation for forthcoming negotiations with the municipality and the owner.

Early 2019

Events are organized where the local neighborhood is invited, and association members start a project to creatively promote the visibility of Poortgebouw. Negotiations with the municipality and the owner persist and the future of the association remains uncertain.

Vrijdag-3 okt 1980

Eindelijk is het dan zover, het Poortgebouw heeft een bestemming gekregen!

Afgelopen nacht hebben wy, Rotterdamse Kraakgroepen, met zo'n 50-70 man/vrouw het al jaren leegstaande Poortgebouw gekraakt.

Dit, omdat het in deze tyd van vele woningzoekenden asociaal is om woonruimten als kantoren (leeg), en dergelyke leeg te laten staan.

Dok echter als protest tegen de nieuwe op handen zynde "LEEGSTANDSUJET", waarin de overheid pretendeert de leegstand tegen te willen gaan, naar die in feite neerkomt op een "ANTI-KRAAKUET", waarin het recht op het kraken van lege panden verkracht wordt.

Kraken is een verweer van vele woningzoekenden tegen 't feit dat fundamenteel recht op wonen wordt vertrappt door beleggers en speculanten.

Tegelykertyd ook een gevecht tegen gemeenten en overheid, die er niet in (willen)slagen de grote woningnood te bestryden.

Wy hebben daarom speciaal het P.G.B. gekraakt, omdat dit al jaren leegstaat, het best te bewonen is, en omdat het pand goed te gebruiken is voor allerlei activiteiten.

Onze bedoeling is om het pand beboubaar te maken, om er een kraaksprekkur te gaan draaien en in overleg met de buurt te gaan gebruiken voor jongeren-activiteiten, zoals een jongeren centrum e. id.

Wy hopen met deze verklaring op uw solidariteit.....
het ROTTERDAMS OVERLEG KRAAKGROEPEN



WOENSDAG v.a
7 UUR

ZONDAG v.a 4 UUR

**POORT-
GEBOUW**

8-12-1983
CONCEPT

De gemeente Rotterdam, te dezen vertegenwoordigd door ambtenaar ter secretarie van de gemeente Rotterdam, daartoe aangegeven door de burgemeester van deze gemeente krachtens het bepaalde in artikel 78 lid 2 van de Gemeentewet, en als zodanig handelende ter uitvoering van het besluit van dd. 1984,

hierna te noemen de verhuurster

en

de bewonersvereniging "Vereniging Poortgebouw", te dezen vertegenwoordigd door haar bestuur, met name door

Karin A.M. Roelofs, voorzitter
Ivo A. Steverink, secretaris
Cornelis F. van den Berg, penningmeester

hierna te noemen de huurster,

in overweging nemende

dat tussen partijen een overeenkomst dd. 17 november 1982 (besluit van de Raad van de gemeente Rotterdam dd. 28 oktober 1982) is gesloten tot verbouwing van het Poortgebouw, Stieltjesstraat 27-38, Rotterdam, tot woongebouw voor de huisvesting van 28-32 jongeren, bevattende 28 zg. H.V.A.T.-eenheden met gemeenschappelijke voorzieningen, van welke verbouwingsovereenkomst een kopie aan deze akte is gehecht,

dat ingevolge artikel 3 van de verbouwingsovereenkomst dd. 17 november 1982 met ingang van de datum van oplevering van de verbouwing de gemeente Rotterdam het Poortgebouw zal verhuren aan de Vereniging Poortgebouw,

dat op de verbouwing is opgeleverd en dat mitsdien per deze datum de huurovereenkomst tussen partijen ingaat,

verklaren te zijn overeengekomen als volgt:

Artikel 1

Verhuurster verhuurt met ingang van bovengenoemde datum voor onbepaalde tijd aan huurster het Poortgebouw, welk gebouw huurster verklaart per genoemde datum in huur aan te nemen en te aanvaarden in de staat waarin het aan haar wordt geleverd, zijnde het gebouw aan huurster volkomen bekend, zodat zij daarvan geen nadere beschrijving verlangt.

Artikel 2

- 2.1. De aanvangshuurprijs van het gehuurde bedraagt f 3.343,20 per maand, welke huurprijs de huurster zich verbindt bij vooruitbetaling te zullen voldoen door overmaking op postrekening nr. 14920 van het Gemeentelijk Woningbedrijf Rotterdam. De eerste huurbetaling is verschuldigd per de eerste van de maand volgende op de datum van oplevering van de verbouwing van het gehuurde.

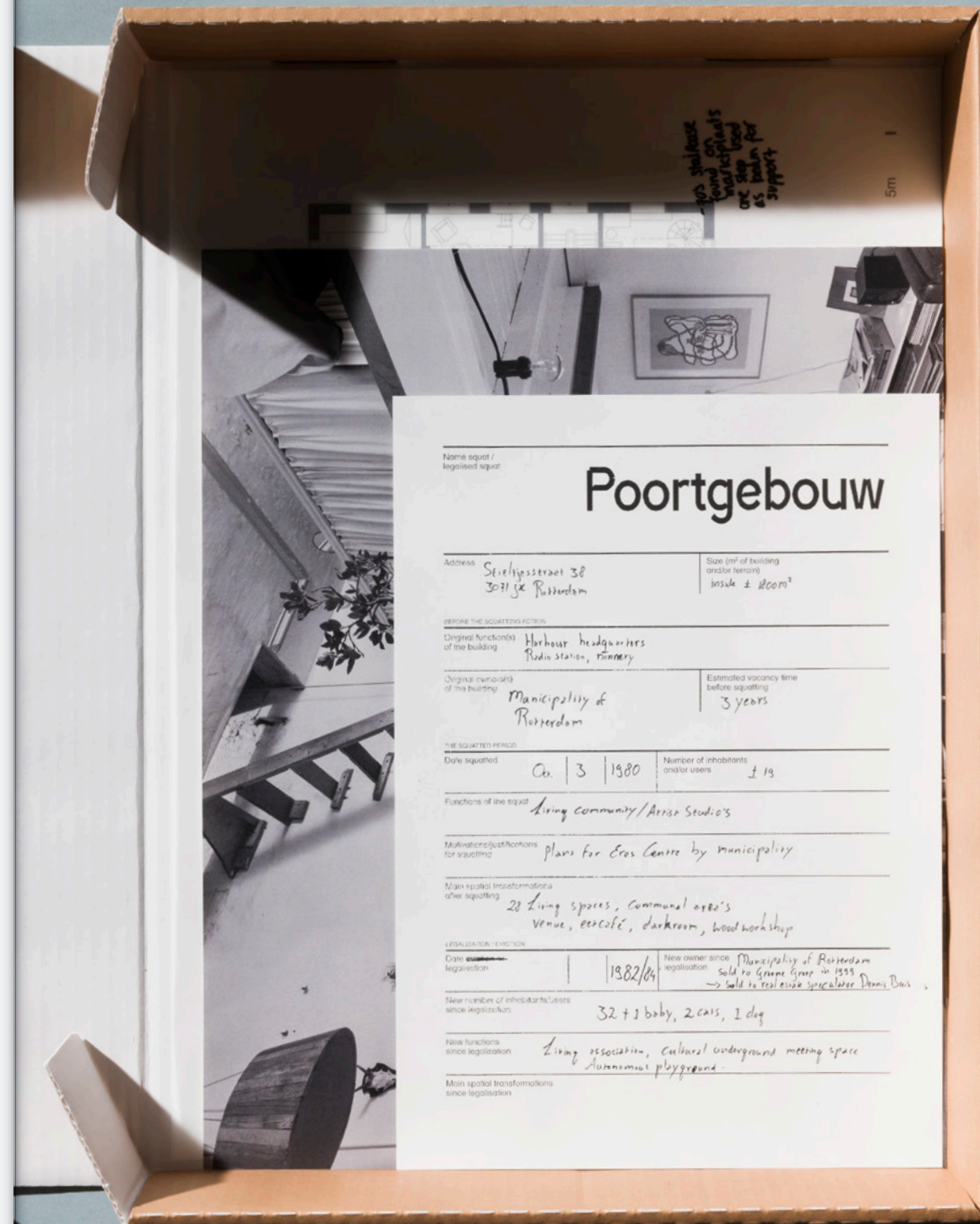

SQEK CONFERENCE
SQUATTING EUROPE KOLLECTIVE
 18-23 MAY 2016 . ROTTERDAM

**RESISTANCE TO
 CENTRALIZATION**

THE SQUATTING EUROPE KOLLECTIVE (SQEK)
 IS A RESEARCH NETWORK FOCUSING ON THE SQUATTERS' MOVEMENT. OUR AIM IS TO PRODUCE RELIABLE AND FINE-GRAINED KNOWLEDGE ABOUT THIS MOVEMENT NOT ONLY AS AN END IN ITSELF, BUT ALSO AS A PUBLIC RESOURCE, ESPECIALLY FOR SQUATTERS AND ACTIVISTS.
[HTTPS://SQEK.SQUAT.NET/](https://sqek.squat.net/)

THE CONFERENCE
 IS A RESEARCH NETWORK MEETING WITH DISCUSSIONS AT THE POORTGEBOUW. ALONGSIDE THIS, A FEW PUBLIC EVENTS SUCH AS A FILM NIGHT AT WORM, A SEMINAR AT THE ERASMUS UNIVERSITY, A DEBATE AT V2 AND A BICYCLE TOUR OF SQUATTED ROTTERDAM WILL TAKE PLACE.

MORE DETAILS AT: ROFFASQEK.WORDPRESS.COM
 POORTGEBOUW / WORM / V2 / ERASMUS UNIVERSITY - ROTTERDAM - THE NETHERLANDS

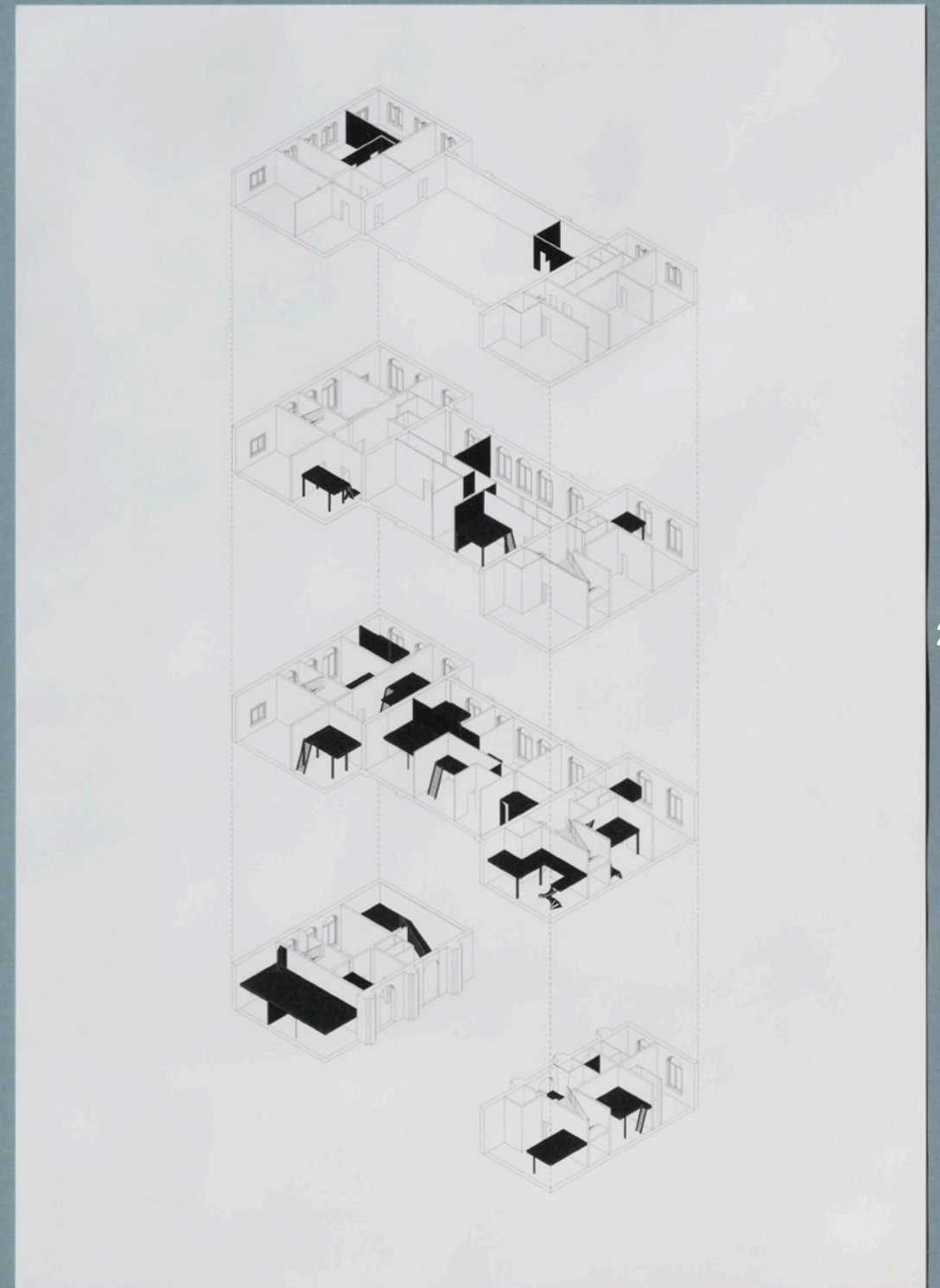

The construction of mezzanines throughout the building has been key in the transformation process of the building.

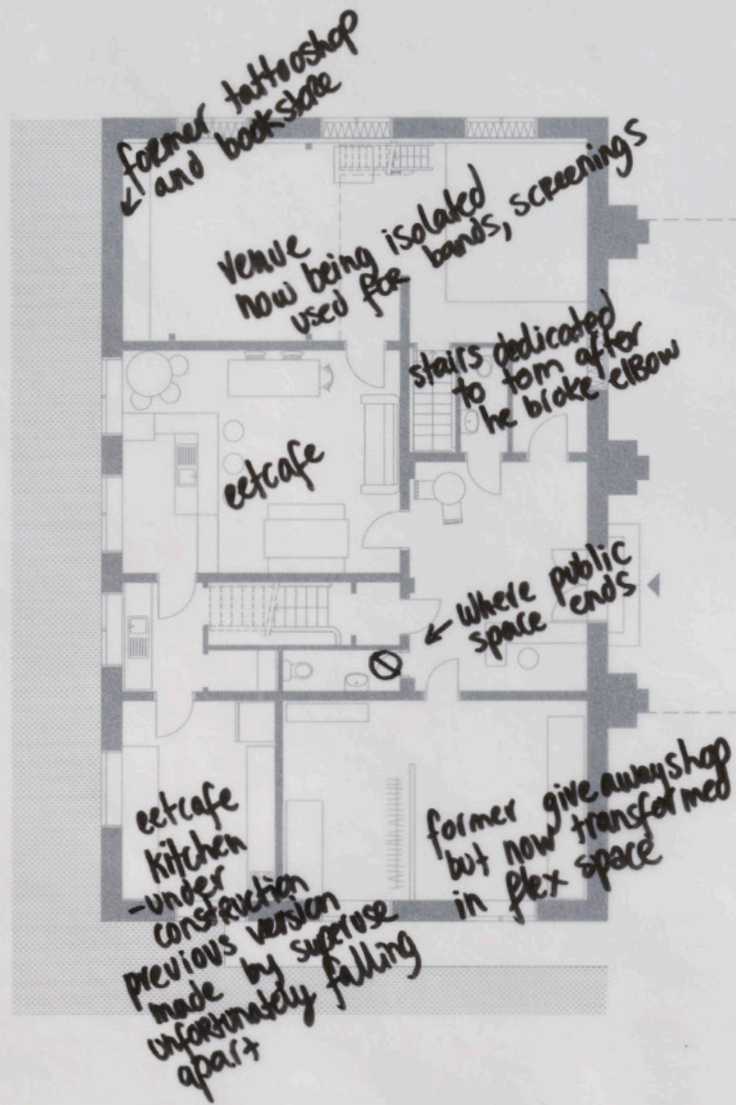

sometimes we get hit by unilever trucks

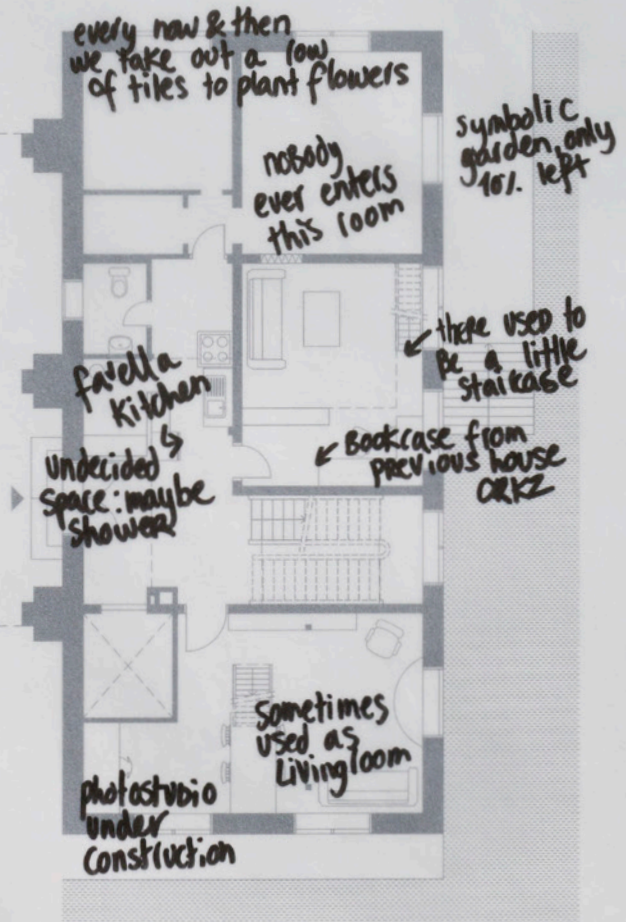

1:100



5m



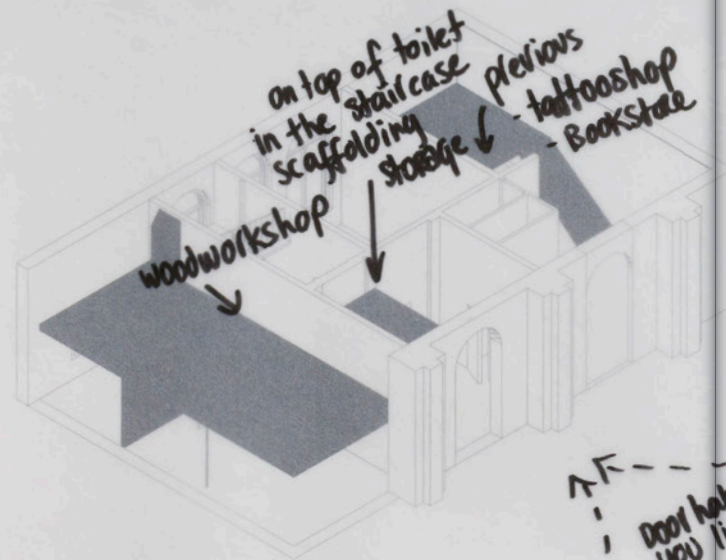

Door habits: depends on which side you live, or communal spaces you use

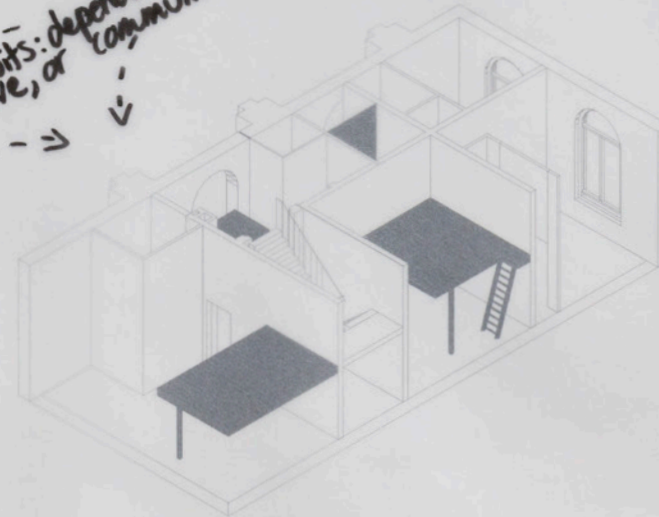

Divisions – Various divisions have emerged and dissolved in the community, but their origins and histories are often vague. Once, the building was divided into an artistic and an anarchist wing, each using a separate

entrance, and even the main kitchen was divided in two. In another period, the attic was claimed as a safe space by the building's female inhabitants.



Private, common and public spaces – Poortgebouw is divided into three type of spaces. Besides private rooms, there are shared spaces for the community such as a guest room and a kitchen-cum-living room. The ground floor also hosts various public spaces, such as a give-away store, a café, and a small event space with a stage.

Economic structure – Inhabitants pay rent to the Poortgebouw Association. From the overall amount around 40% goes to the owner of the building and the rest is used to cover utility bills, cleaning and maintenance supplies, legal and financial assistance, and a communal savings fund. The public spaces operate on a non-profit and donation-only basis. The surplus is used for the audiovisual equipment, bigger maintenance projects, and other free spaces and projects.



Ground floor – Give-away store



Ground floor – Wood workshop

Arches – Many interventions have arch-shaped openings, created using templates found in the basement by the first group of squatters. Originally, these templates were used for renovations of the arches in the façade.



246

247

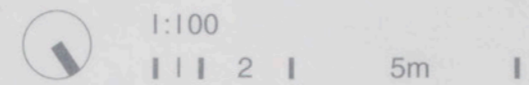

First floor

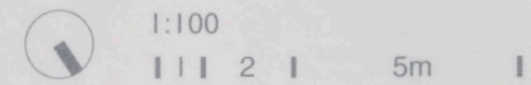
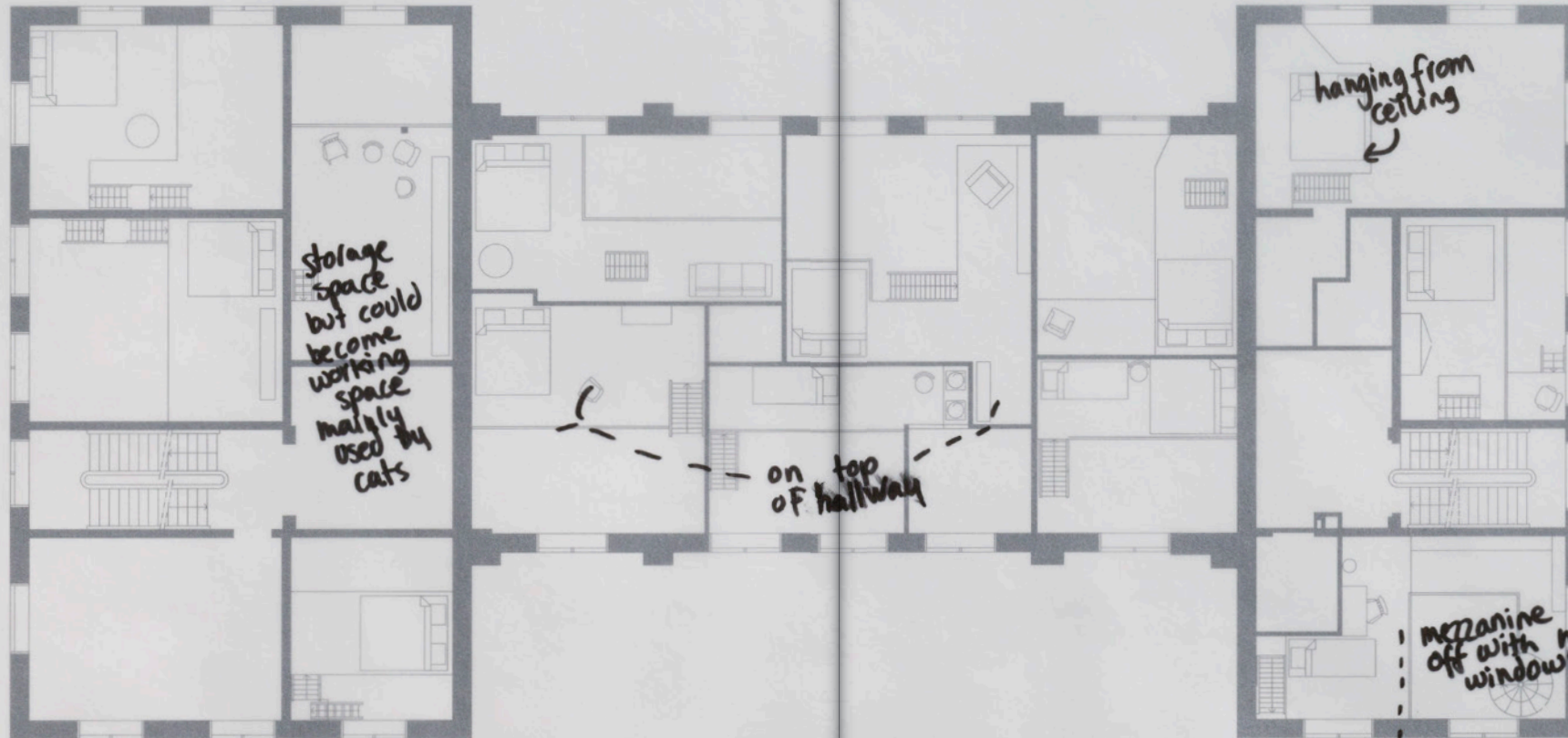

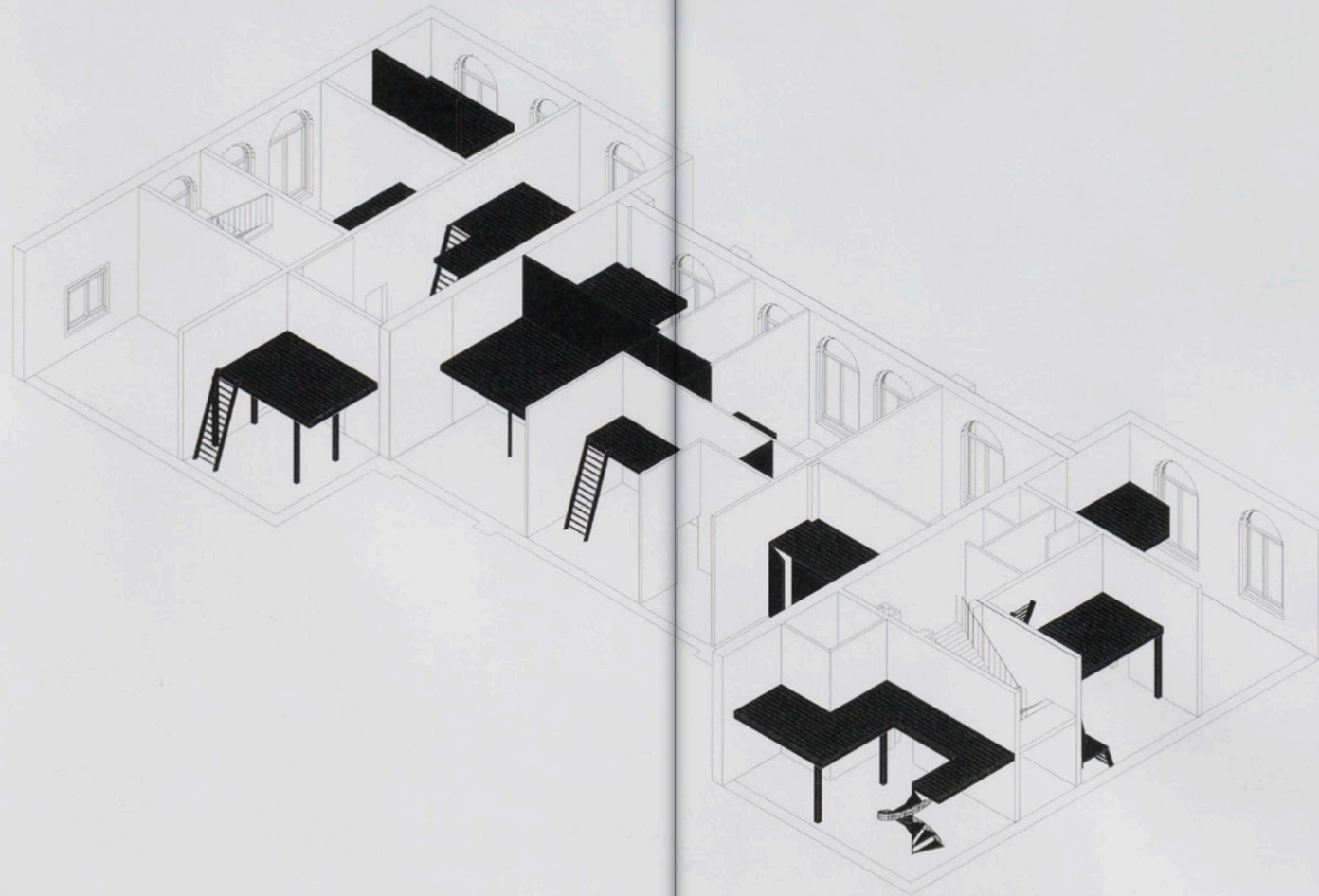

The high ceilings of the former office building allowed for the insertion of mezzanines into almost all of the bedrooms, typically with living space below and sleeping area above.



Building mezzanines is also a spatio-political strategy; in the case where a deal would be made with the current owner to move the community to



a new building, the community could claim more square meters as an appropriate substitute.

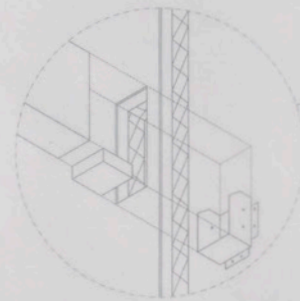
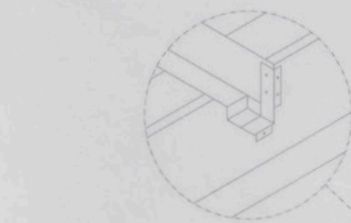

mobile stairs →

← reinforcement for the mezzanine

← Bought in the neighbourhood

← Backcases from previous house OKRZ

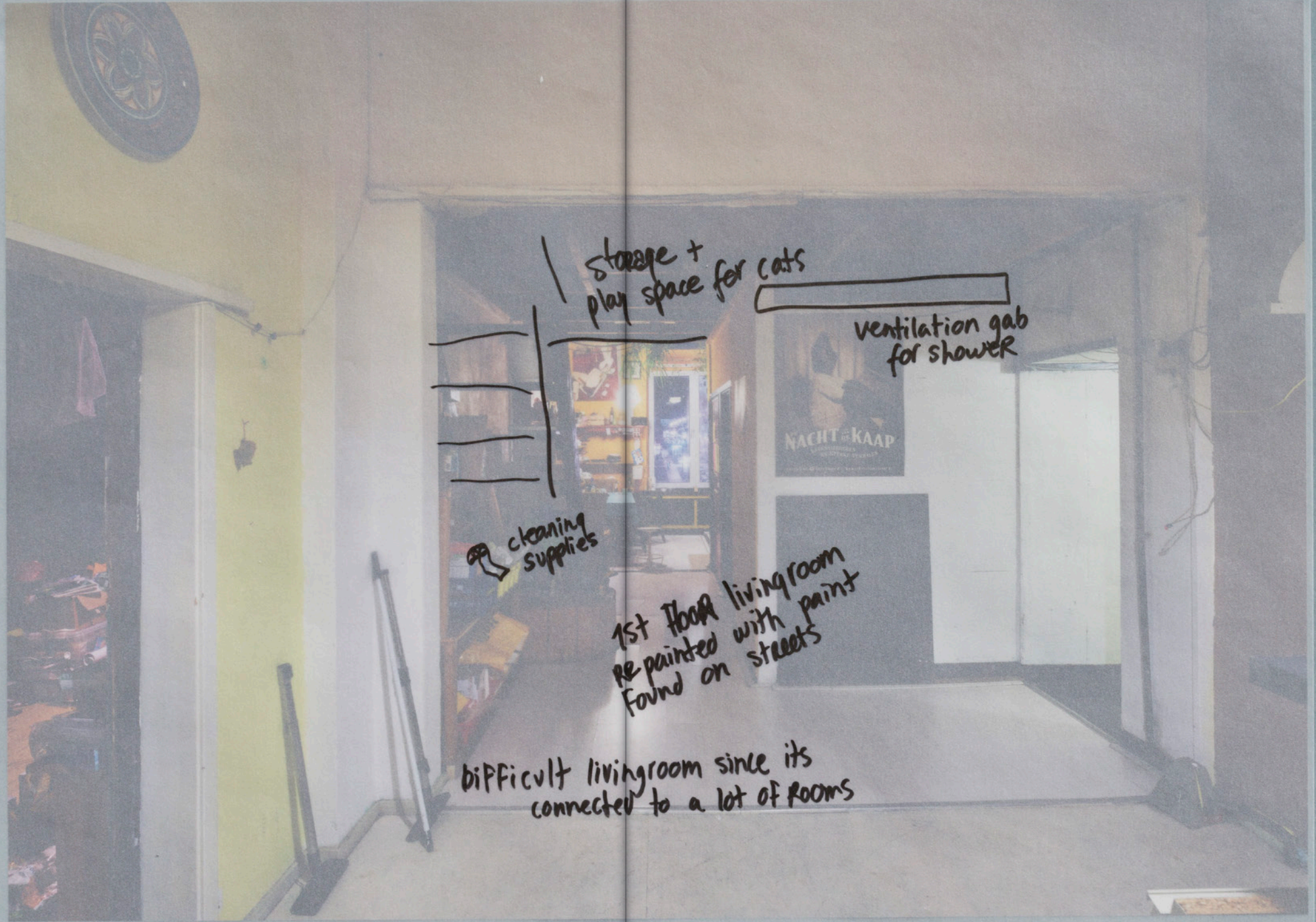

Ground floor – Hallway with communal bathroom and kitchen

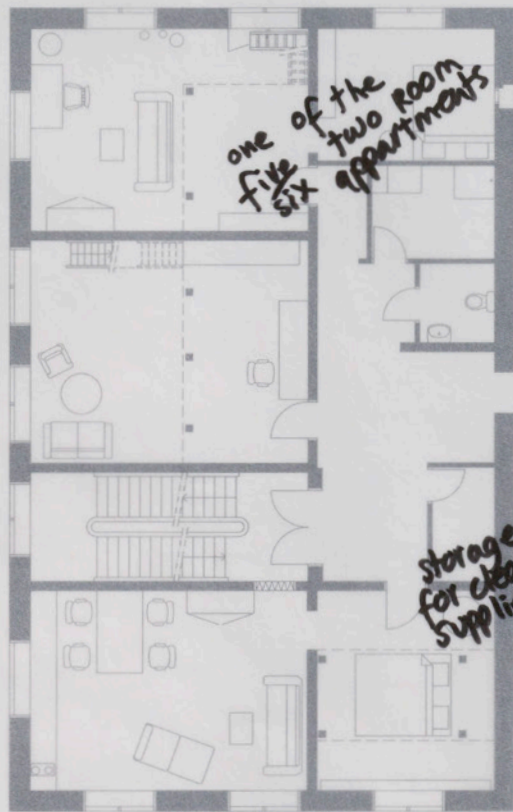

one of the
five
six
apartments

storage
for cleaning
supplies
"monkey cage"
platforms on
different levels

originally built
as an open space

office
+ print
room
+ archive

There used to be a wall
dividing livingroom and
kitchen, teared down

squatting
sign in
tiles

← internal staircase
to 1st floor



1:100

||| 2 |

5m

|

Assembly space – The shared kitchen-cum-living room occupies a key position inside the building and is used for monthly house meetings. Other functions include the house library, personal mail boxes, and announcements.



NEW PEOPLE G.

FUTURE GROUP



BOARD
once a month



HOUSE MEETING
every month

GARDEN GROUP

OPEN STAGE G.

IT&WEBSITE G.



ACTIVITY G.
2 times a month



MAINTENANCE G.
once in 2 months

ART GROUP

EETCAFE GROUP

GUEST ROOM G.

CLEANING G.

GIVEAWAY SHOP G.

Organizational model – The inhabitants make decisions at monthly house meetings according to a consensus model. Specific groups, such as the board, maintenance, activities or the future planning committee, meet once

a month. Other informal groups, for example focusing on IT, art, or the garden, convene periodically as necessary. Housemates are chosen based on a voting process after meeting potential members in organized encounters.

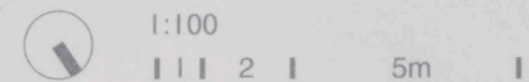

Ghosts – Some inhabitants prefer not to participate in house meetings, collective construction projects, or other events. The community respects their space and refers to them as the building's 'ghosts'.

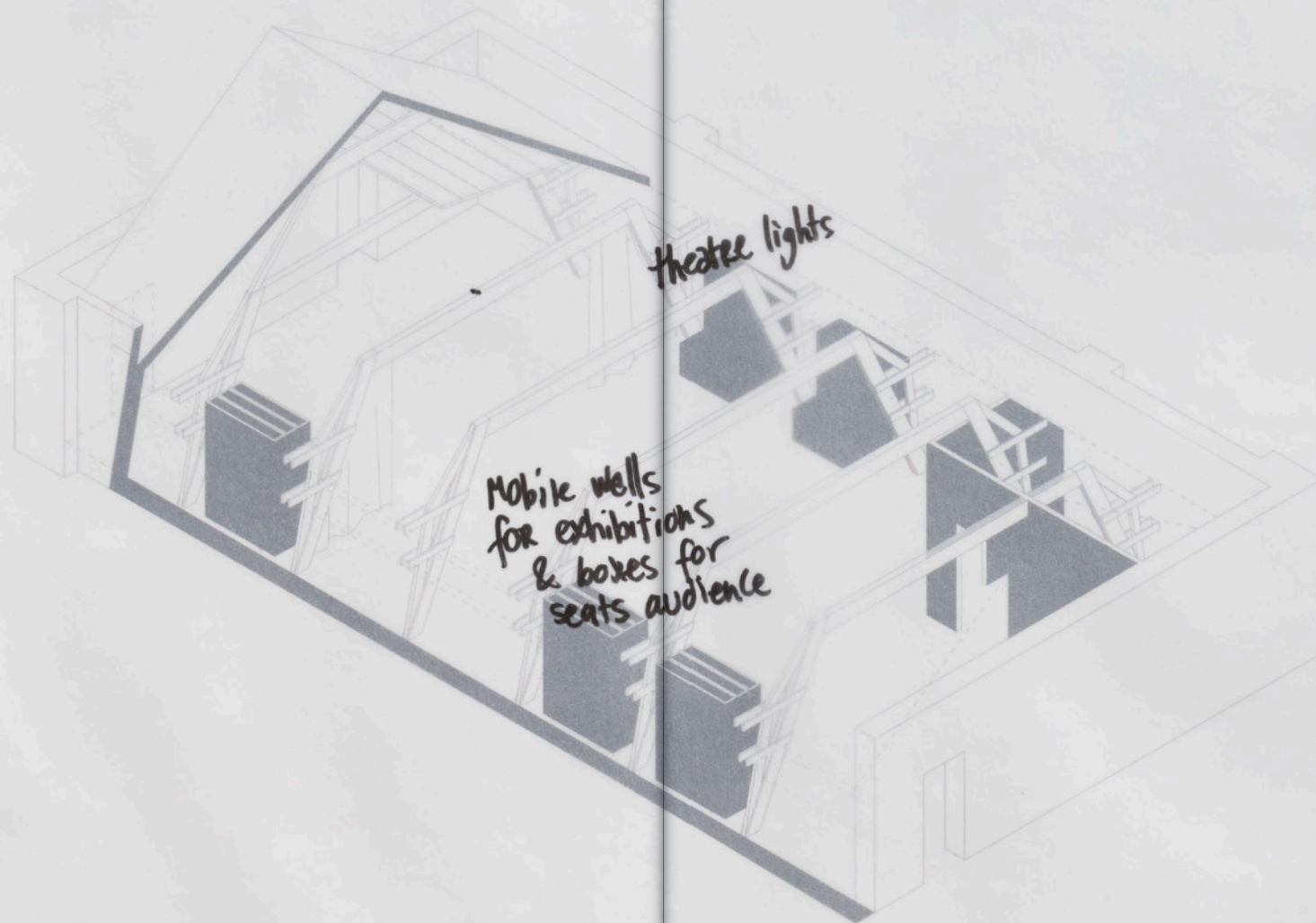

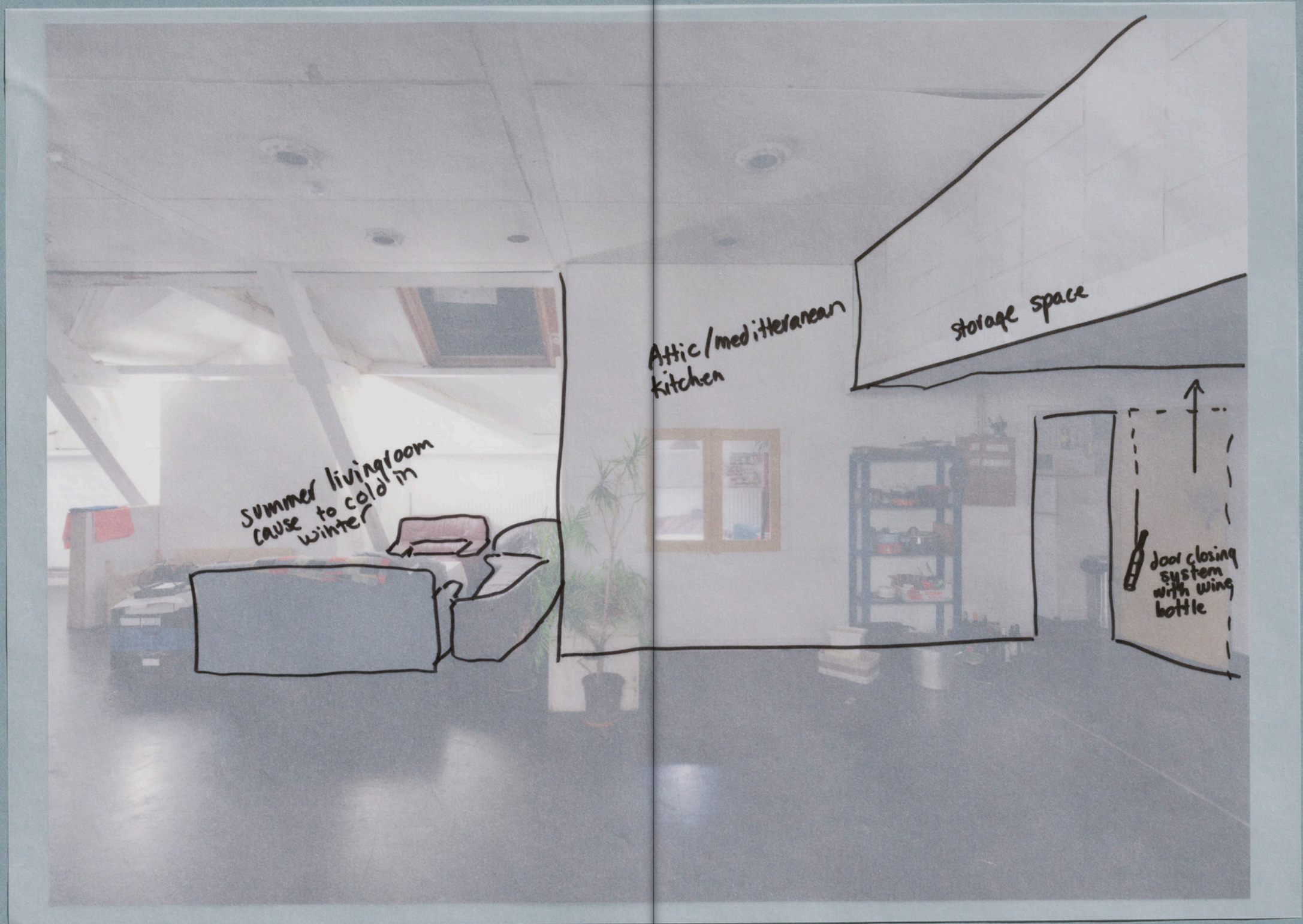

The top floor is characterized by a large, vaulted, open space that functions as a venue for dinners, conferences and a bimonthly circus. Moveable

elements on wheels are used for partitioning and mounting exhibitions. The attic also contains one of the five shared kitchens.

270



271

Third floor – Dark room



A conversation with lawyers Rahul Uppal and Willem Jebbink

René Boer (RB): You have been working with squatters for a long time. Could you explain what the situation was before the squatting ban and what it allowed squatters to do?

Willem Jebbink (WJ): Maybe I should first explain that the squatting ban has actually been there for a long time. In 2010 squatting was changed in legal terms from a misdemeanor to a felony. When it was just a misdemeanor there was the possibility to squat after one year vacancy.

RB: So when a building was empty for more than one year, it was still a misdemeanor if you squatted something, or only if you squatted before that one year period?

WJ: If you would squat after the one year period it would not be a criminal offense. What the government wanted to pursue after the new law of 2010 was legislation regarding vacancy, and to totally criminalize use of the belongings of another person.

RB: Is it right that if you squatted something which was empty for more than one year, you could still get into conflict, in terms of civil law, with the owner?

WJ: Yes, those procedures were taking place in more or less the same fashion as they are now. Since the squatting ban there is more weight, perhaps psychologically or morally, in favor of the owner as squatting is a criminal offense now, even when the property is empty for more than one year. In civil law cases, owners often use the argument that squatting is a criminal offense to support their case, but educated judges still question whether the owner has concrete plans for the site that are convincing enough and won't result in unjustified vacancy.

RB: So, at the time, the owner would directly sue the squatters?

WJ: Yes, that happened much more often than today. In addition, the squatting ban took the financial burden off the shoulders of the owners and provided them with a free instrument to get an eviction. Now they don't have to pay anything as long as they can present plans to the prosecutor.

RB: And sometimes squatters could win such a civil law case?

WJ: Yes, now and then.

Marina Otero Verzier (MOV): How do property owners prove that they have concrete plans?

Rahul Upal (RU): It really depends on what kind of procedure you're referring to. Looking at the civil court cases between owners and squatters, the person who squats and their lawyer team have full insight into all the evidence being presented by the owner, because the owner has to prove that they have urgent interest.

If there is a potential renter there is a rental contract presented, if there is a buyer there is a purchase contract presented. If there are plans for development then there is a permit or maybe an application for a permit presented, alongside a construction contract, planning for the project, and proof of financial means to realize the plans. In addition, there is often an anti-squat contract to bridge the short gap between the eviction and starting the project.

If there is a criminal eviction, the counterparty is not the owner but the state. In those cases it's statistically much harder to counter an eviction, because apart from the owner's interests, the state also suggests interest in an eviction in order to end a criminal offense. I find that argument rather weak, because by that stage a squat has usually lasted for weeks or months already. Arrests have not been made in nine years following the squatting ban. So I think it's more an argument to strengthen the case, rather than an actual separate interest. Criminal evictions are nothing more than a gesture from the state towards property owners, and I believe it should be treated as such, and that means that courts should cease to make a distinction between criminal evictions and civil evictions, because there should be one basic rule – no

1. At the time of this conversation, in October 2017.

eviction for vacancy, regardless of whether it's a criminal or civil eviction case. As far as I know it only happened once that there was a victory for the squatters, based on a clear proportionality verdict (a judge weighing the rights of the squatters versus the rights of the owners, etcetera).¹ Even though there was a plan for the building, the squatting refugees could stay for six more weeks. It was a very small victory, but for me it was huge.

MOV: Could you explain what were the reasons that this particular judge took into consideration to rule in their favor? Was it because of humanitarian reasons?

RU: Yes. The point I made was that this was the most vulnerable subgroup within a group of refugees, who had been sleeping rough for months and there was no space for them in a night shelter. We could provide the proof that they would actually be on the street. If these people get an eviction then it means that there is no proportionality assessment, because it was the whole point of a 2010 case that we won that there has to be an individual assessment in every case. But if the worst case scenario is negative, then how can you say there is an individual assessment?

WJ: I've also seen such a verdict in a criminal eviction case, in which the court decided that the squatters could stay for a little while longer, based on the fact that planned work wasn't due to start immediately.

RB: Let's go back to the introduction of the

2. Marcel Schukkink-Kool is a lawyer based in The Hague.

squatting ban in 2010 for a moment. You have been contesting it in long court cases, but what would the original law have meant for squatters in its pure form, without your contestation? What did it propose?

WJ: It would have meant that squatting would be completely illegal, so it would act as a deterrent for people to squat. People would not want to continue squatting or would become very careful in doing so.

RB: But was the idea that, in theory, the entire act of squatting would be evaluated under criminal law instead of civil law? That was the idea of the 2010 law.

RU: Yes, but in the end the policy was changed based on a case in The Hague. It was the first case for Willem or Marcel Schukkink-Kool after the squatting ban.² The new law should have been in effect, but they decided to repair the lack of protection by giving a person who is under the threat of eviction the possibility to present a case in court, within a period of eight weeks.

In addition, cities have expressed that they will uphold the principle of not evicting for vacancy. There are certain owners who want to stay below the radar, perhaps they have a criminal history and they don't want relationships with authorities and the interference that would cause. In a few cases, the owners went to court themselves to get the verdict and force the city to do the eviction.

RB: So there are reasons for owners to choose civil court instead of criminal court?

RU: Yes, there are a few reasons. Usually the owner really wants help from the state, and it's cheaper for them to use criminal law.

RB: So after this eight-week court case was won in The Hague, you also engaged in a long lawsuit together with the Schijnheilig squatting group. How did this come about and how did it change the situation?

WJ: After the law was introduced we came together with a group of lawyers and studied the possibilities to start an injunction procedure. The main issue was that in the legislation of the new law not a single word was said about the protection of the right to home under the European convention for human rights. The law did not hold any possibility for a squatter to go to an independent and free judge and be judged in their favor.

MOV: So before the ban the right to housing, a home, was acknowledged to be more important than the right to property.

WJ: At least according to the legislature, and at least after a period of one year of vacancy. You could argue in court that according to the legislature at that point there is no interest in protecting the ownership and the right to home automatically becomes more important.

MOV: Does it mean that, since the ban, the right to housing is not a right anymore?

WJ: It is still a fundamental right.

RU: It is not about the right to home, but about the proportionality.³

MOV: Does it make any difference to make a case for a squat depending on the number of people living there? How big the community is or the type of building it is? Are there certain conditions that make a difference, for instance in the case of the refugees? What conditions would facilitate a more successful construction of a case?

WJ: Perhaps I should firstly explain that when it comes down to proportionality the European convention on human rights holds the possibility to violate the right to home, but only when it is justified. It is stated that there should be access to court, in order to have the proportionality assessed. This is what was lacking in the new law – the legal framework in the Netherlands lacked this access to court. That is why the state decided to repair it with a new policy, to make up for the missing element. Still, in my opinion this is a very weak way of repairing it since the costs of the legal procedure are payable by the squatters.

RB: This is quite an achievement. You made sure that there is a legal framework that allows people to actually go to court.

WJ: It's quite unusual what happened. A new law was introduced with a long parliamentary history, of which some documents were rewritten. A lot of discussion took place. In the end the government stated that they will enforce the criminality of squatting by any means.

3. In European law there are several parts of the proportionality discussion – there must be a legitimate aim for a measure, it must be suitable to achieve the aim and it must be reasonable, considering the competing interests of the different groups at hand. In these scenarios, the measure is eviction.

In response, we argued that the law in itself is, generally speaking, not sufficient. We're not talking about one case, we're talking about the whole legal framework. We could be very proud of ourselves, but it is still such a shame that the parliament, and a considerable number of politicians, did not look at the protection of human rights for squatters.

RB: The result of your efforts is also that there is again a certain amount of security for squatters. When you squat something, you cannot be arrested right away. You have the protection of going to court to defend your case.

WJ: That is sadly not true. The possibility to be arrested is still there. Although they never operate like that.

RU: I've always seen it as a sign of tolerance that the public prosecutors did not decide to use that part of the law.

WJ: Yes, that is why I argued in a case in the supreme court last year that in fact this policy comes down to tolerating squatting for at least eight weeks, if someone takes the right action and starts an injunction procedure.

RB: Now we're nine years after the introduction of the squatting ban. What have you seen in the last several years? You created this legal framework to be able to go to court – have other things changed?

RU: There emerged a few exceptions to this system, of course. These exceptions mean

that there is no protection in the case that a building might collapse, or in cases of trespassing. Or if other criminal acts are being committed in the house, apart from squatting. The health of the squatters can be at risk, like in the case of asbestos. In December 2010 I think many prosecutors were trying to see how far they could go with using those exceptions. There was a trend in 2012 where there were a lot of speed-evictions, with limited information about why and what actually happened. I would call the public prosecutor and ask for an explanation. Their response is always that there were development plans in place, but they don't have to give any further information.

Another thing that has struck me in nine years of litigation after the squatting ban is that it makes a significant difference which judge decides a court case. It should not be so, but there are clear patterns in how judges decide in squatting cases. I've come to find that rather disappointing.

WJ: I think what you have to understand is that the policy is talking about the inhabitants. The inhabitants of certain premises. Speed-evictions were based on a public prosecutor arguing that if the squatters started squatting this morning at nine, I can send the police there at 11:00 to try to evict.

In that case we can't talk of inhabitants, so there is not really a right to home for the squatters yet. The problem is that there are not any definitions of what an inhabitant is. It is quite dubious that the whole discussion even exists about whether you are an inhabitant or not.

MOV: Who says there is a condition that it is not safe?

RU: The municipality rules when somewhere is considered dangerous, and this is something we do not tend to contest. The municipality or the fire department visits to make an inspection, and there are people who give their opinion about asbestos and construction quality.

WJ: The squatting laws made in 2010 were two-fold, firstly making squatting illegal, and the second part was through administrative law to enforce house owners to actively use their belongings. This was left to the municipality to enforce and for a long time, they did not do anything at all with the framework that was offered to them. But I think recently the city of Amsterdam put that framework into use and summoned house owners to do something with their properties.

RB: For the first time a fine was given to a house owner based on this law, after nine years.

WJ: I've heard stories about the canal houses that are in the ownership of rich Chinese and Russian people, that only come here once a year to spend a weekend. I think the city can and should be able to enforce that people that are always in the city can live there or use the property for whatever reason, like an office of a law firm for instance.

RB: How did so many squatted places keep their existence after the squatting ban? For example ADM survived for another eight years after the

introduction of the ban. Why were they not charged by the state for squatting?

RU: The diplomacy and lobbying of ADM. I also think that the squatting law itself left out the word 'land'. Through this loophole, I think places like ADM are very hard to evict if you consider that it is composed of few existing buildings and more space surrounding them.

RB: But it's not just land. For example, places like Bajesdorp or Joe's Garage still existed seven years after the introduction of the ban.

RU: Apparently there is no urgency. It would have to do with the plans.

MOV: When squatters are evicted, do they have any rights to another place to live or are they left on the streets?

WJ: Yes, they are. The policy does not include any further rights of people being literally forced out of the premises. Even with regard to their belongings, there is no policy and no legislation.

RU: That's an interesting aspect and kind of frustrating.

RB: All squatters know both of you, and have been working with you on many cases. How do you position yourself from a personal perspective in this movement? How have you experienced this over the last 10 years?

RU: I used to go to ADM festivals, and I also

have contacts in the squatting movement that border on friendship. I feel grateful to have been able to follow this path of law. I also deal with lots of family cases, but the other part is squatting, and so far it has been very interesting and I will continue to do it for as long as I feel that I can make some kind of contribution of significance.

WJ: The same applies to me. A key aspect is that I want to get to the bottom of things. Not superficially assist, but to try and look for the loopholes and the possibilities. I think what we achieved in 2010 was really something spectacular and that is the joy of my work.

MOV: Do you think what we are trying to do will make any difference? The fact that there is a national institution of architecture claiming that it constitutes an important legacy? Is that at all useful in a court case, or is it significant only in the cultural or political realm?

WJ: Yes. It is important to keep doing things like you do, because it puts the criminalization of squatting into perspective.

RB: In the case of ADM, there are self-built homes that we deem an interesting contribution to architecture in the Netherlands. Such an acknowledgment by a national institute, would that be relevant in a court case?

WJ: Yes, it would make a difference. Projects like these, that's the main thing, they will keep putting things into perspective.



VLUCHTMAAT – This office building was squatted by a refugee collective in 2015, and later legalized following an innovative economic model, allowing for a durable transformation.

In October 2015 a section of the refugee collective We Are Here squatted an office building on a remote business park beside Amsterdam's A10 ring road. We Are Here consists of refugees and migrants whose application for an official status in the Netherlands has been rejected and who cannot return to their country of origin, yet are not allowed to work or access regular housing. To fight this situation, the group squatted an empty church building in Amsterdam's Bos en Lommer neighborhood in 2012, dubbing it *Vluchtkerk (Refuge Church)*. Since then the group has occupied more than 50 buildings across the city.

Vluchtmaat is one of the few buildings squatted by We Are Here whose occupation was legalized shortly after. A number of volunteers involved with the group set up Stichting Noodzaak, a foundation to offer forms of social management for unoccupied buildings. The foundation signed a two year contract with the owner and together with the refugee group divided the largely open-plan office space inside the two storey building into small rooms for the inhabitants. A number of spaces are let out to creative entrepreneurs, whose financial contribution is used to pay the owner for utilities and insurance.

Program – Housing for 40 to 50 people, office space for 13 small businesses and organizations, event space, give-away store and monthly restaurant. Half of the ground floor has been restored to its original function as an office space and is being rented out to freelancers, artists and small organizations and companies.

1960s

The office complex is built.

November 2011

Bouwmaat BV becomes the owner.

Early 2015

The last occupant of the building officially moves out, but continues to rent part of the building.

Mid 2015

The building becomes vacant.

October 2015

After gathering at a nearby private address, and with the help of squatters and volunteers affiliated with We Are Here, a section of the group squats the building, and around 40 to 50 refugees from Ethiopia and Eritrea move in.

January 2016

The owner is open to discussing legalization, after which volunteers set up a foundation called Stichting Noodzaak. Unlike the refugees, this legal entity can enter into a user agreement with the owner. Stichting Noodzaak calls this 'social management', and intends to make more buildings available for refugees.

April 2016

Stichting Noodzaak and Bouwmaat BV sign a contract for the use of the building for two years.



Figure 1: Constructing new walls.

April–June 2016

Stichting Noodzaak and the occupants start renovation works (fig. 1). The open office floors are divided into private rooms, communal spaces, and into workspaces of 20 to 40 square meters. The costs of using the building are covered by letting these workspaces to creative entrepreneurs. A shared event space allows for the interaction between the different inhabitants and users of the building.

(p. 290: Poster for the Vluchtmaat opening party, September 2016).

June 2016

Stichting Noodzaak starts to let out the offices, and hosts regular communal meals and meetings.

July 2017

Vluchtmaat is nominated for the Dutch Design Awards in the category 'Habitat'.

October 2017

Monthly dinner events are organized to allow the inhabitants to

have extra income, and to open the space up to people interested in getting to know the building and meet with the group.

(p. 291: Announcement for a monthly restaurant).

Early 2019

Compared with other groups within We Are Here, who have had to squat a succession of other buildings, the occupants of Vluchtmaat enjoy a certain stability. Stichting Here to Support, one of the workspace tenants, organizes support through projects such as the We Are Here Academy and We Are Here Collective. The owner does not currently have detailed plans to demolish the building, and Stichting Noodzaak, the occupants and the other businesses in the building hope the contract will be extended.

Naam van de gekraakte / gelegaliseerde locatie
Vluchtmaat

Adres **Joan Muyskensweg 32** Grootte (m² van het gebouw en/of terrein) **1780 m²**

VOOR DE KRAAKACTIE
Originele functie(s) van het gebouw **kantoorgebouw / office building**

Oorspronkelijke eigenaar(s) van het gebouw **Bouwmaat** Geschatte periode van leegstand voor de kraakactie **enkele weken**
some weeks

DE GEKRAAKTE PERIODE
Datum van de kraak **15 | 11 | 2015** Aantal inwoners en/of gebruikers **40 residents**
inwoners

Functies van de gekraakte locatie **alleen wonen / only living**

Motivatie of redenen voor de kraakactie **No shelter for the 40 members of We Are Here (refugees in limbo)**

Belangrijkste ruimtelijke transformaties na de kraakactie **- adding of walls & doors**

LEGALISATIE / ONTRUIMING
Datum aanruiming of legalisatie **01 | 05 | 2016** Nieuwe eigenaars sinds legalisatie **Bouwmaat**

Nieuw aantal inwoners/gebruikers sinds legalisatie **40 residents**
10 offices

Nieuwe functies sinds legalisatie **10 workspaces** **3 living room**
33 rooms **& event space**

Belangrijkste ruimtelijke transformaties sinds legalisatie **adding more walls**

HELLO EVERYONE!

SEPTEMBER 19 - MEETING

ON MONDAY EVENING SEPTEMBER 19, WE WANT TO ORGANIZE A MEETING WITH THE RENTERS OF THE OFFICES AND THE PEOPLE LIVING IN THIS BUILDING. MORE INFO SOON!

SEPTEMBER 22 - PARTY

ON THURSDAY EVENING THE 22ND OF SEPTEMBER WE WANT TO HAVE A PARTY IN THE VLUCHTMAAT FOR WE ARE HERE, SUPPORTERS AND OUR NETWORK. IT IS TO CELEBRATE WE MOVED OUR OFFICE TO THIS BUILDING. WE HOPE WE CAN WORK TOGETHER ON THIS PARTY AND ORGANIZE FOOD, MUSIC, CLEANING, SECURITY, ETC.

IF YOU HAVE ANY QUESTIONS / IDEAS
PLEASE COME TO US
OR EMAIL:
INFO@HERETOSUPPORT.NL

THANK YOU! & SEE YOU SOON!
HERE TO SUPPORT



290

HUISKAMER
restaurant de Vluchtmaat



Come the **20th of October** to enjoy the
hospitality and a delicious meal
at the **HUISKAMER**
restaurant de Vluchtmaat.

Joan Muyskensweg 32, 1114 AN Amsterdam Duivendrecht.

291

here people dry their clothes
dark hallway
2 people
- the most beautiful (but very small) room

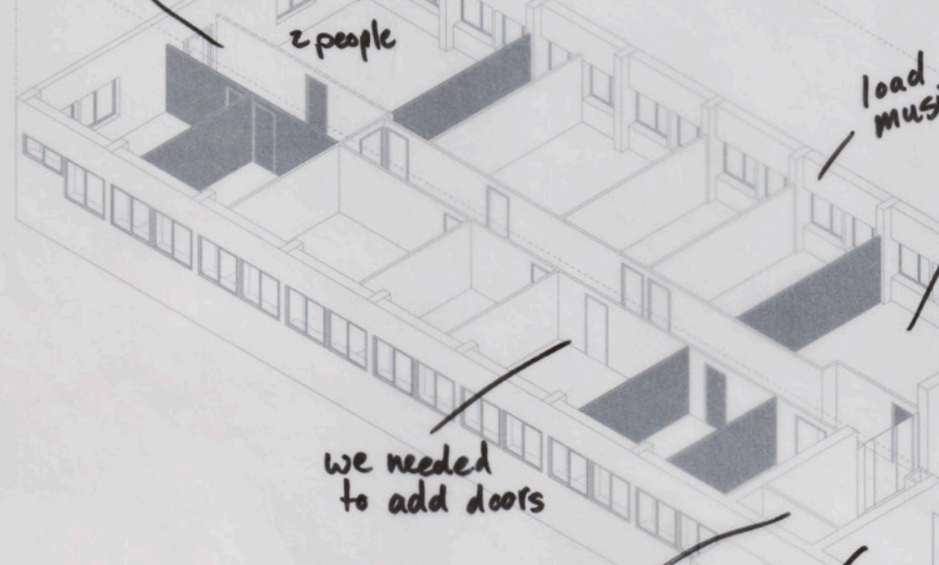

we needed to add doors

post box

information board
the doors should be closed but they are (almost) never

entrance hall with give away store

load music

Living ROOM
Restaurant
TV Room
Kitchen
kitchen used for dishes

shower
coffee import
computer reparation

artist
graphic designer
artists
journalists
fashion design
fashion designer
musician
documentary makers
here to support
writer

walls were being built when a new renter come in - adjusted to their needs

people used to live here but now these are working spaces

Space formally used as storage for building material

originally office floodzaak

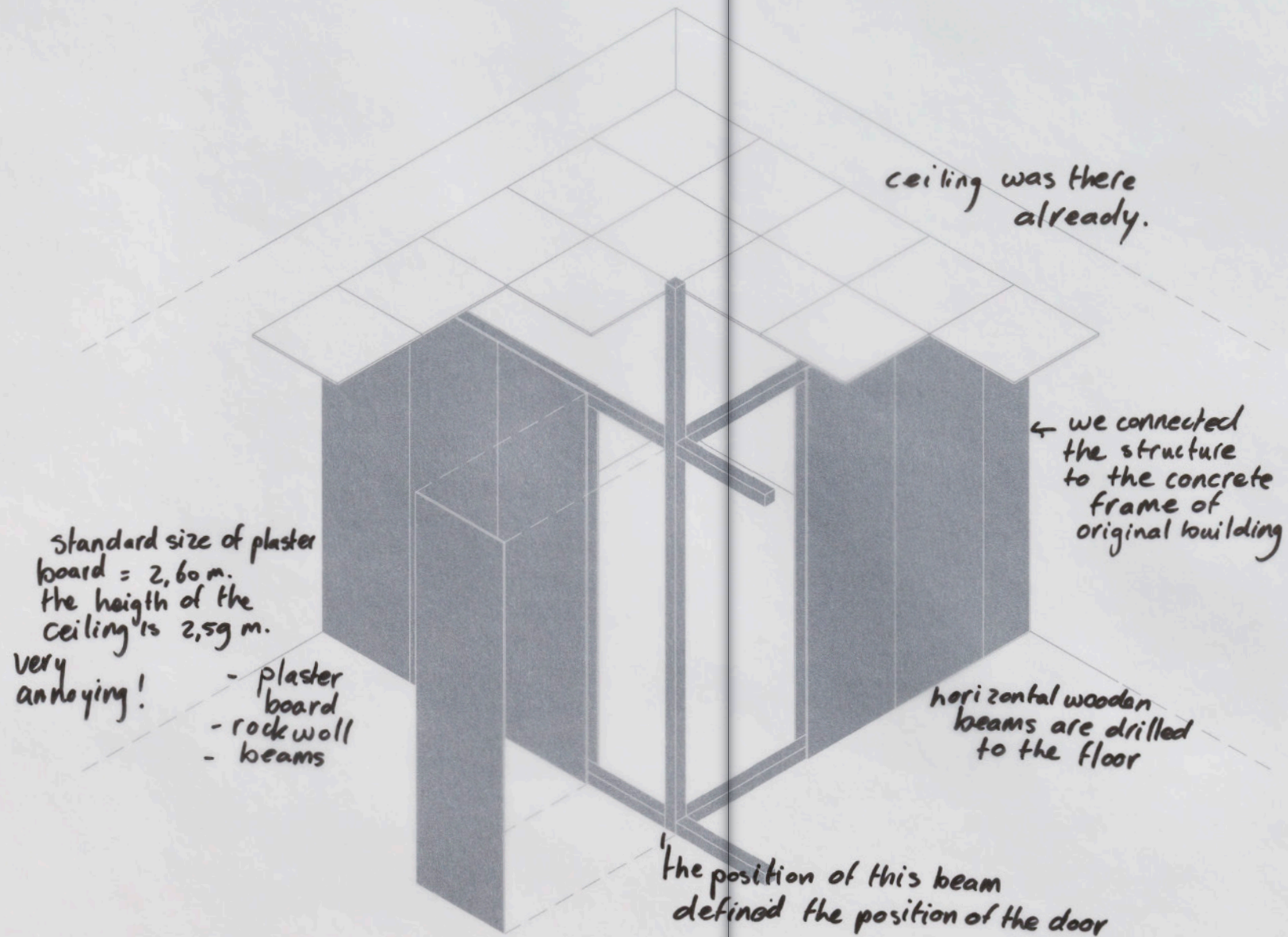

Transformation of the building – During the renovation, a timber structure with drywall is added to the existing partitions by the inhabitants and

volunteers in order to divide the remaining open office areas into private rooms and offices.

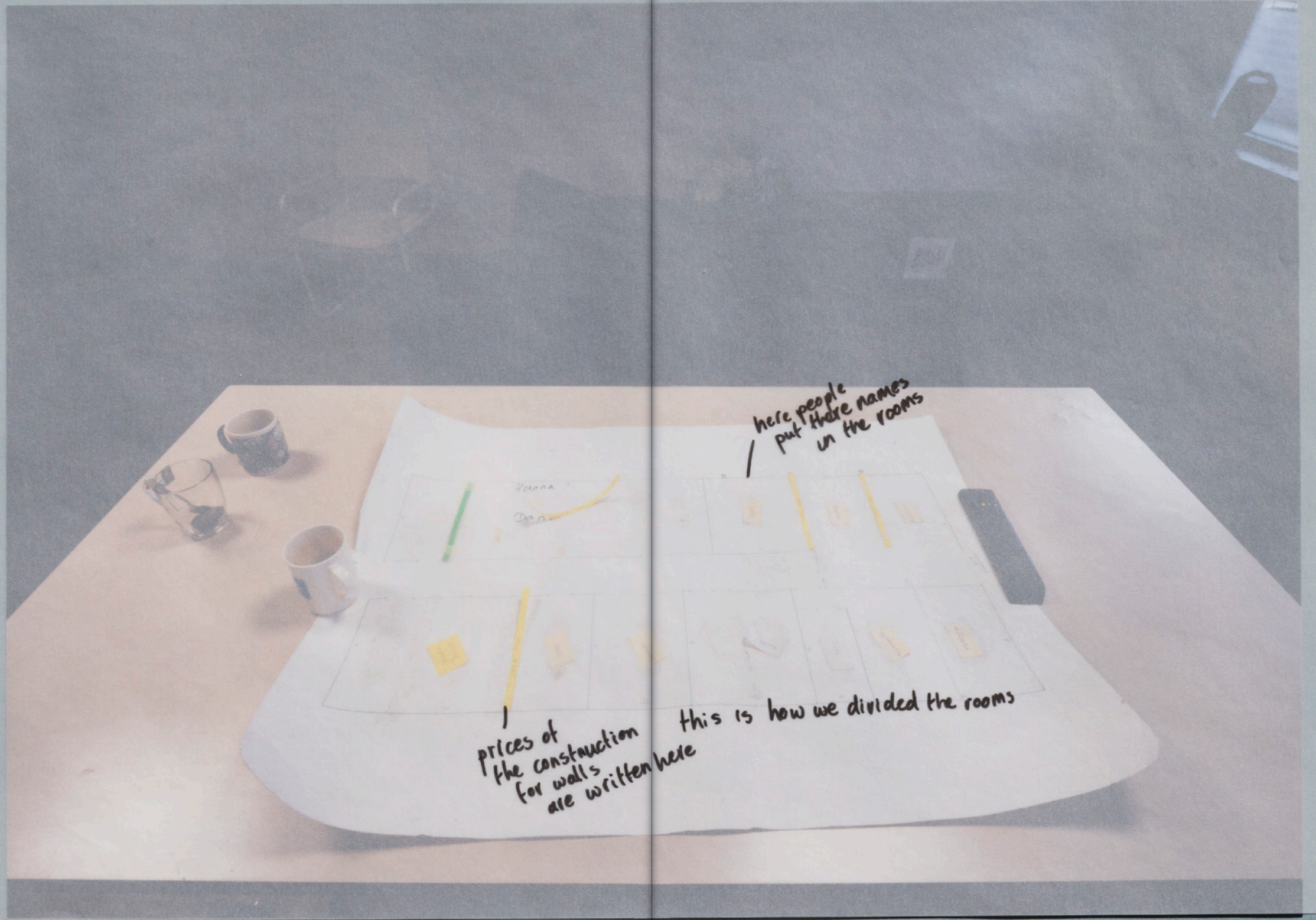

prices of
the construction
for walls
are written here

here people
put there names
in the rooms

this is how we divided the rooms



Ground floor

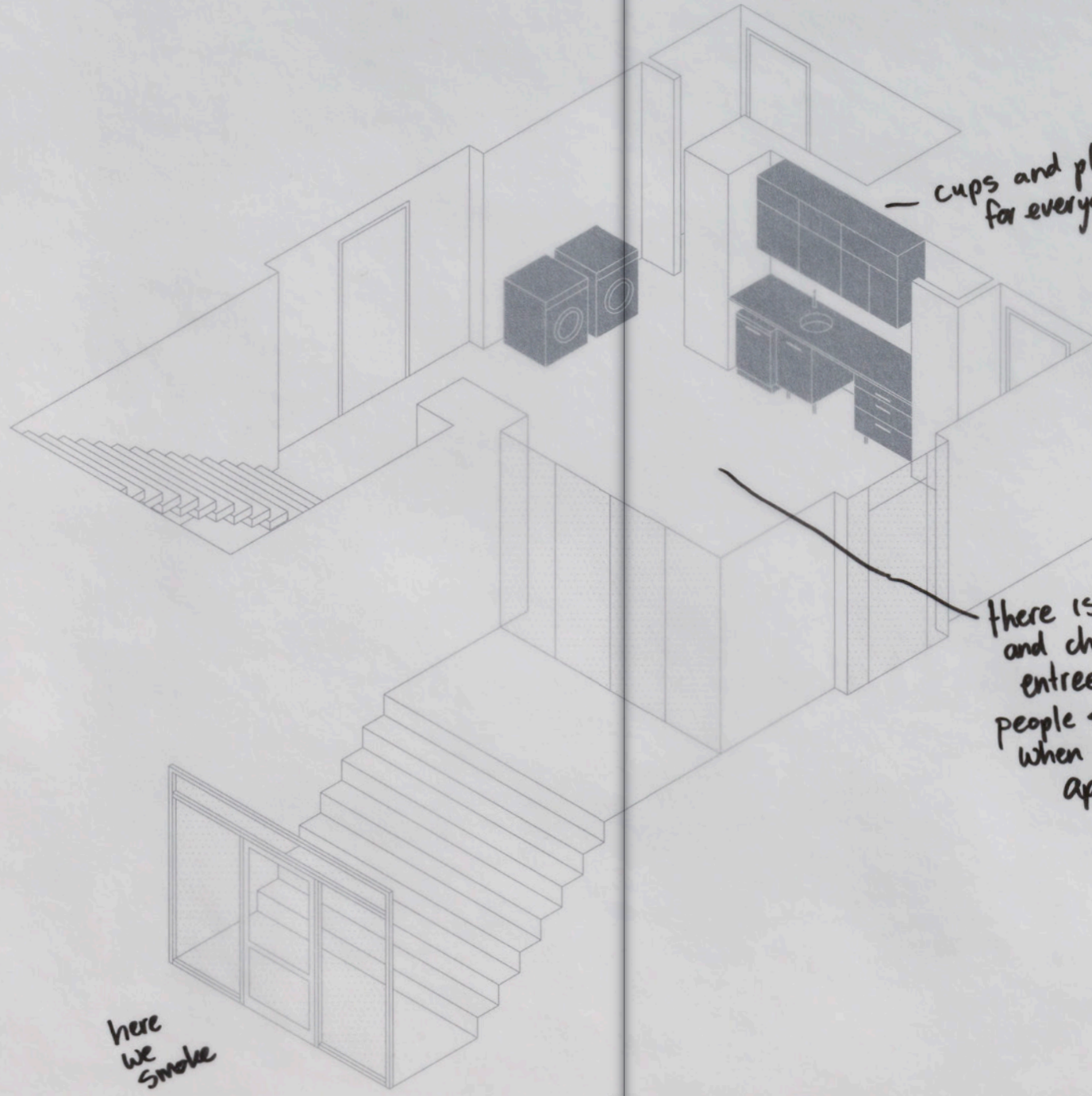

lots of bikes here

here we smoke

lots of bikes here

cups and plates and such for everyone to use

entree hall & communal kitchen. is where tenants & inhabitants meet

there is a table and chairs in the entree hall. people sometimes wait there when they have an appointment.

Entrance – This flexible, open space is where NGOs supporting the refugees announce important information, where to exchange goods through

a give-away store, and wash clothes and dishes. It is also the only place where the office tenants and the refugees meet each other.

302



303

Ground floor – Office space



306

307



Ground floor – Kitchen

308



309

Ground floor – Private room

310



Ground floor – Private room

311



First floor

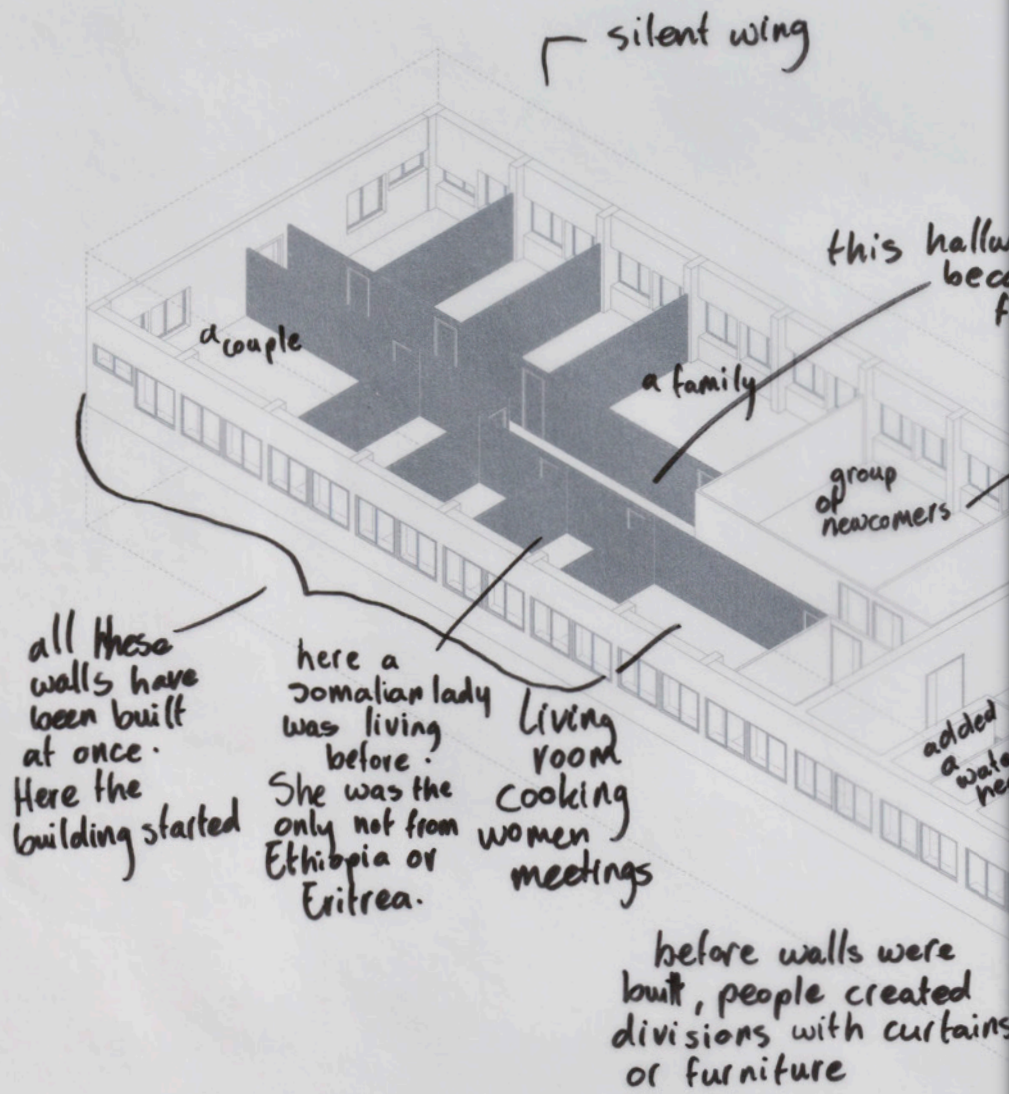

all these walls have been built at once. Here the building started

here a somalian lady was living before. She was the only not from Ethiopia or Eritrea.

Living room cooking women meetings

before walls were built, people created divisions with curtains or furniture

silent wing

this hallway is wide because of fire-exit regulations

as soon as a room gets free, one of them moves there

more than a year there was no shower. buckets were used cold water

added a water heater

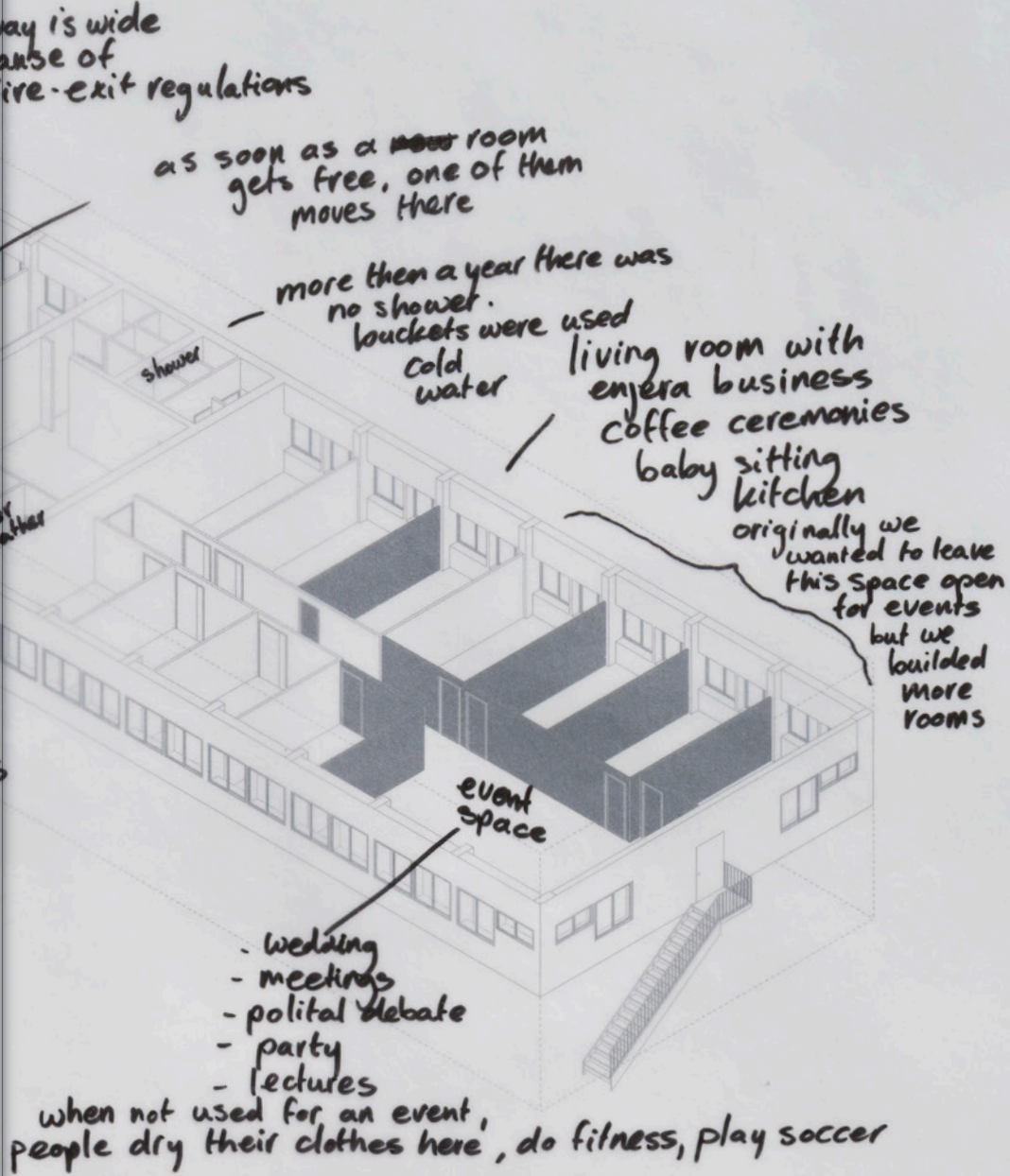

living room with enjera business coffee ceremonies baby sitting kitchen

originally we wanted to leave this space open for events but we builded more rooms

event space

- wedding
- meetings
- political debate
- party
- lectures

when not used for an event, people dry their clothes here, do fitness, play soccer

Shared spaces – The first floor contains a women’s living room, a small room that doubles as an Ethiopian coffee bar and kitchen, and a large open space sometimes used by residents or rented out for events.

314



315

First floor – Women's living room

316



317



ADM – This large harbor complex, squatted for more than 20 years, was transformed into a thriving, alternative free-zone, home to more than 100 people.

Amsterdamse Droogdok Maatschappij, a shipbuilding company, was once situated on a large harbor terrain to the west of Amsterdam, including an office building, a large warehouse, and two piers. After the company's bankruptcy it was first squatted in 1987 and soon became home to about 100 squatters and many creative businesses. In 1993 the site's inhabitants were evicted, yet after lying vacant for several years it was squatted again. Due to the problematic relationship between the city and the new owner, the infamous real estate tycoon Bertus Lüske, ADM was not evicted.

After Lüske was assassinated in 2003 his heirs showed little interest in the property, allowing ADM to develop into one of the most important squats in Amsterdam. Dozens of self-built homes and multipurpose structures were erected giving shape to an alternative micro-society and a permaculture haven. Free-thinking festivals, among them the famous Robodock Festival, were organized and attracted many people to the site, providing a fresh impetus for new structures and developments on each occasion. Since 2015 the Lüske heirs have tried to clear the squat, and after ADM won multiple court cases the tide turned in 2018, resulting in its eviction in early 2019.

Program – A large office building with a multifunctional space (events, restaurant, bar) and diverse residential spaces, a large hangar, open air bar Suwanne's Clit Club, many self-built houses, various houseboats, and various multifunctional structures used as festival stages, among other things.

1877

Opening of Amsterdamsche Droogdok Maatschappij NV (ADM NV) on a site in Amsterdam Noord.

1960–1965

ADM NV buys a new 42 hectare site in Amsterdam's western port area from the municipality and builds an office building, a warehouse and a pier (fig. 1).



Figure 1: ADM in use in the early 1960s.

September 1978

Merger between ADM NV and the Nederlandsche Dok en Scheepsbouw Maatschappij NV (NDSM NV), now called ADM/NSM.

February 1985

ADM/NSM is declared bankrupt and the site becomes the property of Westhaven Amsterdam NV, later renamed WestInvest NV.

1985–1987

The site is for sale and, according to an old contract, the City of Amsterdam is the first prospective buyer. The city considers the price too high and a deadlock ensues.

1987

The former shipyard is squatted and soon inhabited and used by a large community.

1987–1993

At its zenith, the squat is home to approximately 100 squatters. Together they set up numerous small businesses including a bronze foundry, a furniture upholsterer, and the notorious recording studio Koeienverhuur, frequented by bands such as De Kift and De Ex (fig. 2).



Figure 2: Poster for the ADM opening party, entry cost seven guilders and 50 cents or construction materials.

January 1992

WestInvest NV signs an agreement

with stevedore company Ter Haak BV to rent the site.

June 1992

Ter Haak BV secures its permits and wins a court case for the eviction of the squatters.

February 1993

The squatters instigate legal proceedings to prevent the eviction as Ter Haak BV has shown no intention of developing the site and, additionally, the rental contract expired in late 1992. Before the case is heard, however, WestInvest NV produces a contract extension, after which the squatters' case is dismissed.

March 1993

ADM is evicted peacefully, and the houseboats are permitted to remain until 1 April.

(p. 323: Het Parool newspaper reports on the eviction of ADM, March 1993).

1993–1997

The site remains unused and is protected by a security company. As bullet holes in the buildings reveal, during this period the police use the site as a training ground.

May 1997

Chidda BV, a company owned by property tycoon Bertus Lüske, acquires the site. Previously, the City of Amsterdam had paid a substantial sum of money to acquire his extensive property portfolio

in the city center, in an attempt to loosen his grip on the city.

July–August 1997

In secret meetings, city officials aggravated by Lüske's actions remind a group of squatters that the ADM site is still vacant. Groups of squatters from the Silo and Ruigoord squats prepare to occupy the site.

October 1997

The site is squatted by a new group, with links to the inhabitants who occupied the site from 1987 to 1993 (fig. 3).



Figure 3: ADM, soon after the second squatting action, October 1997.

Late 1997–1998

A space in the office building is made inhabitable and functions as a base to gradually occupy the rest of the building and the site.

Early 1998

The first caravans arrive on the property.

April 1998

Lüske sends in a heavy mob in an attempt to evict the site even without the support of the authorities. He starts to demolish the office building with an excavator while squatters are asleep inside (fig. 4). The police arrive in time and prevent the eviction; a few days later, Lüske is arrested and held in prison for a month.



Figure 4: Lüske tries to evict ADM after the second squatting action, April 1998.

August 1998

Chidda BV announces its intention to clear the site through a standard court procedure.

Late August 1998

Droogdok Festival, the first festival in the Robodock series takes place (fig. 5).

1998–2003

Despite the continuous efforts by Chidda BV to approve the eviction of ADM, the court repeatedly decide in favor of the squatters as the plans for the site are often

incompatible with the local zoning. In the meantime, an increasingly large portion of the site is occupied by an array of self-built structures. Groups of travellers move onto the edge of the ADM site, around the main entrance.

August 2003

Lüske is assassinated. The site becomes the property of his heirs.



Figure 5: Alternative poster for Robodock Festival, 2004.

November 2006

Amsterdam's Alderman Lodewijk Asscher proposes to evict ADM to allow the construction of a new river harbor. No action is taken.

March 2015 – March 2016

After years of silence the Lüske heirs, still operating under the company name Chidda BV, take up the legal battle again. Chidda finds a tenant for the site (Koole Maritiem BV), yet the court refuses to grant the eviction on the basis of uncertainty concerning the zoning plan, the permits, and the actual use of the site. In further legal proceedings the judge also determines that the interest of the occupants in continuing their right of use is, for now, greater than the interest of the owners in 'exercising their rights of ownership undisturbed'.

(p. 328: Poster for ADM festival, 2016).

June 2017

At the behest of Chidda BV, an Amsterdam court rules that the squatters are violating the zoning law, and that the municipality should take actions to uphold the plan.

August 2017

The municipality informs ADM that they will start upholding the zoning plan in six months.

February 2018

ADM appeals and wins an 'interim measure' that suspends their eviction and allows the community to wait for the result of the appeal while residing on the property.

June 2018

The Council of State (*Raad van State*) rules that the owner now has proper proof that it will use the site after the eviction and cancels the interim measure. ADM could therefore be legally evicted six months later, in December 2018.

Late 2018

ADM remains suspicious that Chidda BV's prospective renter, Koole Maritiem BV, will not use the site according to the zoning plan. In that case, the zoning law would be expanded in practice and the property's value would increase, preventing any attempt by the municipality to buy it back. ADM still hopes the municipality will start negotiating to buy the site, both in preparation for the future expansion of Amsterdam and to safeguard ADM.

(p. 324: Statement by ADM on their current situation / pp. 325-326: Letter written by Het Nieuwe Instituut's Research Department to Amsterdam's mayor about the current situation of ADM).

Early January 2019

Despite ongoing campaign efforts, the police proceed with the eviction of ADM.

AMSTERDAM

(Van een verslaggever)
AMSTERDAM – Het kantoorpand op het voormalige ADM-terrein in het Westelijk Havengebied is vanmorgen door de politie ontruimd. De krakers hebben zich nu teruggetrokken op de schepen aan de pier.

Op ongeveer twintig meter vanaf het water hadden de bewoners een rood lint gespannen en zich er met hun hele hebben en houden achter teruggetrokken. Het ontruimingsvonnis gold immers alleen voor de gebouwen.

Onder muzikale begeleiding van de bewoners kwam de politie vanmorgen om

Koffie en koek tijdens ontruiming ADM-pand

acht uur met ongeveer twintig mensen het terrein oprijden. De politie had afgesproken dat zij koek mee zou nemen en dat de krakers voor koffie zouden zorgen. "Dat leek me wel een aardig idee," licht adjudant J. S. Poulissen toe. "We hebben de afgelopen anderhalf jaar geregeld contact gehad met de bewoners. Daarbij hadden we nooit problemen. Ze zullen het

pand nu zelf verlaten. Ik denk dat dat een beetje hoort bij deze mensen."

Bewoner Kees van den Haak bekijkt de ontruiming met gemengde gevoelens. "Ik heb het idee dat er voor leegstand wordt ontruimd. West-Invest wil het terrein aan de gemeente verkopen. Een zogenaamde nieuwe huurder wordt als breekijzer gebruikt om het nu voor elkaar te krijgen.

We hebben hoger beroep ingediend tegen de ontruiming lopen en dat zetten we zeker door."

H. Duiverman van West-Invest zegt blij te zijn dat het terrein ontruimd is. "Het heeft mij al veel te lang geduurd. Die mensen gaan niet weg tot ze weggejaagd worden. Vandaar al die agenten."

Duiverman zegt een schriftelijke afspraak met de krakers te hebben dat ook de pier zal worden ontruimd.

Bewoner Dolf Koeienverhuur ontkenndat. "Laat hem maar lullen, we gaan hier zeker niet weg. Ik ben bang dat Duiverman zelf een paar knokploegen op ons af zal sturen. Het terrein ligt van alles en iedereen verlaten. Niemand zou dat merken."



Amsterdam: ADM news update

- October 7th, 2018



Another Amsterdam council meeting took place on October 3 in the Committee for Economic Affairs. To most councillors it is obvious that there will not be a shipyard here, which is the only activity that is legally allowed on the ADM

terrain (26 ha). In spite of the controversy and contradictory expertise the Aldermaster (wethouder) insisted he does not have a choice but to evict the ADM because he has to uphold the law.

Of course most people feel that respecting the law would mean waiting until the legal fight against the permission for an asbestos company to start on the ADM terrain is over. There is no date set for this appeal, and our left/green council accepts that eviction comes first, and that getting our right as citizens is of minor importance.

To ease the pain the council is offering the current ADMers a 2 ha piece of polluted wasteland beside the A10 motorway in the north of Amsterdam, for the duration of only two years. With this land come many restrictions: no more cultural events or festivals, very little space to work and no communal or public spaces. There is not enough room for even half the ADMers, and where are all the ships supposed to go? The ADM forest, habitat for wild animals and rare species will not be relocated...

ADMers have been looking around for additional alternatives, but nothing concrete has come out so far or is likely to be realised before the 25 of december, the date that everyone on the ADM terrain is expected to have moved out voluntarily. To date the only realistic option is to keep what is here. Why evict for some hardly realistic business plan, which is all that is needed to get rid of the ADM community.

Without restrictions on land use, or with a local authority that can not be bothered to ensure the restrictions are respected, the terrain will at least triple in value. The ONLY people that will benefit from an eviction are the owners of the terrain, who are jumping on this chance to multiply their fortune. A fortune that was made with public money, as the council paid millions to get the family to give up their properties in town, in order to clear the inner city of the whitewashing, thuggery and intimidation that secured the family business.

The ADMers have put in a massive effort to look for realistic alternatives and to continue to keep every option open, and to try and convince the council of the value of the ADM, fitting exactly into the brand new coalition priorities. But to no avail so far. It is now up to all of us, to all of Amsterdam and to the worldwide community that is connected to the ADM to put a stop to this madness and create a better future for the ADM and the rest of Amsterdam.

Het Nieuwe
Instituut

Museumpark 25
3015 CB Rotterdam
The Netherlands

+31 (0)10 440 12 00

service@hetnieuweinstituut.nl
www.hetnieuweinstituut.nl

Postbus / PO Box 237
3000 AE Rotterdam

The Netherlands

Kamer van Koophandel
Chamber of Commerce
54584353

Datum: 27 augustus 2018

Betreft: voortbestaan ADM

Hoogedelachtbare vrouwe Halsema,

Het **ADM** is één van de zeven unieke plekken die centraal staan in het meerjarig onderzoek 'Architecture of Appropriation' (architectuur van toe-eigening), dat zich richt op de ruimtelijke erfenis van kraken in Nederland, en de mogelijkheid tot het archiveren daarvan verkent. Het onderzoek wordt uitgevoerd door de afdeling Research van Het Nieuwe Instituut, het instituut voor architectuur, design en digitale cultuur in Rotterdam en tevens het Rijksarchief voor Nederlandse Architectuur en Stedenbouw. Het onderzoek loopt sinds 2016 en heeft inmiddels geresulteerd in een gelijknamige tentoonstelling van januari tot september 2017. Eind 2018 wordt een boekpublicatie verwacht, waarin ADM een centrale plaats krijgt.

Het **ADM** wordt in dit onderzoek om diverse redenen beschouwd als een unieke plaats met een eigen architectuur en een groot cultureel en maatschappelijk belang. Allereerst is het ADM terrein één van de langst bestaande gekraakte locaties van Nederland (eerst van 1987-1992, daarna onafgebroken sinds 1997), ondanks de fysieke bedreigingen door de eigenaren van het terrein. Daarnaast betreft het één van de meest omvangrijke gekraakte locaties van Nederland, wat mede dankzij de lange

levensduur het ontstaan van een alternatieve samenleving heeft mogelijk gemaakt. Inmiddels wonen hier 100 tot 200 mensen in verschillende samenstellingen vreedzaam samen, die grotendeels voor hun eigen faciliteiten zorgen, het gebied onderhouden en zelfs wegen en nutsvoorzieningen hebben aangelegd.

Het **ADM** biedt ruimte aan kunstenaars en creatieven die vrijuit op het terrein kunnen experimenteren, en aan festivals waar diversiteit omarmd wordt en vrije kunst en cultuur met een breed publiek gedeeld wordt. Daarnaast biedt het ADM een stabiele woonplek voor mensen die zich in de reguliere maatschappij minder op hun gemak voelen. Met name van belang voor 'Architecture of Appropriation' is ten slotte de **uitzonderlijke, zelfgebouwde architectuur** die op **ADM** te vinden is. Het terrein omvat tientallen, incrementeel uitgebouwde structuren, veelal van gevonden en hergebruikte materialen, die zowel voor wonen als werken gebruikt worden.

Onder andere de pizza-toren, het huis van M., het huis van D., het huis aan het water, en de stalen boomstructuur in het hoofdgebouw zijn unieke voorbeelden van vrije, ongereguleerde en spontane architectuur voor eigen gebruik waarvan maar weinig voorbeelden in Nederland te vinden zijn. De mogelijke ontruiming van ADM vormt voor het voortbestaan van deze architectuur, en de samenleving die er gebruik van maakt, een directe bedreiging. Daarnaast is uit het onderzoek gebleken dat er een grote kans bestaat dat het terrein na een ontruiming niet in gebruik zal worden genomen.

De fundamentele bijdrage van de kraakbeweging, en van **ADM** in het bijzonder, aan het stimuleren van en een plek bieden aan (sub)cultuur en alternatieve kunst en architectuur is evident. De afdeling Research van Het Nieuwe Instituut hoopt van harte dat dit belang wordt erkend en meegewogen in de verdere besluitvorming.

Namens de afdeling Research,



Marina Otero Verzier
Director of Research
Het Nieuwe Instituut

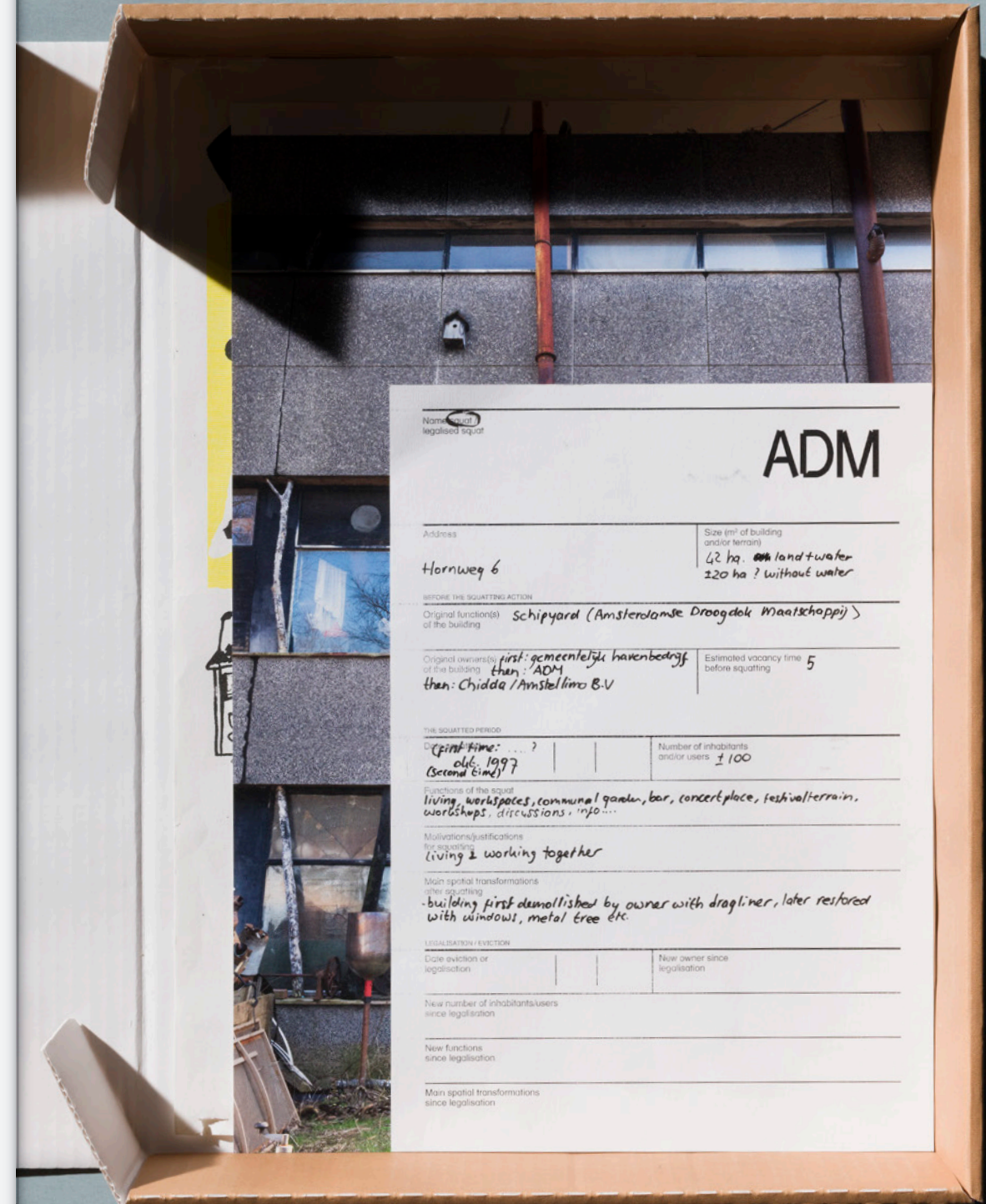



Festivals – After ADM was squatted for the second time, festivals became a key part of the community’s life. Held once or twice a year, the multi-day festivals hosted a wide range of acts from Amsterdam’s underground culture and beyond. The festivals brought the ADM community closer together, creating incentives for new construction or maintenance projects, and made ADM a beloved place in the subcultural and squatting scenes.

330



331

The main building

Wounded and healed – The large office building was the first structure to be inhabited after the squatting action.



332



The former owner, Bertus Lüske, started to demolish the structure while people were sleeping inside, and caused serious damage to one side of the building. The ADM community repaired the structure by inserting self-made walls.



333



Using the strengthening steel from the damaged concrete, an artist created a metal tree sculpture in a public space with a restaurant, bar, and music venue.

334



335

The warehouse

The large hall behind the main office building, mostly used for the construction of artworks and installations, was the site of festivals until safety concerns prevented them.





Self-built structures – Over time people started to build their own homes on the ADM site. The core of most structures consists of a prefabricated

and originally moveable object that could be heated easily. The houses are further extended following the wishes and needs of the residents.





Pizza tower

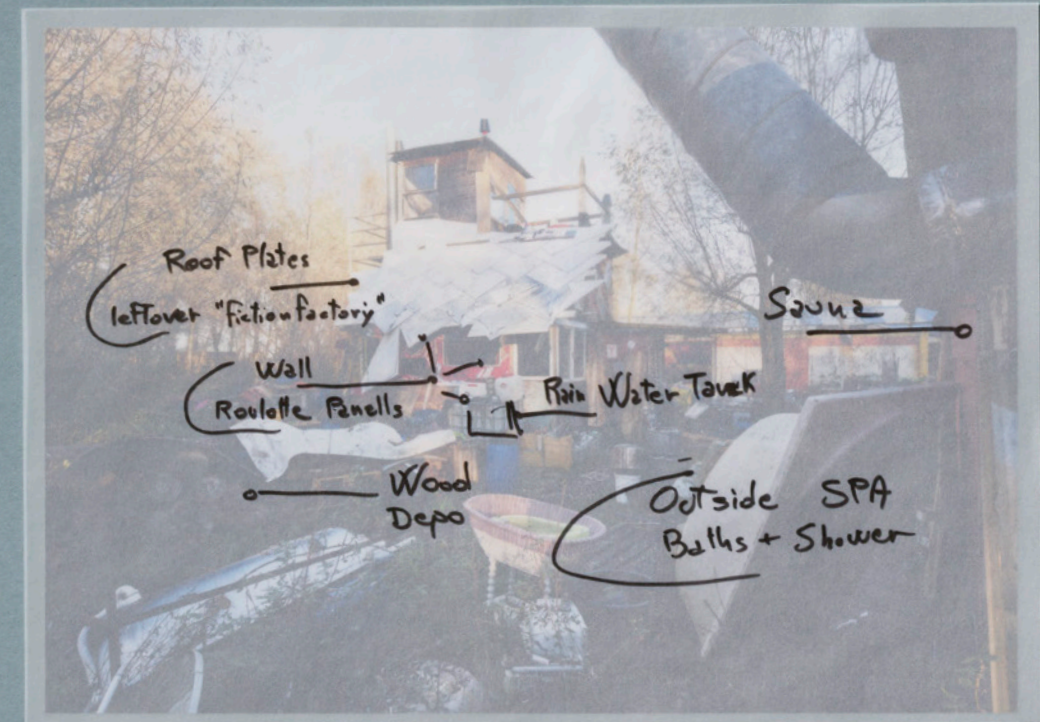

This three-storey house, located on a former heliport, takes its name from the pizza restaurant on the ground floor, which serves as a back-stage restaurant during ADM festivals.

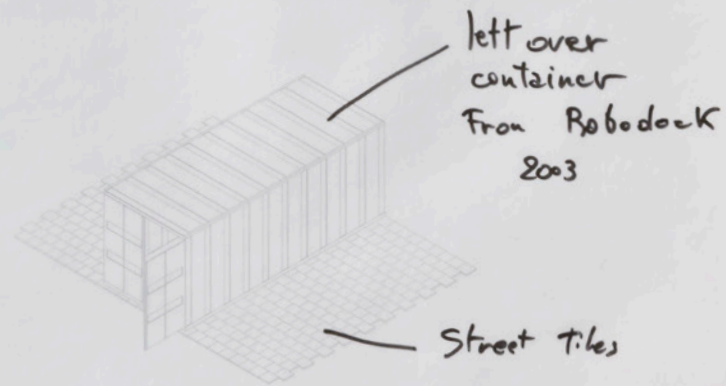

344

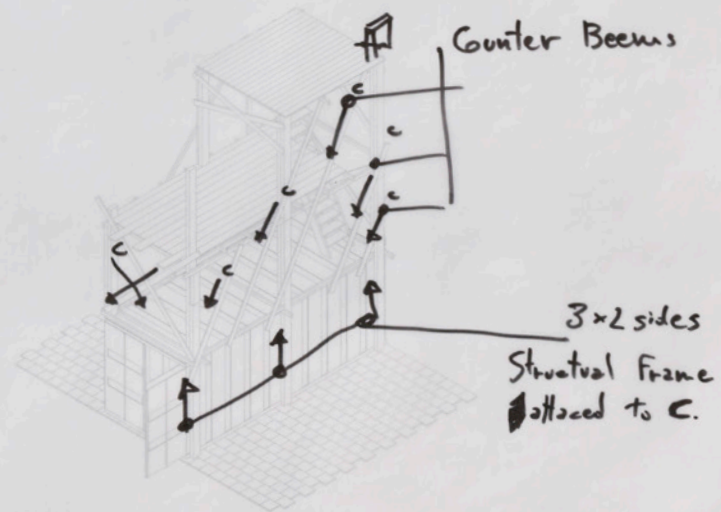

Pizza tower

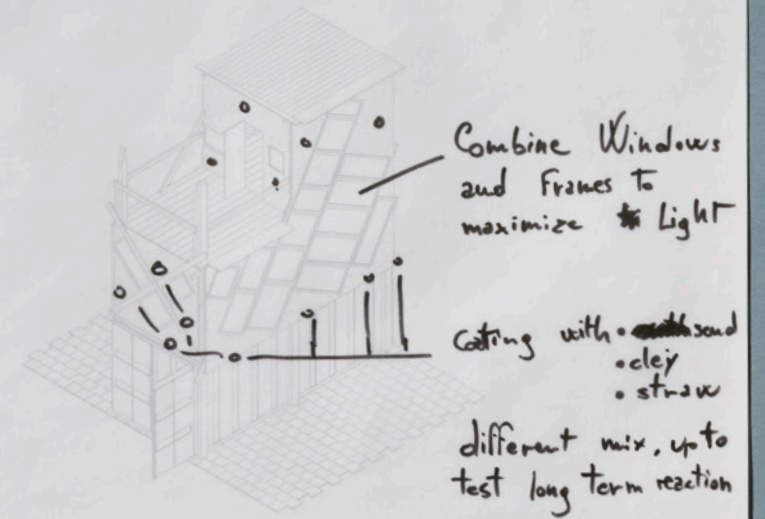

345

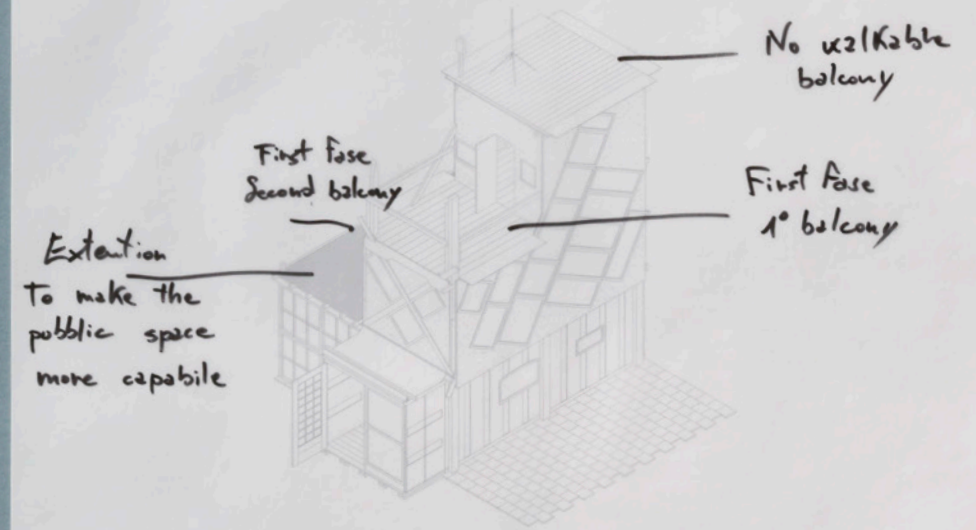

A 20 foot container provided the basis for this architecture that over time was expanded using timber trusses. The pizza oven, built of scrap metal, also serves as central heating for the whole house.

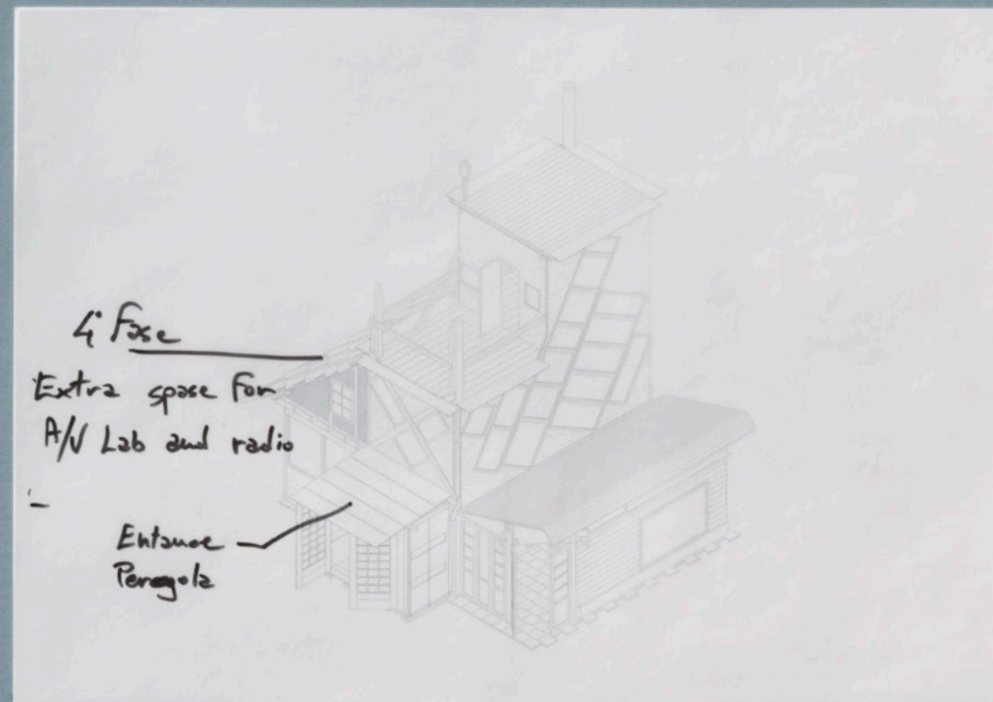
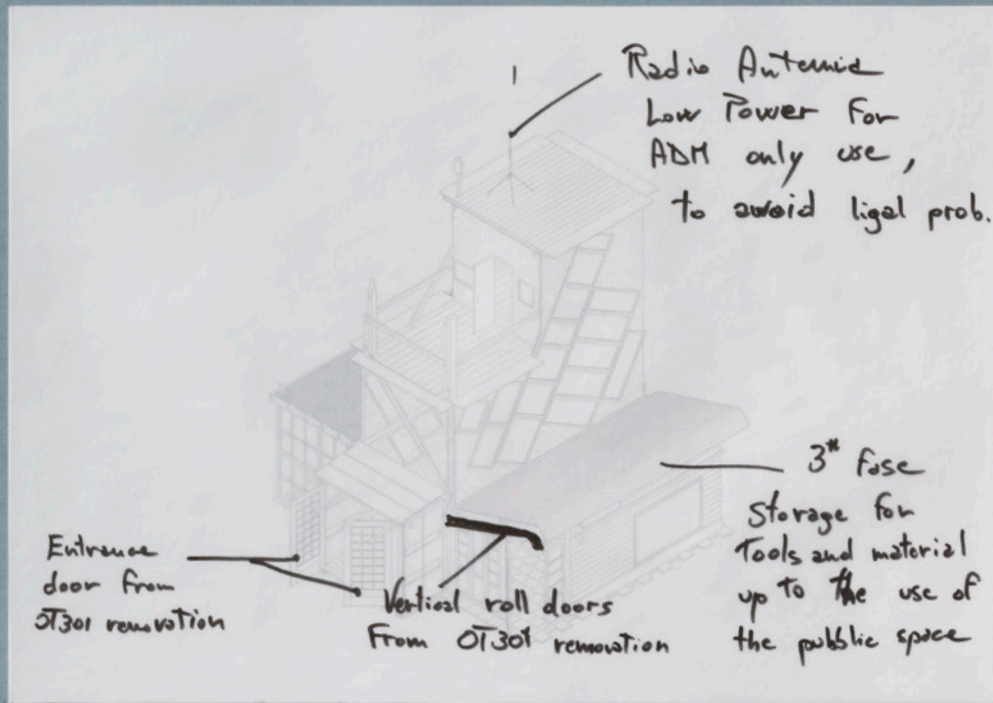



Tree house

350

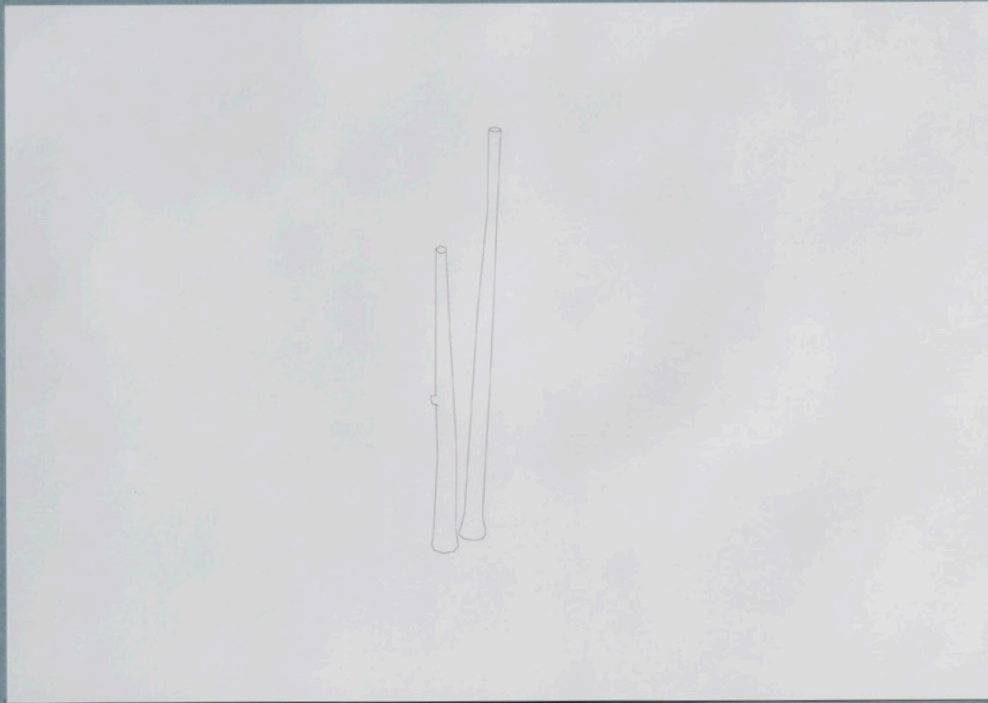

Tree house

351

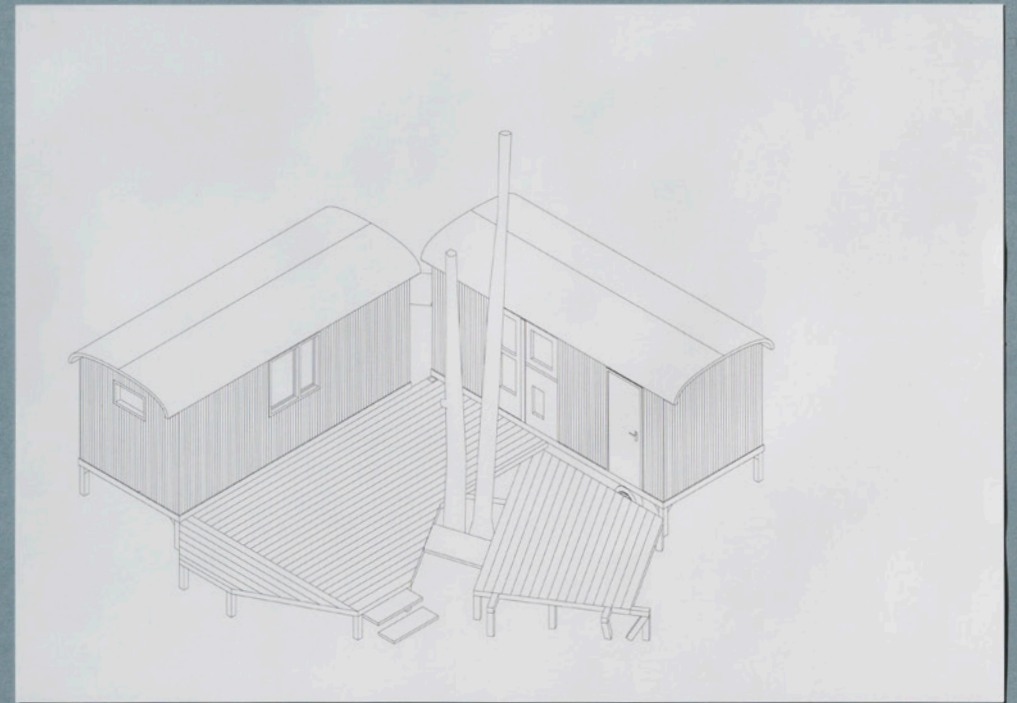

Two old caravans placed at an angle provide the basis for this house. One contains a kitchen, the other a bedroom-cum-living room. The position of the caravans was chosen in such a way as to preserve as many trees as possible.

352

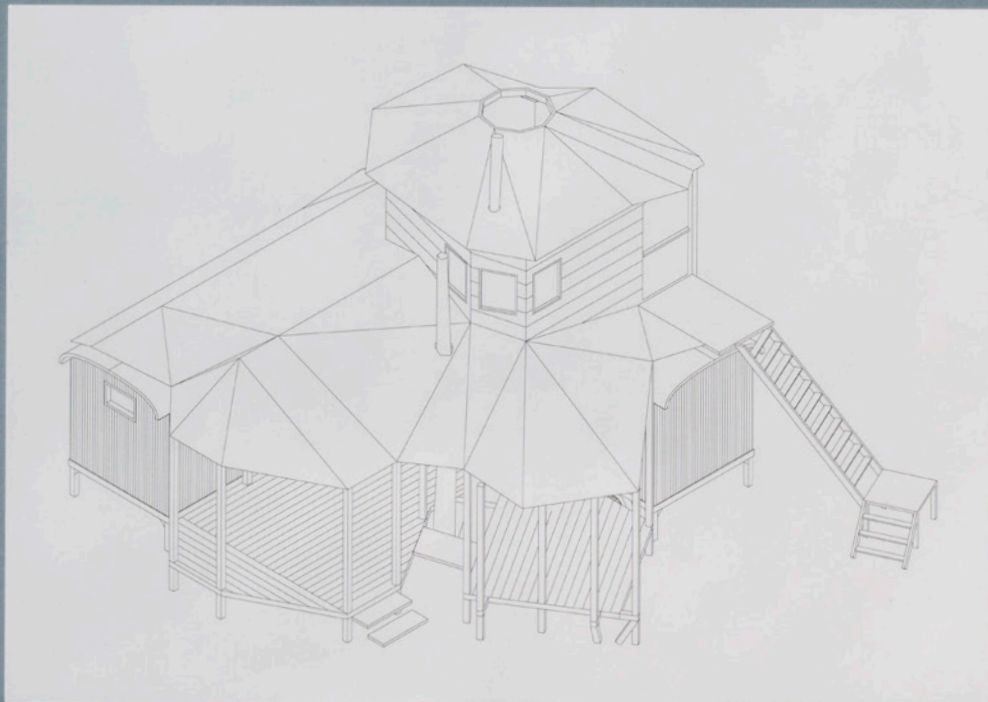
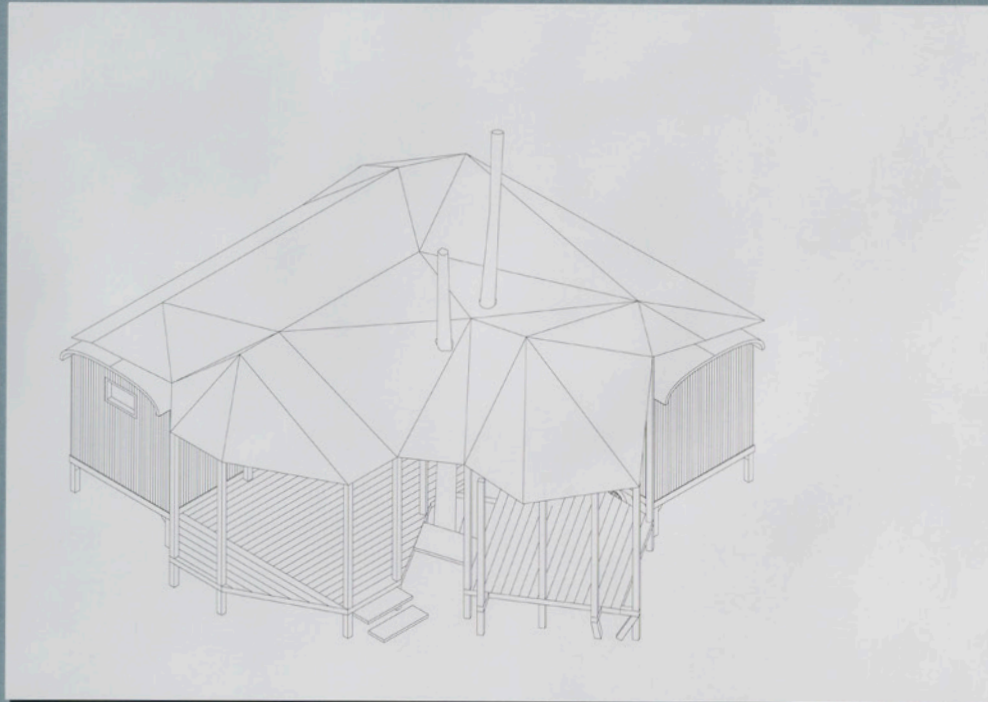

Built on top of the caravans and over the terrace, an irregular shaped construction made from found materials and old windows contains a small guest room partly supported by a large tree.

353



A lot of inspiration was drawn from shelter (an amazing book) Tree houses, gnome houses, spirals and mushroom shapes.

354

this is the first beam placed so all the supports could be connected to it.

all joints are cut so the wood transfers the weight. the screws are there to hold it together only.

Bedroom

- it all started with the porch. The floor plan was laid out on what felt estatic. A level change seemed nice and playful.

All the entrances are placed in such a way that you can enter the building from different sides enter the big space from the kitchen bedroom, ~~garden~~ garden upstairs. go around the trees and enter upstairs from the outside.

355

Willow tree I like it. let's keep it.

roofing structure is designed ~~with~~ combining structure and estetics, there was room for designing with estetics was desirable because insulation was on the outside.

The kitchen wagon. Was the second of the 2. Theoretically it could still be moved.

kitchen, shower room

The floor was made from beams left over from steel transport. the floor made from left over festival floor. The only things bought for building was tools and screws.

1:50

| | | 2m |

356



Merel's house



357



A yurt-like timber structure forms the core of this family home, whose irregular shape responds to the desire to fell as few trees as possible.

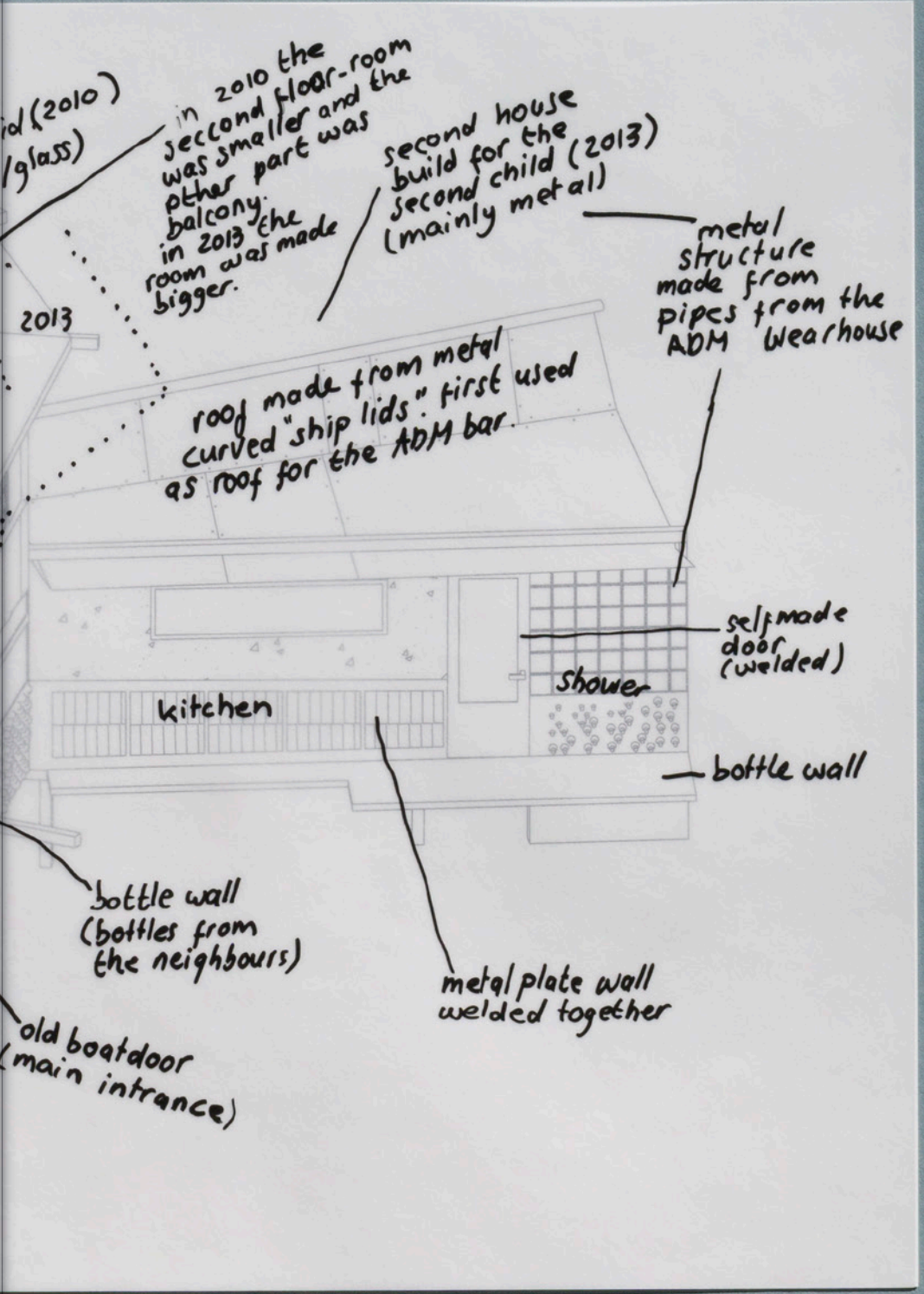
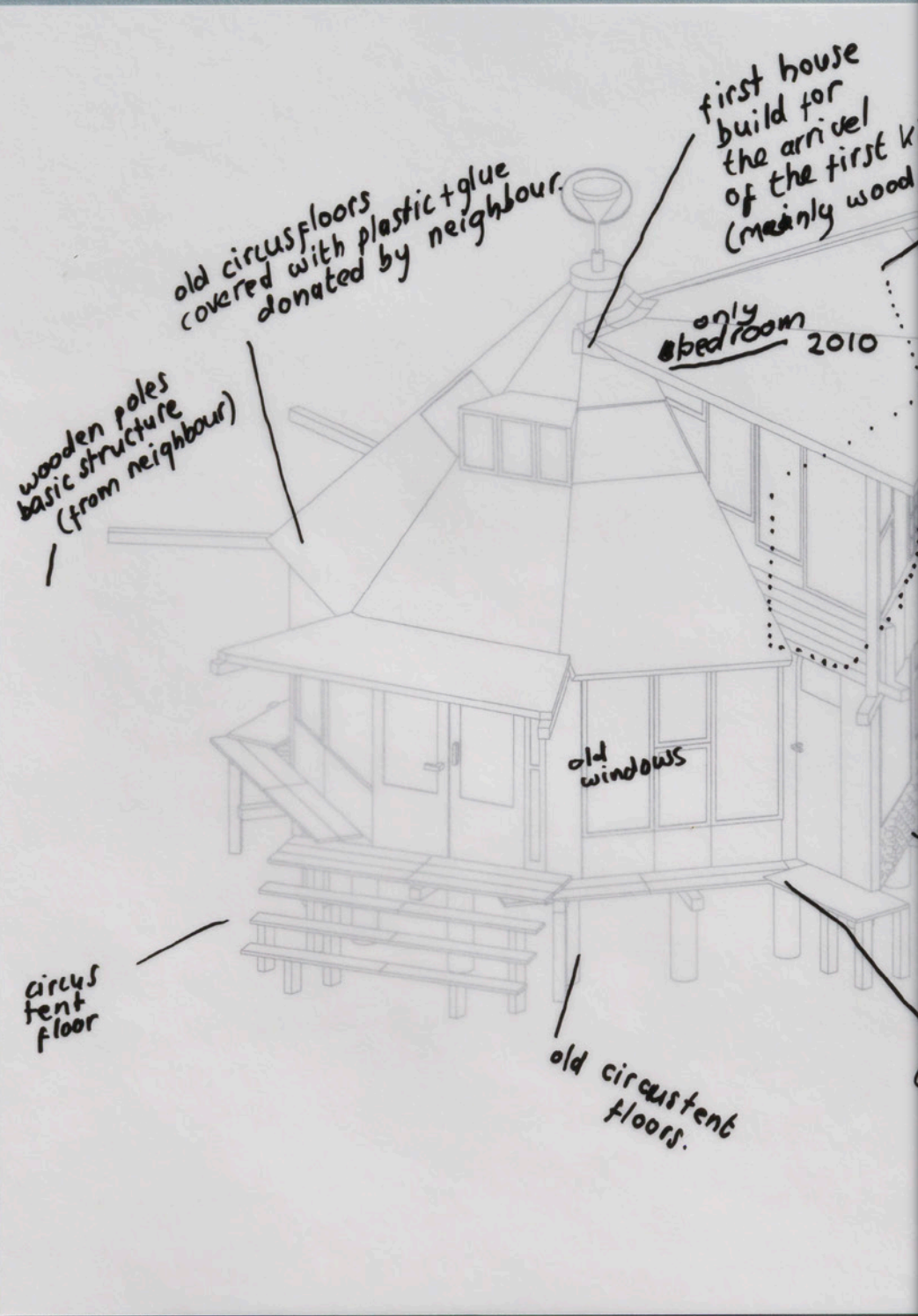

After their first child was born, the inhabitants built an extension; the structure became the bedroom and playroom, while the extension became the kitchen and living room.

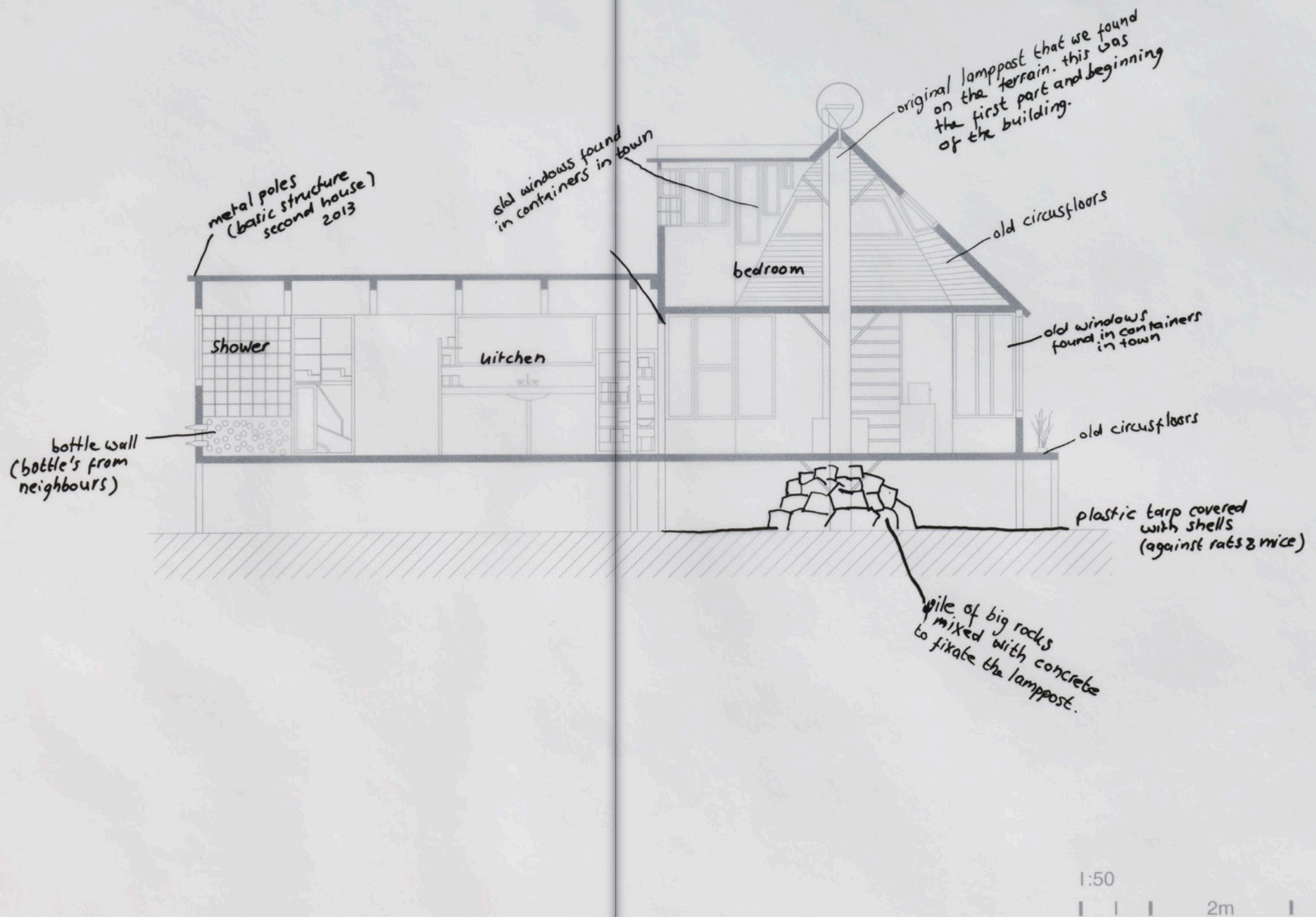

Merel's house

This is one of the few houses to be lifted clear of the ground, making it less susceptible to moisture and vermin.





Coreen's house

Constructed by a carpenter from ADM using timber beams found on the site, and following traditional timber construction techniques, this house on the waterside sits opposite the large warehouse.

366



367

Coreen's house

Originally the house had a simple outdoor kitchen which was eventually expanded into an indoor kitchen with gas stove, refrigerator and even a shower. There is a small terrace with an outdoor toilet.

Main House Built 2004

Hein Kuipers had found/been given a large amount of wood. He was no carpenter but had a desire to build a cabin. His brother and friends helped him make this. He lived in a boat and used the house as a meditation place. He had an outdoor kitchen.

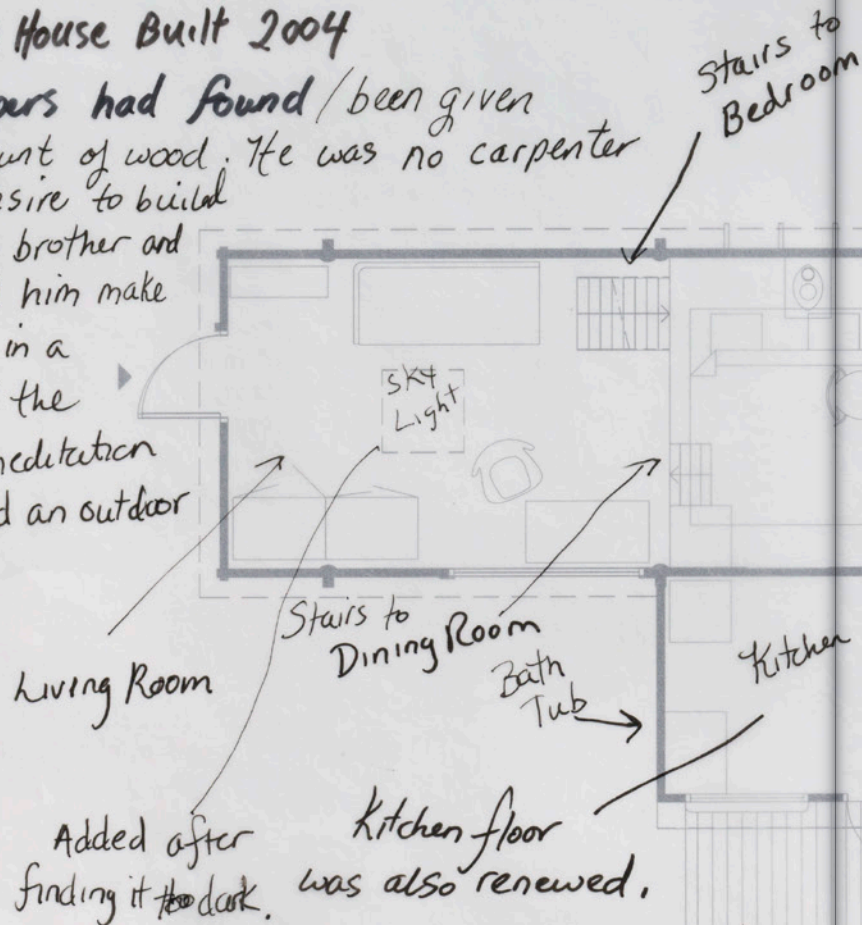

Hein had put plastic under the house to help with draft under floor, this caused too much moisture to gather and after a small fire where a lot of water ended up in the house it never drained and so I replaced floor (at least all rotten parts).

I put an extra wall in front of original wall with all of the wind and water from under the wood was deteriorating. This helped protect the house.

Under house there are some metal jacks helping to support old beams.

These walls and windows were added to make an indoor kitchen/bathroom

This part of deck was built on later so that you could walk on to the pier. Actually the whole deck was rebuilt including the pier. A large boat put their engines on full blast and caused the pier to collapse. We are still using the cracked main beam but replaced everything else.

Around 2007 I moved in. My boyfriend enclosed the kitchen and built in a small bath and plumbed in a washing machine.

The toilet was completely rebuilt only the floor is the same.

370



371

The Clit-Club

A late-night queer bar, occasionally open to the public, was built from various structures on the southern side of the ADM forest.

A quest for non-normative spaces

At the time of publishing, some of the squatting communities presented in this publication have already been evicted by the authorities. The pace and processes by which these spaces are targeted render visible the forces and interests that are leading the contemporary transformation of cities. Yet the spatial and legal strategies used by squatters to inhabit the urban fabric are a reminder that other urban and domestic arrangements, and non-commercial forms of communal living, are still possible today.

Regrettably, discussions among architects, urban planners, scholars and policy-makers around affordable housing and the growing barriers to equal access housing in cities too often abstain from questioning notions of property. Meanwhile, platforms such as AirBnb and the anti-squat business sector have turned the sharing of unoccupied domestic spaces into a synonym for corporate monetary exchange instead of a form of solidarity; co-working and co-living are now mantras for high-end developments targeted at young entrepreneurs. Increasingly appropriated by designers, developers and anti-squat companies, the architectural typologies and strategies of the temporary occupation of uninhabited spaces, and the reuse of materials and aesthetics instigated by the squatting movement, are now marketed devoid of their original ideals.

Rather than a person's right, the architecture of the home is a preferred form of investment and repository of capital. Apartments sit vacant in cities around the world, yet these spaces are not residencies for rent or sale. Instead, these architectures are assets. The object of speculative operations are completely imbricated in the neo-liberal policies of urban development, and the majority of contemporary housing projects and policies follow the logic of the market. House scarcity, insufficient supply and excessive demand, attract investors. As a result, prices rise and distort the market, housing shortages worsen to the detriment of residents, inhabitants are pushed out of the city, and conditions of precarity, and the processes of unequal access and accumulation of capital among the population, proliferate. These inequalities perpetuate centuries of targeted violence towards the excluded and oppressed through master plans and design strategies, in which the architectural community is also complicit.

Paradoxically, it has been the neo-liberal grip of the past decades, and its economic and political pressures, that has pushed people to rely on their own means and on infrastructures of commonality. This has manifested in the construction of alternative forms of collectivity, and new political and civic agency. By inhabiting vacant premises and imagining other models of family and ownership, the squatting movement has set up infrastructures of domestic solidarity. Across the Netherlands, squatters have opened spaces for diverse and multigenerational habitation for those who advocate collective

living, who don't have access to a home, or even to legal residency status. Through the appropriation and maintenance of industrial, historic, empty and abandoned structures, the inhabitants are at the same time activists, builders and architects who design the architectures of new forms of belonging, and new ways of being together.

Rather than romanticizing informal urban practices, the aim of *Architecture of Appropriation* has been to reflect on the physical outcomes of the spatial strategies of squatters, on their forms of collective decision making, on their models for creating welcoming, inclusive, affordable architecture with cultural value. These non-normative architectures are even formalized, at least in the context of the Netherlands, and follow clear protocols and tactics for occupation. The fact that squatting was legal before the ban of 2010 evidences how this model of inhabitation, and occupation not based on property, is possible even within capitalist regimes.

Many of the squats presented here are organized around open-ended structures capable of housing diverse communities and programs, accommodating forms of living for short-term projections. Bodies, materials, artifacts and ideas travelled across the network, from squat to squat, strengthening the sense of collectivity, and giving shape to a distributed, diffuse organization ready to reuse and reclaim the city and occupy its vacant premises.

Inevitably the permeable, even vulnerable, structures and spontaneous, everyday practices of squatting are impregnated by a sense of instability and precarity. Yet many

of these spaces have been home to multiple generations, and became stable residencies for entire communities, having a long-lasting influence on the everyday interactions and futures of entire neighborhoods. In this process, not all residents might have enjoyed living collectively, as group dynamics around decision-making and space-shaping can be a conflictive process. Contrary to how alternative forms of habitation might appear, the careful management of these self-organized and self-built spaces is fundamental for accommodating individual desires within the common good. The administration of a squat demands trust, commitment, time, and energy from its inhabitants. Living is not a passive action, but an active political practice that could potentially become emancipatory. Successful, long-lasting squats learned to creatively organize communal living by destabilizing hierarchies, shifting roles, and using democratic committee meetings to take decisions. In addition, squats often align with and are supported by unconventional approaches to economic and cultural exchanges, forms of collective care, and more equitable and inclusive social, political, technical as well as biological ecologies.

These spaces are important nodes in the cultural landscape of the city, whose actions and initiatives are relevant for its livability. By weaving structures of solidarity, creativity and activism, squatters transgress and disrupt normative forms of domestic inhabitation, patriarchal structures, and neo-liberal forms of living. In the transformation of the state from a provider of public

welfare to a promoter of markets, society and the economy are dominated by forms of extraction and appropriation of value derived from the ownership or control of scarce assets, such as property. The appropriation of vacant premises by squatters serves to infiltrate and transform these regimes of extraction, overcoming the gap between the population who has easy access to assets and those who don't. Their actions expose these systems of exclusion, challenge the seemingly idealized imaginaries of political democracy, and show the bodies, spaces and territories bypassed by forms of state-based redistribution.

It is precisely within this tension that *Architecture of Appropriation* situates itself. By including the spatial practices of the squatting movement, whose actions and architectures are criminalized, inside the State Archive – a symbolic, public, state-run building and institution – the project exposes the forms of extraction, nomination, validation, and exclusion intrinsic to these types of archives, their documents, and the systems they represent. This publication infuses the institution with a different ethos and language, as well as other voices and forms of architectural practice. With these strategies *Architecture of Appropriation* invites reflection upon methodological and historiographical questions connected to archiving, as well as to the architecture of the archive itself, and to challenge, from within, the imposing presence of the archive, its material, and its symbolic preoccupation with authorship and eternity.

Our role as mediators is ambiguous and

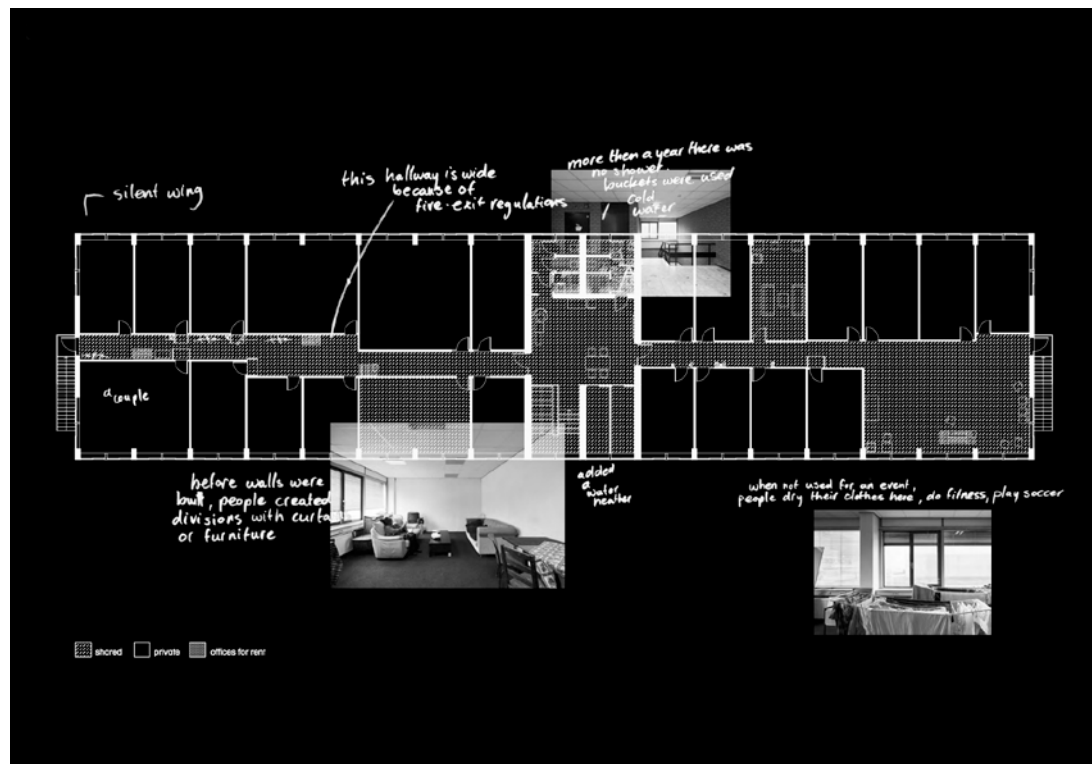
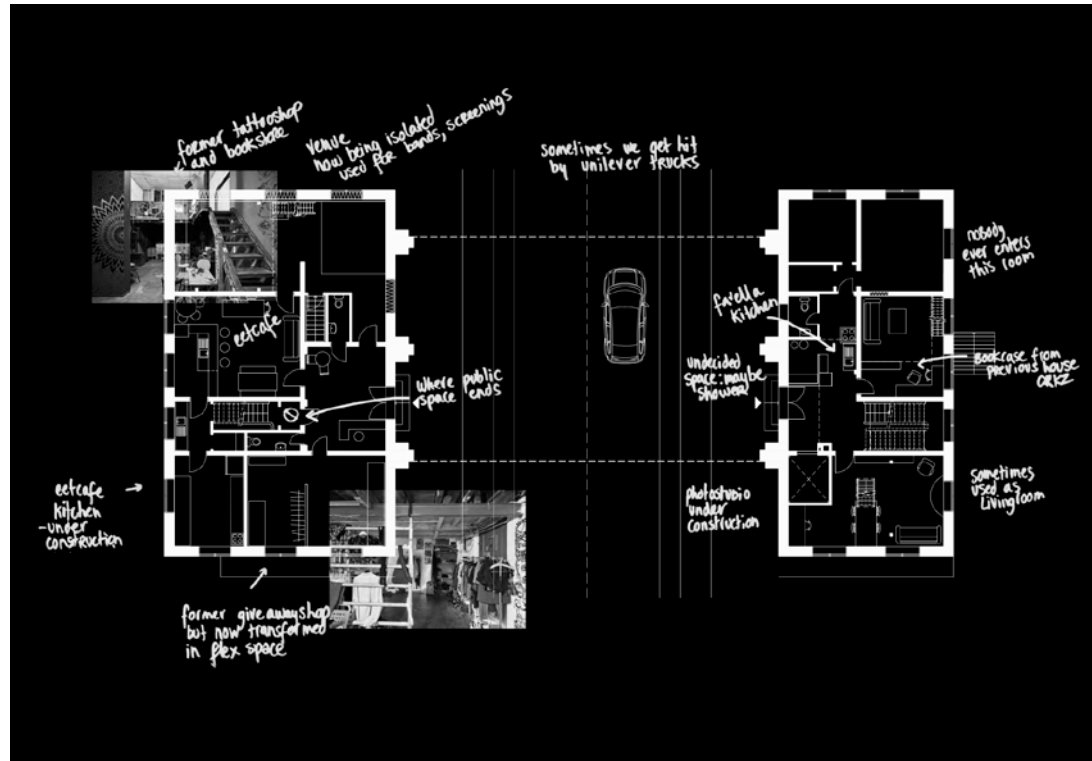

Annotated architectural representations could infiltrate architectural discourses, as well as legal and administrative procedures.

even problematic. In spite of a strong belief in the importance of public institutions and their capacity to convene forms of collectivity and political action, this project simultaneously sets out to defy their fixed structures, and give way to more permeable, humble, open ones. We understand 'heritage' to mean that which citizens recognize as their own assets, that which manifests and stimulates the human values of a social group, that we wish to keep for future generations. This position has infused the methodology, the forms of architectural representation, the relationships established, and the organization of the project itself. As researchers, and in this case editors, we do not shy away from possible challenges and contradictions, and instead fully explore them to transcend conventions and imagine other alternatives.

This publication is not the end of the journey, but just a small step into a larger active process. In addition to the debates the project triggered both within and outside the institutional context, the collective research has also manifested in other initiatives, including new policies for the State Archive, autonomous squatting archives, and even a nomination for one squat for the 2017 Dutch Design Awards. With the inclusion of the six archives of squats in the State Archive for Dutch Architecture and Urban Planning, keywords and tags were added to the collection's inventory, allowing new vocabularies derived from the architecture of squatting to be present at the interface of the archive, as well as creating new connections between new and existing archives. The project was presented

1. In early 2019 a landmark court case prohibited the Dutch state from evicting a group of squatters in Amsterdam. After years of vacancy, the court weighed the squatters' right to stay as more important than the owners' right to regain control over their property. This case has made a considerable impact on the significance of the squatting ban.

and discussed in international conferences such as MuseumNext, ICAM, International Philosophy Olympiad, and Mextropoli, fueling conversations and collaborations with other institutions around the possibility of opening their otherwise hermetic structures. Essays and examples of these architectures have been included in architecture magazines, exhibitions, biennales, as well as in school curricula, pushing the boundaries of the profession and leading to urgent group discussions on city developments, the right to housing, and local and national policies together with programs in architecture history, art history, design, art, sociology and philosophy.

It is not certain that these radical experiments in redefining the role and capacity of collaborative modes of living and action will survive in the long-term. Yet the recent court decision to allow a community of squatters to remain in their occupied premises is an event that seems to mark a new phase in the struggle for housing (pp.381-386).¹

In naam van de Koning

vonnis



RECHTBANK AMSTERDAM

Afdeling privaatrecht, voorzieningenrechter civiel

zaaknummer / rolnummer: C/13/662644 / KG ZA 19-201 FB/MV

Vonnis in kort geding van 1 april 2019

in de zaak van

1. [REDACTED]
 2. [REDACTED]
- beiden wonende te Amsterdam,
eisers bij dagvaarding van 28 februari 2019,
advocaat mr. R.K. Uppal te Amsterdam,

tegen

de publiekrechtelijke rechtspersoon
DE STAAT DER NEDERLANDEN,
gevestigd te 's-Gravenhage,
gedaagde,
advocaat mr. M.L.A. Rijndorp te 's-Gravenhage.

Eisers zullen hierna ook [REDACTED] worden genoemd. Gedaagde zal hierna ook de Staat worden genoemd.

1. De procedure

Ter zitting van 18 maart 2019 hebben [REDACTED] gesteld en gevorderd overeenkomstig de in kopie aan dit vonnis gehechte dagvaarding. De Staat heeft verweer gevoerd met conclusie tot weigering van de gevraagde voorziening. Beide partijen hebben producties en een pleitnota in het geding gebracht. Ter zitting waren – voor zover van belang – aanwezig [REDACTED] met mr. Uppal en mr. Rijndorp. Ook waren aanwezig F.D. Appel (eigenaar van het pand Zeeburgerpad 22 te Amsterdam), zijn advocaat mr. J.L. Pit en M.H. Hagagg, die als informant zijn gehoord. Na verder debat hebben partijen verzocht vonnis te wijzen.

2. De feiten

2.1. Eind 2018 is het pand aan het Zeeburgerpad 22 te Amsterdam (hierna het pand) dat eigendom is van F.D. Appel gekraakt. ██████████ maken deel uit van de groep krakers.

2.2. Op 11 december 2018 heeft M.H. Hagagg, directeur van Hagatex B.V. (hierna Hagatex), aangifte gedaan van de kraak bij de politie. Volgens het proces-verbaal van aangifte is Hagatex huurder van het pand.

2.3. Op 21 februari 2019 heeft de officier van justitie het voornemen tot ontruiming van het pand aangekondigd. De ontruiming zal, aldus de aankondigingsbrief, plaatsvinden binnen acht weken na uitreiking van die brief, derhalve vóór 19 april 2019.

3. Het geschil

3.1. ██████████ vorderen – kort gezegd – de Staat, en daarmee ook de officier van justitie, te verbieden op strafrechtelijke gronden tot ontruiming van het pand over te gaan, op straffe van een dwangsom van € 10.000,-.

3.2. ██████████ stellen hiertoe – samengevat weergegeven – dat zij op grond van artikel 8 lid 1 EVRM beschikken over een huisrecht. De proportionaliteit van een inbreuk op dit huisrecht moet door een onafhankelijke rechter worden getoetst. Op grond van het arrest van de Hoge Raad van 28 oktober 2011 (ECLI:NL:HR:2011:BQ9880) kan het zijn dat in een concreet geval het belang van de krakers zwaarder weegt dan het belang van de eigenaar van een gekraakt pand. ██████████ zijn van mening dat in dit geval de proportionaliteitstoets in hun voordeel dient uit te vallen. Zij voeren hiertoe aan dat het pand voorafgaand aan de kraak langdurig heeft leeggestaan. De geschiedenis van het pand blijkt onder meer uit een vonnis van de voorzieningenrechter van deze rechtbank van 7 januari 2011. Hierin is ontruiming van de toenmalige krakers afgewezen – kort gezegd – omdat onvoldoende aannemelijk was dat het pand werd gebruikt op het moment van de kraak en omdat de eigenaar geen concrete plannen had voor toekomstig gebruik. Vervolgens is het pand in 2013 strafrechtelijk ontruimd, wat niet heeft geleid tot ingebruikneming door de eigenaar, waarna het pand in 2014 opnieuw is gekraakt. Uit een vonnis van de voorzieningenrechter van deze rechtbank van 9 april 2014 blijkt dat een vordering tot ontruiming opnieuw is afgewezen. Nadat de eigenaar tegen dit laatste vonnis hoger beroep had ingesteld en in die procedure een huurovereenkomst kon overleggen, zijn de toenmalige krakers vrijwillig vertrokken. Nadien heeft het pand echter opnieuw langdurig leeggestaan en is het verloederd. Dit blijkt uit verklaringen van burens en uit de foto's die ██████████ in het geding hebben gebracht. Op die foto's is de enorme ravage te zien die ██████████ aantreffen bij hun kraak van het pand. Hieruit blijkt dat het pand noch door

de eigenaar, noch door de beweerde huurder Hagatex werd gebruikt. Ook heeft de eigenaar op dit moment geen concrete plannen voor toekomstige ingebruikneming. Er dreigt dan ook te worden ontruimd voor leegstand. De verhuurplannen die de eigenaar thans zegt te hebben (waarbij zijn dochter als makelaar optreedt), zijn dermate vaag dat sprake lijkt van een schijnconstructie om een spoedeisend belang bij ontruiming te creëren. Dit geldt ook voor de 'overeenkomst tijdelijk beheer' die de Staat als productie 5 in het geding heeft gebracht. Uit dit alles volgt dat het belang van de eigenaar bij ontruiming minder zwaar weegt dan het belang van de krakers. Het gaat om een groep jongvolwassenen die zich hebben georganiseerd onder de naam 'De kinderen van Mokum'. Zij zijn geboren in Amsterdam en zij werken en/of studeren in Amsterdam. Op de huidige Amsterdamse woningmarkt zijn zij niet in staat woonruimte te vinden. Zij beschikken niet over de inkomsten om een woning in de vrije sector te huren en zij zijn gezien de lange wachttijden te jong om in aanmerking te komen voor een woning in de sociale sector. Tot slot voeren ██████████ aan dat zij het pand hebben opgeruimd en opgeknapt en dat zij daarin ook maatschappelijke activiteiten (ook voor de buurtbewoners) organiseren.

3.3. De Staat heeft – samengevat weergegeven – het verweer gevoerd dat het pand sinds 1 november 2014 is verhuurd aan Hagatex en wordt gebruikt voor de opslag van hotel- en bedrijfslinnen. Medio 2018 heeft de eigenaar de huurovereenkomst opgezegd omdat hij het pand tegen betere voorwaarden wilde gaan verhuren. Door de kraak heeft de eigenaar hiertoe niet de kans gekregen. Bovendien belemmert de kraak dat Hagatex haar eigendommen uit het pand kan halen.

Het pand staat thans te huur, hetgeen blijkt uit een in het geding gebrachte advertentie, en er hebben zich diverse geïnteresseerden gemeld bij de makelaar. Ook is een overeenkomst gesloten tot tijdelijk gebruik zodat het pand direct na ontruiming en in afwachting van verhuur in bruikleen kan worden gegeven aan een anti-kraakwacht. Van ontruiming voor leegstand is dan ook geen sprake. De wetgever heeft bepaald dat het belang van de eigenaar van een gekraakt pand in abstracto zwaarder weegt dan het belang van de krakers. Dat de krakers na ontruiming hun woonruimte verliezen is een omstandigheid die de wetgever heeft meegewogen. Dit vormt dus geen bijzondere omstandigheid die ertoe kan leiden dat de afweging van belangen in dit concrete geval anders dient uit te vallen.

3.4. Op de stellingen van partijen wordt hierna, voor zover van belang, nader ingegaan.

4. De beoordeling

4.1. Vooropgesteld wordt dat kraken strafbaar is gesteld in de artikelen 138, 138a en 139 van het Wetboek van Strafrecht. In geval van een verdenking van overtreding van deze wetsartikelen kan in beginsel op de voet van artikel 551a

Wetboek van Strafvordering tot ontruiming worden overgegaan (Hoge Raad 28 oktober 2011, ECLI:NL:HR:2011:BQ9880).

4.2. Daarom kan de Staat in beginsel overgaan tot (aanzegging van de) strafrechtelijke ontruiming van het pand, temeer nu blijkt de aangifte van huisvredebreuk (zie 2.2) en gezien de verklaring van de eigenaar van het pand ter zitting, bij hem bezwaar bestaat tegen het gebruik van het pand door de krakers.

4.3. Ingevolge artikel 8 lid 1 EVRM komt [REDACTED] echter een huisrecht toe op grond waarvan zij het voorgenomen besluit tot ontruiming in kort geding ter toetsing kunnen voorleggen. Het in artikel 8 lid 2 EVRM besloten proportionaliteitsvereiste brengt mee dat de voorzieningenrechter, naast de wederrechtelijkheid, tevens heeft te toetsen of de in abstracto door de wetgever gegeven voorrang aan het belang van de openbare orde en de bescherming van de rechten van derden boven het huisrecht van de kraker, in de concrete omstandigheden van het geval de proportionaliteitstoets kan doorstaan. Gezien enerzijds het belang van de openbare orde en anderzijds het belang dat het eigendomsrecht in beginsel bescherming verdient (ook door de overheid) tegen inbreuk daarop, heeft de wetgever het als een door de Staat (het openbaar ministerie) te behartigen belang beschouwd dat aan het wederrechtelijk verblijf door derden in een gekraakt pand, een einde wordt gemaakt. In het kader van de proportionaliteitstoets dient te worden bezien of in het concrete geval tot een andere dan de door de wetgever in het algemeen gemaakte afweging moet worden gekomen.

4.4. Gelet op de stukken en hetgeen ter zitting naar voren is gebracht is de voorzieningenrechter voorshands van oordeel dat in de gegeven omstandigheden de strafvorderlijke ontruiming niet kan plaatsvinden.

Enerzijds is gesteld noch gebleken dat de krakers schade toebrengen aan het pand of dat het gebruik dat zij daarvan maken, leidt tot gevaarlijke situaties. Integendeel, niet weersproken is dat zij het pand in verloederde staat hebben aangetroffen en het na de kraak juist hebben opgeruimd.

Anderzijds is ter zitting het belang van de eigenaar van het pand bij een ontruiming op korte termijn, niet goed uit de verf gekomen. Het pand kent immers al een jarenlange geschiedenis van kraken (zie 3.2 van dit vonnis), terwijl het steeds aan dezelfde eigenaar heeft toebehoord. Weliswaar heeft die eigenaar in 2014 een huurovereenkomst gesloten met Hagatex, maar voorshands kan niet worden aangenomen dat die overeenkomst heeft geleid tot regulier gebruik van het pand. Wat dit betreft wordt verwezen naar de verklaringen van omwonenden (producties 4 en 5 van [REDACTED]); bovendien spreken de (niet weersproken) foto's die [REDACTED] als productie 3 in het geding hebben gebracht, waaruit de verloederde staat van het pand ten tijde van de kraak blijkt, boekdelen. Overigens is ter zitting gebleken dat de huurovereenkomst met Hagatex met instemming van de eigenaar/verhuurder op korte termijn zal worden beëindigd. Verder heeft de eigenaar

van het pand ter zitting geen duidelijkheid kunnen verschaffen over de plannen die hij daarmee heeft. Er zou volgens hem een kandidaat-huurder zijn die bereid is een huurprijs van € 50.000,- per jaar te betalen (terwijl Hagatex slechts € 10.000,- betaalde), maar wie dit is en welke bestemming die nieuwe huurder aan het pand zal geven, wist de eigenaar niet te vertellen. Voorshands is daarom deze nieuwe huurovereenkomst onvoldoende aannemelijk geworden.

4.5. Onder deze omstandigheden is het feit dat het pand thans te huur staat, zoals de advocaat van de Staat heeft aangevoerd en dat met betrekking tot het pand een gebruiksovereenkomst ('anti kraak') is gesloten, onvoldoende zwaarwegend om thans tot ontruiming over te gaan. Onvoldoende aannemelijk is geworden dat de eigenaar van het pand daarvan tot dusver overeenkomstig zijn bestemming gebruik heeft gemaakt, zelfs niet na de strafrechtelijke ontruiming in 2013, en het vrijwillige vertrek – na herkraak - van de toenmalige krakers in 2014 (zie 3.2). Mede gezien het feit dat thans de dochter van de eigenaar als makelaar optreedt, en de eigenaar toch niet op de hoogte is van de meest elementaire bijzonderheden van de gestelde, ophanden zijnde, nieuwe huurovereenkomst, kan worden getwijfeld aan de gestelde daadwerkelijke bedoeling het pand op korte termijn te verhuren. Evenmin kan worden uitgesloten dat de gebruikersovereenkomst slechts is gesloten om in dit kort geding een spoedeisend belang te creëren.

Het vorenstaande komt erop neer dat op dit moment onvoldoende aannemelijk is dat ontruiming niet (opnieuw) tot leegstand zal leiden. De vordering zal dan ook worden toegewezen.

Omdat de Staat rechterlijke vonnissen pleegt na te komen, hoeft aan de veroordeling geen dwangsom te worden verbonden.

4.6. Als de in het ongelijk gestelde partij zal de Staat in de kosten van dit geding worden veroordeeld.

5. De beslissing

De voorzieningenrechter

5.1. verbiedt de Staat (de officier van justitie) op strafrechtelijke gronden tot ontruiming van het pand aan het Zeeburgerpad 22 te Amsterdam over te gaan, waaronder begrepen het verlenen van medewerking aan het in gebruik geven van het pand aan derden,

5.2. veroordeelt de Staat in de kosten van dit geding, tot op heden aan de zijde van [REDACTED] begroot op € 81,- aan griffierecht en op € 980,- aan salaris advocaat,

5.3. verklaart dit vonnis tot zover uitvoerbaar bij voorraad,

5.4. wijst het meer of anders gevorderde af.

Dit vonnis is gewezen door mr. F.B. Bakels, voorzieningenrechter, bijgestaan door mr. M. Veraart, griffier, en in het openbaar uitgesproken op 1 april 2019.

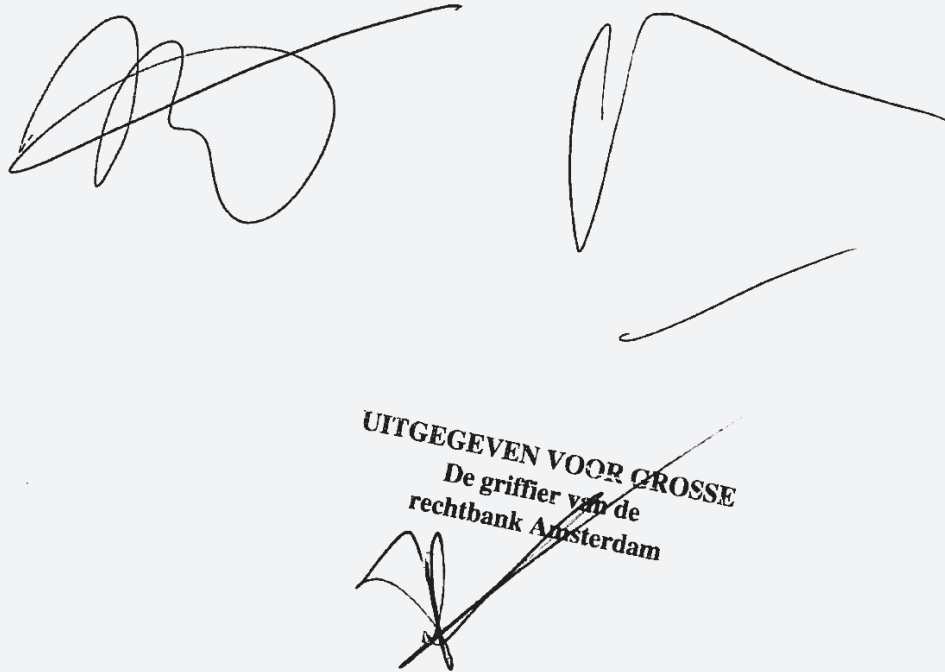

UITGEGEVEN VOOR GROSSE
De griffier van de
rechtbank Amsterdam

type: MV
coll: JT

ARCHIVE INVENTORY

Project file
Plantage Dok, Plantage Doklaan
8–12, Amsterdam

Content
Floor plans, axonometries, sections,
annotations on tracing paper, photo-
graphs and posters

Sub files
AOAA1
Drawings (plans, axonometries,
sections) and annotations on
tracing paper
(pp. 62, 71, 78-80, 90-91)

AOAAf1
Interior and exterior photographs
(pp. 49, 63-70, 72-77, 81-89, 92-96)

AOAA2
Annotations on tracing paper

AOAA3
Posters
(pp. 58, 60-61)

Architecture of Appropriation
Identifier: AOAA
Period: 2016–2019
Repository: Het Nieuwe Instituut
Creators: Architecture of
Appropriation Research Collective

Project file
Wijde Heisteeg 7, Amsterdam

Content
Floor plans, axonometries, sections,
annotations on tracing paper, photo-
graphs and posters

Sub files
AOAA4
Drawings (plans, axonometries,
sections) and annotations on
tracing paper
(pp. 130-131, 134, 138, 141, 146-147)

AOAAf2
Interior and exterior photographs
(pp. 121, 132-133, 135-137, 139-140, 142-145,
148-151)

AOAA5
Annotations on tracing paper

AOAA6
Posters
(p. 128)

Architecture of Appropriation
Identifier: AOAA
Period: 2016–2019
Repository: Het Nieuwe Instituut
Creators: Architecture of
Appropriation Research Collective

Project file
Landbouwbelang, Biesenwal 3,
Maastricht

Content
Floor plans, axonometries, sections,
annotations on tracing paper, photo-
graphs and posters

Sub files
AOAA7
Drawings (plans, axonometries,
sections) and annotations on
tracing paper
(pp. 173-175, 184-185, 192-193)

AOAAf3
Interior and exterior photographs
(pp. 165, 177-183, 186-191, 194-204)

AOAA8
Annotations on tracing paper
(pp. 174-175, 184-185, 192-193)

AOAA9
Posters
(p. 172)

Architecture of Appropriation
Identifier: AOAA
Period: 2016–2019
Repository: Het Nieuwe Instituut
Creators: Architecture of
Appropriation Research Collective

Project file
Poortgebouw, Stieltjesstraat 138,
Rotterdam

Content
Floor plans, axonometries, sections,
annotations on tracing paper, photo-
graphs and posters

Sub files
AOAA10
Drawings (plans, axonometries,
sections) and annotations on
tracing paper
(pp. 235-239, 246-251, 254-255, 258-261,
264-267)

AOAAf4
Interior and exterior photographs
(pp. 225, 240, 242-245, 252-253, 256-257,
268-272)

AOAA11
Annotations on tracing paper
(pp. 244-245, 256-257, 268-269)

AOAA12
Posters
(p. 234)

Architecture of Appropriation
Identifier: AOAA
Period: 2016–2019
Repository: Het Nieuwe Instituut
Creators: Architecture of
Appropriation Research Collective

Project file
Vluchtmaat, Joan Muyskenweg 32A,
Amsterdam

Content
Floor plans, axonometries, sections,
annotations on tracing paper, photo-
graphs and posters

Sub files
AOAA13
Drawings (plans, axonometries,
sections) and annotations on
tracing paper
(pp. 292-295, 300-301, 312-313)

AOAAf5
Interior and exterior photographs
(pp. 285, 296-299, 302-311, 314-316)

AOAA14
Annotations on tracing paper
(pp. 296-297)

AOAA15
Posters
(pp. 290-291)

Architecture of Appropriation
Identifier: AOAA
Period: 2016–2019
Repository: Het Nieuwe Instituut
Creators: Architecture of
Appropriation Research Collective

Project file
ADM, Hornweg 6, Amsterdam

Content
Floor plans, axonometries, sections,
annotations on tracing paper, photo-
graphs and posters

Sub files
AOAA16
Drawings (plans, axonometries,
sections) and annotations on
tracing paper
(pp. 344-346, 350-352, 354-355, 358-361,
368-369)

AOAAf6
Interior and exterior photographs
(pp. 317, 330-343, 347-349, 353, 356-357,
362-367, 370-371)

AOAA17
Annotations on tracing paper
(p. 343)

AOAA18
Posters
(p. 328)

Architecture of Appropriation
Identifier: AOAA
Period: 2016–2019
Repository: Het Nieuwe Instituut
Creators: Architecture of
Appropriation Research Collective

LIST OF ILLUSTRATIONS

- p. 12
Architecture of Appropriation exhibition at Het Nieuwe Instituut, 2017.
 Photo: Johannes Schwartz
- p. 16
 Figure 1: White Houses Plan pamphlet by Provo movement, April 1966.

 Figure 2: The Squatter Housing Agency opens its Squatting Information Center at the entrance to the Office for Housing Relocation, Amsterdam, December 1970.

 Figure 3: A squatting manual with the slogan 'Save a building, occupy a building' by the Squatter Housing Agency, May 1969.

 Collection: International Institute of Social History, Amsterdam
- p. 23
 Figure 4: Poster (detail) created in 2010 in response to the upcoming squatting ban. Source: Collaborating squatting groups

 Figure 5: Students squatting empty apartments in Amsterdam West, 2009. Source: SKSU, Amsterdam

 Figure 6: Squatting action in central Amsterdam, late 2018. Source: IndyMedia
- pp. 25, 27, 29-31
 The spatial practice of squatting in seven steps.
 Drawings: Anastasia Kubrak
- p. 36
 Figure 1: Poortgebouw, axonometric drawing of the first floor with mezzanines.

 Figure 2: ADM, axonometric drawing of the Pizza Tower.
- Drawings: Architecture of Appropriation research collective and students from the MA in Architecture, Urban Design and Engineering at Eindhoven University of Technology
- p. 40
 Figure 3: *Architecture of Appropriation* staircase, designed by ZUS (Zones Urbaines Sensibles).
 Photo: Johannes Schwartz
- p. 44
 Figure 4: The first annotation session at Poortgebouw in Rotterdam, September 2017.

 Figure 5: Group discussion after the first annotation session at Poortgebouw in Rotterdam, September 2017.

 Photos: Marina Otero Verzier
- Figure 6: Landbouwbelang annotation session in Maastricht, November 2018.
 Photo: Katia Truijen
- p. 45
 Figure 7: The outcome of the first annotation session at Poortgebouw in Rotterdam.
 Photo: Marina Otero Verzier
- p. 47
 Figure 8: *Architecture of Appropriation* was installed in the Ocupação 9 de Julho, a squatted skyscraper in the city center.
 Photo: Celine de Waal-Malefijt, Jens Jorritsma, Cédric Van Parys
- Figure 9: *Architecture of Appropriation* at the 11th São Paulo Architecture Biennial.
 Photo: Luiza Strauss
- p. 51
 Figure 1, 2: Plantagekerk around 1928.
- Figure 3: Kampert and Helm printing firm.
 Collection: Amsterdam City Archives
- p. 54
 Press release to announce a new squat.
 Collection: International Institute of Social History, Amsterdam
- p. 55
 Alarm system of Artis Squatter Groups.
 Collection: International Institute of Social History, Amsterdam
- p. 56
 Neighborhood map and list of buildings squatted by Artis Squatter Groups.
 Collection: International Institute of Social History, Amsterdam
- p. 57
 Press release to announce a new squat.
 Collection: International Institute of Social History, Amsterdam
- p. 58
 20th anniversary poster.
 Source: Plantage Dok, Amsterdam
- pp. 60-61
 Monthly activity posters.
 Drawings: Maia Matches
- pp. 103-104, 109-110, 115-117
 Figure 1-11: ORKZ in Groningen.
 Photos: Johannes Schwartz
- p. 124
 Figure 1: 'What is not allowed is still possible', 2015/2016 squatting manual.
 Source: www.kraakhandleiding.nl
- p. 126
 Statement about an upcoming eviction.
 Source: IndyMedia
- p. 127
 Press release about a squatting action.
 Source: IndyMedia
- p. 128
 Poster for a give-away store.
 Source: Wijde Heistee 7, Amsterdam
- p. 155
 Figure 1: The NRC newspaper reporting on a squatting action, February 2009. The action was supported by the SKSU.
 Source: SKSU, Amsterdam
- p. 156
 SKSU pamphlet, Amsterdam, May 2019.
 Source: SKSU, Amsterdam
- p. 167
 Figure 1: Landbouwbelang's main hall in use.

 Figure 2: Landbouwbelang in operation.

 Source: Rijksdienst voor het Cultureel Erfgoed
- p. 170
 Page four of Landbouwbelang's vision document, which outlines some of the most important points of the debate.
 Source: Landbouwbelang, Maastricht
- p. 172
 15th anniversary poster.
 Source: Landbouwbelang, Maastricht
- p. 206
 Figure 1: *Whose Urban Appropriation Is This?* exhibition at TENT in Rotterdam, 2017.
 Photo: Aad Hoogendoorn
- pp. 221-224
A Note on Gezelligheid, an essay by Adeola Enigbokan.
- p. 227
 Figure 1: Poortgebouw, 1900.
 Collection: Rotterdam City Archives
- p. 228
 Figure 2: Monthly activity program, 2003.
 Source: Poortgebouw, Rotterdam

- p. 229
Figure 3: 24th anniversary poster, 2004.
Source: Poortgebouw, Rotterdam
- p. 230
Letter circulated to inform the neighborhood about a new squatting action.
Source: Poortgebouw, Rotterdam
- p. 231
Announcement for the Squatter Café.
Source: Poortgebouw, Rotterdam
- p. 232
Rental contract between the city and the Poortgebouw Association.
Source: Poortgebouw, Rotterdam
- p. 234
Flyer for the SqEK conference.
Source: Poortgebouw, Rotterdam
- p. 287
Figure 1: Constructing new walls.
Source: Vluchtmaat, Amsterdam
- p. 290
Poster for the Vluchtmaat opening party, September 2016.
Source: Vluchtmaat, Amsterdam
- p. 291
Announcement for a monthly restaurant.
Source: Vluchtmaat, Amsterdam
- p. 319
Figure 1: ADM under construction in the early 1960s.
Collection: NSDM Wharf Museum, Amsterdam
- Figure 2: Poster for the ADM opening party, entry cost seven guilders and 50 cents or construction materials.
Source: ADM Archive, Amsterdam
- p. 320
Figure 3: ADM, soon after the second squatting action, October 1997.
- Source: Het Parool / Royal Library, The Hague
- p. 321
Figure 4: Lüske tries to evict ADM after the second squatting action, April 1998.
- Figure 5: Alternative poster for Robodock Festival, 2004.
Source: ADM Archive, Amsterdam
- p. 323
Het Parool newspaper reports on the eviction of ADM, March 1993.
Source: Het Parool
- p. 324
Statement by ADM on their current situation.
Source: IndyMedia
- pp. 325-326
Letter written by Het Nieuwe Instituut's Research Department to Amsterdam's mayor about the current situation of ADM.
Source: Het Nieuwe Instituut, Rotterdam
- p. 328
Poster for ADM festival, 2016.
Source: ADM, Amsterdam
- p. 378
Annotated architectural representations could infiltrate architectural discourses, as well as legal and administrative procedures.
Images: Anastasia Kubrak
- pp. 381-386
Court decision, squatting case, April 2019.
Source: Court of Amsterdam

Colophon

Editors

René Boer, Marina Otero Verzier and Katía Truijen in collaboration with the communities of ADM, Landbouwbelang, Plantage Dok, Poortgebouw, Vluchtmaat and Wijde Weisteeg 7

Photography

Johannes Schwartz

Graphic design

Maud Vervenne

Architectural drawings

Maria Fernanda Duarte, Jere Kuzmanić and Anastasia Kubrak in collaboration with Farah Abdullaa, Sander Drooge, Adam Gill, Jaqueline Sio, Damian Sobol Turina and Christiaan Wijers (MA Architecture, Urban Design and Engineering at Eindhoven University of Technology)

Copy-editing

Jack Eden

Printing

Raddraaier BV

Distribution

IDEA Books

ISBN 978-90-830152-0-0

Published by Het Nieuwe Instituut
©2019

Het Nieuwe Instituut
Artistic and General Director: Guus Beumer

Research Department: Marina Otero Verzier
(Director of Research), Marten Kuijpers (Senior
Researcher), Katía Truijen (Senior Researcher),
Anastasia Kubrak (Researcher)
Assistant Researchers: Aimee Albers, Flora
Bello Milanez, Rianne de Beer, Maria Fernanda
Duarte, Fiona Herrod

Heritage Department: Behrang Mousavi (General
Manager), Hetty Berens (Conservator), Suzanne
Mulder (Conservator), Ernst des Bouvrie
(Archivist Assistant), Frans Neggers (Digital
Archivist)

Art Director: Maureen Mooren

Exhibitions

Architecture of Appropriation, Het Nieuwe
Instituut, Rotterdam, 2017.

Spatial design: ZUS (Zones Urbaines Sensibles)
Curators and researchers: René Boer, Marten
Kuijpers, Marina Otero Verzier, Katía Truijen
Assistant researchers: Roos van Strien, Maria
Fernanda Duarte
Graphic design: Jakub Straka
Project manager: Arianne van der Veen
Producer: Malou Zumbrink

Architecture of Appropriation, International
Architecture Biennial of Sao Paulo, 2017.

Curators and researchers: René Boer, Marina
Otero Verzier, Katía Truijen
Spatial design: Maria Fernanda Duarte
Graphic design: Anastasia Kubrak



