

# **A FOUNDATION FOR ELECTRONIC MUSIC**

**2ND EDITION**

 **Roland**

# Contents

|                                                |    |
|------------------------------------------------|----|
| Introduction .....                             | v  |
| <b>Chapter One: What is Sound?</b>             |    |
| 1-1 Introduction .....                         | 1  |
| 1-2 Sound .....                                | 1  |
| 1-3 Pitch .....                                | 1  |
| 1-4 Resonance in Air Columns .....             | 2  |
| 1-5 Resonance in Strings .....                 | 3  |
| 1-6 Timbre .....                               | 4  |
| 1-7 Tone Color in Vibrating Air Columns .....  | 4  |
| 1-8 Tone Color in Vibrating Strings .....      | 5  |
| 1-9 Tone Color in Musical Instruments .....    | 7  |
| 1-10 Loudness .....                            | 8  |
| 1-11 Propagation of Sound Waves .....          | 8  |
| 1-12 Echo and Reverberation .....              | 9  |
| 1-13 Spatial Effects .....                     | 10 |
| 1-14 Questions .....                           | 11 |
| <b>Chapter Two: Electronic Music</b>           |    |
| 2-1 Introduction .....                         | 13 |
| 2-2 Live Electronic Music .....                | 13 |
| 2-3 <i>Musique Concrète</i> .....              | 13 |
| 2-4 Recorded Electronic Music .....            | 14 |
| 2-5 Waveforms .....                            | 14 |
| 2-6 Additive and Subtractive Synthesis .....   | 16 |
| 2-7 The Voltage Controlled Synthesizer .....   | 19 |
| 2-8 An Approach to Subtractive Synthesis ..... | 19 |
| 2-9 Noise .....                                | 20 |
| 2-10 Computer Music .....                      | 20 |
| 2-11 Direct Synthesis .....                    | 23 |
| 2-12 Questions .....                           | 25 |
| <b>Chapter Three: Pitch</b>                    |    |
| 3-1 Introduction .....                         | 27 |
| 3-2 Pitch Relationships in Music .....         | 27 |
| 3-3 Beat Frequencies .....                     | 28 |
| 3-4 The Natural Harmonic Series .....          | 29 |
| 3-5 Consonance and Dissonance .....            | 30 |
| 3-6 Pitch Standard .....                       | 31 |
| 3-7 Exponential Progressions .....             | 31 |
| 3-8 Cents .....                                | 32 |
| 3-9 Voltage-to-Frequency Relations .....       | 32 |
| 3-10 The Linear VCO .....                      | 33 |
| 3-11 The Exponential VCO .....                 | 33 |
| 3-12 The Low Frequency Oscillator .....        | 36 |
| 3-13 Frequency Modulation .....                | 36 |
| 3-14 The Basic Synthesizer Patch .....         | 36 |
| 3-15 Questions .....                           | 38 |

**Chapter Four: Loudness**

|      |                               |    |
|------|-------------------------------|----|
| 4-1  | Introduction                  | 39 |
| 4-2  | Measuring Loudness            | 39 |
| 4-3  | Frequency Response of the Ear | 40 |
| 4-4  | Dynamic Range                 | 41 |
| 4-5  | Intensity of Harmonics        | 42 |
| 4-6  | Envelopes                     | 44 |
| 4-7  | VCA Control Response          | 45 |
| 4-8  | Amplitude Modulation          | 47 |
| 4-9  | The Basic Synthesizer Patch   | 47 |
| 4-10 | Questions                     | 49 |

**Chapter Five: Timbre**

|      |                                             |    |
|------|---------------------------------------------|----|
| 5-1  | Introduction                                | 51 |
| 5-2  | Noise                                       | 51 |
| 5-3  | Filters                                     | 51 |
| 5-4  | The Low Pass Filter                         | 52 |
| 5-5  | The Voltage Controlled Low Pass Filter      | 55 |
| 5-6  | The High Pass Filter                        | 56 |
| 5-7  | The Band Pass Filter and Band Reject Filter | 57 |
| 5-8  | Effects of Filtering on Waveforms           | 58 |
| 5-9  | Resonance in Filters                        | 60 |
| 5-10 | Ringling in Filters                         | 64 |
| 5-11 | The Basic Synthesizer Patch                 | 64 |
| 5-12 | Questions                                   | 66 |

|                       |             |    |
|-----------------------|-------------|----|
| Frequency Range Chart | facing page | 66 |
|-----------------------|-------------|----|

|                                                  |             |    |
|--------------------------------------------------|-------------|----|
| Metric Conversion Table and Metric Relationships | facing page | 67 |
|--------------------------------------------------|-------------|----|

|              |  |    |
|--------------|--|----|
| <b>Index</b> |  | 67 |
|--------------|--|----|

# Introduction

As the title implies, the purpose of this book is to lay a foundation for the study of electronic music, particularly in relation to the voltage controlled synthesizer. *Practical Synthesis for Electronic Music* (published by Roland) should also prove useful to the reader. Through a series of practical exercises it shows how theory can be applied to a particular electronic music system. It also includes a step-by-step example of recording electronic music using a synthesizer and equipment found in most hi-fi systems.

With the advent of smaller synthesizer systems and semi-professional studio equipment such as mixers and multi-channel tape recorders, the world of electronic music is no longer restricted only to large institutions and organizations. For the creative musician, this opens up a whole new world. Not many unknown musicians get the chance to work with an orchestra to try their own arrangements or original compositions and the people at the record companies do not have time to work through a score to mentally "hear" what a new song sounds like; they want to hear a demonstration tape. Besides, there are many things which go into a composition which simply cannot be written down on paper. Budding young composers seldom get a chance to hear their works performed by a full orchestra or a large band, and how are they to learn the art of instrumentation if they never hear the results of their efforts? By studying the scores of great music? By analyzing the sounds on great records? That is a little like studying great works of sculpture and then trying to make a statue while wearing a blindfold.

The marriage of electronics and music opens up a world limited only by the musician's imagination. The synthesizer can create all the sounds of conventional music and create sounds never heard before. But without at least a basic understanding of acoustics and the synthesizer this world is unapproachable. This book tries to give that understanding.

I would like to express grateful appreciation to my fellow workers at Roland without whose help and patience this work would have been impossible.

Robin Donald Graham  
Synthesizer Project Manager  
**Roland Corporation**

Osaka, Japan  
December, 1978

# What is Sound ?

## 1-1 Introduction

In dealing with methods for synthesizing sounds many texts, including this one, seem to emphasize the imitation of conventional musical instruments and natural sounds. There is an important reason for this. All synthesis is based on one simple principal: the building of sound from basic elements. To understand these elements, we must understand acoustics. If we learn to imitate sounds with which we are familiar we are well on the road to being able to synthesize any sound we can imagine, all the way from purely electronic wailings, blips, and bumps to the creation of imaginary instruments, instruments which do not exist in the real world but which sound as if they actually did exist somewhere as acoustic instruments.

The purpose of this chapter is to provide that essential background in basic acoustics.

## 1-2 Sound

**Sound** is what we experience when the ear reacts to a certain range of vibrations. These vibrations themselves can also be called sound.

Most sound sources produce sound by means of some part or parts which vibrate when rubbed, struck, or excited by some other means. Others produce sound by direct excitation of the air as, for example, blowing across the mouth of a bottle to set the air inside vibrating thus producing sound. Electronic instruments produce sound only indirectly; they produce variations in electrical current which are normally processed and passed through an amplifier where they are made strong enough to drive a speaker. The vibrating speaker cone then produces sound.

The three qualities of sound are pitch, timbre (tone color), and loudness. It is the combination of these three qualities that allows us to distinguish between different sounds.

## 1-3 Pitch

**Pitch** is that quality of sound which makes some sounds seem "higher" or "lower" than others. Pitch is determined by the number of vibrations produced during a given time period. The vibration rate of a sound source is called its **frequency**; the higher the frequency (or the higher the vibration rate), the higher the pitch.

Tuning forks are used to produce accurate test pitches for use in laboratories and for tuning musical instruments. A close inspection will reveal that when a tuning fork is struck on the surface of a piece of hard rubber, the prongs appear slightly blurred due to their vibration. Dipping the vibrating prongs into a beaker of water will cause the water to be violently agitated.

In a similar way, the vibrating prongs of the tuning fork agitate the air around them, sending out sound waves.

## 2 What is Sound?

This is shown in Fig. 1-1. When the prong moves to the side, it compresses the air particles together. This disturbance of air particles moves in such a way that a pulse of **compression** travels away from the prong. When the prong moves to the other side, it produces a **rarefaction** of air particles which move outward similarly.

It is important to realize that the individual air particles are only moving back and forth, transmitting the waves of compression and rarefaction outward from the source.

The distance between any two corresponding points in two consecutive pulses is called the **wavelength** ( $\lambda$ ). The wavelength will depend on how fast the vibrations of sound occur and the speed at which the waves travel.

The speed of sound in air may be given as approximately 331 meters per second (or about 700 miles per hour). This speed will vary slightly with the temperature and density of the air. Neglecting these effects and assuming the speed of sound to be constant, the wavelength will be directly related to the rate of vibration of the source.

$$\lambda = \frac{V}{f} \quad f = \frac{V}{\lambda} \quad V = \lambda f$$

where:  $\lambda$  = wavelength in meters  
 $V$  = velocity of sound in meters per second  
 $f$  = frequency in vibrations per second

Thus the higher the frequency of the vibrations, the shorter the wavelength, the higher the pitch.

Frequency is often measured in units called the **Hertz (Hz)**, named after Heinrich Rudolf Hertz (1857-1894). If a sound source vibrates at a rate of 100 vibrations per second, it is said to have a frequency of 100 Hertz.

The frequency response of the ear, or in other words the range of frequencies which can be heard, will vary from person to person. The average person can hear sound from about 20 Hz to about 20,000 Hz. Some people can hear sounds as high as 25,000 Hz. The upper frequency limit will drop, however, as a person gets older. For example, a person of 40 or 50 years of age may be able to hear only up to about 15,000 Hz while in old age this may fall to 10,000 Hz.

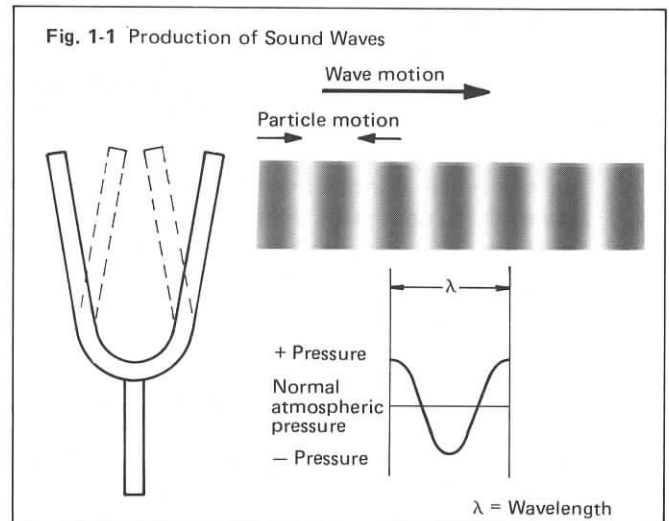

**Fig. 1-2 Examples of Pitch Ranges**  
 (See also chart facing p. 66)

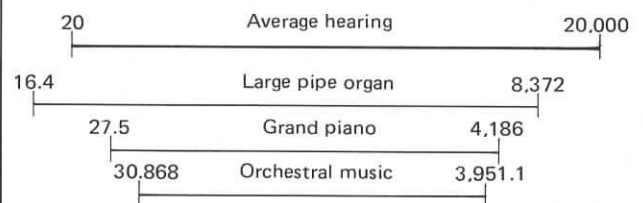

The extremely low organ pitch is explained in Chapter 5 (p. 57).

### 1-4 Resonance in Air Columns

An analysis of pitch might begin with an investigation of resonance. It is well known that the best way to keep a child's swing in motion is to give it small pushes in time with its natural period of swing. This is a classic example of resonance. The amount of energy exerted to keep the swing in motion is quite small compared to the amount of energy available from the motion of the swing.

**Resonance** occurs whenever a body or system is set into vibration at its own natural frequency as a result of impulses received from some other body or system vibrating at the same frequency.

Resonance with sound waves can be demonstrated by using resonance tubes as shown in Fig. 1-3. By raising and lowering a tube placed inside a tall container of water, the effective length of the air column inside the tube is changed. Starting with a very short air column, a vibrating tuning fork is held over the mouth of the tube. As the tube is slowly raised, resonance will occur when the air column reaches a certain critical length and a relatively strong tone will be produced. If the tube is raised more, other resonance points will be found.

Fig. 1-4 shows why this happens. Assume that the lower prong is moving down, as shown in (a). This will cause a pulse of compression to travel down the tube which will bounce off the surface of the water and return to the mouth. If the compression reaches the mouth of the tube just as the prong has reached its lowest position and is about to move upwards (as in (b)), the compression will be followed by a rarefaction pulse which will also travel down the tube and reflect from the surface of the water. Up to this point, the prong has finished one complete cycle of wavelength of sound and the sound wave (one compression and one rarefaction) has travelled twice down and up the tube. It follows, then, that the length of the column is one quarter the wavelength of the sound.<sup>1</sup> This is the principal which determines the pitch produced by all sound sources which consist of a tube with a closed end.

Resonance may also be obtained with a pipe which is open at both ends, as shown on Fig. 1-5. In this case, the compressions and rarefactions travel the full length of the tube because there is no closed end to reflect the waves. The length of the tube will be one half the wavelength of the sound wave; or the wavelength of the sound wave will be twice the length of the tube.<sup>2</sup>

## 1-5 Resonance in Strings

Three factors determine the pitch that a vibrating string will produce: its length, its mass, and the amount of tension which holds the string stretched. As an example of these, the guitarist changes the length of the strings by pressing them against the frets to raise their pitches; each guitar string is of a different diameter, the lower pitched strings being thicker; the guitar is tuned by adjusting the tension on the strings, the tighter the string, the higher the pitch.

Experiments with vibrating strings may be conducted with an easily constructed **monochord** (sometimes called a **sonometer**), as shown in Fig. 1-6.

1. In actual practice, if measurements are made, a discrepancy in the tube length will be noted. This is due to the fact that the sound waves produced at resonance actually extend slightly beyond the open end of the tube as a result of air disturbance in this area. The amount by which the wave extends is called **end correction**.
2. This statement neglects the slight deviation due to end correction. (Since both ends of the tube are open, end correction occurs at both ends).

Fig. 1-3 Closed End Resonance Tube

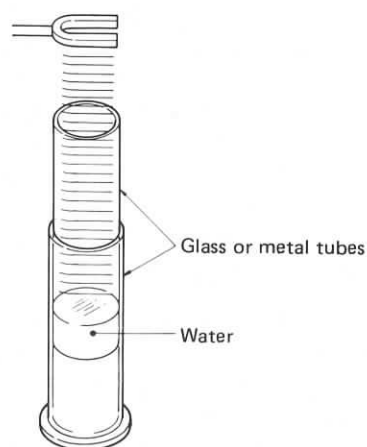

Fig. 1-4 Resonance in a Closed Tube

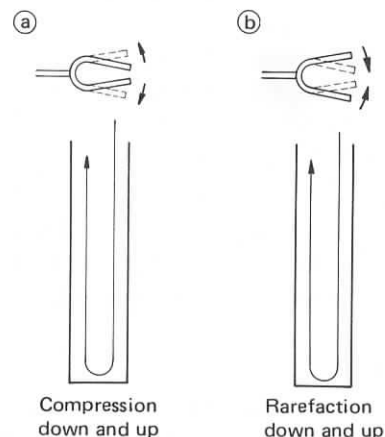
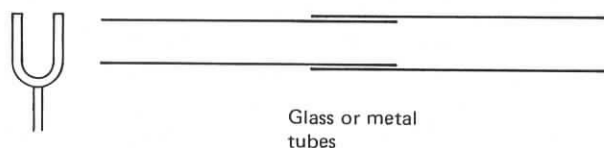

Fig. 1-5 Open End Resonance Tube



## 4 What is Sound?

Resonance in a vibrating string can be demonstrated with a monochord and a tuning fork. The simplest approach would be to tune the monochord to unison with the tuning fork by adjusting the tension on the string and the position of the bridges. If the unison is perfect, placing the stem of the vibrating tuning fork on the point of one of the bridges near the string will cause the string to vibrate. It is possible to find other resonance points of the string by moving the opposite bridge closer (without changing the tension on the string) and noting the positions where the string vibrates.

The frequency of the vibrations of a stretched string is inversely proportional to its length. Assuming the tension and diameter of the string remain unchanged, if a string of  $l$  length (distance between the bridges) produces a frequency of  $x$  Hertz, then a string of  $\frac{1}{2} l$  will produce a frequency of  $2x$  Hertz, a string of  $\frac{1}{3} l$  will produce a frequency of  $3x$  Hertz, etc.

The thicker and heavier a string is, the lower its frequency for a given length and tension. Thicker strings are usually stiffer which means that the sound will die away rather quickly, a feature not particularly desirable in musical instruments. To achieve the necessary mass without loss of flexibility, lower pitched strings are often wound with wire. This can be seen by examining the strings of a piano or guitar.

It would be possible to present a similar discussion on the relation of size, tension, and mass to the pitches produced by other vibrating objects such as reeds, metal bars, etc.

Fig. 1-6 Monochord

Ideally, a pulley should be located here. For simple experiments where accuracy is not too important, the pulley may be omitted, as shown.

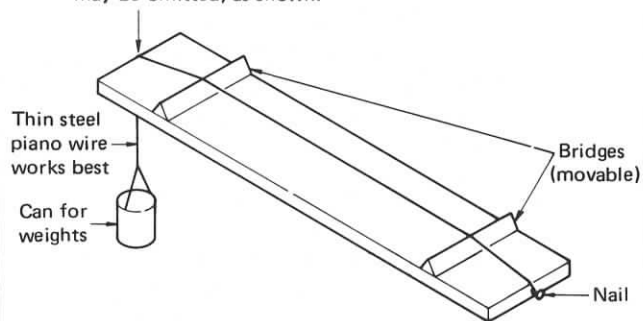

### 1-6 Timbre

*Timbre* comes from French and means "tone color". In English, we pronounce it: tam' bär or: tim' bär.<sup>3</sup>

**Timbre** or **tone color** is that quality of sound which allows us to distinguish between two sound sources producing sustained sound at the same pitch.

Sound waves are the result of vibration. The vibrations of most vibratory systems tend to be quite complex so that they vibrate at several frequencies simultaneously. It is the combination and interaction of these frequencies, called **overtones**, which give a sound the quality we know as tone color.

### 1-7 Tone color in Vibrating Air Columns

In 1-4 above, it was shown how acoustic resonance points can be found using open or closed tubes and a tuning fork. Starting with the air column at its shortest, if the tube is slowly extended there will be several points at which resonance occurs. The first resonance point will be stronger than the others with the next resonance points being progressively lower in intensity. Using the child's swing as an analogy of resonance, the secondary resonance points in the tubes would be like giving the swing a push every other swing, or

3. a is in fat; i as in is; æ as a in ago



every third, fourth, or fifth swing, and so on. From this, it follows that if the impulses are not delivered every swing (assuming pulses of equal energy), the swings will be of lower intensity.

Since various lengths of air column will vibrate in resonance to the one frequency of a tuning fork, it follows that one air column of fixed length will form resonances at several frequencies.

Assuming that the length of an open end pipe is such that it forms a resonance with the frequency of a tuning fork, the vibrating prongs of the tuning fork will act as impulses to set the air inside vibrating. Since the tube is resonant at various frequencies in addition to that of the fork, the impulses supplied by the fork will tend to cause the air inside to vibrate at all of these resonant frequencies simultaneously. These types of overtones are called **harmonics** because of their musically harmonic relation to each other.

The lowest of these frequencies, or the **first harmonic**, has a wavelength equal to twice the length of the open end pipe.<sup>4</sup> This frequency is usually the strongest and it is this frequency which gives the total sound its overall musical pitch. For this reason, the first harmonic is also called the **fundamental**.

The remaining harmonics are all multiples of the first harmonic or fundamental. The next higher harmonic is the second harmonic with a frequency twice that of the fundamental. Following that is the third harmonic with a frequency three times that of the fundamental and so on, theoretically upwards to infinity.

This series of harmonics is called the **natural harmonic series**. Most vibratory systems tend to produce harmonics, but not necessarily all of the harmonics in this series. The sound from a closed end pipe, for example, contains only the odd numbered harmonics. This is because for even numbered harmonics, the portion of the wave being reflected from the closed end is cancelled by the opposite portion of the wave coming from the open end. The tone quality produced by a closed end pipe, then, is different from that of the open end pipe; it contains fewer harmonics and thus is a little duller.

## 1-8 Tone Color in Vibrating Strings

In 1-5 above, it was shown how string resonance can be demonstrated with a monochord and a tuning fork. As with a fixed length of air column, a string with fixed characteristics will also be resonant at various frequencies, all of which fall within the natural harmonic series. In the above mentioned string resonance experiment, if it were possible to obtain several tuning forks, each tuned to one of the harmonics of the first tuning fork, it would be seen that these forks would also cause resonant vibration of the string. As with the open end pipe, the vibrating string can produce all of the harmonics in the natural harmonic series.

4. Neglecting end correction, as before.

Fig. 1-7 shows three of the vibratory modes of a string (or three of the harmonics) as they would look if it were possible to completely separate them from each other. In the fundamental mode of vibration (a), **nodes**, or points of minimum agitation, naturally appear at the ends of the string since it is anchored at these points. In its next mode of vibration (b), another node appears at the center of the string. Since this effectively cuts the length of the string in half, the frequency produced by this mode of vibration is twice that of the fundamental, or in other words, the second harmonic. The next mode of vibration (c) adds another node which effectively divides the string into thirds, thus producing the third harmonic.

The tone color actually produced by a vibrating string will depend on how the string is excited and at what point along its length it is excited. Logic would dictate that a node could not appear at the point of excitation. If the string is plucked or bowed at its center, it is impossible for any nodes (points of rest) to appear at this point, thus, since all even numbered harmonics produce nodes at the center, these harmonics would be missing from the sound.

**Antinodes**, or points of maximum agitation, for the second harmonic occur at a point one quarter of the way from the end of the string, as shown in Fig. 1-7 (b). If the string is excited at either of these points, the second harmonic will dominate the sound and any harmonic with a node at these points will be missing from the sound (or in other words, the fourth harmonic and any multiple of the fourth harmonic). Since the fundamental has neither a node nor an antinode at these points, it will be present, but weaker than if the string were excited at its center. It is possible to suppress the fundamental entirely by lightly touching the second harmonic nodal point (the center of the string) with the edge of a card or feather, as shown in Fig. 1-8 (a). If the fundamental is completely suppressed, the musical pitch of the string will seem to be that of the second harmonic, since this is now the lowest harmonic present. Other harmonics may be obtained with this same method using the related nodes and antinodes. Fig. 1-8 (b) shows how to obtain the sixth harmonic. The pitch produced will be two octaves and a fifth above the missing fundamental. Most string instruments are excited near one end of the string, thus the sounds produced are rich in harmonics.

A very similar discussion can be presented concerning the position of the pickup in relation to the strings of an electric guitar. The pickup detects the motion of the string passing back and forth above it and generates minute electrical currents which electrically mirror the string vibrations. Assuming all harmonics to be present in the vibrating string, if the pickup is placed under the center of the string, it will be in the position of the node for the second harmonic. Since a node is a point of minimum vibration, the pickup will detect very little, if any, of the second harmonic portion of the string vibration. All harmonics with a node at this point will be missing from the output of the pickup. Other pickup

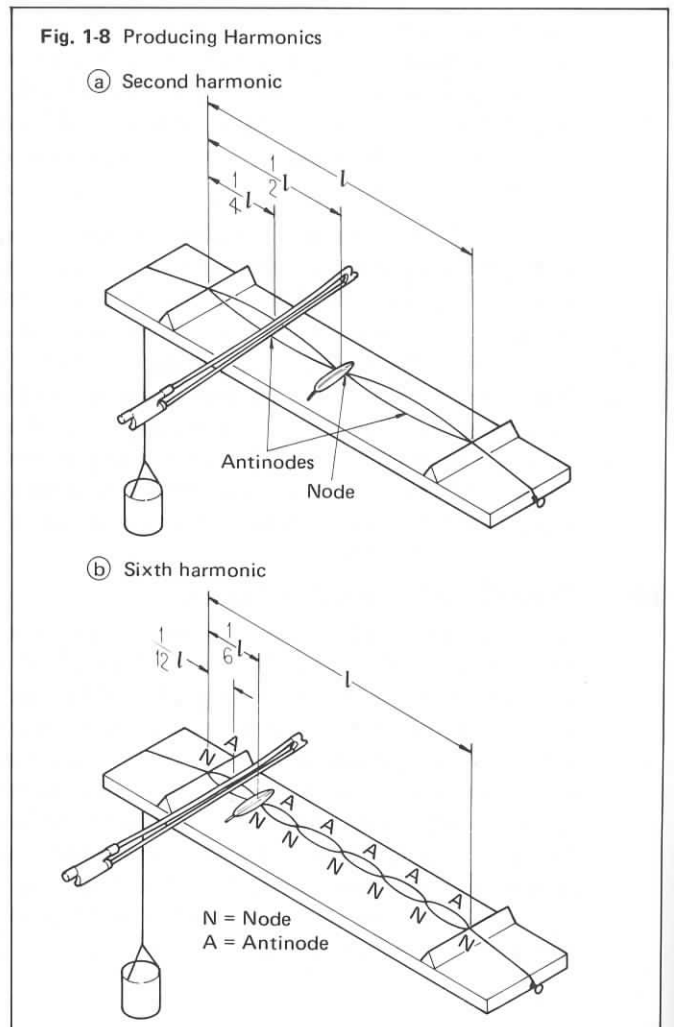
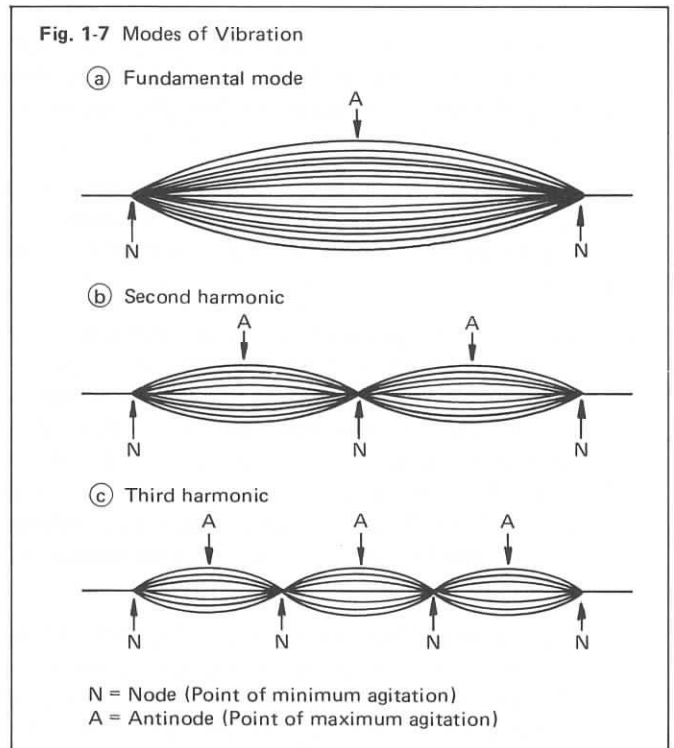

positions will produce sound with different tone coloring. This is the reason that many electric guitars have more than one pickup.

The material with which a string is made, and its diameter will affect the tone color produced. Most string instrument players are aware of this fact; they often have favorite brand name strings they prefer for use with their instruments. Thicker strings will be stiffer and therefore will have difficulty vibrating freely at higher frequencies. With thicker strings, the higher harmonics tend to die away very quickly.

## 1-9 Tone Color in Musical Instruments

Up to this point we have been primarily concerned with sources of vibration which produce sound, particularly vibrating air columns and vibrating strings. The body of a given instrument also has a profound effect on the total tone color produced by that instrument.

The solid parts of the body of an instrument have their own resonances which are very similar to those in the vibrating string in that the frequency of these resonances depend on the dimensions, elasticity, and tensions of the various parts of the body. Many instruments such as violins, acoustic guitars, and drums also contain air cavities which resonate in ways similar to vibrating air columns. These body and air resonances all interact with each other and the source of vibrations so as to emphasize or de-emphasize different overtones produced by the vibrating sound source, and in some cases to completely cancel some overtones and/or add new overtones not present in the original source of vibrations. This explains why two violins which look exactly the same may still sound quite different. For example, the wood used in the bodies may be different.

As an example of the factors which decide the tone color of a musical instrument, let us consider briefly the factors which in general affect all wind instruments. First is whether the air column is closed or open. Closed pipes cannot produce even numbered harmonics. Next is the **scale** of the pipe. This refers to the ratio of the length of the pipe to the diameter of the pipe. The larger the scale, the more difficult it is to produce the upper harmonics. Third is the shape of the pipe. Fourth is the intensity of the wind pressure used to produce the vibrations. Fifth is the method of excitation; in other words, whether by air passing across an edge, or by reed. Sixth is the nature and thickness of the walls confining the air column. And last is the size and shape of the mouth and related parts.

Bells and cymbals are good examples of instruments which produce overtones that do not fall in the natural harmonic series. In the case of the cymbals, these **non-harmonic** overtones are so strong and numerous that they drown out any existing fundamental so that it is impossible for the ear to detect a specific musical pitch. Bells often contain enough harmonic overtones that our ears can recognize a musical pitch. The non-harmonic overtones are what give the sound its metallic "clanging" tone quality and is typical of sound

## 8 What is Sound?

sources which use metal plates or bars as a source of vibration.

One other point in connection with tone color should be mentioned. The room in which a sound occurs will also affect the tone color of that sound. The room forms an air cavity with its own resonances which react to the sound. Smaller rooms, such as the average living room, often have a very strong effect on the sound produced in them. Especially affected are the lower frequencies.

### 1-10 Loudness

The first thing that may come to mind concerning **loudness** is perhaps **dynamics** (changes in loudness) in music. At first glance, loudness as a quality of sound might seem rather simple and not as important as the other two qualities, but this is not so.

The loudness of a sound will vary during its production. This loudness contour is called the **envelope** of the sound and often forms a very important clue as to the identity of the sound. Fig. 1-9 shows two envelopes. In (a) is shown the envelope for a single guitar note. As soon as the finger releases the string, the sound jumps very quickly up to its maximum loudness after which it begins to die away slowly. The actual maximum sound level reached and the length of time required for the sound to die away will depend on how much force is used in picking the string.

In fig. 1-9 (b) is shown the envelope for a vocalized "ah" sound. With the guitar sound the basic shape of the envelope will remain unchanged; the only possible variation from this basic shape would be to dampen the string before the string vibration ceases. In the case of the voice, the envelope can be altered considerably, depending on the intonation of the singer or speaker.

The relative intensity or loudness of the overtones contained in a sound also affect its tone color. The high overtones in a cymbal crash, for example, are very strong, much stronger than the lower overtones.

### 1-11 Propagation of Sound Waves

Sound spreads from the source in the form of a series of expanding spheres. As the sound waves travel away from the source, they become weaker in intensity. If we imagine a square measuring one centimeter on a side drawn on the surface of a balloon, we can see that the square will become progressively larger as the balloon expands. As sound waves travel away from the source, they must progressively cover a larger area, thus the sound energy is gradually dissipated until it finally becomes too small to detect.

Fig. 1-10 shows what happens to sound waves when they encounter an obstruction such as a wall. A part of the sound is reflected from the surface. Note the relation between the source of the sounds and the apparent source of the reflected waves. A part of the sound striking the wall is absorbed by the wall, and any sound which is not absorbed

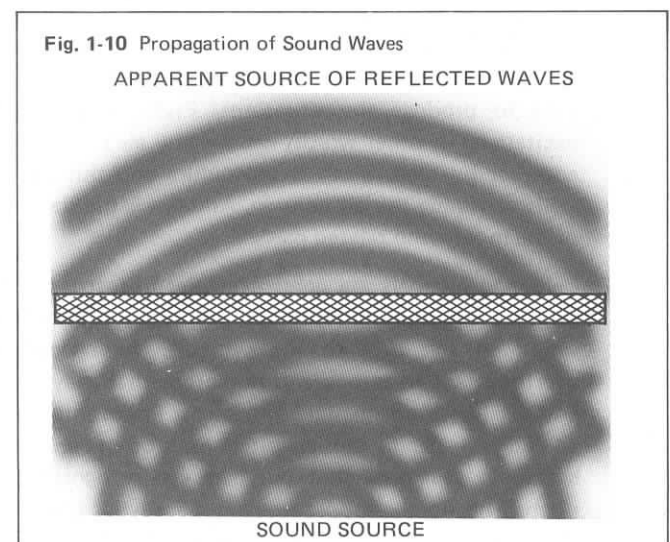
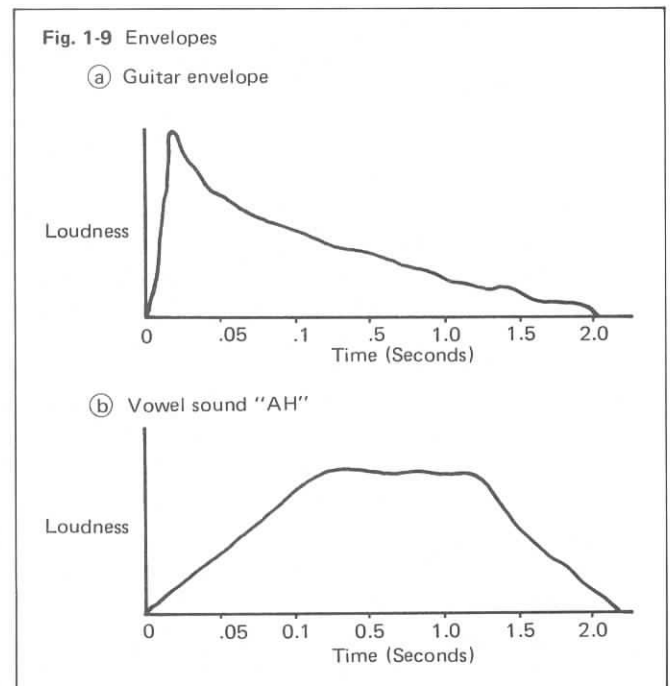

or reflected will be transmitted by the wall to the air behind it.

The amount of sound reflected, absorbed, and transmitted by the wall will depend on the materials used in its construction. Hard smooth walls tend to reflect a great deal of sound. Shower rooms and indoor swimming pools are good examples of rooms with highly reflective walls. Soft porous materials tend to absorb sound. Heavy drapes and thick carpets are good examples of sound absorbers. Thin walls tend to transmit more sound than thicker walls. Most professional sound studios use heavy thick walls to prevent transmission of sound into or out of the studio.

## 1-12 Echo and Reverberation

Echoes are produced when sound waves are reflected from a hard smooth surface such as a wall or cliff. If a person stands at a distance from such a hard surface and claps his/her hands, the time elapsed before the reflected sound is heard will depend on the distance to the surface. In order for the sound to be heard as a separate **echo**, it must be separated from the original sound by at least 0.1 second (100 milliseconds). Assuming the speed of sound to be 331 meters per second, the sound must travel a total of about 33 meters, or about 16.5 meters one way. If the surface is less than this distance, the returning echo will not be distinct but will seem to be a continuation of the original sound.

A sound emitted within the confines of a room will expand from the source and bounce back and forth between the walls, floor, and ceiling of the room. Remembering that sound expands as a series of spheres, it can be seen that these multiple reflections will soon become very complex. The effect is that the sound will be reinforced and will seem to continue for a time beyond the point when the original sound source ceases emitting sound. This type of echo is called **reverberation**.

Reverberation time is the amount of time required for the sound reflections within a room to die down to a given level after the source ceases emitting sound. The reverberation time of a room will depend on the reflective qualities of the surfaces within the room and the placement of objects in the room. Some experts are said to be able to judge the size of a room merely by listening to its reverberation characteristics. Many performers have been disconcerted by the seeming loss of carrying power they produce during a show as compared to rehearsals in the same hall when empty. The audience and their clothing are good absorbers of sound.

Many people like to sing while taking a bath. Most bathrooms have very good reflective qualities with long reverberation times. The reverberations tend to reinforce the sound of the singing so that even a person with a weak voice sounds powerful and dramatic in the environment of the bath.

In electronic music, it is important to differentiate between echo and reverberation. **Echo** is the effect produced by distinctly separate reflections of sounds. **Reverberation** is the

## 10 What is Sound?

effect produced by multiple reflections. In echo, the reflections can be easily heard as separate repetitions of the original sound even when they overlap. This is the familiar echo effect obtained by shouting in the mountains. In reverberation, the reflections are blurred together so that distinct repetitions are not heard, but rather the original sound seems to continue longer than normal.

### 1-13 Spatial Effects

In electronic music, most sounds start out as electrical vibrations generated and controlled by the synthesizer and related studio equipment; therefore, it is usually quite "dead" sounding when put through a speaker. An artificial environment must be added to the sound to give it life. This is one of the concepts of **spatial effects**.

The most important effect in electronic music is reverberation. With reverberation we can create the feeling of intimacy felt with a chamber orchestra in a small room or the feeling of overwhelming power produced by the pipe organ in a large cathedral. The amount of reverberation controls the size of the space in which our electronic performance seems to take place. Not only that, but we are not limited to a one size "room". We can change the apparent size of the space at will so that it matches the mood of the music at each moment.

Reverberation can also be used to control depth or distance. The person who sits in the front row at the concert hall hears mostly the sound received directly from the instruments, while the person in the last row will hear more of the reverberations than the direct sound (assuming speakers are not used). This gives a clue to the control of distance in electronic music. A melody played very softly with a great deal of reverberation added will sound very distant from the listener. A melody played loudly with little reverberation will sound very close to the listener.

Besides special effects, echo can add complexity to music by giving slightly delayed repetitions of sounds. When used with sustaining sounds such as string sounds, it can also add a great feeling of depth. The late repetition of these delayed sounds gives the effect of a much larger group of instruments.

When a group of musicians (or singers) play in unison together, they will each be playing a slightly different pitch. This is one of the clues that tells us that we are listening to a group rather than a solo. Units designed to generate **chorus effects** process the sound by altering the pitch slightly, then re-combining this with the original sound to give the effect of a group of players.

**Phase shifting** is another common effect used in electronic music, but the actual effect on the sound processed by a phase shifter is very difficult to describe with words. One description which comes fairly close, however, is to compare phase shifted synthesizer noise output to the sound produced by a jet plane which has just taken off and is moving into the distance. Phase shifting is an effect which is also common with acoustic instruments and electric guitars.

**1-14 Questions**

1. What are the three qualities of sound? Define them.
2. Assuming the speed of sound to be 330 meters per second, what is the wavelength of a sound wave with a frequency of 440 vibrations per second?
3. What is the frequency response of the ear in the normal average human being?
4. Define resonance. Give examples of resonance which occur in daily life.
5. List three factors which affect the pitch produced by a vibrating string and show how changes in each will affect the pitch.
6. How are overtones produced and how do they affect the sound?
7. Define envelope. Give some examples of familiar sounds and make diagrams showing the approximate envelope of each.
8. What three things happen when a sound wave encounters an obstruction such as a wall. Make a sketch showing this.
9. What is the difference between echo and reverberation?
10. Explain how reverberation can be used to control the apparent distance between the sound and the listener.

**Words to define:**

antinode  
echo  
envelope  
frequency  
fundamental  
harmonics  
Hertz  
Hz  
loudness  
monochord  
natural harmonic series  
node  
non-harmonic overtones  
overtones  
pitch  
rarefaction  
resonance  
reverberation  
sound  
sound waves  
spatial effects  
timbre  
tone color  
wavelength

# Electronic Music

## 2-1 Introduction

Throughout the ages composers have strived to break the bonds imposed by their art. A study of musical scores will show how again and again composers have tried to break away from the conventions of their times in search of newer avenues of expression. The use of newer harmonic structures and the invention of new instruments all came about as a result of this search. It is not surprising, then, that the discovery of electricity should usher in the development of non-acoustic instruments.

This text deals primarily with electronically generated (synthesized) sound. In electronic music we are not so much concerned with sound sources, but more with sources of electrical signals (or waveforms) which, when processed and passed through an appropriate amplifier/speaker system, become sound. We cannot, however, exclude the electronic processing of *acoustic* sound sources. Picking up sound with a microphone and passing it through an amplifier/speaker system is, technically speaking, electronic processing. For this reason it sometimes becomes quite difficult to draw the line between electronic music and non-electronic music, especially since electronic music often uses acoustic sound sources — sometimes with no alteration of the original sound quality.

In this chapter we shall look very briefly at some of the forms electronic music takes and explore methods for synthesizing sounds on a synthesizer.

## 2-2 Live Electronic Music

One form of live electronic music involves the use of a pre-recorded tape of electronically processed or generated sounds which is played on stage where one or more "live" solo instruments play in counterpoint to the tape. Another form of live electronic music involves the use of one or more synthesizers; the smaller stage type or sometimes the larger studio type. This type of music may or may not include the use of a pre-recorded tape. Acoustic instruments may also be involved. It is common to use human voices in their natural form and/or processed electronically. Stage action may be a part of the performance, as well as special lighting effects, including the use of lasers.

## 2-3 *Musique Concrète*

In *musique concrète*, portions of tape recorded sounds are cut up and patched together in different ways to form the finished composition. Many times the portions are altered before editing into the final composition. Among the many changes possible are abrupt stopping and starting of a sound, drastic or subtle changes in speed, playing the sound backwards, filtering, or any combination of these. Any sound which can be recorded on tape becomes a candidate for this art form. Considered from this point of view a tape recorder can be thought of as a musical instrument with as many creative possibilities as any other musical instruments.



Although the subject of *musique concrète* is not dealt with in any detail in this book, its importance cannot be overlooked. In the early days of electronic music, *musique concrète* was considered to be a completely different form of music with no relation to music generated with electronic oscillators, but today this is not so. Indeed, *musique concrète* techniques often form an integrated part of synthesizer generated electronic music, and synthesizers are often used as sound sources and sound modifiers in *musique concrète*.

## 2-4 Recorded Electronic Music

In most forms of electronic music the final product is a recording. In almost all of these cases it would be impossible to hear this recorded music in any other form. This type of electronic music usually involves the use of a multichannel tape recorder or the use of ordinary tape recorders in a fashion which imitates multichannel recording techniques. Usually, each voice in the composition is synthesized and recorded one at a time. This is very much like the process involved if we tried to record a symphony by having each musician come into the studio one at a time to record his/her part.

## 2-5 Waveforms

The tuning fork is an example of a sound source which vibrates only as a whole; therefore, it produces only the fundamental and no other harmonics. This sound is very clean and pure. If we could watch the movement of one of the prongs and graph this movement, we would get a diagram like that shown in Fig. 2-1 (a). The vibrating prongs of the tuning fork cause minute changes in air pressure. If these air pressure changes were diagrammed, they would appear as shown in (b). If we placed a microphone near the vibrating tuning fork, it would generate minute variations of electrical current whose voltage changes would be as shown in (c). An amplifier could be connected to the microphone and used to drive a speaker. The moving cone of the speaker would produce changes in air pressure which, assuming perfect equipment, would exactly mirror the air pressure changes originally produced by the tuning fork. The only difference would be that air pressure changes produced by the speaker could be larger (**amplified**) or smaller (**attenuated**) than the air pressure changes reaching the microphone, depending on the position of the amplifier volume control.

The three diagrams shown in Fig. 2-1 represent the **waveform** of the sound produced by the tuning fork. The only difference between these waves is the medium; in other words (a) is the movement of a prong, (b) is air pressure changes, and (c) is voltage changes. In electronic music, of course, we are usually more concerned with the medium of voltage changes.

The waveform produced by the tuning fork is called a **sine wave**. Imagine a pen attached to the end of a pendulum. If we place a length of paper under the pendulum in such a way that the pen remains in contact with the paper and if we pull

Fig. 2-1 Waveforms

(a) Movement of one prong

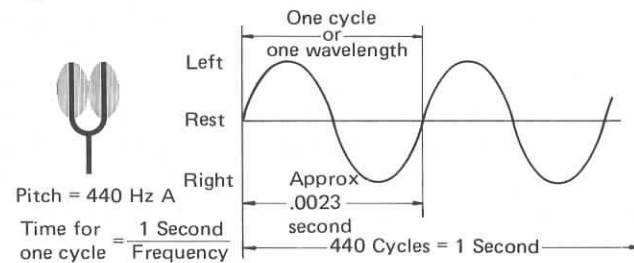

(b) Air pressure changes as a result of tuning fork vibration

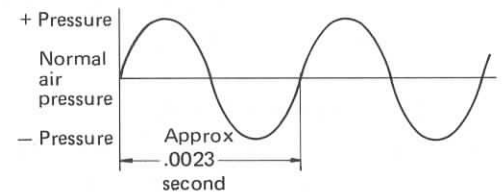

(c) Voltage generated by microphone (picking up tuning fork)

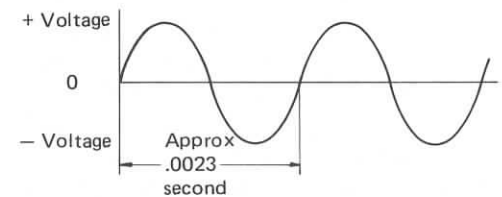
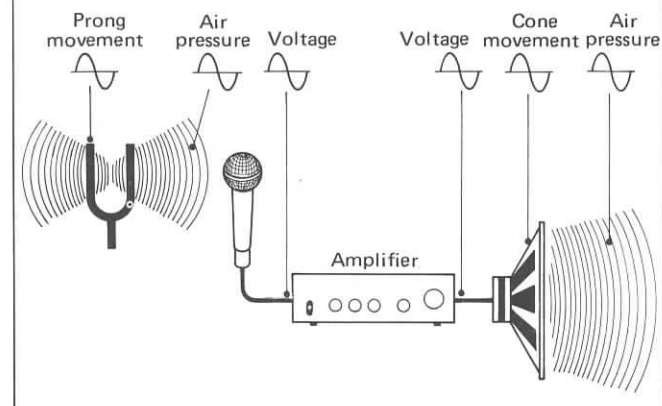
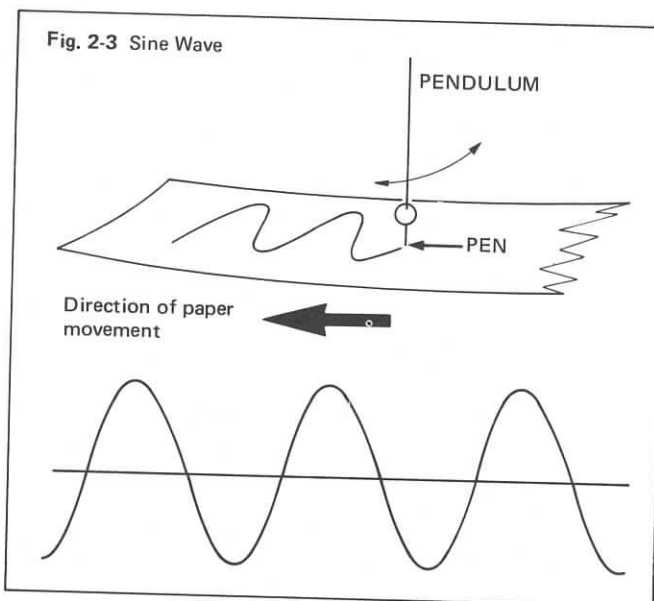

Fig. 2-2 Waveforms in an Audio System



the paper at a steady rate of speed as the pendulum swings, the pen will draw a perfect sine wave, as shown in Fig. 2-3. Sine waves are mathematically very closely related to the circle and they are very easy to generate using mechanical means that are based on the principle of the wheel. Ordinary household electricity is generated with machines which spin and thus produce current in the form of a sine wave. Most countries use either 60 Hz or 50 Hz for household electricity. 60 Hz produces the approximate pitch of B below the bass cleft, while 50 Hz produces the approximate pitch of the A below that. If we had tuning forks which could produce these pitches, the only difference between the sound of these tuning forks and the sound which could be produced by an ordinary house current would be one of intensity. The sound of the tuning fork would also gradually die away.

Since the complex vibration modes of different types of sound sources produce sounds with a different harmonic content, each type of sound source will produce its own unique waveform. A few waveforms are shown in Fig. 2-4.



**Fig. 2-4 Waveforms**

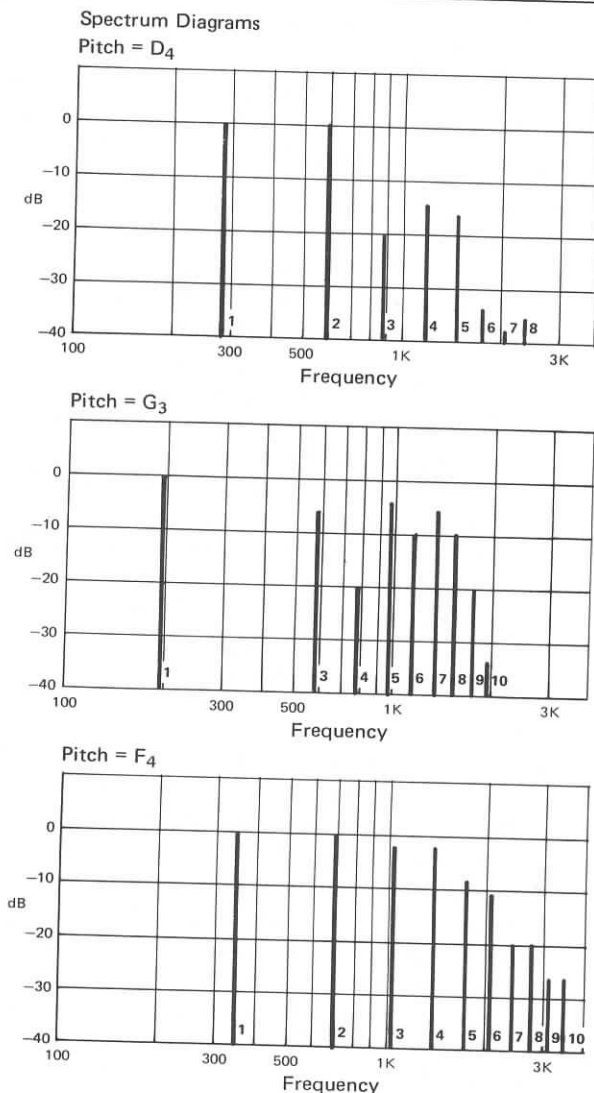
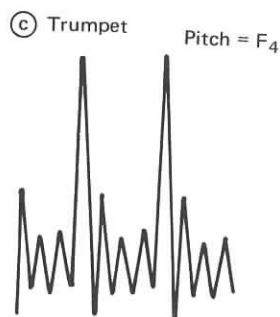
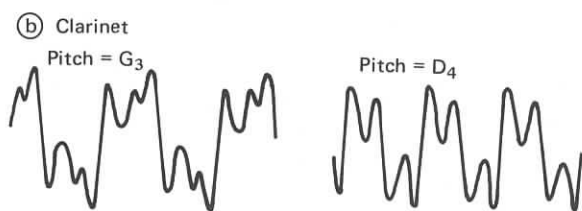
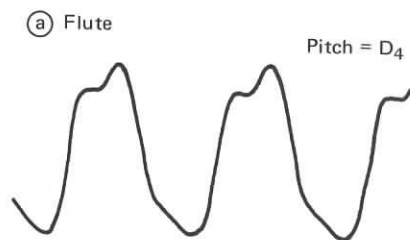

With each waveform is shown a **spectrum diagram**. Spectrum diagrams show the harmonic content of a sound or waveform. Frequency is shown along the bottom of each diagram. Each heavy vertical line represents a harmonic and the length of each line represents the relative amount of that harmonic which is contained in the total sound. In synthesizing sounds, spectrum diagrams will often prove much more useful than drawings showing waveforms. Waveforms are sometimes helpful, however, as seen with the flute waveform which is close to a sine wave indicating that the flute tone quality contains relatively few, low-intensity harmonics.

## 2-6 Additive and Subtractive Synthesis

In electronic music there are two basic approaches to synthesizing sounds: additive synthesis and subtractive synthesis.<sup>1</sup>

In **additive synthesis** we start with sine waves of various frequencies and add them together in the correct amounts to produce sound with the desired harmonic content. This method usually requires a large number of sine wave sources (one for each harmonic desired). The harmonic content of many sounds changes during its production, thus the accurate control of the amount of each individual sine wave becomes quite complex. For these reasons additive synthesis is not as common as subtractive synthesis, but even so, it is sometimes used to a certain extent with synthesizers designed for subtractive synthesis.

In **subtractive synthesis** we start with a waveform which is already rich in harmonics and use electronic filters to remove unwanted harmonics to produce the desired sound. In place of the vibrating air column, string, metal plate, etc., we use an **oscillator** (electronic waveform generator) which is set to generate a waveform rich in harmonics. The output of the oscillator is connected to a **filter** which alters the basic tone coloring in ways not unlike the effects of the body of a musical instrument. In many cases, one filter is enough to easily synthesize at least passable imitations of many sounds, but it is usually advantageous to use several filters to help imitate more closely the physical characteristics of the body of the instrument and the changes which occur during the production of each note. The oscillator, then, would be analogous to the vibrating portion of an instrument and the filter analogous to the body of the instrument.

In subtractive synthesis, two of the more common waveforms are the **sawtooth** (or **ramp**) **wave** and the **square wave**, shown in Fig. 2-5. A glance at the mechanical symmetry of these waveforms will hint at the fact that they are very simple to generate electronically. For example, a square wave can be generated very simply with a circuit which continually turns itself on and off. It is also easy to accurately control the frequency of such wave generators, this being an important consideration for accurate pitch control in music. The exactness of these waveforms also gives a hint of the regularity of the harmonic content of each, as shown in the respective spectrum diagrams.

1. This discussion disregards direct synthesis by computer which is presented later in this chapter (2-11; p. 23).

Fig. 2-5 SYNTHESIZER WAVEFORMS

(a) HARMONIC SPECTRUM OF PERFECT SAWTOOTH WAVE

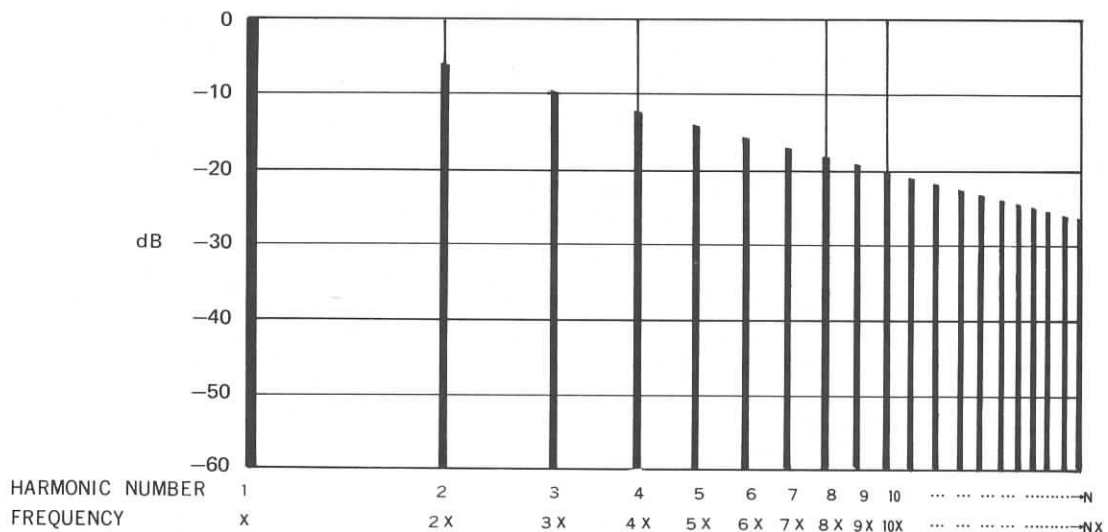
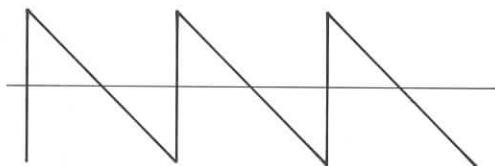

(b) HARMONIC SPECTRUM OF PERFECT SQUARE WAVE

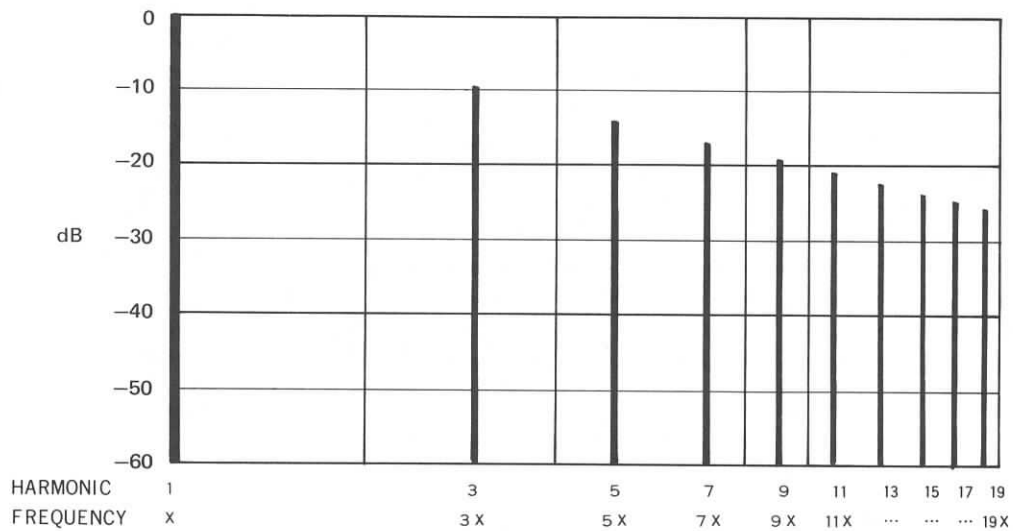
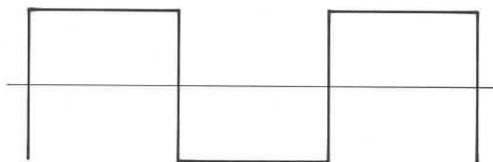

In Fig. 2-6 (a), three sine waves representing the frequencies  $x$ ,  $2x$ , and  $3x$  (in other words, the first, second, and third harmonics) are added together, the result of which looks much like a sawtooth wave. If more harmonics were added, the result would be a more perfect sawtooth wave. The perfect sawtooth wave (Fig. 2-5 (a)), then, contains harmonics which extend theoretically upwards to infinity. In Fig. 2-6 (b), three sine waves of frequencies  $x$ ,  $3x$ , and  $5x$  (odd numbered harmonics) are added together with the result looking much like a square wave.

The sine wave and square wave are exactly symmetrical, both horizontally and vertically; the wave patterns continually repeat themselves, and if they are inverted, they look and sound the same, as shown in Fig. 2-7. When inverted, only the **phase**, or starting point, is different. Notice that if waveforms (a) and (b) are added together, the result is zero, or no sound. The same is true of waveforms (c) and (d).

The sawtooth wave may seem vertically unsymmetrical because it looks different when inverted; the ramps go up instead of down. Fig. 2-8 (a) shows what happens when we add three inverted sine waves of frequencies  $x$ ,  $2x$ , and  $3x$ . Since the sound of a sine wave does not change when it is inverted, we might expect that adding inverted sine waves together would not produce a sound different from that obtained by adding non-inverted sine waves, and this is exactly what happens. The sound of the inverted sawtooth wave and the sound of the non-inverted sawtooth wave are exactly the same. For this reason, it is not important whether a synthesizer produces up-going or down-going ramps as a source for sawtooth waves.

In Fig. 2-6, all harmonics are in phase with each other. In other words, at the point where the harmonics all cross the center "0" line at the same time (as they do at the beginning of the periods diagrammed), they are moving in the same direction: up. In Fig. 2-8 (a), they are all moving down. Fig. 2-8 (b) shows what happens when we try to make a square wave with odd numbered harmonics, but invert one (the third harmonic) so that it is out of phase with the others. The important point here is that although the resulting waveform does not look anything like a square wave, it contains exactly the same harmonics as the wave in Fig. 2-6 (b), *thus it will sound exactly the same*. The tone color of a sound source, then, will depend on the harmonic content of that sound and will usually have no relation to the phase relationships of those harmonics except in sound sources where the phase relation is in constant change (an effect produced by a phase shifter). This is why spectrum diagrams are usually more useful than knowing the waveform of a sound source.

Even so, in some cases knowing the waveform of a sound source can be helpful, as with the flute example cited in 2-5 above. Another example is that of the clarinet, whose waveforms are shown in Fig. 2-4 (b). These waveforms are clearly quite near a square wave and checking the spectrum diagram reveals that the odd numbered harmonics are stronger than

Fig. 2-6 Addition of Harmonics

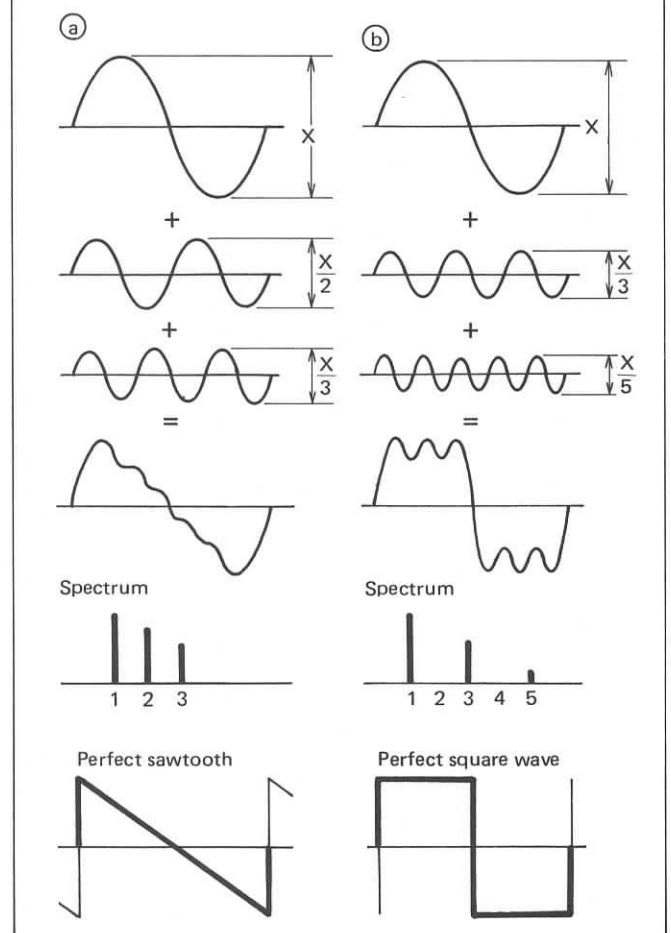
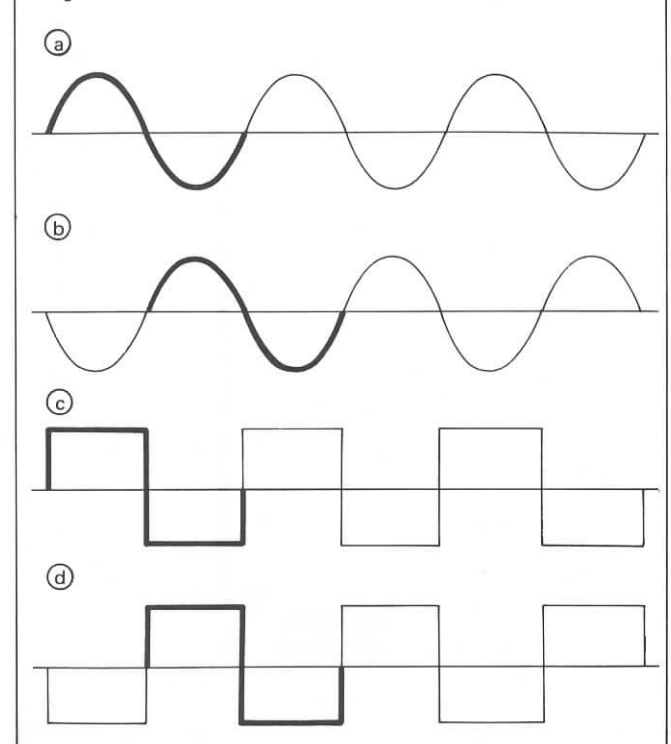

Fig. 2-7 Inversion of Waveforms



the even numbered harmonics. This, and the shape of the waveforms, suggests that the square wave would be a good place to start in synthesizing a clarinet. This is borne out by the fact that the perfect square wave already sounds much like a clarinet without any processing. Note that the waveforms for the two pitches shown are a little different, indicating that the tone color of the instrument changes with pitch.

## 2-7 The Voltage Controlled Synthesizer

All voltage controlled synthesizers are basically alike. The main differences are the package, the number of elements or modules available for synthesis, the number of communication points between the musician and the internal circuits, and the sophistication of the circuits. The principals of synthesis remain the same for all synthesizers.

**Voltage control** is based on the concept of **modulation**: the control of one parameter by another. Most sound sources produce sound which is quite complex. During the production of only one note, many acoustical events may take place. The most common are changes in loudness (the envelope) and changes in the harmonic content of the sound. Most of these events occur much too rapidly for them to be controlled manually. This is where voltage control comes in. If we know exactly how a parameter (such as loudness or harmonic content) will react to a specific voltage change, it is often relatively simple to provide controlled voltage changes which will produce the exact effect desired. With systems which allow free interconnection of the synthesizer elements (**patching**), another advantage of the concept of voltage control is that it is possible to connect *any* element output to any other element input, thus providing a tremendous variety of possibilities in synthesis.

## 2-8 An Approach to Subtractive Synthesis

The synthesis of sound is an art in itself. The most important ingredients to its mastery are patience and practice; practice particularly in the sense of familiarity with the synthesizer controls and their effect on the output sound.

Fig. 2-9 shows the basic patch or connection of the three basic synthesizer elements which are the most closely related to the three qualities of sound: pitch, tone color, and loudness. As shown, the arrangement is relatively useless because there are no control (modulation) inputs. These will be added in later chapters.

The **voltage controlled oscillator** or **VCO** is the basic source of pitch. An oscillator is simply an electronic circuit which generates electrical waveforms. The frequency or pitch of these waves is controlled by means of a **control voltage**. The most obvious source of pitch control voltage would be a keyboard, but there are many other possible sources.

The **voltage controlled filter** or **VCF** is the basic element concerned with control of tone color. A filter is an electronic circuit which is able to remove or accent desired frequencies

Fig. 2-8 Inversion of Harmonics

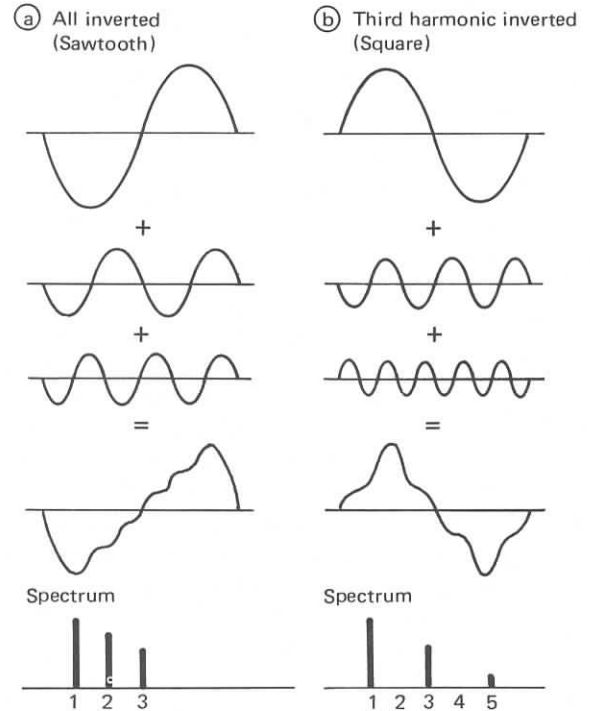
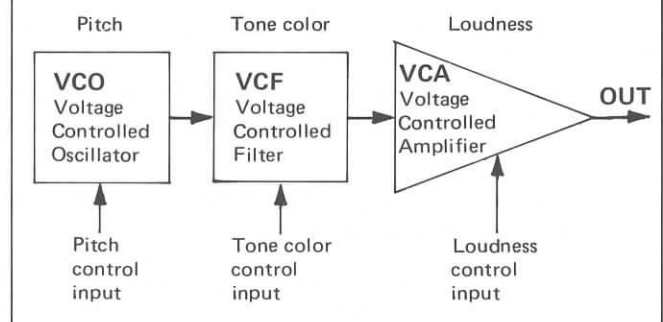

Fig. 2-9 The Basic Synthesizer Patch



or harmonics in a sound source. The particular frequencies or harmonics acted on can be decided by means of a control voltage. The advantage of voltage controlled filter characteristics is with sounds in which the harmonic content changes during the production of a note and for creating the tone color changes in those sounds which are particularly associated with the synthesizer.

The **voltage controlled amplifier** or **VCA** is used to control the articulation of the sound by means of a control voltage.

Of the three qualities of sound, pitch and loudness usually present little problem in synthesis. If we want to synthesize a piccolo or a pizzicato string bass, it is extremely simple to decide and set the correct pitch range, and by repeatedly pressing a key on the keyboard while adjusting the loudness related controls, we can easily arrive at the correct envelope for the desired sound. Tone color is a different matter, however, and often requires much trial and error no matter how logically it is approached. This is where practice and patience will pay off. Tone color is also strongly affected by pitch and envelope or loudness. For these reasons, it is usually best to approach the synthesis of a specific sound by first deciding and setting the correct pitch range, then the correct loudness contour or envelope. Once these qualities of sound are more or less correct, it is possible to approach and experiment with tone color.

## 2-9 Noise

The VCO forms the basic sound source for synthesizing pitched sounds. Most synthesizers also include another source of sound called the **noise generator** which is used for synthesizing non-pitched sounds. Usually, two types of noise are provided: white noise and pink noise. **White noise** is the random combination of all frequencies and produces a hissing sound much like that which can be heard when an FM radio tuner is set between stations. **Pink noise** contains fewer higher frequencies and produces a rushing sound much like a waterfall. Noise is discussed in a little more detail in Chapter 5 (p. 51). Fig. 2-10 shows a noise waveform.

Fig. 2-10 Noise Waveform

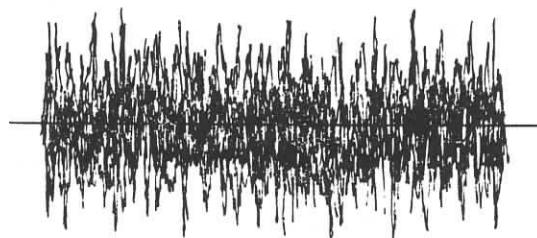

## 2-10 Computer Music

The computer is becoming more and more common in the production of electronic music. Many of the first experiments involving computers and music were aimed at trying to have computers "compose" music, thus the term computer music may often be much misunderstood. This approach is no longer common.

The use of computers in music more recently can be divided into two basic categories:

1. The use of computers to completely or partially control a synthesizer.
2. Direct synthesis in which a computer is used to generate any desired waveform.

Before discussing these two categories, it might be well to

look at the question of why musicians would want to use a computer in music.

At best, the score is only a poor representation of the musical sounds the composer/arranger intended, and, therefore, must be translated or interpreted. Fig. 2-11 illustrates this process.

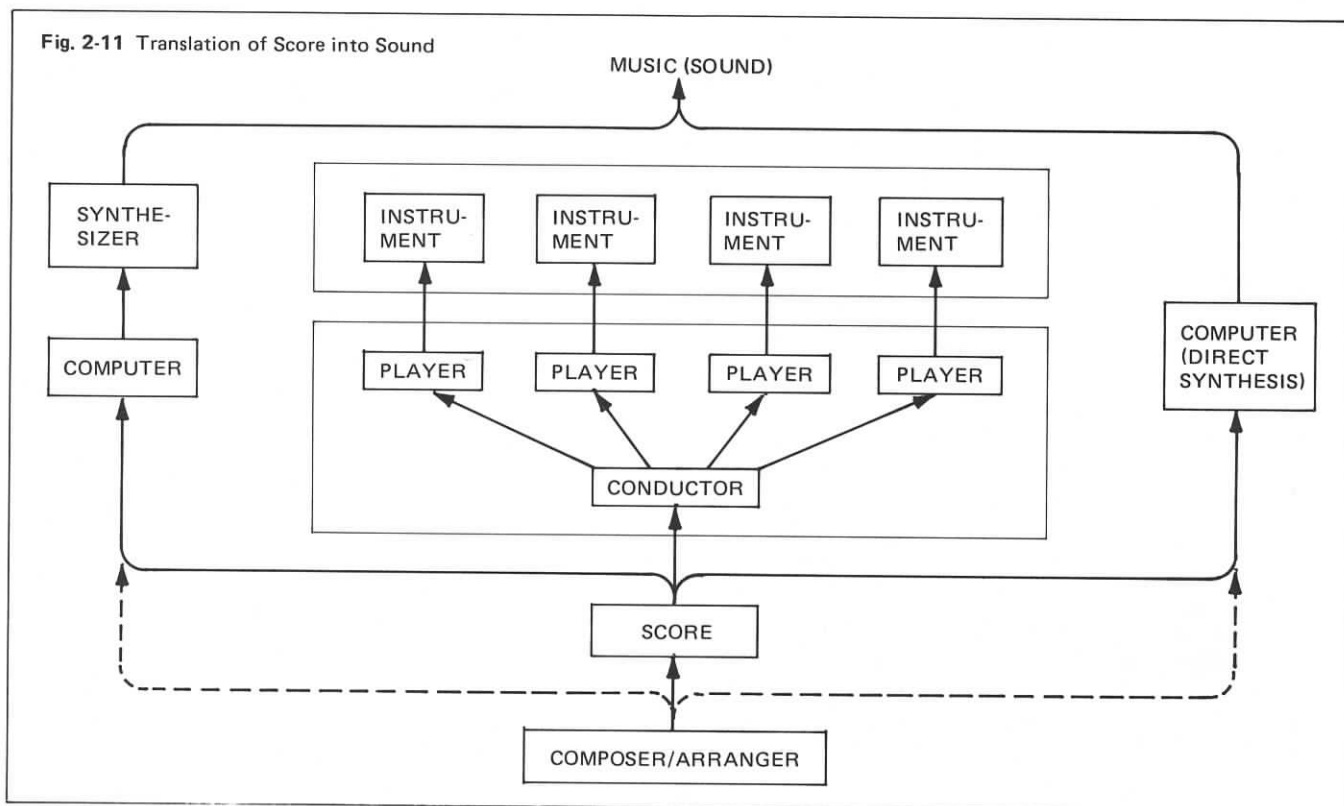

Normally, the conductor interprets the score. In one passage the horns should be louder than the other instruments, and in another the music should slow down with these notes being held a little longer than the other notes, and so on. During the actual performance, the conductor can normally use only body motions to remind the players of what is desired of them. Even in the best of bands and orchestras there will be some loss as the music filters down through each player to the instruments, and thus finally emerges as sound. Using a computer, the composer/arranger may translate music into sound without the need to filter it through a group of people.

It is a simple matter to translate a score directly into computer data for the production of music, but the result would be very mechanical sounding. The result would be the same if a conductor conducted the score without trying to interpret it in any way, except that the computer could produce more accurate timing. It is very important for the musician who uses a computer to interpret the music and incorporate these interpretations into the computer program.

Returning to the two categories in which computers are used, in the first category a computer is programmed with



numbers which represent the voltage levels and pulse timings desired by the musician for the control of an ordinary voltage controlled synthesizer. The computer, in effect, takes the place of the keyboard controller or other controllers used with the synthesizer.

Most electronic music is recorded one melody line at a time, hence it is very difficult to judge how the different parts will sound when mixed together. The result is often unacceptable and some or all of the parts must be recorded over. Computers offer a large advantage in this area since they can be programmed to provide simultaneous control of several melody lines thus allowing the musician to hear how the combination will sound.

Within the category of computer controlled synthesizers are two approaches. The first is to use a standard computer system in which a special "music" program would have to be written and implemented. This requires an intimate knowledge of computer programming which becomes one of the major drawbacks of this approach. The other major drawback is that it would usually be necessary to design and build custom interfacing units in order to convert the computer outputs into control voltages and gate pulses which the synthesizer can use. If the musician is not interested in learning enough to do this, he/she might be lucky enough to enlist the aid of a computer hobbyist. The larger of the home computer systems is capable of handling a rather sophisticated music program which would make it quite easy for the musician to use. The smaller of these systems would also be capable of music programs, but would be rather limited in what they could do and would probably require a rather specialized music encoding procedure.

The second approach to computer controlled synthesizers would be to use a specialized computer which has been designed so that its sole purpose is the control of a synthesizer. The Roland MC-4 MicroComposer is the first example of this type of computer to be put on the market. It uses a simple encoding system which was first developed by composer Ralph Dyck for use with a programmable digital sequencer which he built for his commercial studio in Vancouver, Canada.

The fundamental difference between the MicroComposer and a digital sequencer, programmable or otherwise, is that the MicroComposer was designed around an integrated circuit called a **microprocessor** or **CPU** (Central Processing Unit). It is the microprocessor which is responsible for the versatility of the MicroComposer. Since the MicroComposer was designed with the musician in mind, it requires no knowledge of computers or computer programming. It provides control for as many as eight melody lines plus as many as six percussion voices, all completely independent of each other. Its operation is very much like that of an electronic desk calculator and, due to the use of a microprocessor, the MicroComposer provides a great number of operating functions which give the musician an unprecedented amount of control over the music being produced. To produce a similar amount of control in a home type computer would

require a rather large system and sophisticated programming techniques.

### 2-11 Direct Synthesis

In the second category of computers used in music, a series of numbers which represent the instantaneous values of voltage levels at different points in a waveform are stored in a computer memory and called forth as needed to produce sound. This is **direct synthesis**.

It is easier to understand direct synthesis by first demonstrating how a waveform can be analyzed and stored in a computer as data. This is done by sampling the sound wave at regular closely spaced intervals. Each sample would represent the instantaneous voltage level of the sound wave at the sampled time. Each of these voltage values is converted into a number which is then stored in its own space in the memory. This is shown in Fig. 2-12 (a).

Fig. 2-12 Direct Synthesis

(a) Wave sampling

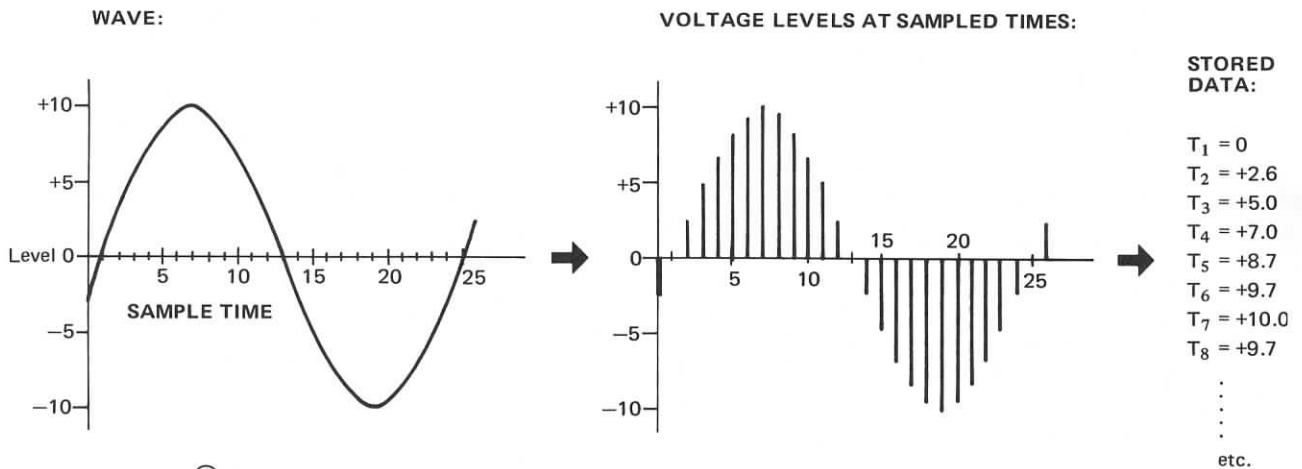

(b) Wave generation

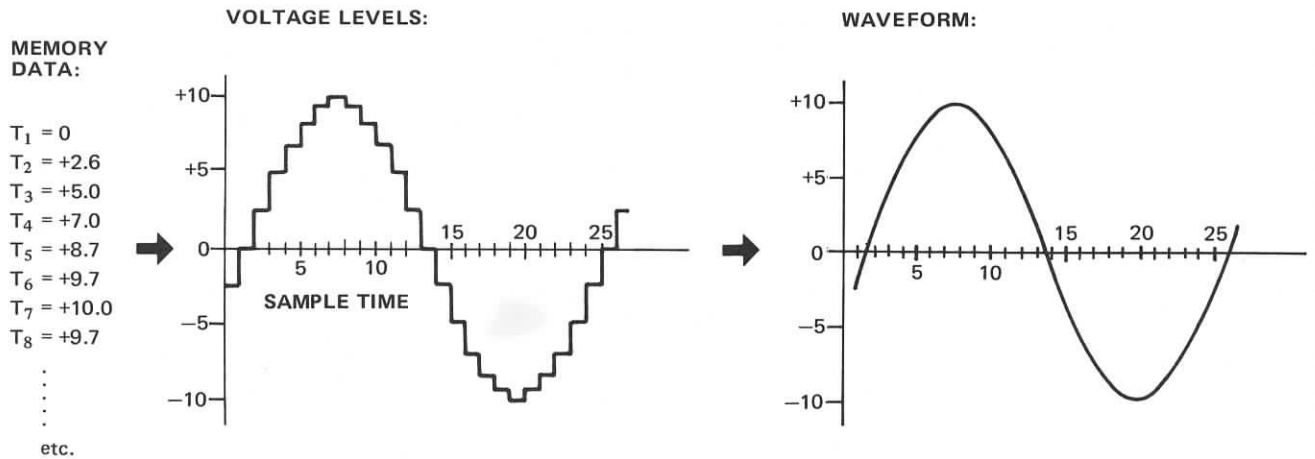

To retrieve the sound wave, the computer reads the stored data in the memory much as a person might run a finger steadily down a column of figures. As each number is read, it is converted into its corresponding voltage level. Each voltage level is held until a new level comes along. The total result is a sound wave which is squared off; it has only horizontal and vertical lines, no slants or curves. A filter is used to smooth these corners off. This process is shown in Fig. 2-12 (b).

First, it can be seen that the sampling rate would have to be rather fast compared to the sound wave. The more samples taken, the more closely the reproduced sound wave will resemble the original. There is a definite upper limit of sampling speed which each computer can handle.

Second, there will be a limitation to the numbers available for showing voltage levels. In the example shown in Fig. 2-12, if the computer cannot handle the digits to the right of the decimal point, the data for the sine wave would have to be rounded off and written:

|           |              |
|-----------|--------------|
| $T_1 = 0$ | $T_6 = 10$   |
| $T_2 = 3$ | $T_7 = 10$   |
| $T_3 = 5$ | $T_8 = 10$   |
| $T_4 = 7$ | $T_9 = 9$    |
| $T_5 = 9$ | $T_{10} = 7$ |
|           | ETC.         |

Thus it will be less like the original sine wave than the original example was, as shown in fig. 2-13.

Since numbers representing the waveform are stored in the computer memory, it becomes a very simple matter to alter the wave by altering the numbers. From this it can be seen that it is possible to invent *any* waveform and convert it to data for loading into the memory. This is direct synthesis which can *exactly* imitate any known sound, or can create completely new sounds.

The major disadvantage of direct synthesis is that it requires an extremely large computer system and is thus limited to large institutions. It also requires an intimate knowledge of computers and programming, including advanced mathematics.

Fig. 2-13 Distortion in Direct Synthesis

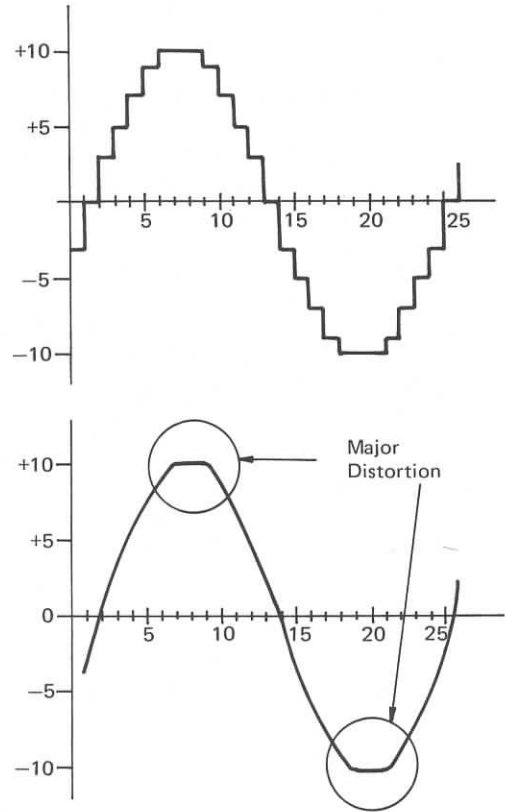

## 2-12 Questions

1. List some of the forms which electronic music can take.
2. Draw a sine wave. Explain this drawing in terms of air pressure changes. In terms of variations of electrical current.
3. Explain additive and subtractive synthesis. Which is more common? Why?
4. What are two commonly used waveforms in subtractive synthesis? Why are they good for subtractive synthesis? Give the harmonic content of each.
5. What effect does inverting a waveform have on its tone color? What effect does inverting some of the harmonics in a sound have on the waveform? On the tone color?
6. What is the advantage of voltage control in a synthesizer?
7. In what ways are a stage type synthesizer and a large studio system synthesizer different? In what ways are they alike?
8. What are the three qualities of sound and what are the synthesizer elements most associated with each?
9. Generally, in which order should the three qualities of sound be considered when synthesizing a sound? Why?
10. What are the two categories in which computers are used in electronic music?

### Words to define:

additive synthesis  
 computer music  
 direct synthesis  
 electronic music  
 modulation  
*musique concrète*  
 noise  
 noise generator  
 oscillator  
 phase  
 pink noise  
 sawtooth wave  
 sine wave  
 spectrum  
 square wave  
 subtractive synthesis  
 synthesis  
 VCA  
 VCF  
 VCO  
 voltage controlled amplifier  
 voltage controlled filter  
 voltage controlled oscillator  
 voltage controlled synthesizer  
 waveform  
 white noise

# Pitch

## 3-1 Introduction

The first quality of sound which we shall discuss in detail is pitch. **Pitch** is that quality of sound in which some sounds seem higher or lower than others. In the voltage controlled synthesizer, the main source of pitch is the Voltage Controlled Oscillator or VCO.

One of the most common sources of control voltage for the VCO is the keyboard controller. The keyboard controller is nothing more than a voltage divider; the level of the voltage output depends on which key is pressed. When the control voltage is applied to a properly calibrated VCO, the VCO will generate a pitch which is related to the key pressed.

In order to better understand the relation between the frequency output of the VCO to the voltage input, it is necessary to review the construction of our musical scale system.

## 3-2 Pitch Relationships in Music

In music, instead of frequencies, pitches are given letter names or syllable names, or sometimes numbers.

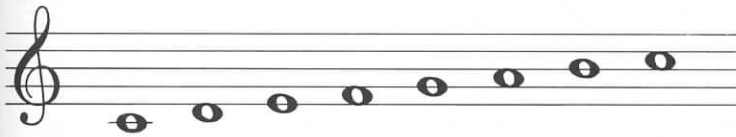

|    |    |    |    |    |    |    |           |
|----|----|----|----|----|----|----|-----------|
| C  | D  | E  | F  | G  | A  | B  | C         |
| DO | RE | MI | FA | SO | LA | TI | DO        |
| 1  | 2  | 3  | 4  | 5  | 6  | 7  | 8 (or 1)) |

When more than one note is sounded together, this is called a chord.<sup>1</sup> The result we hear as harmony. Different chords produce harmony which to our ears has different qualities.

The distance between two pitches is called an **interval**. The two qualities of an interval are: consonance and dissonance. A **consonant** interval (sometimes called a **concord**) is an interval which to our ears seems to be harmonically at rest or comfortable. A **dissonant** interval (sometimes called a **discord**) is an interval which seems jarring to our ears and not harmonically restful.

It is possible to play a number of intervals and have a group of people judge in which order they should be placed so that when played they would move gradually from consonant to dissonant. Somewhere near the middle of this progression would be a dividing line between consonance and dissonance. The position of this dividing line has changed over the years so that chords which we consider consonant now would have been considered dissonant in the earlier periods of music.

The interval which causes the least amount of jarring when it is heard is **unison**: two pitches of exactly the same frequency. The next most pleasing interval is the **octave**. In the

1. Some scholars would prefer to define a chord as having at least three different pitches, but this point is not important to the present discussion.

octave, the frequency of the upper pitch is exactly twice that of the lower pitch. Most musical scale systems are based on the relationship of the octave. For example, the Arabs use an octave divided into equal sixteenths, and the Hindus divide the octave into twenty-two steps, but use only seven of these.

The Western system of music usually divides the octave into twelve parts. In the early days of music, these divisions were tuned in what is called **just** (as in "right") **intonation**. Although the twelve divisions are unequal, the frequencies of these pitches have very close relations to each other. As an example, the perfect fifth has a ratio of 3:2. In other words, if the upper pitch is 300 Hz, then the lower pitch will be 200 Hz. Fig. 3-1 shows the frequency ratios of the intervals in the just tuned scale. It should be noted that the consonance or dissonance of an interval is closely related to the ratio of the frequencies of that interval. The smaller the numbers used to express the ratio, the more consonant the interval.

The scale of just intonation produces harmony which is pleasing to the ear because of these interval relations, but it causes major problems with instruments using fixed tuning systems such as the piano or organ keyboard and guitar frets. It is impossible for this type of instrument to modulate to distantly related keys without retuning the instrument.

The inability to modulate freely was one of the reasons for the development of what we call the scale of **even** (or **equal**) **temperament**. In this scale, the octave is divided into twelve *equal* parts. The frequency ratio between any two adjacent notes (semitones) is exactly the same. With equally spaced pitches it becomes obvious that the intervals in a scale retain the same relationship no matter which note is used for the starting point. The frequency ratio of a major sixth will remain exactly the same no matter which pitch is used to build it on. The unequal divisions of the just scale will form correct intervals only when certain pitches are used as the starting point.

Fig. 3-2 shows the frequency ratios for the scale of even temperament. Fig. 3-3 shows a comparison of the frequencies between the scale systems using a one octave scale starting on middle C. If we assign middle C the frequency of 264 Hz (which it often is in scientific laboratories), the frequencies of the two scale systems would be as shown. Also note that expressing the frequencies of the just scale accurately requires fewer digits.

### 3-3 Beat Frequencies

Although Western music primarily uses the equally tempered scale, the scale of just intonation is not obsolete. The violin, for example, has no frets and can, therefore, play intervals of any frequency ratio. Most good violinists have a tendency to sound just intervals in whatever key they are playing even when playing with inflexible evenly tempered instruments.

The reason for this is the interaction which takes place when two closely related pitches are sounded together. This interaction takes the form of a wavering in the loudness

Fig. 3-1 Frequency Ratios for Scale of Just Intonation

(a) Interval Ratios

| Interval               | Frequency ratio | Cents* from starting point |
|------------------------|-----------------|----------------------------|
| Unison                 | 1:1             | 0                          |
| Semitone               | 16:15           | 111.731                    |
| Minor tone             | 10:9            | 182.404                    |
| Major tone             | 9:8             | 203.910                    |
| Minor third            | 6:5             | 315.641                    |
| Major third            | 5:4             | 386.314                    |
| Perfect fourth         | 4:3             | 498.045                    |
| Augmented fourth       | 45:32           | 590.224                    |
| Diminished fifth       | 64:45           | 609.777                    |
| Perfect fifth          | 3:2             | 701.955                    |
| Minor sixth            | 8:5             | 813.687                    |
| Major sixth            | 5:3             | 884.359                    |
| Harmonic minor seventh | 7:4             | 968.826                    |
| Grave minor seventh    | 16:9            | 996.091                    |
| Minor seventh          | 9:5             | 1,017.597                  |
| Major seventh          | 15:8            | 1,088.269                  |
| Octave                 | 2:1             | 1,200.000                  |

\*(See p. 32)

(b) Intervals in Order from Consonance to Dissonance

Interval: Unison Octave Perfect fifth Major sixth Major third Perfect fourth Minor third Minor sixth  
 Frequency ratio: 1:1 2:1 3:2 5:3 5:4 4:3 6:5 8:5

Fig. 3-2 Frequency Ratios for Equally Tempered Scale

| Interval                                 | Frequency ratio | Cents* from starting point |
|------------------------------------------|-----------------|----------------------------|
| Unison                                   | 1:1             | 0                          |
| Semitone or minor second                 | 1.059463:1      | 100                        |
| Whole tone or major second               | 1.122462:1      | 200                        |
| Minor third                              | 1.189207:1      | 300                        |
| Major third                              | 1.259921:1      | 400                        |
| Perfect fourth                           | 1.334840:1      | 500                        |
| Augmented fourth }<br>Diminished fifth } | 1.414214:1      | 600                        |
| Perfect fifth                            | 1.498307:1      | 700                        |
| Minor sixth                              | 1.587401:1      | 800                        |
| Major sixth                              | 1.681793:1      | 900                        |
| Minor seventh                            | 1.781797:1      | 1,000                      |
| Major seventh                            | 1.887749:1      | 1,100                      |
| Octave                                   | 2:1             | 1,200                      |

\*(See p. 32)

Fig. 3-3 Comparison of Scale System Frequencies

| Scale System    | C        | D        | E        | F        | G        | A        | B        | C        |
|-----------------|----------|----------|----------|----------|----------|----------|----------|----------|
| Just Intonation | 264.0    | 297.0    | 330.0    | 352.0    | 396.0    | 440.0    | 495.0    | 528.0    |
| Equal Tempering | 264.0000 | 296.3300 | 332.6191 | 352.3978 | 395.5530 | 443.9934 | 498.3657 | 528.0000 |

of the total sound and is called a **beat**. Fig. 3-4 illustrates this. For simplicity, 6 Hz and 5 Hz are shown rather than audio frequencies. Waveform (c) represents the algebraic addition of waveforms (a) and (b). The changes in loudness can be seen clearly in (c) where the sound starts at maximum loudness, dies down to minimum at the center of the diagram, then expands again to maximum loudness at the end of the period shown. In other words, the frequency of the loudness variations is one cycle per second, or 1 Hz. Note that  $6 \text{ Hz} - 5 \text{ Hz} = 1 \text{ Hz}$ . For near unison, then, the beat frequency will be the difference between the two pitches.

Other intervals will also produce beats when they are mistuned. The ease with which these beats can be heard will depend on the consonance or dissonance of the interval; the more consonant, the easier they are to hear.

As an example, if we start with a pitch of 440 Hz, a perfect fifth above this would be 660 Hz because the frequency ratio of a perfect fifth is  $3:2$  ( $\frac{3}{2} = \frac{660}{440}$ ). If the upper pitch happens to be 663 Hz, then we will hear a beat frequency of 3 Hz because the upper pitch is 3 Hz higher than the correct 660 Hz.

In the equally tempered scale, the frequency of a perfect fifth above 440 Hz is 659.26 Hz (see chart facing p. 66). The result is that when an equally tempered fifth is sounded, we hear a beat of 0.74 Hz ( $660 - 659.26 = 0.74$ ). A good violinist would have a tendency to adjust his/her pitch to eliminate this beat when playing harmony with other instruments.

Musical instruments are very often tuned using beat frequencies. The instrument being tuned is first adjusted so that it produces a pitch at approximate unison (or some other interval, if desired) with a reference such as another instrument, a tuning fork, or a test oscillator. The instrument is then sounded together with the test pitch and fine tuned to eliminate the beat.

The presence of beat-producing intervals in the equally tempered scale is a useful point to keep in mind when working with electronic music. Many sounds in electronic music are of a character which makes these beats easier to hear than if the music were played on acoustic instruments; therefore, it is sometimes necessary to compensate for this by hiding these beats under the overall musical texture, or by employing some other means to correct offending pitches.

### 3-4 The Natural Harmonic Series

In Chapter One it was shown how vibratory systems tend to be quite complex, vibrating at various frequencies at the same time. These frequencies are called **overtones**. In most systems, these overtones have definite mathematical relationships with each other so the upper overtones are all multiples of the lowest or fundamental. Overtones of this type are called **harmonics**.

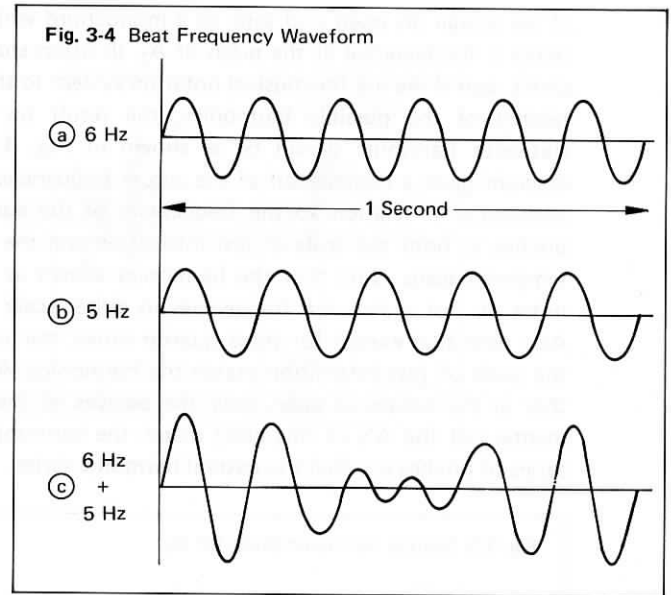

If we design an open end pipe or a monochord which produces a fundamental at the pitch of  $A_2$  (bottom space bass clef), and if we use the musical notation system to show the pitches of the possible harmonics, the result up to the sixteenth harmonic would be as shown in Fig. 3-5. This diagram gives a comparison of the actual frequencies of the harmonics in relation to the frequencies of the equivalent pitches in both the scale of just intonation and the equally tempered scale. Note that the harmonics shown as quarter notes do not match the frequencies in either scale system. Also note that except for these quarter notes, the pitches in the scale of just intonation match the harmonics. And last, that in the tempered scale, only the octaves of the fundamental (all the A's in this case) match the harmonics. This series of pitches is called the **natural harmonic series**.

Fig. 3.5 Natural Harmonic Series for  $A_2$



| Name of note:                          | $A_2$  | $A_3$  | $E_4$  | $A_4$  | $C\#_5$ | $E_5$  | $G_5$  | $A_5$  | $B_5$  | $C\#_6$ | $D\#_6$ | $E_6$   | $F\#_6$ | $G_6$   | $G\#_6$ | $A_6$   |
|----------------------------------------|--------|--------|--------|--------|---------|--------|--------|--------|--------|---------|---------|---------|---------|---------|---------|---------|
| Number of harmonic:                    | 1      | 2      | 3      | 4      | 5       | 6      | 7      | 8      | 9      | 10      | 11      | 12      | 13      | 14      | 15      | 16      |
| Frequency of true harmonic:            | 110    | 220    | 330    | 440    | 550     | 660    | 770    | 880    | 990    | 1100    | 1210    | 1320    | 1430    | 1540    | 1650    | 1760    |
| Actual frequencies of the notes shown: |        |        |        |        |         |        |        |        |        |         |         |         |         |         |         |         |
| Just intonation:                       | 110.0  | 220.0  | 330.0  | 440.0  | 550.0   | 660.0  | 770.7  | 880.0  | 990.0  | 1100.0  | 1237.5  | 1320.0  | 1466.7  | 1540.0  | 1650.0  | 1760.0  |
| Equal tempering:                       | 110.00 | 220.00 | 329.63 | 440.00 | 554.37  | 659.26 | 783.99 | 880.00 | 987.77 | 1108.70 | 1244.50 | 1318.50 | 1480.00 | 1568.00 | 1661.20 | 1760.00 |

### 3-5 Consonance and Dissonance

With the preceding as background it is possible to give a better understanding of what causes consonance and dissonance in musical intervals. In Fig. 3-6 are shown some pitches with some of their harmonics written above them. The pitch in (b) is shown one octave above the root in (a). Note that if these two pitches are sounded together, most of the harmonics in (a) reinforce the first harmonics in (b). Note that in (c), which shows the perfect fifth above the root, fewer harmonics match. With the strong dissonance of the minor second shown by (e), none of the harmonics match. Also note that (a), (b), (c), and (d) form a major triad and that when sounded together many of the harmonics coincide with each other.



Fig. 3-6 Consonance and Dissonance

The diagram illustrates five musical intervals on a grand staff (treble and bass clefs). Each interval is represented by a whole note in the treble clef and its lower harmonics in the bass clef. Harmonic numbers are indicated by dots and arrows pointing to the corresponding notes.

- (a) ROOT: Treble clef has notes 7, 6, 5, 4, 3. Bass clef has notes 2, 1.
- (b) OCTAVE (Consonant): Treble clef has notes 5, 4, 3, 2. Bass clef has notes 1, 1.
- (c) FIFTH: Treble clef has notes 6, 5, 4, 3, 2. Bass clef has notes 1, 1.
- (d) THIRD: Treble clef has notes 7, 6, 5, 4, 3, 2. Bass clef has notes 1, 1.
- (e) MINOR SECOND (Dissonant): Treble clef has notes 7, 6, 5, 4, 3. Bass clef has notes 2, 1.

Whole notes represent musical pitch; quarter notes represent the lower harmonics of those pitches.

### 3-6 Pitch Standard

Usually, the A above middle C is used as a standard for designating the frequencies of the pitches in music. The pitch of this A has changed over the years but most countries today use  $A = 440$  Hz. Throughout history, however, this pitch has varied from about 373 Hz to about 462 Hz. As an example, the A in Handel's time was 426.6 Hz.

### 3-7 Exponential Progressions

The relation between pitch and frequency is an important one, especially from the point of view of electronic music. If we start at the bottom of the piano and play a chromatic scale all the way to the top of the keyboard, to our ears it will sound as if all the pitches move upward in evenly spaced steps. For example, the distance between a C and a D at the bottom of the keyboard and at the top of the keyboard will sound the same because the *ratios* between the frequencies are the same. The frequencies themselves, however, are quite different. The difference between the lowest C and D is about 4 Hz. The difference between the highest C and D is about 256 Hz.

If we start at the bottom of the keyboard and play all the A's moving upwards, the distance between each pair of A's remains musically the same (one octave), but the frequency doubles with each A. This kind of progression is called an **exponential progression**.

In measuring things we usually use a **linear** scale in which the divisions are equally spaced. The divisions on our rulers are equally spaced. A centimeter on one end is just as long as a centimeter on the other end. The compass has 360 equally spaced degrees. A day has twenty-four evenly spaced hours.

With some things it is more convenient and practical to use an exponential scale. The slide rule is a good example. The divisions of most of its scales are unequally spaced; a measure of one unit is longer on the left end than it is on

the right end. Moving from left to right, the distances for one unit become progressively shorter.

Fig. 3-7 shows a comparison between a linear scale and an exponential scale. The upper divisions represent octave intervals. Frequencies are shown below this and result in an exponential scale, a scale in which the divisions become progressively smaller towards the right. Most graphs which deal with sound use an exponential scale to show frequencies because this has a "linear" sound to our ears.

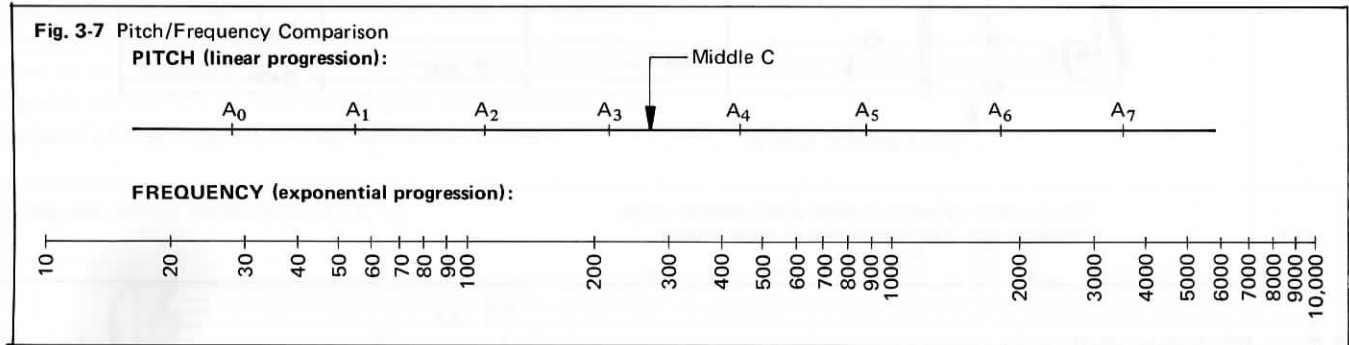

### 3-8 Cents

In the above, the differences between the frequencies of the pitches of a minor second at the top of the keyboard and at the bottom of the keyboard show that the use of frequency for the measure of the accuracy of pitches is inconvenient. For this we use the **cent**. The cent is based on the equally tempered scale with 1200 cents equal to one octave. This means that a minor second is 100 cents. In experiments it has been shown that when two independent pitches are sounded one after the other for comparison, the average person can detect a difference of pitch as small as about three cents.

### 3-9 Voltage-to-Frequency Relations

From the above, it can be shown that there are two possible practical approaches to establishing the relationship between the amount of control voltage change needed to produce a given VCO pitch change.

The first of these systems uses what is known as a **linear VCO**. In this type VCO, the *frequency* output of the VCO is directly proportional to the control voltage applied. For example, such a VCO might have the following voltage-to-frequency relations:

|                                  |         |                                         |                                       |
|----------------------------------|---------|-----------------------------------------|---------------------------------------|
|                                  | control | VCO                                     |                                       |
|                                  | voltage | frequency                               |                                       |
|                                  | input   | output                                  |                                       |
| Linear<br>voltage<br>progression | }       | 1 volt = 110 Hz (A <sub>2</sub> )       | } Exponential<br>pitch<br>progression |
|                                  |         | 2 = 220 (A <sub>3</sub> )               |                                       |
|                                  |         | 3 = 330 (approximately E <sub>4</sub> ) |                                       |
|                                  |         | 4 = 440 (A <sub>4</sub> )               |                                       |
|                                  |         | etc.                                    |                                       |

Or, to produce the octaves only:

|                                       |                                                                              |                                                                                                                     |                                                                                                    |      |
|---------------------------------------|------------------------------------------------------------------------------|---------------------------------------------------------------------------------------------------------------------|----------------------------------------------------------------------------------------------------|------|
|                                       | control                                                                      | VCO                                                                                                                 |                                                                                                    |      |
|                                       | voltage                                                                      | frequency                                                                                                           |                                                                                                    |      |
|                                       | input                                                                        | output                                                                                                              |                                                                                                    |      |
| Exponential<br>voltage<br>progression | $\left\{ \begin{array}{l} 1 \text{ volt} \\ 2 \\ 4 \\ 8 \end{array} \right.$ | $\left\{ \begin{array}{l} = 110 \text{ Hz } (A_2) \\ = 220 (A_3) \\ = 440 (A_4) \\ = 880 (A_5) \end{array} \right.$ | $\left. \begin{array}{l} \text{Linear} \\ \text{pitch} \\ \text{progression} \end{array} \right\}$ |      |
|                                       |                                                                              |                                                                                                                     |                                                                                                    | etc. |

To produce a series of octaves moving upwards, therefore, requires a control voltage source which increases in exponential steps.

The second approach uses what is known as an **exponential VCO**. In this type VCO, the *pitch* output of the VCO is directly proportional to the control voltage applied. For example, such a VCO might have the following voltage-to-frequency relations:

|                                  |                                                                              |                                                                                                                     |                                                                                                    |      |
|----------------------------------|------------------------------------------------------------------------------|---------------------------------------------------------------------------------------------------------------------|----------------------------------------------------------------------------------------------------|------|
|                                  | control                                                                      | VCO                                                                                                                 |                                                                                                    |      |
|                                  | voltage                                                                      | frequency                                                                                                           |                                                                                                    |      |
|                                  | input                                                                        | output                                                                                                              |                                                                                                    |      |
| Linear<br>voltage<br>progression | $\left\{ \begin{array}{l} 1 \text{ volt} \\ 2 \\ 3 \\ 4 \end{array} \right.$ | $\left\{ \begin{array}{l} = 110 \text{ Hz } (A_2) \\ = 220 (A_3) \\ = 440 (A_4) \\ = 880 (A_5) \end{array} \right.$ | $\left. \begin{array}{l} \text{Linear} \\ \text{pitch} \\ \text{progression} \end{array} \right\}$ |      |
|                                  |                                                                              |                                                                                                                     |                                                                                                    | etc. |

In this system, it is necessary to provide linear changes in voltage to produce a progression of octaves.

### 3-10 The Linear VCO

Fig. 3-8 (a) shows a plot of the voltage-to-frequency relations in the linear VCO of the example in 3-9 above. From this it can be seen where the term "linear" originates. In (b) is shown the plot for the voltage-to-pitch relations for the same VCO. The resulting plot forms an exponential curve. To produce any even progression of pitches, such as octaves (as shown) or a chromatic scale, would require exponential changes in the control voltage source. This fact produces problems in connection with tuning and transposing. If we have a voltage source which produces an exponential sequence of voltages, as for example: 1v\*, 2v, 4v, 8v, and feed this sequence to the linear VCO of this example, it will produce pitches which make one octave jumps starting at 110 Hz A<sub>2</sub> and ending on 880 Hz A<sub>5</sub>, as shown in (b). To raise this pitch sequence one octave so that it starts on 220 Hz A<sub>3</sub> and ends on 1760 Hz A<sub>6</sub> would require that we double (multiply by 2) the input control voltage. The linear VCO, then, needs the addition of an electronic multiplier at its input if it is to be able to transpose freely. It also requires an exponential keyboard, or a keyboard which produces voltage steps which increase exponentially when a chromatic scale is played. Since the keyboard control voltage is often used for other synthesizer control functions, other system parameters would also have to be designed to match this exponential relation.

### 3-11 The Exponential VCO

Fig. 3-9 (a) shows a plot of the voltage-to-frequency relation in the exponential VCO. The main difference between this

\* (v = volt)

Fig. 3-8 Linear VCO

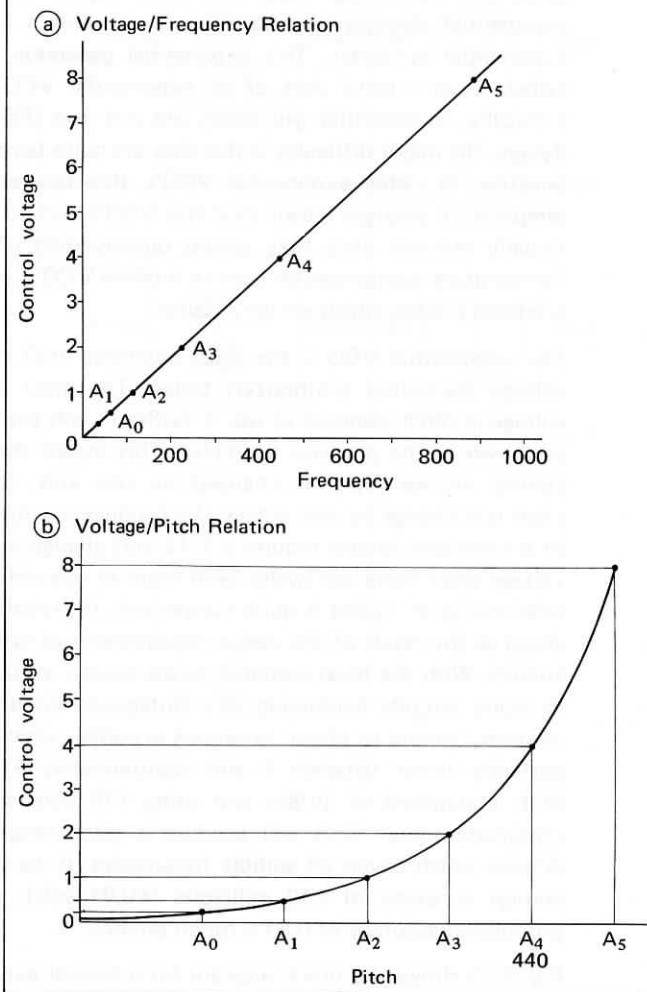

curve and the one shown in Fig. 3-8 (b) is that it moves up and turns right instead of moving right and turning up. Fig. 3-9 (b) shows the voltage-to-pitch relation in the exponential VCO. From this it can be seen that the names which are applied to these two types of VCO depend merely on point of view. The exponential VCO produces a linear voltage-to-pitch relation and the linear VCO produces an exponential voltage-to-pitch relation. Electrical engineers are usually more concerned with oscillator frequency relations than with musical pitch relations, and it should be remembered that VCO's are used in other areas of electronics and not just as pitch sources for synthesizers. The names applied to VCO's are from the point of view of frequency.

In music, since we are usually more concerned with pitch relations than frequency relations, the use of exponential VCO's where pitch is directly related to control voltage might seem the more logical choice for synthesizer pitch generation. Any linear source may be used to produce accurate musical scales, and linear voltage sources are easier to match to other system parameters. Transposing and tuning become extremely simple, merely the mathematical addition of voltage sources. To transpose or tune an exponential VCO it is necessary only to supply a fixed voltage of the proper level in addition to the pitch control voltage.

Since the exponential VCO uses linear inputs to produce exponential changes in frequency, it requires a linear-to-exponential converter. This **exponential generator**, as it is called, is an integral part of all exponential VCO's. Electronically, exponential generators are not too difficult to design. The major difficulty is that they are quite temperature sensitive. In earlier exponential VCO's, this dependency on temperature changes meant that the VCO's had to be continually retuned since they would quickly drift off pitch. Temperature compensation used in modern VCO's, however, produces pitches which are very stable.

The exponential VCO is the most common VCO in use in voltage controlled synthesizers today. The most common voltage-to-pitch standard in use is  $1\text{v}/8\text{va}$  (1 volt per octave), as shown in the previous examples. This means that if the control voltage input is changed by one volt, the VCO pitch will change by one octave. To produce a pitch change of a semi-tone would require a  $1/12$  volt change in control voltage since there are twelve semi-tones in one octave. The relationship of  $1\text{v}/8\text{va}$  is quite convenient. It probably came about as the result of the design requirements of synthesizer circuits. With the most common power supply voltages used in many circuits containing IC's (integrated circuits), it is relatively simple to obtain variations in voltage which remain perfectly linear between 0 and approximately +12 volts. With a standard of  $1\text{v}/8\text{va}$  and using +10 volts as an approximate upper limit will produce a pitch range of ten octaves which covers all audible frequencies. If we specify a voltage accuracy of  $\pm 10$  millivolts ( $\pm 0.01$  volt), this will produce an accuracy of 0.01% for all pitches.

Fig. 3-10 shows the block diagram for a typical exponential

Fig. 3-9 Exponential VCO

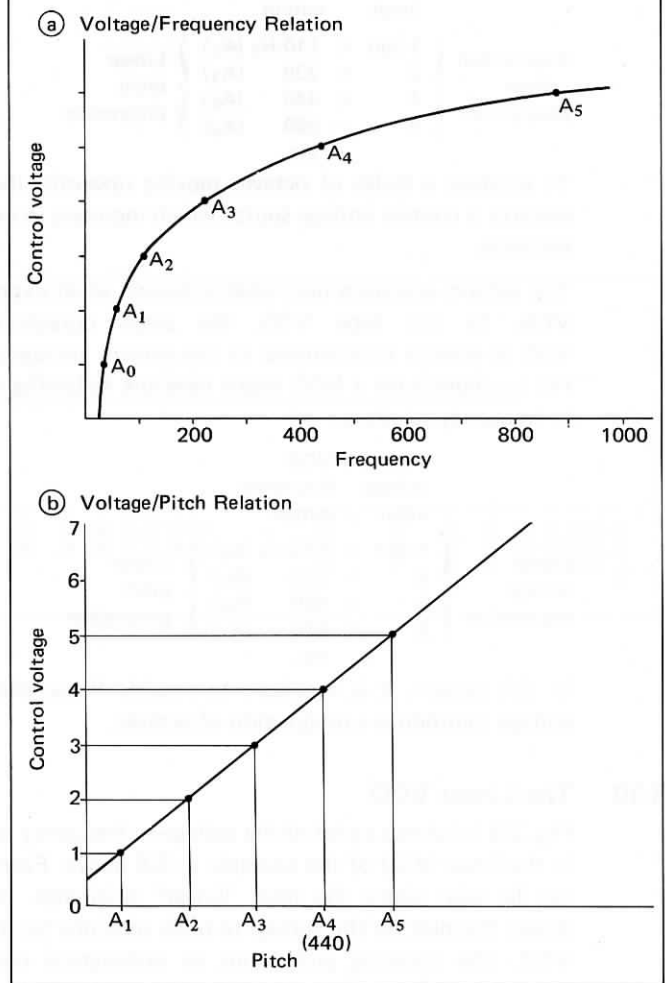

voltage controlled oscillator. At the bottom of the diagram are three control voltage (CV) inputs. The KEY CV (from the keyboard) has an ON/OFF switch so that, if desired, the VCO frequency output will have no relation to the keyboard. The VCO in this example provides two other control voltage inputs, both with volume controls so that the input may be **attenuated** (reduced). The VCO TUNING control is nothing more than a variable voltage source inside the VCO. The **summing amplifier** does exactly what the name implies: it adds all the control voltage inputs together to produce one voltage level to produce the desired VCO pitch. For example, if the four control voltage inputs were +1.50v, -0.82v, +1.32v, and 0.00v respectively, the sum would be: +2.00v.

Fig. 3-10 VCO Block Diagram

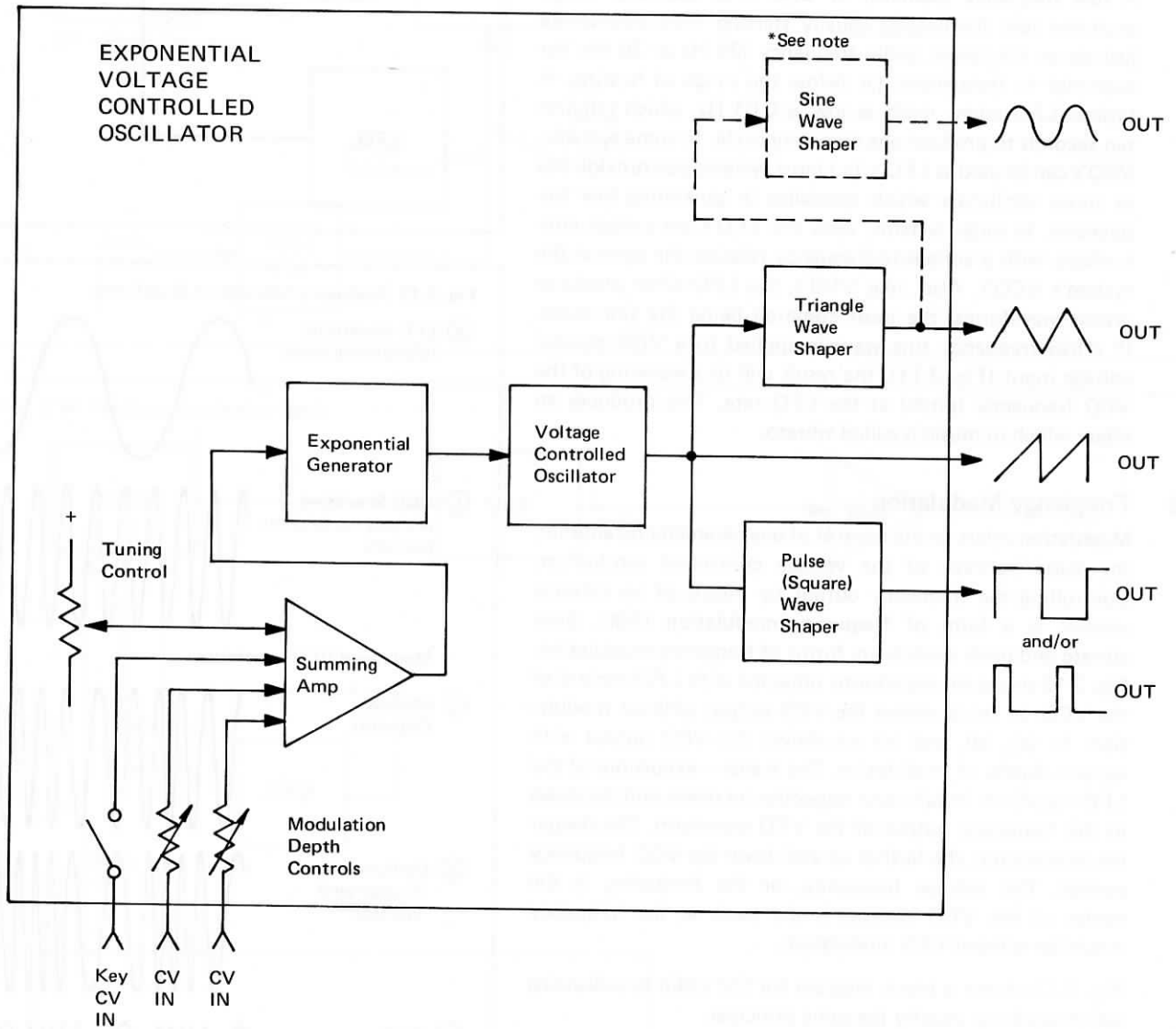

\*NOTE: Many VCO's do not provide sine wave shapers since the sine wave is easily produced by filtering the triangle wave.

This voltage might produce the pitch of middle C, as an example. The actual pitch will depend on the design of the VCO but the standard used is not too important because we are usually more concerned with the resulting pitch than the actual internal voltage necessary to produce that pitch.

After the summing amplifier is the exponential converter which converts linear changes of voltage input into the exponential changes which control the oscillator itself. The most common form of oscillator is a type which generates a sawtooth wave; if other waveforms are desired, wave shaping circuits must be incorporated at the output as shown in the diagram.

### 3-12 The Low Frequency Oscillator

A **low frequency oscillator** or **LFO** is an oscillator which produces low frequencies usually starting from somewhere just above the lowest audio frequency (25 Hz or 30 Hz, for example) to frequencies far below the range of hearing. A typical LFO might reach as low as 0.01 Hz, which requires ten seconds to produce one complete cycle. In some systems, VCO's can be used as LFO's, but most systems also provide one or more oscillators which specialize in generating low frequencies. In large systems, even the LFO's are voltage controllable with a voltage-to-frequency relation the same as the system's VCO's. Also, like VCO's, the LFO often produces several waveforms, the most common being the sine wave. If a low frequency sine wave is applied to a VCO control voltage input (Fig. 3-11), the result will be a wavering of the VCO frequency (pitch) at the LFO rate. This produces an effect which in music is called **vibrato**.

### 3-13 Frequency Modulation

**Modulation** refers to the control of one parameter by another, the basic concept of the voltage controlled synthesizer. Controlling the frequency output by means of an external control is a form of **frequency modulation (FM)**. Both vibrato and pitch control are forms of frequency modulation. Fig. 3-12 shows the waveforms obtained with LFO control of the VCO. In (b) is shown the VCO output without modulation. In (c), (d), and (e) are shown the VCO output with various depths of modulation. The + and - excursions of the LFO waveform in (a) cause respective increases and decreases in the frequency output of the VCO waveform. The deeper the modulation, the farther up and down the VCO frequency sweeps. The average frequency, or the frequency in the center of the VCO sweeps, is the same as the frequency would be without LFO modulation.

Fig. 3-13 shows a block diagram for FM radio broadcasting which works on exactly the same principal.

### 3-14 The Basic Synthesizer Patch

Fig. 3-14 shows the basic synthesizer patch with the addition of VCO modulation inputs. The VCO generates its waveform continuously, the frequency of the waveform depending on

Fig. 3-11 LFO Modulation of VCO

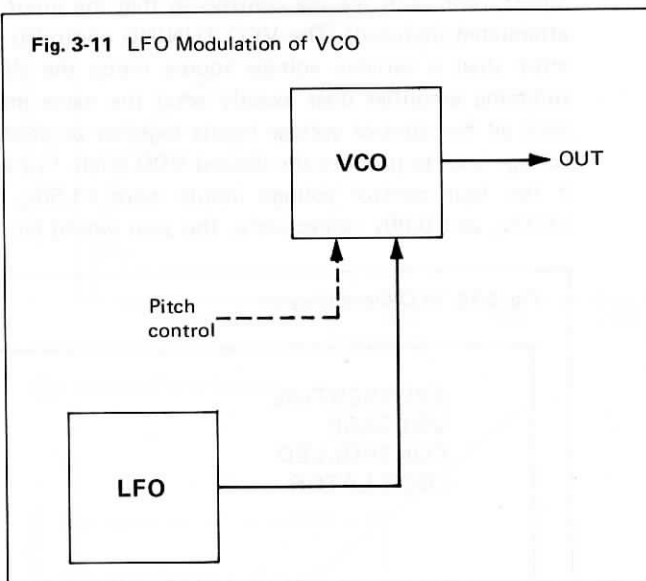
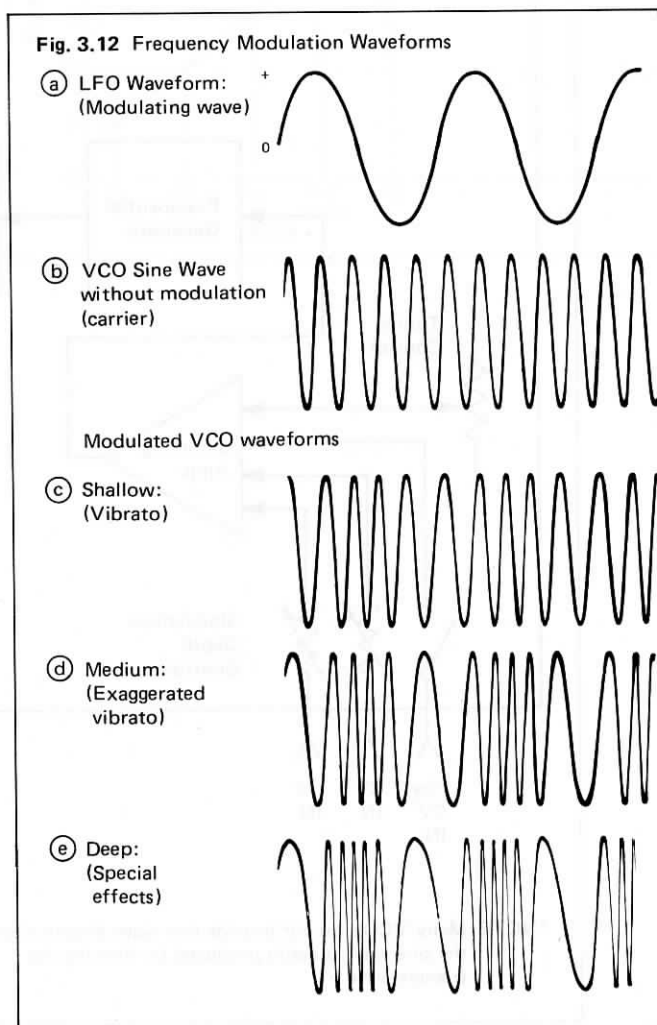

Fig. 3.12 Frequency Modulation Waveforms



the sum of the control inputs. The next chapter shows how to start and stop the sound in order to produce separate musical notes.

Fig. 3-13 Frequency Modulation

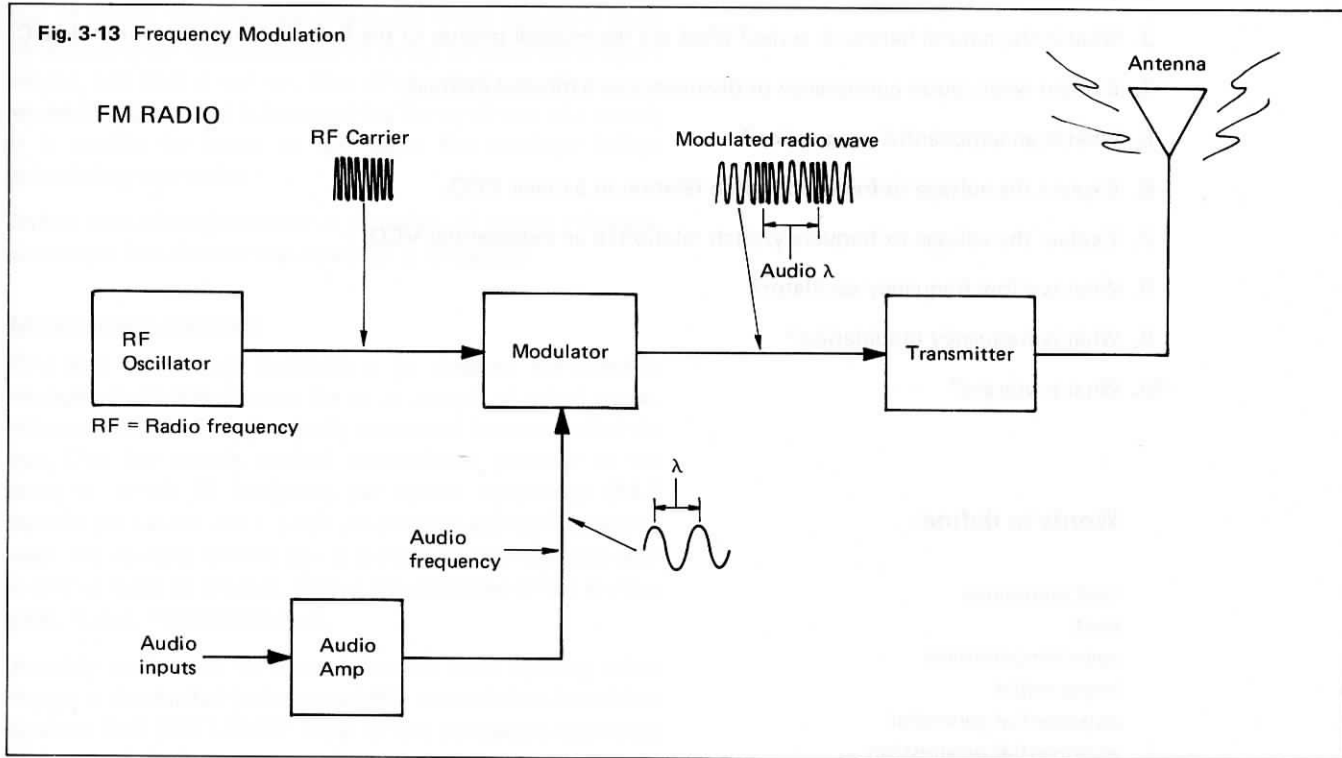
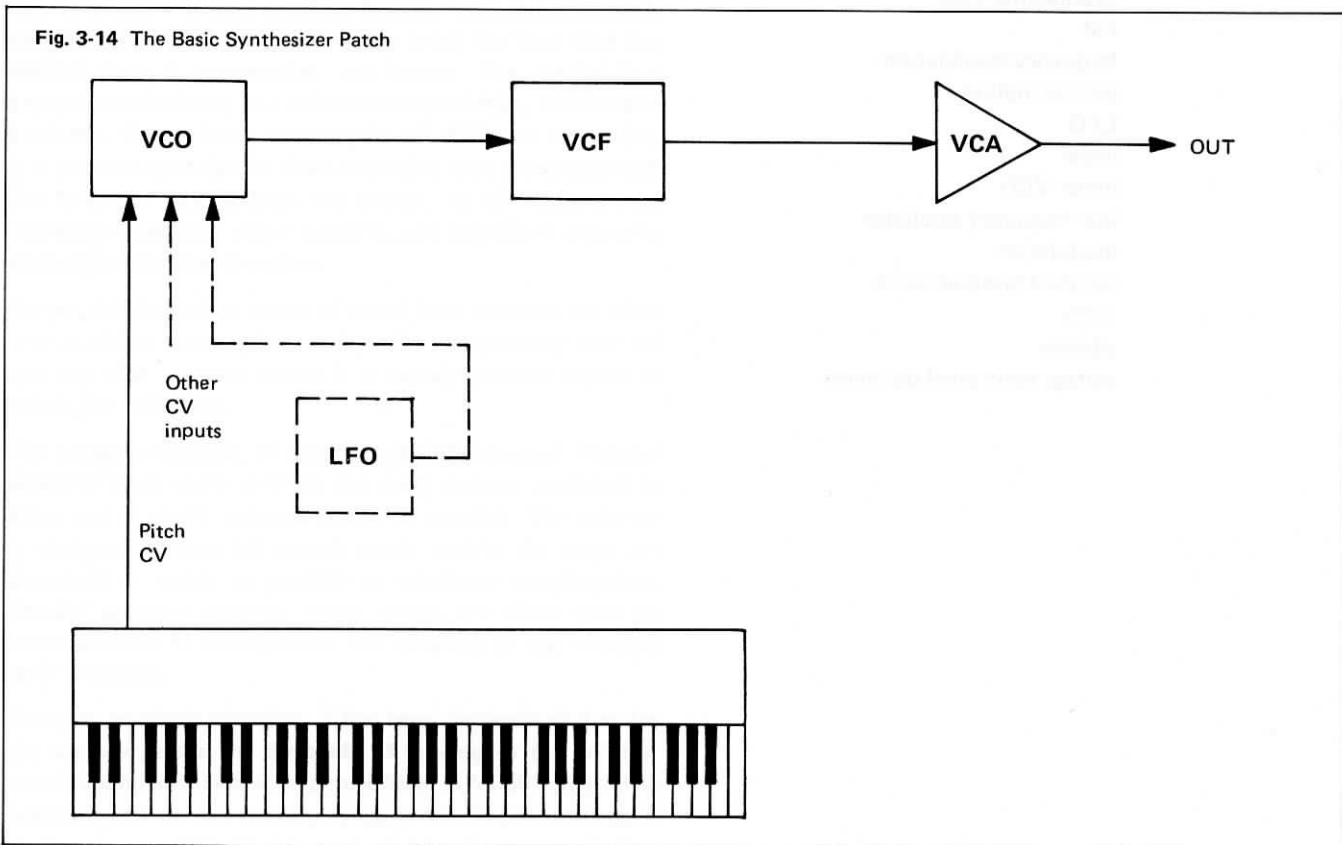

Fig. 3-14 The Basic Synthesizer Patch



## 3-15 Questions

1. What is the difference between the scale of just intonation and the equally tempered scale?
2. What is a beat frequency? Describe how an instrument is tuned using beat frequencies.
3. What is the natural harmonic series? What are the musical pitches of the first six harmonics for middle C?
4. Explain what causes consonance or dissonance in a musical interval.
5. What is an exponential progression?
6. Explain the voltage-to-frequency/pitch relation in a linear VCO.
7. Explain the voltage-to-frequency/pitch relation in an exponential VCO.
8. What is a low frequency oscillator?
9. What is frequency modulation?
10. What is vibrato?

**Words to define:**

beat frequency  
 cent  
 even temperament  
 exponential  
 exponential generator  
 exponential progression  
 exponential VCO  
 FM  
 frequency modulation  
 just intonation  
 LFO  
 linear  
 linear VCO  
 low frequency oscillator  
 modulation  
 natural harmonic series  
 VCO  
 vibrato  
 voltage controlled oscillator



# Loudness

## 4-1 Introduction

The first thing that comes to mind concerning **loudness** is perhaps **dynamics** (changes in loudness) in music, so loudness might seem less important than the other two qualities of sound. The envelope of a sound might also seem to be of not too great importance when trying to identify a sound source, but this is not so. The effect of the envelope on a sound is so great that in approaching the synthesis of a sound, it is usually far better to synthesize the envelope before considering tone color.

Before considering loudness as a quality of sound, however, we should first discuss how loudness is measured.

## 4-2 Measuring Loudness

One way to measure loudness is to measure the pressure changes which take place in the air as a result of sound waves. Atmospheric pressure is usually measured in units called the **bar**. One bar equals normal atmospheric pressure at sea level; or about 70 kilograms per square centimeter (14.7 pounds per square inch). Since air pressure changes caused by even the loudest sounds are too small to be measured with a unit as large as the bar, we use the **microbar** (often written  $\mu\text{bar}$ ;  $1 \mu\text{bar} = 0.000001 \text{ bar}$ ).

Another unit used to measure sound level (among other things) is the **decibel** (abbreviated **dB**), named after Alexander Graham Bell (1847-1922). Most of the confusion associated with the decibel is the result of the fact that it is not in itself a measure of level and therefore, by itself, is meaningless. (Another point of confusion arises from the fact that the decibel scale is exponential, not linear). The decibel is a comparison between, or a ratio of two quantities, in this case, loudness. If we hear two sounds of different intensities, it is possible to measure them and state that the first is 6dB (for example) louder than the second. At this point we do not know how loud either sound is, just that one is a specific amount louder than the other.

To use the decibel as a unit of sound level measure, we must first establish some reference level for comparison; then we can say that a given sound is a certain amount above or below this reference.

For acoustic research, an **anechoic chamber** is used. This is a specially built room with all the walls heavily insulated to keep out as much external sound as possible. The interior is designed so that all sounds made within the room are absorbed as much as possible to eliminate reverberation. Besides acoustic research, these rooms are often used by manufacturers of microphones and speakers to test and rate their products.

Using an anechoic chamber, it has been determined that for the average person the **threshold of hearing**, or the point at which sound just becomes perceptible, is  $0.0002 \mu\text{bar}$ . The opposite end of our hearing range is the threshold of pain, or the point where sound starts to be perceived as feeling (pain). The threshold of pain was found to be about  $1,000 \mu\text{bars}$ .

**Sound pressure level** (abbreviated **SPL**) is a decibel scale which uses the  $0.0002 \mu\text{bar}$  threshold of hearing level as a zero reference point. The threshold of hearing, then, is  $0\text{dB SPL}$ .

Fig. 4-1 shows the sound pressure levels of some common sounds. Note particularly the relation between the SPL scale and the  $\mu\text{bar}$  scale, and compare this to the relation between pitch and frequency (Fig. 3-7). If we insert a test signal into a hi-fi amplifier which is capable of producing very loud sound, and if we start with the volume control at "0" and turn it up at a steady rate of speed in steps of about  $3\text{dB}$  each, to our ears the loudness of the sound will seem to increase in steady even steps, much in the same way as pitch increases in a chromatic scale. And like frequency, the air pressure changes in  $\mu\text{bars}$  will increase exponentially.

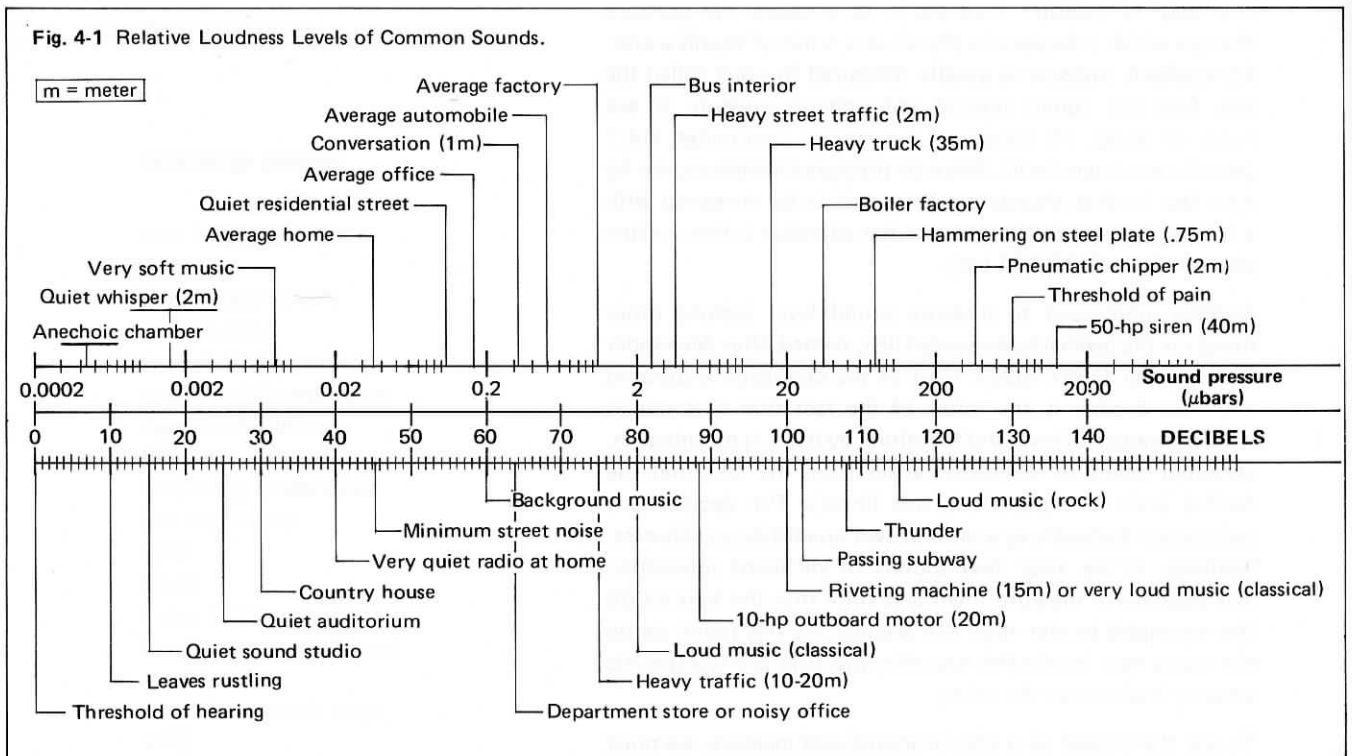

The smallest perceptible change in sound level which the average person can detect is roughly  $3\text{dB}$  but this will depend on the overall level and the frequencies involved. In other words, if we produce two separate sounds of the same pitch one after the other, they would have to be approximately  $3\text{dB}$  different in intensity before the levels would seem different.

### 4-3 Frequency Response of the Ear

The ear is more sensitive to some frequencies than others. This sensitivity is also strongly dependent on the loudness of the sound. This is shown in Fig. 4-2. The left margin of the graph shows sound **intensity** in  $\text{dB SPL}$ . Intensity refers to the level of sound as measured with instruments. The curves on the graph show **loudness**, which refers to the subjective level of sound as perceived by the ear. Both

loudness and intensity are measured in decibels, but to minimize confusion between the two, since they do not coincide at all frequencies, the term **phon** is often used to measure loudness.

Note that most of the loudness curves have a short flat spot at the 1,000 Hz point. This is why 1,000 Hz is used as a reference point in these curves (and why recording studios often use 1,000 Hz as a test frequency or a level reference in equipment). In other words, for a frequency of 1,000 Hz, the loudness level in phons is exactly the same as the intensity level in dB SPL. These curves can be thought of as showing the intensity levels which would be necessary to give all frequencies the same apparent loudness as the 1,000 Hz reference frequency. For example, to make a 100 Hz pitch sound as if it has the same intensity as a 50dB SPL 1,000 Hz pitch would require an intensity level of about 68dB SPL (the 50 phon curve crosses the 100 Hz line at about 68dB SPL).

The bottom-most curve on the graph, the 0 phon loudness curve, represents the threshold of hearing for various frequencies. At 1,000 Hz, the threshold of hearing is 0dB SPL. Lower frequencies, however, require higher intensities before they start to be heard. For example, 100 Hz requires a level of 38dB SPL before it starts to be heard, while a frequency of 30 Hz requires an intensity of more than 60dB SPL. From this it can be seen why soft bass passages will cause a tape recorder VU meter to jump higher than treble passages of the same apparent loudness.

These curves, of course, represent average values. They would look slightly different for different people and slightly different for the left and right ears. This would perhaps explain why people like different settings of amplifier tone controls. One might wonder at a friend who likes to turn the treble control up too high; it could be because his/her hearing is different.

Another point in connection with these curves is that most knobs which control level in electronic equipment control the intensity rather than the loudness. Thus, it is quite possible to set a control low enough that the lower frequencies are below the threshold of hearing. Some hi-fi amplifiers have a "loudness" control which theoretically can be set at any point and still retain the same apparent loudness for all frequencies so that with low listening levels they are not lost.

Since the loudness of different frequencies varies with the setting of the system level controls, it can be seen that it would be extremely important during the process of recording electronic music to monitor the output at the same level at which the finished recording is expected to be played.

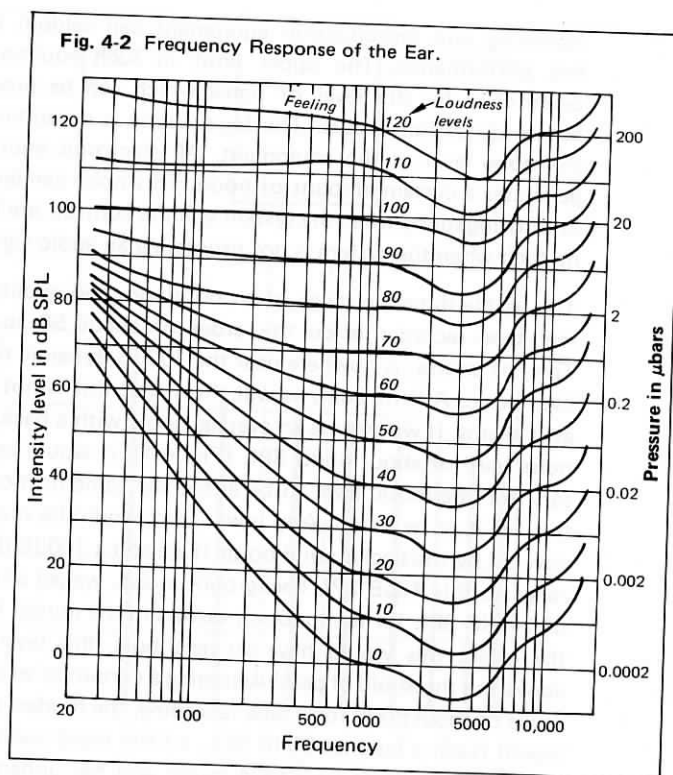

#### 4-4 Dynamic Range

The **dynamic range** of orchestral music can exceed 100dB. In other words, if we call the level of the softest passage 0dB, the loudest passages can exceed +100dB. Electronic

recording and reproduction equipment can seldom match this performance. The upper limit in such equipment is determined by the level of signal which can be processed before distortion occurs. The lower limit is determined by the **noise** level of the equipment. All electronic equipment generates a certain amount of noise. This noise can be heard as a hissing sound when the system volume controls are turned up high when the system is not processing an audio signal.

The usable dynamic range of an ordinary good quality open reel tape recorder is on the order of about 50 to 60dB. This, of course, is nowhere near the 100dB dynamic range of live music. A little analysis will show that this is not as bad as it seems. If we assume an average home with a background noise level of about 45dB SPL (Fig. 4-1), it would be necessary for the music level to be either the same or more than this for it to be heard. Any lower level would be masked or covered by the background noise. If we add a 100dB dynamic range to this 45dB SPL background noise, we get a top level of 145dB SPL for the loudest passages in the music. Ignoring the effect this would have on neighbors, this level is well above the threshold of pain! Assuming a conservative dynamic range of about 50dB for a tape recording, the loudest passages would reach a level of 95dB SPL, a little more realistic level if the listener likes very loud music and has understanding neighbors.

Fig. 4-3 shows two audio waveforms. In (a), the input level of the signal has been adjusted so that the peaks are just inside the maximum permissible level of the equipment processing the signal. The dotted line shows the average level which represents its apparent loudness. In (b), even with the peaks going over the maximum permissible level (thus distorting the signal), the average level and the apparent loudness is lower than that of (a).

#### 4-5 Intensity of Harmonics

The tone color of a sound source is determined by the number of harmonics contained in the sound and their relative intensities. This is another aspect of loudness as a quality of sound. The importance of the intensity of the harmonics in a sound can be demonstrated by examining the harmonic content of two waveforms commonly used in synthesis: the **square wave** and the **triangle wave**. The spectrum diagram for the square wave is repeated in Fig. 4-4 for easy comparison with the spectrum diagram of the triangle wave. Note that, except for the intensity of the harmonics, these waveforms contain the same harmonics: all the odd numbered harmonics. In the case of the triangle wave, the intensity of the existing harmonics is so low that the triangle wave has a tone quality very near that of the sine wave; a tone quality very far from that of the square wave. In Chapter 5 it will be shown how the square wave can be filtered so that it very closely approaches the shape of the triangle wave.

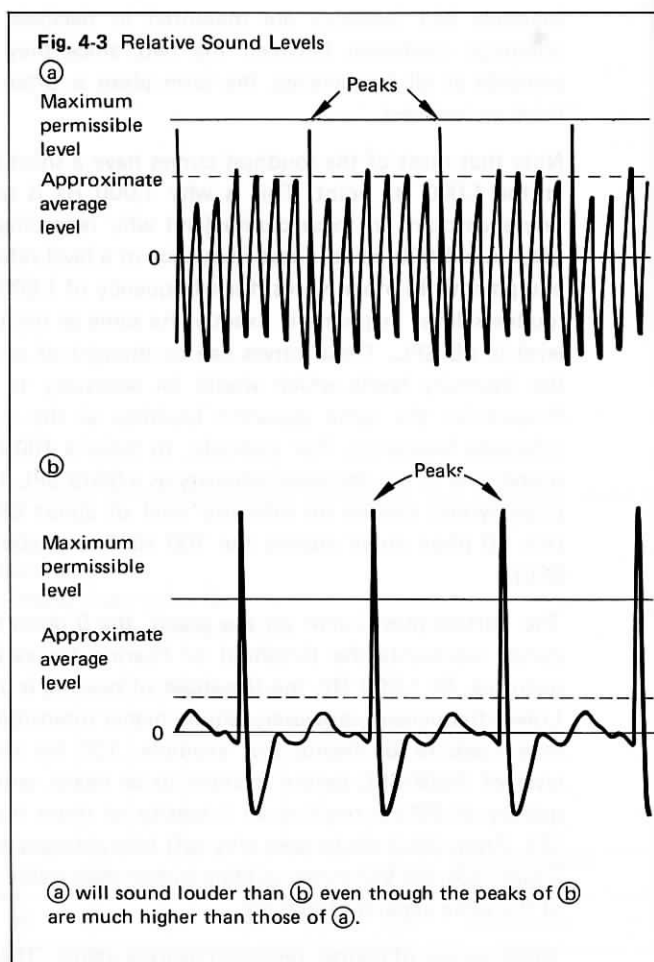
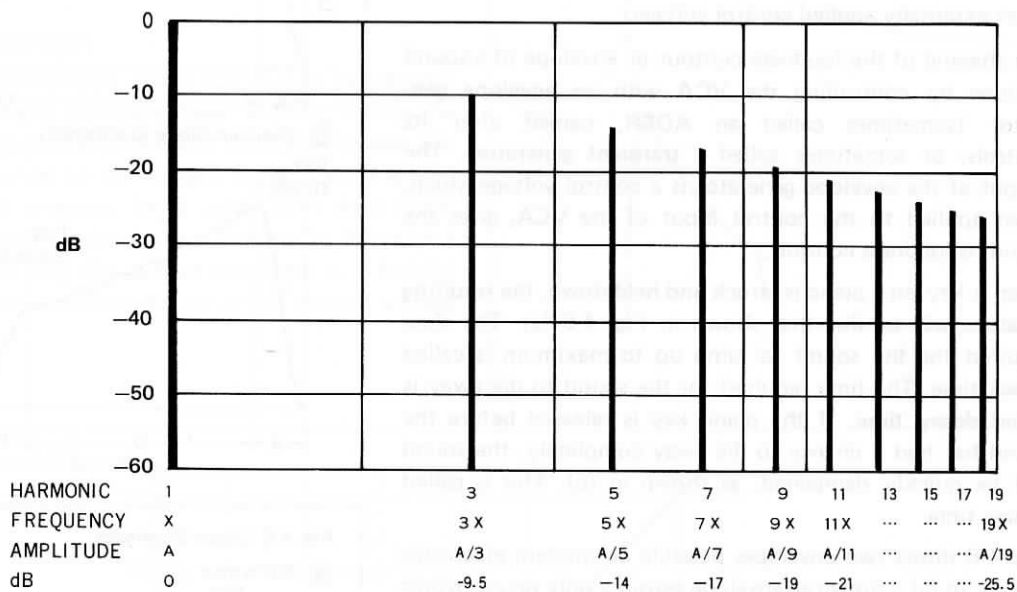
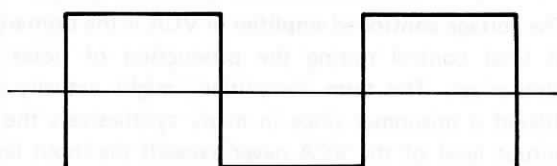

Fig. 4-4 SYNTHESIZER WAVEFORMS

(a) HARMONIC SPECTRUM OF PERFECT SQUARE WAVE



Note that the denominators of the amplitude fractions above are the same as the harmonic number.

(b) HARMONIC SPECTRUM OF PERFECT TRIANGULAR WAVE

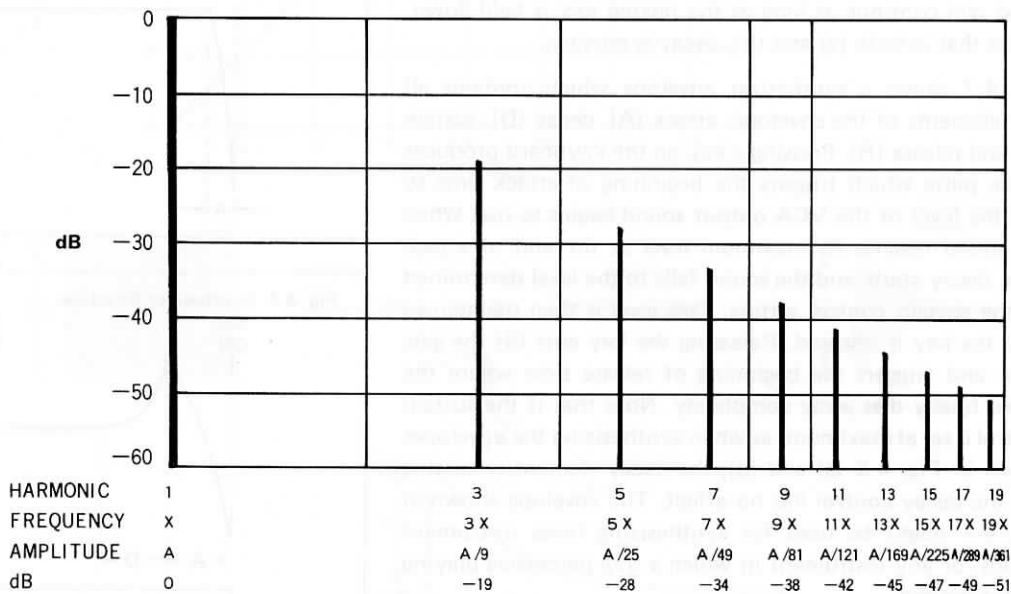
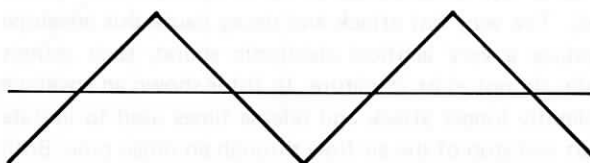

Note that the denominators of the amplitude fractions above are the squares of the harmonic number.

## 4-6 Envelopes

The **voltage controlled amplifier** or **VCA** is the primary source of level control during the production of notes on the synthesizer. The term "amplifier" might actually be considered a misnomer since in many synthesizers the normal output level of the VCA never exceeds the input level. The important point, however, is that the output level is controlled by an externally applied control voltage.

The shaping of the loudness contour or envelope of a sound is done by controlling the VCA with an **envelope generator** (sometimes called an **ADSR**, named after its controls, or sometimes called a **transient generator**). The output of the envelope generator is a control voltage which, when applied to the control input of the VCA, gives the sound its loudness contour.

When a key on a piano is struck and held down, the resulting envelope will be like that shown in Fig. 4-5 (a). The time required for the sound to jump up to maximum is called **attack time**. The time required for the sound to die away is called **decay time**. If the piano key is released before the sound has had a chance to die away completely, the sound will be quickly dampened, as shown in (b). This is called **release time**.

Fig. 4-6 shows two envelopes possible on modern electronic organs. In (a) is shown an envelope possible only on electronic instruments. As shown, attack and release times are zero, an impossibility. In actual practice, these are probably on the order of a few milliseconds or so (1 millisecond = 0.001 second). The very fast attack and decay cause this envelope to produce a very artificial electronic sound; such sounds normally do not exist in nature. In (b) is shown an envelope with slightly longer attack and release times used to imitate the start and stop of the air flow through an organ pipe. Both these envelopes introduce the element of **sustain** since the sound will continue as long as the related key is held down. Notice that in both (a) and (b), decay is missing.

Fig. 4-7 shows a synthesizer envelope which contains all four elements of the envelope: attack (A), decay (D), sustain (S), and release (R). Pressing a key on the keyboard produces a **gate pulse** which triggers the beginning of attack time so that the level of the VCA output sound begins to rise. When the sound reaches its maximum level at the end of attack time, decay starts and the sound falls to the level determined by the sustain control setting. This level is then maintained until the key is released. Releasing the key cuts off the gate pulse and triggers the beginning of release time where the sound finally dies away completely. Note that if the sustain control is set at maximum, as when synthesizing the envelopes shown in Fig. 4-6 (a) and (b), the decay element is missing and the decay control has no effect. The envelope shown in Fig. 4-7 might be used for synthesizing brass instrument sounds, or any instrument in which a *sfz* percussive playing style is desired.

Fig. 4-8 shows the envelope generator output when synthe-

Fig. 4-5 Piano Envelopes

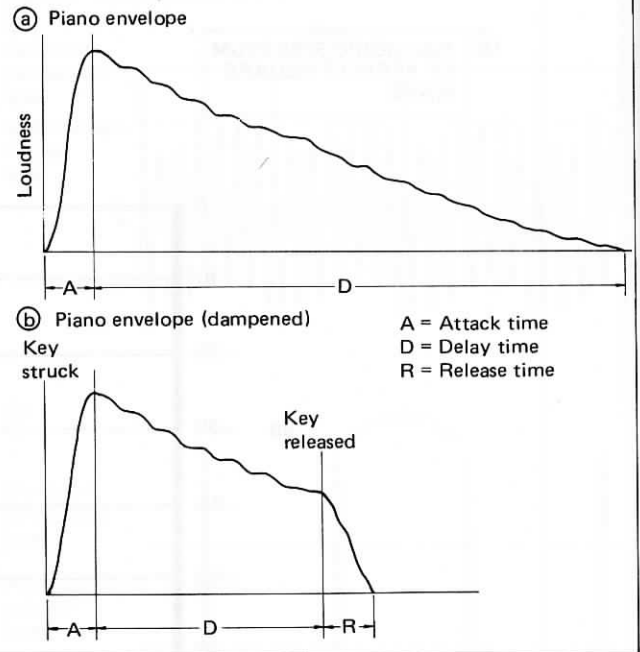

Fig. 4-6 Organ Envelopes

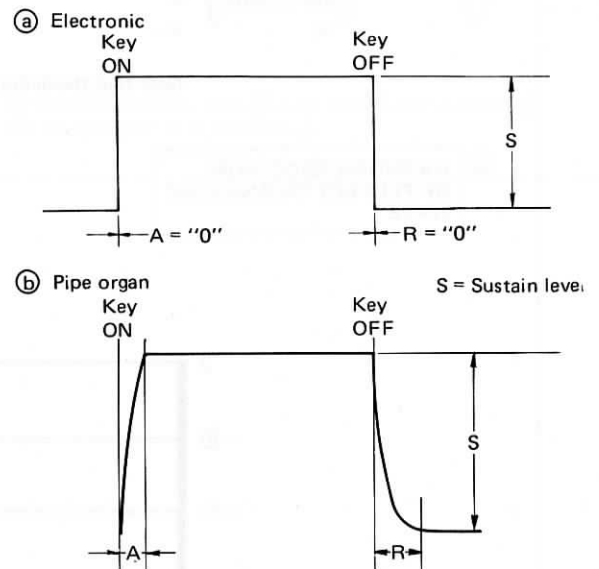
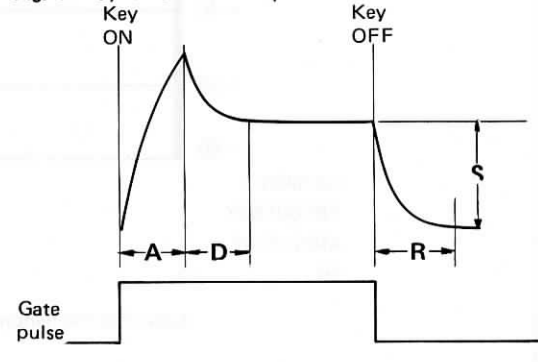

Fig. 4-7 Synthesizer Envelope



sizing piano-like envelopes. Note the differences between these and the envelopes shown in Fig. 4-5. The curves formed by the synthesizer envelopes are exponential curves. Experiments have shown that exponential attack, decay, and release curves sound natural and that trying to generate the small fluctuations encountered in natural sounds seems to add nothing useful to the sound as perceived by the ear.

### 4-7 VCA Control Response

One important consideration about the VCA is its response in relation to the input control voltage. In most VCA's, the response is linear; a change of one volt in control voltage will cause one volt change in the output signal level. Fig. 4-9 shows the control response for a given VCA with linear response. For example, if the control input is 2v, the output will also be 2v. In (b), the output waveform is a faithful reproduction of the loudness contour at the control voltage input.

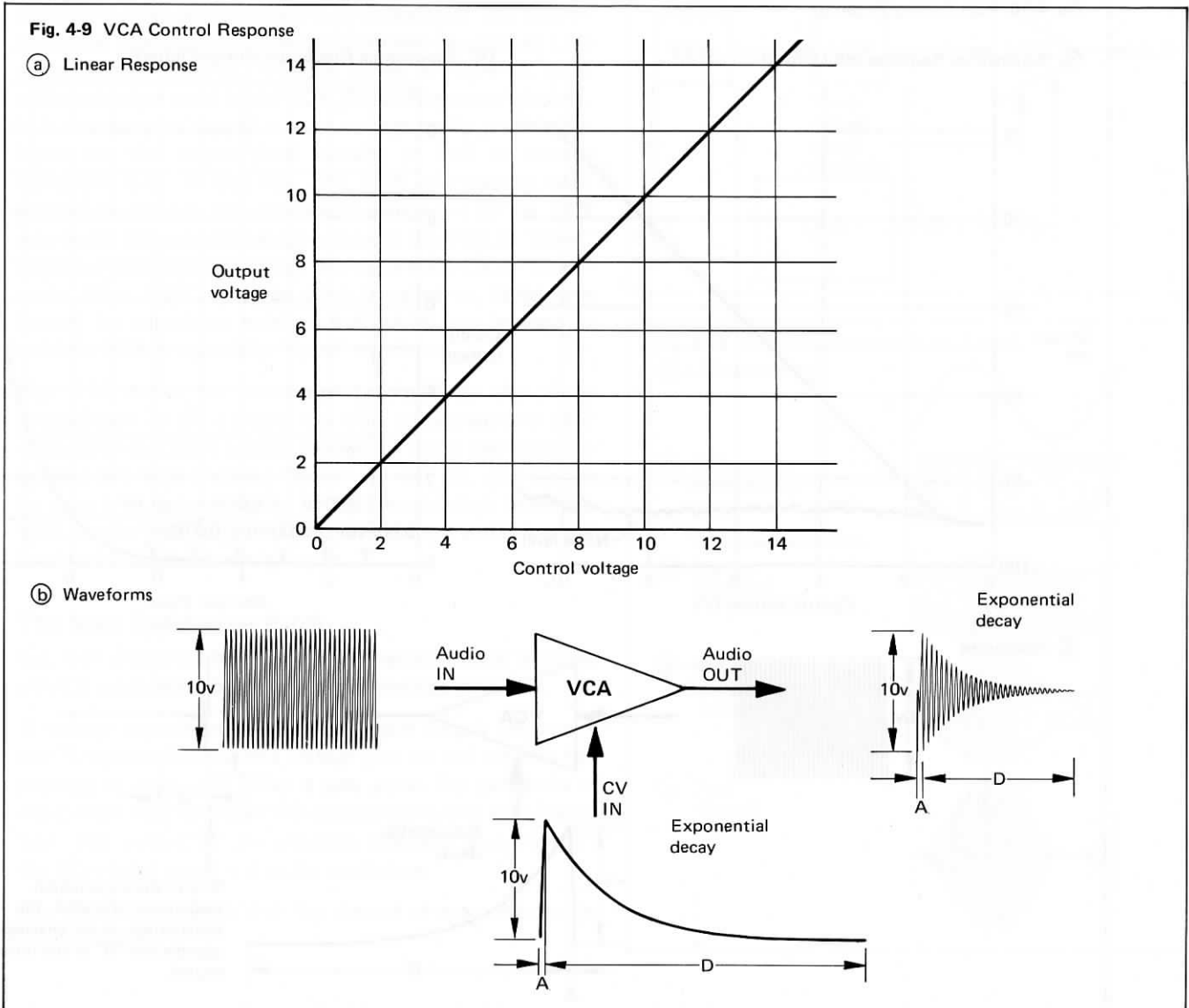
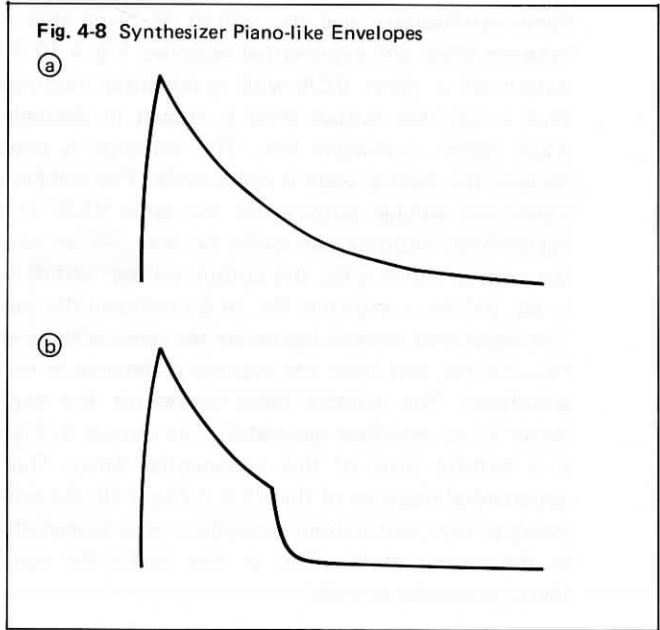

Some synthesizers give the option of being able to select between linear and exponential response. Fig. 4-10 shows the output of a given VCA with exponential response. Note that in (a), the output level is shown in decibels so the graph forms a straight line. The response is exponential because the decibel scale is exponential. For comparison, (b) shows the voltage outputs for the same VCA. In this the exponential response can easily be seen. As an example, if the control input is 6v, the output will be  $-40\text{dB}$  as shown in (a), or  $0.1\text{v}$ , as shown in (b). In (c) is shown the waveforms. The signal and control inputs are the same as those shown in Fig. 4-9 (b), but note the marked difference in the output waveform. The control input represents the exponential decay of an envelope generator. The output in Fig. 4-9 (b) is a faithful copy of this exponential decay. Due to the exponential response of the VCA in Fig. 4-10, the exponential decay of the control input produces a very exaggerated decay in the output at (c). This is very useful for synthesizing sharp, percussive sounds.

Fig. 4-10 VCA Control Response

(a) Exponential Response (dB Output)

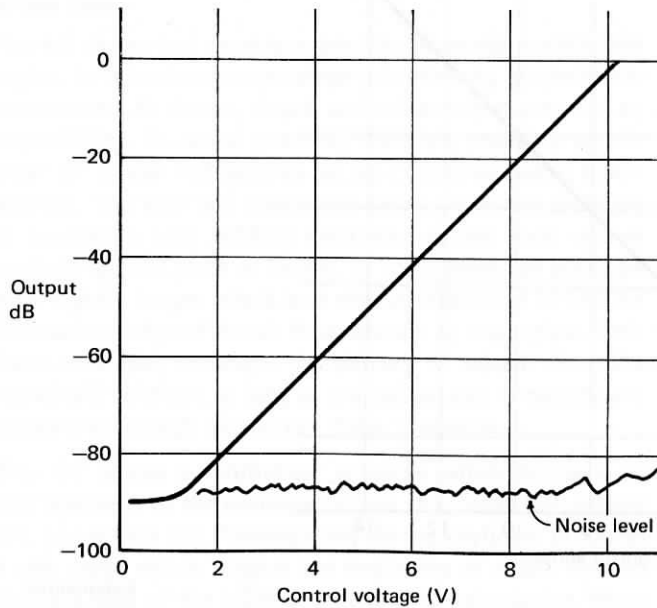

(b) Exponential Response (Voltage Output)

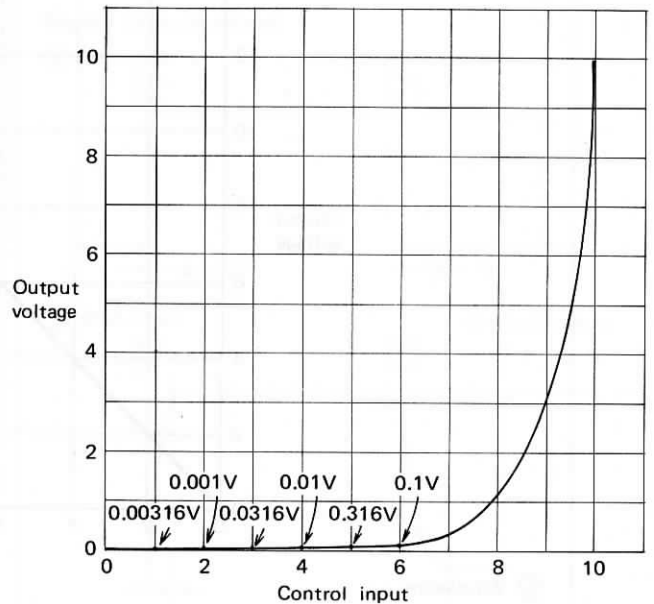

(c) Waveforms

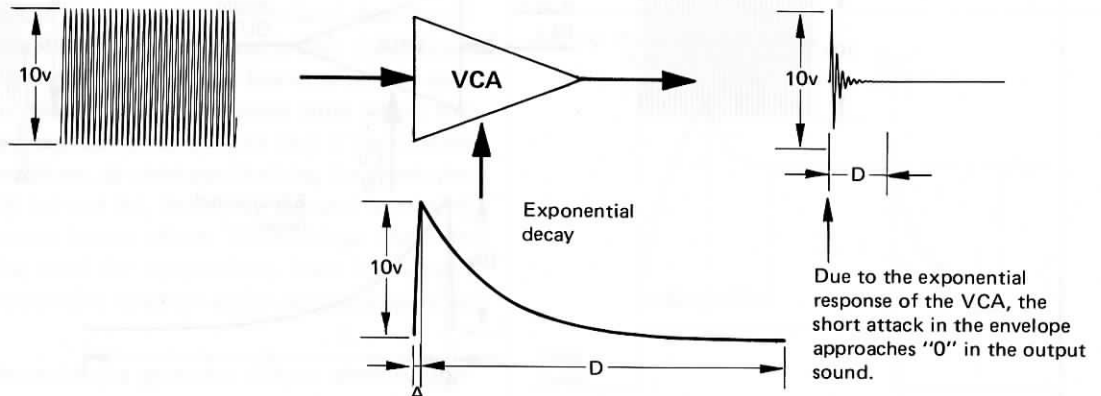



## 4-8 Amplitude Modulation

Using the VCA to control the level of a source signal is a form of **amplitude modulation (AM)**, the same principal as

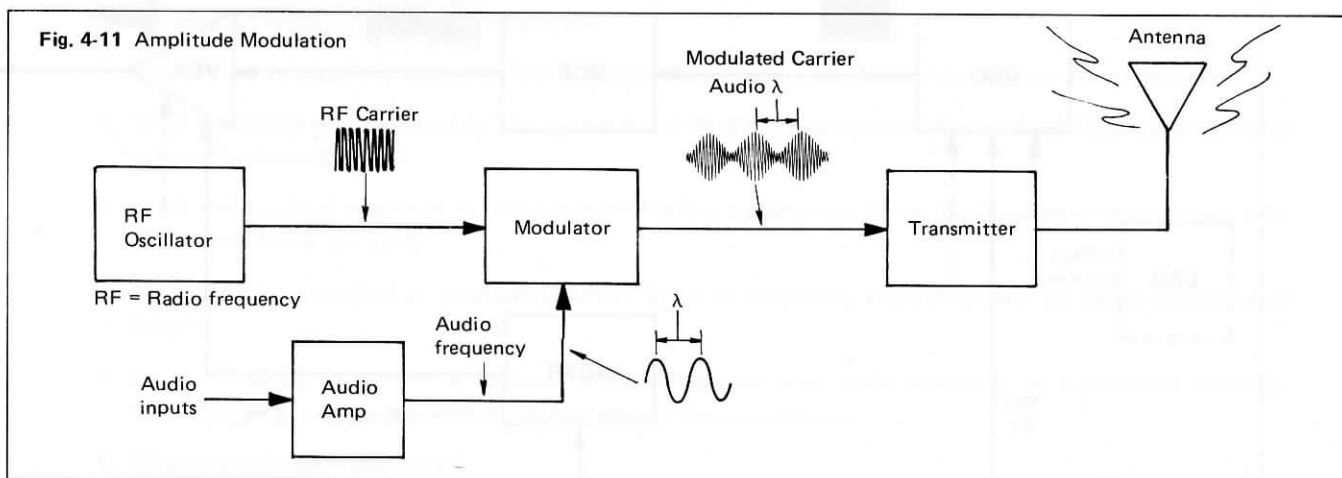

is used in AM radio broadcasting (see Fig. 4-11). In music, a regular wavering of sound level is called **tremolo**. This type of amplitude modulation can be demonstrated by using an LFO as the control input to a VCA, as shown in Fig. 4-12. Since with no control input to the VCA, the VCA remains "closed", it is necessary to supply a fixed voltage to the modulation input so the output level remains at half its normal maximum level. In this way, the VCA will react to both upward swings (+) and downward swings (-) of the LFO waveform. The upward swings will cause the VCA to "open" more and the downward swings will cause the VCA to "close" more. Most VCA's provide what is called an **initial gain control** (or sometimes **hold control**) which can be used to hold the VCA in a partially "open" condition.

Fig. 4-13 shows the waveforms produced by the above arrangement. In (b) is shown the VCA output with no LFO modulation but with a fixed voltage (or initial gain control) holding the VCA partially "open". In (c), (d), and (e) can be seen how various depths of LFO modulation cause the VCA output level to periodically waver above and below the level set by the fixed voltage input.

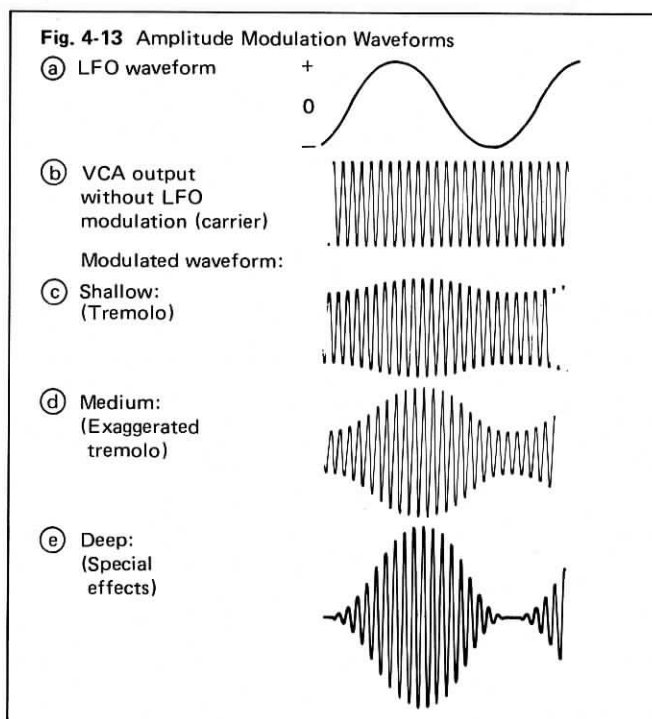
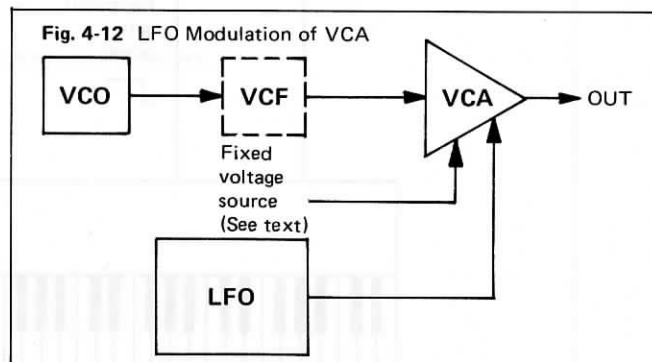

## 4-9 The Basic Synthesizer Patch

Fig. 4-14 shows the basic synthesizer patch with the addition of VCA modulation by means of the envelope generator.

A voltage appears at the keyboard gate output anytime a key is depressed. Since this voltage goes on and off with the pressing of keys, it is called a **gate pulse**. The gate pulse is most often used to trigger the envelope generator into operation. The output of the envelope generator then "opens" the VCA to let sound out of the synthesizer.

The next chapter deals with the control of tone color in the output sound.

Fig. 4-14 The Basic Synthesizer Patch

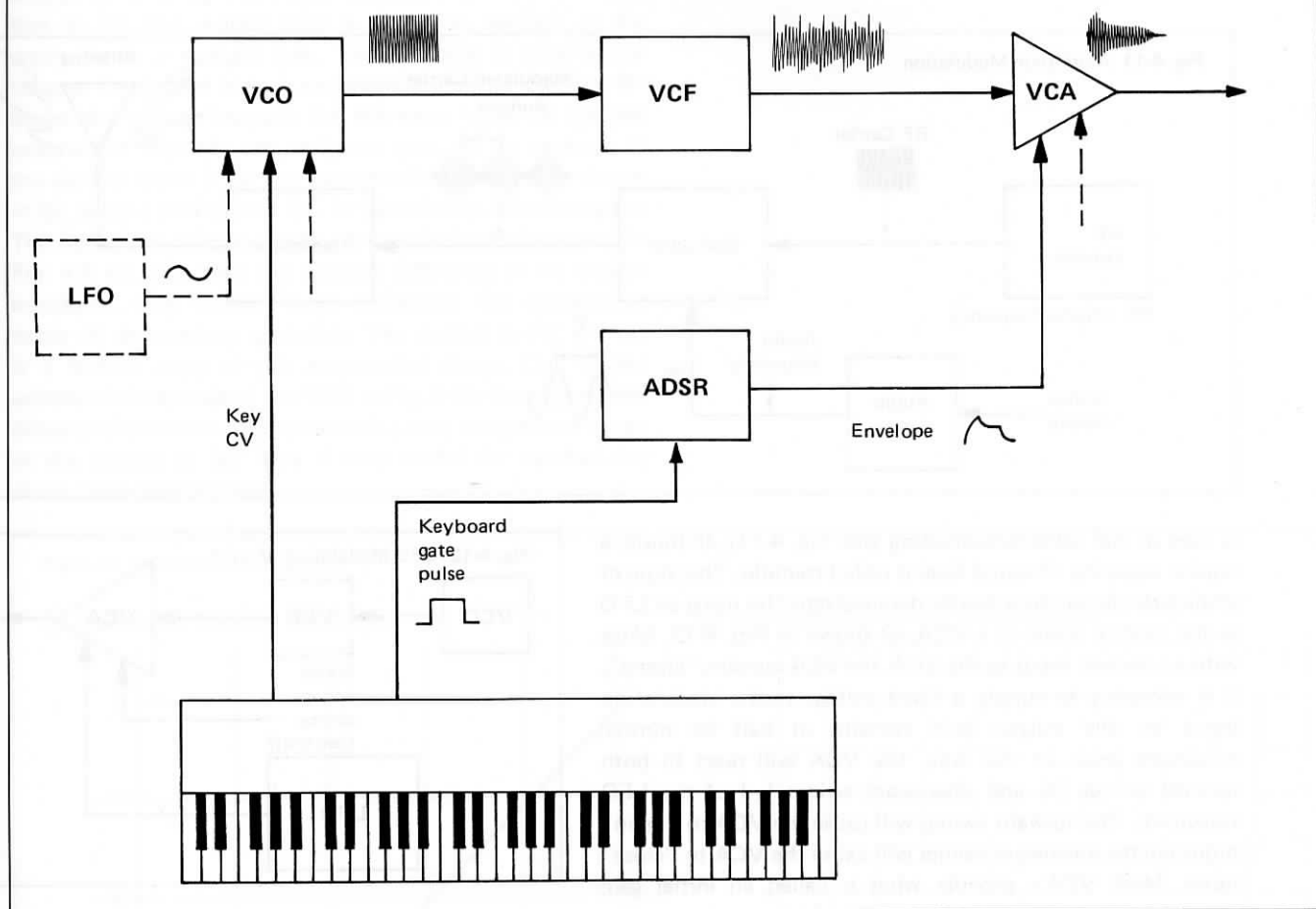

#### 4-10 Questions

1. How is loudness measured?
2. When recording electronic music, why is it important to monitor the music at the same level at which the finished recording is expected to be played?
3. What limits the dynamic range possible in a given piece of electronic equipment such as a tape recorder?
4. What harmonics are contained in the square wave? In the triangle wave? What is the difference in harmonic content between the two?
5. Draw the envelope produced by striking and releasing a piano key. Draw the envelope produced by a pipe organ note. Name the parts.
6. If the sustain control of an envelope generator is set at maximum, what effect will the decay control have? Why?
7. Show the output waveform of a linear VCA with a sine wave input controlled by a piano-like envelope. Show the output of an exponential VCA under the same conditions.
8. What is amplitude modulation?
9. What is tremolo?
10. Draw a diagram of the basic synthesizer patch and explain how it works.

#### Words to define:

ADSR  
 AM  
 amplitude modulation  
 attack time (A)  
 dB  
 dB SPL  
 decay time (D)  
 decibel  
 envelope  
 exponential decay  
 exponential VCA  
 gate pulse  
 intensity (of sound)  
 linear VCA  
 loudness  
 microbar ( $\mu\text{bar}$ )  
 phon  
 release time (R)  
 sound pressure level  
 SPL  
 sustain (S)  
 threshold of hearing  
 tremolo  
 triangle wave  
 VCA  
 voltage controlled amplifier

# Timbre

## 5-1 Introduction

**Timbre** or **tone color** is that quality of sound which allows us to distinguish between two sound sources producing sustained sounds at the same pitch. Tone color is usually very much affected by the pitch range and the loudness contour (envelope) of the sound, so it is usually better to consider tone color last when synthesizing sounds.

## 5-2 Noise

All electronic circuits generate a certain amount of **noise** and in most cases this noise is undesirable. In electronic music, however, noise often forms the starting point for tone color in the synthesis of non-pitched sounds or for non-pitched elements in sounds. In electronic music we are concerned with two types of noise: white noise and pink noise.

Like white light, which is a combination of equal amounts of all colors, **white noise** is a combination of equal amounts of all audio frequencies and produces a hissing sound. A review of Fig. 3-7 will show that the number of separate frequencies contained in each octave is double the number contained in the next lower octave. For example, the octave between  $A_2$  (110 Hz) and  $A_3$  (220 Hz) contains 110 separate frequencies (excluding fractions) the next higher octave,  $A_3$  (220 Hz) to  $A_4$  (440 Hz), contains twice as many frequencies: 220. Each successive octave, then, contains twice the number of frequencies as the next lower octave. A doubling of frequencies for each octave means a power increase of 3 decibels per octave. Since there are more of the higher frequencies, these frequencies dominate the sound to give it its characteristic hissing sound. This is aided by the fact that the ear is less sensitive to lower frequencies.

**Pink noise** is noise which contains equal amounts of energy in each octave. Since each octave (rather than each frequency) is equal in energy, this type of noise sounds, to our ears, as if it has an equal amount of all frequencies and produces a rushing sound much like a waterfall.

## 5-3 Filters

The major *source* of tone color in the voltage controlled synthesizer is the VCO for pitched sounds and the noise generator for non-pitched sounds. The major source of *control* over tone color changes are the filters, the most common of which is the **voltage controlled filter** or VCF.

In Chapter One it was shown how a pipe or tube is resonant at various frequencies. The fact that this is so makes the tube a form of acoustical filter. If we speak into the end of a tube, the quality of the voice emerging from the other end will be quite different. The human voice contains a great many different frequencies. When one or more of these frequencies coincide with any of the resonances of the tube, these frequencies are accented in the output sound in exactly the same way as the sound of a tuning fork will be accented when its frequency matches any of the tube resonances.

The tube, acting as an acoustical filter, alters the harmonic content of any sound which passes through it. Changing the length of the tube changes the resonance points and, therefore, the tone color of the sound emerging from the opposite end. Rooms also act as acoustical filters since they affect any sound made within them.

In this text, we shall be primarily concerned with four basic types of filters commonly used in electronic music: the low pass filter (LPF), the high pass filter (HPF), the band pass filter (BPF), and the band reject filter. The names imply the functions. The low pass filter passes low frequencies and blocks high frequencies, the high pass filter passes high frequencies and blocks low frequencies, and the band pass filter passes a band or group of frequencies while the band reject filter rejects a band or group of frequencies. The most common form of VCF is the voltage controlled low pass filter. This type of VCF is so common that when we hear or see the term VCF, it is usually safe to assume that it is a low pass filter. Many synthesizers also provide a high pass filter; in some systems, this high pass filter is voltage controlled. Larger systems also sometimes provide for voltage controlled band pass filtering.

#### 5-4 The Low Pass Filter

Fig. 5-1 shows the **frequency response** of a given **low pass filter (LPF)**. The 0dB level is a reference which represents the normal output level of the filter when a signal of a given level is applied at the input. The actual levels involved will depend on the design of the particular filter. The shading shows the range and levels of frequencies which can be passed by the filter. For example, if we apply a 100 Hz sine wave of the correct level to the input of the filter, the output will be 0dB, or normal. If we change this sine wave to 1,000 Hz without changing the input level, the output will be  $-20\text{dB}$ , or 20dB below the 0dB reference level. Again, changing the sine wave to 11,000 Hz, the output level will be below  $-60\text{dB}$ . This level is so low in relation to the 0dB

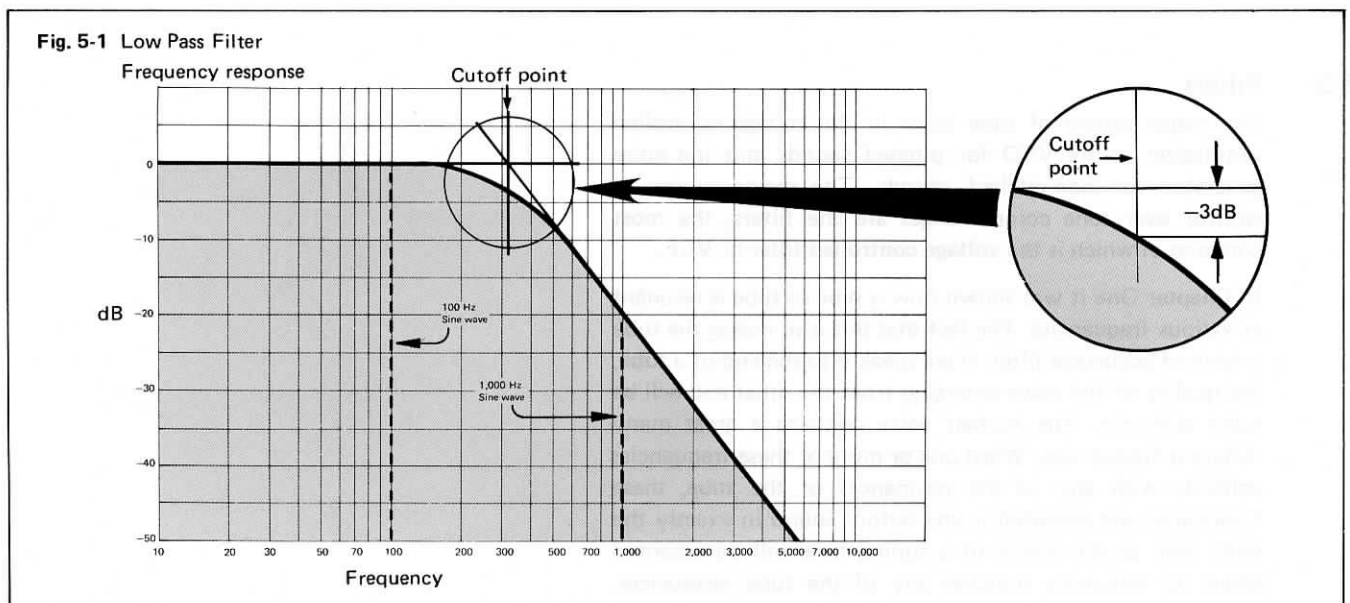

reference level that we may consider the 11,000 Hz sine wave as being missing at the output of the filter. In many filters, this would probably be below the noise floor of the filter anyway.

For lower frequencies, the response of the filter is flat; no matter what the frequency of the sine wave input, the output will be 0dB (assuming the input level remains as before). Remember that it requires approximately 3dB difference in level before the ear can detect a difference in loudness; therefore, a sine wave of about 320 Hz, which in Fig. 5-1 produces an output of -3dB, can be considered the upper limit of the flat portion of the response. This point on the filter's curve is called the **cutoff point** or **cutoff frequency**; any frequencies above this point will produce an output level below -3dB, or levels not as loud as lower frequencies. With filters used in electronic music, this cutoff point is almost always adjustable.

The rate of fall-off of the filter slope is an important consideration because it affects the relative levels of the frequencies above the cutoff point. The slope is measured by determining the amount of level change which occurs for one octave change in frequency. This measurement is taken from a portion of the slope which is representative of the whole. In other words, measuring the slope at the cutoff point would be inaccurate since the slope is curved at this point. Above about 500 Hz in Fig. 5-1, the slope falls in a relatively straight line. For a 1,000 Hz sine wave input, the output level is -20dB. A sine wave one octave above this, or 2,000 Hz, would produce an output of -32dB, an output level which is 12dB less than the first sine wave. The slope of the filter, then, is -12dB/8va (-12 decibels per octave). The minus sign indicates that the slope falls for an increase in frequency. A plus sign would indicate that the slope rises for an increase in frequency. The most common filters, at least as far as electronic music is concerned, are -3dB, -6dB, -12dB, and -24dB per octave. Pink noise is usually generated by passing white noise through a -3dB/8va low pass filter, as shown in Fig. 5-2. -12dB/8va and -24dB/8va are the most common slopes found in voltage controlled filters.

Fig. 5-3 shows the frequency response of what could be termed the perfect low pass filter because all frequencies above the cutoff point are missing from the sound and all frequencies below the cutoff point are at the 0dB reference level. In the case of electronic music this type of filter is probably undesirable.

Up to this point we have been primarily concerned only with the effects of the low pass filter on sine waves of given frequencies. In subtractive synthesis we are usually more interested in the effects of filtering on waveforms rich in harmonics. Fig. 5-4 (a) gives a repetition of the spectrum diagram for the sawtooth wave. Let us assume a sawtooth wave with a pitch of  $A_2$  (bottom space bass clef) passed through a low pass filter with a cutoff point set at about 300 Hz. The results can be shown by superimposing the spectrum diagram of the sawtooth wave onto the frequency response

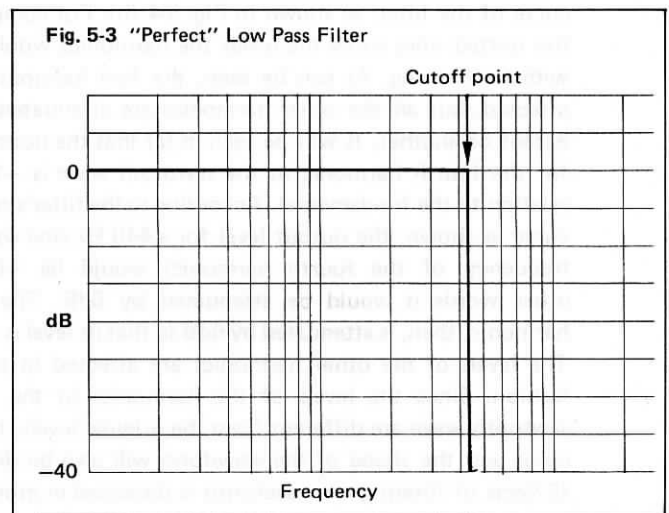
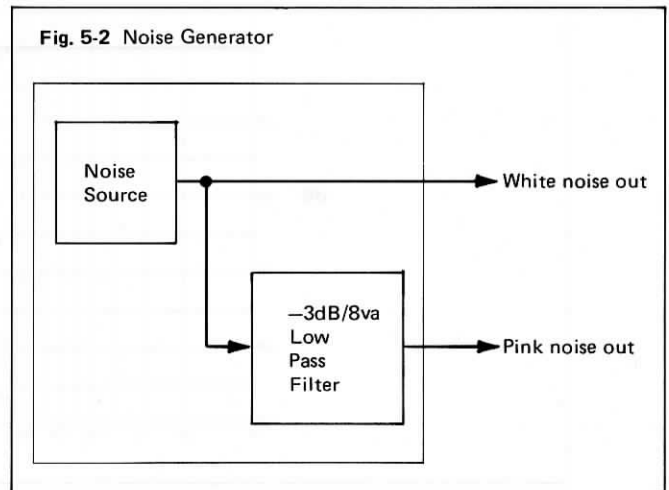
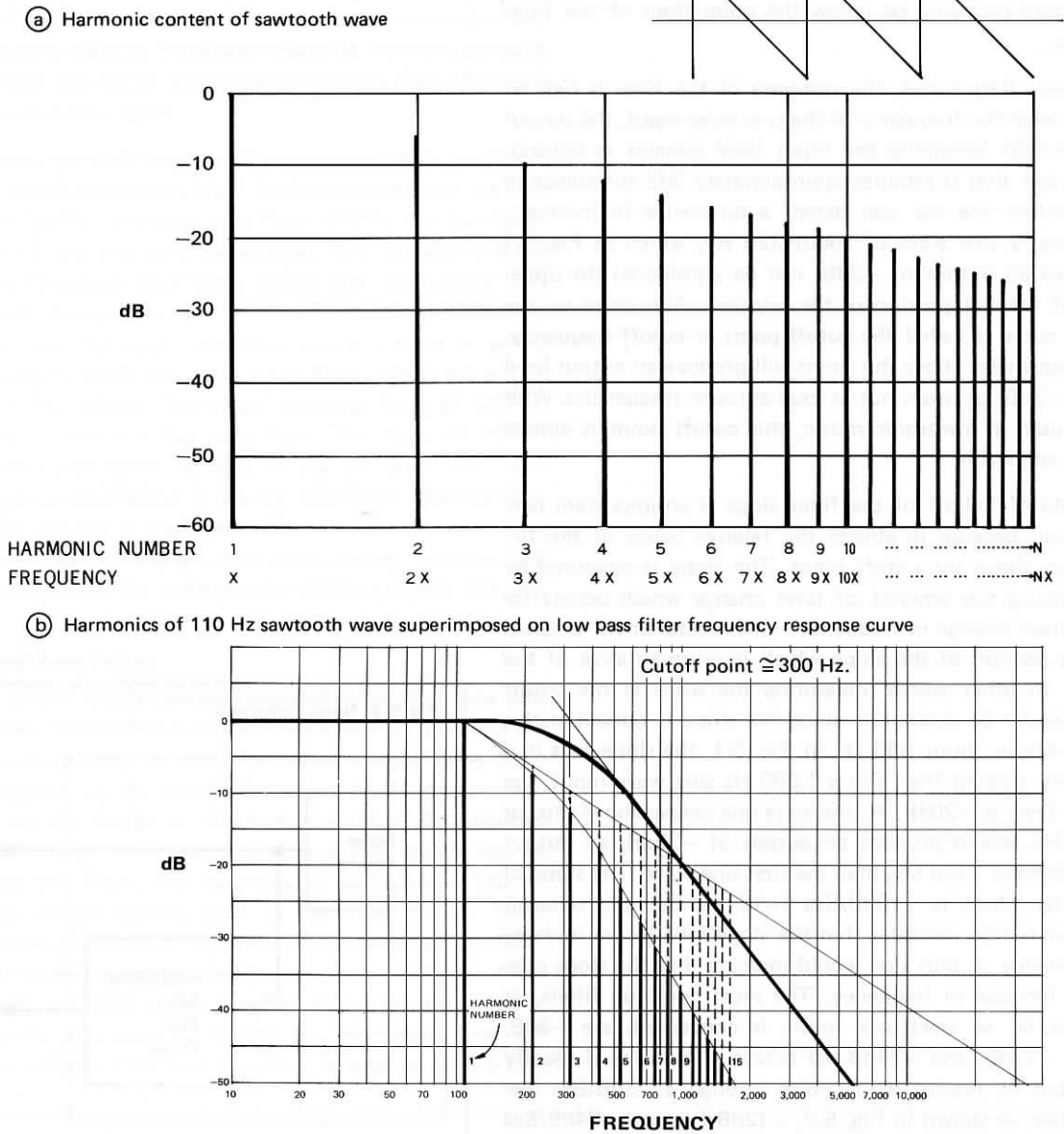

Fig. 5-4 Effect of Filtering on Harmonics



curve of the filter, as shown in Fig. 5-4 (b). For comparison, the dotted lines show the levels the harmonics would reach without filtering. As can be seen, the first harmonic is not affected, but all the other harmonics are attenuated to one extent or another. It will be seen in (a) that the normal level for the fourth harmonic in the sawtooth wave is  $-12$  dB in relation to the fundamental. According to the filter's response curve as shown, the output level for a 440 Hz sine wave (the frequency of the fourth harmonic) would be  $-6$  dB, in other words it would be attenuated by 6 dB. The fourth harmonic, then, is attenuated by 6 dB so that its level is  $-18$  dB. The levels of the other harmonics are affected in a similar fashion. Since the levels of the harmonics in the filtered sawtooth wave are different from the original levels, the tone color and the shape of the waveform will also be different. (Effects of filtering on waveforms is discussed in more detail later in 5-8.)

## 5-5 The Voltage Controlled Low Pass Filter

It can be seen in Fig. 5-4 (b) that as long as the cutoff point of the filter remains fixed, the harmonic content of the output sound will remain fixed only if the pitch of the sawtooth wave also remains fixed. Changing the pitch of the sawtooth wave would effectively move the spectrum diagram to the right or left in relation to the filter response curve, changing the harmonic content of the output sound. In other words, playing a chromatic scale will produce notes each of which has a different tone color. If we play the pitch of 880 Hz  $A_5$  (one ledger line above the treble clef), the level of the fundamental will have fallen off more than 15dB. Going much higher will considerably reduce the output sound level.

Like the VCO TUNING control, the VCF CUTOFF FREQUENCY control sets the initial cutoff point of the filter, after which it can be altered with externally applied control voltages. If we use the keyboard control voltage output to control the cutoff point of the VCF, it is possible to cause the filter cutoff point to follow the pitch. In the example given in 5-4 above, the filter cutoff point was set at the approximate frequency of the third harmonic of the 110 Hz  $A_2$  sawtooth wave. By applying the pitch control voltage to the VCF, it is possible to cause the cutoff point to move with the pitch and remain at the approximate point which represents the third harmonic of any pitch played. From this, logic would seem to dictate that it would be essential that the VCF have exactly the same voltage-to-frequency relation as the VCO. If a change of 1 volt causes one octave change in VCO pitch, it should also cause one octave change in the VCF cutoff frequency. With this relation, the VCF can follow exactly any changes in pitch in the music being played.

The tone color of most instruments changes with pitch. Usually the higher pitches are brighter than the lower pitches. Since high harmonics of high level produce a bright tone color, this might seem to imply that if a chromatic scale is played up the keyboard, instead of exactly following the pitch of the music, the VCF cutoff point should actually anticipate the pitch by moving higher than normal so as to allow more harmonics to pass. Instead of  $1v/8va$  it might seem that something on the order of two octave change of the cutoff point should occur for 1 volt change in pitch control voltage. In actual practice, because of the peculiarities in our hearing, this is not necessary. In experimenting with  $1v/8va$  filters, it will be found that if the pitch control voltage is attenuated by approximately half, the tone color of the output sound will seem to our ears to retain an approximately constant harmonic content. If the pitch control voltage is not attenuated, the tone color will seem to get brighter with higher pitches. A response of  $1v/8va$  remains valid.

The tone color of many instruments, especially wind instruments and plucked strings, changes during the production of each note. This can be imitated by using an envelope generator to cause the VCF cutoff point to change. Often the same envelope which is used to control the VCA can also be used to control the VCF. In other cases, it is advantageous to use a



second envelope generator so that the sweep of harmonics is independent of the loudness contour. Some synthesizers allow inversion of the envelope so that the harmonics can sweep in the opposite direction from what is normally expected.

Another common source of modulation for the VCF is the LFO, which produces a wavering of the tone color called growl.

### 5-6 The High Pass Filter

The high pass filter (HPF) may be thought of as an exact mirror image of the low pass filter. Fig. 5-5 (a) shows the frequency response of a high pass filter with a slope of 12dB/octave. In (b) is shown the spectrum diagram of a sawtooth wave superimposed on the response curve of the filter. In this example, the frequency of the sawtooth wave is 110 Hz and the cutoff point of the filter is set at about 770 Hz which is the frequency of the seventh harmonic of the sawtooth wave. The seventh harmonic is the strongest, while the fundamental is attenuated by almost 35dB. The third harmonic is normally 9.5dB lower than the fundamental. It is attenuated by 15dB due to the filter's slope so that its level becomes -24.5dB.

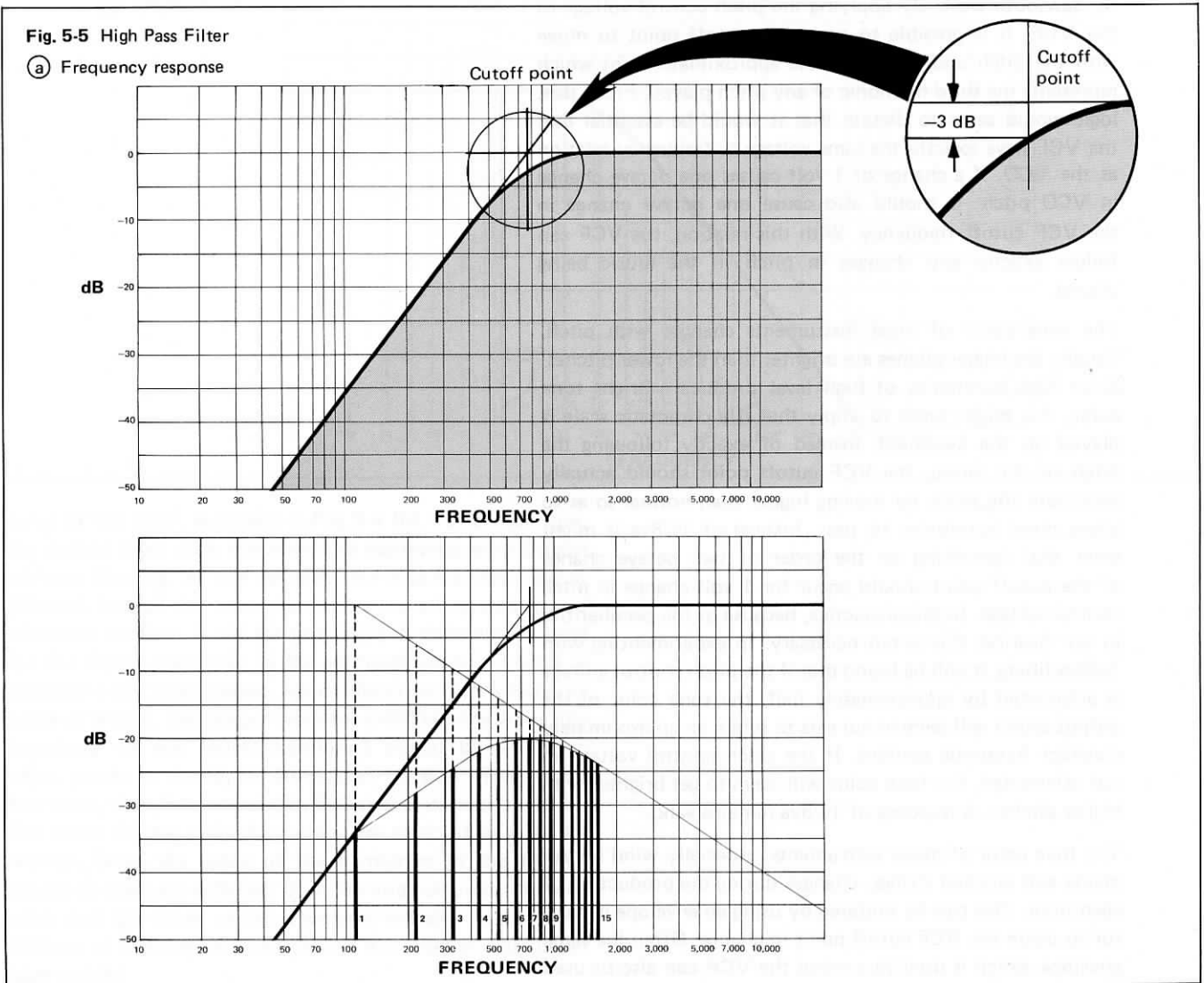

Experiments have shown that if the ear is simultaneously given a series of overtones which fall within the natural harmonic series, it will hear the fundamental pitch even if the fundamental is completely missing from the series. This explains the 16 Hz organ pitch shown in Fig. 1-2 which falls below the normal frequency range of the ear. The ear hears all the harmonics which are within its normal range and "mentally" furnishes the fundamental which is too low to hear. This phenomenon also explains why a sound with even a great amount of high pass filtering usually does not lose its previous pitch sense.

Since high pass filters block lower frequencies, they are often used to brighten synthesized sounds. Some synthesizers include voltage controlled high pass filters.

## 5-7 The Band Pass Filter and Band Reject Filter

The **band pass filter (BPF)** passes a band or group of frequencies. The average band pass filter has a narrow band width as shown by the response curve in Fig. 5-6 (a), the only differences being in the slopes. In this example, the center frequency of the filter is 1,000 Hz so that frequencies higher and lower than this will be attenuated. The response for a wide band pass filter is shown in (b) (next page). In this filter, the response between the upper and lower limits is flat. A wide band pass filter of this type can be made by patching a low pass filter in series with a high pass filter as shown in (c). In this case, the control of the upper and lower limits are independent of each other so that the limits may be set at any desired point.

Fig. 5-6 Band Pass Filters

(a) Narrow bandwidth

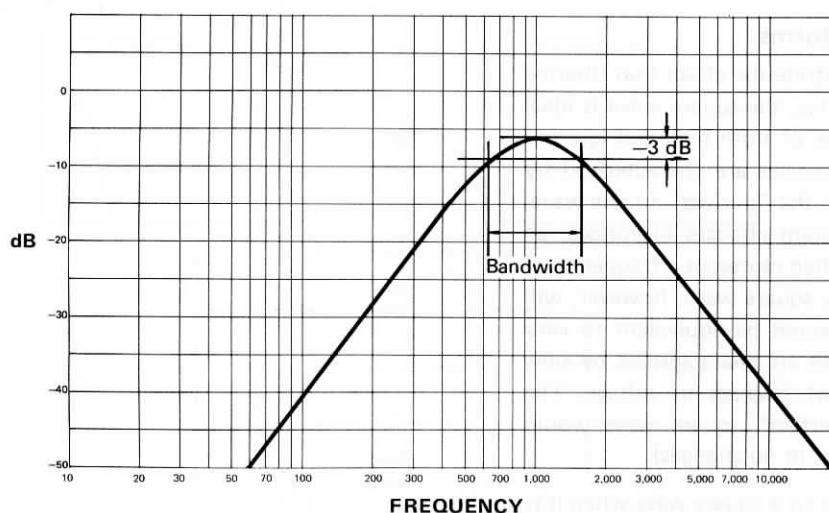

(Fig. 5-6)

(b) Wide bandwidth

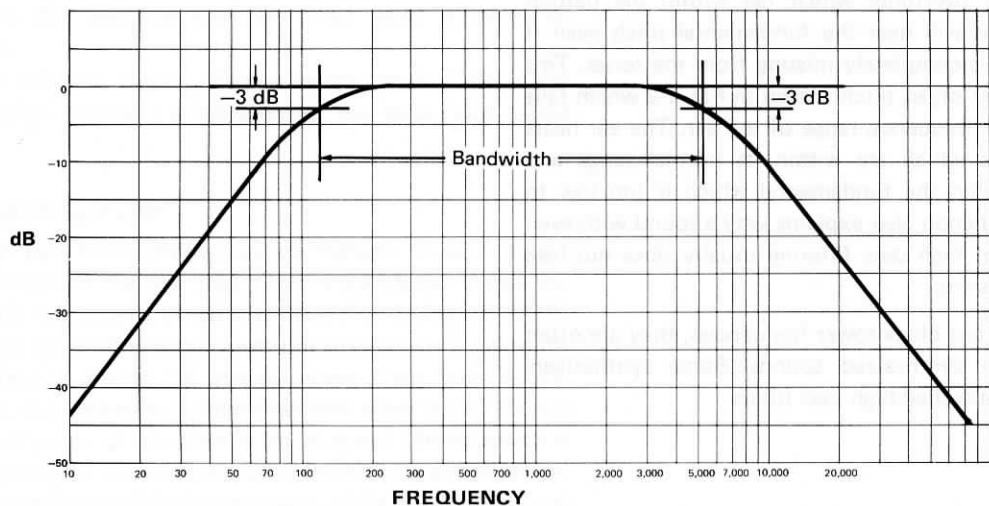

(c) Making a band pass filter

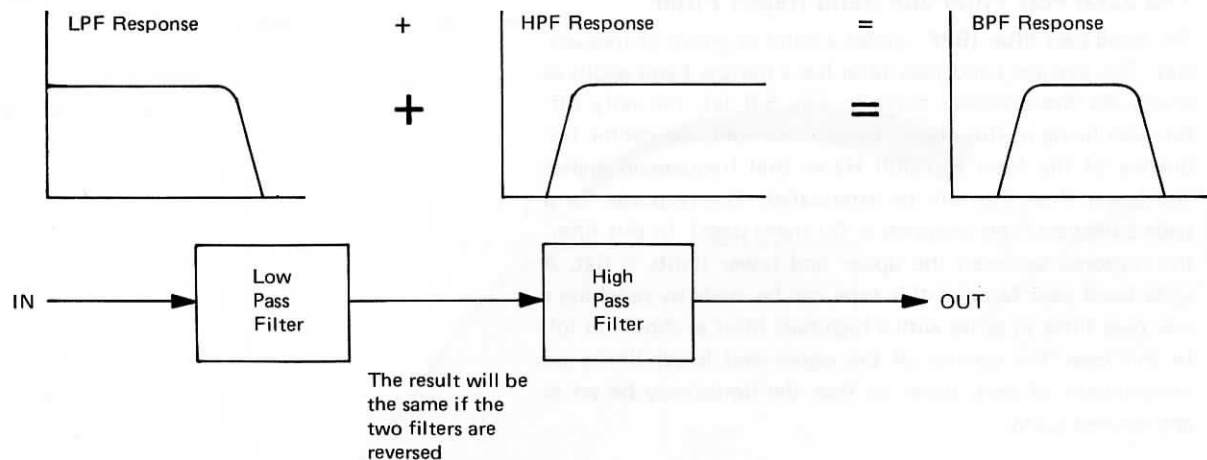

The **band reject filter** is an inversion of the band pass filter, as shown in Fig. 5-7, and can be made by patching a low pass filter in parallel with a high pass filter as shown in (c).

## 5-8 Effects of Filtering on Waveforms

It is of a certain value to demonstrate the effect that filtering has on a given waveform. For this, the square wave is ideal because it contains the extremes of both high and low frequency components. High frequencies are characterized by rapid changes in voltage level. In the "perfect" square wave, the vertical edges would be instant changes in voltage, an impossibility since they would then represent a frequency of infinity. Even a medium quality square wave, however, will produce vertical edges which would be equivalent to very high frequencies. Low frequencies are characterized by slow (from the audio point of view) changes in voltage. The horizontal portions of the "perfect" square wave would represent zero Hertz (DC voltages, or no changes).

Fig. 5-8 (b) shows what happens to a square wave when it is passed through a low pass filter. The low pass filter can be

Fig. 5-7 Band Reject Filters

(a) Narrow bandwidth

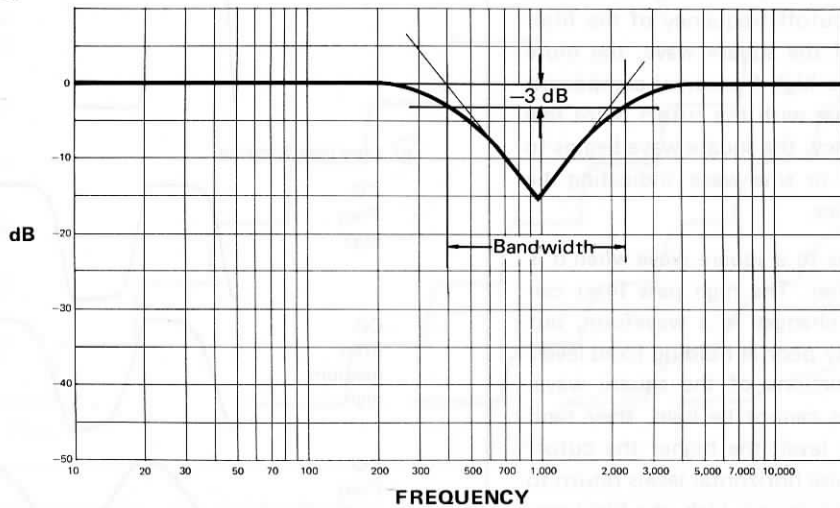

(b) Wide bandwidth

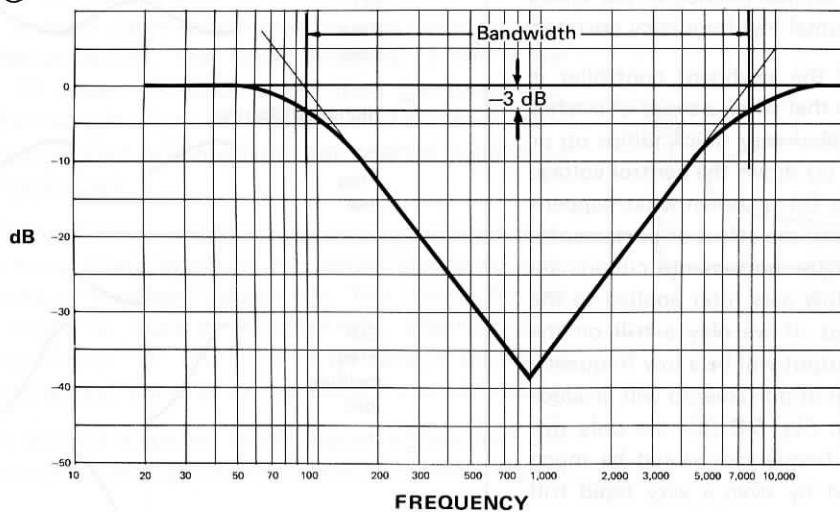

(c) Making a band reject filter

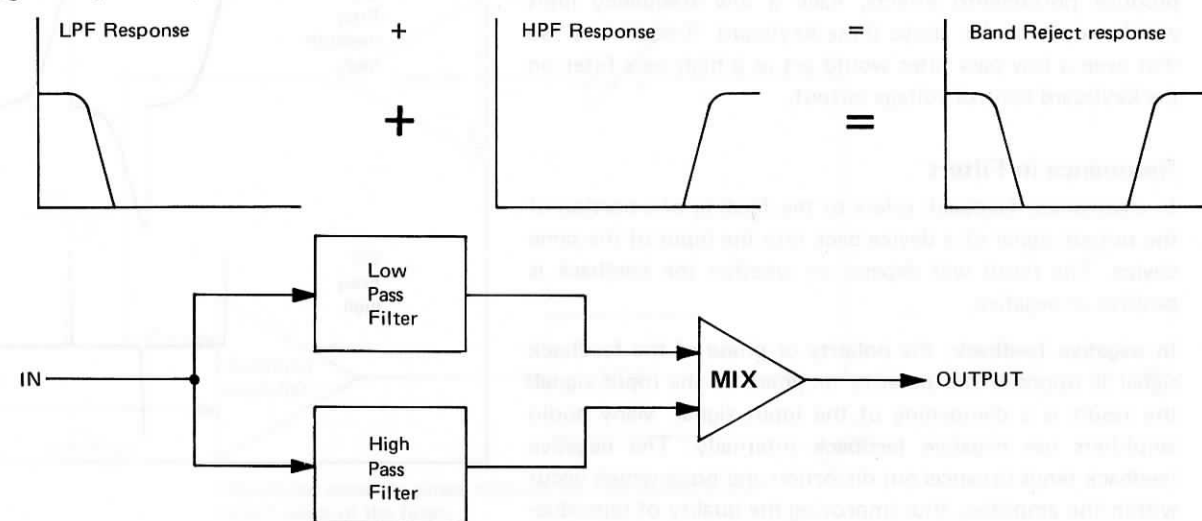

thought of as being slow and sluggish, resisting fast changes. This tendency causes the output of the filter to lag behind the quick changes in the square wave, softening the corners of the squares. The lower the cutoff frequency of the filter in relation to the frequency of the square wave, the more pronounced the softening of the high frequency component vertical edges will be. Notice that with the cutoff point low in relation to the input frequency, the square wave begins to look very much like a triangle or sine wave, indicating the suppression of the upper harmonics.

Fig. 5-8 (c) shows what happens to a square wave when it is passed through a high pass filter. The high pass filter can react very quickly to sudden changes in a waveform, but it can be thought of as being very poor at holding fixed levels as occur in the horizontal portions of the square wave. Since these horizontal portions cannot be held, they tend to fall back towards the zero level; the higher the cutoff point of the filter, the faster these horizontal levels return to the zero level. With the cutoff point very high, the filter produces a waveform with only sharp spikes since it effectively passes only the high frequency vertical portion of the square wave and blocks all of the horizontal low frequency portions.

The control voltage output of the keyboard controller is very much like a square wave in that when a series of pitches is played, the output voltage makes very quick jumps up or down to each new level. Fig. 5-9 (a) shows the control voltage output for a chromatic scale. In (b) is shown what happens to this control voltage when we add the effect of **portamento**. This demonstrates the fact that the portamento circuits are basically nothing more than a low pass filter applied to the keyboard control voltage output. If we play a trill on the keyboard, the control voltage output will be a low frequency square wave. Using various depths of portamento will produce waveforms exactly as shown in Fig. 5-8 (b), the only difference being that the related frequencies would be much lower. The frequency produced by even a very rapid trill on the keyboard is very low compared to ordinary audio frequencies. Most filters, except of course those designed to produce portamento effects, have a low frequency limit which would be far above these keyboard "frequencies" so that even a low pass filter would act as a high pass filter on the keyboard control voltage output.

## 5-9 Resonance in Filters

In electronics, feedback refers to the feeding of a portion of the output signal of a device back into the input of the same device. The result will depend on whether the feedback is positive or negative.

In **negative feedback**, the **polarity** or phase of the feedback signal is opposite the polarity or phase of the input signal; the result is a dampening of the input signal. Many audio amplifiers use negative feedback internally. The negative feedback tends to cancel out distortion and noise which occur within the amplifier, thus improving the quality of reproduction.

Fig. 5-8 Effects of Filtering on Waveforms

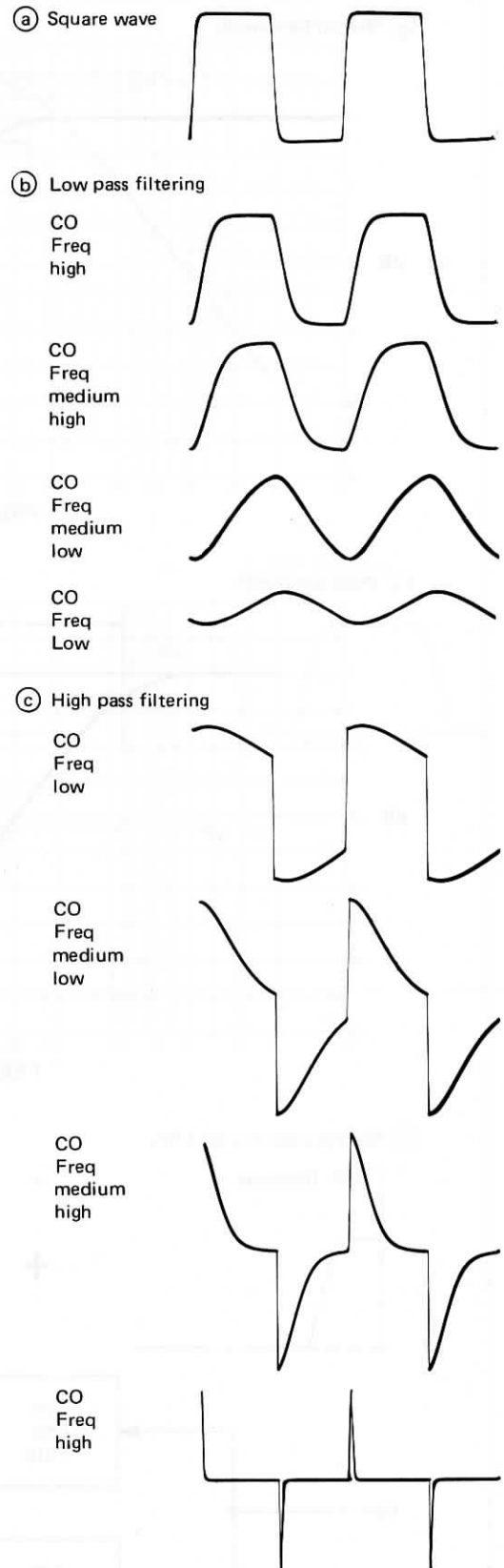
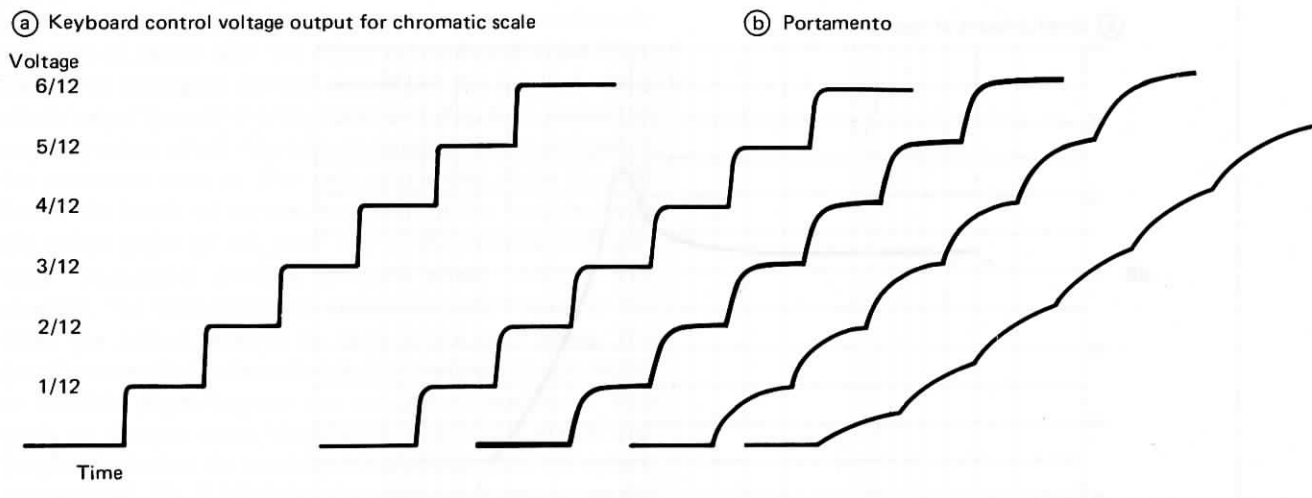

Fig. 5-9 Keyboard Portamento



In **positive feedback**, the feedback signal is of the same polarity or phase as the input signal. The feedback signal reinforces the input signal. It is easily possible for this positive feedback signal to reinforce the input so much that **self-oscillation** occurs. The classic example of this is the howling PA system in which sound from the speaker re-enters the microphone to be amplified over and over again. Many types of electronic oscillators use positive feedback to produce oscillations.

Resonance in filters is produced by inducing positive feedback. In many filters, especially the voltage controlled type, the amount of feedback is adjustable. The control for this purpose might be labelled: RESONANCE, EMPHASIS, or sometimes simply "Q" ("Q" is a factor used in measuring circuit resonances), but all of them perform the same function.

Fig. 5-11 shows a simplified block diagram of how feedback is applied inside a voltage controlled filter. For frequencies at

Fig. 5-10 Positive Feedback in a PA System

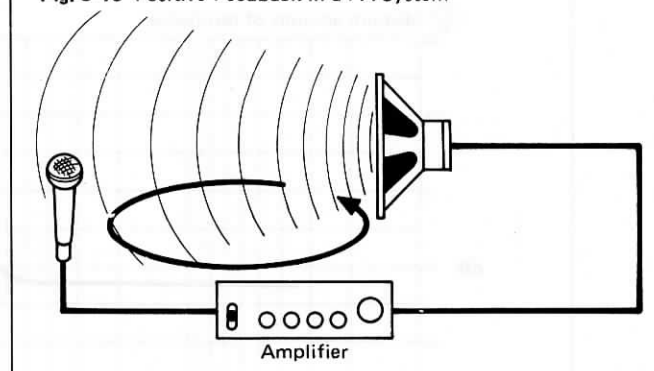
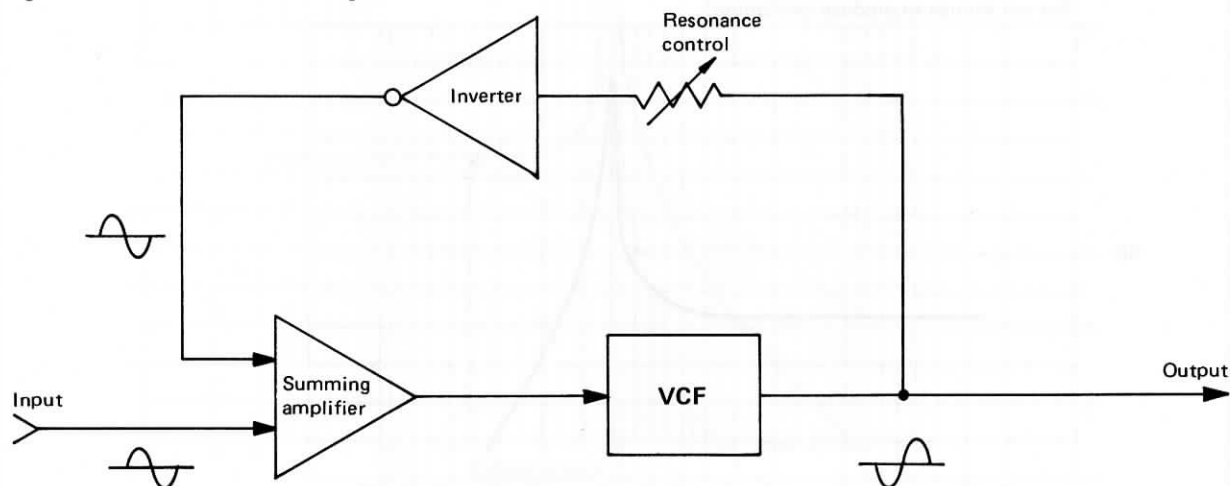
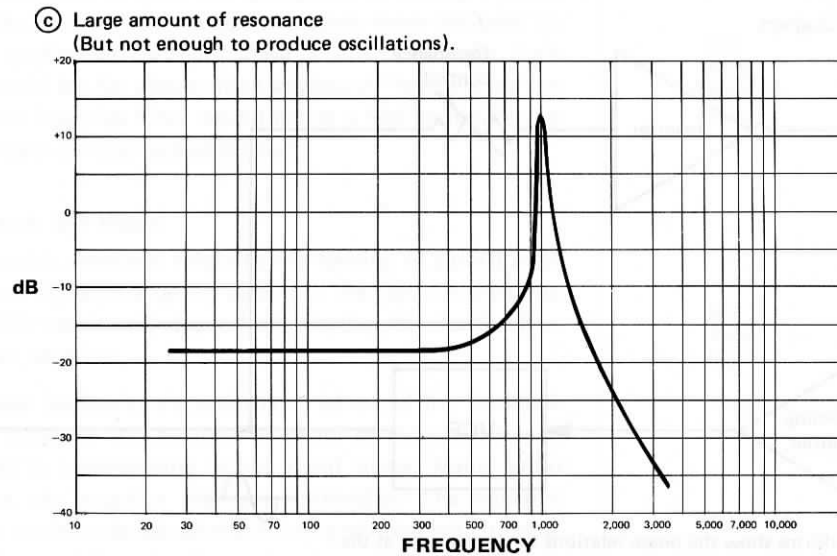
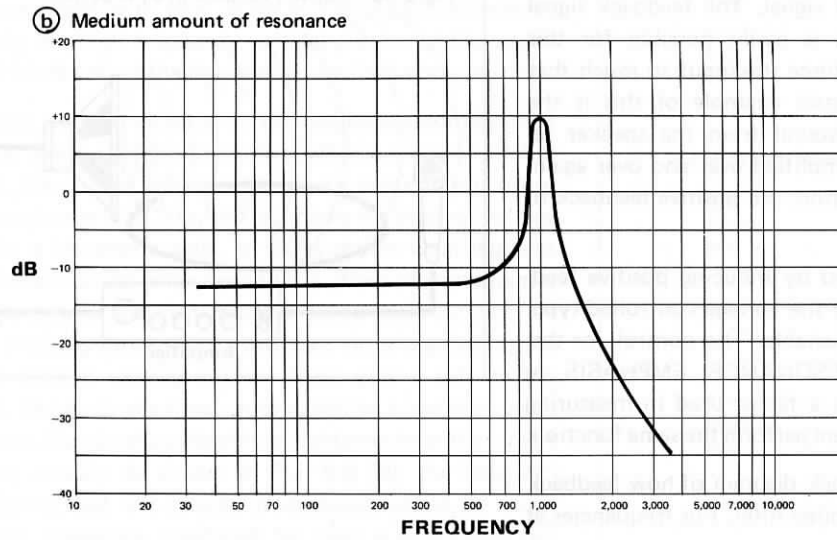
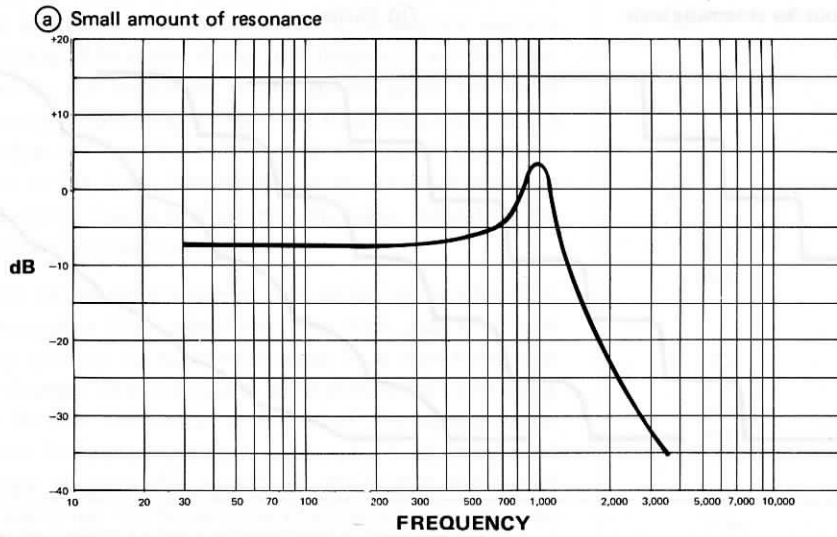

Fig. 5-11 VCF Resonance Block Diagram



Waveforms show the phase relations for frequencies at the cutoff point of the filter.

Fig. 5-12 VCF (Low Pass) Resonance



### 5-10 Ringing in Filters.

In Chapter One it was stated that: Resonance occurs whenever a body or system is set into vibration at its own natural frequency as a result of impulses received from a body or system vibrating at the same frequency. Returning to the analogy of the child's swing, if the swing is hanging motionless and a single impulse or push is given to the swing, it will begin to swing at its natural frequency or period, after which it will slowly die to a motionless state again. A filter with resonance reacts in a similar way to impulses supplied by the waveform at the input of the filter. This type of reaction is called **ringing**.

Fig. 5-14 shows what happens to a square wave applied to a filter with various degrees of resonance. Note that due to positive feedback, the vertical edges of the square wave overshoot their normal level, then waver up and down as they try to settle to the correct level. The frequency of these waverings is determined by the cutoff point of the filter. The waveform at (e) will of course occur whether there is an input waveform or not (the oscillations will begin as a result of internal circuit noise) and the frequency will be that of the cutoff frequency of the filter.

### 5-11 The Basic Synthesizer Patch

Fig. 5-15 shows the completed basic synthesizer patch. This is the most common arrangement used to produce sounds. The variations possible on this patch are almost limitless. One of the most common variations is to use more than one module or element. For example, with many sounds it is better to use more than one VCO and/or more than one VCF.

The VCF is a **dynamic filter** since, due to control voltages acting on it, its characteristics often change during the production of each note. Often it is desirable to simultaneously imitate the tone colors which do not change. This can be done by means of a **static filter**, a filter whose characteristics remain fixed once it has been set by means of its front panel controls. Such a filter would normally be added between the VCF and VCA.

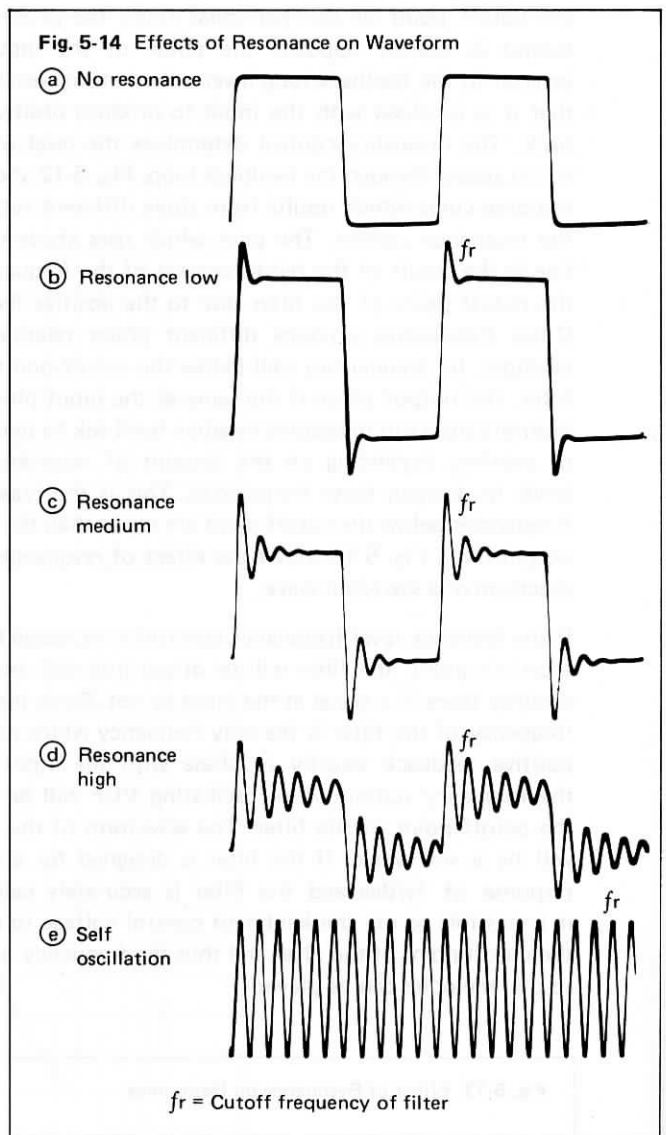
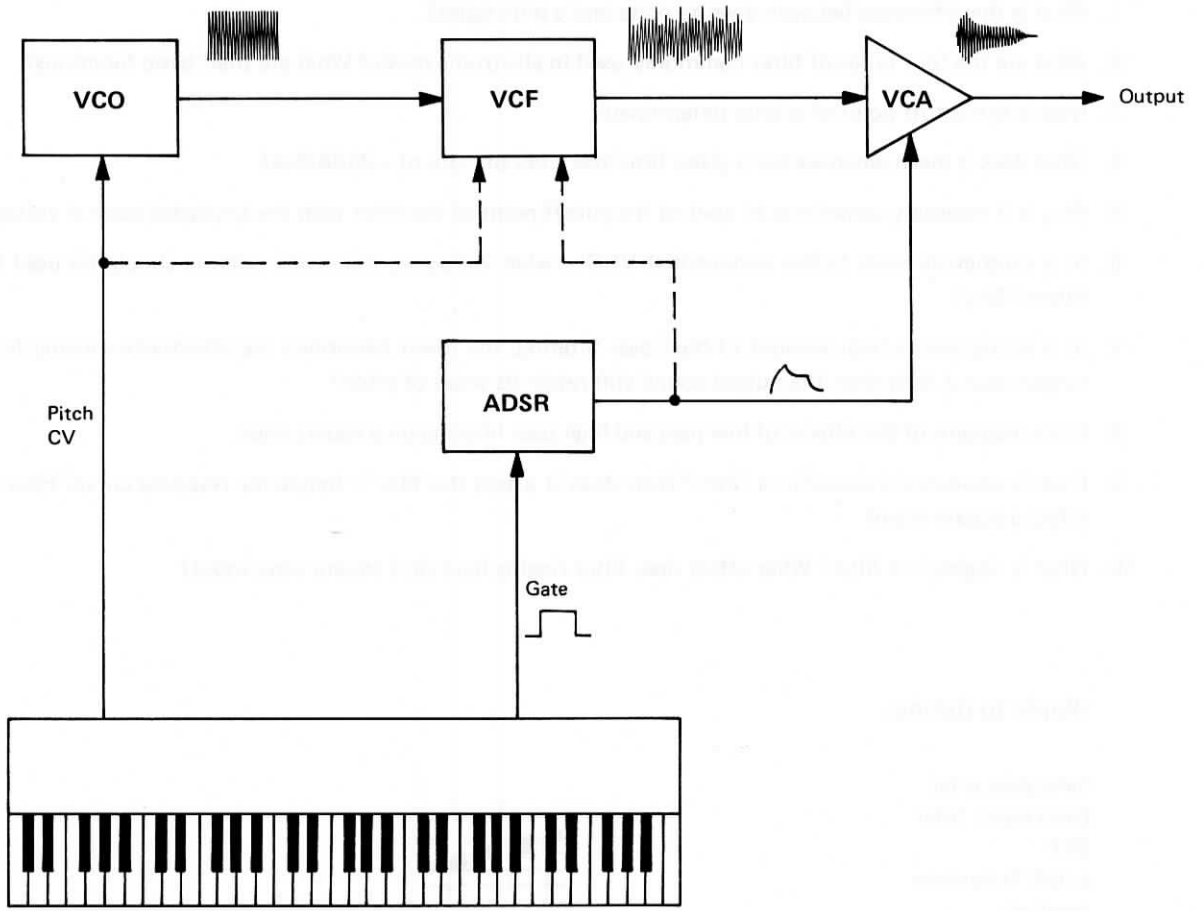



Fig. 5-15 The Basic Synthesizer Patch



## 5-12 Questions

1. What is the difference between a white noise and a pink noise?
2. What are the four types of filter commonly used in electronic music? What are their basic functions?
3. How is the cutoff point of a filter determined?
4. What does it mean when we say a given filter has a fall off rate of  $-24\text{dB}/8\text{va}$ ?
5. Why is it necessary sometimes to control the cutoff point of the filter with the keyboard control voltage?
6. In a synthesizer with  $1\text{v}/8\text{va}$  exponential VCO's, what voltage-to-frequency relation should be used for the filters? Why?
7. In a sound with a high amount of high pass filtering, the lower harmonics are effectively missing from the output sound. Why does the output sound still retain its sense of pitch?
8. Make diagrams of the effects of low pass and high pass filtering on a square wave.
9. How is resonance induced in a filter? How does it affect the filter's frequency response curve? How does it affect a square wave?
10. What is ringing in a filter? What affect does filter ringing have on a square wave input?

## Words to define:

band pass filter  
 band reject filter  
 BPF  
 cutoff frequency  
 feedback  
 filter  
 filter slope  
 growl  
 high pass filter  
 HPF  
 low pass filter  
 LPF  
 negative feedback  
 noise  
 oscillation  
 pink noise  
 positive feedback  
 resonance (filter)  
 ringing (filter)  
 self-oscillation  
 VCF  
 voltage controlled filter  
 white noise

# Metric Conversion Table

The conversion table below allows quick and easy conversion from one metric prefix to another. The prefixes listed are those which are commonly used in electronics and electronic music. To use the table, find the given prefix in the column on the left, then follow the line horizontally to the vertical column containing the desired prefix. The figure indicates the number of places the decimal point must be moved and the arrow indicates the direction.

EXAMPLE: Convert 3 kHz to units (Hz). (3 kHz = 3 kilohertz.) Find "kilo" in the left-hand column; move to the right to the vertical column headed "units". 3 ⇒ indicates that the decimal point must be moved three places to the right, thus:

$$3 \text{ kHz} = 3,000 \text{ Hz}$$

EXAMPLE: Convert 380 milliseconds to seconds. Find "milli" in the left column; to the right, under "Units", read: ⇐ 3, thus:

$$380 \text{ milliseconds} = 0.38 \text{ second}$$

Metric Conversion Table

| ORIGINAL VALUE | DESIRED VALUE |      |       |      |       |       |       |            |
|----------------|---------------|------|-------|------|-------|-------|-------|------------|
|                | Mega          | Kilo | Units | Deci | Centi | Milli | Micro | Micromicro |
| Mega           |               | 3 ⇒  | 6 ⇒   | 7 ⇒  | 8 ⇒   | 9 ⇒   | 12 ⇒  | 18 ⇒       |
| Kilo           | ⇐ 3           |      | 3 ⇒   | 4 ⇒  | 5 ⇒   | 6 ⇒   | 9 ⇒   | 15 ⇒       |
| Units          | ⇐ 6           | ⇐ 3  |       | 1 ⇒  | 2 ⇒   | 3 ⇒   | 6 ⇒   | 12 ⇒       |
| Deci           | ⇐ 7           | ⇐ 4  | ⇐ 1   |      | 1 ⇒   | 2 ⇒   | 5 ⇒   | 11 ⇒       |
| Centi          | ⇐ 8           | ⇐ 5  | ⇐ 2   | ⇐ 1  |       | 1 ⇒   | 4 ⇒   | 10 ⇒       |
| Milli          | ⇐ 9           | ⇐ 6  | ⇐ 3   | ⇐ 2  | ⇐ 1   |       | 3 ⇒   | 9 ⇒        |
| Micro          | ⇐ 12          | ⇐ 9  | ⇐ 6   | ⇐ 5  | ⇐ 4   | ⇐ 3   |       | 6 ⇒        |
| Pico           | ⇐ 18          | ⇐ 15 | ⇐ 12  | ⇐ 11 | ⇐ 10  | ⇐ 9   | ⇐ 6   |            |

# Index

- Additive synthesis, 16
- ADSR, 44
- AM, 47
- Amplifier, summing, 35
  - voltage controlled, 20, 44
- Amplify, 14
- Amplitude modulation, 47
- Anechoic chamber, 39
- Antinode, 6
- Attack time (A), 44
- Attenuate, 14, 35
  
- Band pass filter (BPF), 52, 57
- Band reject filter, 52, 58
- Bar, 39
- Basic synthesizer patch, 19, 38, 48, 65
- Beat, 29
- Beat frequency, 29
- Bell, Alexander Graham, 39
- BPF, 52, 57
  
- Cent, 32
- Central processing unit (CPU), 22
- Chord, 27
- Chorus effect, 10
- Clarinet, waveform of, 15
- Compression (of air), 2
- Computer music, 20-24
- Concord, 27
- Consonance, 27, 30
- Control response of VCA, 45
  - of VCF, 55
  - of VCO, 32-36
- Control voltage, 19
- Cutoff frequency, filter, 53
- Cutoff point, filter, 53
  
- dB, 39
- dB SPL, 40
- Decay time (D), 44
- Decibel, 39
- Direct synthesis, 23
- Discord, 27
- Dissonance, 27, 30
- Dyck, Ralph, 22
- Dynamic filter, 64
- Dynamic range, 41-42
- Dynamics, 8, 39
  
- Echo, 9
- Electronic music, 13-14
  - live, 13
  - recorded, 14
- Emphasis, 61
- End correction, 3
- Envelope, 8, 44
  - organ, 44
  - piano, 8, 44, 45
  - synthesizer, 44
  - vowel sound "ah", 8
- Envelope generator, 44
- Equal temperament, 28
- Even temperament, 28
- Exponential decay, 45
- Exponential generator, 34
- Exponential progression, 31-32
- Exponential VCA, 46
- Exponential VCO, 33
  
- Feedback, negative, 60
  - positive, 61
- Filter, 16, 51
  - band pass, 52, 57
  - band reject, 52, 58
  - cutoff frequency, 53
  - frequency response of, 52, 56-59, 62
  - fall off rate, 53
  - dynamic, 64
  - effects of resonance, 63
  - effects on waveform, 58, 60
  - high pass, 52, 56
  - low pass, 52-56, 60
  - pink noise, 53
  - ringing in, 64
  - slope, 53
  - static, 64
  - voltage controlled, 19, 51, 55-56
- Flute, spectrum of, 15
  - waveform of, 15
- FM, 36
- Frequency, 1
- Frequency modulation (FM), 36
- Frequency response of ear, 2, 40-41
  - of filter, 52
- Fundamental, 5
  
- Gate pulse, 44, 47
- Growl, 56
- Guitar, 6, 8
- Harmonics, 5, 29
  - first, 5
  - intensity of, 8, 42
  - inversion of, 18, 19
  - second, 5
- Harmonic series, natural, 5, 30
- Harmony, 27
- Hearing, threshold of, 39
- Hertz (Hz), 2
- Hertz, Heinrich Rudolf, 2
- High pass filter, 52, 56-57
- Hold control (VCA), 47
- HPF, 52, 56-57
  
- Initial gain, 47
- Intensity, 40
  - of harmonics, 8, 42
- Interval, 27
  - consonance and dissonance of, 30
  
- Just intonation, 28
  
- LFO, 36, 47, 56
- Linear scale, 31
- Linear VCA, 45
- Linear VCO, 32, 33
- Loudness, 8, 39, 40
- Low frequency oscillator (LFO), 36, 47, 56
  - control of VCA, 47
  - control of VCF, 56
  - control of VCO, 36
- Low pass filter (LPF), 52-56, 60
  - control response of, 55
  - cutoff frequency, 53
  - perfect, 53
  - voltage controlled, 55-56
  - voltage-to-frequency relation, 55
- LPF (see Low pass filter)
  
- Microbar ( $\mu$ bar), 39
- MicroComposer, 22
- Microprocessor, 22
- Modulation, 19, 36
  - amplitude, 47
  - frequency, 36
- Monochord, 3-4
- Music, computer, 20-24
  - electronic, 13-14
  - scale systems, 28
- Musique concrète*, 13
  
- Natural harmonic series, 5, 30
- Negative feedback, 60
- Node, 6
- Noise, 20, 42, 51
  - pink, 20, 51, 53
  - waveform of, 20
  - white, 20, 51
- Noise generator, 20, 42, 53
- Non-harmonic overtones, 7
  
- Octave, 27
- Oscillator, 16, 19, 27
  - exponential, 33
  - linear, 32, 33
  - low frequency, 36, 47, 56
  - voltage controlled, 19, 27
- Overtone, 4, 29
  - non-harmonic, 7
  
- Patching, 19
- Pendulum, 14-15
- Phase, 18, 60
- Phase shifter, 10, 18
- Phon, 41
- Pickup (guitar), position of, 6
- Pink noise, 20, 51, 53
- Pink noise filter, 53
- Pipe, closed end, 3
  - open end, 3
  - scale of, 7
- Pitch, 1, 27
- Polarity, 60
- Portamento, 60
- Positive feedback, 61
- Propagation of sound waves, 8
- Pulse, gate, 44, 47
  
- Q, 61
  
- Ramp wave, 16
- Rarefaction, 2
- Release time, (R), 44
- Resonance, body (instrument), 7
  - defined, 2, 64
  - effect on waveform, 64
  - frequency response in filters, 62, 63
  - in closed end air columns, 3
  - in filters, 61
  - in open air columns, 3
  - in strings, 3-4
- Resonance tubes, 3
- Response, filter frequency, 52
- Response, VCA control, 45
  - VCF control, 55
  - VCO control, 32-36
- Reverberation, 9
- Ringling in filters, 64
- Roland MC-8 MicroComposer, 22

- Sawtooth wave, 16-18,  
 inversion of, 18  
 spectrum of, 17,  
 waveform of, 17
- Scale, comparison of linear and exponential, 32  
 exponential, 31  
 linear, 31  
 musical, 28
- Scale of pipe, 7
- Self-oscillation, 61, 63
- Sine wave, 14, 60, 63  
 inversion of, 18
- Sonometer, 3-4
- Sound, 1  
 defined, 1  
 loudness of, 41  
 speed of, 2  
 three qualities of, 1
- Sound pressure level (SPL), 40
- Sound waves, 2  
 propagation of, 8
- Spatial effects, 10
- Spectrum diagrams, 16  
 effects of filtering, 54, 56, 63  
 of clarinet, 15  
 of flute, 15  
 of sawtooth wave, 17,  
 of square wave, 17, 43  
 of triangle wave, 43  
 of trumpet, 15
- SPL, 40
- Square wave, 16, 42, 58  
 inversion of, 18  
 spectrum of, 17, 43
- Static filter, 64
- Subtractive synthesis, 16, 19-20, 53
- Summing amplifier, 35
- Sustain, (S), 44
- Synthesis, 16, 19  
 additive, 16  
 direct, 23  
 subtractive, 16, 19-20, 53
- Synthesizer, basic patch, 19, 35, 48, 65  
 computer control of, 22  
 voltage controlled, 19
- Threshold of hearing, 39
- Threshold of pain, 39
- Timbre, 4, 51
- Tone color, 4, 51  
 changes with pitch, 20, 55
- Transient generator, 44
- Tremolo, 47
- Triangle wave, 42, 60  
 spectrum of, 43  
 waveform of, 43
- Trumpet, spectrum of, 15  
 waveform of, 15
- Tuning fork, 1-2, 3, 4, 14
- Unison, 27
- VCA (*see* Voltage controlled amplifier)
- VCF (*see* Voltage controlled filter)
- VCO (*see* Voltage controlled oscillator)
- Vibrato, 36
- Voltage control, 19
- Voltage controlled amplifier (VCA), 20, 44  
 control by LFO, 47  
 control response, 45  
 exponential, 46  
 linear, 45
- Voltage controlled filter (VCF), 19, 51, 55-56  
 control by LFO, 56  
 control response, 55  
 cutoff frequency, 53  
 frequency response, 52
- Voltage controlled oscillator (VCO), 19, 27  
 control by LFO, 36  
 control response, 32-34  
 exponential, 33  
 linear, 32, 33
- Voltage controlled synthesizer, 19
- Waveform, 14  
 air pressure changes, 14  
 amplitude modulated, 47  
 clarinet, 15  
 effect of filtering, 58  
 effect of resonance, 64  
 electrical, 14  
 flute, 15  
 frequency modulated, 36  
 household electricity, 15  
 noise, 20  
 sawtooth, 17  
 sine wave, 14  
 square wave, 17, 43, 60, 64  
 triangle wave, 43  
 trumpet, 15
- Wavelength, 2
- White noise, 20, 51