

FOR IMMEDIATE RELEASE
November 23, 2020

Contact:

Steve Sigmund – ssigmund@gatewayprogram.org; 917-459-7794

Craig Schulz – cschulz@gatewayprogram.org; 302-632-2865

GATEWAY PROGRAM DEVELOPMENT CORPORATION RELEASES INDEPENDENT ANALYSIS OF NORTH RIVER TUNNEL REHABILITATION

Conceptual study by London Bridge Associates believes that full rehabilitation of tunnel “in-service” with the same scope and useful life, in conjunction with construction of new tunnel may be feasible and improved customer experience may be possible sooner if a number of pre-construction activities are undertaken immediately and expedited to completion. GDC and Partners to consider recommendations.

Newark, NJ – The Gateway Program Development Corporation (GDC) today released [an analysis](#) of the North River Tunnel (NRT) rehabilitation project that provides an independent, third-party review of the Hudson Tunnel Project rehabilitation plan. London Bridge Associates (LBA) considered the scope and implementation timing of the NRT rehabilitation based on its experience in global best practices.

The analysis confirms that all elements of the rehabilitation scope included in the Hudson Tunnel Project are required to comprehensively rehabilitate the NRT. This includes reconfiguring and rebuilding the tunnel’s concrete bench walls; replacing high-voltage electrical cables and other cables currently inside the bench walls; a 360 degree repair of the tunnel’s concrete lining including areas behind the bench walls and beneath the ballasted track bed; replacing the outdated ballast and wood tie trackbed with a direct-fixation concrete system; and upgrading and replacing the catenary overhead system and dated cables and signals with state-of-the-art equipment. The report acknowledges that existing levels of Northeast Corridor service must be maintained throughout the construction period.

LBA’s report recommends a conceptual approach to repairing the tunnel lining and sealing leaks first and considering alternatives to the existing concrete bench walls for protecting cables, such as combinations of racking, troughs, and metal strongboxes that have successfully been used elsewhere. LBA’s approach prioritized the root causes of unreliability evidenced by train delay data attributed to track conditions, overhead power, and signal problems and recommends accelerating work to correct these issues as quickly as possible.

LBA noted, based on other tunnel rehabilitation works around the world, that NRT rehabilitation could be expedited, may be possible to carry out during “in service” maintenance windows on nights and weekends, and that the concept warranted further study by the Gateway partners. The report says further design and contractor outreach would be required to determine, develop, test and practice the means and methods that allow for maintaining current levels of service.

The analysis recommends proceeding with rehabilitation while continuing ongoing state of good repair work on the North River Tunnel. It assumes between 85 and 100% of regular weeknight and weekend maintenance windows where tracks are out of service for repair work can be utilized for these activities, an assumption being further studied by the NRT railroad operators to determine its feasibility.

Under LBA's recommendation, the rehabilitation projects would be sequenced on nights and weekends to bring benefits to customers online in stages, with reliability improving as the refurbishment work progresses.

Steven M. Cohen, New York Trustee and Chairman, said, "New York and the nation need 21st Century rail transportation, and the new Hudson River Tunnel, combined with a full rehab of the existing century old tunnel, delivers the first big step of that vision. We will work together with our partners to speed up delivery of reliable service to customers in the existing tunnel by inviting innovation and applying world's best practice to the rehabilitation plan, because that's the right thing to do for customers and economic growth. But make no mistake, we need both the new tunnel and a fully working, reliable existing tunnel to have the capacity and reliability our region and nation can depend on for the future."

Tony Coscia, Amtrak Trustee and Vice Chairman, said, "The construction of a new Hudson River Tunnel is the fundamental reason GDC was created and our top priority. As we await Federal environmental approval so we can begin construction, a full review of the very best means, methods and practices to preserve the existing North River Tunnel is an important part of Amtrak's stewardship of this critical infrastructure. The concepts suggested by LBA are being evaluated to determine feasibility, cost, and schedule impacts, so that we can determine the best ways to assure the continued reliability of rail travel into and out of New York while we advance the new tunnel."

Jerry Zaro, New Jersey Trustee and Treasurer, said, "To rebuild our economy and ensure the future of the Northeast Corridor, the Hudson Tunnel Project needs to do two things, construct a new two-track tunnel and rehabilitate the existing tubes to serve for the next hundred years, and to do so as soon as possible. In that spirit, we welcome the advice and suggestions contained in the LBA report. But we will take no action recommended by the report, such as replacing track overnight, unless and until we are 100% certain we can reliably do so and bring back uninterrupted service the following morning."

LBA are a London-based tunnel engineering firm with international tunnel rehabilitation experience, and are completely independent of the partner agencies involved in the Gateway Program.

#

The Gateway Program is the most urgent infrastructure program in the country – a comprehensive rail investment program that will improve commuter and intercity services, add needed resiliency and create new capacity for the busiest section of the Northeast Corridor (NEC). The NEC is the most heavily used passenger rail line in the country hosting more than 2,200 train movements and 800,000 passenger trips daily. The Gateway Program Development Corporation (GDC) is a New Jersey not-for-profit entity with Board members representing Amtrak and the States of New York and New Jersey. It was incorporated in 2016 to oversee and effectuate the Gateway Program in coordination with federal and local partner agencies. Follow the GDC on Twitter [@GatewayProgNews](https://twitter.com/GatewayProgNews).



Doc. No. D627-005-P01

LBA PROJECT D627

**INDEPENDENT REVIEW OF THE REFURBISHMENT PROPOSALS FOR THE
NORTH RIVER TUNNEL REHABILITATION PROJECT, NEW YORK**

BY LONDON BRIDGE ASSOCIATES

Issue	Date	Description	Produced by	Reviewed by
P01	23/11/2020	First Issue	JL	RLI & MCK

London Bridge Associates Ltd.,

Cranhurst Lodge,
37 – 39 Surbiton Hill Road,
Surbiton,
Surrey, KT6 4TS,
United Kingdom.

Tel: +44 (0)20 8399 8614
E-mail: welcome@lba.london
Web: www.lba.london



**INDEPENDENT REVIEW OF THE REFURBISHMENT PROPOSALS FOR THE NORTH
RIVER TUNNEL REHABILITATION PROJECT, NEW YORK**

BY LONDON BRIDGE ASSOCIATES (LBA)

CONTENTS

1	Introduction	8
1.1	Overview	8
1.2	LBA Background.....	8
1.3	Process of Review	8
1.4	Objectives and Assumptions	9
1.5	NRT Current Conditions - Overview	10
1.6	Current Refurbishment Plan	10
2	Executive Summary	10
2.1	Overview	10
2.2	Finding: The NRT is Experiencing Significant Deterioration	12
2.3	Finding: What is Not Recommended:	12
2.4	Finding: What is Recommended:.....	13
2.5	Finding: Schedule	15
2.6	Finding: Cost Impact.....	16
2.7	Finding: Risks to Passenger Operations	16
2.8	Finding: Risks to Health and Safety During Refurbishment.....	19
2.9	Finding: Next Steps	19
3	LBA Findings and Considerations for The Gateway Partners	20
3.1	General Findings Regarding the Refurbishment of the NRT	20
3.2	Findings: Outage Planning	21
3.3	Findings: M & E Services and Cable Protection	21
3.4	Findings: Civil Works and Bench Replacement Solutions	22
3.5	Findings: Track, Trackbed, and Overhead Line Clearances.....	23
3.6	Findings: Refurbishment Logistics	23
3.7	Findings: Implementation of the Recommendations.....	25
3.8	Findings: Overall Scheme Assessment	26
3.9	Findings: Risks	26

3.10	Findings: Next Steps.....	27
4	NRT Current Conditions.....	28
4.1	Deteriorating Concrete.....	29
4.2	Tunnel Lining	29
4.3	Mechanical & Electrical (M&E) Issues	30
4.4	Railway Issues.....	31
4.5	Track Deterioration	31
4.6	Current Refurbishment Plan	31
5	Conceptual Approach – Outage Planning.....	33
5.1	Introduction	33
5.2	Outage Planning	33
5.3	Railway Passenger Train Operations	33
5.4	Train Planning Analysis	34
5.5	The Opportunity for Outages	36
5.6	Integration of Refurbishment Works and Other Planned and Short Notice Activities in the NRT	36
5.7	Outage Planning - Findings	37
6	Refurbishment in Service	39
6.1	Introduction	39
6.2	Refurbishment Activities	39
7	Conceptual Approach - Mechanical & Electrical	41
7.1	Introduction	41
7.2	Need for Renewal	41
7.3	Standards and Future Requirements.....	41
7.4	High Voltage (HV) Cables.....	42
7.5	Emergency Cables	43
7.6	Low Voltage Cables.....	44
7.7	Signalling System	45
7.8	Fire Alarm System	45
7.9	Findings	45
8	Conceptual Approach - Civil Works.....	46
8.1	Introduction - Need for Reconstruction	46
8.2	Bench Walls & Safe Egress Walkway	46
8.3	Fire-Main and Drainage Discharge Pipe.....	50
8.4	Environmental Sustainability Considerations.....	50
8.5	Findings	50

9	Conceptual Approach – Track, Trackbed, and Overhead Line Clearances	52
9.1	Need for Reconstruction	52
9.2	Drainage Issues	52
9.3	Stray Currents and Corrosion Issues	52
9.4	Clearances	53
9.5	Dynamic Movement – Summary	54
9.6	Electrical Clearances	54
9.7	AAR (Association of American Railroads) Static Loading Gauges	55
9.8	Fixed Track Concrete “Slab Track”	56
9.9	Containment of a Derailed Train	56
9.10	Third Rail	58
10	Refurbishment Logistics	60
10.1	Introduction	60
10.2	Bench Wall Replacement	60
10.3	Mechanical & Electrical (M&E) Services Installation Methodology	61
10.4	Overall Sequence and Programme (Schedule) of Operations	62
10.5	Typical Schedule of Refurbishment of One NRT Tube	63
10.6	Availability of Outages	71
10.7	Removal and Reinstatement of Benches	71
10.8	Health, Safety, and Well-being	74
10.9	Servicing Facilities (Railhead)	74
10.10	Overhead Line and Trackbed Replacement	74
10.11	Teams and Shift Working	78
10.12	Overall Feasibility and Approach Proposed	78
10.13	Implementation	78
10.14	Cost Impact	85
10.15	Case Studies, References and Reference Documents	85
11	Risks	86
11.1	Introduction	86
11.2	General Risk Mitigation	86
11.3	Risk of Doing Nothing: Existing Risks	87
11.4	Risks During Refurbishment	88
11.5	Risk – Outage Overrun: Mitigations	88
11.6	Risk – Remaining Tube Incident: Mitigations	90
11.7	Comparison of Existing (Do Nothing) Scenario Risks with Risks Involved in the In-service Refurbishment	90

11.8	Risks During Construction	96
11.9	Cable Protection Risks	98
11.10	Flooding Risk	100
11.11	Risk of Interference with the new Hudson River Tunnel Construction.....	100
11.12	Cast Iron Lining.....	100
11.13	Seismic Risks	101
11.14	Buoyancy of the Tunnels	101
12	References	102
12.1	Documents provided to LBA by Gateway Partners	102
12.2	LBA Originated Documents	102
APPENDIX 1 - London Bridge Associates Ltd – Overview & Experience.....		106
A1.1	About London Bridge Associates (LBA)	106
A1.2	Project Experience.....	106
A1.3	Refurbishment Experience	106
A1.4	LBA - Gateway Project Team	107
A1.5	Extended Biographies – LBA Team Leads.....	108
APPENDIX 2 - Civil Works		109
A2.1	Re-Profile and Repair the Existing Concrete Bench Walls	109
A2.2	Re-Profile the Existing Concrete Bench Walls and Clad with FRP Panelling and Cable Ducts (Similar to the Canarsie Solution)	111
A2.3	Demolish the Existing Concrete Bench Walls and Replace with Steel Walkways and Maintenance Platforms, then Cast New Concrete Bench Wall Below...	113
A2.4	Demolish Existing Concrete Bench Walls and Replace with Pre-Cast SFRC Bench Walls.....	115
A2.5	Demolish the Existing Concrete Bench Walls and Replace with Fire Resistant GRP Boxes and Conventional Ducts Mounted on Steel Hanger Brackets...	117
A2.6	Demolish the Existing Concrete Bench Walls and Replace with Fire Resistant Bench Wall Facings and Ducts.....	119
A2.7	Demolish the Existing Concrete Bench Walls and Replace with Cantilevered Steel Walkways and Conventional Ducts Mounted on Steel Hanger Brackets	121
A2.8	Demolish the Existing Concrete Bench Walls and Replace with Steel Walkways and Maintenance Platforms with Cables or Cable Ducts Mounted on Steel Hanger Brackets with Critical Cables Contained in a Fire-Proof Box Below the Walkway	123
A2.9	Fire Resistant Ducting	125
APPENDIX 3 - Rail Infrastructure Drawings.....		126
APPENDIX 4 - Bench Demolition and Reinstatement Methodology.....		131
A4.1	Detailed Approach	131
A4.2	Performance of the System (i.e. the fully equipped works train).....	131



A4.3	Plant and Equipment	132
A4.4	Detailed Sequence of Operations	132
APPENDIX 5 - Dust Control during Bench Demolition and Reinstatement of Walkways.....		142
A5.1	Background.....	142
A5.2	Dust Control Measures	142
A5.3	Sketch-up of Dust Control Measures.....	144
A5.4	Extract from Safety and Health Regulations for Construction CFR 1926.1153	145
A5.5	Extract from OSHA Fact Sheet.....	146
A5.6	Specimen Specification for Spray Cannon Cited in OSHA Fact Sheet.....	147
APPENDIX 6 - In-Service Trackbed Options		148
A6.1	Introduction	148
A6.2	Issues to be Addressed	148
A6.3	Information Required	148
A6.4	Assumptions Made (for the purposes of identifying possible methods).....	148
A6.5	Simple Criteria for Assessment of Ideas.....	149
A6.6	Options Identified.....	149
A6.7	Track Lowering	149
A6.8	Precast Units	151
A6.9	Paving Machines	153
A6.10	Replacement with Booted Track Ties (Sleepers)	156
A6.11	Replacement of Ballast and Timber Ties (Sleepers) by New Concrete Trackbed with Rail Remaining in Place at all Times.....	161
A6.12	Assessment of the Options.....	165
A6.13	Refurbishment In-Service: References.....	167
APPENDIX 7 - Tunnel Refurbishment Works Trains and Railhead		169
A7.1	Proposed Locations	170
A7.2	Clayton Equipment’s Battery Hybrid Locomotive.....	170
A7.3	Battery challenges and solution.....	172
APPENDIX 8 - Time Chainages: Further Explanation and Pre-construction Activities.....		173
A8.1	Outputs and Durations.....	174
A8.2	Time Chainage	178
A8.3	Gantt Chart	179
A8.4	“What If” Time Chainage.....	180
A8.5	“What If” Gantt Chart.....	181
A8.6	Pre-Construction Activities.....	182

A8.7 Construction Timeline Comparison	183
APPENDIX 9 - The Use of Slab Track in Other Railways Around the World.....	184
A9.1 Examples of In-situ Cast Concrete Slab-Track Cited by Tayabji & Bilow.	184
A9.2 Slip-paved Slab-track in the North River Tunnel.....	186
A9.3 Failure in the Substrate Causing Failure of a Slip-paved Slab.	186
A 9.4 Fixing Base Plates to the Slab Track. Avoidance of Fastener Related Problems Noted by Tayabji & Bilow at Some Early Slab-track Sites.	187
A9.5 Survey Data and Detailed Assessment Ahead of Commencement of Slab-track.	187
APPENDIX 10 – Implementation	191
A10.1 Introduction	191
A10.2 Process for Taking the NRT Refurbishment Forward	191
A10.3 Early Contractor Involvement (ECI)	191
A10.4 Early Decisions	192
A10.5 Early Contractor Involvement (ECI) Stage 1.....	194
A10.6 ECI - Stage Two (Execution)	195
A10.7 Mock-ups, “Pilot” Sections, testing and proving.....	196
A10.8 Case Studies and Reference Documents.....	198
A10.9 Documents and References	207

1 INTRODUCTION

1.1 Overview

The North River Tunnel (NRT) Refurbishment is part of the urgent and critical Gateway Program for improvement of the rail facilities between New York and New Jersey to provide reliable operational capability for Amtrak and NJ TRANSIT customers.

In July 2019, the Gateway Program Development Corporation (GPDC) commissioned London Bridge Associates Ltd (LBA), a London-based construction consultancy with infrastructure industry experience in tunnelling (including rehabilitation), metro, and rail projects, led by Bob Ibell and Martin Knights, who, combined, have over 80 years of experience. For the review, LBA mobilised a bespoke expert team in the fields of: tunnelling, rail tunnel refurbishment, drainage and maintenance, mechanical and electrical engineering (including power, OLE, and traction) rail and metro systems requirements (including signalling and communications), operations and maintenance, trackwork, construction, cost, risk, safety, and scheduling.

1.2 LBA Background

LBA is an employee-owned construction consultant that has a strong contracting background and offers construction management skills and experience. LBA has an extensive pedigree in the refurbishment of underground infrastructure, particularly while maintaining ongoing in-service operational needs. LBA has worked with London Underground, UK Network Rail, and the UK Highways Authority, among other transportation agencies, which all have demanding requirements for the maintenance, assurance, and planning for the continuous adaption of key underground infrastructure assets to be fit for the future.

LBA is independent because it has no prior affiliation with GPDC or any of its partners and LBA is not active in the New York market.

1.3 Process of Review

In July 2019, GPDC commissioned LBA to carry out an independent review of the refurbishment proposals of the North River Tunnel (NRT).

From the Task Order issued to LBA:

- Provide an independent, third-party review of the current NRT Rehabilitation Plan by engineering experts with international rail tunnel rehabilitation expertise.
- Evaluate the current condition of the NRT, the current rehabilitation project plan, and provide a consideration of the various categories of rehabilitation work.
- Consider options for returning the tunnel to a fully operational state and assess those options for the feasibility, logistics, sequence, value, timescale, impact on operations, safety, and longevity of the various elements of the rehabilitation plan.
- Any such options must comply with US code requirements, including NFPA 130.

LBA were granted access to recent and historical documents, reports, photographs, and drawings for the NRT and East River Tunnel including relevant information on the design for refurbishment solutions. Specific documents have been useful to inform the LBA review, whilst other documents have added to the 'wider picture.' Following LBA's review of the initial materials, LBA identified the need for further information and the Gateway Partners responded with the requested additional information.

The following actions have been carried out by LBA:

- Conference calls and meetings with the Gateway Partners
 - Presentations and updates to the Gateway Partners
- Site visit to New York

- Visited relevant Amtrak- and MTA-operated tunnels under the Hudson and East Rivers
- Met with Amtrak technical and operational staff
- Workshops
 - Teleconferences with the Gateway Partners
 - Internal LBA workshops with the LBA team of technical experts
- Report with findings and considerations

1.4 Objectives and Assumptions

1.4.1 Gateway Partners' Objectives

In carrying out the review, LBA were advised that the objectives of the Gateway Partners for the Hudson Tunnel Project were as follows:

Goal 1: Improve service reliability and upgrade existing tunnel infrastructure in a cost-effective manner.

- Objective 1.1: Reduce infrastructure-related delays due to poor condition of the North River Tunnel following Superstorm Sandy.
- Objective 1.2: Rehabilitate the North River Tunnel to modern system standards.

Goal 2: Maintain uninterrupted existing NEC service, capacity, and functionality by ensuring North River Tunnel rehabilitation occurs as soon as possible.

- Objective 2.1: Optimise use of existing infrastructure.
- Objective 2.2: Use conclusions from prior planning studies as appropriate and to the maximum extent possible.
- Objective 2.3: Avoid regional and national economic impacts associated with loss of rail service.

Goal 3: Strengthen the NEC's resiliency to provide reliable service across the Hudson River crossing, facilitating long-term infrastructure maintenance and enhancing operational flexibility.

- Objective 3.1: Construct additional tracks to allow for continued NEC rail operations during maintenance periods and unanticipated human-caused and natural events.

Goal 4: Do not preclude future trans-Hudson rail capacity expansion projects.

- Objective 4.1: Allow for connections to future capacity expansion projects, including connections to Secaucus Junction Station through to the Portal Bridge over the Hackensack River, and connections to station expansion projects in the area of PSNY.

Goal 5: Minimise impacts on the natural and built environment.

- Objective 5.1: Avoid/minimise adverse impacts on communities and neighbourhoods.
- Objective 5.2: Strive for consistency with local plans and policies.
- Objective 5.3: Preserve the natural and built environment to the extent practicable.

1.4.2 LBA Assumptions

For the purposes of the review, LBA made the following high-level assumptions:

- The reference data provided by the Gateway Partners is the source of information.
- Compliance with NFPA 130 is required as far as reasonably practical.
- The operational railway services must be maintained.

- Track bed and overhead line replacement is a priority because it is responsible for a large percentage of the delays.

1.5 NRT Current Conditions - Overview

The NRT consists of two tubes and was constructed in the early 1900s and, in addition to suffering from old age, was impacted by Superstorm Sandy, the deadliest and most destructive, as well as the strongest, hurricane of the 2012 hurricane season. The NRT is located on the Northeast Corridor (NEC), the most heavily used passenger railway in the United States and is used for over 200,000 passenger trips by NJ TRANSIT and Amtrak customers. The NRT is experiencing the following conditions:

- Long-term damaged and deteriorating tunnel infrastructure
- Leaks in shafts and tubes
- Tunnel services are beyond their useful life and need replacement
- Track faults
- Overhead line (catenary) issues
- Poor drainage and maintenance issues
- Salts/chlorides from Superstorm Sandy corrode rails and exacerbate stray current

Due to the long-term deterioration and the conditions described above, the NRT's two tubes are currently experiencing incidents that are increasing in frequency and unpredictability and are threatening the reliable operation of the NRT for Amtrak and NJ TRANSIT customers. A report from the Northeast Corridor Commission (Ref 12.1.6) analysed more than 3 million train movements and 750,000 daily delay records between 2014 and 2018. The report found there were 65 days where incidents in or around the NRT resulted in more than 5 hours of train delay, of which 45 were caused by infrastructure issues, resulting in 2,500 delayed trains and 65,800 train delay minutes. The report indicated that the delay minutes were due to:

- Signal Problems (13% of delay minutes)
- Track Conditions (31% of delay minutes)
- Overhead Power (35% of delay minutes)
- Other (21% of delay minutes)

1.6 Current Refurbishment Plan

The current proposal for the NRT Refurbishment proposes a solution that would be completed after the construction and completion of the new Hudson River Tunnel (HRT) in 2028, thus leaving the NRT "at risk" until 2032, at the earliest (as of the 2019 Financial Plan). Based on LBA's review of the current NRT conditions, LBA believes that this is an unsatisfactory situation, does not meet global best practice, and that there are approaches that could be adopted to target the refurbishment at a much earlier time.

LBA, therefore, considered how this risk to the NRT infrastructure and to the Amtrak and NJ TRANSIT customer experience could be reduced and a resilient and reliable service established at the earliest possible time whilst delivering better value.

2 EXECUTIVE SUMMARY

2.1 Overview

This report takes into account the current NJ TRANSIT and Amtrak rail operations and concludes that regular weeknight and weekend periods of a one-tube outage are feasible, reliable, and safe. This would necessitate an in-service sequence of work in only one of the NRT tubes at any point in time and refurbishment could be undertaken simultaneously in a

number of locations in the occupied NRT tube by means of bespoke highly productive works trains or road rail vehicles.

This review is conceptual and general in nature, based on limited information provided. Further diligence is required to verify the feasibility of the LBA proposals and to confirm the assumptions made concerning the NRT, as well as developing the planning and budgeting for the NRT Refurbishment work.

Refurbishment activities identified are:

- Repair the tunnel lining and seal the leaks
- Replace the mechanical and electrical services in the tunnel with new and improved systems
- Replace the High Voltage (HV) cables which pass through the tubes
- Demolish the bench walls (which are too high and failing) and replace them with new walkways and cable containments
- Replace the trackbed, track, and overhead catenary
- Replace the signalling system

The refurbishment activities that are proposed to be accomplished through an in-service refurbishment are broadly the same as the activities currently proposed in the full outage scenario.

The specific target of LBA's review has been to consider whether it is feasible, safe, and with no impact to the rail service, to carry out the refurbishment while both of the NRT's two tubes remain in service, with refurbishment work being carried out in agreed off-peak outage periods during both overnights and weekends.

In doing so, LBA have leaned on their experience gained on recent projects in the United Kingdom and also referred to international best practice on other recent projects in the United Kingdom, Europe, Hong Kong, and the United States (the Canarsie Tubes/L-Train). Refurbishment in-service is becoming increasingly the norm of international best practice as highly utilised railway systems/tunnels get older and are under increasing pressure due to rising passenger demand. Some examples of refurbishment in-service on the London Underground, a very old and busy system, include the refurbishment of the Central Line and Northern Line tunnels as well as 3.2 km of the Metropolitan Line (the world's first underground railway dating back to 1863) between Baker Street and Finchley Road Underground Stations.

To demonstrate the feasibility of an in-service NRT Refurbishment that would implement the refurbishment activities identified above, LBA has developed a conceptual approach and developed an outline plan and program for the NRT:

- A conceptual approach, strategy, and system of work
- Outputs and calculated durations of work based on the available working time (weeknight and weekend one-tube outages)
- A schedule for the refurbishment activities for each tube
- The logistics arrangements (at an outline stage):
 - The equipment which could be used to demolish, remove, and reconstruct the walkways/benches
 - The safety equipment required to carry out the works
- The options for trackbed replacement

LBA have carried out a construction planning exercise of all of the main activities with the purpose of demonstrating the overall feasibility and possible schedule of NRT Refurbishment in-service while managing risks to NJ TRANSIT and Amtrak customers. LBA emphasises that such construction planning study is conceptual and general in nature, with limited information.

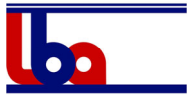

2.2 Finding: The NRT is Experiencing Significant Deterioration

The NRT consists of two tubes and was constructed in the early 1900s and, in addition to suffering from old age, was impacted by Superstorm Sandy, the deadliest and most destructive, as well as the strongest, hurricane of the 2012 hurricane season. The NRT is experiencing the following conditions: Long-term damaged and deteriorating tunnel infrastructure, leaks in shafts and tubes, tunnel services are beyond their useful life and need replacement, track faults, overhead line (catenary) issues, poor drainage and maintenance issues, and salts/chlorides from Superstorm Sandy corrode rails and exacerbate stray current.

2.3 Finding: What is Not Recommended:

2.3.1 Waiting for the Construction of the New Tunnel to Start NRT Refurbishment

The current proposal for the NRT Refurbishment proposes a solution that would be completed after the construction and completion of the new Hudson River Tunnel (HRT) in 2028, thus leaving the NRT “at risk” until 2032, at the earliest (as of the 2019 Financial Plan). Based on LBA’s review of the current NRT conditions, LBA believes that this is an unsatisfactory situation, does not meet global best practice, and that there are approaches that could be adopted to target the refurbishment at a much earlier time.

2.3.2 Removing Scope from the Current NRT Refurbishment Plan

The NRT’s two tubes are currently experiencing incidents that are increasing in frequency and unpredictability and are threatening the reliable operation of the NRT for Amtrak and NJ TRANSIT customers. The NRT Refurbishment requires an approach that includes a scope of work necessary to address the long-term deterioration of the existing infrastructure, and should be broadly the same as the activities currently proposed in the full outage scenario.

2.3.3 Repairing the NRT Incrementally Through Smaller Repairs

A “stabilisation” type approach is poor value and will not solve the basic problems.

2.3.4 Leaving the NRT Bench Walls, As They Currently Exist, in Place

The NRT bench walls cannot be left as is because:

- 1) The height of the existing bench wall is higher than the level of the train vestibule, requiring an unacceptable stepping distance in an emergency,
- 2) The headroom of the emergency walkway needs to be increased.

The concrete forming the existing bench walls is likely to be relatively weak with numerous internal voids. There is a requirement to lower the level of the bench wall in the NRT by 2-3 feet in order to achieve satisfactory emergency egress according to NFPA 130. Further, a low-level Maintenance Platform bench wall on the opposite side of the tube from the emergency bench wall is proposed for railway workers to gain access to the train bogies (underneath the train/ wheel truck). It should be noted that the Canarsie Tubes (L-Train) bench walls could be left at their existing height, but this is not possible in the NRT based on current information.

2.3.5 Leaving the Track, Trackbed, and Overhead Line, As They Currently Exist, in Place

The NRT track, trackbed, and overhead line failures, according to the Northeast Corridor Commission report on train performance, are the causes of a significant proportion of the delays to NJ TRANSIT and Amtrak customers and do not meet global best practice. It should be noted that the Canarsie Tubes (L-Train) already had a fixed concrete trackbed system, unlike the NRT, and only partial refurbishment was required.

2.3.6 Leaving the Mechanical and Electrical (M&E) Services, As They Currently Exist, in Place

Mechanical and Electrical (M&E) Services, including cables, ducting, water and fire main piping, signalling, and communications cabling, are currently operable, but are not considered to be “State of the Art,” are contained in degraded benchwalls, and contribute to system failures. Any form of in-service refurbishment will require sequential and phased management of the relocation and replacement of these services, which will be moved in synchronization with the demolition and replacement of the bench walls and necessary repairs to the tunnel concrete lining. The M&E services will need to be protected and fireproofed in compliance with contemporary regulations (operational and emergency compliance requirements).

2.3.7 Replacing Cables in Ducts Encased in Concrete

It has been previously considered that the only way to protect cables from fire and mechanical damage is to pull them into ducts encased by concrete forming the bench walls. This cumbersome solution restricts the lengths of HV cables which can be pulled into ducts, does not give easy access for maintenance, and requires frequent joint pits which are current sources of failure.

2.4 **Finding: What is Recommended:**

2.4.1 Implement NRT Refurbishment “In-Service”

LBA believes that regular weeknight and weekend periods of one-tube outages are feasible. This would necessitate an in-service sequence of work in only one of the NRT tubes at any point in time and refurbishment could be undertaken simultaneously in a number of locations in the occupied NRT tube. Planning should utilise weeknights for non-invasive work and weekends for more linear, invasive construction work.

- Repair the tunnel lining and seal the leaks
- Replace the mechanical and electrical services in the tunnel with new and improved systems
- Replace the High Voltage (HV) cables which pass through the tubes
- Demolish the bench walls (which are too high and failing) and replace them with new walkways and cable containments
- Replace the trackbed, track, and overhead catenary
- Replace the signalling system

2.4.2 Reduce the Service Impacts at the Earliest Possible Stage

The prioritisation of track, trackbed, and overhead line replacement is important in planning the NRT Refurbishment, therefore, early activities should include:

- Lower trackbed, Where Possible: To achieve a greater clearance between the overhead catenary cable and the train pantograph (arm)
- Direct Fixation Trackbed: Replace the existing traditional ballasted (crushed stone) trackbed with a fixed concrete system (direct fixation track) to avoid blocked drains and salt-contaminated ballast (that result in signal problems)
- Modify or Replace 12.5kV Overhead Line: To achieve the full dynamic and electrical clearances that are required in the crown of the tubes for compliance with standards

2.4.3 Utilise In-Line Methodologies and Sequences for Bench Wall Demolition & Replacement

LBA have detailed a number of possible methodologies for the replacement of the NRT bench wall based on benchmark performance information from successful international projects to provide an emergency egress walkway, a maintenance platform for railway workers, and

locations for the tunnel's electrical/communication cables and third-party services, including a precast solution, GRP encasement solution, duct bank solution with fire protection, fireproof duct solution, and cable in racks only solution. All options have their advantages and disadvantages, but the fireproof duct solution incorporated in a steel cantilevered walkway conceptually seems to offer the best potential ahead of a formal fire risk assessment.

2.4.4 Utilise modern cable solutions and comply with NFPA 130 Fire Life Safety requirements

LBA makes recommendations for modern cable solutions and an approach to cable management and containment based on laying cables rather than pulling them. Utilizing the longest possible lengths of cable reduces joints and joint pits and ultimately potential cable failures. High Voltage (HV) cables (power cables) and Low Voltage (LV) cables (lighting, telephony, fire detection, alarm, and communications) may require different types of solutions, depending on the level of Fire Protection required under the NFPA 130 standard.

LV cable containment systems could include continuous troughs and cable racking with fire protection to emergency circuits provided by the direct cable sheathing or a sheathing which contains the cable.

HV cables with intrinsic resistance to fire are not available but fire protection may be required to protect business continuity as the result of a fire risk assessment identifying an unacceptable level of risk. Cables could be contained in a number of ways including securing to low level cable racks and fireproof ducting. Suitable fireproof ducting has been identified if required and included in the conceptual bench wall replacement options. Space constraints are an important consideration because the fire resistance is dependent on the duct material thickness and air gaps are required around the cables for cooling. A detailed design would be required to determine the final solution for the duct.

Protection to all cables and services should be provided by derailment protection provided by guard rails, which sit inside the running rails.

Refurbishment should ensure that the emergency egress walkway clearances are safe and compliant with NFPA 130 requirements.

2.4.5 Remove the Third Rail

LBA believes that the Third Rail should be removed because it is not used routinely, there are alternatives to its use in an emergency, the cost of installing and maintaining is unnecessary, it is an unnecessary complication in safety and emergency procedures, and, if required, the Third Rail can be re-installed at the end of construction or another future date.

2.4.6 Treat the In-Service Refurbishment Operation as a System

Optimise the overall performance rather than maximise component elements of the cycle and propose using mechanical measures where practicable to enhance productivity and promote innovation, refinement, and improvement.

2.4.7 Utilise Bespoke and Highly Productive Works Trains & Railhead

Battery or hybrid locomotives could be used for train rescue and for handling works trains for NRT refurbishment. A railhead should be constructed to support the activities within the NRT tubes to service and load work trains for the refurbishment.

2.4.8 Incorporate Risk Mitigation Throughout the Planning of the Refurbishment

Mitigations have been implemented successfully to help other refurbishment projects of comparable age, complexity, and essentiality. The risk chapter of this report identifies specific risks and proposes appropriate mitigations. LBA recommends that a risk assessment is conducted by the Integrated Work Team, which includes the Gateway Partners, to compile and address the risks and deficiencies that could occur during the refurbishment program.

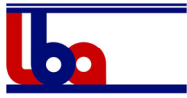

2.4.9 Develop a Multi-Step Framework, Including Collaborative Arrangements & Integrated Work Team

These types of arrangements will facilitate a cooperative, responsible, and managed risk approach that respects the concerns and the priorities of the rail operators by collaborative working between the Gateway Partners and the contractor(s), designer(s), and sub-contractor(s) in a single integrated team approach (the “Integrated Work Team”).

They are particularly suitable for the NRT which needs a customised approach because:

- It will be done in outages
- There will be a number of parties directly or indirectly involved
- It needs to move forward swiftly to mitigate the risks and avoid delay to the service and impacts to NJ TRANSIT and Amtrak customers
- It requires a cooperative, open relationship with disciplined teams to manage risk to the service

2.4.10 Adopt a Two-Stage “Early Contractor Involvement” (ECI) Procurement Arrangement

The Gateway Partners would procure the contractor(s) and designer(s) once the decision to proceed had been taken and would then enter into a two-stage contract with the selected firm(s).

- ECI - Stage 1: Design, Planning, and Procurement of Long-Lead Essential Items: The contractor(s) and designer(s) would work with the rest of the Integrated Work Team and stakeholders to develop the NRT Refurbishment workplan and provide innovation, creative ideas, and practical knowledge
- ECI - Stage 2: Execution of the refurbishment: The Integrated Work Team carries out the refurbishment

2.4.11 Rely on Global Experiences, Where Appropriate

In developing this implementation framework, LBA has relied on global experiences; the NRT’s degradation resembles the issues that European engineers are facing while refurbishing railways across Europe. European engineers are bringing innovation to bear on refurbishment of tunnels in service because taking the tunnel out of service was deemed by the railway operators to be too disruptive to operations. LBA believes a similar level of sophistication and innovation can be brought to bear by American engineers.

2.5 Finding: Schedule

2.5.1 The In-Service NRT Refurbishment Can Take Place Prior To, Or in Parallel With, the Construction of the New Hudson River Tunnel

There would be minimal conflict or interference should the proposed construction of the new Hudson River Tunnel (HRT) also proceed in parallel with the NRT Refurbishment work. The NRT Refurbishment will effectively be executed within the existing footprint of the existing railway and hence cannot cause physical interference to the HRT works.

2.5.2 In Service - Estimated 31 Months Per Tube vs. Out-of-Service 18.5 Months Per Tube

Based on the conceptual study, LBA’s best estimated conceptual schedule for each NRT tube refurbishment is 31 months, which assumes most outages, weeknights and weekends were available over that 62-month period.

2.5.3 In-Service Refurbishment Could Bring the Commencement of Refurbishment Forward

Conceptually, the in-service plan could start NRT Refurbishment 96 months earlier than the current plan. The in-service plan would complete the NRT Refurbishment 71 months earlier than the current plan. If the in-service refurbishment is conducted in parallel with the

construction of the HRT, the entire Hudson Tunnel Project could be completed 37 months earlier than estimated in the current plan. LBA estimate that customers would have access to two new or renewed tubes 34 months (111-77) earlier than currently planned.

	Current Plan	In-Service Plan	Notes
HRT Procurement Duration	15 Months	15 Months	<i>In-Service Plan: NRT 15-Month Procurement In-Parallel</i>
HRT Construction Duration	96 Months	96 Months	
NRT Refurbishment Start	Month #112	Month #16	<i>In-Service Plan: 96-Month Savings</i>
NRT Refurbishment Duration	37 Months	62 Months	<i>Current Plan: NRT Refurb after HRT completed</i>
NRT Tube #1 Improvement	Month #129.5	Month #46	<i>In-Service Plan: 84-Month Savings</i>
NRT Tube #2 Improvement	Month #148	Month #77	<i>In-Service Plan: 71-Month Savings</i>
Total Program Length (HRT & NRT)	148 Months	111 Months	<i>In-Service Plan: 37-Month Savings</i>

Note:

- HRT assumptions provided by GPDC
- Start of month 16 for NRT refurbishment assumed for comparison purposes only

2.6 Finding: Cost Impact

2.6.1 Caution and Subject to Further On-Going Review

Comparing costs when schemes are conceptual is always challenging. Assuring that the comparison is 'like for like' is a very detailed and subjective exercise.

2.6.2 The Cost of In-Service Refurbishment Should be Within the \$1.8bn Current Allowance

- The "construction" cost of the refurbishment should be similar to the current 10% NRT Design estimate (Ref 12.1.2)
- There should be savings on the professional fees and management costs due to the integrated team approach
- There are savings on inflation costs due to the earlier construction timescale

2.7 Finding: Risks to Passenger Operations

2.7.1 Amtrak and NJ TRANSIT Improved Customer Experience is the Principal Reason for the NRT Refurbishment

The customer experience is very unlikely to improve and will possibly decrease with time unless refurbishment is carried out in a prioritised manner related to the most prominent causes and frequencies of delay. This will involve some management of risks such as outage overruns which have been looked at in detail and are summarised below. However, as has

been demonstrated elsewhere in the world, planning, attention to detail and a continuous improvement culture can mitigate and minimise these risks to a low level while the overall risks to Passenger operations decrease.

LBA agrees that the current proposed one tube out-of-service NRT Refurbishment solution offers a reliable risk-averse approach. However, it disregards the highly probable operational and reliability risks to Amtrak and NJ TRANSIT and their customers in not commencing any essential NRT Refurbishment until at least 2028 with probable completion not before 2032, some 12 years hence. The chart in Figure 2-1 shows a conceptual comparison of the risk profiles of the “Existing (and continuing) Risk” against the “Refurbishment Risk.” The Refurbishment Risk profile decreases as the new or replacement infrastructure and services are installed, whereas the Existing Risk remains and over time increases.

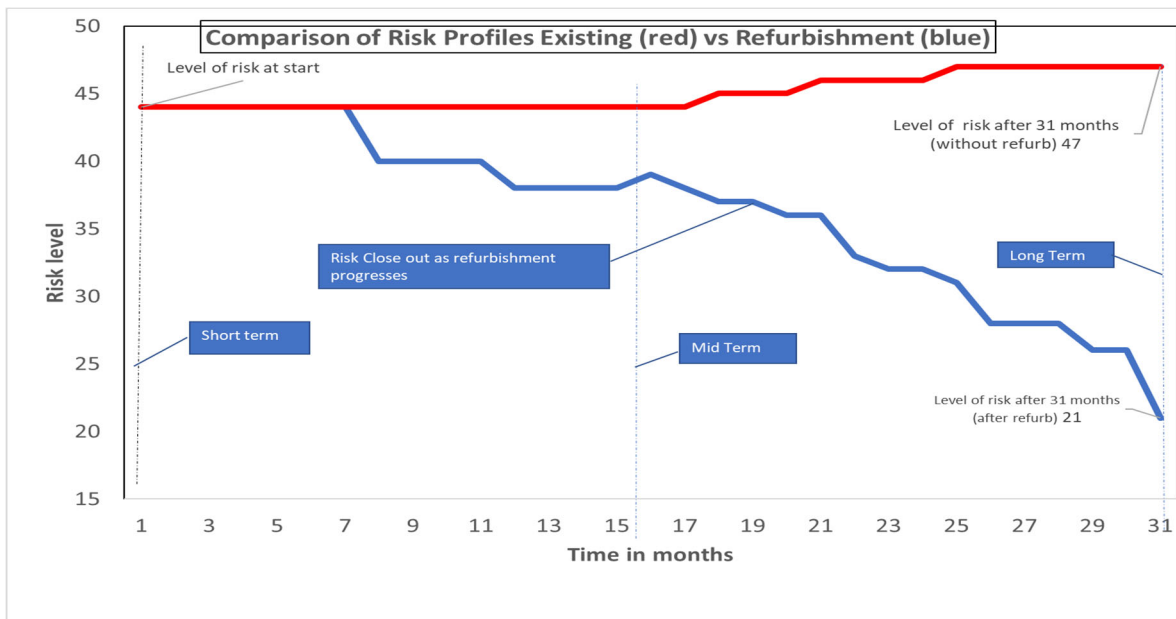





Figure 2-1: Comparison of Risk Profiles Existing vs Refurbishment

2.7.2 Mitigating the Risk of an Outage Overrun (Returning a Tube Late and Delaying the Reopening for Morning Rush) Requires Extensive Planning and Preparation

LBA start from the basis that work can be carried out during an overnight outage and a weekend outage when only one NRT tube will be in use. This places a requirement to have all refurbishment activities as controlled and as efficient as possible. Investment will be required in the best equipment and working environment to achieve the required outputs and avoid interference with the peak-hour NJ TRANSIT and Amtrak services.

Successful refurbishment of the NRT will require a suitable economic and buildable design, a carefully planned construction methodology, a rigorous risk assessment, on-going contingency planning, and a “can do” attitude from the Integrated Work Team. Early actions such as designing, and testing mock-ups and materials will be necessary to prove design and planning and reduce construction and operational risks. The construction work processes and actions can be prepared and practiced in advance of starting work, as illustrated in the minute-by-minute delivery trialling timetable in Figure A10.2 and early warning to the rail operators can be given during an outage that is trending towards an outage overrun. Planning each work activity in advance on a minute-by-minute basis and planning for contingencies, among other planning activities, will be important prior to and during construction. The refurbishment methodologies must be thoroughly tested and proven through mock-ups and/or pilot studies before being taken forward into the NRT. Mitigations, as described to address these kinds of risks, have been developed and successfully proven on other comparable refurbishment projects globally.

The photographs below are examples of the mock-up of the Baker Street to Finchley Road London Underground (UK) Renewal:

<p><i>Figure 2-2: A carefully constructed replica of a section of the tunnel invert</i></p>	<p>Figure 2-3: The “tunnel mock-up” for inspection and acceptance by all</p>	<p><i>Figure 2-4: Mock-up concreting trial</i></p>
		

2.7.3 Contingency Plans and Emergency Procedures are Required to Mitigate the Risk to NJ TRANSIT and Amtrak Customers of an Incident in the Remaining Tube

This is the situation where we have an outage in tube #1 for refurbishment during a weeknight or weekend and there is an incident in tube #2, the remaining operating tube, necessitating the scheduled outage in tube #1 to be ended early.

While an Outage Overrun (as described above para 2.7.2) can be avoided by preparing and practicing the construction work processes, a Remaining Tube Incident is an unscheduled incident. When there is an unexpected event in the operating tube, the Integrated Work Team will need to avoid interference with the peak-hour NJ TRANSIT and Amtrak services by bringing the scheduled outage to a swift conclusion so that service can resume. It is important that the Integrated Work Team should have an agreed cooperative process to determine the best way to address an individual incident and get the tube under refurbishment back in service ahead of the conclusion of the scheduled outage. Contingency planning and preventative actions should include:

- Tube Restoration – Contingency plans developed by the Integrated Work Team that determines the time required to restore the outage tube back to service and how those plans are enacted. Contingency plans will be specific to the type of work in progress and must accommodate the safe exiting of works trains out the tube.
- Equipment & Materials – Redundant equipment and materials (back-up plant, equipment, transport, materials) should be kept on-site to prevent delays caused by unexpected refurbishment issues or to put the outage tube back in service ahead of the conclusion of the scheduled outage.
- Alternative Service – Since this risk can only materialise at off-peak hours, consider where bus services or other forms of transport could be used to take passengers between stations as enhancements to existing NRT/trans-Hudson contingency and emergency plans.
- Actively Look for Infrastructure Issues – The Integrated Work Team (including the railway operators) should actively look for infrastructure issues outside the NRT or within the NRT which could unexpectedly prevent access to the working tube and righting this to the extent possible so that the risk is prevented. In addition, review numbers of Dispatchers and Tower Operators on-duty during outages to ensure that resources are there to deal with these situations in off-peak hours.
- Advancing New Infrastructure Early – Consider the cost/benefit of bringing forward the construction of extended or modified tracks earlier (currently planned for the future HRT), including doubling the track to Secaucus Junction with additional crossovers that would assist in managing train paths.

2.8 Finding: Risks to Health and Safety During Refurbishment

2.8.1 Risks to Construction Personnel Requires Careful and On-Going Refinement

A great emphasis is placed on safety, health and welfare, planning, method refinement, lessons learned and improvement, a team approach, and a shared and aligned purpose and culture throughout the team to identify and mitigation risk events.

2.8.2 Risks to Customers Requires Careful and On-Going Refinement

Silica and other dust are possible during demolition, though mitigation measures such as misting during demolition and the use of proper ventilation should mitigate any risk to customers. Given public concern regarding silica and other dust, it will be appropriate to set up a full monitoring system against defined standards and make the results available to the public demonstrating very low levels of exposure.

2.9 Finding: Next Steps

2.9.1 Further Diligence is Required to Verify Feasibility of LBA Proposals

Successful refurbishment of the NRT will require a bespoke, efficient, economic, and buildable design, a carefully planned construction methodology, a rigorous risk assessment, contingency planning and a positive “can do” attitude from all project stakeholders, reinforced by the appointment and oversight of a senior sponsor (a “Project Champion”).

Further diligence is required during the implementation phase to verify the feasibility of the LBA proposals and to confirm the assumptions made concerning the NRT, as well as developing the planning and budgeting for the NRT Refurbishment work.

2.9.2 Undertake the Following Areas of Work to Clarify and Confirm Conceptual Proposals

- Trackbed Replacement Activities
 - Commission an invert survey as soon as possible
 - Re-examine the clearances (electrical and structural) that need to be achieved for fault-free operation of the overhead line and agree with all interested parties
 - Examine the trackbed design options which meet the clearance requirements
 - In parallel, examine the construction logistics with a view to developing a solution which could be carried out in overnight and/or weekend outages
 - Develop a solution which meets the service requirements and delivers a new trackbed at an earlier time
- Resolve the requirements for Fire Protection to High Voltage Cables
- Carry out a detailed cable survey to allow planning and design of tunnel services to proceed
- Firm up on proposals for a construction logistics railhead
- Prepare a detailed and integrated programme of all activities going forward including pre-refurbishment activities
- Prepare a budget cost for the in-service refurbishment work
- Develop proposals for mock-ups, trials, refining and testing of refurbishment logistics and sequencing
- Commission a Hydrographic survey
- Develop and discuss the risk mitigation proposals to give confidence to the Railway operations and interface with their procedures
- Commence the repairs to the concrete and potentially combine with an intrusive survey of the cast iron lining

3 LBA FINDINGS AND CONSIDERATIONS FOR THE GATEWAY PARTNERS

This chapter summarises the findings and considerations raised within the respective chapters of this report.

3.1 General Findings Regarding the Refurbishment of the NRT

The NRT is experiencing deterioration from age and the on-going impact of Superstorm Sandy, resulting in incidents that are increasing in frequency and unpredictability and are threatening the reliable operation of the NRT for NJ TRANSIT and Amtrak customers. The report from the Northeast Corridor Commission (Ref. 13.6) on train performance found that between 2014 and 2018 there were 65 days where incidents in or around the NRT resulted in more than 5 hours of train delay, of which 45 were caused by infrastructure issues, resulting in 2,500 delayed trains and 65,800 train delay minutes.

LBA's review of this report suggests that Track (31% of delay minutes) and Overhead line (35% of delay minutes) replacement is a priority. Further data and engineering studies are needed, including an invert survey to inform the options for improving structural and electrical clearance (see Section 3.10 - "Next Steps" below).

The current proposal for the NRT Refurbishment proposes a solution that would be completed after the construction and completion of the new HRT, therefore, the current proposal does not envisage doing any major refurbishment work to reduce the frequency and risk of delays and disruptions to NJ TRANSIT and Amtrak customers.

LBA believes that this is an untenable situation, does not meet global best practice, and that there are approaches that could be adopted to target the refurbishment at a much earlier time. LBA, through this report, proposes in-service refurbishment approaches that could be adopted to target the entire NRT Refurbishment in a much earlier time than is currently proposed (i.e. approximately 12 years' time). LBA's conceptual review has demonstrated the feasibility of an in-service NRT Refurbishment that would implement the required refurbishment activities.

LBA found that there is sufficient capacity in the railway operations to allow overnight and weekend outages. Normal Amtrak outages are overnight from 11 PM until 5 AM and weekends from 11 PM Friday until 5 AM Monday. Time must be allowed to set up the outage and check before restoring service whilst maintaining Amtrak and NJ TRANSIT frequency of off-peak service.

Routine on-going maintenance should be integrated with the refurbishment operations, both in terms of outages and locations. Utilisation of outages for NRT Refurbishment is dependent on an Integrated Work Team working collaboratively throughout the planning and construction of the NRT Refurbishment.

This report takes into account the current NJ TRANSIT and Amtrak rail operations and concludes that regular weeknight and weekend periods of one-tube outages are feasible, reliable, and safe. This would necessitate an in-service sequence of work in only one of the NRT tubes at any point in time and refurbishment could be undertaken simultaneously in a number of locations in the occupied NRT tube by means of bespoke highly productive works trains or RRVs.

LBA have leaned on their experience gained on recent projects in the United Kingdom and also referred to international best practice on other recent projects in the United Kingdom, Europe, Hong Kong, and the United States. Refurbishment in-service is becoming increasingly the norm or international best practice as highly utilised railway systems/tunnels get older and are under increasing pressure due to rising passenger demand.

3.2 Findings: Outage Planning

The NRT provides a maximum of 24 trains per hour peak service in the peak direction, with a lesser frequency of service in the non-peak direction during the working week. A lower frequency is operated during the remainder of the working day. On weeknights and weekends, the service is no more than 6 trains per hour each way.

LBA have concluded that it is possible to provide 6 trains each way service using only one NRT tube. In order to enable a regular program of overnight and weekend refurbishment work to be carried out in one of the NRT tubes, regular periods must be provided by the PSCC during which up to 6 trains per hour each way would operate in the other tube.

The proposed on-going program of outages for the NRT Refurbishment would be achieved by taking an outage in one NRT tube to permit refurbishment work, whilst operating the second NRT tube as a bi-directional single track with trains dispatched in “flights” of up to three trains at 2.5 minute intervals in one direction followed by “flights” of up to three trains in the reverse direction throughout the outage. This would achieve 12 train-paths per hour, 6 eastbound plus 6 westbound. LBA understands that this is already being used to some extent.

It should be possible to achieve nil perceptible disturbance to the timetable for customers of NJ TRANSIT and Amtrak Northeast Corridor services throughout the outage periods by adjusting the published passenger train timetable and utilising the train-paths that would become available with trains operated in “flights” during each hour overnight and at weekends, and careful re-planning of platform occupation requirements at Penn Station New York during these outage periods.

3.3 Findings: M & E Services and Cable Protection

Many of the systems in the NRT, whilst currently operable, are not considered to be “State of the Art” from a technology perspective.

Subject to detailed design, LBA believe that an in-service refurbishment and improvement of the M&E services in the NRT tubes could be achievable and would provide the following benefits:

- Increase system reliability and life span
- Improve maintainability
- Improve the resilience and reliability of the rail service
- Provide a safer railway for the travelling public
- Provide compliance with NFPA 130 (where possible)

LBA proposes an efficient methodology for moving and replacing the HV cables using longer lengths and laying, rather than pulling, the cables. The rehabilitation of the M&E systems can be integrated within a number of bench refurbishment options.

LBA does not believe that the HV cables require fire protection under the NFPA 130 standard, However, LBA have provided an option that envisages a fireproof duct to contain cables which need protection, but are not available as intrinsically fire resistant. LBA’s reading of NFPA 130 does not concur with the current 10% NRT Design Refurbishment proposal (Ref 12.1.2) that the HV cables require the fire containment measures. However, LBA does agree that, if this is deemed necessary, for example, as a result of a fire or business continuity risk assessment, then fire protection measures may well be required and certain options for bench replacement can provide this.

LBA proposes a modern type of HV cable that could be available in longer lengths and have more flexibility for laying, while reducing joints, joint pits, and risk. Cables should be laid instead of being pulled through ducts because “pulling” cables is an uneconomic process which limits the lengths of cable that can be installed so requiring more frequent jointing of shorter lengths

of cable in suitable joint pits. The appropriate replacement cables, needed to service the NRT's operational systems, and the provision of newly specified services, have been identified.

A possible option for the cable and the installation of other M&E equipment methodology is discussed in the report, e.g. locating services on the tunnel side wall where possible, and providing suitable protection as required by NFPA130 (fire resistant sheathed cables).

The current 10% NRT Design Refurbishment proposal (Ref 12.1.2) indicates that HV cables passing through the NRT should continue to be encased in concrete ducts to protect against physical shock (train derailments). LBA suggests that this risk could be better dealt with by guard rails as derailment and physical damage protection.

3.4 Findings: Civil Works and Bench Replacement Solutions

The NRT bench walls, as they currently exist, cannot be left in place because:

- The height of the existing bench wall is higher than the level of the train vestibule, requiring an unacceptable stepping distance in an emergency
- The headroom of the emergency walkway needs to be increased and
- The concrete forming the existing bench walls is likely to be relatively weak with numerous internal voids (clay pipes and ducts)

LBA is proposing in-line methodologies and sequences for the demolition and replacement of the bench walls; these solutions and methodologies were reviewed to meet various criteria, including safety NFPA 130 compliance, value, buildability, durability, and sustainability.

Of the conceptual options considered in APPENDIX 2 - Civil Works, the first three (A2.1, A2.2 & A2.3) aim to provide a finished concrete bench containing cable ducts in a similar manner to the Jacobs 50% design for the ERT, but may offer advantages in terms of programme time and overall cost. The least favourable of these would be option A2.1 (re-profile and repair the existing concrete bench walls), since it would result in an uncertain quality of finish and long-term sustainability. Also, Option A2.1 is not likely to have the required ducting capacity, although it may be the lowest cost option. Options A2.2 and A2.3 would offer a high quality, low maintenance solution with the required ducting capacity and could be considered for further development.

The remaining four options (A2.4, A2.5, A2.6 & A2.7) all aim to replace the concrete benches with more lightweight prefabricated installations that would greatly reduce the time required for installation and provide a high quality, relatively low maintenance solution. All of these options, however, provide varying degrees of fire protection and no train impact protection, possibly requiring additional train anti-derailment measures to be incorporated into the new lowered track slab. Fire-resistant Fibre Reinforced Plastic (FRP) structures and ducting have been proposed in options A2.4 & A2.5, which, although they would have the benefits of ease of construction and low maintenance, may be considered unproven. On the other hand, options A2.6 and A2.7, which utilise steel walkways and fixings, are widely used in railway and metro tunnels worldwide. Of these, option A2.8 incorporates a standard lagged steel fireproof box ducting below the steel walkway that would provide very good fire protection for the more HV cabling if required and would facilitate easy laying of cables. This could be considered for further development.

The Canarsie (L-Train) Tunnel solution has been reviewed and considered by LBA for use on the NRT, and whilst it offers several advantages (as shown in A2.2) it is not the recommended solution for the NRT Refurbishment because there is a requirement (as discussed above) to lower the level of the bench walls on both sides of the NRT tubes in order to achieve satisfactory emergency egress (according to NFPA 130) and to provide a proper maintenance platform for railway workers. While the Canarsie (L-Train) Tunnel bench walls could be left at their existing height, this is not possible in the NRT.

3.5 Findings: Track, Trackbed, and Overhead Line Clearances

The Northeast Corridor Commission report on train performance identified that a significant proportion of the delays are due to track, trackbed, and overhead line failures. Therefore, the prioritisation of track, trackbed, and overhead line (OHL) replacement is important in planning the NRT Refurbishment.

Any refurbishment design solution should provide an equivalent, or better system of drainage and all drainage ducts must be capable of being 'rodded' in case of blockages. Consideration may be given to the provision of fire traps in the main collector drains to mitigate against spillage and accumulation of inflammable liquids.

LBA recommends that the existing traditional ballasted trackbed be replaced with a fixed concrete system (direct fixation track). It should be noted that the Canarsie (L-train) Tunnel already had a fixed concrete trackbed system, and only partial refurbishment was required.

LBA further recommends that the trackbed should be lowered, where possible, to achieve a greater clearance between the overhead catenary cable and the train pantograph (arm). The NRT Refurbishment should include modifications to, or replacement of, the 12.5kV OLE to achieve the full dynamic and electrical clearances that are required in the crown of the tubes for compliance with standards. Many of the current overhead line and damaged pantograph issues are due to a lack of clearance requiring the lowering of the existing track level. LBA have proposed how this might be done by reducing the length of the track timber ties before using bespoke equipment to lower the track with the ballast in place. This should be done as a precursor to replacing the trackbed during weekend outages.

A number of possible methodologies have been identified for the NRT based on benchmark performance information from successful international projects. We explain in this report that the existing track could be lowered and that the trackbed can be replaced during weekend outages. An allowance for this has been incorporated in the proposed high-level schedules in order to demonstrate the feasibility of this approach. Further due diligence of the trackbed replacement method is required to confirm a preferred solution for the NRT.

LBA also believes that the Third Rail should be removed because:

- it is not used routinely,
- there are alternatives to its use in an emergency,
- the cost of installing and maintaining is unnecessary, and
- it is an unnecessary complication in safety and emergency procedures

However, if required, the Third Rail can be re installed at a future date.

Anti-derailment rails, or guard rails, should be considered for use throughout the NRT to protect the services from possible damage caused by a derailed train.

3.6 Findings: Refurbishment Logistics

LBA have carried out a construction planning exercise of all the main activities with the purpose of demonstrating the overall feasibility and possible schedule of NRT Refurbishment in-service, while managing risks to NJ TRANSIT and Amtrak customers. Chapter 10 looks at the refurbishment methodology and logistics and gives some detail to show LBA believe an in-service solution can be achieved.

LBA emphasises that such review is conceptual and very general in nature, with limited information. LBA have based the study on the under-river section, which is well detailed and the longest uniform section and have then extrapolated planning and scheduling to the whole NRT to understand the feasibility of refurbishment logistics and so, the in-service refurbishment.

Successful refurbishment of the NRT will require a suitable economic and buildable design, a carefully planned construction methodology, a rigorous risk assessment, on-going contingency planning, and a “can do” attitude from the Integrated Work Team. In addition, early actions such as designing and testing mock-ups and materials will be necessary to prove design and planning and reduce construction and operational risks.

LBA’s strategy has been to treat the refurbishment operation as a system and to optimise the overall performance rather than maximise component elements of the cycle. LBA propose using mechanical measures where practicable to enhance productivity and promote innovation, refinement and improvement.

Criteria for developing the bench wall replacement options have been quality, speed of erection, cable protection, and maintenance of emergency response facilities. LBA believe all of these options can be refined to achieve outputs rates comparable with bench wall demolition. LBA see this being accomplished through a “moving workshop.”

Typical activities, durations and outputs have been estimated. They are subsequently developed into Gantt charts and a Time Chainage ‘TILOS’ diagram showing sequence and work patterns.

The NRT Refurbishment planning is based upon weeknight outages of 5 hours and weekend outages of 55 hours (48 hours of effective work). Deriving a shift pattern which is economic, staff welfare friendly, and responsible is not easy and needs the willing endorsement of all stakeholders. Optional schedules have then examined the effects of less available weekend outages, and or less weeknight outages (four instead of 5 weeknight shifts). This could impact the time taken for the refurbishment by some few months, but does not detract from the feasibility and desirability of expediting the refurbishment in service.

In Chapter 5, LBA discuss the availability of outages. For the purposes of preparing the conceptual schedule, LBA have assumed that these outages will be generally available when required at weekends and weeknights.

LBA also accept that there will be times when it is not possible to have a weekend outage in the tube under refurbishment because of unforeseen issues in the other tube (see also Section 11.2.2 System Risks Mitigation). LBA have, therefore, examined the situation where there is a loss of 15% of weekend outages and have calculated the possible schedule impacts in the outputs for scheduling and amended the durations to suit - see Section A8.4 – “What If TILOS” and A8.5 “What If Gantt Chart”, where this ‘loss’ adds 4 months onto the schedule of each tube (8 months overall).

The basis of the planning of the refurbishment is that most of the M & E services work is carried out in overnight outages, being that the amount of time available is well suited to that type of targeted work packages. Some weekend work would be required when cable stringing was happening.

Based on the conceptual study, LBA’s best estimated schedule for each NRT tube refurbishment is 31 months, which assumes most outages, weeknights and weekends were available over that period. This schedule shows trackbed and bench wall demolition on weekends only and M & E services generally on weeknights. There is doubt whether it would be possible to work Friday nightshift if there was a weekend activity. However, sensible planning should minimise the effects of this. Logistics through both tunnel portals would significantly help to enhance outputs, but also mitigate the risks to the service by rapid clearance of the tunnel.

To carry out the refurbishment of the NRT in-service in an efficient manner, a railhead would be required at a convenient location so that short works trains can be prepared, maintained and loaded ready for entry into the tunnel at the beginning of the shift.

3.7 Findings: Implementation of the Recommendations

The service delays now experienced by NJ TRANSIT and Amtrak customers are not likely to diminish until a start is made on the NRT Refurbishment. LBA believe that the NRT Refurbishment work will require an innovative approach to managing the works in order to be successful.

Implementation, for the purposes of this report, is defined as the steps necessary to advance the NRT Refurbishment beyond this conceptual review and report. LBA proposes a multi-step framework as a means of managing risks and addressing the particular issues of refurbishment in service. In developing this implementation framework, LBA has relied on global experiences; the NRT's degradation resemble the issues that European engineers are facing while refurbishing railways across Europe. European engineers are bringing innovation to bear on refurbishment of tunnels in service because taking the tunnel out of service was deemed by the railway operators to be too disruptive to operations. LBA believe a similar level of sophistication and innovation can be brought to bear by American engineers.

LBA believe the multi-step framework, including collaborative arrangements, discussed below are particularly suited to the in-service refurbishment of the NRT, because they facilitate a cooperative, responsible, managed risk approach respecting the concerns and the priorities of the rail operators. These arrangements can promote innovation in design, construction methodology, and risk mitigation unfettered by commercial barriers while delivering the benefits of that innovation to the Stakeholders.

LBA believe that the NRT Refurbishment will be best taken forward rapidly by collaborative working between the Gateway Partners and contractor, designer, and sub-contractors in a single integrated team approach ("Integrated Work Team"). A fully integrated team brings resources together and their responsibility is to the team and the team's objectives, breaking down barriers for working together openly. Prior to the addition of contractor(s) and designer(s), the Integrated Work Team will consist of various subject matter experts from the Gateway Partners. The Gateway Partners will need to make early decisions and engage in activities before starting the procurement process. Early decisions include:

- Outline decision to proceed and basic responsibilities
- Produce plan for proceeding
- Develop team concept
- Decide what is required of team participants/ develop outline scope(s)
- Decide the skills and attributes which are required for contractors to be considered
- Decide method of selection of contractor(s) and designer(s)
- Prepare an information statement for the market
- Explain how contractors will be selected
- Go out to tender to a small number of selected contractors
- Adjudicate tenders and decide Early Contractor Involvement contractors/approach (see below)

The NRT Refurbishment might be best achieved by a two-stage "Early Contractor Involvement" arrangement:

- ECI Stage 1: Design, Planning, and Procurement of Long-Lead Essential Items
 - The contractor and designer would work with the rest of the integrated team and stakeholders to develop the NRT Refurbishment workplan provide innovation, creative ideas and practical knowledge.
- ECI Stage 2: Execution of the refurbishment
 - The Integrated team carries out the refurbishment

Examples of this process are more fully described in Appendix 10.

The goal of an Integrated Work Team approach and an ECI implementation method is to create an environment that avoids the placement of commercial barriers to true collaborative working should minimise the cost and time taken while delivering best value and quality.

Key elements of the implementation process are:

- Establishing an Integrated Work Team, collaborating with common objectives in an open, transparent manner
- Using an Early Contractor Involvement (ECI) two stage contract type arrangement.
- Developing the planning of activities in the tunnel in meticulous detail to ensure that most efficient use is made of the working time available
- In the same manner developing contingency planning and emergency response in conjunction with the rail operators so that the risks to the service are properly managed and mitigated
- Preparing Mock-ups on the surface to demonstrate, develop, train and give confidence that timings and risk mitigation plans, are robust

3.8 Findings: Overall Scheme Assessment

LBA believe that the current 10% NRT Design proposal (Ref 12.1.2) for the NRT Refurbishment may not:

- Provide the most economical solution
- Provide best value
- Mitigate the risks in a timely manner

We believe that in our experience, and that of other Operators/Owners, the refurbishment requirements of the NRT tubes do not differ significantly from other rail tunnels in the US and UK, or elsewhere. Rail Operators around the world are experiencing increased demand on their aging infrastructure and in order to provide, and continue to provide, an acceptable level of passenger service, they successfully implement in service refurbishment schemes. These are referenced in the Report and Appendices.

The NRT Refurbishment either prior to, or in parallel with, the new Hudson River Tunnel construction is a feasible concept. It should be pursued in a timely manner, and the overall scheme optimised to reduce the time taken to provide a fully resilient system.

3.9 Findings: Risks

The principal reason for carrying out the refurbishment of the NRT and the services within the tubes is to mitigate the current risks to the rail operations caused by failures in the tunnel services and the structure of each tube of the NRT in order to provide an improved customer experience and service reliability for Amtrak and NJ TRANSIT customers. This is also a compelling reason for proceeding immediately with the refurbishment to mitigate unpredictable impacts to service reliability and safety.

The following risks are appropriate to consider, and are all influenced by the existing degrading condition of the NRT tubes:

1. Risks of Doing Nothing: Risks to rail service/customers if nothing is done to improve the NRT beyond preserving the status quo
2. Risks During Refurbishment: Risks to rail service/customers associated with the refurbishment activities
3. Risks During Construction:
 - a. Risks to construction personnel

- b. Risks to customers
- c. Quality Risks

Risk mitigation should take place throughout the planning of the NRT Refurbishment works. Such mitigations have been implemented successfully to help other refurbishment projects of comparable age, complexity, and essentiality.

LBA identifies the above risks and recommends appropriate mitigations for each type of risk. A range of mitigation measures will be required for the various possible hazards/events during an in-service NRT Refurbishment. These mitigations will need to be developed by the Integrated Work Team as the design and planning for the refurbishment goes forward. The *additional* risks during an in-service refurbishment, as compared to the existing risks, require special attention because of their potential impacts on the service for NJ TRANSIT and Amtrak customers and the amount of staff required from the Gateway Partners for the Integrated Work Team and Amtrak railway operations force. A full-scale risk assessment should also be part of the early implementation actions to inform contingency planning and the development of pre-thought solutions. The refurbishment methodologies must be thoroughly tested and proven through mock-ups and/or pilot studies before being taken forward into the NRT. Mitigations, as described to address these kinds of risks, have been developed and successfully proven on other comparable refurbishment projects globally.

3.10 Findings: Next Steps

LBA propose that the following areas of work should be undertaken in order to clarify and confirm the conceptual proposals made in this report as follows:

- A key activity is the replacement of the trackbed, and we believe that the following actions are necessary:
 - Commission an invert Survey as soon as possible
 - Re-examine the clearances (electrical and structural) that need to be achieved for fault free operation of the OLE and agree with all interested parties
 - Examine the trackbed design options which meet the clearance requirements
 - In parallel, examine the construction logistics with a view to developing a solution which could be carried out in overnight and/or weekend outages.
 - Develop a solution which meets the service requirements and delivers a new trackbed at an earlier time
- Resolve the requirements for Fire Protection to HV cables
- Carry out a detailed cable survey to allow planning and design of tunnel services to proceed
- Firm up on proposals for a construction logistics railhead
- Prepare a detailed and integrated programme of all activities going forward including pre-refurbishment activities
- Prepare a budget cost for the in-service refurbishment work
- Develop proposals for mock-ups, trials, refining and testing of refurbishment logistics and sequencing
- Commission a Hydrographic survey
- Develop and discuss the risk mitigation proposals to give confidence to the Railway operations and interface with their procedures
- Commence the repairs to the concrete and potentially combine with an intrusive survey of the cast iron lining

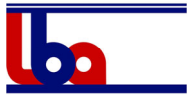

4 NRT CURRENT CONDITIONS

The NRT consists of two tubes and was constructed in the early 1900s and, in addition to suffering from old age, was impacted by Superstorm Sandy, the deadliest and most destructive, as well as the strongest, hurricane of the 2012 hurricane season. The NRT is located on the Northeast Corridor (NEC), the most heavily used passenger railway in the United States and is used for over 200,000 passenger trips per day by NJ TRANSIT and Amtrak customers.

A structural assessment and detailed survey of the NRT carried out in September 2014 by HNTB identified that the tubes were in a poor state and needing refurbishment. In 2015, Amtrak engaged Jacobs to conduct preliminary engineering for the NRT. While Amtrak and Jacobs have advanced design on the NRT to a 10% level (Ref 12.1.2), little meaningful progress has been made towards removing or mitigating the overall infrastructure or operational risk.

The NRT is experiencing the following conditions:

- Long-term damaged and deteriorating tunnel infrastructure
- Leaks in shafts and tubes
- Tunnel services are beyond their useful life and need replacement
- Track faults
- Overhead line (catenary) issues
- Poor drainage and maintenance issues
- Salts/chlorides from Superstorm Sandy corrode rails and exacerbate stray current

Due to the long-term deterioration and the conditions described above, the NRT's two tubes are currently experiencing incidents that are increasing in frequency and unpredictability and are threatening the reliable operation of the NRT for Amtrak and NJ TRANSIT customers. A report from the Northeast Corridor Commission (Ref 12.1.6) analysed more than 3 million train movements and 750,000 daily delay records between 2014 and 2018. The report found there were 65 days where incidents in or around the NRT resulted in more than 5 hours of train delay, of which 45 were caused by infrastructure issues, resulting in 2,500 delayed trains and 65,800 train delay minutes. The report indicated that the delay minutes were due to:

- Signal Problems (13% of delay minutes)
- Track Conditions (31% of delay minutes)
- Overhead Power (35% of delay minutes)
- Other (21% of delay minutes)

Given the existing conditions of the NRT, there are a number of areas of interest for the refurbishment:

- Deteriorating Concrete, particularly the bench walls
- The Tunnel Lining
- The Mechanical and Electrical services
- Railway issues, including Clearances
- Trackbed Deterioration and drainage
- Compliance with NFPA 130, as far as reasonably practical

4.1 Deteriorating Concrete

The poor condition of the existing bench walls, together with the inherent impracticalities associated with their geometry, means that a comprehensive reconstruction of these tunnel elements is required to conform with modern standards and improve safety.

Of primary concern is the quality and condition of the concrete, particularly in the bench wall facings adjacent to the track. This appears to be partly due to the general deterioration of the concrete surface over time, exacerbated by corrosion of steel reinforcement causing localised spalling and more extensive longitudinal cracking. The deteriorating situation was not helped by the inundation of the NRT during Superstorm Sandy which, although the NRT's tubes were expeditiously dewatered, the flood exposed the concrete directly to saline conditions. These conditions persisted for a number of weeks until the tubes dried out, but still left behind a crystalline salt residue, particularly where the water penetrated the cable ducts and cracks in the concrete. Steel members are present at the numerous splicing vaults, metal steps, and alignment clips of the conduit sections. The steel at the splicing vaults is in the form of structural members that support a facing of concrete spanning across the vault cavities. Steel is also set around the vault opening at the top of the bench walls.

The bench wall concrete surrounds clay ducts that are used to house electrical services for power, train operations, signal, and communications. These have also deteriorated over time and some are known to have become blocked.

The original construction of the bench walls in the early 1900s involved the staged placement of concrete and conduits. This staged construction resulted in the creation of numerous 'cold' joints, where fresh concrete was placed against un-prepared concrete surfaces in the completed bench walls. In addition, as the bench walls were built up from the tunnel invert, a system of horizontal cold joints was cast in the concrete. Furthermore, a cold joint probably exists between the main 2-foot thick tunnel lining and the back of the bench walls along the entire length of each tube. In addition, a common feature is the erosion of the concrete where the bench walls intersect the track ballast. Here, the aggregate in the concrete is exposed in a honeycomb pattern which could have been caused by poor compaction during placement of the concrete, but it is more likely that the cement paste has been dissolved out of the concrete over time, resulting in erosion at this location in the bench wall facings.

Repairs have been, and continue to be, carried out, but these can only be regarded as stopgap measures and do little to address the long-term concerns for the concrete tunnel structures, in particular, the side bench walls.

The geometry of the concrete side bench walls is also not suited for the provision of safe access for maintenance and emergency or for safe passenger egress from trains and evacuation along the walkway. Both the emergency egress and the maintenance walkway on the opposite side bench have a number of problems that include:

- Unacceptably high step-up from the train or the track to the walkways
- Restricted headroom along the walkways
- Poor walking surfaces with potential slips and trip hazards
- Potential obstructions including pipework
- Potential clash with the maximum train kinematic envelope

4.2 Tunnel Lining

The NRTs are lined with bolted cast iron outer rings and an internal concrete lining up to 2 feet thick. The outer and inner linings combine to form a stiff tube.

The 10% Draft Feasibility Report July 2019 (Ref 12.1.2) and the Bench Wall Analysis White Paper January 2016 (Ref 12.1.1) state that the structural integrity of the NRT lining (walls) is sound and that any ongoing repairs are generally superficial in nature.

The HNTB (2014) (Ref 12.1.5) report states that from the observations that were made, the cast iron lining appeared to be “structurally sound” but admitted that there was very little direct evidence available except where the lining was exposed. The possible presence of cracking in the cast iron is not discussed as it appears not to have been observed, in a similar manner there is no reason to anticipate corrosion of the cast iron lining. Localised movement may well have occurred at the ring joints and this is likely to be the reason for the seepage in localised areas which are addressed in the repair schedule. The NRT appears to have generally maintained shape and longitudinal profile and the stiffness of the combined concrete (inner) lining and cast iron (outer) lining will have assisted this.

The interior surface and immediate subsurface of the lining should be in a state fit for securing supporting fixtures to the interior lining. Repairs and addressing leaks in the lining have been assessed and solutions identified. It would not appear that these are making a significant contribution to operational delays but would sensibly need to be done before the erection of new services on the tunnel lining.

During the LBA visit to the NRT, it was evident from observations during the visit that the superficial condition of the concrete lining at the junction with the shafts (particularly the New Jersey shaft) was not good. Grout and concrete/grout detritus adhering to the concrete lining was noted at various overhead locations at the junction that could easily fall onto the operating railway.

Also, a constant flow (or at least a periodic constant flow) of surface water was evident down the shaft walls and onto the tunnel lining, benches, and tunnel invert at the shaft junction. This must contribute to the ongoing deterioration of the tunnel infrastructure (not just the concrete, but tunnel fixtures and fittings). The source of this water should be located and permanently prevented from entering the shaft/ tunnel.

4.3 Mechanical & Electrical (M&E) Issues

Both of the NRT tubes contain a number of mechanical and electrical systems (cables, ducting, water and fire main piping, signalling, and communication cabling) located within or on the walkway surface of the existing concrete benches or fixed to the tunnel lining. These systems have been in some way impaired following the flooding of the NRT as a result of Superstorm Sandy. Many of these systems, while currently operable, are approaching “end-of-life” and are not considered to be “State of the Art.” These services have had a series of “running repairs” to maintain operability but the system reliability is reducing, and a programme of replacement and upgrade is proposed. This report looks at the options for replacement and upgrade whilst maintaining safety of passengers, critical safety system integrity, and compliance as far as reasonably practical with NFPA 130.

A particular issue has been the high voltage (HV) cables which pass through the NRT tubes and are part of the catenary supply system. These have been particularly impacted by old age and saltwater and are subject to explosive failures. These are currently encased in the bench walls and pulling a replacement cable is not an easy task.

This report is confined to longitudinal tunnel M&E services. Tunnel Ventilation has not been addressed as it has little impact on the refurbishment work, being principally contained in the shafts.

For the purposes of considering the feasibility of refurbishment, it has been assumed that the M&E services would be replaced, and new services added, as per the scope of the preliminary 10% NRT Design (Ref 12.1.2).

4.4 Railway Issues

The NRT tubes were opened for traffic in 1910, but construction began in 1904 and their design dates back to about 1902. Since 1902 much has changed in the operation of railroads and their trains. The cross-section size of trains, the “Static Loading Gauge,” has been enlarged in height and width over time, and the traction power system employed in these tunnels, originally 700V DC 3rd rail, is now overhead line equipment (OLE) electrified at 12kV AC. These changes, together with the addition of many services fixed to the interior walls of the tunnels, have taken up much of the clear space that had been available to provide an emergency escape route and passing clearance all around the “dynamic” displacement envelope of the “Static Loading Gauge” of trains as they pass through the tunnels.

It is an aspiration that the refurbishment work should provide another 100 years life for these tubes. If this is to be achieved in a meaningful manner, then it will be important for all aspects of track, traction power, drainage, signalling, fire prevention and evacuation, and all other electrical services installed in the tubes to be entirely upgraded from 1902 standards to modern standards in the expectation that they may then be capable of further adaptation to meet the standards that will apply in a 100 years’ time. However, the infrastructure components will have different life expectancies, but most will not expire before 2120.

The greatest challenge is, and will remain, spatial conflicts within the cross-section of the tubes. An inspection of the NRT today reveals that there is not adequate clearance around the OLE or around the electrically “live” “dynamic envelope” of the pantograph of 2020 electric trains. Dynamic envelopes given on the drawings (Jacobs NRT 10% Design - Appendix A.2 0 Drawings – page 7 - Proposed Tunnel Section – Space Proofing) (Ref 12.1.2) do not appear to be appropriate to the situation: trains operating on fixed track and trains of “Static Loading Gauges” that are generally permitted to run in North America today, 2019, the AAR (Association of American Railroads) loading gauge “Plates.” For these reasons it becomes important to:

- Consider the question: ‘How much space for the dynamic cross-section is really required?’
- Put forward a reasoned proposal as to how it might be achieved

4.5 Track Deterioration

The Northeast Corridor Commission report on train performance, which analysed more than 3 million train movements and 750,000 delay records between 2014 and 2018 found that there were 65 days where incidents in or around the NRT resulted in more than 5 hours of train delay. As discussed earlier, overhead (traction) power and track incidents were 66% of these. Apart from the clearance problems mentioned above, there are also serious problems with the track which can be summarised as:

- Poor drainage, maintenance issues, delays
- Salts/chlorides from Superstorm Sandy have corroded rails and exacerbated stray current issues
- Frequent, costly & disruptive maintenance required
- Track faults causing delays
- Overhead Line (catenary) causing delays

4.6 Current Refurbishment Plan

The current proposal for the NRT Refurbishment proposes a solution that would be completed after the construction and completion of the new HRT, therefore, the current proposal does not envisage doing any major refurbishment work to reduce the frequency and risk of delays and disruption to NJ TRANSIT and Amtrak customers.



Under the current NRT Refurbishment plan, assuming that the construction of the new HRT does not commence until at least 2021, there will be no start to significant improvement to the NRTs until at least 2028 and would not be completed until 2032, at the earliest (as of the 2019 Financial Plan). LBA believes that this is an untenable situation, does not meet global best practice, and that there are approaches that could be adopted to target the refurbishment at a much earlier time.

5 CONCEPTUAL APPROACH – OUTAGE PLANNING

5.1 Introduction

The NRT Refurbishment is currently planned to take place following the construction, completion, and commissioning of the two new tubes of the HRT. This chapter of the report looks at the opportunity and feasibility, from a railway operation perspective, of carrying out most, if not all, of the NRT Refurbishment work prior to completion of new HRT. Later chapters and appendices of this report consider the means of carrying out the refurbishment works.

In this chapter, LBA addresses the availability and reliability of outages (tube/track closures) that would allow work to be executed in one of the NRT tubes at a time prior to the completion of the HRT. Further, LBA examines the service requirements and the system for outage planning.

5.2 Outage Planning

Under consideration by LBA is the execution of a significant proportion of the NRT Refurbishment work by means of “in-service refurbishment” during a series of short track and overhead line equipment (OLE) outages over a period of three to six years.

A requirement for such a program of work is that during this period there should be no disturbance to weekday commuter journeys eastwards into New York in the morning and westwards back to New Jersey in the evenings, no planned long-term outages, and no severe reduction of train services. This, of necessity, implies that the program of in-service refurbishment work must be achieved using short, weeknight outages and Friday evening to Monday morning weekend outages (see further below).

In order for this work to be achieved during an in-service scenario, it will be necessary for the Integrated Work Team to be able to plan the overall project in small units of work and to be able to rely on these units of work being achieved on their specified dates during the refurbishment program.

This program of outages would be distinct from and, as far as possible, separate from outages required for routine and urgent maintenance and repairs throughout the railroad district controlled by the Penn Station Central Control (PSCC) that are planned and agreed at the weekly outage planning group meeting at the PSCC. Nevertheless, it will remain important for the week-by-week NRT Refurbishment planning to be integrated with the weekly outage planning meetings that are hosted by the PSCC.

The proposed on-going program of outages for the NRT Refurbishment would be achieved by taking an outage in one NRT tube to permit refurbishment work, whilst operating the second NRT tube as a bi-directional single track with trains dispatched in “flights” of up to three trains at 2.5 minute intervals in one direction followed by “flights” of up to three trains in the reverse direction throughout the outage. This would achieve 12 train-paths per hour, 6 eastbound plus 6 westbound (see train planning analysis below). LBA understands that this is already being used to some extent.

It should be possible to achieve nil perceptible disturbance to the timetable for customers of NJ TRANSIT and Amtrak Northeast Corridor services throughout the outage periods by adjusting the published passenger train timetable and utilising the train-paths that would become available with trains operated in “flights” during each hour overnight and at weekends, and careful re-planning of platform occupation requirements at Penn Station New York during these outage periods.

5.3 Railway Passenger Train Operations

LBA understands from the “Route Stack Diagram” provided by the Gateway Partners to us and copied included here as Figure 5-1, that the railway through the NRT provides a maximum

24 trains per hour peak service in the peak direction, with a lesser frequency of service in the non-peak direction during the working week. A lower frequency is operated during the remainder of the working day. On weeknights and at weekends, the service is no more than 6 trains per hour each way, according to the collation of the various operators published passenger train timetables.

LBA have identified the following after reviewing operators published passenger timetables:

- Overnights: Between 10 PM and 6 AM the following morning, the timetable never requires more than 6 train paths each way
- Weekends: On weekends, the timetable requires only up to 6 train paths each way

LBA has concluded in the previous section that it is possible to provide 6 trains each way service using only one NRT tube. It would be necessary to adjust the overnight and weekend train service timetable to take account of the “flighting” of trains.

LBA has been informed by Amtrak that if for any reason one of the NRT tubes is out of service (whether a planned outage or an unplanned outage), the track layouts and signalling configuration allow an alternating bi-directional service to operate using the remaining tube. LBA understands that with trains operating reciprocally (successive trains operating in alternate directions), the resulting capacity of a single NRT tube is considered to be 3 trains per hour in each direction, or 6 train movements per hour (one train movement every 10 minutes). LBA have also been informed that it takes 6 minutes for a train to run from a passenger platform track in Penn Station New York, to passing Bergen Junction, New Jersey, where double track re-commences. This indicates that the PSCC allows 4 minutes for proof that the single line is clear and to set the new route using the single-track tunnel.

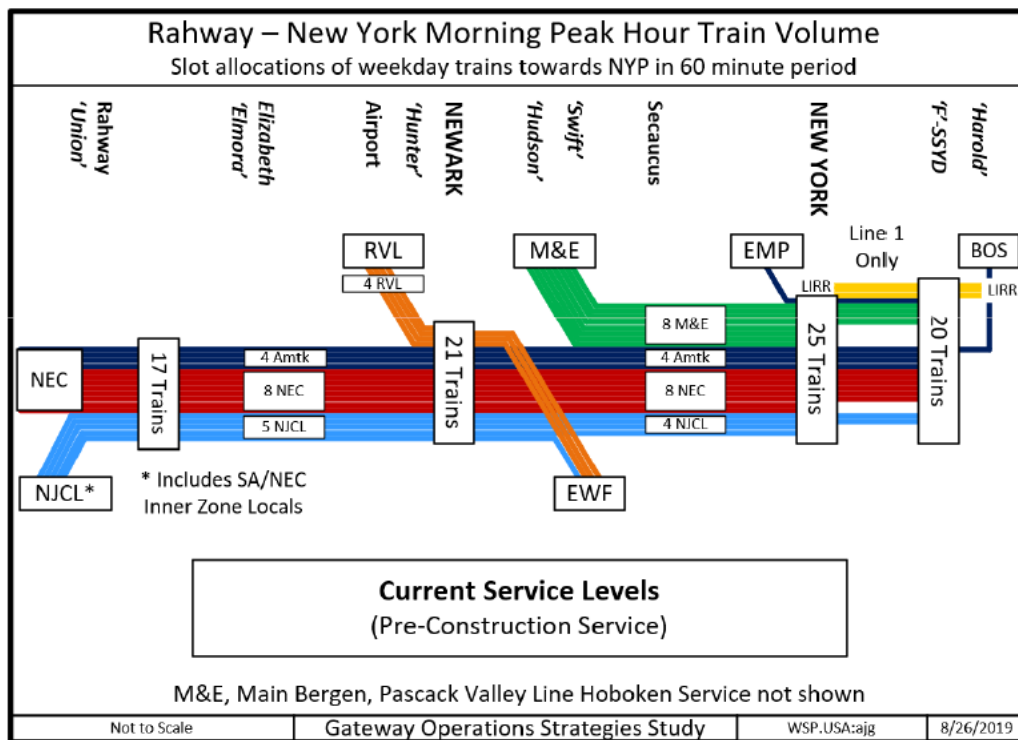
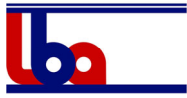

Figure 5-1: Route stack diagram provided by the Gateway Partners

5.4 Train Planning Analysis

LBA carried out a train planning analysis seeking to maximise capacity when only one NRT tube is available. LBA studied the use of “flighting” trains, a technique of operating trains to that a set of trains pass in one direction before the direction of travel is reversed to allow



another set of trains to use the same tube in the opposite direction. LBA understands that this is already being implemented by NJ TRANSIT and Amtrak to some extent. LBA’s hypothesis was the following: By operating trains in “flights” so that 3 trains pass in one direction before the direction of travel is reversed to allow 3 trains to use the same tube in the opposite direction, the capacity can be increased to 6 trains per hour in each direction. This method of operation is employed on many railroads around the world, not least on many of the very long sections of single track on the freight railroads of North America.

In order to test and demonstrate this hypothesis, LBA prepared a draft working time-table included here as Figure 5-2 from which a “Train Graph,” Figure 5-3 was produced. Input data was as follows:

- Periodicity of departures from Penn Station New York and from Secaucus Junction: 2.5 minutes, derived from Figure 5-2 showing 24 trains per 60 minutes = 1 per 2.5 minutes)
- Time Penn Station New York to Bergen Junction, NJ (see above): 6 minutes
- Time to prove single track clear and reset route (see above): 4 minutes

The “Train Graph” shows that trains dispatched in this way do not pass each other within the length between Penn Station New York and Bergen Junction, NJ. By sending trains in “flights” of three trains each way, it is possible to avoid the need for trains to pass in the NRT.

In order to enable a regular program of overnight and weekend refurbishment work to be carried out in one of the NRT tubes, regular periods must be provided by the PSCC during which up to 6 trains per hour each way would operate in the other tube. To achieve this, the overnight and weekend passenger timetable may need to be slightly re-planned to accommodate the proposed “flighting” of passenger train services. The timetable adjustments would also need to take into account the dwell time and position of trains on platforms at Penn Station New York.

The main beneficiaries of this proposed method of train operations through the NRT and the reliability of a total route capacity of 12 train paths per hour throughout each overnight and weekend, would- be NJ TRANSIT and Amtrak customers.

	Down 1	Up 1	Down 2	Up 2	Down 3	Up 3	Down 4	Up 4	Down 5	Up 5	Down 6
Penn Station NY	0.00	21.00	2.50	23.50	5.00	26.00	30.00	51.00	32.50	53.50	35.00
Hudson Portal NY	1.00	20.00	3.50	22.50	6.00	25.00	31.00	50.00	33.50	52.50	36.00
Bergen Portal NJ	6.00	15.00	8.50	17.50	11.00	20.00	36.00	45.00	38.50	47.50	41.00
Secaucus Jcn	9.00	12.00	11.50	14.50	14.00	17.00	39.00	42.00	41.50	44.50	44.00
Portal Bridge	13.00	8.00	15.50	10.50	18.00	13.00	43.00	38.00	45.50	40.50	48.00
Newark Penn Stn	21.00	0.00	23.50	2.50	26.00	5.00	51.00	30.00	53.50	32.50	56.00

	dn Up 6	up Down 7	dn Up 7	up Down 8	dn Up 8	up Down 9	dn Up 9	up Down 10	dn Up 10	up Down 11	dn Up 11
Penn Station NY	56.00	60.00	81.00	62.50	83.50	65.00	86.00	90.00	111.00	92.50	113.50
Hudson Portal NY	55.00	61.00	80.00	63.50	82.50	66.00	85.00	91.00	110.00	93.50	112.50
Bergen Portal NJ	50.00	66.00	75.00	68.50	77.50	71.00	80.00	96.00	105.00	98.50	107.50
Secaucus Jcn	47.00	69.00	72.00	71.50	74.50	74.00	77.00	99.00	102.00	101.50	104.50
Portal Bridge	43.00	73.00	68.00	75.50	70.50	78.00	73.00	103.00	98.00	105.50	100.50
Newark Penn Stn	35.00	81.00	60.00	83.50	62.50	86.00	65.00	111.00	90.00	113.50	92.50

Figure 5-2: A draft timetable developed by LBA for a maximised frequency of overnight or weekend passenger train services using one of the NRT tubes as a single track railway

Note: Point-to-point times west of Bergen are approximate for this exercise.

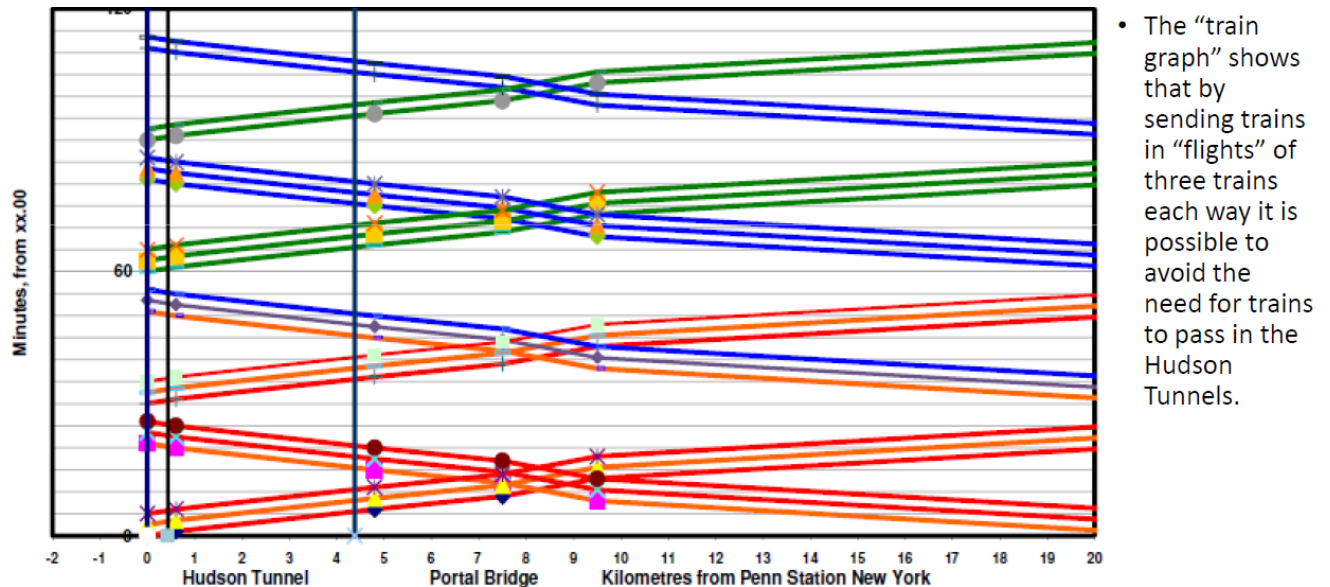

Figure 5-3: “Train Graph” developed by LBA and derived from the draft timetable for a maximised frequency of overnight or weekend passenger train services using one of the NRT tubes as a single track railway

5.5 The Opportunity for Outages

With a revised timetable to achieve 6 trains each way by “flighting” using a single NRT tube, it is possible to undertake refurbishment works in the other tube.

Based on UK railway engineering experience and existing Amtrak operations, time must be allowed to set up the outage and check before restoring service.

Normal Amtrak outages are overnight from 11 PM until 5 AM and weekends from 11 PM Friday until 5 AM Monday.

- Overnights: Effective 5-hour working time per night after deducing an hour at the beginning and end for set-up/clean-up processes (a total of 4 overnight outages/week)
- Weekends: There is a possible outage period of 1 hour (Friday night), plus 24 hours (Saturday), plus 24 hours (Sunday), plus 5 hours (Monday morning), giving a total of 54 hours. Weekend work may include more linear, invasive construction work, therefore, LBA has assumed a 48-hour weekend working time (6 x 8-hour shifts) to allow for some float and time for additional outage processes that may be necessary. Based on UK railway engineering experience (allowing for one hour at the start and end of each outage for taking the outage and later handing it back, and including for isolating and subsequently re-energising the overhead line), this gives 4 weeknight 5-hour periods for refurbishment work and a 54 hour weekend period for refurbishment work. This would be subject to detailed discussions and the establishment of satisfactory arrangements with the transport operator.

NRT Refurbishment planning should utilise:

- Weeknights for non-invasive work
- Weekends for more linear, invasive construction work

5.6 Integration of Refurbishment Works and Other Planned and Short Notice Activities in the NRT

The outage regime outlined above is both a challenge and an opportunity in respect of other works to be carried out in the NRT tubes. The NRT and its approaches are over 100 years old

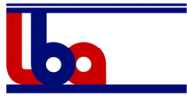

and require routine on-going maintenance to provide safe operations for over 200,000 daily NJ TRANSIT and Amtrak passenger trips.

An in-service NRT Refurbishment could provide a unique opportunity to enable routine and essential maintenance activities either within the NRT closed for refurbishment or at locations outside of the NRT since there will be a series of planned outages that could also be “shared.” Sharing of outages will require total integration between the refurbishment works and any other planned maintenance works or any reactive fault repairs.

The challenge of sharing outages will be different since LBA assumes that the overnight outages and weekend outages will have different types of work, with the more intensive work taking place during the longer weekend outages. The ability to use a refurbishment outage for other routine or emergency maintenance activities will also vary according to the type of work to be carried out in the outage; the disruption (or not) it could cause; and the implications to the smooth operation of the railway.

The other challenge will be obtaining an outage during an overnight period for maintenance or fault repairs in the tunnel tube not undergoing refurbishment on a particular night. LBA considered the need for routine on-going or emergency maintenance of an NRT tube and its approaches or for other regional work when this cannot be integrated with the refurbishment activities and examined the possible impact of a 15% loss of weekend outages. As the Integrated Work Team plans for the NRT Refurbishment during the implementation phase (see corresponding chapter), it will need to take into account this need.

It will be possible as part of the definition of the outage regime to allocate predefined outages for work in the tunnel tube not being refurbished. This can provide a planned break in the shift pattern for the NRT Refurbishment work crews.

Planning the overall NRT Refurbishment in small units of work and being able to rely on these units of work being achieved on their specified dates will be important so that regular on-going maintenance activities can be carefully planned and integrated into shared or non-shared outages.

5.7 Outage Planning - Findings

LBA found that there is sufficient capacity in the railway operations to allow overnight and weekend work.

Timetables indicate a 7-hour period overnight, which, after deducting an hour at the beginning and end for set-up/clean-up processes, provides an effective 5-hour working time. This conforms with what LBA was told by Amtrak.

“Flighting” techniques could ensure an optimum number of train paths, but we understand that this, to some extent, is already an existing operating procedure. Flighting trains through one of the NRT tubes could provide a total route capacity of 12 train paths per hour throughout each overnight and weekend outage.

At weekends, there is a possible outage period of 1 hour (Friday night), plus 24 hours (Saturday) plus 24 hours (Sunday), plus 5 hours (Monday morning), giving a total of 54 hours, but LBA have assumed a 48-hour weekend working time to allow a degree of “float” and time for additional outage procedures that may be necessary after more invasive work on weekends.

NRT Refurbishment planning should utilise:

- Weeknights for non-invasive work
- Weekends for more linear, invasive construction work

Current routine NRT maintenance should be integrated with the main refurbishment operations, both in terms of outages and locations.



Planning for the refurbishment logistics, including the implementation processes, is critical in managing the allocation of work locations, resources, and all other issues that may occur during an outage period. The success of outage utilisation is dependent on an Integrated Work Team (see Section 10.13, Implementation) working collaboratively throughout the planning and construction of the NRT Refurbishment. Risk management is also important to mitigate risks during refurbishment to the rail service/customers and risks during construction to construction personnel and quality. It will be important that there is a good working relationship between the NRT operator (Amtrak) and the refurbishment team to deal with resourcing issues and all other issues in relation to outages (see Chapter 11, Risks).

6 REFURBISHMENT IN SERVICE

6.1 Introduction

In-service refurbishment of railway tunnels must be approached with a determination to find safe and reliable solutions. Highly utilised railway systems / Metros / tunnels around the world are getting older and are under increasing pressure due to rising passenger demand. In-service refurbishment is utilised in order to ensure continuous functioning of busy major metropolitan transit systems. This type of work has been carried out across the world including in Hong Kong, Austria, Germany, Switzerland and the United Kingdom. For example, London Underground, which is over 160 years old and a very busy system, recently commissioned the replacement of 123 switch and crossing units, 13km of track, and 11km of drainage; all carried out in night-time outages. See APPENDIX 6 - In-Service Trackbed Options for references for to further information and examples of in-service refurbishment programs.

6.2 Refurbishment Activities

The refurbishment activities that were identified are as follows:

- Repair the tunnel lining and seal the leaks
- Replace the mechanical and electrical services in the tunnel with new and improved systems
- Replace the HV cables which pass through the tubes
- Demolish the bench walls (which are too high and failing and replace with new walkways and cable containments)
- Replace the trackbed, track, and overhead catenary
- Replace the signalling system

The refurbishment activities that are proposed to be accomplished through an in-service refurbishment are the same as the activities currently proposed in the full outage scenario.

For an in-service refurbishment to be feasible for the NRT, this would necessitate a sequence of work in only one of the NRT tubes at any point in time and refurbishment could be undertaken simultaneously in a number of locations in the occupied NRT tube by means of bespoke and highly productive works trains or road rail vehicles (see Chapter 10, Refurbishment Logistics).

In parallel with identifying the key refurbishment activities LBA also considered the current NJ TRANSIT and Amtrak rail operations and believe that regular weekday night and weekend periods of a one-tube outage for refurbishment is feasible, reliable, and safe.

LBA therefore reviewed the feasibility of in-service refurbishment of the NRTs in order to save time, reduce scheme risks, and improve the NJ TRANSIT and Amtrak customer experience. The possible options, scenario's and sequencing for undertaking these specific refurbishment activities are developed into an outline plan and programme (see Chapters 7 to 10).

6.2.1 Planning Work

To demonstrate the feasibility of an NRT Refurbishment in-service that would implement the refurbishment activities identified above, LBA has developed a conceptual approach and developed an outline plan for the NRT:

- A conceptual approach, a strategy, and a system of work
- Outputs and calculated durations of work based on the available working time (weeknight and weekend one-tube outages)
- A schedule for the refurbishment activities for each tube
- The logistics arrangements (at an outline stage):



-
- The equipment which could be used to demolish, remove, and reconstruct the walkways/benches
 - The safety equipment required to carry out the works
 - The options for trackbed replacement

The conceptual approach for the provision of technical solutions, sequencing, and refurbishment logistics are explained in Chapters 7 to 10 inclusive.

7 CONCEPTUAL APPROACH - MECHANICAL & ELECTRICAL

7.1 Introduction

The existing NRT mechanical and electrical (M&E) services (cables, ducting, water and fire main piping, signalling, and communications cabling) are currently located within or on the walkway surface of the existing concrete benches or fixed to the tunnel lining.

Any form of in-service refurbishment will require sequential and phased management of the relocation and replacement of these services, which will be moved in synchronisation with the demolition and replacement of the bench walls and necessary repairs (superficial and in-depth repairs) to the tunnel concrete lining. Also, the M&E services will need to be protected and fireproofed in compliance with contemporary regulations, i.e. both operational and emergency compliance requirements. This chapter reviews the M&E requirements for the NRT Refurbishment including:

- Current cabling in degraded benching
- Services that contribute to system failure
- NFPA 130 compliance
- Overall safety maintainability and timing whilst in the rehabilitation and operation phases

7.2 Need for Renewal

Many of the systems in the tunnel, whilst currently operable, are not considered to be “State of the Art” from a technology perspective; i.e. there is no modern automatic train control (ATC) or automatic train operation (ATO) signalling system and this upgrade should be considered by others where appropriate. However, it is essential that where system replacement is considered, the opportunity to upgrade to latest technologies is taken. This approach is in harmony with the project definition set out in the 10% Draft Feasibility Report by Jacobs (Ref 12.1.2).

7.3 Standards and Future Requirements

7.3.1 Application of Standards

The overarching requirement for the rail systems is to provide a safe environment for the operation of the railway and most importantly to ensure safety of passengers and operatives of the railway. In this regard, the standard NFPA 130 Standard for *Fixed Guideway Transit and Passenger Rail Systems* is the overarching applicable standard to be applied as far as it is reasonably practical.

7.3.2 Standards – NFPA 130

The NFPA 130 standard covers all areas of railway operation. Its relevance to LBA is chiefly in the areas of M&E services and emergency egress arrangements, but also the need to ensure safety of the railway, service reliability, and avoidance of delays for NJ TRANSIT and Amtrak passengers.

LBA assume above that tunnel cabling will require replacement and so Chapter 12 of NFPA 130 Wire and Cable Requirements, takes a particular relevance.

7.3.3 NFPA 130 Chapter 12 requirements

In summary NFPA 130, Chapter 12 Clause 12.4.4 requires the following:

- *“All cables and wires shall be resistant to the spread of fire and shall have reduced smoke emissions (12.2.1).”*

- *Wires and cables (except communication cables) shall be suitable for wet conditions and be moisture and heat resistant to 90deg C*
- *Emergency power, emergency lighting and emergency communications circuits shall be protected from physical damage by vehicles and from normal operation conditions and shall be fire protected for at least one hour*
- *All cables except 'leaky feeder' Radio transmitter cables should be armoured."*

This is a common and logical requirement of fire standards. In order to apply NFPA 130, it is essential that the categorisation of what constitutes an "emergency circuit" is understood. Normally these would include:

- Emergency Lighting circuits
- Sprinkler systems
- Fire alarm systems
- Fire and emergency services lifts
- Smoke and heat extraction systems
- Emergency power systems

7.4 High Voltage (HV) Cables

It has been suggested by Amtrak that the HV cables that pass through the tunnel (currently in the bench walls) and connect Substations on either side of the Hudson River to provide catenary supplies inside and outside the tunnel, are required by NFPA 130 to have 1-hour fire protection against an external fire. These cables are part of the normal supplies to the catenary in and around the tubes. LBA understand there is redundancy in this cabling system, but this is limited for full operation.

Amtrak says that the HV cables are described in their Emergency Procedures as "safety critical." LBA have not seen the Emergency Procedures but can quite understand why Amtrak may have concluded that these cables are critical to their business continuity. Designating them as "Emergency" does not make them subject to the standard in our opinion because they do not support a Fire Life Safety system.

A risk assessment that assessed the external fire risk as a justification for fireproof enclosure would be important to review because, unlike LV cables, suitable HV cables with intrinsic resistance to fire are not available. This is important because it limits the flexibility to route the cables through the tunnel. If the risk assessment concluded that the cables could be hung from racks on the wall, that would be an advantage for the refurbishment and operational situation. If the risk assessment concluded that that the HV tunnel feeds required fire protection, this could be achieved in several ways, as below, each of which has advantages and disadvantages.

A further consideration is temporary or staging of the rehabilitation of the tubes. If it is a requirement to maintain the HV feeds through the tubes at all times during a progressive reconstruction, there will be a requirement to temporarily re-locate these HV feeds.

In these circumstances, a combination of protective solutions (fireproof ducting and anti-derailment rails) could be employed.

Replacement of the HV traction cables should be undertaken to improve reliability using low smoke and fume, zero halogen cabling to bring the system in-line with current practice regarding splicing and at distances commensurate with optimal drum-sized and pulling tensions. Further details are below in Section 7.5.3.

7.5 Emergency Cables

7.5.1 Compliance installation methodologies for Emergency Cables

Clause 12.4.4 of NFPA 130 details acceptable methods for the installation of emergency cables, and in general terms the simplest means of compliance is to ensure all emergency circuits are wired with cables that are fire resistant for a one-hour period.

This allows cables to be installed on or in cable management systems (which should be of fire-resistant materials themselves), thereby improving maintenance, ease of installation and ease of connection without compromising safety integrity. Redundancy in supply (dual feeds) can also be an effective way to provide security but is not always possible.

Options for physical protection from normal operations (train movements/derailments) could include incorporation in concrete benching, thereby providing containment, so that the train is prevented from hitting cables. Containment could alternatively be provided by anti-derailment rails (see Section 9.5).

Options	Remarks
Embedding in concrete (See <i>Figure A2.3</i>)	Physical protection Ease of/ low cost installation Poor maintainability Short cable lengths between splices due to cable pulling restrictions
Putting in a Fireproof (FP) box (See <i>Figure A 2.8</i>) protected from vehicles or operational activities	Space requirement Cost – (FP ducting) Mechanical strength Good maintainability Anti-derailment rails mitigate against vehicle impact Cable lengths between splices extended due to ease of installation
Adding duplication in other tubes and mounting on racks (See <i>A 2.8</i> and other options) protected from vehicles or operational activities	Cost (multiple cables) Space constraints Mechanical protection Anti-derailment rails mitigate against vehicle impact

7.5.2 Fireproof Ducting

Proprietary systems do exist which provide up to 2-hour fire protection for enclosed cables and are suitable for the installation of the HV cables. The space constraint is an important consideration as the fire resistance is dependent on the duct material and the necessary air gaps around the cables. In general terms, a duct size of 2ft by 2ft may be required to locate up to 4 installed and supported HV cables. However, detailed design would be required, and the required physical protection assessed.

An example is provided in Appendix 2, Figure A 2.9.

7.5.3 HV Cable Specification

The current HV cables are paper insulated and have had a history of failures, which are increasing in frequency and a full replacement will increase the reliability of the system. As detailed above, cables should be halogen-free and fire retardant (HFFR). Dependent on the conditions, (i.e. humidity and water presence) lead sheathing to give moisture protection should be used, although cost and ease of installation issues are negatively impacted.

Note that the lead sheath on the current paper insulated cable is required due to the hygroscopic nature of the paper insulation and would not be required in most circumstances when using XLPE (cross linked polyethylene) copper or aluminium conductor armoured cable.

A graphite coating of the cables should also be considered to facilitate sheath testing as part of a proactive maintenance regime.

It should be noted that the current paper-insulated cables have an inferior bending radius characteristic than for similar HFFR cables of similar electrical performance. This criterion impacts the drumming specification and therefore could allow an increase in the cable lengths between splices.

7.6 **Low Voltage Cables**

7.6.1 Low Voltage (LV) Cable Containment Systems

Cable containment systems, such as continuous troughs and cable racking, should be designed to provide the following advantages over embedded ducting:

- Ease of and cost-effective installation
- Ease of maintenance
- Connectivity and location, i.e. near fittings and termination boxes

Examples:

- Metallic cable tray / cable ladder:
 - Advantages:
 - Ease of cable installation and termination
 - Cable visibility for proactive maintenance
 - Ease of jointing and splicing
 - Disadvantages:
 - Requires anti derailment protection/ additional physical protection.
- Modified acrylic resin (Modar) cable troughs – as used in the UK Channel Tunnel:
 - Advantages:
 - Ease of cable installation
 - Good anti-corrosion resistance
 - Good fire properties
 - Disadvantages:
 - Requires anti-derailment protection/ additional physical protection
 - Cost

In addition, the detailed design of the NRT Refurbishment should ensure that the egress walkway clearances are compliant.

Cable containment options, where incorporated into walkways, are described in Chapter 8 and Appendix 2, however, certain cables would be wall mounted in such a position as to ensure ease of connection with equipment such as lighting, telephony, fire detection, and alarm and communications.

7.7 Signalling System

LBA understand that there is an ongoing project looking at the upgrade of the signalling system across the whole Amtrak network so any changed/improved signalling system would have to be part of the NRT system upgrade.

LBA conclude that the current signalling system may have to be retained, but a thorough and comprehensive maintenance service is required, with all replaced cabling meeting compliance with NFPA 130 (full scope). This would be undertaken so that reliability and resilience is improved until the overall system is modified.

Where the signalling equipment restricts the evacuation walkway then consideration should be given to the relocation to the maintenance walkway side as part of the proposed rehabilitation.

7.8 Fire Alarm System

There is no fire alarm system currently in the NRT. However, in order to comply fully with NFPA 130, a fire alarm and detection system should be installed, as is set out in the 10% NRT Design Submission (Ref 12.1.2).

7.9 Findings

Subject to detailed design, LBA believe that an in-service refurbishment and improvement of the M&E services in the NRT tubes could be achievable and would provide the following benefits:

- Increase system reliability and life span
- Improve maintainability
- Improve the resilience and reliability of the rail service
- Provide a safer railway for the travelling public
- Provide compliance with NFPA 130 (where possible)

LBA proposes an efficient methodology for moving and replacing the HV cables using longer lengths and laying, rather than pulling, the cables. The rehabilitation of the M&E systems can be integrated within a number of bench refurbishment options.

LBA does not believe that the HV cables require Fire Protection under the NFPA 130 standard but have provided an option that envisages a fireproof duct to contain cables which need protection but are not available as intrinsically fire resistant.

LBA proposes a modern type of HV cable that could be available in longer lengths and have more flexibility for laying.

8 CONCEPTUAL APPROACH - CIVIL WORKS

8.1 Introduction - Need for Reconstruction

This chapter and Appendix 2 principally addresses the challenges posed by the current and ongoing deteriorating condition of the existing bench walls and the upper surface of the bench walls, which are currently used as an emergency walkway for passenger evacuation in emergencies, a maintenance walkway, and the location of some services (e.g. pipework, signalling equipment, electrical/communication cables). Given that the bench wall as it currently exists cannot be left in place, LBA proposes in this chapter in-line methodologies and sequences for the demolition and replacement within a confined environment. Importantly, the options that are discussed in this chapter are integrated with the requirements and accessibility of the M&E services that are discussed in the previous chapter.

8.2 Bench Walls & Safe Egress Walkway

8.2.1 Emergency Stepping Distance and Track Lowering

At present, the height of the existing bench wall is higher than the level of the train vestibule, requiring an unacceptable stepping distance in an emergency. The stepping distance from the train vestibule to the emergency walkway on the bench wall top is over 2 feet in height and up to about 9 inches in width. The need to lower the track to obtain better electrical clearance for the train pantograph would exacerbate this already unacceptable stepping distance. Consequently, it is highly desirable to reduce the emergency walkway bench height to a level corresponding more closely to the train vestibule platform height above track level (see *Figure 8-1*).

In addition, emergency egress access must be provided for workers to the escape walkway under FRA requirements.

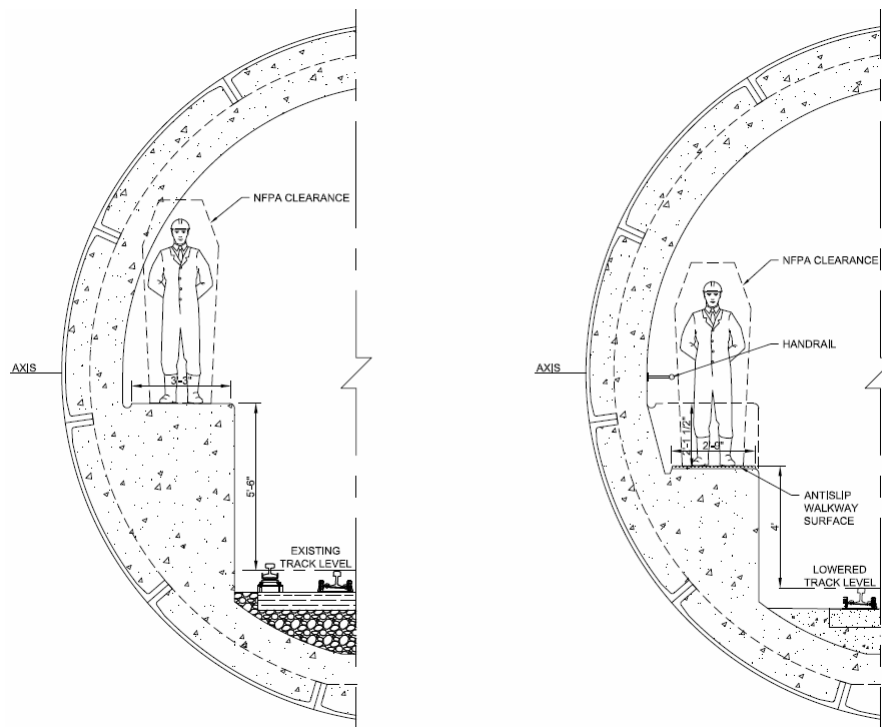

Figure 8-1: Increased walkway headroom and reduced stepping distance from emergency train egress following bench lowering

8.2.2 Headroom

Reducing the height of the emergency walkway bench also greatly improves the headroom clearance, particularly where pipework is located above shoulder height (see *Figure 8-1*).

8.2.3 Width

A disadvantage in reducing the height of the emergency walkway bench is the consequent reduction in walkway width at footfall level of about 6 inches (see *Figure 8-1*).

However, this would only be the case for the 'bored' (underwater) tunnel; the 'mined' (through rock) tunnel sections that have vertical sidewalls would retain the full walkway width. It is, therefore, important to limit or eliminate the positioning of large diameter services ducts and pipes alongside the emergency walkway. Also, the walkway should be provided with an anti-slip surface and a handrail fixed to the tunnel lining rather than the guard rail shown in the East River Tunnel 50% design, which would create a barrier for safe egress from a stationary train. A guard rail would also further restrict the walkway width, particularly for wheelchair access.

8.2.4 Temporary Emergency Walkway Ramp

During construction through an in-service refurbishment scenario, it will be necessary to create a gap between the existing and newly cut bench wall, assuming that bench wall demolition and reconstruction will take place simultaneously. It will therefore be necessary to install a temporary, quickly mountable/de-mountable bridging ramp to span the gap before the train service is resumed after the temporary works closure (see *Figure 8-2*).

The span of the gap and slope of the ramp will depend on the construction design and programming and may also vary as work progresses but is likely to be at least 24 feet in length manufactured from aluminium to reduce weight. Consequently, it may be necessary to have a selection of ramp lengths and gradients available or to devise an adjustable, possibly telescoping, ramp. The ramp would also require a guard rail on the track side. Since the ramp would be relatively short in length, a track side guard rail would be preferable and should not present a significant risk. However, the safety implications will need to be carefully considered in the design of the ramp. In addition, the ramp will need to be firmly fixed in place to prevent any displacement owing to the draught caused by passing trains.

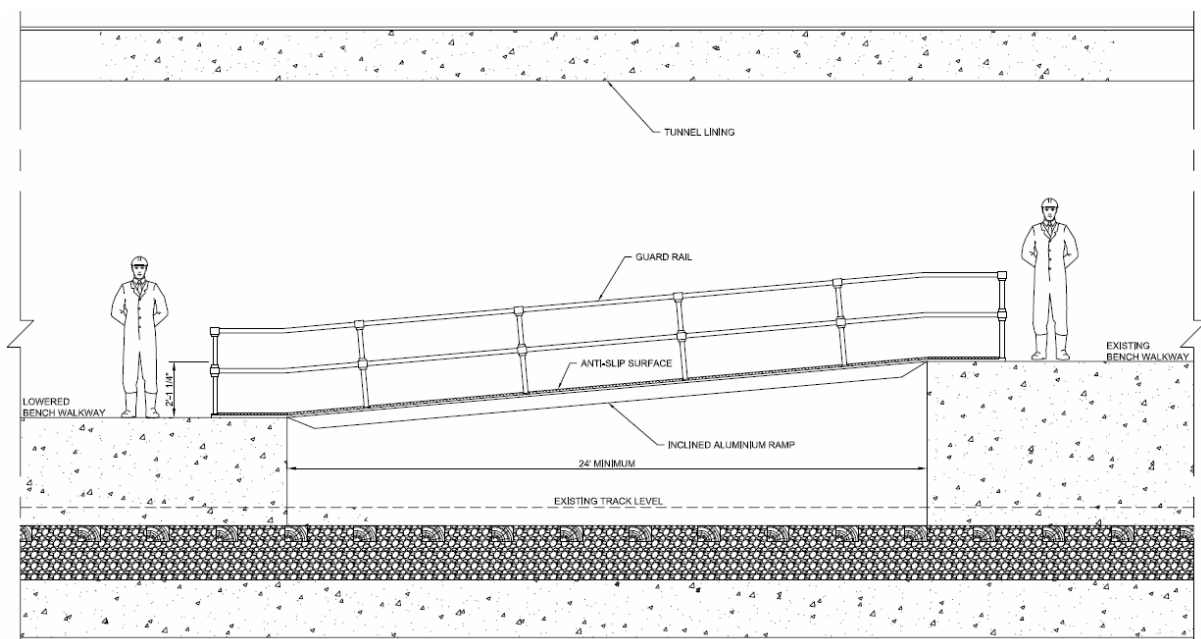

Figure 8-2: Demountable steel ramp spanning the gap between existing and the new walkway bench.

8.2.5 Safe Maintenance Platform Bench

There is also a need to replace the existing bench wall on the opposite side of each tube from the emergency walkway discussed above and provide a new maintenance walkway for railway workers. The main consideration in the design is a safe maintenance platform to replace the existing refuges set in the side of the existing concrete. The platform will need to be at a suitable stepping distance from the lowered track bed (see *Figure 8-3*).

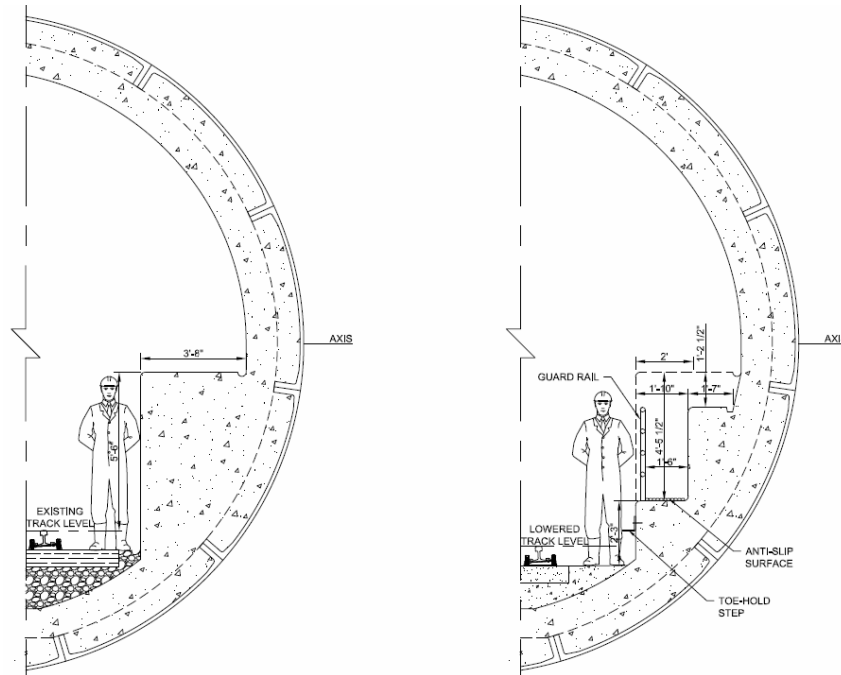

Figure 8-3: Provision of a safe refuge working platform following bench lowering

However, the geometry of the circular profile tunnel is such that in order to create a platform of adequate width and to incorporate a guard rail on the track side where required, the stepping distance would be more than 2 feet, thus requiring a toe-hold step. These steps would be inset or fixed at suitable intervals along each tube immediately below gaps in the guard rail to allow access to the platform. Also, the upper bench wall height will need to be lowered to provide easier maintenance access to services and equipment mounted on or above it by an operator standing on the platform. This platform should be provided with an anti-slip surface.

8.2.6 Bench Wall Demolition

Since the concrete forming the existing bench walls is likely to be relatively weak with numerous internal voids (clay pipes and ducts), cracks, and cold joints, the bench walls should be readily demolished using conventional pneumatic and hydraulic breaker tools. Fragmentation should be good for loading and transport from the tubes. However, the concrete does contain variable amounts of steel that may require separation before disposal. An estimate of the likely concrete weight and volume arising from demolition is given below to aid the assessment of its removal from the tunnels.

It is hoped that the bench wall concrete would break back to a cold joint between the rear of the bench walls and the intrados of the 2-foot thick concrete tunnel lining. This is, at present, far from certain and may result in overbreak that will require filling or underbreak that will require scabbling back to the required profile before construction of the new benches.

The cross-sectional area of each of the two concrete bench walls, defined by the intrados of the tunnel concrete lining, is approximately 15½ square feet for the bored tunnel and approximately 28½ square feet for the mined tunnel. The available drawings of the existing

NRT indicate that there are 40 No. 2-inch longitudinal ducts contained in the emergency walkway bench, which would reduce its cross-sectional area by about 1 square foot. The maintenance bench appears to contain 15 No. 3-inch ducts, which would reduce its cross-sectional area by about $\frac{1}{2}$ square foot.

Assuming a concrete density of 145 lbs per cubic foot, for the 'bored' tunnels:

- Walkway bench > $14\frac{1}{2}$ cu ft / lin ft = 2,102 $\frac{1}{2}$ lbs / lin ft = approx. 1.05 tons / lin ft.
- Maintenance bench > 15 cu ft / lin ft = 2,175 lbs / lin ft = approx. 1.09 tons / lin ft.

and assuming a bulking factor of 1.6 for a poor-quality concrete of low strength:

- Walkway bench > $14\frac{1}{2}$ cu ft / lin ft solid = approximately 23 $\frac{1}{4}$ cu ft / lin ft bulked.
- Maintenance bench > 15 cu ft / lin ft solid = approximately 24 cu ft / lin ft bulked.

Similarly, for the 'mined' tunnels:

- Walkway bench > $27\frac{1}{2}$ cu ft / lin ft = 3,987 $\frac{1}{2}$ lbs / lin ft = approx. 1.99 tons / lin ft.
- Maintenance bench > 28 cu ft / lin ft = 4,060 lbs / lin ft = approx. 2.03 tons / lin ft.

and assuming a bulking factor of 1.6 for a poor-quality concrete of low strength:

- Walkway bench > $27\frac{1}{2}$ cu ft / lin ft solid = approximately 44 cu ft / lin ft bulked.
- Maintenance bench > 28 cu ft / lin ft solid = approximately 77 cu ft / lin ft bulked.

8.2.7 Existing and LBA Bench Wall Replacement Proposals

The ERT 50% Design Draft Progress set prepared for Amtrak by Jacobs (Ref 12.1.7) for the East River Tunnel envisages the complete demolition of the existing concrete bench walls in both the "bored" and "mined" tunnels and their replacement with new cast-in-situ reinforced concrete bench walls to a lower and modified profile to meet the modern requirements for safe passenger evacuation and maintenance access. In addition, the track level is lowered and is replaced by a cast-in-situ reinforced concrete track slab. Many of the M&E services cables are installed in ducts that are cast inside the new concrete benches, though a number of cables and pipes are to be mounted on the tunnel lining above the benches.

This approach is considered to be perfectly reasonable and practical, but it may present a number of drawbacks in terms of programming, cost, and disruption to the operational railway during construction. Consequently, LBA have detailed eight options for the replacement of the bench wall to provide an emergency egress walkway, a maintenance platform for railway workers, and locations for the tunnel's electrical/communication cables and third-party services. These options are presented in APPENDIX 2 - Civil Works of this report, each based on the general arrangement of the ERT 50% design, which seeks to address these issues. These options include:

- A2.1 Re-Profile and Repair the Existing Concrete Bench Walls
- A2.2 Re-Profile the Existing Concrete Bench Walls and Clad with FRP Panelling and Cable Ducts (Similar to the Canarsie Solution)
- A2.3 Demolish the Existing Concrete Bench Walls and Replace with Steel Walkways and Maintenance Platforms, then Cast New Concrete Bench Wall Below.
- A2.4 Demolish Existing Concrete Bench Walls and Replace with Pre-Cast SFRC Bench Walls
- A2.5 Demolish the Existing Concrete Bench Walls and Replace with Fire Resistant GRP Boxes and Conventional Ducts Mounted on Steel Hanger Brackets
- A2.6 Demolish the Existing Concrete Bench Walls and Replace with Fire Resistant Bench Wall Facings and Ducts

- A2.7 Demolish the Existing Concrete Bench Walls and Replace with Cantilevered Steel Walkways and Conventional Ducts Mounted on Steel Hanger Brackets
- A2.8 Demolish the Existing Concrete Bench Walls and Replace with Steel Walkways and Maintenance Platforms with Cables or Cable Ducts Mounted on Steel Hanger Brackets with Critical Cables Contained in a Fire-Proof Box Below the Walkway

These options also observe in-service NFPA 130 emergency egress requirements for evacuation of the NRT and (if required) the protection of the HV cables in the event of a fire from a train. All options have their advantages and disadvantages, but the fireproof duct solution incorporated in a steel cantilevered walkway conceptually seems to offer the best potential.

8.3 Fire-Main and Drainage Discharge Pipe

Assessment of the fire main and drainage pipework should be undertaken and, where necessary, replaced. However, it is noted that they are not currently impacting the railway's operational reliability and therefore a "repair and maintain" strategy could be adopted until such time as a full replacement could be more easily undertaken.

There are, however, lengths where the current pipe systems are supported on the existing bench walling. In these locations, a temporary support arrangement will be required during the reconstruction of the bench walling. This, however, would not achieve the desired NFPA 130 compliance and LBA suggest that a fully compliant design and erection is expedited, probably taking little longer than refurbishing/moving the existing system but delivering a more satisfactory outcome.

8.3.1 The Canarsie (L-Train) Tunnel Solution

The Canarsie Tunnel under the East River serves the MTA's L-Train subway service between Brooklyn and Manhattan. The Canarsie (L-Train) Tunnel was flooded and damaged during Superstorm Sandy in 2012 and required a reconstruction program. LBA had the opportunity to visit the Canarsie (L-Train) Tunnel during an overnight construction outage period. The Canarsie (L-Train) Tunnel reconstruction does not include the demolition of the bench walls, but instead the reconstruction wraps the existing bench walls in a fiberglass polymer with the cables placed on the tube walls. This solution has been reviewed and considered by LBA for use on the NRT. It offers several advantages (see A2.2) but is not the recommended solution for the NRT Refurbishment. This is because there is a requirement, as discussed above, to lower the level of the bench walls on both sides of the NRT tubes in order to achieve satisfactory emergency egress according to NFPA 130 and to provide a proper maintenance platform for railway workers. While the Canarsie (L-Train) Tunnel bench walls could be left at their existing height, this is not possible in the NRT.

8.4 Environmental Sustainability Considerations

Environmentally friendly construction methods and methodologies, as far as LBA knows, have not been included in any prior study scope and further investigations may be necessary to achieve the best sustainable refurbishment solutions.

8.5 Findings

The NRT bench walls, as they currently exist, cannot be left in place because:

- The height of the existing bench wall is higher than the level of the train vestibule, requiring an unacceptable stepping distance in an emergency
- The headroom of the emergency walkway needs to be increased and
- The concrete forming the existing bench walls is likely to be relatively weak with numerous internal voids (clay pipes and ducts)

LBA is proposing in-line methodologies and sequences for the demolition and replacement of the bench walls.

Of the conceptual options considered in APPENDIX 2 - Civil Works, the first three (A2.1, A2.2 & A2.3) aim to provide a finished concrete bench containing cable ducts in a similar manner to the Jacobs 50% design for the ERT but may offer advantages in terms of programme time and overall cost. The least favourable of these would be option A2.1 (re-profile and repair the existing concrete bench walls), since it would result in an uncertain quality of finish and long-term sustainability. Also, Option A2.1 is not likely to have the required ducting capacity, although it may be the lowest cost option. Options A2.2 and A2.3 would offer a high quality, low maintenance solution with the required ducting capacity and could be considered for further development.

The remaining five options (A2.4, A2.5, A2.6, A2.7 & A2.8) all aim to replace the concrete benches with more lightweight prefabricated installations that would greatly reduce the time required for installation and provide a high quality, relatively low maintenance solution. All of these options, however, provide varying degrees of fire protection and no train impact protection, possibly requiring additional train anti-derailment measures to be incorporated into the new lowered track slab. Fire-resistant Fibre Reinforced Plastic (FRP) structures and ducting have been proposed in options A2.4 & A2.5, which, although they would have the benefits of ease of construction and low maintenance, may be considered unproven. On the other hand, options A2.6, A2.7 & A2.8, which utilise steel walkways and fixings, are widely used in railway and metro tunnels worldwide. Option A2.8 incorporates a standard lagged steel fireproof box ducting below the steel walkway that would provide very good fire protection for the more HV cabling if required and would facilitate easy laying of cables. This could be considered for further development.

The Canarsie (L-Train) Tunnel Solution has been reviewed and considered by LBA for use on the NRT, and while it offers several advantages shown in A2.2, is not the recommended solution for the NRT Refurbishment because there is a requirement, as discussed above, to lower the level of the bench walls on both sides of the NRT tubes in order to achieve satisfactory emergency egress according to NFPA 130 and to provide a proper maintenance platform for railway workers. While the Canarsie Tunnel bench walls could be left at their existing height, this is not possible in the NRT.

9 CONCEPTUAL APPROACH – TRACK, TRACKBED, AND OVERHEAD LINE CLEARANCES

9.1 Need for Reconstruction

The Northeast Corridor Commission report on train performance identified that a significant proportion of the delays are due to track, trackbed, and overhead line failures. Therefore, the prioritisation of track, trackbed, and overhead line (OHL) replacement is important in planning the NRT Refurbishment. The NRT Refurbishment should reduce the service impact risks at the earliest possible stage.

This chapter reviews the current issues with NRT's track, trackbed, and overhead line clearances. Section 10.10 discusses the feasibility of in-service track and trackbed replacement. Section 11.3 posits the risks of not addressing the fundamental needs for replacing the track, trackbed, and overhead line and also the mitigations for the possible risks during the in-service refurbishment of the track and trackbed. Appendix 6 looks at the options for constructing a new trackbed and which of these might be most suitable for the in-service refurbishment. Appendix 6 also provides some international examples.

9.2 Drainage Issues

It is anticipated that even after tunnel refurbishment is completed there will continue to be a need for long-term water collection and drainage disposal from several sources including:

- Seepages through the tunnel lining (which should be reduced by renovations)
- Water brought in by wet trains
- Firefighting

The bench walls on either side of the bored circular tube currently each have longitudinal open gutter drains alongside the tunnel lining that feed down-pipes set partly in the bench concrete and partly in the 2-foot thick tunnel concrete lining at 200-foot intervals along the tunnel length. These discharge at the base of the benches into the track ballast where the water flows to a longitudinal collector drain located centrally below the track to the sump located at the low point of the tunnel alignment where it is then pumped to the surface for disposal.

The mined tunnel drainage differs in that the downpipes from the longitudinal open gutters are set entirely in the bench concrete. Also, there are two longitudinal collector drains located either side of the track below the ballast.

Any refurbishment design solution should provide an equivalent, or better system of drainage and all drainage ducts must be capable of being rodded in case of blockages. Consideration may be given to the provision of fire traps in the main collector drains to mitigate against spillage and accumulation of inflammable liquids.

9.3 Stray Currents and Corrosion Issues

It is intended that a number of high voltage (HV) cables will be installed in the refurbished NRT, together with the overhead power catenary to the trains. Also, LBA have proposed that removal of the third rail DC traction current supply system should be considered (at least during the period of refurbishment). High voltage, alternating current electricity transmission carries the risk of induced stray currents being generated and transmitted through adjacent metal installations, in particular steel reinforcement embedded within the concrete. Flashovers are also a hazard between the train pantographs and the tunnel lining, particularly where the tunnel lining contains steel reinforcement. These flashovers may have the effect of disrupting sensitive signalling and other control and communications equipment in the tunnel and can also induce corrosion. It is essential, therefore, that all critical installations are fully bonded or earthed.

Where reinforced concrete is used it would be advantageous to use steel fibre reinforced concrete (SFRC) wherever possible instead of conventional steel rebar reinforcement. Plastic fibres could also be considered, particularly for fire protection.

SFRC produces high strength, high quality concrete as well as providing reinforcement along edges and corners, preventing spalling and providing impact resistance. Furthermore, since steel fibres do not provide electrical continuity or connectivity through the concrete mass there is a lower potential for stray current leakage. Also, since each of the steel fibres is isolated within the alkaline environment of the concrete matrix it is also not susceptible to corrosion.

9.4 Clearances

9.4.1 Transverse to Track Centre Line

Dynamic movement of a rail vehicle cross-section transversely to the track can be considered in two parts:

- Upper body sway
- Lower body sway

A complete “quasi-static” analysis to produce the “Kinematic Envelope” to BR CM&EE (British Railways Chief Mechanical & Electrical Engineer’s department Design Guide 501) has not been carried out for this review because it requires significant input data concerning the suspension characteristics of the vehicle; maximum running speed at the location to be analysed; together with alignment and maintenance characteristics of the length of rail track for which the envelope is to be derived.

However, based on LBA’s experience in the field of rail vehicle quasi-static displacement analysis, LBA can say that the additional cross-section of the “Swept Envelope” over and above the Static Loading Gauge through the length of track within the NRT tubes will be modest because:

- Rail track within the complete length of the old NRT tubes is essentially straight, in plan.
- Although crossties are laid on traditional ballast, their ends are, today, substantially held in alignment by the bases of the concrete benches throughout the length of the tubes, so there should be very little “track alignment error”.
- When fixed “slab track” is installed allowances in the “swept envelope” calculation for “track alignment error” and for “track cross-level error”(which can account for much of the displacement at roof-edge level) will be reduced to nil since the tunnels are essentially straight and not operated at high speed no “track cant” will be required.

Inputs for which LBA do not have data and have made assumptions are:

- Trains approaching and departing Penn Station New York will not, today or in the future, be travelling at speed in excess of 60mph at any point within the NRT as far as the New Jersey portals.
- Since the track is essentially straight, there is no “installed track cant,” “tilt” of the track to compensate for centrifugal force when curving at maximum permitted speed through the 1910 tunnels.
- For the present-day track condition on ballasted track with “cribs” excavated out between and under crossties over the mid-18” between rails to assist drainage, LBA assume that allowance for “cross-level error” must be included.

In order to represent the track situation today on the drawings that are appended to this report we have allowed 5.1” (130mm) for “upper body sway” and 3.5” (90mm) for “lower body sway.”

If a partial derailment event were to occur, the wheel that has climbed a rail and moved to one side of centre line of the track by up to 3.15" (80mm) so far as to be in contact with a "guard rail" (see below) will have compressed the springs and raised the body on the same side, thereby inducing considerable sway and lateral movement towards the other side of centre line. Hence, lateral movement on suspension and displacement through partial derailment are not additive. Derailment is considered more fully in Section 9.8 as part of the text addressing containment of a derailment event.

In the forgoing analysis, LBA have shown how it will be possible to achieve modern standard clearances around the dynamic envelope of railway rolling stock whose cross-section complies with present day AAR standards and also achieve correct electrical clearances around the 12 kV AC OLE.

The principal means of achieving this are by two measures:

- A careful analysis of the true dynamic envelope of the rolling stock that uses the NRT. This should include discounting of displacement tolerances normally included for rail alignment, level and cross-level on conventional "ballasted track" because in the NRT, the rails will be laid on a fixed, concrete, track bed.
- The adoption of a track slab cast to the prepared invert of the tunnels, set as low as possible, in such a way as to liberate as much space in the crown of the tubes as possible, for correct clearances around the dynamic displacement of passing trains, and for electrically live pantographs and 12kV AC OLE constructed with full electrical clearances throughout the length of the tunnels.

By achieving full compliance with these and related standards, the NRT will be presented in a state of fitness to meet the evolving standards expected during the forthcoming 100 years.

9.4.2 Vertically

At speeds under 60mph on straight track (as in the present case at the NRT), the only significant upward movement of the Static Loading Gauge will be due to car body "roll". Based on data available, LBA estimate that this will not exceed 1¼" (32mm) above static, unladen, condition.

9.5 **Dynamic Movement – Summary**

Figure A3.1 shows an estimated static loading gauge cross-section for a 10'-0" wide x 14'-6" tall NJ TRANSIT double deck passenger car, indicated blue, with the above series of assumptions and quasi-static movement allowances, indicated red, inside the existing 19'-0" diameter tunnel. Track is shown at the original 1910 designed level relative to tunnel centre level and invert. Side "bench walls" are indicated at the 1910 designed dimensions: 5'-10" each way from tunnel centre line and 5'-6" above track level, together with the option in the current 10% NRT Design scheme (Ref 12.1.2) to reconstruct the concrete "bench walls" at 4'-0" above existing track also shown.

9.6 **Electrical Clearances**

Clearances to the overhead line 12.5kV AC electrification equipment (OLE) and rail vehicle pantograph in Appendix Figure A3.2 is based on current British practice for 25kV AC OLE (also former 6.25kV AC) as set out in the UK Health & Safety Executive, HM Railway Inspectorate, Railway Safety Principles & Guidance, Part 2 Section C: Guidance on Electric Traction Systems. The design allows for 1" (25mm) upward deflection of the OLE under pressure from a passing pantograph. This is the worst case for electrical clearance to the corners of the pantograph including allowance for "upper body sway": estimated to be 5.6" (142mm) – which is at the lower limit of acceptable electrical clearance to obviate risk of electrical flash-overs at the pantograph corners.

However, this is based on the further assumptions that:

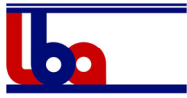

- The OLE contact wire has been installed throughout its length at the level relative to the crown indicated on the drawing, Appendix Figure A3.2.

and

- That the tunnel long section follows the same vertical curve profile as the track with no additional tolerances than the +/- 3/8" (10mm) for contact wire installed level and +/- 1" (25mm) for track level.

Since:

1. LBA do not know construction details of the actual OLE installed in the tubes

and

2. it is likely that track engineers have optimised the vertical curve profile of the track over the 110-year life of the NRT tubes.

LBA believes that these assumptions are overly ambitious for use in the design of refurbishment works to the NRT tubes because this estimated cross-section allows for no further tolerance around the 12.5kV AC OLE and the electrically live pantograph, either upwards towards the tunnel crown or downwards towards the swept envelope of passenger trains passing through the tunnels.

Hence, Appendix Figure A3.1. and Appendix Figure A3.2. represent the ideal cross-section but, by inspection, do not represent the true situation throughout the length of the tubes.

During the NRT inspection LBA noted:

- That a pocket had been taken out above the OLE for complete lengths between some adjacent pairs of insulator fixing pockets. It was not possible to take measurements, but the chase appeared to be of the order of 6" wide by 2" to 3" deep. This suggests that flash-over had been occurring between the catenary support cable and the concrete tunnel interior. The chase may now achieve acceptable clearance between catenary and the concrete interior.
- Scorch marks at about the width of a passing pantograph at these lengths indicate that since the OLE is mounted at a high level, perhaps 2" or 3" higher than indicated in Appendix Figure A3.2, the theoretical relationship to tunnel interior, then the pantograph of passing electric rolling stock is passing unacceptably close to the tunnel interior. Indeed, it may be possible that this has been the cause of some damage to pantographs.

9.6.1 Role of Track Lowering (1)

It has been proposed (NRT 10% Design) (Ref 12.1.2) that the existing traditional ballasted track should be replaced by a fixed concrete slab system. This change would provide the opportunity to lower the OLE catenary cable and contact wire to achieve the 6" clearance shown on Appendix 3 Figure A 3.1 and Figure A 3.2 to the 9'-6" radius concrete tunnel lining (with pockets repaired) as a minimum clearance throughout the length of the tunnels. This would require designed rail level relative to the invert of the tunnel to be lowered by at least 2", preferably 3", throughout the length of the tubes if possible.

9.7 **AAR (Association of American Railroads) Static Loading Gauges**

North American railroads operate trains over track operated by many different companies that all follow common standards set by the AAR. One of the most important groups of standards is the "Static Loading Gauges".

The AAR defines "all line" static loading gauge for passenger cars whose leading dimensions are: 14'-6" tall by 10"-6" wide. The double deck car fleet operated by NJ TRANSIT are 14'-6"

tall by 10'-0" wide whereas Long Island Rail Road (LIRR) passenger cars are 10'-6" wide below cant rail level.

Appendix Figure A3.1, therefore, shows that NJ TRANSIT passenger cars may operate through the NRT, but that no freight trains to Plate B or taller can be accepted through these tubes.

9.8 Fixed Track Concrete "Slab Track"

There are a number of methods of providing a "fixed" (direct fixation) track system. The object is generally to provide a "fixed" position in line, level, cross-level, and cant to the track centre line, for the two rails. The concrete track slab replaces traditional ballast and cross-ties with the result that the maintenance requirements for the traditional track system, cleaning the ballast, and lifting and realigning track to the designed position, can be dispensed with. For rail routes in tunnels the main benefit is often regarded as being that, since track alignment and level errors no longer occur, allowances for these errors that are normally included in the development of the "dynamic" or "swept" envelope for a rail vehicle, may also be omitted. The omission of ½ inch allowance for track cross-level error reduces predicted upper body sway at 14'-6" (174") above track level by 1.5" directly, increased further by spring deflection as the centre of gravity moves to the side, so of the order of 1.9" (48mm).

A number of systems of "slab track" have been developed. Pre-cast track units mounted on resilient fixings or complete resilient mats are used in subway systems because they dramatically reduce ground-borne vibrations that may otherwise be transmitted through the tunnel structure. These systems have also been used to provide slab track on surface railways. However, just as in a tunnel, the pre-cast units must be anchored to / supported by a sound concrete structure because these systems have been known to fail and behave like a "run" on the keys of a piano, each unit dipping and rocking in turn.

Section 10.10 discusses Overhead Line and Trackbed replacement and the options are further developed in APPENDIX 6 - In-Service Trackbed Options.

The refurbished NRT will include modifications to, or replacement of, the 12.5kV Overhead Line Electrification Equipment (OLE) to achieve the full dynamic and electrical clearances that are required in the crown of the tunnels for compliance with standards.

9.9 Containment of a Derailed Train

LBA were told that an important role of the concrete bench walls each side of the track throughout the length of each tube of the NRT is to contain a derailed train. Although there is evidence that passing rolling stock, or loads carried by passing trains, have struck the benches in the past, LBA have been shown no record of trains having actually de-railed. The following is an analysis of this issue:

- Track through the tunnels is essentially straight or of no significant curvature.
- Crossties are effectively retained laterally by the "bench walls" which thereby eliminates track alignment tolerances in the swept envelope already.
- The vertical faces of the bench walls are each 5'-10" from the centre line of track.
- Maximum static width for any rolling stock passing over this railroad, AAR Plates B, C or Passenger Car, is 10'-8" overall width or 5'-4" each way from centre line of track.
- Normal dynamic movements of a rail vehicle body on its suspension components at a level about 5'-0" above rail, with wheel rolling contact circle running with flange contact to one side of the rail head and normal track tolerances, may usually be expected to add 3.75" (95mm) to the swept envelope each side of centre line, total: 5'-7.75" (maximum width rolling stock), but not more.

- This will leave a minimum of 2.25" clearance to the bench walls, an adequate passing clearance to the dynamic loading gauge at this level, 5'-0" above rail.
- A rail wheelset will have an average clearance of 0.29" (7.5mm) at each flange when running without flange contact, wheel rolling contact circle running central on the rail head.
- If there is a lateral force function, in order to become "de-railed" a wheel must move 0.29" (above note) to "flange contact", plus "flange climbing": 1.14" (the width of the flange), plus 2.8": the width of the rail head, approximate total: 4.23" (107mm) before derailment occurs (this dimension is irrespective of dynamic movement of vehicle body above its suspension).

In the UK and elsewhere in Europe it is common practice to install "anti-derailment rails" or "guard rails" along the complete length of track crossing vulnerable bridges and viaducts. The guard rails are arranged to provide, in effect, a flangeway inside each of the running rails with a clear width of 3.75" (95mm). This is much larger than the 1.75" (44mm) flangeway provided at switches.



Figure 9-1: Guard rail

See Appendix 3 Figure A3.4: Continuous Checking Guard Rail extract from standard drawing "Continuous Checking Guard Rail" Section F-F, Guard Rail Chair GR3, and Appendix Figure A3.5: Baseplate standard drawing "Pandrol LGN Baseplate for Continuous Guard Rail", the key features of which are:

- The guard rail top edge is 1" (26mm) higher than the running rail, hence 2.1" higher than the lowest point on the flange when the train is running correctly.
- With this "guard rail" arrangement, if a lateral force function is applied to a wheelset where the flange face to wheel-back dimension is 53.62" (1362mm) on 4'-8 1/2" gauge track, the wheelset can only move laterally 3.15" (80mm) before the back of the wheel is trapped by the "guard rail".

- Since the flange lowest point is: 1.1" below running rail, the guard rail is: 1" higher than the running rail, and it presents a vertical face, it is regarded by British and European Track Engineers as impossible for a trapped wheel to "climb" the guard rail and derail the train.

This method of containment traps any train after just 3.15" (80mm) lateral movement compared with the NRT "bench walls" which only trap the widest train after it has derailed and moved 6" laterally, or in the case of a 10'-0" wide NJ TRANSIT train: derailed and moved 10" laterally.

In Summary, use of the "guard rail" or "anti-derailment rail" technique would prevent derailment events at a much earlier stage than by reliance on containment between two concrete "bench walls". Guard rails can be included in slab track, fixed track systems.

9.10 Third Rail

Each time a track and traction power outage are taken, time and skilled technicians are required to the isolation of the Third Rail from its 750V DC traction current supply. The Third Rail is continuous into Penn Station New York's Platform # 5 and above, but at the New Jersey end of the NRT, it terminates just outside the Bergen portals. It has been suggested to LBA that this equipment is retained because it may be useful to enable a dual current format (DC & AC) locomotive to run into the NRT tubes from Penn Station New York to rescue a 12kV AC train in the event of a 12kV AC catenary "tear down" or other type of AC traction failure.

However, LBA understand that in some emergency circumstances it is Amtrak policy to switch off the traction current supply to the Third Rail for the protection of track staff and first responders who may need to walk or to work at track level, between the bench walls. LBA have been advised that no maintenance or emergency work to the infrastructure or underneath trains may be carried out in the tubes without first switching off traction current supply and ensuring that the Third Rail and OLE are grounded.

Certainly in the UK it is standard practice and a UK Health & Safety Executive (HSE) requirement, that if there is a severe incident on the Third Rail 750V DC railway network (in South London and the counties to the south of London), then the 750V DC power supply must be turned off as quickly as possible. This is regarded as particularly important if Fire Service, Paramedic, or other non-railway engineering staff are required to attend the emergency. In this situation, the HSE Inspector, who will also be called to the scene, will most certainly require the 750V DC traction current supply to be switched off and Third Rail grounded before allowing emergency services staff onto the railway track bed.

It has been indicated to LBA that the 750V DC Third Rail has not been made "live" during the last four years. Furthermore, a diesel locomotive is permanently running and crewed on standby in Sunnyside Yard so that it is available to rescue any failed train in the Penn Station New York area.

Diesel locomotives routinely operate for maintenance and shunting purposes through the NRT and are perfectly able to rescue any failed 12kV AC passenger train from these tubes.

These factors indicate to LBA that it would be worthwhile to commence a discussion with the railroad operators and the PSCC with the objective of establishing general agreement that the Third Rail and its 750V DC traction current supply arrangements can be omitted from both the refurbishment of the NRT tubes and the "fitting out" of the two new HRT tubes. It might then also be removed from the NRT at as early a date as is convenient.

A comment has been made that if a diesel locomotive is sent into the NRT to rescue a failed passenger train there may be a build-up of diesel exhaust fumes to an unacceptable level. Similarly, if several works trains are to be in an NRT tube during a weekend outage, diesel exhaust fumes will build up to a level that is not acceptable for the engineering staff. This situation might be avoided if a diesel engine is switched off, but this is not, in fact, normal operating practice for the very large diesel engines installed in US Class 1 railroad freight

locomotives. Engineers prefer to keep the diesel engines running to avoid the engine and its cooling system from cooling down, which incurs the risk of loss of coolant fluid at many joints on the system as a whole.

The alternative used on London Underground and on other underground mass transit railways around the world is to use battery or hybrid locomotives (see Appendix A 7.2) for train rescue and for handling works trains. There are UK and European suppliers of these locomotives but the adhesion weight required to pull a 10 car bi-level NJ TRANSIT train up the gradient out of the NRT tubes and into Penn Station New York, indicates that a US freight locomotive should be used as a “donor” locomotive on which a US loco re-manufacturer could build a suitable tunnel works and rescue locomotive. There are variants of this type of locomotive that include smaller (than main line freight) diesel engines that de-toxify their own exhaust fumes to recharge batteries during a long working period or to supplement traction output when hauling a heavy train; such an arrangement could be procured from the re-manufacturer.

The in-service NRT Refurbishment program would require of the order of six of these locomotives and they could be made available both during the refurbishment program and afterwards as the Penn Station New York rescue locomotives that are retained and always crewed at Sunnyside Yard. The existing locomotives maintained for this emergency duty could cover any incident in the 2 NRT tubes or the 4 ERT tubes. Up to now, these emergency locos have been provided as one diesel plus one dual voltage electric locomotive, though LBA understand the dual voltage locomotive may be withdrawn from service. See Appendix 7, NRT Tunnel Refurbishment Works Trains for more information.

In summary, LBA believe that the Third Rail should be removed because:

- it is not being routinely used
- there are alternatives to its use in an emergency
- the cost of installing and maintaining is unnecessary
- it is an unnecessary complication in safety and emergency procedures, and
- it can if necessary be reinstated should circumstances or service/operations change.

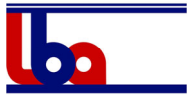

10 REFURBISHMENT LOGISTICS

10.1 Introduction

LBA have carried out a construction planning exercise of all the main activities with the purpose of demonstrating the overall feasibility and possible schedule of NRT Refurbishment in-service, while managing risks to NJ TRANSIT and Amtrak customers. This chapter looks at the refurbishment methodology and logistics and gives some detail to show LBA believe an in-service solution can be achieved.

LBA emphasises that such review is conceptual and very general in nature, with limited information. LBA have based the study on the under-river section, which is well detailed and the longest uniform section and have then extrapolated our planning and scheduling to the whole NRT to understand the feasibility of refurbishment logistics and so, the in-service refurbishment.

Successful refurbishment of the NRT will require a suitable economic and buildable design, a carefully planned construction methodology, a rigorous risk assessment, on-going contingency planning, and a “can do” attitude from the Integrated Work Team. In addition, early actions such as designing, and testing mock-ups and materials will be necessary to prove design and planning and reduce construction and operational risks.

LBA start from the basis that work can be carried out during an overnight outage and a weekend outage when only one NRT tube will be in use, as discussed in Section 10.5 This places a requirement to have all refurbishment activities as controlled and as efficient as possible. Investment will be required in the best equipment and working environment to achieve the required outputs and avoid interference with the peak-hour NJ TRANSIT and Amtrak services. The Northeast Corridor Commission’s report on train performance (Ref 12.1.6) is an important guide on what elements of the NRT need to be replaced/repared as soon as possible to provide improvements to NJ TRANSIT and Amtrak customers. This analysis data suggests that trackbed replacement followed by the demolition of the bench walls is the critical activity and the activities that follow will be designed and planned to avoid impeding progress.

10.2 Bench Wall Replacement

In Section 8.2 and Appendix 2, LBA look at a variety of bench wall replacement options and their advantages and disadvantages. The methods employed in reconstruction of the side bench walls are considered more linear, invasive work, therefore this work will require minimum interference with the operational railway and must be phased wherever possible to work within the constraints of planned weekend outages.

Criteria for developing the bench wall replacement options have been quality, speed of erection, cable protection, and maintenance of emergency response facilities. LBA believe all of these options can be refined to achieve outputs rates comparable with bench wall demolition. LBA see this being accomplished through a “moving workshop” that:

1. demolishes,
2. trims,
3. drills for fixings, and
4. erects the bench wall replacement.

For the purposes of planning the possible logistics, LBA have assumed that entire length of the bench walls in each tube will be demolished.

The quality of the finish to the concrete of the tunnel lining will be a key consideration and it is difficult to judge a specific reconstruction solution until the actual mechanics of concrete breakout (off) are evident. Some investigation and testing will be necessary to assist decisions

on design. Contingency planning should consider what should be done if the bench wall concrete does not break cleanly away to make the cut surface acceptable visually, (particularly above the walkway) and for bedding steelwork and pre-cast concrete units.

10.3 Mechanical & Electrical (M&E) Services Installation Methodology

10.3.1 Considerations

During the NRT Refurbishment, the Mechanical & Electrical (M&E) installation should be undertaken considering the following:

1. Operative Safety – by maximising mechanised installation methods, thereby removing risk from manual handling, working at height, and other avoidable manual activities.
2. Efficiency – by maximising prefabrication to reduce “at workface activities.”
3. Design for Installation - by considering innovative designs that reduce working hours (e.g. design of cable support systems to allow laying rather than pulling).
4. Traceability and Quality Verification – by using a barcode or QR code to ensure correct sequencing and correct location of equipment.

Wherever possible, working platforms on railway flatbed trailers would be designed specifically for individual refurbishment activities to maximise the above considerations. Depending on the working patterns eventually designed in advanced planning and ultimately adopted by the Integrated Work Team, specially equipped road-railers may be an alternative.

The methodologies proposed have been utilised in other rail tunnels and can be adapted to suit the needs of the NRT programme.

10.3.2 Mechanical Systems – Drainage, Fire Main, and Compressed Air

A three-stage process would be undertaken, after the tunnel crown had been repaired to the extent necessary to allow pipe bracket holding bolts to achieve fixing pull-out strength:

1. Marking out and drilling of bracket holding bolts (either resin or undercut, as required). This work would be undertaken from rail mounted platforms constructed on flatbed trailers. A drilling rig incorporated in the platform would be utilised to reduce manual drilling and ensure alignment, quality and speed. To avoid multiple passes and reconfiguration, the drilling rig could be configured to facilitate fixings for all primary bracketry.
2. Primary bracket installation for piping systems (i.e. a manipulator arm would be used to reduce manual lifting).
3. Pipe installation from flatbed mounted stillages utilising a manipulator arm. Jointing would be undertaken as the pipe is installed from platforms mounted behind the stillages.

10.3.3 Electrical Containment

Electrical primary brackets would be sufficiently simple and light and mounted manually. Pre-mounting of smaller equipment items and signage would be accommodated.

Cable containment located above the bench walls, including any required cleats for low frequency transmitter cable etc. Prefabricated lengths would be installed from rail mounted platforms (at or above walkway level). Consideration should be given to designing cable containment, ready fitted with cleats or banding and, where possible, ‘plug and play’ light fittings, alarms, sounders, etc.

Cable containment mounted below the walkways would be installed in prefabricated sections and panels from track level, where practical, using manipulator arms. If FP ducting is required, it would be prefabricated with internal cable support systems to allow the laying of HV cable in maximised lengths.

10.3.4 Equipment Mounting

Where possible, equipment would be pre-mounted on primary brackets installed from flatbed mounted working platforms. Where substantial items, such as heavy pipe brackets, are to be fitted, these would be installed from rail mounted equipment using a manipulator arm.

10.3.5 Cabling and Termination

In all cases, other than where cables are in enclosed ducts, cables would be installed from cabling trains; laying cables into / onto racking; moulded open troughs, or ducting. Cable trains would operate at up to 2 miles per hour and allow one-pass for multiple cables. Cables would be mounted on jacks and fitted where necessary with strain gauges. Cleating, banding and dressing would be performed from working platforms forming part of the train. In order to maintain progress, cable termination and splicing would be a separate exercise from smaller distributed mobile platforms.

10.4 Overall Sequence and Programme (Schedule) of Operations

For the purposes of planning and scheduling only, we have assumed that there will be 4 HV cables placed in a fireproof enclosure (See Appendix A 2.7.) This relates to one tube; the other tube will be almost identical. It is emphasised that this is one possible sequence of operations and integration of operations. It is chosen to address the mitigation of the largest number of delays which have been experienced in the past but discovered circumstances during advanced planning and design may dictate or influence changes.

Activity No.	Tube	Sequence of NRT Refurbishment	Working Hours
1	N	Clean and repair tunnel crown, move services locally as required	Weekday Nights
2	N	Install cable containment systems for LV, fireproof and transmission cables Install fireproof cables, other non-emergency LV cables and radio on tube walls in containment	Weekday Nights & Weekends
3	N	Replace track bed removing ties and ballast and replacing with concrete	Weekends Only
4	N	Install bracketry for fire main, compressed air, and pump discharge lines. Install pipework/hydrants and commission systems De-commission and strip-out old pipework	Weekday Nights & Weekends
5	N	Fix and terminate new lighting and call points comms equipment Refurbish existing signalling equipment and support from tube walls (reposition from walkways)	Weekday Nights
6	N	Decommission old electrical systems and recommission new circuits	Weekday Nights & Weekends
7	N	Decommission any cables on egress walkway side of the tube	Weekday Nights
8	N	Demolish the egress walkway and rebuild with chosen option	Weekends Only
9	N	Install new HV Cables in egress walkway and commission all four cables	Weekday Nights & Weekends

Activity No.	Tube	Sequence of NRT Refurbishment	Working Hours
10	N	Decommission the HV cables in the maintenance walkway	Weekends & Weekday Nights
11	N	Demolish the walkway on the maintenance side and rebuild cable support provision	Weekends Only
12	N	Install new HV cables on the maintenance side in new cable containment	Weekday Nights & Weekends
13	N	Install handrails and finishes and commission all remaining systems	Weekday Nights & Weekends
14	N/S	Takeover duty from HV cables in S Tunnel (assume can reconfigure circuits, may require some additional LV cables)	Weekday Nights & Weekends
15	S	Proceed to refurb S tube as N but no need to install HV cables until all complete when you swap over one set of HVs from N or put an additional set in place creating redundancy	Weekday Nights & Weekends

N=North Tube; S=South Tube

10.5 Typical Schedule of Refurbishment of One NRT Tube

10.5.1 Purpose of Schedule

This schedule is strictly for the purpose of demonstrating the feasibility of in-service refurbishment. Based as it is on incomplete information it will not be correct in detail but does, LBA believe, demonstrate the feasibility of this in-service refurbishment approach.

10.5.2 Understanding the Schedule

Below is a table that calculates durations from outputs and quantities and this feeds into the Gantt chart schedule. To aid understanding of this schedule LBA provide a TILOS Time / Chainage chart in "APPENDIX 8 - Time Chainages: Further Explanation and Pre-construction Activities," which gives more detail on the durations, workshop locations, and how they progress down each tube.

10.5.3 Assumptions

Shown below is a typical refurbishment schedule. In preparing this, LBA have made the following conservative assumptions and show that refurbishment can be accomplished in a feasible and timely timescale:

- Effective working hours as being outages of 5 hours each weekday evening and 48 hours at the weekends.
- 5 nights per week for an activity that proceeds on weeknights only.
- Work can be carried out in a number of locations, and activities are planned for installation in a variety of working patterns as shown in the "Outputs for Scheduling" table.
- The repairs to the concrete lining and leaks do not seem to be causing operational delays but would sensibly need to be done before the erection of new services on the tunnel walls.
- Construction of the new trackbed will happen at weekends with some M & E activity proceeding as well.



-
- Demolition is the critical activity and that the replacement can easily be placed, erected, fixed to keep pace with the demolition and allow for a temporary bridge to maintain walkway access.
 - Demolition rate of 27 feet per shift for the egress walkway, the first walkway to be demolished but then assume that refined systems and familiarity will take the output up to 35 ft/shift for the maintenance walkway (second bench demolition). Both rates are still judged to be conservative.

LBA have based this outline planning on the under-river cross-section as being probably the most difficult to demolish and reinstate, although the planning is extrapolated for the whole tunnel length. Certain sections of the mined tunnel, for example, have no egress walkway bench.



10.5.4 Outputs and Durations

WORKING PATTERN	ACTIVITY	ITEM	OUTPUT	FOR TOTAL LENGTH.						IMPACT OF LOCAL FACTORS		
				No shifts	Weeks	No of Fronts	Weeks total	Months/ Front	Notes	Impact of Friday NS included weekend	15% reduction in Weekend outages	Durations after losing outages
Mon-Fri Weekdays N/S only	Clean and repair tunnel crown	Concrete repairs, leak repairs, grout up cracks.	Assume carried out early as set up in process	Allow 3 months		2	12	3	Start Ch 19015 and work towards Ch 25707 and the second front Ch 25707 to Ch32400 intention to get all 3-month lead on next item .	No impact N/S only	No impact N/S only	12
Mon-Fri Weekdays N/S only and weekend	Install cable containment systems for LV, fireproof and transmission cables	Primary brackets	25m/ nightshift	163	33	2	Require 1225/2 w/e hrs=612.5. equates to 25 weeks of nights only. W/e reduce to 19 weeks per front.	4.75	Assume weekend working as well during this period takes 6 weeks off. Assume Front one starts at Ch 19015, Front 2 at Ch25707.	0.5 month impact	Assuming only some W/e outages only so no Impact.	19
		Ladder tray	50m/ nightshift	82	16							
Weekends shifts only.	Trackbed replacement	Lower track to spec level. Remove ties and place concrete.	31.5m per 8hr shift, plus 2 w/e to lower track	130	24	1	24	5.9	Ideally other activities done on overnights while this in progress.		Would add 5 weeks to programme.	31



WORKING PATTERN	ACTIVITY	ITEM	OUTPUT	FOR TOTAL LENGTH.						IMPACT OF LOCAL FACTORS		
				No shifts	Weeks	No of Fronts	Weeks total	Months/ Front	Notes	Impact of Friday NS included weekend	15% reduction in Weekend outages	Durations after losing outages
Mon-Fri Weekdays N/S only and weekend	Install fireproof cables, other non-emergency LV cables and radio on tunnel walls in containment.	Cabling including banding to tray/cleating to ladder.				2	6	1,5	Two fronts for compatibility.	No impact actually only requires 2.5 weeknights and weekends, not 6 no.	No impact was conservative already.	6
		12 No cables	2km/cable per nightshift	24	5							
		Leakey feeder cleated in place.	1km/nightshift.	4	1							
Mon-Fri Weekdays N/S only	Install bracketry for fire main, compressed air and pump discharge lines.	Pipe bracketry (3 m spacing).	2 brackets/ nightshift (6m run).	680	136	2	68	8.5		No impact N/S only	No impact N/S only.	68
Mon-Fri Weekdays N/S only	Install pipework/hydrants and commission systems.	Install pipe	24 m per nightshift	170	34	1	34	8.5	Run one front through tunnel.	No impact N/S only.	No impact N/S only.	34
		Hydrants.	Allow 1 per shift brackets and fixing						Hydrants included.	Parallel activity.	No impact N/S only.	

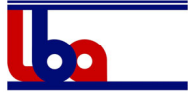

WORKING PATTERN	ACTIVITY	ITEM	OUTPUT	FOR TOTAL LENGTH.						IMPACT OF LOCAL FACTORS		
				No shifts	Weeks	No of Fronts	Weeks total	Months/ Front	Notes	Impact of Friday NS included weekend	15% reduction in Weekend outages	Durations after losing outages
Mon-Fri Weekdays N/S only	De commission and Strip out old pipework.	Allow			1	allow		0.25	Allowance is e/o install.	No impact	No impact N/S only.	1
Mon-Fri Weekdays N/S only	Fix and terminate new lighting, call points comms equipment.	Fix & terminate lights from mobile platform 2,5 m spacing.	4 per shift per team.	408	82	2	41	10	Start Ch 19015 and work towards Ch25707 and the second front Ch 25707 to Ch32400.	No impact N/S only.	No impact N/S only.	41
Mon-Fri Weekdays N/S only.	Install new signalling equipment and support from tunnel walls.	Maintenance and reposition signalling system.	100m/week plus 1 w/e	41	8	1	8	2		No impact N/S only.	No impact N/S only.	8
Mon-Fri Weekdays N/S only and weekend.	Decommission old electrical systems and recommission new circuits.	Phased system to suit progress of bench.	Assume 1 week per circuit 10 systems.		10		10	2.5		No impact.	Add 0.375 months to duration. Assume 3-month overall duration.	12
Mon-Fri Weekdays N/S and weekend	Decommission any cables on Egress walkaway side of the tunnel	Allow.			10		10	2.5	Allow one week in line.	No impact Weekends only.	One weekend only!!	1



WORKING PATTERN	ACTIVITY	ITEM	OUTPUT	FOR TOTAL LENGTH.					IMPACT OF LOCAL FACTORS			
				No shifts	Weeks	No of Fronts	Weeks total	Months/ Front	Notes	Impact of Friday NS included weekend	15% reduction in Weekend outages	Durations after losing outages
Weekends shifts only	Demolish the Egress walkway rebuild with chosen option	Whole operation is related to demolition and prepare.	162 feet advance in a weekend or 27ft per shift.	496	83	2	41		Start Ch 19015 and work towards Ch25707 and the second front Ch 25707 to Ch32400.	No impact Weekends only.	Add 6 weeks.	47
Weekends shifts only	Install new cables in Egress walkway and commission all 4 cables	1 weekend shift per 2 cables length including splices 300 metre drum.	600metres of cable per weekend.		27		27	6.75	4 cables 4079 length, 600, per weekend divided by 4 for months. Working behind the demolition/recon fronts.	No impact Weekends only.	Add one month to duration making it 7.75 <u>but retain overlap as 1.5 months.</u>	31
Weekends shifts only	Demolish maintenance walkway and reconstruct bench	Whole operation is related to demolition and prepare.	180 feet advance in a weekend or 30ft per shift.	446	74	2	37	8	Start Ch 19015 and work towards Ch26480 and the second front Ch 26480 to Ch32400. Faster advance rate due to learning curve and refinement of logistics.	No impact Weekends only.	Add one month to the duration making 9 months.	43

N/S = Nightshift

W/E = Weekend

Ch = Chainage

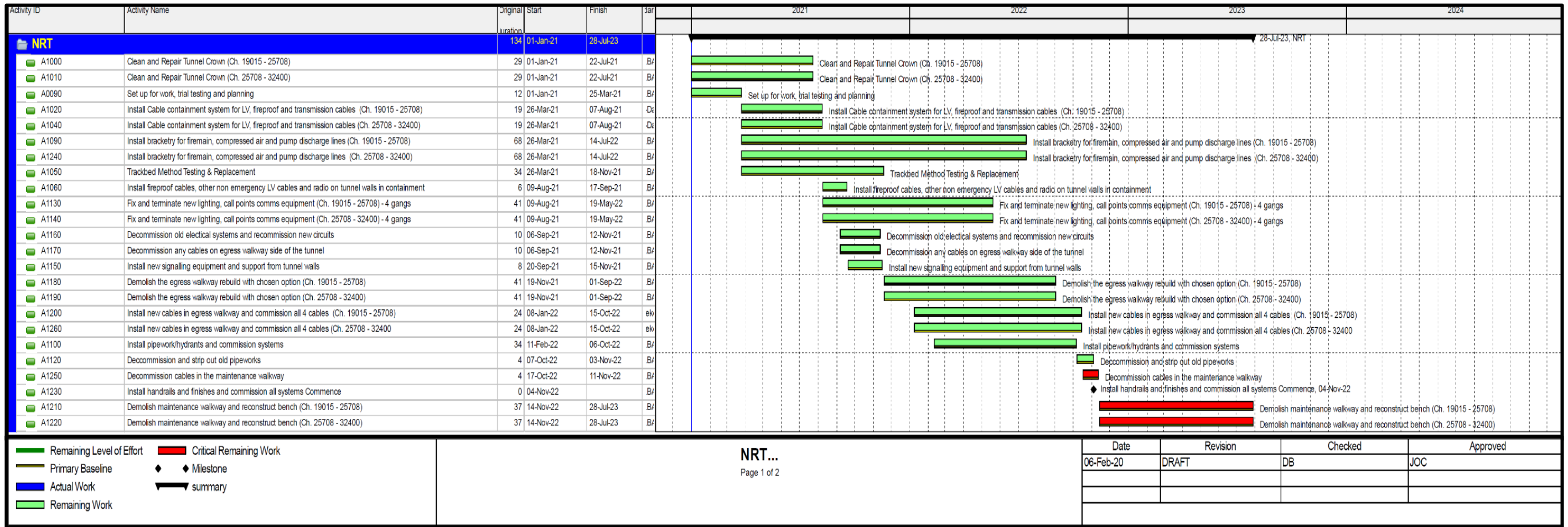

Figure 10-1: Gantt chart for in-service refurbishment works

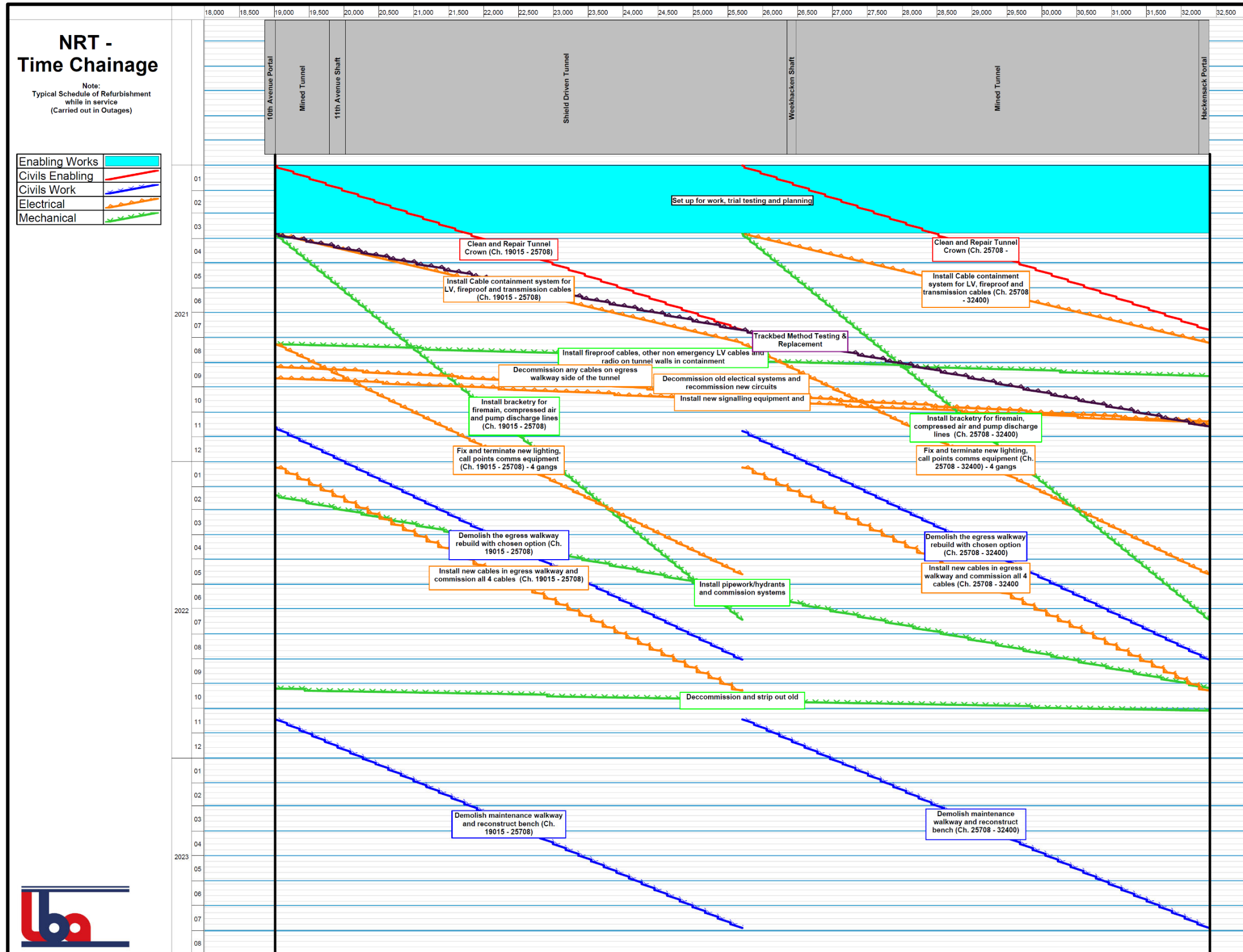

Figure 10-2: Time-chainage diagram for in-service refurbishment works

10.6 Availability of Outages

In Chapter 5, LBA talk about the availability of outages. For the purposes of preparing the conceptual schedule, LBA have assumed, as above, that these outages will be generally available when required at weekends and weeknights.

LBA also accept that there will be times when it is not possible to have a weekend outage in the tube under refurbishment because of unforeseen issues in the other tube (see also *Section 11.2.2 System Risks Mitigation*). LBA have, therefore, examined the situation where we lose another 15% of weekend outages and have calculated the possible schedule impacts in the outputs for scheduling and amended the durations to suit. This adds 4 months onto the schedule for each tube, or 8 months overall (see A8.4 – “What If TILOS” and A8.5 “What If Gantt Chart”).

The basis of the planning of the refurbishment is that most of the M & E services work is carried out in overnight outages, being that the amount of time available is well suited to that type of targeted work packages. Some weekend work would be required when cable stringing was happening.

LBA’s best estimated schedule is 31 months, which assumes most outages, weeknights and weekends were available over that period. This schedule shows trackbed and bench wall demolition on weekends only and M & E services (as above) on weeknights. There is a doubt whether they would be able to work Friday nightshift if there was a weekend activity, however, sensible planning should minimise the effects of this.

The achievement of weeknight outages has also been questioned, although we understand that these outages are routine for Amtrak currently. If there were to be none or very few weeknight outages, the consequence would be M & E services installations happening at weekends as well. This could create some issues and special planning at times but there would seem no reason why careful routine logistics planning should not cope with the situation and leave the 31-month programme intact. The key to good progress and flexibility of working is logistics access. Access from both ends of the tube would be a great benefit and should be rigorously examined to see if achievable.

10.7 Removal and Reinstatement of Benches

10.7.1 Approach

LBA have set out to determine a safe, compliant, and cost-efficient removal and reinstatement of benches and services during planned overnight and weekend closures of a single tube with the aim of:

- Avoiding damage to facilities in place: catenary cables and utilities on the tunnel walls
- Avoiding adverse effects on track and ballast
- Avoiding manual handling and minimise human physical effort
- Returning the service to safe timely and reliable operation at the end of each planned closure

We have to do this within the constraints of:

- A linear rail bound operation, because the works occur within a spatially constrained single-track tube environment
- Working party having to enter tube in the sequence of the planned operations
- Plant, materials and personnel entering and leaving the tube within the closure periods
- No interference with existing structure and remaining utilities
- Emergency walkway must be returned to service at end of each closure
- No interference with timetabled NJ TRANSIT and Amtrak operations outside planned closures

10.7.2 Strategy

LBA's strategy has been to treat the refurbishment operation as a system and to optimise the overall performance rather than maximise component elements of the cycle. LBA propose using mechanical measures where practicable to enhance productivity and promote innovation, refinement, and improvement.

This does not mean that we reject the bespoke readily available solutions (equipment) that has been developed; the equipment must be suitable and achieve all the performance requirements. "Making do" should not be an answer.

10.7.3 Outline Process

Activities as follows:

- Enter the tube with new bench wall materials and all other construction plant, railway equipment, materials, and personnel
- Remove the temporary walkway bridge and store on the work train as shown
- Break out a section / sections of existing bench wall
- Load out the material from the demolition for removal from tube
- Trim the excavated surface / surfaces as required
- Install permanent bench refurbishment materials
- Replace the temporary walkway bridge

10.7.4 Options for Planning

There are several possible options for the use of plant and equipment depending on the developed construction approach method. Options of construction approach could be:

- Approach from above
- Approach laterally from track level
- Approach laterally from intermediate level

The right choice will depend on the "as-found" state of the concrete in the bench walls and the duct bank, so there are many lines of weakness/dry joints/cracked concrete. There is steel reinforcement in some areas, but this is surmountable. Early investigations and experimentations are vital if the operation is to go smoothly and speedily and we recommend that the process is approached in a careful manner so as not to put return of an outage at risk.

10.7.5 Set Up of Possible Works Train for Bench Demolition and Reinstatement

A schematic set up of possible works train for bench demolition and reinstatement is shown in Figure 10.1 below.

Further details of our planning and our suitable plant for bench demolition and reinstatement are provided in APPENDIX 4 - Bench Demolition and Reinstatement Methodology.

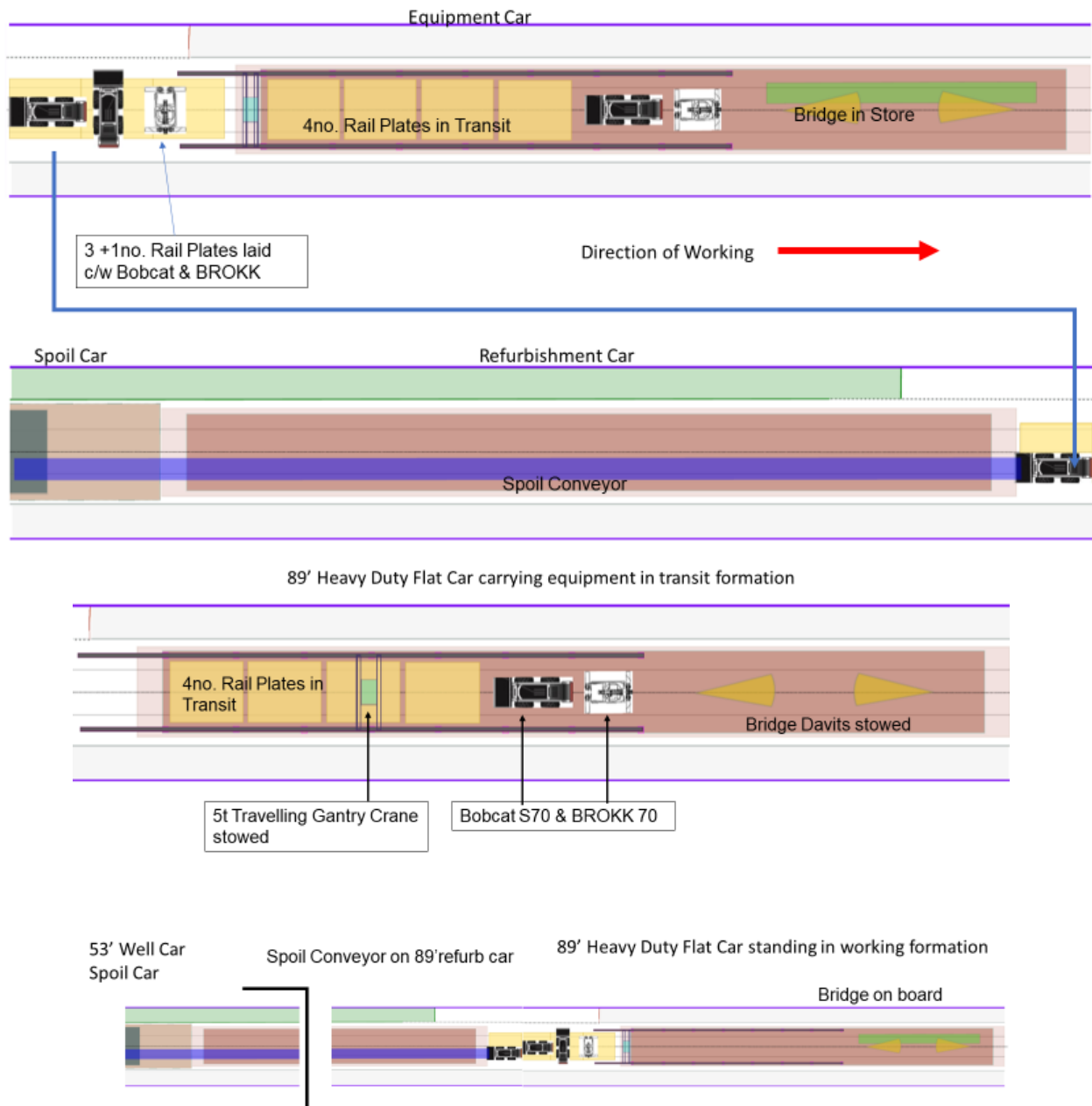

Figure 10.1 Schematic set up of possible works train for bench wall demolition and reinstatement

10.8 Health, Safety, and Well-being

Operations of this type have a combination of the risks of working in confined spaces and a railway environment combined with the usual construction risks. We look at the construction risks in Section 11.8 “Risks During Construction.” Aspects that require particular attention are dust management, achievement of a consistent, reliable, and aligned workforce and ensuring the wellbeing of those workers by health surveillance, education and welfare facilities. In accordance with “working in confined space” thinking, we would have the necessary minimum number of people working in the tube at any one time. Communications and location monitoring for emergency response would be required and travel to the workplaces in the tunnel should be on the works trains for safety and efficiency.

We discuss how the dust may be managed in APPENDIX 5 - “Dust Control during Bench Demolition and Reinstatement of Walkways” as part of the logistical set up for the bench demolition, following the advice of OSHA OCCUPATIONAL SAFETY AND HEALTH STANDARDS CFR 1910.12(b).

10.9 Servicing Facilities (Railhead)

To carry out the refurbishment of the NRT in-service in an efficient manner a railhead would be required at a convenient location so that short works trains can be prepared, maintained and loaded ready for entry into the tunnel at the beginning of the shift. This needs to happen as soon as the last shifts trains have come out to maximising the valuable working time window. Efficiency and safety will be aided if the crews travel with the trains or embark en-route. The requirements for the railhead and the works trains are set out in APPENDIX 7 - Tunnel Refurbishment Works Trains and Railhead,” and what would seem to be possible locations identified for further consideration.

10.10 Overhead Line and Trackbed Replacement

Initially when we considered the possibilities for track and overhead line replacement, we believed that they could only be achieved in a full outage and that this activity would have to follow the construction of a new tunnel to provide at least two tunnels to maintain normal service.

Following our visit to Newark, NJ, during November, LBA were given the opportunity to study the report by the Northeast Corridor Commission - Train Performance Reporting -Special Enquiry. The report has given us much better information as to the nature of delays that are being experienced and it is apparent that a significant proportion of delays and lost time are caused by both Track and Overhead Line problems.

In summary, these specific delays included: track failures (31% of the NRT delays) and catenary issues (35% of the NRT delays) due to lack of clearance, broken wires, and damaged pantographs leading to loss of power.

This prompted LBA to look again at the possibility of bringing forward the timing of refurbishment of these key components of the tunnel railway infrastructure and carry out trackbed and OLE replacement in-service as has been done internationally (see *APPENDIX 6 - In-Service Trackbed Options*).

Issues with Trackbed and OLE replacement

- There is currently a lack of clearance between rail level and overhead line (see Chapter 9)
- The track in the NRT needs to be replaced with a modern form of track structure so that recurring drainage, track movement, and signalling faults can be addressed.
- In order to relieve the clearance issues at the OLE above, the new track will be at a lower level than the current ballast and cross-tie track structure
- Overhead line replacement must also be carried out in long sections, appropriate to the tensioning and isolation sections.

- The plans for the overhead line replacement are not known and neither is the current condition of the equipment.
- LBA suggest considering a bar type contactor, but that could have problems with changeover unless as one continuous operation.
- It has been suggested that a special low profile booted tie could be used for the trackbed replacement and this is an alternative if depth permits. However, LBA feel it would be unwise to rely on booted ties in that they could limit the amount of lowering that can be achieved.
- The condition of the invert concrete and its exact profile is not precisely known. It should be surveyed as part of the next steps because this data will be needed to make the choice of trackbed solution.
- Until the invert is uncovered, we shall not know whether there are any cracks and leaks in the invert concrete, (joints in the cast iron lining). This will require a pre-planned response.

Logistics issues

Logistics issues associated with the replacement of track and overhead line in an efficient manner include:

- Logistics access to the tube(s), from both portals would be ideal.
- Preparation of the invert for the track slab concrete; as above, track survey, condition survey and local investigation is needed.

10.10.1 Track Replacement Proposals

In Appendix 6 we look at the options for track replacements in weekend outages. Eventual design and construction methodology choice should depend on the invert survey, design, and ease of partial construction.

For the purposes of bringing track replacement into the in-service refurbishment schedule, we have assumed the use of a simple replacement of the track ties (sleepers) by concrete or concreted booted tie blocks. We have confidence that this could be achieved in overnight outages, let alone weekend outages, based on the experience in London on the Bakerloo Metro line between Baker Street and Finchley Road stations, although the outage taken was an extended outage three days a week (Mon-Wed) of 6 hours. We have based our schedule calculations for the NRT Refurbishment's track replacement on weekends only. See Appendix A.6.7 for more details on track lowering.

10.10.2 Trackbed Schedule

The first activity is to lower the track to the desired level by reducing the length of the timber ties and we have allowed two weekends for this. This could be augmented by overnight work if required. The track (long welded rail) is not disturbed in this operation.

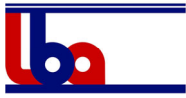

The cycle of track replacement for a 35 feet length is as below:

Activity	Time taken	Comments
Suck out ballast	2.5 hrs	These timings are taken from a prolonged operation at London Underground. Concrete quantity was greater due to invert shape.
Remove timber ties		
Clean out invert		
Fix base plates and hang bolts		
Fix shutters/drainage		
Concrete (Rapid Setting)	1.0 hr	
Cure, Gain strength	1.5 hrs	

If one assumes that the time to completion of the first concrete is 3.5 hours and that excavation of ballast and preparation is a continuous process, we could expect two more lengths be poured in an 8-hour shift. What is more, the next shift would start with an excavated area. We have therefore allowed for 103 feet per 8-hour shift or 618 feet per weekend.

We say “conservative” because a continuous operation is only limited by logistics and quantities of concrete and ballast. Ideally, there would be a continuous operation where excavation proceeds continuously, as does the rail setting operations and concreting.

We also believe that we will have to do some support work to ensure that the rail remains in its correct position, as discussed in “APPENDIX 6 - In-Service Trackbed Options.”

There are other, faster options which are worthy of further consideration, but more information is needed on the invert and the possible logistics to assess the risks.

The schedule allowance needed is:

- Length of tunnel13,385 feet
- Per Weekend progress618 feet

Estimated Weekends needed = 22, plus 2 weekends for track lowering, giving 24 weeks in total. This track replacement schedule is very much an estimate based on experience elsewhere. It relies on outages availability, design, invert survey, logistics, careful planning and an integrated approach.

In addition to replacing the track, time needs to be allowed for testing and refinement of methodology and we have allowed 10 weeks for this, making a total duration of 34 weeks.

10.10.3 Track Replacement Sequence

The track replacement schedule provided is an estimate based on experience elsewhere. It relies on outages availability, design, invert surveys, logistics, careful planning and an integrated approach.

Given the need to reduce track and overhead line failure and increase the clearances, LBA see no reason why Trackbed Replacement should not be an early activity. This fits quite well with LBA's current proposed sequencing of the refurbishment when most of the early activity (M & E) is weeknights only. It will also assist the bench replacement work by avoiding the issue of ballast contamination.

Track Replacement is currently entered into LBA's proposed schedule from end of month 3 to middle of month 11. This is a total of 34 weeks, that allows for 24 weeks of execution, plus 10 weeks of testing.

10.10.4 Overhead Line (OLE) Replacement

The purpose of lowering the track is to enable the lowering of the OLE. There is also a need to lower the OLE to enable the pantographs on the top of the trains or locomotives to move through the NRT without striking anything or creating flashing over of 25kV lightning strikes (at their lateral horn ends) in the crown of the tunnel.

In LBA's view, the OLE needs to be lowered to approximately half of the extent to which the track can be lowered.

Since the NRT is a main line railway tunnel, the ambient temperature remains fairly stable and the thermal expansion and contraction of the OLE catenary and contact cables diminishes, so long lengths of cable wiring would probably be acceptable.

Once the track has been lowered, a progressive re-cabling programme, in which tension is taken off progressively in overnight and/or weekend outages, with the 'running on' and 'running off' of cable lengths, should be a straightforward repetitive process.

Other considerations include the currently installed OLE supports that might have to be refurbished or replaced. There is a potential for there to be a requirement to adopt a 'bar type' OLE system. If that is the case, then we would suggest this is carried out at a later date when the tube can be temporarily closed and, in the meantime, the problems are addressed by refurbishment and lowering.

A possible sequence of operations could be undertaken as follows:

Before or After Track Laying

LBA suggest that the OLE work can be done from rail mounted working platforms – approx. 50m of tube per Road-Rail Vehicle (RRV) per night – weeknight or weekend shifts as appropriate:

1. Refurbishment/replacement of the supports (in pockets – in the tunnel crown)
2. Installation of the tensioning devices and anchors
3. Installation of new switches and earthing devices (maintenance walkway side)

After Track Laying (when Track has been lowered)

OLE could be done in 1 km lengths over the course of one weekend from an OLE wiring train:

1. Removal of one tension length of old catenary
2. Rerun of new wire onto refurbished supports
3. Reconnect to tensioning devices
4. Re connection to isolation switch
5. Heights and stagger check
6. Electrical test and commission

Replacing the catenary wire should be a routine maintenance undertaking and Amtrak will have a prepared methodology for doing this approximately every five years (or whatever their

operating pantograph pressure and weekly / annual traffic level indicates for these lengths of track).

10.10.5 Logistics of OLE Replacement

We emphasise that we have limited detailed knowledge of the NRT's OLE arrangements and the condition of equipment. However, based on our conceptual review and bearing in mind that further studies are required in parallel with further discussion with Amtrak, LBA believes that this particular area of refurbishment could be carried out within weeknight and weekend outages and having access to the works via both tunnel portals. It should be possible for the OLE work to follow the track bed at suitable intervals and fit within the current proposed overall construction schedule.

10.11 **Teams and Shift Working**

The NRT Refurbishment planning is based upon weeknight outages of 5 hours and weekend outages of 55 hours. Deriving a shift pattern which is economic, staff welfare friendly, and responsible is not easy and needs the willing endorsement of all stakeholders.

It would obviously be possible to have teams on weeknight shifts only and teams on weekend shifts only. The problem is that everyone is working part weeks, which can be very inefficient. Working 12-hours shifts at weekends could be an effective option and require fewer resources, but still very uneconomic unless this included daytime working in the week. It could reduce the amount of trains needed but conversely it would increase the amounts to transported in and out each shift by 50% which could be an issue and put at risk the plan for single movements per shift. Rotating shifts and multi-discipline teams may be the answer.

This has often in the past been regarded as the Contractor's problem, but it will be an important issue for all stakeholders in the planning, logistics, and design to enable the success of the refurbishment operation.

10.12 **Overall Feasibility and Approach Proposed**

LBA believe that refurbishment in-service is feasible and an imperative to mitigate the risk of further deterioration and unpredictable impact on the rail services and the travelling public and should proceed with urgency and determination.

It requires a different approach to the current approach, and LBA believe that this is a way to minimise the risk, maximise efficiencies, lower the overall cost, and reduce time to ensure a robust and reliable operation of the Northeast Corridor for NJ TRANSIT and Amtrak customers.

LBA know from its experience that the constraints of undertaking critical refurbishment work in prescribed outages require carefully planned, designed, and engineered construction solutions.

LBA also know that other rail and metro owners currently undertake in-service track refurbishment in night-time and weekend outages (see *Appendix "A6.13 Refurbishment In-Service: References"*). LBA have indicated a number of options in Appendix 6 for this (of course there will be more) but favour an approach where the rail is not disturbed.

LBA's finding is that the refurbishment work, starting with the repairs in the crown of NRT and the lowering of the trackbed, should be started with all alacrity. The time taken would be longer than the time that a tunnel closed refurbishment would be, but this is to be expected due to the available working hours within each outage.

10.13 **Implementation**

Implementation, for the purposes of this report, is defined as the steps necessary to advance the NRT Refurbishment beyond this conceptual review and report. LBA proposes a multi-step framework as a means of managing risks and addressing the particular issues of refurbishment in service. In developing this implementation framework, LBA has relied on global experiences;

the NRT's degradation resemble the issues that European engineers are facing while refurbishing railways across Europe. European engineers are bringing innovation to bear on refurbishment of tunnels in service because taking the tunnel out of service was deemed by the railway operators to be too disruptive to operations. We believe a similar level of sophistication and innovation can be brought to bear by American engineers.

LBA believe the multi-step framework, including collaborative arrangements, discussed below are particularly suited to the in-service refurbishment of the NRT, because they facilitate a cooperative, responsible, managed risk approach respecting the concerns and the priorities of the rail operators. These arrangements can promote innovation in design, construction methodology, and risk mitigation unfettered by commercial barriers while delivering the benefits of that innovation to the Stakeholders.

This chapter provides an overview of a multi-step implementation framework that can be utilised to further develop the NRT in-service refurbishment plan, as proposed by LBA in this report.

10.13.1 Process for Taking the NRT Refurbishment Forward

The Issues

Taking forward the refurbishment of the NRT requires a careful, well-thought out solution because:

- it will be done in outages,
- there are a number of parties directly or indirectly involved,
- it needs to move forward swiftly to mitigate the risks and avoid delay to the service, and
- it requires a cooperative, open relationship with disciplined teams to manage risk to the service.

10.13.2 The Proposed Approach

Integrated Work Team/ Management of the Works

LBA believes that the NRT Refurbishment will be best taken forward rapidly by collaborative working between the Gateway Partners and contractor, designer, and sub-contractors in a single integrated team approach ("Integrated Work Team"). A fully integrated team brings resources together and their responsibility is to the team and the team's objectives, breaking down barriers for working together openly. The experience of an Integrated Work Team includes:

- A mix of staff sitting side-by-side, sharing one office, one management system, one filing/document control system, one quality system, one safety management plan, one team logo, and common protective clothing/helmets, that holds inclusive meetings.
 - You should not be able to distinguish the individual companies who are contributing.
- The best available person for a position should be assigned to it. Disciplines will be grouped but as a matter of policy all of a section should not be from the same company.
- Issues like Professional indemnities and Works Insurance (Contractors All Risks or Project Insurance) are dealt with for the whole entity.
- The team has **one budget, one schedule**, one set of **risk allowances**.

An Integrated Work Team can enhance performance in the areas of cost reduction, time reduction, and cost management since they facilitate a good control of costs, an absence of arguments over responsibilities, a culture which is non-confrontational, and a challenging environment focussed on achieving the team objectives rather than any one member of the teams' individual interest. All members of the team must understand each other's problems and seek to assist them to solve them. They achieve these benefits by:

- Promoting transparency in everything, which builds trust and understanding
- Removing the contractual interfaces in the office and at the workplace

- Managing risks in all areas, including service interruptions, safety, quality, community relations, and political
- Forecasting outturn cost and having one set of information, costs, budget, and schedule, to which all subscribe. This enables decisions to be made with knowledge and understanding of the likely consequences
- Convening discussions, meetings, and workshops focussed on the project objectives, rather than individual stakeholder positions. The team imposes its own discipline, which is much more effective than any contract
- Implementing greater efficiency, leading to lower cost and speedier execution

The Integrated Work Team, prior to the addition of contractor(s) and designer(s), will consist of various subject matter experts from the Gateway Partners. The Gateway Partners will need to make early decisions and engage in activities before starting the procurement process, as described below.

10.13.3 Early Contractor Involvement (ECI)

The NRT Refurbishment might be best achieved by a two-stage “Early Contractor Involvement” arrangement:

- ECI Stage 1: Design, Planning, and Procurement of Long-Lead Essential Items
 - The contractor and designer would work with the rest of the integrated team and stakeholders to develop the NRT Refurbishment workplan provide innovation, creative ideas and practical knowledge
- ECI Stage 2: Execution of the refurbishment
 - The Integrated team carries out the refurbishment

Examples of this process are more fully described in Appendix 10.

The goal of an Integrated Work Team approach and an ECI implementation method is to create an environment that avoids the placement of commercial barriers to true collaborative working should minimise the cost and time taken while delivering best value and quality. This approach has had success internationally, including for the implementation of the Ramsgate Port Access Tunnel (UK), London Bridge Station Jubilee Line Extension (London Underground, UK), Channel Tunnel Rail Link (HS1, UK), and Bond Street Station Upgrade (London Underground, UK), among others. APPENDIX 10 – Implementation” includes descriptions of the projects listed here as well as others that have had success utilising this approach.

10.13.4 Early Decisions/ Activities

The early decisions to be taken by the Gateway Partners, prior to the addition of ECI team members, include:

1. Outline decision to proceed and basic responsibilities: A clear brief that outlines the intent/scope of the project and basic stakeholder responsibilities and is endorsed by the Gateway Partners.
2. Produce plan for proceeding: Make basic policy decisions on the process and the commercial procurement model. The procurement model should include decisions on objectives, incentive alternative(s), contractor qualifications/competence, and distribution of work, among other items.
3. Develop team concept: Set out the Integrated Work Team and bring in key staff members.
4. Decide what is required of team participants (Gateway Partners, Designer, Contractor, Delivery Partner, Project Auditor, etc.)/Develop Outline Scope(s)
5. Decide the skills and attributes which are required for contractors to be considered.
6. Decide method of selection of contractor(s) and designer(s):

Decide contracting basis: The contract between the parties should be determined based on the type of delivery methodology chosen. Standard UK forms are available. The contract example referenced in Appendix 10 is based on a standard UK form of contract published by the Institution of Civil Engineers and is a “Target Cost” type contract (essentially a cost reimbursable contract with an incentive mechanism to reduce cost).

7. Prepare an information statement for the market which goes out with a short description of the works. Information to identify how the Client wants contractors to participate and how they will be incentivised/recompensed. Also, how they are required to be open, deliver high performance and work with others.
8. Explain how contractors will be selected for the ECI type arrangement. and how their submissions will be accessed and verified.
9. Go out for tender to a small number of selected contractors.
A focused response and short response period is suggested due to the urgency and the form of arrangement proposed.
10. Adjudicate tenders and decide ECI contractor(s): A small team (or panel) of the Gateway Partners is needed to review contractor proposals. The method of adjudication needs careful consideration so that it is as fair as possible and must be oriented towards competence, willingness to initiate improvements and willingness/ability to work collaboratively. Examples of contract procurement documents are included in Appendix 10.

10.13.5 Early Contractor Involvement (ECI) Arrangements

Essential to selecting the right contractor will be the ability for the Gateway Partners to define the performance criteria which they Gateway Partners wish to achieve. Developing Key Performance Indicators (KPIs) should be established by the Gateway Partners to identify the requirements and standards that which define what the GPDC Integrated design/construction team(s) need to achieve. This, will aid the selection of the contractors and the sub-contractors, including the. Key attributes required from contractor(s) and designer(s) such as experience, commitment, and being good to work with, while aligning with the Gateway Partner’s objectives and values. When contractor, designer and sub-contractors (if appropriate) have been selected, the ECI process commences.

10.13.6 ECI - Stage One

ECI Stage 1 is focused on further developing the Integrated Work Team by selecting the contractor(s), designer(s), and sub-contractors, to develop the design and construction methodology for implementing the NRT Refurbishment.

1. Design activities would include:
 - i. Detailed scope of the refurbishment
 - ii. Develop the design with contractor and sub-contractors working with the Gateway, the designer and other stakeholders (rail operators for example)
 - iii. Initiate the surveys/investigations necessary to allow the design to proceed:
 - a. Cable locations and circuits
 - b. Invert survey (depth and profile)
 - c. Overhead line survey (to check clearances and condition of support)
 - d. Lead and asbestos surveys
 - e. Tunnel condition survey (to identify any potential problems not currently identified or changed since last inspection)
 - f. Shaft water investigation
 - iv. Identify the solutions, specifications and the method of installation

- v. Gain more information and complete option studies on methodologies. Develop the working systems. Prepare the detailed working procedures and instructions for the various installation methodologies.
2. Identify all long lead items to be procured (e.g. cables, rail baseplates,): The Integrated Work Team should do advanced work and make a decision as a team on identifying necessary long-lead items. If a cost-based contract is utilised, the ownership of the long-lead items will rest with the Gateway Partners as the client.
3. Identify equipment (cranes, locos, concrete batchers), required and procure: The Integrated Work Team should do advanced work and make a decision as a team on identifying necessary equipment as the construction methodology is developed. Particular attention should be paid to Locomotives where modern designs for use in the tunnel including battery powered should be examined as a priority.
4. Identify and prioritise testing areas and detail, design, and build test facilities: Before a method can be taken into the tube during an outage any doubt about its efficacy and predictability must be removed by demonstrating that the system will work and contingency plans are in place to manage the situation where something does not work and the tube must be returned to working on time at the end of the outage. The Integrated Work Team should identify opportunities for, develop methodology for, and implement the testing/demonstration of materials and construction methods.
 - i. Material specification and testing is important where materials properties and deliveries are crucial. Examples include the bench replacement solution, the track bed concrete and baseplates, and the cables.
 - a. The performance of the concrete in respect of controllability of strength gain, of handling of mixing to order, of finishing, and reliability will be absolutely crucial to the risk management of the track replacement operations. Work should not proceed until this is tested and proven, firstly above ground and then below ground in the different environmental conditions.
 - ii. Prepare details of mock-ups, testing and proving regimes, pilot studies to investigate specific areas of uncertainty.
 - iii. Mock-ups, targeted to the at-risk areas, should be used to test/verify:
 - a. The process-timings and equipment
 - b. The concrete mix strength gain, manageability and reliability, and the controls necessary
 - c. The time taken to excavate the ballast and fix shutters and all other equipment
 - d. The technology package that will meet the requirements
 - iv. Mock-ups can be used for training new team members before they start work in the NRT.
 - v. A section of an NRT tube could be identified to carry out a "Pilot" study to test the planned method and equipment. This type of study would be subjected to the same rigours of planning and risk management as the main works and used to inform the future construction methodology.



Figure 10-3: Mock-up built to trial method and develop concrete mix and concrete finish for Slipform paved Haunches for HS1 London Tunnels Alliance

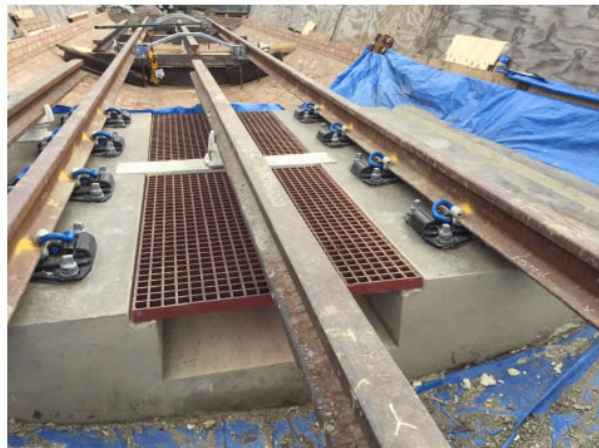

Figure 10-4: LUL Baker Street to Finchley Road Mock-Up Trials

5. Finalise location and draw up plans for railhead location: The Integrated Work Team should work together to identify the best location for a railhead as mentioned in Section 10.9 and Appendix 7.
 - i. Develop the planning of the refurbishment and the railhead. Develop operating plans out of which will come requirements for locomotives and

- rolling stock and other equipment. Also, the needs for servicing facilities at the railhead.
6. Prepare cost model: Prepare full build-up of costs going forward and agree. Prepare risk schedule and estimate risk contingency appropriate and agree incentive arrangements.
 - i. The cost model should act as a control from the commencement of the works. This should be detailed to a level where it can be accurately monitored, and all sections should have their budget so that decisions are made in knowledge and outturns can be constantly forecast. Usually one of the commitments of an integrated team is “No Surprises” because of the problems that these can cause to the transparent culture of the team. In a similar manner all activities down to the last plan or procedure should be scheduled so that performance monitoring starts at the outset and the impetus, the risk management, the quality and the safety and environmental management is assured from the start.
 7. Prepare detailed plans and procedures for proceeding: Develop typical team procedures, plans, methodologies, risk management plans, and contingency plans:
 - i. Prepare contingency plans, outage management procedures, and timed models for working.
 - ii. Working plans and procedures, Admin, Commercial. Quality, Communications, etc.
 - iii. Develop Refurbishment methods in conjunction with design development.
 - iv. Develop pre thought solutions to events, incidents, uncovered issues so that there is a process to deal with them expeditiously.
 - v. Risk management, Emergency Response and Contingency plans and procedures.
 8. Complete Stage 1, set up arrangements for proceeding:
 - i. Design sufficiently advanced for procurement and construction to start
 - ii. Authority to proceed and operating procedures approved.
 - iii. Determine the items of plant and equipment that will be needed and place orders for these to suit the schedule of works if not already done.
 9. Proceed to stage 2 Agreed on basis that:
 - i. Cost plan and schedule agreed for the refurbishment project
 - ii. Operating procedure agreed for first activities
 - iii. Commercial and incentive arrangement. concluded

10.13.7 ECI - Stage Two (Execution)

Stage 2 of the ECI process is focused on commencing NRT Refurbishment work after detailed checks and approval of all construction and safety methodologies/procedures and contingency arrangements.

1. Complete all the planning for the on-going refurbishment sections:
 - i. Establish a system of Continuous Improvement of risk management, output, contingency planning and adherence to schedule.
 - ii. Establish efficient and wide reporting placing emphasis on performance and measurement of performance against KPIs including non-interruption of service with the intention of giving confidence to all the stakeholders.
 - iii. Construct Mock-ups and test rigs to demonstrate the proposed methods
2. Execute the NRT Refurbishment work.

10.14 Cost Impact

10.14.1 Caution and Subject to Further On-Going Review

Comparing costs when schemes are conceptual is always challenging. Assuring that the comparison is 'like for like' is a very detailed and subjective exercise.

10.14.2 The Cost of In-Service Refurbishment Should be Within the \$1.8bn Current Allowance

- The "construction" cost of the refurbishment should be similar to the current 10% NRT Design estimate (Ref 12.1.2)
- There should be savings on the professional fees and management costs due to the integrated team approach
- There are savings on inflation costs due to the earlier construction timescale

10.15 Case Studies, References and Reference Documents

Throughout APPENDIX 10, which shows the process in a tabular form, LBA reference documents which aid the understanding and vouch for the performance of collaborative working and integrated teams.

LBA also provide some illustrations of mock-ups built to prove methods and assist the success of the relevant operation.

LBA provide an outline, high level organisation chart showing what an Integrated team for Gateway might look like from our experience. This is purely an illustration to explain the concept.

11 RISKS

11.1 Introduction

The principal reason for carrying out the refurbishment of the NRT and the services within the tubes is to mitigate the current risks to the rail operations caused by failures in the tunnel services and the structure of each tube of the NRT in order to provide an improved customer experience and service reliability for Amtrak and NJ TRANSIT customers. This is also a compelling reason for proceeding immediately with the refurbishment to mitigate unpredictable impacts to service reliability and safety.

The following risks are appropriate to consider, and are all influenced by the existing degrading condition of the NRT tubes:

1. Risks of Doing Nothing: Risks to rail service/customers if nothing is done to improve the NRT beyond preserving the status quo.
2. Risks During Refurbishment: Risks to rail service/customers associated with the refurbishment activities.
3. Risks During Construction:
 - a. Risks to construction personnel
 - b. Risks to customers
 - c. Quality Risks

11.2 General Risk Mitigation

Risk mitigation should take place throughout the planning of the NRT Refurbishment works. Such mitigations have been implemented successfully to help other refurbishment projects of comparable age, complexity, and essentiality.

11.2.1 Management of the Refurbishment

Planning for the refurbishment should be developed with the Gateway Partners and selected designer(s) and contractor(s) through an Integrated Work Team approach.

LBA believe that the construction contract should be cost reimbursable, with incentives for the contractor to minimise actual cost and complete on time.

LBA believe that an Integrated Work Team, which embraces mutual objectives, will be the most successful in achieving a best value outcome (See Section 10.13).

Planning must include full trialling and testing of equipment, methods, and work sequences before attempting in the tube so that all stakeholders have confidence that the work can be completed, and the tube returned to service in the time allotted. Early method development, design, and planning is therefore essential (See Section 10.13.4).

11.2.2 System Risks Mitigation

The current two-tube (two track) NRT system has existing vulnerabilities in the event of a disabled train or unplanned service outage. The vulnerability is that if an incident happens in the system which impacts the operability of one of the two tubes, the whole system will be impacted and could be closed until the other tube can be brought back into operation.

This vulnerability is increased if one of the two tubes is taken out of service for refurbishment. If there is a disabled train or unplanned service outage in the one tube operating, the whole system will be impacted and closed until the tube closed for in-service refurbishment can be re-opened.

These risks can be mitigated by carrying out a detailed risk analysis of the route(s) outside the NRT and addressing and minimising those risks by selective and timely repairs and contingency planning, such as the ready availability of critical spares.

11.2.3 Equipment Investment

Investing in best quality, tunnel and task adapted rail mounted equipment is important in mitigating risks associated with potential delays to return to service after an overnight or weekend outage. This should be a joint planning exercise by the Integrated Work Team, all of whom have a vested interest in success.

11.2.4 Risk Management

This situation would seem to us to be worthy of 'Bow Tie' risk analysis (BTA). This looks at the initiators and the outcomes of a risk event and can be a useful tool in planning emergency response of all kinds. It is a most effective contribution to risk management particularly when composed by the team doing the works. This should be a very early task as soon as the whole integrated team has come together and before the detail planning commences so that the results of the analysis can inform the plans and processes. An example of a Bow Tie Diagram is provided in "Ref 1 Appendix A10.9".

11.3 **Risk of Doing Nothing: Existing Risks**

11.3.1 Risk Identification

The "Train Performance Report-Special Inquiry Final Report" dated 06/19/2019 prepared by the Northeast Corridor Commission at the request of Amtrak and NJ TRANSIT looks at the frequency, causes, and impacts of delays associated with Portal Bridge and the NRT over a five-year period (1/1/2014-12/31/2018). The analysis found that NRT delays caused by infrastructure issues (as distinct from operating issues) accounted for major incidents on 45 days out of 65 "major incident days" (a major incident day being a day when there was more than 5 hours of train delays). These infrastructure issues include:

- Track Failures - 31% of the NRT delays: Broken rails, failed insulated joint, standing water (drainage issues), which all not only affect the track, but also the signalling system
- Catenary - 35% of the NRT delays: Lack of clearance, broken wires, damaged pantographs leading to loss of power
- Leaks - 6% of the NRT delays: in the tunnel walls which during winter allow the formation of icicles which can disrupt transmission and traction power circuits.

The above are identified as causing a significant proportion of the major delays. LBA note that the major delays are just 35% of all train delays and 43% of all train minutes attributed to either the Portal Bridge or the NRT. To what extent the old and damaged infrastructure was responsible for rest of the delays is not clear.

We are told that "conditions of the systems cables are unknown within the bench walls; however they continue to fail with increasing frequency and are considered unreliable due to damage and on-going chemical attack resulting from Superstorm Sandy": (Jacobs Memorandum in reply to LBA questions August 29 2019).

In summary the risks are evident and remain a threat to a resilient and reliable service until action is taken to refurbish the tunnels and improve the tunnel systems.

11.3.2 Risk Mitigation (Existing Risks)

- The most effective way to mitigate the existing risks is a programme of refurbishment, which addresses the risk areas in order of their current impacts. Other possible limited options might include:
 - A programme of planned repairs e.g. damage to the tunnel lining and water leaks
 - Lowering the track as proposed in Chapter 10 of this report
 - Rigorous inspections to (hopefully) identify the minor issues which also contribute to the failures and repairing these

- Measures to improve the resilience of the track power system

We do not however propose a “stabilisation” type approach believing it to be poor value and not solving the basic problems.

11.4 Risks During Refurbishment

11.4.1 Risk Identification

Most of the risks to the railway operations that will be experienced during in-service refurbishment are the same as currently experienced (discussed above), although the risks should decline in potential likelihood, frequency and impact as the refurbishment progresses and the defective infrastructure is replaced. We tabulate these below in Section 11.7.

The additional risks to the service which the refurbishment activities or any outage in one of the tubes introduce include:

- **RISK - Outage Overrun:** Outage in the tube under refurbishment during a weeknight or weekend not brought back to service at the due time, resulting in delay to re-opening the tube and associated rail service delays and/or trains in the wrong location for the morning peak period service.
- **RISK - Remaining Tube Incident:** Outage in tube #1 under refurbishment during a weeknight or weekend and there is an incident in tube #2, the operating tube (or the approaches to the tube), which puts that tube #2 out of service or inaccessible necessitating the scheduled outage in tube #1 to be brought to a swift conclusion so that service can resume.

The above situations differ: the first (outage overrun) could be planned for. The construction work processes and actions can be prepared and practiced in advance of starting work, and early warning to the rail operators can be given during an outage that is trending towards an outage overrun.

For the second (remaining tube incident): what can be done is to prepare contingency plans for a range of eventualities as one might do for Emergency Procedures. Presumably contingency plans and emergency procedures for the NRT exist now but would need to be reviewed and revised as necessary to account for the in-service refurbishment work activities, which must be looked at on a specific work activity basis.

11.4.2 Risk Mitigation during refurbishment

A range of mitigation measures will be required for the various possible hazards/events during an in-service refurbishment. These mitigations will need to be developed by the Integrated Work Team as the design and planning for the refurbishment goes forward (discussed further in *Section 10.15* and *APPENDIX 10*). Many risks should be mitigated through the design and engineering of the system/item or through refinements in working methods and equipment.

The *additional* risks during an in-service refurbishment (identified above) as compared to the existing risks require special attention because their potential impacts on the service and the amount of staff required from all stakeholders. A full-scale risk assessment to guide contingency planning and the development of prepared solutions should be part of the early implementation actions. Key mitigation requirements are identified by risk.

11.5 Risk – Outage Overrun: Mitigations

11.5.1 Integrated Work Team

Establish an Integrated Work Team between the Gateway Partners and the designer, contractor, and sub-contractors to work with the railway operators and other stakeholders to deliver the refurbishment while maintaining existing service levels (see *Section 10.13* and *APPENDIX 10*).

11.5.2 Risk Assessment

Conduct a risk assessment in conjunction with the Integrated Work Team to compile and address the risks and deficiencies that could prevent a return to service so that this can inform preparation of the contingency procedures.

11.5.3 Advance Preparation

Careful advance preparation by the Integrated Work Team guided by the Risk Assessment with an emphasis on the development of mock-ups, testing, and training, and revision of the work plan, if necessary, to provide confidence in the work plan/activity. When the Integrated Work Team is confident that the work plan is correct and has all the safeguards in place, only then can the work in outage can proceed.

11.5.4 Outage Planning

Advance planning of each work activity on a minute-by-minute basis. The work plan needs to be checked, validated, and continuously monitored to form (and revise if necessary) a shift work pattern with calculated points of no return, float present in the plan, clear decision points to cater for things not being as they should be and possible work curtailment if an overrun is predicted by the continuous monitoring.

- Monitoring: The Integrated Work Team needs to monitor the work plan/activities and be prepared to revise all or part of the approach to achieve a robust working plan.
- Technology: Use of technology to manage the work plan activities and the information generated by them, with warning systems (i.e. Red, Amber, Green) to ensure that the work plan/activities are followed, and decisions taken and recorded.

11.5.5 Risk Assessment

Risk assessment in conjunction with rail operator addressing the deficiencies that could prevent a return to service so that these can be given special attention in terms of inspection, testing and supervision.

11.5.6 Contingency Planning

Contingency planning for construction incidents which could occur preventing a return to service (i.e. failure of a new installation, accidental damage to a new or existing component, breakdown of construction equipment). Plans could include back up plant equipment, transport, and materials.

11.5.7 Information Sharing

Integrated Work Team should have a good visibility of the outage activities/progress by sharing output with all relevant stakeholders (i.e. the railway control rooms) so that “everyone knows what is going on” and processes can be refined in a transparent manner.

11.5.8 Equipment Safety

Equipment should be risk assessed to ensure that the necessary limits and controls are installed (e.g. limits on boom movement, fail safe design).

11.5.9 Equipment & Materials

Redundant equipment and materials (back up plant, equipment, consumables transport, materials) should be kept on-site to prevent delays caused by breakdowns and unexpected conditions.

11.6 Risk – Remaining Tube Incident: Mitigations

11.6.1 Integrated Work Team

It is important that the Integrated Work Team should have an agreed cooperative process to determine the best way to address an individual incident and get the tube #1 back in service ahead of the conclusion of the scheduled outage.

11.6.2 Contingency Planning

- Tube Restoration: Contingency plans should be developed by the Integrated Work Team that determines the time required to restore the outage tube #1 back to service and how those plans are enacted. These plans must address the key areas for service resumption in the outage tube. Contingency plans will be specific to the type of work in progress, e.g. Track, OLE, bench demolition, M&E services installation. These plans must accommodate the safe exiting of works trains out of the tube in the minimum time to allow service resumption.
- Equipment & Materials: Redundant equipment and materials (back up plant, equipment, transport, materials) should be kept on-site to prevent delays caused by unexpected refurbishment issues or to put tube #1 back in service ahead of the conclusion of the scheduled outage.
- Alternative Service: Since this risk can only materialise at off peak hours consider where bus services or other forms of transport could be used to take passengers between stations as enhancements to existing NRT/trans-Hudson contingency and emergency plans.

11.6.3 Preventative Actions (see also System Risks above in Section 11.2.2)

The Integrated Work Team (including the railway operators) should actively look for infrastructure issues (track power systems, catenary, signalling) outside the NRT which could unexpectedly prevent access to the working tube and righting this to the extent possible so that the risk is prevented. In addition, review numbers of Dispatchers and Tower Operators on duty during outages to ensure that resources are there to deal with these situations in off-peak hours.

11.6.4 New Infrastructure

Consider the cost/benefit of bringing forward the construction of extended or modified tracks earlier (currently planned for the future HRT), including doubling the track to Secaucus Junction with additional crossovers would assist managing the train paths.

11.7 **Comparison of Existing (Do Nothing) Scenario Risks with Risks Involved in the In-service Refurbishment**

LBA have identified risk categories, possible risk events within each category, assigned a “risk rating,” and identified possible mitigations. These risk categories have been compared between the existing (do nothing) scenario and the in-service refurbishment scenario. LBA notes that levels of risks are intuitive and based on LBA’s interpretation of the information provided. In reviewing these risks, we have combined this with our knowledge of construction and railways.

We have adopted the following “risk rating” terminology for the likelihood of an event occurring:

Risk	Allocated number
Remote	1
Unlikely	2

Possible	3
Likely	4
Very Likely	5

Risks Existing and During Refurbishment							
Risk	Timing	Possible event	Level	Numerical assessment			Possible Mitigation
				Near Term	Med Term	Long term	
Service failure	Existing	Pump failure Pipe failure, bracket failure	Possible but maybe no impact on service	3	3	3	Maintenance schedule
	During refurb	Pump failure, Pipe failure, bracket failure. Adjusted or recommissioned service failure	Possible	3	2	1	Monitoring of installed services and careful inspection and sign off of all new installations
HV Cable failure	Existing	Cable failures, insulation breakdown, joint fails	Possible with existing cables	3	3	3	Replace cables as soon as possible when new locations identified
	During refurb	Cable fractures, insulation breakdown, joint fails.	Possible. With existing cables, diminishing as new cables fitted	3	2	1	Renewal of cables and joints reduces risk exposure as refurbishment progresses
Structural failure (tunnel lining) Crumbling Concrete	Existing	Chunks fall onto trains from crown of tunnel	Unlikely until repairs done	2	2	3	Commence repairs
	During refurb	Crown of tunnel, fragments fall onto trains	Unlikely to remote as repairs done	2	2	1	Crown repairs carried out early in the refurbishment programme.
Structural failure (bench)	Existing	Bench concrete crumbling onto tracks unnoticed	Possible until repairs done	3	3	3	Programme of inspections
	During refurb	Bench concrete chunks fall onto trains	unlikely, as repairs done and monitored and bench concrete all removed	3	2	1	Bench that has not yet been refurbished will require careful checks on completion of outage.
Structural failure (supports and fixings)	Existing	Cable or pipe bracket failure(rust)	Possible	3	3	3	Detailed regular examination replacements of suspect brackets.
	During refurb	Cable and pipe support failure when supported by lining or bench prior to refurbishment	Possible	3	2	1	Detailed examination and repair of defects. Rigorous testing of fixings prior to final design.

Risks Existing and During Refurbishment							
Risk	Timing	Possible event	Level	Numerical assessment			Possible Mitigation
				Near Term	Med Term	Long term	
Flooding	Existing	Recurrence of superstorm	Unlikely (assumption is that measures taken outside tunnel)	2	3	3	Assumption is that mitigations (Flood Protection) in place outside tunnel
	During refurb	Recurrence of superstorm	Unlikely	2	3	2	Refurbish drainage system provide great capacity ensure pumps continue to operate
Derailment	Existing	Worn track/clips or rail fracture	Unlikely	2	2	3	Track inspections on a planned basis
	During refurb	Worn track/clips or rail fracture. Obstruction left on track after outage.	Unlikely	2	2	1	End of outage inspections should include this and particularly debris on Track. Fitment of guard rail at start of refurbishment period.
Leaks via lining	Existing	Leaks dripping onto OLE and or impacting signalling in track level	Likely	4	3	3	identify and treat during an outage
	During refurb	Leaks dripping onto OLE and or impacting signalling in track level	Possible moving to remote as new trackbed in place and new drainage system in place	4	2	1	Follow leak sealing with installation of new trackbed as first priority. Ensure drainage system keeps pace
Fire In tunnel	Existing	Fire in joint box /switch box.	Unlikely, but high impact if HV cables impacted	2	3	3	Emergency response procedures, redundancy of supply
	During refurb	Fire in joint box /switch box.	Unlikely decreasing as new cable entered.	2	2	1	Normal fire precautions replace during outage, standby cable ready
Fire In tunnel	Existing	Fire on train passing through tunnel	Remote (unless dangerous goods in transit)	1	1	1	Normal fire precautions' 130 requirements for rolling stock
	During refurb	Fire on train passing through tunnel	Remote (unless dangerous goods in transit)	1	1	1	Normal fire precautions' 130 requirements for rolling stock
Fire In tunnel	Existing	Fire caused by maintenance activities	Fire of any consequence Remote	1	1	1	Fire precautions, control of hot work (if any), electrical safety.
	During refurb	Fire caused by construction activities	Fire of any consequence Remote	1	1	1	Full fire precautions, strict control of hot works (if any) and flammable materials in tunnel. No Smoking
O/H line Failure	Existing	Damage to the OH line from Pantograph	Likely based on past events	4	4	4	Constant maintenance of Pantographs and OLE.

Risks Existing and During Refurbishment							
Risk	Timing	Possible event	Level	Numerical assessment			Possible Mitigation
				Near Term	Med Term	Long term	
	During refurb	Damage to the OH line from Pantograph	Likely based on past events but improving as refurbished.	4	3	2	Lower track, renewal of trackbed, Refurbishment of O/H line early activities
Signalling failure	Existing	Cable and equipment failure/ signal failure, power failure/ grounding fault (water in invert)	Likely due to a mix of problems, historic system, grounding, cabling	4	4	4	Requires regular maintenance to ensure acceptable performance. Clean out drainage regularly, check cabling and grounding regularly
	During refurb	Cable and equipment failure/ signal failure, power failure/grounding fault (water in invert)	Likely with existing signalling system	4	3	2	Replace signalling system as soon as practical. Install new trackbed as soon as possible
Terrorist Threat or ED	Existing	ED placed in tunnel, ED on train	Remote	1	1	1	Emergency Response procedures
	During refurb	ED placed in tunnel, ED on train, on works train	Remote: with Tunnel Security in place and Personnel monitoring	1	1	1	Emergency Response procedures
Outage overruns	Existing	Tunnel not ready to go into service at end of outage.	Possible	3	3	3	Carefully planned and applied outage planning and procedures and contingency plans for overruns.
	During refurb	Tunnel not ready to go into service at end of outage.	Possible declining as system worked and teams trained.	3	2	2	Carefully planned and applied outage planning and procedures. Readiness reviews, point of no return identification see above
Failure on railway system adjacent to tunnels outside tunnel	Existing	Impacts Single tunnel working and requires "other" to be brought back into service unexpectedly	Possible	3	3	3	Contingency plans
	During refurb	Impacts Single tunnel working and requires "other" to be brought back into service unexpectedly	Possible	3	3	2	Before refurb carry out careful review of points of weakness and address. Establish contingency plans



Risks Existing and During Refurbishment							
Risk	Timing	Possible event	Level	Numerical assessment			Possible Mitigation
				Near Term	Med Term	Long term	
Failure of some type in one tunnel when the other tunnel is "out"	Existing	Impacts Single tunnel working and requires "other" to be brought back into service unexpectedly	Possible	3	3	3	Contingency planning for rapid end to maintenance operation and return to service
	During refurb	Impacts Single tunnel working and requires "other" to be brought back into service unexpectedly	Possible	3	3	2	Preventive maintenance in other tunnel must be phased in plus contingency planning in the refurb operations to allow rapid response to this situation

Timings shown		Notes relating to the Chart below	
Near term	Commencement of Refurbishment activities	For the Refurbishment Risk levels the risks have been linked to the activities that impact the risk and the risk level modified when the activity is complete	For the Existing Risks level these have been considered Mid-term and Long term and the small increase gradually applied
Mid term	Halfway through the refurbishment period		
Long term	End of refurbishment		

The chart below compares the risks of the existing (do nothing) scenario with the risks of the in-service refurbishment scenario and makes the assumption that as infrastructure items are replaced and the construction team gains more experience working in the NRT, the risk to service diminishes.

As can be seen, LBA’s assessment is that the existing risks (the risks involved in doing nothing) remain constant and with time increase marginally as the existing infrastructure elements in the NRT continue to age and degrade, while the in-service refurbishment risks gradually decline to a residual level. The spreadsheet that supports the chart below is provided in Ref 2 Appendix A10.9.

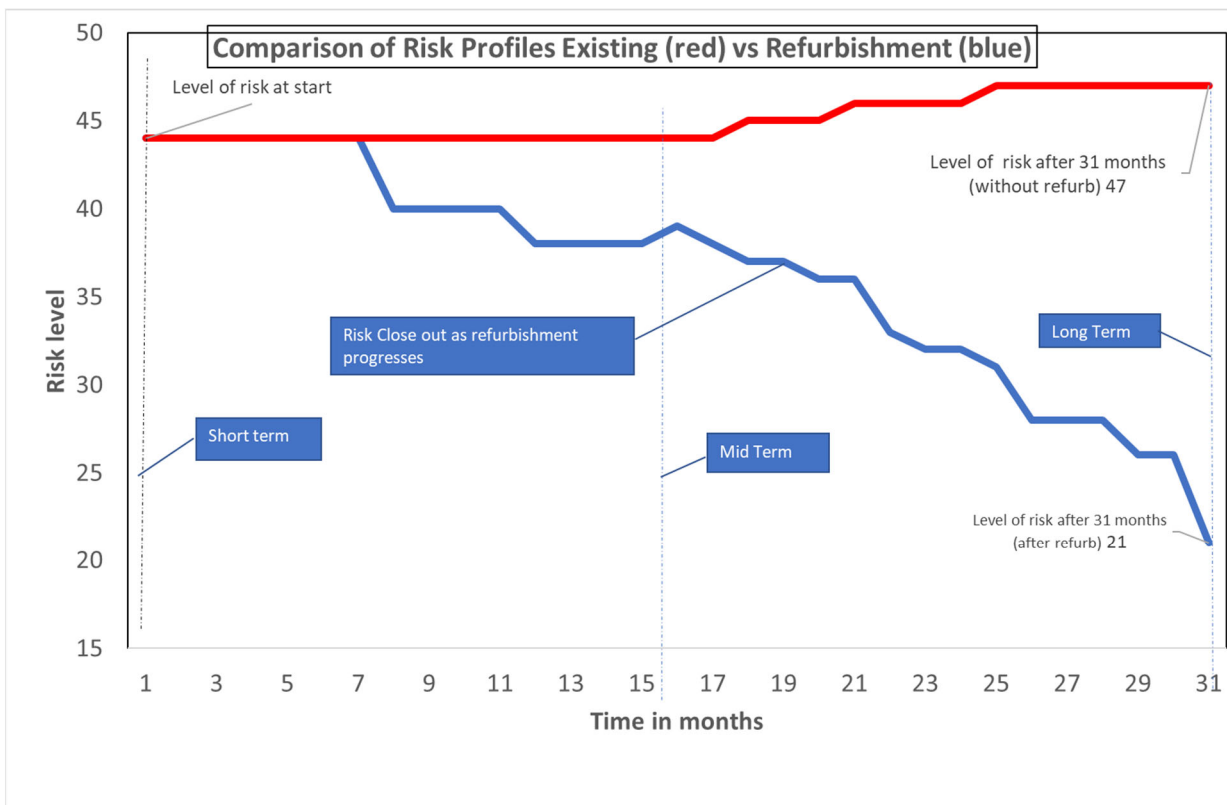

Figure 11-1: Comparison of Risk Profiles Existing vs Refurbishment

It can be argued that this analysis fails to take account of the impact of the additional risks or the likelihood of these risks occurring and how they compare with the other risks. This argument is correct, but very much depends on one’s assessment of the mitigation measures which have been suggested and which have in comparable precedents given a very controlled activity causing very few late returns of outages (See *LUL Experience, APPENDIX A6.11*). In addition, during working shifts, members of the Integrated Work Team will be in the tube who will check,

inspect, report, and repair, if necessary, the existing infrastructure, helping to ensure the continuous operation of the railway.

11.8 Risks During Construction

11.8.1 Risks to the Construction Personnel

LBA have identified construction work activity risks categories, possible risk events within each category, assigned a “risk rating,” and identified possible mitigations. These risk events include conventional construction risks as well as those that could impact the operating railway. This assessment assumes that good construction and safety controls are in place and that work activities are managed closely by the Integrated Work Team to mitigate risks.

Great emphasis is placed on safety; health and welfare; planning; method refinement; lessons learnt and improvement; a team approach and a shared and aligned purpose and culture throughout the team. See also comments above regarding Management of the Refurbishment 11.2.1.

Construction Risks – Risks to Personnel			
Risk	Possible Event	Assessment before mitigation	Possible Mitigation
Mechanical Shock	Hit by moving machinery.	Unlikely (2)	Separation, no-go zones.
	Hit by moving rail cars/Road railers.	Unlikely (2)	Audible warnings, proximity cameras and warnings.
	Falls off benches.	Possible (3)	Guard rails, working platforms at appropriate height.
	Fall off Railcars/Road railers.	Possible (3)	Guard rails, working platforms at appropriate height.
	Hit by new bench replacement item.	Unlikely (2)	Careful development of MS of work.
	Lifting Failure.	Unlikely (2)	Planned system, inspection & testing of tackle and lifting points.
Health Hazards	Dust, Silica, HAVs.	Possible (3)	Careful planning of dust control/damping, ventilation, monitoring system in tunnel. Health Surveillance & Monitoring scheme. Excellent Welfare facilities.
	Lead exposure.	Unlikely (2)	Benchmark Testing followed by regular testing, survey of possible problem areas.
Electrical shock	M & E Installations. Overhead line contact.	Remote (1)	Full suite of electrical procedures, authorised personnel. Isolation procedures and checks for.
Fire/explosion	Hot works cause sparks.	Remote (1)	Hot works procedures.

Construction Risks – Risks to Personnel			
Risk	Possible Event	Assessment before mitigation	Possible Mitigation
	Hydraulic oil mists catch fire.	Remote (1)	Socks on hoses. Non-mineral oil used.
	Rags/paper.	Remote (1)	Manage ALL flammables into tunnel.
	Electrical fire.	Remote (1)	Suitable fire extinguishing systems available.
Flooding	Water pipe failure.	Remote (1)	Shut off valves and emergency response procedure in place.

The above construction risks are remote or unlikely and good construction practice should ensure that these are effectively managed. A risk assessment will normally accompany each method statement specifying actual mitigation measure to demonstrate that the risks have been reduced to an acceptable level. The emphasis should be on a safe controlled operation with a very well trained and committed workforce and the highest standards of welfare and health surveillance. The working hours, the environment, and the length of the works will require a bespoke approach from all parties concerned to assure a sustained and reliable refurbishment operation.

11.8.2 Risks to Customers

Risks to the customers who use the tube which are introduced by the refurbishment works can be identified. There will be a similarity between these risks and the risks which the integrated team must manage as part of the refurbishment/reconstruction process (as above) and the responsibility to manage these will be with the integrated team and must form part of the Health and Safety planning and risk management process.

Construction Risks-Risks to Customers			
Risk/Hazard	Hazardous Event	Risk Level	Mitigation
Health Hazards	Silica and other dust	Possible (3)	Misting during demolition, use of ventilation to dilute. See Note 1 below
	Lead vapours	Remote (1)	Lead survey done and protection measure taken.
	Asbestos	Remote (1)	Asbestos survey done and managed if found according to Regulations.
Derailment	Debris on track	Possible (3)	Rigorous inspection regime for end of outage.

Construction Risks-Risks to Customers			
Risk/Hazard	Hazardous Event	Risk Level	Mitigation
Escape in Emergency	Walkway incomplete	Possible (3)	Rigorous inspection regime for end of outage. Planned bridge provision.

Note 1: Given possible public concern on this issue it will be appropriate to set up a full monitoring system against defined standards and make the results available to the public demonstrating very low levels of exposure.

11.8.3 Quality Risks

Poor quality is unacceptable anywhere and particularly in this “confined” environment where future access for maintenance and repair will always be difficult. Quality can be ensured through good planning and design of the refurbishment so as to achieve the kind of outputs necessary to carry out an efficient and economic refurbishment programme. As with many areas in outage working, a high level of inspection would be anticipated not so much to check on the quality control, but more importantly to check that the agreed quality control was being exercised and that all the other risk aspects of outage working were included.

Quality of the finished refurbishment will be a concern because of:

- working to tight deadlines.
- having to cease an operation at a less than ideal stage; and
- restriction on methods because of the working environment.

Construction Risks--Quality			
Risk/ Hazard	Possible Event	Risk Level Assessment Before Mitigation	Possible Mitigation
Quality	Tight Deadlines	Possible (3)	Time made available in the work plan to ensure Quality requirements are addressed. Inspection and test plans prepared, check sheets monitored and reported.
	Incomplete Work	Possible (3)	Improve scheduling and planning to match work content to outage time available. Good records to ensure picked up. Contingency planning to allow satisfactory completion
	Confined Working Environment	Unlikely	Workplan takes into account in planning. Process, equipment and plant engineered to accommodate confined environment

11.9 **Cable Protection Risks**

Risk Identification

The risks to the operational railway are influenced by the presence of high voltage cables which maintain supplies for railway services: principally outside the tunnel. A failure of one of these cables could (we are informed) cause major delays to the railway system although we are not sure of the degree of redundancy there is in the system. The existing cables are old and failing

in areas. Cable failure causes delays in and outside of the tunnel and is one of the primary reasons for the refurbishment proposals.

Current NRT 10% Design Refurbishment Proposal (Ref 12.1.2)

It is proposed in a number of Amtrak documents that the HV cables and some other cables should be installed in ducts surrounded by concrete. Amtrak interpret that this protection is required by the Standard NFPA 130. The standard relates to Fire Protection for Emergency Power circuits and it has not been evidenced to us as to how the HV feeds fit into this “Emergency Power” category. Nevertheless, we demonstrate alternative bench wall solutions that could meet the required level of fire protection (See *Chapter 8 and APPENDIX 2*).

NRT 10% Design Refurbishment Proposal	LBA Assessment
<p><i>“A 3rd Party Threat Vulnerability Risk Assessment report reflected the importance of these assets to the operation of the Northeast Corridor and would likely have recommended against a less resilient bench wall as their reporting routinely placed an emphasis on robustness, resilience (in the form of speed to return to service and minimisation of the foreseeable loss and damage from any single event)”</i></p> <p>(Bench Wall analysis White paper; July 2019 Para 2.2) (Ref 12.1.1)</p>	<p>It is a matter of judgement to decide how robustness and resilience is best delivered. Putting large heavy cables in concrete ducts has its own issues in terms of accessibility replaceability and number of joint pits.</p>
<p>The probable risks to the HV cables and other cables include derailment, fire or explosive blast and after discussion with Amtrak’s systems departments, conclude that concrete encasement of conduits is essential for the long-term resilience of Amtrak’s systems. and <i>“Simply put the concrete encased bench wall provides the tunnel and systems with the highest level of resilience and long-term durability”</i>.</p> <p>(Bench Wall analysis White paper; July 2019 Para 2.2) (Ref 12.1.1)</p>	<p>This risk and others could be mitigated by the use of guard rails.</p>
<p>Jacobs then proceed to examine the electrical explosion risk, which is not about Fire Protection but Fire Initiation from the ever-present risk of a cable failure in a joint box or duct and how a failure in one cable could cause a failure in another.</p> <p>Bench Wall analysis White paper; July 2019 Para 4.3) (Ref 12.1.1)</p>	<p>This suggests that it is not about protecting the cable from fire but preventing cables causing a fire. Cable laid in longer lengths with fewer jointing pit would decrease this risk.</p>

These statements seem to follow the principle that removing the risk as they see it, is the only way to mitigate the risk. No attempt seems to have been made to balance the risks against the likelihood of the risks occurring; the mitigation which might be applied (e.g. derailment containment);not to mention the benefits of enhanced maintenance, from better access, longer cable lengths, reduction in the number of joints and jointing chambers (currently expected to be 70 in number High Tension and Low Tension). It is opportune to consider the lowering of risks by effective planning and design to produce an optimised balance between cost and risk reduction.

The need for concrete protection should be based on an assessment of the risks to personal safety; public safety and business continuity balanced against mitigation from improvements in containment (guard rails), fire protection to emergency system supply cables, fire rated cables, SCADA systems (to detect fires) and the economic advantages as set out above.

It is not possible to conclude at this time how that balance may be affected without knowledge of all the past data, frequency of occurrences, future improvements, flammable material in the tunnel, dangerous goods going through the tunnel etc. However, we do believe that this approach to the assessment of risks should form the basis of the refurbishment design decisions and could allow for the consideration of other methodologies for the placement of cables. We have therefore considered a variety of options, design solutions, and methodologies.

By making this statement, LBA does not see any significant difference between the risks in the NRT and other comparable tunnels, e.g. London Underground, HS1, HS2, Taiwan High Speed Rail, and many Metro tunnels around the world, that demands a cumbersome and expensive solution that entails maintenance and accessibility issues that can impact on the service.

11.10 Flooding Risk

The risk that does not get much attention is the possibility of a further inundation/flooding risk as per the 2014 storm surge of water through the tunnel portals. LBA do not have information on the action that has been taken to prevent this happening again, but we assume that appropriate measures have been taken. It would be reassuring to understand that that assumption was justified.

11.11 Risk of Interference with the new Hudson River Tunnel Construction

LBA believe that there would be minimal conflict or interference should the proposed construction of the new Hudson River Tunnel also proceed in parallel with the NRT Refurbishment work. Possible risk areas identified include:

Physical interference of the work activities: This is most unlikely because the NRT Refurbishment will effectively be executed within the existing footprint of the existing railway and hence cannot cause physical interference to the HRT works. Part of the HRT scheme is additional trackwork between the new HRT and Secaucus Junction, and it is our view that this should be in place at the earliest possible time to allow greater flexibility in the 'train pathing' once this work is in progress.

Rail logistics interference: This is unlikely to be a problem, although it could be that the HRT contractor(s) will need to use the rail yards and the rail system at specific times and perhaps for equipment and material deliveries, thus necessitating some coordination of logistics; dependent on the relative schedules.

Resources (labour, staff, etc.): One of the advantages of embarking on the Integrated Work Team and ECI procurement approach is that it encourages the efficient use of resources. The NRT Refurbishment works will require a different type of contractor to that of the new HRT construction and will be much more suited to a local/regional contractor who has local labour and is prepared to commit to a 5-6-year project. The proposed ECI approach is ideal for developing a trained, static, reliable and flexible labour force. Whereas the HRT works contractor will need to bring specialist labour to the site.

Environmental issues: LBA has not actively considered environmental issues for the NRT at this stage and any rehabilitation of the NRT may require compliance with relevant environmental regulations.

11.12 Cast Iron Lining

LBA have no evidence that the cast iron lining is deficient except for the small amount of seepage which has occurred in a few local areas along the NRT tubes. However, the opportunity should be taken when carrying out the repairs to properly investigate the condition of the cast iron lining.

The intrusive investigations carried out by HNTB (2014) (Ref 12.1.5) were primarily to obtain samples for testing of the inner concrete lining. HNTB's secondary purpose to examine the condition of the outer cast iron lining was not conclusive, as it was restricted solely to cored holes penetrating into the intrados of the cast iron segmental pans. A more certain approach would be to cut out small windows to expose not only the pans but the flanges and bolts. This is commonly undertaken in London Underground stations where the cast iron has been similarly encased in a secondary lining prior to undertaking works that may affect the cast iron structure.

This approach would also enable an accurate measurement of the thickness of the cast iron lining and an assessment of the condition of the flange joints and bolts to be carried out. Visual and magnetic particle inspections could also be made to evaluate cracking and samples of the cast iron taken to determine its grade. This could then be compared with the findings from other cast iron lined tunnels of similar vintage to assess the likelihood of cracking. Corrosion susceptibility and cracking can be evaluated according to the cast iron grade and metallurgical testing. This would provide some reassurance of the lining condition.

Pre-designed repairs should address any deficiencies found so that the progress of the refurbishment is not impeded.

11.13 Seismic Risks

LBA has not assessed the seismic risk. Tunnels generally survive earthquakes with little critical damage. In silty ground conditions, liquefaction can also be an issue depending on the exact composition of the silts and the frequency and severity of the quake. A specific seismic assessment could be useful, if determined necessary, to identify any areas where risks could be mitigated.

11.14 Buoyancy of the Tunnels

The HNTB report (2014) (Ref 12.1.5) and work carried out by Jacobs in the '10% Draft Feasibility Report' (Ref 12.1.2) reviewed buoyancy of the NRT tubes to check that there was an adequate factor of safety against uplift.

These analyses made assumptions regarding the depth of material above the NRT tubes and LBA suggest that these should be verified by a Hydrographic Survey.

A quick and relatively inexpensive survey of the riverbed above the NRT tubes could be carried out using side-scan sonar, which provides bathymetric information and will indicate the sedimentary layers and rock head at shallow depth. It should also detect the location of tubes. This exercise was successfully carried out recently in London for the Thames Tideway Combined Sewer Outfall project and the Silvertown Link highway tunnel project. A boat towing a sonar array and traversing a specific area of the river would build up a 3D model of the riverbed and sediment structure.

A review of the refurbishment sequence results should be carried out to ensure that there are no buoyancy issues during the removal of the concrete /ballast within the NRT tubes. Previous studies (by others) on the NRT assume that all the concrete haunches and track are removed at the same time, whereas the LBA proposal does not, providing a margin of safety. Cross checking against the Hydrographic survey is advised. Future events that might affect the riverbed should be repeated on a regular basis to provide on-going assurance.

12 REFERENCES

These are selected documents that are referenced in the report, they are only a small number of the documents that have been made available to LBA:

12.1 Documents provided to LBA by Gateway Partners

- 12.1.1 North and East River Tunnels Reconstruction for Amtrak Bench wall Analysis White Paper July 2nd, 2019 by Jacobs.
- 12.1.2 Preliminary Design of Track and facilities Reconstruction for Amtrak North and East River tunnels -Task 2-10% draft Feasibility Report by Jacobs.
- 12.1.3 North and East River Tunnels Reconstruction for Amtrak Task 6 Preliminary Deficiency Prioritisation report by Jacobs.
- 12.1.4 Amtrak North River Tunnel Reconstruction - Replies to London Bridge Associates Review Questions; Memorandum from Jacobs to David Pittman August 29, 2019.
- 12.1.5 Structural Assessment of the Amtrak Under River Tunnels in NYC inundated by Super Storm Sandy by HNTB September 2014.
- 12.1.6 Train Performance Reporting; Special Inquiry Report into Portal Bridge and North River Tunnel Delays by North East Corridor commission June 19th, 2019.
- 12.1.7 East River Tunnels Reconstruction Task 8 (50% Submission) for Amtrak by Jacobs September 8th, 2019.

12.2 LBA Originated Documents

1. BOW TIE Example Fire (V2)
2. Risk Comparison Do nothing v Refurbish



APPENDICES

APPENDIX 1 - London Bridge Associates Ltd – Overview & Experience 106

A1.1 About London Bridge Associates (LBA) 106
A1.2 Project Experience 106
A1.3 Refurbishment Experience 106
A1.4 LBA - Gateway Project Team 107
A1.5 Extended Biographies – LBA Team Leads 108

APPENDIX 2 - Civil Works 109

A2.1 Re-Profile and Repair the Existing Concrete Bench Walls 109
A2.2 Re-Profile the Existing Concrete Bench Walls and Clad with FRP Panelling and Cable Ducts (Similar to the Canarsie Solution) 111
A2.3 Demolish the Existing Concrete Bench Walls and Replace with Steel Walkways and Maintenance Platforms, then Cast New Concrete Bench Wall Below 113
A2.4 Demolish Existing Concrete Bench Walls and Replace with Pre-Cast SFRC Bench Walls 115
A2.5 Demolish the Existing Concrete Bench Walls and Replace with Fire Resistant GRP Boxes and Conventional Ducts Mounted on Steel Hanger Brackets 117
A2.6 Demolish the Existing Concrete Bench Walls and Replace with Fire Resistant Bench Wall Facings and Ducts 119
A2.7 Demolish the Existing Concrete Bench Walls and Replace with Cantilevered Steel Walkways and Conventional Ducts Mounted on Steel Hanger Brackets 121
A2.8 Demolish the Existing Concrete Bench Walls and Replace with Steel Walkways and Maintenance Platforms with Cables or Cable Ducts Mounted on Steel Hanger Brackets with Critical Cables Contained in a Fire-Proof Box Below the Walkway 123
A2.9 Fire Resistant Ducting 125

APPENDIX 3 - Rail Infrastructure Drawings 126

APPENDIX 4 - Bench Demolition and Reinstatement Methodology 131

A4.1 Detailed Approach 131
A4.2 Performance of the System (i.e. the fully equipped works train) 131
A4.3 Plant and Equipment 132
A4.4 Detailed Sequence of Operations 132

APPENDIX 5 -Dust control during bench demolition and reinstatement of walkways 142

A5.1 Background 142
A5.2 Dust Control Measures 142
A5.3 Sketch-up of Dust Control Measures 144
A5.4 Extract from Safety and Health Regulations for Construction CFR 1926.1153 145



A5.5	Extract from OSHA Fact Sheet	146
A5.6	Specimen Specification for Spray Cannon cited in OSHA Fact Sheet.....	147
APPENDIX 6 - In-service Trackbed Options		148
A6.1	Introduction.....	148
A6.2	Issues to be Addressed	148
A6.3	Information Required	148
A6.4	Assumptions Made (for the purposes of identifying possible methods)	148
A6.5	Simple Criteria for Assessment of Ideas	149
A6.6	Options Identified	149
A6.7	Track Lowering.....	149
A6.8	Precast Units	151
A6.9	Paving Machines	153
A6.10	Replacement with Booted Track Ties (Sleepers).....	156
A6.11	Replacement of Ballast and Timber Ties (Sleepers) by New Concrete Trackbed with Rail Remaining in Place at all Times.	161
A6.12	Assessment of the Options	165
A6.13	Refurbishment In-Service: References	167
APPENDIX 7 - Tunnel Refurbishment Works Trains and Railhead		169
A7.1	Proposed Locations.....	170
A7.2	Clayton Equipment's Battery Hybrid Locomotive	170
A7.3	Battery challenges and solution	172
APPENDIX 8 -Time Chainages: Further Explanation and Pre-construction Activities		173
A8.1	Outputs and Durations	174
A8.2	Time Chainage	178
A8.3	Gantt Chart.....	179
A8.4	“What If” Time Chainage	180
A8.5	“What If” Gantt Chart	181
A8.6	Pre-Construction Activities	182
A8.7	Construction Timeline Comparison	183
APPENDIX 9 - The Use of Slab Track in Other Railways Around the World		184
A9.1	Examples of In-situ Cast Concrete Slab-Track Cited by Tayabji & Bilow.....	184
A9.2	Slip-paved Slab-track in the North River Tunnel.	186
A9.3	Failure in the Substrate Causing Failure of a Slip-paved Slab.....	186
A 9.4	Fixing Base Plates to the Slab Track. Avoidance of Fastener Related Problems Noted by Tayabji & Bilow at Some Early Slab-track Sites.....	187
A9.5	Survey Data and Detailed Assessment Ahead of Commencement of Slab-track.	187

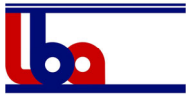

APPENDIX 10 – Implementation	191
A10.1 Introduction.....	191
A10.2 Process for Taking the NRT Refurbishment Forward.....	191
A10.3 Early Contractor Involvement (ECI).....	191
A10.4 Early Decisions.....	192
A10.5 Early Contractor Involvement (ECI) Stage 1	194
A10.6 ECI - Stage Two (Execution).....	195
A10.7 Mock-ups, “Pilot” Sections, testing and proving.	196
A10.8 Case Studies and Reference Documents	198
A10.9 Documents and References.....	207

APPENDIX 1 - LONDON BRIDGE ASSOCIATES LTD – OVERVIEW & EXPERIENCE**A1.1 About London Bridge Associates (LBA)**

LBA is a London-based construction consultancy with infrastructure industry experience in tunnelling, metros and rail projects, led by Bob Ibell and Martin Knights, who, combined, have over 80 years of experience:

- Bob Ibell: Former Chairman of the British Tunnelling Society (an Associated Society of the Institution of Civil Engineers), a founder of LBA, and a past Director of Tunnelling for premier UK Contractor Taylor Woodrow. Over 40 years' tunnelling and refurbishment experience.
- Martin Knights: LBA Chairman, former President of the International Tunnelling Association. Over 40 years' experience in the planning, design and construction of tunnel infrastructure globally and the US, including 20 years of tunnel refurbishment. Former SVP of the international Colorado-based company, CH2M, with responsibility for its 600-strong international tunnel engineering and geoscience practice, as well as tunnelling teams in New York and the Northeast US.

LBA works with owners, major international contractors and designers to deliver solutions primarily for infrastructure projects.

- Other industry areas include water, sanitation and mining, especially in relation to tunnel construction logistics, project management costing, scheduling and planning.

A1.2 Project Experience

- **UK:** Crossrail; High Speed Rail 1 & 2; London Underground & UK Network Rail refurbishment.
- **USA:** Rail and metro projects in the San Francisco Bay Area and Seattle.
- **Australia:** Melbourne and Sydney metro programme.

LBA works alongside owners at the front end of the development of projects, ensuring that planning and reference designs achieve practical and constructible solutions prior to procurement of major infrastructure.

- Key members of their team have been responsible for, or participated in, the delivery of: Channel Tunnel railway between the English and French coastlines; the Channel Tunnel Rail Link Tunnels in East London; the Jubilee Line Extension in East London and the Tideway tunnels.

A1.3 Refurbishment Experience

LBA has an extensive pedigree in the refurbishment of underground infrastructure, particularly whilst maintaining ongoing in-service operational needs. London Underground, UK Network Rail and the UK Highways Authority all have demanding requirements for the maintenance, assurance and planning for the continuous adaptation of key underground infrastructure assets to be fit for the future. In this context LBA was involved in:

- The delivery of the refurbishment of the East London Line tunnel under the River Thames; the Central, the Northern and the Bakerloo Underground lines in central London and under the River Thames; two twin three-lane highway tunnels along the London Orbital Highway.
- Plans for securing the LIRR and other East River metro/rail tunnels post-9/11; the upgrading of the UK West Coast Mainline; the upgrading of the CERN underground Nuclear Research centre in Geneva; and other UK Network Rail tunnels in the UK.

A1.4 LBA - Gateway Project Team

In addition to Bob Ibell and Martin Knights, the LBA's Gateway Project Team includes the following experts:

- Dorian Baker: Leading UK rail infrastructure and operations expert with international experience on rail upgrades, maintenance, timetabling, rail track and power.
- David Hindle: Past Chairman of a leading tunnel design company and responsible for a number of metro, railway and other tunnel refurbishment projects.
- Bob Halsey: Expert on tunnel systems - high voltage power logistics, including the upgrading of power requirements for the UK's West Coast Mainline Railway.
- Miles Ashley: Former Director of Major Programmes for London Underground.
- Kevin McManus: Experienced as tunnel manager/director for rail and major utility tunnel projects.
- Stephen Dart: Expert on strategic/detailed costings for rail and metro projects in the UK & Australia.
- Joanne Lambert: Construction & planning expertise on London rail, metro and water tunnelling.

A1.5 Extended Biographies – LBA Team Leads

ROBERT IBELL BSC MICE	
PROFILE:	 <p>Robert (Bob) Ibell commenced his career in Nuclear Power. He had brief involvements with highways, coastal defence and heavy civil construction at London Heathrow Central station before getting involved in tunnelling on the Tyne & Wear Metro in 1976.</p> <p>He has remained involved with tunnelling for the 43 years following that introduction and has had senior roles in most of the major tunnelling projects in the UK including the Tyne and Wear Metro, the Piccadilly Line extension to Heathrow Terminal 4, Channel Tunnel, the Jubilee Line Extension, and the Channel Tunnel Rail Link (CTRL). Then more recently Tideway and HS2 Section 1.</p> <p>For most of his career, Bob was with a contractor (Taylor Woodrow), but he and eight colleagues formed London Bridge Associates Ltd, the construction management consultancy, in 2000 where he took up the role of Managing Director. Bob was Project Director for the Costain Skanska Bachy Joint Venture on Contract 240 part of the London Tunnels of the CTRL (now HS1) where he was involved in the London Tunnels Alliance, and he is a past Chairman of the British Tunnelling Society.</p>
RECENT PROJECTS:	<ul style="list-style-type: none"> • Mott MacDonald – High Speed 2 Phase 1, London to Birmingham: provided advice & managed the LBA team input into the London Metropolitan section of HS2 in respect of costing, construction planning and risk in preparation for the Hybrid Bill to go before the UK Parliament. This is a mainly tunnelled section, involving some 80km of 8m dia tunnel. • Pacifica Law Group – Seattle Tunnel Expert Services • Retained Adjudicator between Mass Rapid Transit Corporation Sdn. Bhd. Kuala Lumpur and MMC Gamuda KVMRT (T) Sdn. Bhd.

MARTIN KNIGHTS BSc (Hons), CEng, FICE, FREng	
PROFILE:	 <p>Martin has over 40 years' experience directing and managing all aspects of worldwide civil engineering and infrastructure projects, with particular technical emphasis on tunnelling, geotechnical, hydro, rail, highway and subsurface urban engineering projects.</p> <p>Specifically, he led planning, design and construction management teams for tunnel refurbishment over a 20-year period for three major river rail crossings for London Metro and two tunnel upgrade/refurbishment projects (20kms) for two of London's busiest metro lines, all subject to rail and public operational constraints. In addition, Martin worked with MTA/LIRR/PoNY in New York re strengthening plans for four rail crossings under the East River and one under the Hudson Rivers post 9/11. Other underground refurbishment projects include CERN in Geneva, water and stormwater tunnels and road tunnels in UK and Colorado.</p> <p>He has significant experience with UK/USA global consulting/engineering companies, and from 2005 until 2017 was with Jacobs/CH2M where he was a Senior Vice President and founder/MD of a 600-strong International Tunnel Engineering and Geoscience Practice. In 2010 Martin founded an International Tunnel Technology Forum. He is a past President of the International Tunnelling Association.</p>
RECENT PROJECTS:	<ul style="list-style-type: none"> • Engineering Concept Proposal for a new transit system linking the north of London and the Financial centre. • BART proposals for the proposed San Jose Metro, CA.

APPENDIX 2 - CIVIL WORKS

This appendix contains eight possible modifications of, or alternatives to, the Jacobs ERT 50% design. They are presented in no particular order of preference, however in Chapter 7 of this report several have been recommended for further evaluation. Advantages and disadvantages are listed against each option. These should be treated with caution because they could be amended by M&E system design and the condition of the bench walls and lining as it becomes apparent.

The sketches shown are generally geometrically compliant with the space proofing shown in the Jacobs ERT 50% design but are at this stage only very preliminary schemes for discussion and further development if adopted in whole or in part to go forward for detailed design.

Each option also shows track lowering by the installation of a cast-in-situ reinforced concrete track slab replacing the conventional ballasted track with timber track ties. The third rail is included because it may be required. Options where the new installations that would replace the existing concrete sidewall benches would not be sufficiently robust to restrain a de-railed train include a derailment preventer rail in the track configuration.

In addition, all of the options shown except for A2.2, which retains the existing OLE, show a rigid (bar) overhead conductor. This is because this is our preferred replacement although logistic of replacement may preclude this.

A2.1 Re-Profile and Repair the Existing Concrete Bench Walls

Rather than demolish the existing concrete benches and replace them entirely, it may be possible to carefully excavate, re-profile and repair the existing benches (see *Figure A2.1*). This will require the careful selection of tools to produce the profile required including hydraulic breakers, rotary cutters and “scabblers.”

As well as lowering and reshaping the benches, it will be necessary to remove the vertical face, probably to a depth of about 6 inches, although this could be more depending on the depth of any reinforcement encountered. Re-establishment of the bench face to the required track centreline offset would then require re-casting of the concrete behind shuttering using grouted dowels to key the new steel fibre reinforced concrete to the old mass concrete bench.

Advantages:

- Minimum bulk materials excavated and replaced
- Existing drainage pipes and ducting are retained as well as junction access wells, although these installations will require extensive refurbishment
- Provides anti-derailment containment

Disadvantages:

- Heavily labour intensive
- Likely to disturb and damage the portions of the existing benches that are intended to remain, particularly as a result of cold joints
- Likely to be slow to demolish and reinstate
- Difficult to achieve the required quality of finish
- Unlikely to achieve the required life expectancy
- Inadequate ducting remaining after reconstruction, particularly larger sizes
- Reliant on the condition of the existing ducts and drains

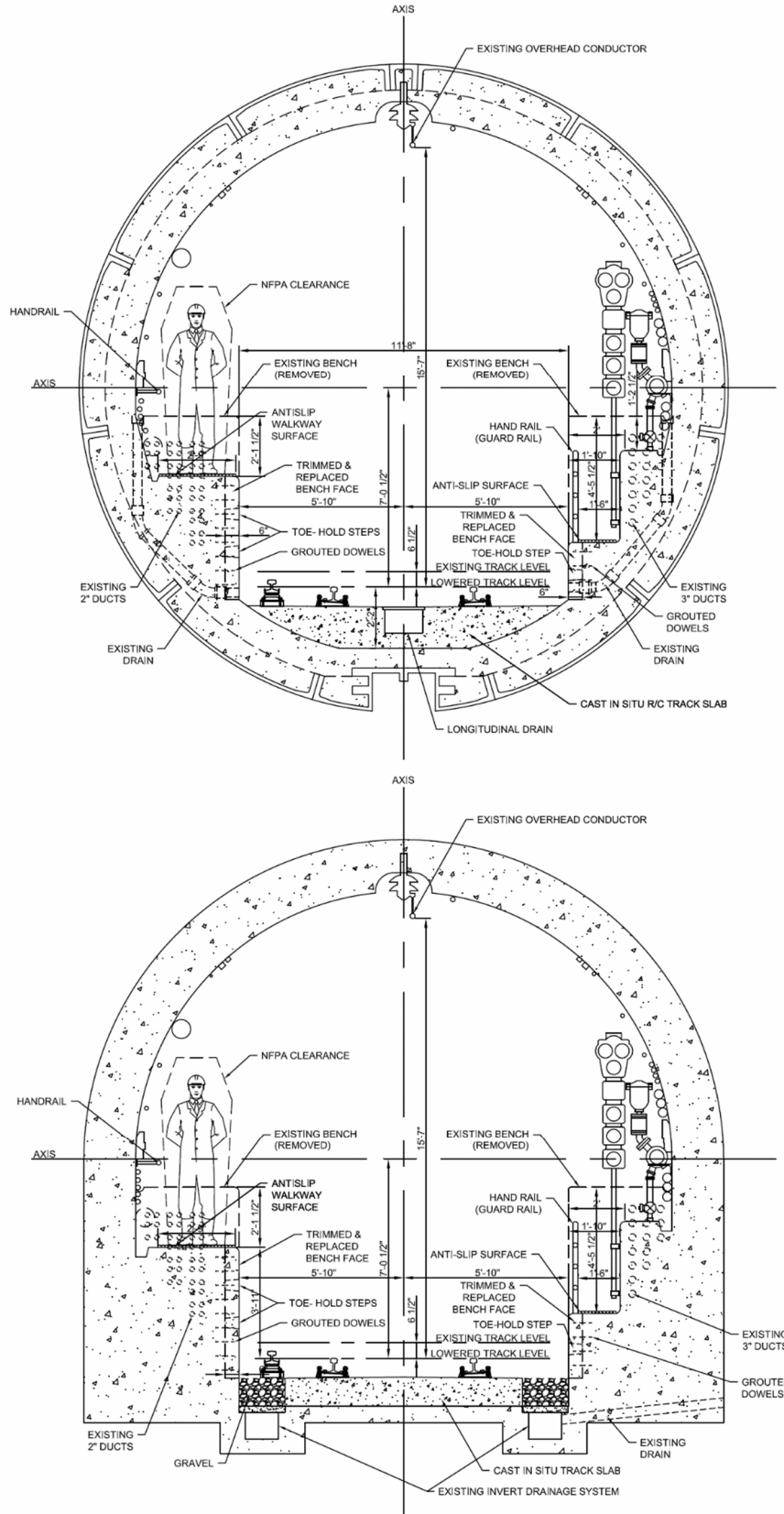

Figure A2.1: Re-profile & repair the existing concrete benches.

A2.2 Re-Profile the Existing Concrete Bench Walls and Clad with FRP Panelling and Cable Ducts (Similar to the Canarsie Solution)

Rather than demolish the existing concrete benches and replace them entirely, it may be possible to carefully excavate, re-profile and repair the existing benches, which are then clad with fibre reinforced plastic (FRP) panels that may incorporate covered longitudinal duct troughs (see *Figure A2.2*). This will require the careful selection of tools to produce the profile required including hydraulic breakers, rotary cutters and scabblers.

The bench facings will require careful trimming in order to accurately fit the panels, which are secured in place using grouted steel dowels and will likely require back-grouting to infill any voids remaining after trimming possibly due to the removal of steel reinforcement of very poor quality or corroded concrete.

There would be an option to incorporate longitudinal cable duct troughs below the walkways on either or both benches that would accommodate the larger size cables. These would incorporate detachable lids, which may also be hinged, the upper surfaces of which would be covered with an anti-slip walking surface. Some form of fire proofing could be incorporated into the duct design.

Advantages:

- Minimum bulk materials excavated and replaced
- Provides a clean and durable surface finish that can be easily maintained
- Existing drainage pipes and ducting are retained as well as junction access wells, although these installations will require extensive refurbishment
- Provides anti-derailment containment

Disadvantages:

- Heavily labour intensive
- Likely to disturb and damage the portions of the existing benches that are intended to remain, particularly as a result of cold joints
- Likely to be slow to demolish and reinstate
- Difficult to achieve an accurate concrete profile which may require some reinstatement before FRP panels are fitted
- Reliant on the condition of the existing ducts and drains

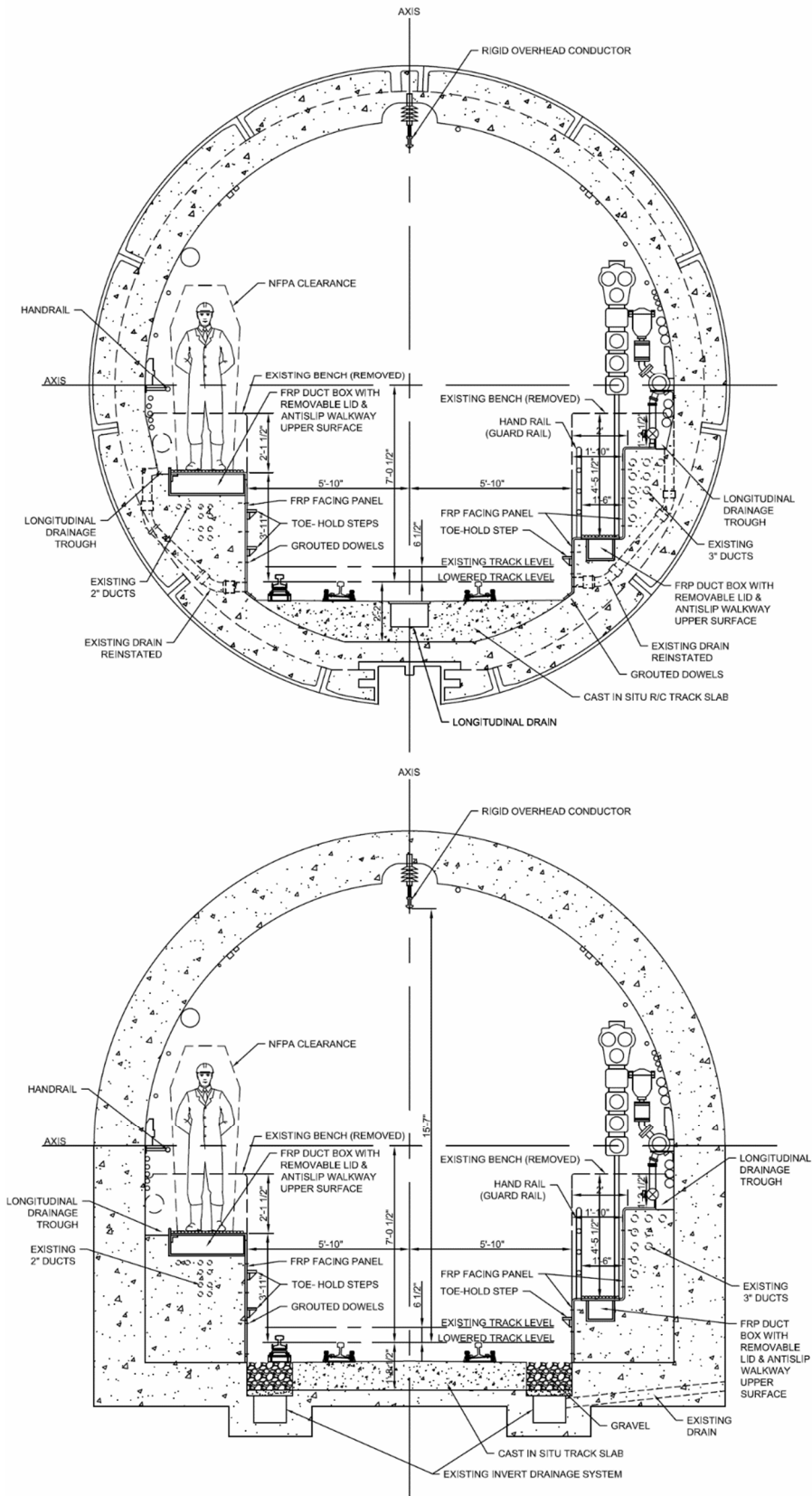

Figure A2.2: Re-profile the existing concrete benches and clad with FRP panelling and cable ducts

A2.3 Demolish the Existing Concrete Bench Walls and Replace with Steel Walkways and Maintenance Platforms, then Cast New Concrete Bench Wall Below.

This option is basically a variation on the current proposals for the ERT that allow for more rapid construction and the provision of good temporary walkway access during construction and in the permanent condition. The existing concrete benches in this option are completely demolished and replaced by a steel walkway and maintenance platform below which the new steel fibre reinforced concrete bench is cast with the required cable ducts and drainage gutters and pipes cast in (see *Figure A2.3*).

The existing benches would be removed initially using bulk demolition methods followed by more precise scabbling of the tunnel lining to form the required profile. The length of bench removal left before installation of the new bench will depend on the production rate that can be achieved in the railway closure time allowed. In the mined tunnel section, it may only be necessary to demolish the existing benches to track bed level to allow secure founding for the new bench units. This would also be the case for all other options involving the demolition of the existing benches.

The steel walkway and platform sections can then be lifted into place using hydraulic lifting gear mounted to the flatbed of the engineering train carrying the units and manhandled to be fixed to the tunnel sidewalls and base using grouted anchors. Individual walkway and maintenance platform units are simply bolted together longitudinally. Some flexibility in the joints should take up the slight difference in the vertical curve alignment of the tunnel between the walkway and maintenance platform units. The walkway and maintenance platforms are fixed to the tunnel lining sidewalls and are propped from the invert with steel struts, which will later serve to support the shuttering during the concrete pour and may be either removed or left in place following casting. The walkway and maintenance platforms would form the top shutter and as such will require access ports for pouring the concrete.

Since the ducts will impede the use of poker vibrators for concrete compaction during pouring, the side shutters could be vibrated. Alternatively, a self-compacting concrete mix could be used. In the circular bored tunnel section, steel shear pin dowels will need to be installed to key the new concrete benches to the existing tunnel lining. This approach will allow the walkway and maintenance platform to be used throughout construction, enabling the installation of the ducting and pouring of the concrete to take place as a continual operation after completing the demolition of the existing benches.

Advantages:

- High quality walkway and maintenance platform products achievable by manufacturing in a specialist factory using well-established technology
- Long life expectancy
- Rapid bulk demolition of the existing concrete benches using remotely operated pneumatic and hydraulic tools
- Only limited repair required to tunnel lining after bench demolition
- Rapid installation of relatively lightweight steel units to form temporarily supported walkways and maintenance platforms
- Provides excellent fire protection to enclosed cable ducts
- Easy access to the open ducts mounted on hangers
- Provides anti-derailment containment

Disadvantages:

- No fire protection of cables in the open ducts mounted on hangers
- Some labour-intensive activities requiring hand tools
- Possible damage to the tunnel lining behind the benches during demolition

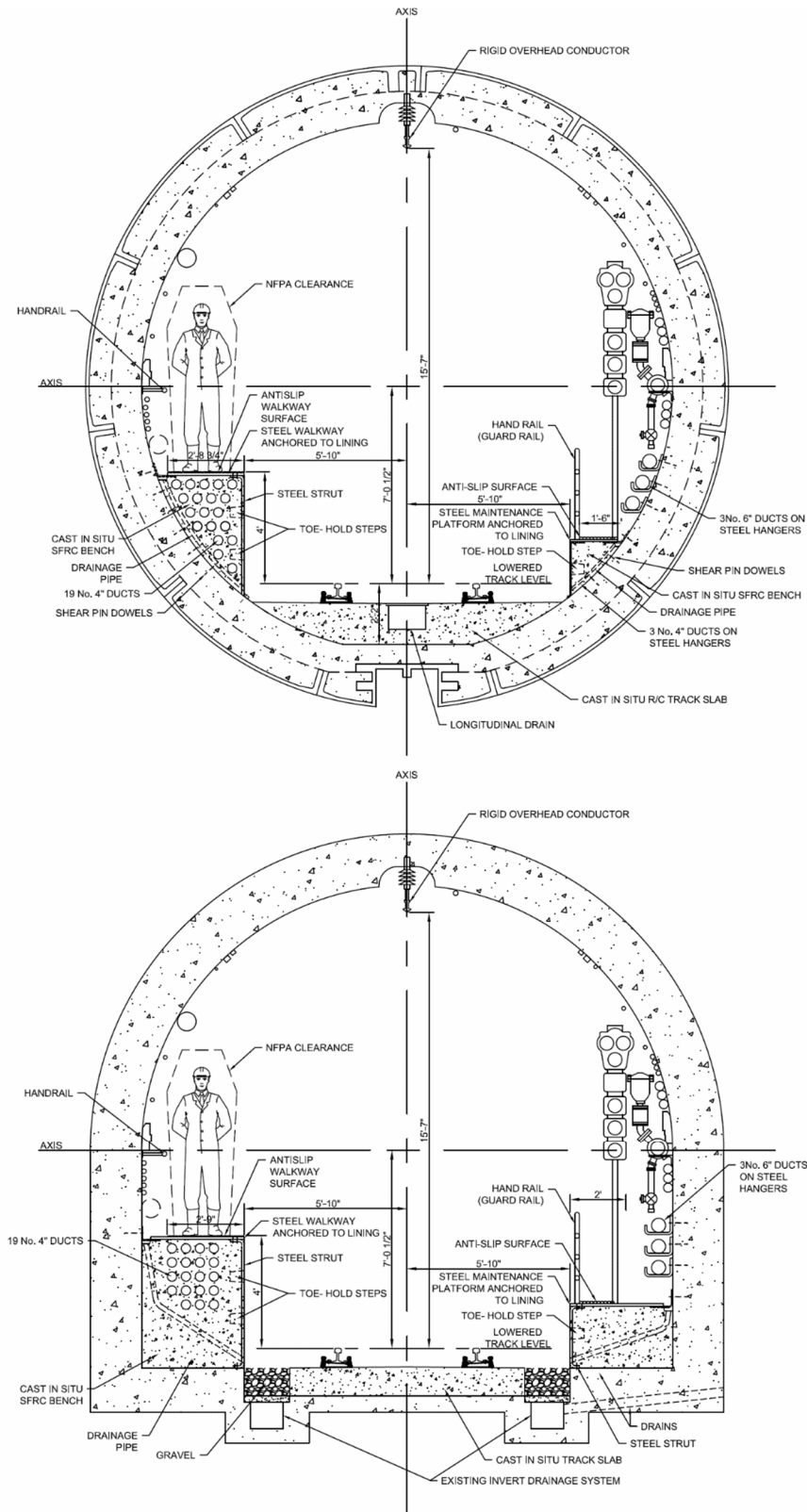

Figure A2.3: Demolish the existing concrete benches and replace with steel walkways and maintenance platforms then cast new concrete benches below.

A2.4 Demolish Existing Concrete Bench Walls and Replace with Pre-Cast SFRC Bench Walls

The existing concrete benches in this option are completely demolished and replaced by pre-cast modular structures manufactured from Steel Fibre Reinforced Concrete (SFRC) with the required cable ducts and drainage gutters and pipes cast in (see *Figure A2.4*).

The existing benches would be removed initially using bulk demolition methods followed by more precise scabbling of the tunnel lining to form the required profile. Any overbreak would require filling using fast-setting mortar or, where overbreak is excessive, locally shuttered cast-in-situ concrete, possibly using a left-in-place expanded metal shuttering system to speed production. Such overbreak may be unavoidable, being induced by cold joints left by the original bench casting or bench drainage pipes that cross into the tunnel lining. The length of bench removal left before installation of the new bench will depend on the production rate that can be achieved in the railway closure time allowed.

Following the existing bench removal and re-profiling of the tunnel lining, horizontal sill brackets are accurately installed by anchoring into the tunnel lining using grouted bolts. The pre-cast bench unit is then transferred by a hydraulic lifting arm off the engineering train flatbed truck using cast-in lugs and manoeuvred by hand into place resting on the sill brackets. The rear face and base of the pre-cast units would be provided with a compressible elastomeric surface seal that ensures an even, waterproof fit with the rough, re-profiled tunnel lining. Once the unit is fully seated on the sill brackets it is temporarily clamped loosely in place by lintel brackets anchored into the tunnel lining.

The end face of the pre-cast bench unit is fitted with a compressible fireproof gasket so that when the next unit is manoeuvred into place it can be jacked hard against it to form a tight, fireproof seal. Once this operation is complete, the lintel bracket can be fully tightened, and the unit clamped permanently in place. The compressible gasket will also take up the slight difference in the vertical curve alignment of the tunnel between the pre-cast units.

The walkway bench (on the opposite side of the track) is a single pre-cast unit whilst the maintenance bench comprises two separate smaller benches in the circular bored tunnel section and a single stepped bench in the mined tunnel section. However, they are set in place in the same manner described above. Special splicing box sections could either be precast or more likely fabricated from welded steel box units.

Advantages:

- High quality product achievable by manufacturing in a specialist factory using well-established technology providing long life expectancy with minimal maintenance
- Long life expectancy with minimal maintenance
- Rapid bulk demolition of the existing concrete benches using remotely operated pneumatic and hydraulic tools
- Rapid installation of modular pre-cast units
- Able to contain the required ducting and drainage
- Excellent fire protection to enclosed cables/ducts
- Provides anti-derailment containment

Disadvantages:

- Some labour-intensive activities requiring hand tools
- Transport, handling and installation of heavy pre-cast units
- Possible damage to the tunnel lining behind the benches during demolition
- Accurate re-profiling and possible repair of the tunnel lining required before installation of the pre-cast units

- HV cables will be pulled in short lengths not laid in long lengths

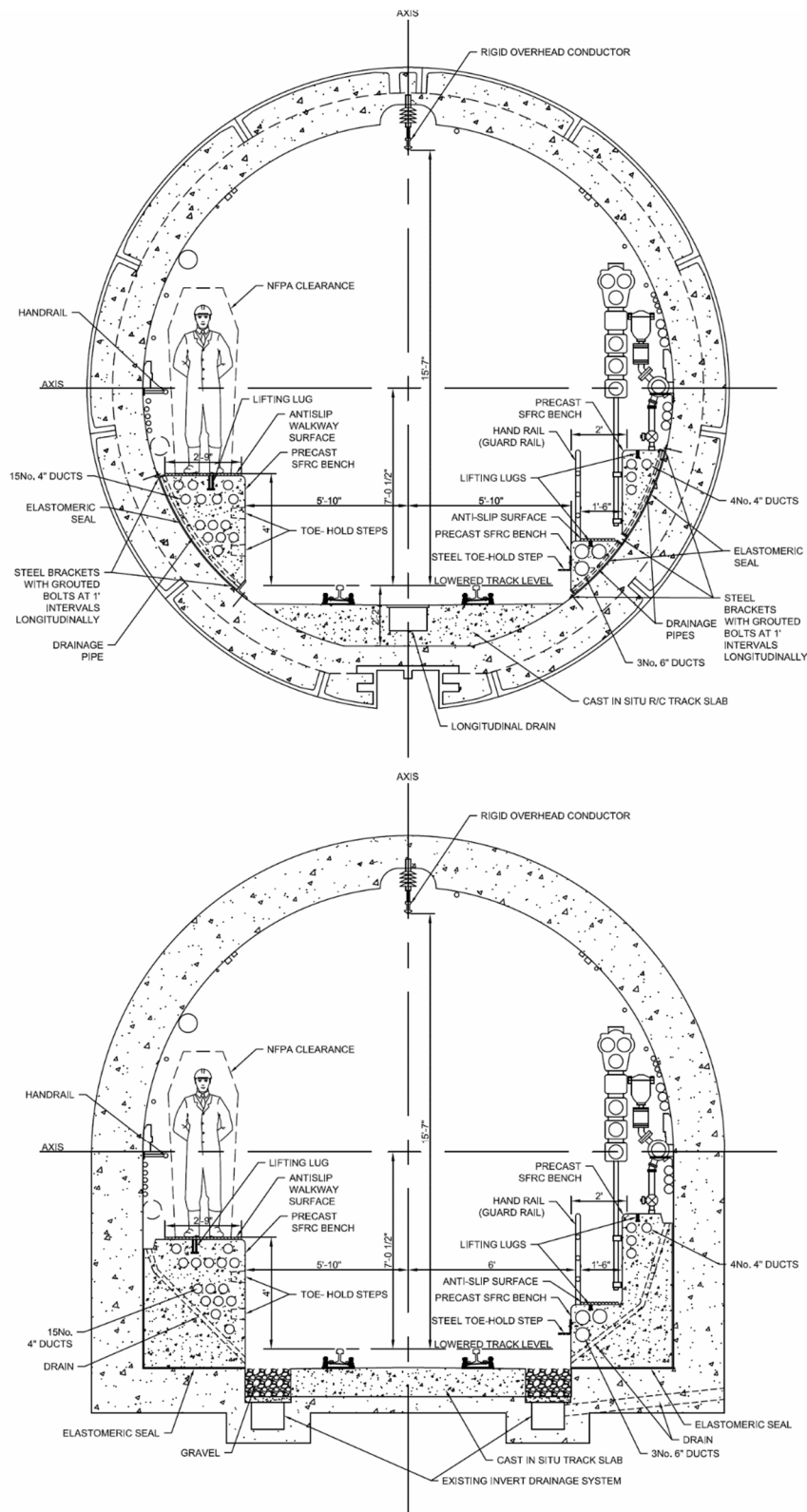

Figure A2.4: Demolish existing concrete benches & replace with pre-cast SFRC benches

A2.5 Demolish the Existing Concrete Bench Walls and Replace with Fire Resistant GRP Boxes and Conventional Ducts Mounted on Steel Hanger Brackets

The existing concrete benches in this option are completely demolished and replaced by fire retardant Glass-Reinforced Plastic (GRP) or steel box units (internally lagged with 2½ inches of fire-resistant material) and fixed directly to the internal face of the tunnel lining. The box units enclose conventional longitudinal cable ducts spaced at 4-inch air gaps along steel or other suitable NFPA130 fire-rated hangers that are also fixed to the tunnel lining (see *Figure A2.5*).

The existing benches would be removed in the same way as described in the previous options and the exposed tunnel lining similarly repaired, although a high-quality finish to the repairs and re-profiling will not be so necessary. Following the removal of the benches the cable or cable duct hangers are anchored to the tunnel lining using grouted bolts. The longer hangers on the walkway side of the bored tunnel will require additional vertical bracing. Once the hangers have been fixed in place and the cables or the cable ducts are mounted on them, the box sections can be lowered into place using hydraulic lifting gear mounted to the flatbed of the engineering train carrying the units and manhandled to be fixed to the tunnel sidewalls and base using anchored brackets.

The box sections will necessarily require some form of lapping joint between adjacent sections to ensure accurate sealing and continuity of the bench profiles. Some flexibility in the joints should take up the slight difference in the vertical curve alignment of the tunnel between the box units. Similarly, the longitudinal gaps between the box units and the tunnel lining and base will need to be suitably lagged and sealed. This may present some difficulty in providing drainage of water seepage from above and behind the sealed box sections, however this is expected to be slight and water will naturally flow towards the low point of the tunnel where it can be intercepted. Special, easily demountable box sections can be manufactured for installation at cable splicing locations.

Since the box sections will provide only very limited impact resistance against train derailment, anti-derailment measures may need to be incorporated in the track.

Advantages:

- High quality product achievable by manufacturing in a specialist factory using well-established technology
- Long life expectancy with minimal maintenance
- Rapid bulk demolition of the existing concrete benches using remotely operated pneumatic and hydraulic tools
- Rapid installation of relatively lightweight modular box units
- Good fire protection of cables in ducts
- Lightweight box sections can be easily demountable for access to cable ducts or replacement following damage

Disadvantages:

- May be insufficient space in the bored tunnel section to carry all of the required cable ducts
- May require anti-derailment in the track bed
- Some labour-intensive activities requiring hand tools
- Possible damage to the tunnel lining behind the benches during demolition
- Re-profiling and possible repair of the tunnel lining required before installation of the duct hanger frame and box units
- GRP may lose structural strength during a severe fire
- HV cables will be pulled in short lengths not laid in long lengths

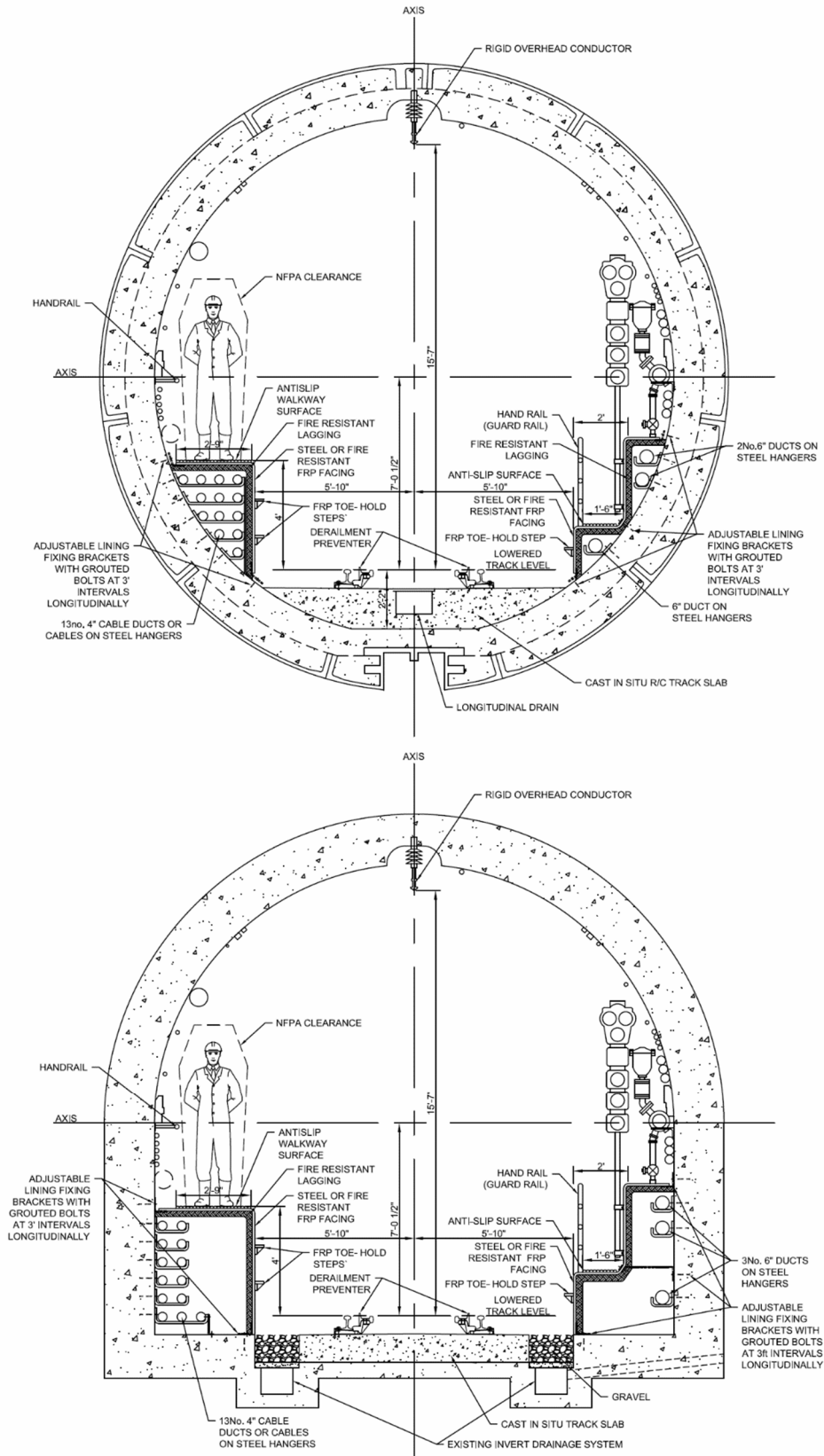

Figure A2.5 Demolish the existing concrete benches & replace with fire resistant GRP or steel boxes & conventional ducts mounted on steel hanger brackets

A2.6 Demolish the Existing Concrete Bench Walls and Replace with Fire Resistant Bench Wall Facings and Ducts

A variation of the fire-resistant box option described in Appendix 2.4, the existing concrete benches in this option are again completely demolished and replaced by fire-retardant GRP box units. However, rather than enclosing conventional cable ducts mounted on hangers fixed to the internal face of the tunnel lining, the ducts are themselves extruded fire-resistant square profile GRP tubes that are bonded to the fire-resistant GRP box. Additional fire protection is provided by smaller fire-retardant GRP tubes that are filled with fire-resistant lagging that completely surround each cable duct (see *Figure A2.6*). The GRP tubes will also provide extra rigidity and strength to the box unit.

The existing benches would be removed in the same way as described in previous sections and the exposed tunnel lining similarly repaired, although a high-quality finish to the repairs and re-profiling will not be so necessary. The fire-retardant GRP box sections can be lowered into place using hydraulic lifting gear mounted to the flatbed of the engineering train carrying the units and manhandled to be fixed to the tunnel sidewalls and base using anchored brackets.

The cable duct tubes are offset longitudinally by several inches, protruding out of one end of the unit so that longitudinal bonding and continuity of the fire protection is achieved by slotting the protruding ends of the cable ducts into the corresponding sockets left in the opposite face of the already installed unit, rather like Lego blocks. Some flexibility in the joints should take up the slight difference in the vertical curve alignment of the tunnel between the box units.

Since there will be no need to seal the small gap between the units and the tunnel lining and base, it will allow water to freely flow to the invert drainage system.

Special easily demountable box sections, probably similar to that for the previous option (See *Appendix 2.4*), can be manufactured for installation at cable splicing locations. However, the GRP box sections will provide only very limited impact resistance against train derailment, so anti-derailment measures may need to be incorporated in the track.

Advantages:

- High quality product achievable by manufacturing in a specialist factory using well-established technology
- Long life expectancy with minimal maintenance
- Rapid bulk demolition of the existing concrete bench walls using remotely operated pneumatic and hydraulic tools
- Less need for high quality concrete finish on lining
- Rapid installation of relatively lightweight modular GRP units
- Potentially good fire protection of cables in ducts
- Could accommodate all the required cable ducts
- Free draining behind the units

Disadvantages:

- May lose structural strength during a severe fire
- May be difficult to install new units if badly damaged
- May require anti-derailment in the track bed
- Some labour-intensive activities requiring hand tools
- Possible damage to the tunnel lining behind the bench walls during demolition.
- Re-profiling and possible repair of the tunnel lining required before installation of the GRP box units
- HV cables will be pulled in short lengths not laid in long lengths

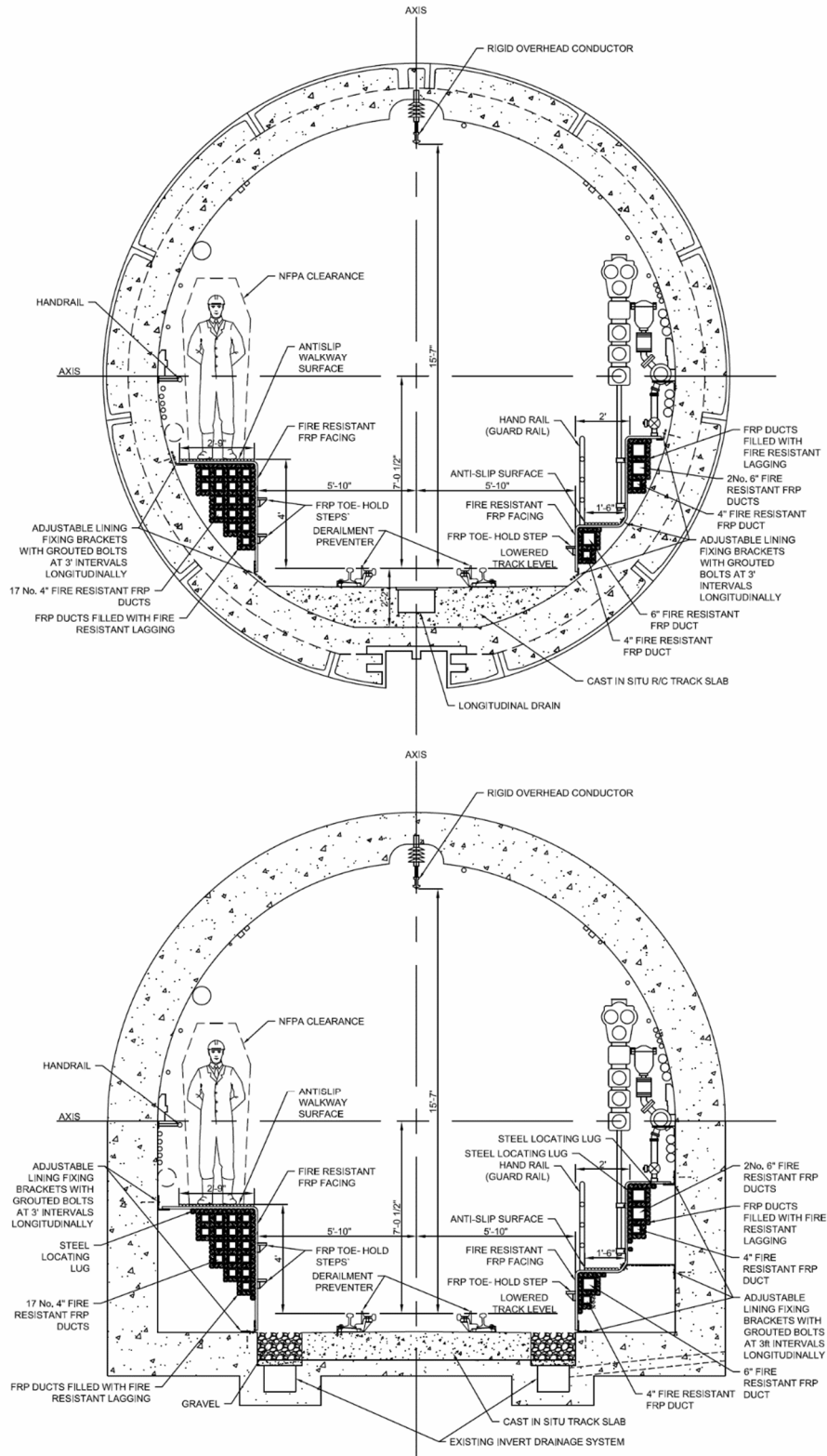

Figure A2.6: Demolish the existing concrete benches & replace with fire-resistant bench facings and ducts

A2.7 Demolish the Existing Concrete Bench Walls and Replace with Cantilevered Steel Walkways and Conventional Ducts Mounted on Steel Hanger Brackets

The most basic option for concrete bench wall replacement would be to replace them after demolition with a simple steel cantilevered walkway and a maintenance platform anchored to the tunnel lining. The cables or cable ducts would then either be fixed directly to the tunnel lining or mounted on steel hangers anchored to the sidewalls and supported by vertical steel struts below the walkway (see *Figure A2.7*).

The existing benches would be removed in the same way as described in previous sections and the exposed tunnel lining similarly repaired, although a high-quality finish to the repairs and re-profiling will not be so necessary. Following the removal of the benches the steel cable duct hangers are anchored to the tunnel lining using grouted bolts and the sections of the cable ducts mounted on them.

The steel walkway and platform sections can then be lifted into place using hydraulic lifting gear mounted to the flatbed of the engineering train carrying the units and manhandled to be fixed to the tunnel sidewalls and base using grouted anchors. Individual walkway and maintenance platform units are simply bolted together longitudinally.

Flexibility in the joints should accommodate the slight difference in the vertical curve alignment of the tunnel between the walkway and maintenance platform units.

This will be a completely “open” arrangement and will allow water to freely flow to the invert drainage system and a simple demountable box covering will be required at cable splicing locations.

Since the walkways and maintenance platforms will provide very little impact resistance against train derailment, anti-derailment measures may need to be incorporated in the track.

Since the cable ducts will be completely exposed in the tunnel, there will be little opportunity to provide fire protection.

Advantages:

- High-quality product achievable by manufacturing in a specialist factory using well-established technology
- Long life expectancy but will require routine maintenance
- Damaged or deteriorated units are easily replaced
- Rapid bulk demolition of the existing concrete bench walls using remotely operated pneumatic and hydraulic tools
- Rapid installation of relatively lightweight steel units
- Could accommodate all the required cable ducts
- Free draining
- Easy access to the cable ducts and cables-HV cables laid not pulled
- Likely to be the least expensive option

Disadvantages:

- No fire protection of exposed cables or cables in ducts
- May require anti-derailment in the track bed
- Some labour-intensive activities requiring hand tools
- Possible damage to the tunnel lining behind the bench walls during demolition
- Re-profiling and possible repair of the tunnel lining required before installation of the hangers, walkway and maintenance platform

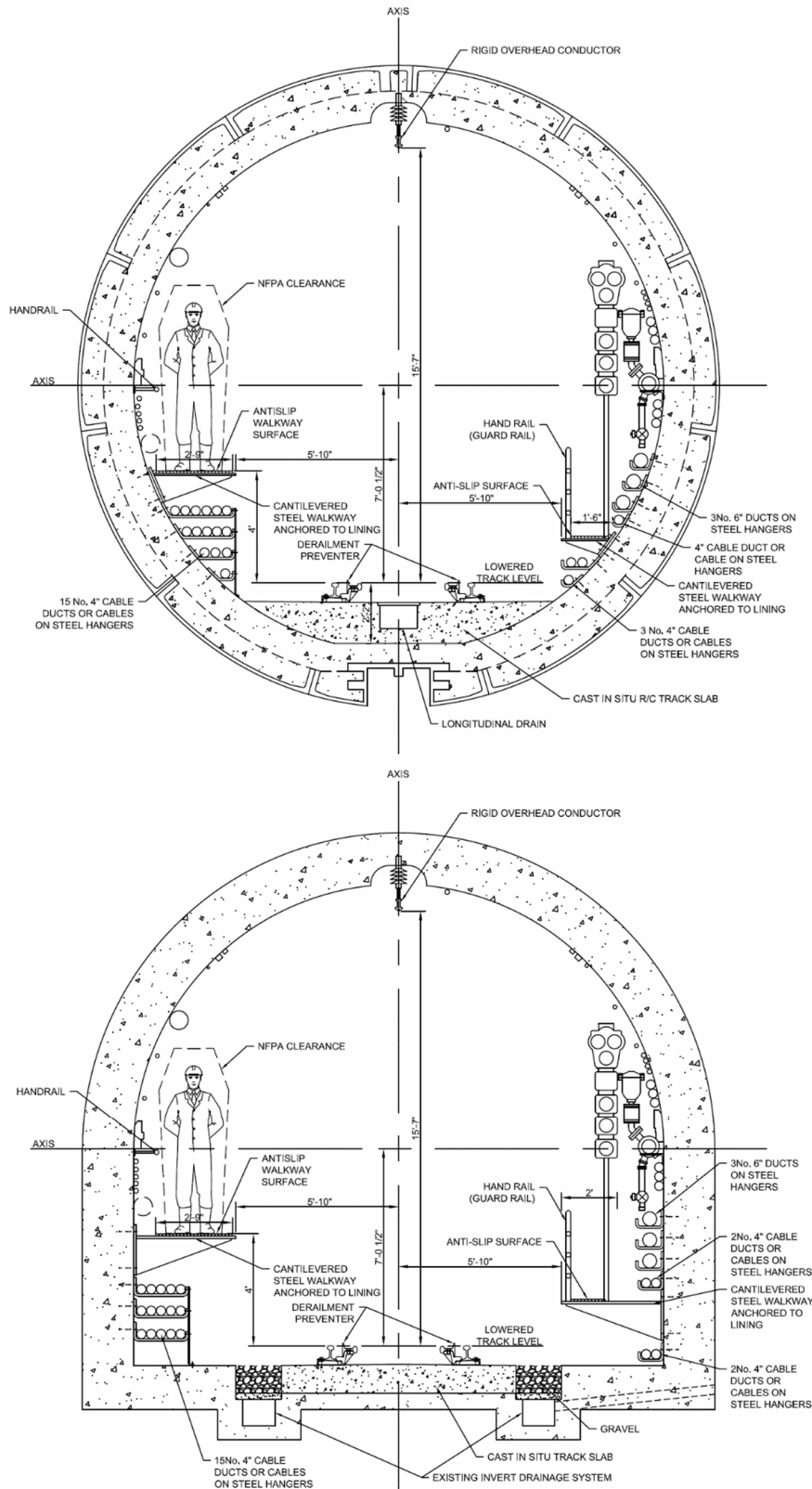

Figure A2.7: Demolish the existing concrete benches & replace with cantilevered steel walkways & conventional ducts mounted on steel hanger brackets (note that the P/C track slab includes anti-derailment measures).

A2.8 Demolish the Existing Concrete Bench Walls and Replace with Steel Walkways and Maintenance Platforms with Cables or Cable Ducts Mounted on Steel Hanger Brackets with Critical Cables Contained in a Fire-Proof Box Below the Walkway

This option is similar to that described in Appendix 2.6 above, but in this instance a fire-proof box is installed directly below the walkway containing critical cables (here 4No. cables are shown). The fire-proof box duct is mounted on steel hangers fixed to the tunnel sidewall and supported by vertical struts (see *Figure A2.8*). It comprises open-ended, square steel box sections internally lagged with 2½ inches of fire-resistant material and connected laterally by bolted steel flanges to form a continuous duct. The design would necessarily be fireproofed and physically robust to meet NFPA130 and fixed to the internal face of the tunnel lining.

Once the steel walkway is installed, access can be gained to the top of the box by lifting the walkway panels by means of hinges along the rear of the walkway. It may even be possible to incorporate the walkway itself into the design of the fire-proof box sections as the upper lid, in which case the steel box would provide additional support to the walkway. By simply lifting the walkway lids, the cables can then be laid along the duct with 4-inch air gaps between cables, supported internally on a framework and fixed in place by cleating. In the same fashion, the cables can be readily maintained or replaced.

Advantages:

- High-quality product achievable by manufacturing in a specialist factory using well-established technology
- Long life expectancy but will require routine maintenance
- Damaged or deteriorated units are easily replaced
- Rapid bulk demolition of the existing concrete bench walls using remotely operated pneumatic and hydraulic tools
- Rapid installation of relatively lightweight steel units
- Provides very good fire protection to critical cables
- Free draining
- Easy access to the open cable ducts and cables mounted on hangers
- HV cables laid not pulled
- Likely to be a low-cost option

Disadvantages:

- May be insufficient space in the bored tunnel section to carry all of the required cable ducts
- No fire protection of cables or cable ducts mounted on hangers
- May require anti-derailment in the track bed
- Some labour-intensive activities requiring hand tools
- Possible damage to the tunnel lining behind the bench walls during demolition
- Re-profiling and possible repair of the tunnel lining required before installation of the duct hangers, walkway and maintenance platform

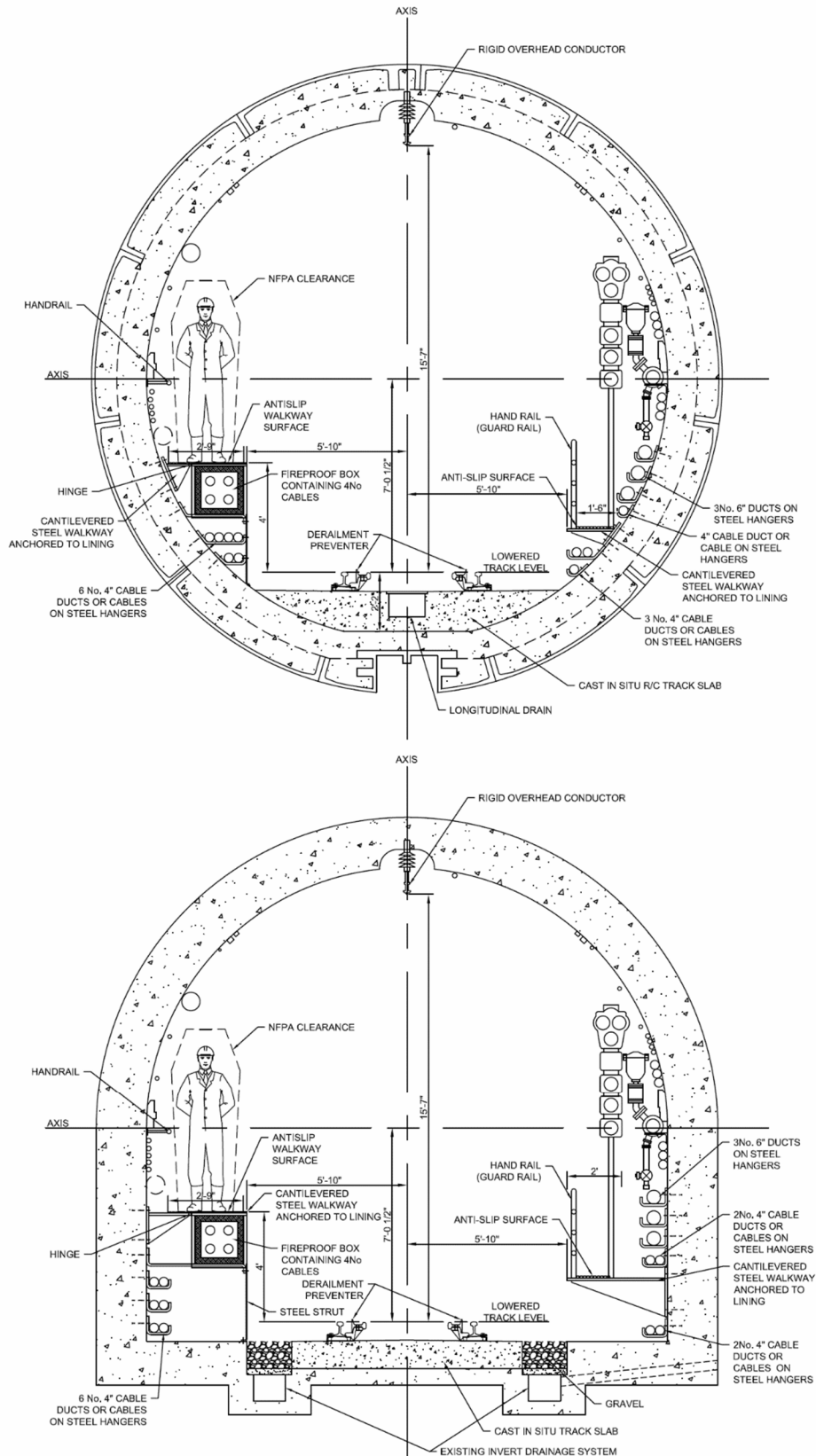

Figure A2.8: Demolish the existing concrete benches and replace with steel walkways and maintenance platforms with cables or cable ducts mounted on steel hanger brackets with critical cables contained in a fire-proof box below the walkway.

A2.9 Fire Resistant Ducting

An example of suitable fire resistant cable ducting is the Flamebar BW18 fire resistant HV cable enclosure, which was developed to meet standard BS8519: 2010, "Inclusion of new and revised technical guidance relating to the selection and installation of fire resistant cables and systems for life safety and fire-fighting applications." and is shown in Figure A2.9 below:

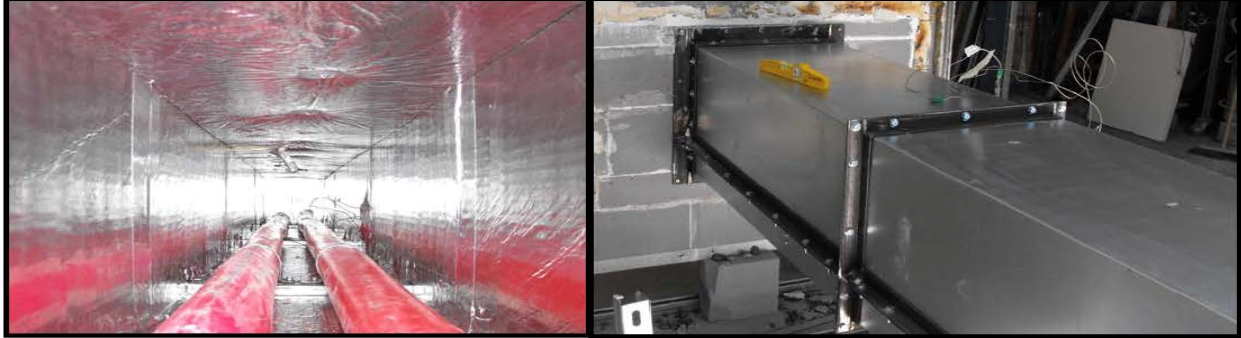

Figure A2.9 This is one example of a ducting system which could be used if it is required.

Effective since February 2010, this was introduced specifically to apply only to large and complex buildings. The new standard offers guidance for the fire-resistant power and control cables in life safety and firefighting systems such as smoke barriers, smoke extract systems, pressurisation systems, sprinkler systems, firefighting and evacuation lift supplies.

Consequently, BS 8519: 2010 should increase protection of emergency and fire personnel, as well as evacuees who may be inside a large or complex building when fire breaks out. The fire enclosure is required to prevent the potential adverse effects caused by heat gain to the cables. The surface of the cables inside the enclosure should not exceed 180°C above the initial ambient temperature to ensure reliable operation.

When a cable is involved in a fire, the temperature could rise above the maximum conductor temperature, upon which tabulated current rating and voltage drop data are based. The enclosure and supports are all constructed to retain stability and insulation throughout the 120 minutes duration of the fire.

APPENDIX 3 - RAIL INFRASTRUCTURE DRAWINGS

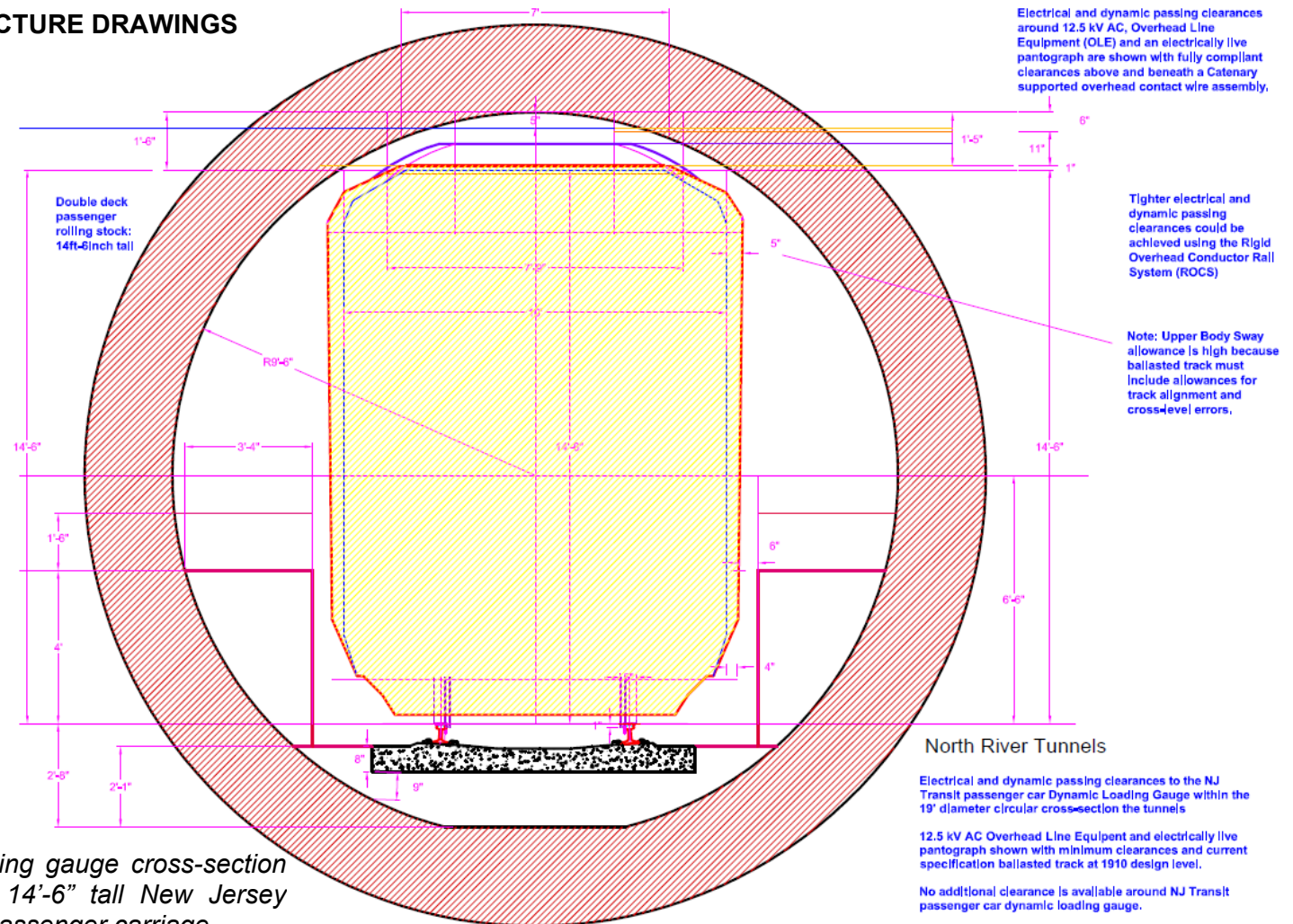

Figure A3.1: Estimated static loading gauge cross-section for a 10'-0" wide x 14'-6" tall New Jersey Transit double deck passenger carriage

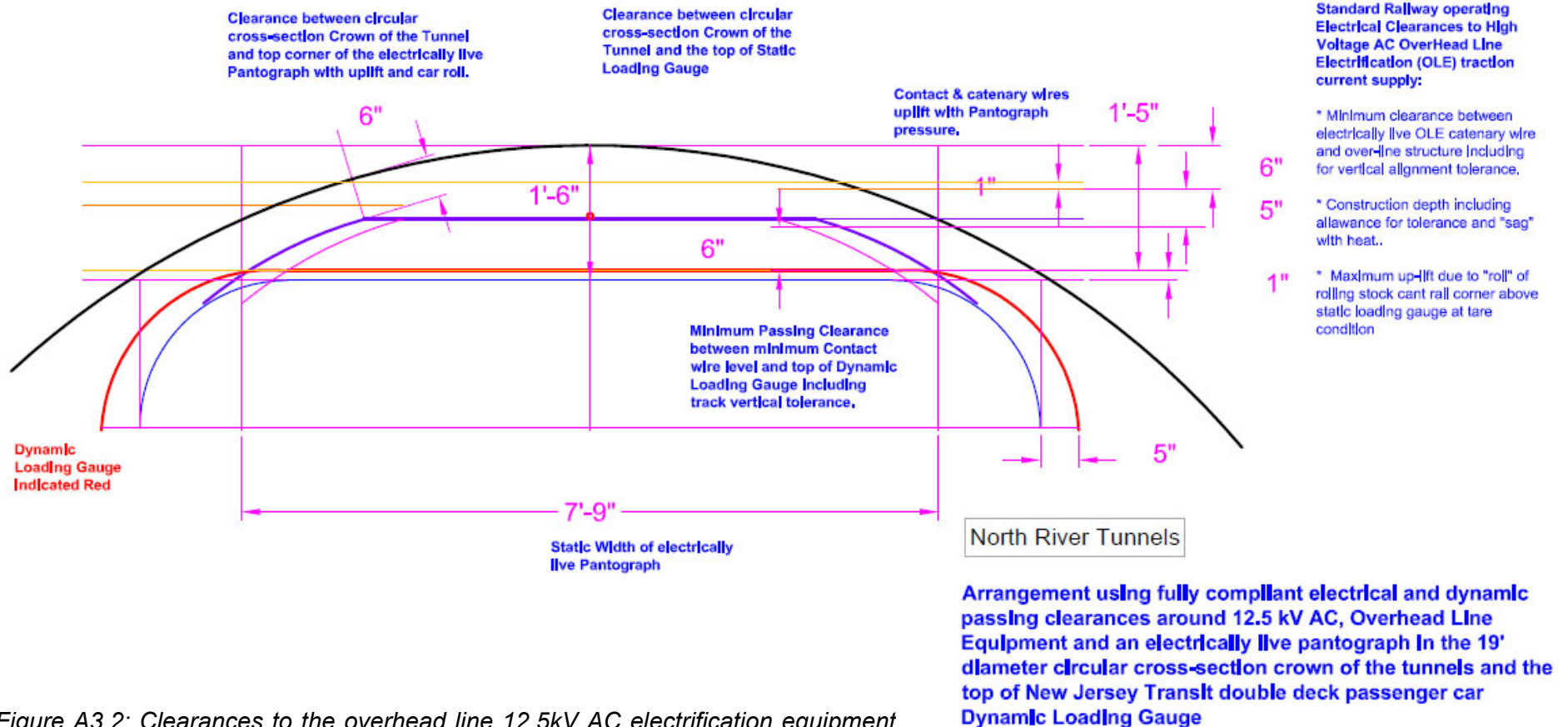

Figure A3.2: Clearances to the overhead line 12.5kV AC electrification equipment (OLE) and rail vehicle pantograph

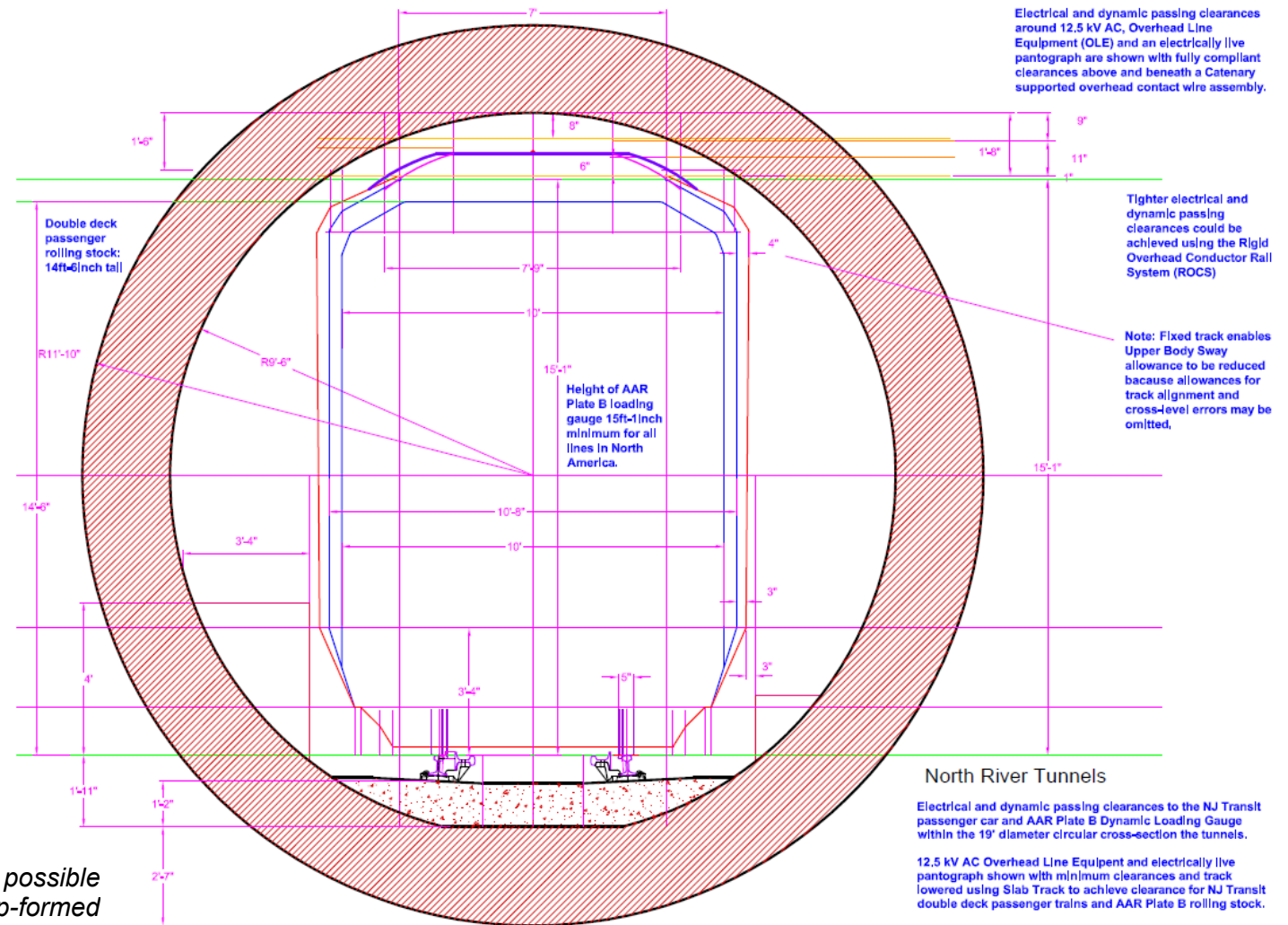

Figure A3.3: Track lowering and possible arrangement for slip-formed slab track

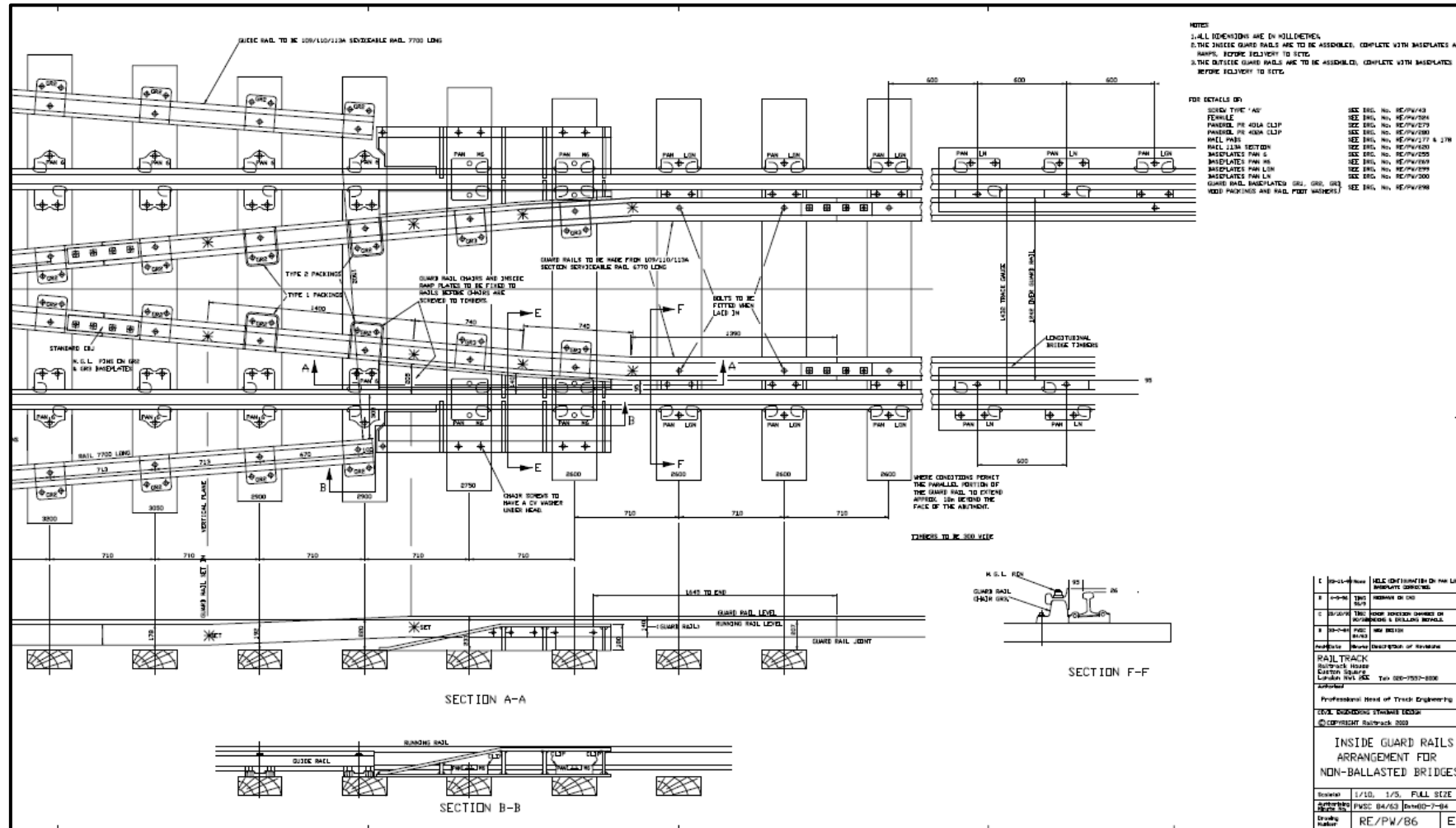

Figure A3.4: Continuous Checking Guard Rail

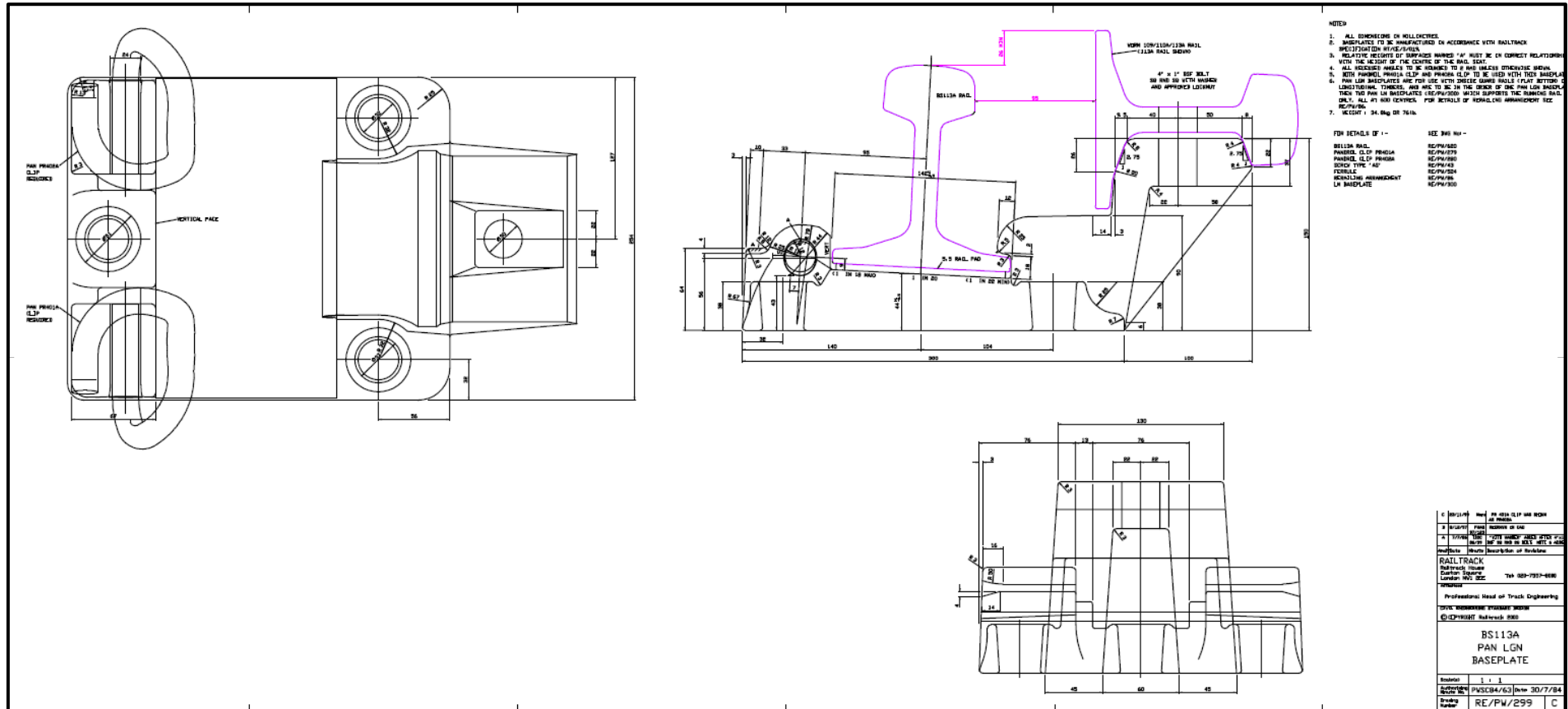

Figure A3.5: Baseplate

APPENDIX 4 - BENCH DEMOLITION AND REINSTATEMENT METHODOLOGY**A4.1 Detailed Approach**

The objective is to safely and efficiently remove and replace the large benches in the NRT tubes during weekend outages. In this appendix, the outline methodologies are described, all of which will require detailed examination, and proving either by pilot studies in the tunnel or by mock-ups and testing on the surface. This is described in more detail in Section 10.13 Implementation and Section 11.5.3 Risk - Advance Preparation.

In the main, the bench structures are cast in place mass concrete with a number of horizontal cold joints and incorporating a significant quantity of continuous linear voids. In the circular bored tunnel, the benches have been formed against a cast in place concrete circular secondary lining and the junction formed may be an adverse curved cold joint. The bench concrete shows signs of long-term chemical attack.

It is considered that the benches are generally not competent enough for removal as intact sections and that demolition in place is the most reliable approach. Most options require full demolition but two options which only partially demolish the benches are considered.

The benches occupy most of the lower half of the tunnel outside the structure gauge. In the upper half of the tunnel, there is a limited amount of space above the benches outside the structure gauge. Removing the concrete from above is possible but constrained by the curved tunnel profile overhead.

Removal by utilising the full structure gauge down to track level will offer maximum flexibility for demolition in place.

The overall volume of material in the bench will expand as a consequence of being broken up but will become easier to handle. A bulking factor has been assumed taking account of the voids already existing in the concrete. Given the limited space available within the tube, it is preferable to remove this material before the resumption of time tabled service.

The installation of a full-length temporary tunnel conveyor for continuous removal of arisings during outages is not considered feasible.

It is considered that spoil should be stored temporarily within the tunnel as it arises and removed at the end of the outage. It is also considered preferable that demolition arisings are loaded out in the opposite direction to the advancing face of concrete breaking.

Installation of new bench elements follows demolition and loading out. It is at this juncture that the need, if any, for trimming of the exposed surface is determined. As with spoil removal, intermittent transport of new materials within the outage is not considered efficient and all elements planned for installation should be taken to the workplace at the start of the shift.

Therefore, it is considered that the process of demolition, spoil removal and the bench reinstatement should be integrated into a single system that can be located on a fully equipped works train which enters the tube and returns to the works rail head at the start and end of each start

A4.2 Performance of the System (i.e. the fully equipped works train)

There are three components to the removal of the existing concrete benches i.e. demolition, loading of the demolished material and reinstatement of the bench using one of the options described Appendix 2 – Civil Works above. The relevant constraints are:

1. **Demolition** can only proceed if the equipment is in place, serviceable and the “target area” for demolition is available.

2. **Loading out** can proceed if demolition arisings are available and can be loaded and stored on the works train
3. **Reinstatement** can proceed if the materials are available and the “target area” is prepared.

If demolition does not occur, the whole cycle cannot proceed. If loading out fails, spoil accumulates in the tunnel tube, reinstatement cannot proceed, and resumption of planned railway service is jeopardised. Contingent provision should be planned for the eventuality that reinstatement phase falters. Spoil handling and removal is the critical factor in the process.

A suitable works train assembly comprising of rail mounted wagons and loading plant for the temporary storage of demolition spoil during any shift as well as the provision of the bench replacement units to suit this whole cycle approach has been identified.

A4.3 Plant and Equipment

A suitable works train includes the following items (see *Figures 4.1 to 4.9*):

- Plant Car 1 no 89' heavy duty flat car mounted with 1no. 2t gantry crane and 2no. nominal 90" davits.
- Conveyor and reinstatement car (see *Figure A4.3*)
- 1no. 89' heavy duty flat mounted with an extendable 24" spoil conveyor and materials handling equipment for installing replacement bench elements.
- Spoil Car
- 1no. 53' well car carrying 5no. 10' heavy duty half height stone transit containers.

Other plant and equipment to be carried on the plant car includes as follows:

- 1no. S70 skid steer loader or equivalent plus spare (see *Figure A4.7 and A4.8*)
- 1no. Brokk 70 or equivalent fitted with hydraulic breaker and additional milling head (see *Figure A4.9*)
- 4no. steel rail plates 96" x 76" x 1/2" and 16no steel side plates 48" x 28" x 3/8"
- 1no. portable generator c50kW tbc
- 1no. 100ft³ header tank with 1no.DB-30 Spray Cannon (see *Appendix A5* concerned with Dust Control)
- 1no. 2" electric diaphragm pump with 1no 100ft³ return tank.

It is anticipated that the permanent tunnel fans will be used to provide forced air ventilation during each outage with supplementary air movers used locally within the work area as required.

The works train will be configured such that the spoil conveyor is on the opposite side to the bench intended for demolition and reinstatement.

A4.4 Detailed Sequence of Operations

The sequence of operations in the tunnel proposed by LBA is as follows:

- Whole works train enters the tunnel until the lifting davits (fixed crane that swivels) are abreast of the temporary walkway bridge.
- The bridge is lifted on board the plant car and stowed together with the davits.
- The whole train 'inches forward' until the outside rear of the conveyor car is approximately 2' in arrears of the leading edge of the remaining existing bench to be demolished.
- The plant car is uncoupled and advances approximately 10'



- 1no. rail plate and 4no. side plates are unloaded in turn by the gantry crane. The rail plate is placed centrally on the track. The side plates are placed on opposite flanks butting up to the base of the existing bench to cover the first 8' of the demolition.
- The "stop end", secured at the leading edge of the cut bench at the end of the previous shift, is removed and stowed on the plant car.
- The plant car repeats the advance and unload stage, in increments of 8', until all rail plates and side plates are in place. The plant car is then secured at a stand for the shift.
- The skid steer loader is placed on the rail plate deck by the gantry crane. The loader travels to the outside rear of the conveyor car and steers to face the demolition bench.
- The breaker machine is placed on the steel deck and travels to the leading edge of the remaining bench where it is set up to start demolition.
- The dust cannon and the return diaphragm pump are set up at the rear end of the plant car.
- At the same time, the rear section of the spoil conveyor is extended to a position above the empty stone containers in the well car.
- Work to install the new bench elements starts and proceeds from the bed of the conveyor and reinstatement car.
- Once the breaker has demolished a length of bench sufficient to enable the skid loader to turn to the conveyor car', the breaker advances to continue demolition and the skid steer starts to load out the arisings onto the spoil conveyor.
- Operations proceed in this manner until the target length of bench has been demolished.
- The dust cannon and diaphragm pump are demobilised.
- The breaker machine and skid loader are raised in turn to the bed of the plant car and secured for transit.
- The ¾" plywood profiled stop end is placed at the leading edge of the cut bench and secured in place by steel L brackets bolted to the face of the bench.
- The plant car gantry raises the forward rail plate and places it on the bed of the car approximately 10' from the rear with the side plates placed on the bed ahead of it.
- The car retreats to the next plate and stacks it on top of the plate already in the bed of the car. The remaining plates are stowed in a similar configuration at the rear of the flatcar.
- Reinstatement works are brought to an orderly close, the spoil conveyor is retracted from over the well car and secured for transit.
- The plant car recouples with the rest of the works train. The whole train retreats until the stowed temporary bridge is abreast of the discontinuity between the existing bench and the new installed section.
- The temporary bridge is placed adjacent to the davits and then secured for transit. The whole works train the leaves the tunnel tube.

The following plant and equipment will be required:

Rail Plant

- 89' Heavy Duty Flatcar
- 53' Well Car
- Half Height ISO Containers

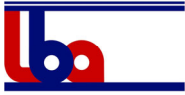

Civil Plant

- 2t Gantry Crane
- 24" Spoil Conveyor
- S70 Skid Steer Loader plus 1no spare
- Brokk 70

Power Plant

- c50kW Generator tbc.

Ancillary equipment

- Dust Cannon
- Diaphragm Pump

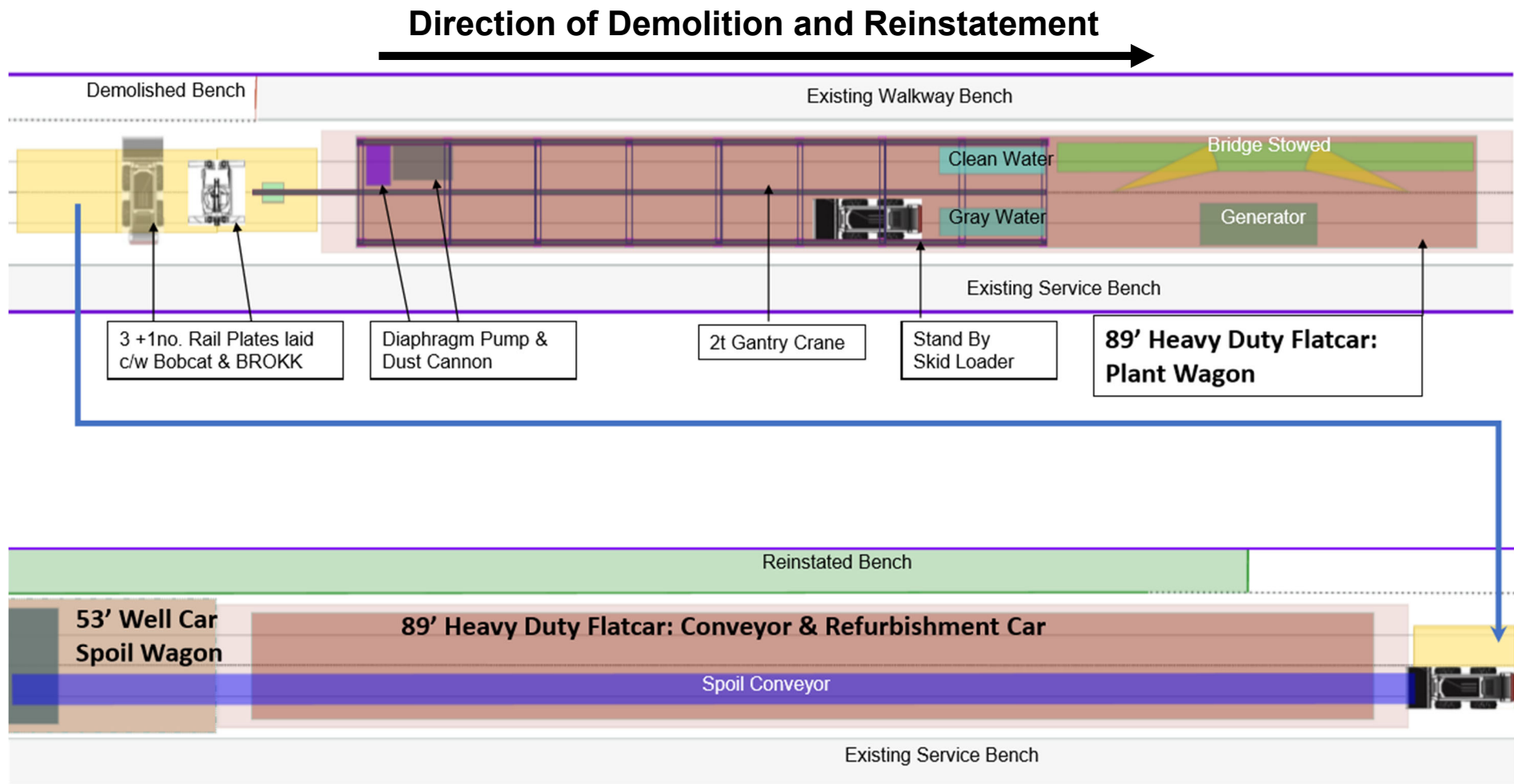

Figure A4.1 – Works train in operational mode

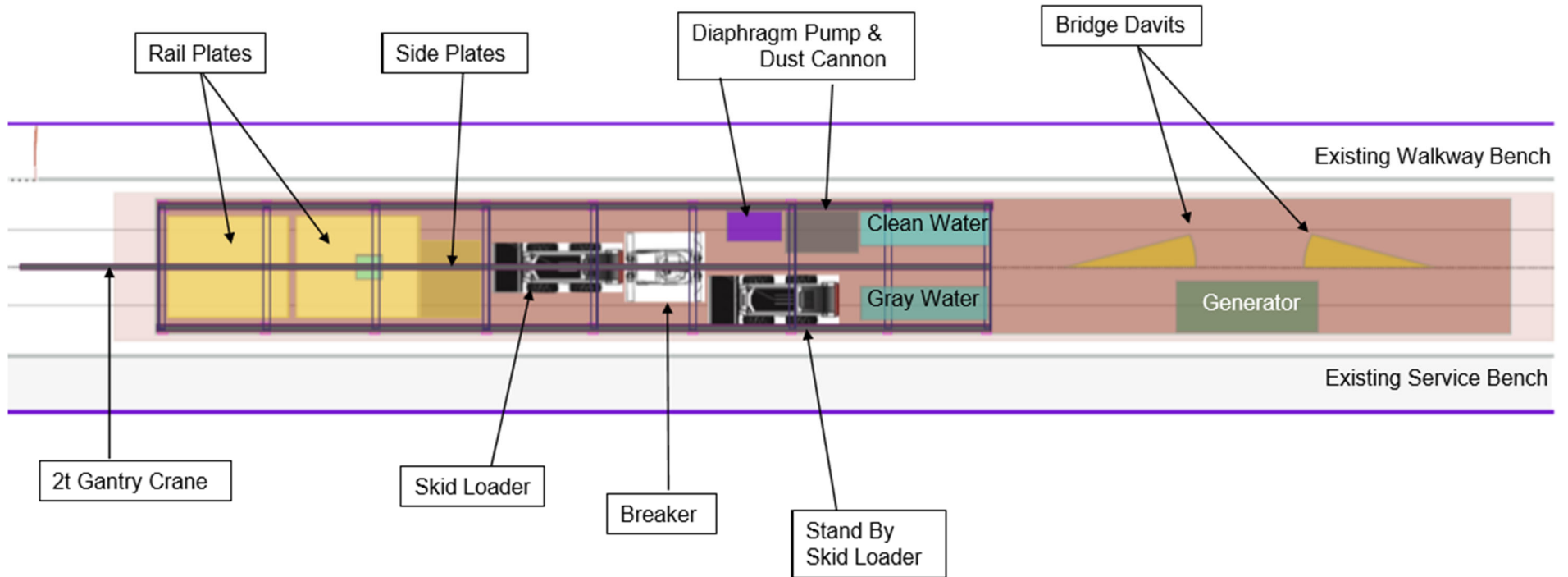

Figure A4.2 – Plant car in transit mode

89' HEAVY-DUTY FLATCAR

This 89'-4" flat car is equipped with a flat steel floor, stake pockets, fixed winches, lading anchors and chain tie-down channels. Trucks have 110-ton nominal capacity, allowing this car optimal use in heavy industrial applications. This car can be configured with wood risers or chains based on customer requirements.

DIMENSIONS (APPROX.)	
Length, inside	89'-4"
Length, over couplers	94'-8"
Height, inside	N/A
Height, extreme	N/A
Clearance	AAR Plate C
Width, inside	8'-4"
Width, extreme	9'-3"
Door opening, width	N/A
Height, top of rail to threshold	3'-7 5/8"

WEIGHT/CAPACITY (EST.)	
Light weight	83,000 lbs.
Capacity/Load limit	203,000 lbs.
Gross rail load	286,000 lbs.

CURVE NEGOTIABILITY RADIUS	
Uncoupled	180'
Coupled to base car	345'
Coupled to like car	239'



THE GREENBRIER COMPANIES
One Centerpointe Drive, Suite 200
Lake Oswego, Oregon 97035
sales.info@gbrx.com

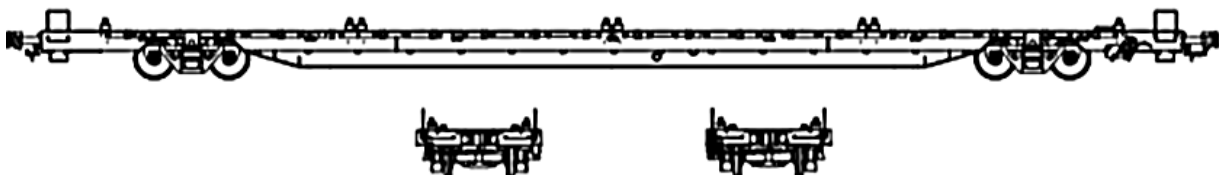

Figure A4.3 - 89' Heavy Duty Flatcar

53' ALL-PURPOSE HUSKY STACK

The 53' all-purpose double-stack well car is a single unit designed to maximize flexibility. It can carry either containers or trailers with ease. This car has a 53' well to accommodate containers from 20' to 53' long, as well as containers from 40' to 53' long in the top position. Additionally, the AP53 can accommodate two 28' pup trailers or one long trailer up to 57' long. Each car is capable of carrying nose-mounted containers or trailer refrigeration units and can be operated as a single car or be configured as a multiple-unit drawbar car.

DIMENSIONS (APPROX.)

Length, inside	53'-1 3/8"
Length, over couplers	76'-9 1/4"
Height, inside	N/A
Height, extreme	N/A
Clearance	AAR Plate H
Width, inside	8'-9 3/16"
Width, extreme	9'-11 15/16"
Door opening, width	N/A
Height, top of rail to threshold	N/A

WEIGHT/CAPACITY (EST.)

Light weight	55,000 lbs.
Capacity/Load limit	165,000 lbs.
Gross rail load	220,000 lbs.

CURVE NEGOTIABILITY RADIUS

Uncoupled	180'
Coupled to base car	300'
Coupled to like car	304'



THE GREENBRIER COMPANIES
One Centerpointe Drive, Suite 200
Lake Oswego, Oregon 97035
sales.info@gbrx.com

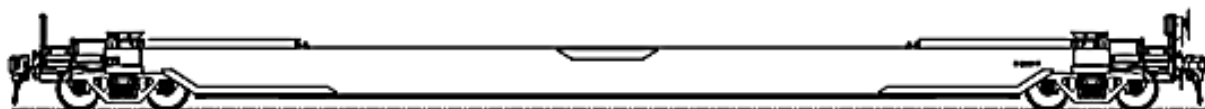
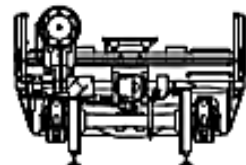

Figure A4.4 - 53' Well Car



These containers, which are made mostly of steel, are half the height of full-sized containers. They are used especially for coal, stones etc., which need easy loading and unloading.

SPECS

Units: US Metric

Product Description	External Length	External Width	External Height	Internal Length	Internal Width	Internal Height	Tare Weight	Payload	Maximum Gross Weight
Half Height Container	10 (ft)	8 (ft)	5 (ft)	9 (ft)	7 (ft)	3 (ft)	3748 (lbs)	18298 (lbs)	22046 (lbs)
Half Height Container	10 (ft)	8 (ft)	5 (ft)	9 (ft)	7 (ft)	3 (ft)	4806 (lbs)	22752 (lbs)	27558 (lbs)
Half Height Container	15 (ft)	8 (ft)	5 (ft)	14 (ft)	7 (ft)	3 (ft)	6526 (lbs)	22796 (lbs)	29321 (lbs)
Half Height Container	20 (ft)	8 (ft)	5 (ft)	19 (ft)	7 (ft)	3 (ft)	8201 (lbs)	22223 (lbs)	30424 (lbs)
Half Height Container	23 (ft)	8 (ft)	5 (ft)	22 (ft)	7 (ft)	3 (ft)	9182 (lbs)	23887 (lbs)	33069 (lbs)
Half Height Container	23 (ft)	8 (ft)	5 (ft)	22 (ft)	7 (ft)	3 (ft)	9182 (lbs)	23887 (lbs)	33069 (lbs)
Half Height Container	30 (ft)	8 (ft)	5 (ft)	30 (ft)	7 (ft)	3 (ft)	14451 (lbs)	34050 (lbs)	48502 (lbs)

Figure A4.5 - Half Height Containers

TECHNICAL DATA SHEET

EK600

EASIKIT



BASE TENSION UNIT
(Tail)

4' (1.2m) SECTION
(Short)

8' (2.4m) SECTION
(Long)

HEAD DRIVE UNIT
(Head)

EK600 SECTIONS	Length (in)	Width (in)	Height (in)	Weight (lb)
Head Unit without motor (H)	59 1/2"	36 1/2"	11 1/2"	188
Head Unit with 3kW motor	60"	40"	12"	265
Base Tension Unit (T)	60 3/4"	30"	11 1/2"	180
4' (1.2m) Section	53"	24 1/2"	11 1/2"	90
8' (2.4m) Section	100 1/2"	24 1/2"	11 1/2"	175
Small Steel Hopper	31"	33 1/2"	12"	35
Medium Steel Hopper	37"	37"	20"	66

Length	Conveyor Section Combinations				Approx. Belt Length (ft)	Weight (lb)*
	Tail	Short	Long	Head		
9' (2.86m)	1	-	-	1	20' (6.1m)	525
13' (4.06m)	1	1	-	1	28' (8.5m)	642
17' (5.26m)	1	-	1	1	36' (10.9m)	756
21' (6.46m)	1	1	1	1	44' (13.3m)	873
25' (7.66m)	1	-	2	1	52' (15.7m)	988
29' (8.86m)	1	1	2	1	60' (18.1m)	1,105
33' (10.06m)	1	-	3	1	68' (20.5m)	1,220
37' (11.26m)	1	1	3	1	75' (22.9m)	1,336
41' (12.46m)	1	-	4	1	83' (25.3m)	1,450
45' (13.66m)	1	1	4	1	91' (27.7m)	1,568
49' (14.86m)	1	-	5	1	99' (30.1m)	1,682
Snub drum unit and 4kW 415v motor for lengths of 16.06m and over						
53' (16.06m)	1	1	5	1	107' (32.6m)	1,924
57' (17.26m)	1	-	6	1	115' (35m)	2,040
61' (18.46m)	1	1	6	1	123' (37.4m)	2,156
65' (19.66m)	1	-	7	1	131' (39.8m)	2,271
69' (20.86m)	1	1	7	1	139' (42.2m)	2,388
73' (22.06m)	1	-	8	1	146' (44.6m)	2,502
77' (23.26m)	1	1	8	1	154' (47m)	2,619
81' (24.46m)	1	-	9	1	162' (49.4m)	2,734
85' (25.66m)	1	1	9	1	170' (51.8m)	2,851
LONGER COMBINATIONS AVAILABLE						

*Weights provided include plain belt and motor; Allow 3.3' (1m) extra belt length for vulcanized belt joints; Maximum length of conveyor depends on application.

High Performance Modular Conveyors

EASIKIT modular conveyor systems offer an adaptable solution for virtually any application, being assembled with standard components and built to project-specific requirements.

- Same-Day Quotations
- Availability from Stock
- Supplied Ready-to-Assemble
- Adaptable Modular Design
- Fast Toggle Joints
- Durable Galvanized Construction
- Trough Belt
- **Safe by Design**

Ideal for construction work, tunneling, and sewage handling.

Figure A4.6 - Spoil Conveyor

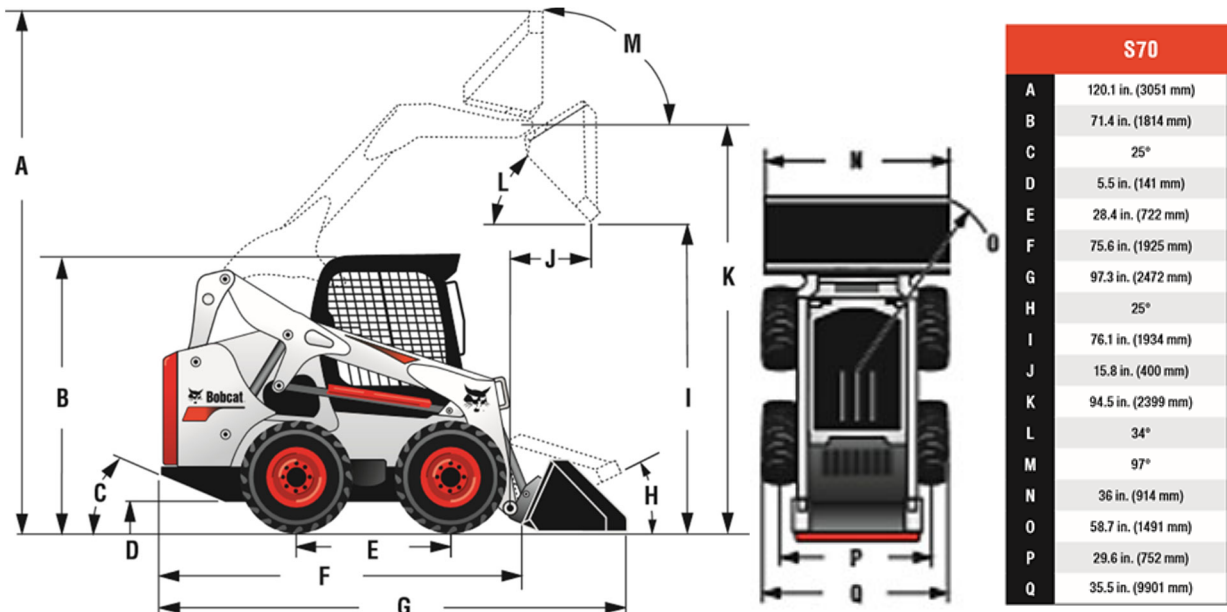

Figure A.7. - Skid Steer Loader

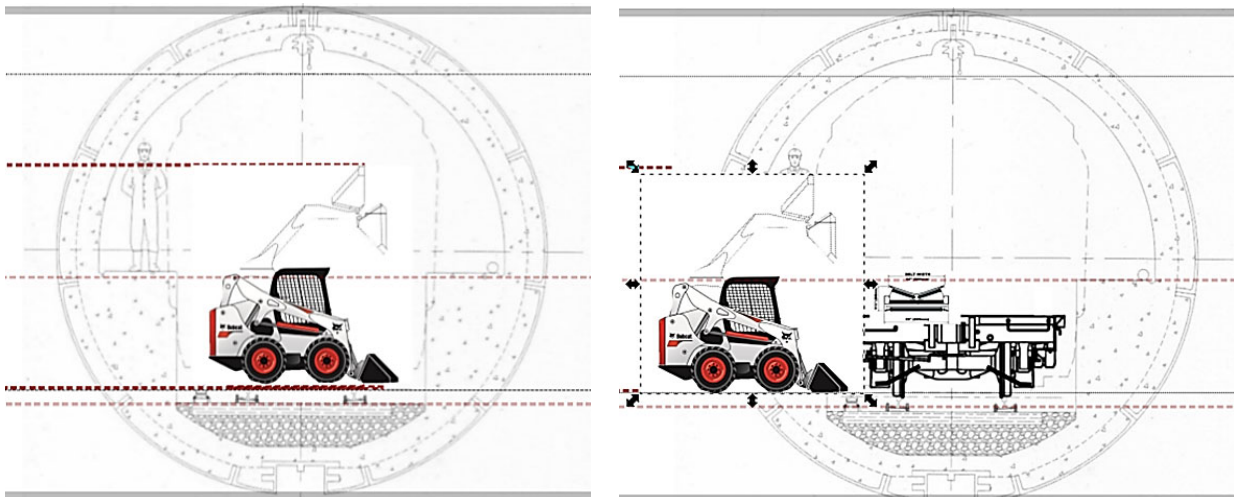

Figure A4.8. - Skid Steer Loader

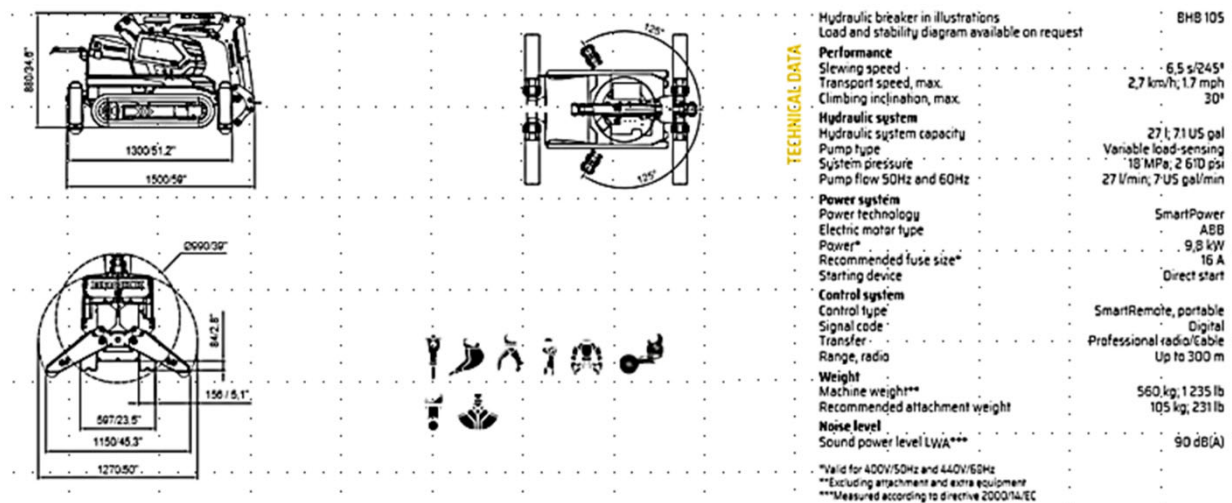

Figure A4.9. - Brokk 70 Breaker and Trimmer

APPENDIX 5 - DUST CONTROL DURING BENCH DEMOLITION AND REINSTATEMENT OF WALKWAYS

A5.1 Background

Dust would need to be controlled during all works activities. A fuller explanation is therefore set out below to demonstrate how to comply with the regulations and yet achieve the outputs required to maintain schedule

A5.2 Dust Control Measures

The refurbishment of the NRTs, removal and replacement of existing concrete benches, falls within the definition of "Construction Work" contained in OSHA OCCUPATIONAL SAFETY AND HEALTH STANDARDS CFR 1910.12(b) namely, work for construction, alteration, and/or repair (relevant extracts are included below. The work is subject to SAFETY AND HEALTH REGULATIONS FOR CONSTRUCTION CFR 1926 which include:

The requirements as follows:

1926.1153(a)

Scope and application. This section applies to all occupational exposures to respirable crystalline silica in construction work.

1926.1153(c)(1)

For each employee engaged in a task identified on Table 1, the employer shall fully and properly implement the engineering controls, work practices, and respiratory protection specified for the task on Table 1.

Extracts from Table 1 detailing the required control measures for the proposed equipment and activities are in A8.2.2 The Regulations further state as follows:

1926.1153(c)(2)

When implementing the control measures specified in Table 1, each employer shall:

1926.1153(c)(2)(i)

For tasks performed indoors or in enclosed areas, provide a means of exhaust as needed to minimize the accumulation of visible airborne dust

1926.1153(c)(2)(ii)

For tasks performed using wet methods, apply water at flow rates sufficient to minimize release of visible dust

In order to comply with the foregoing and other requirements, the refurbishment operation must include respirable control provisions for crystalline silica hazard as follows:

General:

- Ventilation
- Tunnel ventilation fans to provide a minimum air flow of 20,000 cfm (100cfm/kw DPM dispersal)
- Concrete breaking and non-electric plant to be located down draft of bench reinstatement.
- Water supply
- Break tanks containing float valves and fed from the tunnel fire main to supply dust suppression hoses and sprinkler devices.
- Concrete breaking and handling with plant

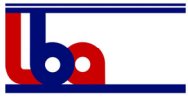

- Activities to be covered by dust suppression mist cannon and sprinklers.
- Concrete drilling and chipping with handheld power tools
- Tools to be equipped with shroud and dust collection system or water delivery system.
- Personnel Protective Equipment
- All personnel to use Assigned Protection Factor 10 Respiratory Protection

A5.3 Sketch-up of Dust Control Measures

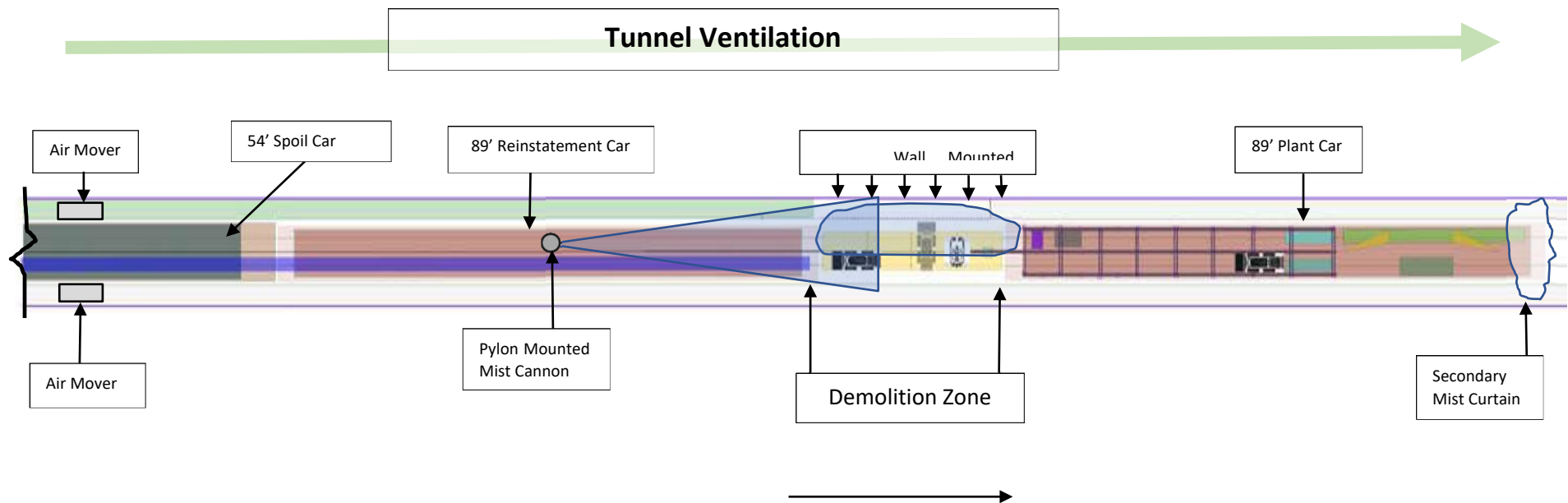

A5.4 Extract from Safety and Health Regulations for Construction CFR 1926.1153

Extract from Table 1

Equipment/task	Engineering and work practice control methods	Required respiratory protection and minimum assigned protection factor (APF)	
		≤ 4 hours/shift	>4 hours/shift
	-When used outdoors	None	None
-When used indoors or in an enclosed area	APF 10	APF 10	
(vii) Handheld and stand-mounted drills (including impact and rotary hammer drills)	<p>Use drill equipped with commercially available shroud or cowling with dust collection system</p> <p>Operate and maintain tool in accordance with manufacturer's instructions to minimize dust emissions</p> <p>Dust collector must provide the air flow recommended by the tool manufacturer, or greater, and have a filter with 99% or greater efficiency and a filter-cleaning mechanism</p> <p>Use a HEPA-filtered vacuum when cleaning holes</p>	None	None
(x) Jackhammers and handheld powered chipping tools	Use tool with water delivery system that supplies a continuous stream or spray of water at the point of impact:		
	-When used outdoors	None	APF 10
	-When used indoors or in an enclosed area	APF 10	APF 10
	OR		
	Use tool equipped with commercially available shroud and dust collection system		
	Operate and maintain tool in accordance with manufacturer's instructions to minimize dust emissions		
	Dust collector must provide the air flow recommended by the tool manufacturer, or greater, and have a filter with 99% or greater efficiency and a filter-cleaning mechanism:		
	-When used outdoors	None	APF 10
-When used indoors or in an enclosed area	APF 10	APF 10	
(xvii) Heavy equipment and utility vehicles used to abrade or fracture silica-containing materials (e.g., hoe-ramming, rock ripping) or used during demolition activities involving silica-containing materials	Operate equipment from within an enclosed cab	None	None
	When employees outside of the cab are engaged in the task, apply water and/or dust suppressants as necessary to minimize dust emissions	None	None

A5.5 Extract from OSHA Fact Sheet



CONTROL OF SILICA DUST IN CONSTRUCTION

Heavy Equipment and Utility Vehicles Used During Demolition Activities

Using heavy equipment and utility vehicles for tasks such as demolishing, abrading, or fracturing silica-containing materials such as brick, block, and concrete can generate *respirable crystalline silica* dust. When inhaled, the small particles of silica can irreversibly damage the lungs. This fact sheet describes dust controls that can be used to minimize the amount of airborne dust when using heavy equipment or utility vehicles during demolition activities as listed in Table 1 of the Respirable Crystalline Silica Standard for Construction, **29 CFR 1926.1153**. A separate fact sheet addresses heavy equipment use for earthmoving tasks such as grading and excavating activities.

Engineering Control Methods: Enclosed cab **AND** water sprays and/or dust suppressants if other workers are present

The use of an enclosed cab when operating heavy equipment and utility vehicles during demolition activities, or when fracturing and abrading silica-containing materials, can reduce operator exposures to silica dust. If other workers are present in the area, water and/or dust suppressants must be applied as necessary to minimize visible dust.



Excavator equipped with an enclosed cab and hoe-ram demolishing a concrete wall.

Operator Isolation

Operators using heavy equipment and utility vehicles must stay inside an enclosed cab with the doors and windows closed while work is in progress. The cab must:

- Be well-sealed and well-ventilated, using positive pressure.
- Have door jambs, window grooves, power line entries and other joints that work properly and are tightly sealed.
- Have heating and air conditioning so that operators can keep windows and doors closed.
- Use an intake air filter with a minimum MERV-16 rating (at least 95 percent efficient in the 0.3–10.0 μm range).
- Be kept free from settled dust by regular cleaning and maintenance to prevent dust from becoming airborne inside the enclosure.

Modern heavy equipment typically comes equipped with enclosed, filtered cabs that meet the requirements of the silica standard in Table 1. Retrofit equipment is available for older equipment.

A5.6 Specimen Specification for Spray Cannon Cited in OSHA Fact Sheet

**DB-30
SPECS**



The most compact unit in the DustBoss family of high-performance suppression equipment, the DB-30 capably delivers coverage over more than 5,500 square feet (511 square meters) with its fine dust-trapping mist. The unit may also be equipped with optional user-definable oscillation (up to 359°), increasing its coverage to more than 31,000 square feet (2,880 square meters).

**WHEN IT COMES TO DUST,
WE'VE GOT YOU COVERED.**



1607 W. Chanute Road
Peoria, IL 61615
309 693-8600

www.dustboss.com

GENERAL SPECIFICATIONS

- Throw as much as 100 feet (30 meters).
- 9,200 CFM (260.50 CMM) generated by 7.5 HP fan. Optional single-phase motor generates 8,000 CFM (226.50 CMM).
- 5,500 square feet (511 square meters) coverage.
- More than 31,000 square feet (2,880 square meters) coverage available with optional user-definable oscillation, up to 359°.
- Oscillator gives 0°–70° of movement on standard unit.
- Adjustable angle of throw 0° to 50° of height adjustment.
- 30 brass nozzles (also available in stainless and nylon) dispense droplet size of 50–200 microns.
- Integrated fan & nozzle ring design for safety.
- Premium efficiency motor.

ELECTRICAL SPECIFICATIONS

- U.S.: 3 Phase / 7.5 HP fan / 480 Volt / 60 Hertz. Full load current is 11 amps. 30 Kw gen set is recommended.
- OPTIONAL — U.S. specs: Single Phase / 5 HP fan / 240 Volt / 60 Hertz. Full load current is 28 amps. 20 Kw gen set is recommended.
- Other motor options available, including all international electrical motors:
 - 3 Phase / 7.5 HP fan / 208 Volt / 50 Hz (Europe, Middle East, N. Japan, Latin America)
 - 3 Phase / 7.5 HP fan / 240 Volt / 50 Hz (Europe, Middle East, N. Japan, Latin America)
 - 3 Phase / 7.5 HP fan / 380 Volt / 50 Hz (Europe, Middle East, N. Japan, Latin America)
 - 3 Phase / 7.5 HP fan / 400 Volt / 50 Hz (Europe, Japan, New Zealand, Australia)
 - 3 Phase / 7.5 HP fan / 415 Volt / 50 Hz (Europe, New Zealand, Australia)
 - 3 Phase / 7.5 HP fan / 575 Volt / 60 Hz (Canada)
 - 3 Phase / 7.5 HP fan / 380 Volt / 60 Hz (Korea)
- 1/8 HP (0.10 Kw) oscillator.
- 100 foot (30.48 meters) 10/4 electrical cord.
- Bare wired electrical cord (no male plug).
- NEMA 3R cabinet with control panel.

WATER SPECIFICATIONS

- Do not operate above 100 PSI (6.89 BAR) water pressure or unit may be damaged.
- In-line 75-mesh (200-micron) filter system is included and should be used at all times.
- Contact us for recommendations if using non-potable water.
- Standard 5/8" (15.80 mm) garden hose connection.

ENGLISH UNITS					
Water Pressure, psi	25	40	60	80	100
Water Flow, gpm	1.4	1.8	2.2	2.5	2.8
METRIC UNITS					
Water Pressure, bar	1.72	2.76	4.14	5.5	6.89
Water Flow, lpm	5.3	6.7	8.2	9.5	10.6
5/8" (15.8 mm) GARDEN HOSE WATER SUPPLY					

DIMENSIONS (on standard carriage mount)

- 5.20 feet (61 inches; or 1.60 meters) wide.
- 8.50 feet (102 inches; or 2.60 meters) long.
- 5.30 feet (62 inches; or 1.60 meters) tall.
- 800 lbs. (363 kilograms).

NOISE LEVELS

DISTANCE	CONTROL PANEL SIDE	BACK SIDE OF FAN	OPPOSITE SIDE	DISCHARGE
0 feet	89	106	91	108
12 feet	83	86	81	82

PERFORMANCE ADDITIVES

- Full line of DustBoss surfactants, tackifying agents, or odor controllers can be used with optional dosing pump.

OPTIONS

- Unit is available with optional user-definable oscillation to allow up to 359° of movement. Standard oscillation provides 0°–70° of movement.
- Available on frame with skid mount or on a tower. Standard unit comes on wheeled carriage.
- Dosing pump can be added to unit for chemical applications.

MAINTENANCE

- If using potable water, nozzles need to be inspected once a year.
- Fan motor should be greased every 10,000 hours.
- Turntable bearing should be greased on a regular maintenance schedule, or as needed.

WARRANTY

- 3-year/3,000-hour warranty.

APPENDIX 6 - IN-SERVICE TRACKBED OPTIONS**A6.1 Introduction**

The Special Enquiry into Train Performance Reporting by Northeast Corridor Commission identified that a significant proportion of the delays that have been experienced are due to track failures.

LBA always believed that the existing track should be replaced with a concrete track bed, but during the first appraisal this was not contemplated until either a 3-month window was available, or another tunnel was in operation to allow closure of an NRT. This meant that a major risk was not addressed for a considerable period of time i.e. not until one of the HRTs was completed. A further consideration of track bed replacement is therefore required with the aim of reducing the service impact risks at a much earlier stage.

At this stage the form of the concrete track bed has not been designed, and a booted sleeper solution, or a straight slab track solution are both potential design options. The amount by which the track must be, and can be, lowered to provide structure gauge and electrical clearances is not yet known and that will be key to selecting the eventual solution. However, the current assumption is that the track does need to be lowered because lack of clearances and subsequent damage have been a source of train and timetable delays.

This Appendix examines the possible options for trackbed replacement and compares them against some chosen criteria to gain insight into their suitability.

A6.2 Issues to be Addressed

Track must be tested and approved for use each weekday morning and /or Monday morning.

- Signal circuitry is key and is a prime consideration in method analysis.
- The track needs to be lowered (see assumptions below)
- Whether the track replacement is best done before or after the rest of the refurbishment or afterwards?
- Logistics inside and outside the tunnel.

A6.3 Information Required

As identified above, there is a need to design the track lowering, but LBA have not seen details of the invert profile. LBA are not sure if an invert survey was carried out when the Superstorm Sandy Impact Assessment survey was undertaken.

It was suggested by Amtrak that some survey work had been done to ascertain the invert level relative to the current track levels, but LBA have not seen these details. This information is key to designing a track form and hence a method of construction.

The following survey data is required in order to assess the trackbed refurbishment:

- Depth to invert throughout
- Profile of invert throughout
- Amount of track lowering required/possible
- Is the issue the same throughout the tunnel length (mined and SGI)?

In addition, the constraints, influences and possible logistics of the track refurbishment have to be assessed:

A6.4 Assumptions Made (for the purposes of identifying possible methods)

- The track has to be lowered from its current position

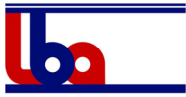

- Outages available are Weekends and Overnights only
- Time is the critical factor-risk reduction
- Speed limits may sensibly be required and are acceptable

A6.5 Simple Criteria for Assessment of Ideas

Initial thoughts on what could be used for the assessment criteria:

- Time to lower track (reduce significant risk)
- Operational impacts (speed limits, ramp issues, delays)
- Risks to the service due to unexpected prolonged outage.
- Technical issues e, g. curing time, strength gain
- Logistics feasibility access from both ends and down shafts

A6.6 Options Identified

Methodologies considered for in-service replacement of track bed:

1. **Track lowering** by conventional ballast cleaner to move track to desired level.
2. **Precast units** on a grouted lean mix base.
3. Intermittent use of **Paving machines** producing a slab track.
4. Replacement with **Concrete booted track ties (sleepers)**
5. **Replacement of ballast and ties(sleepers)**by with **Concrete slab track**. Rail remaining in place at all times.

A6.7 Track Lowering

Many of the delays attributed to the track and overhead line failures are, it would seem, due to the track being too high in the tunnel thus leaving insufficient electrical and perhaps structural clearances.

The possibilities for lowering are limited by the actual levels of the invert of the tunnel and its shape and regularity. Estimates vary and will impact the choice of design and methodology. What is clear is that if the track could be lowered to its required level at would be a good step forward, firstly in order to limit the risk of “track failures” in the near term and also to facilitate the future in-service track replacement. in service.

What follows is a suggestion on how this could be accomplished. Further survey data would be needed to properly demonstrate its validity but based on the information that we have there would seem no reason why it would not work.

Outline method

In the attached series of drawings, the existing track on its timber cross-ties can be lowered if they are first shortened by about 2 feet from 8’-6” length to about 6’-6” length, so that they do not hit the tunnel lining when lowered and still have a some of ballast between the corners and the concrete tunnel lining. The only real challenge is that they will need a good “shoulder” of ballast at the ends of the sleepers to hold the track to the correct alignment.

How much the track can be lowered by is not yet known and Amtrak think that only 3” will be possible, but that will require a full invert survey to confirm this. In terms of trackbed replacement in service, it is important to be able to work at the correct level from the outset.

As shown on the attached series of four drawings, the track could then be lowered by an ordinary on-track Plasser Ballast Cleaner machine. Probably 2" per pass over a couple more weekends per tunnel until the full lowering required is achieved.

Track Lowering-Stages

Stage 0: Existing track on base plates and timber cross-ties. 3rd rail to be removed before commencement of track renewal. Not shown here with guard-rail base plates but could be added from this stage).

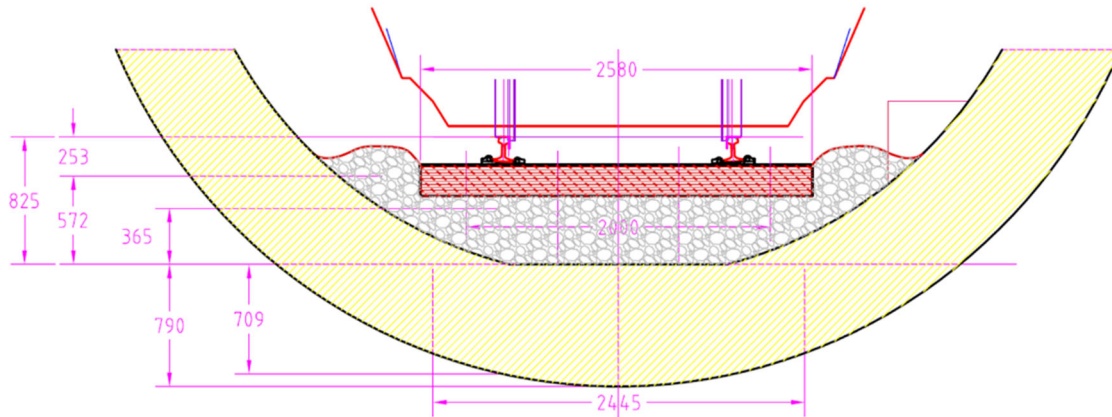

Stage 1: Timber cross-ties shortened by 24 inches.

Additional ballast at shoulders to ensure track alignment

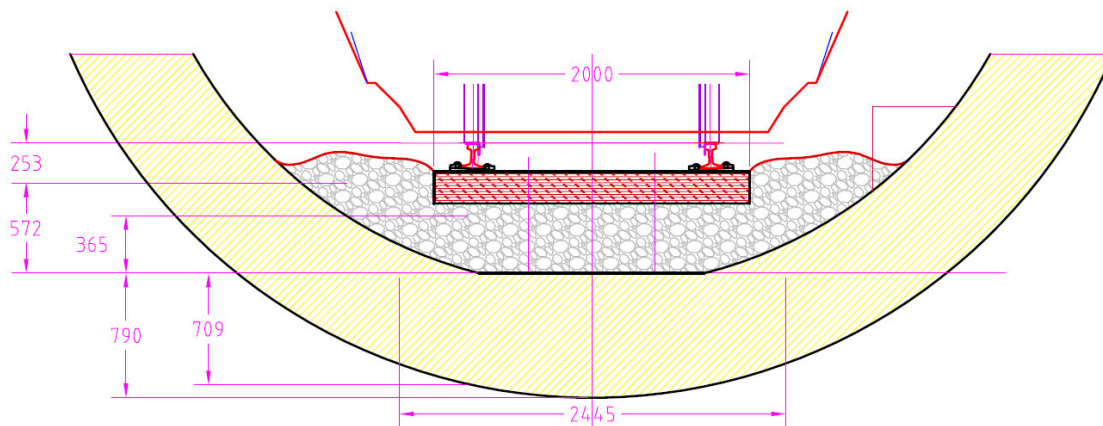

Stage 2: Track lowered to new designed level Excess ballast removed during several passes by Ballast Cleaner machine 95mm minimum clearance timber cross-tie to intrados.

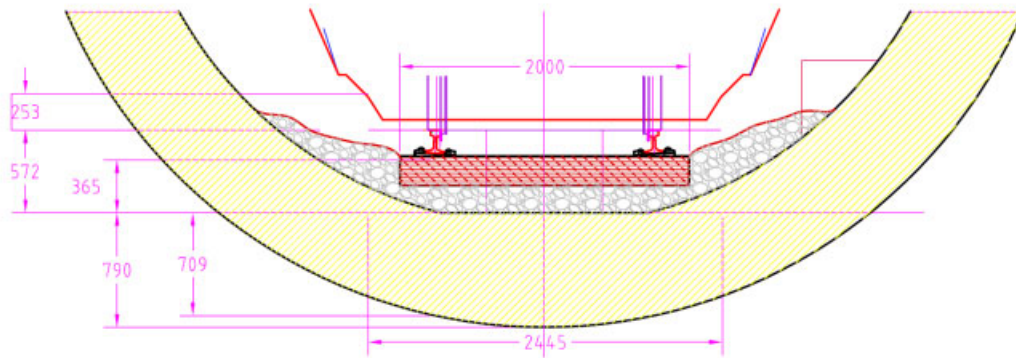

This shows one example only of a replacement track bed, but other designs are equally achievable.

A6.8 Precast Units

Introduction

Sectional precast slab track bed systems have been extensively developed in recent times and are increasingly deployed for new track installations including tunnels.

A typical system consists of prefabricated, prestressed slab track sections which are joined longitudinally. This construction method provides a homogenous trackway with a good long-term behaviour.

Outline of Method

The slab track sections are placed on a hydraulically bound layer or in pre-existing structures such as tunnels, on a reinforced concrete base layer.

The slab track sections of around 20ft long are installed with a standard separation of around 2 inches. Vertical and horizontal adjustment takes place using screw jacks and a computer-aided surveying system. The vertical gap between slab and base layer is sealed and fully filled using a specifically formulated grout.

The longitudinal jointing of the slab sections follows which provides a continuous track bed with a high resistance to longitudinal and transverse displacement. The jointing counteracts the “whipping effect,” a potential warping of the slab ends due to thermal differences.

Advantages

- High quality and accuracy and straight forward adjustment
- Preinstalled rail chairs, drainage falls and crack inducer
- Low maintenance over the estimated 60-year life

Disadvantages

- Sectional installation requires multiple rail joints.
- Requires specialist heavy lifting equipment
- Requires sound and reasonably consistent track formation
- Generally designed with a flat base

Risks

Risk	Possible event	Likelihood	Possible Mitigation
Process interruption	Plant and or logistics failure	possible	Planned Preventive Maintenance and back up plant
Damage to precast elements	Impact during handling or placement	possible	Spare capacity in system and programme
Misalignment	Sections inaccurately placed	possible	Detailed Plan of Works and ITP
Delay to removal of outage.	Issues with rail re-jointing and signal testing	likely	Spare capacity in system and programme

Typical Precast Slab Track System

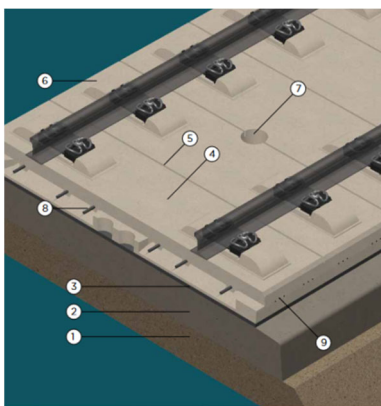

- 1 FROST PROTECTION LAYER (FSS)
- 2 HYDRAULICALLY BOUND LAYER (THB), D = 30 CM
- 3 GROUTING MASS
- 4 SLAB TRACK
- 5 DESIGN CRACKING JOINT
- 6 RAIL SUPPORT POINT
- 7 OPENING FOR GROUTING MASS
- 8 GEWI STEEL
- 9 PRESTRESSED STEEL
- 10 TURNBUCKLES AND NUTS
- 11 CONSTRUCTION JOINTS

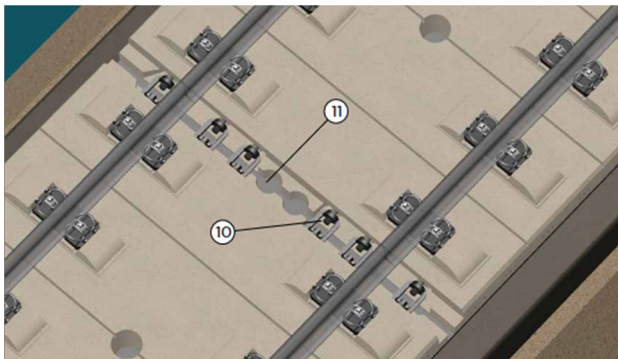

Construction height (from OK THB to OK rails):	474 mm
Slab length (System length: nominal 6.5 m):	6,45 m
Slab width:	2,55 m
Slab height:	0,20 m
Rail supports:	10 pairs per slab; spacing 650 mm
Prestressing:	transversal
Longitudinal coupling:	GEWI steel



A6.9 Paving Machines

Introduction

The use of mechanised pavers as manufactured by Gomaco offer the opportunity to achieve high outputs of paved track bed. Good examples can be taken from the 'Perthus Tunnel' which connects Spain and France and also the work done on High Speed 1 (Channel Tunnel Rail Link/ CTRL/ HS1) in the UK where Pavers were used to construct the track bed and the benches. Supply of concrete is key and critical to the output to be achieved. But large outputs are possible.

The NRT track

Evidence

- Outputs achieved on the 'Perthus tunnel'—18.8km paved in 11 weeks-154m/ shift (12hrs).48,000 cu m of concrete laid; that is an average of 311 cu metres per shift. Track bed is 5.4 m wide and 600mm deep. Overall average advance 109 metres.
- Outputs achieved on the stage1 trackbed at HS1 -167 m/ shift (12hrs) overall average advance

Outline of Method

The basics of this option are:

- Following track lowering
- Take up a section of track
- Clear the ballast and prepare the surface
- Bring in a paver, commence paving with concrete supply from the opposite portal
- In parallel continue removing track
- Drill for fixings and lay rail on the new concrete
- Connect to existing track and re-establish service

Details are for a weekend outage:

- Shift One Friday night — lift a length of track (150 metres) and clean out. Set up paver
- Shift Two Sat Day — Pave the 150 metres and clean out a further length
- Shift Three Sat Night — Pave 150metres start laying rail on the dayshift concrete
- Shift Four Sun Day — Remove paver, continue track laying and prepare junction with existing track
- Shift Five Sun Night —Complete track laying and restore to service

Issues to be Solved

- The sequence is governed by logistics of concrete supply and the criteria that concrete supply and clean out cannot happen simultaneously at the same place
- So, supply of concrete from the "other end" of the tunnel is necessary. This requires moving fresh concrete over the recently laid concrete
- Rail would also have to brought in from the same portal the concrete supply unless it was brought in early and sat on brackets out of the way of the paver
- For the purposes of schedule comparison, we have allowed 250 metres per weekend outage although 150 metres per 12 hour shift should be achieved
- If there is a level difference to be accommodated, the plan would be to lay temporary track on top of the paved slab with appropriate sleepers to take out the level difference
- Fixings for the permanent track would be staggered so that these can be prepared in a future outage
- Permanent track could then be laid to level using a moveable ramped section of track

Advantages

- 250-300 metres per weekend—1km per month, or 4 months per tunnel
- If level difference taken out -Produces final track very fast
- If level difference not taken out still produces but just a little bit slower
- Method is applicable across the NRT, ERT and even the new HRT
- Attractiveness increases rapidly if longer outages found possible
- High quality finish and alignment

Disadvantages

- Could be judged risky if there is another incident which closes the other NRT when there is a large amount of track opened up. Would require contingency planning.
- Does depend on good outputs (but the assumptions are probably conservative)
- Does depend on sustained and reliable concrete supply
- Does depend (on current thinking) on concrete access from one end and rail and sleepers taken out the other end of the tunnel

Quality

- Paving techniques are well advanced as is concrete technology. Guidance and achievement of tolerances would be by using laser guided survey systems, again a proven technique.
- Preparation of the invert surface would be key and investment in plant and equipment to effect rapid and satisfactory preparation would be required.
- Developed concrete technology will be required to ensure that suitable concrete is delivered to the paver.
- Very important that testing and proving of the planning is done so that the risks during in operation are reduced. Early outages should not be ambitious in length until system has been proven.

Risks

Risk	Possible event	Likelihood	Possible Mitigation
Delay to removal of outage	Concrete supply failure	Possible	Detailed look at all the risks to this and appropriate contingency planning
Delay to removal of outage	Breakdown of paver	Unlikely	Rigorous and continuous maintenance, spares and consumables available
Delay to removal of outage	Breakdown of supply train	Unlikely	Contingency arrangements and equipment to remove train and bring in another needed.
Delay to removal of outage	Delay in concrete achieving strength delaying Rail laying and so end of outage	Unlikely	temperatures may need attention depending when done to ensure Concrete performance is as required
Misalignment of track	Paver goes out of line or level. Or track fixed inaccurately	Unlikely	Detailed plan of works and ITP Surveyor supervision on hand.



Figure A6.1 Gomaco paver getting ready to provide stage 1 track bed on High Speed 1 in the UK

A6.10 Replacement with Booted Track Ties (Sleepers)

Introduction

Booted track tie systems have been widely used in Europe, predominantly in tunnels. The system offers considerable advantages for simplicity of construction and maintenance. The low capital cost and experience of use of the system makes it a relatively low risk option.

Outline of Method

The rail is mounted on pre-cast concrete twin-block bases via a conventional rail fastening system. The blocks sit on resilient elastic sole pads and are surrounded by a natural or synthetic rubber "boot" into which additional lateral resilient pads can be placed if required.

The boot is sealed to prevent ingress of water and the blocks are connected by a horizontal steel beam that sets the gauge of the track.

The elasticity in the system is provided by the pad beneath the rail, the resilient pads and boot. A typical booted tie arrangement and tunnel installation is shown in the Figure A 6.2. below.

In normal circumstances a Stage 1 track bed (a levelling layer) is provided and then the trackwork is laid out in panels. The track geometry is monitored by laser guidance is achieved by jacks / props, providing lateral and vertical support prior to placing the mass concrete bedding around the booted sleepers (see *Figures A6.3 & A6.4*). Adjustment can be made to track levels by placing a layer of grout underneath the sleeper. If necessary, the level of concrete surround would be increased once the sleeper has been lifted, to maintain a good embedment depth. Alternatively, some fastener systems allow placing of shims beneath the rail seat.

Issues to be Solved

The main issue with this option is likely to be the geometry and condition of the invert concrete. The existing tunnel intrados geometry below the track ballast means that when the track is lowered there will be insufficient space to cast the Stage 1 base layer. Consequently, the existing tunnel concrete lining will need to be utilised for this purpose and its geometry, condition and concrete quality will need to be verified as suitable for this purpose. Furthermore, the remaining depth for the bedding of the booted track ties may be insufficient.

This could be solved by a modification to the standard booted track block design to produce a profile that would better fit the tunnel invert geometry and provide a more uniform bedding thickness below the block. Also, the bedding concrete could be reinforced with steel fibres to provide additional strength and durability. LBA understand that Amtrak is already looking at this method.

A possible construction sequence is provided in Figure A6.5.

Advantages

Booted track tie systems perform well re acoustic reduction for ground-borne noise and vibration. The resilience in the boot can be varied to achieve acoustic requirements for ground-borne noise and vibration without any direct effect on the rail fastening integrity.

A very high degree of track alignment accuracy can be achieved.

The track tie unit can be easily replaced by lifting the blocks out of their boots, which themselves can be repaired or replaced if necessary and a new track tie slotted in, with the rail fasteners already pre-assembled. In case of derailment this is advantageous and should reduce the time to reopen the track as there are no reinforced concrete plinths to be permanently damaged.

Also, the track ties can readily be lifted out of their boots to replace the resilient sole pads if necessary.

Disadvantages

The main problem with using a booted tie system is related to the ingress of water in the invert, which penetrates between the blocks and the boot and between the boot and the concrete surround. Over time, the action of passing train traffic causes wear and deterioration of the concrete surfaces, which can affect the stability of the track as the ties work loose. A waterproof polyurethane seal is normally applied around the sleeper to reduce or eliminate this problem. Problems can also occur with the corrosion of the steel connecting bar in a corrosive environment.

The traffic through the tunnel tube will need to be stopped for an extended period so that the existing track and ballast can be completely removed in order to install the system.

During construction, access along the track will be made difficult due to the positioning of the adjustable levelling struts. However, the walkway benches will provide a reasonably accessible route alongside the work areas.

Quality

Because the booted track tie system is manufactured under factory conditions, a high-quality product can be provided to a high specification and installed within tight tolerances.

The system can be very accurately aligned before the concrete base is cast rather than relying on the accuracy of anchoring and adjusting the track chairs to the track slab.

The existing invert concrete will need to be closely inspected for its geometry and condition and repaired and/or its profile adjusted if necessary.

The quality of the bedding concrete mix design, placement and finish will be critical to the final performance of the system.

Risks

Risk	Possible event	Likelihood	Possible Mitigation
Condition of the existing invert concrete.	When the track ballast is removed the exposed concrete is found to be of poor quality or has deteriorated.	Possible	Cut out and repair with high strength mortar.
Geometry of the existing invert concrete.	When the track ballast is removed the profile of the exposed concrete is found to provide insufficient space for the booted track blocks and bedding concrete.	Possible	Re-profile to the require geometry using scabbling equipment.
Delay to removal of outage.	Failure of supply of concrete.	Possible	Contingency back up plan to restore track to working condition.
Delay to removal of outage.	Alignment issues resulting in unsatisfactory track.	Unlikely	ITPs, surveyors to hand, effective laser guidance and checking system.

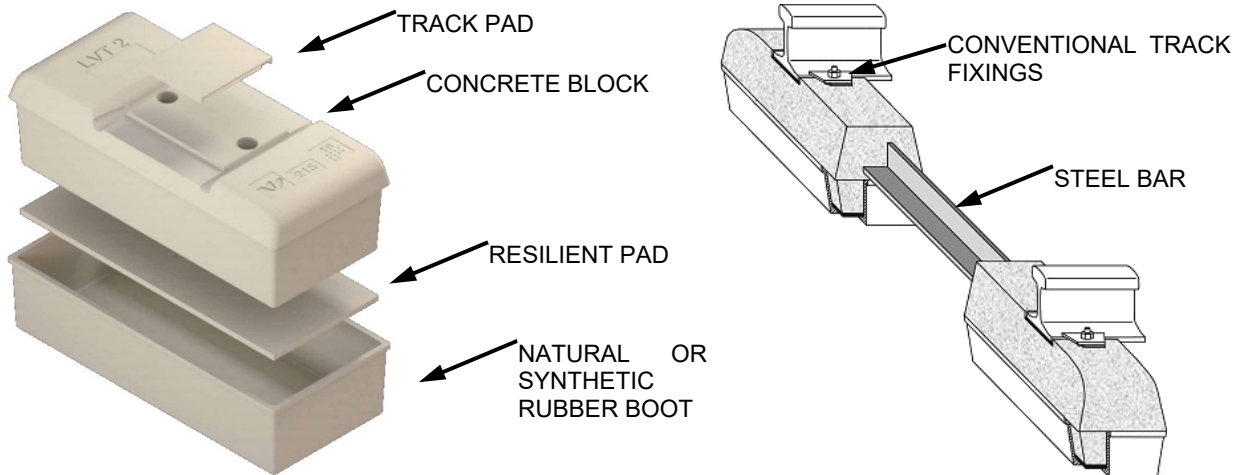

Figure A6.2 Key elements of the booted track tie system

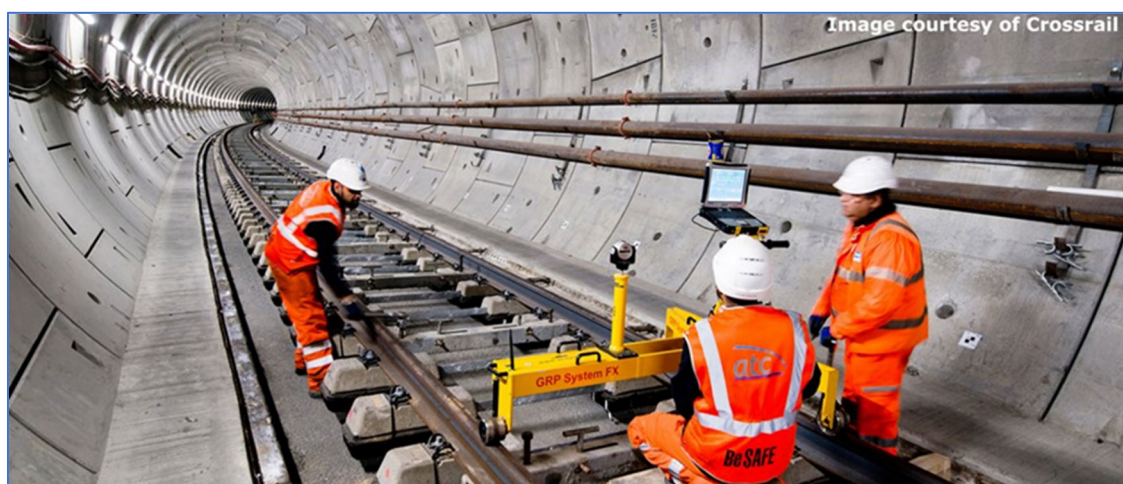
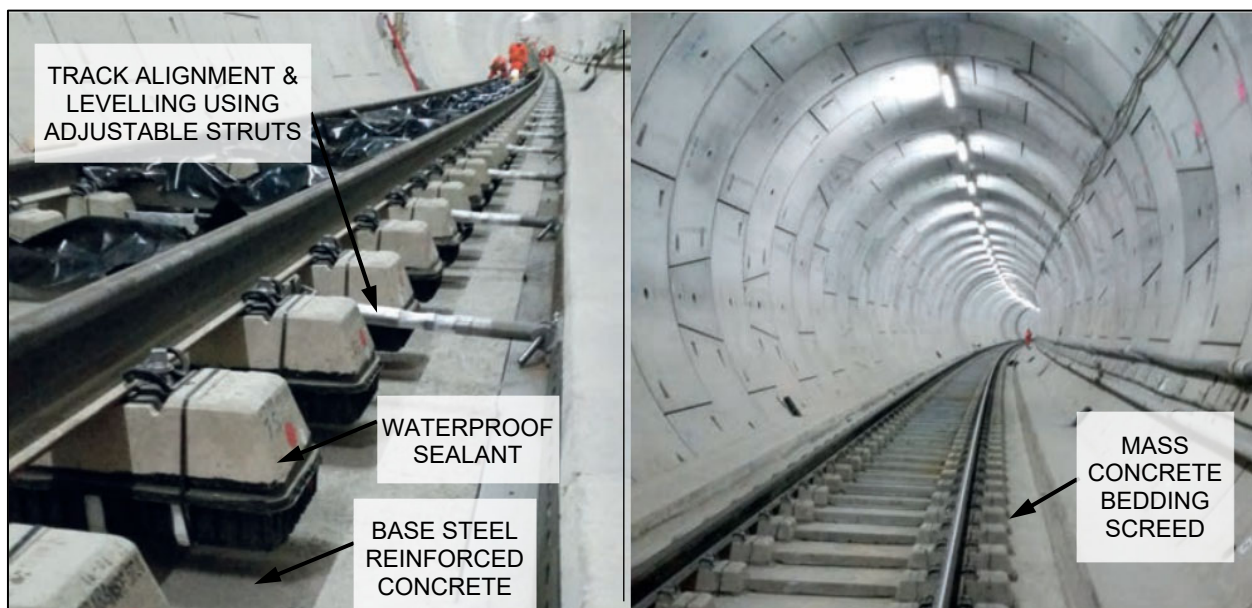

Figure A6.3 Crossrail tunnels, London, UK. - Setting out of booted sleeper track (above left) above the steel reinforced cast concrete base before the second stage mass concrete screed bedding is poured above (right). Above final checking of alignment.

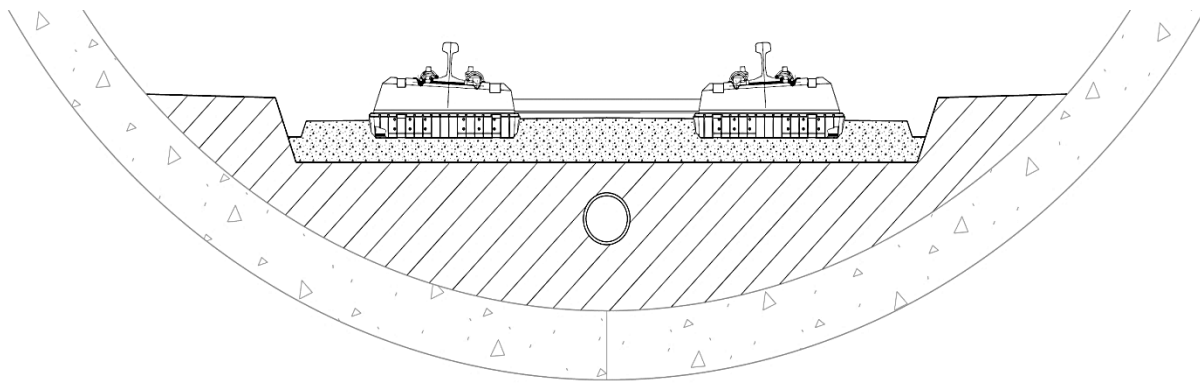

Figure A6.4 Crossrail tunnels, London, UK. – Track slab and booted track ties design.

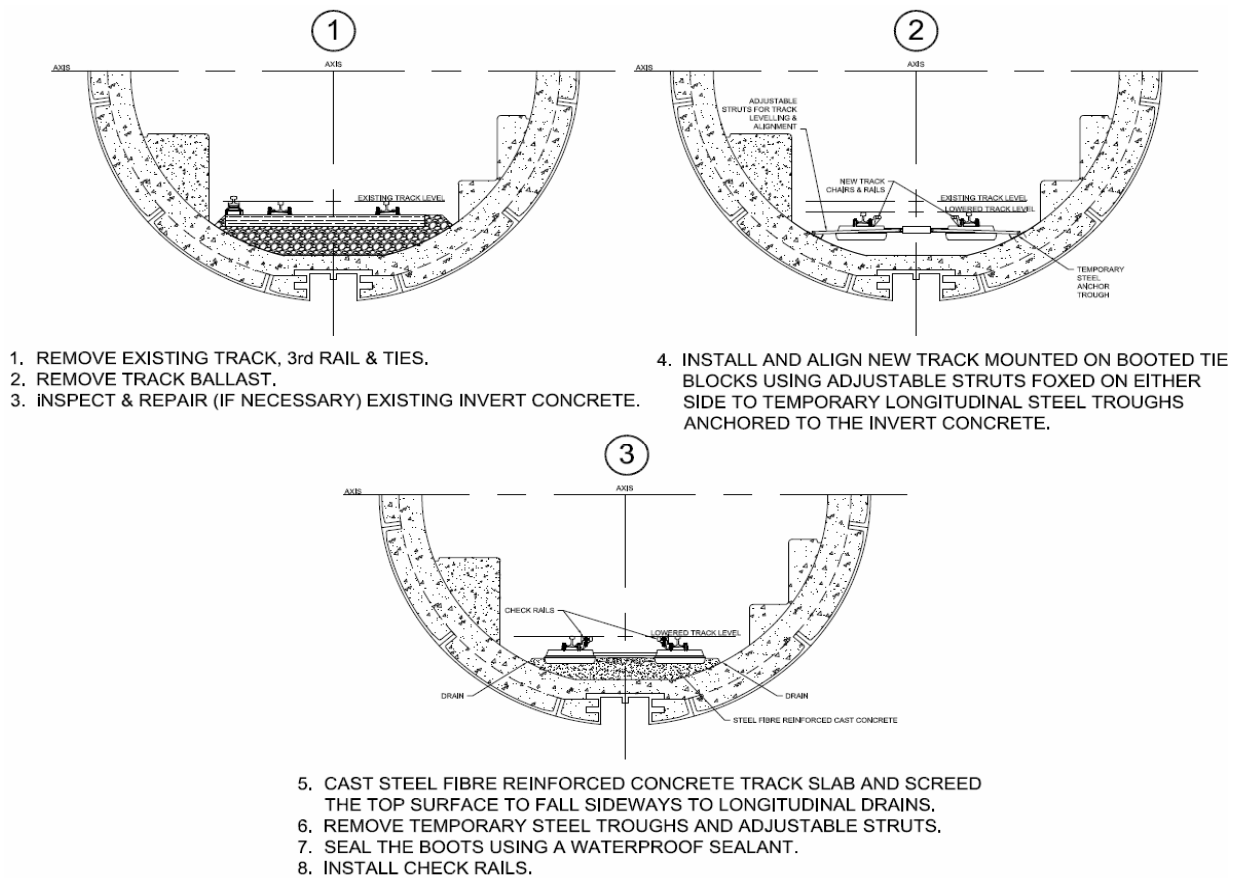

Figure A6.5 Construction Sequence Track bed with booted cross ties.

A6.11 Replacement of Ballast and Timber Ties (Sleepers) by New Concrete Trackbed with Rail Remaining in Place at all Times.

Introduction

One of the issues to be addressed is the amount of time it takes to put the track back into service after an outage. Continuity will be required so that signalling will operate correctly and have to be demonstrated. The methodology of track replacement that allows the rail itself to remain undisturbed during an outage whilst the support to the rail is replaced could have many advantages.

Assuming the rail is at the correct level the ballast is removed over a short length related to the outage available, and then removing the sleepers (ties) over that same length. Then place the new trackbed, either by using rapid setting fibre reinforced concrete trackbed or booted sleepers (if space permits) with the boots surrounded in concrete.

The method described below is based on cast in bolted baseplates, but could equally apply to booted sleepers.

Outline of Method

Process is:

1. Support rail if required (see below)
2. Suck out ballast using a ballast 'sucker' mounted on the service train
3. Remove sleepers (Ties) - or cut out if simpler
4. Attach Baseplates to rail and hang bolts
5. Tape up exposed bolt heads and baseplates
6. Fix shutters, fix drainage pipes (if the design)
7. Concrete with rapid setting concrete using a volumetric mixer in the Service train
8. Repeat (if time) in the outage and eventually allow curing time before restoring service

Issues to be solved - Two principal issues

- **Support of the rail:** It is very important that the rail does not depart from its required level and alignment and this will have to be checked prior to each delivery of concrete mix. There may be a need to support the rail either by jacking from beneath or by hanging from above. From above could be facilitated by a rolling bridge (see figures below) which sits across the section of forward moving trackbed replacement when the concrete has gained the requisite strength or via temporary beams resting on the benches. Alternatively, facilitated from below by jack/props resting on the invert with a "lost" section and side jacks against the bench walls to maintain alignment. Selection of the right solution would depend on the outage length (and the length of concrete to be cast). The rolling bridge concept is shown below in Figures A6.6 & A6.7.
- **Logistics:** Efficient and productive progress could be achieved over a weekend outage, but for full efficiency there would be a need to be able to import into the tunnel the concrete materials and the excavated ballast for the total production in a shift. A sequential operation operating like this could achieve 30-40 cu m concrete (i.e. @100 ft of progress)

Advantages

- Adaptable for long or short outages
- Does not disturb rail

- Could produce 100-200 metres in a weekend outage (10.5 m produced per 5-hour outage LUL)
- Running rail can be quickly restored in sudden curtailment of outage (low risk)

Disadvantages

- Not suitable if there is a level difference to be accommodated
- Not as fast as other options
- Relies on sufficient depth beneath lowered rail

Quality

Good quality of the finished product should be achieved if designed to make concrete finishing and drainage requirements simple. The fibre reinforced cast in bolts (with protection to avoid contamination by concrete) should provide a sound solution and not give any issues such as loose bolts.

Risks

Risk	Possible event	Likelihood	Possible Mitigation
Delay in restoring service.	Rail alignment/level 'goes out' whilst concreting.	Unlikely given technology available.	Contingency plan for break out (arrest set) and replace.
Delay in restoring service.	Concrete fails to set in planned time.	Delay in restoring service.	Contingency plan for temporary jacks to maintain rail in place to restore service.
Delay in restoring service.	Logistics delay/breakdown.	Possible impact would depend on failure.	Must have redundancy and "emergency" response in place
Delay in restoring service.	Outage curtailment, caught midway in a cycle.	Possible, easier to correct with this method.	Again, contingency plan to reverse process and restore track to service state.

Figure A6.6 The Rolling Bridge concept – Cross-Sections

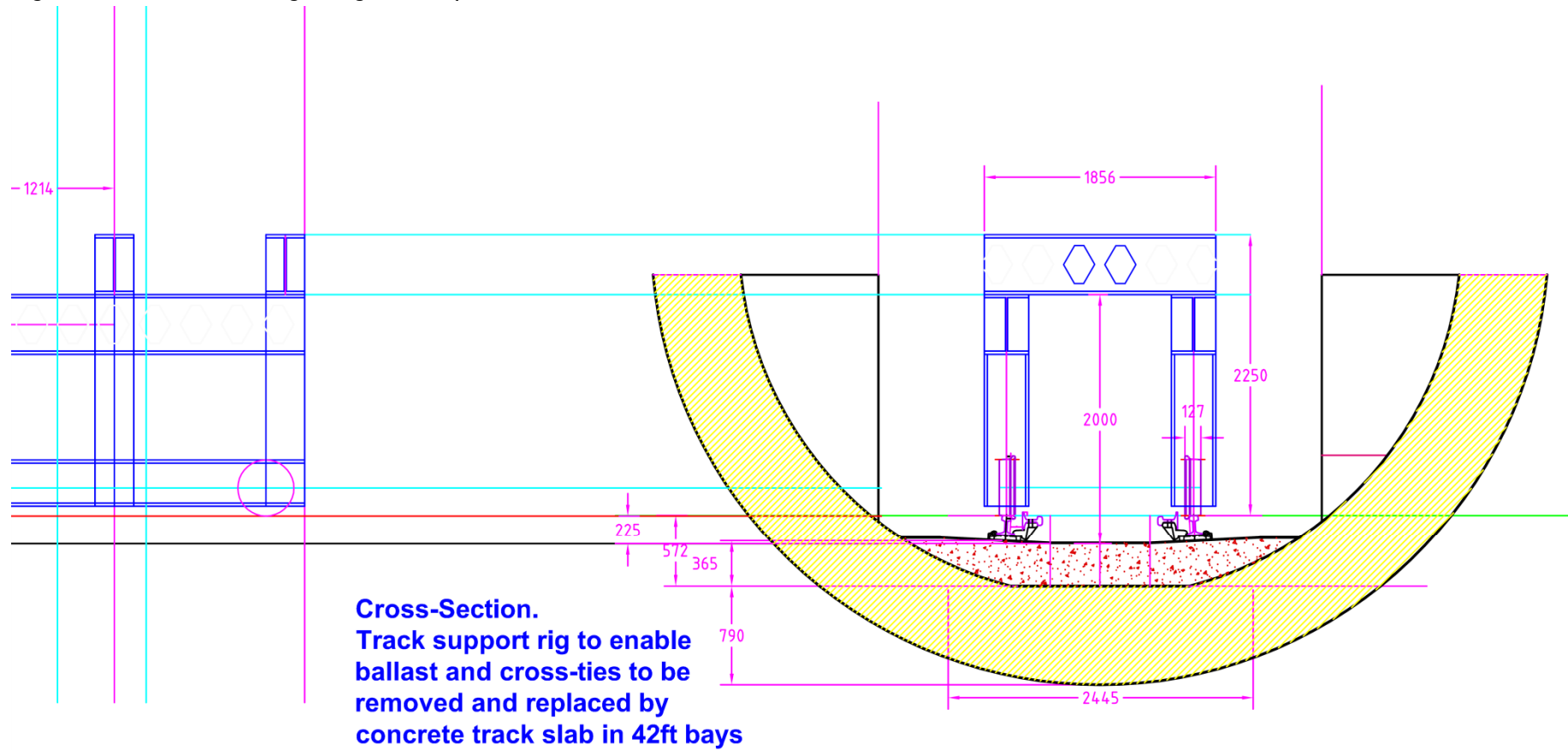

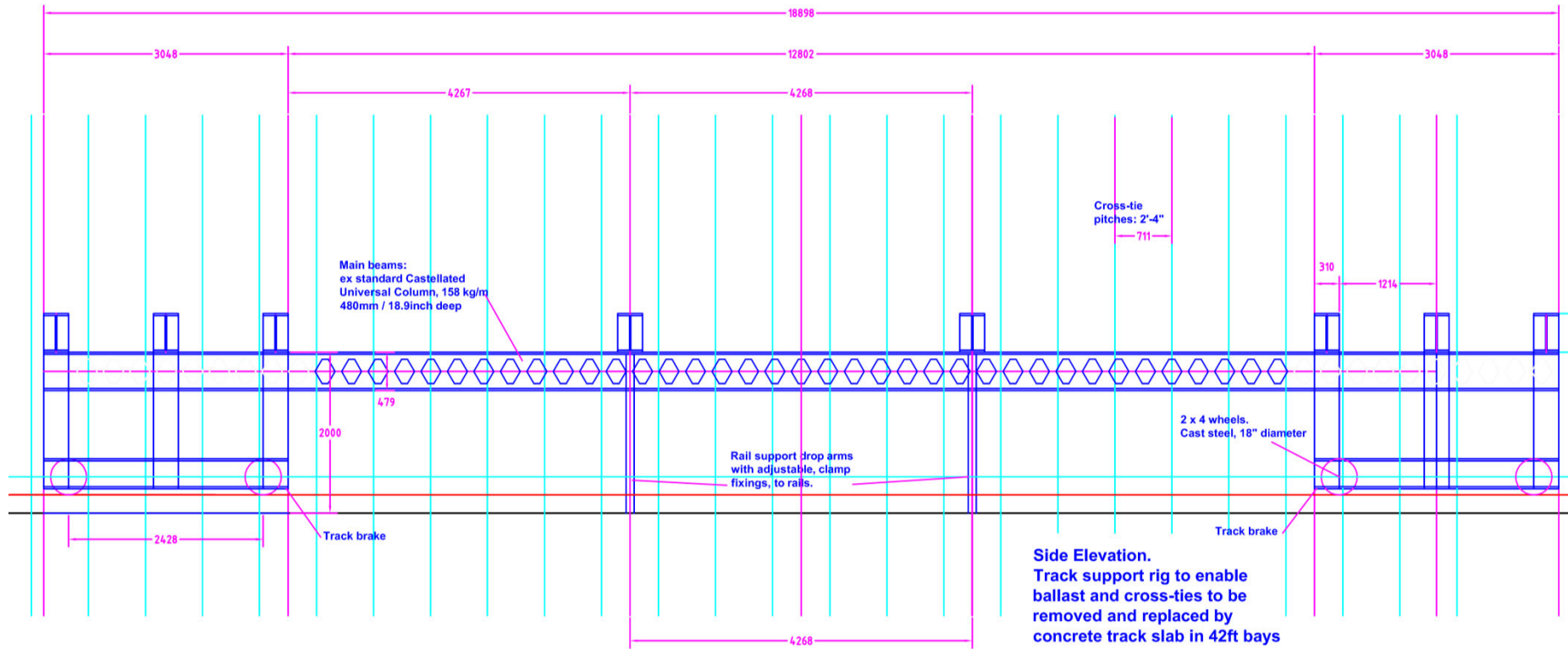

Figure A6.7 The Rolling Bridge concept – Elevation

A6.12 Assessment of the Options

The selection of preferred options is not a straightforward exercise because there are so many unknowns, and considerable development work would be needed to give assurance that the service was not being put at risk. LBA has looked at the advantages and disadvantages and has also compared the options against the criteria for assessment that were identified at the beginning of this appendix.

The results are given below:

Option	Option Description	Time	Operational Impacts	Risk to the Service	Technical Issues	Logistics Feasibility
1	Lower the existing track to new position.	Lower by stages over 2-3 weekends	Can be carried out in engineering hours. Essentially normal practice	Low-This is normal practice although cutting sleepers may present some personal safety challenges	Ballast property and contamination . Drainage issues	Reliance on ballast cleaner. Concrete on one side. Ballast remover and other plant on other side. Potential for working at more than one location. Can be carried out with single ended access.
2	Precast Units to form Slab track	12m in 5-hour shift	Signalling continuity to be considered.	Moderate to high. Rail would need to be taken out and replaced so could take time to restore to service although depends on length taken out at a time.	Concern about the 'fixity' of the blocks. Existing invert regularity/suitability for bedding and grouting up.	Labour intensive. Complex operation with a number of discrete operations and materials.
3	Intermittent use of a Paving Machine	Weekends only 250-300 metres possible	Signalling continuity to be considered.	<u>Relatively high</u> Could take time to restore normal service to large length opened for paving Concrete does not go off Breakdowns - particularly paver blocking the tunnel.	Existing invert regularity/suitability for bedding and grouting up	Logistics of concrete supply and ballast removal could be a challenge. Good potential if could be solved.
4	Replacement with Lengths of concrete booted sleeper track	300m in a weekend	Timetable risk at the end of each weekend outage. Signalling continuity to be considered.	<u>Moderately High</u> Risk of not finishing Concrete delivery to the work front. Batching capacity.	Issue is whether there is enough depth. Peaks of concrete requirements	Plan for 300m, programme for 250m (+50m). Potential for pumping the concrete from the shafts.



APPENDICES

Option	Option Description	Time	Operational Impacts	Risk to the Service	Technical Issues	Logistics Feasibility
						Concrete supply to be considered.
5	Replacement of ballast and sleepers while keeping rail intact	31.5 m per 8hr shift as part of a rolling process.	Should have least operational impact because rail essentially undisturbed.	<u>Moderate – Low</u> Logistics are key and quite demanding to achieve progress potential, but less demanding than other options.	Track support system. Since rapid hardening needs mix at workplace capability.	Ability to deal with ballast and concrete on a rolling process.

A6.13 Refurbishment In-Service: References

Refurbishment in service is becoming increasingly the norm of international best practice as highly utilised railway systems/tunnels get older and under increasing pressure due to rising passenger demand. Work has been carried out across the world including Hong Kong, Austria, Germany, Switzerland and UK.



In the 1990's, London Underground (LUL), for example, a very old and busy system, carried out night-time major in-service replacement of tunnelling lining over a 10km (@6miles) length of twin rail tunnels (@ 4.5m diameter) on the Central line and Northern Line metro tunnels over a two year period, without disruption to the late night or early morning service.

More recently, LUL commissioned the in-service replacement of 123 switch and crossing units, 13km (8 miles) of track and 11km of drainage to be carried out in outages.

A **particular example** of this is the London Metropolitan Line (the world's first underground railway dating back to 1863) between Baker Street and Finchley Road. 3.2km (@5 miles) of life-expired Bullhead rail on timber sleepers in 7 single bore tunnels was replaced with concrete slab track at the rate of 10.5m(35 ft) per night outage.

The London Underground Limited (LUL) Track and Drainage Group managed the recent refurbishment of the track and drainage of the Bakerloo Metro line between Baker Street and Finchley Road Station. The contractor Balfour Beatty was selected via a lump sum bid based on a reference design, and a schedule of rates. The Procurement Contract was based on a target sum with cost saving share with LUL.

The LUL Drainage Group were latterly involved as they wanted to upgrade the drainage. The track refurbishment would have damaged existing drainage infrastructure during the removal of the existing track. Once the various LUL Departments had aligned and agreed the total works scope it then took >1 year to evaluate, select, mobilise, trial and train and form an Alliance between Balfour Beatty and LUL (no other parties involved).

LUL held the risk of obtaining internal approvals and permits. Balfour Beatty held the construction risk. All other risks were shared. LUL and Balfour Beatty trialled and rehearsed for 6 months before commencing work in order to demonstrate to LUL management that the daily timetable was not going to be put at risk.

Over a continuous 2-year period, there was minimal disruption to the start of the daily timetable.

LUL had a number of stop / go 'back- up plans' in case the refurbishment experienced problems e.g. during mid shift and LUL had established decision trees as to when to cease work or change the shift schedule mid shift should an incident or delay occurred during any outage i.e. thus ensuring a timely handing back of the tunnel to LUL Operations.

The key to the success of the refurbishment contract was to ensure that good communications were maintained at all times so that real time decisions could be made and that the tunnel was returned to LUL Operations at the start of the daily timetable.

A particular issue for LUL was forcing Balfour Beatty to make, or relay, late changes to shift work schedules in sufficient time for LUL track Department to negotiate approvals with LUL Operations. It was frustrating to begin with, but communications improved as the work achieved a regular 'rhythm' of shift work.

LUL believe that the main lessons learned from the delivery of the above in-service refurbishment work were robust planning; collaborative behaviours of all parties; coupled with aligned incentives to complete the work and backed up by constant communication

Further information can be found at:

<https://www.youtube.com/watch?v=L9PVCJSJfY>

<https://www.railengineer.co.uk/2016/12/15/new-london-underground-slab-track-cast-in-situ/>

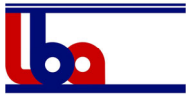

APPENDIX 7 - TUNNEL REFURBISHMENT WORKS TRAINS AND RAILHEAD

To carry out the refurbishment of the NRT in service in an efficient manner, a railhead would be required at a convenient location so that short works trains can be prepared, maintained and loaded ready for entry into the tunnel at the beginning of the shift as soon as the last shift's trains have exited the tunnel so maximising the valuable working time window. Efficiency and safety will be aided if the crews travel with the trains or were to embark en route.

The NRT in-service refurbishment will require works trains, initially for bench removal and reinstatement and subsequently for the installation of cables and mains. The critical works train configuration for the bench renewal has been identified as follows:

- 2no. 89' flatbed cars @ 95' outer length.
- 1no. 53' well car @ 77' outer length.
- 2no. locos @ around 18' outer length.
- Total length of works train around 300'.

Bespoke works train hybrid locomotives suited to work in tunnels can be obtained and would probably prove cost-effective over the duration of the refurbishment and overcome the problem of "long idling" diesel engines causing pollution in the tunnel during working.

Options might be:

- Switcher Locomotives (not preferred).
- All Battery locomotives such as the Clayton Equipment's Battery Hybrid Locomotive which can be seen in A7.2.
- Genset locomotives such as the Leaf by Railserve.

And there are other options mentioned elsewhere in other areas of this document.

Included herein are some marked-up proposals for railhead locations. These have been determined by LBA through an appraisal of what look to be suitable locations and are done with very limited knowledge of the localities. This would need much further consideration by the Gateway Partners to determine the credibility of these and perhaps other locations, taking into account efficiency, turn-round times, travel times, environmental and community concerns, and supply logistics.

Of the potential railhead locations identified adjacent to the Northeast Corridor, the Croxton Yard site would require an access viaduct and ramp to be constructed and the South Kearney multi-modal yard may have interlocking issues and third-party agreements that are yet to be determined.

The Hudson Yard at Harrison, although 5.8 miles from the NRT west portal, appears prima face to offer a viable location for a refurbishment railhead. The yard includes three tracks with access to the Northeast Corridor, sufficient space for a run around and is long enough to cater for up to four works trains that may be required at peak operations. These tracks could also be enclosed within a weatherproof shed incorporating a traveling gantry crane and other material and equipment handling facilities, in addition to maintenance and welfare facilities.

A7.1 Proposed Locations

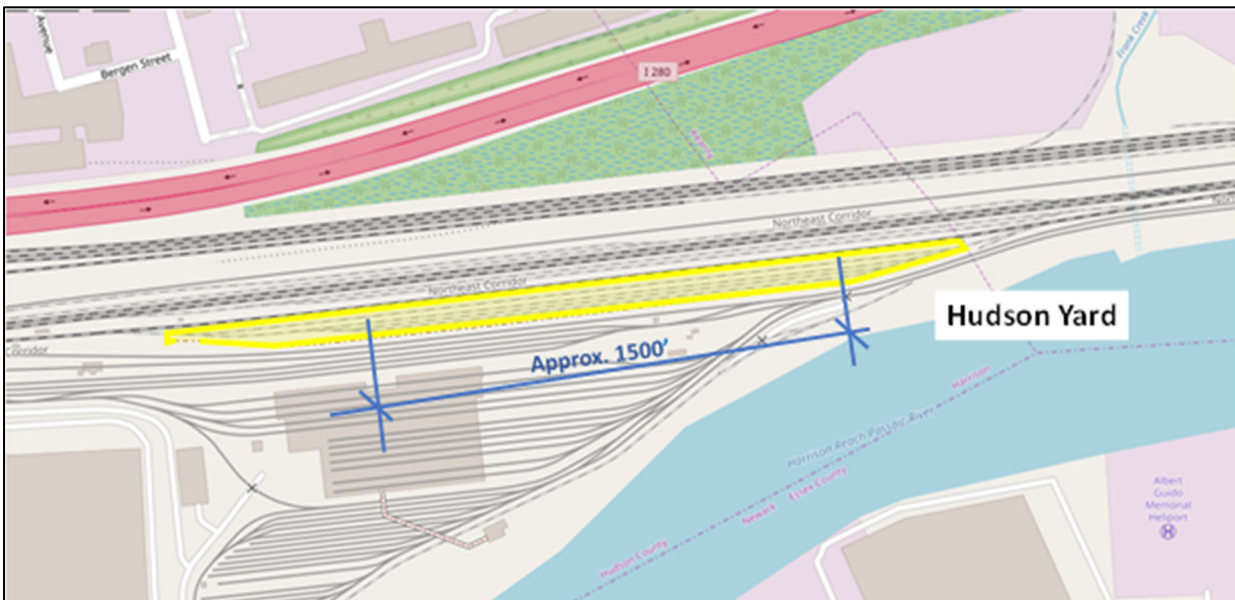
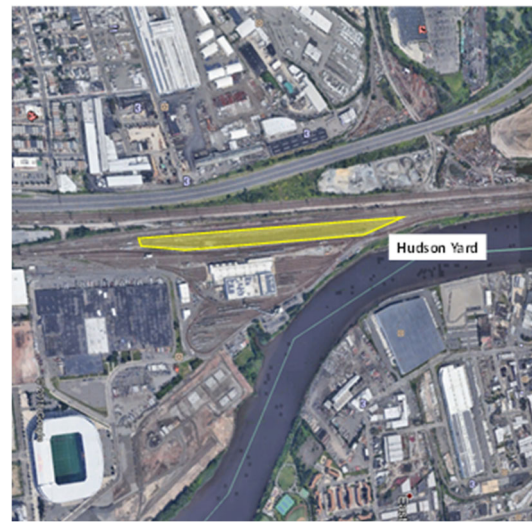
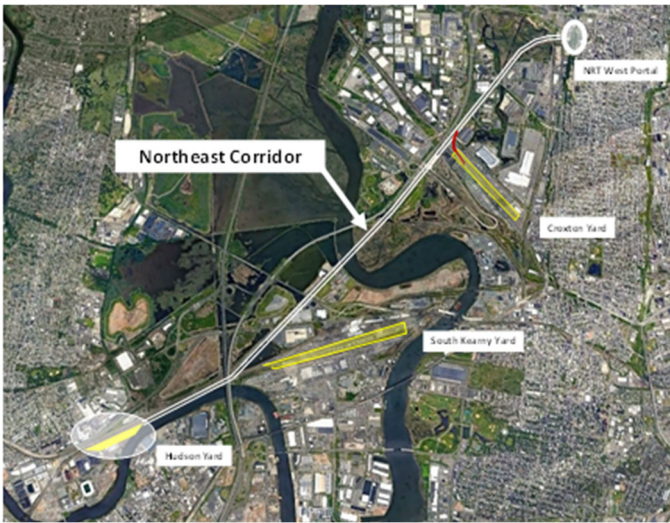

A7.2 Clayton Equipment's Battery Hybrid Locomotive

Clayton Equipment designs new battery hybrid locomotive - Jul 22, 2019

<https://www.railjournal.com/author/david-burroughs/>

British locomotive manufacturer Clayton Equipment has developed a new battery hybrid Bo-Bo locomotive. The class CBD90 90-tonne bespoke locomotive, which can be manufactured, tested and commissioned in just over 24 weeks, offers high torque and haulage capability with over 300kN tractive effort, delivering 2500-tonne loads, operating on a maximum gradient of 1.7%. The locomotive is self-contained, with on-board battery charging from a low-emission, EU Stage V compliant diesel engine charging a traction battery, which in turn powers four 104kW switched-reluctance, maintenance-free, high-torque electric motors.

Clayton Equipment says the setup yields several advantages, including around-the-clock availability. Fuel costs and emissions are significantly reduced by the hybrid technology, and the diesel engine can operate at the optimum speed for recharging the battery on-board. Regenerative braking from both gradients and flat tracks also boosts battery charging.

Maintenance costs, time and fuel use are reduced due to the hybrid design which eliminates the need to idle, as the engine can be switched off while waiting.



A7.3 Battery challenges and solution

The Hawker Perfect Plus traction batteries, designed by EnerSys, accept charge from the diesel engine or from an external 400V three-phase supply, and provide power to the electric motors.

The Perfect Plus batteries' flooded lead-acid design, which can be charged relatively simply unlike VRLA or lithium-ion battery technologies.

The first challenge of designing the CBD90 locomotive was that the motors required an unusually high DC operating voltage of 564V, compared with more usual levels of around 80V used by vehicles such as forklifts. There are systems for charging these locomotives i.e.

the Perfect Plus batteries' flooded lead-acid design, which can be charged relatively simply unlike VRLA or lithium-ion battery technologies.

The batteries provide high levels of power and reliability, from low-load applications up to heavy-duty multi-shift operations. Their long running time, availability and high discharge efficiency meet DIN/EN 60254 and IEC 254-2 requirements, which EnerSys says is essential as non-standard cells cannot be used, especially in remote locations.

The high resistance to electrolytic leakage and provision for escape of charging gases is also important as the locomotives can work underground, in mines, tunnels or other enclosed spaces

Labour is considerably reduced for the large number of cells needed to support the high voltage, as the batteries are easy to top up from one central point, and bolt-on connectors enable easy cell removal and replacement.

Categories: Europe Fleet Locomotives News: <https://www.railjournal.com/category/news/>

Tags: Clayton Equipment England: <https://www.railjournal.com/tag/clayton-equipment/>

APPENDIX 8 - TIME CHAINAGES: FURTHER EXPLANATION AND PRE-CONSTRUCTION ACTIVITIES

This appendix is provided to give more detailed information on the typical schedule that is contained in Chapter 10.

In A10.1, we provide a full version of the Outputs and Durations spreadsheet which calculates the durations used in the time chainages and Gantt charts.

The time chainage diagram (see *Figure A8.2*) that follows shows the main activities to be carried out in the refurbishment of the NRT. This is essentially the same programme as shown in the Gantt chart in A18.3, but provides better information on sequence, direction of work, number of work fronts and interaction between activities.

We have considered the situation where not all the weekend outages are available to the refurbishment. The results of that examination are shown in A10.1 and incorporated into the Gantt chart and the Time chainage in A8.4 "What If" T & A8.5.

We have also looked at the case where working is at weeknights and weekends i.e. there is, in effect, no Friday Night shift. This would only be an issue when this form of working nights and weekends on the same activity was planned. LBA find that it makes no material difference to the schedule. This is noted in the Outputs and durations spreadsheet.

Refurbishment with the tunnels in service is proposed to reduce the risks of failures and improve the reliability and resilience of the services which operate through the tunnels. The aim must be to mitigate these risks by refurbishing at the earliest possible stage. Only in this way is best value achieved. We therefore provide a simple Gantt chart in A10.6 showing the pre-construction activities vital to getting the refurbishment underway. Some of the activities may require an approach unusual to the Gateway Partners, but we remain convinced that this can deliver the value that is sought.

As can be seen Track bed replacement, although needing further information and diligence, is included in the schedule and planned as a weekend only activity. 34 weeks are shown which includes track lowering activities in advance as well as 8 weeks for trialling and testing before going into the tunnel to work. Final track bed replacement methodology requires confirmation, but the outline planning is based on performance achieved elsewhere globally.

It has been possible to incorporate Track bed replacement within the 31 months, but it should be noted that this uses all the available weekend outages.

If the overnight outages that the M & E refurbishment activities are planned to utilise are not available, these activities can happen on the weekend, but there may be some logistical inefficiencies and impacts from other operations.



A8.1 Outputs and Durations

Working pattern	Activity	Item	Output	For Total Length.						Impact of Local Factors		
				No shifts	Weeks	No of Fronts	Weeks total	Months/ Front	Notes	Impact of Friday NS included weekend	15% reduction in Weekend outages	Durations after losing outages
Mon-Fri Weekdays N/S only	Clean and repair tunnel crown		Assume carried out early as set up in process.	allow 3 months		2	12	3	Start Ch 19015 and work towards Ch25707 and the second front Ch 25707 to Ch32400 intention to get all 3-month lead on next item	No impact N/S only	No impact N/S only	12
Mon-Fri Weekdays N/S only and weekend	Install cable containment systems for LV, fireproof and transmission cables	Primary brackets	25m/ nightshift	163	33	2	Require 1225/2 wkd hrs=612.5. equates to 25 weeks of nights only. W/e wkd reduce to 19 weeks per front	4.75	assume weekend working as well during this period takes 6 weeks off Assume Front one starts at Ch 19015, Front 2 at Ch25707	0.5 month impact	Assuming only some w/e outages only so no Impact	19
		Ladder tray	50m/ nightshift	82	16							
Weekends shifts only	Trackbed replacement	Lower track to spec level. Remove ties and place concrete	31.5m per 8hr shift, plus 2 to lower track	130	24	1	24	5.9	Ideally other activities done on overnights while this in progress		Would add 5 weeks to programme	31



APPENDICES

Working pattern	Activity	Item	Output	For Total Length.						Impact of Local Factors		
				No shifts	Weeks	No of Fronts	Weeks total	Months/ Front	Notes	Impact of Friday NS included weekend	15% reduction in Weekend outages	Durations after losing outages
Mon-Fri Weekdays N/S only and weekend	Install fireproof cables, other non-emergency LV cables and radio on tunnel walls in containment	Cabling including banding to tray/cleating to ladder				2	6	1.5	Two fronts for compatibility	No impact actually only requires 2.5 weeknights and weekends, not 6 no	No impact was conservative already	6
		12 No cables	2km/ cable per nightshift	24	5							
		Leakey feeder cleated in place	1km/ nightshift.	4	1							
Mon-Fri Weekdays N/S only	Install bracketry for fire main, compressed air and pump discharge lines	pipe bracketry (3 m spacing)	2brackets/ nightshift (6m run)	680	136	2	68	8.5	Run one front through tunnel	No impact N/S only	No impact N/S only	68
Mon-Fri Weekdays N/S only	Install pipework/hydrants and commission systems	Install pipe	24 m per nightshift	170	34	1	34	8.5		No impact N/S only	No impact N/S only	34



APPENDICES

Working pattern	Activity	Item	Output	For Total Length.						Impact of Local Factors		
				No shifts	Weeks	No of Fronts	Weeks total	Months/ Front	Notes	Impact of Friday NS included weekend	15% reduction in Weekend outages	Durations after losing outages
		Hydrants	allow 1 per shift brackets and fixing				Hydrants included		Parallel activity	No impact N/S only		
Mon-Fri Weekdays N/S only	De commission and Strip out old pipework	Allow			1		allow	0.25	allowance is e/o install	No impact	No impact N/S only	1
Mon-Fri Weekdays N/S only	Fix and terminate new lighting, call points comms equipment	Fix & terminate lights from mobile platform 2,5 m spacing	4 per shift per team	408	82	2	41	10	Start Ch 19015 and work towards Ch25707 and the second front Ch 25707 to Ch32400	No impact N/S only	No impact N/S only	41
Mon-Fri Weekdays N/S only	Install new signalling equipment and support from tunnel walls	Maintenance and reposition signalling system	100m/week plus 1 w/e	41	8	1	8	2		No impact N/S only	No impact N/S only	8
Mon-Fri Weekdays N/S only and weekend	Decommission old electrical systems and recommission new circuits	Phased system to suit progress of bench	Assume 1 per week per 10 circuit systems		10		10	2.5		No impact	Add 0.375 months to duration. Assume 3-month overall duration	12



APPENDICES

Working pattern	Activity	Item	Output	For Total Length.						Impact of Local Factors		
				No shifts	Weeks	No of Fronts	Weeks total	Months/ Front	Notes	Impact of Friday NS included weekend	15% reduction in Weekend outages	Durations after losing outages
Mon-Fri Weekdays N/S and w/e	Decommission any cables on Egress walkway side of the tunnel	Allow			10		10	2.5	allow one week in line	No impact Weekends only	One weekend only!!	1
Weekends shifts only	Demolish the Egress walkway rebuild with chosen option	Whole operation is related to demolition and prepare	162 feet advance in a weekend or 27 ft per shift	496	83	2	41		Start Ch 19015 and work towards Ch25707 and the second front Ch 25707 to Ch32400	No impact Weekends only	Add 6 weeks	47
Weekends shifts only	Install new cables in Egress walkway and commission all 4 cables	1 weekend shift per 2 cables length including splices 300 metre drum	600metres of cable per weekend		27		27	6.75	4 cables 4079 length, 600, per weekend divided by 4 for months. Working behind the demolition/recon fronts	No impact Weekends only	Add one month to duration making it 7.75 but retain overlap as 1.5 months	31
Weekends shifts only	Demolish maintenance walkway and reconstruct bench	Whole operation is related to demolition and prepare	180 feet advance in a weekend or 30 ft per shift	446	74	2	37	8	Start Ch 19015 and work towards Ch26480 and the second front Ch 26480 to Ch32400 Faster advance rate due to learning curve and refinement of logistics	No impact Weekends only	Add one month to the duration making 9 months	43

A8.2 Time Chainage

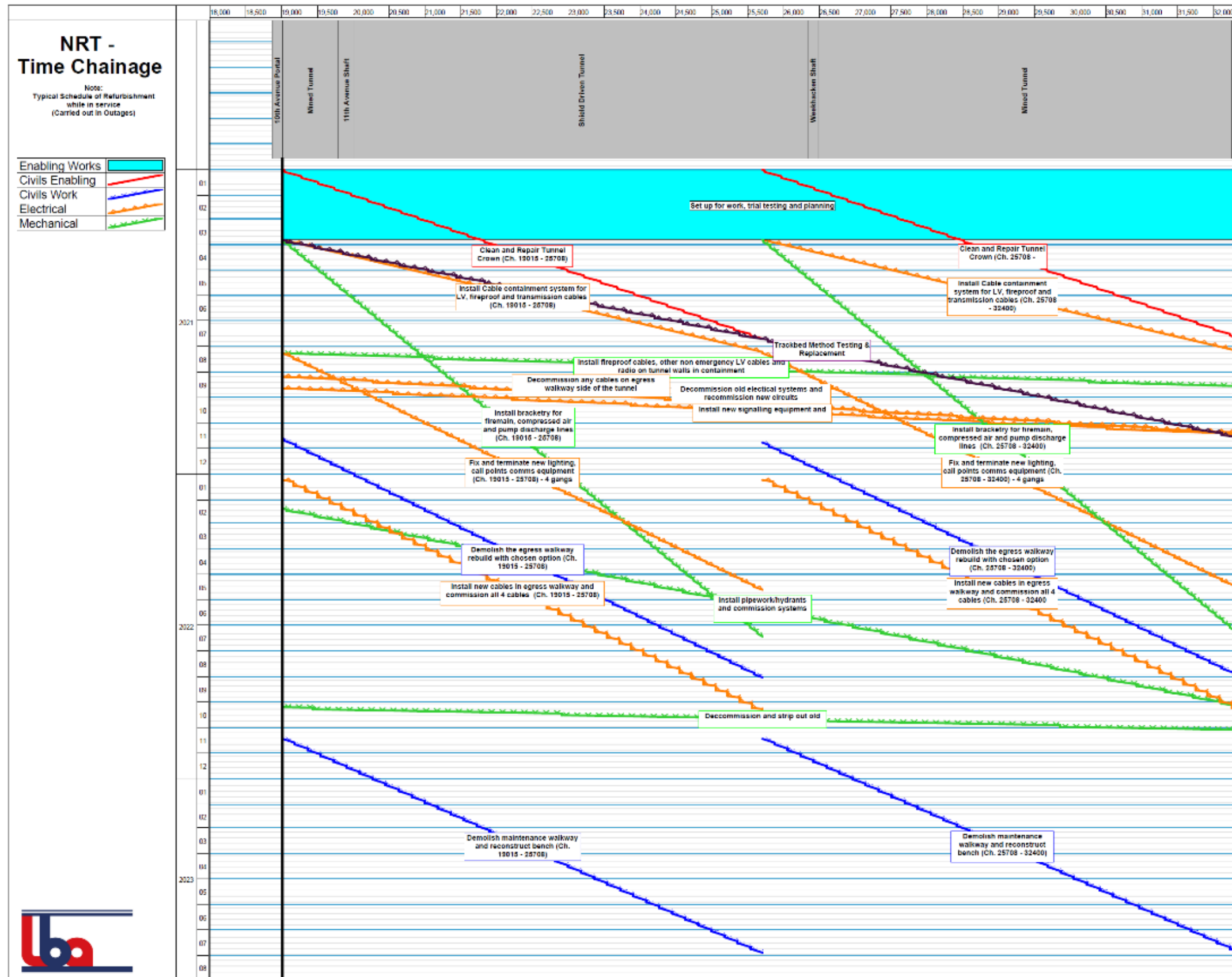



A8.3 Gantt Chart

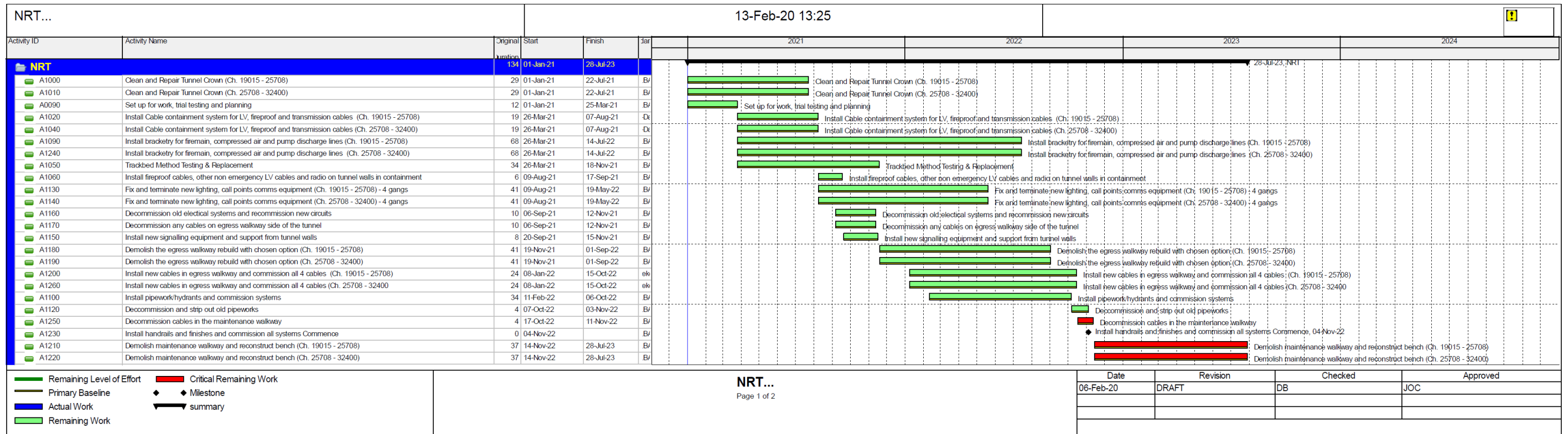

A8.4 "What If" Time Chainage

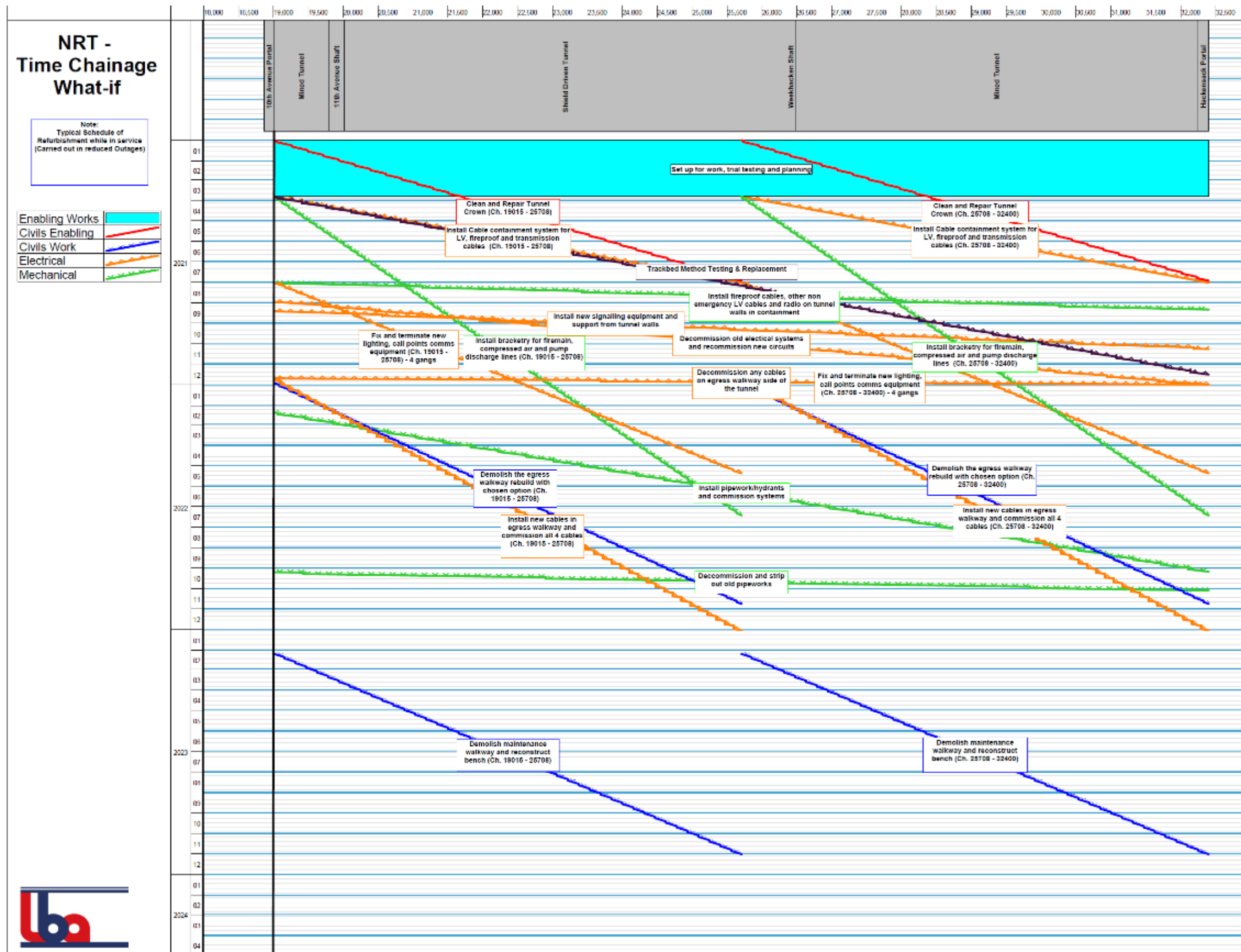



A8.5 "What If" Gantt Chart

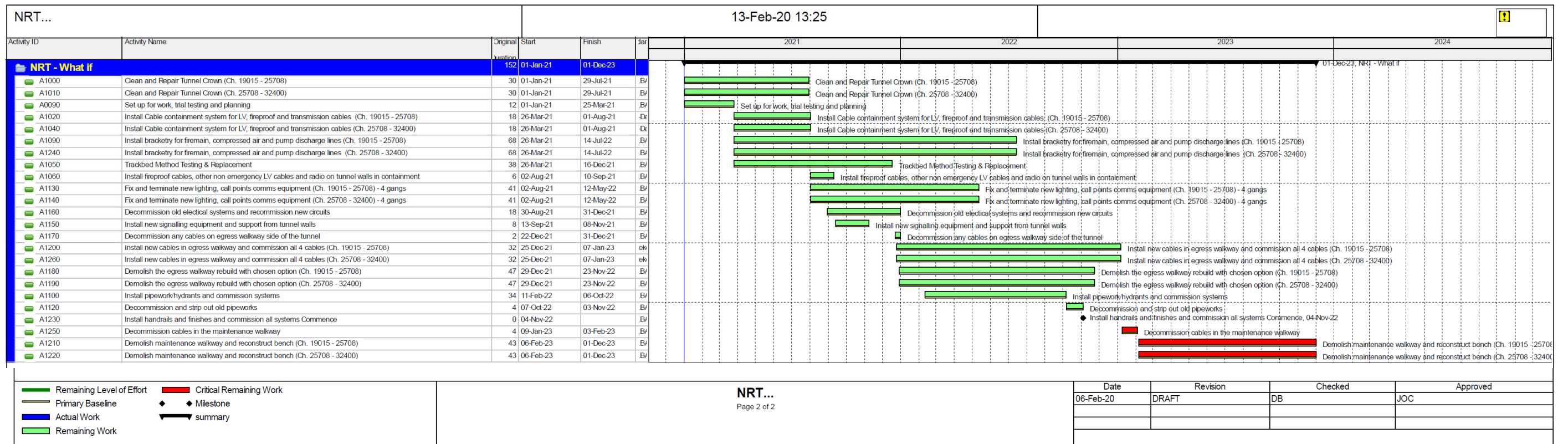

A8.6 Pre-Construction Activities

Outline schedule of Pre- construction activities in connection with the NRT Refurbishment													Date 07/12/2019		
Activity		Months												Comments	
	Duration (months)	1	2	3	4	5	6	7	8	9	10	11	12		
Management Set up															
Develop Integrated Team		→													
Develop Delivery Organisation				→											
Prepare plans and procedures				→											
Develop Quality System						→									
Detail Management Systems, H & S, Environmental, Administration, Community Relations							→								
Submissions to statutory bodies				→				→	→	→	→				
Prepare Plan and Schedule		→													
Prepare Cost estimate		→													
Prepare addendum to EIS?				→											
Design															
Commission design				→											
Design Surveys e.g.					→										
Cables					→										
Invert					→										
Develop design with Contractor(as soon as on board)					→										
Investigate and Solve Shaft water problems						→									
Develop materials and methods for repairs										→					
Procure Contractor															
Decide Contractor Selection method		→													
Prepare Contract docs				→											
Select contractor					→										
Contribution to design and planning on ECI basis as part of integrated team							→								
Detailed Scheduling and planning								→							
Development of method statements and working processes								→							
Develop Mock ups and testing planning										→					
Finalise Commercial Arrangements												↓			
Plant Procurement															
Identify and procure long lead plant															
Rail mounted plant including locos	6										→			On-going	
Conveyors	4									→				On-going	
Road Railers	6									→				On-going	
Develop requirements for specialist fabricated items									→						
Materials Procurement															
Procure Long lead Items for M & E systems	6										→			On-going	
Sub Contractors															
Identify and define Specialist SC Packages										→					
Railhead															
Identify location and develop planning for rail head		→													
Detailed design of railhead								→							
Construction of rail head	6									→				On-going	

A8.7 Construction Timeline Comparison

	Current Plan	In-Service Plan	Notes
HRT Procurement Duration	15 Months	15 Months	<i>In-Service Plan: NRT 15-Month Procurement In-Parallel</i>
HRT Construction Duration	96 Months	96 Months	
NRT Refurbishment Start	Month #112	Month #16	<i>In-Service Plan: 96-Month Savings</i>
NRT Refurbishment Duration	37 Months	62 Months	<i>Current Plan: NRT Refurb after HRT completed</i>
NRT Tube #1 Improvement	Month #129.5	Month #46	<i>In-Service Plan: 84-Month Savings</i>
NRT Tube #2 Improvement	Month #148	Month #77	<i>In-Service Plan: 71-Month Savings</i>
Total Program Length (HRT & NRT)	148 Months	111 Months	<i>In-Service Plan: 37-Month Savings</i>

Note

- HRT assumptions provided by GPDC.
- Start of month 16 for NRT refurbishment assumed for comparison purposes only.
- First new tunnel under Current scheme is First HRT at 15 + 96 months=111months
- First NRT refurbished in 15 +31 months = 46 months
- Saving on delivering first new or refurbished tube is 111- 46 =65 months
- Saving on delivering both NRT tubes is 111-(15+31+31) =34 month

APPENDIX 9 - THE USE OF SLAB TRACK IN OTHER RAILWAYS AROUND THE WORLD

This appendix is prepared in response to a request from Amtrak and is based on a paper written by Dr S Tayabji & D Bilow for the US Portland Cement Association titled: "Concrete Slab Track, State of the Practice". It was published in January 2001 by the US Transportation Research Board (TRB). The paper describes a range of designs of slab-track system in use on various railways around the world at that time and provides a methodology and series of design standards for the design of slab-track for any specific location. The methodology Tayabji & Bilow propose is based on an analysis of the strength and stability characteristics of conventional ballasted track. In this short note the LBA writer also refers to some examples of slab-track and "slip-formed" concrete pavements with which he is familiar.

Slab track designs can be divided into two groups:

- Cast in situ concrete pavements
 - Continuously reinforced concrete (CRC) pavement with track fixed directly to the pavement with conventional resilient rail pads and clips at each base plate. Generally laid flat with cant to centre line provided by the base plates.
 - Slip-paved pavement, usually with track fixed directly to the pavement including resilient rail pads and clips, but without base plates. The track slab is generally laid with 1:20 cant to centre-line formed by the slip-paving machine.
- Pre-cast concrete track bearers include fixings and cant to centre line.
 - Units are laid in place on site-cast concrete base with flexible bedding joint.
 - Units laid in place then surrounded in concrete with vibration isolation material between the bearer and the in-situ concrete.

Since the Tayabji & Bilow paper was published in 2001 there have been significant advances in the use and capability of fibre reinforced concrete, particularly steel fibre reinforced concrete. When the detailed design of a track slab solution for the NRT is prepared, the characteristics of these modern materials should be used to achieve a design meeting the performance specification put forward in the Tayabji paper (by the US Portland Cement Association to AREMA-The American Railway Engineering and Maintenance-of-way Association).

A9.1 Examples of In-situ Cast Concrete Slab-Track Cited by Tayabji & Bilow.

- LIRR Massapequa Station Project

In the late 1970s just east of Massapequa station, LIRR constructed two separate track-slabs, 1.13 miles in length, using conventional formwork, CRC. These two parallel lengths of track were not slip-formed. The slab is 12 inches thick, 10.5ft wide and includes conventional reinforcement bars in two layers providing 0.9% of cross-sectional area longitudinally plus transverse reinforcement, a fairly conventional continuously reinforced concrete (CRC) pavement structure. Rail fastenings were drilled and glued to provide standard base plates for Pandrol E-clips.

- LIRR West Side Storage Yard and Richmond Hill Yard

Slab-track was laid in these two yards because they are both very heavily used – at West Side Yard: to accommodate LIRR trains that have unloaded passengers at Penn Station, New York, and must be held until the evening peak period when they will take these same commuters home eastwards. These tracks are occupied all day, every day, so there was not adequate time to carry out necessary routine maintenance in this formerly ballasted track yard. The CRC slab-track has now obviated the need for most plain line of the track maintenance attention.

NB The Specification and construction was as for the Massapequa Station project.

- Some British examples of slab-track in refurbished tunnels.

In the UK the first lengths of slab-track were designed and built by British Rail with McGregor Paving Ltd who developed and patented the PACT-TRACK slip-paving system. A length was laid on open track in 1968 and since then many lengths have been laid through tunnels where additional clearance has been required either for Overhead Line Electrification (OLE) at 25kV AC or to permit taller ISO containers, boxes up to 9'-6" on UK standard flat cars, to pass through 19th century tunnels originally built for British loading gauge trains with conventional ballasted track.

The LBA writer was involved with the specification and design of several of these schemes including Southampton Rail Tunnel, a scheme to enable 9'-6" containers to be moved by rail to and from the Port of Southampton. Here the electrification is 3rd rail 750V DC. At Farringdon in central London, Kidgrove Manchester, Charing Cross Glasgow, there are examples of slab track laid to improve clearance for OLE only.

In the UK where maximum axle load is 25.5 metric tonnes / 28.1 US tons, the PACT slab is usually 200mm (8") thick under rail seats at 1500mm (59") centres and 2300mm (90.5") overall width. The 1:20 cant under the rail seats is continued towards the centre line to form a defined drainage channel. Pandrol shoulders are epoxy resin glued to holes drilled at positions to suit 113lb/yard rail, the former UK standard rail section, fixed using the standard Pandrol E-clip.

Standard cross-section drawing for a UK PACT-TRACK installation.

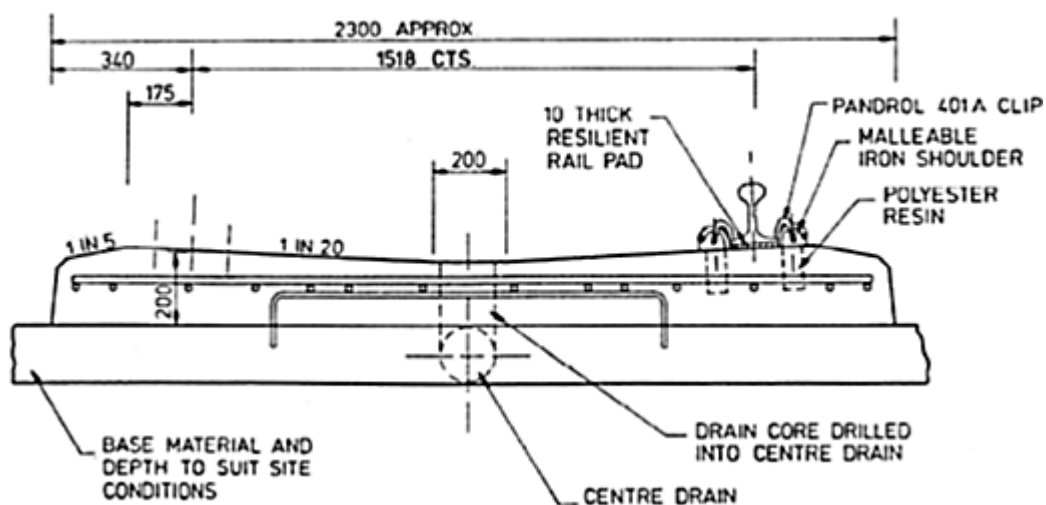

- Canadian Pacific examples: Albert Canyon, Mount MacDonald and Mount Shaughnessy Tunnels.

Canadian Pacific (CP) railroad adopted the McGregor PACT-TRACK system at two locations. For AAR 36 ton axle loads (32.66 m-tonnes) the slab was 229mm (9") thick under the rail seats at 1500mm (59") centres and 2430mm (96") overall width with the 1:20 cant under the rail seats continued towards the centre line to form a defined drainage channel. Pandrol shoulders are epoxy resin glued into holes drilled at positions to suit 136lb/yard rail, fixed using the standard Pandrol E-clip. In these CP examples the specification called for fixings at 12-inch centres to cope with significant track curvature together with a continuous 12.7mm / 0.5-inch rail pad.

The Tayabji & Bilow paper proposed rail fixings at 30-inch centres on straight track – as per the existing NRT cross-tie spacings. Therefore, we currently believe that the NRT fixings to a

track slab would be at 30-inch centres, with rail pads only under each base plate to allow free drainage between base plates. This specification must be subject to further detailed design.

The Tayabji & Bilow paper also discusses a series of alternative designs using pre-cast panel track slabs, generally laid on a lower strength concrete base or on prepared crushed aggregate road base. These systems do not facilitate improved headroom where this is a requirement as to why slab-track is to be installed. The LBA writer also has some experience with the Budapest tramway track slab system which was of the pre-cast panel type.

A9.2 Slip-paved Slab-track in the North River Tunnel.

Currently we have proposed that a slip paved slab 14.4 inches (365mm) thick at the rail seat, could be added to the scabbled surface of the inner face of the concrete lining of the tunnel giving a total structural depth of 42.3 inches (1074mm) at the rail seats. This final structure would include a properly bonded junction between the tunnel lining and the slab-track, but the plane of this joint, approximately horizontal, is perpendicular to the action of the axle load, acting vertically. Being unreinforced concrete, this will be considerably stronger than any other example of slab-track having no flexible, or isolating, joint to the tunnel lining.

The only vulnerable locations in the NRT are at the junction of mined to driven tunnels i.e. the junction between hard rock and geologically recent riverine sedimentary material. Potentially the structural bending moment of the lining may be in “hogging” at these points and, for the purposes of our review only, we have estimated that the additional concrete of the track slab properly bonded to the tunnel lining may add of the order of 14% to the moment of inertia of the structure in bending in this mode at these points. However, a detailed assessment of the structural implications of the addition of a slip-paved track-slab at these points will need to be assessed.

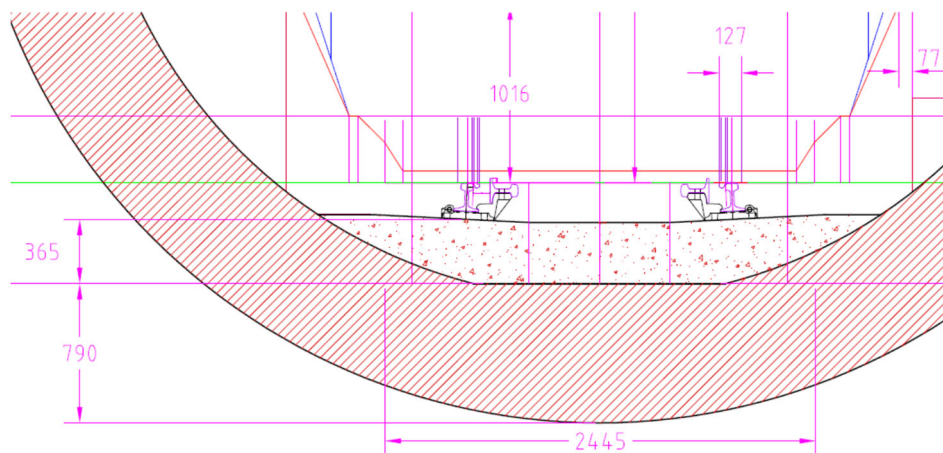

Extract from LBA Gateway Report, Figure 9.3, Slab-track in the NRT tunnel invert.

A9.3 Failure in the Substrate Causing Failure of a Slip-paved Slab.

At a number of points in their report, Tayabji & Bilow note that slab-track can be vulnerable to differential movement in the substrate at junctions between substrate materials of markedly different bearing strength, particularly at a change from cutting to embankment.

In 1972, the LBA writer was involved with construction of an early slip-paved concrete highway pavement in Somerset, England, the M5 Taunton Bypass. This new motorway was constructed on a new alignment with extensive cut and fill to produce a good vertical profile for this three-lane, dual carriageway, 70 mph highway. The slip-paved pavement was designed and laid by McGregor Paving in two passes, one three lane carriageway (11m wide) each pass, and 10.2 inches thick, with unreinforced concrete, but including dowel bars at contraction joints and tie bars across the

two longitudinal joints, (as used on the McGregor Paving railway applications). This was many years before the availability of any form of fibre-reinforced concrete.



Within the NRT, the proposed slip paved track slab would be laid entirely onto the concrete invert of the tunnel. However, there are two known zones where the support of the tunnel structure changes from hard rock to soft riverine sedimentary material. At these sites detailed structural assessments will be required and appropriate measures included in the final design and construction of the slab track over relatively short lengths at these sites.

Similarly at the two ends of the slab-track, west of the New Jersey portal and in the approach to Penn Station, NY, "throat" the slabs will need to terminate with "transition slabs" to manage the change in track flexibility between slab-track and ballasted track. At these locations the risk that must be mitigated is that of local stress concentrations inducing fatigue at a point on the rails and consequently: broken rails.

A 9.4 Fixing Base Plates to the Slab Track. Avoidance of Fastener Related Problems Noted by Tayabji & Bilow at Some Early Slab-track Sites.

In practice, 40 years after the LIRR Massapequa Station Project slab-track was carried out, steel fibre reinforced concrete is normally specified for slip-formed pavements. This will greatly improve the resistance of the finished track-slab to micro-cracking which will become particularly important at points where the slab must be drilled and holding-down fixings epoxy glued in for the track base plates.

The possibility of the glued holding-down fixing breaking out is a serious issue and one that has been raised by Amtrak during this NRT Refurbishment study. However, the adoption of steel fibre reinforcement in the concrete of the track-slab to guard against micro-cracking when the holes are drilled is a first, and important, step towards elimination of this risk. The second step will be to specify, and ensure the achievement of, adequate curing time and concrete strength before drilling for the base-plate fixings is commenced. The third requirement will be to ensure the appropriate choice of specification and use of the epoxy resin to be used

If a base-plate fixing site does spall, modern epoxy cement materials and procedures are available to make good these sites whilst fixing the base-plate holding-down bolts at the same time. These should be prepared before the drilling and fixing phase commences so that it is immediately available if the need were to arise.

A9.5 Survey Data and Detailed Assessment Ahead of Commencement of Slab-track.

We understand that during March 2014 Spacetec GmbH carried out a 3D laser survey of each of the two NRT tubes. From this data it is possible to produce wire-frame drawings of the tunnels that will show where there are existing discontinuities in the alignment which must be allowed for in order to achieve the required clearance at the crown, as the slab-track pavement is laid through each tunnel. For the final design, geotechnical analysis will also consider the

extent to which there may be further deformation over the forthcoming 100 years, for which flexure points in the track-slab structure may be required.

During the development of the slab-track scheme for the 1584 feet long (483 metres) Southampton Tunnel, to enable 9'-6" containers to move by rail to the Port of Southampton in the UK, a 3D "wire-frame" drawing and 2D composite of a series of cross-section surveys of Southampton Tunnel were produced from 3D laser survey data. Copies of these drawings are below for information. The deformation of this tunnel over its 160-year life can be clearly seen, together with a length of tunnel where a partial collapse was caused by water trapped in an abandoned early 19th century canal tunnel that ran alongside the "newer" railway tunnel. The failed length, sections 35 to 53 on the "wire frame" drawing, was made good using Cast Iron (CI) rings during the 1980s. At the time the 3D laser survey was made it was not possible to include points below ballast level. For the design, original cross-section drawings were over-laid to the survey drawings in order to develop the slab-track design which included breaking out parts of the original brick invert. A photograph of the interior of this tunnel, during construction of the south-westbound track-slab during the 12 day construction Christmas to New Year track outage in 2009-10, is appended; the CI ring length can be seen in the middle distance.



Southampton Tunnel, UK, during 12-day outage to install 1600 ft long slab-track.

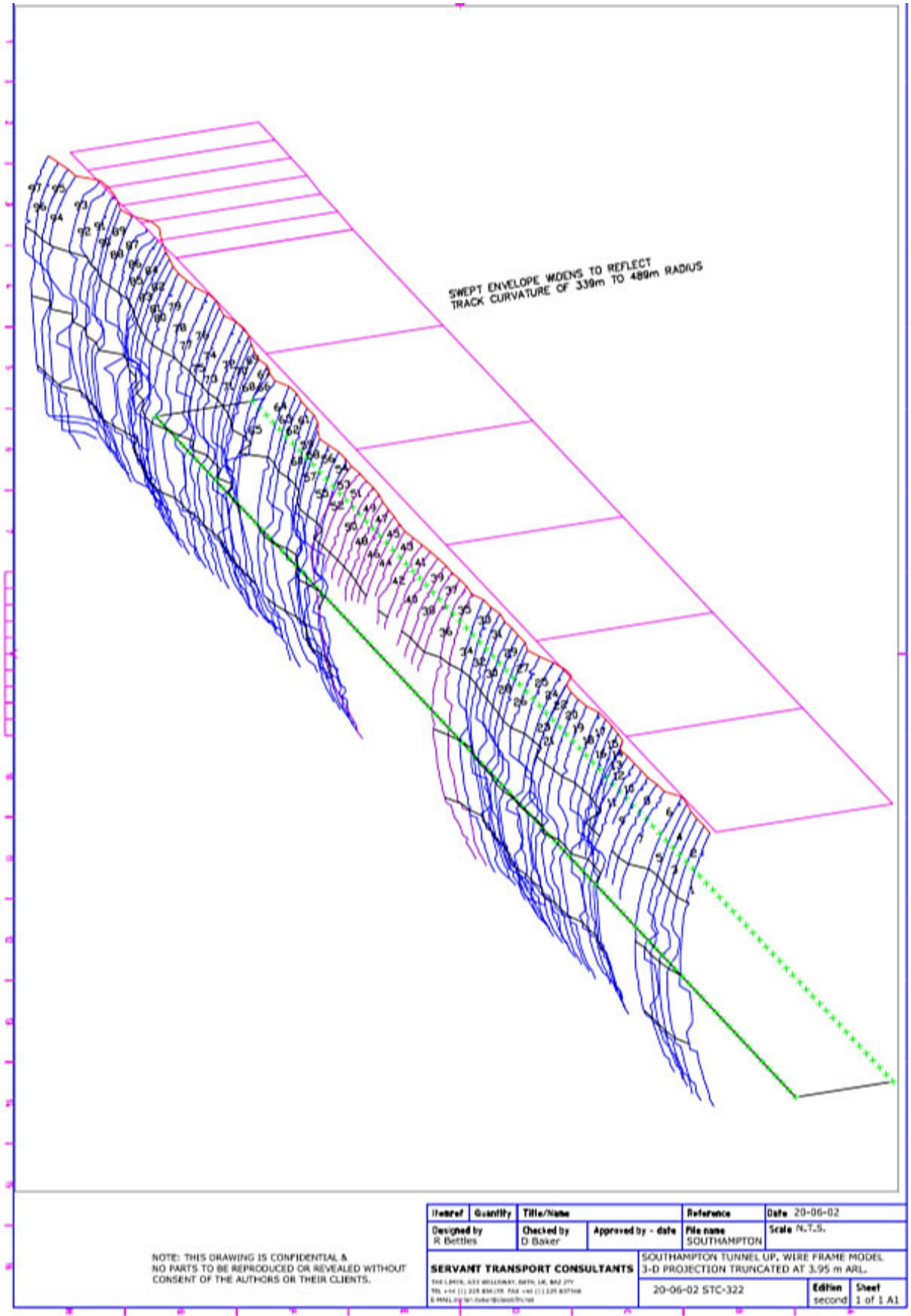

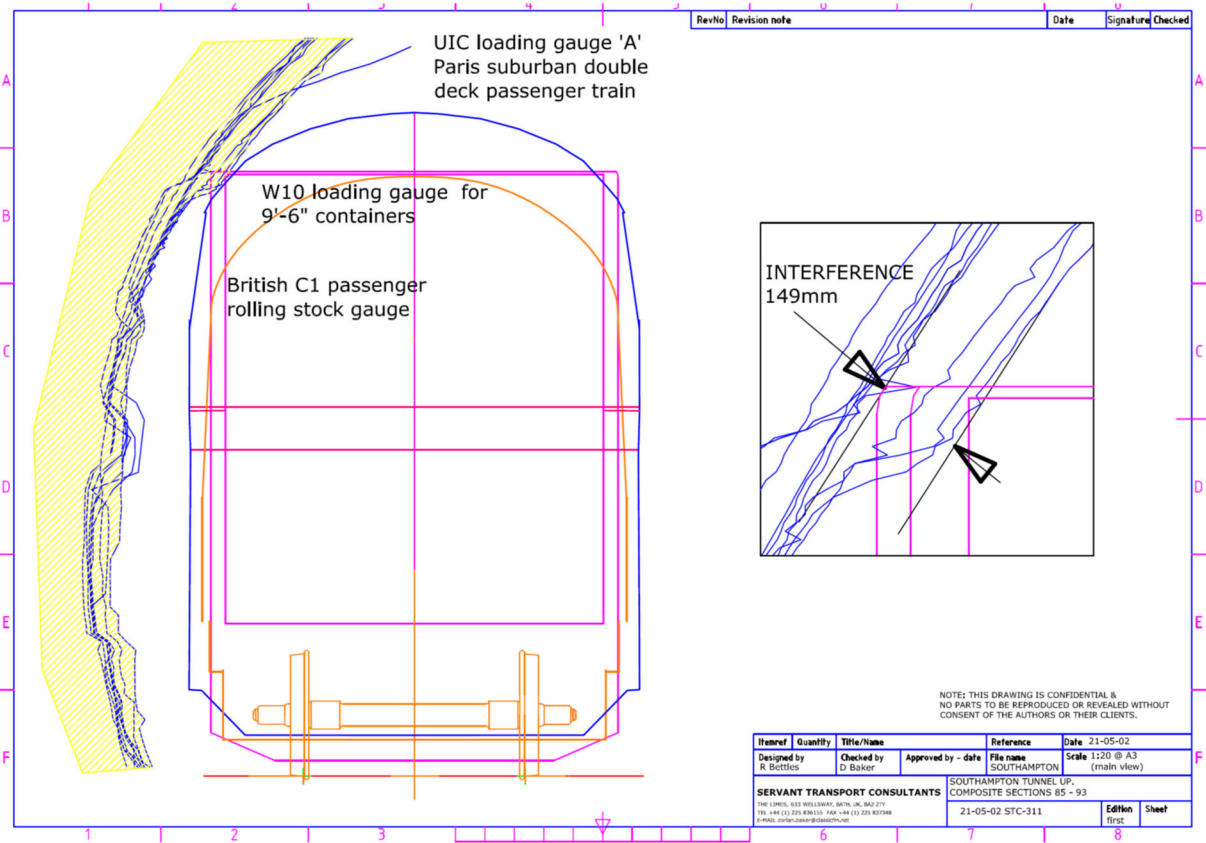

APPENDIX 10 – IMPLEMENTATION**A10.1 Introduction**

This purpose of this appendix is to provide further information and international examples of LBA's proposed approach for the implementation of the NRT in-service refurbishment. Section 10.13 on Implementation and this Appendix describes:

- How the NRT Refurbishment might rapidly progressed by collaborative working
- How the refurbishment might be most effectively managed by a single integrated team
- The early and important actions to investigate and prove methods and materials; the surveys for design; and the procurement of long lead items

Case studies and reference documents support the LBA implementation proposals in Appendix 10.4

A10.2 Process for Taking the NRT Refurbishment Forward

There are two key elements of the proposed approach in order to facilitate a rapid, yet best value execution of the refurbishment works i.e. Building an Integrated Team and Early Contractor Involvement (ECI)

Integrated Work Team/Management is described in some detail in Section 10.13 and referenced with case studies below.

The ECI process is also described in some detail in Section 10.13 but is also tabulated below and referenced at each stage to precedent and documentation.

A10.3 Early Contractor Involvement (ECI)

The NRT Refurbishment might be best achieved by a two-stage “Early Contractor Involvement” arrangement:

Following the formation of an integrated Gateway and Partners team a number of early decisions must be taken (as shown below) leading to the procurement of a contractor, designer and sub-contractors to join the Integrated team. A two-stage early contractor involvement approach is proposed. This allows the whole team to work together to contribute innovation and creative ideas to the development of the workplan for the NRT Refurbishment

- Stage 1: Design, Planning, and Procurement of Long-Lead Essential Items
- Stage 2: Construction and Implementation

This ECI is a process that has been used for several years in the UK with some considerable success. Examples are given in Case Studies below, including a particularly good example at M25 Holmesdale Contract and now being used on High Speed Two from London to Birmingham, Manchester and Leeds.

A10.4 Early Decisions

Activity	Actions	Comments/Precedents
Outline Decision to proceed and basic responsibilities	A clear brief that outlines the intent/scope of the project and basic stakeholder responsibilities and is endorsed by the Gateway Partners.	To ensure that Gateway Partner stakeholders have the same understanding and are in agreement on the process moving forward.
Produce plan for proceeding	Make basic policy decisions on the process and the commercial model. The procurement model should include decisions on objectives, incentive alternative(s), contractor qualifications/competence, and distribution of work, among other items.	It is very important that one sets out with the right objectives. Hopefully agree that the “carrot” approach works better than the “stick”, and that the Client is willing to pay the actual cost of the contract and provide incentives for team performance, delivering better value and meeting KPIs. See Ref 1 New Style MP toolkit Ver 1.01_Nov 2005 . UK Highways Agency KPIs. .
Develop team concept	Set out the organisation of the Integrated Work Team and bring in the relevant key staff.	Important that the basic plan is clear to tell the team. Information: Ref 2 Article on T2A alliance See Figure A10.3 Organisation Chart .
Decide what is required of team participants. <ul style="list-style-type: none"> • GPDC Partners • Designer • Contractor • Delivery Partner • Project Auditor Develop Outline Scope(s)	Prepare and issue an information statement that goes out with a short description of the works. This statement will identify how the Client wants contractors to participate and how they will be incentivised/ recompensed. Also, how they are required to be ‘open’, deliver high performance and work collaboratively with others. This should also detail the skills and attributes which are required for contractors to be considered.	<p>Firstly, one has to ascertain the experience, competence and ‘behaviours’ of the bidding contractors to do this i.e. do they have the experience, the resources, the cultural alignment and the expertise that they will be required to contribute.</p> <p>So, competence criteria and cultural criteria will be required.</p> <p>This concept may be difficult at first and developing a set of KPIs up front may be vital to get the concept across. (See Ref 1 HA KPIs).</p> <p>Also need at this stage to consider how one manages a team member who does not perform in some way so that it can be built into future contracts</p>
Decide method of selection of contractor(s) and designer(s)	<p>Explain how the contractors will be selected for the ECI type arrangement.</p> <p>Explain how their submissions will be accessed and verified.</p> <p>Invite applications for selection</p>	<p>Crucial that this does not erect commercial barriers which turn into performance barriers and very importantly encourages the behaviours we want. See Ref 3</p> <p>Do need to explain that their submissions must be based on evidence from previous involvements and that the evidence will need to be verified or validated before a contract is let.</p>

Activity	Actions	Comments/Precedents
Decide contracting basis	The contract between the parties should be determined based on the type of delivery methodology chosen. For this project a two stage ECI type arrangement is proposed.	<p>The Contract example in Ref 3 is based around a standard UK form of Contract published by the Institution of Civil Engineers. It is a Target Cost type contract which is essentially a cost reimbursable contract with an incentive mechanism to reduce cost. This works better than some older forms, but still creates commercial barriers. However, this can be easily be modified to suit the arrangements for dealing with cost</p> <p>Ref 12. Draft 2 SA (C550 Supplemental agreement) See also Ref 21 Union Railways North (URN) Conditions of Contract</p>
Issue tenders to selected contractors	Given the urgency the suggestion this would be a short tender period and a minimal submission	Invitation to Tender M25 Holmesdale (See Ref 3) is a good example. The Quality Statement on which the award was almost exclusively based and was restricted to 75 sheets of paper (A4).
Adjudicate tenders and decide ECI contractor(s)	A small team (or panel) of the Gateway Partners is needed to review contractor proposals. The method of adjudication needs careful consideration so that it is as fair as possible and must be oriented towards competence, improvement potential, and willingness/ability to work collaboratively.	<p>The procurement outcome should be based on the review of a small team/panel and be a team decision ensure fairness. Quality statement will need to be validated from previous involvements which supports their proposals regarding competence to achieve the Clients objectives. Willingness and potential to initiate improvements and ability to work collaboratively is essential to confirm selection Ref 7 M 25 Holmesdale evidence summary, Ref 3-5 Contract documents including Invitation to Tender for M25 Holmesdale</p>

A10.5 Early Contractor Involvement (ECI) Stage 1

Activity	Actions	Comments/Precedents
Introduce the designer in and develop design as a team/ develop detailed scope	The appointment of the designer should be by the Integrated Work Team, and depending on the designer, could possibly be contracted directly to the Gateway Partners and/ or to the selected contractor.	A combination of an established consultant with a Small Medium Enterprise (SME) specialist company could encourage innovation and practical solutions Needs to be an early decision. Ref 3-5 Contract documents including Invitation to Tender for M25 Holmesdale
Identify long lead items to be procured	The Integrated Work Team should do advanced work and make a decision as a team on identifying necessary long-lead items. If a cost-based contract is utilised, the ownership of the long-lead items will rest with the Gateway Partners as the client.	The ECI facilitates the advance work on this, but it must be a team decision. If you have a cost-based contract, then ownership will always rest with the Client and this allows early progress in stage 1.
Identify equipment required and procure	The Integrated Work Team should do advanced work and make a decision as a team on identifying necessary equipment as the construction methodology is developed.	The ECI facilitates advance work on this, but it must be a team decision. Ownership will of course be with the Client. Hire or Purchase should not be a difficult decision with the timescale of the work to be done
Identify and prioritise testing areas and detail, design, and build test facilities	Before a method can be taken into the tube during an outage any doubt about its efficacy and predictability must be removed by demonstrating that the system will work and contingency plans are in place to manage the situation where something does not work and the tube must be returned to working on time at the end of the outage. The Integrated Work Team should identify opportunities for, develop methodology for, and implement the testing/demonstration of materials and construction methods.	See photographs of mock-ups prepared for other projects below Figs 10.1-10.12
Finalise location and draw up plans for railhead location	The Integrated Work Team should work together to identify the best location for a railhead.	Develop the planning of the refurbishment and the railhead. Develop operating plans out of which will come requirements for locomotives and rolling stock and other equipment. Also, the needs for servicing facilities at the railhead.
Prepare cost model	Prepare full build-up of costs going forward and agree. Prepare risk schedule and estimate risk contingency appropriate, also agree incentive arrangements.	It is absolutely vital that all parties contribute to this cost model including contractors' sub-contractors and designers. It must be prepared in sufficient detail to enable proper monitoring and continuous end cost forecasting. Our suggestion is that a cost reimbursable arrangement is best with a defined risk 'pot' in which all share the savings provided key dates have been achieved. This is similar to the HS1 arrangements. Ref 10 Incentivisation Proposal Mk5 HS1 & Ref 13 Holmesdale

Activity	Actions	Comments/Precedents
		Adjustments and Value Engineering (VE) to Target Cost (TC)
Prepare detailed plans and procedures for proceeding	Develop typical team procedures, plans, methodologies, risk management plans, and contingency plans.	Typical team procedures and plans. Methodology plans, procedures and instructions Risk Management plans including contingency planning. Early actions listing. Readiness reviews See Ref 19 A4 Diagram-Project Management System
Complete Stage one set up arrangements for proceeding	Design sufficiently advanced for procurement and construction to start. Agree the incentivisation proposals to go forward. Authority to proceed.	This can be a difficult stage, but, the important thing will be a balance between the cost estimates and the sharing arrangements.
Proceed to Stage 2 on basis that all agreements in place	Cost plan and schedule agreed. Operating procedures approved, for first activities. Commercial and incentive arrangements agreed.	

A10.6 ECI - Stage Two (Execution)

Proceed with NRT Refurbishment works when all necessary plans, procedures, checks and approvals are in place.

Activity	Actions	Comments/Precedents
Establish a system of continuous improvement in risk management, output, contingency planning and adherence to schedule	Continuous improvement in all areas, a team approach is needed. Emphasis placed in forward improvement rather than history	Risk management is most effective when led from the top with whole team involvement. Action plans to manage all identified risks required. Areas needing Improvement identified and improvement plans prepared.
In contract place emphasis on performance and measurement of performance against KPIs	Reporting is key; particularly cost reporting and forecasting.	Rigorous criteria are necessary and must be applied. Work must not proceed without the necessary level of confidence. In addition, all processes must be reinforced with a proving- review-re-plan if necessary, process Ref 14-18 performance reporting
Construct/ complete mocks up and test programmes to demonstrate the proposed methods	Extent to which mock-ups are commissioned and constructed in Stage 1 will depend on spend arrangements and time constraints	Once used initially to prove and train should be retained if possible, for training of new staff and /or ideas for improvements to process. See Figs 10.1, 10.2 below

A10.7 Mock-ups, “Pilot” Sections, testing and proving.

Baker Street to Finchley Road Track replacement

Track replacement on the Metropolitan Line (the world's first underground railway dating back to 1863) between Baker Street and Finchley Road; where 3.2 km of life expired Bullhead rail on timber sleepers in 7 single bore tunnels was replaced with concrete slab track at the rate of 10.5 m per night outage. Detailed mock-ups were prepared to develop the method and prove the concrete mix.





Figure A10.1 –Surface mock-up of the planned rail replacement for Baker Street to Finchley Road underground stations.

Delivery Trialling - Timeline

		Planned Start	Planned Finish
BTR Works		01:22:00	03:25:00
Mobilise staff to site, access minidigger from wideway to position on track	10 mins	01:22:00	01:32:00
Manpower to remove nylons from sleepers and replace keys	5 mins	01:27:00	01:32:00
Minidigger to complete excavation to ballast box	45 mins	01:45:00	02:30:00
Manpower to install geotextile	2 mins	02:30:00	02:32:00
Sleepers to be reset in position	5 mins	02:32:00	02:37:00
RRV to install stone with bucket into both excavations	10 mins	02:37:00	02:47:00
Mini compactor to compact stone	5 mins	02:47:00	02:52:00
Manpower to kango pack fit for traffic and box off	15 mins	02:52:00	03:07:00
Return minidigger to wideway	10 mins	02:47:00	02:57:00
Signals test / Handback test	15 mins	03:07:00	03:22:00
Egress staff from site	3 mins	03:22:00	03:25:00
Ballast/Spoil Handling		01:22:00	03:08:00
Access 1st RRV with 2 x trailer and 2 x ballast box	13 mins	01:22:00	01:35:00
Travel 1st RRV to site send and receive	10 mins	01:35:00	01:45:00
Access 2nd RRV with 1 x trailer and 1 x ballast box	10 mins	01:35:00	01:45:00
Load 1 x ballast box with 20ton ballast	22 mins	01:45:00	02:07:00
Travel 2nd RRV to site send and receive	10 mins	02:07:00	02:17:00
Move 2nd RRV around Woodford Junction	2 mins	02:17:00	02:19:00
Travel 1st RRV with spoil to Woodford Junction send and receive	10 mins	02:30:00	02:40:00
Unload spoil at Woodford	18 mins	02:40:00	02:58:00
Egress 1st RRV with 2 x trailer and 2 x ballast box from RRAP	10 mins	02:58:00	03:08:00
Move 2nd RRV over Woodford Junction and to site	4 mins	02:33:00	02:37:00
RRV to install stone with bucket into both excavations	10 mins	02:37:00	02:47:00
Travel 2nd RRV to Woodford send and receive	10 mins	02:47:00	02:57:00
Egress 2nd RRV, 1 x trailers and 1 x ballast box at Woodford RRAP	10 mins	02:57:00	03:07:00

Figure A10.2 – Example delivery trialling – timetable

A10.8 Case Studies and Reference Documents

Organisation Chart

We provide an outline, high level organisation chart in Figure A10.3 showing what an integrated team might look like from our experience. This is an illustration to explain the concept.

Early actions Schedule-Pre-Construction activities

In Appendix A8.6 we have developed an outline schedule of Pre-Construction activities and is intended to explain how the activities referred to in this appendix ,and the actions referred to in Section 10.15, can be scheduled for a rapid start up.

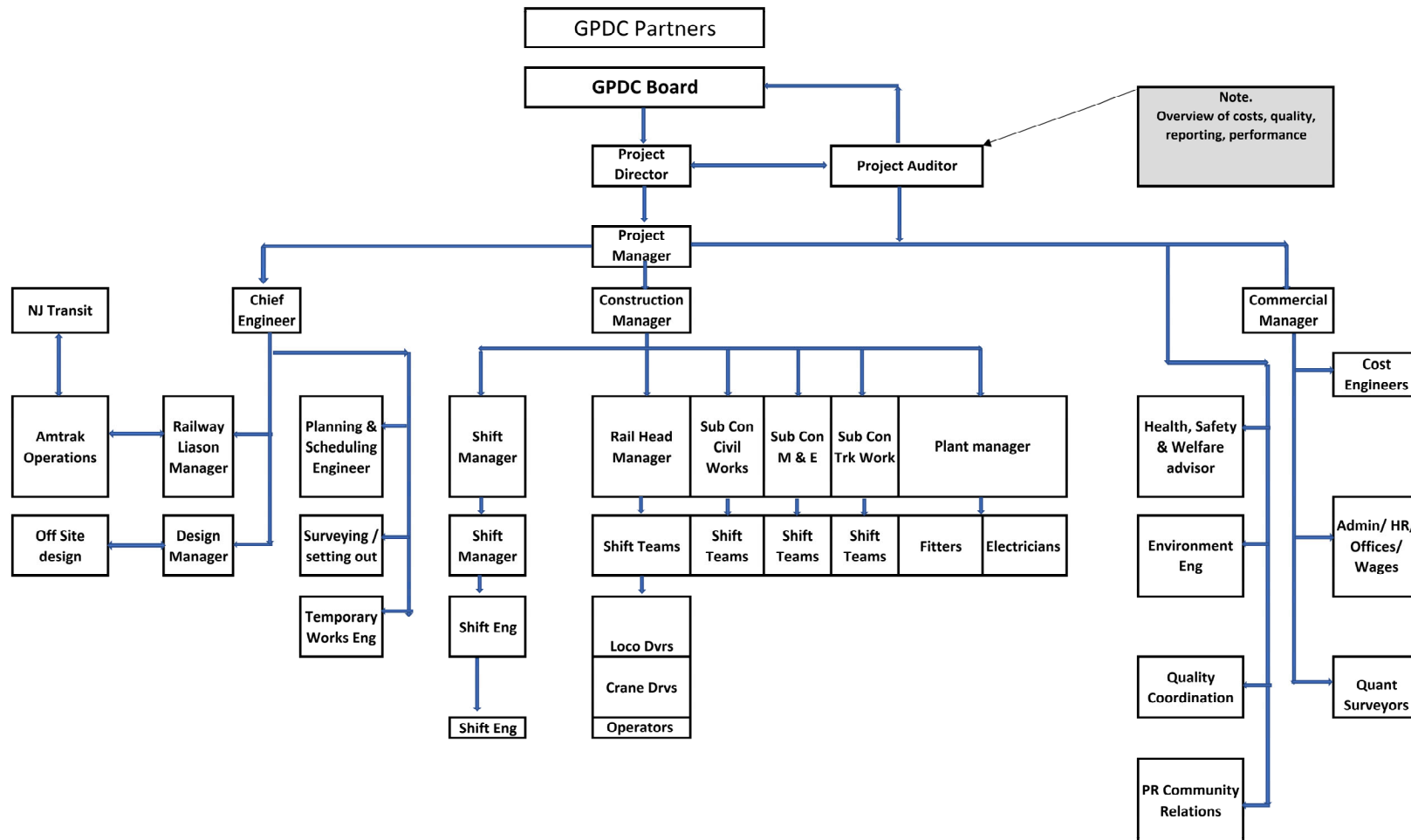

Figure A10.3 – Example organisation chart for Gateway Integrated Team

Case Studies - Integrated Teams/ Collaborative Working.

Not all experiences have been good with collaborative working (partnering), but if it fails it is usually because of the behaviours of the partners; their inability to stick to the agreed objectives; and one to seek to take advantage over others. We can speak with knowledge of how a contractor manages their finances and can say with confidence that the Client always gets a good deal by paying a fair actual cost for the project, while at the same time bringing quality, value and innovation.

The concept has been practised in the UK for around 30 years and a number of reports and papers have been written on the subject in support of the approach and its benefits. The latest of these is the Project 13 Concept, but there has been slow uptake in the UK. There has been a reluctance to commit fully to the process thus leaving in place commercial barriers (liquidated damages, penalties and risks) which prevent working together with common objectives.

The biggest issue (barrier) is usually the belief that competition is about price and that risk can be transferred. These are myths; a lower price is only about the extent to which the contractor is:

- Prepared to gamble
- Competent at estimating

No contractor will settle a contract until one has at least covered their cost. This is a very wasteful process.

An incentivised cost reimbursable contract gives the Client:

- a fair cost
- the behaviours required
- fuller involvement as to where their money is being spent (i.e. the cost decisions).

A number of case studies follow, some of which the LBA team have had involvement which gives us intimate knowledge of the set up and its effectiveness. As you can see from the examples below, all were successful in achieving their objectives.

Some teams worked better than others and, some had commitment from all parties whilst some from only selected parties. However, we believe that the Client was pleased with results in all cases.

Ramsgate Port Access tunnel (Road) £35m 1998-2000

This was a relatively small job i.e. a new 2.2km road and a single bore two lane 800m tunnel constructed by a JV between Taylor Woodrow and French Contractor Perforex. Work commenced in 1998 and was carried out from the outset by an integrated team (as a condition of the contractors offer). The team on site consisted of representatives from Taylor Woodrow (leading contractor), Perforex (specialist tunnelling machine), VVB (temporary and permanent M and E services), Kent County Council (ultimate Client), Babbie (Consulting Engineer), Brown and Root Civil (Consulting Engineer/ Project Supervisor) Halcrow (designer), Taylor Woodrow Foundation Engineering, CA Blackwell (Earthmoving Contractor).



Figure A10.4: Pre vaulting tunnelling machine Ramsgate Port Access tunnel

Integration was established from the outset and worked generally very well. There were issues, but these were not allowed to get in the way of delivering a project full of innovative ideas to achieve the scheme, deliver to time and budget and also meet the environmental constraints.

See Ref 22, 23 & 24

London Bridge Station Jubilee Line Extension project (Rail/ Metro) £250m 1994-1997

This was a project that had good relationships from the outset but with fairly onerous contract conditions. A major collapse at a neighbouring contract at London's Heathrow Airport, using the same relatively new technique caused a delay of 9 months to the contract which was set to impact the whole of the extension.



Figure A10.5: London Bridge Station Northern Line Link under the river Thames

Collaborating to solve problems achieved a redesign, rework of construction methods, innovative ways of constructing the complex station and pulled the contract back to a position where the other system wide contractors were able to progress through the station unimpeded. The Client put forward the project for a partnering award. Companies/ bodies involved were LUL Jubilee Line Project Team (separate team brought in to manage the project and interface

with the Operator), Taylor Woodrow, Costain (JV Partners), Bachy Soletanche (Compensating Grouting Sub Contractor) and Dr Sauer & Partners (designer).

See Ref 25

Channel Tunnel Rail Link (HS1) London Tunnels Alliance (Rail) £60m 2000-2004

This is probably one of the best examples of an integrated team and what it can achieve. There were three tunnelling contracts and one large station box. The contracts were originally set up as target cost contracts and realistic target costs were deliberately established. Initially it was seen that working together could achieve great savings, for example a high-performance precast facility was set up on the Stratford site to manufacture the lining for two of the contracts. This facility ended up producing approximately 50% over its design capacity and made significant savings against allowances.



Figure A10.6: CTRL (HS1) running tunnel showing cross passage provision

Some delays on the box prompted a much bigger rethink and a much closer arrangement was set up where the four contracts involving 8 contractors worked together to deliver on time and within the project budget, sharing savings in the risk budget.

There is large amount of documentation about this, with a selection only attached.

See Ref 27-31

Bond Street Station Upgrade (Rail/Metro) £300m 2013 2017



Figure A10.7: Bond Street Station Upgrade below ground works

Bond Street Station upgrade is another large and complex project on one of the busiest streets in London. The LUL station required an upgrade to improve the passenger flow and provisions had to be made to connect existing underground to the new Crossrail station nearby. The usual and also some of the unusual construction problems started to appear, so the Client brought the team together as one team with an “independent” leader under one contract. This was a very successful move which managed to get the project back on track and achieved its Sectional Completion/Handover dates.

Ref 32

M25 Holmesdale Tunnel Refurbishment (Road) £75m 2014-2018

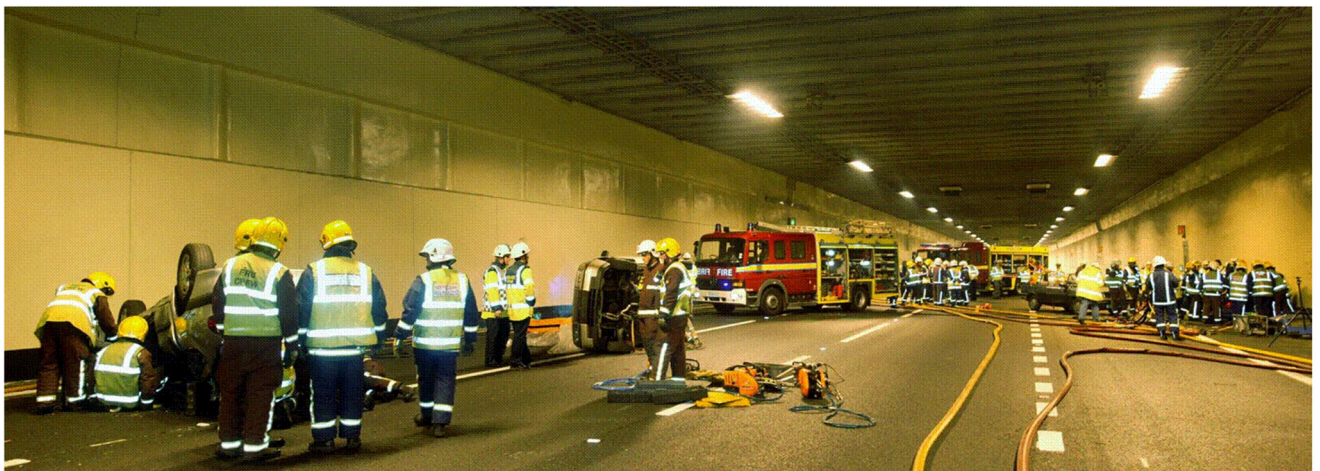

Figure A10.8: M25 Holmesdale full scale emergency exercise

M25 Holmesdale project was a refurbishment project on the busiest motorway in the UK, the London Orbital motorway (120,000 vehicles per day passing through the works). It was an ECI two stage D & C contract; the profit margin in the fee was fixed by the Client and a target cost arrangement for Stage 2 (execution). This finished on target and ahead of time. Very good team integration, with many ‘interested’ stakeholders to satisfy. The project was successful,

and the Contractor went on to refurbish the next tunnel which was again very successful. The Project won a number of awards and attribute their success due to the following:

- A truly integrated team focussed on success
- Close supply chain involvement and input from the start
- Client commitment underpinned by an appropriate for of contract
- A continuous desire to improve delivery.

See Ref 33 & 34

London Kings Cross Eastern Range (KXER) £55m Feb 2008-March 2009 This was an unusual project, that comprised of a large building, one wing of Kings Cross Mainline Station. The contract was let as a fairly standard remeasurement contract to a contracting JV. The contract was the first in a sequence of refurbishments to the station and needed to be completed to allow the next stage and also an end target was to be ready for Olympics 2012. The contract had got itself into difficulties with no design, no worthwhile programme and ever-expanding costs.



Figure A10.9: Kings Cross Eastern Range Building

Contractors proposed an integrated team, a different kind of contract (target cost) with fixed incentives and an independent manager (RLI, LBA). Defined the scope, prepared cost estimate, agreed pain gain arrangements and commenced work after 3 months. The work was completed (access available) 9 months later.

Ref 35 & 36

CERN (Conseil European pour la Recherche Nucléaire-Geneva) (Research) £45m 1996-1999

This was a project in connection with the underground particle accelerator ring. It comprised a mixture of tunnelling, earthworks, buildings and facilities. The contractor was a Joint venture between, Taylor Woodrow, AMEC and Spie Batignolles. Clients Engineer was Kellogg Brown & Root (KBR), and the Client had their own engineering and supervisory staff.



Figure A10.10: CERN Main Street Shaft

The contract got into difficulties as the Scientists changed their requirements and timings for their continuing experiments. The Client realised that they could not tolerate the cost increases which the contract would propose so they approached KBR asking them how they could manage the future costs in a better way.

KBR proposed (having spoken to the contractor) that they set up an Alliance which would be open book; a fixed target embracing all known scope increases and offering the contractor 70% of any cost savings against the target. It took a little time to convince the contractors but, in the end, it was a win-win situation of which everyone was justly proud—all objectives achieved. Again, contract delivered to time and budget



Figure A10.11: CERN Collider Tunnel

Trackbed replacement by Track Partnership for London Underground (Rail)

The London Metropolitan Line was the world's first underground railway dating back to 1863. On this line between Baker Street and Finchley Road. 3.2km (@ 5 miles) of concrete sleepers replaced life-expired Bullhead rail on timber sleepers in 7 single bore tunnels at the rate of 10.5m (35 ft) per night outage. This was part of a programme of track replacement with new ballasted track and new concrete slab track. In all LUL commissioned the in-service replacement of 123 switch and crossing units, 13km (8 miles) of track and 11km of drainage all carried out in outages.



Figure A10.12: Baker Street to Finchley Road ballast removal

This was carried out by Track Partnership, an integrated team of Balfour Beatty a contractor who undertakes a large proportion of the work on the London Underground system and LUL.

LUL input included design, and supervision. The integrated team worked alongside plate layers, concreting operatives and also shuttering operatives. The whole operation was well planned and controlled, and made good use of web-based reporting and communication to ensure that what was needed for the next night shift was undertaken during the following dayshift, and was loaded and checked ready and in a defined location ready for the next night shift. Most important was the culture of the team i.e. mission orientated, determined, disciplined, each knew their role and there was a developed plan which included for all anticipated eventualities. **See Ref 37**

A10.9 Documents and References

No	Document	Comments
1	New Style MP toolkit Ver 1.01_Nov 2005	This sets out the Highways Agency Key Performance Indicators (KPIs) and how they are measured
2	Article on T2A alliance	This article explains how an integrated team came into being on HS1 (CTRL)
3	M25 Holmesdale Invitation to Tender Volume 0	These are copies of documents used at Holmesdale and intended to explain the possible process (only). See form of contract Ref
4	M25 Holmesdale Conditions of Contract Volume 1	
5	M25 Holmesdale Works Information Volume 2	
6	CAF-ECI projects _VO_1 20041018	Cultural Assessment Framework to judge readiness for ECI work.
7	M 25 Holmesdale evidence summary	Evidence the contract has to able to produce to support their submission,
8	Benefits of Incentivisation Proposals	Document prepared on CTRL(HS1) looking at how the contract should go forward
9	Notes on HA ECI	Note prepared by RLI explaining the way that the HA very successfully used ECI (early Contractor Involvement)
10	Incentivisation Proposal Mk5 HS1 S1	Finalised proposal on HS1 even includes money.
11	Future of the T200CTRL(HS1) 200 Series Contracts	Justification on why we should go this route. Ref 8 & 10 are all leading to the same conclusion
12	Draft 2 SA (C550 Supp Agreement)	This is the legal section of the HS1 agreements
13	Holmesdale Adjustments and VE to TC	This was the report on the exercise in cost reduction as the "target" cost was being settled (Value Engineering)
14	M25 Holmesdale Balanced Scorecard	All are all about measuring performance against KPIs that are so important in a contract managed in this way. Also makes the contractor think what they have to do to demonstrate improvement. Good ideas and culture can come out of the exercise.
15	Holmesdale PPI Report Phase 1	
16	Holmesdale Performance report proforma Phase 1a	
17	Holmesdale Performance report proforma Phase 2	
18	Performance measurement all Holmesdale	
19	Typical procedures and plans arrangements	This gives an idea of the planning that is necessary to go to work, in the UK
20	P13 Blueprint	Explains Project 13

No	Document	Comments
21	Union Railways North (URN) Condition of Contract	HS1 contract document
22	World Tunnelling - New Route to Port Ramsgate	Project summary including contract arrangements
23	Tunnelling Industry Awards – Ramsgate Harbour Approach Road	Brief summary including integrated team approach
24	Highways Agency Letter - Ramsgate	Site visit and discussion points including contract information
25	Tunnels and Tunnelling – JLE Contract 104	Jubilee Line Extension – Modified ‘NATM’
26	JLE Racking	Photo
27	CTRL – Alliance Workshop	PowerPoint Presentation – Alliance Feedback
28	CTRL – Alliance Roll Out	PowerPoint Presentation
29	CTRL – Costain Skanska Partnering	PowerPoint Presentation
30	CTRL – Alliance Contract	PowerPoint Presentation
31	CTRL 240 – Case Study	Alliancing including organisation charts
32	Tunnels and Tunnelling – Bond Street Station Upgrade Project	Project summary including one team approach
33	ICE – M25 Holmesdale Tunnel	Project summary
34	M25 Holmesdale Charter	N/A
35	Kings Cross Eastern Range Integrated Team Seminar	PowerPoint Presentation – including contractual and commercial arrangements
36	Kings Cross Eastern Range – CEO Presentation	PowerPoint Presentations including principles of an Alliance Partnership
37	LUL – Baker Street to Finchley Road Track Conversion	Project summary including design, delivery, trials and timings.
38	Canarsie (L-Train) Tunnel, MTA NYCT Subway, New York	https://www.governor.ny.gov/programs/l-project-tunnel-rehabilitation
39	Baker Street to Finchley Road, London Underground Metro Tunnel, London (YouTube)	https://www.youtube.com/watch?v=L9PVCJSJfY&feature=youtu.be