

MARCH 2013

JOSEPH HOLLIDAY

MIDDLE EAST SECURITY REPORT 8

THE ASSAD REGIME

FROM COUNTERINSURGENCY TO CIVIL WAR



Photo Credit: A poster of Syria's president at a checkpoint on the outskirts of Damascus, January 14, 2012. Photo taken by VOA Middle East correspondent Elizabeth Arrott while traveling through Damascus with government escorts.

All rights reserved. Printed in the United States of America. No part of this publication may be reproduced or transmitted in any form or by any means, electronic or mechanical, including photocopy, recording, or any information storage or retrieval system, without permission in writing from the publisher.

©2013 by the Institute for the Study of War.

Published in 2013 in the United States of America by the Institute for the Study of War.

1400 16th Street NW, Suite 515 Washington, DC 20036.

<http://www.understandingwar.org>

JOSEPH HOLLIDAY

MIDDLE EAST SECURITY REPORT 8

THE ASSAD REGIME

FROM COUNTERINSURGENCY TO CIVIL WAR

ABOUT THE AUTHOR

Joseph Holliday, a Senior Research Analyst at the Institute for the Study of War, served as an Infantry and Intelligence officer in the U.S. Army from June 2006 to September 2011, and continues to serve in the Army reserves. During his time on active duty, Joe deployed to East Baghdad, Iraq from November 2007 to January 2009 with the 10th Mountain Division. From May 2010 to May 2011 Joe deployed to Afghanistan's Kunar Province as the Intelligence Officer for 2-327 Infantry Battalion, 101st Airborne Division. He has a Bachelor's degree in History from Princeton University.

He is the author of *Syria's Maturing Insurgency* in June 2012, *Syria's Armed Opposition* in March 2012, and *The Struggle for Syria in 2011* in December 2011.

ACKNOWLEDGEMENTS

I would like to thank the team at ISW that contributed so much to this report. Analyst Elizabeth O'Bagy, and interns Jonathan Dupree, Michael Lynch, Jeffrey Bolling, and Tess deBlanc-Knowles all contributed to painstaking social media research. Jessica Lewis, Aaron Reese, and Maggie Rackl polished this research through their editing and layout. I would also like to thank our technology partners Praescient Analytics and Palantir Technologies, who allowed me to manipulate and visualize data in ways that made the analysis here possible. In particular, many of the maps and graphics in this report derive from data visualization in Palantir.

ABOUT THE INSTITUTE

The Institute for the Study of War (ISW) is a non-partisan, non-profit, public policy research organization. ISW advances an informed understanding of military affairs through reliable research, trusted analysis, and innovative education. ISW is committed to improving the nation's ability to execute military operations and respond to emerging threats in order to achieve U.S. strategic objectives.

ABOUT OUR TECHNOLOGY PARTNERS

ISW believes superior strategic insight derives from a fusion of traditional social science research and innovative technological methods. ISW recognizes that the analyst of the future must be able to process a wide variety of information, ranging from personal interviews and historical artifacts to high volume structured data. ISW thanks its technology partners, Palantir Technologies and Praescient Analytics, for their support in this innovative endeavor. In particular, their technology and implementation assistance has supported creating many of the maps and graphics in this product.



Praescient Analytics is a Veteran Owned Small Business based in Alexandria, Virginia. Our aim is to revolutionize how the world understands information by empowering our customers with the latest analytic tools and methodologies. Currently, Praescient provides several critical services to our government and commercial clients: training, embedded analysis, platform integration, and product customization.



Palantir Technologies is working to radically change how groups analyze information. We currently offer a suite of software applications for integrating, visualizing and analyzing the world's information. We support many kinds of data including structured, unstructured, relational, temporal and geospatial.

TABLE OF CONTENTS

MIDDLE EAST SECURITY REPORT 8 | THE ASSAD REGIME | JOSEPH HOLLIDAY | MARCH 2013

EXECUTIVE SUMMARY	07
INTRODUCTION	09
COUNTERINSURGENCY IN ASSAD’S SYRIA.....	10
FROM COUNTERINSURGENCY TO CIVIL WAR.....	19
CONCLUSION	40
APPENDIX 1: COMPOSITION OF THE SYRIAN ARMY	42
APPENDIX 2: DOCTRINAL ORDER OF BATTLE.....	48
APPENDIX 3: SECURITY APPARATUS.....	54
APPENDIX 4: AIR FORCE, BALLISTIC MISSILES, AND CHEMICAL WEAPONS....	56
NOTES.....	60
 MAPS & FIGURES	
MAP 1 SYRIA LOCATIONS LISTING	08
MAP 2 FORCES DEPLOYED TO DERA A AND HOMS	13
FIGURE 1 MONTHLY CLASHES IN HOMS, IDLIB, AND ALEPPO	15
FIGURE 2 ASSAD FAMILY SHABIHA.....	17
PHOTO 1 AREEN AL-ASSAD	18
MAP 3 ORONTES RIVER VALLEY ETHNICITIES	21
FIGURE 3 2012 AIRSTRIKE TRENDS	23
PHOTO 2 BALLISTIC MISSILE STRIKE IN DERAYA.....	25
FIGURE 4 REGIME DEPLOYABLE FORCES.....	27
FIGURE 5 REGIME ATTRITION DATA	28
PHOTO 3 REGIME TROOPS IN DAMASCUS.....	30
MAP 4 STRONGPOINTS IN NORTHERN SYRIA	34
FIGURE 6 REGIME FORCES IN NORTH/EAST VS CENTER/SOUTH.....	35
FIGURE 7 DAMASCUS AIRSTRIKE TRENDS	37
MAP 5 DAMASCUS MILITARY BASES AND NEIGHBORHOODS	38
MAP 6 CONTRACTED ZONES OF MINORITY CONTROL BEFORE AND AFTER ASSAD.....	39
FIGURE 8 GENERIC ORDER OF BATTLE	43
MAP 7 DOCTRINAL ORIENTATION.....	46
MAP 8 DOCTRINAL ORIENTATION-INSET	47
FIGURE 9 DOCTRINAL ORDER OF BATTLE	48
FIGURE 10 SECURITY APPARATUS	55
FIGURE 11 BALLISTIC MISSILES HOLDINGS	57
FIGURE 12 BALLISTIC MISSILE STRIKES	58
FIGURE 13 CHEMICAL WEAPON CHARACTERISTICS.....	59

EXECUTIVE SUMMARY

MIDDLE EAST SECURITY REPORT 8 | THE ASSAD REGIME | JOSEPH HOLLIDAY | MARCH 2013

The conflict in Syria transitioned from an insurgency to a civil war during the summer of 2012. For the first year of the conflict, Bashar al-Assad relied on his father's counterinsurgency approach; however, Bashar al-Assad's campaign failed to put down the 2011 revolution and accelerated the descent into civil war. This report seeks to explain how the Assad regime lost its counterinsurgency campaign, but remains well situated to fight a protracted civil war against Syria's opposition.

Hafez al-Assad subdued the Muslim Brotherhood uprising in the early 1980s through a counterinsurgency campaign that relied on three strategies for generating and employing military force: carefully selecting and deploying the most trusted military units, raising pro-regime militias, and using those forces to clear insurgents out of major urban areas and then hold them with a heavy garrison of troops. Bashar al-Assad attempted unsuccessfully to employ the same strategy in 2011-2012.

Bashar al-Assad's reliance on a small core of trusted military units limited his ability to control all of Syria. He hedged against defections by deploying only the most loyal one-third of the Syrian Army, but in so doing he undercut his ability to prosecute a troop-intensive counterinsurgency campaign because he could not use all of his forces. Defections and attrition have exacerbated the regime's central challenge of generating combat power. These dynamics have weakened the Syrian Army in some ways but also honed it, such that what remains of these armed forces is comprised entirely of committed regime supporters.

Pro-Assad militias have become the most significant source of armed reinforcement for the Syrian Army. The mostly-Alawite *shabiha* mafias are led by extended members of the Assad family and have been responsible for some of the worst brutality against the Syrian opposition. The local Popular Committees draw their ranks from minorities who have armed themselves to protect their communities against opposition fighters. Both types of militia coordinate closely with and receive direct support from the regime, as well as from Iran's Islamic Revolutionary Guards (IRGC) and Lebanese Hezbollah.

Bashar al-Assad's forces have displaced populations in opposition strongholds, which has deepened Syria's sectarian division. The regime has employed artillery, air power, bulldozers, sectarian massacres, and even ballistic missiles to force Syrian populations out of insurgent held areas. This strategy ensures that even when the rebels win towns and neighborhoods, they lose the population. Chemical weapons are now the only unused element in Assad's arsenal, which could be used for large-scale population displacement to great effect.

Fears of retribution have pushed conventional and paramilitary loyalists to converge upon the common goal of survival, resulting in a broadly cohesive, ultra-nationalist, and mostly-Alawite force. The remnants of the Syrian military and the powerful pro-regime militias are likely to wage a fierce insurgency against any opposition-led Sunni government in Syria if the Assad regime collapses. Iran and Lebanese Hezbollah are likely to encourage the militias and regime remnants to converge, supporting this transition to insurgency in order to preserve Iranian interests after Assad.

The regime has concentrated conventional forces in Damascus and Homs. The relatively small force deployed to northern and eastern Syria have disrupted rebel advances, but isolated strongpoints have been overrun as the regime struggles to maintain logistical lines of communication. The majority of the regime's deployable forces have remained in Homs and Damascus, where rebels have made significant gains but remain unable to dislodge regime troops.

Assad is unlikely to regain control over all of Syria, although he is well situated to continue fighting in 2013 and to prevent the opposition from taking over the rest of the country. The regime has contracted around a corridor that connects Damascus, Homs, and the coast, and Assad can continue to rely on a broadly cohesive and mostly Alawite core of soldiers and militias, backed by Iran and Lebanese Hezbollah.

Assad is more likely to continue fighting in Damascus and Homs than to retreat to the coast in 2013, although it will become difficult for the regime to claim to govern Syria if the opposition breaks into downtown Damascus. Assad is more likely to destroy Damascus than to abandon it to the opposition. Hopes of a clean opposition victory and a peaceful transition are therefore dim.



MAP 1 | SYRIA LOCATIONS LISTING

1 Abu Duhur	16 Dumayr Airbase	31 Khirbet Ghazaleh	46 Qalat al Madiq	61 Taftanaz Airbase
2 Abu Kamal	17 Furqlus	32 Kiswah	47 Qamishli	62 Tal Aybad
3 Afrin	18 Haffeh	33 Laqbah	48 Qardahah	63 Tal Qartal
4 al Bab	19 Halfiyah	34 Maarat al Numan	49 Qataneh	64 Tal Rifat
5 al Lejah	20 Harim	35 Marea	50 Qbeir	65 Talbisseh
6 al Qusayr	21 Houleh	36 Marj Ruhayl Airbase	51 Qutayfah	66 Taqba Airbase
7 al Safir	22 Izraa	37 Mastouma / Shayrat Airbase	52 Rabia	67 Telkalakh
8 Ariha	23 Jableh	38 Masyaf	53 Rankous	68 Tiyas Airbase
9 Atareb	24 Jarrah Airbase	39 Mayadin	54 Ras al Ayn	69 Wadi Nasariyah
10 Azaz	25 Jasim & Inkhil	40 Minakh Airbase	55 Rastan	70 Yabrud
11 Bab Hawa	26 Jebal al-Zawiya	41 Mismiyah	56 Saiqal Airbase	71 Zabadani
12 Baniyas	27 Jisr al-Shughour	42 Muhradeh	57 Sanamein	
13 Binnish	28 Khalkalakh Airbase	43 Nasariyah Airbase	58 Saraqib	
14 Dael	29 Khan Sheikhoun	44 Nawa	59 Suqalabiyah	
15 Damascus Int'l Airport	30 Kherweis Airbase	45 Palmyra / Tadmor	60 Suwayda Airbase	

MIDDLE EAST SECURITY REPORT 8

THE ASSAD REGIME

FROM COUNTERINSURGENCY TO CIVIL WAR

By Joseph Holliday

In early January 2013, a triumphant Bashar al-Assad declared that his regime will defeat the Syrian opposition. “Syria will remain as it is and will return, God willing, stronger,” the President assured his audience of loyalists, “Your steadfastness over two years tells the whole world that Syria is impervious to collapse...”¹

This was Assad’s first public address since rebels brought the war to the capital in July 2012 by assassinating four of the regime’s top security officials. At the beginning of 2013, Bashar seems no closer to negotiating than he was at the start of the uprising nearly two years ago, despite his weakened position. United Nations Special Envoy Lakhdar Brahimi, who was hopeful in the fall of 2012 that the regime might entertain serious negotiations, called the January speech “uncompromising,” concerned that Assad was moving away from any political settlement.²

Bashar’s overt confidence seems divorced from reality. Since the summer of 2012, rebels have steadily overrun regime positions in the north and closed in on Damascus. A map recovered from Syrian Republican Guard troops in late 2012 showed half of the capital’s suburbs under opposition control.³ Just days after Assad’s January speech, rebels successfully concluded a months-long siege of Taftanaz Airbase in northern Idlib, overrunning the key logistical hub and further isolating regime forces in the north.⁴ Given this rebel momentum, Bashar al-Assad’s confidence seems unfounded.

But Bashar’s self-assurance may not derive from a belief that his regime will end the insurgency. Rather, it may reflect his awareness that the regime is well situated to fight a civil war even if it loses its counterinsurgency campaign. Bashar may accept that he will not govern all of Syria again, but remains confident that he can also prevent the opposition from doing so.

During the summer of 2012, the conflict in Syria transitioned from an insurgency to a civil war. For the first year of the conflict, Bashar al-Assad relied on his father’s counterinsurgency approach, developed in response to the Muslim Brotherhood uprising in the early 1980s. Bashar’s campaign failed to put down the 2011 revolution, however,

and even accelerated the transformation to civil conflict. This report seeks to explain how the Assad regime lost its counterinsurgency campaign by the summer of 2012, but remains well positioned to fight a protracted civil war against Syria’s opposition.

For the purposes of this report, counterinsurgency describes a government’s campaign to restore order and ensure its own reach throughout the geographical confines of the state against armed opponents who aim at the government’s overthrow. In this case, counterinsurgency describes the Assad regime’s attempts to regain control over the whole of its territory, an objective it likely abandoned by the fall of 2012. By contrast, civil war implies that controlling the entire territory within the state is no longer feasible because armed opposition has become strong enough to stop government advances consistently. In this construct, the distinction between counterinsurgency and civil war is practical rather than theoretical because it implies that Assad has a different set of objectives and requirements. In short, Assad may never again regain control over all of Syria, but the regime and its remnants can continue to compete for limited geographical regions within it.

In the early 1980s, Hafez al-Assad put down the Muslim Brotherhood uprising with a brutal and successful counterinsurgency campaign that relied on three strategies for generating and employing military force: carefully select and deploy the most trusted military units, raise pro-regime militias, and use those forces to clear insurgents out of major urban areas and hold them with a heavy garrison of troops.

In 2011 and 2012, Bashar attempted to employ the same strategy, but in so doing transformed the conflict. Attempting to clear insurgents out of opposition

strongholds, Assad instead displaced entire populations, deepening Syria's sectarian atomization. Assad's deep reliance on a hard core of trusted military units and pro-regime militias limited the regime's ability to control all of Syria simultaneously with sufficient forces. Stripped down to this narrow support base, Assad had to concentrate his forces in only the most strategically significant areas of the country, namely Damascus and Homs, while projecting relatively little force in other locations in order to maintain pressure on the rebels. Fears of retribution, whether real or perceived, have pushed conventional and paramilitary elements to converge upon the common goal of survival, resulting in a broadly cohesive, ultra-nationalist, and mostly Alawite force.

This devolution of Assad's security institutions also means that the remnants of the Syrian military and the powerful pro-regime militias are likely to wage a fierce insurgency against any opposition-led Sunni government in Syria that might emerge after Assad. As formal security institutions diminish, it will become harder to re-establish order while both sides engage in unconventional warfare. Hopes of a clean opposition victory and a peaceful transition are therefore dim.

Iran and Lebanese Hezbollah are working to prevent such a clean victory in order to preserve their interests in Syria after Assad. Syria has been Iran's closest state ally since the Islamic Republic's inception and has been the crucial link between Iran and Lebanese Hezbollah, acting as a hub to transport personnel, weapons, and finances. Both Iran and Hezbollah are deeply involved in the Syrian conflict, not only investing in what remains of Assad's security institutions but also developing relationships with the minority-based militias fighting on Assad's side. These militias represent Iran's "Plan B," the groundwork for the contingency of regime collapse. This report focuses on the Assad regime itself rather than the increasingly significant role played by these external actors. The importance of Iranian support to the Assad regime will be addressed directly in a forthcoming report entitled "Iranian Strategy in Syria."

This report examines the Syrian conflict from the perspective of the Assad regime. Comparisons between Hafez al-Assad's approach to the Muslim Brotherhood uprising and Bashar's response to the ongoing conflict do not take into account the great differences between the Brotherhood's Fighting Vanguard and the more broadly

based, but majority-Sunni revolutionaries of today. This report will not attempt to explain what the opposition has both caused and accomplished, but rather how the regime has behaved and reacted to its armed opponents.

COUNTERINSURGENCY IN ASSAD'S SYRIA

Bashar al-Assad's approach for the first year of the conflict mirrored his father's approach to the Muslim Brotherhood uprising over thirty years prior. Reviewing Hafez's approach to the 1980 uprising will help frame Bashar's counterinsurgency campaign in 2011-2012. Hafez al-Assad combined three strategies for generating and employing forces that have parallels to the current conflict:

Selective Deployment: Hafez relied on a handful of politically reliable units, pairing elite all-Alawite forces with line troops to compel allegiance.

Paramilitaries: Hafez raised pro-regime militias to supplement the armed forces.

Clear and Hold: Hafez deployed armored forces to clear major population centers, with indirect fire if necessary, and held them with a heavy garrison of troops.

Similarly, between March 2011 and March 2012, Bashar al-Assad generated reliable forces by selectively deploying units, raising pro-regime militias, and pursuing a clear and hold strategy in major urban areas using indirect fire.

1979-1982: Hafez and the Uprising

Selective Deployment: Hafez al-Assad hedged against defections by carefully selecting the most politically reliable units to face down the Muslim Brotherhood, which openly professed its strategy to force the regime to commit the regular army to fighting the population. The Brotherhood believed that because the army was "mostly Sunni, its loyalty to the regime could, under sufficient pressure, be cracked."⁵ The Assad regime prevented this outcome by deploying only the most trustworthy Syrian Army units. "The officers and men of the most sensitive and strategically important armed units were Alawis," Syria scholar Nikolaos van Dam explains, "and the regime realistically preferred to trust only these units with the task of dealing with popular disturbances."⁶

Hafez al-Assad deployed only the most politically reliable commanders to carry out his orders, many of them family members. During the 1960s era of coups and counter-coups that had brought Assad to power, the President learned to ensure that close friends and family members commanded the Syrian Army's most important brigades and divisions. Hafez relied most heavily on his brother Rifat's Defense Companies. Rifat, in turn, relied on his deputy commander and son-in-law, Muin Nasif Kheirbek.⁷ When the conflict intensified in early 1980, Assad sent his first cousin, General Shafiq Fayyad, commander of the 3rd Armored Division, to quell unrest in Aleppo.⁸ Alawite officers commanded the two brigades from 3rd Armored that deployed to Hama in 1982.⁹

The Assad regime ensured loyalty among the Army rank and file by engineering a favorable proportion of loyal Alawites on the battlefield. According to a detailed Muslim Brotherhood internal account of the battle, 90 percent of the officers and soldiers of the Defense Companies who deployed to Hama in 1982 were Alawites, while over 90 percent of the officers and nearly half of the soldiers in the Special Forces regiments were Alawites. Only two conventional Army brigades deployed to Hama in 1982, the 3rd Armored Division's 47th Armored and 21st Mechanized Brigades. Three quarters of the officers and one third of the soldiers in these brigades were Alawites. The regime took the additional precaution of expelling all the men who came from Hama before the start of the operation.¹⁰

Decades of sectarian consolidation within the Syrian Army made this Alawite majority force possible. Overrepresentation of minorities—and particularly Alawites—within the Syrian Army dates back to the post-World War I French Mandate, when French authorities encouraged the enlistment of minorities in the *Troupes Speciale du Levant*. This trend continued after Syrian independence; as early as 1955 the chief of Syria's intelligence bureau found that approximately sixty-five percent of the non-commissioned officers belonged to the Alawi sect.¹¹ Heavy recruitment among Alawi communities after the 1963 Ba'athist officers' coup exacerbated this trend. Some units became overwhelmingly staffed by one sect or another during the 1960s, and sectarian rivalries occurred between officers' factions.¹²

Pairing elite all-Alawite units with reliable conventional Army brigades provided an additional hedge against dissent among rank and file conscripts. When Assad sent the 3rd Armored Division to Aleppo and the Special Forces to Hama in early 1980, he reinforced these already trusted units with detachments from Rifat's Defense Companies.¹³ Deploying detachments from the Defense Companies with conventional brigades also put these unquestionably loyal and ruthless troops in position to intervene swiftly in the case of defections.¹⁴

Paramilitaries: Carefully selecting and organizing Syrian Army units generated reliable forces to face the Muslim Brotherhood, "But the real innovation," Syria historian Patrick Seale has explained, "was the arming of the party and its sympathizers. In every city, citizen militias were formed and weapons distributed to Ba'ath-affiliated Popular Organizations."¹⁵ After the January 1980 Ba'ath Party Congress, the regime began to arm and train thousands of regime supporters throughout the country. As Van Dam wrote, "...not only the armed forces but also the civilian party apparatus, equipped with arms, participated in crushing any armed opposition."¹⁶

Ba'athist paramilitary forces pre-dated the Muslim Brotherhood uprising. After coming to power in 1963, the Ba'ath party established several paramilitary forces, "which the party could rely on in the event of domestic turmoil and as a counterweight to the conventional army."¹⁷ The tendency among the regime's supporters to stockpile arms and ammunition likely expedited standing up pro-regime militias.^{*18}

Mobilizing paramilitary support was so central to the regime's strategy that Hafez al-Assad became directly involved in the effort. Throughout March and April 1980, the president put aside his usual aversion to public oration and spoke to large congresses of the various Popular Organizations: "Preaching the use of 'armed revolutionary violence' against the 'reactionary violence' of the guerrillas, he brought tens of thousands of young men and women cheering to their feet."¹⁹

* Recounting the early stages of the 1982 Hama uprising, Seale describes an engagement in which insurgents attacked the governor's residence: "but like others on the government side he had stockpiled arms and ammunition, and with his brother and four bodyguards kept the assailants at bay..."

Clear and Hold: Hafez al-Assad deployed his combined force of elite military units, trustworthy conventional brigades and militias to clear insurgents out of major population centers. When the 3rd Armored Division and detachments from the Defense Companies arrived in Aleppo in March 1980, the troops proceeded to “seal off whole quarters and carry out house-to-house searches, often preceded by tank fire,” rounding up hundreds of suspects.²⁰ Meanwhile Special Forces regiments “cordoned off and rudely and thoroughly combed out” Hama, killing and arresting many.²¹ The regime also combed Deraa with house-to-house searches.²² The internal Muslim Brotherhood report published after the uprising described this strategy in detail: the security forces cordoned off each city one district at a time, searched every house, and arrested or executed suspected insurgents.²³

When the Muslim Brotherhood insurgents became strong enough to inflict heavy losses on regime troops, Assad massed artillery ahead of the ground offensive. During the showdown in Hama in 1982, Hafez laid siege to the city with heavy artillery. “After heavy shelling, commandos and party irregulars supported by tanks moved in to subdue the acres of mud-and-wattle houses... many civilians were slaughtered in the prolonged mopping up, whole districts razed...”²⁴ By the end of the fighting, about a third of the historic inner city had been reduced to rubble.

After clearing out these urban areas with combined ground forces and artillery, Assad’s troops held these population centers with long-term troop garrisons. After the initial clearance of Aleppo, the 3rd Armored Division garrisoned the city for a whole year, “with a tank in almost every street... backed up by armed party irregulars.”²⁵ The next year in Damascus, “the city was turned into an armed camp,” full of army checkpoints and roadblocks.²⁶

As the next section outlines, these principles for generating reliable forces and employing them against insurgents underpinned Bashar al-Assad’s approach to the first year of the conflict. The strategy worked in localized cases, but it ultimately fell short of Hafez’s success in restoring regime control over all of Syria in the early 1980s. By the summer of 2012, it became clear that the Assad regime had failed to end the insurgency.

2011-2012: Bashar and the Revolution

Selective Deployment: Bashar al-Assad has employed forces that are politically reliable and frequently majority Alawite, much as his father did during the Muslim Brotherhood uprising.

Despite Syria’s impressive doctrinal force structure, the Assad regime has from the beginning of the conflict been unable to mobilize all of its forces without risking large-scale defections.* The single greatest liability that the Assad regime has faced in employing its forces has been the challenge of relying on units to carry out orders to brutalize the opposition.

Like his father, Bashar paired elite units with specifically selected conventional forces from the outset of the conflict. When Bashar moved to clear Deraa in early 2011, elements of three different Special Forces regiments took the lead in the assault. Elements of the 41st and 47th Special Forces Regiments traveled from the al-Dreij base complex near Damascus, while the 35th Special Forces Regiment traveled the shorter distance from its base in As Suwayda Province.²⁷ Leaked regime documents show that this careful force selection came from the highest echelon of regime command, as Bashar al-Assad himself signed the order for the 47th Regiment to maneuver to Deraa for the operation.²⁸ Interviews conducted by Human Rights Watch demonstrate that the regime attached a conventional brigade to the 35th Special Forces Regiment during the operation, and that this conventional brigade took orders from the Regiment’s commander.²⁹

Two conventional brigades joined these elite troops in Deraa, at least one of which was likely considered more reliable than other conventional units. The regime deployed the 5th Mechanized Division’s 132nd Mechanized Brigade, stationed nearby, but also deployed the 65th Armored Brigade, stationed with the 3rd Armored Division north of Damascus and nearly 150 kilometers away.³⁰ The 132nd Mechanized may have been selected on the basis of proximity, but the 65th Armored seems to have been selected on the basis of capability and political reliability.

Bashar relied on the Special Forces regiments in Deraa to pair with specially selected regular units and serve as a

* See Appendices 1 & 2 for a discussion of Syria’s doctrinal force structure.

hedge against defections, just as Hafez al-Assad had done with the unquestionably loyal Defense Companies in his day. Pairing mostly reliable armored forces—capable of establishing checkpoints, cordons, and heavy fire support—with elite troops from the most loyal units has allowed the current regime to leverage its armored capacity while limiting the risk of defections. Furthermore, the regime has been able to rely on Special Forces regiments for the most brutal forms of repression and limit conventional troops' exposure to the population.

In addition to the elite regime-protection forces, Bashar has also relied heavily on the four overlapping agencies of the security apparatus to limit defections and enforce compliance with orders.* By leveraging all four, each of which is responsible for identifying possible defectors and reporting directly to the President, Assad has been able to remove commanders from key positions at the first sign of suspicion. For example, Manaf Tlass, the son of long-serving Sunni Defense Minister Mustafa Tlass, was removed from command of his Republican Guard Brigade and even put under house arrest before he defected.³¹ In this way, the security apparatus has successfully ensured that no major military units have defected with their leaders. The security apparatus has also enforced compliance with orders, shooting or detaining and torturing soldiers who failed to follow orders to shoot at protestors.³²

Syrian Army brigades and regiments have served as the regime's primary maneuver units during the conflict, although they have not deployed at full strength. Understanding which brigades and regiments have participated in operations is essential to this analysis, but studying deployments by unit number does not convey the whole story. The Assad regime has task-organized its maneuver units, meaning that it has taken units out of doctrinal formations and combined or broken them up in order to perform assigned missions. According to one Syrian defector, this task-organization occurs as low as the battalion level. For example, the regime will assign one company from the loyal 4th Armored Division to work with two companies from a conventional unit. This task-organized unit then becomes a battalion, usually under the flag of the 4th Armored and under the leadership of that elite company's commander.³³ This task-organization

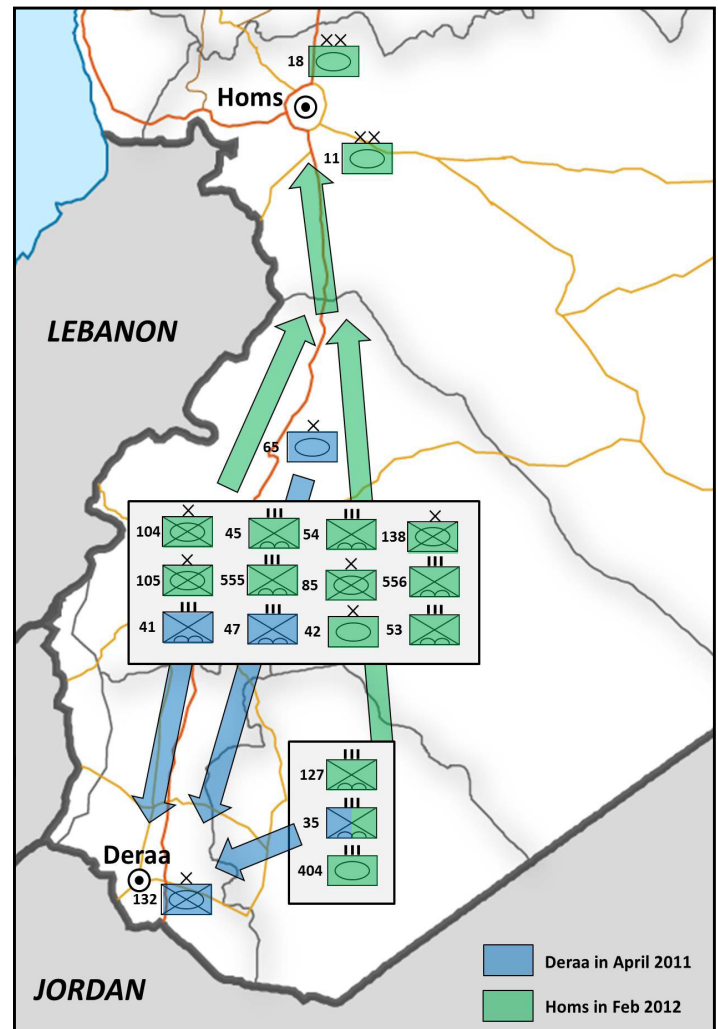

MAP 2 | FORCES DEPLOYED TO DERA'A AND HOMS

may help to explain why the 4th Armored Division is so frequently reported throughout the country by opposition media.[†]

The regime has also task-organized its forces to ensure their loyalty by consolidating trustworthy sub-units to form effective conventional brigades. Like the regime's task-organization at the battalion level, this consolidation complicates the analytical utility of tracing Syrian units by unit number. Perhaps the best example of this consolidation has taken place in the 1st Armored Division, historically one of the most reliable conventional units in the Syrian Army. Between the summer of 2011 and fall of 2012, opposition media reported activity from three of 1st Armored Division's brigades—the 91st, 153rd, and 58th—but in every case that activity was within ten kilometers of

* See Appendix 3 for further information about the Security Apparatus.

† See Appendix I for further explanation about the importance of the 4th Armored Division.

the Divisional base in Kiswah, south of Damascus.³⁴ If the regime had maintained its doctrinal order of battle, analysis of these unit deployments would suggest that the Division per se has not been particularly effective, because three of its component brigades have not moved far from the parent headquarters.

Elements of the division have been deployed farther afield, however, and with lethal effects. The regime probably consolidated loyal troops across 1st Division into the 76th Armored Brigade, which it sent north to Idlib via the coastal Latakia road in February 2012.³⁵ Over the next two months, the 76th Armored conducted a series of violent clearance operations in rural Idlib province, during which its soldiers committed numerous atrocities across a swath of Syrian villages and left behind graffiti proclaiming the work of the “Death Brigade.”³⁶ The 76th Armored Brigade remained a critical component of the regime’s forces remaining in Idlib through 2012. Given the vast disparity in action between this brigade and the three others left in southern Damascus, it seems likely that the 76th Armored is a particularly trusted unit, and that its capability and strength has been bolstered by transferring loyal battalions, companies, or individual soldiers from other brigades in the 1st Division.

The Assad regime used all of its conventional divisions in the counterinsurgency campaign, but only deployed small and trustworthy detachments from each unit. When Bashar moved to retake the Damascus suburb of Zabadani from opposition insurgents in early 2012, he sent an elite detachment from the 4th Armored Division with elements of the 3rd, 7th, and 10th conventional Divisions.³⁷ However, the regime only deployed small detachments, approximately company-sized, from each of these divisions. There are a few ways to detect the difference between the Assad regime’s doctrinal order of battle, a subject addressed in detail in Appendices 1 and 2, and its functional order of battle comprised of task-organized units. In this particular case, imagery released by the State Department shows only 40 armored vehicles approaching Zabadani, which is approximately one battalion of combat power according to Syrian Army doctrine.³⁸ If Assad had sent even one doctrinally-organized battalion from each of these four

* During the siege, elements of the 7th Division helped provide the outer cordon while the 10th Division’s 62nd Mechanized and the 3rd Division’s 81st Armored helped clear the restive valley.

divisions, instead of company-sized detachments formed into a battalion, the imagery would likely show four times as many armored vehicles.[†]

In other cases the regime has relied almost entirely on elite formations. The February 2012 siege of Homs incorporated elements of the 4th Armored Division, Special Forces, and Republican Guard. The 4th Armored Division troops began to arrive in early February and established checkpoints outside the city. When troops finally pushed into the opposition stronghold of Baba Amr at the end of the month, the Division’s 555th Special Forces Regiment led the assault.³⁹

At least two battalions of Republican Guards were also committed to Homs. A leaked video of a briefing with Major General Badiia al-Ali of the Republican Guard shows him congratulating a group of officers from the Republican Guard’s 104th Brigade on their victory. He tells the men that they will go on 100 man shifts, which suggests that the unit is comprised of approximately 300 men, roughly battalion strength. The general also informs the men that a battalion from their sister brigade, the 105th, would be sent north to reinforce them.⁴⁰

At least six Special Forces regiments, or half of those in the Syrian Army, participated in the Homs operation. Consistent reporting in mid-February 2012 showed that all three regiments of the 15th Special Forces Division had left their bases near the Jordanian border to join the fight in Homs.⁴¹ The regime also committed much of the 14th Special Forces Division to the assault, which fought in some of the strongest rebel positions of Homs’ southwest Baba Amr, Inshaat, and Jobar neighborhoods.⁴² Two

† See Figure 8, Appendix I for further information about the number of vehicles doctrinally assigned to different Syrian Army units.

‡ Opposition reports describe the activity of the 127th Special Forces Regiment, the 35th Special Forces Regiment and the 404th Armored Regiment, meaning that the regime effectively detached the 15th Special Forces Division from 1st Corps.

§ Opposition reports specifically cited activity from the 556th Special Forces Regiment, but most frequently cited the 14th Special Forces Division generally. Activity was reported in different parts of the city during similar timeframes, suggesting that at least one additional regiment from the 14th Special Forces was involved in the Homs operation.

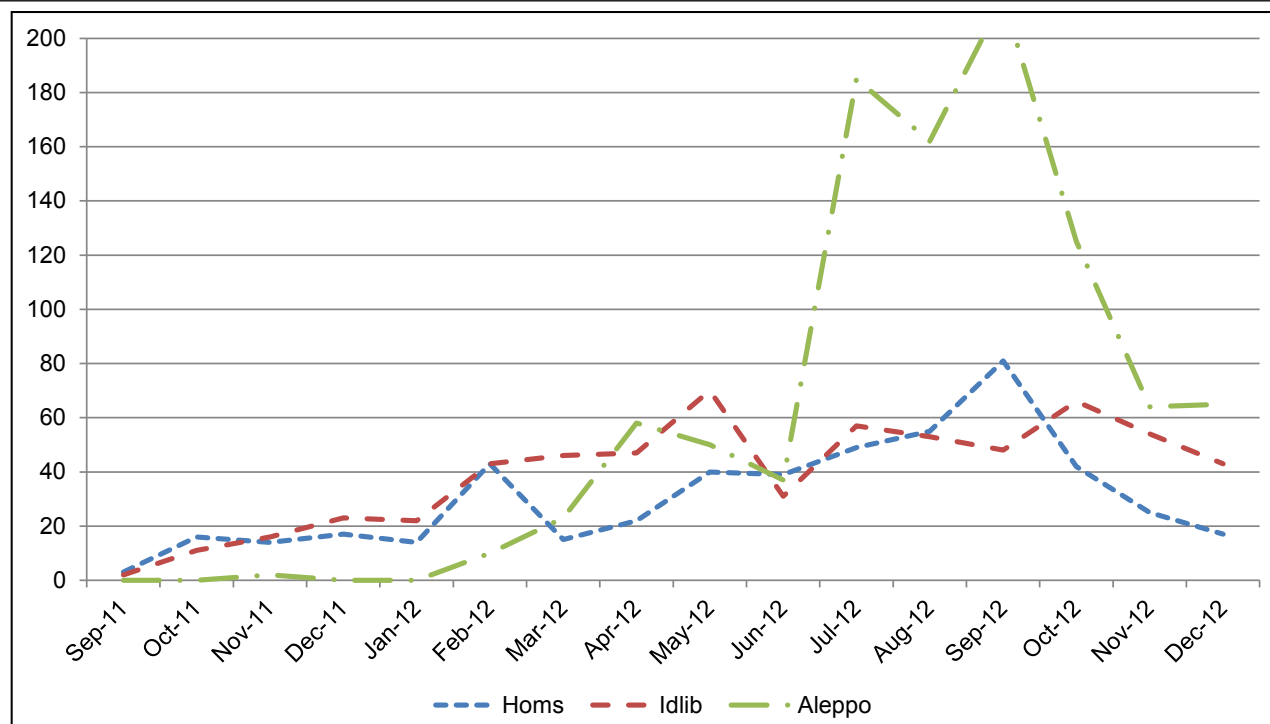

FIGURE 1 | MONTHLY CLASHES IN HOMS, IDLIB, AND ALEPPO.

additional independent Special Forces Regiments—the 53rd and 54th—also joined the effort to retake this opposition stronghold.⁴³

Assad's reliance on trustworthy military units has effectively prevented unit-level defections throughout the conflict, although it has severely undercut the regime's available combat power. Assad has relied heavily on elite forces and deployed only small and trustworthy detachments from most conventional brigades. Taken together, Assad has relied on approximately one-third of the Syrian Army's doctrinal combat power to conduct his counterinsurgency campaign. A later section of this report, entitled *From Army To Militia* will examine this dynamic in detail.

Clear and Hold: The February 2012 operation in Homs also provides the best example of the regime's clear and hold strategy. After amassing a wide array of elite forces in the city and shelling opposition-held neighborhoods, Assad's forces were able to clear the strongest point of rebel resistance in Syria up to that point in the conflict. The regime held the city with a heavy troop presence after clearing it, preventing the insurgency from regaining momentum there through the rest of 2012.

Although the regime committed many elite troops, these forces relied on indirect fire in order to clear out strong rebel resistance without incurring an unacceptably high

loss of ground forces. Assad had only recently begun to use artillery at the beginning of 2012. Throughout 2011, regime forces had easily routed the nascent rebel movement across Syria with ground forces alone. When rebels stopped a regime ground offensive in Zabadani at the beginning of 2012, the regime started to shell the rebel-held town, which allowed them to mass firepower while preserving ground forces.⁴⁴ This event marked the beginning of the regime's use of artillery against its population, which it has regularly incorporated since.

At the beginning of February 2012, Assad's forces laid siege to Homs by stationing troops at the outskirts, digging a two-meter trench around parts of the city, and steadily shelling opposition neighborhoods with artillery.⁴⁵ After a month of shelling, regime forces pressed into Homs and cleared opposition strongholds sector by sector, house by house, and forced rebels to retreat at the beginning of March 2012.

Most media reports highlighted the scale of death and destruction caused by this bombardment, but even so, the regime did not employ as much artillery as it had available. The most conservative opposition estimates for the number of shelling deaths during this period are as low as 80 to 100.⁴⁶ Imagery released by the State Department in late February 2012 showed two batteries of five artillery pieces aimed at Homs and another three pieces aimed

at the contested town of al-Qusayr to the southwest.⁴⁷ Because the Assad regime possesses upwards of 3,000 artillery pieces, this deployment represents a small portion of the regime's total artillery capacity.⁴⁸ In the leaked video taken at the end of the siege, Major General al-Ali of the Republican Guard explains that the unit did not bring its own artillery assets from Damascus because regime forces had only used eighty percent of the artillery capacity in the region, and that twelve additional 82mm mortars were available in reserve.⁴⁹ In other words, there was no need to bring along assets that were already in place.

A significant portion of the troops committed in Homs stayed in the city to hold it and prevent the resurgence of armed opposition there. Throughout 2011, Assad's forces cleared centers of unrest one after the other, but rarely stayed behind to hold them.⁵⁰ Starting in early 2012, Assad's troops adjusted to maintain control over the areas they cleared. Elements of the 4th Armored Division and many of the Special Forces regiments continued north to Idlib or returned south to Damascus or Deraa, but many of these units remained in the city.* In the same leaked video of the Republican Guard briefing, General al-Ali tells the men of the 104th Brigade that they will not be able to take leave, and that they will go on shifts to continue security operations in the city. Furthermore, he says that another battalion from the 105th would reinforce the ongoing security effort there.⁵¹ Regime engineers constructed a ten-foot high cement barrier around the former rebel stronghold of Baba Amr, and soldiers and security officers guarded a few narrow gaps in the wall, arresting any military-aged males who tried to pass their checkpoints.⁵²

The effectiveness of the regime's clear and hold approach in Homs remained evident through the remainder of 2012, as the Figure 1 illustrates. After the initial clearance operation, monthly instances of fighting with rebels across Homs province dropped down to pre-February 2012 levels and did not reach those levels again until July. By October 2012, clashes again dropped below February levels. Meanwhile rebel activity in Idlib and Aleppo spiked during the spring and summer of 2012 before declining to a level that was nevertheless twice as high as that seen in

Homs by the end of 2012.⁵³ The regime's tactics worked in Homs, but Assad ultimately lacked the forces necessary to repeat the approach in Syria's northern provinces. Given the force restrictions described above and below, Assad's clear and hold strategy was not sufficient for a country-wide campaign.

Paramilitaries: The rapid emergence of pro-Assad militias was predictable at the outset of the uprising, given the regime's history of using paramilitary forces in domestic conflict. Hafez al-Assad relied heavily on the Ba'ath-affiliated Popular Organizations, or *munazzamat sha'biya*, during the early 1980s. By the mid-1980s, the Ba'ath party referred to its institutional militia as the *Jaysh al-Sha'bi*, or People's Army, and in 2011 the *Jaysh al-Sha'bi* included an estimated 100,000 paramilitaries.^{†54}

From the outset of the 2011 conflict, Bashar has relied heavily on two classes of pro-regime militias. The first type is the notorious *shabiha*, made up of mostly Alawite criminal smuggling networks led by members of the extended Assad family. There is no evidence to suggest that these mafia-like organizations played a role during the Muslim Brotherhood uprising, although they have been responsible for much of the worst brutality against the Sunni opposition in the current conflict.

The second type of militia more closely mirrors Hafez's Popular Organizations and the institutionalized People's Army, and draws its ranks from minority populations who have armed themselves to protect their towns and neighborhoods from anti-government fighters. These more locally-oriented militias most frequently call themselves Popular Committees, or *lijan sha'biya*.

The opposition has not distinguished between these two types of militias, referring to both as *shabiha*.[‡] The word *shabiha* is uniquely Syrian slang that originally described a particular class of Alawi smugglers that grew up in Latakia in the 1970s and 1980s.⁵⁵ The most frequently cited derivation of the term is the model of car reportedly favored

* The breakdown between Syrian Army units that remained in Homs and those that moved on to new areas of operation will be discussed in greater detail in a section below, entitled *From North to South*.

† Major General Mohammed Ibrahim al-Ali, a close confidant of Hafez al-Assad, was a long-serving commander of the *Jaysh al-Sha'bi*.

‡ Despite similar the English transliterations of *sha'biya* and *shabiha*, the words do not share the same root in Arabic.

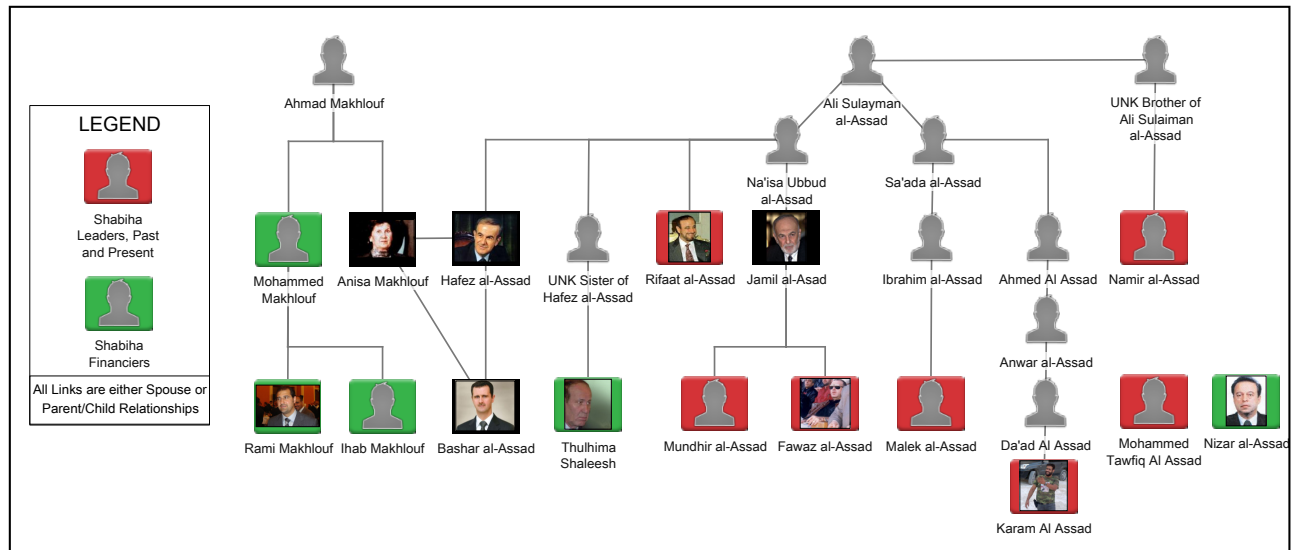

FIGURE 2 | ASSAD FAMILY SHABIHA

by these smugglers, the Mercedes *Shabah*, or Ghost.^{*56}

Members of the extended Assad family have historically led the *shabiha* militias. The regime tolerated and even profited from their smuggling operations, but never fully controlled these mafia-like organizations. Fawaz and Mudhir al-Assad, two of Hafez al-Assad's nephews, became the most infamous *shabiha* leaders, and their smuggling activities became interwoven with general intimidation and gang behavior in Latakia. They began to wear paramilitary outfits and carry weapons instead of wearing luxury clothes.⁵⁷ Hafez never fully controlled his nephews' smuggling gangs, and he periodically cracked down on them, even sending family members to prison.⁵⁸ The *shabiha*'s ranks may have grown significantly in the mid-1980s when Hafez dismantled Rifat al-Assad's Defense Companies, availing its former members to join the smuggling networks.⁵⁹ Rifat maintained some loyalty within the *shabiha* in Latakia,

* Smuggling goods across the Syria-Lebanon border became a lucrative enterprise after Syria's 1976 intervention in the Lebanese Civil War. The protectionist policies of Ba'athist Syria restricted the import of luxury goods—cars, electronics, fancy clothes—that were available in Lebanon. The smugglers could also buy basic commodities subsidized by the Syrian government and sell them in war-torn Lebanon for a profit. This lucrative business fell under the control of young Alawite men, and Assad family relatives in particular, for practical reasons. These smugglers dressed up in uniforms and pretended to be members of all-Alawite Defense Companies to get through Syrian Army checkpoints on the Lebanese border.

even after his exile.^{†60}

At the outset of conflict in 2011, the *shabiha* quickly assumed a leading role in the crackdown. Faced with the majority-Sunni opposition movement seeking to depose Alawite rule in Syria, the *shabiha*'s loyalties fell squarely behind Bashar al-Assad. The Assad family's black sheep had a history of insubordination to the regime, but nevertheless owed their position and influence to their relationship with Syria's rulers. This historically contentious relationship, however, suggests that the *shabiha*'s activities have not always been directed or controlled by Bashar's inner circle.

An interview of one Alawite *shabiha* militiaman, Abu Jaafar, sheds light on the decentralized but fiercely loyal nature of these mafia militias. Jaafar explained that during his military conscription he was recruited to join the security services, and a senior security officer asked him “to be his man in dealing with some Alawite smugglers” after leaving the service. Jaafar typifies the *shabiha* stereotype, selected for his “physical strength, lack of education and blind loyalty to the Alawite sect and the Assad family in particular.”^{†61} Indoctrinated into the network, Jaafar soon pledged loyalty to his “mualem” or master, and describes himself as a member of the *shabiha* with pride.

† In 1999, regime security forces clashed with supporters of the exiled Rifat when they moved to close down his shipping operations in the port of Latakia. The confrontation was part of a broader regime effort to secure against potential challengers prior to Bashar al-Assad's succession.



PHOTO 1 | SHABIHA MEMBER AREEN AL-ASSAD WITH BASHAR TATTOO. SOURCE: YouTube, <http://youtu.be/bOot1ffRuuU>

Bashar has mustered additional *shabiha*-type militias from non-Alawi criminal networks in areas without substantial Alawi communities.* In Aleppo, the Sunni Berri family, “known for its involvement in drugs and arms smuggling, its close ties to the regime and its occasional clashes with state institutions,” has fielded a significant portion of pro-regime militias.⁶² In Deir ez-Zor and Deraa the *shabiha* are also reportedly Sunnis who support the regime.⁶³ Recruits have different motivations for joining these militias, as the *shabiha* are usually paid for their services. Recruits often come from the lowest socio-economic spectrums of Syrian society, including criminals released from prison in exchange for loyalty to the regime.⁶⁴

The second type of pro-regime militia, the Popular Committees, has not received the same level of attention as the intimidating *shabiha*, but they are likely to be more numerous. The more locally-oriented Popular Committees often act as neighborhood watch groups, and more closely resemble the paramilitary Popular Organizations that Hafez al-Assad raised during the Muslim Brotherhood uprising. “Some minority communities, notably the Alawites and Christians, have formed armed self-defense groups to protect their neighborhoods from anti-Government fighters by establishing checkpoints around these areas,” described the UN Commission for Human Rights.⁶⁵

* The *shabiha* in Damascus hail from Alawite slums like Mazze 86; in Homs and Hama the *shabiha* are recruited from Alawite neighborhoods and villages of central Syria.

As the conflict progressed into late 2011, pro-regime communities of Alawites and other minorities began to arm themselves. A journalist visiting the Alawite village of Rabia, near Hama, described ten men in civilian clothes with rifles stopping cars at a checkpoint outside town. In the town square, residents had erected a statue of Hafez al-Assad holding an olive branch and a sword.⁶⁶ These local militias are not limited to Alawite communities. In Damascus’ Jaramana neighborhood, Druze and Christian communities also formed militias that manned checkpoints at entrances to the neighborhood by fall 2012.⁶⁷

The militarization of minority communities has been driven by the desire for self-protection as much as by the desire to support Assad. “Armed men control things. I am armed,” explained one Alawite resident of Homs in late 2011. “It’s a response, if the state fails to provide security then it’s down to me. You cannot, as an Alawite, put all your trust in the state.”⁶⁸ One reporter recalled making wide detours around Alawi villages in rural Homs and Hama, as opposition escorts explained, “They’ve all got weapons from the regime there. They may not all support Assad, but there are militias in every village.”⁶⁹

The Alawite community should not be considered a single entity, and some Alawites have been among the Assad regime’s principal opponents from its beginning. The ongoing conflict has nevertheless severely exacerbated fears that are deeply embedded in Alawi collective conscience. The Alawites have a long history of persecution at the hands of the Sunni majority. In one such story of persecution from the early 1500s, Alawite clerics travelled to Aleppo for talks with Ottoman leadership, but when they arrived they were restrained and decapitated one by one.⁷⁰ Many in the Alawi community fear that they will be punished for the Assad regime’s actions over the past 40 years, regardless of whether they have been a part of the regime.

Both the *shabiha* and the Popular Committees work closely with the Army and security services. “Since the beginning of the unrest in Syria,” a U.S. Treasury designation explains, “the *shabiha* have operated as a direct action arm of the Government of Syria and its security services.” They have provided security at regime facilities, manned checkpoints, and interrogated and killed suspected supporters of the Syrian opposition.⁷¹ The interviewed *shabiha* member Abu Jaafar claimed to receive both money and weapons from the government.⁷²

The regime also directly supports the Popular Committees. One Homs security officer explained that thousands of Popular Committee members in Alawite neighborhoods coordinate with security forces, continuing to draw government salaries but no longer working at their usual jobs.⁷³ Locals in Jaramana, Damascus told Reuters that their Christian and Druze community had been armed by the security forces.⁷⁴

Whether criminal-sectarian gangs or neighborhood militias, a broad segment of the Syrian population will continue to stand with Assad against the opposition. The *shabiha* militias appear to be motivated as much by their fear of the opposition as their loyalty to the Assad family. Abu Jaafar explained that he took up arms “to fight those Wahhabi radicals who will force my wife and daughters to wear the veil and will close all the wine shops.”⁷⁵ The Popular Committees are just as likely to remain militarized because of collective fear of reprisals. “I am sure there will be massacres [of Alawites],” explained one Alawite man interviewed in Latakia, “The regime made us enemies over the past two years.”⁷⁶ Both types of militias are thus likely to continue resisting the ascendant majority-Sunni opposition whether or not Assad remains in power.

FROM COUNTERINSURGENCY TO CIVIL WAR

In the first quarter of 2012, Assad’s troops cleared all of Syria’s major urban areas and remained in place to hold the terrain they cleared, although Assad never generated enough forces to control the whole countryside. After major sequential clearance operations in Damascus, Homs, and Idlib, the regime stopped maneuvering large forces and instead focused on holding what it could, namely Syria’s provincial capitals.

The regime opted to concentrate on population centers rather than to pursue the insurgency in the countryside. This approach was not only imposed by limitations of available ground forces, but also derived from the recognition that controlling Syria’s urban population centers was critical for regime survival. This strategy represented a continuation of the counterinsurgency approach, but it also guaranteed the failure of Assad’s counterinsurgency campaign. The freedom of movement outside of cities granted to the insurgency accelerated its growth.

Three dynamics have led to the ultimate failure of Assad’s counterinsurgency campaign since the summer of 2012, while simultaneously creating the conditions for the regime to fight a civil war. Each of these trends represents both a cause and an effect of the conflict’s transformation. These operational and dispositional transformations are:

From Clear to Cleanse: The regime’s attempt to separate the insurgents from the population only accelerated population displacement along sectarian lines, which in turn entrenched broader civil conflict in Syria.

From Army to Militia: Assad lacked enough reliable forces to control all of Syria, although he can still rely on a hard core of regime supporters among the remnants of the Syrian Army.

From North to South: The uneven distribution of regime forces across the country has made it impossible for Assad to regain control of Syria, but has made it easier to maintain control over a more limited geographical area.

The clear and hold strategy that was so effective for Assad in Homs and elsewhere has displaced populations in a way that has accelerated the emergence of sectarian civil conflict. Similarly, the regime could not generate enough forces to end the insurgency, but these forces are nevertheless well suited to continue fighting against the Syrian opposition for the foreseeable future.

From Clear to Cleanse

The Assad regime has tended to force civilians out of insurgent-held areas, rather than clear insurgents out of population centers. This internal displacement has effectively separated the insurgents from the population, but has hardened sectarian lines as communities grouped together out of fear and the need for self-protection. Population displacement emerged as an unintended outcome of the early 2012 Homs siege. Over subsequent months, however, the regime began to pursue population displacement deliberately, using artillery shelling, air strikes, massacres, and even ballistic missile strikes in opposition-controlled areas. Assad thus transformed the clear-and-hold counterinsurgency strategy into a form of ethnic cleansing.

Shelling Homs in February 2012 successfully cleared insurgents out of Homs, but also displaced much of the city’s population in the process. Rather than massing

artillery to destroy the city, the Syrian Armed Forces used artillery to facilitate ground clearance, allowing regime troops to clear Homs without suffering unacceptable casualties. “Our people make forays, but casualties are heavy on both sides,” explained one regime official, “For us to really go in would entail levels of violence that we cannot consider at this stage. There are many children and women, and this is one of the reasons why we must think twice before proceeding.”⁷⁷

Whatever the regime’s intent, the shelling resulted in large-scale population displacement that spread the geographical scope of the opposition. “The fight for Homs essentially was over,” wrote International Crisis Group, “the city largely depopulated.” The report goes on to describe the effect of this policy as the end of the “Syrian territory’s compartmentalization.” Poor displaced families sought refuge in the Damascus suburbs, reinvigorating the protest movement in the capital. “When refugees from Homs got here, the popular movement was energized. Before, we used to demonstrate two or three times a week at most,” explained one Damascus resident, “After their arrival, we went out every day.”⁷⁸

Counterinsurgency theorists frequently paraphrase Mao Tse-Tung’s axiom, “the people are the water in which the insurgent swims,” and surmise that the task of the counterinsurgent is therefore to separate the insurgents from the people. Rather than going fishing, as the metaphor suggests, Assad drained the lake by displacing the population and consequently spread unrest further.

In the early 1980s Hafez al-Assad was able to defeat the rebellion one area at a time, sequentially quelling unrest with large military operations; the regime’s population displacement in 2012 made the conflict much more difficult to contain. Other factors help to explain Bashar al-Assad’s inability to compartmentalize the conflict, particularly 21st century information technology that has allowed opposition media to broadcast Assad’s campaign across the country. Nevertheless, by displacing restive populations, Assad did more to spread the conflict than contain it.

After Homs, the regime began to employ artillery decoupled from ground force operations by periodically shelling towns and neighborhoods without ever mounting operations to clear them. This evolution was largely a result of Assad’s lack of available ground forces, particularly in northern

Syria where troops became pinned down in strongpoints across the countryside.* By shelling opposition areas from a distance, the military was able to limit casualties and defections among its already overstretched forces. “From strict counterinsurgency [the campaign] morphed into collective punishment and verged on wholesale scorched earth policy,” described the August International Crisis Group report.⁷⁹

This approach was successful in certain respects, and the regime eventually began to pursue the strategy deliberately in order to prevent the opposition from effectively governing the areas it controlled. “Scorched earth policy” is a classical counterinsurgency approach, as Tacitus famously described Roman security policy in the empire, “They make a desert and call it peace.” Even when the rebels are able to win terrain, they frequently lose the population, either through literal displacement or because people blame their plight on the rebels as well as the regime. “In July 2012, Rastan is liberated but a ghost town,” described one reporter, “half destroyed and surrounded by armored divisions, artillery emplacements and army troops that shell the city daily. The rebels are the only people still here.”⁸⁰

A related outgrowth of this dynamic has been the regime’s ability to hold urban areas hostage, which largely explains why the rebels have been unable to win a major city. Rebel commanders in Idlib and Aleppo frequently describe their unwillingness to confront regime forces more aggressively in these northern provincial capitals, concerned that the regime will destroy the city if they escalate operations.⁸¹ In this way, the regime has used artillery not just to clear cities in a way that preserves ground forces, but also to hold cities without committing ground forces to control every intersection.

Evidence suggests that elements of the regime subscribed to a depopulation strategy at the outset of the conflict, at least in Alawite-majority coastal regions. Repeated clearance operations in coastal Sunni enclaves like Baniyas, Bayda, Tel Kalakh, and Latakia’s Ramal neighborhood throughout the spring and summer of 2011 resulted in large-scale displacement of Sunni populations, as terrorized families fled inland to Sunni-majority provinces like Idlib.⁸²

* The disposition of Syrian Army units in northern Syria will be discussed in greater detail in a section below, entitled *From North to South*.

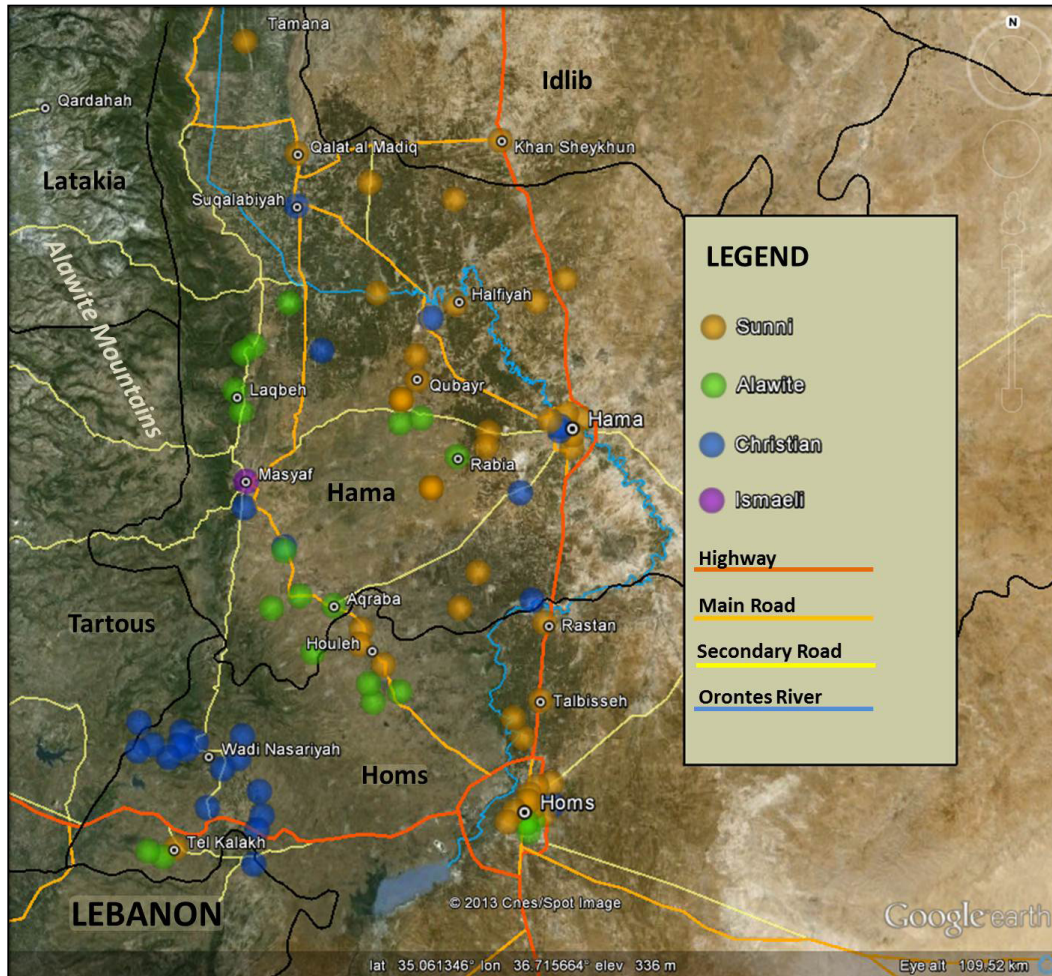

MAP 3 | ORONTES RIVER VALLEY ETHNICITIES

During the summer of 2012, population displacement became a central pillar of the regime's approach to the conflict, even if the strategy had at first emerged inadvertently. Assad's forces have employed a range of tactics to achieve the effect of displacing the populations of opposition strongholds. In the fall of 2012 the regime embarked on a campaign of **bulldozing** neighborhoods in Damascus, including Qadoun, Tadamoun, and Mezzeh.⁸³ Hussein Makhoul, an Assad family relative and governor of Damascus Province, did not mince words when he explained the regime's tactics to one western journalist: "we are not finished yet with cleansing operations," essential to driving out the "terrorists," and demolitions would soon begin in Daraya, Harasta, and Yalda, all opposition strongholds.⁸⁴

Paramilitary forces have been accused of operating alongside the bulldozers to ensure that populations fully vacate the area. As early as July 2012, pro-regime militias

worked with regime soldiers, tanks, and bulldozers to drive people out of restive sections of Mazzeh, Damascus.⁸⁵ Activists in Hama reported in October 2012 that 120 houses were destroyed by regime bulldozers in the Mesha al-Arbeen neighborhood, and again the *shabiha* worked with the bulldozers to displace the population.⁸⁶

One of the most effective forms of population displacement has been **massacres** of men, women, and children in Sunni villages and neighborhoods across Syria. Although pro-regime militias have been primarily responsible for these killings, it is difficult to exonerate the regime of responsibility in most cases.

At the end of May 2011, pro-regime militias murdered at least 108 residents of the predominately Sunni village of Taldou, in the Houleh area of Homs province. After investigating the incident, the UN reported that 49 children and 34 women were among the dead, and that the majority had been stabbed or shot at close range.⁸⁷ As

information emerged about the incident, it became clear that Syrian Army forces had been close by, and even shelled the town with artillery in support of the militias.⁸⁸ Less than two weeks later in Qubeir, Hama province, militias killed another 100 Sunni villagers, including 40 women and children.⁸⁹ Houleh and Qubeir shared a number of important geographic and demographic similarities. Both of these Sunni agricultural villages neighbored Alawi villages, part of the patchwork Sunni, Christian, and Alawite villages that dot the fertile Orontes river valley between Homs and Hama.

Militias have also massacred women and children in the Sunni districts of Damascus that border important Alawite and Shia neighborhoods. In late August 2012, after three days of heavy shelling killed 70 people, Syrian Army and pro-regime militias entered the Sunni suburb of Daraya and executed hundreds of people. The victims were primarily military-aged males, but included women and children. The death toll eventually reached over 300, most shot at close range in the head or neck.⁹⁰ Daraya has been a center of revolutionary unrest throughout the conflict, and its proximity to downtown Damascus and the Mazzeh military airport make it an immediate threat to the regime's position in the capital.

In Damascus' southern Thiabieh suburb, militias killed over 100 people at the end of September, following clashes between pro-regime and rebel forces in the area.⁹¹ Thiabieh is a Sunni neighborhood that neighbors the Sayedda Zeinab neighborhood, home to a significant Shia religious site, the shrine of the daughter of Ali. Evidence emerged in late 2012 and early 2013 that Lebanese Hezbollah and Iraqi Shia militants had joined pro-regime militias in defending the Sayedda Zeinab neighborhood.⁹²

The examples above do not constitute a full list of massacres committed by pro-regime elements, but rather are some of the clearest examples of a tactic that has contributed to displacing Sunni populations. Massacres like those mentioned above happen nearly once a month. In December 2012 there was a similar massacre in Barzeh, Damascus; in January 2013 it happened again in Basatin al-Hasawiya, Homs.⁹³

There have been no confirmed massacres of Alawite communities committed by the Sunni opposition, even in areas where the regime no longer maintains significant

armed forces.* Although this situation may be due to the restraint shown by the Syrian opposition, it is also likely that the rebels have not had the opportunity. Alawite communities in Syria have consolidated and sufficiently armed themselves. Even in Northern Latakia, the Alawi village of al-Sarayah, "has been emptied of its inhabitants except for the armed men, while Latakia city now overflows with Alawite refugees."⁹⁴

These massacres are both a cause and an effect of sectarian polarization. As early as the summer of 2012, Alawite and Sunni families left mixed communities to cluster together along sectarian lines. A journalist who visited Rabia that summer reported that thirty Alawite families had recently moved there from one nearby majority-Sunni village because they felt it was no longer safe to stay in their homes.⁹⁵ Another reporter described two Sunni villages in northern Hama that "had largely been emptied after the killings of a woman and four of her children by pro-government militias."⁹⁶

Air power has become the most significant instrument in the regime's efforts to displace populations. The regime first employed its helicopters in bombing and strafing runs in the spring of 2012 when rebels opened new fronts in northern Aleppo and Latakia, beyond the reach of overstretched ground troops.⁹⁷ After northern rebels went on the offensive in June 2012, and after confirming that the international community would not move to impose a No Fly Zone, the regime significantly expanded its use of helicopter gunships in June and July.⁹⁸

During the battle for Aleppo in August, the regime needed Syrian Air Force jets to compensate for the regime's relative lack of artillery capacity. Unlike the battle for Homs, where the regime used artillery ahead of ground offensives, the regime used airstrikes in the districts of Aleppo after rebels pushed them out, despite the fact that the regime did not have the ground forces necessary for a ground counter-offensive. In the month of August, the Syrian Air Force conducted approximately 20 jet airstrikes and

* On December 12, 2012, the *New York Times* reported that Alawite women and children were murdered in the village of Aqraba, near Houleh. Pro-regime militias were fighting Sunni rebels in the area, and taped interviews with survivors published by opposition media suggests that the massacre was committed by Alawite *shabiha*; however, it is a strange and unresolved case in which many have understandably accused Sunni rebels.

10 helicopter strikes in Aleppo city, all of which targeted neighborhoods behind the front lines where rebels battled Syrian Army units.⁹⁹

Aside from logistics and reconnaissance, the Syrian Air Force has been used primarily to strafe and bomb rebel-held areas, not to engage armed opposition directly in support of the Syrian Army. The vast majority of reported regime airstrikes have occurred in locations where there were no reported clashes that day, suggesting that the airstrikes were not in tactical support of Syrian Army units fighting rebels.¹⁰⁰ This is largely due to the fact that the Syrian Air Force does not have the precision targeting capability to provide direct support without significant risk of friendly fire. Indeed, the only regime aircraft that could reliably provide accurate direct support is the MI-25 HiND, and the regime never possessed more than 40 of these valuable attack helicopters.¹⁰¹

The lack of capability may explain one reason the regime has focused its air power against whole villages and neighborhoods, but the effect of this approach has been either to displace the civilian population or, in the case of Aleppo, to turn the population against the insurgency. People in Aleppo blame the rebels for the destruction brought with them.¹⁰² This use of air power in the battle for Aleppo therefore helped stop the rebels from dislodging the regime by ensuring that the opposition could not govern the areas it controlled.

This dynamic has allowed Assad to hold Aleppo hostage. In some cases, rebel attempts to gain new neighborhoods in the city have been prevented not by regime forces, but by civilians who fear regime bombardment. One mother of two, who had been forced to flee from Aleppo after clashes broke out near her home in early January 2013, blamed the armed opposition for her evacuation. “The regime left us alone until they [the rebels] came. We had water, and food, and electricity, and there was a sense a normalcy. Then they came, even though we didn’t ask, and the regime punished us for it by bombing our houses, cutting off the electricity, and we could find no food or water.”¹⁰³ She added that some of the district’s residents had tried to fight the rebels and prevent their entry into the neighborhood. Incidents such as these have forced a shift in rebel calculations and allowed the regime to maintain its grasp in the area despite dwindling resources.

A rebel commander from the Tawhid Brigade in Aleppo discussed the rebels’ reluctance to enter deeper into regime-held neighborhoods due to concerns over civilians. “We can’t risk it. We don’t have the capabilities to provide for the people in these areas. Our resources are already limited. When we enter and the regime starts bombing and we have no food or supplies to give them, they turn against us and then we become the enemy. We’ve had to work around Aleppo instead of taking it like we should.”¹⁰⁴

Similar regime tactics have effectively undermined rebel attempts to take other Syrian urban centers. “The regime

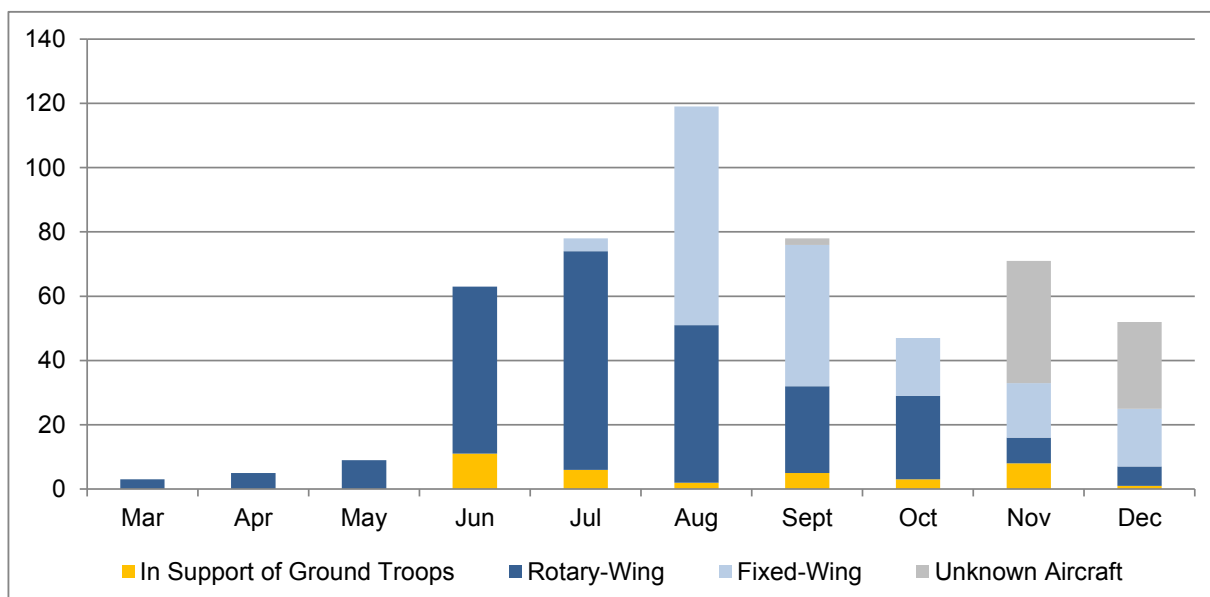

FIGURE 3 | 2012 AIRSTRIKE TRENDS

will defend its existence by the most brutal means,” explained a Damascene opposition leader, referring to fears that shelling and airstrikes could destroy heritage sites in the ancient city.¹⁰⁵

Assad’s use of so-called “barrel-bombs,” improvised bombs constructed from oil drums and dropped by Syrian helicopters, also becomes clear within the construct of population displacement. The regime’s decision to use these improvised incendiary bombs as early as August 2012 at first seemed like a sign of munitions shortages, but the regime has continued to use conventional munitions throughout the conflict. The regime’s munitions are designed for conventional war with Israel over the Golan Heights, however, and many are ill-suited to the objective of destroying urban structures. The barrel-bombs may be a regime attempt to devise new methods that better destroy buildings than the conventional munitions in stock.¹⁰⁶

The regime has also depopulated rebel-held areas through air power by targeting bakeries, reducing the opposition’s ability to provide basic services for populations under rebel control. The regime has even used cluster bombs and targeted bakeries when long bread lines have formed, ensuring high numbers of civilian casualties. According to McClatchy, two Syrian opposition groups have counted over 100 airstrikes on bakeries, and McClatchy was able to verify independently 80 of the attacks. Furthermore, the story notes, the attacks could not have been inadvertent because at least 14 of the bakeries were targeted repeatedly.¹⁰⁷

One of the most devastating of these bakery bombings occurred in Halfiyah, a small Sunni town in rural Hama. At the end of December 2012, warplanes killed 23 people waiting in line for bread at a bakery. The town had been seized by rebels the previous week as part of a broader campaign in rural Hama.¹⁰⁸ The Halfiyah bombing was just 10 kilometers from a massacre that emptied the village of Qubeir months earlier.¹⁰⁹

By the autumn of 2012, Syrian opposition became increasingly adept at shooting down regime aircraft and embarked on a campaign to overrun or neutralize the Assad regime’s air bases across the country. By the end of 2012, the opposition had downed at least 15 regime aircraft—more than four times that many by some estimates—and destroyed many more on the runways of bases they had attacked. This increasing effectiveness exacerbated the strain on the regime’s ability to sustain the Syrian Air Force logistically.

By the end of 2012, the Syrian helicopter and jet fleet had flown consistent sorties for over a year, and bombing and resupply missions for over six months—far longer than the Syrian Air Force has ever operated continuously.

In fact, the regime’s use of air power peaked in August 2012, with both helicopters and jets strafing and bombing across the country, particularly around Aleppo. As Figure 3 depicts, regime helicopter strikes were highest in August and have declined since. The Assad regime only had approximately 150 helicopters in the inventory, and even if one assumes a very high effective rate of 50 percent at the outset of the conflict, diminishing supplies of spare parts, combined with increasingly effective opposition air defense artillery, have taken a heavy toll on the Syrian Air Force.¹¹⁰ “Syrian Air Force support, almost continuous in [Aleppo] over the summer, has dwindled,” explained a western journalist in late December 2012, “The sound of Russian-made helicopters, once constant is now unusual.”¹¹¹

Reduced numbers of jet aircraft strikes since late 2012 show that overall Syrian Air Force capability is degrading, probably due to lack of logistical capacity. As early as August 2012, the regime relied heavily on easily maintained L-39 trainer jets.¹¹² High-grade aviation fuel may be another limiting factor on the regime’s use of air power. Unless Assad receives a significant infusion of spare parts or additional aircraft, the Syrian Air Force is likely to become combat ineffective in 2013.^{*113}

The regime adapted to the diminishing capacity of its air force in December 2012 by beginning to use its Surface-to-Surface **Ballistic Missile** (SSBM) inventory against the Syrian opposition.[†] At first the regime launched missiles against remote areas of northern Syria, such as Maraa, a rebel stronghold near the Turkish border, and Sheikh Sultan Air Defense Base, which had been overrun by rebels.¹¹⁴ Introducing ballistic missiles seemed like a natural progression in the Assad regime’s escalation, particularly given the increasing air defense risk posed by rebel forces in northern Syria.

Assad began to use this new weapon to continue displacing the population from rebel-held areas in January 2013,

* See Appendix 4 for more information on the Syrian Air Force.

† See Appendix 4 for more information on Syrian ballistic missile holdings.



PHOTO 2 | BALLISTIC MISSILE STRIKE IN DARAYA

after confirming that the international community would not respond to the ballistic missile strikes. On January 15, an errant SCUD missile struck Aleppo University, killing more than 80 people and wounding more than 180.* Some have argued the strike was actually an air-to-ground missile fired by a Syrian jet, which is a possibility that cannot be discounted based upon available evidence.¹¹⁵ Either way, it is doubtful that the Assad regime deliberately targeted the University, which was firmly under regime control, but likely that the ballistic missile was meant to hit a rebel-held portion of Aleppo.

Days later, a ballistic missile struck Damascus' Daraya neighborhood, which had been the target of a massacre in August 2012. The regime's decision to target Daraya with a ballistic missile when it is well within the range of conventional artillery seems strange. However, the regime has invested a great deal of combat power in Daraya and may see it as the keystone in the rebel encroachment on downtown Damascus.

Assad's ballistic missile holdings are limited, although accurate open-source estimates are not available. Most sources indicate that the regime has more than 400 ballistic missiles and long range rockets. Between mid-December 2012 and late February 2013, the regime used more than 40 ballistic missiles, or roughly 20 missiles each month.¹¹⁶ Assad can thus continue ballistic missile strikes at this rate and expend approximately half of its inventory in 2013, although the rate of missile use may be increasing.

* Robert Mackey, "Video Suggests Missile Hit Syrian University," The Lede Blog, *New York Times*, January 23, 2013.

Bashar al-Assad had developed a significant SSBM inventory as a strategic deterrent against Israel, but he has turned these missiles against his own people. Similarly, most indications suggest that Assad developed a robust chemical weapons program as a strategic deterrent, but this does not imply that Assad will not use chemical weapons against Syrians in the future. Assad has not used chemical weapons as of March 2013. For the time being, Assad likely recognizes that chemical weapons would trigger international intervention in the conflict, making their usage a suicide play. But if the regime believes that it is facing defeat, or that outside intervention is unlikely, it may resort to the weapon best suited to drive the Syrian people out of opposition strongholds.

Assad's depopulation strategy has resulted in an expanding humanitarian crisis of refugees and internally displaced persons (IDPs). Over 20,000 Syrian refugees crossed into Jordan over just seven days at the end of January 2013.¹¹⁷ As of February 2013, U.N. estimates of the number of refugees reached 800,000 to 1 million, while estimates of IDPs ranged from 2 to 2.5 million.¹¹⁸ Taken together, this displacement represents a staggering 15 percent of Syria's population.¹¹⁹ In mid-February U.N. officials in northeastern Syria estimated that 40,000 people had fled their homes during heavy fighting between rebels and government troops, suggesting that the rate of displacement has further increased.¹²⁰

These official estimates probably underestimate the scale of internal displacement. Estimates of IDPs do not include those who move to a different neighborhood within the same city, which almost certainly describes

tens of thousands more civilians in Damascus, Aleppo, and Homs. Surveys conducted by an independent NGO in mid-February 2013 found that there were 1.1 million internally displaced persons in northern Syria alone, not including Aleppo city.¹²¹

From Army to Militia

The Assad regime's strategy of selective deployment of politically reliable troops has ensured that the Syrian Army has avoided any significant defection of an entire maneuver unit during the conflict. The strategy also explains why the regime has been unable to generate enough troops to control the whole country even though the doctrinal order of battle would suggest it has combat power available. This central challenge of generating combat power is rooted in the regime's over-reliance on trusted units and has been exacerbated over time by defections and attrition. Selective deployment, rampant defection of individuals, and battlefield deaths have limited Assad's available military forces, but have also trimmed the fat, such that the remains of the Syrian Army are comprised entirely of die-hard regime supporters capable of continuing to fight for months, if not years.

On paper, the Assad regime maintained approximately 60 brigade-level maneuver units with which it might have put down the uprising.* In practice, the regime has not deployed all of these units, and those that have deployed have rarely operated at full strength. Taken together, these limitations suggest that from the outset of the conflict, Assad has relied on approximately one-third of the Syrian Army's doctrinal combat power to conduct his campaign against the opposition.

At the outset of conflict in 2011, only the 4th Armored Division and Republican Guard likely operated at full strength. These units have frequently operated since then as small detachments, and they have suffered some defections; nevertheless, the two divisions at full strength would include approximately 26,000 soldiers.[†]

The regime's twelve highly-active Special Forces regiments

* See Appendix 2 for the doctrinal order of battle of the Syrian Army.

† Three regiments of 1,500 soldiers (4,500), four mechanized brigades of 3,500 soldiers (14,000), and three armored brigades of 2,500 soldiers (7,500).

probably never operated at full strength. Historically the Special Forces were led by an almost all-Alawite officer corps, but half of their soldiers were Sunnis, and the number of early defectors from Special Forces units suggests that the ratio of Sunni soldiers remained higher than the other elite divisions at the outset of the conflict.¹²² Assuming that the Special Forces regiments could count on two-thirds' strength, the Special Forces included approximately 12,000 soldiers.[‡]

Deriving estimates of troop strength within the conventional divisions presents greater analytical challenges, but as a rule of thumb the regime has been able to deploy the equivalent of one brigade's combat power from each conventional division (which consists of four brigades). In certain cases, this consolidation of combat power is evident: recall the argument above that the 1st Armored Division consolidated to deploy its 76th Armored Brigade to Idlib.¹²³ In most cases, limited geographical or numerical deployment suggests severe combat power limitations.

Most conventional Syrian Army brigades have remained within ten or fifteen kilometers of their bases. The one or two brigades from each division that have deployed farther afield have not deployed as full brigades. Across the fourteen conventional brigades of 1st Corps, ten have remained close to their bases, and four have deployed detachments to reinforce nearby areas.^{§124} In 3rd Corps, the historically reliable 3rd Armored Division deployed elements of three brigades from its bases around Qutayfah to Deraa, Zabadani, and Hama, while the 11th Armored Division stayed close to its bases in Homs and Hama.^{¶125}

‡ Twelve regiments of 1,000 soldiers each; the percentage of Alawites in the Special Forces may have increased after the dissolution of Rifat's Defense Companies in the mid-1980s or after the expulsion of long-standing Special Forces commander Ali Haydar in the mid-1990s. For further information on the history of the Syrian Special Forces, see Appendix 1.

§ The 7th Division sent detachments from three of its brigades—the 68th, 78th, and 121st—to reinforce positions in Zabadani and the Golan, while the 9th Division sent its 52nd Mechanized Brigade to As Suwayda after the 15th Special Forces Division deployed north to Homs.

¶ The 3rd Division's 65th Armored Brigade deployed to Deraa early in the conflict, and later deployed the 47th Armored Brigade to Hama. A portion of the 81st Armored deployed to Zabadani, but elements remained around its base near Ad Dumayr.

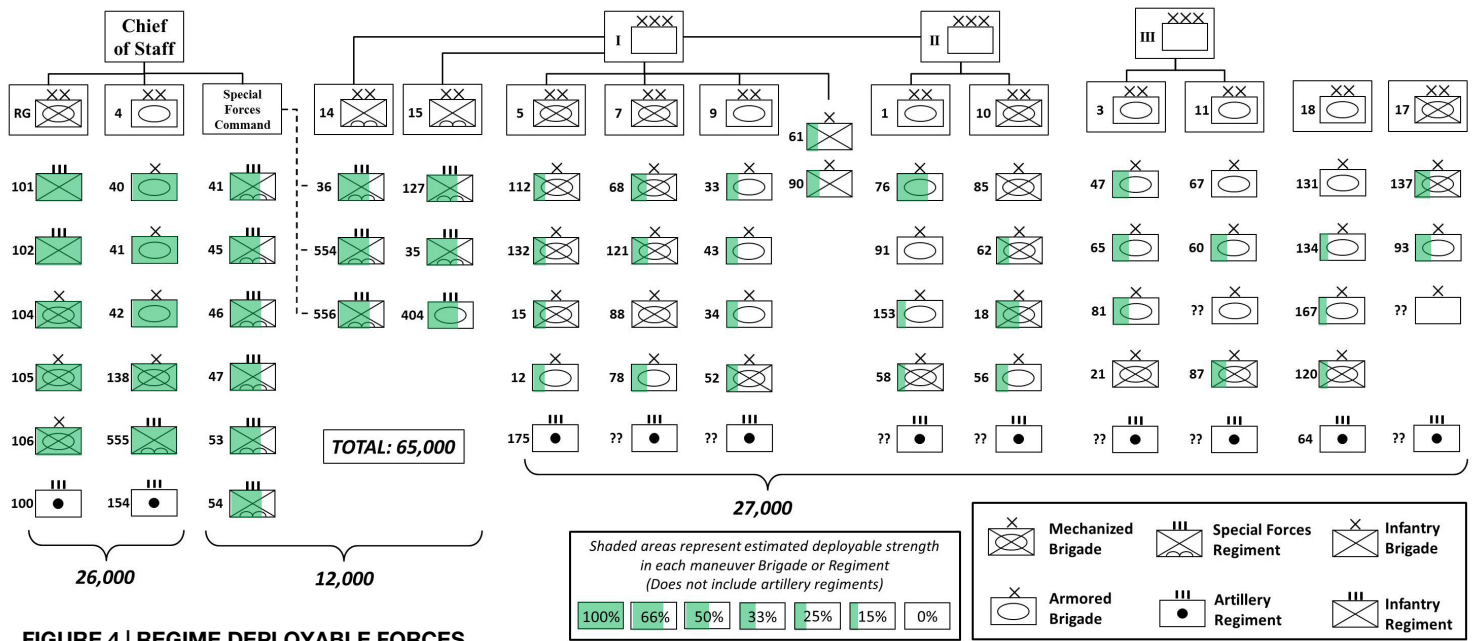

FIGURE 4 | REGIME DEPLOYABLE FORCES

This disparity in troop deployment within and across divisions suggests that the regime’s deployable troop capacity within the conventional divisions has not been greater than an average of one brigade per division. Assuming that the regime has deployed one brigade equivalent from each conventional division, Assad has been able to rely on 27,000 troops from across the Syrian Army’s nine conventional divisions.

The Syrian Army had an estimated 220,000 soldiers in 2011, but the above estimates suggest that the regime has only been able to rely on approximately 65,000 troops.¹²⁶ This number is similar to existing opposition estimates. Opposition sources tend to use the figure of one-third of the Army being deployed against the opposition, which equates to 73,300 using the 220,000 figure.¹²⁷ Other opposition sources have estimated that “Assad can currently count on the loyalty of some 70,000 well-equipped troops.”¹²⁸ Taken together, a working estimate of 65,000 to 75,000 loyal, deployable Syrian regime troops emerges.

Assad has marginalized the remaining two-thirds of the Syrian Army in the process of selectively deploying this loyal core of military supporters. The Syrian Army’s Sunni conscripts and untrustworthy officers have represented a risk for the regime. Although it is difficult to accurately account for the numbers and whereabouts of this majority, defections and imprisonment help to explain what has happened to these troops.

Defectors only account for 20 to 30 percent of the Syrian Armed Forces, a basis that includes over 300,000 troops (including Air Force and Air Defense personnel). In April 2012, leading defector Mustafa Sheikh estimated 50,000 defectors; another rebel leader suggested 90,000 the next month.¹²⁹ In July a defected leader from Syrian Air Force intelligence cited regime-internal estimates of 100,000, while Turkish intelligence estimated 60,000 defectors.¹³⁰

Many more Syrian soldiers may have defected if they had the chance, but elite regime forces and members of the security apparatus have gunned down or imprisoned many soldiers when they refused to follow orders or tried to defect. One defector even witnessed the execution of ten soldiers from the normally reliable 4th Armored Division.¹³¹ Many soldiers have been locked in detention centers on their bases, but others have been sent to regime prisons.* In late 2012, over 1,500 Sunni officers deemed likely to defect were also imprisoned.¹³²

Functional imprisonment of Syrian Army units and individuals help account for the remaining half of the Syrian Army’s estimated 220,000 troops. Defectors have

* Appendix 3 briefly discusses the security apparatus’ role as keepers of the prison system. Assad’s prison system is extensive and diffuse. The largest and most notorious prisons include Tadmor, Saydnaya, and Aadra, but all of the intelligence services maintain a network of smaller prisons throughout Syria’s major cities.

claimed that tens of thousands of troops have been confined to their barracks since early 2012.¹³³ “Conscripts are often locked up on bases when there is a security threat and the armed forces are placed on high alert, which has been the case for over a year and a half,” one Damascus-based opposition leader explained. Furthermore, “only trusted groups will be called for a battle, which leaves the rest in their barracks.” As for the officers, he explained, “there are still many Sunni officers on active duty, but they’re being kept away from combat for the fear of defection.”¹³⁴

Just as much of the Syrian Army’s troop strength has been confined to the barracks, much of the military’s equipment has been confined to the motor pool. During the regime’s mid-February 2012 assault on Zabadani, imagery released by the U.S. State Department identified fewer than forty armored vehicles participating in the operation, despite the fact that brigades from four divisions reportedly took part in the operation.¹³⁵ During the mid-March Idlib clearance, released imagery showed fewer than thirty-five armored vehicles involved in the operation, despite reports that elements of the 4th Armored Division, the 76th Armored Brigade, and the 35th Special Forces regiments were all involved.¹³⁶ Forty armored vehicles do not represent even one full-strength brigade, let alone four brigades. Given the maintenance challenges of operating tracked vehicles, it is not surprising that significant portions of the regime’s armored capacity would remain non-functional.

The regime’s over-reliance a small proportion of its total force has resulted in tremendous fatigue among the loyal one-third of the Syrian Army that has been fighting for over a year without leave. In the leaked Republican Guard briefing video referenced above, General al-Ali apologizes

for cancelling his troops’ leave. He suggests that troops who directly petition their commanders might get three days to see their families.¹³⁷ This fatigue has compounded self-imposed force limitations, making it even more difficult for Assad to deploy sufficient forces across the whole country.

Adding to these challenges, the regime began to suffer significant attrition during the summer of 2012. From the beginning of the uprising through June 2012, the regime carefully reported death figures of security forces, about seventy-five percent of which were military personnel rather than police, security officers, or civil servants. By November 2011, the regime had suffered over 500 soldiers killed. Just four months later, after major clearance operations in the first quarter of 2012, this number more than doubled. By the end of June 2012 that number nearly doubled once more to reach over 2,300.¹³⁸ Assuming that four were wounded for every one killed, as many as 9,300 regime forces were taken off the battlefield by that time.

At the beginning of July 2012 the regime stopped reporting casualties, another indication that the nature of the war changed fundamentally during the summer. Reporting casualties began as a good way to reinforce the regime’s narrative that it faced a terrorist conspiracy, not a mostly peaceful revolution. By the end of June 2012, the eagerness to reinforce this narrative gave way to concern that admitting casualty figures betrayed the regime’s weakness. Opposition media began to report regime casualty figures shortly thereafter, and conservative estimates suggest that the regime may have suffered as many as 7,000 killed and 30,000 wounded by the end of November 2012.¹³⁹ If the regime has only deployed 65,000-75,000 troops,

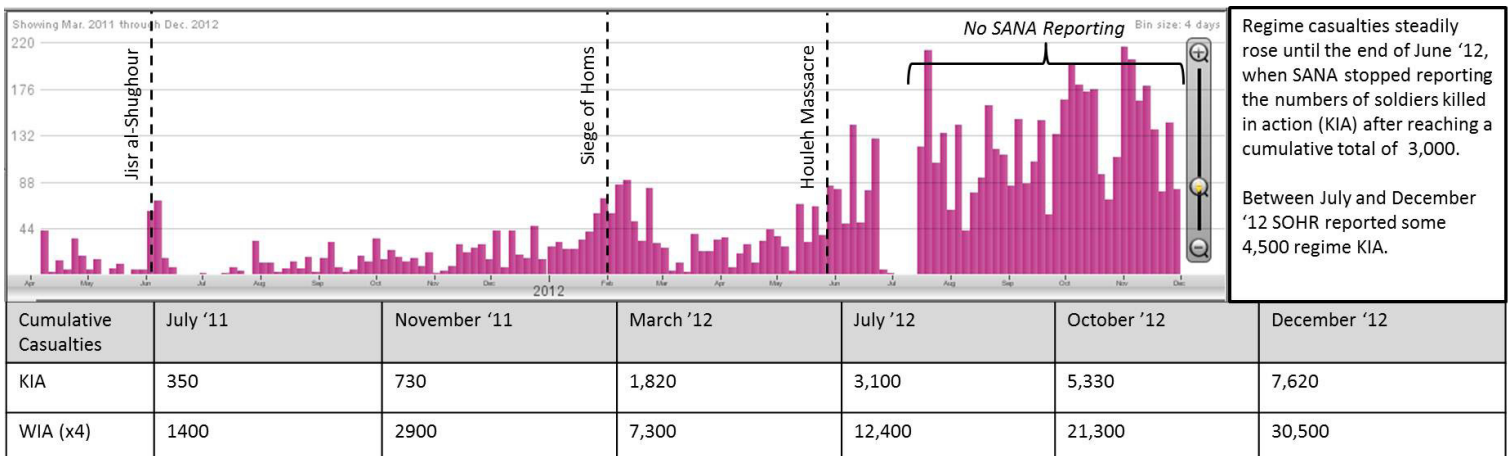

FIGURE 5 | REGIME ATTRITION DATA

this is a potentially huge number of casualties, particularly considering that the regime's most active formations have presumably suffered a disproportionate number of these casualties.

Anecdotes describing heavy regime casualties reinforce these statistics. One reporter described "a steady stream of coffins" arriving in loyalist Alawite villages, and cited the "widely touted number of at least 10,000 Alawite deaths." The reporter went on to relate the story of mother who, presented with the body of her third son to die fighting the rebels, asked the officer, "Are you going to kill every one of us just so that one man may survive?"¹⁴⁰ Another reporter visiting the military hospital in Damascus reported that more than forty coffins leave the hospital each day.¹⁴¹ A leaked video from an Alawite wedding shows General Ali Khouzam explaining to the young men at the wedding that only three members of his fifty-man Republican Guard unit remain alive. General Khouzam reportedly died just days after the video was taken.¹⁴²

Limited regime recruitment efforts may have been partially successful in both offsetting attrition within existing formations and even standing up new military units. In September 2012, Assad attempted to call up thousands of reservists, and one loyalist army officer estimated that half had reported for duty.¹⁴³ Interestingly, these recruitments were limited to Tartous, Homs, and Damascus, all cities with substantial Alawi populations. These recruitments may allow the regime to form new units as well as replace losses in existing units. In the above-mentioned leaked video of a Republican Guard briefing, the General explains, "we are forming the 416th Special Forces Battalion and they are being trained now by domestic and foreign trainers."¹⁴⁴ The reference to foreign trainers is particularly interesting, and likely refers to training support provided by Iran's Islamic Revolutionary Guard Corps or Lebanese Hezbollah. Such recruitment and training efforts likely mitigate regime attrition, though only marginally.

The combined effects of selective deployment, defections, imprisonments, and casualties severely undercut the Assad regime's ability to prosecute a troop-intensive counterinsurgency strategy across Syria. On the other hand, the forces that continue to fight for the regime represent a hard core of soldiers and officers who should be expected to continue fighting regardless of whether or when the opposition deposes Bashar al-Assad. "The

filtering process has reached an advanced stage," explained one Damascene opposition leader. "Whoever wanted to defect has either done so or got shot trying. And whoever is left is either willing to fight for the regime (Alawis) or Sunnis who are happy doing what they're doing."¹⁴⁵

As the Syrian Army transforms into a weakened but hardcore nucleus of regime supporters, these forces will converge with the pro-regime militias. The Syrian Army has transformed "into an entity more akin to a militia than an army in both make-up and ethos," explained the International Crisis Group. "That the regime has been weakened is incontrovertible. But it has been weakened in ways that strengthen its staying power."¹⁴⁶

The decentralization of Syrian Army command and control has improved the regime's operational flexibility, but also contributed to this convergence between Army and militia. Hafez al-Assad's traditional insistence on a highly centralized chain of command resulted in the Syrian Army's operational inflexibility, which manifested itself during 2011-2012 as sequential rather than simultaneous operations.* After the Assad regime stopped major force maneuvers during the summer of 2012, one Syrian official has explained, low- and mid-level officers were given the freedom to execute broad "directives" from the regime's top leadership without having to communicate with their superiors.¹⁴⁷ The decentralization of command responsibility since the summer of 2012 has significant implications for the future of Army units if Bashar al-Assad is deposed.

Pro-regime militias working closely with the Syrian Army and security forces have become the most important source of reinforcement for Assad's troops. The distinction between Syrian Army soldiers and pro-regime paramilitaries has become increasingly irrelevant. A photograph published in Iranian news sources shows Syrian Army troops in Midan, Damascus with an even mix of baseball caps and helmets.¹⁴⁸ The soldiers often wear T-shirts like the militias, and residents say they take turns manning many of the checkpoints, making it impossible to tell who is a soldier and who is a militia member.¹⁴⁹

* Appendix I discusses the Syrian Army's traditional operational inflexibility. "The Struggle for Syria in 2011" (ISW, December 2011) and "Syria's Maturing Insurgency" (ISW, June 2012) discuss the Assad regime's sequential operations in 2011 and early 2012.



PHOTO 3 | REGIME FORCES IN DAMASCUS: SOLDIERS OR MILITIAMEN?

Assad's security apparatus began to act more like militias than intelligence agencies long before the Syrian Army began to experience this transformation.* The security apparatus had relied on networks of informers and the threat of imprisonment to protect the regime, but the collapse of what Syrians dubbed the "wall of fear" caused them to resort to violence in a vain attempt to rebuild their authority. "Their mostly Alawite make-up and frequently sectarian behavior," describes an International Crisis Group report, "deepened the divide by imparting it with a clear confessional character."¹⁵⁰

No good estimates for the size of the security apparatus exist, but one former regime insider suggested it could be as large as 200,000 security officers and personnel.¹⁵¹ Even if this estimate is accurate, it is unlikely that all of the security apparatus has participated in the violence and sectarianism described above. Nevertheless, a much higher proportion of the security apparatus than the Syrian Army will be likely continue supporting Assad.

The degradation and decentralization of the Syrian Army and security apparatus has dovetailed with the rise of both the *shabiha* and the Popular Committees militias. Pro-regime paramilitaries have become an increasingly significant component of the regime's functional force structure. Opposition sources claimed that as many as 10,000 pro-Assad militiamen reinforced a regime offensive in Homs at the beginning of 2013. "They go in infantry

formations behind the soldiers," described an opposition source, demonstrating the degree to which these militias have become an integrated component of the regime's formations.¹⁵² The increasing professionalization and integration of *shabiha* militias into the Syrian military has significantly contributed to the Syrian Army's resilience.

Some of the most trusted and effective paramilitaries have been consolidated under the "People's Army" or *Jaysh al-Sha'bi*, which has been trained and supported by Iran's Islamic Revolutionary Guard Corps-Qods Force (IRGC-QF) and Lebanese Hezbollah. U.S. officials first acknowledged Iranian support for Syrian paramilitaries in August 2012, when U.S. Secretary of Defense Panetta testified that there are "indications that [Iran is] trying to develop or trying to train a militia within Syria to be able to fight on behalf of the regime." Chairman of the Joint Chiefs of Staff General Martin Dempsey further clarified that Iran referred to this militia as the *Jaysh al-Sha'bi*, and that it was "made up of Syrians, generally Shia and some Alawite."¹⁵³

The next month IRGC Commander Mohammed Ali Jafari explained at a news conference, "there is no need for external support in order to preserve security in Syria, since 50,000 popular forces called the *Jaysh al-Sha'bi* are fighting alongside the Syrian military."¹⁵⁴ In December 2012 the U.S. Treasury Department sanctioned *Jaysh al-Sha'bi*, accusing IRGC-QF of providing advice, training, weapons, equipment, and "funding worth millions of dollars." The designation further explains that the militia "was created, and continues to be maintained, with support

* See Appendix 3 for more information on the security apparatus.

from Iran and Hizballah and is modeled after the Iranian Basij militia.”¹⁵⁵

The pro-Assad militias supported by IRGC-QF are likely referred to as the *Jaysh al-Sha’bi*, although the Treasury designation mischaracterizes the origin and character of these militias. As discussed above, the pro-Assad militias grew out of distinctly Syrian dynamics, neither created by Iran nor modeled after the Basij, and the *Jaysh al-Sha’bi* pre-dated the current conflict. Although pro-Assad paramilitaries emerged from within Syria’s own circumstances and history, Iran and Lebanese Hezbollah have invested in these militia units. The investment may allow them to influence the development of these forces. This support not only bolsters Assad’s strength but also develops reliable proxies that could pursue Iranian interests post-Assad.*

By the beginning of 2013, Assad took steps to formalize and professionalize the locally-oriented Popular Committee militias under a new group dubbed the National Defense Forces, or *Quwat ad-Difa’a al-Watani*. Iran has contributed to establishing this new organization, which gathers together existing neighborhood militias into a functioning hierarchy and provides them with better equipment and training.¹⁵⁶ One journalist who has extensively interviewed regime insiders has claimed that members of the National Defense Forces have received training from Iranian advisors.¹⁵⁷

Iran is likely to develop reliable proxies that can continue to pursue Tehran’s interests if Assad falls. The militias and the remnants of Assad’s security institutions will likely look to Iran for continued support, fearful of the ascendant Sunni opposition. Indeed, even if Assad falls and the Sunni opposition consolidates control over most of Syria, the regime’s remnants are well situated to transform themselves into a complex and capable insurgent network, a transformation that Iran is well situated to encourage and facilitate.

From its inception, the Assad regime’s security institutions have first and foremost operated as an expansive system of personal relationships and patronage, frequently based on extended family networks. The regime’s security apparatus of overlapping agencies full of decentralized “branches” run

* Iranian support for Syrian paramilitary forces will be examined in greater detail in a forthcoming report entitled, “Iranian Strategy in Syria.”

by regime confidants could easily form the framework for an insurgent network. As described above, the regime has never fully controlled the *shabiha*, which have nevertheless fought the opposition on the basis of beliefs and personal loyalties. Traditionally operating as a criminal network, the *shabiha* are ideally suited to continue fighting as a proxy militant force.

The transformation to insurgent tactics may have already begun in northern Syria where the regime has abdicated control over so much of the countryside. In mid-February 2013, pro-regime militias reportedly kidnapped hundreds of civilians from rebel-controlled villages around Idlib city.¹⁵⁸ By adapting asymmetric tactics, pro-regime forces can continue to disrupt the Syrian opposition without controlling the terrain.

Assigning numbers to Assad’s militias is difficult, especially as minority populations arm themselves for protection. As the Syrian conflict transforms from an insurgency to a civil war, it is useful to consider the possibility of a fully mobilized and militarized Alawi population. The CIA World Factbook estimates that roughly seven million of Syria’s total of 22.5 million people are males between 15 and 64 years old.¹⁵⁹ If this age structure holds true in Syria’s Alawite community, and if the Alawites represent 12% of Syria’s population, then as many as 840,000 Alawite men could bear arms. If women also bear arms, that number could be higher; early 2013 reports about the formation of the National Defense Force highlighted the role of up to 500 women in the new militia organization.¹⁶⁰

This outcome is unlikely because treating Syria’s Alawite community as a single entity is not appropriate. Not all of the Alawite community supports Assad, let alone fights on his behalf. Many of the regime’s principal opponents, both historically and in the current conflict have been Alawites. In fall 2012, clashes broke out in Assad’s home town of Qardahah, during which Alawites opposed to the regime shot Mohammed al-Assad, a prominent *shabiha* leader.¹⁶¹

Alawite opposition to Assad, however significant, will likely be tempered by the hardening sectarian enmity that has accompanied Syria’s transition to civil war. Even the large segments of the Alawite population that do not support the regime must feel trapped by their fear of reprisal from the Sunni opposition. Indeed, Assad’s brutal campaign has done much to ensure these fears are valid.

The fighting in Syria is likely to continue whether or not Assad falls, but a number of factors will determine the extent of the Alawi community's ultimate militarization. The most important factor will be the conduct of Syria's opposition towards minority communities as they gain the upper hand against Assad. Another key factor could be the degree to which Iran encourages continued militant activity post-Assad.

Extremist elements on both sides of the conflict will ensure that the war will continue in one form or another. Extremist elements of Syria's opposition have promised retribution. In May 2012, Jabhat Nusra claimed credit for a major suicide car bombing and warned Assad in virulently sectarian terms, "Stop your massacres against the Sunni people. If not you will bear the sin of the Alawites. What is coming will be more bitter, God willing."¹⁶² Even if most of the opposition is willing to reconcile with the Alawite community, elements of the opposition will not.

Extremists on the government side are just as likely to continue fighting. The *shabiha* militiaman interviewed in Tartous, Abu Jaafar, explained why he is prepared to kill women and children to defend his Alawite sect, "Sunni women are giving birth to babies who will fight us in years to come, so we have the right to fight anyone who can hurt us in the future."¹⁶³ Jaafar is resigned to continued, existential conflict against the mostly-Sunni opposition: "I know the Sunnis will take revenge for what we have done. I am fighting to guarantee a good future for my sons and grandsons. So this is the final battle: Win, or die. There's no third choice."¹⁶⁴

From North to South

Assad's shortage of reliable Syrian Army units has resulted in an uneven distribution of troops across Syria. From the beginning of the conflict, Assad has maintained a much higher proportion of force in Homs, Damascus, and the south than in Syria's northern or eastern provinces. This force disparity has resulted in the regime's contraction, as the opposition has seized vast territories across Syria. Just as the Syrian Army has weakened in ways that have increased its staying power, the regime's geographical consolidation has rendered the regime unable to regain control of all Syria without sacrificing strongholds. Assad consequently retains not only a consolidated hardcore force, but also a consolidated geographical area to contest.

Much of the analysis below relies on tracking the disposition of Syrian Army forces, but this type of information is sparse, and analytical gaps remain. For example, little information is available about the regime forces deployed to Hama. The 11th Armored Division has been the primary conventional force operating in the area, but sporadic opposition reports suggest that one brigade from the 3rd Armored Division has been active in the area as well. The only elite formation reportedly active in Hama has been the 47th Special Forces Regiment.^{*165}

The apparent lack of regime forces in coastal Latakia and Tartous presents a challenging question. Limited opposition activity suggests that there are certainly forces there, but it is unclear which units they are.^{†166} This could be the result of an analytical gap, but it could also be because the regime has been able to rely on the security apparatus, paramilitary forces, and ultimately the population, which is 75 percent Alawite and Christian.¹⁶⁷

Despite these analytical challenges, available information about the disposition of regime forces suggests that Assad has invested a much smaller proportion of his total force in Syria's northern and eastern provinces than he has in central Homs or southern Damascus. When the regime stopped major force maneuvers in the spring of 2012, this uneven disposition significantly affected the trajectory of the conflict. Media cycles have tended to portray rebel victories in the north as signs of imminent victory and setbacks in Homs as examples of stalemate, but the course of the war has actually reflected the relative strength of regime forces geographically.

Eastern Syria: The opposition's geographical gains are most evident in vast and sparsely populated eastern Syria, where Assad has committed the smallest proportion of forces.

* Opposition media has reported 11th Armored Division activity around Hama and the Division's 87th Mechanized in Hama city itself. One report from January 2012 suggested that the 3rd Division's 47th Armored Brigade was also active in the Hama countryside. The 47th Special Forces Regiment moved to Hama after the April 2011 Deraa operation and has likely remained in the area since.

† In coastal Latakia and Tartous the regime had an even lighter troop presence. Reported regime activity has been largely limited to the 45th and 53rd Special Forces Regiments, which led multiple clearances in Banyas, Markab, Bayda, and Basateen, all coastal Sunni enclaves in northern Tartous.

The 17th Reserve Division has been a major contributor to this economy-of-force effort, active in Deir ez-Zor province throughout 2012. The Division's 93rd Brigade left Idlib to secure al-Raqqa province by early 2012.¹⁶⁸ The 54th Special Forces moved to northeast Hasakah province, after participating in the February 2012 siege of Homs.¹⁶⁹ Other regime forces may have deployed to the east, such as small detachments of elite units, but reliable opposition media has reported activity from only this small group of Syrian Army units.

This minimal commitment has allowed rebels to force the Assad regime out of the vast majority of eastern Syria since summer 2012. Assad chose to withdraw most of his forces from Syria's Kurdish regions in July 2012, leaving only small forces behind in Qamishli and at key oil and gas infrastructure locations. These troops do not leave their bases, leaving these portions of the country under the de facto control of the Democratic Union Party (PYD), the Syria affiliate of the Kurdistan Worker's Party (PK).¹⁷⁰ In November, rebels overran regime positions in Abu Kamal and Mayadin in quick succession and claimed control over the Euphrates river belt from Deir ez-Zor city to the Iraqi border.¹⁷¹ Also in November, the Free Syrian Army reported that elements of the 17th Division were in Rastan, which raises the possibility that elements of the Division withdrew from the east as the regime lost positions there.¹⁷²

Northern Syria: A similar dynamic has prevailed in Northern Syria's Idlib and Aleppo provinces, although Assad has deployed far more forces there. The regime committed at least one Special Forces regiment to Idlib in 2011 and strongly reinforced the region with three additional Special Forces regiments, an armored brigade, and a detachment of 4th Armored Division troops by the spring of 2012.^{*173} The 76th Armored Brigade and 41st Special Forces Regiment arrived in Idlib by late February 2012, establishing positions in the north and south of Idlib province respectively.¹⁷⁴ Two of the Special Forces regiments that participated in the February 2012 siege of Homs also moved to Idlib, namely, the 15th Division's 35th Special Forces Regiment, which moved to Jisr al-Shughour

* Assad sent the 46th Special Forces Regiment to Idlib in 2011, where they established a base between Idlib and Aleppo that became the unit's namesake when the opposition began to call the place "Base 46." Rebels overran the base in November 2012.

where it secured the key line of communication to coastal Latakia, and the 14th Division's 556th Special Forces Regiment, which occupied positions south of Maarat al-Numan.¹⁷⁵ Elements of the 4th Armored Division also moved to northern Syria after the siege of Homs, but it is unclear how long those elite forces remained. Most of the Division's reported activity in the north took place that spring, and it is difficult to see whether activity or reporting tapered off.^{†176}

In mid-March 2012, troops from the 4th Armored Division, 76th Armored Brigade, and 35th Special Forces Regiment quickly cleared rebels out of Idlib city, but pushed rebels into the surrounding countryside in the process. The operation represented a relatively modest force commitment. Imagery released by the U.S. State Department showed between thirty and thirty-five armored vehicles encircling Idlib in the operation, which represents far less than one brigade's worth of vehicles according to Syrian Army doctrine.¹⁷⁷

The regime did not have the forces necessary to continue into the countryside to pursue the rebels, who opened new fronts to the north and west that regime forces never effectively countered. In Atareb and Ariha rebels blunted regime assaults throughout the spring of 2012.¹⁷⁸ When rebels mounted offensives in the northern regions of Latakia and Aleppo in summer 2012, the regime had no ground forces available to counter them and instead relied consistently on helicopter gunships for the first time in the conflict.¹⁷⁹

Because the Assad regime allocated this relatively small force to control such a large portion of Syria, the armed forces in Idlib and Aleppo focused on controlling only the most important areas, namely each provincial capital. When the regime did try to mass enough troops to counter the insurgency's growing strength in the countryside, they wound up losing control of most of Aleppo city. At the beginning of July 2012, regime forces from Aleppo city mounted a major offensive in rural northern Aleppo. The rebels stopped Assad's offensive and counterattacked, bringing the fight to Aleppo city by the beginning of

† In mid-March, elements of the 4th helped retake Idlib city from rebel control and later appeared patrolling along Idlib's border with Turkey, north of Jisr al-Shughour. At the end of March, elements of the 4th stormed the town of Sarmeen, and at the end of the summer, 4th Armored Division troops fought rebel forces in Ariha.

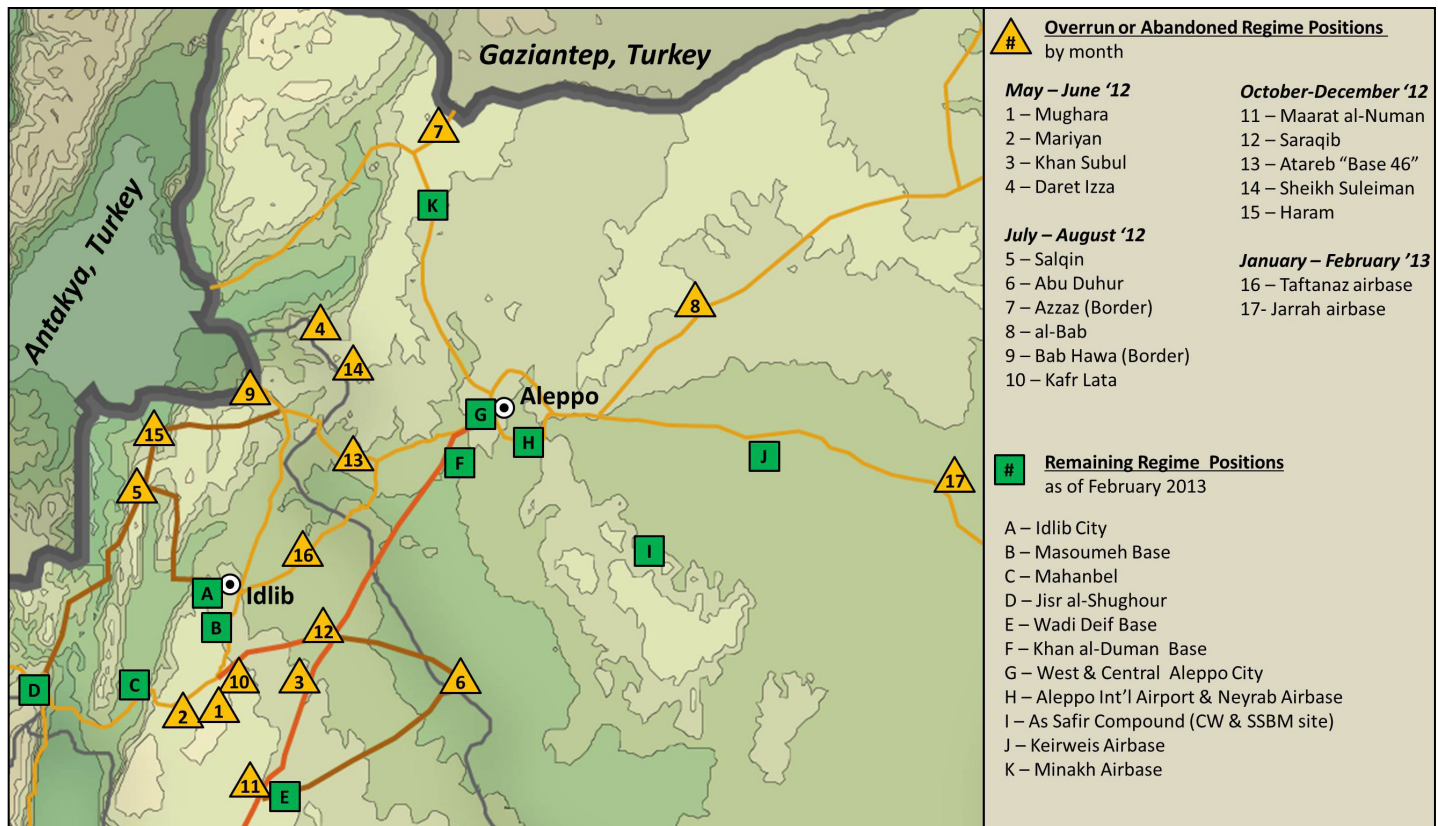

MAP 4 | STRONGPOINTS IN NORTHERN SYRIA

August 2012.¹⁸⁰

The rebel offensive compelled Assad to reinforce Aleppo with troops from Idlib and fully deploy the Syrian Air Force to shore up his position in Syria's largest city. At the end of July 2012 opposition sources reported that a 23-vehicle convoy left Idlib to reinforce operations in Aleppo, and claimed to destroy a third of the convoy in ambushes.¹⁸¹ After using helicopters in remote rebel strongholds in June and July, the regime decided to deploy the Syrian Air Force's jet aircraft to bomb and strafe Aleppo starting in August 2012.¹⁸²

Assad's forces also established strongpoints across the north, both to preserve long logistical lines to regime positions in the provincial capitals and disrupt rebel formations. The decision to establish checkpoints allowed thinly stretched units to conserve combat power and reduce logistical and maintenance requirements. Without frequent patrols, loyalist troops did not have to expose themselves to rebel ambushes that featured increasingly effective roadside bombs by the summer of 2012.¹⁸³ Furthermore, rebels eager to attack regime forces had to engage dug-in troops with strong defenses, armored vehicles, and artillery.

The strongpoints had the additional benefit of isolating less reliable regime troops from contact with the Syrian population and reducing the likelihood of defection.

Hunkering down in strongpoints also meant that the regime did not maneuver to disrupt rebel activity in the countryside, which made logistical lines vulnerable and gave rebels the space to organize in brigade-level organizations with increasing access to weapons via Turkey.¹⁸⁴ While the strongpoints bought Assad a great deal of time in the north with minimal troop commitment, withdrawal from the countryside gave the rebels the opportunity to mass forces against the isolated strongpoints. Since May 2012 rebels in Idlib and Aleppo have either overrun or forced the regime to withdraw from at least seventeen different positions.¹⁸⁵ The rebels were able to overrun them one by one by laying siege for months at a time. As of January 2013, the regime maintains only seven positions in the north outside of the provincial capitals.

As the regime lost strongpoints throughout the latter half of 2012, the armed forces that remained in Idlib and Aleppo became increasingly reliant on air power to resupply these beleaguered positions, largely cut off from

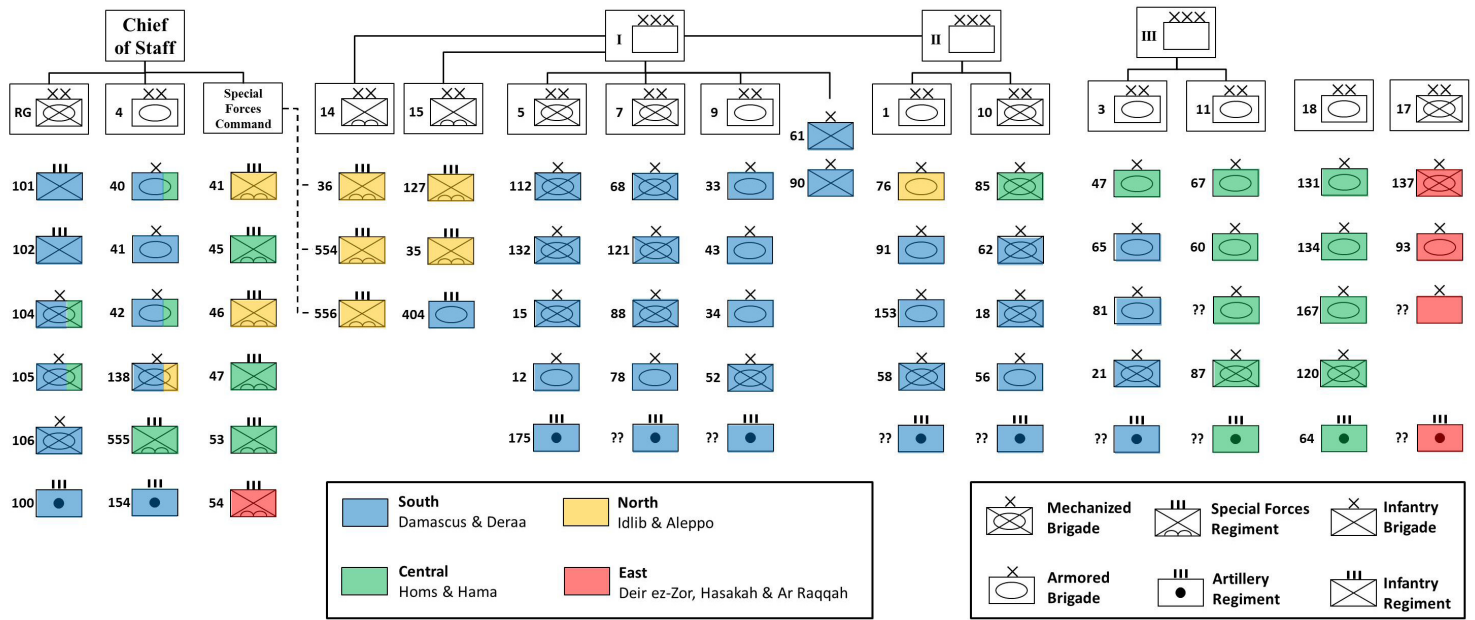

FIGURE 6 | REGIME FORCES IN NORTH/EAST VS CENTER/SOUTH

ground resupply. For much of the summer and fall of 2012 the regime relied on air resupply flying IL-76 heavy transport aircraft into Aleppo International Airport.¹⁸⁶ By November 2012 increasingly effective rebel anti-aircraft capacity made landing at Aleppo International treacherous enough to restrict the flow of air traffic.¹⁸⁷ At the many outposts without runways, the regime has had to rely on helicopters. For example, the regime airbase in Minakh, northern Aleppo province, has survived months of siege, deep behind rebel lines thanks to this critical helicopter air bridge.¹⁸⁸ The logistical challenges posed by the lack of secure ground or air lines of communication is likely to result in further rebel gains and continued regime contraction in northern Syria.

Homs: Assad has maintained a much higher proportion of force in central Homs than he has in the north or east. One of the Syrian Army’s most significant troop concentrations has remained in Homs since the February 2012 siege, where Assad deployed half of his Special Forces regiments, elements of the 4th Armored Division and the Republican Guard, as well as contingents from conventional units.*

After clearing Homs, the regime maintained its grip on the rebel stronghold by leaving most of the forces involved

* The Syrian Army units initially deployed to Homs in February 2012 are discussed in detail above, in the section entitled *Bashar and the Revolution*.

in the clearance in place.[†]

The regime’s continued concentration of force in Homs has enabled the successful application of Bashar’s earlier clear-and-hold strategy. Government forces continue to dominate what was once the opposition’s most significant stronghold. This is not to say that the Assad regime controls all of Homs province. Northern Homs’ Rastan and Talbisseh have been under rebel control since the summer of 2012, and pockets of resistance inside Homs city have remained. Nevertheless, regime forces have continued to blunt large, coordinated rebel offensives in the city as late as January 2013.¹⁸⁹

Deraa: The Syrian Army has always maintained a disproportionate troop presence in southern Deraa province, traditionally oriented toward potential conflict with Israel. Nominally organized under Ist Corps, more than half of these formations have remained in Deraa’s Hawran plain throughout the conflict. Only the 15th Special Forces Division and a portion of the 7th Mechanized Division left the province during the early 2012 offensive.

† At least one of the 15th Special Forces Division’s regiments, either the 127th or the 404th, likely remained in Homs, along with the 45th, 47th, and 53rd Independent Special Forces Regiments. Elements of the 104th and 105th Republican Guards also remained in Homs, along with unknown elements of the 4th Armored Division. The 11th and 18th Divisions have also been reportedly active in Homs.

Part of the 15th Special Forces even returned to Deraa after the regime retook Homs.¹⁹⁰

The Syrian Army has reoriented forces within Deraa province, but the majority of 1st Corps' brigades have remained active only in the immediate vicinity of their bases. The 9th Armored Division sent its 52nd Mechanized Brigade to southeast Deraa to cover areas left vacant by the 15th Special Forces, while elements of the 7th Mechanized Division reinforced positions occupied by the Independent Infantry Brigades along the Golan Heights.¹⁹¹ At least five of the brigades and regiments from 5th and 9th Divisions have only been active within ten kilometers of their bases.¹⁹²

The opposition's inability to seize territory in Deraa is largely due to this preponderance of regime positions; Deraa boasts a higher number of brigades per province than anywhere outside of Damascus. Terrain is also a factor, as the Hawran plain confers distinct advantage to the regime's armored forces, unlike mountainous Idlib or urban Homs. As a result the regime maintains greater control of the Jordanian border than any other national boundary, aside from the Golan Heights.

A combination of factors might account for Assad's decision not to redeploy these southern forces to northern hotspots. Much of 1st Corps was neither politically reliable nor logistically capable enough to deploy in greater numbers. The high level of defections among the brigades and divisions of 1st Corps during late 2011 and early 2012 calls into question the political reliability of these units.¹⁹³ Indeed, Assad may have stationed less politically reliable units away from Damascus and close to the Israeli front, as any hostilities with Israel would inevitably invite political unity among Syrians who might otherwise oppose the regime.

Furthermore, regime concern about opening the door

* The 61st and 90th Independent Infantry Brigades traditionally controlled positions along the southern and northern Golan, respectively. In February 2012, elements of 7th Division's 121st Mechanized and 78th Armored Brigades reinforced positions in the northern Golan.

† 5th Division's 12th Armored Brigade and 175th Artillery Regiment have stayed close to their base in Izraa. 9th Division's 33rd and 34th Brigades have not travelled outside of Mismiya, and the Division's 15th Brigade has remained close to its base in Sanamein.

for an Israeli ground invasion likely affected its calculus, however unlikely this scenario might appear to be. Hostility toward Israel has been integral to the Assad regime's psyche, and this likely continued to shape regime decision-making well into the uprising. Finally, Assad might have believed external support to the opposition would be organized most effectively in King Abdullah's sometimes-hostile Jordan, representing a more imminent threat to Damascus than support emanating from fragile Lebanon, which has long been dominated by Syrian influence.¹⁹⁴

The regime began to pull forces from Deraa into Damascus in late summer 2012, despite these considerations. During the July 2012 rebel offensive in Damascus, Israeli officials reported that Syrian forces withdrew from the Golan to reinforce the capital.¹⁹⁵ By October, Syrian opposition sources reported that regime forces had pulled equipment out of a 90th Brigade base to prevent the arsenal from falling into rebel hands.¹⁹⁶ This operational withdrawal represents just one example of Assad's willingness to invest forces in Damascus above all.

Damascus: Damascus has from the beginning of the conflict enjoyed a greater proportion of Syrian forces than any other part of the country. The 4th Armored Division and Republican Guard have clashed with Damascene opposition from the outset of the conflict. The 555th Special Forces, 104th, 105th, and 106th Republican Guards violently dispersed protests throughout Damascus' suburbs between March and May 2011.¹⁹⁷ Assad later deployed detachments from these trusted units throughout the country in an effort to end the protest movement, but the majority of these praetorian divisions remained in the capital throughout 2011.¹⁹⁸

Damascus' suburbs have also received a high proportion of regime forces. Assad committed elements of the 4th Armored, as well as the 3rd, 7th, and 10th Divisions to clear Zabadani at the beginning of 2012, and there is no evidence to suggest that the troops from the three conventional divisions have left the area since then. In fact, elements of each division have continued conducting operations in nearby Qalamoun, Yabrud, and Halalah as recently as

‡ During the Muslim Brotherhood uprising of the late 1970s and early 1980s, much of the opposition's support arrived over the Jordanian border, to the extent that Hafez al-Assad ordered cross-border raids into Jordan in July 1980.

October 2012.^{*199}

The majority of Assad's two praetorian divisions, the 4th Armored Division and Republican Guard, constitute the backbone of regime strength in the capital. Assad committed a portion of the 4th Armored Division to the siege of Homs in early 2012, but many of those troops eventually returned to Damascus. In March, 4th Armored Division troops heading south from Homs stormed villages in northern Damascus province near Yabrud and established security checkpoints there.²⁰⁰ 4th Armored continued operations throughout Damascus' hotspots for the rest of 2012; the 41st Armored Brigade fought rebels in Damascus' northeastern suburbs of Harasta and Douma, while other brigades focused mostly on the southern neighborhoods of Maadamiya and Daraya.²⁰¹

An even higher proportion of the Republican Guard has remained in Damascus, although the regime has also deployed Republican Guard detachments to other parts of Syria. Even as one battalion of the 105th Brigade helped secure Homs in March 2012, another element secured Damascus International Airport.²⁰² Throughout 2012, Republican Guard troops battled rebels in Damascus' eastern and southern suburbs, while the Division's 100th Artillery Regiment shelled Damascus' southern hotspots of Maadamiya and Daraya from their base near Judayat Artuz.²⁰³ The regime could be sending small Republican Guard detachments to other parts of Syria; the leaked video that exposed Republican Guard involvement in Homs is a rare occurrence, and their role would not have been visible without it. Nevertheless, the balance of this regime-protection force has remained in the capital.²⁰⁴

Given this geographic disparity in regime forces, it seemed likely that the regime would commit some of its reserves around Damascus to arrest the deteriorating situation in the north during the summer of 2012. One significant consequence of relative regime strength in the south has been the continued atomization of the southern rebel movement, which has yet to come together into large brigade-level formations, unlike Syria's northern rebels. Nevertheless, Damascene rebels demonstrated surprising capability in a late July offensive dubbed "Damascus Volcano." Rebels assassinated four of the regime's top

* The 10th Division's 56th Armored Brigade, the 3rd Division's 65th Armored Brigade, and the 7th Division's 68th Mechanized Brigades have continued to conduct operations near Zabadani.

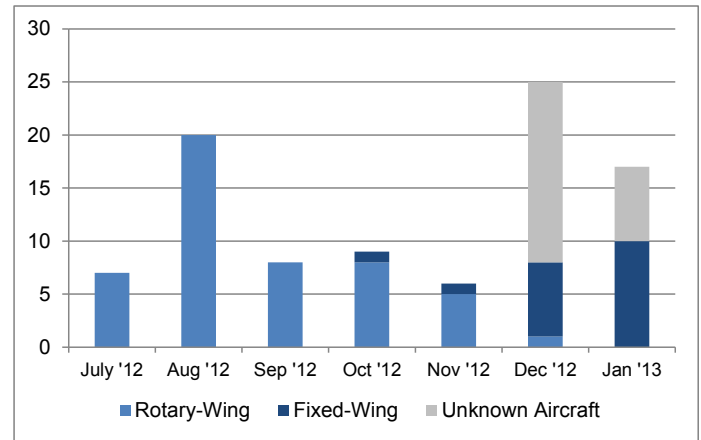

FIGURE 7 | DAMASCUS AIRSTRIKE TRENDS

security officials, seized half a dozen districts, and held their ground against the regime's crack troops' counter-offensive for a week before withdrawing.²⁰⁵

Assad's troops stopped the July 2012 offensive and waged a ground counter-offensive, supported by helicopter gunships that bombarded the capital for the first time in the conflict.²⁰⁶ But the rebels' offensive effectively ended the regime's chance of conducting a major operation to reinforce its positions in northern Syria. In fact it had the opposite effect, triggering additional consolidation of force in Damascus. "Assad has removed many of his forces that were in the Golan Heights," explained Israel's top military intelligence officer. He "mainly wants to augment his forces around Damascus."²⁰⁷

Despite these additional forces, the opposition continued to make gains in Damascus in late 2012 and early 2013, continuing to force the regime to contract into the capital. At the end of November, rebels overran a regime helicopter base in Damascus' Eastern Ghoutta suburbs.²⁰⁸ The same day, a map showing the rebels in control of most of Eastern Damascus depicted the regime's perspective of the situation on the ground, purportedly recovered from Republican Guard troops.²⁰⁹ By January 2013, rebels mounted another major offensive in southern Damascus' Daraya district, and the regime invested heavily in a counter-attack. Assad pulled 4th Armored Division troops out of Homs to reinforce the capital, demolished houses to remove rebel cover, shelled the district with artillery and rockets, and even employed ballistic missiles.²¹⁰

The Syrian Army seems prepared to hold the line in Damascus in early 2013, having consolidated as much as half of what remains of the Syrian Army in the capital.

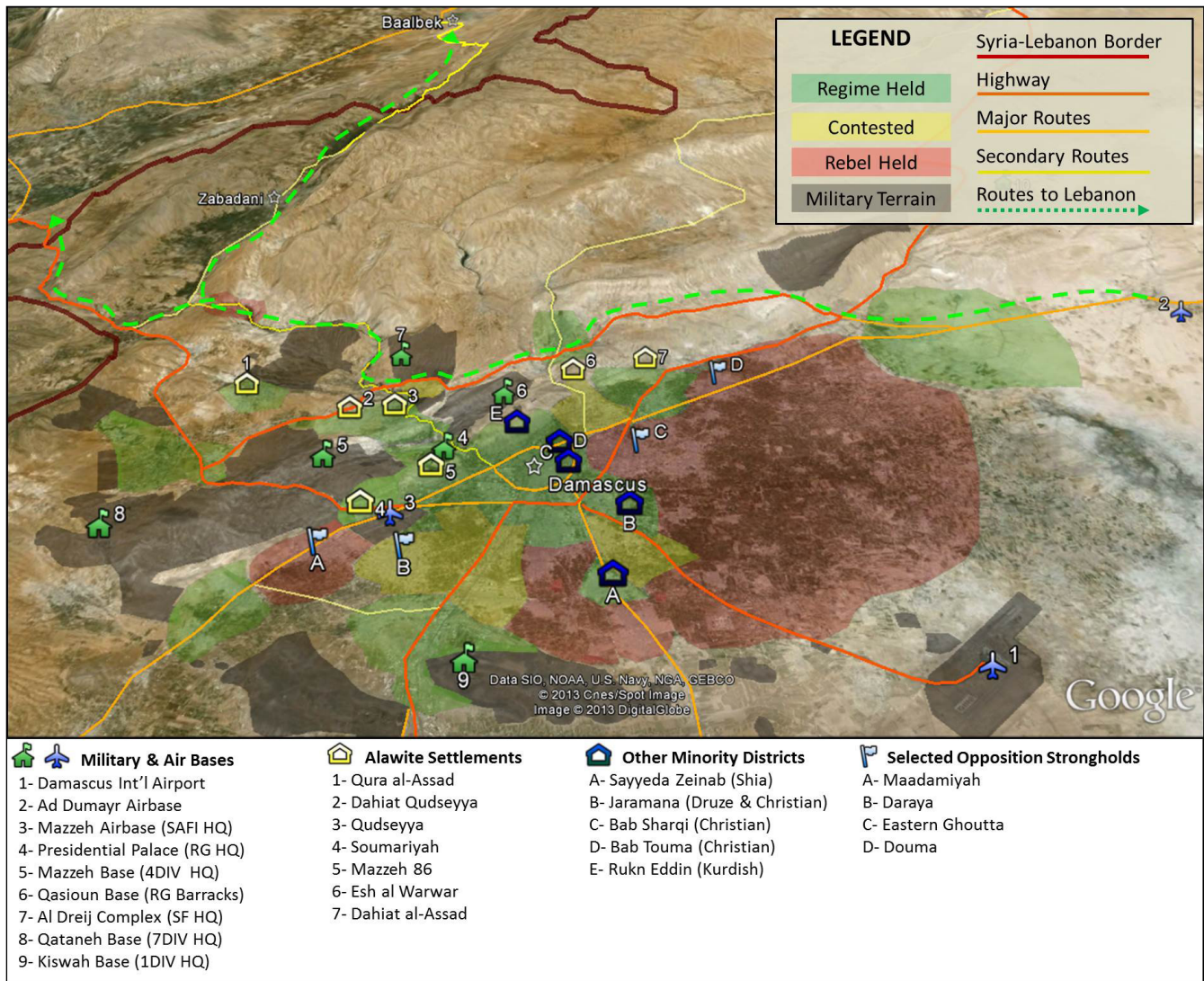

MAP 5 | DAMASCUS MILITARY BASES AND NEIGHBORHOODS

Journalists embedded with Republican Guard troops in Daraya travelled inside armored vehicles plastered with portraits of Hafez and Bashar al-Assad and published videos of troops with high morale, wearing helmets and body armor, fighting and being supported by T-72 main battle tanks.²¹¹ Nevertheless, the rebels have shown no signs of letting up, and they are likely to seize portions of downtown Damascus before the end of the year.

When Syria's opposition pushes into downtown Damascus, it will become increasingly difficult for the Assad regime to claim to govern Syria. It remains unclear, however, whether the rebels will be able to evict the regime completely from the capital. The mountains that loom over western Damascus bristle with Assad's strength. Four large military complexes in Qasioun, Mazzeh, al-Dreij, and Qatana sprawl across most of the territory between Damascus and the Lebanese

border. The Presidential Palace, the headquarters of the Republican Guard, and the 4th Armored Division's headquarters are virtually impregnable fortresses that the opposition would have extreme difficulty overcoming without heavy artillery or an air force.

All of the housing settlements around these bases are populated by Alawites, many of whom work for the regime's security institutions. Since Hafez al-Assad took power in Syria, between 200,000 and 300,000 Alawites have settled in Damascus' outskirts.²¹² Some Alawite settlers ended up joining the ranks of the urban middle classes, but "most came as members of the security apparatus and military units and were settled in ramshackle neighborhoods and suburbs encircling major urban centers," explains activist Ammar Abdulhamid, "serving as a security belt meant to safeguard Assad's

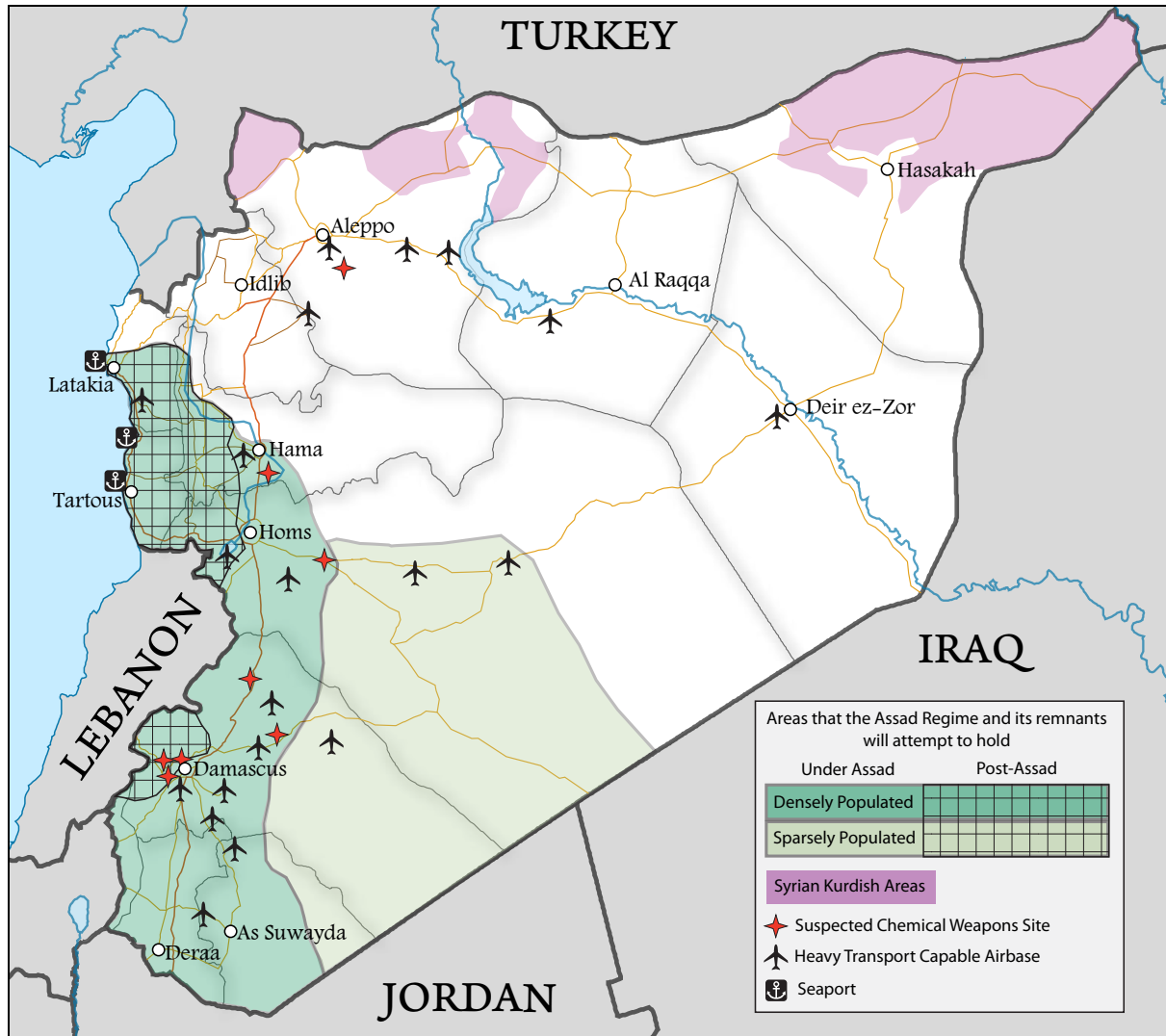

hold—a strategy that is currently unfolding.”²¹³

“Most of Rabia’s men serve in the army or security forces elsewhere in the country,” observed one journalist visiting a rural Alawite village near Hama in 2011. “Many live in military housing complexes or have settled in the working-class Alawite neighborhoods of greater Damascus” where soldiers are given housing. Many of the settlements were built on state land, where “the authorities turn a blind eye to these informal settlements because the residents are pillars of the security forces.”²¹⁴ Sunni enclaves in Western Damascus have been deliberately cleared out. For example, the majority Sunni suburb of Qudsaya has just two Alawite areas, but Republican Guard troops were busy clearing out Sunni enclaves there throughout the summer and fall of 2012.²¹⁵

If Syria’s opposition seizes downtown Damascus, which is likely in 2013, the Assad regime is likely to continue shelling the city and fighting for the areas inhabited by regime supporters. The Druze and Christian population of southeastern Damascus’ Jaramana district transformed itself into a formidable militia by late 2012.²¹⁶ By early 2013, the nearby Sayyeda Zeinab district, which houses the shrine of the first Shia Imam Ali’s daughter, also housed hundreds of Iraqi Shia militants and Hezbollah cadres defending the neighborhood against the Sunni Arab opposition.²¹⁷

Many analysts have suggested that the regime might attempt to retreat to a coastal stronghold and establish an “Alawite rump state.” Millions of displaced Syrians, clustering together with co-religionists, are driving a demographic shift that notably includes the consolidation of Alawite and

Christian families in the coastal regions, but this does not imply Assad's intention to retreat to the coast. As discussed above, significant Alawite populations remain in western Damascus, and the regime's depopulation campaign in the Orontes River valley has resulted in the demographic consolidation of minority communities there.

It is more likely that Assad will remain in Damascus until the bitter end and attempt to hold the line in the capital, Homs, and Hama rather than retreat to the coast. It is worth noting that all of Syria's suspected chemical weapons sites fall behind that line, with the exception of al-Safir, south of Aleppo.* In northern and eastern Syria, Assad will likely leave forces in place as long as possible to disrupt opposition momentum, but supporting this remaining troop presence will likely become logistically infeasible during 2013.

If the opposition successfully deposes Bashar al-Assad, this line of control is likely to collapse, but pockets of minority communities—along the coast, in Damascus, and in rural Homs and Hama—will continue to frustrate consolidation by the Sunni-majority opposition. Protected by the militias and the regime's remnants, supported by Iran and Lebanese Hezbollah, and freed from the imperative of controlling so much terrain, these minority communities can adopt asymmetric tactics against any new government as it struggles to establish state security institutions. Some of Assad's chemical weapons facilities around the capital could remain in minority-controlled areas, although others in Homs and Hama would likely fall into opposition hands if the Iranian or Syrian regimes do not close them down.

Syria's sectarian atomization is likely to preclude the possibility of a grand bargain between the Sunni opposition and the remnants of the regime, but a series of tactical ceasefires could emerge as the Syrian people tire of bloodshed and strife. Indeed, these tactical ceasefires have already begun to emerge in early 2013. In the Sunni enclave of Telkalakh, near the Lebanese border west of Homs, rebels and regime forces agreed to a fragile ceasefire.²¹⁸ Rebels in Binnish have negotiated a limited ceasefire with regime forces in nearby Idlib, in which the regime abstains from shelling the town in exchange for opposition assurances that they will not attack a

village of minorities nearby.²¹⁹ These local agreements have the potential to develop into platform for national reconciliation that could pave the way to eventual stability in a post-Assad Syria.

CONCLUSION

There will be no moment of opposition victory in Syria if Bashar al-Assad falls, only transition to a new phase of the conflict. The remnants of the regime are likely to join forces with Assad's militias, enjoy enduring Iranian support, and continue to resist the Sunni oppositionists, who will themselves be reluctant to put down their arms given the volumes of blood spilled over the past two years of conflict.

In August 2012, U.S. Secretary of Defense Leon Panetta explained why maintaining the Assad regime's security institutions would be critical for future stability. "The best way to preserve that kind of stability is to maintain as much of the military and police as you can, along with the security forces, and hope that they will transition to a democratic form of government. That's the key."²²⁰ This caution derives from lessons learned from the Bush Administration's decision to disband the Iraqi security forces, which became an important catalyst of insurgency in Iraq.

Bashar al-Assad's approach to the conflict has precluded the possibility of such a transition. As the International Crisis Group wrote in August:

"As its political backbone disintegrates, the regime is being reduced to its repressive apparatus, while the latter gradually morphs into an entity more akin to a militia than an army in both make-up and ethos. The regime essentially has been stripped down to a broadly cohesive, hardcore faction fighting an increasingly bitter, fierce and naked struggle for collective survival. It is mutating in ways that make it impervious to political and military setbacks, indifferent to pressure and unable to negotiate."²²¹

What remains of the regime will cluster together out of the fear of reprisal violence. If cracks in the regime were going to emerge, they would have occurred in 2012, before sectarianism became fully entrenched in the conflict's

* See Appendix 4 for more information on Syria's chemical weapons program.

narrative and conduct. Syria's opposition squarely blames the Alawis, not just the Assad regime, for the bloodshed.²²² Assad's brutal treatment of the opposition has ensured that the existential Alawi fears are valid. In the mid-1990s, historian Nikolaos Van Dam concluded his monumental study of the Assad regime with the following: "Many Alawis, including many of the regime's initial opponents, might nevertheless feel forced to cluster together for self-preservation if they would be given the impression, whether justified or not, of being threatened by the Sunni majority."²²³

The mechanics of the Assad regime's campaign are largely responsible for this transformation. Bashar al-Assad's scorched earth counterinsurgency campaign accelerated Syria's sectarian atomization, and his over-reliance on a hard core of loyalist soldiers and militiamen has reduced Hafez' Ba'athist institutions to a narrow sectarian militia. The longer Assad pursues his depopulation campaign, the less likely it will become for the opposition to reconcile with the Alawite community. As the opposition becomes less likely to reconcile, the Alawite community will become more likely to cluster around Assad or the remnants of his regime. Iran and Lebanese Hezbollah will likely work to ensure that the regime's remnants merge with minority militias into a force that resists the ascendant Sunni-majority opposition and pursues Iranian interests in the Levant. Because Syria's security institutions will not have survived the conflict intact, no coherent national force will be available to re-establish a semblance of security.

In January 2013, Bashar al-Assad reportedly told UN envoy Lakhdar Brahimi, "I can win the war if Damascus is destroyed."²²⁴ This quotation, published in *Asharq Alawsat*, may be spurious, but it reflects the logic of Assad's approach. He may not be able to continue ruling Syria, but he will work to ensure that the opposition will not have a country to rule either. Bashar al-Assad's campaign has fractured Syria such that no one community will be likely to rule without the consent of the rest. As Syria scholar Joshua Landis wrote in August 2012, "In order to survive, Assad and his Alawite generals will struggle to turn Syria into Lebanon—a fractured nation, where no one community can rule. He may lose Syria, but could still remain a player, and his Alawite minority will not be destroyed."²²⁵

When President Obama sided with Syria's opposition in August 2011, calling for Bashar al-Assad to step down, it

appeared that U.S. policy might have been forming based on humanitarian or moral considerations. Since that point, however, U.S. policies seem designed to mitigate risk to U.S. interests while limiting U.S. commitment. The objectives have been threefold: avert the employment or proliferation of chemical weapons, prevent extremists from gaining power, and avert a failed state that becomes a center for regional instability. The strategy to achieve those objectives has been based upon preserving state institutions and achieving a political settlement.

All three of these objectives are unlikely to succeed because vital assumptions about the possibility a political settlement—assumptions that underpin the current approach—are no longer valid. Syria's state institutions have already failed, and the eruption of Syria's sectarian rift has scuttled the possibility of a political settlement. The conflict's transformation from an insurgency to a civil war requires the U.S. and the international community to rethink its strategy fundamentally.

APPENDIX 1: COMPOSITION OF THE SYRIAN ARMY

This appendix has been published as a report entitled “The Order of Battle of the Syrian Army”

Understanding the composition, history, and doctrinal order of battle of the Syrian Army is necessary to explain how the Assad regime prosecuted counterinsurgency operations in 2011-2012. Explaining the structure and orientation of the Syrian Army as it existed at the outset of the conflict forms the baseline from which to analyze Syrian military operations and deployments in the current conflict.

At the beginning of the Syrian conflict in 2011, the Syrian Army was one of the largest and best-trained forces in the Arab world. Organized according to Soviet doctrine, it was oriented to project power into Lebanon and to defend against a potential Israeli invasion. Despite its relatively poor combat record against the Israelis, the Syrian Army had earned a reputation as a disciplined and motivated force.²²⁶ The Army’s cohesiveness and continued logistical capacity in the current uprising is consistent with this reputation.

The Syrian military has also exhibited shortcomings. Most of Syria’s military materiel is outdated Soviet equipment from the 1970s or earlier. Corruption among Syrian military leadership has been pervasive. Most importantly, Syrian military commanders have not traditionally demonstrated initiative or the ability to react to opposing forces without deferring to their superiors in the chain of command. Years of training with Soviet military advisors may have contributed to this inflexibility, but the behavior derives primarily from Hafez al-Assad’s insistence on a highly centralized and personal chain of command reaching directly from the President to individual unit commanders. Bashar seems to have inherited this trait; leaked documents show President Bashar al-Assad himself assigning orders to specific battalions for the late-April 2011 clearance of Deraa.²²⁷

General Composition

As of 2011, the Syrian Army was comprised of 220,000 personnel, most of whom were conscripts.²²⁸ The Chief of Staff of the Syrian Armed Forces maintains operational control of these forces.

After Syria’s defeat by Israel in 1976, nine of the Syrian Army’s thirteen divisions were placed under the operational command of three Corps headquarters in an apparent effort to delegate decision-making authority.²²⁹ There is no evidence to suggest that Syria’s three corps headquarters have been functional levels of command during the current conflict. Syrian opposition, human rights organizations, and international sanctions have not identified corps commanders by name, let alone as active participants in the conflict. Only division and brigade commanders, many of whom have important personal ties to the regime, have been identified.

Eight of Syria’s thirteen Army divisions are conventional armored or mechanized divisions containing four maneuver brigades each. The different brigade types are mixed in a three to one ratio in each division, so that an armored division includes three armored brigades and one mechanized brigade, while a mechanized brigade contains the opposite ratio. Each division possesses additional combat support elements and an artillery regiment. At full strength, each of these conventional divisions is comprised of approximately 15,000 soldiers.²³⁰

Each Army brigade—Syria’s primary maneuver unit—is theoretically made up of 2,500-3,500 soldiers. Understanding this brigade-level echelon is the most useful way to appreciate the combat power and employment of the Syrian Army in the current fight. Each armored brigade is made up of three armored battalions and one mechanized battalion. Each mechanized brigade includes three mechanized battalions and one armored battalion, maintaining the same three to one mix of subordinate unit types as the divisions. Also like Syria’s divisions, these brigades include organic artillery, air defense, engineering, and other combat support elements. Divisional artillery regiments are comprised of approximately 1,500 soldiers, divided into three battalions of 300 to 500 soldiers, and do not include additional combat support elements.²³¹

The Syrian Army’s five specialized divisions include the 4th Armored Division, the Republican Guard, two Special Forces divisions, and the 17th Army Reserve Division. These divisions diverge from the conventional structure stated above, containing both brigades and maneuver regiments. These infantry, armor, and Special Forces regiments are comprised of approximately 1,500 soldiers each, divided into three battalions of 300 to 500 soldiers.















Symbol	Echelon/ <i>Arabic</i>	Command/ <i>Arabic</i> (Equipment)	# of Personnel	Component Units	Total #
	Corps/ <i>Falqa</i>	General/ <i>Awal</i>	50,000	3-4 Divisions	3
	Division/ <i>Firqa</i>	General/ <i>Awal</i>	5,000-15,000	5-6 Brigades/Regiments	14
	Brigade/ <i>Liwa</i>	Maj Gen/ <i>Liwa</i>	2,500-3,500	5-6 Battalions	>40
	Mechanized Brigade 105 IFVs 41 Tanks 3,500 Soldiers			3 Mech Battalions 1 Armored Battalion Artillery/ADA/Engineers	
	Armored Brigade 105 Tanks 31 IFVs 2,500 Soldiers			3 Armored Battalions 1 Mech Battalion Artillery/ADA/Engineers	
	Regiment/ <i>Fawj</i>	Brig Gen/ <i>Amid</i>	1,500	3 Battalions	>20
	Special Forces Regiment 1,500 Soldiers			3 Infantry Battalions	
	Artillery Regiment 45 Howitzers 1,500 Soldiers			3 Artillery Battalions	
	Battalion/ <i>Katiba</i>	Colonel/ <i>Aqeed</i>	300-500	4-5 Companies	
	Company/ <i>Suriya</i>	Captain/ <i>Naqeeb</i>	60-80		

FIGURE 8 | GENERIC ORDER OF BATTLE

Source Note: The above table is based primarily on interviews with an exiled former Syrian Army General Officer on March 20 and April 19, 2012, as well as the appendices in Human Rights Watch’s December 2011 report “By All Means Necessary.”

These regiments do not include additional combat support elements.²³²

Syrian Army brigades and regiments, therefore, are smaller than conventional Western brigades and regiments and larger than Western battalions. Similarly, Syrian battalions are smaller than Western battalions and larger than companies. As the section of this report entitled *From Army to Militia* examines, the full strength of this doctrinal force structure has not been available to the regime during the current conflict. In order to hedge against defections, Bashar al-Assad has deployed only the most loyal elements of the Army. Within the conventional divisions, this loyal

core has been limited to small detachments selectively deployed, while the regime’s praetorian, majority-Alawite divisions have been deployed in full.

Praetorian Units

The **Defense Companies** acted as the primary regime-protection force for the first decade of Assad’s rule, preceding the regime’s modern praetorian units. Commanded by Hafez’s brother Rifat, the Defense Companies accounted for a full third of Syrian land forces at their height—twelve elite brigades of armor, Special Forces, and artillery—and played the leading role in defeating the

Muslim Brotherhood uprising.²³³ “Rifat, self-consciously the shield of his brother’s regime,” historian Patrick Seale explains, “built up his Defense Companies, turning them into the best armed, best trained and best paid units in the Syrian Army.”²³⁴

Alawites made up ninety percent of Defense Companies’ strength, many selected on the basis of “close tribal links to Hafez al-Assad.”²³⁵ After Rifat’s abortive 1984 coup, Hafez al-Assad reduced the Defense Companies to one division, demobilizing or transferring large numbers of troops to other units, primarily the Republican Guards and Special Forces.²³⁶ He then reflagged the truncated Defense Companies as the 569th Armored Division, which in turn reflagged years later to become the 4th Armored Division.²³⁷

The **4th Armored Division** has performed as Bashar al-Assad’s indispensable elite unit since the outset of the 2011 uprising. The Division is organized in similar fashion to conventional armored divisions, with three armored brigades and one mechanized brigade, but the regime has kept these brigades at full strength and attached an additional special forces regiment to the Division, making the Division larger than most. The Division Commander is technically Major General Mohammed Ali Durgham, but Bashar’s brother Maher al-Assad is widely suspected to act as de facto Division commander, despite his title as 42nd Armored Brigade Commander.²³⁸ The son of Ibrahim Safi, a top commander under Hafez al-Assad, commands the Division’s artillery regiment.²³⁹

Almost all of the Division’s troops are career soldiers, and former Syrian Army officers estimate that eighty percent of the Division’s ranks are Alawites.²⁴⁰ Because it served first and foremost as a regime protection force, the 4th Armored Division was oriented against internal threats as well as external ones. Its position at the Mazzeh military complex overlooking the southern suburbs of Damascus allowed the Division to control key access points around the capital, limiting the possibility of a coup. In the event of an Israeli invasion, 4th Armored was expected to act as the last line of defense for the regime.

Hafez al-Assad established the **Republican Guards** in 1976 under the command of Adnan Makhlof, his wife’s first cousin.²⁴¹ Originally, these Presidential Guards, as the unit is still sometimes called, drew their ranks exclusively

from the Air Force, which is the service that was the closest to Hafez.²⁴² The Republican Guards eventually grew to a mechanized-brigade equivalent, and it owes some of its lineage to transfers from the dissolution of the Defense Companies in the mid-1980s.²⁴³

At the outset of the 2011 conflict, the Republican Guard included three mechanized brigades and two “security regiments.”²⁴⁴ The overall force structure is comparable to a conventional mechanized infantry division, but like the 4th Armored Division, the Republican Guard is outfitted with better equipment and maintained at full strength. Brigade commanders include regime stalwarts like Talal Makhlof, who hails from the family of Hafez al-Assad’s wife, and the Division’s officers and soldiers are almost entirely Alawites.²⁴⁵ The Republican Guards did include Sunni leadership at the outset of the conflict, notably Manaf Tlass, son of Syria’s long-serving Defense Minister Mustafa Tlass and close friend to Bashar before the uprising. As early as May 2011, the regime reportedly placed Tlass under house arrest, and he defected in July 2012.²⁴⁶

As the regime’s premier praetorian force, the Republican Guard was primarily oriented to protect against internal threats. The majority of the Division is situated around the Presidential Palace and in the Qasioun military complex overlooking Damascus’ northern suburbs, putting the Division in a good position to counteract a coup, just as the 4th Armored Division controlled key access points to the capital’s south.

The **Special Forces Regiments** enjoy a special place in the Syrian Army because they have served both as a regime protection force and as a critical component of Syria’s national defense. Syrians use the term Special Forces to describe these units, but they more closely resemble conventional light infantry units than Western Special Forces in both mission and composition. The term Special Forces has been applied ostensibly because of their specialized training in airborne and air assault operations, but they should be regarded as light infantry forces, elite only in relation to the conventional armored and mechanized brigades of the Syrian Army.

From the 1970s to the mid-1990s, all of the Special Forces regiments were organized under Major General Ali Haydar’s Special Forces Command. Haydar was an

important ally to Hafez al-Assad, and his regiments served as a critical counterweight to Rifat al-Assad's Defense Companies during the latter's 1984 coup attempt.²⁴⁷ Afterwards the Special Forces absorbed many soldiers and officers from the disbanded Defense Companies, making it the third regime protection force that owes its lineage in part to those Defense Companies, along with the 4th Armored and Republican Guard.²⁴⁸

Haydar did not share the close familial ties of other praetorian commanders, although he was a member of the large Alawite Haddadun tribe, to which the Makhlof family also belongs.²⁴⁹ When Ali Haydar objected to the possibility of Bashar's succession in the mid-1990s, Hafez promptly relieved the General and arrested him.²⁵⁰ Hafez split up the formidable Special Forces Command by standing up the 14th and 15th Special Forces Divisions, each of which commands three regiments. Hafez therefore reduced the total number of regiments under direct control of Special Forces Command to six. The 15th Division fell under the 1st Corps in the South, while the 14th Division was assigned to 2nd Corps and oriented along the Lebanese border.

Some have suggested that the Special Forces are almost entirely composed of Alawites; however, Muslim Brotherhood reports following the early 1980s uprising suggest that only half of the Special Forces soldiers were Alawites, although nearly all the officers were.²⁵¹ The relatively consistent level of defections from the Special Forces during the 2011-2012 conflict suggests that the Special Forces included a greater percentage of Sunni soldiers and junior officers than either the 4th Armored Division or Republican Guard.²⁵²

Special Forces Command, along with at least three of its regiments, is located in the al-Dreij military complex in the mountains between Damascus and the Lebanese border, behind the Presidential Palace.²⁵³ The 15th Special Forces Division and its three regiments were located in the high ground of Jebal Druze near the Jordanian border.²⁵⁴ The Special Forces regiments' specialized training and light infantry capability have allowed them to operate in mountainous terrain such as the Anti-Lebanon Mountains that form Syria's southwest border.

Conventional Divisions

Since the Syrian Armed Forces established the three Corps Headquarters in the mid-1980s, the 1st Corps has formed the first line of defense against an Israeli invasion over the Golan Heights or through Jordan.²⁵⁵ Each of the units within 1st Corps was assigned a sector that conformed to an over-arching operational plan for the defense of Syria. The independent 61st and 90th Infantry Brigades occupied reinforcing fighting positions along the Golan Heights. The second line of defense was divided into southern and northern sectors: the 5th Mechanized Division secured the southern approach and Jordanian border, and its eastern flank was secured in turn by the 15th Special Forces Division utilizing the advantageous terrain of the Jebal Druze. The 7th Mechanized Division secured the most direct approach from the northern Golan to Damascus, with its western flank secured by the heights of Mount Hermon. The 9th Armored Division, positioned to the rear of the mechanized divisions, was poised to reinforce or counterattack the front.²⁵⁶

Most of the divisions within 1st Corps pre-date the Corps-level formation. The 5th Division was one of Syria's first division-level units and has remained in the same area of operation throughout its history. As early as the 1967 Six-Day War, the Syrian 5th Division has held positions along the Jordanian border.²⁵⁷ The 7th Mechanized and 9th Armored Divisions played a role during Rifat's 1984 coup, when their prominent commanders briefly supported Rifat but ultimately sided with the President.²⁵⁸ The 9th Division's Alawite commander General Hikmat Ibrahim has remained close to the Assad family since then, and he went on to command the 4th Armored Division.²⁵⁹ The 9th Armored also fought with the coalition against Saddam Hussein's Iraq in the 1991 Gulf War.²⁶⁰ Only the 15th Special Forces Division is a relatively recent formation, established between the mid-1990s restructuring of Ali Haydar's former Special Forces Command and the beginning of the current conflict.

At its inception, Hafez al-Assad made the Syrian 2nd Corps responsible for managing the Syrian occupation of Lebanon, which had begun almost a decade earlier in 1976. Syrian Armed Forces remained in Lebanon until the 2005 Hariri assassination and subsequent Cedar Revolution forced Syrian withdrawal. Consequently 2nd Corps has been oriented toward Lebanon for most of its existence,



MAP 7 | DOCTRINAL ORIENTATION. INSET FOLLOWS ON NEXT PAGE.

and most available accounts of the 2nd Corps describe it as Syria's Lebanese occupation force.²⁶¹

2nd Corps' two primary divisions also predated the Corps-level restructuring of the mid-1980s. Both the 1st Armored and 10th Mechanized Divisions had been units in the Syrian Army since at least Rifat's 1984 coup attempt.²⁶² In particular, Alawite General Ibrahim Safi's 1st Division played a crucial role in blocking Rifat's Defense Companies, and he later commanded Syrian Armed Forces in Lebanon.²⁶³ The 14th Special Forces Division was established to command three Special Forces Regiments after the mid-1990s restructuring of Ali Haydar's consolidated Special Forces Command.

Before the onset of the 2011 conflict, the 2nd Corps was primarily responsible for securing the Lebanese border and providing a broad second line of defense against potential Israeli invasion. The 10th Mechanized Division was oriented to secure key avenues of approach from Lebanon to Damascus, while the light infantry regiments of the 14th Special Forces Division would seize high ground in the Anti-Lebanon Mountains to conduct reconnaissance and canalize Israeli columns into the 10th Division's engagement zones. The 1st Armored Division was responsible for defending the southern approaches to Damascus from the Kiswah military complex, situated amidst the low ridgelines to the south of the capital.²⁶⁴ 1st Division's control over this key terrain, combined with



MAP 8 | DOCTRINAL ORIENTATION

its historical regime-protection role, suggest that the Division was particularly trusted among the conventional divisions.

The **3rd Corps** was responsible for interior defense and reinforcing the front in a war with Israel, and it was the last Corps Headquarters to stand up in the late 1980s.²⁶⁵ The 11th Armored Division, headquartered near Homs, was responsible for securing central Syria, while the 3rd Armored Division secured the northern approach to Damascus from its military complex near Qutayfah. The 17th and 18th Divisions were independent of the Corps structures, and they were responsible for northern and eastern Syria.²⁶⁶ Of these four divisions, useful historical information only exists for the 3rd Armored Division, which has traditionally acted as one of Assad's most reliable conventional divisions.

During the early 1980s, General Shafiq Fayyad's 3rd Armored Division played a key role in defeating the Muslim Brotherhood uprising. Beginning in March 1980,

the entire 3rd Division cleared Aleppo and garrisoned the city for a whole year "with a tank in almost every street," historian Patrick Seale has explained. He describes General Fayyad "standing in the turret of his tank" and proclaiming that "he was prepared to kill a thousand men a day to rid the city of the vermin of the Muslim Brothers."²⁶⁷ During the 1982 assault on Hama, the 3rd Division's 47th Armored and 21st Mechanized Brigades provided the backbone of the assault. Muslim Brotherhood reports following the early 1980s uprising suggest that three quarters of the officers of these brigades were Alawites, as well as a third of the soldiers.²⁶⁸

During Rifat's 1984 coup attempt, Fayyad's 3rd Division joined Ali Haydar's Special Forces in blocking Rifat's Defense Companies in Damascus.²⁶⁹ Not only was Fayyad one of Hafez al-Assad's first cousins, but one of Fayyad's sons married a daughter of Rifat al-Assad.²⁷⁰ The role of Shafiq Fayyad therefore illustrates the significance of extended family networks in Assad's control over Syrian security institutions.

APPENDIX 2: DOCTRINAL ORDER OF BATTLE

This appendix has been published within the report entitled “The Order of Battle of the Syrian Army”

A number of resources detail the structure of the Syrian Army of the 1990s, but they are out of date. Many changes took place after the Syrian occupation in Lebanon ended following the 2005 Cedar Revolution. Many brigades have been moved, disbanded, or been established since then. These earlier sources form an important baseline, but they are insufficient to describe the structure of the Syrian military as it existed at the outset of the present conflict. Defection videos and interviews with former members of the Syrian military provide critical insight into the structure of the Syrian Army as it existed at the onset of the 2011 revolution.

The doctrinal order of battle presented in this backgrounder is not a factsheet, but rather an assessment, derived from the following sources:

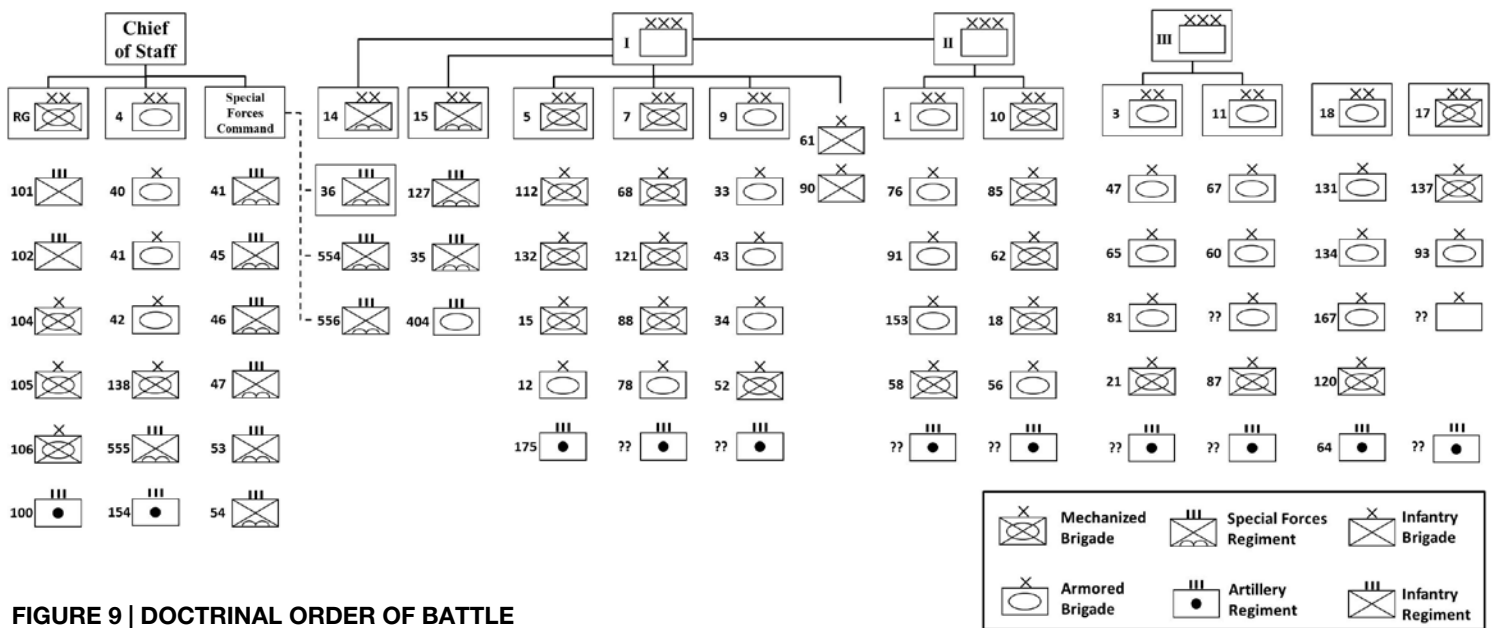

FIGURE 9 | DOCTRINAL ORDER OF BATTLE

Republican Guard

- “By All Means Necessary: Individual and Command Responsibility for Crimes against Humanity in Syria,” Human Rights Watch, December 2011.
- “Private Moussa Mohammed Sadiq (104th Brigade, Republican Guards) defection statement,” YouTube Video, May 16, 2012, <<http://youtu.be/y7h4LGe7CN0>>.

4th Armored Division

- “By All Means Necessary: Individual and Command Responsibility for Crimes against Humanity in Syria,” Human Rights Watch, December 2011.
- Michael Weiss, “My interview with a defected Syrian soldier; plus, more leaked Syrian documents,” *The Telegraph*, August 9, 2011.
- Interview with exiled former Syrian Army General Officer, Washington, DC, March 20, 2012.

- “Private Humam Khabouss (555th Regiment, 4th Division) defection statement,” YouTube video, May 16, 2012, <<http://youtu.be/y7h4LGe7CNo>>.

Independent Special Forces Regiments

- “By All Means Necessary: Individual and Command Responsibility for Crimes against Humanity in Syria,” Human Rights Watch, December 2011.
- Michael Weiss, “My interview with a defected Syrian soldier; plus, more leaked Syrian documents,” *The Telegraph*, August 9, 2011.
- Interview with exiled former Syrian Army General Officer, Washington, DC, March 20, 2012.
- Email from Syrian opposition activist, March 30, 2012.
- “Colonel Bassam Qassim al-Sheikh Ali (41st Regiment, Special Forces) defection statement,” YouTube video, February 15, 2012, <<http://youtu.be/DujnVweuAfA>>.
- “Lieutenant Khalid Mohammed al-Issa (41st Regiment, Special Forces) defection statement,” YouTube video, August 29, 2011, <<http://www.youtube.com/watch?v=zvC8a0Xe500>>.

14th Special Forces Division

- Skype Interview with exiled former Syrian Army General Officer, April 19, 2012.
- “Captain Ibrahim Munir Majbour (556th Regiment, 14th Division) defection statement,” YouTube video, June 15, 2011, <http://www.youtube.com/watch?v=xC5y_T5Go0A>.
- “Captain Maamoun Kilzi (554th Regiment, 14th Division) defection statement,” YouTube video, November 22, 2011 <<http://www.youtube.com/watch?v=qhjwz-3x6tU>>.
- “Captain Mahmoud Mukhaiber (36th Regiment, 14th Division) defection statement,” YouTube video, April 17, 2012, <<http://youtu.be/PHA8qx6osts>>.

15th Special Forces Division

- Interview with Syrian Army Defector and former FSA leader, Washington, DC, April 23, 2012.
- “By All Means Necessary: Individual and Command Responsibility for Crimes against Humanity in Syria,” Human Rights Watch, December 2011.
- “Private Mohammed Abbas (404th Regiment, 15th Division) defection statement,” YouTube video, May 4, 2012, <<http://www.youtube.com/watch?v=2cO44ynFf80>>.
- “Three Privates announce defection (404th Regiment, 15th Division),” YouTube video, December 30, 2011, <<http://www.youtube.com/user/UgaritNews#p/u/5/7tUBXE8OgSU>>.
- “Captain Ziad al-Attr (127th Regiment, 15th Division) defection statement,” YouTube video, May 16, 2012, <<http://youtu.be/k8uz3t4VHNg>>.

- “Lieutenant Jameel al-Hassan (127th Regiment, 15th Division) defection statement,” YouTube video, February 12, 2012, <<http://youtu.be/7Z9ZrtFrMbk>>.
- Human Rights Watch, “We’ve Never Seen Such Horror: Crimes against Humanity by Syrian Security Forces,” June 2011.
- Al Arabiya daily news updates on fighting in Homs <<http://www.alarabiya.net/syria>>, February 13, 2012, translated from Arabic by Elizabeth O’Bagy.

5th Mechanized Division

- Richard M. Bennett, “The Syrian Military: A Primer,” Middle East Intelligence Bulletin, Vol. 3 No. 8, August/September 2001.
- “By All Means Necessary: Individual and Command Responsibility for Crimes against Humanity in Syria,” Human Rights Watch, December 2011.
- Skype Interview with exiled former Syrian Army General Officer, April 19, 2012.
- “Lieutenant Ibrahim Ayoub (15th Brigade, 5th Division) defection statement,” YouTube video, July 12, 2011, <<http://www.youtube.com/watch?v=8ElKe7veCHA>>.
- “Captain Yousif al-Hamoud (15th Brigade, 5th Division) defection statement,” YouTube video, September 26, 2011, <<http://www.youtube.com/watch?v=RAYOz78ze3E>>.
- “Omari Battalion captures two soldiers from 12th Brigade, 5th Division,” YouTube video, February 14, 2012, <<http://www.youtube.com/watch?v=Da7GaMh3dy4>>.

7th Mechanized Division

- Richard M. Bennett, “The Syrian Military: A Primer,” Middle East Intelligence Bulletin, Vol. 3 No. 8, August/September 2001.
- Skype Interview with exiled former Syrian Army General Officer, April 19, 2012.
- “Lieutenant Qassim Ahmed (88th Infantry Brigade, 7th Division) defection statement,” YouTube video, June 18, 2012, <<http://youtu.be/9uGBZMFZFKk>>.
- “Captain Hussam Mahmoud al-Kara’asha (121st Brigade, 7th Division) defection statement,” YouTube video, March 25, 2012, <<http://www.youtube.com/watch?v=IiknfcqQumI>>.
- “Lieutenant Zahir Abdul-Karim (68th Brigade, 7th Division) defection statement,” YouTube video, September 6, 2011, <<http://www.youtube.com/watch?v=Rqz4PLq-XaO>>.

9th Armored Division

- Richard M. Bennett, “The Syrian Military: A Primer,” Middle East Intelligence Bulletin, Vol. 3 No. 8, August/September 2001.
- “By All Means Necessary: Individual and Command Responsibility for Crimes against Humanity in Syria,” Human Rights Watch, December 2011.
- Skype Interview with exiled former Syrian Army General Officer, April 19, 2012.
- “Lieutenant Mohammed Hassan Hussein (43rd Brigade, 9th Division) defection statement,” YouTube video, February 21, 2012, <http://www.youtube.com/watch?v=iv_9zgunVvk>.
- “Lieutenant Hamza Fathallah (43rd Brigade, 9th Division) defection statement,” YouTube video, February 12, 2012, <<http://youtu.be/7Z9ZrtFrMbk>>.
- “Lieutenant Ghazi al-Omar (33rd Brigade, 9th Division) defection statement,” YouTube video, February 21, 2012, <http://www.youtube.com/watch?v=iv_9zgunVvk>.

Independent Infantry Brigades (Golan Heights)

- Richard M. Bennett, “The Syrian Military: A Primer,” Middle East Intelligence Bulletin, Vol. 3 No. 8, August/September 2001.
- Interview with Syrian Army Defector and former FSA leader, Washington, DC, April 23, 2012.
- Skype Interview with exiled former Syrian Army General Officer, April 19, 2012.
- “Major Ali Mohammed Ayoub (61st Brigade) Hamza Battalion formation announcement,” YouTube video, January 23, 2012, <<http://www.youtube.com/watch?v=fviGr4Joudc>>.
- Le Monde Blog, “In Bashar al-Assad’s Syria, Disinformation is also a Family Affair,” February 25, 2012, translated from French by Google Translate <<http://syrie.blog.lemonde.fr/2012/02/25/dans-la-syrie-de-bachar-al-assad-la-desinformation-est-aussi-une-affaire-de-famille>>.

1st Armored Division

- Richard M. Bennett, “The Syrian Military: A Primer,” Middle East Intelligence Bulletin, Vol. 3 No. 8, August/September 2001.
- “They Burned My Heart: War Crimes in Northern Idlib,” Human Rights Watch, May 2012.
- Skype Interview with exiled former Syrian Army General Officer, April 19, 2012.
- Email from Damascus-based Syrian opposition leader, March 30, 2012.
- “Lieutenant Abdulrazaq Hussein Dhabatih (76th Brigade, 1st Division) defection statement,” YouTube video, April 13, 2012, <<http://youtu.be/t4aFqKQpUyU>>.
- Local Coordination Committees Website <lccsyria.org>, July 31, 2012. (91st Brigade)

10th Mechanized Division

- Skype Interview with exiled former Syrian Army General Officer, April 19, 2012.
- “Major Saad al-deen Abdul-Hadi Bakkar (62nd Brigade, 10th Division) defection statement,” YouTube video, May 23, 2012, <<http://youtu.be/s96tLIOVzms>>.
- “Lieutenant Anwar Haj Yousif (62nd Brigade, 10th Division) defection statement,” YouTube video, February 16, 2012, <<http://www.youtube.com/watch?v=kt2AeILZnes>>.
- “Sergeant Mohammed Abdulrazzaq Mohammed (85th Brigade, 10th Division) defection statement,” YouTube video, January 5, 2012, <<http://www.youtube.com/watch?v=q--4tkcoPHM>>.

3rd Armored Division

- “By All Means Necessary: Individual and Command Responsibility for Crimes against Humanity in Syria,” Human Rights Watch, December 2011.
- Nikolaos van Dam, The Struggle for Power in Syria: Politics and Society under Asad and the Ba’th Party, (New York: I.B. Tauris & Co Ltd, 2011), p. 112.
- Skype Interview with exiled former Syrian Army General Officer, April 19, 2012.
- “Lieutenant Moukhlis Ibrahim (81st Brigade, 3rd Division) defection statement,” YouTube video, February 12, 2012, <<http://youtu.be/7Z9ZrtFrMbk>>.

11th Armored Division

- Richard M. Bennett, “The Syrian Military: A Primer,” Middle East Intelligence Bulletin, Vol. 3 No. 8, August/September 2001.
- “By All Means Necessary: Individual and Command Responsibility for Crimes against Humanity in Syria,” Human Rights Watch, December 2011.
- Skype Interview with exiled former Syrian Army General Officer, April 19, 2012.

18th Armored Division

- “By All Means Necessary: Individual and Command Responsibility for Crimes against Humanity in Syria,” Human Rights Watch, December 2011.
- Skype Interview with exiled former Syrian Army General Officer, April 19, 2012.
- “Sergeant Mohammed Awaydha (131st Brigade, 18th Division) defection statement,” YouTube video, April 13, 2012, <<http://youtu.be/ymeARoosl4>>.
- “Lieutenant Mouniem Hussein (167th Brigade, 18th Division) defection statement,” YouTube video, February 21, 2012, <http://www.youtube.com/watch?v=iv_9zgutnVk>.

- “Lieutenant Anass Hussein Haymoud (120th Brigade, 18th Division) defection statement,” YouTube video, March 9, 2012, <<http://youtu.be/zj5YjBgZWGA>>.
- “Lieutenant Kalid Qassim Shreytuh (64th Regiment) defection statement,” YouTube video, February 16, 2012, <<http://www.youtube.com/watch?v=gWtL4g-a-oc>>.
- “64th Regiment,” Al Arabiya News Online <<http://www.alarabiya.net/syria>>, February 1, 2012. Translated from Arabic by Elizabeth O’Bagy.

17th Reserve Division

- Skype Interview with exiled former Syrian Army General Officer, April 19, 2012.
- “Lieutenant Colonel Mohammed Rahmoun (137th Brigade, 17th Division) defection statement,” May 6, 2012, <<http://youtu.be/wb9hFfsw4XM>>.
- “Lieutenant Muhanad Ahmed al-Hallaq (93rd Brigade, 17th Division) defection statement,” YouTube video, February 15, 2012, <<http://youtu.be/zOQiUKjAuU4>>.
- “Captain Ma’moun Mohammed Darweesh (93rd Brigade, 17th Division) defection statement,” YouTube video, February 19, 2012, <<http://www.youtube.com/watch?v=QlqB84oiXjM>>.
- “Lieutenant Ayad Abdul Hamid al-Faris (93rd Brigade, 17th Division) defection statement,” YouTube video, April 16, 2012, <<http://youtu.be/U3yiVuMWeUY>>.

APPENDIX 3: SECURITY APPARATUS

The Assad regime's four intelligence agencies form the backbone of the regime's repressive apparatus. The pervasive *mukhabarat*, as they are known in Syria, are the eyes and ears of the regime as well the keepers of its prison system. In the early stages of the uprising, this security apparatus took the lead in quashing protests, with the army in support for selected major operations.

The security apparatus was introduced by Nasser's union regime (the United Arab Republic), and it was vastly expanded during and after the Muslim Brotherhood uprising.²⁷¹ Hafez al-Assad relied on the security apparatus to help maintain a careful balance of power and influence among security institutions and provide a check against possible military coups. Technically, all four intelligence agencies report to a body that is alternatively called the National Security Bureau or Presidential Security Council.²⁷² In practice, each agency reports directly to the President, rather than being integrated into a single chain of command.²⁷³

The four independent intelligence agencies that make up the Syrian security apparatus are:

- Department of Military Intelligence (*Shu'bat al-Mukhabarat al-Askariyya*)
- Air Force Intelligence Directorate (*Idarat al-Mukhabarat al-Jawiyya*)
- General Intelligence Directorate (*Idarat al-Mukhabarat al-Amma*)
- Political Security Directorate (*Idarat al-Amn al-Siyasi*)

Each agency enjoys broad and overlapping mandates, but with primary focus roughly divided into different categories. The Political Security Directorate is primarily responsible for monitoring internal subversive threats to the Assad regime, while the General Intelligence Directorate is primarily responsible for external intelligence collection and operations, with a particular focus on Lebanon.²⁷⁴

The Department of Military Intelligence leads the intelligence effort for the Syrian Army that includes both evaluation of external military threats and oversight of Syrian military leaders in order to ensure against coups or defections. The Air Force Intelligence Directorate has

been a particularly powerful agency with no clear mandate other than to provide a check against the others. Hafez al-Assad spent his military career in the Syrian Air Force, and therefore trusted this agency particularly.²⁷⁵

Each agency includes between 10 and 20 numbered "branches" or departments that are aligned both regionally and functionally. Each agency maintains a branch in each of Syria's provinces, as well as specialized branches such as operations, information security or counterintelligence. One specialized branch, the Palestinian Investigative Branch (Branch 235), is charged with surveillance on Syria's Palestinian refugee population, although conflicting reports suggest that Branch 235 is linked to both the General Intelligence Directorate and the Department of Syrian Military Intelligence.²⁷⁶

The graphic below depicts all the branches that have been identified as active in the current conflict, either through U.S. and E.U. sanctions or by Human Rights Watch. Some of the branches depicted here could be alternate names for the same department.

The directors of each of these agencies have almost always been close Alawite supporters of Assad, and where there have been exceptions, their deputy directors have been Alawite. For example, the General Intelligence Directorate has at times been led by Sunni or Ismaili officers, but Mohammed Nasif Kheirbek, whose Alawite Kheirbek clan maintains close ties to the Assads, held positions as the Deputy Director and Director of GID's Internal Security Branch for decades.²⁷⁷

Despite the titles and official mandates of the intelligence agencies, each agency's primary mission was to "monitor and intervene aggressively against potential domestic threats to the regime."²⁷⁸ They were created by Hafez as part of his domestic counterbalancing strategy and constituted "rival organizations to check and balance each other and protect the regime as a byproduct."²⁷⁹ Each agency was expected to watch the population, watch the combat forces, and watch each other.

Both the size and role of the intelligence agencies has grown under Bashar. "More so even than his father," explains the International Crisis Group, "Bashar chose to overinvest in the 'police state,' which he trusted more than the military."²⁸⁰ After inheriting Syria in 2000, Bashar

removed much of the old guard and promoted a new generation that would be more loyal to his person.

The *mukhabarat* has also taken the lead in a detention campaign that amounted to over 25,000 documented detentions by July 2012.²⁸¹ Each intelligence agency operates its own network of prisons, in which most detainees have been subjected to some form of torture, and many have died in detention. Human Rights Watch extensively documented the security apparatus' role in these abuses in a July 2012 report.²⁸²

This report does not exhaustively review the activities of Assad's security apparatus, as its size is difficult to quantify and its movements are not identifiable in available open source reporting. One former regime insider suggested it could be as large as 200,000 security officers and personnel, but this figure could include administrative personnel and informants and cannot be verified.²⁸³ Whatever the number, the majority of the security apparatus is likely to continue supporting Assad, if only due to overrepresentation of Alawites.

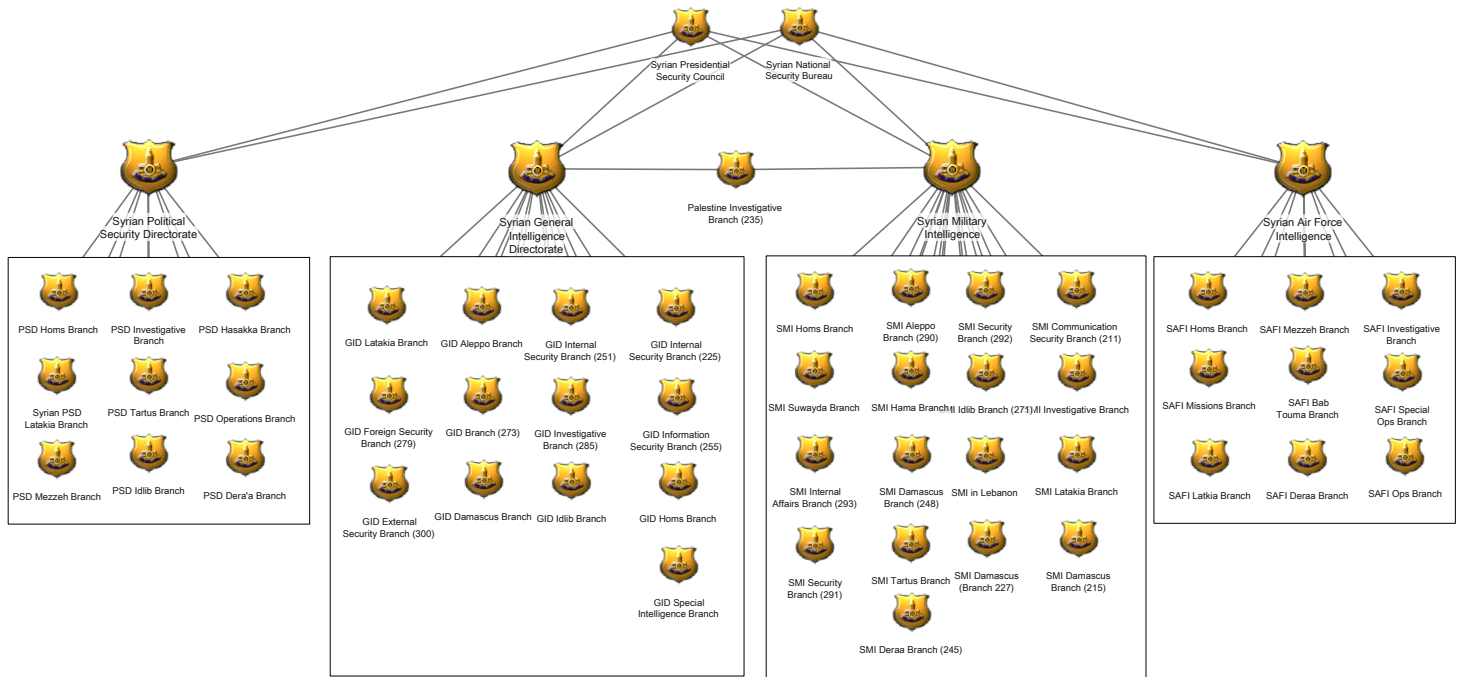

FIGURE 10 | SECURITY APPARATUS

APPENDIX 4: AIR FORCE, BALLISTIC MISSILES, AND CHEMICAL WEAPONS

Research Contributed by Chris Harmer, Senior Naval Analyst, Institute for the Study of War.

More information about the disposition and employment of the Syrian Air Force has been published under a slideshow entitled, “Syrian Air Force & Air Defense Overview.”

The Assad regime invested in strategic weapons in order to defend against and deter external threats: a dense air defense network, a capable air force, a sizeable ballistic missile arsenal and a robust chemical weapons program. As the ongoing domestic conflict unfolded, Bashar reached into this arsenal for additional capability to deploy against Syrian opposition, namely air power and ballistic missiles. This brief overview will not consider the regime’s dense air defense network, as these weapons can’t be employed against an opposition with no air force.

Syrian Air Force

The Syrian Air Force was always of particular interest to Hafez al-Assad, promoted through the ranks of the Air Force before his rise to power in the 1960s. At the outset of the 2011 conflict, the Syrian Air Force was composed of 30-40 squadrons of fixed-wing and rotary-wing airframes.²⁸⁴ All of the regime’s helicopters are considered part of the Syrian Air Force, not the Syrian Army, unlike most Western armies in which the majority of helicopters fall under the Army. These squadrons included training, reconnaissance, and transportation units, as well as squadrons of largely obsolete airframes. Furthermore, it is unlikely that a majority of these squadrons were capable of operating at full strength, even before the beginning of the conflict.²⁸⁵

The Military Balance 2011 assessed that the Assad regime’s military aircraft inventory included approximately 580 fixed-wing and 171 rotary-wing aircraft.²⁸⁶ Many of these aircraft, such as the regime’s newest MiG-29 fighters, are



MAP 9 | AIRBASES

not capable of attacking ground targets. Other aircraft, such as the SA-342 Gazelle helicopter, are primarily effective against conventional armored targets and have not been used in the conflict. Taking this into consideration, theoretically the regime had approximately 500 fixed-wing and 150 rotary-wing aircraft suitable to deploy against the opposition at the outset of the current conflict.

In practice, the number was likely much lower. First, the regime's total aircraft inventory includes 219 1960s-era MiG-21s, many of which are likely long retired. Google Earth imagery shows hundreds of dilapidated aircraft strewn across airbases.²⁸⁷ Even within the portion of regime's inventory that has not been retired, no air force in the world is capable of maintaining a 100% mission capable readiness rate, and a 30% mission capable readiness rate would represent a more accurate estimate for the Syrian Air Force. Therefore, it is reasonable to estimate that the regime had approximately 150 fixed wing and 50 rotary wing aircraft available to deploy against the opposition. The operational and logistical strain of the ongoing conflict has reduced these numbers further.

The Syrian Air Force operates out of 20 airbases across the country, although other airports, such as Damascus and Aleppo International have been used to operate military aircraft. Four of the 20 airbases are rotary-wing only.²⁸⁸ Like much of the Syrian Armed Forces, the Syrian Air Force was oriented primarily against an Israeli threat, with helicopter bases closest to the front, fighter-bomber bases nestled in the low mountains around Damascus, fighter bases deep in the Syrian interior, and training bases in the north around Aleppo. As the map below shows, the Syrian opposition has overrun five airbases—two rotary-wing and three fixed-wing—and laid siege to others since June 2012.

Syrian Missile Command

Syria's Missile Command includes all of the regime's surface-to-surface ballistic missile arsenal as well as its long range rockets. The regime has a wide array of both long range rockets and short range ballistic missiles, primarily acquired as an asymmetric attempt to improve strategic parity with Israel. There is no definitive open-source data on Syria's ballistic missile holdings, but conservative estimates begin at 400.²⁸⁹ The regime's rockets and missiles

System	QTY	Class	Range	CEP	Warheads	Origin
FROG-7	100	BSRBM	68 km	700 m	HE, chemical, submunitions	Russia
SS-21A Scarab	"Dozens"	BSRBM	70 km	95 m	HE, chemical, submunitions	Russia
Fateh-110 (M-600)	UNK	SRBM	250 km	100 m	HE, chemical, submunitions	Iran Domestic production
SCUD-B	200	SRBM	300 km	450 m	HE, chemical, submunitions	Russia Iran North Korea Domestic production
SCUD-C	>80	SRBM	550 km	700 m	HE, chemical, submunitions	Russia Iran North Korea Domestic production
SCUD-D	UNK	SRBM	700 km	50 m	HE, chemical, submunitions	Russia Iran North Korea Domestic production
Sources: http://www.missilethreat.com/missiles-of-the-world/ http://csis.org/files/publication/111213_SyriaMilitaryIntervention.pdf http://www.globalsecurity.org/wmd/world/syria/missile.htm http://www.meforum.org/510/poisoned-missiles-syrias-doomsday-deterrent http://www.nti.org/country-profiles/syria/delivery-systems/						

FIGURE 11 | BALLISTIC MISSILE HOLDINGS

include a number of variants and are a mix of Russian, North Korean, and Iranian stock as well as domestically assembled variants using imported parts.

The Assad regime has domestically produced SCUD B, C, and D models but has depended on foreign-supplied parts and components. Syria also produces a variant of the Iranian Fateh-110, domestically called the M-600.²⁹⁰

There is limited open-source data on the locations of Assad's missile bases, although some locations are known. In late 2012, a number of YouTube videos showed ballistic missile launches from Nasariyah Airbase, about 70 kilometers north of Damascus. Other missile launch videos were reportedly filmed in between Douma and Qutayfah, closer to Damascus' northern outskirts where there are indications of large missile facility.²⁹¹ The compound in al-Safir, south of Aleppo, is also a known ballistic missile site.²⁹²

The Assad regime began deploying ballistic missiles and long range rockets against opposition strongholds in December 2012. Initially, the missiles targeted rebel headquarters areas and overrun regime facilities, but transitioned in January to targeting rebel-held neighborhoods in Aleppo, Homs, and Damascus, after confirming that the international community would not take action.²⁹³ By late February, Turkish officials reported that the Assad regime had fired more than 40 ballistic missiles in northern Syria alone.²⁹⁴

Date	Type	Number	Target	Launch Site	Sources
12-Dec-12	SCUD	6	Sheikh Suleiman, Aleppo	Nasiriyah, Damascus	New York Times <nytimes.com/2012/12/13/world/middleeast/syria-war-developments-assad.html?_r=0> Long War Journal <longwarjournal.org/threat-matrix/archives/2012/12/syrian_regime_reportedly_using.php> YouTube <youtu.be/UzSu0_X_Fck>
20-Dec-12	UNK	UNK	Maraa, Aleppo	UNK	AFP <afp.com/en/news/topstories/syria-firing-scurd-style-missiles-palestinians-return>
22-Dec-12	Fateh-110	2	Homs	UNK	CNN <edition.cnn.com/2012/12/28/world/meast/syria-missiles/index.html>
2-Jan-13	SS-21 Scarab	UNK	UNK	Douma, Damascus	Jerusalem Post <jpost.com/MiddleEast/Article.aspx?id=299070> Rogue Adventurer Blog <rogueadventurer.com/2013/01/05/9k79-tochka-tactical-ballistic-missiles-in-syria/>
5-Jan-13	SCUD	3	UNK	Qutayfah, Damascus	Twitter <twitter.com/DamascusTribune/status/287611715829510144> Twitter <twitter.com/NMSyria/status/287573697655603201> YouTube <youtu.be/ej9cl4Ys1P0>
9-Jan-13	SCUD	4	UNK	Qaldoun, Damascus	Reuters <reuters.com/article/2013/01/10/us-syria-crisis-missile-idUSBRE9090A320130110>
15-Jan-13	SCUD	2	Aleppo	Yabrud, Damascus	YouTube <youtu.be/M0ih0HezdT0> YouTube <youtube.com/watch?v=eka1FK_iIU&feature=youtu.be>
20-Jan-13	SCUD	1	Darayya, damascus	UNK	YouTube <youtu.be/Y3n2AN8V6zY>
16-Feb-13	UNK	UNK	Masaken Hanano, Aleppo	Qutayfah, Damascus	LCC <lccsyria.org/10960> YouTube <youtu.be/SYVA-dmsbrw> YouTube <youtu.be/R0P9bVn0nZM>
16-Feb-13	Fateh-110	1	Hayash, Idlib	Qutayfah, Damascus	You Tube <youtu.be/PpSacolplw> LCC <lccsyria.org/10960>
18-Feb-13	UNK	UNK	Jabal Badro, Aleppo Tariq al-Bab, Aleppo	Nasariyah, Damascus	BBC <bbc.co.uk/news/world-middle-east-21508468> YouTube <youtu.be/tBTU10LIL0s> LCC <lccsyria.org/10968>
18-Feb-13	UNK	1-2	Tal Rifat, Aleppo	Nasariyah, Damascus	Hurriyet <hurriyetdailynews.com/syria-fired-more-than-40-scurd-missiles-in-two-months.aspx?> EAWorldview <enduringamerica.com/home/2013/2/19/syria-live-coverage-regime-fires-scurd-missiles-on-aleppo.html> Local Coordination Committee, <http://www.lccsyria.org/10968> YouTube <youtu.be/ZKMRuBPIBzM>
19-Feb-13	UNK	1	Kafr Nabouda, Hama	UNK	YouTube <youtu.be/LMsOILho0J0>
20-Feb-13	UNK	1	Douma, Damascus	UNK	Reuters <reuters.com/article/2013/02/20/us-syria-crisis-rebel-idUSBRE91J0D420130220>
22-Feb-13	UNK	3	Ard al-Hamma, Aleppo Tariq al-Bab, Aleppo Masaken Hanano, Aleppo	155th Brigade- Qutayfah, Damascus	Naharnet <naharnet.com/stories/en/72984-syria-protectors-vent-fury-at-assad-hizballah> NowLebanon <now.mmedia.me/lb/en/newsyrialatestnews/afp-dozens-killed-after-three-missiles-hit-aleppo-district> Lebanon Broadcasting <lbcgroup.tv/news/75757/ninety-killed-in-thursdays-damascus-bombings-group> New York Times <nytimes.com/2013/02/23/world/middleeast/scurd-missile-aleppo.html?pagewanted=all&_r=2&> LCC <lccsyria.org/10995>
22-Feb-13	UNK	1	Andan, Aleppo	155th Brigade- Qutayfah, Damascus	Strategic Research and Communication Center <strescom.org/briefings/daily-round-ups/item/627-db22213.html> YouTube <youtube.com/watch?v=6FW-xIOI5Y0&feature=player_embedded>
23-Feb-13	UNK	1	Kharitan, Deir Izzour	UNK	YouTube <youtube.com/watch?v=bY9Yrtsj3s&feature=player_embedded> LCC <lccsyria.org/11000>
24-Feb-13	UNK	1	Tal Rifat, Aleppo	UNK	Strategic Research and Communication Center <strescom.org/briefings/daily-round-ups/item/628-db23213.html> Syrian Observatory for Human Rights <facebook.com/syriaohr>
24-Feb-13	UNK	1	Tal Shgheeb, Aleppo	155th Brigade- Qutayfah, Damascus	Strategic Research and Communication Center <strescom.org/briefings/daily-round-ups/item/629-db24213.html> Youtube <youtube.com/watch?v=wh8lCfi_f8&feature=youtu.be> Strategic Research and Communication Center <strescom.org/briefings/daily-round-ups/item/629-db24213.html> LCC <lccsyria.org/11004>

Note: Both Douma and Qutayfah may refer to the same launch area, which sits between the two towns; similarly, Yabrud and Nasariyah are close to one another and may refer to the same location.

FIGURE 12 | BALLISTIC MISSILE STRIKES

Syrian Chemical Weapons Program

The Assad regime has pursued a robust chemical weapons program for decades, and by the beginning of the uprising, it was widely assessed that the regime possessed stockpiles of five primary chemical weapons, listed from lowest to highest toxicity: chlorine gas, mustard gas, cyanide gas, sarin nerve agent, and VX nerve agent. Chlorine gas is readily available, but only mildly toxic and dissipates rapidly. Mustard gas is moderately toxic, and can linger for up to 24 hours. Cyanide gas is very toxic, but dissipates rapidly. Sarin is highly toxic, and dissipates rapidly, although not as quickly as cyanide. VX is the most toxic chemical substance and dissipates very slowly. Both Sarin and VX, as nerve agents, are lethal in minute doses, whether inhaled in gaseous form or through skin contact of just a few drops.

The regime has a small number of chemical weapons production facilities and a number of storage sites. Comprehensive open-source data on Syrian chemical weapons sites are unavailable, but likely locations have been identified throughout Syria, concentrated in southern and central Syria. Around Damascus, at least three facilities have been identified near or in the Mazzeh and Qassioun

military bases. In central Syria two facilities are likely to exist in Furqlu, east of Homs and Tal Qartal south of Hama. The compound in al-Safir, south of Aleppo, is also a suspected chemical weapons facility (See Map 6).²⁹⁵

Assad has not used chemical weapons against the Syrian population, and most analysts agree that the regime views its chemical weapons stockpile primarily as a strategic deterrent; however, few analysts would have predicted that the regime would use its ballistic missile arsenal against Damascus a year ago, and thus the regime may yet use chemical weapons.

Compound	Lethality	Persistence	Exposure	Method of death
Chlorine	low to moderate	< 5 min	Respiratory	Asphyxiation
Mustard	moderate	≤ 24 hrs	Cutaneous, respiratory	Blistering of respiratory system, asphyxiation
Cyanide	high	< 5 min	Respiratory	Asphyxiation, cardiac arrest
Sarin	very high	< 30 min	Cutaneous, respiratory	Nerve agent
VX	extremely high	≤ 2 weeks	Cutaneous, respiratory	Nerve agent

Sources:

<http://www.meforum.org/493/guile-gas-and-germs-syrias-ultimate-weapons>

<http://www.voanews.com/content/west-wary-over-syria-chemical-stockpiles/1573428.html>

http://www.pbs.org/newshour/bb/world/july-dec12/syria1_12-05.html

<http://www.webmd.com/news/20121206/syria-sarin-chemical-weapons-faq>

<http://www.bt.cdc.gov/agent/sarin/basics/facts.asp>

<http://www.nti.org/country-profiles/syria/chemical/>

FIGURE 13 | CHEMICAL WEAPON CHARACTERISTICS

NOTES

INTRODUCTION

¹ “President al-Assad: Out of Womb of Pain, Hope Should be Begotten, from Suffering Important Solutions Rise,” Syrian Arab News Agency, January 6, 2013.

² Kareem Fahim, “New International Envoy, Meeting With Syrian President, Says Crisis is Worsening,” *New York Times*, September 15, 2012; Emad Omar and Erika Solomon, “U.N. envoy says Assad can’t be in Syrian transition,” Reuters, January 9, 2012.

³ Joseph Holliday and Michael Lynch, “The Battle for Damascus: The Current State of Play in Syria,” Institute for the Study of War, December 7, 2012.

⁴ Ned Parker and Nabih Bulos, “Syrian rebels say they’ve seized strategic Taftanaz air base,” *Los Angeles Times*, January 11, 2013.

COUNTERINSURGENCY IN ASSAD’S SYRIA

⁵ Nikolaos van Dam, *The Struggle for Power in Syria: Politics and Society under Asad and the Ba’th Party*, (New York: I.B. Tauris & Co Ltd, 2011), p. 98.

⁶ van Dam, *The Struggle for Power in Syria*, p. 98.

⁷ Patrick Seale, *Asad: The Struggle for the Middle East* (London: I.B. Tauris & Co, 1988), p. 329.

⁸ Seale, *Asad*, p. 327.

⁹ van Dam, *The Struggle for Power in Syria*, p. 112.

¹⁰ van Dam, *The Struggle for Power in Syria*, p. 114.

¹¹ van Dam, *The Struggle for Power in Syria*, pp. 26-28.

¹² van Dam, *The Struggle for Power in Syria*, pp. 31-37.

¹³ Seale, *Asad*, p. 327; van Dam, *The Struggle for Power in Syria*, p. 104

¹⁴ van Dam, *The Struggle for Power in Syria*, p. 114.

¹⁵ Seale, *Asad*, p. 327.

¹⁶ van Dam, *The Struggle for Power in Syria*, p. 105.

¹⁷ Kirk Campbell, “Civil-Military Relations and Political Liberalization: A Comparative Study of the Military’s Corporateness and Political Values in Egypt, Syria, Turkey and Pakistan,” p. 230. Retrieved from: <http://gradworks.umi.com/3330856.pdf>.

¹⁸ Seale, *Asad*, p. 332.

¹⁹ Seale, *Asad*, p. 328.

²⁰ Seale, *Asad*, p. 327.

²¹ van Dam, *The Struggle for Power in Syria*, p. 104.

²² “Syria: Muslim Brotherhood Pressure Intensifies,” Defense Intelligence Agency, May 1982, p. 4. Retrieved from: http://www.foreignpolicy.com/files/fp_uploaded_documents/DIA-Syria-MuslimBrotherhoodPressureIntensifies.pdf.

²³ van Dam, *The Struggle for Power in Syria*, p. 111.

²⁴ Seale, *Asad*, p. 333.

²⁵ Seale, *Asad*, p. 328.

²⁶ Seale, *Asad*, p. 331.

²⁷ “By All Means Necessary: Individual and Command Responsibility for Crimes against Humanity in Syria,” Human Rights Watch, December 2011, pp. 4, 59, 85.

²⁸ Michael Weiss, “My interview with a defected Syrian soldier; plus, more leaked Syrian documents,” *The Telegraph*, August 9, 2011.

²⁹ “By All Means Necessary: Individual and Command Responsibility for Crimes against Humanity in Syria,” Human Rights Watch, December 2011, pp. 20, 31, 36.

³⁰ “By All Means Necessary: Individual and Command Responsibility for Crimes against Humanity in Syria,” Human Rights Watch, December 2011, p. 30, 46.

³¹ “Profile: Manaf Tlas,” BBC News, July 6, 2012.

³² “By All Means Necessary: Individual and Command Responsibility for Crimes against Humanity in Syria,” Human Rights Watch, December 2011, p. 63.

³³ Interview with defected former Syrian Army officer and FSA leader on April 4, 2012 in Washington, DC.

³⁴ Local Coordination Committees Website <http://www.lccsyria.org/1563> July 29, 2011; Local Coordination Committees Website lccsyria.org, November 15, 2012; Local Coordination Committees Website lccsyria.org, November 14, 2012.

³⁵ Syrian Revolution Coordinator’s Union Facebook Page facebook.com/monasiqoon, February 15, 2012.

³⁶ “They Burned My Heart: War Crimes in Northern Idlib during Peace Plan Negotiations,” Human Rights Watch, May 2012, p. 7.

³⁷ Al-Ittihad News Archive alittihad.ae/toc.php?type=archive,

NOTES

January 13, 2012; Local Coordination Committees Website <<http://www.lccsyria.org/5297>>, January 16, 2012; Syrian Revolution Coordinator's Union Facebook Page <<facebook.com/monasiqoon>>, February 7, 2012.

³⁸ Imagery released by the US State Department showing Syrian military deployments near Zabadani, February 11-13, 2012. Retrieved from: <<http://www.humanrights.gov/2012/03/05/situation-in-syria-more-images/>>.

³⁹ Nadiyah al-Turki, "Dissident Colonel Holds the Syrian President Responsible for All the 'Killing and Terrorism' Carried Out by Army Units," *Asharq al-Awsat*, March 11, 2012; Al Arabiya News Online <<http://www.alarabiya.net/syria>>, February 1, 2012; Al Arabiya News Online <<http://www.alarabiya.net/syria>>, February 29, 2012. Translated from the Arabic by Elizabeth O'Bagy.

⁴⁰ YouTube, Republican Guard Briefing in Bab Amr, published April 4, 2012, <<http://youtu.be/voBwOwYnOX4>>.

⁴¹ Al Arabiya News Online <<http://www.alarabiya.net/syria>>, February 8, 2012; Al Arabiya News Online <<http://www.alarabiya.net/syria>>, February 9, 2012; Al Arabiya News Online <<http://www.alarabiya.net/syria>>, February 13, 2012.

⁴² Al Arabiya News Online <<http://www.alarabiya.net/syria>>, February 16, 2012.

⁴³ Al Arabiya News Online <<http://www.alarabiya.net/syria>>, End of January, 2012; Al Arabiya News Online <<http://www.alarabiya.net/syria>>, March 9, 2012.

⁴⁴ Joseph Holliday, "The Struggle for Syria in 2011," Institute for the Study of War, December 2011; "Syria's Armed Opposition."

⁴⁵ Hugh Macleod and Annasofie Flamand, "Syria seals off rebellious neighborhoods," *Global Post*, April 30, 2012.

⁴⁶ Center for Documentation of Violations in Syria, <http://www.vdc-sy.org/index.php/en/home>.

⁴⁷ Imagery released by US State Department showing Syrian artillery deployments near Homs, February 25, 2012. Retrieved from: <<http://www.globalsecurity.org/intell/library/imint/syria-4.htm>>.

⁴⁸ *The Military Balance 2011*, International Institute for Strategic Studies (London: Routledge, 2011), p. 331.

⁴⁹ "Republican Guard Briefing in Bab Amr," YouTube video, April 4, 2012, <<http://youtu.be/voBwOwYnOX4>>.

⁵⁰ Holliday, "The Struggle for Syria in 2011."

⁵¹ "Republican Guard Briefing in Bab Amr."

⁵² Macleod and Flamand, "Syria seals off rebellious neighborhoods."

⁵³ Institute for the Study of War, Middle East Security Project Syria Palantir Database, relevant data primarily derived from Syrian Observatory for Human Rights Facebook Page <<facebook.com/syriaohr>> and Syrian Arab News Agency <sana.sy/index_eng.html>. Hereafter cited as MESP-Syria Database.

⁵⁴ van Dam, *The Struggle for Power in Syria*, p. 208-209; *The Military Balance 2011*, p. 332.

⁵⁵ Hugh Macleod and Annasofie Flamand, "Inside Syria's shabiha death squads," *Global Post*, June 15, 2012.

⁵⁶ Mohammad D., "The Original Shabiha," Syria Comment Blog <<joshualandis.com/blog>>, August 17, 2012; Macleod and Flamand, "Inside Syria's shabiha death squads."

⁵⁷ Mohammad D., "The Original Shabiha."

⁵⁸ Yassin al-Haj Salih, "Syrian Shabiha and Their State," Heinrich Boll Foundation, May 7, 2012.

⁵⁹ STRATFOR, "The Use of Mercenaries in Syria's Crackdown," January 12, 2012.

⁶⁰ Alan George, *Syria: Neither Bread nor Freedom*, (London: Zed Books Ltd, 2003), p. 115.

⁶¹ Macleod and Flamand, "Inside Syria's shabiha death squads."

⁶² Salih, "Syrian Shabiha and Their State;" European Union, Council Implementing Regulation (EU) No 1151/2011, November 14, 2011.

⁶³ Liz Sly, "Tensions among Alawites pose new challenge or Assad," *Washington Post*, October 17, 2012.

⁶⁴ Salih, "Syrian Shabiha and Their State;" STRATFOR, "The Use of Mercenaries in Syria's Crackdown."

⁶⁵ United Nations High Commissioner for Human Rights, Independent International Commission of Inquiry on the Syrian Arab Republic, Periodic Update, December 20, 2012, p. 2.

⁶⁶ Nir Rosen, "Among the Alawites," London Review of Books, September 27, 2011; Nir Rosen, "Assad's Alawites: An entrenched community," Al Jazeera English, October 12, 2011.

⁶⁷ "Minority militias stir fears of sectarian war in Damascus," Reuters, Sep 7, 2012.

⁶⁸ Rosen, "Among the Alawites."

NOTES

⁶⁹ Christoph Reuter, “Increasing Barbarity: Gaining a Clearer View of the Syrian Civil War,” *Der Spiegel*, December 31, 2012.

⁷⁰ Own Bennet Jones, “The Alawis,” BBC Radio 4, February 10, 2013.

⁷¹ “Treasury Sanctions Al-Nusra Front Leadership in Syria and Militias Supporting the Assad Regime,” U.S. Department of the Treasury, December 11, 2012.

⁷² Macleod and Flamand, “Inside Syria’s shabiha death squads.”

⁷³ Rosen, “Among the Alawites.”

⁷⁴ “Minority militias stir fears of sectarian war in Damascus.”

⁷⁵ Macleod and Flamand, “Inside Syria’s shabiha death squads.”

⁷⁶ Ruth Sherlock, “Syrian rebels cut off Bashar al-Assad’s escape route,” *The Telegraph*, December 17, 2012.

FROM COUNTERINSURGENCY TO CIVIL WAR

⁷⁷ “Syria’s Mutating Conflict,” International Crisis Group, August 2012, p. 7.

⁷⁸ “Syria’s Mutating Conflict,” p. 11.

⁷⁹ “Syria’s Mutating Conflict,” p. 7.

⁸⁰ Christoph Reuter, “Increasing Barbarity: Gaining a Clearer View of the Syrian Civil War,” *Der Spiegel*, December 31, 2012.

⁸¹ Elizabeth O’Bagy, interviews with rebel commanders via Skype, December 2012.

⁸² Holliday, “The Struggle for Syria in 2011,” pp. 19-21.

⁸³ Khaled Yacoub Oweis, “Syria army destroys houses in ‘collective punishment,’” Reuters, September 3, 2012; Syrian Observatory for Human Rights Facebook Page <[facebook.com/syriaohr](https://www.facebook.com/syriaohr)>, September 2-29, 2012

⁸⁴ Sam Dagher, “Fighting to Hold Damascus, Syria Flattens Rebel ‘Slums,’” *Wall Street Journal*, November 27, 2012.

⁸⁵ “Syrian forces bombard Damascus; IDF says Assad still in capital,” *Haaretz*, July 22, 2012.

⁸⁶ Amir Ahmed, “Thousands displaced as Syrian authorities demolish Hama neighborhood,” CNN, October 1, 2012.

⁸⁷ “Houla: How a massacre unfolded.” BBC News, June, 8, 2012.

⁸⁸ Frank Gardner, “Satellite image clues to Houla massacre in Syria,” BBC News, May 31, 2012.

⁸⁹ Bassem Mroue, “UN envoy ‘horrified’ by Syria massacre, 108 dead,” Associated Press, May 28, 2012; “Another massacre reported in Syria,” *Albawaba News*, June 07, 2012.

⁹⁰ Patrick McDonnell, “Dozens more bodies found at Syria massacre site,” *Los Angeles Times*, August 27, 2012; Khaled Yacoub Oweis, “Syria activist report ‘massacre’ by army near Damascus,” Reuters, August 25, 2012.

⁹¹ “Witness: Scores killed in ‘massacre’ south of Damascus,” CNN, September 27, 2012.

⁹² Suadad al-Salhy, “Iraqi Shi’ite militants fight for Syria’s Assad,” Reuters, October 16, 2012; Nicholas Blanford, “Video appears to show Hezbollah and Iraqi Shiites fighting in Syria,” *Christian Science Monitor*, January 18, 2013.

⁹³ “Investigators just found evidence of a major war crime in Syria,” Agence France Presse, December 31, 2012; Oliver Holmes, “Massacre of over 100 reported in Syria’s Homs,” Reuters, January 17, 2013; Khaled Yacoub Oweis, “Syrian militias target civilians in Homs, opposition says,” Reuters, January 26, 2013.

⁹⁴ Mohammad D., “The Formation of Alawite Militias in the Kassab region,” Syria Comment Blog <joshualandis.com/blog>, September 5, 2012.

⁹⁵ Rosen, “Among the Alawites.”

⁹⁶ David Enders, “In northern Syria, rebels now control many towns and villages,” McClatchy Newspapers, June 7, 2012.

⁹⁷ Joseph Holliday, “Syria’s Maturing Insurgency,” Institute for the Study of War, June 2012, p. 17.

⁹⁸ Joseph Holliday and Christopher Harmer, “Syrian Air Force & Air Defense Overview,” Institute for the Study of War, October 25, 2012.

⁹⁹ MESP-Syria Database, relevant data derives from Syrian Observatory for Human Rights Facebook Page <[facebook.com/syriaohr](https://www.facebook.com/syriaohr)> and YouTube videos of airstrikes.

¹⁰⁰ MESP-Syria Database, relevant data derives from Syrian Observatory for Human Rights Facebook Page <[facebook.com/syriaohr](https://www.facebook.com/syriaohr)> and YouTube videos of airstrikes.

¹⁰¹ *The Military Balance 2011*, p. 331.

¹⁰² “Syria: Some in opposition fear rebels miscalculated in Aleppo,” *Los Angeles Times*, August 13, 2012.

¹⁰³ Elizabeth O’Bagy, interview with woman living in the Olive Tree Refugee Camp in Atmeh, Syria on January 30, 2013.

NOTES

¹⁰⁴ Elizabeth O’Bagy, interview with rebel commander of a battalion associated with the Tawhid Brigade in Aleppo on January 31, 2013.

¹⁰⁵ “Jim Muir, “Fate of Assad’s Syria still hangs in the balance,” BBC News, December 14, 2012.

¹⁰⁶ Damien McElroy, “Syrian regime deploys deadly new weapons on rebels,” *The Telegraph*, August 31, 2012; “The Mystery of the Syrian Barrel Bombs,” Brown Moses Blog <brown-moses.blogspot.com>, August 30, 2012.

¹⁰⁷ Roy Gutman and Paul Raymond, “Syrian Government has pattern of attacking bakeries, bread lines,” McClatchy Newspapers, January 21, 2013.

¹⁰⁸ Jim Muir, “Syrian peace envoy Lakhdar Brahimi in talks with Assad,” BBC News, December 24, 2012.

¹⁰⁹ Mroue, “UN envoy ‘horrified’ by Syria massacre, 108 dead;” “Another massacre reported in Syria.”

¹¹⁰ Holliday and Harmer, “Syrian Air Force & Air Defense Overview.”

¹¹¹ C.J. Chivers, “Battle for Syrian City Lays Both Sides’ Weaknesses Bare,” *New York Times*, December 27, 2012.

¹¹² Holliday and Harmer, “Syrian Air Force & Air Defense Overview.”

¹¹³ Holliday and Harmer, “Syrian Air Force & Air Defense Overview.”

¹¹⁴ Michael Gordon and Eric Schmitt, “Syria Uses Scud Missiles in New Effort to Push Back Rebels,” *New York Times*, December 12, 2012; Michael Gordon and Eric Schmitt, “Syria Fires More Scud Missiles at Rebels, U.S. Says,” *New York Times*, December 20, 2012.

¹¹⁵ James Miller, “Definitive Evidence of Regime Airstrikes on Aleppo University,” EAWorldView, January 24, 2013.

¹¹⁶ Sevil Kucukkosum, “Syria fired more than 40 Scud missiles in two months,” *Hurriyet*, February 21, 2013.

¹¹⁷ “Jordan reels over Syrian refugee crisis,” Al Jazeera English, January 25, 2013.

¹¹⁸ James Rosen, “Nearly 800,000 refugees flee fighting in Syria, US officials say,” *Fox News*, February 6, 2013; “Regional Analysis Syria,” Relief Web <reliefweb.int>, January 28, 2013.

¹¹⁹ 3.5 million displaced out of an estimated population of 22.5 million, according to the CIA World Factbook.

¹²⁰ “Around 40,000 flee heavy fighting in east Syria: U.N.,” Reuters, February 15, 2013.

¹²¹ Roy Gutman, “U.N. numbers on Syrians in need of help far too low, survey suggests,” McClatchy Newspapers, February 18, 2013.

¹²² van Dam, *The Struggle for Power in Syria*, p. 114; MESP-Syria Database, relevant data derives from defection statements posted on YouTube in late 2011 and early 2012.

¹²³ The role of the 76th Armored Brigade within the 1st Armored Division is described in detail in the section of this report entitled *Bashar and the Revolution*.

¹²⁴ Local Coordination Committees Website <lccsyria.org>, March 22, 2012; Syrian Revolution Coordinator’s Union Facebook Page <facebook.com/monasiqoon>, February 23, 2012.

¹²⁵ “By All Means Necessary: Individual and Command Responsibility for Crimes against Humanity in Syria,” Human Rights Watch, December 2011, p. 36; Syrian Observatory for Human Rights Facebook Page <facebook.com/syriaohr>, January 24, 2012; Syrian Revolution Coordinator’s Union Facebook Page <facebook.com/monasiqoon>, February 7, 2012; Local Coordination Committees Website <lccsyria.org>, November 15, 2012.

¹²⁶ *The Military Balance 2011*, p. 330.

¹²⁷ For example, see “70 percent of Sunni soldiers in Bashar’s army are no longer working,” *Mokhtsar News*, April, 10, 2012. Translated from the Arabic by Elizabeth O’Bagy, retrieved from: <http://www.almokhtsar.com/node/46838>; “Fallen Rebel Heroes Honored by Thousands in Idlib,” YouTube video, February 7, 2012, <http://www.youtube.com/watch?v=qaCVoUUstHo> .

¹²⁸ Anshel Pfeffer, “Syrian Rebel Chief – When Assad Falls, We Will Secure His Chemical Weapons,” *Haaretz*, May 29, 2012.

¹²⁹ “70 percent of Sunni soldiers in Bashar’s army are no longer working,” *Mokhtsar News*, April, 10, 2012. Translated from the Arabic by Elizabeth O’Bagy, retrieved from: <http://www.almokhtsar.com/node/46838>; Anshel Pfeffer, “Syrian Rebel Chief – When Assad Falls, We Will Secure His Chemical Weapons,” *Haaretz*, May 29, 2012.

¹³⁰ “Former Syrian Officer Says Ranks of Defectors Are Swelling,” Al-Monitor, July 10, 2012; Ken Sofer, “Next Steps in Syria: A Look at U.S. Priorities and Interests,” Center for American Progress, August 14, 2012.

¹³¹ “By All Means Necessary: Individual and Command

NOTES

Responsibility for Crimes against Humanity in Syria,” Human Rights Watch, December 2011, pp. 61-67.

¹³² Email from Damascus-based opposition leader, January 25, 2012.

¹³³ Khaled Yacoub Oweis, “Ex-Syrian army commander calls for air strikes on Assad troops,” Reuters, April 9, 2012, <<http://www.reuters.com/article/2012/04/09/us-syria-defector-idUSBRE8380UO20120409>>.

¹³⁴ Email from Damascus-based opposition leader, January 25, 2012.

¹³⁵ Imagery released by US State Department showing Syrian military deployments around Zabadani, February 11-13, 2012. Retrieved from: <<http://www.humanrights.gov/2012/03/05/situation-in-syria-more-images/>>.

¹³⁶ Imagery released by US State Department showing Syrian military deployments around Idlib, March 11, 2012. Retrieved from: <<http://www.globalsecurity.org/intell/library/imint/syria-10.htm>>.

¹³⁷ “Republican Guard Briefing in Bab Amr,” YouTube video.

¹³⁸ Center for Documentation of Violations in Syria Database, <vdc-sy.org>.

¹³⁹ Center for Documentation of Violations in Syria Database, <vdc-sy.org>; Syrian Observatory for Human Rights Facebook Page, <facebook.com/syriaohr>

¹⁴⁰ Liz Sly, “Tensions among Alawites pose new challenge for Assad,” Washington Post, October 17, 2012.

¹⁴¹ Syrian4All News, YouTube video, January 22, 2013, <<http://youtu.be/WpEfRSNwXAM>>.

¹⁴² “Obama Worries Syria Intervention Would Backfire; Medvedev Says Assad Losing Power by the Day,” Syria Comment, January 28, 2012, <<http://www.joshualandis.com/blog/?p=17557&cp=all>>.

¹⁴³ “Strained Syrian army calls up reserves; some flee,” Reuters, September 4, 2012.

¹⁴⁴ “Republican Guard Briefing in Bab Amr.”

¹⁴⁵ Email from Damascus-based opposition leader, January 25, 2012.

¹⁴⁶ “Syria’s Mutating Conflict,” p. ii.

¹⁴⁷ Hassan Hassan, “Assad’s Massacre Strategy,” Foreign Policy, September 4, 2012, Available at: <http://www.foreignpolicy.com/articles/2012/09/04/assad_s_massacre_strategy>.

¹⁴⁸ “Calm Restored in most parts of Aleppo,” Press TV, August 1, 2012.

¹⁴⁹ “Minority militias stir fears of sectarian war in Damascus,” Reuters, Sep 7, 2012.

¹⁵⁰ “Syria’s Mutating Conflict.”

¹⁵¹ Interview with exiled former Syrian Army General Officer, Washington, DC, March 20, 2012.

¹⁵² Khaled Yacoub Oweis, “Syrian troops and militia push to take Sunni Homs area,” Reuters, January 25, 2013.

¹⁵³ Nick Simeone, “Panetta: Iran Increases Support to Assad Regime,” American Forces Press Service, August 14, 2012; “US says Iran training Syrian militia,” BBC News, August 15, 2012.

¹⁵⁴ “*jafari: hamle pish dastaneh nemi konim*” [“Jafari: We will not preemptively attack”], IRNA, September 16, 2012. Translated by Ali Alfoneh at Iran Tracker, <irantracker.org>, September 17, 2012.

¹⁵⁵ “Treasury Sanctions Al-Nusrah Front Leadership in Syria and Militias Supporting the Asad Regime,” U.S. Department of the Treasury, December 11, 2012.

¹⁵⁶ “Syria builds paramilitary force aided by Iran: NGO,” Agence France Presse, January 21, 2013.

¹⁵⁷ Scott Lucas, “Syria & Iran Follow-Up: The Real Story of ‘Syria’s Iran-Hezbollah 50,000-Man Militia’ in 3 Easy Steps,” EAWorldView, February 12, 2013.

¹⁵⁸ Syrian Observatory for Human Rights Facebook Page <facebook.com/syriaohr>, February 16, 2013.

¹⁵⁹ “The World Factbook: Syria,” Central Intelligence Agency, updated February 5, 2013.

¹⁶⁰ Sean O’Hare, “The Lionesses of Syria: Assad recruits army of women as he starts to run out of men,” *Daily Mail*, January 23, 2013.

¹⁶¹ Ruth Sherlock, “Syria: Bashar al-Assad relative wounded in family hometown,” *The Telegraph*, October 3, 2012.

¹⁶² Ben Hubbard, “Militants claim deadly Syria bombings in video,” *Daily Star*, May 12, 2012.

¹⁶³ Macleod and Flamand, “Inside Syria’s shabiha death squads.”

¹⁶⁴ Macleod and Flamand, “Inside Syria’s shabiha death squads.”

¹⁶⁵ Free Syrian Army Facebook Page <facebook.com/syria.army>.

NOTES

free>, February 16, 2012; Syrian Revolution Coordinator's Union Facebook Page <facebook.com/monasiqoon>, November 19, 2012; Syrian Observatory for Human Rights Facebook Page <facebook.com/syriaohr>, January 24, 2012.

¹⁶⁶ Human Rights Watch, "By All Means Necessary," December 2011, pp. 43, 85.

¹⁶⁷ van Dam, *The Struggle for Power in Syria*, p. 6.

¹⁶⁸ "Clashes between Syrian troops and army defectors kill at least 13," *Washington Post*, October 13, 2011; Syrian Revolution Coordinator's Union Facebook Page <facebook.com/monasiqoon>, November 13, 2012.

¹⁶⁹ Email from Persian Gulf-based Syrian activist, March 30, 2012.

¹⁷⁰ John Caves, "Syrian Kurds and the Democratic Union Party," Institute for the Study of War, December 6, 2012.

¹⁷¹ "Syrian rebels seize army base on Iraqi border," *France 24*, November 22, 2012.

¹⁷² Free Syrian Army Facebook Page <facebook.com/syria.army.free>, November 15, 2012.

¹⁷³ "By All Means Necessary: Individual and Command Responsibility for Crimes against Humanity in Syria," Human Rights Watch, December 2011, p. 85; Al-Jazeera Satellite Channel Television in Arabic, November 19, 2012.

¹⁷⁴ Al Arabiya News Online < <http://www.alarabiya.net/syria>>, March 3, 2012; "They Burned My Heart: War Crimes in Northern Idlib during Peace Plan Negotiations," p. 7.

¹⁷⁵ Orient TV, October 8, 2012; Syrian Revolution Coordinator's Union Facebook Page <facebook.com/monasiqoon>, October 9, 2012; Television interview with Idlib local coordination committee member, Al Jazeera Arabic, October 9, 2012.

¹⁷⁶ Al Arabiya News Online < <http://www.alarabiya.net/syria>>, March 11, 2012; "They Burned My Heart," p. 4; Al Arabiya News Online < <http://www.alarabiya.net/syria>>, March 11, 2012; Syrian Revolution Coordinator's Union Facebook Page <facebook.com/monasiqoon>, August 12, 2012.

¹⁷⁷ Imagery released by US State Department showing Syrian military deployments around Idlib, March 11, 2012. Retrieved from: <<http://www.globalsecurity.org/intell/library/imint/syria-10.htm>>.

¹⁷⁸ Holliday, "Syria's Maturing Insurgency," pp. 13-15.

¹⁷⁹ Holliday, "Syria's Maturing Insurgency," pp. 15-16.

¹⁸⁰ Jeffrey Bolling, "Rebel Groups in Northern Aleppo," Institute for the Study of War, August 29, 2012, pp. 8-9.

¹⁸¹ "Russia warns of looming 'tragedy' in Aleppo," *Manilla Times*, July 29, 2012.

¹⁸² "Warplane bombardment of neighborhood," YouTube video, August 3, 2012, <<http://youtu.be/DdY236p-FGk>>.

¹⁸³ C.J. Chivers, "Syrian Rebels Hone Bomb Skills to Even the Odds," *New York Times*, July 18, 2012.

¹⁸⁴ Asher Berman, "Rebel Groups in Jebel al-Zawiyah," Institute for the Study of War July 26, 2012, pp. 2-4; Holliday, "Syria's Maturing Insurgency," pp. 13-15.

¹⁸⁵ Compiled from Asher Berman, Syria Survey Blog <syriasurvey.blogspot.com>, and Syrian Observatory for Human Rights Facebook Page <facebook.com/syriaohr>.

¹⁸⁶ "Syrian IL-76 lands at Aleppo International Airport," YouTube video, September 2, 2012, <<http://youtu.be/Pjw3unsk7Tk>>.

¹⁸⁷ Email from American journalist based in Antakya, Turkey on October 29, 2012.

¹⁸⁸ C.J. Chivers, "The Battle for Syria's Minakh Air Base," *New York Times*, January 30, 2013.

¹⁸⁹ "'Fragile calm' returns to Homs after a year of fighting," BBC News, January 25, 2012.

¹⁹⁰ Syrian Revolution Coordinator's Union Facebook Page <facebook.com/monasiqoon>, March 26, 2012.

¹⁹¹ Interview with exiled Syrian former General Officer, Washington, DC, March 20, 2012; Syrian Revolution Coordinator's Union Facebook Page <facebook.com/monasiqoon>, February 23, 2012.

¹⁹² Local Coordination Committees Website <lccsyria.org>, October 16, 2012; Local Coordination Committees Website <lccsyria.org>, November 19, 2012; Free Syrian Army Facebook Page <facebook.com/syria.army.free>, February 10, 2012; Local Coordination Committees Website <<http://www.lccsyria.org/7920>>, April 10, 2012; Local Coordination Committees Website <lccsyria.org>, November 17, 2012; Local Coordination Committees Website <lccsyria.org>, November 5, 2012.

¹⁹³ MESP-Syria Database, relevant data derived from defection statements posted on YouTube in late 2011 and early 2012.

¹⁹⁴ Seale, *Asad*, p. 329.

¹⁹⁵ Isabel Kershner, "Israel Says Syria Pulls Troops from Golan

NOTES

to Suppress Revolt Elsewhere,” *New York Times*, July 17, 2012.

¹⁹⁶ Syrian Revolution Coordinator’s Union Facebook Page <facebook.com/monasiqoon>, October 16, 2012.

¹⁹⁷ “By All Means Necessary: Individual and Command Responsibility for Crimes against Humanity in Syria,” pp. 34, 64, 69, 83.

¹⁹⁸ Holliday, “The Struggle for Syria in 2011,” p. 17.

¹⁹⁹ Syrian Revolution Coordinator’s Union Facebook Page <facebook.com/monasiqoon>, October 29, 2012; Local Coordination Committees Website <lccsyrria.org>, March 27, 2012; Syrian Revolution Coordinator’s Union Facebook Page <facebook.com/monasiqoon>, October 9, 2012.

²⁰⁰ Local Coordination Committees Website <lccsyrria.org>, March 8, 2012

²⁰¹ Syrian Revolution Coordinator’s Union Facebook Page <facebook.com/monasiqoon>, November 2, 2012; Syrian Revolution Coordinator’s Union Facebook Page <facebook.com/monasiqoon>, November 13, 2012; Syrian Revolution Coordinator’s Union Facebook Page <facebook.com/monasiqoon>, October 22, 2012; Syrian Revolution Coordinator’s Union Facebook Page <facebook.com/monasiqoon>, October 16, 2012.

²⁰² Farouq Battalion Facebook Post, <http://www.facebook.com/farouq.fsa, 3/27/12> March 27, 2012; YouTube, Republican Guard Briefing in Bab Amr, published April 4, 2012, <http://youtu.be/voBwOwYnOX4>

²⁰³ Syrian Revolution Coordinator’s Union Facebook Page <facebook.com/monasiqoon>, November 13, 2012

²⁰⁴ The only Republican Guard activity outside of Damascus visible in collected open source research is the leaked Republican Guard briefing video from Homs in early 2012 (“Republican Guard Briefing in Bab Amr,” <http://youtu.be/voBwOwYnOX4>).

²⁰⁵ “Syrian forces launch all-out Damascus assault,” Agence France Presse, July 21, 2012.

²⁰⁶ Martin Chulov, “Syrian regime hits back in Damascus as ill-equipped rebels struggle,” *The Guardian*, August 24, 2012; See figure, derived from SOHR.

²⁰⁷ “Assad moving troops from Golan to Damascus: Israel,” *The Daily Star*, July 17, 2012.

²⁰⁸ “Syria rebels ‘seize Marj al-Sultan base near Damascus,’” BBC News, November 25, 2012.

²⁰⁹ Diary of an Optimistic Rebel Facebook Page <facebook.com/Optimistic.revolutionary>, November 25, 2012,

²¹⁰ Nicholas Blanford, “Syrian sides prepare for key Damascus battle,” *The Daily Star*, January 26, 2013.

²¹¹ “Syria – Republican Guard in Darayya 13/1,” YouTube video, January 13, 2013, <http://youtu.be/E26wiF4WKL4>; “Syrian Arab Army: Battle for Daraya [Part 6],” YouTube video, January 24, 2013, <http://youtu.be/brzir8VeaVY>.

²¹² Alain Chouet, “L’Espace Tribal Des Alaouties a l’Epreuve du Pouvoir: La disintegration par le politique,” *Maghreb-Mashreq* No. 147, 1995. Retrieved from: <http://alain.chouet.free.fr/documents/Alaouite.htm>; Conversation with UN official in New York City on January 25, 2013.

²¹³ Ammar Abdulhamid, “The creation of an unbridgeable divide,” *openDemocracy*, January 24, 2013.

²¹⁴ Rosen, “Among the Alawites.”

²¹⁵ Al-Jazeera Satellite Channel Television, October 6, 2012

²¹⁶ “Minority militias stir fears of sectarian war in Damascus,” Reuters, Sep 7, 2012.

²¹⁷ Nicholas Blanford, “Video appears to show Hezbollah and Iraqi Shiites fighting in Syria,” *Christian Science Monitor*, January 18, 2013.

²¹⁸ Jonathan Steele, “In a small corner of Syria, rebels attempt to reconcile,” *The Guardian*, February 18, 2013.

²¹⁹ Interview with western journalist travelling in Idlib and Aleppo on January 8, 2013.

CONCLUSION

²²⁰ “Leon Panetta, U.S. Defense Chief, Says Syria Military Must Remain Intact When Bashar al-Assad Is Ousted,” Reuters, August 30, 2012.

²²¹ “Syria’s Mutating Conflict,” p. ii.

²²² Elizabeth O’Bagy, interviews with rebel commanders in Turkey in January 2012.

²²³ van Dam, *The Struggle for Power in Syria*, p. 135.

²²⁴ Abdul Rahman Al-Rashed, “I can win if Damascus is destroyed,” *Asharq Alawsat* <asharq-e.com>, January 23, 2013.

²²⁵ Joshua Landis, “Creating a Syrian Swamp: Assad’s ‘Plan B,’” Syria Comment Blog <joshualandis.com/blog>, August 10, 2012.

NOTES

APPENDIX 1

- ²²⁶ Richard M. Bennett, “The Syrian Military: A Primer,” *Middle East Intelligence Bulletin*, Vol. 3 No. 8, August/September 2001.
- ²²⁷ Michael Weiss, “My interview with a defected Syrian soldier; plus, more leaked Syrian documents,” *The Telegraph*, August 9, 2011.
- ²²⁸ *The Military Balance 2011*, p. 330.
- ²²⁹ Richard Bennet, “The Syrian Military: A Primer,” *Middle East Intelligence Bulletin*, August/September 2001.
- ²³⁰ “By All Means Necessary,” p. 88; Interview with exiled former Syrian Army General Officer in Washington, DC on March 20, 2012.
- ²³¹ “By All Means Necessary,” p. 88; Interview with exiled former Syrian Army General Officer in Washington, DC on March 20, 2012.
- ²³² “By All Means Necessary,” p. 88; Interview with exiled former Syrian Army General Officer in Washington, DC on March 20, 2012.
- ²³³ Seale, *Asad*, pp. 430, 434.
- ²³⁴ Seale, *Asad*, p. 319.
- ²³⁵ van Dam, *The Struggle for Power in Syria*, p.115; Hana Batatu, “Some Observations on the Social Roots of Syria’s Ruling Military Group and the Causes for its Dominance,” *The Middle East Journal*, Vol. 35, No. 3 (Summer 1981), p. 332.
- ²³⁶ Seale, *Asad*, p. 437.
- ²³⁷ Campbell, “Civil-Military Relations and Political Liberalization: A Comparative Study of the Military’s Corporateness and Political Values in Egypt, Syria, Turkey, and Pakistan,” p. 229.
- ²³⁸ “By All Means Necessary,” p. 83.
- ²³⁹ Jawdat Ibrahim Safi is assessed to be the son of Ibrahim Safi; Human Rights Watch, “By All Means Necessary,”; van Dam, *The Struggle for Power in Syria*, p. 83.
- ²⁴⁰ Anshel Pfeffer, “Syrian Rebel Chief – When Assad Falls, We Will Secure His Chemical Weapons,” *Haaretz*, May 29, 2012; Interview with exiled former Syrian Army General Officer in Washington, DC on March 20, 2012; “By All Means Necessary,” p. 83.
- ²⁴¹ Campbell, “Civil-Military Relations And Political Liberalization,” pp. 228-229.
- ²⁴² Seale, *Asad*, p. 431.
- ²⁴³ Seale, *Asad*, p. 437.
- ²⁴⁴ “By All Means Necessary,” p. 82.
- ²⁴⁵ “By All Means Necessary,” p. 82.
- ²⁴⁶ “Profile: Manaf Tlas,” *BBC News*, July 6, 2012.
- ²⁴⁷ Seale, *Asad*, p. 430; van Dam, *The Struggle for Power in Syria*, p. 121.
- ²⁴⁸ Seale, *Asad*, p. 437.
- ²⁴⁹ Alain Chouet, “L’Espace Tribal Des Alaouties a l’Epreuve du Pouvoir”
- ²⁵⁰ “Syria’s Praetorian Guards – A Primer,” *Middle East Intelligence Bulletin*, Vol. 2 No. 7, August 5, 2000.
- ²⁵¹ van Dam, *The Struggle for Power in Syria*, p. 115; Alain Chouet, “L’Espace Tribal Des Alaouties a l’Epreuve du Pouvoir.”
- ²⁵² Derived from defection statements posted on YouTube, collected by the Institute for the Study of War between January and March 2012.
- ²⁵³ Interview with former Syrian Army Captain and opposition leader in Washington, DC on April 23, 2012; Weiss, “My interview with a defected Syrian soldier; plus, more leaked Syrian documents.”
- ²⁵⁴ Interview with exiled former Syrian Army General Officer in Washington, DC on March 20, 2012.
- ²⁵⁵ Bennet, “The Syrian Military: A Primer.”
- ²⁵⁶ Interview with former Syrian Army Captain and opposition leader in Washington, DC on April 23, 2012.
- ²⁵⁷ Kenneth Pollack, *Arabs at War: Military Effectiveness, 1948-1991*, (University of Nebraska Press, 2002), p. 173.
- ²⁵⁸ Seale, *Asad*, p. 430.
- ²⁵⁹ “Syria’s Praetorian Guards – A Primer.”
- ²⁶⁰ Norman Schwarzkopf, *It Doesn’t Take A Hero*, (New York: Bantam Books, 1993), pp. 467-9.
- ²⁶¹ Bennett, “The Syrian Military: A Primer.”
- ²⁶² Seale, *Asad*, p. 430.
- ²⁶³ van Dam, *The Struggle for Power in Syria*, p. 120, 131.

NOTES

²⁶⁴ Interview with exiled former Syrian Army General Officer in Washington, DC on March 20, 2012.

²⁶⁵ Bennett, “The Syrian Military: A Primer.”

²⁶⁶ Skype Interview with exiled former Syrian Army General Officer in Washington, DC on April 19, 2012.

²⁶⁷ Seale, *Asad*, p. 328.

²⁶⁸ van Dam, *The Struggle for Power in Syria*, pp. 114-115.

²⁶⁹ van Dam, *The Struggle for Power in Syria*, p. 121.

²⁷⁰ “Syria’s Praetorian Guards – A Primer;” Shmuel Bar, “Bashar’s Syria: The Regime and its Strategic Worldview,” Institute for Policy and Strategy, 2006.

APPENDIX 3

²⁷¹ Seale, *Asad*, p.338.

²⁷² Andrew Rathmell, “Syria’s Intelligence Services – Origins and Development,” *The Journal of Conflict Studies*, October 1996; “By All Means Necessary.”

²⁷³ Campbell, “Civil-Military Relations And Political Liberalization,” p. 229.

²⁷⁴ “Syria’s Intelligence Services: A Primer.”

²⁷⁵ “Torture Archipelago: Arbitrary Arrests, Torture, and Enforced Disappearances in Syria’s Underground Prisons since March 2011,” Human Rights Watch, July 2012; “Syria’s Intelligence Services: A Primer.”

²⁷⁶ “Syria’s Intelligence Services: A Primer.”

²⁷⁷ “Syria’s Intelligence Services: A Primer;” “Bashar’s Inner Circle,” BBC News, July 30, 2012.

²⁷⁸ Campbell, “Civil-Military Relations And Political Liberalization,” p. 229.

²⁷⁹ Campbell, “Civil-Military Relations And Political Liberalization,” p. 229.

²⁸⁰ “Syria’s Mutating Conflict.”

²⁸¹ “Torture Archipelago: Arbitrary Arrests, Torture, and Enforced Disappearances in Syria’s Underground Prisons since March 2011.”

²⁸² “Torture Archipelago: Arbitrary Arrests, Torture, and Enforced Disappearances in Syria’s Underground Prisons since March 2011.”

²⁸³ Interview with exiled former Syrian Army General Officer, Washington, DC, March 20, 2012.

APPENDIX 4

²⁸⁴ *The Military Balance 2011*, p. 331; “Syria Order of Battle,” *Scramble Magazine* (Dutch Aviation Society) <scramble.nl/sy.htm>, August 28, 2012.

²⁸⁵ “Syria Order of Battle,” *Scramble Magazine*.

²⁸⁶ *The Military Balance 2011*, p. 331.

²⁸⁷ Jarrah Air Base [36.096°, 37.9365°], imaged by GeoEye in 2013, accessed through GoogleEarth.

²⁸⁸ “Syria Order of Battle,” *Scramble Magazine*.

²⁸⁹ Sean Boyne, “Long road to progress,” *Jane’s Defense Weekly*, <jdw.janes.com>, November 15, 2001.

²⁹⁰ Nuclear Threat Initiative: Syria <nti.org/country-profiles/syria/delivery-systems>, February 2013.

²⁹¹ WikiMapia entry, <wikimapia.org/23181596/Missile-Base>, See Figure 12.

²⁹² “Syrian Ballistic Missile Arsenal,” *Defense Update News* <defense-update.com/2003/04/syrian-ballistic-missile-arsenal.html>, April 16, 2003.

²⁹³ See Figure 12.

²⁹⁴ Kucukkosum, “Syria fired more than 40 Scud missiles in two months.”

²⁹⁵ Email from Damascus based opposition leader on December 8, 2012. The information was collected by interviewing defected Syrian officers who were involved in the chemical weapons program.

