

EXHIBITION

# TRAINSTOPPING

INTERVENING IN RAIL TRANSPORT

Blockade & sabotage of rail traffic  
in the context of the anti-nuclear movement



brochure & manual





# CONTENT

	Seite
Foreword	1
Welcome	3
About this exhibition	4
Transports: Achilles heel of the nuclear industry...	5
Safety and security	6
Railway nostalgia and resistance	7
Communicability	9
Reduce threshold fears	10
Variety of tactics	12
Construction of railway system	14
Detect nuclear transports	16
Hazard symbols for transport of radioactive materials	17
Route observation	18
Stopping trains	18
Speed, mass, stopping distance	19
Action "Pull the emergency brake"	19
<b>BLOCKADE</b>	<b>20</b>
Sitting blockades	21
Technical blockades	23
Lock-On...Pipe	24
Lock-On...Concrete Block	26
Lock-On...Pyramid	27
Abseiling blockades	28
Tripod blockades	29
Material blockades	30
In memory of Sébastien Briat	31
<b>SABOTAGE</b>	<b>33</b>
Graveling	34
Sawing & Screwing	36
Lever & Bend	37
Rail (inhibitor) shoe	39
Horseshoe-shaped steel hook-claw	41
Cable shaft - Arson	44
More special	46
<b>RESISTANCE AGAINST NUCLEAR TRANSPORTS - PRESENT &amp; PERSPECTIVE</b>	<b>48</b>
Uranium ore transports Hamburg - Narbonne	49
New Castor track construction Bure (F)	51
<b>CHRONOLOGY OF THE CASTOR TRANSPORTS TO GORLEBEN - Focus on Actions on the Rails</b>	<b>55</b>

## Foreword

### Documentation of the exhibition:

#### „TRANSTOPPING - railblockades and sabotage in the history of antinuclear struggles“

On 3rd of August 2019 the opening ceremony of the exhibition "TRAINSTOPPING" took place in the old station of Lumeville near Bure (FR). We, as polit-art collective Bure/Gorleben, had already shown this exhibition during the "Kulturelle Landpartie" (Cultural Festival) in Meuchefitz (Wendland/Northgermany). In translated version we installed it with great support of many people as a permanent exhibition at the "La Gare".



In and around Bure the CIGEO construction site is located - the French nuclear repository for the waste from all 56 French nuclear power plants is to be built here. In a few years, 2 Castor transports with each 10 containers are to roll up every week, and every 80 minutes a finished portion is to go down into the depths - for a period of 100 years! Resistance to this project has existed in the region since the 90s. More recently, the occupation of the "Bois Lejuc" forest, which has since been evicted and is to become part of the repository, has played an important role. In the sparsely populated, agricultural region, numerous places of resistance have been created in the villages.



The old railway station of Lumeville ("La Gare"), has been one of these places since 2004; the centre of many people's lives and an important "nest of resistance" - also strategic. It is only a few kilometres from Bure. In addition, the former station is located on the planned railway line for the future transport of nuclear waste. As a consequence, it is foreseeable that it will culminate in an attempted expropriation of the area by the state and a battle for La Gare. The fight for La Gare and against future nuclear transports could become an important new strategic (and very exciting) point in the struggle against CIGEO and its world. With this exhibition, we as a Wendish political art collective want to bring the experiences of past anti-nuclear battles to this specific place and so make a small contribution to the debate about future strategies. The choice of the location also had to do with the long-standing solidarity of German-French anti-nuclear struggles - both in Bure and in the CASTOR transports from La Hague to Gorleben.



The reader should make it possible to have a multilingual view of the exhibition. But it is also intended for those who cannot or do not want to go there.

However, this brochure is not only a booklet to accompany the exhibition. The resistance practices shown here may also inspire people from other partial struggles. "The interruption of electricity, goods or data streams with the aim of disturbing the functioning of capitalist logic or the infrastructure of the ruling order has always been a form of resistance." (from the exhibition text) Brown coal trains have often been blocked in the Hambach forest. In Wolfsburg, recently even a train with brand new VW cars - as a sign against a failed climate policy of a state dominated by lobbies and the business world.

We hope this reading can be helpful as a "spark of inspiration" for your very personal blockade and sabotage experiences.

Have fun reading! Your freaks from Wendland.

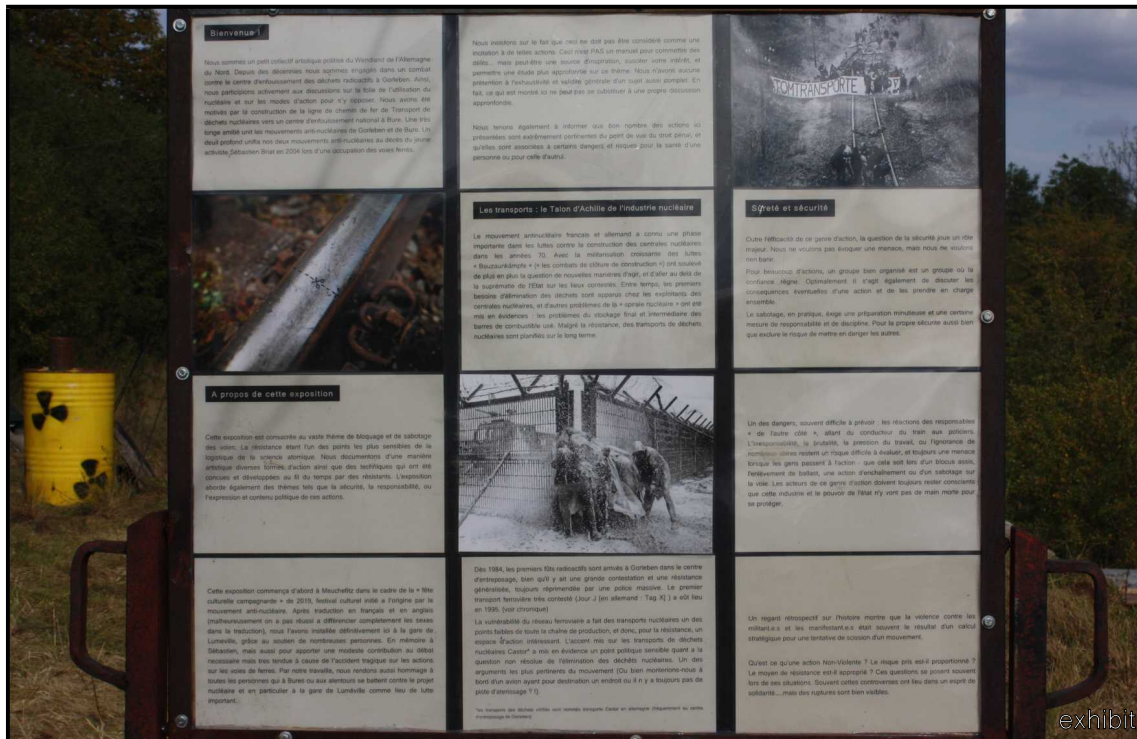

## Welcome

We are a small politic-art collective from Wendland (Northern Germany). Through the fight against a nuclear repository in Gorleben, we have been involved in the confrontations about the insanity of nuclear use and the resistance against it for quite some time. We were motivated by the forthcoming start of construction of the Castor railway line at the French location for a national nuclear repository here in Bure. The resistance in Gorleben and Bure is united by many years of friendship. The tragic death of the young anti-nuclear activist Sébastien Briat in 2004 during a rail blockade was the sad climax of this militant alliance.

The exhibition had its first opening in Meuchefitz during the "Kulturelle Landpartie" 2019, a cultural festival once initiated by the resistance. After the translation into French and English (unfortunately we did not manage to completely gender the translations), we installed it permanently here at Luméville station with the support of many people. In memory of Sébastien, but also in order to make a small statement to the debate about actions on the railway tracks, which was heavily affected by the terrible accident, but which is necessarily upcoming again. We also see our work as a tribute to all those who are fighting against the nuclear project in and around Bure and to the Luméville station in particular as an important place of resistance.

## About this exhibition

The exhibition is devoted to the wide-ranging topic of the blockade and sabotage of tracks; resistance at one of the most sensitive points of nuclear logistics. In an artistic way, we document various forms of action and techniques that have been elaborated and further developed over the course of time by resistant people. The exhibition also touches on questions such as security, responsibility or the possibility of such actions being communicated.

We explicitly point out that this should not be seen as an attempt to induce anyone to do such things! So it's NOT a crime guide...but maybe a spark of inspiration will jump at you, awaken interest, and get you more involved into that stuff. We have no guarantee of completeness and general validity about the presentation of such an immense topic. In fact, what is shown We explicitly point out that this should not be seen as an attempt to induce anyone to do such things! So it's NOT a crime guide...but maybe a spark of inspiration will jump at you, awaken interest, and get you more involved into that stuff. We have no guarantee of completeness and general validity about the presentation of such an immense topic. In fact, what is shown here cannot be a substitute for a detailed discussion of one's own. here cannot be a substitute for a detailed discussion of one's own.

We would also like to mention that many of the actions shown are highly relevant under criminal law as well as potentially attached to some dangers and risks for one's own health or that of others.



## Transports: Achilles heel of the nuclear industry...

The French and German anti-nuclear movement experienced a high phase in the struggles against the construction of nuclear power plants that strongly developed from the 1970s onwards. With the increasing militarization of the "battles about construction fences", more and more questions arose about new areas for action, beyond the state's superiority at the embattled locations. Meanwhile, the first "waste disposal needs" occurred among the companies owning the nuclear power plants. The resistance also focused on other parts of the entire "nuclear spiral": the problem of the final and temporary storage of worn-out fuel rods and the nuclear waste transports perspective connected with it. Already in 1984, the first radioactive barrels rolled to the interim storage facility in Gorleben - under strong protest and wide resistance - with the use of massive police repression. The first hard-fought rail transport (Day X) took place in 1995. (see chronicle)

The vulnerability of the rail network made nuclear transports a weak point in the entire production chain and thus an interesting area of action for the resistance. In addition, the focus on Castor transports (\*) in itself put the finger politically on the wound of the unsolved disposal issue. One of the strongest arguments of the movement (or would you board an airplane at whose destination there is no runway?).

\*the transport of vitrified high-radioactive waste is called Castor transport in Germany (frequently at the Gorleben storage centre)





## Safety and security

In addition to effective functionality, safety also plays a major role. We don't want to conjure up a spectre, but we also don't want to trivialize anything.

For many actions, a well-organised group in which there is a great deal of trust is a good basic condition for safe action. This also optimally includes dealing in advance with possible consequences of an action and carrying them together. The action and sabotage on the track requires detailed preparation and a certain degree of discipline and responsibility. Both for your own safety and to exclude the risk of endangering others as far as possible. A danger that is often difficult to calculate: the actions and reactions of those responsible on "the other side", from the train driver to the Police officer. Different actions result in different levels of violence, which is probably often the case. But irresponsibility, brutality, work pressure or the ignorance of many cops remain a risk that is difficult to evaluate and that always threatens when people take action - whether in a sit-down blockade, when graveling, during an lock-on action or when sabotaging the track. When it comes to the question of how far personal responsibility goes in the planning and execution of track actions, the actors must constantly make themselves aware that this industry and the state power that protects it do not treat human life too carefully.

A look back at history shows that the violence against activists and protesters was often the result of a strategic calculation for an attempt to split a movement.

What is a non-violent action? Was a risk taken reasonable? Was a chosen method of resistance adequate? These are questions that were asked especially in such situations. Such controversies often took place in a spirit of solidarity, but breaks also became visible...



## Railway nostalgia and resistance



Let's take a look back at history. For ever since the beginning of the railroad, the screw of resistance has been turned again and again: rail transport has always been part of the imperial infrastructure.

Developed in the name of profit maximization, developed from the beginning for economic and military uses, and as the spearhead of colonization, the history of the railway is a history of colonialism, capitalism, and war. And where there is oppression and exploitation, there is resistance; people all over the world have shown that the infrastructure

of power is vulnerable. Over time, the railways and their tracks have been the scene of many sabotage actions.

The most prominent example known to many are the attacks of the indigenous population on the railway lines of the Western Union Rail, which is considered to be the driving force behind the colonization of North America by the Europeans/whites and pushed forward the war of displacement against the indigenous population.

On the Yucatán peninsula (Mexico), for example, between 1905 and 1912 independent Mayans repeatedly attacked the Decauville Railway Vigía Chico-Santa Cruz, which had been built especially for military purposes in the war against them. In 1913, the Mayas destroyed the railway.



On a captured train, members of the Brigade del Norte under Pancho Villa and Emiliano Zapata victoriously arrived in the city of Cuernavaca, Morelos, 1911, Mexican Revolution.

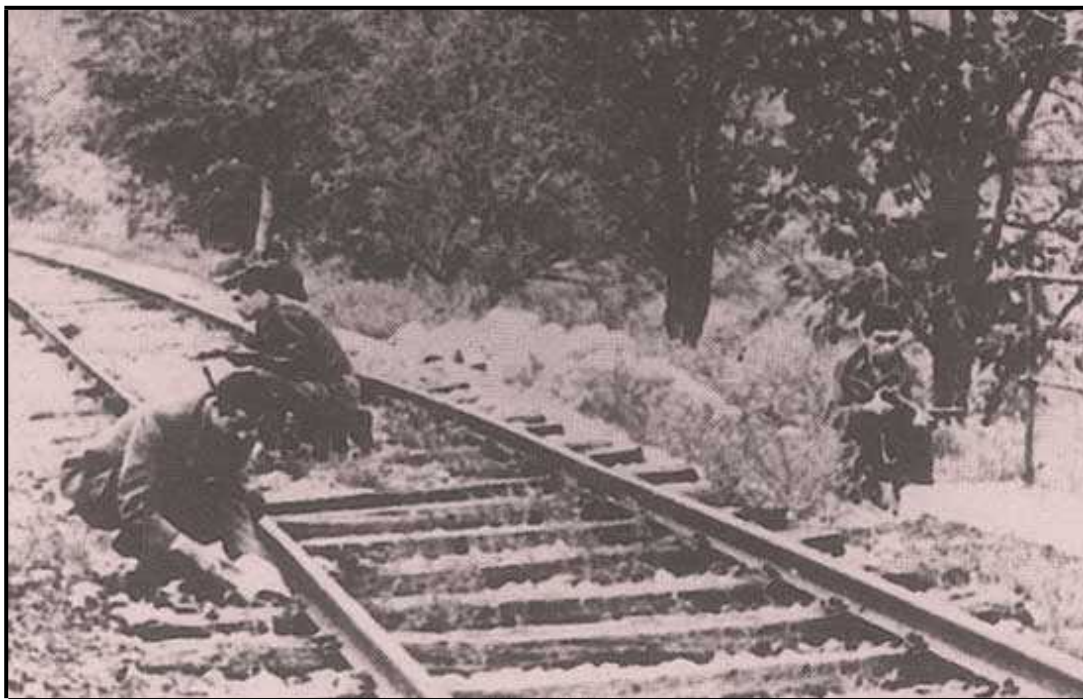

More recent examples from history are the sabotage actions of the antifascist partisans on armament transports and railway lines of the fascist occupiers in World War II. The photo shows the preparation of a track blasting by French partisans.



## Communicability

Fact might be: In any terrain in which resistance is exercised, an active debate between actors with different forms and methods of resistance is necessary. An "intervention in rail transport" includes much more than just technical questions of functionality and safety. If the action is embedded in a social, political struggle, the question arises whether and how a certain method can be used and communicated/transmitted to achieve an objective. And how high the public acceptance for this is. What is appropriate and what is not cannot be determined objectively, but is a question of society's discourse, of one's own strategy, as well as of the collective negotiation of resistance concepts - the "global setting".

Symbolic questions for this could be: How brutal is a nuclear repository planned by a corrupt lobby of entrepreneurs and politicians? How violent is a sit-down blockade, a broken rail, in proportion to this? Is an action self explanatory? How can an understanding of this be communicated in a social environment that is perhaps not directly involved in these disputes? How can people with different, individual, non-negotiable demands for safety and security struggle for or against "one common interest"? Etc...

The term 'intervention in rail transport' is in fact a legal term which can lead to punishment. Nevertheless, this has often been understood as not only legitimate, but also necessary, obvious and ethically necessary action. This is often easier to evaluate if one looks back on history (for example, the evaluation of resistance against the Nazis). In situations in which people themselves - here and today - are or can be the actors, this is much more difficult. Any way of stepping on the railway track also means skating on thin ice. It requires a high degree of personal responsibility. The question of political ethics remains a constant, never-ending challenge.

It was exactly the political consensus in actions, not to endanger human lives, that formed the basis for the relatively high social acceptance of law breaking up to militant actions in the anti-nuclear movement.

### Reduce threshold fears

Sometimes the method of track blocking grows into a mass action of civil disobedience. In combination with a sabotage of the rails - e.g. by cutting-out a piece of a rail line - a diverse, mutually supportive resistance can develop on the tracks. An empowerment to take the first step on the rail takes place in different ways: Reducing threshold fears (Word play in German: *Reducing Thresholds* similar to *Entering the rail sleeper*) can be encouraged by a collective feeling within a bright and colourful rail walk, as well as by trusting a small, well-prepared group of people to make a targeted action. Both are based on the awareness that one's own behaviour and acting is necessary.



## QUOTES:

*„I almost shit my pants, but the faith to be on the road within our group gave me courage. Besides, we were far too many on such a long part of the track. The cops just couldn't stop us.“*

*„When we heard about Sébastien's death, we thought: Now more than ever! He was a few years older than us and we were shocked that they would willingly accept the death of an activist like us... Half a year later we successfully chained ourselves to the tracks - with our friends from France. That was a powerful emotion! With the support of more experienced people we felt quite safe.“*

*„During the transports it was all too exhausting for me. But the protest-actions before were really good. A huge, colourful crowd of people playing music walked across the rails to the crane. Many children were also there. That was really great - we were very loud!“*

*„It is a great moment to see how the rail, which was still intact a moment ago, is suddenly totally bent only by the power of you and your group. There you can see what you are doing (laughs). That makes a good feeling and that's why we planned further actions. They never got any of us.“*

*„We are running, many "armed" with straw mattress, backpack, camping mat and sleeping bag across the fields, through a forest, below barbed wire and over fences straight towards the railway line. But in fact the cops are already there, only about 20 are standing around a bit lost. On the way the police transporters arrive: flanked by policemen we walk the last hundred meters towards the transport line. Again and again "Mettwurst" shouts, the group should stay together if possible, only not quite simply with different baggage and condition. Without problems, the cops don't care a lot, we reach the railway embankment and jump into the valley. On the rails we fall our arms: it is actually done; and it was so easy: we sit on the transport route! [...] We make ourselves comfortable on the tracks, there is a great atmosphere, more and more policecars roll up on the railway embankment.“*



## Variety of tactics

It is particularly the diversity of practices that has always characterized the strength of anti-nuclear resistance. Let us take the CASTOR protests around Gorleben as an example: Often there have been public representations in which the resistance has been presented as separated into non-violent, peaceful and violent protests. This should determine the way in which the protest was read or interpreted. However, the whole picture on the street consisted much more of different facets. How visible, communicable or narratable different forms of action were to the outside world - there were differences: Speakers on a sit-down blockade with a lot of media attention had a different effect than autonomous, militant actions in the forest. But both were part of it.

Lots of people participated in this diversity of resistance, from the "granny next door" who bakes cakes and spreads them on the blockade, over the many spontaneous, unorganized people, up to well-organized actions. In some cases different actions favoured each other and were coordinated with one another or took place side by side in the same chaos, which was unmanageable for the police. Sometimes they took place far away from each other - "it doesn't always fit together, but the playing ground can be divided". Bundling police forces in one place could also create space elsewhere. What was important was a common discussion in which all actors could participate, as well as attempts to establish mutual respect.

This should not hide existing contradictions between the different views or strategies: Sometimes very turbulent debates have always taken place and will always have to take place. And many a discussion has also pointed out contrasts that are difficult or impossible to overcome.

Another aspect of the diversity is the external support of the Gorleben resistance. The great significance of the struggles in Wendland would not have been so enormous without the participation of supporters and newcomers (often first one, then the other) - participation across national borders. After all: nuclear radiation knows no boundaries, nor does the resistance. (This experience inspired us not least for this exhibition.) For example, the anti-nuclear movements in France and Germany have been closely linked since their origins in the 1970s. The relationship between the locals - those who are permanently involved in the local debate - and the supporters of this struggle, which is often a common one (even though it may have different motivations), is an important element in any social and ecological struggle.





## Construction of rail-way system

The **railway formation** forms the track for rail vehicles and consists of the permanent way and the load-bearing track foundation. This is also called "**formation**" refers to all structures that absorb the forces from the permanent way. These include the underlying subgrade, dams, incisions, bridges,



etc. The load-bearing capacity of the formation is decisive for the suitability of a railway line for e.g. high-speed trains or heavy-duty transports. The **permanent way** or track structure of a railway line consists of the ballast and the tracks mounted on it.

The **track** usually consists of a series of sleepers on which two parallel steel **rails** are fixed. Today, Vignol rails made of standardized rolled steel, which are continuously welded, are mainly used for railways.

The **sleepers** made of wood, steel or concrete function as bearing supports for the rails and transmit and balance the weight of the train traffic across the whole track foundation. The rails are fixed to the sleepers with "**small iron fasteners**"; metal base

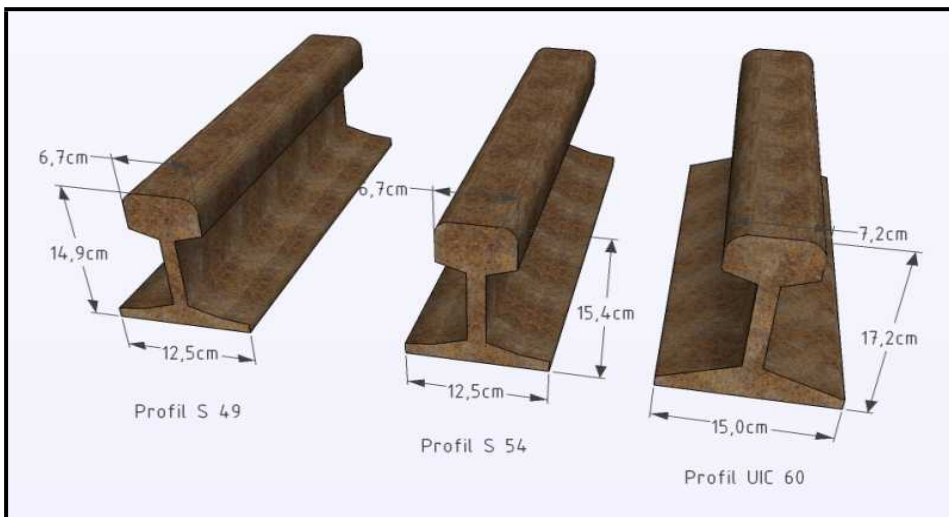

plates screwed into the sleeper, to which the rail is screwed using cast iron chairs. The fasteners keep the rails at the specified distance from each other - the so-called rail gauge.

The sleepers lie in the **ballast**, which usually consists of crushed stones. This type of construction is called "ballasted track". Its advantages are good adjustability, easy adaptability to changes and natural elasticity. Another type of construction is the so-called ballastless track, in which sleepers or other pre-cast



pre-stressed concrete units are integrated into a continuous reinforced concrete slab, laid on a base layer. This is used in Germany for high-speed lines. The stability is significantly better than with ballasted track, but the non-ballasted track is hardly elastic, which has to be compensated by more complex rail bearings and fastenings.

The **signalling systems** along the railway line regulate the blocking and release of line sections and thus regulate train traffic. Power supply and signal transmission are via cables that run parallel to the tracks through covered concrete cable shafts. At the beginning of the year, DeutscheBahn announced a complete "digitalisation of the rail network".

The **overhead power cable** is used to supply electric traction vehicles with electricity. An overhead power cable consists of uninsulated special wire arranged at an approximately constant height above the track. On the locomotives there are the current collectors (pantograph) which are in contact with the overhead cable. The circuit is closed again via the rails as return contacts. A further system of electrification is formed by conductor rails, as they are found in harbours and larger industrial areas. Here the electricity is conducted directly via the rail.

As with all overhead lines up to 30kV, the specified safety distance for non-electrical work in the near of voltage-carrying parts operated at 15 or 25 kilovolts is 3 meters. This may be reduced to 1.5 metres by persons who have been instructed in electrical engineering. The minimum distance may only be reduced when the voltage has been switched off and then all cables involved are grounded or short-circuited (with an earthing rod which has previously been connected to the rail with a clip).

## Detect nuclear transports

Nuclear transports cross Europe and the world every day. The radiating freight is transported by sea, road and rail to the various locations in the nuclear production chain. In the rarest of cases, nuclear transports take place under such spectacular



safety measures as the Castor transports to Gorleben. Not to mention the fact that the train - accompanied by a troop of cops, a sub-locomotive and a helicopter escort - travels at walking speed, as on the last section of track between Lüneburg and Dannenberg.



Ordinarily these are "normal" transports of industrial goods which, packed in barrels, containers and wagons, should only be identifiable by the general label of their classification of dangerous goods. Whether and how the transports are labelled depends on the regulations of the particular country. In Germany, for example, all nuclear transports must be labelled, but not necessarily authorised, depending on their classification. In France, too, transports should be marked, but all questions relating to the nuclear industry belong to the military and are therefore much more difficult to identify.

# Hazard symbols for transport of radioactive materials

	Radioactive substances
	Radioactive materials with low specific activity (LSA-I) e.g. concentrate of uranium ore (U3O8)
	Radioactive materials with low specific activity (LSA-II), fissile e.g. enriched uranium dioxide, unirradiated fuel elements (UO2)
	Radioactive materials with low specific activity (LSA-III), fissile e.g. enriched uranium dioxide, unirradiated fuel elements (UO2)
	Fissile on the transport of enriched, radioactive 'nuclear fuels'
<i>Only in combination with the hazard symbol for radioactive materials:</i>	
	Environmentally hazardous substances e.g. on transport of uranium hexafluoride (UF6) and enriched uranium dioxide (UO2)
	Corrosive on transport of uranium hexafluoride (UF6)

## Danger board (warning sign) with identification number



HAZARD-number  
SUBSTANCE-(UN-) number

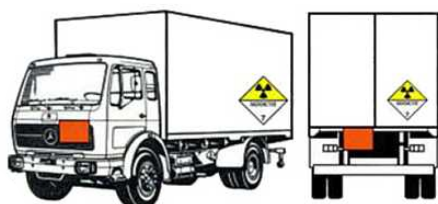

Specified size of danger board (warning sign): 40 cm x 30 cm

### Hazard-number

The upper number is the hazard number, consisting of two or three digits. It indicates the main hazard (1st digit) and additional hazards (2nd and 3rd digits).

- 70: radioactive material
- 72: radioactive gas
- 73: radioactive liquid material, flammable (flash point not above 61 °C)
- 74: radioactive solid, flammable
- 75: radioactive material, oxidizing (fire-intensifying)
- 76: radioactive material, toxic
- 78: radioactive material, corrosive

### UN-number

The UN number (also called substance number) is a fixed four-digit identification number for dangerous goods and substances. It is the lower number on the orange-coloured danger signs and describes the classification and composition of the transported goods.

### Examples:

**70** e.g. uranium ore concentrate  
**2912** (U3O8)

**78** Non Enriched Uranium Hexafluoride (UF6)  
**2978**

**78** Enriched Uranium Hexafluoride (UF6)  
**2977**

**70** Enriched uranium dioxide (UO2) or unirradiated fuel elements (UO2)  
**3325**

**70** Enriched uranium dioxide (UO2) or unirradiated fuel assemblies (UO2)  
**3327**

**70** Unirradiated (MOX-) fuel assemblies (UO2) or irradiated fuel assemblies  
**3328**

## Route observation

In order to be able to research the movement patterns of the various transports and to predict routes and times from the hurly-burly of freight trains that roll across the railways every day, it takes a lot of patience and staying power, in addition to a detailed study of the timetable, to build up a functioning route observing system. During the last Castor transports from La Hague to Gorleben this worked almost completely. Every transit that was sighted was reported by 'track guards' and put online on a ticker. In addition to systematic scouting and attentive residents, vigils play an important role in setting up a route observation system. In this way, the grandmother, who stands with her cardboard sign against the Castor on the platform in Buxtehude, has also made the success of many a track action possible...



## Stopping trains

The blockade and sabotage practices described here by no means causing train accidents! In order not to endanger people, with a few exceptions (e.g. hook claw) the techniques described are designed to prevent standing trains from continuing



their journey. Once again: In the case of blockades in rail traffic, it is essential that the traffic is safely at a standstill! Track actions require very precise preparation and execution - ideally with the help of people with their own experience on this terrain.

What is needed is a well-functioning system consisting of a pre-stop, observation and action group that is in trouble-free (radio) contact. It has been shown to be useful to divide the pre-stop group into two teams to ensure that the train is stopped. These should stop the train at a distance of at least 2km in front of the action group.

Common methods for stopping a train are: a light circle generated by a torch in the air (international optical stop signal in rail traffic), the launch of fireworks, clearly visible banners, a barrier tape stretched across the rails or the attachment of "rail clips" (international acoustic stop signal from railway workers: a kind of mini explosive device is clicked onto a track; emits a typical bang when a train crosses). Usually there is a combination of the various possibilities. The action group only does enter the danger zone (rail), when they receive the message / know that the particular train is standing.

## Speed, mass, stopping distance

Anyone who wants to stop a train during running traffic should be aware that the braking distance of a train weighing tons is very long. It is difficult to calculate the exact braking distance, as many factors have to be taken into account: the type of



brakes, the reaction time of the train driver, weather and visibility conditions, the weight of the train and the speed. An example from freight traffic can, however, illustrate the dimensions that this is all about: for example, a 2000 tonne freight train travelling at a speed of 50 mph only comes to a standstill after approx. 1 km in the case of emergency braking.

## Action "Pull the emergency brake"

This is probably the easiest and safest way to stop a train. The majority of the track of nuclear transports runs on the rail network, on which normal freight and passenger traffic also takes place. These must be restricted as little as possible by such transport. This is why there is a precisely planned timetable. After a detailed study of the route, the planned time schedule and the timing of passenger transport, at favourable rail sections it was possible to stop the (onward) journey of a nuclear transport by activating the emergency brake in passenger trains.

# BLOCKADE





## Sitting blockades

Sitting blockades are the absolute classic of civil disobedience. They have achieved great popularity above all through the sit-ins of the 1960s. Students in particular practiced this form of protest in their rebellion against racism, war or homophobia. As early as the 1930s, sit-in strikes were used by American workers as a strike tactic. Since the 80s, sit-in blockades have also established themselves in Europe. Against nuclear weapons, road construction, NATO and later also summits or Nazi demonstrations.

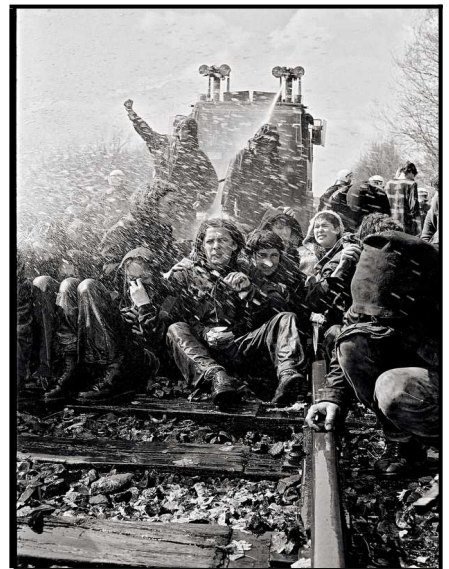

In the CASTOR resistance, seat blockades on rails and roads had an enormously symbolic character and became a characteristic image. It enjoyed such a high level of acceptance that mass blockades regularly occurred, sometimes with thousands of participants from young to old.



Despite a relatively low inhibition threshold, it is above all a courageous decision to use one's own body and expose oneself to police violence by "clearing up" the blockade. The police's strategy is usually a



brutal one: So the use of batons, pepper spray, pain grips, dogs, horses and water cannons. Nevertheless, the collective, mostly peaceful and de-escalative character as well as the possibility to stand up before the eviction, can create a certain feeling of security.

Sitting blockades can drag on for many hours, especially if additional logistical routes for eviction are blocked, people sit behind the blockade again after being evicted or other methods of rail sabotage are used, such as rail shoes, shoveling ballast away (graveling) or similar.



## Technical blockades

By this we essentially mean further developments of human blockades by technical aids. The first uses date back at least to the anti-US nuclear weapons protests in the 1960s. The delay achieved here tends to be in a better proportion to the number of people involved in the blockade than with conventional seat blockades. Like sitting blockades, this form of protest - in addition to the rail actions described - has been used in many environmental actions and on the road against Neo-nazi marches. The most original and sometimes still common form is a combination of handcuffs and a chain or bicycle lock, which is placed around a gate, a rail, a tree or a machine. In the course of time, this form of action has been refined and various possibilities have been developed which make it considerably more difficult to detach the firmly chained person.



Here we present different variants of chaining actions on the track in anti-nuclear resistance. A common feature of the different applications is that the concrete fastening in a corresponding device only takes place shortly before the police reaches the place of action. But only when it is clear that the train is at standstill!



And: The people in the blockade are at the mercy of the police and their procedures. From the moment the police try to break the blockade, they are responsible for the physical integrity. However, it has been shown that in most cases this has been disregarded in one way or

another. Often the action force first used physical and psychological violence and tried to simply pull out chained persons. Verbal harassment and injuries were not uncommon. (By e.g. sending the support persons off, threatening of the police doctor with amputation, by tearing or pulling the chained arm, by twisting the arm, by denying food and drinks or by injuring them with coarse mechanical equipment, etc.)

Since the first task forces at the scene of action are usually not special units ( these are often called in later), it is important that there is a support group of the blocking persons. In addition to the stopper and observation groups, these people, who are directly on site with the chained ones, play an important role. The supporter surrounding field is the "mouthpiece" of the action, and responsive for the police. It can make sense that there are 1-2 people who contact the approaching cops directly and inform them about the type of action. The group also passes on information from "outside" to the chained persons, documents the situation, does public information work and takes care of all important matters, such as demanding sufficient protection (hearing protection, protective glasses, break) during use of equipment.

Successful blockades often dragged on for many hours and sometimes had a lengthy legal aftermath. A good and intensive examination of the material, the railway line, the different tasks and the interaction in the group, the possible police repressions, the legal aftereffects and a common dealing with them afterwards is therefore necessary.

### **Lock-On...Pipe**

Lock-ons by means of a pipe are technically rather easy. Depending on the location of the action and the previous measures taken by the police on the train line, the pipe can be buried under the rails parallel to the sleepers in the ballast or used flexibly before the action. However, this takes up the time for "graveling" shortly before the action.



In many cases, two people chain themselves with one arm in such a way that the work of the police is made more difficult by the location of the bodies. It has been shown that the police's flex work on the pipe is much more complicated if the pipe consists of different layers of material. For example, combinations of different metal pipes, between which concrete or ceramics, sandpaper and tar

paper have been included, are known. Inside the tubes there is a bar in the middle to which the lock is attached.

Special wristbands are used for this purpose. These are very different in their design and range from tube material, through which e.g. a bicycle chain is pulled, to special leather arm bands to wristbands from plaster, into which a chain link is worked in. A wide and padded supporting surface has proven to be advantageous and, above all, pleasant for the arm and wrist. It is common practice for activists to attach themselves with a padlock, which cannot easily be reopened by themselves. Also in consideration of subsequent actions of other groups: Because the police are much more massive and rabier if they assume that the people just need to "let go" or snap a carabiner open.

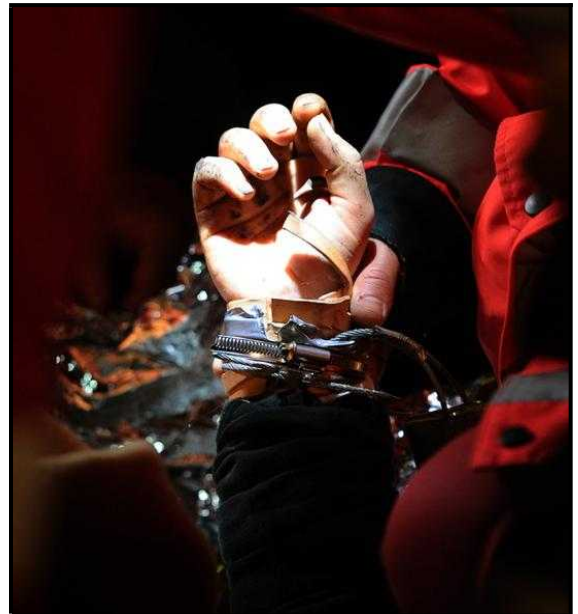

Often the officers then first try to check the exact fixed point and the attachment of the bar as well as the concatenation with the help of an endoscope. However, attempts have also been made to cut arm cuffs with other tools (e.g. telescopic scissors). This was not possible, at all, if the diameter of the tube was such that an arm with clothing fitted comfortably into it, but left no room for the police working equipment.



The only way to remove the blockers is to open the pipe in the middle and cut the chain directly. Depending on the type of lock-on action, special units with technical equipment must then be requested. This means that even heavy equipment such as flexes, pneumatic hammers, drills, crowbars and cutting torches can be used directly.

### Lock-On...Concrete block

A much more complex lock-on is that of a concrete block in the track bed. The structure of such a block usually consists of one or more arm pipes (as described under "Pipe"), which are then set in concrete. For the removal a technical unit of the police has to be requested, because first the concrete mass has to be removed, in order to get to the actual pipes and thus to the chaining device. In addition to the greater expenditure of time, a higher use of machines is also necessary.

Uses of this blockade have shown that armoring by incorporating different materials into the block makes the work of the police considerably more difficult. For example, metal grids, car tyre pieces, various types of rubber, car rims (on the underside of the tube) and tar board were processed in blockades. The arm pipes were



usually surrounded with many metal parts or with several concentrically arranged pipes of increasing diameter, whereby the spaces between them were again filled with concrete. The position of the pipes also plays a role, because these concrete blocks are often designed for several people.



It is known that concrete takes a long time to harden completely, so the production of such a block takes a correspondingly long time. It is an enormous achievement to place such a block well hidden under the ballast between the rails without leaving any traces.

In some cases it became known that such blocks had been found in advance by police patrols on sections of the road and that the lock-on had been made unusable in order to prevent the action. But the quite numerous actions of this kind in the Anti-Castor movement - some of which lasted up to 21 hours - show that it is possible to go through out.



### Lock-On...Pyramid

The pyramid is a very effective blockade technique, which was initially used for road blockades. A blockade by means of a pyramid is complex in its preparation and manufacture. It consists of two concrete pyramids lying one inside the other, each with pipe elements for the arms, in the core of which there are bars for fastening the arm cuff. Unlike the concrete block, however, the pyramid is not rigid because its two parts are not connected. When the



pyramid is upright, the arms can be inserted. As soon as it is moved, the angle of the arm passage changes. This makes it much harder, if not impossible, for the task forces to work on it, because a displacement of the material would cause considerable injury to the arms of the chained people. An example of a blockade of this kind on the street is an action against a Neo-Nazi march in Bad Nenndorf in 2010: The police finally solved this by pushing a plate under the whole construction together with the blockers and then driving it to the side of the road. However, this is not (so easily) possible on the rail. On the last Castor transport to Gorleben in 2011, the blockers released themselves after 14 hours and the police had to declare that they did not have a proportionate solution to break the blockade.

## Abseiling blockades

Another form of blocking, which usually required the police's height rescue team and therefore also is time-consuming and effective, is the abseiling or climbing blockade. This form of action has become particularly well known in the context of tree occupations. With rail blockades of this kind, one or more persons - from a traverse between two trees or from a bridge - rope down a bit and thus hinder the train from continuing its journey.



For such an action it is extremely important to deal in advance with rope structures, material science, climbing techniques as well as voltage conditions of the overhead line and safety. It brings great advantages to gain experience and routine in the single handlings. A well-rehearsed team is also of considerable importance. In addition to the person(s) climbing, there should always be a person with climbing experience plus climbing material in the support team on site for safety reasons, in order to be able to intervene in a supportive and protective manner if necessary.

The securing material (harness, rope, carabiners, slings...) must not be damaged under any circumstances and should be checked again shortly before the action. Abseiling over the rails also only takes place when it has been ensured that the train has stopped.

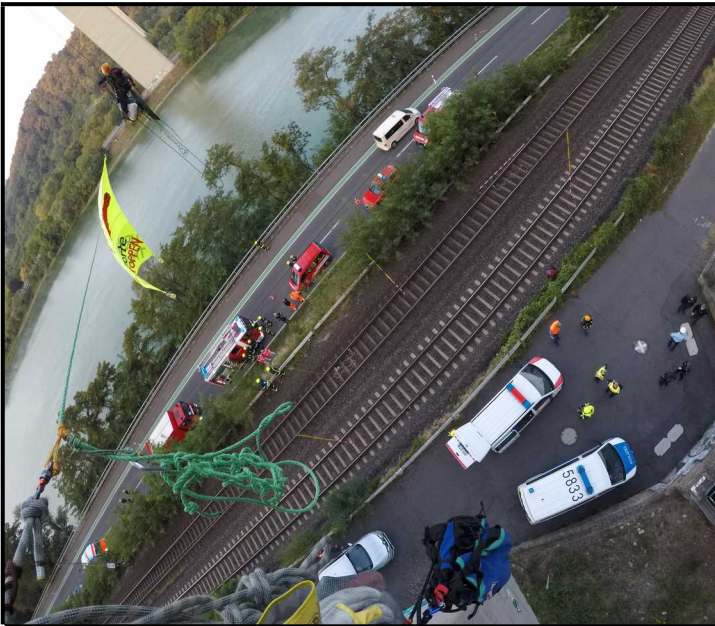

Despite such safety precautions, during a transport there was the case that the Castor simply drove on after a short time, although the person was still hanging on the bridge over the tracks. It also happened again and again that the cops broke such a blockade improperly or ruthlessly and knowingly accepted injuries of the activists.

## Tripod blockades

Another form of blockade is by means of a tripod, in which (in most cases) a person "hangs" on a structure consisting of three long rods with a belt. This form of civil disobedience, which became known through road blockades in England, is increasingly used in actions (especially in the environmental movement), e.g. in the occupation of gene fields.

The three rods are built into a three-legged tower by connecting them together in the upper part. Metal rods are often used for construction (these are usually scaffolding rods and clamps). But also tree trunks, which were constructed with the help of a rope according to the tripod principle, can be seen in





actions. When putting up, it is important to make sure that there is enough space for installing and erecting and that the legs stand securely. It has proved to be ideal to have everything prepared as far as possible, close to the place of action. Anchor points attached in advance at the upper end (e.g. using a strap loop) are used to attach the belt. The person in the belt prevents the "simple" removal of the construction. As with all blockades with technical means, a good preparation and examination of the material is also necessary here.

Depending on the height of the tripod and the nature of the terrain, lifting platforms or vehicles (e.g. a fire-fighting vehicle) that come close and high enough to the person(s) are usually used to bring the activists down safely. However, there have also been cases where the task forces have simply tried to carry away a tripod.

## Material blockades

This category includes all forms of junk put on rails, but also felled trees and more technically sophisticated methods (e.g. using concrete). Also in barricade construction, as in lock-on constructions, the mixing of materials makes it difficult to find the right tool to remove them.



Material blockades are used, for example, in the defence of sabotage actions before cops, or as the last stop signal before a blockade action ("light wood barricade").



Another popular way to make it more difficult to remove a material blockade in the short term is to set it on fire. An essential difference to other forms of blockade is that after the blockade has been set up, people can avoid the police's control and do not have to set up their own bodies.

## In memory of Sébastien Briat

On 7 November 2004, the then 22-year-old activist Sébastien was killed in an accident during a planned Castor chain-action. The group around Sébastien set out to block the La Hague-Gorleben transport by means of a lock-on near the village of Avricourt (Moselle). For this purpose, they had placed metal pipes under the tracks with which they wanted to chain each other after the pre-stop groups had confirmed that the train would stop. There was a concatenation of own misjudgments, mistakes and unforeseeable events, due to which the train could not be stopped. The Action Group, which was still next to the track at that time, was surprised by the sudden arrival of the train. It passed the activists in a curve at high speed. Sébastien did not gain enough distance from the track in the short time and was caught by the train's air suction and rolled over, causing fatal injuries.

In the course of the investigation it turned out that the train had driven at a speed of around 60 mph, more than three times as fast as the regulations required. The Castor transport was only allowed to "travel on sight", which would have corresponded to a speed of 19 mph in the curve. At that time, speculations suggested that the train was trying to make up for the delay of three hours by a recent lock-on action near Nancy. In addition, the police escort helicopter for the route observation - actually a sign of the approaching nuclear transport - was just at a refueling stop.



Many people, like us, felt personally touched by the death of Sébastien, which had the effect of a shock. The blockades of the Castor transport to Gorleben in 2004 continued, albeit under the influence of the accident - in mourning, and often in fury.

Many activists have drawn different conclusions from these dramatic events. This has strongly influenced the further development of lock-on blockades, especially in France.

We still remember him, and we are again and again with the thoughts of his family and former friends. And we have learned a lot from it. His story is part of our own, part of the history of the anti-nuclear movement. The history of Sébastien is particularly closely interwoven with some people from the Meuse region (Nuclear waste repository in Bure). In a possible future of blockade concepts or actions on the Castor tracks to Bure, this should be given an appropriate space.



Those who die gonna keep on living,  
in our struggles, in our hearts anyway.

Those who live shall continue on struggling.

Nos mortes continuerant à vivre  
dans nos cœurs et nos luttes.

Nous vivantes nous continuerans la lutte.

# SABOTAGE





## Graveling

The most simple method of making a track impassable without the use of tools and also the most frequently used form of rail sabotage is "graveling", i.e. removing the ballast stones from the track bed. The superficial removal of the

ballast between the sleepers or the uncovering of the sleeper heads, however, is not sufficient to achieve more than just a symbolic effect. The rails together with the sleepers



must hang freely over a longer section or be hollowed deep under the track.

Graveling has always belonged to the small one-time-one of resistance on the track. On the one hand it forms the basic prerequisite for many further blockade and sabotage practices, on the other hand the relatively low-threshold action approach offers many people the opportunity to come into contact with the topic and can thus have a high connectivity.



## Sawing & Screwing

Because even the most courageous handicraft (and footwork) quickly reaches its limits, the question of the right tool arises. If spades and grave forks already offer a decisive advantage when graveling, most tools suitable for track deconstruction are not available in hardware stores. Except when some modifications have been made with regard to their special purpose. Classic examples are the standard metal hacksaw, whose frame has been extended to rail height (15 cm), or the flexed wrench, which allows a pipe extension to be



fitted to increase leverage. Other rail sabotage tools are directly similar to the track construction tool and are adapted to the needs of subversive use (in terms of noise level, transportability, etc.), such as the shortened and dismountable socket wrench for square screws.

Again and again, the resistance had to adapt to the challenges of new conditions and react with a lot of imagination and creativity to further developments in rail construction. An example: when the Lüneburg - Dannenberg section of the track was renovated at the beginning of the 2000s, the 41 hexagon spanner socket disappeared from the rail fastening range and was replaced by a conical square screw (as is also used for bolting the sleepers). A resistance arsenal of wrenches accumulated over generations ran the risk of becoming scrap metal overnight. Somebody with a clever head then had the saving idea: a 41 mm socket lasered out in the appropriate size as an adapter piece and the problem was solved. Simple, but ingenious!

Both the German and the French rail networks are in a rather desolate state of maintenance. It can always be assumed that rail components are rusty or strongly deformed due to wear. In addition to the actual tool, there are also usually tools such as pipe extensions (levers) and striking tools (e.g. hammer) in the tool boxes of the rail sabotage. The same applies to rust removers (creep oils, etc.), which

should also make sense when using saws as lubricants in order to reduce the wear of the saw blade. Nevertheless, it probably takes several saw blades and quite a while to make a complete rail cut manually.



It would be much faster with the help of heavy equipment (e.g. cutting torch, motor/accumulator flex, etc.). There are some examples for motorized or with burners performed rail cuts documented, such as the public deconstruction of the railway line Uelzen - Dannenberg. However, the use of such means is rather the exception. On the one hand weight, as well as the high noise level do not permit the use under most action scenarios, on the other hand the relatively high procurement costs

might play a role, because action tools are usually disposed after the act.

## Lever & Bend

In addition to the "dismantling techniques" described above, bending the rails is another way of sustainably damaging a track system. This has often been achieved with the aid of lever forces, e.g. by pushing a tree trunk under the graveled track and then lifting or pushing down the other end. Sometimes the bolting was loosened over a longer section before using this method.

A bent rail track cannot be bent back to its original shape, but must be replaced!







Much less power- and personnel - intensive is the levering of the rail by means of a hydraulic car jack. Here, too, the previous loosening of the bolts seemed to have made sense, depending on the lif-

ting force. However, documented experiments with a 10 t truck jack have shown that the rail can also be lifted out of the track bed together with the sleepers. This not only saved a lot of time, but also looked more impressive in the end. Whereby the damage caused and thus the blocking effect was the same.

In a further documentation about an action in 2001, it becomes clear that the ballast was removed between two sleepers enough for the jack to fit under the rail. For better stability, the tool was placed on a wooden plate: enormous forces act when the rail is raised and the maltreated work-piece is put under tension. There is a danger of getting trapped and injured both when the jack is lowered and especially when it slips unexpectedly!

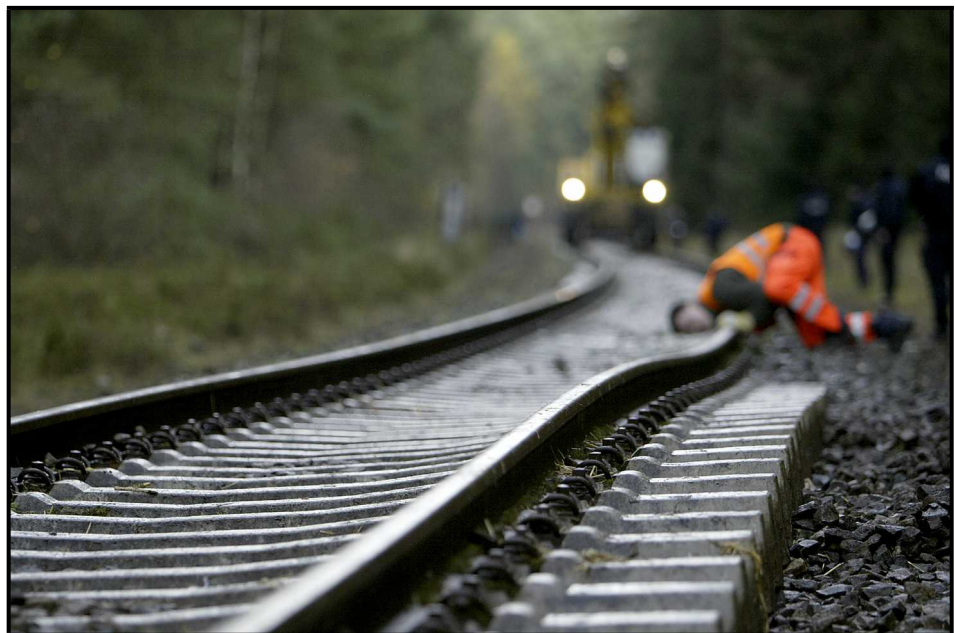

In order to prevent this from happening, bearing timber was sometimes placed under the rail at the same time as being pumped up. In this way, the jack could also be conveniently attached a second time to further bend the rail.

An example from the late 90s is also known, where horizontal levering was used on the already shut down track between Uelzen and Dannenberg, which was only used in exceptional cases for Castor transports: Several sleepers were undercut by graving and then sawn in the middle. Then the now separated rail lines were pushed apart by levering. This meant that the track gauge on a few metres of the once parallel rails was no longer quite correct. There are no limits to the fantasy of bending rails.

### Rail (inhibitor) shoe



Strictly speaking, the rail (inhibitor) shoe - also known as the "rail claw" - belongs to the family of material blockades, because its use prevents the train from continuing its journey, but in itself does not cause any further damage to the track. However, due to its technical sophistication, we tend to classify it as a sabotage practice.

Basically it is a "U" welded together from steel profiles, which encloses the rail head. Once mounted on the rail, it cannot be loosened again and must be removed by flexing. This is ensured by a mechanical locking mechanism based on the laws of gravity: the latch that clamps the rail shoe to the rail has a hole with the diameter of a drop bolt embedded in the frame. If the bolt is pushed inwards, the bolt slides into the hole and locks the mechanism. To unlock the rail shoe again, it would have to be turned upside down, which is prevented by the rail.

Although the use of rail shoes during Castor transports to the Wendland region is amply documented, we are not sure which year this charming invention goes back to. Anyway, the model shown here was used successfully

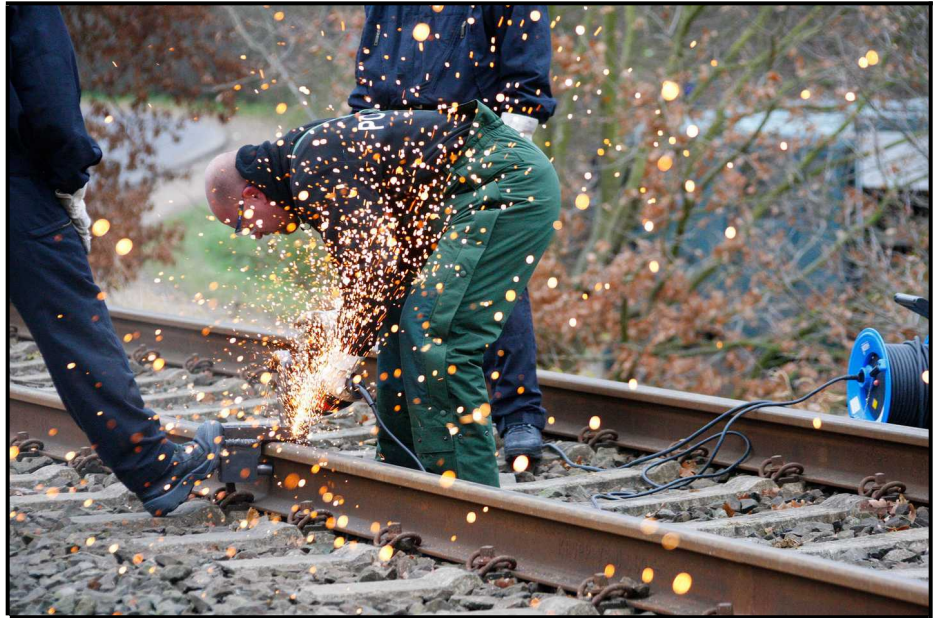

for several years and found increasing popularity. Some technically experienced cop succeeded in unlocking a rail shoe attached to the track

during a Castortransport at the beginning of the 2000s (also with the help of simple physical laws, which we don't want to go into more detail here). In any case, the locking mechanism of the following series was additionally secured by a spring. The second generation was able to solve this problem, but lost some of the charm of its basic idea, because the rail shoe had to be tightened to make it "armed".

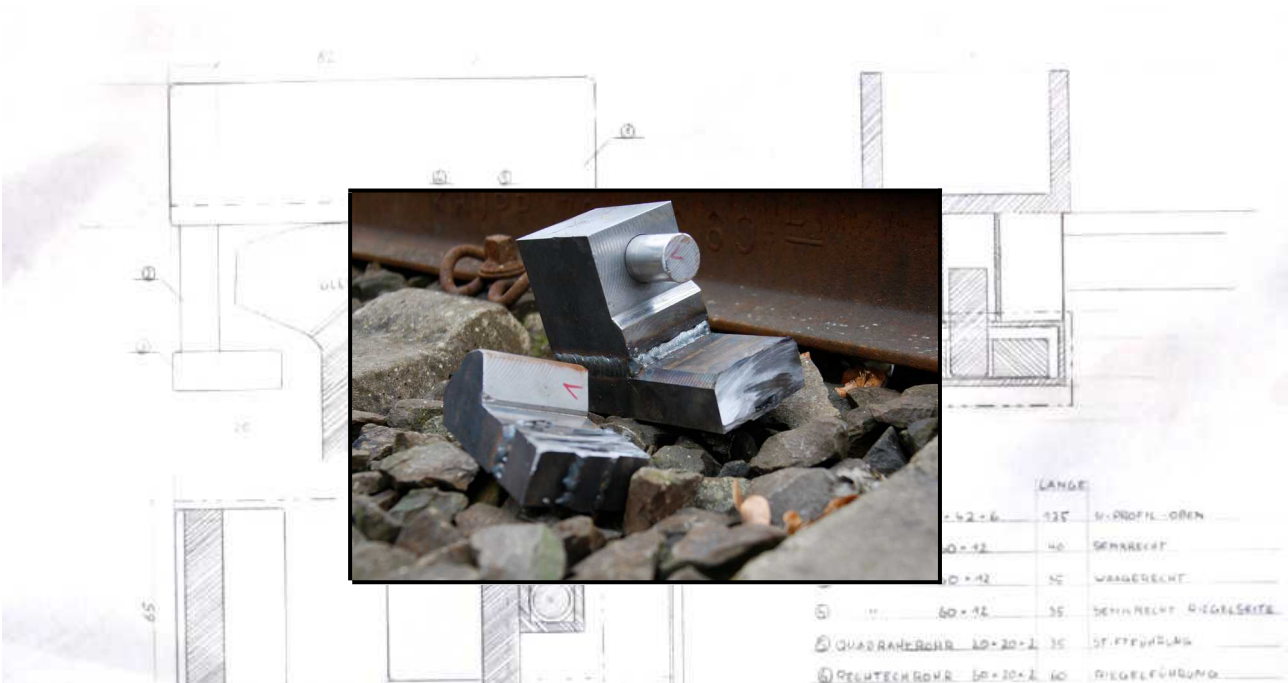

## Horseshoe-shaped steel hook-claw



The invention of the "hook claw" (as we call it in the following for lack of a professional translation) resembles a small revolution in the history of research into effective means in railway sabotage. An inconspicuous piece of metal, placed in the right place, destroys the overhead



line of a railway line with all the power of a train weighing tons!

The first appearance of a hook claw in the early 1990s was documented in the Netherlands and was directed against NATO arms transports in connection with the First Iraq War. Later, it found its way especially into the anti-nuclear resistance.

### Manufacture and handling:

A 2-3 cm thick round steel is bent into the appropriate (horseshoe-)shape or carefully welded together. The stability of the construction is of great importance for the safety of people standing around, as enormous forces are exerted in the moment of impact. In order to prevent skidding around, a movable drop bar also secures the claw on the overhead contact line.

The hook claw is suspended from a bridge in the overhead line by means of a fishing line, or suspended from the track by means of PE pipes inserted into each other. The fixed bracket on the side of the claw is used for suspension. It is important that the claw is in the opposite direction to the driving direction in order to catch the current collector correctly.

Working in contact with the live overhead line requires great care. In order to avoid the danger of an electric shock when attaching a claw, for example, an action should be stopped in rain or even fog.

### **Function and mode of action:**

The current collector of the locomotive hooks into the claw and drags it over the overhead line, whereby the suspensions of the line are torn off and the cable finally comes to a standstill on the roof of the train - a short circuit occurs. Even if the emergency brake is applied immediately, the overhead line is destroyed for at least one kilometre.



Several railway spokespersons have publicly confirmed after attacks that there is no danger to passengers or train personnel if this technique is used "properly".

### **Symbol of the militant anti-nuclear movement:**

However, the hook claw owes its fame less to its innovative character than to the various (unsuccessful) state attempts to bring this practice closer to terrorism and thus discredit the anti-nuclear movement.

At the end of the nineties, a series of attacks on overhead lines in connection with nuclear transports to Gorleben led to an elaborate investigation into the 'foundation of a criminal organisation' according to § 129a. Almost 1000 opponents of nuclear power in Wendland and in several German cities were targeted by the repressive authorities. Many years later, the trial, which became known as the "Golden Hook Claw" (according to the solidarity campaign of the same name) , was abandoned without result.

Probably the best known process today in connection with the use of hook claws is the so-called "Tarnac affair": in November 2007 the overhead lines on several railway lines in Germany and France were sabotaged. The attacks were directed against the Castor transports from La Hague to Gorleben and were intended to commemorate the death of the young anti-nuclear activist Sébastien Briat in 2004.



On the French side, the investigations into "association malfaiteur" (corresponding to the German §129) led to a small rural commune in the village of Tarnac. The case was especially explosive because, in addition to the sabotage acts, the defendants were also partly accused of being authors of several communist-insurrectionist writings using the pseudonym

"Invisible Committee". The texts (the best-known of them is probably "The Coming Uprising") are the basis for a philosophical variation which is called appealism - based on the first work "The Call" - and which, in addition to much (justified) criticism, attracted attention far beyond the left-radical scene. In 2018 - more than ten years later - the "Tarnac case" is heard in court. In the proceedings, which have received a lot of media attention, illegal investigation methods and falsification of evidence by the authorities become obvious. The trial ends with acquittals.

Another way to disrupt rail traffic: The earthing of the overhead line to the rail. In this case, carried out by employees of Deutsche Bahn AG, to finish a climbing blockade / to recover a hook claw discovered early.



HAKENKRALLE

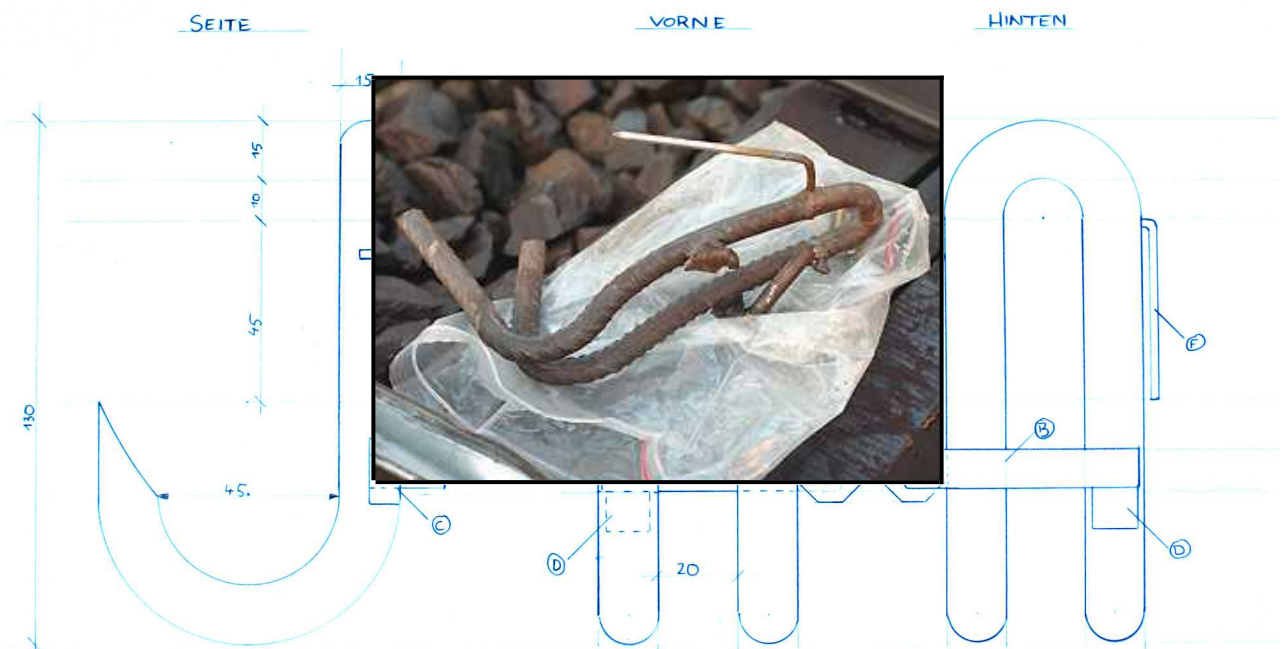

## Cable shaft - Arson

Arson attacks on cable shafts have become widespread in the repertoire of militant action groups. This method is used not only in anti-nuclear struggles, but also, for example, to fight against coal energy, or to disrupt the time course of Neo-Nazi events.

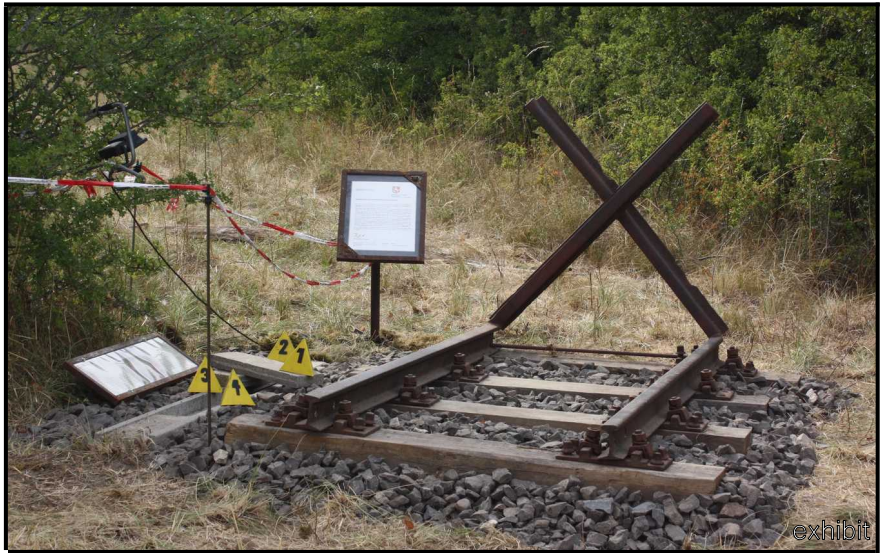

Due to a serious attack on a cable junction of the Berlin S-Bahn in 2011, which not only disrupted rail traffic for several days, but also telephone and Internet connections, the use of the DB cable shafts by third companies is known to a wider public. Under the pseudonym "Grollen des [Rumbling of] Eyjafjallajökull", unidentified individuals had committed an arson attack on a cable shaft of the Berlin S-Bahn. Referring to the eruption of the Icelandic volcano "Eyjafjallajökull" in 2010, whose huge cloud of dust paralyzed air traffic for days throughout Europe, they aimed to strike the "tormenting and murderous normality" of a metropolis and set a "stop signal".

What they proclaimed to be a conscious "interruption of people's rut in the name of a capital city", representing arms exports, nuclear policy, ecological catastrophe and migration control, was subsequently discussed very controversially within the framework of the so-called Slow-down-Debate. The intention to impose the consequences of the attacks (delays, long waiting times) on others and to force them to pause in their everyday (working) lives not only met with incomprehension, but also brought the accusation of arbitrariness and paternalism into the debate.

Beyond this controversy: The interruption of electricity supply, flows of goods or data, with the aim of disrupting the functioning of capitalist logic or the infrastructure of the state order, has always been a kind of resistance. In recent years, this has found new inspiration in the age of digitalization.



North Police Department  
P.O. Box 1312, 23876 Hanover



**North Police Department  
Lower Saxony**

- Department for politically motivated crimes -

**Fictitious report of a possible course of an offence**

During the night of 29.02.2019, an arson attack was carried out on the Berlin-Hamburg railway line at rail kilometre 1312 on signal cables of the German railway, as a result of which service was severely disrupted.

First, the perpetrator(s) opened a cover plate of the cable shaft with a lever tool (screwdriver or similar) to gain access to the signal cables **(1)**. Further plates were removed to supply the source of the fire with sufficient oxygen **(2)**. A piece of metal placed across the cables should probably ensure that there is a short circuit when the cable insulation melts **(3)**. A incendiary composition was then placed in the cable shaft and ignited **(4)**. The perpetrator or perpetrators escaped unidentified.

After conclusion of the forensic investigation at the scene of the crime, it was possible to restart railway services to a limited extent. Until the repair work is completed, the trains are directed by hand signal. The train cancellations caused by the incident, however, would have led to irregularities in the timetable, whose processing could lead to delays for several weeks, according to an expert of Deutsche Bahn AG. Rail passengers were not endangered at any time, as the section of track was automatically closed to rail traffic in the event of signal technology failures.

A claim of responsibility has not been on hand so far. Since a connection to the forthcoming Castor transports cannot be ruled out, however, the police state security took over the investigations.

Signed

XXX

O. Hüppts  
Police superintendent

**service building**

In ambush No. 12  
29439 Lüchow

**opening hours**

Mon. to Fri. 09:00-12:00

**phone**

05841-1312

**email**

police-violence@lower-saxony.de



## More special

### Termite:

Railway rails are made of hardened steel. The running surface in particular is quasi permanently "re-forged" by the regular train traffic weighing tons. This means that rails cannot be worked on with conventional welding methods (electrode, thermal, shielding gas)!

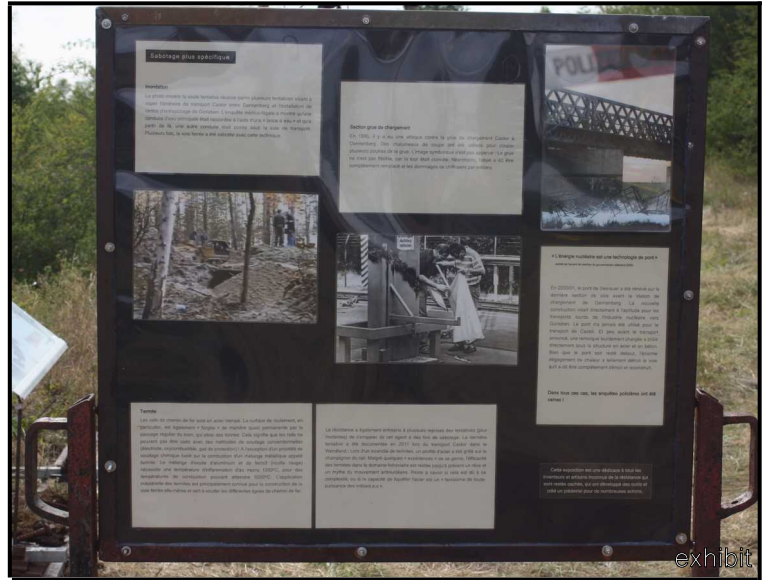

The exception is a chemical welding process based on the combustion of a metal mixture called termite. The mixture of aluminium oxide and ferro3 (red rust) requires an ignition temperature of at least 1200°C, during combustion temperatures of up to 5000°C occur. The industrial application of termite is mainly known from track construction itself and is used to weld the single rail lines to each other.

The resistance has also repeatedly made (smaller) attempts to seize this means for sabotage purposes. The last attempt was documented in 2011 during the Castor transport in Wendland: With a termite fire a steel profile was "grilled" on the rail head. Despite some such "experiments", the big, sustainable termite action in the matter of rail has so far remained a wishful dream and myth of the anti-nuclear movement. It remains to be seen whether this is due to the relative difficulty of procuring it, or whether the ability to liquefy steel is too much of a "militant fantasy of omnipotence".

### Undermining:

The picture shows the only success of several attempts to undermine the Castor transport route between Dannenberg and the interim storage facility in Gorleben. The forensic investigation showed that a main water pipe was tapped by means of a so-called "water lance" and from there a pipe was laid under the transport route. This technique has also been used several times to try to sabotage the railway line.



## Cut of the loading crane:

In 1995 there was an attack on the Castor loading crane in Dannenberg. Cutting torches were used to cut through several beams of the crane. The symbolic image failed to appear: The crane did not bend its knees, because the sinking tower was jammed. Nevertheless, the object had to be completely replaced, and the cost of the damage was in the millions.



## „Nuclear power is a bridging technology“

(from the coalition agreement of some government parties of the FRG 2009)

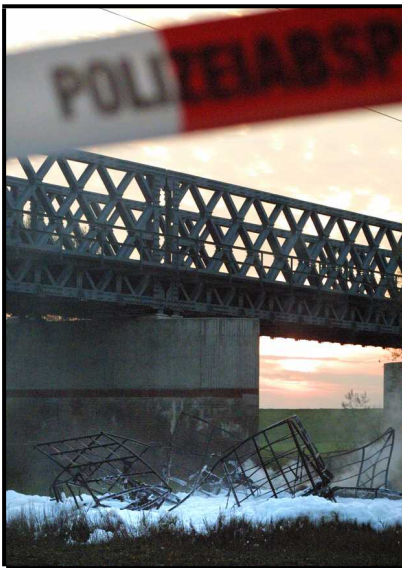

In 2000/01 the ailing Seerauer Bridge was renewed on the last track section before the Dannenberg loading station. The new construction aimed directly at the suitability for the heavy-duty transports of the nuclear industry towards Gorleben. The bridge was never used for the Castor transport: Shortly before the announced transport, a richly loaded trailer burned directly under the steel and concrete structure. Although the bridge remained standing, the enormous heat development affected the statics to such an extent that it also had to be completely removed and built anew.

**In all these cases, the police's investigations petered out!**

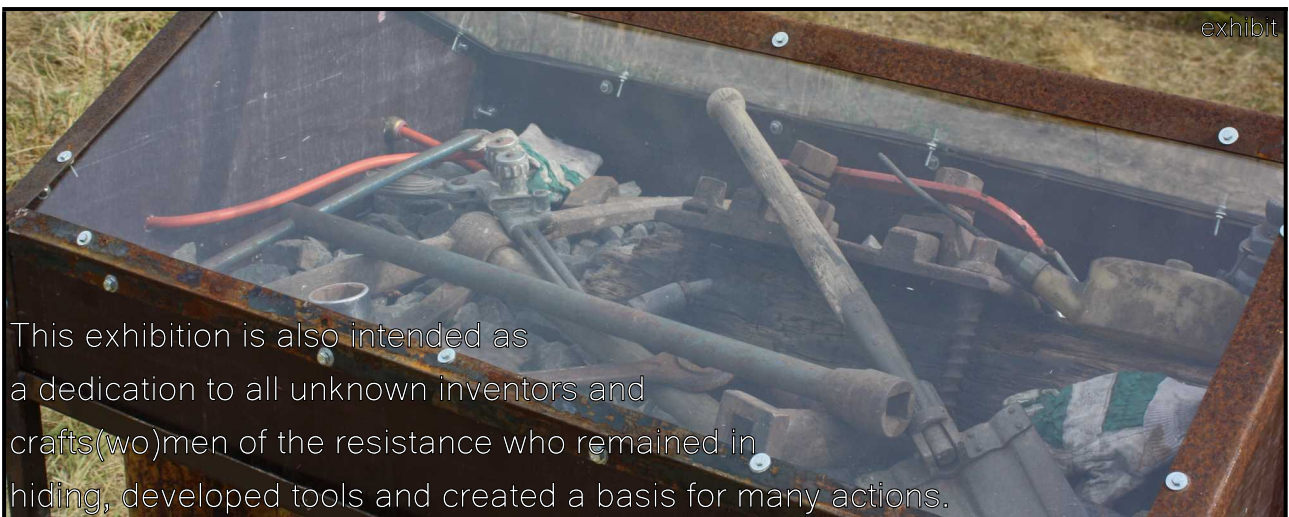

This exhibition is also intended as a dedication to all unknown inventors and crafts(wo)men of the resistance who remained in hiding, developed tools and created a basis for many actions.

# RESISTANCE AGAINST NUCLEAR TRANSPORTS

## PRESENT & PERSPECTIVE

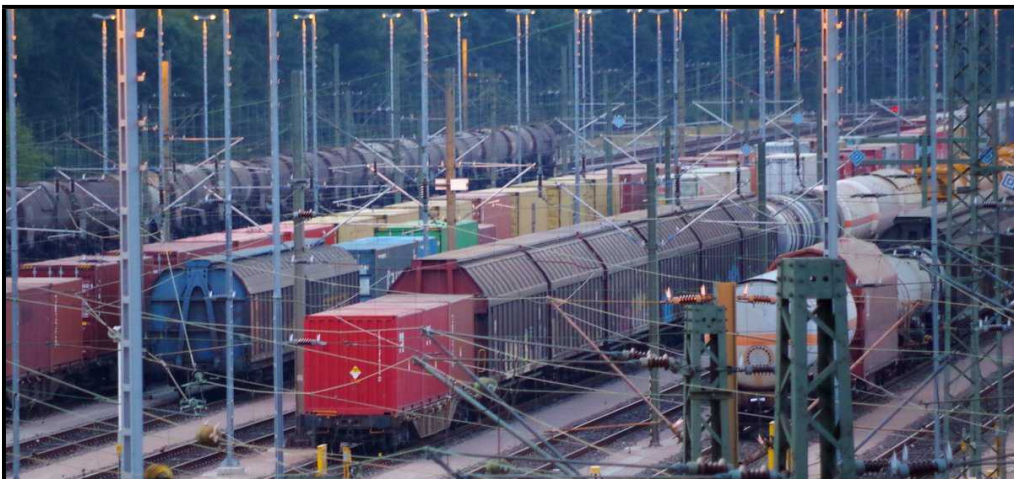

## Uranium ore transports Hamburg - Narbonne

With the announcement by the German government that it would withdraw from the commercial use of nuclear energy after the reactor catastrophe in Fukushima in 2011, the movement faced a fundamentally new situation overnight. This principal "victory" over the nuclear industry brought above all a crisis of legitimacy for

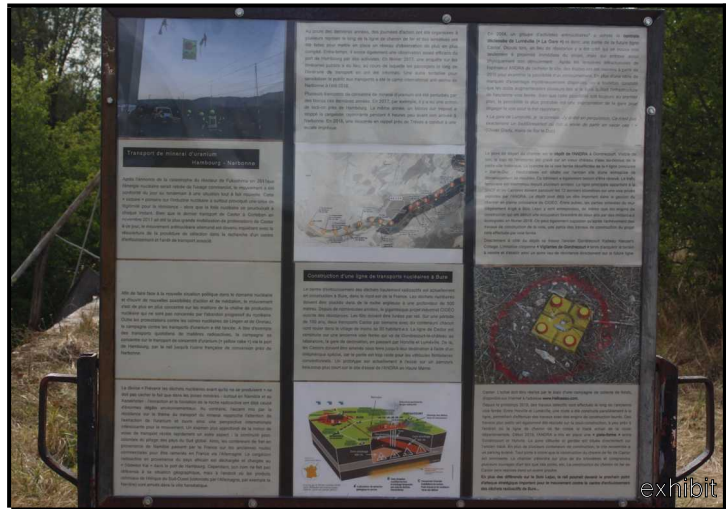

the resistance - while the nuclear madness went on and on at every turn. Although the last Castor transport to Gorleben in November 2011 to date was the largest ever mobilization of Castor protests, the German anti-nuclear movement has become worryingly quiet since the reopening of the selection process in the quest for a final repository and the associated transport stop.



In order to face the new political situation on the question of nuclear power and to open up new scope for action and communicability, the focus of the movement increasingly shifted to those links in the nuclear production chain that were not

affected by the nuclear phase-out. In addition to protests at the nuclear factories in Lingen and Gronau, the campaign against uranium transports was born. As an example of the daily transports of radioactive material, the campaign focuses on the transport of uranium concentrate ("yellow cake") via the port of Hamburg, by rail to the French conversion plant near Narbonne.

The guiding principle "Prevent nuclear waste before it arises" should not hide the fact that in the mining areas - in this case above all Namibia and Kazakhstan - enormous environmental destruction has already been caused by the extraction and leaching of the radioactive rock. On the contrary, the focus of the resistance on the topic of ore transports brings the focus much closer to uranium mining and thus

opens up an interesting international perspective as well. A closer look at the concept of transport routes reveals another aspect: the post-colonial continuity of the plundering of the countries of the global South. Thus the freight containers from Namibia pass through France on the old trade routes in order to be transported back to France via Germany. The radioactive cargo from the African country is unladen and forwarded at the "Südwest Kai" ("South-West quay") in the port of Hamburg. However, its name does not refer to its geographical location, but to the place where colonial goods from occupied German South West Africa (today Namibia, among others) reached the Hanseatic city.



In recent years, there have repeatedly been action days along the railway line and attempts have been made to establish an increasingly comprehensive network of route observation. In the meantime, activists have also been observing the port of Hamburg quite well. In February 2017, a public route survey took place, during which passengers along the transport route were informed about these. Another attempt to increase public awareness of the transports was the international Anti-Atom Camp in Narbonne in the summer of 2018.

Several transports of uranium ore concentrate have been disrupted by blockades in recent years. In 2017, for example, there was a lock-on action near Hamburg. In the same year a tripod blockade stopped the radiating cargo for 4 hours shortly before arrival in Narbonne. In 2018 an abseiling action near Trier led to an unscheduled stopover.



## New Castor track construction Bure (F)

The French repository for highly radioactive waste is currently being built in Bure, in the north-east of France. Nuclear waste is to be stored in clay rock at a depth of 500 meters. For many years there has been resistance to the gigantic industrial project called CIGÉO.



The Castors are to be delivered by rail. Over a period of 100 years, two Castor transports per week with ten containers each are to roll into the village of 90 inhabitants. The Castor line will be built on a former railway line that extends from Gondrecourt-le-château via Horville and Luméville to the laboratory, the destination station. From there, the Castors are to be brought underground to their destination with a special cable railway, as the gradient is too steep for conventional rail vehicles. A prototype is currently being tested on a much shorter route at ANDRA's test site in the department of Haute Marne.

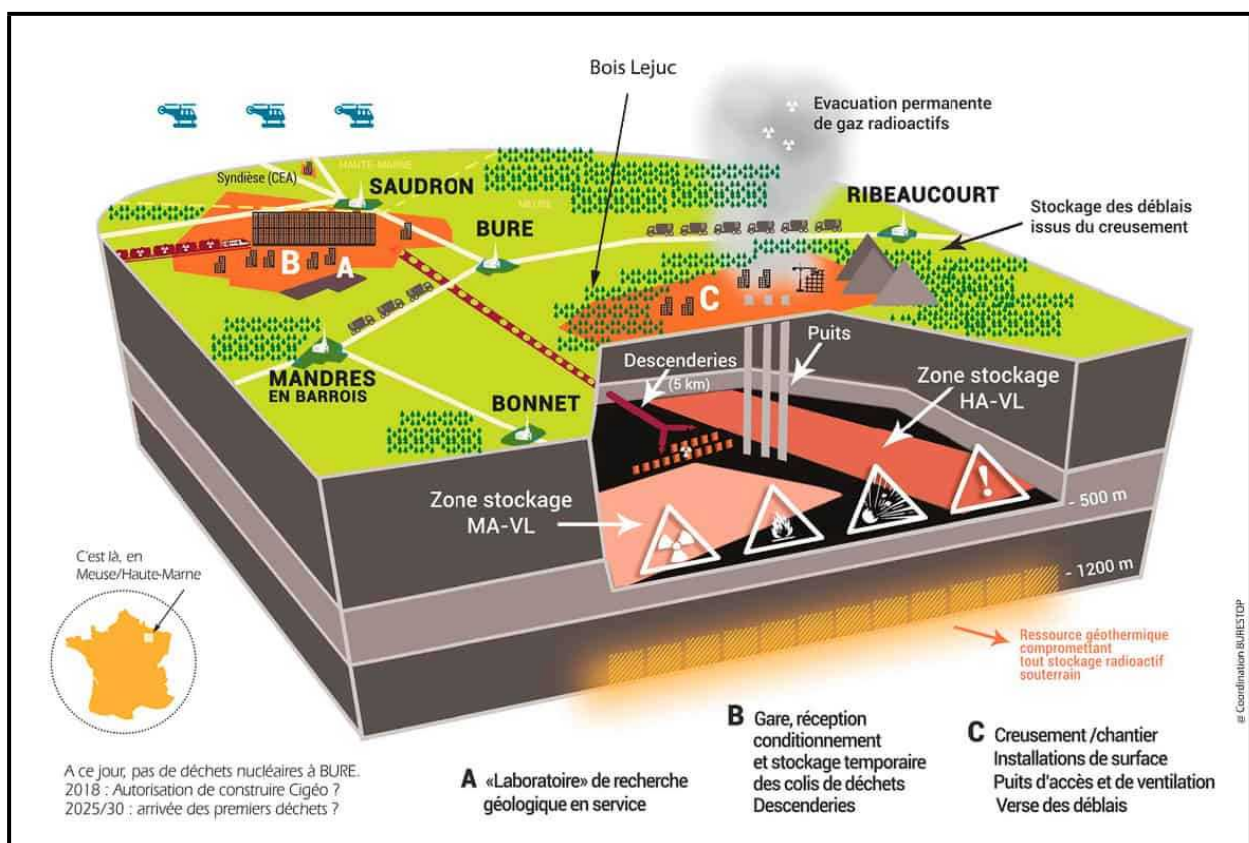

In 2004, a group of anti-nuclear activists bought the abandoned **railway station of Luméville** and thus a piece of the future Castor line. Since then, a place of resistance has emerged there that is not only in the immediate vicinity of the project, but also physically stands in the way of its undisturbed progress. After unsuccessful attempts by the operator ANDRA to buy back the land, surveys were carried out from 2015 to examine the possibility of bypassing the site. In addition to a series of mysteriously disappeared survey marks, however, it was found that the costs would increase many times over if the line left the substructure of the old railway line. Although this possibility is still in the pipeline, the most likely possibility is an expropriation of the station to clear the way for the radiating freight.

*„the station of Luméville? I know this place, I did a house search there... that's not exactly the kind of Bed & Breakfast I dream about - really not!“*

(Oliver Glady, chief prosecutor of Bar le Duc)





The starting point for the track construction site is the **ANDRA depot** in Gondrecourt. Visible from afar, the company logo is emblazoned on an old water tower above the historic small town. The branch of the disused railway line from the "main line" Bar-le-Duc - Neufchâteau is located on the former site of a furniture removal company. This is also in great need of renovation. Rail traffic has been discontinued for several years. The main line is owned by the state railway company SNCF, and the Castor-trains are to run the last 12 km on a private ANDRA track. The depot already plays an important role in handling the growing CIGÉO construction site. Among other things, the removed parts of the illegally erected wall in the forest Bois Lejuc are stored here, as are the construction machines that destroyed a two-year forest occupation by environmental activists in February 2018. It can also be assumed that after completion of the track work, part of the construction work on the project will be carried out by rail.

Directly next to the depot is the former Gondrecourt railway guard's cottage. The citizens' initiative "**Vigilantes de Gondrecourt**" is trying to acquire the land for sale and thus establish a further place of resistance directly on the future Castor line. The purchase is to be realised via a fundraising campaign.



Since spring 2018, sporadic work-activities has been taking place along the old railway line. Between Horville and Luméville, a road has been built parallel to the line, allowing work to be carried out with heavy construction machinery. Smaller works have also been carried out on the substructure, approximately where the railway line crosses the current route of the department road. In early 2019, ANDRA set up a "platform" between Gondrecourt and Horville. The fenced and guarded area is located directly on the old route. In addition to several construction containers, the site resembles an illuminated car park. There is much to suggest that the actual construction of the Castor Railway is imminent. The construction site will extend over more than ten kilometres and include several engineering structures such as bridges, etc. The construction of the Castor Railway will be carried out in the near future.

In addition to the struggles for the Bois Lejuc the track could become the next strategically important point of attack for the movement against the radioactive waste repository in Bure ...



# CHRONOLOGY

## OF THE CASTOR TRANSPORTS TO GORLEBEN

### FOCUS ON ACTIONS ON THE RAILS



The anti-nuclear movement in Wendland lived from numerous, diverse and creative actions and ideas. The chronology of the Castor transports to Gorleben attempts to draw a picture of this lively resistance. But as this diversity would go beyond the scope of the exhibition,



we have illustrated exemplarily the events around the first Castor transports - not all of them - and with a focus on the field of rail action. Since 2002, the transports are only provided with an event or quotation that is characteristic for us.

### 1984 The first DAY X (\*)

08.10 The first transport of nuclear waste rolls by truck with 506 low-level radioactive nuclear waste barrels into Wendland. Guarded by a large contingent of police, helicopters and NATO wire. Shortly before the interim storage facility, anti-nuclear opponents stop it for some time. Another transport has been announced for the next day - road blockades from transverse vehicles, tree trunks and burning bales of straw are prepared at night.

"The Castor transports have changed life in Wendland lastingly. For 10 years the first Castor could be prevented by a mix of processes, actions and political intervention. But then, at least once a year, it was called "Castor-Alert", one „stood across“, on the road and - in the beginning very hesitantly - on the rail. (Gorleben Archive)

### 1994 "Castor Never" "We were deeply convinced to prevent the Castor"

Spring 1994: Decision: The first Castor with highly radioactive nuclear waste is to be transported to Gorleben in July.

The anti-Castor mobilization is running at full speed **"Preventing the Castor before it starts"**. Meetings of the different local groups, action concepts are discussed and developed, posters and slogans appear everywhere, daily and every night actions take place, large-scale blockades of the access roads of the district, attacks on railway lines with hook claws, demos, hundreds of people (among them 17 mayors and the district administrator) explain publicly in the newspaper: **"We stand across!"**

21.06. The group "Raccoon" commits an attack on the info-house of the Federal Office for radiation protection (Bundesamt für Strahlenschutz - BfS) in Gorleben

21.06. Pupils block the Lüchow city centre in the run-up to the upcoming Castor.

(\*) D-Day, in German Day X - the "X" is an important symbol of resistance

23.06. At night, 19 railway sleepers are sawn through in the middle and the rails bent on the railway line between Uelzen and Dannenberg.

02.07. The **"Castornix" hut village** is set up in the wooded area between the final and interim storage facilities.

09.07. The Castor date does not seem to be kept; nevertheless: more than 2000 people gather in the hut village and around the nuclear facilities, blockades are built, a siege tower and 30 tractors block the interim storage facility.

11.07. **Day X passes without Castor transport.**

13.07. The "Castornix" hut village is evicted. 2 days later the transport date is postponed to the end of August, the Castor opponents move in again and celebrate in front of the interim storage facility.

25.07. "Castornix" moves to the river Elbe near Pölitz due to forest fire danger.

17.08. The Castor should not roll before mid-October (parliamentary elections).

20.08. The Castornix caravan starts towards Philippsburg.

05.11. The four most important access roads are blocked by more than 1000 people for one day.

10.11. Barricades of sawn trees and burning bales of straw at night in 20 places on roads in Wendland.

14.11. A hook claw brings train traffic around Hanover to a standstill for hours.

19.11. **"Route inspection"** demo with 2000 people on the rails between Pudripp and Dannenberg (Dbg.) despite assembly ban.

20.11. Prohibition of assembly for the period until Castor transport: over 20 barricades on the tracks between Lüneburg and Dbg. Demo in front of the Philippsburg nuclear power plant with 120 Castor opponents inside.

21.11. "Day of the decision": Thousands of people listen on the Lüchow market place: The transport planned for the next day is stopped by the decision of the administrative court Lüneburg. **Demo in Gorleben becomes a jubilant party.**

## **1995      The Castor is rolling - The Wendland is standing across**

21.01. The concept for "Civil Disobedience" - a **"Public and Common Demontage of Rails"** is published by various Castor groups, the "Unbending" and the "Gorleben Women" in front of the Dannenberg Castor loading crane.

23.01. Decision of the OVG (supreme court) Lüneburg that the Castor transport is legal.

26.01. **Hook claw** on the line Hannover-Hamburg, explanation by the "K.Ollektiv Gorleben".

15.02. Federal Environment Minister Angela Merkel ( today Federal Chancellor ) issues a directive to the Lower Saxony Ministry of the Environment to allow the storage of nuclear fuel elements from the Philippsburg nuclear power plant in the Gorleben interim storage facility. Lower Saxony is to approve the Castor transport within a week.

February & March: **"Emergency brake pulling"** in numerous trains in Germany against the Castor.



12 March: **" Discarded "** action with 800 people despite general decree - railway sleepers of the Castor track are dismantled publicly. 300 signers had previously publicly acknowledged the action of civil disobedience in a newspaper advertisement.

Early April: Day X is scheduled for 25 April.

April: **The Wendland in the Castor alarm:** numerous actions - colorful, disobedient or militant - many demonstrations, barricade construction, track occupations, hut village construction, public events, reference group-, local group- and networking-meetings, discussions...

April: Nationwide again and again actions and sabotage against the DB.

13.04. Between Lüneburg and Dannenberg **2m rail are sawn out** and set up as X.

22.04. Demo against the upcoming Castor with 4.000 people in Dannenberg. The police arrests more than 100 people at the Gorleben interim storage facility because they are in the "prohibition zone".

23.04. The resistance camp "Verladenix" ("Load-nix") is built in Dannenberg near the railway line.

Everywhere in the Wendland region actions continue; thousands of people and many tractors are on the move. **"If the atomic shit's comin' up in the box, we'll put the tractor up the road."** (Rural emergency community Lüchow-Dannenberg)

One hundred Castor opponents demonstrate at Philippsburg nuclear power plant

24.04. 20.05 h The Castor transport (1 container) begins its journey from the Philippsburg nuclear power plant on rails to the Gorleben interim storage facility.

Emergency meeting of the rural emergency community with well over 100 people. **"It was clear that we farmers wanted to do something with our trekkers"**. (Adi Lamke)

At night Hitzacker station: riots, barricades, burning logs.

At night the Uelzen-Dannenberg railway line is blocked at Zernien.

## 25.04.1995 Day X - The first Castor train to Wendland

25.04. Castor rolls into Wendland protected by 7,000 cops. The entire Castor transport route is the target of attacks, blockades and protests. Approximately 2,000 nuclear power opponents in Wendland resist fiercely and "stand across".



During the days the Wendland is in a state of siege by the state power. The schools are closed. A total of 15,000 police officers are on duty, the largest police operation in the history of the Federal Republic of Germany.

Nationwide, about 4,000 opponents of nuclear power are protesting.

After 14 hours by train, the Castor container reaches the Dannenberg loading station.

12.00 noon: The Castor is packed onto a road low-loader and begins the last section on the road at walking pace under police protection to Gorleben.

It needs 6 hours for the 18 km long stretch. **The Castor is repeatedly stopped by blockades and barricades.** The farmers' emergency association blocks the transport route with their tractors shortly behind the loading crane. Hundreds of people surround them and sit on their roofs. The police evicts the track bit by bit with water cannons and truncheons.

17.12: The gates of the interim storage facility close behind the first nuclear waste container.

13.05. Large demonstration against nuclear power plants and other Castor transports in Hanover with 10,000 people and 300 tractors, most of which chugged in a long trek from Wendland to the city.

22.08. Three of the four beams of the loading crane are cut with welding torches. Unfortunately, the crane does not fall over, but nevertheless has to be completely rebuilt.

## 1996 For the second time Castor Alert

13.02. The first week of May is mentioned as a possible transport date for the next Castor.

21.03. **Pupil demo** "Wake up!" with dance and drum by Lüchow.

30.03. Motorcyclists found the anti-castor group IDAS.

06.04. **"Spring cleaning"** with approx. 3,000 people in and around Dannenberg: Demo through the town, blockade of the rural emergency community with trekkers on the bypass, rail sawing exercises on the market square, occupation of the rails on the loading crane (the police clear with water cannons), barricade of large stones and concrete parts at the west-station - and finally: Handover of a monument "X", made of welded railway tracks, to the city of Dannenberg. Every following weekend there is a huge action against the Castor.



14.04. Action "**Discarded**" at the Dannenberg loading crane for the second time. Despite the ban on demonstrations, 2,000 people take part and publicly try to dismantle the rails. The cops try to clear the tracks with water cannons and dog squadrons.

16 - 24 April: "**After-work sawing**" every evening up to 200 people on the Dannenberg Castor track. It is gravelled and railway sleepers are ignited. The BGS (police unit) wins the control only after days.

20.04. "Day B" Action day with activities along the disused railway line Uelzen-Dannenberg with focus on the dilapidated bridges.

**Sabotage actions against Deutsche Bahn** and its lines take place over and over again.

27.04. An explosive device detonates on the Lüneburg-Dannenberg railway line next to a bridge near Nahrendorf. A hole is torn into the track substructure, the nearby bridge remains undamaged.

27.04. The Lüneburg Higher Administrative Court approves the storage of highly radioactive vitrified waste from the La Hague reprocessing plant in the Gorleben interim storage facility.

30.04. The "**Castornix**" **hut village** is built near Splietau, within sight of the loading crane and the road transport route.

02.05. Order: Demo ban in the district along all possible Castor routes for 9 days.

04.05. Demo against the second Castor transport with 10.000 people in Dannenberg.

In the run-up to the Day X<sup>2</sup> thousands of people are on the road, rail and forest in Wendland. During the day and at night there will be a variety of activities.

**"Occupants out"** The Wendland is in a state of emergency - more and more cops are moving in. In Wendland, 9,000 BGS and police officers will protect and enforce the transport. A total of 19,000 officers are stationed during the transport. The whole thing costs 90 million DM (new record).

07.05. **The 2nd Castor transport (one Castor container) starts in La Hague in France towards Gorleben.** The first road blockade after the border takes place shortly after Darmstadt.

08.05. **Day X<sup>2</sup>**

08.05. Bomb threats are coming in all night. Four railway sleepers are burning at Hildesheim station. In Bielefeld, six activists are arrested while barricading a railway line. Near Göttingen the tracks are occupied, the Castor has to take a detour.

5.56 am Castor with 50 minutes delay under the loading crane.



The Castor is blocked on the road route again and again by seat blockades and barricades. The police escort the transport and clear its way step by step to the interim storage facility with water cannons and police tanks. It needs 7 hours for the route.

Besides the transport route, the police demolish 170 parking tractors of the Rural Emergency Community and shut them down.

During the days of the Castor transport, the cops have been systematically harassed and assaulted again and again. On day X<sup>2</sup> alone 500 demonstrators are taken into police custody, more than 100 people are injured.

July/August: Many actions and demos against the planned reconstruction of the loading crane.

The mobilization phase against the 3rd Castor transport begins: groups prepare themselves, demos, blockades, creative and direct actions...

22.08. "Stop Castor!" - A 1.50 m piece of rail is sawn out of a track near Dannenberg.

15.09. "Opening-rail-sawing": Kick-off action of the public disobedience action **"No train to the Castor crane"**. Almost every Sunday morning in autumn and winter 96/97 the saw is swung on the Castor track at the Dannenberg loading crane.

*16.09. A person from Oldenburg is condemned as first by the district court Dannenberg on 26.09. because of public rail sawing with an action of "discarded". "Yes, I sawed, [...] specifically we wanted to increase the political pressure to prevent the dangerous CASTOR transports to Gorleben by dismantling the rail in front of the loading crane, which serves no other purpose than to let the radiating garbage roll." (Michael F. at the county court Dannenberg)*



07.10. On the occasion of the nationwide campaign day **"Stop the train - stop the Castor"** a total of **13 hook claws paralyse rail traffic on 8 different main lines**. In Lower Saxony alone, from September 1994 to the beginning of October 1996 a total of 27 hook claws were used on railway lines.

27.10. "No train to the crane" Breakfast together and rail sawing and dismantling with over 100 people at the rails in Dannenberg in the presence of three hundred police. The oldest participant in the action, 77-year-old Heidi Langebeckmann from Dannenberg, had to be "removed" from the rails by the cops three times.

21.11. The Castor transport is cancelled for November and postponed to spring 1997.

## 1997 **The six-pack is coming**

01.01. "New Year's reception on both sides of the fence" of the Gorleben nuclear power plants with banners and resistance resolution of the activists for the New Year.

Numerous **rail walks and rail action days throughout the year**.

09.01. Lower Saxony announces transport with 6 Castor containers to Gorleben for March.

13.01. **"X-thousand-times across"** begins with the publication of signatories to the non-violent sit-in blockade at the announced Castor transport - by the end of Febr. already 4,000 signatures.



01.02. Nationwide decentral action day introduces the hot resistance phase against the 3rd Castor transport.

01.02. Winter break ended: **"Every Sunday sawing takes place"**. With saws 50 people are between Dannenberg and Breese/Marsch at the rails of the Castor distance on the way.

February: All local political committees in the district Lüchow Dannenberg with the voices of all parliamentary groups speak out against the seizure of public buildings for the use by police and BGS, against an assembly prohibition, and thus against CASTOR transports.

19.-23.02. "Our laughter will defeat them" **20 years of resistance festival**

22.02. The Dannenberg Water Procurement Association prohibits the police and the BGS from filling the water cannons from their water network.

End of February: The district government of Lüneburg withdraws the responsibility of the district parliament of Lüchow-Dannenberg for securing the Castor transport and issues a demo ban along the transport route from 3 to 7 March.

25.02. After the cities Dannenberg and Hitzacker had refused the police and the BGS school and multipurpose halls as accommodations, to which the district government LG reacted with a confiscation order of 5 halls, **600 pupils occupy four of the five halls**.

25.02. 1,500 Castor opponents demonstrate with torches on the Castor railway line.

25.02. Eight hook claw attacks on railway lines nationwide.

Repeated attacks on the DB and electricity facilities.

28.02. Police raid 30 tractors in Splietau, damaging them: DM 70,000 damage.

28.02. 8 o'clock The transport with 3 Castor containers starts in Neckarwestheim. In Wallheim, one Castor from the Gundremmingen nuclear power plant and one from the French La Hague are added.

**Already on the first road section there are several blockades;** in Berg: blockade attempt, in Maximiliansau: blockade, in Wörth and Karlsruhe-Mühlburg: blockade attempts, near Ulm (Westerstetten): blockade, Würzburg: blockade attempts.

01.03. **Opening manifestation in Lüneburg** with over 20,000 people, including 100 farmers with their tractors.

12 resistance camps will be set up along the rail and road transport route.

The live ticker "Nix3" goes online for the first time.

Nationwide demos and actions for day X<sup>3</sup>.

Police evict the occupied gymnasium in Hitzacker.

02.03. **"Stink-parade" with 600 tractors of the Rural Emergency Community and 20,000 people** on the transport route between Dannenberg and Gorleben. The transport route in Splietau is then closed with 80 tractors. Barricades are built under their protection and the road is undermined. *"Traffic rests at the top, and there is bustling activity at the bottom, as in the construction of the subway at Potsdamer Platz. At the top, i.e. on the Dorfstraße, there are about 80 tractors, wedged into each other, so close to the fences of the village front gardens that even individual people cannot get past. Traffic jam. Below, one level lower, as in the capital, sand is dug out of the tunnel system under the road by piecemeal, by spotlight, wheelbarrows for wheelbarrows. Hundreds of hands reach for the shovels, push the wheelbarrows, those who can no longer do so take a break, others step in. There is a folk festival atmosphere in the village, the pub makes a record turnover, garages are open for those who want to warm up, drinks and bread are kept ready for the construction teams on tables and benches. All the peasants, the new townspeople, the autonomous ones and the mueslis, all admire the progress of the common construction works."* (Nix3 ticker - castor.de)

03.03. **Day X<sup>3</sup>**

**The "Six-Pack" starts** in Walheim on the rails in the direction of Gorleben. Blockades and protests everywhere on and around the railway line.

**Wendland is in a state of emergency or resistance:** police and BGS (15,000 officers in Lower Saxony) everywhere, civil rights are severely restricted (e.g. residents are not allowed to leave houses, constant traffic controls, paramedics, lawyers, media are obstructed at work, arrests, establishment of a prisoner collection site (GeSa)). On the other hand, numerous and varied actions - civil disobedience and militant actions; everywhere people (approx. 15-20,000) are on the move, on foot, by car, uncontrollable.



In the morning, the Wendland railway and road line is occupied at various points.

Hundreds of people are on the transport route, blocking and building barricades.

Everywhere **open doors** and support in the villages.

3000 people sitting in a blockade "X-thousand-times across" in front of the loading crane.

**Tractor blockades** at the intersection of Pudripp and Splietau.

Brutal police action, especially in clearing blockades. Nevertheless: many people who come across the fields to oppose the eviction.

16:50 h The Castor reaches Lüneburg

**Lock-On action** near Dumstorf on a concrete block in the track bed.

In Lüneburg, Wendisch Evern and Hitzacker people block the rails.

18:40 h Road line near Quickborn occupied by 200-400 people.

19:4000 people sitting blockade at the loading crane

Lock-on to a concrete block on the road near Quickborn; one person in the track bed and five activists with bicycle locks around the neck on the tracks near Harlingen.

22 o'clock the Castor rolls again.

22.15 In Pommoisel and at Göhrde railway station, other people chain themselves down.

In Dannenberg, **clashes with the police at the 'Esso meadow'** at the large information point. Water cannons are driven up.

04.03. 01:17 h With 8 hours delay the Castor reaches the loading crane. The reloading of the containers onto the trucks takes 13 hours.

**Blockades** in front of the loading crane, in Pudripp and Splietau, on the so-called southern route of road transport, can be maintained. The northern route via Quickborn is sealed off by the police.

Afternoon: At many blockades people are **surrounded** by police for hours, partly ED-treated. Many are taken to unknown places.



05.03. 0:27 o'clock 9000 people at the **sitting blockade "X-thousand-times across"** in front of the loading crane. The eviction begins and takes hours. People who are cleared to the side sit further ahead on the road again. After 4.5 hours, the police use water cannons and batons. However, the evacuation does not proceed any faster and becomes more and more brutal.

10:00 a.m. The road is clear. On a field next to the road is a police kettle with 1,000-2,000 people. **Between the trees above the transport route, activists are still hanging on ropes.** *"Then the Castors roll through under them",* the police say.

11:45 The Castor low-loaders leave the loading crane. The camp in Pölitze is surrounded by 400-500 people. In Quickborn 200 people occupy the street, a bit further burning barricades. BGS troop transport helicopters land at Splietau. The officers cut through fences and destroy 60 tires of the tractors parked in Splietau without warning.

During the road transport, **people manage to get on the road again and again and to stand in the way of the Castor.** Water cannons continue to be used along the route.

15:10 hrs the Castor transport reaches the interim storage 14 hours after loading. It was again the largest police operation in the history of the Federal Republic of Germany: 30,000 officers of police and BGS, almost 15,000 of them in Lower Saxony, in action. The costs: almost 160 million DM.

## **1998 No Castor**

16.03. 46 teachers from the Wendland region are to have their salaries reduced by the district government in Lüneburg, because they were not in school on day X<sup>3</sup>, but protested.

09.05. *"Without the rail nothing goes in the nuclear state, we are preparing for it",* it says during a "rail walk" of about 300 nuclear power opponents at Dahlenburg. The next Castor to Gorleben has been announced for autumn. Until then, there will be more walks on the rails.

25.05. **Castor-Transport-Stopp:** As a reaction to significantly increased radiation levels in Castor containers, the Federal Environment Ministry stops rail transports of spent fuel elements at national and international level.

05.06. The **InfoHouse** of the BLG (fuel element storage) in Gorleben is **occupied, cleared out and redecorated** by 70 members of the citizens' initiative (BI) and the farmers' emergency association for 26 hours. The police does not intervene.

16.09. Coalition negotiations between SPD and Greens: the exploration work at the Gorleben repository is to be interrupted for the time being. The debate about the search for a repository begins.

October: *"We fear that Gorleben will be stuck with a lot if not everything. We will not put our hands in our laps, we will continue to stand across when nuclear waste transports roll."* (Wolfgang Ehmke, spokesman of the BI)

12.12. "Legal aid Gorleben" turns 20-years old.

## 1999 Nuclear phase-out? And stink

Debates and disputes over the phase-out of nuclear power, the search for a final repository, a moratorium on exploration and the Gorleben Pilot Conditioning Plant (PKA) are increasingly preoccupying politicians and opponents of nuclear power in Wendland with the start of the Red/Green federal government at the end of 1998.

24.02. According to DB, the railway bridge in Seerau is not suitable for Castor transports because it is dilapidated and must be renovated.

27.02. Demo with 2.000 people and 60 tractors to the nuclear facilities in the context of the resistance against the commissioning of the PKA and the repository. Fences are torn down, the PCA is besieged, sandbags are dumped in front of the PCA gate as "symbolic protection against the flood of nuclear waste".



01.04. The **Castor transport stop** is cancelled by the governments of France and Germany.

05.05. For the time being it is said: The Seerauer bridge may remain (listed monument), the Castor may not drive over it.

22.-24.10. Autumn conference with 170 representatives of BI's from all over Germany in Danenberg. The unveiling of the travelling monument of the anti-nuclear movement, the "**Golden Hook Claw**", causes a furore among the police union and district politicians.

Early Nov: Environment Minister Jürgen Trittin announces the resumption of Castor transports.

13.11. Legendary trek "Gerhard, we are coming" (Gerhard Schröder, then Federal Chancellor) with 150 trekkers to Berlin and big "Stink-parade" with 6.000 people for the immediate nuclear phase-out. At the final manifestation it says: *"As sure as spring follows winter, so sure will thousands of people take to the streets again when the next Castor rolls to Gorleben"*.

## **2000 Battle for the bridge**

07.01. The Castor cannot be transported to Gorleben via the usual route due to the dilapidated Seerauer Bridge. Discussion: Delivery via the sea route or the city of Arendsee.

06.04. The power company Avacon wants to tear down the transformer house at the Gorleben interim storage facility. BI announces an interest to buy. *"The building was not just a simple meeting place for us. It has been a symbol of our resistance for years, because we carried out our actions in its shadow,"* says BI chairwoman Susanne Kamien.

01.-04.06. **20 years "Republic of Free Wendland"** anniversary celebration "two1004" of the occupation of the drilling site "1004" and the hut village "Republic of Free Wendland".

14.06. Agreement of the red-green federal government and energy supplier on a so-called 'nuclear phase-out concept'.

12.08. **"Rail, track and screw break, but our resistance doesn't"** - in the following months protests and actions against the new construction of a Castor-suitable bridge take place again and again.

23.09. Demo " Nuclear phase-out - all lies" with 5.000 people from Gedelitz to the nuclear facilities.

01.10. Start of the exploration stop at the Gorleben repository mine. The "moratorium" comes into force.

10.10. Action at the loading crane Dannenberg against the rebuilding of the crane, which should make it possible to reload Castor containers faster and more often. Client: DB, donor: BLG.

13.10. **"Day B"** (B = bridge) Construction stop for the railway bridge near Seerau is rejected by the court. Construction work can continue. Castor opponents gather for the bridge demonstration in Hitzacker and - despite a large police presence - also on the rails along the bridge.

01.12. The Federal Office for Radiation Protection (BfS) approves an amendment to the transport container storage facility in Gorleben. This approval is an essential prerequisite for the return of radioactive waste in the form of glass coquilles from France. The way has been paved for the Castor transport in spring 2001.

31.12. **The year ends with burning bales of straw on the Castor tracks.**

## 2001 Two Castor transports per year

From 01.01 on every Sunday "rail walks" on the CASTOR rail line between Lüneburg and Dannenberg.

15 January: A train on the Seerauer Bridge comes to a standstill with the help of the emergency brake from nuclear opponents.

21 January: **"Stress test" of the new Seerauer Bridge** by about 200 opponents of nuclear power inside the train. BGS guards the emergency brake levers, train toilets are locked.

11.02. "Railway walk" by "X-thousand-times across" and ActionAllianceCastor from Lüneburg with 300 people on the rails from LG to Wendisch Evern.

12.02. BGS discovers a 1 cm deep cut in the track in Hitzacker.

18.02. Near Bavendorf, **a 2.5 m section of track is cut from the track with a welding torch** and laid to an X in the track bed. A train driver disregards the barrier tape, but brakes in time.



24.02. Demo "Mummen-schanz und Schienentanz" in Dahlenburg with 1,200 people. At Seedorf the rails are occupied for 20 minutes.

03.03 With the action **"A night in the track bed"** approx. 300 people practice the occupation of the tracks within the framework of "x thousand-times across". Clearing and actions on the tracks until dawn.

08.03. **60 Greenpeace activists occupy the loading crane** and paint a large X on its wall. On the police radio tower they put a banner with "Stop Castor".

09.03. Hook claw attack near Berlin.

10.03. Repeated attempts to divide the anti-nuclear movement: "Protest yes - violence no", it says of posters in the district commissioned by the police. Some have to be removed again because they were stapled to trees and bus shelters, others were removed by unknowns.

21.03. The **construction of the resistance camps begins**: in Govelin (after expulsion in Schmessau), Hitzacker, Tollendorf, Wendisch Evern, Nahrendorf, Splietau, Laase, Gusborn. Almost all camps are banned. After anger and harassment by officials most camps can take place.

23.03. Approximately 50 pupils occupy the gymnasium in Dannenberg and demand that it be made available as a "camp" for foreign anti-castor demonstrators.

24.03. Kick-off demonstration of the Castor protests in Lüneburg with a star march and 16,000 people.

25.03. The farmers' emergency association "Stunk" with a colourful carnival-like parade from Gorleben to Seerau. *"Everywhere in the administrative district one could meet tractor columns, which were on the way to the STINKPARADE"*, writes the dayX ticker .

26.03. Day X<sup>4</sup>

6:45 a.m. The Castor train leaves the Valognes loading station. Greenpeace activists block it directly on departure. Many other actions, demos and blockades take place on and along the railway line to Lüneburg and in various cities throughout Germany.

**Early in the morning, countless people head for the railways.** Vigilantes, walks, visits and sabotage keep the police busy between Lüneburg and Dannenberg.

*"The sun is shining, thousands of sleeping places in private houses, churches, gyms and schools are still available to the demonstrators for the next few days; many supply stands along the transport route offer hot food and drinks,"* says BI spokesman Mathias Edler.

Sitting blockade of " x thousand-times across " goes with 1000 people at Wendisch Evern onto the rails. 400 people are taken into "custody" by rail bus in LG.

Thousands of activists are also on the road and around the road.

Farmers block the road in Splietau with 6 tractors for hours. 600 people are building a protective wall of sandbags there.

300 people make it onto the rails in Wörth.

**The BI in Bar-le-Duc (FR) blocks with 100 people** at the station. (Unfortunately 3 minutes too early a passenger train).

Attack on high voltage line in Uelzen against DB.

27.03. 50 Greenpeace activists board the Seerauer Bridge, partly abseiling under the bridge.

**The farmers block several crossings at the same time in Wendland to hinder movement and police supplies:** In Jameln 20 - 30 tractors with straw bales and approx. 3000 sandbags block the road, in Prisser there are 15 tractors, the crossing is 'protected' with 1000 sandbags. In Lüchow 15 tractors block the roundabout at the end of the town towards Salzwedel. In Pudripp the federal road 191 is also blocked, 500 sandbags have been unloaded at the crossing in Küsten.

" X-thousand-times across" again occupies the tracks near Wendisch Evern with the "five-finger tactic".

**Around the loading crane several blockades** and dozens of tractors.

17:15 The Castor train reaches Lüneburg. At the same time 150 people occupy the tracks in one direction against the Castor, in the other direction against the prisoner train from Wendisch Evern.



6 p.m. Demo in Dannenberg with 10,000 participants to the Info-Camp on the 'Esso-meadow'.

7 p.m. 8 Greenpeace activists chain themselves to the rails with a box in Oldendorf.



7 p.m. In Bavendorf, an activist from Robin Wood chains himself to the railway track with a steel pipe. To clear the track, the police have to cut out a piece of rail. The Castor train stops at 9.30 pm.

22 o'clock **Lock-On of four activists by means of a concrete block under the rails near Süschen**dorf. Another activist chained himself to the tracks next to it. The Castor reaches the blockade at 22.30 and stands.

22:30 Police confiscate 3 motorcycles and arrest their riders.

0 o'clock Lock-On near Hitzacker. A Robin Wood activist has chained himself in Leitstade.

28.03. 5 o'clock The **Castor train has to reverse a bit** & is parked in Dahlenburg.

Many actions and blockades or blockade attempts on the railway line to Dannenberg.

14 o'clock The last person is cut out of the concrete block near Süschendorf.

The paths to the right and left of the railway line are no longer passable - **barricades are everywhere, in many places it is gravelled on the tracks.**

16:50 After 20 hours the Castor drives again, has to stop again and again due to actions and reaches the loading crane at 19:30 o'clock.

The police is kettling the 'Esso-meadow', using water cannons and truncheons.

29.03. Castor transport leaves the loading station in the morning on the road towards Gorleben. **Along the road thousands of people are on their way, trying to stop the Castor and causing unrest.**

More than 2000 people gather in Laase.

The police secure the road with police chains, truncheons, pepper spray, water cannons, clearing vehicles and helicopters.

23.04. "Emergency stop" by emergency brake on the Seerauer bridge and action against an imminent nuclear waste transport from the Neckarwestheim nuclear power plant to the British plutonium factory Sellafield.

09.07. "**Gorleben Archiv e.V.**" is founded.

22.07. Some people and a VoKü (collective, mobile kitchen) from Wendland take part in a **demo against the planned repository in Bure.**

02.09. The action "**snail plague**" and the call "**We don't leave our guests standing in the rain**" for the next Castor transport are introduced. After the camp bans in March, a bed exchange for arrivals is organised; people open their houses at Castor for foreigners. The "snail plague" shifts the protest against the state of siege in Wendland into the apron of a Castor transport, in which many drivers drive in view of BGS and police columns only in the snail speed.

30.09. An eight-day "Way of the Cross for Creation" with a 6-metre-long cross begins at Lüneburg's Clamart Park and leads to the Gorleben nuclear facilities.

06.10. Near Bavendorf a more than 5m long track section is sawn out of the rail bed and laid on top of each other.

14.10. **Burning road barricades** at 9 locations in Wendland from car tires and tree trunks. "Ali Baba and the 40 robbers" set a smoke signal against the bludgeoning of another Castor transport on the back of the civilian population.

20.10. Action day of the department 'Traffic and Interior' in the district of the Free Republic of Wendland with demos in 7 places: *"We got jack of siege, surveillance and persecution! We don't wait until the Castor comes - the peace is over!"*

24.10. **Arson attack on the Seerau Bridge.** 2 trailers with straw, rubber tyres and a barrel with 200 litres of diesel were parked under the bridge and set on fire. 20 m railway sleepers and 15 m rails have to be replaced - the line remains closed for the time being.

25.10: "ReSi(s)t", a big "citizens' blockade" is announced for the Castor transport expected at the end of November. The anti-nuclear initiatives want with their "route concept" have large demonstrations and actions and this time also do blockades on the main lines of the railway.

07.11. BGS finds an embedded concrete block with iron-anchored pipes in the track bed near Dahlenburg.

10.11. **Opening demos** against the Castor in LG with 10.000 and in Karlsruhe with 700 people.

11.11. In the Wendland: demonstration ban on the transport route and the nuclear facilities. The police also prevent people and trekkers from accessing the registered demos; street controls are carried out everywhere.



In Splietau hundreds have made it to the field at the forbidden manifestation, in Nebenstedt also several hundred people and 50 tractors.

3 p.m. **50 tractors wedged into each other block the transport route** in Quickborn. The police take massive action against the tractors during the Castor transport: they forbid the passage to legal manifestations, also fix the tractors far outside the prohibition zone & disable them.

4 p.m. 800 people of the Actiongroup 'ReSi(s)t' are kettled next to the transport route between Nebenstedt and Splietau.

Before the Castor transport departs from the Valognes loading station, **Greenpeace activists occupy a mast as well as signalling systems** on the rails. The train starts at 7.30 p.m., about 6 hours earlier than planned, in order to avoid an announced railway strike in Caen. At the German-French border near Maximilansau, 150 people take part in a track walk in the evening. Actions and blockades of the further transport route.

At Harlingen, activists chain themselves up in treetops over the rails.

12.11. The Castor train is temporarily blocked by 10 activists in Mommenheim (FR).

In the Lüneburger Tiergarten, near Süschendorf and near Eimstorf, **concrete blocks** with lock-on-devices in the track bed are discovered by the police.

**Seat blockade on the rails of 'ReSi(s)t'** near Pisselberg.

Demonstration with 1,000 people and 10 tractors in Hitzacker, 40 tractors at the level crossing and approx. 1,000 people on the rails. 15 m of rails are gravelled. A further 100 tractors block all access to the city.

**13.11. Day X<sup>5</sup>**

**Abseiling action by a Greenpeace activist** over the rails at Pussade.

Another 'ReSi(s)t'-group with 1000 people on their way to the road near Splietau. The police use dogs and horses.

**300 sheep block the tracks** in Pisselberg.

ICE blockade in Lüneburg

**Lock-On with pipe** of 2 persons between Radbruch and Bardowick, the Castor must wait 2 hours.

On the roads of the Wendland the "snail plague" delays the traffic and the police movements.

The Castor's journey is delayed by actions: 200 people on the rails at Dahlenburg, two people have roped down over the railway track; behind the railway station Gührde Lock-On by Robin Wood activists.

**Sitting blockade** of 'ReSi(s)t' with hundreds of people near Splietau on the road line.

200-400 people occupy the street in Laase. They get kettled.

The police are extremely brutal when clearing and "securing" the road, using dogs and horses.

17:15 The Castor reaches the loading crane. Demonstration in Dannenberg with 2,000 people.

6 am The Castor begins the road section to Gorleben.

14.-20.07. 2002 **International resistance camp in Bure** (FR) against the repository project with friends from Wendland. Afterwards, people from France travel with them to the international anti-nuclear summer camp in Gorleben.

## Castor transports to Wendland (La Hague - Gorleben) 2002 - 2011

### Nov. 2002                    6th Castor-Transport

09.11. Kick-off demonstration at the Gorleben repository construction site with 4000 people and 80 tractors. *"Now we stand here again and everything has been said! After 25 years everything is said! [...] As our pupils once formulated it: 'If you don't respect our life, we don't respect your laws' [...] So - everything is said. Now let's do something! Take good care of yourselves".* (Birgit Huneke, BI)

### Nov. 2003                    7th Castor-Transport

**Lock-On action in Luneville by the German-French group "Bandajewsky"** stops the train and keeps it there for over two hours. *"When we were fixed to the rail, several passenger trains drove past the stopped transport. So the passengers were confronted with a total inventory at a distance of 2 m that exceeded the fallout from the Chernobyl supergau. The CASTOR containers scatter their highly poisonous substances meters away.[...] The feather-snake in the name of the action group "Bandajewsky".*

### Nov. 2004                    8th Castor-Transport

*"Sébastien died on November 7, 2004, when the locomotive of the nuclear waste train to Gorleben gripped him. A few weeks earlier he had decided to act with others of us to make the vulnerability of these transports public. [...]"* From the explanation of his companions.

Many actions and blockades nevertheless take place, in **mourning and fury.**

### April 2005

Lock-On action by the German-French action group "A bientôt" near Nancy (FR) stops nuclear transport from the Stade nuclear power plant to La Hague: *"We are carrying out this action here and now; to point out once again the unsolved problem of nuclear waste. We have consciously chosen the form of action of chaining, despite or precisely because of the death of Sébastien [...]. It is [...] not about security, not about human lives and certainly not about the environment; it is about the profit of a few [...]. For us, it doesn't matter where the transports come from or where they go."*

### Nov. 2005                    9th Castor-Transport

The **Ralley Monte Gôhrde** invites punctually to the Castor transport into the forest and to the rails. Thousands of people on foot, on horseback, by cycle or by motorbike are looking for the challenges of building barricades, digging over the new police gravel road, graveling the tracks, tying woollen thread nets against cops and their horses, sitting on the rails or leaving 'rail shoes' behind, setting bales of straw on fire and and and...



**Nov. 2006                      10th Castor-Transport**

**Three pyramids on the street against the Castor** - In Klein Gusborn, Langendorf and Splietau four people each chain up. The cops have great difficulty getting the chained ones out of the pyramid. *"The Wendish pyramids were decorated with the symbols of the four electricity companies EON, Vattenfall, RWE and EnBW in order to draw attention to those responsible for life-despising nuclear technology. For the blockers, the pyramids of Giza stand as a sign of the transience of all man-made works; they are already crumbling after only 4000 years. But power companies and politicians presume to guarantee the safety of highly radioactive nuclear waste for over 100,000 years."* (Rural emergency community)

**Nov. 2008                      11th Castor-Transport**

**"Getting to the train together [Get the ball rolling together]"** - In large or small groups, people in the Göhrde-forest are on their way in the direction of the railway - different forms of action (lock-on in Eichdorf, the "conspiracy of the dwarves" by 'ReSi(s)t', militant actions, civil disobedience) at the same time - stand in the way of the Castor in interaction.

**Nov. 2010                      12th Castor-Transport**

**Five activists, one of them from Wendland, chain themselves to the rail in Caen (FR) with pipes** and stop the train. *"Our resistance knows no national borders!"* and *"Highly active nuclear waste train, neither in Bure nor in Gorleben!"*. The police hastily and with inadequate protective measures remove the chained ones and injure two of them: Burns and a cut. The activists are later sentenced to probation and/or fines.

At the action **"Castor? Graveling!"**, the publicly announced mass graveling on the Castor railway line, thousands of people are taking part.

**French and Croatian policemen are also present at the Castor (!!!)**; in action to learn from the German police; French cops distinguish themselves as perpetrators of violence.



Altogether the Castor is stopped by different actions on the entire distance from Valognes to Gorleben one and a half days - as long as so far no nuclear waste transport before.

**Nov. 2011                      14th Castor-Transport**

In Vastorf near Lüneburg, four activists have anchored themselves in the track bed by means of a concrete construction. The cops need 15 hours to loosen the chains.



**Anti-Castor-Camp in Valognes & the first successful mass Castor blockade in France:** In the morning of the transport day, 500 people set off to block the tracks. The activists gravel, bend tracks; 'rail shoes' clamp on the tracks and a cable burns; the French cops shoot gas and grenades. Residents show solidarity. The Castor is held up there for 2.5 hours. Before the Castor reaches Wendland, the friends from the Valognes Camp are already there.

**"End in the terrain"** a connectable mass action, which wants to offer without central organization and action consensus a space for rail blockade and -sabotage, attracts many small and large action groups for the Castor transport into the GÖhrde → Rail blockades, police cars ignited, light mast flared off, tracks gravelled and defended, rail shoes and jacks are used, barricades on the roads ...

\*\*\*\*\*

Sources: Gorleben Archive, Castor Books (Tolstefanz Wendländisches Verlagsprojekt) , AntiAtomAktuell (Magazine), Memories of Activists



