

भारतीय मानक  
संरचनाओं के भूकम्परोधी डिजाइन के मानदंड

भाग 1 सामान्य प्रावधान और भवन

( पाँचवाँ पुनरीक्षण )

*Indian Standard*

CRITERIA FOR EARTHQUAKE RESISTANT  
DESIGN OF STRUCTURES

PART 1 GENERAL PROVISIONS AND BUILDINGS

( *Fifth Revision* )

ICS 91.120.25

© BIS 2002

**BUREAU OF INDIAN STANDARDS**  
MANAK BHAVAN, 9 BAHADUR SHAH ZAFAR MARG  
NEW DELHI 110002

*Indian Standard*

# CRITERIA FOR EARTHQUAKE RESISTANT DESIGN OF STRUCTURES

## PART 1 GENERAL PROVISIONS AND BUILDINGS

### ( *Fifth Revision* )

#### FOREWORD

This Indian Standard ( Part 1 ) ( Fifth Revision ) was adopted by the Bureau of Indian Standards, after the draft finalized by the Earthquake Engineering Sectional Committee had been approved by the Civil Engineering Division Council.

Himalayan-Nagalushai region, Indo-Gangetic Plain, Western India, Kutch and Kathiawar regions are geologically unstable parts of the country, and some devastating earthquakes of the world have occurred there. A major part of the peninsular India has also been visited by strong earthquakes, but these were relatively few in number occurring at much larger time intervals at any site, and had considerably lesser intensity. The earthquake resistant design of structures taking into account seismic data from studies of these Indian earthquakes has become very essential, particularly in view of the intense construction activity all over the country. It is to serve this purpose that IS 1893 : 1962 'Recommendations for earthquake resistant design of structures' was published and revised first time in 1966.

As a result of additional seismic data collected in India and further knowledge and experience gained since the publication of the first revision of this standard, the sectional committee felt the need to revise the standard again incorporating many changes, such as revision of maps showing seismic zones and epicentres, and adding a more rational approach for design of buildings and sub-structures of bridges. These were covered in the second revision of IS 1893 brought out in 1970.

As a result of the increased use of the standard, considerable amount of suggestions were received for modifying some of the provisions of the standard and, therefore, third revision of the standard was brought out in 1975. The following changes were incorporated in the third revision:

- a) The standard incorporated seismic zone factors ( previously given as multiplying factors in the second revision ) on a more rational basis.
- b) Importance factors were introduced to account for the varying degrees of importance for various structures.
- c) In the clauses for design of multi-storeyed buildings, the coefficient of flexibility was given in the form of a curve with respect to period of buildings.
- d) A more rational formula was used to combine modal shear forces.
- e) New clauses were introduced for determination of hydrodynamic pressures in elevated tanks.
- f) Clauses on concrete and masonry dams were modified, taking into account their dynamic behaviour during earthquakes. Simplified formulae for design forces were introduced based on results of extensive studies carried out since second revision of the standard was published.

The fourth revision, brought out in 1984, was prepared to modify some of the provisions of the standard as a result of experience gained with the use of the standard. In this revision, a number of important basic modifications with respect to load factors, field values of N, base shear and modal analysis were introduced. A new concept of performance factor depending on the structural framing system and on the ductility of construction was incorporated. Figure 2 for average acceleration spectra was also modified and a curve for zero percent damping incorporated.

## IS 1893 ( Part 1 ) : 2002

In the fifth revision, with a view to keep abreast with the rapid development and extensive research that has been carried out in the field of earthquake resistant design of various structures, the committee has decided to cover the provisions for different types of structures in separate parts. Hence, IS 1893 has been split into the following five parts:

Part 1 General provisions and buildings

Part 2 Liquid retaining tanks — Elevated and ground supported

Part 3 Bridges and retaining walls

Part 4 Industrial structures including stack like structures

Part 5 Dams and embankments

Part 1 contains provisions that are general in nature and applicable to all structures. Also, it contains provisions that are specific to buildings only. Unless stated otherwise, the provisions in Parts 2 to 5 shall be read necessarily in conjunction with the general provisions in Part 1.

NOTE — Pending finalization of Parts 2 to 5 of IS 1893, provisions of Part 1 will be read along with the relevant clauses of IS 1893 : 1984 for structures other than buildings.

The following are the major and important modifications made in the fifth revision:

- a) The seismic zone map is revised with only four zones, instead of five. Erstwhile Zone I has been merged to Zone II. Hence, Zone I does not appear in the new zoning; only Zones II, III, IV and V do.
- b) The values of seismic zone factors have been changed; these now reflect more realistic values of effective peak ground acceleration considering Maximum Considered Earthquake ( MCE ) and service life of structure in each seismic zone.
- c) Response spectra are now specified for three types of founding strata, namely rock and hard soil, medium soil and soft soil.
- d) Empirical expression for estimating the fundamental natural period  $T_a$  of multi-storeyed buildings with regular moment resisting frames has been revised.
- e) This revision adopts the procedure of first calculating the actual force that may be experienced by the structure during the probable maximum earthquake, if it were to remain elastic. Then, the concept of response reduction due to ductile deformation or frictional energy dissipation in the cracks is brought into the code explicitly, by introducing the 'response reduction factor' in place of the earlier performance factor.
- f) A lower bound is specified for the design base shear of buildings, based on empirical estimate of the fundamental natural period  $T_a$ .
- g) The soil-foundation system factor is dropped. Instead, a clause is introduced to restrict the use of foundations vulnerable to differential settlements in severe seismic zones.
- h) Torsional eccentricity values have been revised upwards in view of serious damages observed in buildings with irregular plans.
- j) Modal combination rule in dynamic analysis of buildings has been revised.
- k) Other clauses have been redrafted where necessary for more effective implementation.

It is not intended in this standard to lay down regulation so that no structure shall suffer any damage during earthquake of all magnitudes. It has been endeavoured to ensure that, as far as possible, structures are able to respond, without structural damage to shocks of moderate intensities and without total collapse to shocks of heavy intensities. While this standard is intended for the earthquake resistant design of normal structures, it has to be emphasized that in the case of special structures, such as large and tall dams, long-span bridges, major industrial projects, etc, site-specific detailed investigation should be undertaken, unless otherwise specified in the relevant clauses.

Though the basis for the design of different types of structures is covered in this standard, it is not implied that detailed dynamic analysis should be made in every case. In highly seismic areas, construction of a type which entails heavy debris and consequent loss of life and property, such as masonry, particularly mud masonry and rubble masonry, should preferably be avoided. For guidance on precautions to be observed in the construction of buildings, reference may be made to IS 4326, IS 13827 and IS 13828.

Earthquake can cause damage not only on account of the shaking which results from them but also due to other chain effects like landslides, floods, fires and disruption to communication. It is, therefore, important to take necessary precautions in the siting, planning and design of structures so that they are safe against such secondary effects also.

The Sectional Committee has appreciated that there cannot be an entirely scientific basis for zoning in view of the scanty data available. Though the magnitudes of different earthquakes which have occurred in the past are known to a reasonable degree of accuracy, the intensities of the shocks caused by these earthquakes have so far been mostly estimated by damage surveys and there is little instrumental evidence to corroborate the conclusions arrived at. Maximum intensity at different places can be fixed on a scale only on the basis of the observations made and recorded after the earthquake and thus a zoning map which is based on the maximum intensities arrived at, is likely to lead in some cases to an incorrect conclusion in view of (a) incorrectness in the assessment of intensities, (b) human error in judgment during the damage survey, and (c) variation in quality and design of structures causing variation in type and extent of damage to the structures for the same intensity of shock. The Sectional Committee has therefore, considered that a rational approach to the problem would be to arrive at a zoning map based on known magnitudes and the known epicentres ( *see Annex A* ) assuming all other conditions as being average and to modify such an idealized isoseismal map in light of tectonics ( *see Annex B* ), lithology ( *see Annex C* ) and the maximum intensities as recorded from damage surveys. The Committee has also reviewed such a map in the light of the past history and future possibilities and also attempted to draw the lines demarcating the different zones so as to be clear of important towns, cities and industrial areas, after making special examination of such cases, as a little modification in the zonal demarcations may mean considerable difference to the economics of a project in that area. Maps shown in Fig. 1 and Annexes A, B and C are prepared based on information available upto 1993.

In the seismic zoning map, Zone I and II of the contemporary map have been merged and assigned the level of Zone II. The Killari area has been included in Zone III and necessary modifications made, keeping in view the probabilistic hazard evaluation. The Bellary isolated zone has been removed. The parts of eastern coast areas have shown similar hazard to that of the Killari area, the level of Zone II has been enhanced to Zone III and connected with Zone III of Godawari Graben area.

The seismic hazard level with respect to ZPA at 50 percent risk level and 100 years service life goes on progressively increasing from southern peninsular portion to the Himalayan main seismic source, the revised seismic zoning map has given status of Zone III to Narmada Tectonic Domain, Mahanandi Graben and Godawari Graben. This is a logical normalization keeping in view the apprehended higher strain rates in these domains on geological consideration of higher neotectonic activity recorded in these areas.

Attention is particularly drawn to the fact that the intensity of shock due to an earthquake could vary locally at any place due to variation in soil conditions. Earthquake response of systems would be affected by different types of foundation system in addition to variation of ground motion due to various types of soils. Considering the effects in a gross manner, the standard gives guidelines for arriving at design seismic coefficients based on stiffness of base soil.

It is important to note that the seismic coefficient, used in the design of any structure, is dependent on many variable factors and it is an extremely difficult task to determine the exact seismic coefficient in each given case. It is, therefore, necessary to indicate broadly the seismic coefficients that could generally be adopted in different parts or zones of the country though, of course, a rigorous analysis considering all the factors involved has to be made in the case of all important projects in order to arrive at a suitable seismic coefficients for design. The Sectional Committee responsible for the formulation of this standard has attempted to include a seismic zoning map ( *see Fig. 1* ) for this purpose. The object of this map is to classify the area of the country into a number of zones in which one may reasonably expect earthquake shaking of more or less same maximum intensity in future. The Intensity as per Comprehensive Intensity Scale ( MSK64 ) ( *see Annex D* ) broadly associated with the various zones is VI ( or less ), VII, VIII and IX ( and above ) for Zones II, III, IV and V respectively. The maximum seismic ground acceleration in each zone cannot be presently predicted with

## IS 1893 ( Part 1 ) : 2002

accuracy either on a deterministic or on a probabilistic basis. The basic zone factors included herein are reasonable estimates of effective peak ground accelerations for the design of various structures covered in this standard. Zone factors for some important towns are given in Annex E.

Base isolation and energy absorbing devices may be used for earthquake resistant design. Only standard devices having detailed experimental data on the performance should be used. The designer must demonstrate by detailed analyses that these devices provide sufficient protection to the buildings and equipment as envisaged in this standard. Performance of locally assembled isolation and energy absorbing devices should be evaluated experimentally before they are used in practice. Design of buildings and equipment using such device should be reviewed by the competent authority.

Base isolation systems are found useful for short period structures, say less than 0.7 s including soil-structure interaction.

In the formulation of this standard, due weightage has been given to international coordination among the standards and practices prevailing in different countries in addition to relating it to the practices in the field in this country. Assistance has particularly been derived from the following publications:

- a) UBC 1994, Uniform Building Code, International Conference of Building Officials, Whittier, California, U.S.A. 1994.
- b) NEHRP 1991, NEHRP Recommended Provisions for the Development of Seismic Regulations for New Buildings, Part 1 : Provisions, Report No. FEMA 222, Federal Emergency Management Agency, Washington, D.C., U.S.A., January 1992.
- c) NEHRP 1991, NEHRP Recommended Provisions for the Development of Seismic Regulations for New Buildings, Part 2 : Commentary, Report No. FEMA 223, Federal Emergency Management Agency, Washington, D.C., U.S.A., January 1992.
- d) NZS 4203 : 1992, Code of Practice for General Structural Design and Design Loadings for Buildings, Standards Association of New Zealand, Wellington, New Zealand, 1992.

In the preparation of this standard considerable assistance has been given by the Department of Earthquake Engineering, University of Roorkee; Indian Institute of Technology, Kanpur; IIT Bombay, Mumbai; Geological Survey of India; India Meteorological Department, and several other organizations.

The units used with the items covered by the symbols shall be consistent throughout this standard, unless specifically noted otherwise.

The composition of the Committee responsible for the formulation of this standard is given in Annex F.

For the purpose of deciding whether a particular requirement of this standard is complied with, the final value observed or calculated, expressing the result of a test or analysis, shall be rounded off in accordance with IS 2 : 1960 'Rules for rounding off numerical values (*revised*)'. The number of significant places retained in the rounded off value should be the same as that of the specified value in this standard.

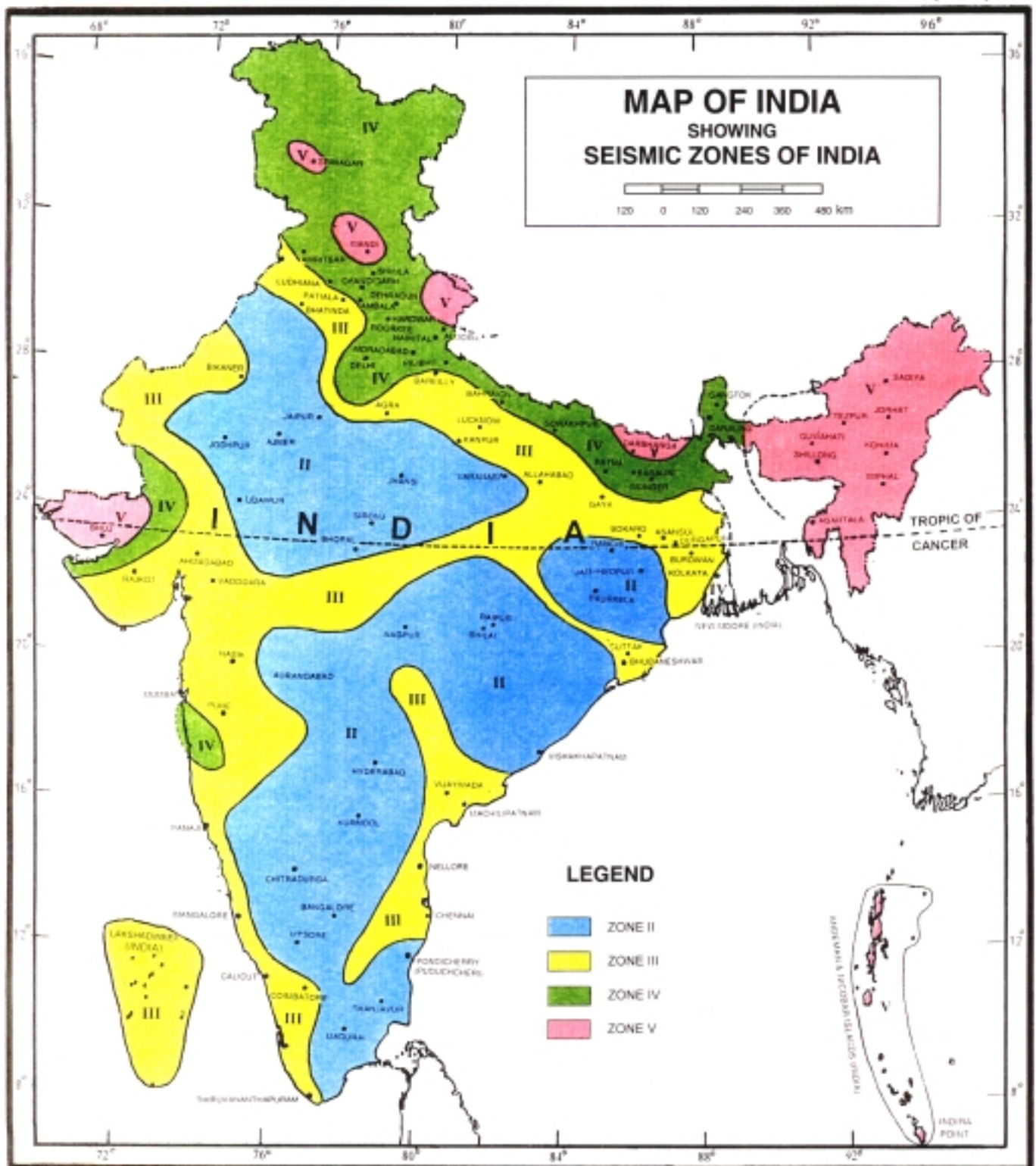

NOTE : Towns falling at the boundary of zones demarcation line between two zones shall be considered in High Zone.

© Government of India, Copyright Year 2001.

- Based upon Survey of India map with the permission of the Surveyor General of India.
- The responsibility for the correctness of internal details rests with the publisher.
- The territorial waters of India extend into the sea to distance of twelve nautical miles measured from the appropriate base line.
- The administrative headquarters of Chandigarh, Haryana and Punjab are at Chandigarh.
- The interstate boundaries between Arunachal Pradesh, Assam and Meghalaya shown on this map are as interpreted from the North-Eastern Areas (Reorganization) Act, 1971, but have yet to be verified.
- The external boundaries and coastlines of India agree with the Record/Master Copy certified by Survey of India.

FIG. 1

As in the Original Standard, this Page is Intentionally Left Blank

*Indian Standard*CRITERIA FOR EARTHQUAKE RESISTANT  
DESIGN OF STRUCTURES

## PART 1 GENERAL PROVISIONS AND BUILDINGS

*( Fifth Revision )***1 SCOPE**

**1.1** This standard ( Part 1 ) deals with assessment of seismic loads on various structures and earthquake resistant design of buildings. Its basic provisions are applicable to buildings; elevated structures; industrial and stack like structures; bridges; concrete masonry and earth dams; embankments and retaining walls and other structures.

**1.2** Temporary elements such as scaffolding, temporary excavations need not be designed for earthquake forces.

**1.3** This standard does not deal with the construction features relating to earthquake resistant design in buildings and other structures. For guidance on earthquake resistant construction of buildings, reference may be made to the following Indian Standards:

IS 4326, IS 13827, IS 13828, IS 13920 and IS 13935.

**2 REFERENCES**

**2.1** The following Indian Standards are necessary adjuncts to this standard:

<i>IS No.</i>	<i>Title</i>	<i>IS No.</i>	<i>Title</i>
		1343 : 1980	Code of practice for pre-stressed concrete ( <i>first revision</i> )
		1498 : 1970	Classification and identification of soils for general engineering purposes ( <i>first revision</i> )
		1888 : 1982	Method of load test on soils ( <i>second revision</i> )
		1893 (Part 4)	Criteria for earthquake resistant design of structures: Part 4 Industrial structures including stack like structures
		2131 : 1981	Method of standard penetration test for soils ( <i>first revision</i> )
		2809 : 1972	Glossary of terms and symbols relating to soil engineering ( <i>first revision</i> )
		2810 : 1979	Glossary of terms relating to soil dynamics ( <i>first revision</i> )
		4326 : 1993	Earthquake resistant design and construction of buildings — Code of practice ( <i>second revision</i> )
456 : 2000	Code of practice for plain and reinforced concrete ( <i>fourth revision</i> )	6403 : 1981	Code of practice for determination of bearing capacity of shallow foundations ( <i>first revision</i> )
800 : 1984	Code of practice for general construction in steel ( <i>second revision</i> )	13827 : 1993	Improving earthquake resistance of earthen buildings — Guidelines
875	Code of practice for design loads (other than earthquake) for buildings and structures:	13828 : 1993	Improving earthquake resistance of low strength masonry buildings — Guidelines
(Part 1) : 1987	Dead loads — Unit weights of building material and stored materials ( <i>second revision</i> )	13920 : 1993	Ductile detailing of reinforced concrete structures subjected to seismic forces — Code of practice
(Part 2) : 1987	Imposed loads ( <i>second revision</i> )	13935 : 1993	Repair and seismic strengthening of buildings — Guidelines
(Part 3) : 1987	Wind loads ( <i>second revision</i> )	SP 6 (6) : 1972	Handbook for structural engineers: Application of plastic theory in design of steel structures
(Part 4) : 1987	Snow loads ( <i>second revision</i> )		
(Part 5) : 1987	Special loads and load combinations ( <i>second revision</i> )		



### 3 TERMINOLOGY FOR EARTHQUAKE ENGINEERING

3.1 For the purpose of this standard, the following definitions shall apply which are applicable generally to all structures.

NOTE — For the definitions of terms pertaining to soil mechanics and soil dynamics references may be made to IS 2809 and IS 2810.

#### 3.2 Closely-Spaced Modes

Closely-spaced modes of a structure are those of its natural modes of vibration whose natural frequencies differ from each other by 10 percent or less of the lower frequency.

#### 3.3 Critical Damping

The damping beyond which the free vibration motion will not be oscillatory.

#### 3.4 Damping

The effect of internal friction, imperfect elasticity of material, slipping, sliding, etc in reducing the amplitude of vibration and is expressed as a percentage of critical damping.

#### 3.5 Design Acceleration Spectrum

Design acceleration spectrum refers to an average smoothed plot of maximum acceleration as a function of frequency or time period of vibration for a specified damping ratio for earthquake excitations at the base of a single degree of freedom system.

#### 3.6 Design Basis Earthquake ( DBE )

It is the earthquake which can reasonably be expected to occur at least once during the design life of the structure.

#### 3.7 Design Horizontal Acceleration Coefficient ( $A_h$ )

It is a horizontal acceleration coefficient that shall be used for design of structures.

#### 3.8 Design Lateral Force

It is the horizontal seismic force prescribed by this standard, that shall be used to design a structure.

#### 3.9 Ductility

Ductility of a structure, or its members, is the capacity to undergo large inelastic deformations without significant loss of strength or stiffness.

#### 3.10 Epicentre

The geographical point on the surface of earth vertically above the focus of the earthquake.

#### 3.11 Effective Peak Ground Acceleration ( EPGA )

It is 0.4 times the 5 percent damped average spectral acceleration between period 0.1 to 0.3 s. This shall be taken as Zero Period Acceleration ( ZPA ).

#### 3.12 Floor Response Spectra

Floor response spectra is the response spectra for a time history motion of a floor. This floor motion time history is obtained by an analysis of multi-storey building for appropriate material damping values subjected to a specified earthquake motion at the base of structure.

#### 3.13 Focus

The originating earthquake source of the elastic waves inside the earth which cause shaking of ground due to earthquake.

#### 3.14 Importance Factor ( $I$ )

It is a factor used to obtain the design seismic force depending on the functional use of the structure, characterised by hazardous consequences of its failure, its post-earthquake functional need, historic value, or economic importance.

#### 3.15 Intensity of Earthquake

The intensity of an earthquake at a place is a measure of the strength of shaking during the earthquake, and is indicated by a number according to the modified Mercalli Scale or M.S.K. Scale of seismic intensities ( *see* Annex D ).

#### 3.16 Liquefaction

Liquefaction is a state in saturated cohesionless soil wherein the effective shear strength is reduced to negligible value for all engineering purpose due to pore pressure caused by vibrations during an earthquake when they approach the total confining pressure. In this condition the soil tends to behave like a fluid mass.

#### 3.17 Lithological Features

The nature of the geological formation of the earths crust above bed rock on the basis of such characteristics as colour, structure, mineralogical composition and grain size.

#### 3.18 Magnitude of Earthquake ( Richter's Magnitude )

The magnitude of earthquake is a number, which is a measure of energy released in an earthquake. It is defined as logarithm to the base 10 of the maximum trace amplitude, expressed in microns, which the standard short-period torsion seismometer ( with a period of 0.8 s, magnification 2 800 and damping nearly critical ) would register due to the earthquake at an epicentral distance of 100 km.

**3.19 Maximum Considered Earthquake ( MCE )**

The most severe earthquake effects considered by this standard.

**3.20 Modal Mass ( $M_k$ )**

Modal mass of a structure subjected to horizontal or vertical, as the case may be, ground motion is a part of the total seismic mass of the structure that is effective in mode  $k$  of vibration. The modal mass for a given mode has a unique value irrespective of scaling of the mode shape.

**3.21 Modal Participation Factor ( $P_k$ )**

Modal participation factor of mode  $k$  of vibration is the amount by which mode  $k$  contributes to the overall vibration of the structure under horizontal and vertical earthquake ground motions. Since the amplitudes of 95 percent mode shapes can be scaled arbitrarily, the value of this factor depends on the scaling used for mode shapes.

**3.22 Modes of Vibration ( see Normal Mode )****3.23 Mode Shape Coefficient ( $\phi_{ik}$ )**

When a system is vibrating in normal mode  $k$ , at any particular instant of time, the amplitude of mass  $i$  expressed as a ratio of the amplitude of one of the masses of the system, is known as mode shape coefficient ( $\phi_{ik}$ ).

**3.24 Natural Period ( $T$ )**

Natural period of a structure is its time period of undamped free vibration.

**3.24.1 Fundamental Natural Period ( $T_1$ )**

It is the first ( longest ) modal time period of vibration.

**3.24.2 Modal Natural Period ( $T_k$ )**

The modal natural period of mode  $k$  is the time period of vibration in mode  $k$ .

**3.25 Normal Mode**

A system is said to be vibrating in a normal mode when all its masses attain maximum values of displacements and rotations simultaneously, and pass through equilibrium positions simultaneously.

**3.26 Response Reduction Factor ( $R$ )**

It is the factor by which the actual base shear force, that would be generated if the structure were to remain elastic during its response to the Design Basis Earthquake ( DBE ) shaking, shall be reduced to obtain the design lateral force.

**3.27 Response Spectrum**

The representation of the maximum response of

idealized single degree freedom systems having certain period and damping, during earthquake ground motion. The maximum response is plotted against the undamped natural period and for various damping values, and can be expressed in terms of maximum absolute acceleration, maximum relative velocity, or maximum relative displacement.

**3.28 Seismic Mass**

It is the seismic weight divided by acceleration due to gravity.

**3.29 Seismic Weight ( $W$ )**

It is the total dead load plus appropriate amounts of specified imposed load.

**3.30 Structural Response Factors ( $S_a/g$ )**

It is a factor denoting the acceleration response spectrum of the structure subjected to earthquake ground vibrations, and depends on natural period of vibration and damping of the structure.

**3.31 Tectonic Features**

The nature of geological formation of the bed rock in the earth's crust revealing regions characterized by structural features, such as dislocation, distortion, faults, folding, thrusts, volcanoes with their age of formation, which are directly involved in the earth movement or quake resulting in the above consequences.

**3.32 Time History Analysis**

It is an analysis of the dynamic response of the structure at each increment of time, when its base is subjected to a specific ground motion time history.

**3.33 Zone Factor ( $Z$ )**

It is a factor to obtain the design spectrum depending on the perceived maximum seismic risk characterized by Maximum Considered Earthquake ( MCE ) in the zone in which the structure is located. The basic zone factors included in this standard are reasonable estimate of effective peak ground acceleration.

**3.34 Zero Period Acceleration ( ZPA )**

It is the value of acceleration response spectrum for period below 0.03 s ( frequencies above 33 Hz ).

**4 TERMINOLOGY FOR EARTHQUAKE ENGINEERING OF BUILDINGS**

**4.1** For the purpose of earthquake resistant design of buildings in this standard, the following definitions shall apply.

**4.2 Base**

It is the level at which inertia forces generated in the structure are transferred to the foundation, which then transfers these forces to the ground.

#### 4.3 Base Dimensions ( $d$ )

Base dimension of the building along a direction is the dimension at its base, in metre, along that direction.

#### 4.4 Centre of Mass

The point through which the resultant of the masses of a system acts. This point corresponds to the centre of gravity of masses of system.

#### 4.5 Centre of Stiffness

The point through which the resultant of the restoring forces of a system acts.

#### 4.6 Design Eccentricity ( $e_{di}$ )

It is the value of eccentricity to be used at floor  $i$  in torsion calculations for design.

#### 4.7 Design Seismic Base Shear ( $V_B$ )

It is the total design lateral force at the base of a structure.

#### 4.8 Diaphragm

It is a horizontal, or nearly horizontal system, which transmits lateral forces to the vertical resisting elements, for example, reinforced concrete floors and horizontal bracing systems.

#### 4.9 Dual System

Buildings with dual system consist of shear walls ( or braced frames ) and moment resisting frames such that:

- a) The two systems are designed to resist the total design lateral force in proportion to their lateral stiffness considering the interaction of the dual system at all floor levels; and
- b) The moment resisting frames are designed to independently resist at least 25 percent of the design base shear.

#### 4.10 Height of Floor ( $h_i$ )

It is the difference in levels between the base of the building and that of floor  $i$ .

#### 4.11 Height of Structure ( $h$ )

It is the difference in levels, in metres, between its base and its highest level.

#### 4.12 Horizontal Bracing System

It is a horizontal truss system that serves the same function as a diaphragm.

#### 4.13 Joint

It is the portion of the column that is common to other members, for example, beams, framing into it.

#### 4.14 Lateral Force Resisting Element

It is part of the structural system assigned to resist lateral forces.

#### 4.15 Moment-Resisting Frame

It is a frame in which members and joints are capable of resisting forces primarily by flexure.

##### 4.15.1 Ordinary Moment-Resisting Frame

It is a moment-resisting frame not meeting special detailing requirements for ductile behaviour.

##### 4.15.2 Special Moment-Resisting Frame

It is a moment-resisting frame specially detailed to provide ductile behaviour and comply with the requirements given in IS 4326 or IS 13920 or SP 6 ( 6 ).

#### 4.16 Number of Storeys ( $n$ )

Number of storeys of a building is the number of levels above the base. This excludes the basement storeys, where basement walls are connected with the ground floor deck or fitted between the building columns. But, it includes the basement storeys, when they are not so connected.

#### 4.17 Principal Axes

Principal axes of a building are generally two mutually perpendicular horizontal directions in plan of a building along which the geometry of the building is oriented.

#### 4.18 $P$ - $\Delta$ Effect

It is the secondary effect on shears and moments of frame members due to action of the vertical loads, interacting with the lateral displacement of building resulting from seismic forces.

#### 4.19 Shear Wall

It is a wall designed to resist lateral forces acting in its own plane.

#### 4.20 Soft Storey

It is one in which the lateral stiffness is less than 70 percent of that in the storey above or less than 80 percent of the average lateral stiffness of the three storeys above.

#### 4.21 Static Eccentricity ( $e_{si}$ )

It is the distance between centre of mass and centre of rigidity of floor  $i$ .

#### 4.22 Storey

It is the space between two adjacent floors.

#### 4.23 Storey Drift

It is the displacement of one level relative to the other level above or below.

#### 4.24 Storey Shear ( $V_i$ )

It is the sum of design lateral forces at all levels above the storey under consideration.

#### 4.25 Weak Storey

It is one in which the storey lateral strength is less than 80 percent of that in the storey above. The storey lateral strength is the total strength of all seismic force resisting elements sharing the storey shear in the considered direction.

### 5 SYMBOLS

The symbols and notations given below apply to the provisions of this standard:

$A_h$	Design horizontal seismic coefficient	$n$	Number of storeys
$A_k$	Design horizontal acceleration spectrum value for mode $k$ of vibration	$N$	SPT value for soil
$b_i$	$i^{\text{th}}$ Floor plan dimension of the building perpendicular to the direction of force	$P_k$	Modal participation factor of mode $k$
$c$	Index for the closely-spaced modes	$Q_i$	Lateral force at floor $i$
$d$	Base dimension of the building, in metres, in the direction in which the seismic force is considered.	$Q_{ik}$	Design lateral force at floor $i$ in mode $k$
$DL$	Response quantity due to dead load	$r$	Number of modes to be considered as per 7.8.4.2
$e_{di}$	Design eccentricity to be used at floor $i$ calculated as per 7.8.2	$R$	Response reduction factor
$e_{si}$	Static eccentricity at floor $i$ defined as the distance between centre of mass and centre of rigidity	$S_a/g$	Average response acceleration coefficient for rock or soil sites as given by Fig. 2 and Table 3 based on appropriate natural periods and damping of the structure
$EL_x$	Response quantity due to earthquake load for horizontal shaking along $x$ -direction	$T$	Undamped natural period of vibration of the structure ( in second )
$EL_y$	Response quantity due to earthquake load for horizontal shaking along $y$ -direction	$T_a$	Approximate fundamental period ( in seconds )
$EL_z$	Response quantity due to earthquake load for vertical shaking along $z$ -direction	$T_k$	Undamped natural period of mode $k$ of vibration ( in second )
$F_{\text{roof}}$	Design lateral forces at the roof due to all modes considered	$T_1$	Fundamental natural period of vibration ( in second )
$F_i$	Design lateral forces at the floor $i$ due to all modes considered	$V_B$	Design seismic base shear
$g$	Acceleration due to gravity	$\bar{V}_B$	Design base shear calculated using the approximate fundamental period $T_a$
$h$	Height of structure, in metres	$V_i$	Peak storey shear force in storey $i$ due to all modes considered
$h_i$	Height measured from the base of the building to floor $i$	$V_{ik}$	Shear force in storey $i$ in mode $k$
$I$	Importance factor	$V_{\text{roof}}$	Peak storey shear force at the roof due to all modes considered
$IL$	Response quantity due to imposed load	$W$	Seismic weight of the structure
$M_k$	Modal mass of mode $k$	$W_i$	Seismic weight of floor $i$
		$Z$	Zone factor
		$\phi_{ik}$	Mode shape coefficient at floor $i$ in mode $k$
		$\lambda$	Peak response ( for example member forces, displacements, storey forces, storey shears or base reactions ) due to all modes considered
		$\lambda_k$	Absolute value of maximum response in mode $k$
		$\lambda_c$	Absolute value of maximum response in mode $c$ , where mode $c$ is a closely-spaced mode.
		$\lambda^*$	Peak response due to the closely-spaced modes only

- $\rho_{ij}$  Coefficient used in the Complete Quadratic Combination ( CQC ) method while combining responses of modes  $i$  and  $j$
- $\omega_i$  Circular frequency in rad/second in the  $i^{\text{th}}$  mode

## 6 GENERAL PRINCIPLES AND DESIGN CRITERIA

### 6.1 General Principles

#### 6.1.1 Ground Motion

The characteristics ( intensity, duration, etc ) of seismic ground vibrations expected at any location depends upon the magnitude of earthquake, its depth of focus, distance from the epicentre, characteristics of the path through which the seismic waves travel, and the soil strata on which the structure stands. The random earthquake ground motions, which cause the structure to vibrate, can be resolved in any three mutually perpendicular directions. The predominant direction of ground vibration is usually horizontal.

Earthquake-generated vertical inertia forces are to be considered in design unless checked and proven by specimen calculations to be not significant. Vertical acceleration should be considered in structures with large spans, those in which stability is a criterion for design, or for overall stability analysis of structures. Reduction in gravity force due to vertical component of ground motions can be particularly detrimental in cases of prestressed horizontal members and of cantilevered members. Hence, special attention should be paid to the effect of vertical component of the ground motion on prestressed or cantilevered beams, girders and slabs.

**6.1.2** The response of a structure to ground vibrations is a function of the nature of foundation soil; materials, form, size and mode of construction of structures; and the duration and characteristics of ground motion. This standard specifies design forces for structures standing on rocks or soils which do not settle, liquefy or slide due to loss of strength during ground vibrations.

**6.1.3** The design approach adopted in this standard is to ensure that structures possess at least a minimum strength to withstand minor earthquakes ( <DBE ), which occur frequently, without damage; resist moderate earthquakes ( DBE ) without significant structural damage though some non-structural damage may occur; and aims that structures withstand a major earthquake ( MCE ) without collapse. Actual forces that appear on structures during earthquakes are much greater than the design forces specified in this standard. However, ductility, arising from inelastic material behaviour and detailing, and overstrength, arising from the additional reserve strength in structures over and above the design strength, are relied upon to account

for this difference in actual and design lateral loads.

Reinforced and prestressed concrete members shall be suitably designed to ensure that premature failure due to shear or bond does not occur, subject to the provisions of IS 456 and IS 1343. Provisions for appropriate ductile detailing of reinforced concrete members are given in IS 13920.

In steel structures, members and their connections should be so proportioned that high ductility is obtained, vide SP 6 ( Part 6 ), avoiding premature failure due to elastic or inelastic buckling of any type.

The specified earthquake loads are based upon post-elastic energy dissipation in the structure and because of this fact, the provision of this standard for design, detailing and construction shall be satisfied even for structures and members for which load combinations that do not contain the earthquake effect indicate larger demands than combinations including earthquake.

#### 6.1.4 Soil-Structure Interaction

The soil-structure interaction refers to the effects of the supporting foundation medium on the motion of structure. The soil-structure interaction may not be considered in the seismic analysis for structures supported on rock or rock-like material.

**6.1.5** The design lateral force specified in this standard shall be considered in each of the two orthogonal horizontal directions of the structure. For structures which have lateral force resisting elements in the two orthogonal directions only, the design lateral force shall be considered along one direction at a time, and not in both directions simultaneously. Structures, having lateral force resisting elements ( for example frames, shear walls ) in directions other than the two orthogonal directions, shall be analysed considering the load combinations specified in 6.3.2.

Where both horizontal and vertical seismic forces are taken into account, load combinations specified in 6.3.3 shall be considered.

**6.1.6** Equipment and other systems, which are supported at various floor levels of the structure, will be subjected to motions corresponding to vibration at their support points. In important cases, it may be necessary to obtain floor response spectra for design of equipment supports. For detail reference be made to IS 1893 ( Part 4 ).

#### 6.1.7 Additions to Existing Structures

Additions shall be made to existing structures only as follows:

- a) An addition that is structurally independent from an existing structures shall be designed and constructed in accordance with the seismic requirements for new structures.

b) An addition that is not structurally independent from an existing structure shall be designed and constructed such that the entire structure conforms to the seismic force resistance requirements for new structures unless the following three conditions are complied with:

- 1) The addition shall comply with the requirements for new structures,
- 2) The addition shall not increase the seismic forces in any structural elements of the existing structure by more than 5 percent unless the capacity of the element subject to the increased force is still in compliance with this standard, and
- 3) The addition shall not decrease the seismic resistance of any structural element of the existing structure unless reduced resistance is equal to or greater than that required for new structures.

#### 6.1.8 Change in Occupancy

When a change of occupancy results in a structure being re-classified to a higher importance factor ( $I$ ), the structure shall conform to the seismic requirements for a new structure with the higher importance factor.

#### 6.2 Assumptions

The following assumptions shall be made in the earthquake resistant design of structures:

- a) Earthquake causes impulsive ground motions, which are complex and irregular in character, changing in period and amplitude each lasting for a small duration. Therefore, resonance of the type as visualized under steady-state sinusoidal excitations, will not occur as it would need time to build up such amplitudes.

NOTE — However, there are exceptions where resonance-like conditions have been seen to occur between long distance waves and tall structures founded on deep soft soils.

- b) Earthquake is not likely to occur simultaneously with wind or maximum flood or maximum sea waves.
- c) The value of elastic modulus of materials, wherever required, may be taken as for static analysis unless a more definite value is available for use in such condition ( see IS 456, IS 1343 and IS 800 )

#### 6.3 Load Combination and Increase in Permissible Stresses

##### 6.3.1 Load Combinations

When earthquake forces are considered on a structure,

these shall be combined as per 6.3.1.1 and 6.3.1.2 where the terms  $DL$ ,  $IL$  and  $EL$  stand for the response quantities due to dead load, imposed load and designated earthquake load respectively.

##### 6.3.1.1 Load factors for plastic design of steel structures

In the plastic design of steel structures, the following load combinations shall be accounted for:

- 1)  $1.7 ( DL + IL )$
- 2)  $1.7 ( DL \pm EL )$
- 3)  $1.3 ( DL + IL \pm EL )$

##### 6.3.1.2 Partial safety factors for limit state design of reinforced concrete and prestressed concrete structures

In the limit state design of reinforced and prestressed concrete structures, the following load combinations shall be accounted for:

- 1)  $1.5 ( DL + IL )$
- 2)  $1.2 ( DL + IL \pm EL )$
- 3)  $1.5 ( DL \pm EL )$
- 4)  $0.9 DL \pm 1.5 EL$

##### 6.3.2 Design Horizontal Earthquake Load

6.3.2.1 When the lateral load resisting elements are oriented along orthogonal horizontal direction, the structure shall be designed for the effects due to full design earthquake load in one horizontal direction at time.

6.3.2.2 When the lateral load resisting elements are not oriented along the orthogonal horizontal directions, the structure shall be designed for the effects due to full design earthquake load in one horizontal direction plus 30 percent of the design earthquake load in the other direction.

NOTE — For instance, the building should be designed for  $( \pm EL_x \pm 0.3 EL_y )$  as well as  $( \pm 0.3 EL_x \pm EL_y )$ , where  $x$  and  $y$  are two orthogonal horizontal directions,  $EL$  in 6.3.1.1 and 6.3.1.2 shall be replaced by  $( EL_x \pm 0.3 EL_y )$  or  $( EL_y \pm 0.3 EL_x )$ .

##### 6.3.3 Design Vertical Earthquake Load

When effects due to vertical earthquake loads are to be considered, the design vertical force shall be calculated in accordance with 6.4.5.

##### 6.3.4 Combination for Two or Three Component Motion

6.3.4.1 When responses from the three earthquake components are to be considered, the responses due to each component may be combined using the

assumption that when the maximum response from one component occurs, the responses from the other two component are 30 percent of their maximum. All possible combinations of the three components ( $EL_x$ ,  $EL_y$  and  $EL_z$ ) including variations in sign ( plus or minus ) shall be considered. Thus, the response due earthquake force ( $EL$ ) is the maximum of the following three cases:

- 1)  $\pm EL_x \pm 0.3 EL_y \pm 0.3 EL_z$
- 2)  $\pm EL_y \pm 0.3 EL_x \pm 0.3 EL_z$
- 3)  $\pm EL_z \pm 0.3 EL_x \pm 0.3 EL_y$

where  $x$  and  $y$  are two orthogonal directions and  $z$  is vertical direction.

**6.3.4.2** As an alternative to the procedure in 6.3.4.1, the response ( $EL$ ) due to the combined effect of the three components can be obtained on the basis of 'square root of the sum of the square (SRSS)' that is

$$EL = \sqrt{(EL_x)^2 + (EL_y)^2 + (EL_z)^2}$$

NOTE — The combination procedure of 6.3.4.1 and 6.3.4.2 apply to the same response quantity (say, moment in a column about its major axis, or storey shear in a frame) due to different components of the ground motion.

**6.3.4.3** When two component motions ( say one horizontal and one vertical, or only two horizontal ) are combined, the equations in 6.3.4.1 and 6.3.4.2 should be modified by deleting the term representing the response due to the component of motion not being considered.

**6.3.5 Increase in Permissible Stresses**

**6.3.5.1 Increase in permissible stresses in materials**

When earthquake forces are considered along with other normal design forces, the permissible stresses in material, in the elastic method of design, may be increased by one-third. However, for steels having a definite yield stress, the stress be limited to the yield stress; for steels without a definite yield point, the stress will be limited to 80 percent of the ultimate strength or 0.2 percent proof stress, whichever is smaller; and that in prestressed concrete members, the tensile stress in the extreme fibers of the concrete may be permitted so as not to exceed two-thirds of the modulus of rupture of concrete.

**6.3.5.2 Increase in allowable pressure in soils**

When earthquake forces are included, the allowable bearing pressure in soils shall be increased as per Table 1, depending upon type of foundation of the structure and the type of soil.

In soil deposits consisting of submerged loose sands and soils falling under classification SP with standard penetration  $N$ -values less than 15 in seismic

Zones III, IV, V and less than 10 in seismic Zone II, the vibration caused by earthquake may cause liquefaction or excessive total and differential settlements. Such sites should preferably be avoided while locating new settlements or important projects. Otherwise, this aspect of the problem needs to be investigated and appropriate methods of compaction or stabilization adopted to achieve suitable  $N$ -values as indicated in Note 3 under Table 1. Alternatively, deep pile foundation may be provided and taken to depths well into the layer which is not likely to liquefy. Marine clays and other sensitive clays are also known to liquefy due to collapse of soil structure and will need special treatment according to site condition.

NOTE — Specialist literature may be referred for determining liquefaction potential of a site.

**6.4 Design Spectrum**

**6.4.1** For the purpose of determining seismic forces, the country is classified into four seismic zones as shown in Fig. 1.

**6.4.2** The design horizontal seismic coefficient  $A_h$  for a structure shall be determined by the following expression:

$$A_h = \frac{Z I S_a}{2 R g}$$

Provided that for any structure with  $T \leq 0.1$  s, the value of  $A_h$  will not be taken less than  $Z/2$  whatever be the value of  $I/R$

where

$Z$  = Zone factor given in Table 2, is for the Maximum Considered Earthquake (MCE) and service life of structure in a zone. The factor 2 in the denominator of  $Z$  is used so as to reduce the Maximum Considered Earthquake (MCE) zone factor to the factor for Design Basis Earthquake (DBE).

$I$  = Importance factor, depending upon the functional use of the structures, characterised by hazardous consequences of its failure, post-earthquake functional needs, historical value, or economic importance ( Table 6 ).

$R$  = Response reduction factor, depending on the perceived seismic damage performance of the structure, characterised by ductile or brittle deformations. However, the ratio ( $I/R$ ) shall not be greater than 1.0 ( Table 7 ). The values of  $R$  for buildings are given in Table 7.

$S_a/g$  = Average response acceleration coefficient

**Table 1 Percentage of Permissible Increase in Allowable Bearing Pressure or Resistance of Soils**

( Clause 6.3.5.2 )

SI No.	Foundation	Type of Soil Mainly Constituting the Foundation		
		Type I Rock or Hard Soil : Well graded gravel and sand gravel mixtures with or without clay binder, and clayey sands poorly graded or sand clay mixtures ( GB, CW, SB, SW, and SC ) <sup>1)</sup> having $N^2$ above 30, where $N$ is the standard penetration value	Type II Medium Soils : All soils with $N$ between 10 and 30, and poorly graded sands or gravelly sands with little or no fines ( SP <sup>1)</sup> with $N > 15$	Type III Soft Soils : All soils other than SP <sup>1)</sup> with $N < 10$
(1)	(2)	(3)	(4)	(5)
i)	Piles passing through any soil but resting on soil type I	50	50	50
ii)	Piles not covered under item i	—	25	25
iii)	Raft foundations	50	50	50
iv)	Combined isolated RCC footing with tie beams	50	25	25
v)	Isolated RCC footing without tie beams, or unreinforced strip foundations	50	25	—
vi)	Well foundations	50	25	25

## NOTES

1 The allowable bearing pressure shall be determined in accordance with IS 6403 or IS 1888.

2 If any increase in bearing pressure has already been permitted for forces other than seismic forces, the total increase in allowable bearing pressure when seismic force is also included shall not exceed the limits specified above.

3 Desirable minimum field values of  $N$  — If soils of smaller  $N$ -values are met, compacting may be adopted to achieve these values or deep pile foundations going to stronger strata should be used.

4 The values of  $N$  ( corrected values ) are at the founding level and the allowable bearing pressure shall be determined in accordance with IS 6403 or IS 1888.

Seismic Zone level ( in metres )	Depth Below Ground	$N$ -Values	Remark
III, IV and V	$\leq 5$	15	For values of depths between 5 m and 10 m, linear interpolation is recommended
	$\geq 10$	25	
II ( for important structures only )	$\leq 5$	15	
	$\geq 10$	20	

5 The piles should be designed for lateral loads neglecting lateral resistance of soil layers liable to liquefy.

6 IS 1498 and IS 2131 may also be referred.

7 Isolated R.C.C. footing without tie beams, or unreinforced strip foundation shall not be permitted in soft soils with  $N < 10$ .

<sup>1)</sup> See IS 1498.

<sup>2)</sup> See IS 2131.



for rock or soil sites as given by Fig. 2 and Table 3 based on appropriate natural periods and damping of the structure. These curves represent free field ground motion.

NOTE — For various types of structures, the values of Importance Factor  $I$ , Response Reduction Factor  $R$ , and damping values are given in the respective parts of this standard. The method ( empirical or otherwise ) to calculate the natural periods of the structure to be adopted for evaluating  $S_a/g$  is also given in the respective parts of this standard.

**Table 2 Zone Factor,  $Z$**   
( Clause 6.4.2 )

Seismic Zone	II	III	IV	V
Seismic Intensity	Low	Moderate	Severe	Very Severe
$Z$	0.10	0.16	0.24	0.36

6.4.3 Where a number of modes are to be considered for dynamic analysis, the value of  $A_h$  as defined in 6.4.2 for each mode shall be determined using the natural period of vibration of that mode.

6.4.4 For underground structures and foundations at depths of 30 m or below, the design horizontal acceleration spectrum value shall be taken as half the value obtained from 6.4.2. For structures and

foundations placed between the ground level and 30 m depth, the design horizontal acceleration spectrum value shall be linearly interpolated between  $A_h$  and  $0.5 A_h$ , where  $A_h$  is as specified in 6.4.2.

6.4.5 The design acceleration spectrum for vertical motions, when required, may be taken as two-thirds of the design horizontal acceleration spectrum specified in 6.4.2.

Figure 2 shows the proposed 5 percent spectra for rocky and soils sites and Table 3 gives the multiplying factors for obtaining spectral values for various other dampings.

*For rocky, or hard soil sites*

$$\frac{S_a}{g} = \begin{cases} 1 + 15 T; & 0.00 \leq T \leq 0.10 \\ 2.50 & 0.10 \leq T \leq 0.40 \\ 1.00/T & 0.40 \leq T \leq 4.00 \end{cases}$$

*For medium soil sites*

$$\frac{S_a}{g} = \begin{cases} 1 + 15 T; & 0.00 \leq T \leq 0.10 \\ 2.50 & 0.10 \leq T \leq 0.55 \\ 1.36/T & 0.55 \leq T \leq 4.00 \end{cases}$$

*For soft soil sites*

$$\frac{S_a}{g} = \begin{cases} 1 + 15 T; & 0.00 \leq T \leq 0.10 \\ 2.50 & 0.10 \leq T \leq 0.67 \\ 1.67/T & 0.67 \leq T \leq 4.00 \end{cases}$$

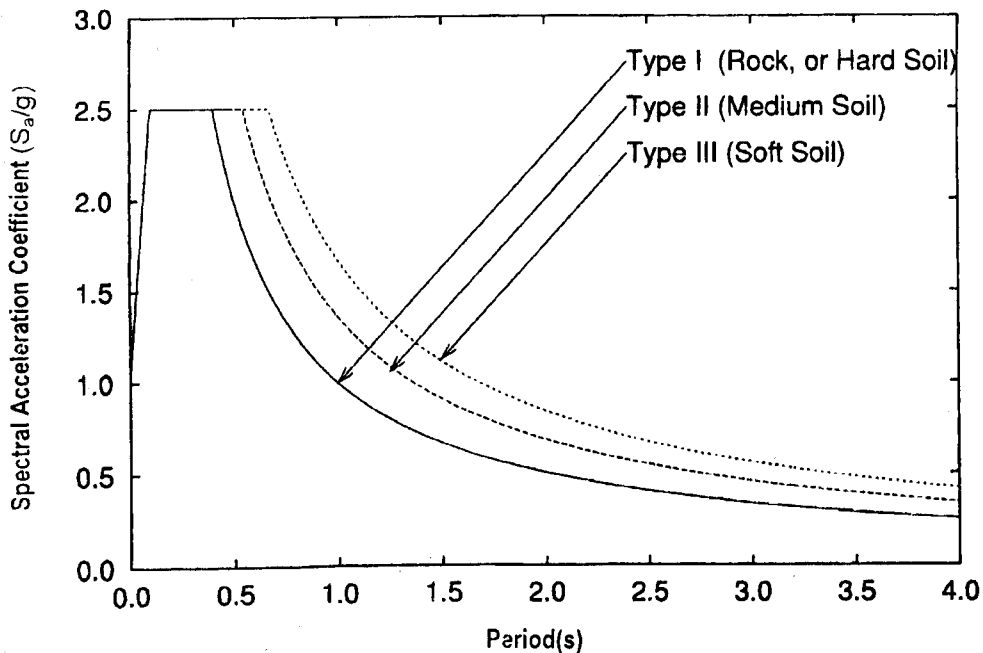

FIG. 2 RESPONSE SPECTRA FOR ROCK AND SOIL SITES FOR 5 PERCENT DAMPING

6.4.6 In case design spectrum is specifically prepared for a structure at a particular project site, the same may be used for design at the discretion of the project authorities

## 7 BUILDINGS

### 7.1 Regular and Irregular Configuration

To perform well in an earthquake, a building should possess four main attributes, namely simple and regular configuration, and adequate lateral strength, stiffness and ductility. Buildings having simple regular geometry and uniformly distributed mass and stiffness in plan as well as in elevation, suffer much less damage than buildings with irregular configurations. A building shall be considered as irregular for the purposes of this standard, if at least one of the conditions given in Tables 4 and 5 is applicable.

### 7.2 Importance Factor $I$ and Response Reduction Factor $R$

The minimum value of importance factor,  $I$ , for different building systems shall be as given in Table 6. The response reduction factor,  $R$ , for different building systems shall be as given in Table 7.

### 7.3 Design Imposed Loads for Earthquakes Force Calculation

7.3.1 For various loading classes as specified in IS 875 ( Part 2 ), the earthquake force shall be calculated for the full dead load plus the percentage of imposed load as given in Table 8.

7.3.2 For calculating the design seismic forces of the structure, the imposed load on roof need not be considered.

7.3.3 The percentage of imposed loads given in 7.3.1 and 7.3.2 shall also be used for 'Whole frame loaded' condition in the load combinations specified in 6.3.1.1

and 6.3.1.2 where the gravity loads are combined with the earthquake loads [ that is, in load combinations (3) in 6.3.1.1, and (2) in 6.3.1.2 ]. No further reduction in the imposed load will be used as envisaged in IS 875 ( Part 2 ) for number of storeys above the one under consideration or for large spans of beams or floors.

7.3.4 The proportions of imposed load indicated above for calculating the lateral design forces for earthquakes are applicable to average conditions. Where the probable loads at the time of earthquake are more accurately assessed, the designer may alter the proportions indicated or even replace the entire imposed load proportions by the actual assessed load. In such cases, where the imposed load is not assessed as per 7.3.1 and 7.3.2 only that part of imposed load, which possesses mass, shall be considered. Lateral design force for earthquakes shall not be calculated on contribution of impact effects from imposed loads.

7.3.5 Other loads apart from those given above ( for example snow and permanent equipment ) shall be considered as appropriate.

### 7.4 Seismic Weight

#### 7.4.1 Seismic Weight of Floors

The seismic weight of each floor is its full dead load plus appropriate amount of imposed load, as specified in 7.3.1 and 7.3.2. While computing the seismic weight of each floor, the weight of columns and walls in any storey shall be equally distributed to the floors above and below the storey.

#### 7.4.2 Seismic Weight of Building

The seismic weight of the whole building is the sum of the seismic weights of all the floors.

7.4.3 Any weight supported in between storeys shall be distributed to the floors above and below in inverse proportion to its distance from the floors.

**Table 3 Multiplying Factors for Obtaining Values for Other Damping**

( Clause 6.4.2 )

Damping, percent	0	2	5	7	10	15	20	25	30
Factors	3.20	1.40	1.00	0.90	0.80	0.70	0.60	0.55	0.50

**Table 4 Definitions of Irregular Buildings — Plan Irregularities ( Fig. 3 )**  
( Clause 7.1 )

SI No.	Irregularity Type and Description
(1)	(2)
i)	<i>Torsion Irregularity</i> To be considered when floor diaphragms are rigid in their own plan in relation to the vertical structural elements that resist the lateral forces. Torsional irregularity to be considered to exist when the maximum storey drift, computed with design eccentricity, at one end of the structures transverse to an axis is more than 1.2 times the average of the storey drifts at the two ends of the structure
ii)	<i>Re-entrant Corners</i> Plan configurations of a structure and its lateral force resisting system contain re-entrant corners, where both projections of the structure beyond the re-entrant corner are greater than 15 percent of its plan dimension in the given direction
iii)	<i>Diaphragm Discontinuity</i> Diaphragms with abrupt discontinuities or variations in stiffness, including those having cut-out or open areas greater than 50 percent of the gross enclosed diaphragm area, or changes in effective diaphragm stiffness of more than 50 percent from one storey to the next
iv)	<i>Out-of-Plane Offsets</i> Discontinuities in a lateral force resistance path, such as out-of-plane offsets of vertical elements
v)	<i>Non-parallel Systems</i> The vertical elements resisting the lateral force are not parallel to or symmetric about the major orthogonal axes or the lateral force resisting elements

**Table 5 Definition of Irregular Buildings — Vertical Irregularities ( Fig. 4 )**  
( Clause 7.1 )

SI No.	Irregularity Type and Description
(1)	(2)
i)	a) <i>Stiffness Irregularity — Soft Storey</i> A soft storey is one in which the lateral stiffness is less than 70 percent of that in the storey above or less than 80 percent of the average lateral stiffness of the three storeys above b) <i>Stiffness Irregularity — Extreme Soft Storey</i> A extreme soft storey is one in which the lateral stiffness is less than 60 percent of that in the storey above or less than 70 percent of the average stiffness of the three storeys above. For example, buildings on STILTS will fall under this category.

**Table 5 — Concluded**

SI No.	Irregularity Type and Description
(1)	(2)
ii)	<i>Mass Irregularity</i> Mass irregularity shall be considered to exist where the seismic weight of any storey is more than 200 percent of that of its adjacent storeys. The irregularity need not be considered in case of roofs
iii)	<i>Vertical Geometric Irregularity</i> Vertical geometric irregularity shall be considered to exist where the horizontal dimension of the lateral force resisting system in any storey is more than 150 percent of that in its adjacent storey
iv)	<i>In-Plane Discontinuity in Vertical Elements Resisting Lateral Force</i> A in-plane offset of the lateral force resisting elements greater than the length of those elements
v)	<i>Discontinuity in Capacity — Weak Storey</i> A weak storey is one in which the storey lateral strength is less than 80 percent of that in the storey above. The storey lateral strength is the total strength of all seismic force resisting elements sharing the storey shear in the considered direction.

**Table 6 Importance Factors, I**  
( Clause 6.4.2 )

SI No.	Structure	Importance Factor
(1)	(2)	(3)
i)	Important service and community buildings, such as hospitals; schools; monumental structures; emergency buildings like telephone exchange, television stations, radio stations, railway stations, fire station buildings; large community halls like cinemas, assembly halls and subway stations, power stations	1.5
ii)	All other buildings	1.0

NOTES

- 1 The design engineer may choose values of importance factor *I* greater than those mentioned above.
- 2 Buildings not covered in SI No. (i) and (ii) above may be designed for higher value of *I*, depending on economy, strategy considerations like multi-storey buildings having several residential units.
- 3 This does not apply to temporary structures like excavations, scaffolding etc of short duration.

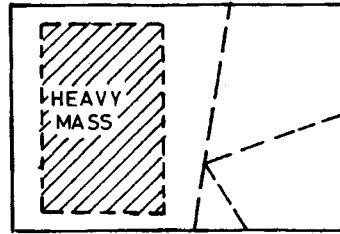
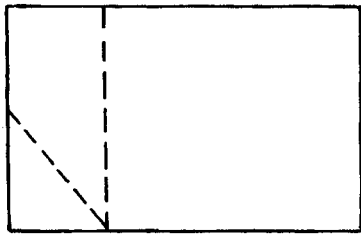

VERTICAL COMPONENTS OF SEISMIC RESISTING SYSTEM

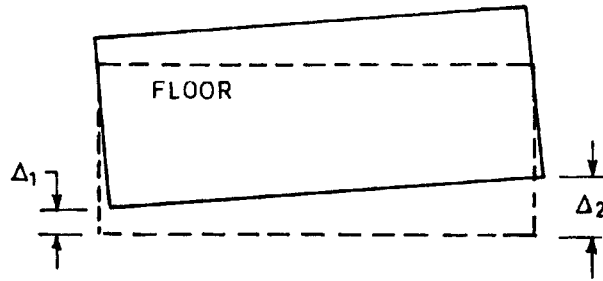

3 A Torsional Irregularity

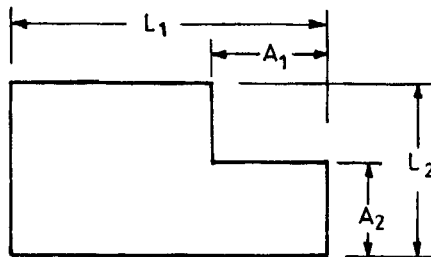
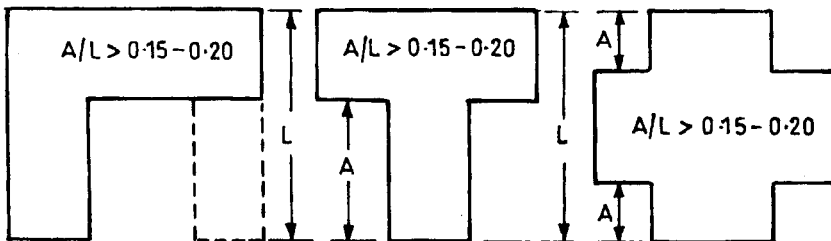

3 B Re-entrant Corner

FIG. 3 PLAN IRREGULARITIES — *Continued*

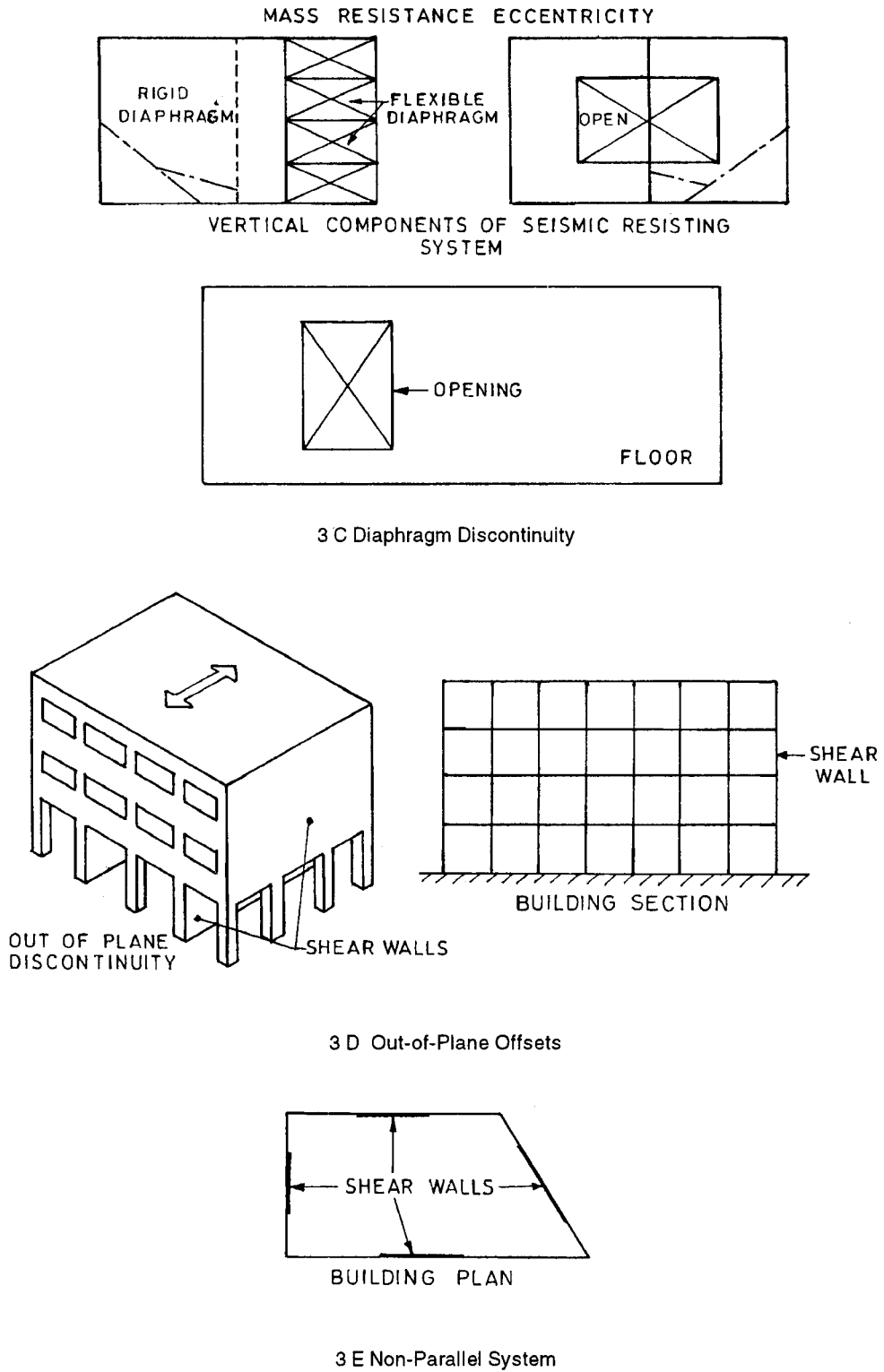
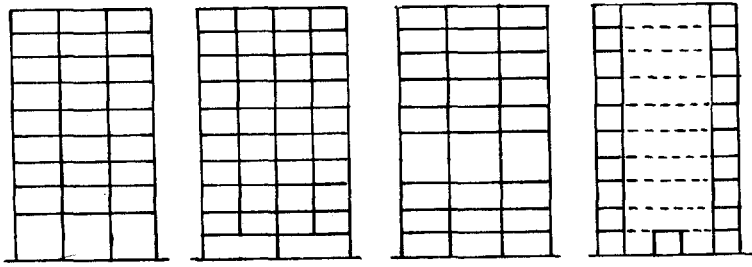
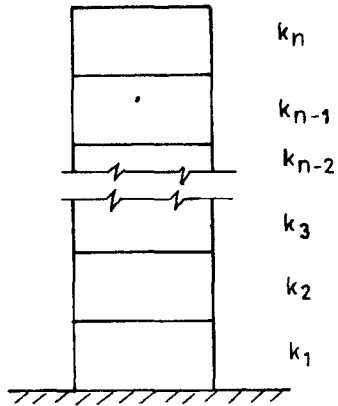

FIG. 3 PLAN IRREGULARITIES

3 E Non-Parallel System



STOREY STIFFNESS FOR THE BUILDING



SOFT STOREY WHEN

$$k_i < 0.7 k_{i+1}$$

$$\text{OR } k_i < 0.8 \left( \frac{k_{i+1} + k_{i+2} + k_{i+3}}{3} \right)$$

4 A Stiffness Irregularity

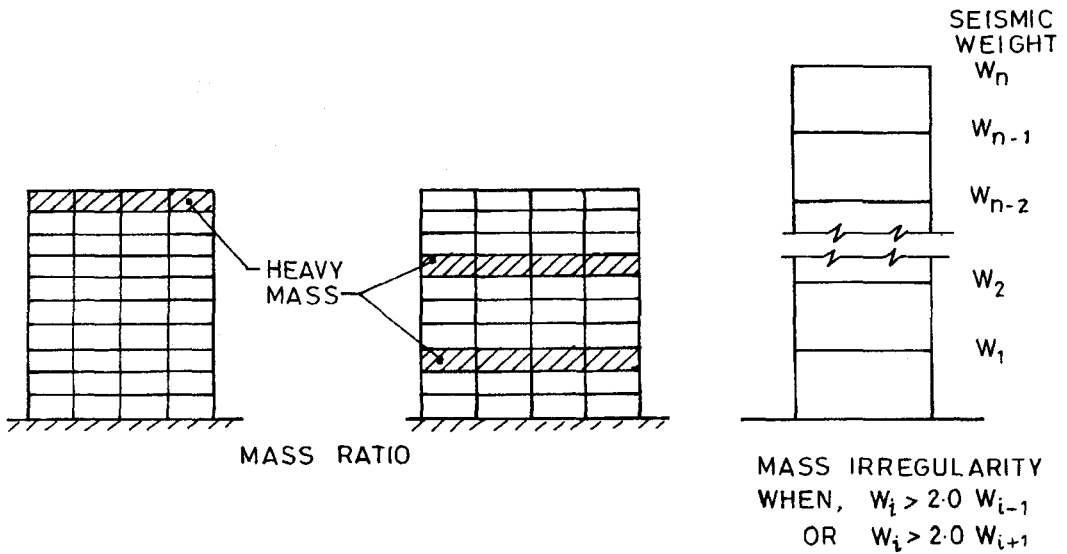

4 B Mass Irregularity

FIG. 4 VERTICAL IRREGULARITIES — *Continued*

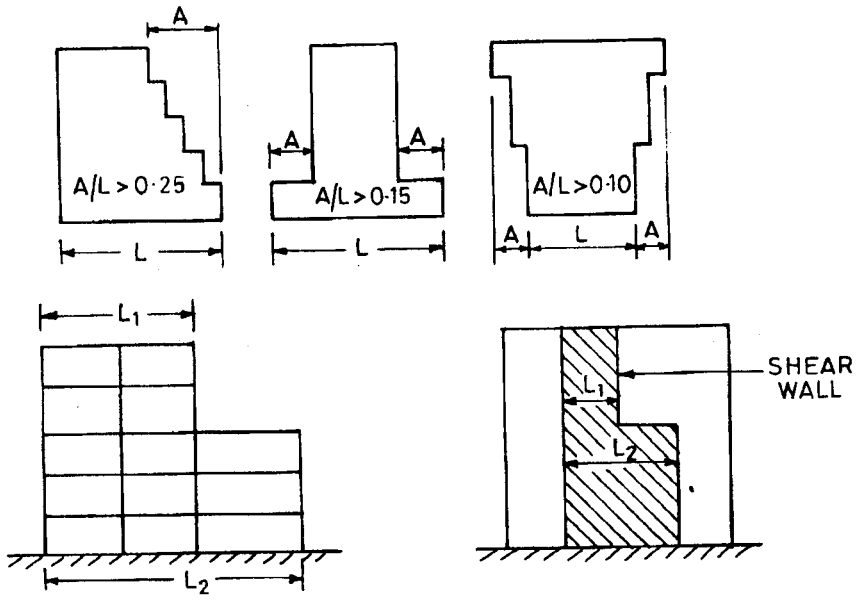

4 C Vertical Geometric Irregularity when  $L_2 > 1.5 L_1$

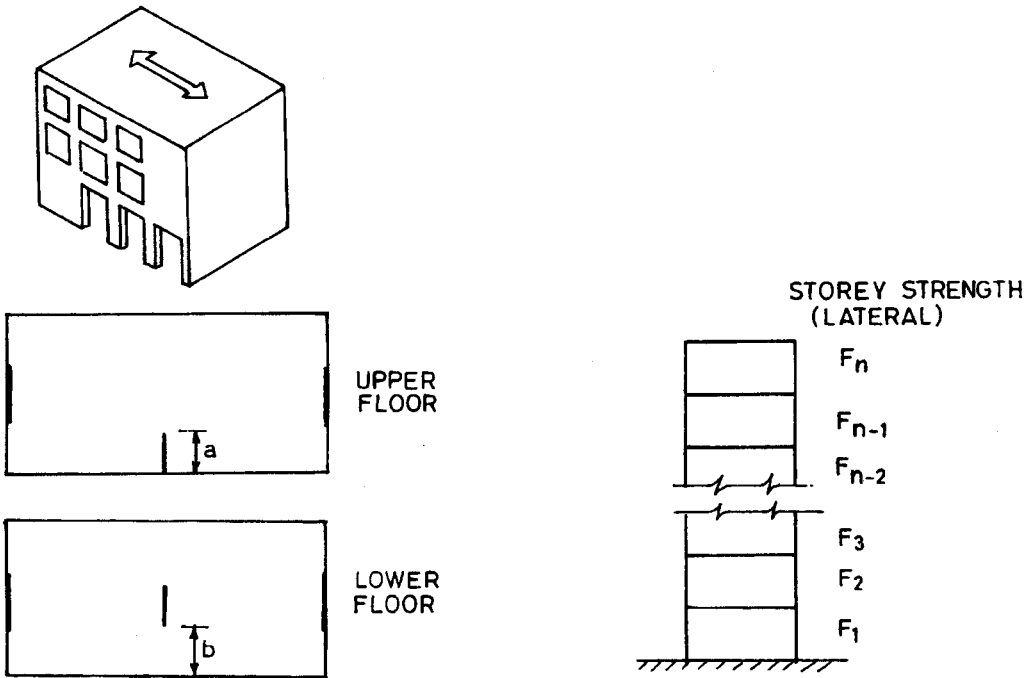

4 D In-Plane Discontinuity in Vertical Elements Resisting Lateral Force when  $b > a$

4 E Weak Storey when  $F_1 < 0.8 F_i + 1$

FIG. 4 VERTICAL IRREGULARITIES

**Table 7 Response Reduction Factor <sup>1)</sup>, R, for Building Systems**

( Clause 6.4.2 )

SI No.	Lateral Load Resisting System	R
(1)	(2)	(3)
	<i>Building Frame Systems</i>	
i)	Ordinary RC moment-resisting frame ( OMRF ) <sup>2)</sup>	3.0
ii)	Special RC moment-resisting frame ( SMRF ) <sup>3)</sup>	5.0
iii)	Steel frame with	
	a) Concentric braces	4.0
	b) Eccentric braces	5.0
iv)	Steel moment resisting frame designed as per SP 6 ( 6 )	5.0
	<i>Building with Shear Walls<sup>4)</sup></i>	
v)	Load bearing masonry wall buildings <sup>5)</sup>	
	a) Unreinforced	1.5
	b) Reinforced with horizontal RC bands	2.5
	c) Reinforced with horizontal RC bands and vertical bars at corners of rooms and jambs of openings	3.0
vi)	Ordinary reinforced concrete shear walls <sup>6)</sup>	3.0
vii)	Ductile shear walls <sup>7)</sup>	4.0
	<i>Buildings with Dual Systems<sup>8)</sup></i>	
viii)	Ordinary shear wall with OMRF	3.0
ix)	Ordinary shear wall with SMRF	4.0
x)	Ductile shear wall with OMRF	4.5
xi)	Ductile shear wall with SMRF	5.0

<sup>1)</sup> The values of response reduction factors are to be used for buildings with lateral load resisting elements, and not just for the lateral load resisting elements built in isolation.

<sup>2)</sup> OMRF are those designed and detailed as per IS 456 or IS 800 but not meeting ductile detailing requirement as per IS 13920 or SP 6 (6) respectively.

<sup>3)</sup> SMRF defined in 4.15.2.

<sup>4)</sup> Buildings with shear walls also include buildings having shear walls and frames, but where:

- frames are not designed to carry lateral loads, or
- frames are designed to carry lateral loads but do not fulfil the requirements of 'dual systems'.

<sup>5)</sup> Reinforcement should be as per IS 4326.

<sup>6)</sup> Prohibited in zones IV and V.

<sup>7)</sup> Ductile shear walls are those designed and detailed as per IS 13920.

<sup>8)</sup> Buildings with dual systems consist of shear walls ( or braced frames ) and moment resisting frames such that:

- the two systems are designed to resist the total design force in proportion to their lateral stiffness considering the interaction of the dual system at all floor levels; and
- the moment resisting frames are designed to independently resist at least 25 percent of the design seismic base shear.



**Table 8 Percentage of Imposed Load to be Considered in Seismic Weight Calculation**  
( Clause 7.3.1 )

Imposed Uniformity Distributed Floor Loads ( kN/ m <sup>2</sup> )	Percentage of Imposed Load
(1)	(2)
Upto and including 3.0	25
Above 3.0	50

## 7.5 Design Lateral Force

**7.5.1** Buildings and portions thereof shall be designed and constructed, to resist the effects of design lateral force specified in 7.5.3 as a minimum.

**7.5.2** The design lateral force shall first be computed for the building as a whole. This design lateral force shall then be distributed to the various floor levels. The overall design seismic force thus obtained at each floor level, shall then be distributed to individual lateral load resisting elements depending on the floor diaphragm action.

### 7.5.3 Design Seismic Base Shear

The total design lateral force or design seismic base shear ( $V_B$ ) along any principal direction shall be determined by the following expression:

$$V_B = A_h W$$

where

$A_h$  = Design horizontal acceleration spectrum value as per 6.4.2, using the fundamental natural period  $T_a$  as per 7.6 in the considered direction of vibration; and

$W$  = Seismic weight of the building as per 7.4.2.

## 7.6 Fundamental Natural Period

**7.6.1** The approximate fundamental natural period of vibration ( $T_a$ ), in seconds, of a moment-resisting frame building without brick infill panels may be estimated by the empirical expression:

$$T_a = 0.075 h^{0.75} \quad \text{for RC frame building}$$

$$= 0.085 h^{0.75} \quad \text{for steel frame building}$$

where

$h$  = Height of building, in m. This excludes the basement storeys, where basement walls are connected with the ground floor deck or fitted between the building columns. But, it includes the basement storeys, when they are not so connected.

**7.6.2** The approximate fundamental natural period of vibration ( $T_a$ ), in seconds, of all other buildings, including moment-resisting frame buildings with brick infill panels, may be estimated by the empirical expression:

$$T_a = \frac{0.09}{\sqrt{d}}$$

where

$h$  = Height of building, in m, as defined in 7.6.1; and

$d$  = Base dimension of the building at the plinth level, in m, along the considered direction of the lateral force.

## 7.7 Distribution of Design Force

### 7.7.1 Vertical Distribution of Base Shear to Different Floor Levels

The design base shear ( $V_B$ ) computed in 7.5.3 shall be distributed along the height of the building as per the following expression:

$$Q_i = V_B \frac{W_i h_i^2}{\sum_{j=1}^n W_j h_j^2}$$

where

$Q_i$  = Design lateral force at floor  $i$ ,

$W_i$  = Seismic weight of floor  $i$ ,

$h_i$  = Height of floor  $i$  measured from base, and

$n$  = Number of storeys in the building is the number of levels at which the masses are located.

### 7.7.2 Distribution of Horizontal Design Lateral Force to Different Lateral Force Resisting Elements

**7.7.2.1** In case of buildings whose floors are capable of providing rigid horizontal diaphragm action, the total shear in any horizontal plane shall be distributed to the various vertical elements of lateral force resisting system, assuming the floors to be infinitely rigid in the horizontal plane.

**7.7.2.2** In case of building whose floor diaphragms can not be treated as infinitely rigid in their own plane, the lateral shear at each floor shall be distributed to the vertical elements resisting the lateral forces, considering the in-plane flexibility of the diaphragms.

## NOTES

1 A floor diaphragm shall be considered to be flexible, if it deforms such that the maximum lateral displacement measured from the chord of the deformed shape at any point of the diaphragm is more than 1.5 times the average displacement of the entire diaphragm.

2 Reinforced concrete monolithic slab-beam floors or those consisting of prefabricated/precast elements with topping reinforced screed can be taken a rigid diaphragms.

**7.8 Dynamic Analysis**

**7.8.1** Dynamic analysis shall be performed to obtain the design seismic force, and its distribution to different levels along the height of the building and to the various lateral load resisting elements, for the following buildings:

- a) *Regular buildings* — Those greater than 40 m in height in Zones IV and V, and those greater than 90 m in height in Zones II and III. Modelling as per 7.8.4.5 can be used.
- b) *Irregular buildings ( as defined in 7.1 )* — All framed buildings higher than 12 m in Zones IV and V, and those greater than 40 m in height in Zones II and III.

The analytical model for dynamic analysis of buildings with unusual configuration should be such that it adequately models the types of irregularities present in the building configuration. Buildings with plan irregularities, as defined in Table 4 ( as per 7.1 ), cannot be modelled for dynamic analysis by the method given in 7.8.4.5.

NOTE — For irregular buildings, lesser than 40 m in height in Zones II and III, dynamic analysis, even though not mandatory, is recommended.

**7.8.2** Dynamic analysis may be performed either by the Time History Method or by the Response Spectrum Method. However, in either method, the design base shear ( $V_B$ ) shall be compared with a base shear ( $\bar{V}_B$ ) calculated using a fundamental period  $T_a$ , where  $T_a$  is as per 7.6. Where  $V_B$  is less than  $\bar{V}_B$ , all the response quantities ( for example member forces, displacements, storey forces, storey shears and base reactions) shall be multiplied by  $\bar{V}_B / V_B$ .

**7.8.2.1** The value of damping for buildings may be taken as 2 and 5 percent of the critical, for the purposes of dynamic analysis of steel and reinforced concrete buildings, respectively.

**7.8.3 Time History Method**

Time history method of analysis, when used, shall be based on an appropriate ground motion and shall be performed using accepted principles of dynamics.

**7.8.4 Response Spectrum Method**

Response spectrum method of analysis shall be performed using the design spectrum specified in 6.4.2, or by a site-specific design spectrum mentioned in 6.4.6.

**7.8.4.1 Free Vibration Analysis**

Undamped free vibration analysis of the entire

building shall be performed as per established methods of mechanics using the appropriate masses and elastic stiffness of the structural system, to obtain natural periods ( $T$ ) and mode shapes  $\{\phi\}$  of those of its modes of vibration that need to be considered as per 7.8.4.2.

**7.8.4.2 Modes to be considered**

The number of modes to be used in the analysis should be such that the sum total of modal masses of all modes considered is at least 90 percent of the total seismic mass and missing mass correction beyond 33 percent. If modes with natural frequency beyond 33 Hz are to be considered, modal combination shall be carried out only for modes upto 33 Hz. The effect of higher modes shall be included by considering missing mass correction following well established procedures.

**7.8.4.3 Analysis of building subjected to design forces**

The building may be analyzed by accepted principles of mechanics for the design forces considered as static forces.

**7.8.4.4 Modal combination**

The peak response quantities ( for example, member forces, displacements, storey forces, storey shears and base reactions ) shall be combined as per Complete Quadratic Combination ( CQC ) method.

$$\lambda = \sqrt{\sum_{i=1}^r \sum_{j=1}^r \lambda_i \rho_{ij} \lambda_j}$$

where

$r$  = Number of modes being considered,

$\rho_{ij}$  = Cross-modal coefficient,

$\lambda_i$  = Response quantity in mode  $i$  ( including sign ),

$\lambda_j$  = Response quantity in mode  $j$  ( including sign ),

$$\rho_{ij} = \frac{8 \zeta^2 (1 + \beta) \beta^{1.5}}{(1 + \beta^2)^2 + 4 \zeta^2 \beta (1 + \beta)^2}$$

$\zeta$  = Modal damping ratio (in fraction) as specified in 7.8.2.1,

$\beta$  = Frequency ratio =  $\omega_j / \omega_i$ ,

$\omega_i$  = Circular frequency in  $i$ th mode, and

$\omega_j$  = Circular frequency in  $j$ th mode.

Alternatively, the peak response quantities may be combined as follows :

- a) If the building does not have closely-spaced modes, then the peak response quantity ( $\lambda$ ) due to all modes considered shall be obtained as

$$\lambda = \sqrt{\sum_{k=1}^r (\lambda_k)^2}$$

where

- $\lambda_k$  = Absolute value of quantity in mode  $k$ , and  
 $r$  = Number of modes being considered.

- b) If the building has a few closely-spaced modes (see 3.2), then the peak response quantity ( $\lambda^*$ ) due to these modes shall be obtained as

$$\lambda^* = \sum_c \lambda_c$$

where the summation is for the closely-spaced modes only. This peak response quantity due to the closely spaced modes ( $\lambda^*$ ) is then combined with those of the remaining well-separated modes by the method described in 7.8.4.4 (a).

**7.8.4.5 Buildings with regular, or nominally irregular, plan configurations may be modelled as a system of masses lumped at the floor levels with each mass having one degree of freedom, that of lateral displacement in the direction under consideration. In such a case, the following expressions shall hold in the computation of the various quantities :**

- a) *Modal Mass* — The modal mass ( $M_k$ ) of mode  $k$  is given by

$$M_k = \frac{\left[ \sum_{i=1}^n W_i \phi_{ik} \right]^2}{g \sum_{i=1}^n W_i (\phi_{ik})^2}$$

where

- $g$  = Acceleration due to gravity,  
 $\phi_{ik}$  = Mode shape coefficient at floor  $i$  in mode  $k$ , and  
 $W_i$  = Seismic weight of floor  $i$ .

- b) *Modal Participation Factors* — The modal participation factor ( $P_k$ ) of mode  $k$  is given by:

$$P_k = \frac{\sum_{i=1}^n W_i \phi_{ik}}{\sum_{i=1}^n W_i (\phi_{ik})^2}$$

- c) *Design Lateral Force at Each Floor in Each Mode* — The peak lateral force ( $Q_{ik}$ ) at floor  $i$  in mode  $k$  is given by

$$Q_{ik} = A_k \phi_{ik} P_k W_i$$

where

- $A_k$  = Design horizontal acceleration spectrum value as per 6.4.2 using the natural period of vibration ( $T_k$ ) of mode  $k$ .

- d) *Storey Shear Forces in Each Mode* — The peak shear force ( $V_{ik}$ ) acting in storey  $i$  in mode  $k$  is given by

$$V_{ik} = \sum_{j=i+1}^n Q_{jk}$$

- e) *Storey Shear Forces due to All Modes Considered* — The peak storey shear force ( $V_i$ ) in storey  $i$  due to all modes considered is obtained by combining those due to each mode in accordance with 7.8.4.4.

- f) *Lateral Forces at Each Storey Due to All Modes Considered* — The design lateral forces,  $F_{\text{roof}}$  and  $F_i$ , at roof and at floor  $i$  :

$$F_{\text{roof}} = V_{\text{roof}}, \text{ and}$$

$$F_i = V_i - V_{i+1}$$

## 7.9 Torsion

**7.9.1 Provision shall be made in all buildings for increase in shear forces on the lateral force resisting elements resulting from the horizontal torsional moment arising due to eccentricity between the centre of mass and centre of rigidity. The design forces calculated as in 7.8.4.5 are to be applied at the centre of mass appropriately displaced so as to cause design eccentricity (7.9.2) between the displaced centre of mass and centre of rigidity. However, negative torsional shear shall be neglected.**

**7.9.2 The design eccentricity,  $e_{di}$  to be used at floor  $i$  shall be taken as:**

$$e_{di} = \begin{cases} 1.5e_{si} + 0.05 b_i \\ \text{or} & e_{si} - 0.05 b_i \end{cases}$$

whichever of these gives the more severe effect in the shear of any frame where

- $e_{di}$  = Static eccentricity at floor  $i$  defined as the distance between centre of mass and centre of rigidity, and

- $b_i$  = Floor plan dimension of floor  $i$ , perpendicular to the direction of force.

NOTE — The factor 1.5 represents dynamic amplification factor, while the factor 0.05 represents the extent of accidental eccentricity.

7.9.3 In case of highly irregular buildings analyzed according to 7.8.4.5, additive shears will be superimposed for a statically applied eccentricity of  $\pm 0.05b_1$  with respect to the centre of rigidity.

### 7.10 Buildings with Soft Storey

7.10.1 In case buildings with a flexible storey, such as the ground storey consisting of open spaces for parking that is Stilt buildings, special arrangement needs to be made to increase the lateral strength and stiffness of the soft/open storey.

7.10.2 Dynamic analysis of building is carried out including the strength and stiffness effects of infills and inelastic deformations in the members, particularly, those in the soft storey, and the members designed accordingly.

7.10.3 Alternatively, the following design criteria are to be adopted after carrying out the earthquake analysis, neglecting the effect of infill walls in other storeys:

- a) the columns and beams of the soft storey are to be designed for 2.5 times the storey shears and moments calculated under seismic loads specified in the other relevant clauses; or,
- b) besides the columns designed and detailed for the calculated storey shears and moments, shear walls placed symmetrically in both directions of the building as far away from the centre of the building as feasible; to be designed exclusively for 1.5 times the lateral storey shear force calculated as before.

### 7.11 Deformations

#### 7.11.1 Storey Drift Limitation

The storey drift in any storey due to the minimum specified design lateral force, with partial load factor of 1.0, shall not exceed 0.004 times the storey height.

For the purposes of displacement requirements only ( see 7.11.1, 7.11.2 and 7.11.3 only ), it is permissible to use seismic force obtained from the computed fundamental period ( $T$ ) of the building without the lower bound limit on design seismic force specified in 7.8.2.

There shall be no drift limit for single storey building which has been designed to accommodate storey drift.

#### 7.11.2 Deformation Compatibility of Non-Seismic Members

For building located in seismic Zones IV and V, it shall be ensured that the structural components, that are not a part of the seismic force resisting system in the

direction under consideration, do not lose their vertical load-carrying capacity under the induced moments resulting from storey deformations equal to  $R$  times the storey displacements calculated as per 7.11.1, where  $R$  is specified in Table 7.

NOTE — For instance, consider a flat-slab building in which lateral load resistance is provided by shear walls. Since the lateral load resistance of the slab-column system is small, these are often designed only for the gravity loads, while all the seismic force is resisted by the shear walls. Even though the slabs and columns are not required to share the lateral forces, these deform with rest of the structure under seismic force. The concern is that under such deformations, the slab-column system should not lose its vertical load capacity.

#### 7.11.3 Separation Between Adjacent Units

Two adjacent buildings, or two adjacent units of the same building with separation joint in between shall be separated by a distance equal to the amount  $R$  times the sum of the calculated storey displacements as per 7.11.1 of each of them, to avoid damaging contact when the two units deflect towards each other. When floor levels of two similar adjacent units or buildings are at the same elevation levels, factor  $R$  in this requirement may be replaced by  $R/2$ .

### 7.12 Miscellaneous

#### 7.12.1 Foundations

The use of foundations vulnerable to significant differential settlement due to ground shaking shall be avoided for structures in seismic Zones III, IV and V. In seismic Zones IV and V, individual spread footings or pile caps shall be interconnected with ties, ( see 5.3.4.1 of IS 4326 ) except when individual spread footings are directly supported on rock. All ties shall be capable of carrying, in tension and in compression, an axial force equal to  $A_h/4$  times the larger of the column or pile cap load, in addition to the otherwise computed forces. Here,  $A_h$  is as per 6.4.2.

#### 7.12.2 Cantilever Projections

##### 7.12.2.1 Vertical projections

Tower, tanks, parapets, smoke stacks ( chimneys ) and other vertical cantilever projections attached to buildings and projecting above the roof, shall be designed and checked for stability for five times the design horizontal seismic coefficient  $A_h$  specified in 6.4.2. In the analysis of the building, the weight of these projecting elements will be lumped with the roof weight.

##### 7.12.2.2 Horizontal projection

All horizontal projections like cornices and balconies shall be designed and checked for stability for five times the design vertical coefficient specified

in 6.4.5 (that is  $= 10/3 A_h$ ).

**7.12.2.3** The increased design forces specified in 7.12.2.1 and 7.12.2.2 are only for designing the projecting parts and their connections with the main structures. For the design of the main structure, such increase need not be considered.

**7.12.3** *Compound Walls*

Compound walls shall be designed for the design horizontal coefficient  $A_h$  with importance factor  $I = 1.0$  specified in 6.4.2.

**7.12.4** *Connections Between Parts*

All parts of the building, except between the separation sections, shall be tied together to act as integrated single unit. All connections between different parts, such as beams to columns and columns to their footings, should be made capable of transmitting a force, in all possible directions, of magnitude  $(Q_1/W_1)$  times but not less than 0.05 times the weight of the smaller part or the total of dead and imposed load reaction. Frictional resistance shall not be relied upon for fulfilling these requirements.

ANNEX A  
(Foreword)

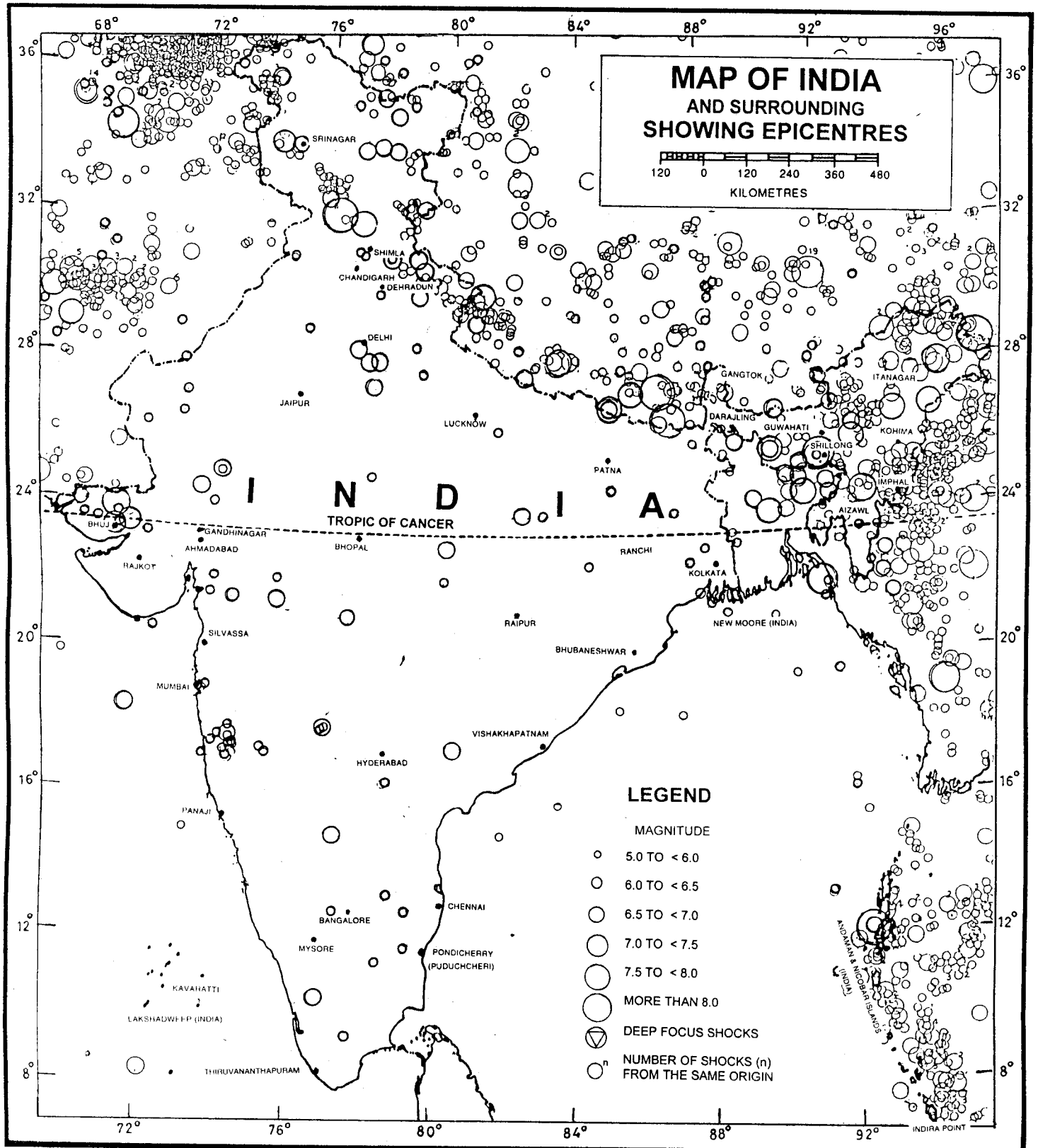

© Government of India, Copyright Year 2001.

Based upon Survey of India map with the permission of the Surveyor General of India.

The responsibility for the correctness of internal details rests with the publisher.

The territorial waters of India extend into the sea to distance of twelve nautical miles measured from the appropriate base line.

The administrative headquarters of Chandigarh, Haryana and Punjab are at Chandigarh.

The interstate boundaries between Arunachal Pradesh, Assam and Meghalaya shown on this map are as interpreted from the North-Eastern Areas (Reorganization) Act, 1971, but have yet to be verified.

The external boundaries and coastlines of India agree with the Record/Master Copy certified by Survey of India.

ANNEX B  
(Forward)

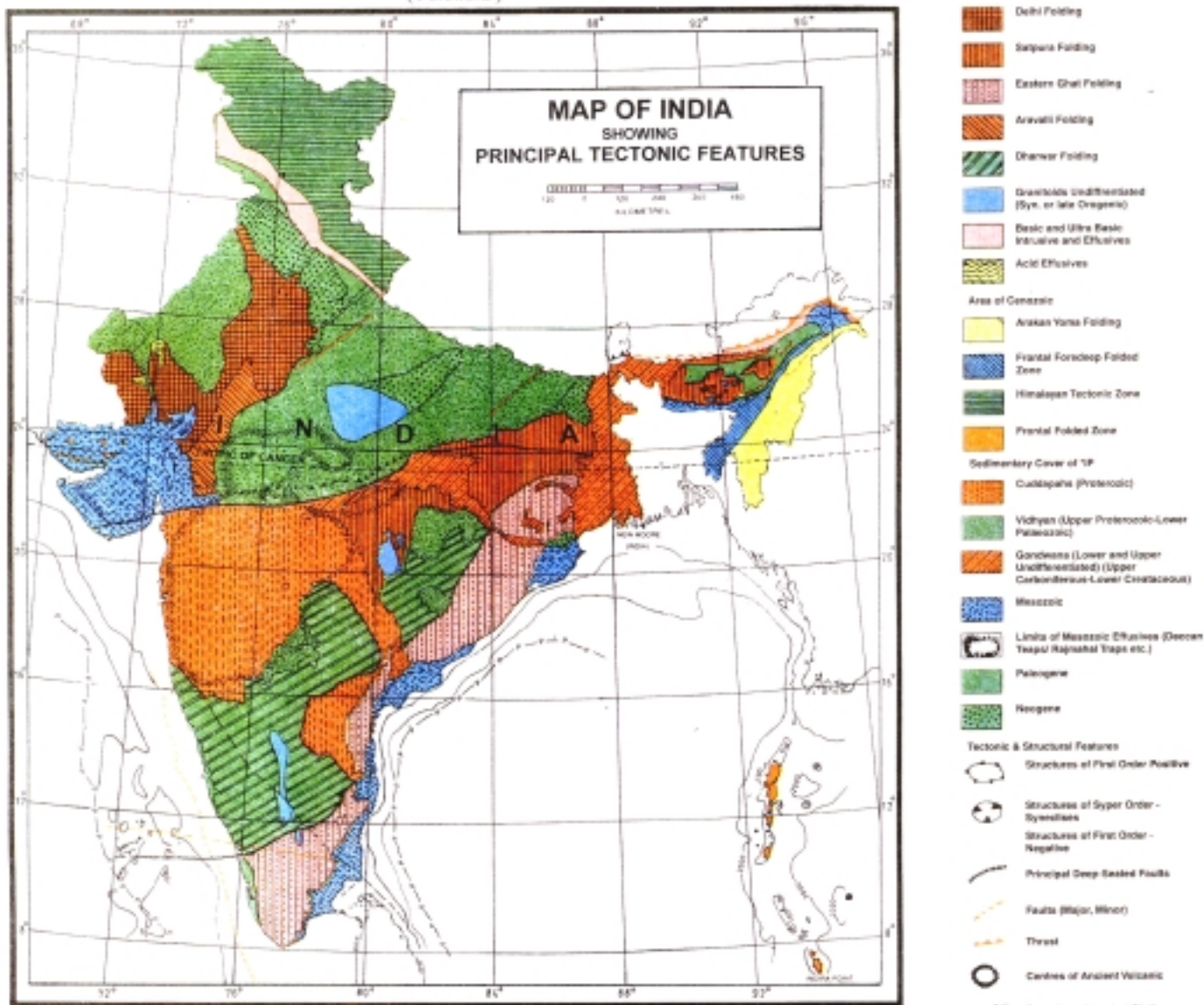

- Based upon Survey of India map with the permission of the Surveyor General of India.
- The responsibility for the correctness of internal details rests with the publisher.
- The territorial waters of India extend into the sea to distance of twelve nautical miles measured from the appropriate base line.
- The administrative headquarters of Chandigarh, Haryana and Punjab are at Chandigarh.
- The interstate boundaries between Anunachal Pradesh, Assam and Meghalaya shown on this map are as interpreted from the North-Eastern Areas (Reorganization) Act, 1971, but have yet to be verified.
- The external boundaries and coastlines of India agree with the Record/Master Copy certified by Survey of India.

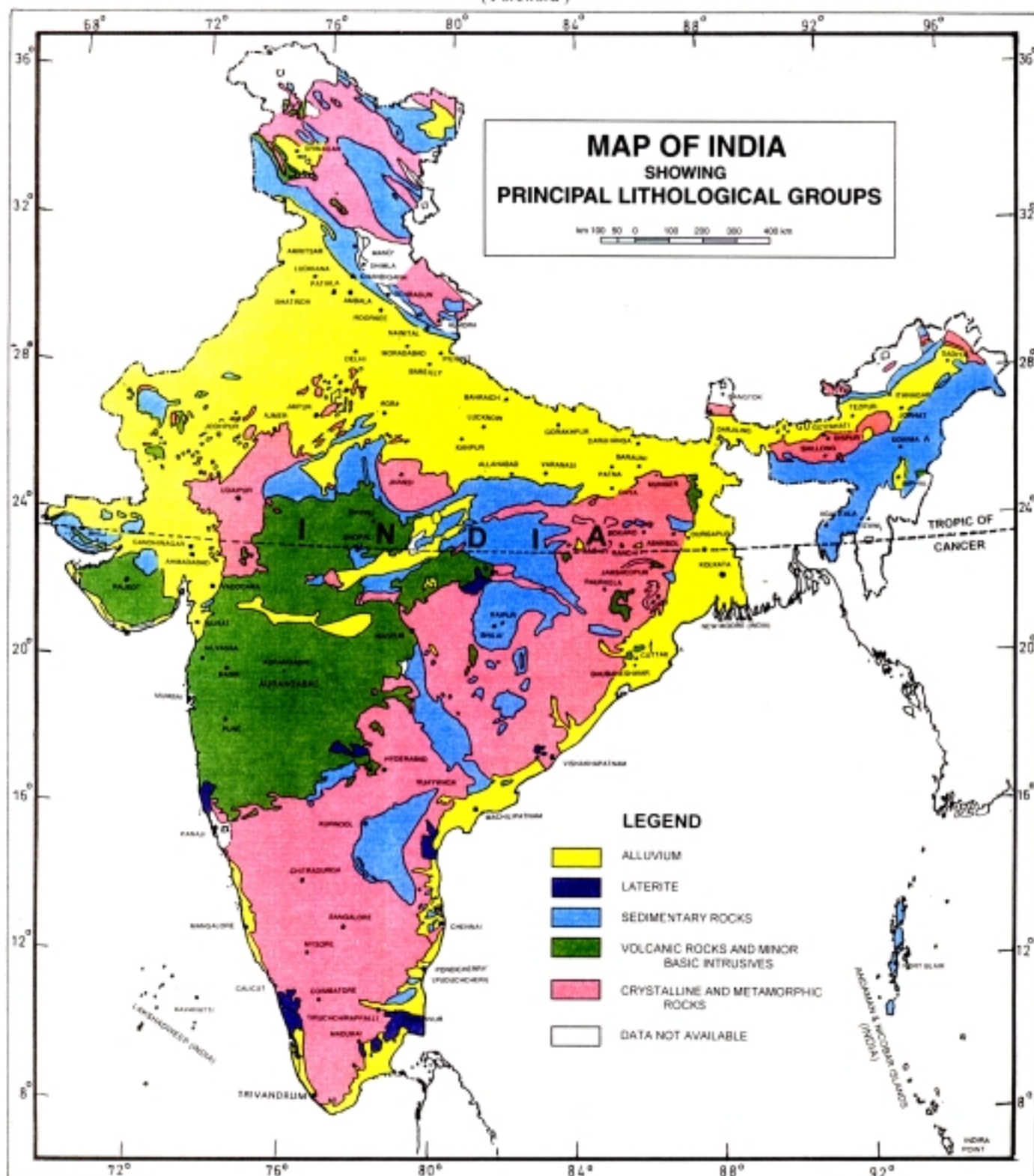

ANNEX C  
( Foreword )

© Government of India, Copyright Year 2001.

- Based upon Survey of India map with the permission of the Surveyor General of India.
- The responsibility for the correctness of internal details rests with the publisher.
- The territorial waters of India extend into the sea to distance of twelve nautical miles measured from the appropriate base line.
- The administrative headquarters of Chandigarh, Haryana and Punjab are at Chandigarh.
- The interstate boundaries between Arunachal Pradesh, Assam and Meghalaya shown on this map are as interpreted from the North-Eastern Areas (Reorganization) Act, 1971, but have yet to be verified.
- The external boundaries and coastlines of India agree with the Record/Master Copy certified by Survey of India.



As in the Original Standard, this Page is Intentionally Left Blank

## ANNEX D

( Foreword and Clause 3.15 )

## COMPREHENSIVE INTENSITY SCALE ( MSK 64 )

The scale was discussed generally at the inter-governmental meeting convened by UNESCO in April 1964. Though not finally approved the scale is more comprehensive and describes the intensity of earthquake more precisely. The main definitions used are followings;

a) *Type of Structures ( Buildings )*

*Type A* — Building in field-stone, rural structures, unburnt-brick houses, clay houses.

*Type B* — Ordinary brick buildings, buildings of large block and prefabricated type, half timbered structures, buildings in natural hewn stone.

*Type C* — Reinforced buildings, well built wooden structures.

b) *Definition of Quantity:*

Single, few About 5 percent

Many About 50 percent

Most About 75 percent

c) *Classification of Damage to Buildings*

Grade 1	Slight damage	Fine cracks in plaster; fall of small pieces of plaster.
Grade 2	Moderate damage	Small cracks in plaster; fall of fairly large pieces of plaster; pantiles slip off; cracks in chimneys parts of chimney fall down.
Grade 3	Heavy damage	Large and deep cracks in plaster; fall of chimneys.
Grade 4	Destruction	Gaps in walls; parts of buildings may collapse; separate parts of the buildings lose their cohesion; and inner walls collapse.
Grade 5	Total damage	Total collapse of the buildings.

d) *Intensity Scale*

1. *Not noticeable* — The intensity of the vibration is below the limits of sensibility; the tremor is detected and recorded by seismograph only.
2. *Scarcely noticeable (very slight)* — Vibration is felt only by individual people at rest in houses, especially on upper floors of buildings.
3. *Weak, partially observed only* — The earthquake is felt indoors by a few people, outdoors only in favourable circumstances. The vibration is like that due to the passing of a light truck. Attentive observers notice a slight swinging of hanging objects, somewhat more heavily on upper floors.
4. *Largely observed* — The earthquake is felt indoors by many people, outdoors by few. Here and there people awake, but no one is frightened. The vibration is like that due to the passing of a heavily loaded truck. Windows, doors, and dishes rattle. Floors and walls crack. Furniture begins to shake. Hanging objects swing slightly. Liquid in open vessels are slightly disturbed. In standing motor cars the shock is noticeable.
5. *Awakening*
  - i) The earthquake is felt indoors by all, outdoors by many. Many people awake. A few run outdoors. Animals become uneasy. Building tremble throughout. Hanging objects swing considerably. Pictures knock against walls or swing out of place. Occasionally pendulum clocks stop. Unstable objects overturn or shift. Open doors and windows are thrust open and slam back again. Liquids spill in small amounts from well-filled open containers. The sensation of vibration is like that due to heavy objects falling inside the buildings.
  - ii) Slight damages in buildings of Type A are possible.
  - iii) Sometimes changes in flow of springs.

6. *Frightening*

- i) Felt by most indoors and outdoors. Many people in buildings are frightened and run outdoors. A few persons lose their balance. Domestic animals run out of their stalls. In few instances, dishes and glassware may break, and books fall down. Heavy furniture may possibly move and small steeple bells may ring.
- ii) Damage of Grade 1 is sustained in single buildings of Type B and in many of Type A. Damage in few buildings of Type A is of Grade 2.
- iii) In few cases, cracks up to widths of 1 cm possible in wet ground; in mountains occasional landslips; change in flow of springs and in level of well water are observed.

7. *Damage of buildings*

- i) Most people are frightened and run outdoors. Many find it difficult to stand. The vibration is noticed by persons driving motor cars. Large bells ring.
- ii) In many buildings of Type C damage of Grade 1 is caused; in many buildings of Type B damage is of Grade 2. Most buildings of Type A suffer damage of Grade 3, few of Grade 4. In single instances, landslides of roadway on steep slopes; crack in roads; seams of pipelines damaged; cracks in stone walls.
- iii) Waves are formed on water, and is made turbid by mud stirred up. Water levels in wells change, and the flow of springs changes. Some times dry springs have their flow resorted and existing springs stop flowing. In isolated instances parts of sand and gravelly banks slip off.

8. *Destruction of buildings*

- i) Fright and panic; also persons driving motor cars are disturbed. Here and there branches of trees break off. Even heavy furniture moves and partly overturns. Hanging lamps are damaged in part.
- ii) Most buildings of Type C suffer damage of Grade 2, and few of Grade 3. Most buildings of Type B suffer damage of Grade 3. Most buildings of Type A suffer damage of Grade 4. Occasional breaking of pipe seams. Memorials and monuments move and twist. Tombstones overturn. Stone walls collapse.
- iii) Small landslips in hollows and on banked

roads on steep slopes; cracks in ground upto widths of several centimetres. Water in lakes become turbid. New reservoirs come into existence. Dry wells refill and existing wells become dry. In many cases, change in flow and level of water is observed.

9. *General damage of buildings*

- i) General panic; considerable damage to furniture. Animals run to and fro in confusion, and cry.
- ii) Many buildings of Type C suffer damage of Grade 3, and a few of Grade 4. Many buildings of Type B show a damage of Grade 4 and a few of Grade 5. Many buildings of Type A suffer damage of Grade 5. Monuments and columns fall. Considerable damage to reservoirs; underground pipes partly broken. In individual cases, railway lines are bent and roadway damaged.
- iii) On flat land overflow of water, sand and mud is often observed. Ground cracks to widths of up to 10 cm, on slopes and river banks more than 10 cm. Further more, a large number of slight cracks in ground; falls of rock, many land slides and earth flows; large waves in water. Dry wells renew their flow and existing wells dry up.

10. *General destruction of buildings*

- i) Many buildings of Type C suffer damage of Grade 4, and a few of Grade 5. Many buildings of Type B show damage of Grade 5. Most of Type A have destruction of Grade 5. Critical damage to dykes and dams. Severe damage to bridges. Railway lines are bent slightly. Underground pipes are bent or broken. Road paving and asphalt show waves.
- ii) In ground, cracks up to widths of several centimetres, sometimes up to 1 m. Parallel to water courses occur broad fissures. Loose ground slides from steep slopes. From river banks and steep coasts, considerable landslides are possible. In coastal areas, displacement of sand and mud; change of water level in wells; water from canals, lakes, rivers, etc, thrown on land. New lakes occur.

11. *Destruction*

- i) Severe damage even to well built buildings, bridges, water dams and

railway lines. Highways become useless. Underground pipes destroyed.

- ii) Ground considerably distorted by broad cracks and fissures, as well as movement in horizontal and vertical directions. Numerous landslips and falls of rocks. The intensity of the earthquake requires to be investigated specifically.

#### 12. Landscape changes

- i) Practically all structures above and below

ground are greatly damaged or destroyed.

- ii) The surface of the ground is radically changed. Considerable ground cracks with extensive vertical and horizontal movements are observed. Falling of rock and slumping of river banks over wide areas, lakes are dammed; waterfalls appear and rivers are deflected. The intensity of the earthquake requires to be investigated specially.

## ANNEX E

### ( Foreword )

#### ZONE FACTORS FOR SOME IMPORTANT TOWNS

Town	Zone	Zone Factor, Z	Town	Zone	Zone Factor, Z
Agra	III	0.16	Chitradurga	II	0.10
Ahmedabad	III	0.16	Coimbatore	III	0.16
Ajmer	II	0.10	Cuddalore	III	0.16
Allahabad	II	0.10	Cuttack	III	0.16
Almora	IV	0.24	Darbhanga	V	0.36
Ambala	IV	0.24	Darjeeling	IV	0.24
Amritsar	IV	0.24	Dharwad	III	0.16
Asansol	III	0.16	Dehra Dun	IV	0.24
Aurangabad	II	0.10	Dharamपुर	III	0.16
Bahraich	IV	0.24	Delhi	IV	0.24
Bangalore	II	0.10	Durgapur	III	0.16
Barauni	IV	0.24	Gangtok	IV	0.24
Bareilly	III	0.16	Guwahati	V	0.36
Belgaum	III	0.16	Goa	III	0.16
Bhatinda	III	0.16	Gulbarga	II	0.10
Bhilai	II	0.10	Gaya	III	0.16
Bhopal	II	0.10	Gorakhpur	IV	0.24
Bhubaneswar	III	0.16	Hyderabad	II	0.10
Bhuj	V	0.36	Imphal	V	0.36
Bijapur	III	0.16	Jabalpur	III	0.16
Bikaner	III	0.16	Jaipur	II	0.10
Bokaro	III	0.16	Jamshedpur	II	0.10
Bulandshahr	IV	0.24	Jhansi	II	0.10
Burdwan	III	0.16	Jodhpur	II	0.10
Cailcut	III	0.16	Jorhat	V	0.36
Chandigarh	IV	0.24	Kakrapara	III	0.16
Chennai	III	0.16	Kalapakkam	III	0.16

**IS 1893 ( Part 1 ) : 2002**

<i>Town</i>	<i>Zone</i>	<i>Zone Factor, Z</i>	<i>Town</i>	<i>Zone</i>	<i>Zone Factor, Z</i>
Kanchipuram	III	0.16	Pondicherry	II	0.10
Kanpur	III	0.16	Pune	III	0.16
Karwar	III	0.16	Raipur	II	0.10
Kohima	V	0.36	Rajkot	III	0.16
Kolkata	III	0.16	Ranchi	II	0.10
Kota	II	0.10	Roorkee	IV	0.24
Kurnool	II	0.10	Rourkela	II	0.10
Lucknow	III	0.16	Sadiya	V	0.36
Ludhiana	IV	0.24	Salem	III	0.16
Madurai	II	0.10	Simla	IV	0.24
Mandi	V	0.36	Sironj	II	0.10
Mangalore	III	0.16	Solapur	III	0.16
Monghyr	IV	0.24	Srinagar	V	0.36
Moradabad	IV	0.24	Surat	III	0.16
Mumbai	III	0.16	Tarapur	III	0.16
Mysore	II	0.10	Tezpur	V	0.36
Nagpur	II	0.10	Thane	III	0.16
Nagarjunasagar	II	0.10	Thanjavur	II	0.10
Nainital	IV	0.24	Thiruvananthapuram	III	0.16
Nasik	III	0.16	Tiruchirappali	II	0.10
Nellore	III	0.16	Tiruvennamalai	III	0.16
Osmanabad	III	0.16	Udaipur	II	0.10
Panjim	III	0.16	Vadodara	III	0.16
Patiala	III	0.16	Varanasi	III	0.16
Patna	IV	0.24	Vellore	III	0.16
Pilibhit	IV	0.24	Vijayawada	III	0.16
			Vishakhapatnam	II	0.10

**ANNEX F***( Foreword )***COMMITTEE COMPOSITION****Earthquake Engineering Sectional Committee, CED 39**

<i>Organization</i>	<i>Representative(s)</i>
In personal capacity ( 72/6 Civil Lines, Roorkee 247667 )	DR A. S. ARYA ( <i>Chairman</i> )
Bharat Heavy Electrical Ltd, New Delhi	SHRI N. C. ADDY DR C. KAMESHWARA RAO ( <i>Alternate I</i> ) SHRI A. K. SINGH ( <i>Alternate II</i> )
Building Materials Technology Promotion Council, New Delhi	SHRI T. N. GUPTA SHRI J. K. PRASAD ( <i>Alternate</i> )
Central Building Research Institute, Roorkee	SHRI S. K. MITTAL SHRI V. K. GUPTA ( <i>Alternate</i> )
Central Public Works Department, New Delhi	SUPERINTENDING ENGINEER (D) EXECUTIVE ENGINEER (D) III ( <i>Alternate</i> )
Central Water Commission ( ERDD ), New Delhi	DIRECTOR CMDD ( N&W ) DIRECTOR EMBANKMENT ( N&W ) ( <i>Alternate</i> )
Central Water and Power Research Station, Pune	SHRI I. D. GUPTA SHRI S. G. CHAPHALAKAR ( <i>Alternate</i> )
D-CAD Technologies Pvt Ltd, New Delhi	DR K. G. BHATIA
Delhi College of Engineering, Delhi	DR ( SHRIMATI ) P. R. BOSE
Department of Atomic Energy, Mumbai	SHRI P. C. KOTESWAR RAO SHRI S. RAMANUJAM ( <i>Alternate</i> )
Department of Civil Engineering, University of Roorkee, Roorkee	PROF ASHOK JAIN
Department of Earthquake Engineering, University of Roorkee, Roorkee	DR S.K. THAKKAR DR D.K. PAUL ( <i>Alternate I</i> ) DR S. BASU ( <i>Alternate II</i> )
Engineer-in-Chief's Branch, Army Headquarters, New Delhi	COL ( DR ) SHRI PAL SHRI Y. K. SINGHAL ( <i>Alternate</i> )
Engineers India Ltd, New Delhi	DR V. Y. SALPEKAR SHRI R. K. GROVER ( <i>Alternate</i> )
Gammon India Limited, Mumbai	SHRI S.A. REDDI SHRI A. K. CHATTERJEE ( <i>Alternate I</i> ) SHRI V. N. HAGGADE ( <i>Alternate II</i> )
Geological Survey of India, Lucknow	SHRI P. PANDEY SHRI Y. P. SHARDA ( <i>Alternate</i> )
Housing Urban and Development Corporation, New Delhi	SHRI V. ROY SHRI D. P. SINGH ( <i>Alternate</i> )
Indian Institute of Technology, Kanpur	DR S. K. JAIN DR C. V. R. MURTY ( <i>Alternate</i> )
Indian Institute of Technology, Mumbai	DR RAVI SINHA DR A. GOYAL ( <i>Alternate</i> )
Indian Meteorological Department, New Delhi	DR S. N. BHATTACHARYA SHRI V. K. MITTAL ( <i>Alternate</i> )

*( Continued on page 38 )*

**IS 1893 ( Part 1 ) : 2002***( Continued from page 37 )*

<i>Organization</i>	<i>Representative(s)</i>
Indian Society of Earthquake Technology, Roorkee	SHRI M. K. GUPTA DR D. K. PAUL ( <i>Alternate</i> )
Larsen and Toubro, Chennai	SHRI K. JAYARAMAN SHRI S. KANAPPAN ( <i>Alternate</i> )
Maharashtra Engineering Research Centre ( MERI ), Nasik	SHRI R. L. DAMANI SHRI S. V. KUMARA SWAMY ( <i>Alternate</i> )
Ministry of Surface Transport, New Delhi	SHRI N. K. SINHA SHRI R. S. NINAN ( <i>Alternate</i> )
National Geophysical Research Institute ( CSIR ), Hyderabad	SHRI S. C. BHATIA SHRI M. RAVI KUMAR ( <i>Alternate</i> )
National Highway Authority of India, New Delhi	SHRI N. K. SINHA SHRI G. SHARAN ( <i>Alternate</i> )
National Hydro-Electric Power Corporation Ltd, New Delhi	CHIEF ENGINEER, CD-III
National Thermal Power Corporation Ltd, New Delhi	SHRI R. S. BAJAJ SHRI H. K. RAMKUMAR ( <i>Alternate</i> )
North Eastern Council, Shillong	SHRI L. K. GANJU SHRI A. D. KHARSHING ( <i>Alternate</i> )
Nuclear Power Corporation, Mumbai	SHRI U. S. P. VERMA
Railway Board, Ministry of Railways, Lucknow	EXECUTIVE DIRECTOR ( B&S ) JOINT DIRECTOR ( B&S ) CB-1 ( <i>Alternate</i> )
School of Planning and Architecture, New Delhi	SHRI V. THIRUVENDGADAM
Structural Engineering Research Centre ( CSIR ), Chennai	SHRI C. V. VAIDYANATHAN DR B. SIVARAM SARMA ( <i>Alternate</i> )
Tandon Consultants Ltd, New Delhi	DR MAHESH TANDON SHRI VINAY GUPTA ( <i>Alternate</i> )
Tata Consulting Engineers, Mumbai	SHRI K. V. SUBRAMANIAN SHRI M. K. S. YOGI ( <i>Alternate</i> )
Wadia Institute of Himalayan Geology, Dehra Dun	SHRI SURINDER KUMAR
In personal capacity ( <i>E-53, Kapil Vihar, Faridabad</i> )	SHRI P. L. NARULA
BIS Directorate General	SHRI S.K. JAIN, Director & Head ( Civ Engg ) [ Representing Director General ( <i>Ex-officio</i> ) ]

*Member-Secretary*

SHRI S. CHATURVEDI

Joint Director ( Civ Engg ), BIS

**Earthquake Resistant Construction Subcommittee, CED 39 : 1**

In personal capacity ( <i>72/6 Civil Lines, Roorkee 247667</i> )	DR A. S. ARYA ( <i>Convener</i> )
Building Material Technology Promotion Council, New Delhi	SHRI T. N. GUPTA SHRI J. K. PRASAD ( <i>Alternate</i> )
Central Building Research Institute, Roorkee	SHRI M. P. JAISINGH SHRI V. K. GUPTA ( <i>Alternate</i> )

*( Continued on page 39 )*

(Continued from page 38)

<i>Organization</i>	<i>Representative(s)</i>
Central Public Works Department, New Delhi	SUPERINTENDING SURVEYOR OF WORKS ( NDZ ) SUPERINTENDING ENGINEER (D) ( <i>Alternate</i> )
Delhi College of Engineering, Delhi	DR ( SHRIMATI ) P. R. BOSE
Department of Earthquake Engineering, University of Roorkee, Roorkee	DR S. K. THAKKAR DR D. K. PAUL ( <i>Alternate</i> )
Engineer-in-Chief's Branch, Army Headquarters, New Delhi	EXECUTIVE ENGINEER ( DESIGN )
Housing and Urban Development Corporation, New Delhi	SHRI B. K. CHAKRABORTY SHRI D. P. SINGH ( <i>Alternate</i> )
Hindustan Prefab Ltd, New Delhi	SHRI M. KUNDU
Indian Institute of Technology, Mumbai	DR ALOK GOYAL DR RAVI SINHA ( <i>Alternate</i> )
Indian Institute of Technology, Kanpur	DR SUDHIR K. JAIN DR C. V. R. MURTY ( <i>Alternate</i> )
North Eastern Council, Shillong	SHRI D. N. GHOSAI
Public Works Department, Government of Himachal Pradesh, Simla	SHRI V. KAPUR SHRI V. K. KAPOOR ( <i>Alternate</i> )
Public Works Department, Government of Jammu & Kashmir	SHRI G. M. SHOUNTHU
Public Works Department, Government of Assam, Guwahati	SHRI SUBRATA CHAKRAVARTY
Public Works Department, Government of Gujarat, Gandhi Nagar	SUPERINTENDING ENGINEER ( DESIGN )
Research, Design and Standards Organization, Lucknow	JOINT DIRECTOR STDS (B&S)/CB-I ASSISTANT DIRECTOR STDS ( B&S )/CB-II ( <i>Alternate</i> )
Structural Engineering Research Centre ( CSIR ), Chennai	SHRI C. V. VAIDYANATHAN SHRI B. SIVARAMA SARMA ( <i>Alternate</i> )
Tandon Consultants Pvt Ltd, Delhi	DR MAHESH TANDON SHRI VINAY GUPTA ( <i>Alternate</i> )
<b>Maps Subcommittee, CED 39 : 4</b>	
In personal capacity ( <i>E-53 Kapil Vihar, Faridabad</i> )	SHRI P. L. NARULA ( <i>Convener</i> ) BRIG K. K. GUPTA ( <i>Alternate</i> )
Central Water and Power Research Station, Pune	DIRECTOR SHRI I. D. GUPTA ( <i>Alternate</i> )
Department of Earthquake Engineering, University of Roorkee, Roorkee	DR S. BASU DR ASHWANI KUMAR ( <i>Alternate</i> )
Indian Meteorological Department, New Delhi	DR S. N. BHATTACHARYA SHRI V. K. MITTAL ( <i>Alternate</i> )
Institute of Petroleum Engineering Oil and Natural Gas Commission, Dehra Dun	DEPUTY GENERAL MANAGER SUPERINTENDING GEOPHYSICIST ( <i>Alternate</i> )
National Geophysical Research Institute ( CSIR ), Hyderabad	SHRI S. C. BHATIA DR B. K. RASTOGI ( <i>Alternate</i> )
Survey of India, Dehra Dun	SHRI G. M. LAL



## Bureau of Indian Standards

BIS is a statutory institution established under the *Bureau of Indian Standards Act, 1986* to promote harmonious development of the activities of standardization, marking and quality certification of goods and attending to connected matters in the country.

### Copyright

BIS has the copyright of all its publications. No part of these publications may be reproduced in any form without the prior permission in writing of BIS. This does not preclude the free use, in the course of implementing the standard, of necessary details, such as symbols and sizes, type or grade designations. Enquiries relating to copyright be addressed to the Director (Publications), BIS.

### Review of Indian Standards

Amendments are issued to standards as the need arises on the basis of comments. Standards are also reviewed periodically; a standard along with amendments is reaffirmed when such review indicates that no changes are needed; if the review indicates that changes are needed, it is taken up for revision. Users of Indian Standards should ascertain that they are in possession of the latest amendments or edition by referring to the latest issue of 'BIS Catalogue' and 'Standards : Monthly Additions'.

This Indian Standard has been developed from Doc : No. CED 39 ( 5341 ).

#### Amendments Issued Since Publication

Amend No.	Date of Issue	Text Affected

## BUREAU OF INDIAN STANDARDS

### Headquarters:

Manak Bhavan, 9 Bahadur Shah Zafar Marg, New Delhi 110 002  
Telephones : 323 01 31, 323 33 75, 323 94 02

Telegrams: Manaksanstha  
( Common to all offices )

### Regional Offices :

Central : Manak Bhavan, 9 Bahadur Shah Zafar Marg  
NEW DELHI 110 002

Telephone

{ 323 76 17  
323 38 41

Eastern : 1/14 C. I. T. Scheme VIIM, V. I. P. Road, Kankurgachi  
KOLKATA 700 054

{ 337 84 99, 337 85 61  
337 86 26, 337 91 20

Northern : SCO 335-336, Sector 34-A, CHANDIGARH 160 022

{ 60 38 43  
60 20 25

Southern : C. I. T. Campus, IV Cross Road, CHENNAI 600 113

{ 254 12 16, 254 14 42  
254 25 19, 254 13 15

Western : Manakalaya, E9 MIDC, Marol, Andheri (East)  
MUMBAI 400 093

{ 832 92 95, 832 78 58  
832 78 91, 832 78 92

Branches : AHMADABAD. BANGALORE. BHOPAL. BHUBANESHWAR. COIMBATORE.  
FARIDABAD. GHAZIABAD. GUWAHATI. HYDERABAD. JAIPUR. KANPUR.  
LUCKNOW. NAGPUR. NALAGARH. PATNA. PUNE. RAJKOT. THIRUVANANTHAPURAM.