

ABB

1 | 16
en

review

A sea of innovations 6

Rural electrification transformed 12

Test-driving drives 30

3-D visualization 49

The corporate
technical journal

Innovation

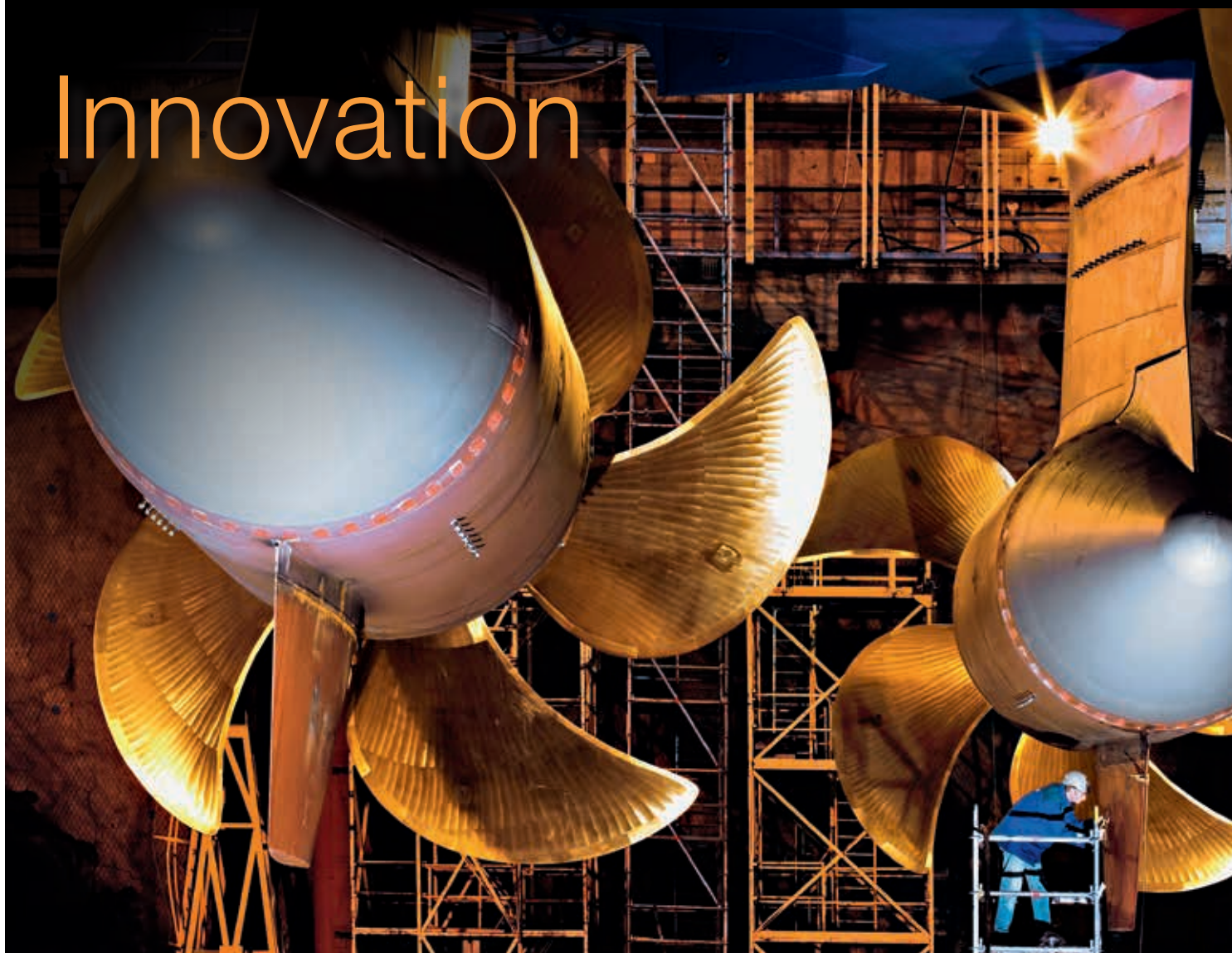

Power and productivity
for a better world™





ABB Review regularly dedicates its first issue of the year to innovations, celebrating the latest fruits of the company's research and development efforts. The front cover of this issue shows the propellers of an Azipod. Azipod drive units permit ships to navigate with greater accuracy and fuel efficiency (see also page 11). The inside front cover shows a 50 MVA power transformer installation (also discussed in the article on pages 12–17).

Innovation highlights

- 6 Innovation highlights**
ABB's top innovations for 2016

Portraits of power

- 12 Small wonder**
Station service voltage transformers for small power requirements
- 18 A flexible friend**
ABB's flexible tank concept for transformers mitigates rupture risk
- 23 Protect and survive**
Fault protection analysis in low-voltage DC microgrids with photovoltaic generators

Drives in motion

- 30 Test drive**
ABB's new test laboratory lets customers optimize motor/drive combinations
- 34 Driving force**
Rare-earth-free electric motors with ultrahigh efficiencies deliver sustainable and reliable solutions

Taming the power

- 41 Twist off**
Damping torsional oscillations at the intersection of variable-speed drives and elastic mechanical systems

Plants and knowledge

- 49 Visionary**
3-D visualization enhances production operations
- 53 Pulp mill optimization no longer pulp fiction**
Producing high-quality pulp consistently with advanced process control
- 60 Alarming discoveries**
Improving operator effectiveness through alarm life-cycle support
- 65 From paper to digital**
A research project for extracting object-oriented descriptions of piping and instrumentation diagrams

Readership survey

- 70 Our readers have spoken**
Presenting the results of our readership survey

Innovation



Bazmi Husain

Dear Reader,

It gives me great pleasure to present to you the first issue of ABB Review under my tenure as Chief Technology Officer. I've been an avid reader of the Review since I joined ABB in 1981, and am honored to join the editorial board of this highly respected technology journal.

Our research at ABB is guided by the needs of our customers and of society. Chief among those today are lower environmental impact, and greater reliability, safety and productivity.

Digitalization offers great potential to address all of these needs by interconnecting devices and systems, and enabling unprecedented levels of collaboration between machines and the humans who run them. For this reason, ABB has taken the lead in developing technologies for what we call the Internet of Things, Services and People. Some are featured in this issue of ABB Review, in a series of short articles highlighting a cross-section of our recent breakthroughs.

Further articles take a look at innovation in rural electrification, fault protection in microgrids, 3-D visualization in enhancing process operations, operator effectiveness through support in alarm handling, and automating the transfer of legacy diagrams into computer-accessible formats.

The third article in our four-part "Taming the power" series on the mitigation of oscillations looks at challenges involving variable-speed drives and elastic mechanical systems.

Your feedback is important to us in developing ABB Review, and I'd like to thank all readers who participated in our recent readership survey, the results of which are shown on page 70.

This year ABB is celebrating two important anniversaries. It is 125 years since the foundation of Brown, Boveri & Cie, one of ABB's predecessor companies, and 100 years since we opened our first corporate research lab. We will mark these anniversaries during the course of the year with articles looking back at our innovation track record and forward to new opportunities for pioneering technological developments.

Please note that besides the print edition, ABB Review is available as a pdf and as an app, both of which can be found at <http://www.abb.com/abbrevreview>.

The technology innovations highlighted in this issue of ABB Review describe just a few examples of the many developments occurring in our labs that address the challenges facing our customers today. If you have suggestions for articles or improvements, we would be delighted to hear from you.

A handwritten signature in blue ink, appearing to read "Bazmi Husain".

Bazmi Husain
Chief Technology Officer and
Group Senior Vice President
ABB Group



Innovation highlights

ABB's top innovations for 2016

Research and development is about discovering and shaping the future of technology. Every year, hundreds of new discoveries or improvements to existing discoveries come out of ABB's labs. In the following a

selection are presented. Some of these innovations are revisited in full length articles in this and upcoming issues of ABB Review.

An alternative to SF₆ as an insulation and switching medium

For decades, the unique properties of sulfur hexafluoride (SF₆) have made it popular as an insulation medium for electrical switchgear. However, SF₆ is a greenhouse gas and there are increasing life-cycle management costs associated with its use.

The considerable efforts made by many research groups to find SF₆ alternatives with lower environmental impact but with insulation and arc interruption properties as good as those of SF₆ have, until now, proved fruitless.

However, ABB has developed an environmentally friendly alternative, with properties similar to SF₆, with a gas mixture based on a product from the company 3M called Novec 5110 Dielectric Fluid – a perfluorinated ketone with five carbon atoms.



The fluoroketone-based gas mixture for switchgear applications was developed in collaboration with 3M. This fluorinated molecule decomposes under ultraviolet light in the lower atmosphere, giving a lifetime of around 15 days, versus 3,200 years for SF₆. The global warming potential (GWP) of the gas mixture is below 1. In a joint pilot project with ewz, a leading Swiss utility, the world's first

gas-insulated switchgear (GIS) installation to use the new gas mixture was recently commissioned in a substation in Zurich, Switzerland. Altogether, eight high-voltage GIS bays and 50 medium-voltage GIS bays using a gas mixture based on the ketone were installed in the substation, which is adjacent to the ABB GIS factory.

A light UPS that won't take downtime lightly

ABB's power protection portfolio for industrial applications spans a range of products including static frequency converters, voltage and power conditioners as well as uninterruptible power supplies (UPSs) for industrial markets. The new light industrial UPS PowerLine DPA is an online double-conversion UPS for lighter duties – such as a factory with less harsh conditions.

PowerLine DPA encompasses a modular approach based on ABB's unique DPA (decentralized parallel architecture): In this approach, each UPS module contains all the hardware

and software needed for autonomous operation. The UPS power modules are swappable online, implying zero downtime. PowerLine DPA offers a redundant system configuration, sharing and protecting the load. The solution is fault tolerant and has no single points of failure.

PowerLine DPA secures the power supply to critical industrial processes that require a high level of safety and protection. Its robust design is suitable for industrial plant environments that have high ambient temperatures, dust, moisture and corrosive contaminants. The modular architecture of the PowerLine DPA provides high availability, easy serviceability, fail safe electrical design and a low total cost of ownership (TCO).



High-voltage circuit breaker operating mechanisms type HM – the third generation

Since their introduction, ABB's HMA and HMB operating mechanisms for high-voltage circuit breakers have sold over 110,000 units. Now, the new HMC family – the latest generation – provides even better performance, quality and reliability.

The goal of the HMC development was to improve the characteristics of the existing product – for example, its high level of functionality and compactness as well as ease of adaptation to the circuit breaker – by creating a new product structure and new technology, providing better quality and reliability. Great emphasis was placed on achieving economies of scale and enhanced serviceability.

The design methodology was chosen accordingly:

- Modular design
- Common part strategy
- Standardization of options
- Simplification of assemblies
- Design for excellence (manufacturing, assembly, service, protection against incorrect operation, etc.)

The HMC family is suitable for circuit breakers with ratings of up to 550 kV. Customer requirements can be met flexibly with defined options. In addition, reliability and operational safety are enhanced by a range of improvements – for example, a directly driven pump unit, a direct coupling of control module switching devices as well as an integrated, automatic interlocking pin that can be overrun without damage.

One outstanding innovation is the stroke-dependent resistance of the storage module. This enables the use of helical compression springs in combination with optimized switching characteristics. Furthermore, the most advanced hydraulic components and materials were used – eg, wiper-protected sealing systems are now employed.



Voice control

ABB recently unveiled the world's most advanced voice-activated smart home automation system – ABB-free@home. The innovation allows users to control more than 60 home automation functions in a typical residential smart home environment using voice commands.

ABB-free@home is a central control system for monitoring and controlling an entire living area: light dimming and switching, timers, blind controls, temperature regulation and door entry. Now, the system can be voice controlled – eg, “Please switch on John’s bedroom lights,” or “John’s room – lights on.” ABB-free@home provides confirmation that a com-

mand has been activated and also responds to questions about the status of its functions.

The dialog processor within the voice control system, which combines voice recognition and a statistical speech model, uses algorithms to recognize the user’s intention and the context. The speech model adapts based on the words programmed in the system. Should the command not be complete enough, the system will ask the user for more information.

The home automation solution is sold under the Busch Jaeger brand in Germany, the Netherlands and Austria and under the ABB brand in all other markets around the world.

For more information on ABB-free@home, see “Intelligent living” in *ABB Review* 3/2015, pp. 48–49.

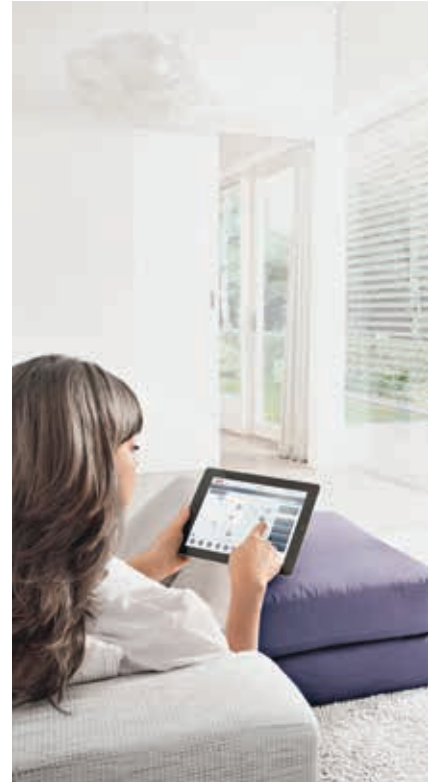

FlexFeeder helps robots take their pick

The FlexFeeder, in combination with ABB’s Integrated Vision supports the sorting of components, ranging in size from 3 mm to 30 mm, without having to change the feeder each time a different component is fed into the system.

The automation of small-parts assembly demands flexibility, reliability and speed. ABB’s new FlexFeeder can interface with the company’s IRC5 robot controller or any PLC controller. It is available in two variants of different sizes (a larger feeder means more time between refills). The reduced internal gaps and integrated backlight option increase flexibility in feeding small parts.

Both variants are designed to save on installation space and shorten cycle times. Additionally, two or more feeders can work side by side, eliminating the need for separate vision



systems. Driven by pneumatic cylinders, the FlexFeeder takes parts from an unordered bulk supply and dispenses them in small quantities onto the flat picking surface in the field of view of the robot’s vision system. Sensors detect when the tank needs to be refilled. The tank can be purged without power

and changing parts can be done easily and safely. Ground and rack mounting methods simplify installation of the FlexFeeder. Handles make moving and lifting these units much easier. The GUI makes it possible to test the FlexFeeder with one click and to monitor the production status.

Motors that know when it is time for service

A new and easy-to-use remote monitoring functionality will soon be helping operators save money through improved maintenance planning and by tackling unplanned stops. Smart sensor tags can monitor key parameters and so identify “problem” equipment, highlighting motors that need to be serviced or even replaced. The tool is currently at an advanced stage of development.

Smart tags with sensors will be factory fitted on selected ranges of ABB low-voltage (LV) motors. The tags can also be retrofitted onto other motors. The motors can then communicate wirelessly to the Internet through a smartphone or a gateway. Key operating parameters that are regularly and accurately monitored include:

- Operating information
- Energy consumption (within 10 percent)
- Overloading
- Operating hours and starts
- Motor body vibration and temperature
- Condition related information
- Rotor winding health
- Internal misalignment
- Bearing condition
- Cooling health

The operator will be able to access this data using a smartphone app. The service will support users in identifying potential issues and planning their maintenance accordingly, permitting a reduction in overall maintenance costs and enabling the plant to reduce or even eliminate unplanned stops.

There are also opportunities to optimize a motors’ energy consumption: By combining data on the energy consumption levels of individual motors with plant operating information, it will be possible to formulate better loading strategies aimed at cutting overall energy costs.

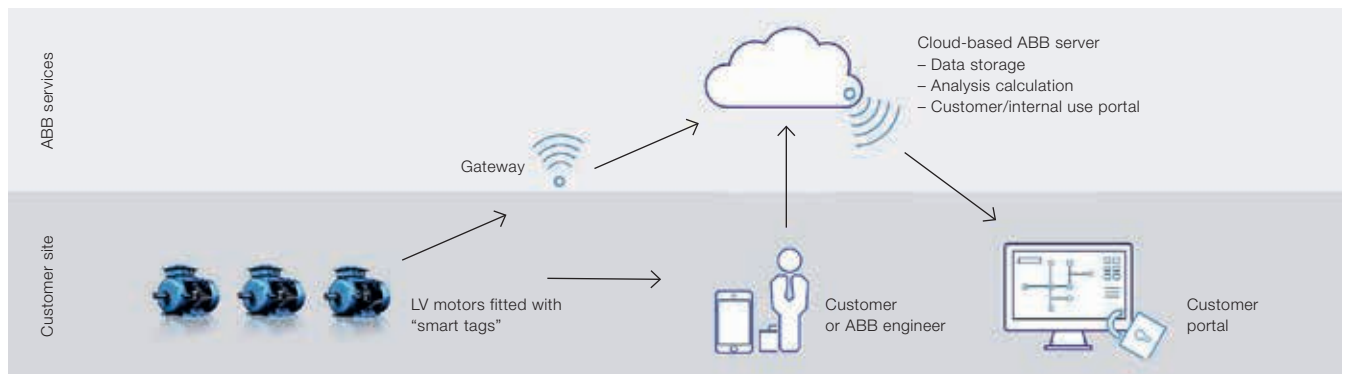

World’s first magnet-free IE5 motor for fixed-speed applications

During the present decade, the minimum efficiency for low voltage motors in most regions of the world will be harmonized to a higher level called IE3 (as defined by IEC 60034-30). IE3 is considered to be the maximum practical efficiency level for induction motors. With motor efficiency now harmonized, focus is turning to machines. Machine manufacturers must face two main questions: How can they further leverage energy efficiency for the entire machine, and how will

they seek to differentiate themselves from their competitors when it comes to energy efficiency?

Over the last five years, efforts to overcome the practical limits of induction motor technology made rare-earth permanent-magnet motors more and more popular. There are however cost and sustainability issues related to these materials. ABB is seeking to offer sustainable and cost-efficient high-efficiency motor alternatives for both variable-speed and fixed-speed applications.

Enter SynRM (synchronous reluctance motor) technology. SynRM is available either totally without magnets or with sustainable ferrite magnets. The latest addition to SynRM family is the first magnet-free IE5 motor with line-start capability: DOLSynRM. A 1.5 kW IE5



DOLSynRM motor was presented at EEMODS in Helsinki, in September 2015 and attracted much attention. Sustainable and cost-efficient ultrahigh efficiency motors have become reality! Now it is up to machine manufacturers to take advantage of them. DOLSynRM showcases how ABB is helping its customers maintain their competitive edge while taking responsibility for the future.

Smartphone apps drive data

Drive operators need to access information about their equipment in order to monitor, control and commission it. Above all, this should be possible in an intuitive manner. What better way to achieve this than using a smartphone? ABB has launched two apps for drive operators: Drivebase and Drivetune.

Drivebase is an app for keeping track of drives. It can identify a drive using a QR code and use this to provide fault analysis, service recommendations, reporting on service actions, easy access to product manuals and a search function for ABB contacts. It can also be used to

register a drive to obtain additional warranties.

Drivebase helps operators track their installed base of drives, providing rapid support and easy access to ABB's services. The app can be downloaded for free from Apple's App Store, Google Play and the Windows Store.

Drivetune is an advanced mobile app for monitoring and controlling drives. It allows users to see the status of their drives and to easily perform drive commissioning via an intuitive interface. The app connects to the drive with Bluetooth, enabling data exchange in both directions.

Drivetune is free and available in Google Play. An iOS version will be released in the near future.



Reaction to sunlight

Optimized use of locally generated solar power is one of the drivers inspiring new generation photovoltaic (PV) systems. Overcoming the misalignment between the daily solar power profile and household demand is one of the challenges that must be addressed for new solutions to emerge that meet customer needs, be they the household user or the grid manager. ABB's REACT has been created with the aim of offering customers the optimum trade-off between the cost of the storage solution and the size of the PV array.

REACT (Renewable Energy Accumulator and Conversion Technology) is made of a grid-tied PV inverter up to 5kW fed from a DC link where a bidirectional battery charger and the MPPTs (maximum power point trackers), connected to the PV array, are attached. Its integrated DC link architecture has the best return on

investment for new installations, but it can also be used to retrofit existing PV plants as an AC link battery charger, simply by not connecting the PV array to its input. The energy storage component of REACT is made of lithium ion batteries with a modular architecture that allows the system to expand from

its native 2kWh up to 6kWh. A simple, but effective onboard load management system allow interaction with selected loads/appliances, boosting the energy independency of the household up to 60 percent with a basic system configuration.



A sea of savings with Azipod D

ABB's gearless Azipod propulsion system already sees widespread application on cruise vessels, icebreakers, and offshore accommodation ships. The newest member of the Azipod family, Azipod D, expands the range by specifically addressing shipping segments such as offshore drilling, construction and support vessels and ferries. These applications require high maneuverability (such as dynamic positioning mode) as well as reliability.

ABB's Azipod is a streamlined steerable pod used to propel and steer ships. The pod's propeller is driven by an electric propulsion system con-

tained in the pod. By orienting the pod flexibly, ships can benefit from high maneuverability.

The latest addition to the Azipod family, Azipod D, is raising profitability of vessels by cutting both maintenance costs and fuel consumption. Further benefits include superior maneuverability, competitive investment cost, ease of servicing and maintenance, and a significant performance increase compared with mechanical thrusters.

Azipod D offers designers and builders of ships greater flexibility by accommodating a wide range of hull shapes and propeller sizes, as well as simplicity of installation. The Azipod D requires up to 25 percent less installed power, in part due to its new hybrid cooling that increases the performance of the electric motor by up to 45 percent.



According to Clarkson's Research, the number of vessels with electric propulsion has been growing at a pace of 12 percent globally per year over the last decade, three times faster than the world's fleet.

Integration no longer by parts

The sheer number of intelligent devices performing measurements or actuation tasks in process plants has long represented a challenge for plant operators. These devices typically come from different vendors and communicate through different protocols. Various standards are available for drivers to integrate them into maintenance tools or control systems. Unfortunately each standard is only optimized for a subset of typical tasks in a plant and exposes compatibility and interoperability issues. ABB has taken a leading role in an industry consortium that developed a new single standard – FDI, or Field Device Integration – combining all benefits of the existing ones and supporting unmatched interoperability.

Furthermore, ABB looked beyond the actual technology and ran a study identifying what additional concerns



users have when working with process instruments. Based on this, the company created a new device management tool designed to support both the technician on the plant floor and the maintenance manager in the office by focusing on the essential information and functions of devices. The new tool bridges the classical split between PC-based tools featuring rich graphics and custom-designed hardware tools used on the plant floor featuring limited functionality and restricted graphical user interfaces.

The new software is ready for the new generation of mobile computing equipment designed in ruggedized format and thus suitable for environments with explosion hazards, eg, in chemical or oil and gas plants.

The combination of an advanced integration standard and modern software design is set to open a new area of instrument management in process plants.



Small wonder

Station service voltage transformers for small power requirements

MATHEW PAUL – An estimated 1.3 billion people worldwide have no access to electricity. In small communities, this is often due to the cost of installing a substation. ABB can now alleviate this situation with its microsubstation, a low-cost substation that exploits station service voltage transformers (SSVTs) to supply local power for a small capital outlay, with ease of design and low maintenance. SSVTs are single-phase power transformers in their simplest configuration: connected line-to-ground on the primary side and pedestal-mounted, they step down power from high voltage levels to medium or low voltage in one step. By avoiding two, or more, stepdowns, SSVTs can save on costs, improve efficiency and enhance reliability. SSVTs make it economical to supply power to locations that cannot justify the expense of a full-scale substation, such as oil and gas pumping stations, mining projects, cell phone towers and hospitals, to name but a few.



Small communities often have no access to electricity due to the cost of installing a substation. ABB can now alleviate this situation with its microsubstation.

An SSVT combines power and instrument transformer characteristics in a product with high reliability, low costs, simplicity and compactness that is ideal for small power applications. The SSVT's capabilities allow it – or an SSMV, which is an SSVT for medium-voltage (MV) levels – to meet the power requirements of a remote community or a substation with just a single unit. The SSVT has a small footprint and is easily configured by virtue of its single-phase design.

Construction

An SSVT or SSMV has a single-phase, shell-type construction and is connected between the primary line and ground, with

a grounded shield winding interposed between the high-voltage (HV) and low-voltage (LV) windings to protect the secondary from transient voltage surges. An SSVT or SSMV is, for the most part, built according to ANSI C57.13 [1] and IEC 61869-3 [2], and complies with C57.12.00 [3] and IEC 60076 [4] → 1. A

new standard – C57.13.8, IEEE Station Service Voltage Transformers – is being drafted that will incorporate the relevant parts of C57.12.00 and C57.13.

Protection

In the SSVT protection scheme, a current transformer (CT) on the HV neutral or ground connection will detect any line-to-ground fault on the secondary winding → 2.

A CT on the tank ground wire can detect a ground fault on the primary side. An optional, under-oil, sudden-pressure relay

The SSVT has a small footprint and is easily configured by virtue of its single-phase design.

can also detect internal faults just as in a power transformer.

In the event of a fault on the primary side, the line protection can isolate the SSVT. Since the transmission line is a critical element, many utility customers want an isolating mechanism for the SSVT substation. At present, up to a 750 kV basic impulse level (BIL) HV dropout fuse protection is available to isolate a defec-

Title picture

ABB's SSVT provide a low-cost and simple way to draw power from a high-voltage line where the expense of a full-scale substation cannot be justified. Shown is an oil-filled SSVT.

The microsubstation is a low-cost substation that makes use of SSVTs to supply local power for a small capital outlay, with ease of design and low maintenance.

1 Comparison of ANSI standards

Class II power transformer	SSVT/SSMV instrument transformer
ANSI C57.12.00	ANSI C57.13
115 – 450 kV (550 kV optional) BIL	115 – 550 kV BIL
138 – 550 kV (650 kV optional) BIL	138 – 650 kV BIL
161 – 650 kV (750 kV optional) BIL	161 – 750 kV BIL
230 – 750 kV (825 kV optional) BIL	230 – 900 kV BIL
345 – 1050 kV (1,175 kV optional) BIL	345 – 1,300 kV BIL
Partial discharge: 500 pC	Partial discharge: 10 pC, partial discharge extinction voltage (PDEV) 135% of nominal voltage
Overvoltage factor: maximum continuous overvoltage (MCOV) 105%, maximum momentary overvoltage (MMOV) 110%	Overvoltage factor: MCOV 115%, MMOV 125%
	Shield winding

tive SSVT/SSMV from the transmission line → 3.

Above 750 kV, a single-phase circuit breaker can be used → 4. Gas-filled SSVTs can be offered with a built-in circuit breaker or isolator for added protection.

Fault level and overvoltage withstand capability

An SSVT/SSMV has about 5 to 10 percent impedance on its own base. By virtue of its small kVA frame size, secondary-side fault current is limited to a safe level. A fuse or miniature circuit breaker (MCB) can protect the SSVT from overload on the secondary side under normal operation. An MV circuit breaker could perform the same function in an SSMV. If the HV primary nominal voltage is rated at 230 kV, the full load current is 1.5 A at 200 kVA and the most severe fault on the secondary side would induce 30 A on the primary.

Environmental impact

By eliminating one or more intermediate transformers, no-load losses and copper losses are reduced, making the system more energy efficient. Further, the SSVT's oil volume is a fraction of that of a comparable power transformer, so the consequences of spillage are far less severe and refilling needs are reduced, as are fire protection and containment requirements. SSVTs are also virtually silent in operation – emitting only about 30 dBA

compared with 70 dBA for a large transformer.

Substation control power supply

Substations come in many sizes and have many purposes. In a distribution substation, power is stepped down from high voltage to medium voltage or from medium voltage to low voltage for powering a number of distribution feeders. A switching substation is for interconnecting HV power transformers in an HV grid or simply for connecting transmission lines that are at the same voltage level. Yet other substations are connected to often remote generating stations to evacuate power from them.

Whatever the type, all substations have metering and protection systems that run off an LV power supply – the so-called control power supply. For reliability, every substation requires two redundant control power supplies. Usually, the main transformer in the substation is the primary source of control power. However, a second power supply is needed – for a number of reasons. For example, in a generator substation, where the primary supply is often tapped off the generators themselves, the generators may stop for maintenance or may be mothballed for a long period, or, in a wind or solar plant, the energy source may wane.

2 SSVT protection

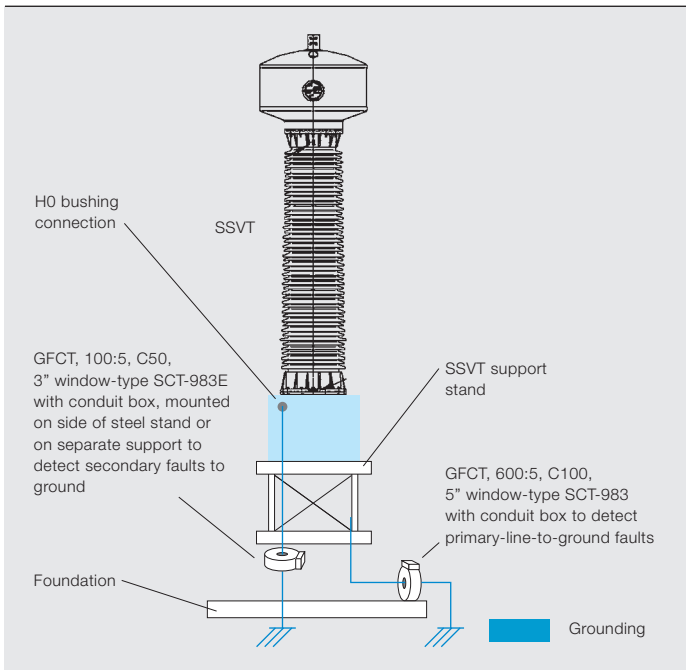

When there is no power generation, control power has to be drawn from the grid. There are several ways to do this: A large power transformer can be kept energized in order to supply the secondary control power – but this is very inefficient as the losses incurred are high compared with the load (to say nothing of the capital costs). Drawing power from a feeder connected to a local LV distribution network or from a standby generator is another option, but one that is expensive and prone to disruptions from external factors.

Substation designers may, from lack of choice, resort to using a distribution feeder from another location to get a redundant control power supply – an expensive undertaking that may be subject to quality and reliability concerns, and open to disruptive influences outside of the operator's control.

In some cases, the main HV transformer is equipped with a third winding to provide the control power supply. However, this is not an ideal solution as it limits the power transformer engineer's design scope. In most cases, it also complicates the design disproportionately, diminishes

the transformer's reliability, and adds cost in terms of losses and the larger oil tank and oil quantity required. Conductor and coil sizes have to be bigger, too. Another deficiency of using the tertiary is the requirement to keep the power transformer energized even if the secondary load is switched off.

An SSVT combines power and instrument transformer characteristics in a product with high reliability, low costs, simplicity and compactness that is ideal for small power applications.

Another option that readily lends itself as a secondary source of control power supply is a standby generator. This option probably has the lowest initial costs, but the highest lifetime costs, compared with an SSVT or a power transformer. Generators using fuel introduce concerns relating to reliability, fire hazard and maintenance as well as environmental factors like noise pollution, fuel spill hazard, etc.

As an alternative to the approaches outlined above, an SSVT/SSMV can, in many cases, be used to provide the control

3 Oil-filled SSVT with dropout fuse





power supply – for a fraction of the cost and much more easily.

The microsubstation concept

Many communities around the world are denied electric power due to the cost of installing a substation. HV transmission lines may pass nearby, but cannot be tapped to power a water supply system, community center, a school or a primary health care facility. An SSVT or SSMV, though not a replacement for a full substation, can, however, expand the reach of electricity to these deprived communities → 5. When the quality of life in the area improves, power demand may grow enough to justify a large substation. At that time, the SSVT/SSMV can easily be relocated to another area.

The initial costs and total life-cycle costs of an SSVT make it an attractive proposition for applications like those just mentioned → 6 and inside cover.

Power transformers are not only costlier but also require extensive monitoring and maintenance to keep them running. For example, a power transformer's dielectric liquid will have to be replaced during its

lifetime, and a 230kV/100MVA power transformer may contain 25,000kg of oil compared with 2,000kg of oil in a 230 kV / 200 kVA SSVT.

Further, a substation using a single-phase SSVT or SSMV can be unmanned and very straightforward, with just an arrester, HV circuit breaker, isolator, earthing grid and LV distribution board – all in a single-phase configuration. This simple arrangement also reduces footprint.

Single-phase configuration also allows the SSVT/SSMV to be connected in a star or delta configuration on the secondary

By eliminating one or more intermediate transformers, no-load losses and copper losses are reduced, making the system more energy efficient.

side. In a secondary three-phase delta configuration, two SSVT/SSMVs can provide a three-phase supply (open delta) at reduced capacity, providing even more flexibility than a three-phase power transformer → 7. Alternatively, one SSVT can be taken out of a three-phase system, in an emergency, to power up another location.

6 A 100 kVA / 220 kV SSVT installation costs around \$200,000 and takes 12 months to complete.



7 SSVTs in a three-phase arrangement



SSVT/SSMV units are significantly lighter and smaller than a power transformer – ideal for transportation to poorly accessible sites.

They can be used as a power source during the construction phase of the installation before being configured as a control power source for the operation phase.

Applications

Isolated load feeds are required by many applications such as oil and gas pumping stations, oil rigs, mining projects, cell phone towers, defense projects, hospitals, railroad substations and transmission tower lighting. SSVT/SSMVs can be designed to cope with the variety of environmental conditions met in these locations – such as high altitude, high/low ambient temperatures, seismic activity or high salt or dust contamination. They can supply power from 25 kVA to 333 kVA,

subject to certain limitations on voltage, at 50 Hz or 60 Hz. SSVT/SSMVs can be tested for seismic withstand capability by a shaker table test if required.

An SSMV, with an MV secondary, can send power to distant loads through an MV distribution feeder. The power can be stepped down at the load end using pole-mounted distribution transformers. This reduces the distribution losses and improves voltage regulation.

SSVTs can be offered with measurement windings so that they can serve a dual purpose. Also, SSVTs with higher kVA ratings are under development, which will make microsubstations even more attractive and enable even larger isolated applications and communities to benefit from the convenience of electricity delivered through the grid.

Mathew Paul

ABB Power Grids, High Voltage Products
Lexington, KY, United States
mathew.paul@us.abb.com

References

- [1] *IEEE Standard Requirements for Instrument Transformers*, IEEE C57.13, 1993.
- [2] *Instrument Transformers*, IEC 61869-3:2011.
- [3] *IEEE Standard General Requirements for Liquid-Immersed Distribution, Power, and Regulating Transformers*, IEEE C57.12.00, 2010.
- [4] *Power Transformers*, IEC 60076, 2011.



A flexible friend

ABB's flexible tank concept for transformers mitigates rupture risk

SAMUEL S. BRODEUR, YASSER S. SALMI, ANDREW COLLIER – Explosions in oil-insulated transformers are primarily related to arcing between parts inside the transformer tank that are at different electric potentials. Such a failure event causes a rapid formation of gas and, as the volume of gas builds up, the pressure inside the tank increases significantly. As the metal tank starts to expand, it will deform and may even rupture. The consequences of such an explosion can include oil spills and even extensive fire damage to both the transformer and surrounding equipment. Traditional mitigation methods use, for example, circuit breakers, and mechanical relief and expansion chamber approaches – all of which have drawbacks – such as effectiveness, footprint or cost. ABB's flexible tank concept is a simple and cost-effective way to mitigate tank rupture risk that has none of the disadvantages of the traditional methodologies.



Despite design precautions to prevent internal arcing in oil-immersed transformers and reactors, there is always a residual risk of such an event, with the possibility of a subsequent tank rupture leading on to a fire and, possibly, an explosion. This risk is a major concern for the safety of employees, the general public and the environment. A statistical survey of 735 kV transformers revealed that approximately 32 percent of explosions were caused by bushing failures and almost half of those ended up in a fire [1]. This fire risk can be reduced significantly by using resin-impregnated paper (RIP) or resin-impregnated synthetics (RIS) bushings.

It is also reported that 54 percent of fires are caused by rupture of the tank or bushing turrets. Another large survey [2], covering 47,000 transformers, con-

cluded that transformers with on-load tap changers (OLTCs), transformers in voltage classes above 300 kV, auto transformers and generator step-up transformers all tend to have higher failure rates than other types of transformers. Furthermore, the average probability of an explosive failure over a transformer's lifetime of 40 years is 40 percent, where 4 percent of these events lead to a catastrophic oil fire and 22 percent to a major oil spill. A catastrophic failure of a transformer is, therefore, by no means a negligible risk → 1.

Traditional risk mitigation techniques

The potential energy released by a low-impedance fault in a large transmission transformer can be as high as 147 MJ. However, several electrical and mechanical protection techniques can, individually or collectively, avert most of the major damage caused by arcing events.

Electrical protection methods include:

- Fast-acting circuit breakers. These are the most important type of electrical protection as they minimize the fault duration, which is linearly proportional to the arc energy generated.
- Buchholz relays, which sense the buildup of gas within the oil. However, these are situated some distance from the potential source of a high-energy fault and may only start to trip after the pressure wave has already propagated.

- Circuit protection techniques such as differential protection or earth fault detection. These techniques must be robust enough to deal with the daily

Despite design precautions to prevent internal arcing in oil-immersed transformers, there is always a residual risk of such an event, with the possibility of a subsequent tank rupture.

demands of inrush currents, phase imbalances and load fluctuations while having sufficient tolerance to ensure that nuisance tripping does not occur.

Even with modern commissioning tools, a human element will remain in the final choice of settings for many of these devices.

There are several mechanical approaches, such as the simple pressure relief valve. With a shorter opening time and lower resistance along the venting path is another mechanical approach – the rupture disc, which requires a containment system, complicating installation. An alternative is the large-volume expansion chamber. Here, a large connecting duct connects the tank to an expansion tank or enlarged conservator (the reservoir for the transformer oil). These absorb any sudden expansion.

Title picture

No matter how good the design and construction are, there is always a residual risk of a transformer catching fire or exploding. Traditional methods to mitigate the effects of such an event have their drawbacks. How does ABB's flexible tank concept get around these?

2 A 20 MJ arc energy event: The risk of rupture is mitigated by much lower tank stresses compared with a rigid tank.

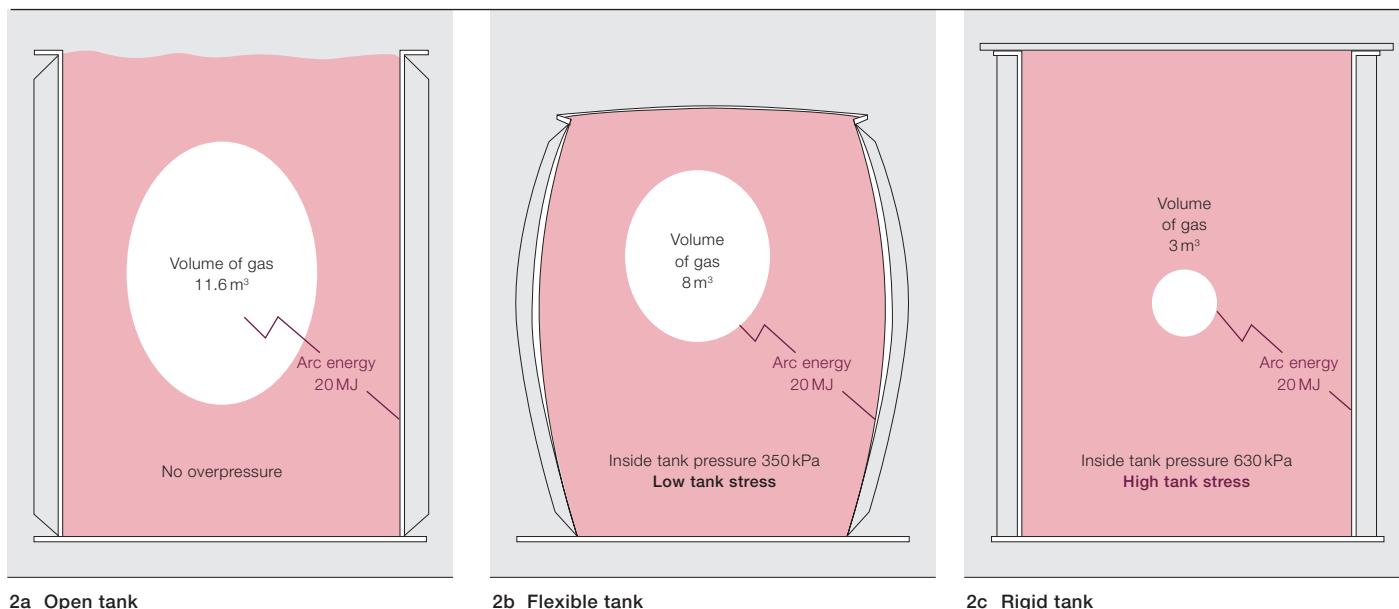

Gas-insulated transformers (GITs) avoid the oil issue altogether by using inert SF₆ gas for cooling and as an insulating medium. However, SF₆ is an extremely potent greenhouse gas, which means that potential leakage to the atmosphere is a concern.

Flexible tank concept

ABB has explored fire risk mitigation in large power transformers since the 1990s. Following an extensive evaluation in 2007 of the different technological approaches, the decision was made to focus on what is now known as the flexible tank concept.

The idea behind this concept is to absorb a certain arc energy in a deformation of the tank → 2. The tank is designed to rupture above this defined energy level. For safety reasons, the point of rupture is typically arranged to be at the edge of the cover, making dangerous ejections and major oil spills less likely.

The flexible tank solution is better than a pressure venting approach – eg, rupture disc or large-volume expansion chamber as it became clear from studies that even a large venting area of 1.0 to

1.5 m² would reduce the peak pressure by only 10 to 30 percent during an internal arcing fault – insufficient to mitigate the tank rupture risk under normal circumstances [4].

Tank withstand capability

The flexible tank concept includes many safety features that mitigate the risk of an oil fire or major spill during an internal fault → 3.

Following an extensive evaluation in 2007 of the different technological approaches, the decision was made to focus on what is now known as the flexible tank concept.

Tank design and controlled rupture point (→ 3, a and c)

A 3-D numerical simulation and evaluation were performed to verify a given theoretical tank capability. This finite element analysis (FEA) included nonlinear material properties, the large deflection effect, a careful meshing refinement and an analysis of the results by an experienced engineer. It applies the quasi-steady-state model, which is based on the conservative assumption of an isothermal expansion of the gas bubble and uniform pressure distribution amplified by a dynamic factor. The tank capa-

3 Tank withstand capability

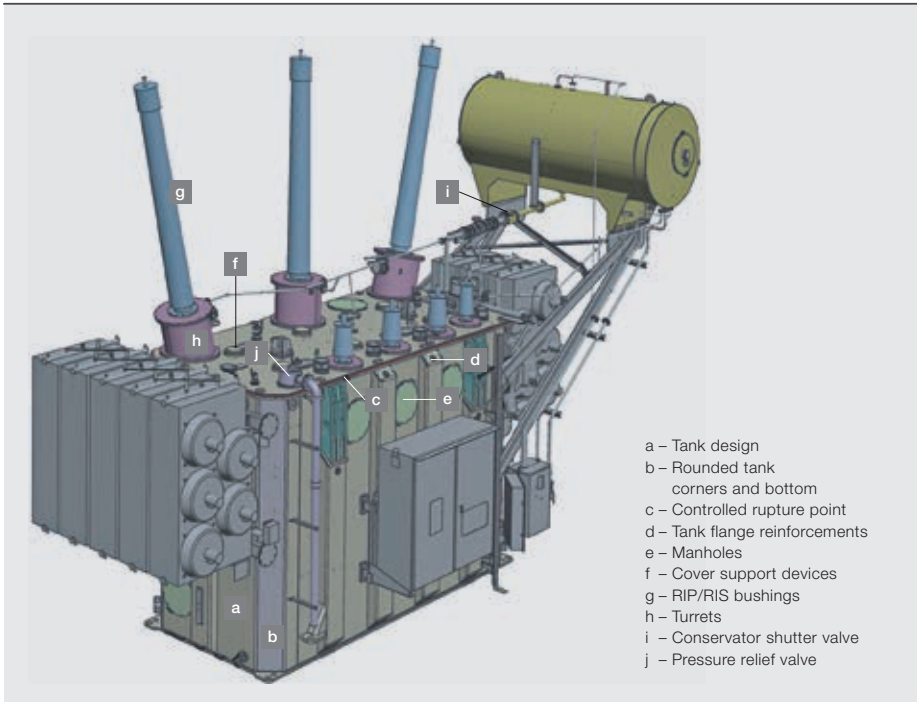

For safety reasons, the point of rupture is typically arranged to be at the edge of the cover, making dangerous ejections and major oil spills less likely.

4 Tank flange reinforcements failure



ability is a function of the controlled rupture point prediction predefined at the tank cover weld. The evaluation results are detailed in a technical report that is provided at the transformer order stage.

Shaped tank corners and bottom (→ 3, b)

The weld joints at the tank wall corners and those between the tank wall and base plate are likely points of failure during internal arcing. For this reason, the flexible tank concept includes shaped tank corners to move the weld joint from this high-stress location. Furthermore, a flexible connection between the tank wall and the bottom plate reduces the risk of rupture. For additional safety, all the weld joints of the tank wall are full-penetration welds certified by ultrasound testing during the manufacturing process.

5 Manhole experimental test



Tank flange reinforcements and cover support devices (→ 3, d and f)

The tank flange reinforcements and the cover support devices are highly loaded and will fail first during internal arcing → 4. This behavior was observed during transformer failure investigations and is implemented in the FEA evaluation routine to improve result accuracy.

Manholes and turrets (→ 3, e and h)

The tank manhole withstand capacity under overpressure has been successfully qualified by an experimental test at the IREQ (Institut de recherche d'Hydro-Québec) laboratory [5] → 5. Furthermore, this same qualified bolting system with o-rings is applied to the turrets, valves and bushing connections.

RIP and RIS bushings (→ 3, g)

RIP and RIS bushings mitigate the risk of major oil spills, fires and porcelain



For additional safety, all the weld joints of the tank wall are full-penetration welds certified by ultrasound testing during the manufacturing process.

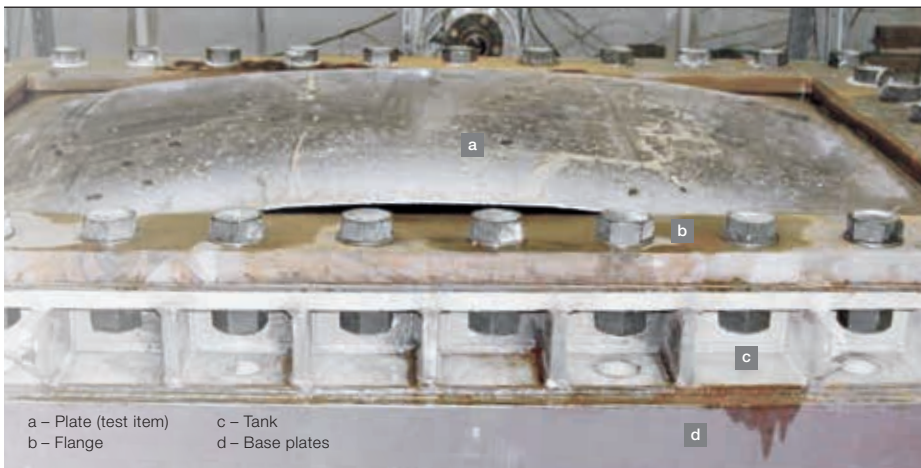

shattering during an internal arcing. They contain, at most, a very small amount of oil.

Conservator shutter valve and pressure relief valve (→ 3, i and j)

The conservator shutter valve is installed on the oil pipe connecting the conservator to the tank → 6. The shutter valve allows oil flow in both directions, but in order to mitigate the risk of oil spilling from the conservator and feeding the fire, it will close and initiate an alarm if the flow rate exceeds a certain limit.

ABB expertise

As mentioned, ABB has been investigating risk mitigation of tank rupture since the early 1990s and so has gained a wealth of knowledge and understanding in this area. In 2007, the ABB plant in Varennes, Canada, began designing tanks according to the flexible tank concept. Over the last five years, more than 20 flexible tank concepts have been designed, analyzed and delivered – including autotransformers, generator step-up transformers, shunt reactors, and single-phase and three-phase transformers – and from this work, further valuable lessons have been learned. The ongoing ABB development work in this area has resulted in a good correlation between FEA failure predictions and experimental tests, and has shown that the simplest and most efficient tank rupture risk mitigation approach is the flexible tank concept → 7.

Samuel S. Brodeur

Yasser S. Salmi

ABB Power Grids,
Large and Medium Power Transformers
Varennes, Canada
samuel.s.brodeur@ca.abb.com
yasser.s.salmi@ca.abb.com

Andrew Collier

ABB Power Grids,
Large and Medium Power Transformers
Bad Honnef, Germany
andrew.collier@de.abb.com

References

- [1] M. Foata and J.-B. Dastous, "Power transformer tank rupture prevention," Cigré, Paris, 2010.
- [2] Cigré, "Guide for transformer fire safety practices – Working Group A2.33," Cigré – Technical Brochure 537, 2013.
- [3] J.-B. Dastous *et al.*, "Numerical method for the investigation of fault containment and tank rupture of Power Transformers," IEEE Transactions on power delivery, vol. 25, pp. 1657–1665, July 2010.
- [4] M. Foata, "Transformer fire risk and mitigation," in Cigré Session 2010, Paris.
- [5] S. Beauregard *et al.*, "Essai en pression du trou d'homme sur enceinte rigide," IREQ report EMMH-2013-015, Varennes, 2013.



Protect and survive

Fault protection analysis in low-voltage DC microgrids with photovoltaic generators

MARCO CARMINATI, ENRICO RAGAINI – The connection of renewable-energy-based microgrids to national power grids has many advantages. However, care has to be taken when linking these two quite different electrical worlds to make sure that fault conditions are appropriately handled – in particular when a microgrid that includes a photovoltaic (PV) installation or an energy storage system (ESS) is connected to the grid by means of a front-end converter (FEC). This configuration can allow fault currents from the AC grid to pass straight through the converter, thus further exacerbating the fault. Most general-purpose FECs are based on insulated-gate bipolar transistors (IGBTs) combined with freewheeling diodes and are not able to interrupt fault currents in all situations. Therefore, a specific protection system is needed to ensure fault clearance and safety, especially when ESSs or DC generators are involved.

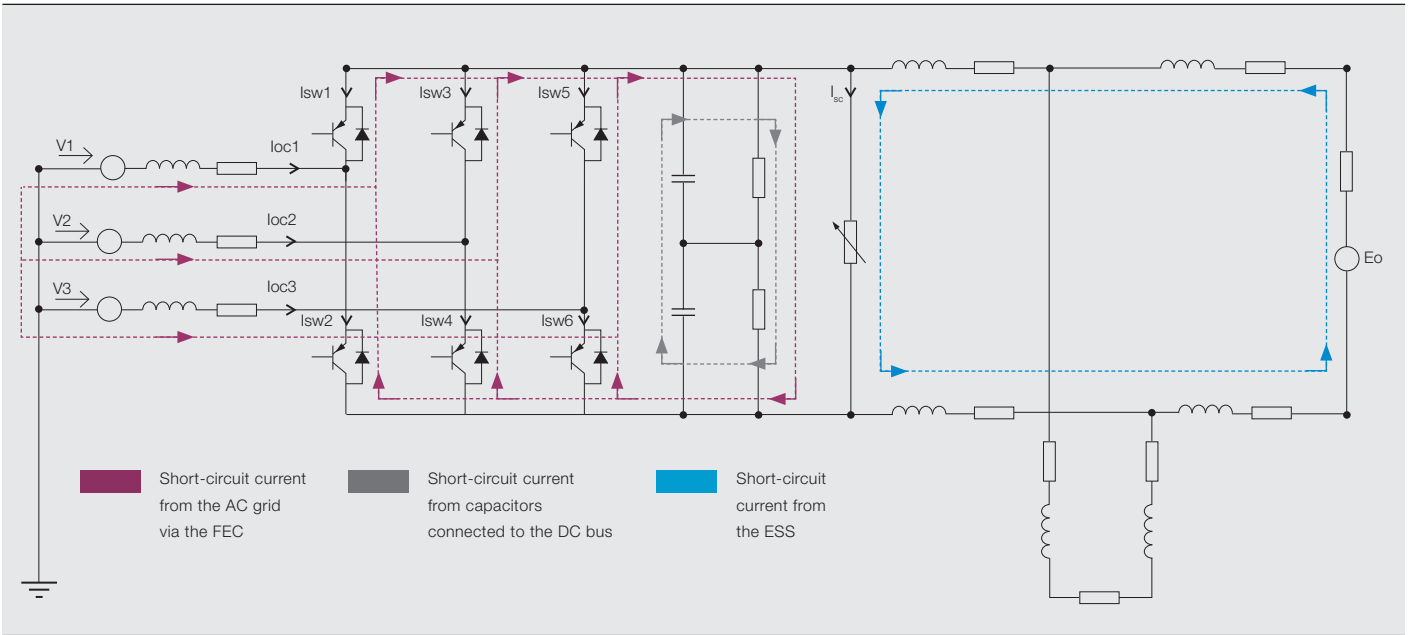

The connection to AC systems of low-voltage direct current (LVDC) microgrids that include PV plants is a topic that is becoming very relevant as ever more renewable power is fed into national grids. Apart from the usual electrical considerations of connecting these two worlds, thought also has to be given to how to deal with fault conditions as, depending on the different possible grounding schemes, PV plants and ESSs and their related electronics can behave in different ways during faults and thus have different consequences for grid operation and fault behavior.

In an LVDC microgrid, the DC section is typically separated from the AC grid by an FEC that feeds any surplus microgrid power into the AC grid.

Title picture

When feeding renewable power from microgrids into a national grid, special measures have to be taken to protect the microgrid equipment from grid faults.

The most critical issue here is that when short circuits and ground faults occur on the DC side, most general-purpose converters are not able to limit fault currents. This happens in converters based on IGBTs with antiparallel freewheeling diodes – the most common design → 1. A large current from the AC grid may pass through the FEC’s freewheeling diodes. Therefore, specific protection designs are needed. (It is worth noting that thyristor rectifiers cannot be used as front-end

Thought has to be given to how to deal with fault conditions as PV plants and ESSs and their related electronics can behave in different ways during faults.

converters because when the power flow is reversed they require voltage polarity to be switched – with, obviously, serious implications for devices connected to the DC bus.)

If correctly sized circuit breakers are installed, even if the energy let through may lead to semiconductors overheating, current is limited, safety is preserved and further damage to the installation is prevented.

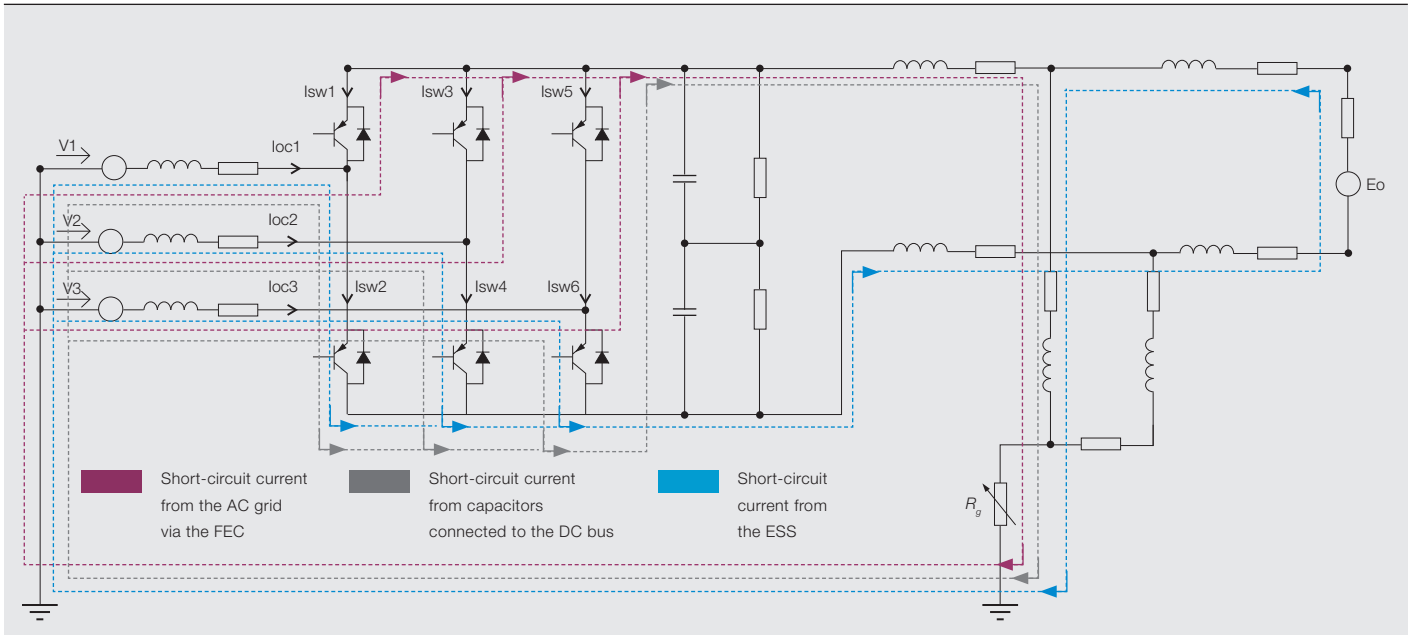

The two main types of faults that these designs have to protect against are DC short circuits and ground faults.

DC side – short circuit

When a short circuit occurs between the terminals of a microgrid DC bus without any source on the DC side, different scenarios, which depend on the value of the fault resistance, may occur: for high values of fault resistance, the FEC may be able to maintain the DC voltage at the nominal value, but below a certain value, the FEC starts working in overmodulation mode.

The limit condition is when the short-circuit resistance is very small, approaching zero. At this point, because current flows in the freewheeling diodes, the FEC works as a rectifier in a short-circuit condition. In this case, current is no longer limited by the FEC. The short-circuit current is the sum of contributions from the AC grid through the FEC, from the capacitors connected to the DC bus and from the DC generators or ESS, if present → 1.

If a PV plant or an ESS is installed on the DC side, additional fault current is provided by the active generator – with each contribution depending on the microgrid structure. On the other hand, the active component, which includes a controller with its own voltage feedback loop, also helps keep the DC voltage at a value that is higher than in a passive DC grid. Therefore, the values of the short-circuit

resistance for which the converter starts limiting the current absorbed from the AC side – and at which the control starts to operate in overmodulation conditions – are lower than in a passive DC network.

When short circuits and ground faults occur on the DC side, most general-purpose converters are not able to limit fault currents.

This means that, in systems equipped with a PV plant or ESS it is not possible to calculate the fault current by superposing the values that would be obtained from each single source, because each one affects the others in ways that are not immediately apparent. Fault currents should then be calculated in each case, taking the whole system into account.

DC side – ground fault

DC sections of electrical installations are generally isolated from ground. On the other hand, for safety reasons, the transformer on the AC side of the FEC is typically grounded.

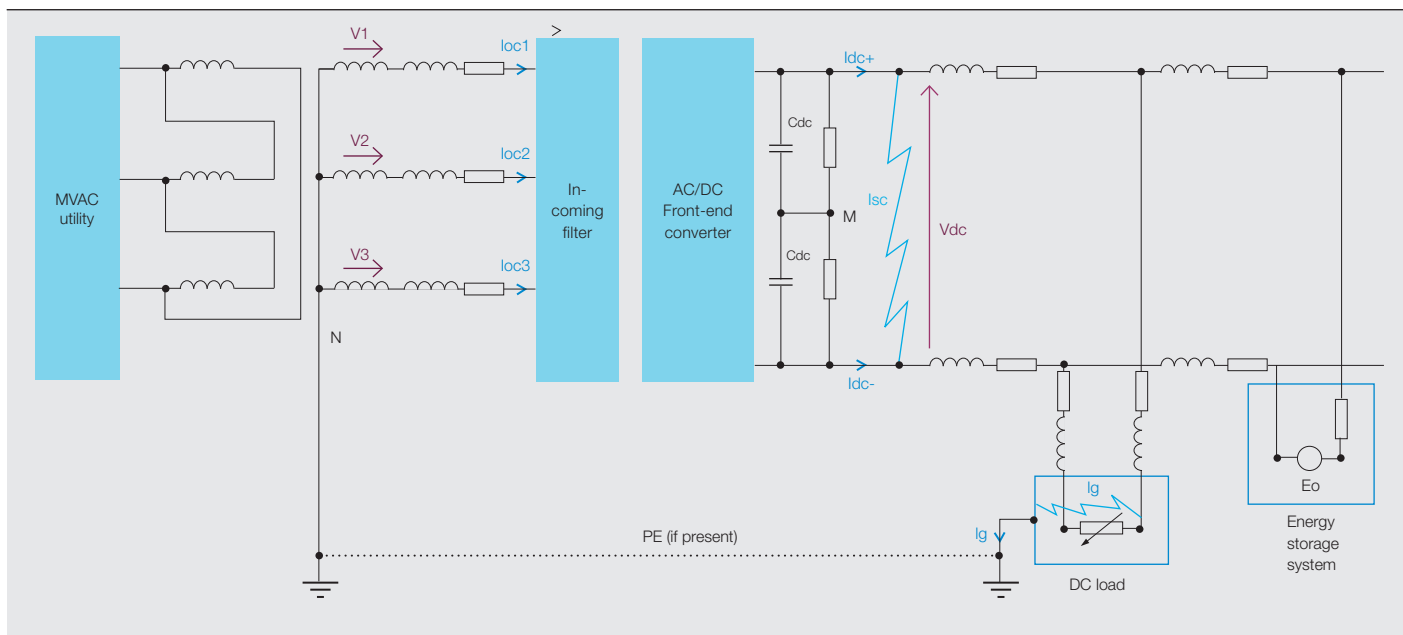

The two main types of faults that designs have to protect against are DC short circuits and ground faults.

When a ground fault occurs on the DC side, fault currents may flow through the converter, with unexpected results.

In the case of a passive DC network, depending on fault resistance, scenarios similar to those described above also occur, with the converter moving into over-modulation mode and, finally, behaving as a rectifier. A PV generator, or an ESS, though contributing to keeping the DC voltage at a higher value than a comparable purely DC passive microgrid, provides a return path for a unidirectional current component at low values of the fault resistance.

In fact, a ground fault in one of the two poles of the DC grid generates a return path for the current toward the AC neutral point. For low values of fault resistance and if the fault occurs on the positive pole, the AC grid fault contribution passes through the freewheeling diodes of the FEC cathodic star, while the ESS contribution passes through the IGBTs of the FEC anodic star → 2.

The situation is reversed if the fault occurs on the negative DC pole.

This can cause currents to flow out of both DC terminals of the FEC – instead of out of just one, which is the normal case. Such currents can be high enough to damage the FEC, yet it is a common mistake to neglect them when calculating ground fault current in the design phase.

In real applications, the electronic protection system embedded in the converter measures the voltage across the IGBT when its gate is pulsed. If this voltage is higher than a fixed threshold, the

In systems equipped with a PV plant or ESS, it is not possible to calculate the fault current by superposing the values that would be obtained from each single source, because each one affects the others in ways that are not immediately apparent.

control circuit turns off the IGBT, pulling down the gate. This protection, called DESAT (desaturation) protection, blocks the IGBTs within a few microseconds of the current flowing through them, ex-

4 Trend of fault current (I_{sc}) during a short circuit on the DC side

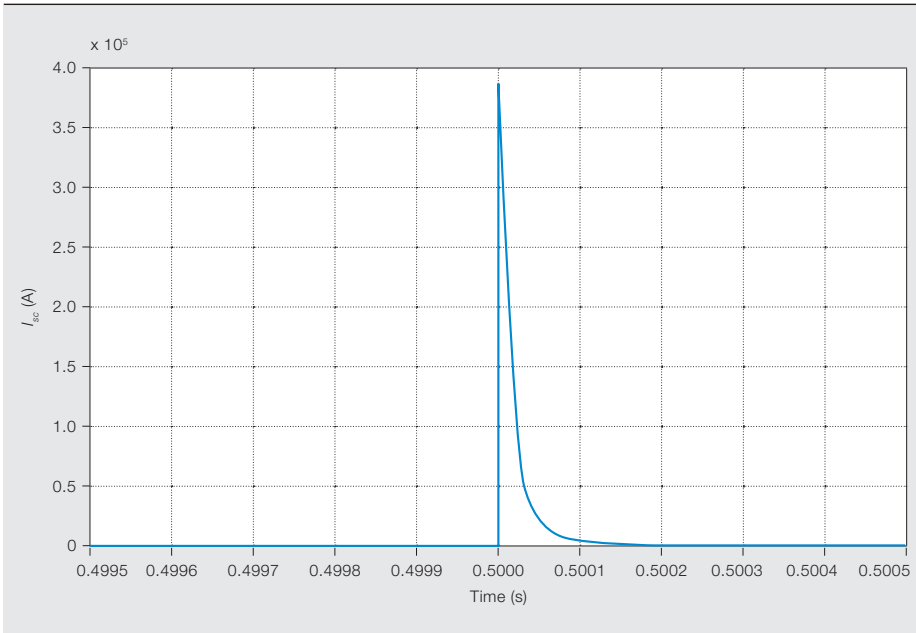

For the DC short-circuit case with a low fault resistance, fault current flows in the freewheeling diodes without any way for the IGBTs to limit it.

ceeding a set limit. Therefore, the fault current contribution of the PV plant, or of the ESS, is interrupted by turning off the modulation of the signal driving the FEC's IGBTs. Nevertheless, the AC grid fault contribution is still fed by the FEC through its uncontrolled freewheeling diodes. Therefore, a suitable external protection device must be installed to interrupt the fault current and protect the FEC.

Case study

Several simulations were performed to analyze the behavior of the microgrid in → 3 during DC short-circuit and ground faults. Usually, the neutral point is connected directly to ground in order to avoid a dangerous voltage transfer to the low-voltage (LV) side in the case of a fault between the primary and secondary windings.

For the DC short-circuit case with a low fault resistance, fault current flows in the freewheeling diodes without any way for the IGBTs to limit it, even if an IGBT block signal is sent by the control system. The IGBT modulation turnoff is ineffective in this case because the diode connected in antiparallel to the IGBT makes the FEC work as a three-phase diode rectifier. The currents involved can reach values several times the FEC nominal current on the DC side (125 A, with $R_{sc} = 1 \text{ m}\Omega$) → 4.

With low fault resistances, the FEC contribution to the short-circuit current may reach values up to 16 times that of the FEC nominal current on the DC side.

For the DC ground fault case with a low fault resistance, fault current flows in the freewheeling diodes of the cathodic star, without any way for the IGBTs to limit it, as well as in the IGBTs of the anodic star. The currents reach values several times that of the FEC nominal current on the DC side (125 A, $R_g = 100 \text{ m}\Omega$) [1]. The IGBT modulation turnoff can interrupt the ESS contribution only.

Depending on the value of R_g , the current on the AC side may be completely positive and all of the AC component that is absorbed by the converter during a fault transfers power to the fault [1] → 5.

With the decrease of R_g , the FEC contribution to the short-circuit current may reach values up to 27 times that of the FEC nominal current on the DC side. Such a contribution cannot be removed by the IGBT block since it passes through the freewheeling diodes.

Fault protection analysis

It is worth noting that while for DC short-circuit protection a unipolar breaker could be used, but for a ground fault a bipolar circuit breaker is necessary since the PV system and the ESS can supply the fault through the healthy DC pole and, moreover, the ground fault is equally likely to occur on either the positive or negative DC pole.

With increasing interconnections of LVDC microgrids and AC power grids, sophisticated fault protection will become an essential part of power system design.

5 Trend of I_{ac1} current during a ground fault on DC side with ESS and $R_g = 100\text{ m}\Omega$

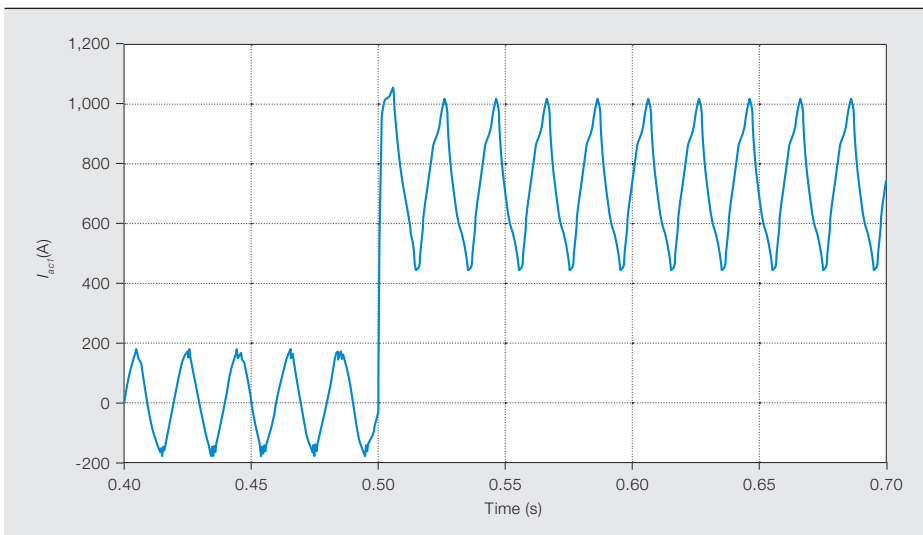

6 Currents flowing in the two poles of the circuit breaker

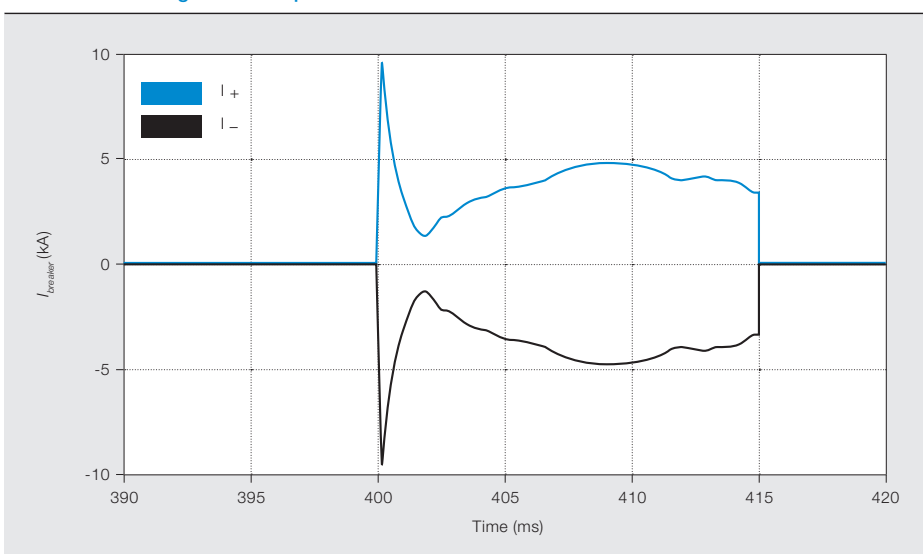

DC short-circuit analysis

For the DC short-circuit simulation, the modulation is turned off after a typical DESAT protection time ($2\text{ }\mu\text{s}$), while tripping is delayed 15 ms to simulate a DC circuit breaker → 6 [2].

To reduce overvoltage, the circuit breaker is located downstream with respect to the DC bus capacitances. Because of the DESAT protection, the currents depicted in → 7 flow in the FEC diodes.

The energy content of a transient (the I^2t) during interruption is about $170\text{ kA}^2\text{s}$. This value is too high for the FEC used. For the semiconductors considered in the simulation, the allowable I^2t value is $42\text{ kA}^2\text{s}$. Therefore, some oversizing of diodes is required to make the FEC capable of withstanding the transient.

Ground fault analysis

The same fault as described above was simulated between the positive DC pole and ground, with interruption by a DC circuit breaker [2]. Resulting AC currents were similar to those of the pole-to-pole short circuit. On the other hand, currents flowing through the DC poles of the FEC are very different → 8. Indeed, the current through the faulty pole increases while the other remains close to zero, thanks to the DESAT protection. The I^2t is about $157\text{ kA}^2\text{s}$ and is comparable with that of the short circuit. Oversizing of diodes is again required.

In summary, DC pole-to-pole and pole-to-ground faults in DC grids fed by an FEC and equipped with PV generation systems and/or ESSs cannot be neglected. Further, DESAT protection is not enough to protect the FEC switching

7 AC currents in the three phases during the circuit breaker trip

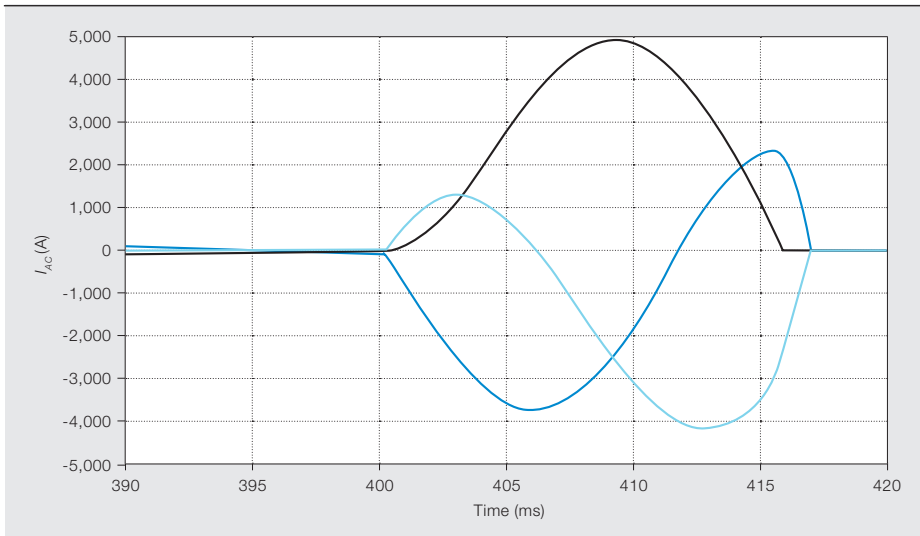

8 Currents flowing in the two poles of the circuit breaker

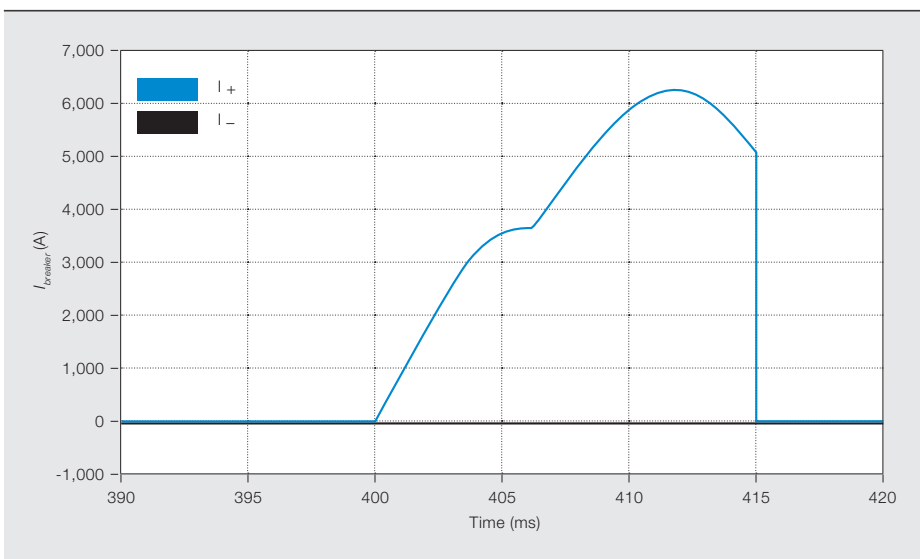

components as turning off the IGBT modulation does not limit the currents flowing through the freewheeling diodes. For this reason, specific protection devices have to be introduced and carefully dimensioned in order to safely interrupt fault currents and limit consequential damages.

With increasing interconnections of LVDC microgrids and AC power grids, sophisticated fault protection will become an essential part of power system design.

Marco Carminati

Enrico Ragaini

ABB Electrification Products,
Protection and Connection
Bergamo, Italy
marco.carminati@it.abb.com
enrico.ragaini@it.abb.com

References

- [1] M. Carminati *et al.*, "DC and AC ground fault analysis in LVDC microgrids with energy storage systems," in *Proceedings of the IEEE 15th International Conference on Environment and Electrical Engineering*, Rome, 2015, pp. 1047–1054.
- [2] M. Carminati *et al.*, "Fault protection analysis in low-voltage DC microgrids with PV generators," in *Proceedings of the 5th International Conference on Clean Electrical Power Renewable Energy Resources Impact*, Taormina, 2015, pp. 190–197.



Test drive

ABB's new test laboratory lets customers optimize motor/drive combinations

JUKKA JUOTTONEN – Located beside ABB's Helsinki drives factory, the ABB drives test laboratory is one of the few ABB test facilities that is intended primarily for external customers. The laboratory provides high-precision measurements of drive/motor dynamic performance, loadability and efficiency that enable customers to find an optimal drive system for their application and thus

reduce costs, equipment size and energy consumption. The measurements are obtained using an extremely precise device. In addition, the laboratory makes it possible to verify motor control performance and match customer motors with ABB drives so that customers have an opportunity to rapidly and accurately verify ABB as a new supplier.



Over the past few decades, the number of motors designed for use with drives has increased significantly. Also, drive prices have steadily decreased while quality has improved considerably. At the same time, machine builders and other users have realized that it is economically attractive to use drives.

The new ABB drives test laboratory → 1 gives customers the opportunity to verify ABB as a new supplier, with a minimum amount of work. Before introducing a new ABB product into serial production, a motor/drive combination can be tested in the drives laboratory. This is an easy and reliable way for customers to find an optimal drive system for their application.

(Sometimes, customers play it safe by going for a bigger drive than necessary – along with equally overdimensioned protection and cabling.)

Title picture

ABB's new drives test laboratory enables customers to run their motors with ABB drives so they can be sure to find the drive that is most suitable.

Customer benefits: optimization and verification

The ABB customer drives test laboratory is an entirely new concept and is primarily aimed at high-volume customers like OEMs (original equipment manufacturers), system integrators and relevant ABB partners in, for example, the machine-building industry.

Before making a significant drives investment, a customer wants to see objective measurements and proven functionality.

Previously, customers were unable to test – at least at this level – their motors on ABB premises but now they have an opportunity to obtain accurate measurements of dynamic performance, loadability and efficiency, and use this data to verify their drive systems.

The laboratory also makes it possible to verify motor control performance and match customer motors with ABB drives in this respect. This is particularly useful when the customer is making a decision concerning a new product. There had

been a strong customer demand for such a service for some years, and months before the laboratory opened there was already a waiting list for test slots.

The customer usually sends his motor to the laboratory a few weeks in advance so that the appropriate test setup

The ABB customer drives test laboratory is an entirely new concept and is primarily aimed at high-volume customers like OEMs, system integrators and relevant ABB partners.

can be prepared. A customer team will witness the testing and see the collection of the measurements in real time. These extremely precise measurements ensure that the system is working as specified.

2 The load drive simulates the load in the customer's application and the performance of the test drive is measured.

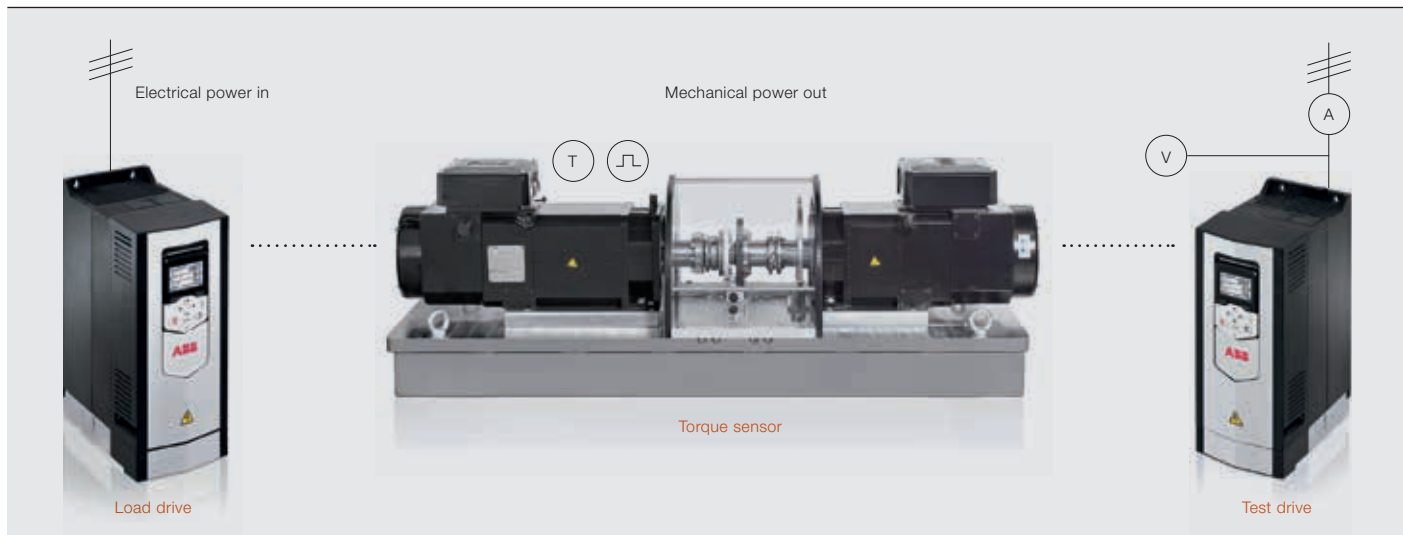

3 Test motors (right) and load motors (left)

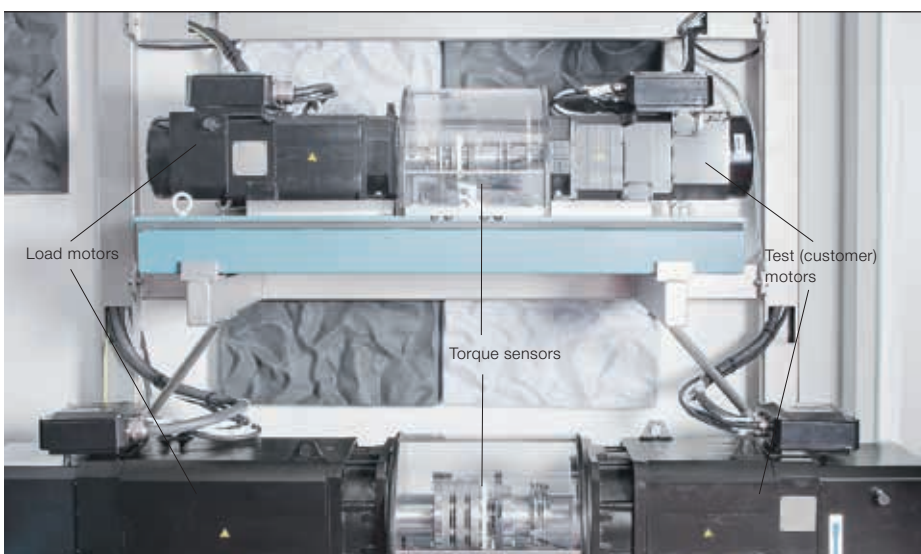

The exact drive system performance needed is now known so an optimal drive system can be chosen or even be tailored to a customer's application.

In other words, customers now have accurate and verified objective measurement data to support their decision making and their purchase process is shortened.

High-precision measurements

One key element of the laboratory is its accurate and reliable torque measurement device, with which the torque of almost any motor up to 385 kW can be measured → 2-4.

There are three setups for three different shaft heights (100, 160 and 250 mm).

The load motors are ABB HDP (high dynamic performance) models. The load motor and test motor are each connected to an ABB drive. The load motor simulates the actual load in the customer's

The new ABB drives test laboratory gives customers the opportunity to verify a drive system, with the minimum amount of work.

application. As a result, the suitability of the motor/drive combination can be verified and optimized.

4 Digital torque transducer with magnetic rotational speed measuring system

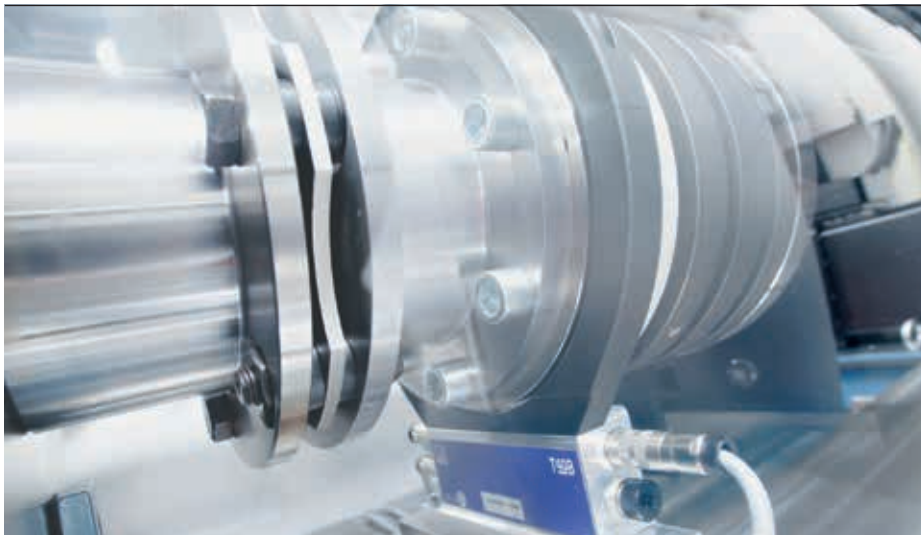

The laboratory makes it possible to verify motor control performance and match customer motors with ABB drives in this respect.

5 Drives customer lab – technical perspective

Tests and parameters

- Parameters: electrical and mechanical measurements
- Tests: dynamics, loadability, efficiency at different load points, customizable load points
- How ABB drives work with different settings such as speed adjustments and torque adjustments

Methods

- Electrical power is measured in the network before the ABB test drive.
- The mechanical power is measured between test and load motors.
- With electrical and mechanical power measured, the efficiency of the system can be calculated.

Equipment

- Yokogawa WT3000 precision power analyzer
- HBM T40B torque sensor
- Hitec MACC plus high-precision current measuring system

Minimum and maximum values that can be tested

- Three setups: biggest one up to 385 kW; smallest up to 8.2 kW (smallest load point is 25 percent)
- Torque sensor: up to a speed of 20,000 rpm

In addition to customer-specific motors, all ABB motors can be tested.

Moreover, speed, torque and efficiency can be measured at any given operation point and the customer can even define his own test points → 5.

This new laboratory is expected to strengthen ABB's role as an agile and flexible partner. The facilities now available underline the reality that this type of collaboration with customers – especially those in the machine-building industry – is essential.

Before a customer introduces a new supplier into serial production, he can test a motor/drive combination in the drives laboratory to make sure it is right for his application.

Jukka Juottonen

ABB Discrete Automation and Motion,
Drives and Controls
Helsinki, Finland
jukka.juottonen@fi.abb.com



Driving force

Rare-earth-free electric motors with ultrahigh efficiencies deliver sustainable and reliable solutions

FREDDY GYLLENSTEN, PETER ISBERG, ALESSANDRO CASTAGNINI, GIULIO SECONDO, JOUNI IKÄHEIMO, ARI TAMMI – Highly efficient electric motors in industrial applications often use permanent magnets containing rare earth elements (REEs) such as neodymium and dysprosium. These elements are subject to price variations due to changing market demands. Now, thanks to recent developments in variable-speed drive (VSD) motor technologies, there are alternative high-performance motors that are free of REEs. One is the synchronous reluctance motor (SynRM), characterized by being very energy efficient, reliable in operation and exceptionally easy to maintain. Another is the ferrite-assisted synchronous reluctance motor (SynRM²), which is more energy-efficient and more powerful than the SynRM.

1 SynRM principle: The rotor will create torque whenever there is a magnetic field present in the air gap that is not aligned with the rotor.

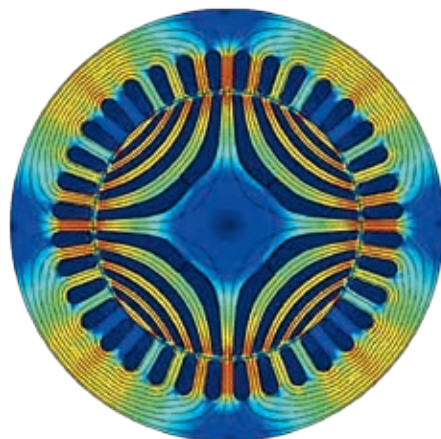

1a The rotor is aligned with the magnetic field, so no torque is produced.

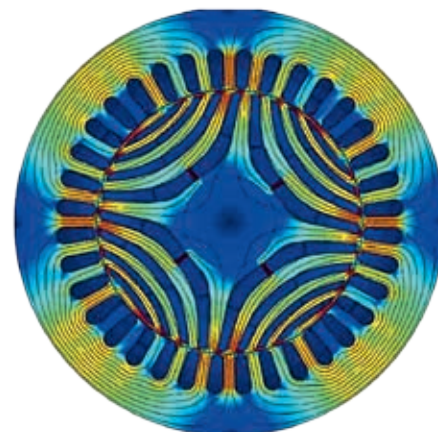

1b The rotor is not aligned with the magnetic field, and (counter-clockwise) torque is produced.

Although introduced over a century ago, electric motors continue to experience bursts of innovation and recent years have seen remarkable progress in electric motor efficiency improvements.

Since electric motors are involved in a significant fraction of energy conversion – 28 to 30 percent of all electrical energy is converted to mechanical energy in electric motors – special attention is devoted to their efficiency and all industrialized regions have minimum efficiency performance standards (MEPS) for them. In order to further reduce industry's energy consumption and CO₂ emissions, regional legislation sometimes sets a higher minimum level. Soon, all industrial regions will adopt the so-called IE3 classification level as the minimum requirement for almost the full power range of direct-online (DOL) low-voltage electric motors (0.12 to 1,000 kW, 50 to 1,000 V). Similar requirements for VSD motors are undefined today, but are expected in the near future.

Title picture

ABB's new SynRM and SynRM² represent a major step forward in sustainable electric motor technology in terms of efficiency and power density. Shown is SynRM's unique rotor.

Induction motors

The induction motor (IM) is by far the most common in industry. This powerful and efficient motor does not have a commutator or brushes, which makes it reliable and relatively maintenance-free. It is continuously under development to make it more efficient.

Despite universal use, IMs have some inherent drawbacks caused by their asynchronous speed, which results in conductor losses in the rotor that negatively affect efficiency, generate more heat and result in warmer bearings with a consequently shorter lifetime.

Permanent magnet motors

Although long known, permanent magnet (PM) AC motors really only became competitors to IMs in the 1980s with the creation of a new generation of permanent magnets based on materials such as neodymium iron boron (NdFeB), which was developed independently by General Motors and Sumitomo Special Metals in 1982. A prerequisite for the introduction of these new magnets into motors was the parallel advancement of the AC drives that were needed to control and operate the motors.

PM motors have magnets mounted on the surface of, or embedded into, the rotor. Further, unlike the asynchronous induction motor, where the rotor "slips" – ie, has a lower rotational frequency than the magnetic field driving it – the PM motor is synchronous, meaning the rotor rotates in synchronism with the magnetic field. This offers more precise speed control, higher efficiency and lower rotor/bearing temperature. PM motors eliminate rotor conductor losses, have lower conductor losses or Joule losses in the stator (mainly due to lower current), and exhibit a flatter efficiency curve. They also run cooler than IMs, resulting in longer insulation and bearing lifetimes. Also, PM motors give more torque for the same size of package, or the same torque in a smaller package.

However, the use of rare-earth elements (REEs), such as neodymium and dysprosium, has certain drawbacks. REEs are

Twenty-eight to 30 percent of all electrical energy is converted to mechanical energy in electric motors.

costly and can be subject to price variations. In addition, their strong magnetic rotor field can make servicing – a key feature of a mainstream industrial motor – more difficult.

The IEC 60034-30-1 standard defines minimum limits for different efficiency classes for line-operated motors – ie, induction motors and motors with line-starting capabilities, like line-starting PMs (that have cages like the IM for allowing starting) [2]. The complication when trying to define the efficiency of SynRMs and other pure VSD-operated concepts is that no efficiency standards currently exist for these motors. But standardization work is ongoing and a future IEC 60034-30-2 will include these types of motors. The efficiency class definition of the ABB SynRMs has, therefore, used the limit values from IEC 60034-30-1, even though the SynRMs have been operated with a VSD during classification testing. Operating with a VSD will always give rise to higher motor losses for the same working point, compared with sinusoidal operation as is the case for line operation, since the VSD induces high harmonic voltages to the motor caused by pulse-width modulation (PWM) switching, with associated higher losses in the motor. The efficiencies claimed for SynRM are, therefore, conservative.

The lower operating temperature of a SynRM has multiple benefits – including longer insulation life, and longer bearing greasing intervals or lifetime.



Applications and customers that currently favor PM motors may look for alternatives in the future, depending on price and market developments.

REE-free motors

A future economically and ecologically sustainable solution may lie in REE-free motors. ABB has now introduced two such motors, which are aimed at providing very high efficiency, high power density and freedom from the complications surrounding REE materials. These motors are the synchronous reluctance motor (SynRM) and the permanent-magnet-assisted synchronous reluctance motor (SynRM²), which uses ferrite magnets.

Synchronous reluctance motors for VSD applications

SynRMs work on a very elegant principle that has been known for a long time, but only since the recent rise of sophisticated VSD control electronics did it become possible to fully exploit these super-efficient electrical machines. In SynRMs, the rotor is designed to produce the smallest possible magnetic reluctance (the resistance to the flow of a magnetic field) in one direction and the highest in the direction perpendicular → 1. The rotor turns at the same frequency as the stator field (as in the PM motor). Introduced at

the Hanover Fair in 2011 (incidentally, the SynRM won the Automation Award at the SPS Fair in Germany the same year) ABB's first SynRMs were designed exclusively for variable-speed operation.

SynRMs perform better than conventional IMs. They can be designed for high-efficiency performance or to provide a higher power density for a smaller footprint than an equivalent IM. They need less maintenance, have a reduced inertia and are extremely reliable.

Without magnets and without a cage, the rotor construction is simpler than either IMs or PM motors.

The lower operating temperature of a SynRM has multiple benefits – including longer insulation life, and longer bearing greasing intervals or lifetime (bearing failure is a major cause of motor outage).

ABB's SynRM hardware is identical to that of ABB's equivalent IMs. Only the rotor is different. This simplifies spare-part provision and maintenance. It also means that replacing an existing IM with a SynRM is easy.

Recent advances in the efficiency of ABB SynRMs has been so rapid that existing IE efficiency classifications have been



SynRM motors work on a long-known and very elegant principle – but only since the recent rise of sophisticated VSD control electronics have these super-efficient electrical machines been fully exploited.

outstripped → 2. While the EU requires IE3 as a minimum, ABB already has a catalog of IE4 SynRMs. The potential of SynRMs has not been fully explored and higher efficiency levels are quite feasible.

It is important to note that only DOL motors have been classified as to their efficiency; VSD motors have not. So, when ABB VSD motors now undergo “classification,” they do so in the frame of reference used for DOL motors, which does not properly reflect VSD operation – for instance, the excellent performance

Two SynRM ranges are available: IE4 SynRM (5.5 to 315 kW) and compact high output SynRM (1.1 to 350 kW). These currently come in several motor/drive packages → 3–4:

- IE4 SynRM and ACS880 for industrial users and end users
- IE4/HO SynRM and ACS850 for machine builders and original equipment manufacturers (OEMs)
- IE4 SynRM and ACQ810 for the water and wastewater segments
- IE4/HO SynRM and ACH580 for heating, ventilation and air-conditioning (HVAC) applications

An expansion to the SynRM product palette – SynRM² – was introduced in 2014 when the 15 kW model was displayed in Hanover as the first ABB demonstrator of an IE5-enabling technology.

As mentioned above, efficiency is becoming a critical issue for manufacturers of motors and motor systems: The trend in the EU, United States and Asia is in the direction of further legislation – not only for motors, but for the system in which

of VSD systems at partial load and the harmonic losses that are significantly lower than those of IMs under VSD operation.

they are embedded. This is why ABB is a step ahead – with SynRM² technology.

SynRMs can be designed for high-efficiency performance or to provide a higher power density for a smaller footprint than an equivalent IM motor.

5 Comparison of IM, SynRM and SynRM² of different IE classes

Efficiency class ²	IE2	IE3	IE4	IE5 ³
Motor data¹ (from tests in frequency converter operation)				
ABB product	M3BP (160)	M3BP (160)	M3BL (160)	N.A. (160)
Type	IM	IM	SynRM	SynRM ²
Output power (kW)	15	15	15	15
Speed (r/min)	1,500	1,500	1,500	1,500
Voltage (V)	380	380	380	380
Current (A) ⁴	29.9	29.5	31.5	25.2
Power factor (-)	0.845	0.838	0.763	0.949
Efficiency (%)	90.6	92.2	94.7	95.2
Converter data (network voltage 400 V)				
ABB converter product in tests	ACS850-035A	ACS850-035A	ACS850-035A	ACS880-087A
Suggested ABB converter for end users	ACS880-032A	ACS880-032A	ACS880-032A	ACS880-032A
Control type	DTC	DTC	DTC	DTC
Comparison cases with IE2 motor and drive system as reference				
Constant torque (75 % duty (with 8,585 hours of annual operation in duty cycle according to graph))				
Annually consumed electricity (kWh)	74,846	73,536	71,924	70,745
Annual electricity savings (kWh) ⁵	0	1,310	2,922	4,100
Annual electricity cost savings (\$)	0	210	470	658
Average output power (kW)	7.6	7.6	7.6	7.6
Average system efficiency (%)	87.1	88.7	90.6	92.2
Payback time (months)	-	< 10	< 10	< 11
Quadratic torque duty (with 8,585 hours of annual operation in duty cycle according to graph)				
Annually consumed electricity (kWh)	56,386	55,335	54,089	53,275
Annual electricity savings (kWh)	0	1,050	2,296	3,110
Annual electricity cost savings (\$) ⁵	0	168	368	500
Average output power (kW)	5.7	5.7	5.7	5.7
Average system efficiency (%)	86.7	88.4	90.4	91.8
Payback time (months)	-	< 12	< 13	< 15

1 Motor data from tests at nominal working point.

2 Minimum efficiency limits according to IEC 60034-30-1.

3 An IE5 efficiency class is not yet defined, but is calculated to have 20 percent lower losses than the IE4.

4 The currents are scaled from measured values for harmonizing to an equal voltage of 380V, for simple comparison.

5 The comparisons are done with Germany as an example with an industry electricity price of \$0.16/kWh.

5a Summary of test data

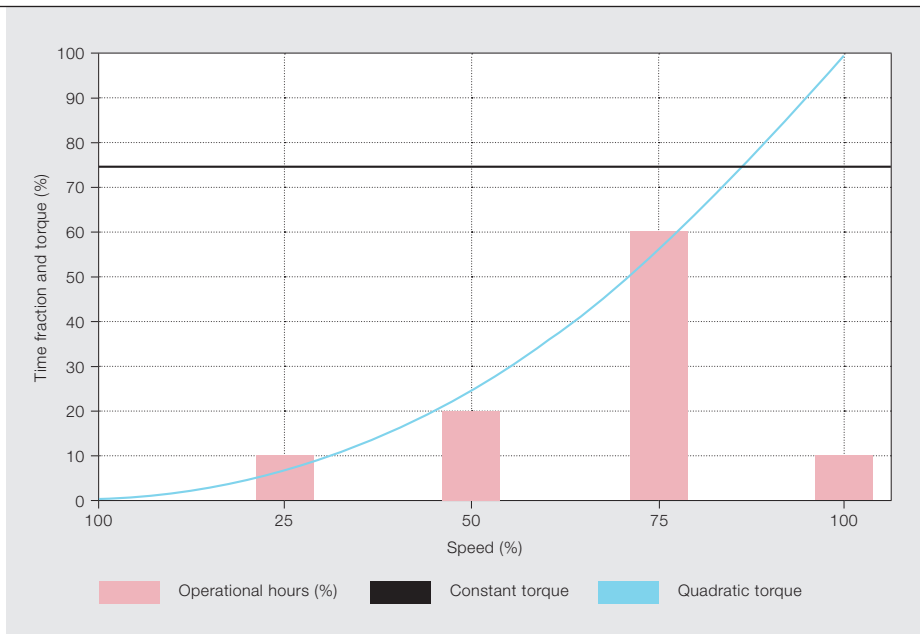

5b Basis of the energy calculations

SynRM²

An expansion to the SynRM product palette – SynRM² – was introduced in 2014 when a 15 kW model with an IEC shaft height of 160 mm (“SH160”) was displayed in Hanover as the first public ABB demonstrator of an “IE5”-enabling technology. IE5, at the moment undefined by IEC 60034-30-1, is envisaged to have 20 percent lower losses than the IE4 class. (This cut in losses is typical between IE classes.)

rite magnets, to be strong enough. With the rapid development and increasing intelligence of VSD drives, full control and utilization of these motors is now possible – as in the case of SynRMs.

The IE5 SynRM² is designed for customers chasing ever-higher efficiency and power density levels. Moreover, with power factor levels equal to PM motors and excellent field-weakening properties, the IE5 SynRM² can enable new, more compact

motor-plus-drive package solutions. ABB is working to develop a SynRM² range, from 0.55 to 15 kW, targeting, for example, the HVAC market. Moreover, based on the attractive properties of the motor tech-

After 10 years of operation, the initial purchase price corresponds to only around 2 to 3 percent of the electricity cost, for all VSD systems compared.

A unique feature of this motor is that it uses ferrite (iron oxide, Fe₂O₃) magnets, which are generally more cost-effective and more easily available than rare-earth permanent magnets. Their use results in a more economical and ecologically sustainable product.

Ferrites have been used before in low-power applications, but in industry a ferrite-based motor alone could not compete against an IM. A motor has to have a dominant reluctance, assisted by fer-

nology, ABB is proposing this technology to large OEMs in other application fields for whom it would be of great interest and benefit.

Test comparisons for different motor types in VSD operation

The IE energy efficiency classes are defined for DOL motors in the IEC 60034-30-1 standard and classified at the nominal working point (ie, at full load and speed). Naturally, the relative efficiency performances of VSD motors and drives are

ABB is prepared to meet the requirements of DOL motors with the newest member of the SynRM family – DOLSynRM, a concept version of which was demonstrated at the 2015 Hanover Fair.

not given by this motor class definition alone, since partial load and speed working-point performances and harmonic losses in the motors caused by frequency converter operation, as well as the losses in the frequency converters, are not accounted for. Therefore, the system efficiencies using different motor types and efficiency classes have been characterized in tests → 5a. Two different and typical industry load profiles – constant torque (eg, for a conveyor belt) and quadratic torque (eg, pumps and fans) – versus speed are used, according to the definition in → 5b, including duty cycles.

The energy savings are also calculated with the IE2 induction motor and drive system as the reference for Germany, with an industry electricity price of \$0.16/kWh. Since the electricity cost is such a dominating part of a life-cycle cost of electric motors for industry, the payback time for choosing a VSD system with higher efficiency is extraordinarily short. The payback times for the IE3 induction motor, the IE4 SynRM and the IE5 SynRM² using similar ACS880-032A converters from ABB, compared with the reference IE2 induction motor system, are less than 10 to 15 months, depending on motor type and duty cycle. After these relatively short payback times, the higher efficiency systems save on costs for the rest of their lifetimes. After 10 years of operation the initial purchase price corresponds to only around 2 to 3 percent of the electricity cost, for all VSD systems compared.

Field tests/implementation example

Installations run by water utilities are among the United Kingdom's most efficient users of electricity. South Staffordshire Water's Somerford Pumping Station is no exception – yet its annual electricity bill adds up to around \$13 million, 90 percent of which is used for pumping water. The company's effort to increase energy efficiency led to the decision to replace a 20-year-old 115 kW IM – controlled by a more modern ABB ACS800 frequency converter – with a new 110 kW IE4 SynRM and ACS850 drive package. The drive system ran a borehole pump that extracted 2.5 million L of water per day. The customer expectations were that efficiency would be improved and maintenance costs lowered by deploying the latest motor drive technology. The results far exceeded customer expectations: 6 percent energy savings; 58 percent reduction in frame temperature hotspots; 28 percent reduction in drive end bearing temperature; and 75 percent reduction of audible noise, compared with the induction motor that was replaced.

Motoring into the future

In motors, ABB provides the right solution for any industrial need and as a response to market demands for higher output, higher efficiency, longer service intervals and footprint reduction, ABB has brought out new synchronous reluctance motors. The environmental credentials of SynRM and SynRM² go beyond energy saving, however, as they use standard production methods and commonly available materials with low environmental impact. ABB is also prepared to meet the requirements of DOL motors with the newest member of the SynRM family – DOLSynRM, a concept version of which was demonstrated at the 2015 Hanover Fair. This technology, which combines a special cage (similar to those in IMs) with a SynRM structure, is under development but has already demonstrated that IE4 – and even, with careful optimization, IE5 – levels can be achieved, without the use of REE magnets or other special materials. The state-of-the-art design of SynRM provides the base for sustainable efficiency technology of electric motors into the future.

Freddy Gyllensten

Peter Isberg

ABB Discrete Automation and Motion,
Motors and Generators
Västerås, Sweden
freddy.gyllensten@se.abb.com
peter.j.isberg@se.abb.com

Alessandro Castagnini

Giulio Secondo

ABB Discrete Automation and Motion,
Motors and Generators
Vittuone, Italy
alessandro.castagnini@it.abb.com
giulio.secondo@it.abb.com

Jouni Ikäheimo

Ari Tammi

ABB Discrete Automation and Motion,
Motors and Generators
Vaasa, Finland
jouni.ikaheimo@fi.abb.com
ari.tammi@fi.abb.com

References

- [1] M. Meza, "Industrial LV Motors & Drives: A Global Market Update – January 2014, IHS," presented at Motor & Drive Systems 2014 – Advancements in Motion Control and Power Electronic Technology, Orlando, FL, 2014.
- [2] *Rotating Electrical Machines – Part 30-1: Efficiency Classes of Line Operated AC Motors*, IEC Standard 60034-30-1:2014.

TAMING THE POWER

ABB Review series
Part III



Twist off

Damping torsional oscillations at the intersection of variable-speed drives and elastic mechanical systems

MEHMET MERCANGÖZ, SILVIA MASTELLONE, STEFAN ALMÉR, THOMAS BESSELMANN, PIEDER JÖRG, JOUKO NIIRANEN, LUCA PERETTI, VELI-MATTI LEPPÄNEN – Like the damage that can be caused by soldiers marching in step across a bridge or the effects of the wind on the ill-fated Tacoma Narrows Bridge, resonance effects, if left undamped, can prove harmful to electric drives too: Pulses in the driving torque can be amplified by resonance with one of the driveline eigenfrequencies – leading to torsional oscillations and large torque variations that can eventually damage the gears and transmission. Three main approaches can be used to tackle torsional vibrations: Eliminate them through design; confine operation to a speed range known to be safe and rely on the system inertia to attenuate any excitation; and actively control and manipulate the drivetrain itself to counter any torsional oscillations that arise. These approaches all have their merits, as can be seen from case studies conducted in the field.

TAMING THE POWER

ABB Review series
Part III

1 Example of an AC drive electrical system

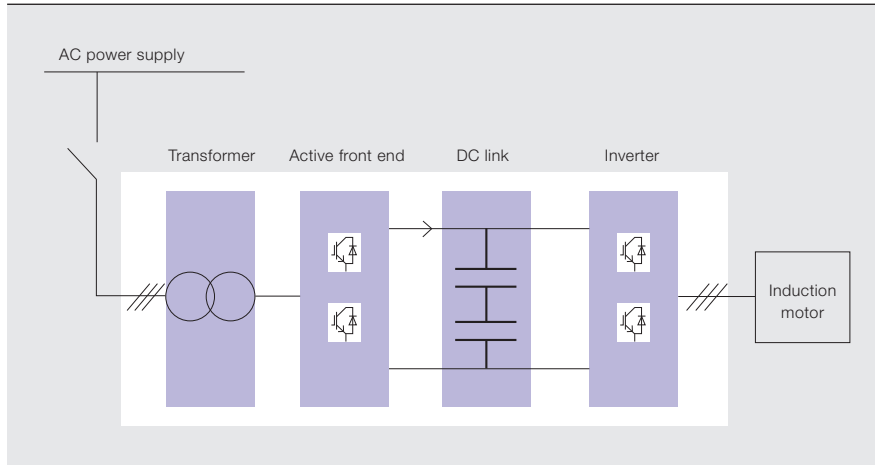

Electrical drivetrains are all-pervasive in the modern world, converting electrical power to mechanical power in a plethora of industrial applications and performing the reverse conversion in power generators. However, all these rotating, variable-speed systems can experience torsional vibrations to some degree during startup, shutdown and operation. In problematic cases, excessive torsional vibrations can develop and these may lead to outcomes ranging from gear wear to broken shafts. Consequently, the torsional response characteristics of rotating equipment and the corresponding control loops have to be analyzed and evaluated to verify the stable operation of the system. This is especially important when the rated power is high because the shaft diameters, and thus the mechanical strength, cannot be increased proportionally with the power. The consequences of mechanical failure of a high-power drive are also more significant.

The severity of the torsional vibrations depends upon the magnitude of the torsional excitation and the difference between the excitation frequencies and natural frequencies associated with mode shapes of the shaft system

and their damping. The desired situation is, naturally, one that avoids any coincidence of a torsional excitation frequency with a natural torsional frequency. Therefore, the natural torsional frequencies of the system should be calculated and the excitation forces that can be produced in the system, and the frequencies thereof, have to be defined. This is not a trivial task for complex systems with many elements in the drivetrain. In some cases even the finite stiffness of the motor bed and other flexible parts of the surrounding structures have to be taken into account.

One specific challenge in the case of electromechanical systems is the fact that the electrical and mechanical parts are typically designed, analyzed and controlled separately, without considering their interaction with each other or with other components. Additionally, there can be cases where accurate information about the system is not known in advance. Reducing the degree of uncertainty by defining boundaries for the system parameters and taking care of the robustness margin for the whole range by proper control is the way forward in providing guaranteed stable operation across the entire drivetrain.

Drivetrains

Three key components can be identified in an electromechanical drivetrain: the power grid, plus possibly transformers and input/output filters; the power converter and motor or generator; and the load or turbine. Each of

Title picture

Potentially harmful oscillations can arise in electric motor drivetrains. What can be done to counter them?

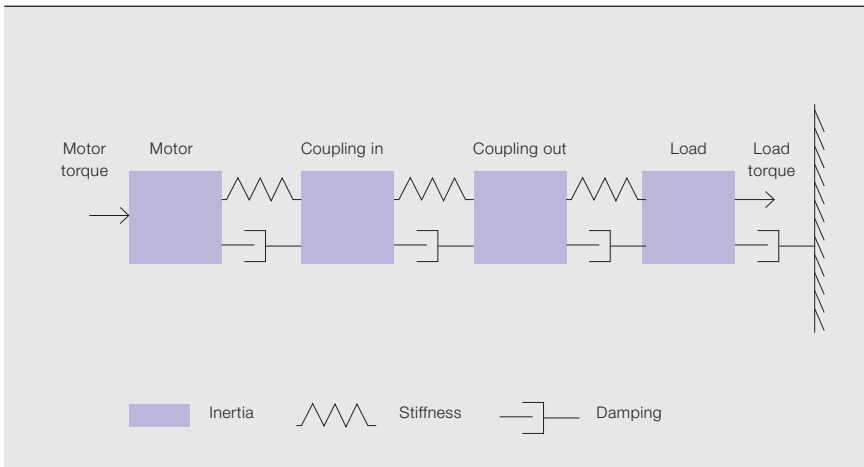

Rotating, variable-speed systems can experience torsional oscillations to some degree during startup, shutdown and operation.

these can contribute to the torsional dynamics. Power grid variations can directly affect the torsional behavior of a direct online motor drivetrain. A power converter can largely isolate the torsional system from grid disturbances but, due to the semiconductors switching, a set of excitation frequencies that depend on the motor speed is produced. Most AC electric machines have very smooth torque when driven by sinusoidal voltage but special constructions such as some permanent magnet machines may have significant cogging torque. Fi-

with the possible excitation frequencies. For more detailed studies, the electrical system is modeled as discrete resistive, inductive and capacitive elements, while the mechanical driveline is modeled as discrete inertias connected with inertia-free elastic elements representing shafts and couplings → 1-2. Using the transfer functions or differential equations of the control system, the response for various excitations can be verified and optimized.

Ideally, if the model were to fully capture system behavior, appropriate control design could be carried out and performance could be guaranteed – but this is rarely the case as usually only the large concentrated inertias and the main elasticity are known with reasonable accuracy. For example, smaller and distributed inertias – such as those in a gearbox – are more difficult to estimate. The damping coefficients are another source of inaccuracy as it is usually difficult, if not impossible, to obtain these for many elements, so they are often neglected, even though damping can have a significant effect on the resonance frequency and – especially – the amplitude. On the other hand, the electrical characteristics of the motor and motor control certainly cannot be neglected in the drivetrain torsional model since these can significantly change the natural frequencies and the amplification of the excitations.

In problematic cases, excessive torsional oscillations can develop and these may lead to outcomes ranging from gear wear to broken shafts.

nally, the mechanical load of a motor or turbine power of a generator may vary depending on the application and is in some cases difficult to predict.

When studying possible torsional resonances in drivetrains, a so-called modal analysis is first performed and the natural frequencies found are compared

Because the drivetrain's electrical and mechanical parts are interconnected and oscillations might propagate be-

TAMING THE POWER

ABB Review series
Part III

The natural torsional frequencies of the system should be calculated and the excitation forces that can be produced in the system have to be defined.

3 Example of a Campbell diagram for a two-pole motor, showing frequencies excited by an LCI at given rotational speeds

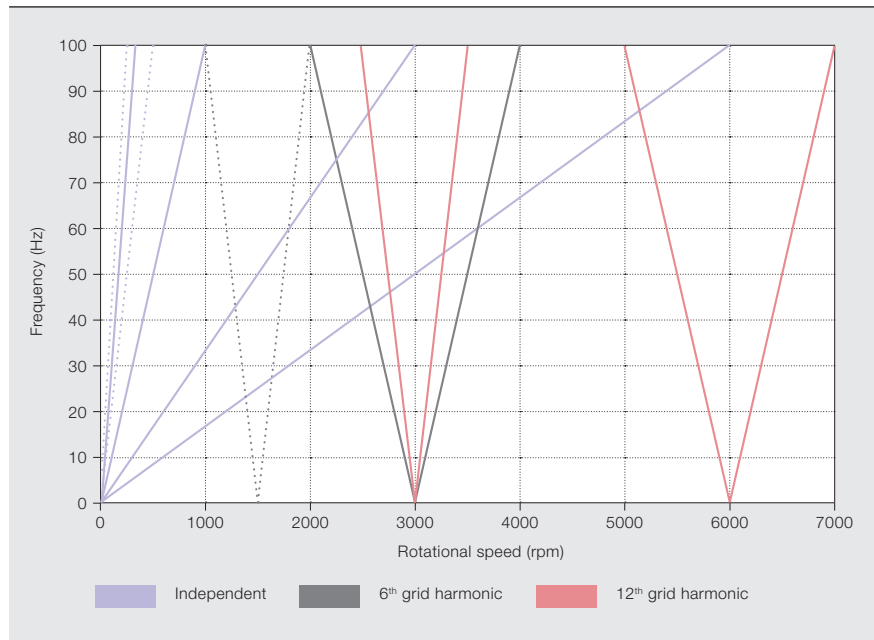

tween them, analysis cannot always be limited to one or the other, but must be extended to cover from the shaft end all the way back to the electric grid, including any optional frequency converter. Once this is done, solution strategies can then be formulated.

Solution strategies

Depending on the nature of the vibrations, different strategies can be employed to reduce, restrict or prevent them. These strategies generally fall into one of three categories: system design, system operation and active damping.

The system design strategy takes preventive action against vibrations by introducing dissipative components such as elastomer or hydrodynamic damped couplings that decrease the vibration amplitude by converting the energy from excitations into heat, or by shaping the spectrum of the excitations with hardware-based sine filters at the converter output. Such methods are also referred to as passive damping methods. Although practical in some applications, they have the drawback that the energy dissipated constitutes wasted energy and the mechanical or electrical filtering slows the system dynamics. These measures are often costly and elastomer couplings suffer from aging.

The second approach uses the modal analysis to determine resonance-free speed ranges in which continuous operation is possible. As the number of motor poles affects these speed ranges, the optimum pole number is selected to give the best fit for the process needs. The method is practical and simple to implement. However, it is not always possible to find wide enough speed ranges, and the rapid accelerations and decelerations required to cross the forbidden resonance speed ranges are not always acceptable.

The third class of strategies is based on the emulation of the physical behavior of dampers. Virtual-resistor and model-based active damping methods are examples of such software-based active solutions. State-space methods are particularly advantageous for high-order systems – they allow the full system, including the interconnections, to be modeled and controlled, and nonlinearities such as friction and backlash to be considered. On the other hand, frequency-based methods are best suited to identifying the critical modes.

Hybrid methods are also often employed by combining two or more of the strategies described above. For example, stiffness of the shafts or the

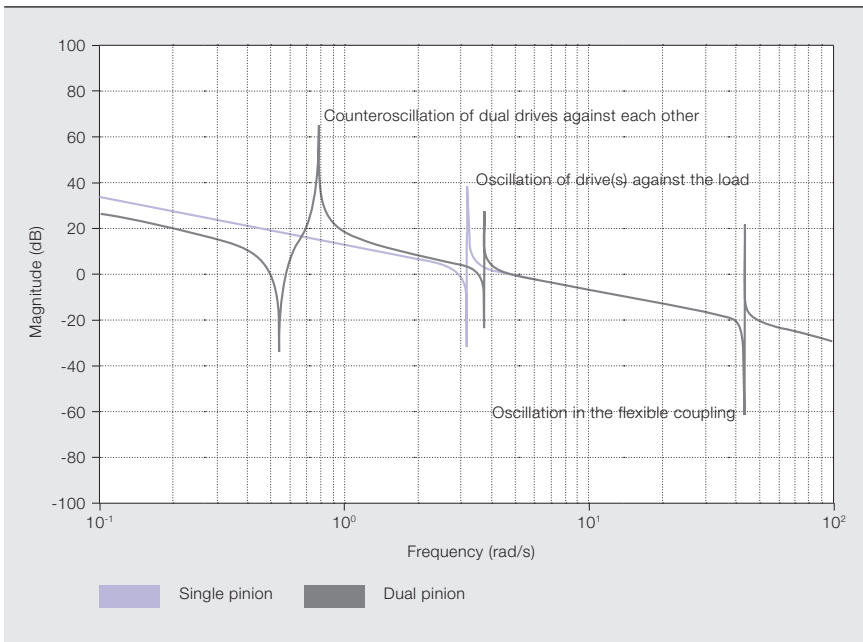

A modal analysis is performed to determine the natural frequencies in the drives and compare them with the possible excitation frequencies.

couplings can be lowered in order to move the resonance of the system into a bandwidth where an active damping method can then be used to counteract the oscillations. Another example is the use of frequency analysis to provide the system spectrum and the desired target spectrum – afterwards, time-based energy shaping

Some practical examples serve to illustrate the different approaches.

Electrically driven compressor stations

Variable-speed drives (VSDs) are commonly employed in natural gas compressor stations. The power range of such stations is typically between 10 and 70 MW, and the rotor rotates with a speed of a few thousand rpm. A step-up gear and relatively long and thin driveshaft links the VSD with a number of compressor stages, forming a rather flexible structure with high load inertia and distinct torsional natural frequencies. A continuous excitation of these frequencies, stemming from one of the compressor stages or from the VSD, can lead to high torsional oscillation amplitudes, which the driveshaft may not be able to endure. The consequences vary from increased wear and reduced lifetime of the gear to catastrophic failure of the couplings or the shafts.

The torsional response desired is generally one that avoids any coincidence of an operating speed or torsional excitation harmonic with a natural torsional frequency.

methods can be employed to shape the system spectrum. This example of a hybrid of time and frequency methods gets the best of both worlds: capturing the frequency behaviors and employing state-space techniques.

Due to its proven reliability and efficiency, a classic configuration of the VSD system comprises a synchronous machine fed by a load-commutated inverter (LCI), such as ABB’s Megadrive-LCI. However, the LCI can generate harmonics in the drive torque, the frequencies of which depend on the drive’s pulse number and which

TAMING THE POWER

ABB Review series
Part III

There are many active control strategies to dampen torsional oscillations and a specific formulation for dual-pinion drives has been patented by ABB.

5 Typical compensation algorithm

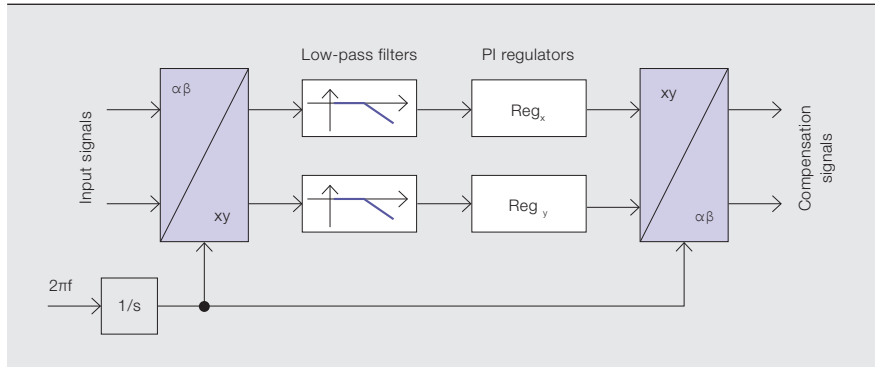

vary with rotor speed → 3. For certain speeds, these frequencies match the natural frequencies of the driveshaft. A straightforward measure to reduce torsional oscillations is to avoid certain speed ranges, when feasible. Any remaining torsional oscillations excited by, for example, crossing natural frequencies, are either dampened actively or are just left to fade away by themselves.

Variable-speed mill drives

Though a relatively rare event in grinding mills, the undamped effects of torque pulses resonating with one of the drivetrain eigenfrequencies could be serious.

Dual-pinion ring-gear mill drive solutions, for example, are very attractive for medium-sized grinding applications, but they also present a challenge due to their torsional resonance profile and preventive action may need to be taken. In the simplest view, the dual-drive system can be considered to be a collection of flexibly coupled elements formed by the two motors and the mill, which leads to two natural modes of torsional oscillation → 4:

- One in which the motors oscillate in phase against the mill – this frequency is often about 0.5 to 0.6 Hz.
- One in which the motors oscillate against each other – the speed of one increases, while the other's decreases, then this situation reverses itself, ad infinitum. The motors thus alternate at driving the mill, which maintains a constant speed. With relatively long drive-shafts and soft couplings, the

natural frequency of this mode is around 0.1 to 0.2 Hz.

Special attention needs to be paid to the second mode since issues such as worn-out gearing can lead to excitations in the relevant range. There are many active control strategies to dampen torsional oscillations and a specific formulation for dual-pinion drives has been patented by ABB (WO/2012/020031).

In that particular approach, measurements from both drives are used to compute distinct feed-forward control actions to dampen both natural modes, whereas the mill speed is regulated in a traditional master-follower configuration.

Wind

Describing the interactions between systems in a wind turbine is not always straightforward. The aerodynamic interaction between the wind and the blades leads to effects like wind shear and tower shadow, which could be visible as torque harmonics in the rotating shaft. The latter, moreover, is a multi-mass system with natural resonances that cannot be neglected. Even the natural resonances of the tower could contribute to torque oscillations during transients. At the other end of the shaft, the generator torque might also not be ripple-free. Depending on the generator type and structure, different sources of ripples may exist – for example, cogging torque in permanent-magnet synchronous generators, or grid voltage asymmetry in doubly-fed induction generators.

6 Laboratory example of third-harmonic compensation

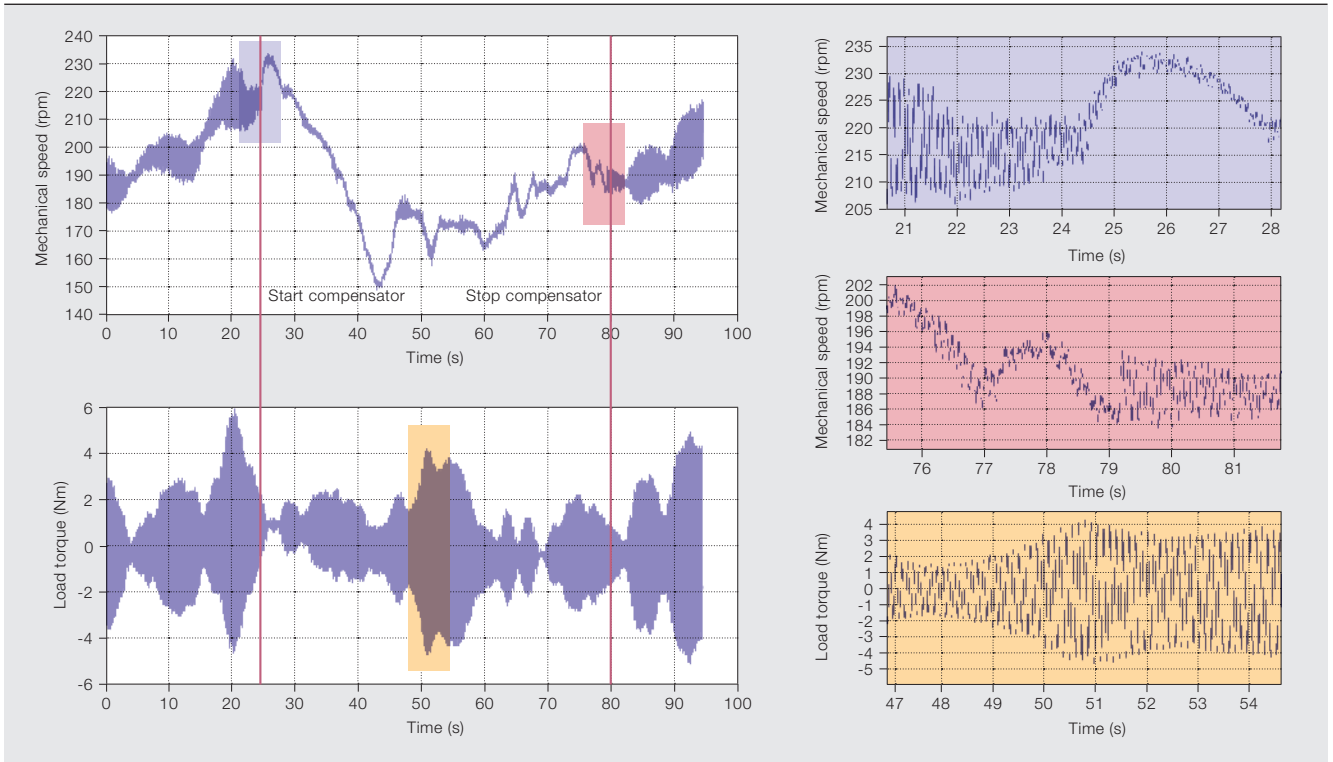

For all the torque harmonics appearing in the main rotating shaft, there is the opportunity to perform a real-time signal frequency analysis, and classification and compensation of the ripple.

Achieving torsional oscillation damping in these systems cannot always rely on a priori knowledge of the harmonics so real-time analysis of measured or estimated signals (currents, speed) is sometimes used. However, the analysis must always be followed by an automatic classification (eg, “Where does the harmonic come from?”) and, of course, a compensating action performed by the drive control. A typical algorithm for compen-

sating a single frequency is shown in → 5. A laboratory emulation of the third-harmonic compensation in a small-scale wind turbine test bench is shown in → 6, where the emulated turbulence of the wind moves the average value of the speed while generating torque loads with varying magnitude.

The sheer number of applications that use electromechanical drivetrains and the potential for damage resulting from unchecked torsional oscillations in them means that it is essential that close attention is paid to eliminating these harmful effects. Rigorous design and analysis techniques have been shown to be effective at accomplishing this.

Mehmet Mercangöz

Silvia Mastellone

Stefan Almér

Thomas Besselmann

ABB Corporate Research
Baden-Dättwil, Switzerland
mehmet.mercangoez@ch.abb.com
silvia.mastellone@ch.abb.com
stefan.almer@ch.abb.com
thomas.besselmann@ch.abb.com

Pieder Jörg

ABB Discrete Automation and Motion,
Drives and Controls
Turgi, Switzerland
pieder.joerg@ch.abb.com

Jouko Niiranen

ABB Discrete Automation and Motion,
Drives and Controls
Helsinki, Finland
jouko.niiranen@fi.abb.com

Luca Peretti

ABB Corporate Research
Västerås, Sweden
luca.peretti@se.abb.com

Veli-Matti Leppänen

ABB Oy
Helsinki, Finland
veli-matti.leppanen@fi.abb.com





Visionary

3-D visualization enhances production operations

MARIA RALPH, ALVARO ARANDA MUÑOZ, SUSANNE TIMSJÖ, MATS LUNDEMALM – Despite the changes in the industrial landscape that have been brought about by the IT revolution, many production operations are still predominantly paper-based. Communicating information via paper is time-consuming and ineffective for many production teams as keeping track of issues and maintaining an up-to-date overview of the production status in this way can be challenging. ABB has developed a prototype 3-D visualization tool that helps production teams overcome these challenges and improve efficiency. The prototype mitigates the limits of paper-based operations and enhances production capability by providing a digital means of accessing and interpreting vital information.

Title picture

Effective presentation of information to the relevant personnel helps production processes – such as the gas-insulated switchgear production line shown here – become more efficient.

ABB uses interviews and observation to obtain an in-depth understanding of how people perform their work.

1 The prototype gives a comprehensive overview of the state of production. Information displayed can be filtered based on safety, quality, etc.



2 Adherence to targets is tracked.



In production processes, time is of the essence: Products have to be delivered on time and within budget. To achieve this objective, production personnel must have ready access to the right information so they can quickly understand any situation that may arise and intervene effectively and promptly to mitigate any issues. Enhancing situational awareness is, therefore, crucial.

Technology can be exploited to provide this awareness, but to build such technology, an in-depth understanding of the production process itself first needs to be established. To achieve this, ABB uses interviews and observations to examine how people perform their work. The resulting information gives a valuable insight into the challenges, goals, needs and concerns relating to daily tasks and informs the key design considerations for the creation of any human-machine interface (HMI). For the 3-D prototype presented here, various production personnel were interviewed and observed, including production managers and factory floor workers. These interviews and observation sessions led to the identification of high-level requirements. In short, the production personnel need to have:

- The ability to quickly and accurately understand and interpret the produc-

- tion flow (eg, the logical relationship between different production lines)
- Access to key production status information at each step of the process
- A facility to detect, understand and resolve issues quickly (eg, identify and resolve bottlenecks)
- Information on, and awareness of, the current day's production and shift situation (eg, pacing information, throughput information)
- Enhanced information mobility (tablet, smartphone, etc.)
- An effective production order tracking system
- A supply of support data for the morning tours (during which the day's production is discussed)
- A visualization of progress toward meeting the different goals of production

Design concepts

With these key items identified, an initial 3-D prototype – based on a Unity 3-D gaming engine – was developed to assist personnel in their efforts to enhance the production process. The prototype was used to capture important information – such as the number of parts coming into and out of a certain production line in the production flow. The prototype also presents a high-level map that gives an overview of the entire production process as well as possible bottleneck locations so these can be easily identified and quickly dealt with to mitigate production stalls or stoppages.

The design of the prototype is closely related to the ABB Collaboration Table that connects to and interacts with ABB's Extended Automation System 800xA – an arrangement that features an integrated 3-D KPI (key performance indicator)

3 A data historian tracks the progress of KPIs – in this case, the current number of orders, models and customers for a certain country selected.



It is easy to navigate between different levels of information – from a high-level overview to detailed information about each production line and buffer.

4 Detailed information of work progress

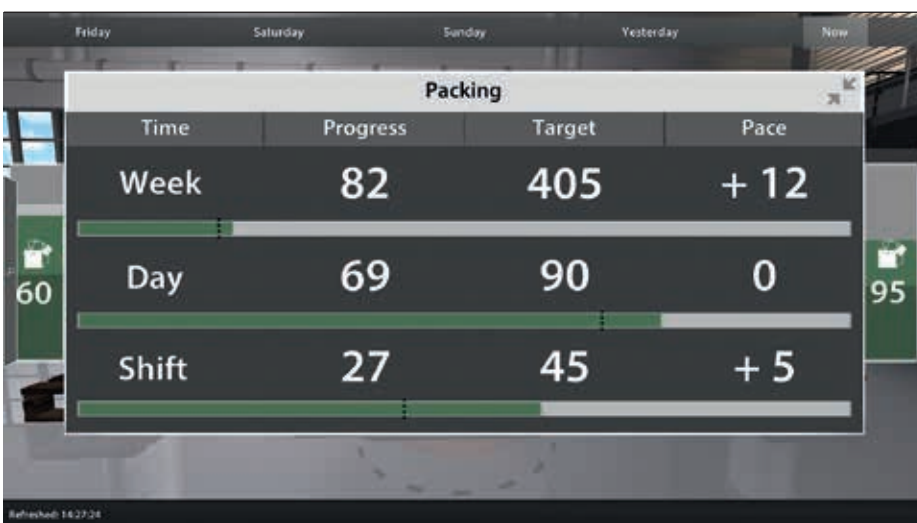

line → 4. This allows the user to check that no single line is falling behind or overproducing and helps users to identify and avoid potential bottlenecks → 5.

Easy navigation

It is easy to navigate between different levels of information – from a high-level overview to detailed information about each production line and buffer. This allows production personnel to accurately track the progress of each customer order until it is completed and shipped. They can also search and filter on customer orders, trend views over time for specific KPIs and so on.

Color-coded visualization

Information is color-coded based on predefined threshold levels that are tailored for each specific KPI. These thresholds are visualized in such a way as to quickly identify warnings and critical situations as they arise during production.

Color-coded 3-D bars grow and shrink to represent the production progress, the quality of the orders that are being produced, the safety levels of the factory and the planning of coming orders. These 3-D visualizations can help managers to quickly identify current or potential issues. They also give information on items such as KPI trends and

Personnel can visualize production progress in relation to goals for the shift, day and week for each production line.

interface. Taking inspiration from the ABB Collaboration Table, the proposed prototype has a similar look and feel and also runs on a large touch screen; the difference is in the production process details. The 3-D prototype presents the user with many options:

Holistic view

The user is presented with a holistic view that contains all the vital production information and the relationship between the production lines in terms of buffers and work in progress. This helps the operators to interpret the work flow quickly and get a summary of the current production status on the factory floor → 1–2.

Customer orders can be filtered by country, customer name and model or order identifier → 3. The result of this filtering is visualized in the production flow, showing the order identifier and in which production line or buffer the order is currently located. The filtering can be refined to retrieve more information about a specific order.

Personnel can also visualize production progress in relation to goals for the shift, day and week for each production

Information is color-coded based on predefined threshold levels that are tailored for each specific KPI.

5 A bottleneck in the process can be visualized



production history so they can understand the cause of any problems and react accordingly.

Communication

The prototype encourages and supports communication and collaboration between factory personnel. As an example, different filters allow data to be displayed that supports morning meeting tours in which the production of the day is discussed based on the safety, quality, progress and planning KPI values of previous shifts.

Issue resolution

The resolution of issues such as bottlenecks is facilitated by the inclusion of markers that can be placed in different parts of the flow to allow the personnel to indicate where the cause of the problem might lie.

Data mobility

Mobility is also facilitated: The application has been designed to run both on personal computers and tablets, which presents the ability to access live factory data from any place with an Internet connection and the right security settings.

Production management benefits

Only a subset of features from the prototype have, so far, been incorporated into a real production process. These features include a visualization of where each part of a customer order is in the production flow and the tracking of customer orders. At present, the project is still an ongoing endeavor, in which new

features from the prototype are iteratively integrated into a real production process and evaluated.

The 3-D prototype provides a holistic view of the production process and improves overall awareness of the current production status. Providing production personnel on the factory floor with the right information at the right time in an intuitive and easy-to-understand format enables them to more effectively understand the current production status. Also, they can more easily identify which parts of the production process need immediate attention, thus allowing for timely intervention.

Maria Ralph

Alvaro Aranda Muñoz

Susanne Timsjö

ABB Corporate Research

Västerås, Sweden

maria.ralph@se.abb.com

alvaro.aranda@se.abb.com

susanne.timsjo@se.abb.com

Mats Lundemalm

ABB Discrete Automation and Motion, Robotics

Västerås, Sweden

mats.lundemalm@se.abb.com



Pulp mill optimization no longer pulp fiction

Producing high-quality pulp consistently
with advanced process control

ABHIJIT BADWE, RAMESH SATINI – When Mondi – the global paper and cardboard producer – decided to modernize their largest pulp mill in Poland, they chose ABB as partners to help improve and optimize the mill's two pulp production lines. For this undertaking, ABB developed an advanced process control solution based on model predictive control and soft sensors. The modernization resulted in an improvement of 56 percent in pulp quality as well as standardized solutions that can now be offered to other pulp mills.

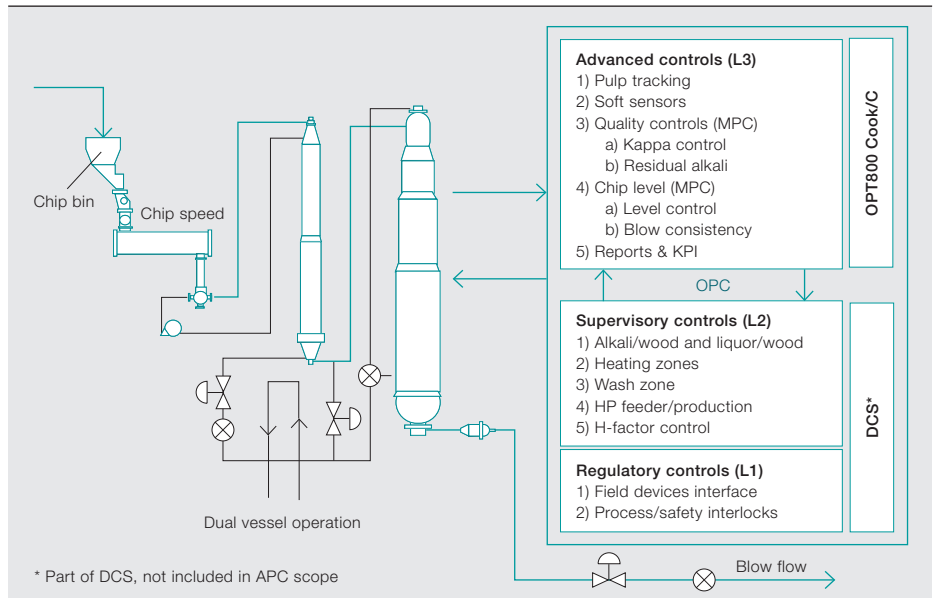

In 2011, Mondi embarked on a project to look for ways to improve pulp quality and chemical usage, enhance production and reduce cost for its two pulp production lines in the Mondi Swiecie pulp mill. A number of factors played a role in this search. One was the company's policy of reducing the environmental impact of its operations – and in pulp mills this means cutting the use of heat energy and chemicals. A second factor was the requirement to improve the quality of the product. Mondi Swiecie mostly makes containerboard, corrugated packaging and industrial bags, which are surprisingly high-tech products. Thirdly, there were the universal goals of all industrial processes: increasing production volumes and decreasing production costs.

In 2011, Mondi Swiecie awarded ABB a contract to improve the quality and efficiency of its pulp mill. To better understand the challenge involved in this task, it pays to take a closer look at how the pulp process works.

Title picture

Advanced process control at the largest pulp mill in Poland has increased productivity – and stabilized the processes in the cooking and pulp washing lines in a way that conventional methods of DCS control could not.

Separating cellulose

The raw material for cardboard and paper is wood. The purpose of the pulping process is to separate the valuable cellulose fibers in wood from the lignin and hemicellulose polymers that bind them. Traditionally, this was done by physically beating the wood, but nowadays chemical methods are used – not least because they better preserve the integrity of the cellulose.

The process begins by stripping the wood of its bark, turning it into chips, screening the chips to achieve a roughly similar size, impregnating them with chemicals and feeding them into a pressure cooker (the digester).

In the sulfate process used at Swiecie, the chips are mixed with a solution of sodium hydroxide and sodium sulfide (known as white liquor), pressurized and heated to a temperature of about 160°C with steam from coal-fired boilers. After a few hours, the material takes on the consistency and color of porridge and the amount of alkali in the sodium hydroxide decreases as it is turned into sulfates and carbonates as a result of reacting with the lignin in the wood.

At the end of the process, the pulp is squeezed out of the digester through an airlock called the blow line. The sudden depressurization results in the rapid expansion of the cellulose fibers, which helps to separate them. They are then suspended in a liquid that is known to pulp workers as brown stock.

The next stage of the process is to “wash” the brown stock to remove the cooking chemicals (now referred to as black liquor) together with the degraded lignin and hemicellulose. After progressing through a number of tanks, the extracted liquid is reduced and its sodium and sulfur compounds recovered to make more white liquor. Meanwhile, the clean cellulose pulp is bleached, if necessary, and then pressed and heated to remove water, after which it is ready to

One of the first things that the newly formed Mondi Swiecie did was look for ways to improve the pulp mill's production process.

be cut and rolled or bailed for further processing.

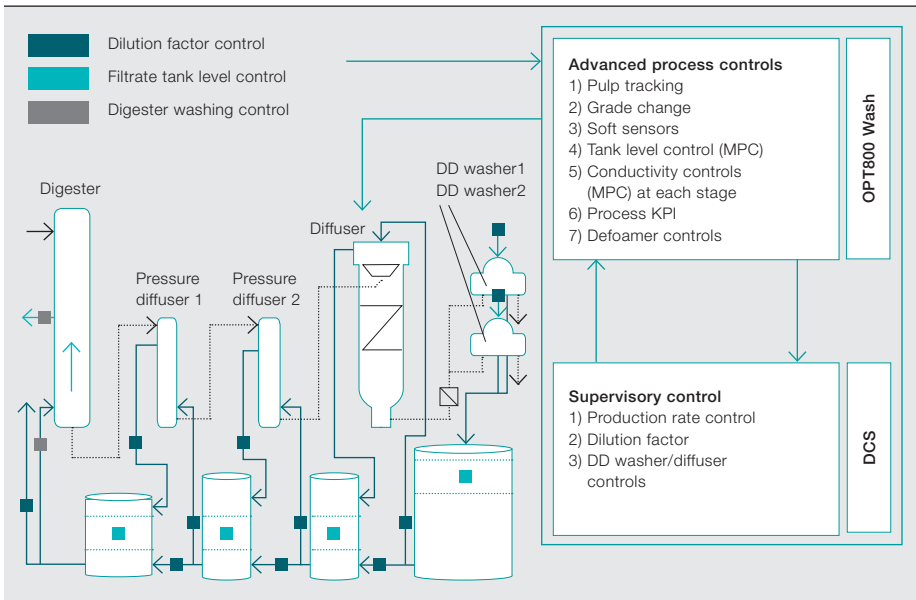

In 2011, Mondi Swiecie awarded ABB a contract to improve the quality and efficiency of its pulp mill.

The challenge was to make the process work more efficiently and to higher tolerances without replacing anything except the control system that operated the existing equipment.

How to improve the process

The challenge was to make the process work more efficiently and to higher tolerances without replacing anything except the control system that operated the existing equipment. The key to this was to optimize the operation of the two lines' digester and brown stock washing stages. The first step was to audit and analyze the control loops, then develop an advanced process control (APC) action plan based on model predictive control (MPC) and soft sensors.

The cooking process

For the digester, the key variable for product quality is the Kappa number – this measures the lignin level in the pulp and thereby indicates how well the chips

have been cooked. This number is difficult to control for two reasons. Firstly, because all the chips that are fed in have different moisture content and physical characteristics. Secondly, the Kappa number cannot be physically measured in the digester, but only after the chips have passed through it and entered the blow line. This is a problem because it is essential to know what the Kappa number is before this point. Like anything else that goes into an oven, the pulp has to stay there for just the right amount of time – long enough to yield as much cellulose as possible, but not so long as to break down its physical structure.

Therefore, to maintain a steady process with minimal variations in the quality of pulp, the Kappa number has to be arrived at by taking continuous measurements of the various process variables before the chips enter the digester and feeding these numbers into a mathematical model (or soft sensor) that considers the multiple nonlinear process effects.

This is what ABB's solution does → 1. The advanced process control scheme employs a soft sensor – based on ABB's Inferential Modeling Platform – that yields soft measurements of the Kappa number from a series of process variable measurements. These measurements are tracked using a tracking function that creates a virtual model of the chips on their journey through the digester. Along the way, measurements are derived from the chip's characteris-

ABB's APC solution maintains the chip level by optimally manipulating the digester bottom scraper speed and the pulp flow out of the digester.

3 APC implementation approach

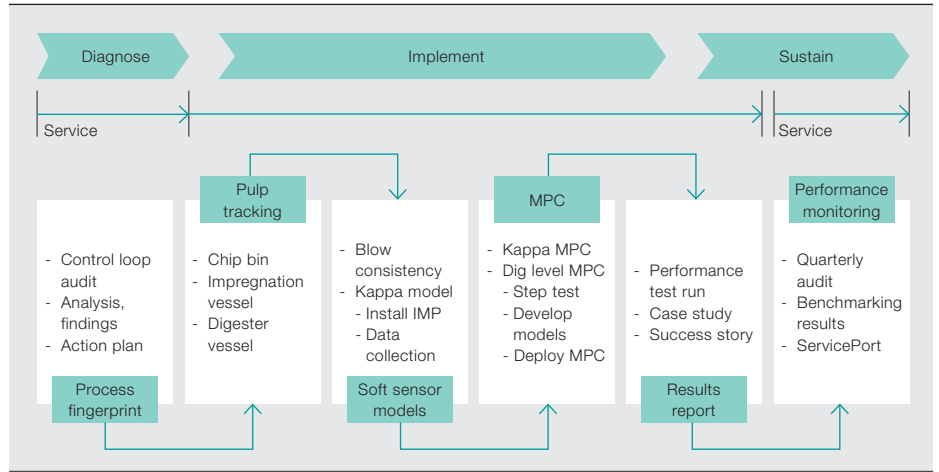

4 Reduction in Kappa Variation (2 Sigma)

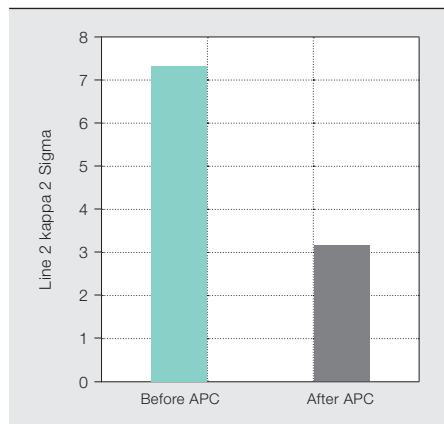

5 Reduction in residual alkali variation (2 Sigma)

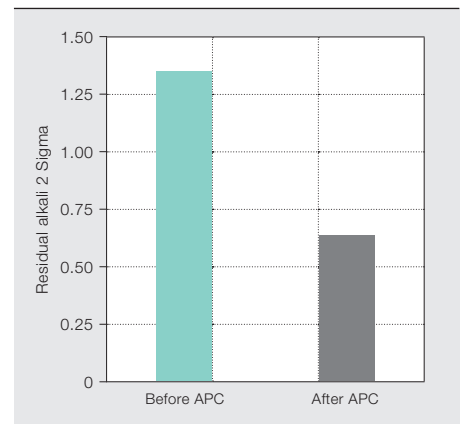

tics and these are fed into the model to predict the Kappa number in every zone of the digester. The soft sensor is deployed online and yields real-time virtual measurements of quality variables (such as the Kappa number) that are then used by a model predictive controller to optimize the cooking process, to decide the length of time the chips are exposed to a given concentration of effective alkali and to keep the concentration of alkali the same throughout the digester vessel. The APC is also able to maintain a consistent production rate of pulp. Finally, a log of the data that has been collected is packaged into concise reports, complete with measurements of key performance indicators.

Another important variable in the continuous cooking process is the level of chips inside the digester. Variations in this chip level leads to nonuniform cooking, disturbances in the overall liquor bal-

The first step was to audit and analyze the control loops, then develop an advanced process control action plan based on model predictive control and soft sensors.

ance of the process and nonuniform pulp flow at the digester outlet. ABB's APC solution maintains the chip level by optimally manipulating the digester bottom scraper speed and the pulp flow (or blow flow) out of the digester.

6 APC stabilizes chip level

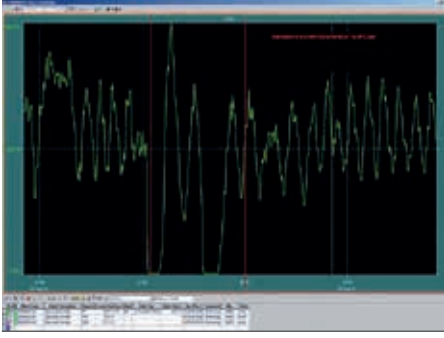

6a Chip level with no APC

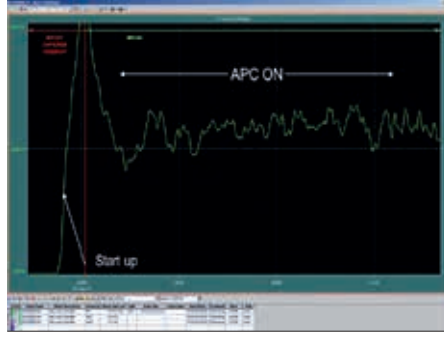

6b Chip level with APC

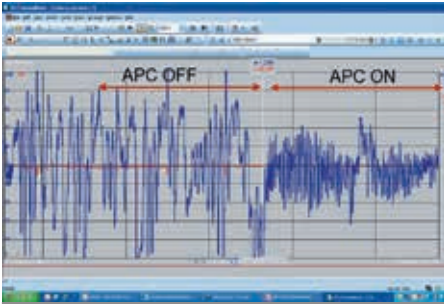

6c Process stability is greater when APC is on.

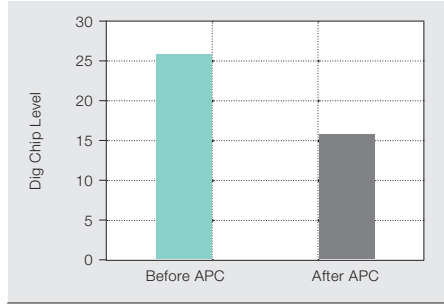

6d APC leads to reduced digester chip levels.

While the APC is handling these complex measurements, making real-time predictions about the process and implementing optimal control actions, the ABB Extended Automation System 800xA distributed control system (DCS) handles the basic controls such as liquor and chip flows, temperature, pressure, etc. It also performs the vital job of controlling the H-factor – that is, the rate at which the lignin is being dissolved. As this is largely a function of temperature, the amount of heat applied to the digester has to be closely controlled. A variance from the optimal of just a couple of degrees can make a big difference to the quality of the pulp.

The obvious advantage of the APC and the DCS is that the outcome meets all of the customer's requirements for this step of the pulping process. The fact that just the right amount of steam has been added and just the right volume of white liquor or alkali injected means that as much waste as possible has been squeezed out of the process. And as the maximum amount of highest quality cellulose has been produced, the quality and quantity criteria have been met as well.

The brown stock washing process

The second key area where optimization has been achieved through an APC system is the brown stock washing. As with

the digester, the data is gathered on a continuous basis so that soft sensors can give predictive readings of what is taking place.

The aim in this stage of the process is to control the levels in the numerous filtrate tanks so that just the right amounts of fresh water are added for each ton of brown stock to be washed (this is known as the dilution factor). If an optimal value for this variable can be continuously solved for, then the maximum quantity of the cooking chemicals can be recovered and the minimum amount of energy used in the evaporators. The alkali losses will also be reduced. This is achieved by the brown stock washing APC → 2, which computes the optimal dilution factor at each washing stage based on pulp conductivity measurements at various locations in the process; at the same time, it ensures that the levels in the filtrate tanks are within their specified ranges. As with the digester, the information gathered throughout the operation is presented to the control room in the form of key performance indicators.

The implementation methodology

The approach followed to achieve Mondi's objectives was based on ABB's Advanced Services philosophy – diagnose, implement and sustain → 3.

The approach followed to achieve Mondi's objectives was based on ABB's Advanced Services philosophy – diagnose, implement and sustain.

While the APC is handling these complex measurements, making real-time predictions about the process and implementing optimal control actions, the ABB System 800xA DCS handles the basic controls.

7 APC stabilizes blow flow

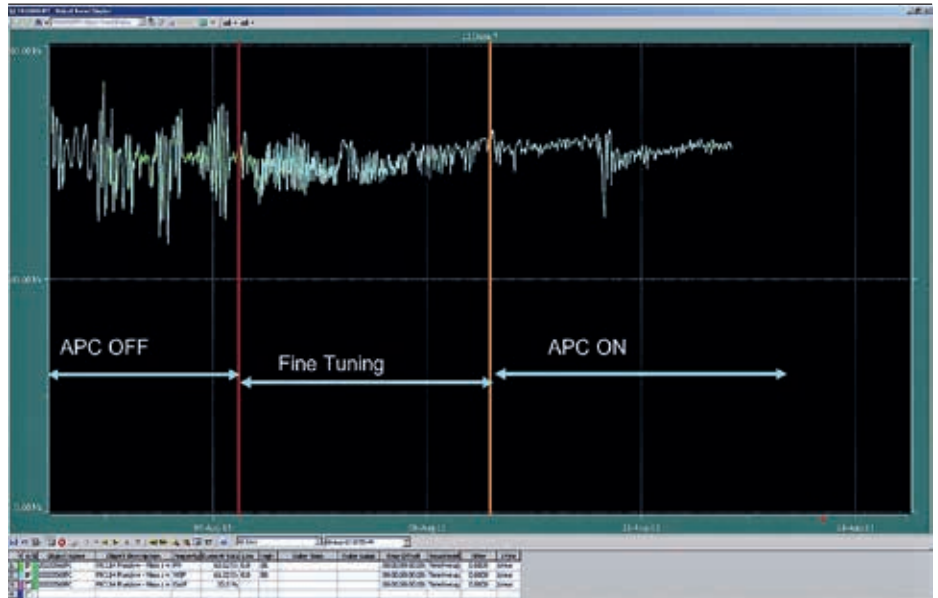

The diagnose phase involved performing a detailed audit of the process and control loops at Mondi Swiecie, which led to the development of a specific action plan for implementing the APC system.

The implementation phase involved the deployment of the pulp tracking function in the DCS followed by the development of online soft sensors to model the Kappa number. Subsequently, step tests were carried out on the process to develop mathematical models for use in the model predictive controller, which was then commissioned, tuned and handed over to the mill operators.

The APCs are currently in the sustain phase, in which ABB helps Mondi maintain the optimal performance of the APCs by performing quarterly audits, remote monitoring and online retuning.

A similar approach was followed for the implementation of the APC in the washing area.

The result

This work was carried out in phases between August 2011 and December 2013, by which time the system was completely installed and tested. During this process, the pulp mill's engineers were kept fully engaged to make sure they were confi-

dent in using the APC and were able to adapt their working and training practices to make best use of it.

Once the entire system was up and running, it was possible to arrive at some quantitative measures as to how well the objective had been fulfilled:

- Variations in the Kappa number in the digester were reduced by 56 percent, meaning that the APC has helped produce pulp of a consistently high quality → 4.
- Variations in residual alkali fell by 48 percent, implying a better utilization of white liquor in the cooking process → 5.
- Variations in the digester chip level were cut by 40 percent → 6, resulting in reduced variations in the blow flow → 7. This has led to much more stability in the pulping and washing processes.

The obvious advantage of the APC and the DCS is that the outcome meets all of the customer's requirements for this step of the pulping.

- A 30 percent reduction in alkali losses in the washing process was achieved → 8.

8 APC reduces alkali losses in brown stock washing

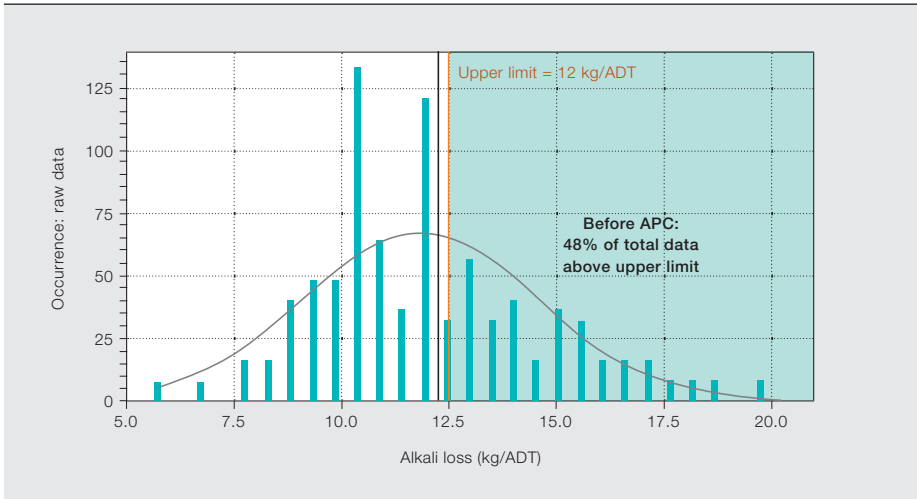

8a Before APC

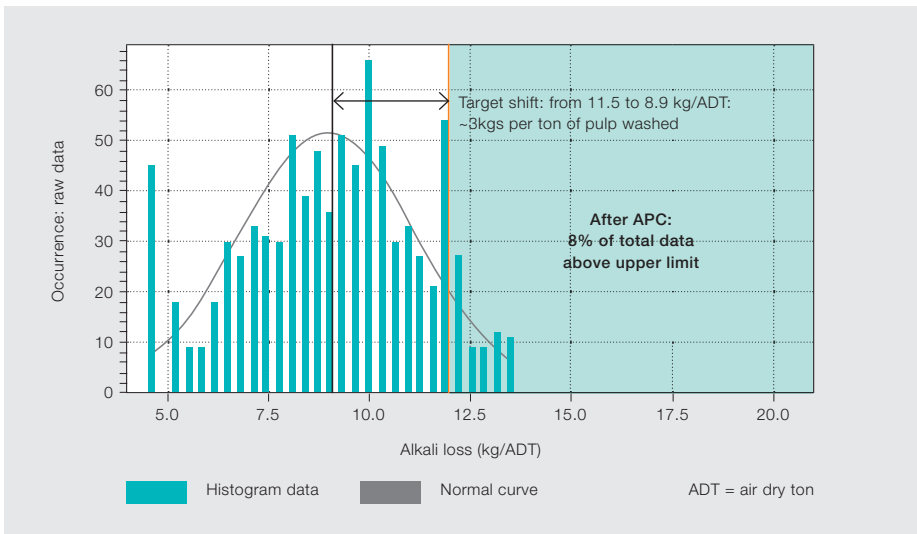

8b After APC

- The volume of fresh water used in the washing area and consequently steam consumption by the evaporators were both reduced.
- Washing filtrate and blow tank levels were stabilized, resulting in a reduced carbon dioxide and effluent load.

siderations was to have a proven APC solution on top of the DCS – the Mondi Swiecie project provided this.

The whole process of solving the optimization problem and having that solution validated by the mill itself has made it possible for ABB to offer standardized solutions to other pulp mills – these solutions are now called OPT800 Cook/C for continuous digesters and OPT800 Wash for brown stock washing.

Finally, the APC solution has proved to be a door opener not only for other APC opportunities but also for System 800xA DCSs as well. One recent example is a DCS order for the world's largest pulp and paper mill, which is being set up in Indonesia. One of the key customer con-

Abhijit Badwe

Ramesh Satini

ABB Pulp and Paper Control Systems

Technology Center

Singapore

abhijit.badwe@sg.abb.com

ramesh.satini@sg.abb.com

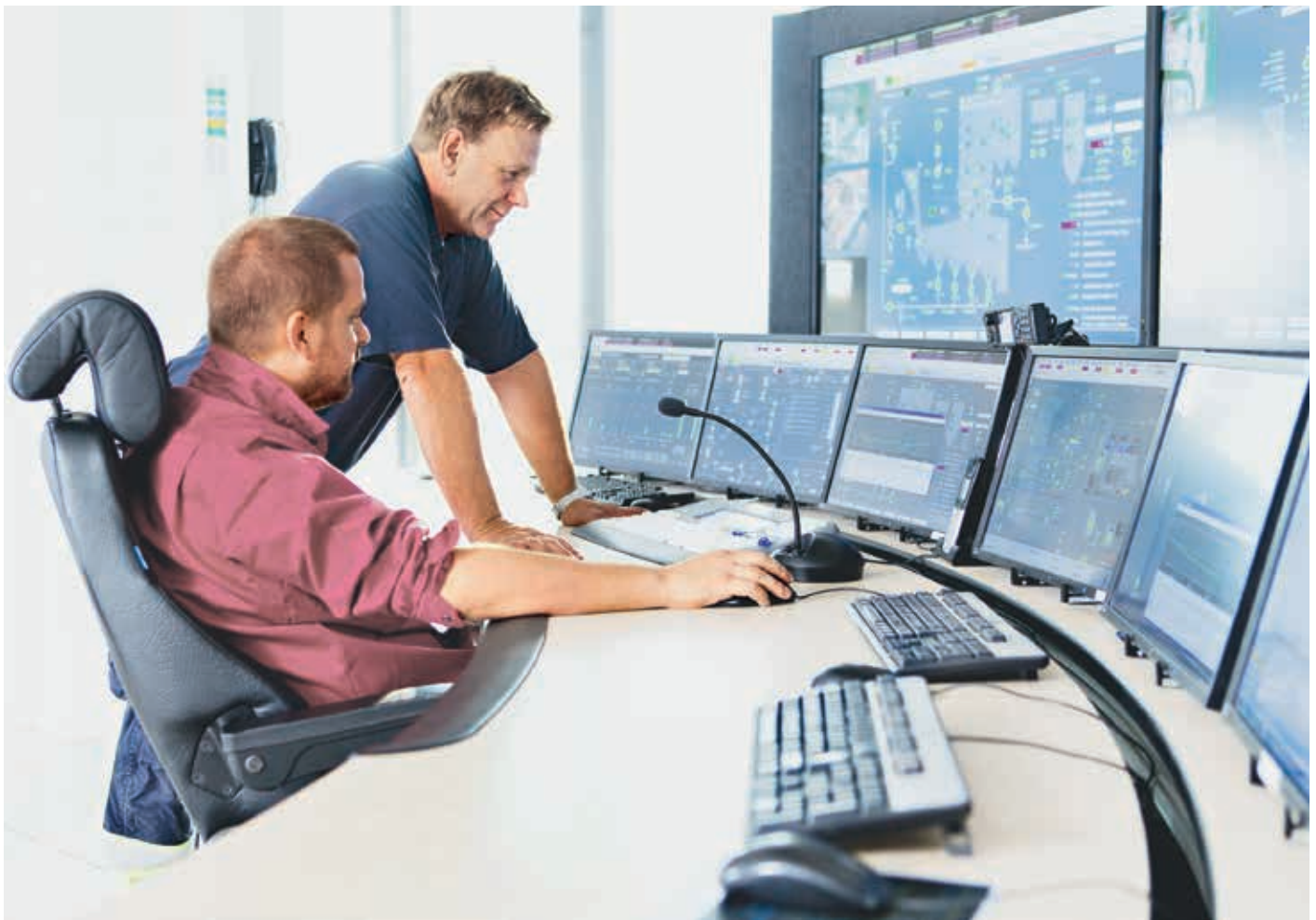

Alarming discoveries

Improving operator effectiveness through alarm life-cycle support

MARTIN HOLLENDER, JOAN EVANS, THOMAS-CHRISTIAN SKOVHOLT, ROY TANNER – Ahead of a recent simulation exercise at Star City in Moscow, British astronaut Tim Peake was asked what the greatest challenges are during the simulation. He replied, “The most difficult thing to deal with is multiple failures” [1]. Likewise for industrial facilities using distributed control systems, alarm “floods” remain one of the biggest challenges. To get alarm floods under control, alarm-related design knowledge from early life-cycle phases needs to be easily accessible in the operational phase when additional information becomes available, so that decisions about advanced alarming methods like alarm suppression can be made with confidence. Having good management-of-change and life-cycle support in place makes it possible to keep the alarm system consistent with the changing reality in the plant and allows continuous improvement. To help, alarm management standards such as IEC 62682 and ISA 18.2 emphasize the importance of life-cycle support in alarm management.

1 Life-cycle thinking in functional safety and alarm management

	Functional safety		Alarm management
1996	ANSI/ISA 84.01	2009	ANSI/ISA 18.02
2003	IEC 61511	2014	IEC 62682

2 Life-cycle of IEC 62682

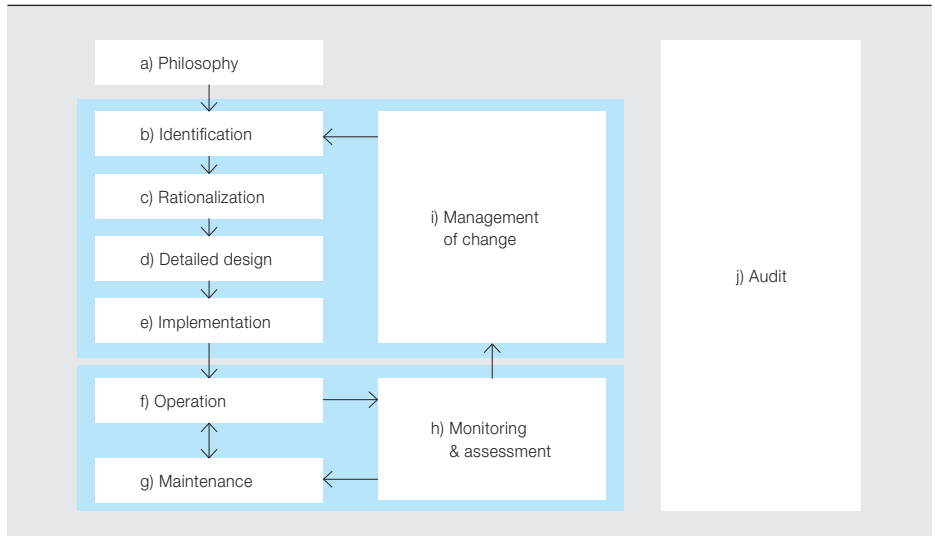

Although the need for effective alarm management is now generally recognized, accidents like the one in 2010 in the DuPont plant in Belle, West Virginia [2] show that even well-known safety leaders like DuPont still have deficiencies. Since software-configurable distributed control systems (DCSs) came into the mainstream, multiple alarms could be added at little or no cost to the end user. Unfortunately this has led to control systems that include a low alarm-system quality due to too many alarms being configured. A classic example is the explosion in the Texaco Milford Haven refinery in 1994 [3], where the two operators received 275 alarms in the last 11 minutes before the explosion. This is now seen as a characteristic of an overloaded alarm system, which makes it impossible for an operator to be properly aware of a situation and to diagnose and correct it. These types of alarm systems are neither useful nor acceptable and resulted in the development of systematic alarm management approaches first documented in the EEMUA 191 guideline published in 1999.

Ten years later the ISA 18.2 standard added a life-cycle approach to alarm management similar to the life-cycle approach already well established in the safety community with ISA 84 and IEC 61511. Simply put: Ensuring safe operation and useful alarms needs ongoing efforts.

The new IEC standard 62682 (published in 2014) [4] – the first international standard for alarm management – is based on ISA 18.2 → 1. It emphasizes the importance of systematic life-cycle management. IEC 62682 requires, for example, that all information used to design alarms (safety studies, equipment specifications, etc.) should be systematically captured and documented. Later, during plant operations, additional information can supplement or revise the original design decisions. Such a revision requires that all information upon which the original decision was based is available and fully understood, to deter any potentially hazardous side effects from the changes.

→ 2 captures the essence of IEC 62682 and can be used to develop and maintain an alarm system compliant with the requirements of IEC 62682 and good industry practice.

A classic example of an overloaded alarm system is the explosion in the Texaco Milford Haven refinery, where the two operators received 275 alarms in the last 11 minutes before the explosion.

Alarm philosophy

The first step in the project life-cycle is the alarm philosophy. The alarm philosophy is the plan for how alarms are to be managed for the site. It defines:

- Roles and responsibilities
- Alarm requirements
- Work processes and procedures to deliver agreed requirements

IEC 62682, among others, provides useful guidance on the content and structure of an appropriate alarm philosophy.

Title picture

Advanced alarm methods provide critical support for operators running modern plants.

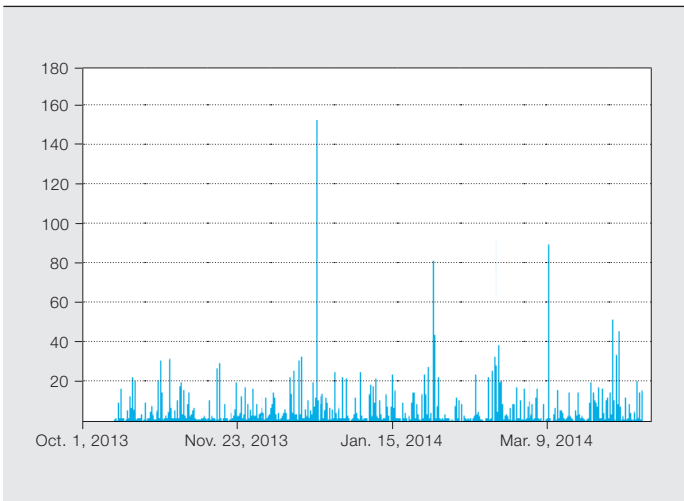
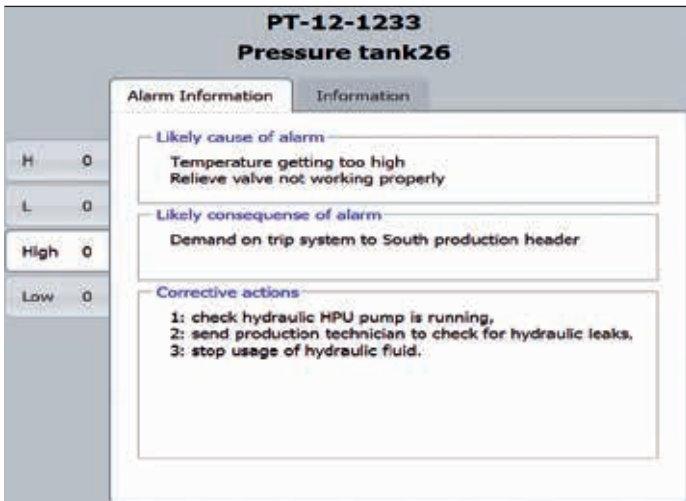

Alarm management principles have to be translated into concrete project activities.

In ABB’s experience, the challenge is not in the authoring of the document, but in its application to the project life-cycle. ABB consultancy support for this activity therefore focuses on the translation of alarm management principles into concrete project activities and deliverables while communicating the impact of alarm requirements to the extended project team.

This is crucial in ensuring that the purpose and design intent of alarms are identified and documented during project reviews such as hazard and operability studies (HAZOP), layer of protection analysis (LOPA) and piping and instrumentation diagram (P&ID) reviews.

As this alarm design information becomes available, the project continues by deciding how and where alarm-related data will be stored and managed. For this purpose IEC 62682 has confirmed the concept of having a master alarm database, which is defined as “an authorized list of rationalized alarms and associated attributes.” ABB’s implementation of this is called Alarm Rationalization Tool (ART) and offers many important advantages:

- Full database functionality for capturing and fast navigation of all alarm-related configuration and design data.

- Input forms that show all configuration settings related to an alarm on a single screen and are designed to support efficient alarm rationalization meetings.
- Controlled copy facilities that allow the reuse of existing configurations for similar cases.

Rationalization

IEC 62682 [5] reminds us that in the rationalization phase of the alarm life-cycle, the following need to be identified for every alarm:

- Recommended operator action
- Consequence of inaction or incorrect action
- Probable cause of alarm

Having this information available during operation leads to more consistent op-

As alarm design information becomes available, the project continues by deciding how and where alarm-related data will be stored and managed.

erator actions and helps inexperienced operators build up their knowledge base and confidence. Where existing facilities are being revamped, operations staff are the most reliable source of this information. For new plants the full definition of required alarms is more challenging, relying heavily on design and vendor



data to define the required alarm configuration.

As well as capturing alarm requirements and design data, a key feature of ABB's ART is the ability to export operator response data to ABB's online Alarm Helper facility → 3. The Alarm Helper provides all of this information in Extended Automation System 800xA's operator workplace. Both Alarm Helper and ART are

quires continuous efforts to maintain good practice and ensure consistency.

Today, many plants have their average alarm rate well under control with low average alarm rates during normal operation. However, alarm floods are frequently still a challenge.

→ 4 shows the alarm rate of a petrochemical plant over half a year. Although the average alarm rate is below one alarm every 10 minutes and is therefore well under control, sometimes floods of more than 100 alarms every 10 minutes exist and smaller floods of about 20 alarms every 10 minutes occur quite regularly.

Unfortunately these floods often occur during the most demanding phases when operators most need support (eg, during startup or shutdown). Alarm flood scenarios include:

- Alarms floods generated because process sections are shut down (eg, low flow alarms after pump stops), operating in different operating modes (eg, cleaning), or instruments being calibrated. These alarms can become a problem if they occur together with a process problem and important alarms are buried inside a flood of unnecessary alarms.
- Alarm floods along the causal chain following a process upset. A single root cause can generate lots of

consequential alarms. The first alarm in the alarm list might not be the alarm closest to the root cause – depending on the process dynamics and how thresholds are configured, secondary and misleading alarms might show up first.

Such alarm floods cannot be avoided just by choosing good configuration values for limits, hysteresis or delay timers. Advanced alarming techniques like hiding (called suppression-by-design in IEC 62682) and grouping come into play. ABB's System 800xA provides a powerful toolbox for advanced alarming on controller, server and workstation levels, and include alarm grouping, hiding (dynamic suppression) and alarm shelving (time-limited operator-driven suppression).

Balanced risk

When addressing alarm floods, the challenge is to strike a balance between the potential risks associated with suppressing an alarm during a particular scenario, versus the need to address peaks in the alarm rate during abnormal conditions. These risks are best mitigated via a combination of a proven, comprehensive toolsets such as ABB's AlarmInsight → 5 and a robust management of change (MOC) process to include the appropriate level of review and approval.

Initial (prospective) rationalization reviews may have identified candidates for basic alarm suppression such as alarm grouping for alarms to be masked when equipment is out of service. Later alarm flood studies during the operations phase will seek to go further and draw on

Alarm floods cannot be avoided just by choosing good configuration values for limits, hysteresis or delay timers.

parts of ABB's comprehensive alarm management package called AlarmInsight. AlarmInsight is a full featured alarm management toolset developed and tested to work with System 800xA today and in the future.

Ready access to this online help facility is seen as particularly important for critical (in IEC terms highly managed [6]) alarms and is increasingly expected by safety regulators. Plants already using Alarm Helper also report that it is a very popular and effective operator support tool.

Continuous efforts

Moving into the operations phase, life-cycle management is a central part of IEC 62682 and ISA 18.2 and has also been integrated in to the third edition of EEMUA 191. Alarm management re-

ABB was able to reduce the average alarm rate in a Rashpecto offshore gas production plant, reducing plant trips from 25 to six per year.

6 Reducing the alarm rate at the Rashpetco offshore gas plant using ABB's AlarmInsight

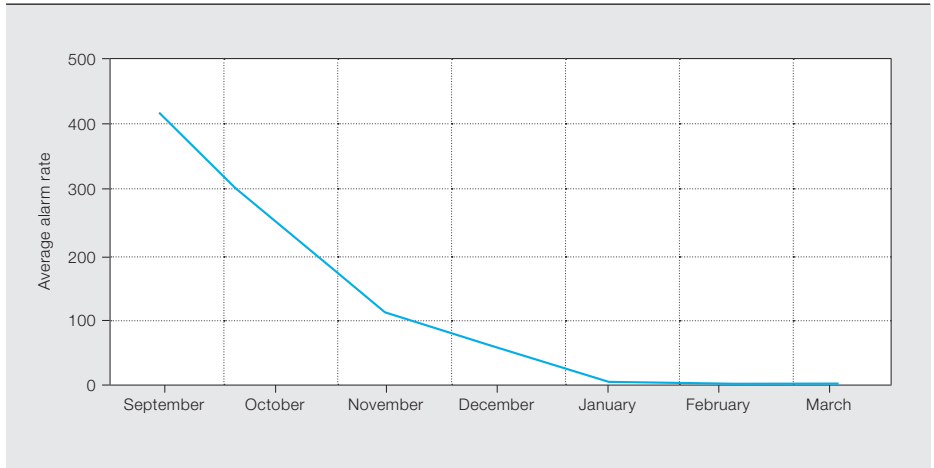

the full portfolio of AlarmInsight functionality:

- Operator comments on alarm responses stored and presented in Alarm Helper
- Detailed alarm analysis data via Expert Tool and Alarm Analysis
- Current alarm attributes from the ART database

This combined toolset facilitates the identification of potential alarm suppression scenarios based on analysis of actual plant data. With the need for manual “ad hoc” analysis removed, the potential for human error in deducing cause and effect is greatly reduced and conclusions can be based on much larger data sets – extending over several years if appropriate. Once a particular scenario has been identified, reviewed and confirmed, the toolset can then be used to explore whether there are other instances in which the same logic can be applied. The product integration between ABB’s System 800xA and AlarmInsight enables continuous alarm optimization, enforcement and monitoring over time.

This approach has been of proven value in a number of cases, including:

- Identification of consequential alarms following a particular shutdown
- Critical event analysis, highlighting event triggers with potential for early operator response (intervention) and mitigation of equipment shutdown/ plant upset

The main benefits are achieved through a life-cycle toolset providing a framework for continuous improvement, and include:

- Reduced production trips
- Reduced legislative risk – safer, more environmentally robust operations
- Improved operator effectiveness

→ 6 shows how ABB was able to reduce the average alarm rate in a Rashid Petroleum Company (Rashpetco) offshore gas production plant. This resulted in a reduction of plant trips from 25 down to six per year. As each trip is associated with significant costs, the overall savings are substantial.

Insight achieved

Alarm management is an area of increasing concern to regulators, other public bodies and the public at large who are pushing for evidence of a life-cycle approach and continuous improvement, resulting in safer plant operations. With IEC 62682 the best practice in alarm management is finally available as an international standard. ABB delivers alarm management improvements with a comprehensive toolset, delivering documented bottom-line savings, which are accepted by regulatory authorities as good practice.

Martin Hollender

ABB Corporate Research
Ladenburg, Germany
martin.hollender@de.abb.com

Joan Evans

ABB Process Automation, Oil, Gas & Chemicals
Billingham, United Kingdom
joan.evans@gb.abb.com

Thomas-Christian Skovholt

ABB Process Automation, Oil, Gas & Chemicals
Oslo, Norway
thomas-christian.skovholt@no.abb.com

Roy Tanner

ABB Process Automation, Control Technologies
Wickliffe, OH, United States
roy.tanner@us.abb.com

References

- [1] D. Shukman. (2015, November 11). *Tim Peake: British astronaut's training nears end*. Available: <http://www.bbc.com/news/science-environment-34788169>
- [2] S. Smith, “Did DuPont Prioritize Cost Over Safety at Belle, W.Va., Facilities? Chemical Safety Board Investigation Indicates It Did,” *EHS Today*, July 2011.
- [3] “The explosion and fires at the Texaco Refinery, Milford Haven, 24 July 1994,” Health and Safety Executive, Norwich, 1997.
- [4] *Management of Alarm Systems for the Process Industries*, IEC 62682, 2014.
- [5] *Required and Recommended Alarm Philosophy Content*, IEC 62682, section 6.2.1, Table 3, p. 36.
- [6] *Highly Managed Alarms*, IEC 62682, section 6.2.9, p. 38.



From paper to digital

A research project for extracting object-oriented descriptions of piping and instrumentation diagrams

ESTEBAN ARROYO, STEVE ROYSTON, ALEXANDER FAY, MARIO HOERNICKE, PABLO RODRIGUEZ – Documentation in process industries can rise to bewildering dimensions. Furthermore, the difficulties of accessing it can be compounded by the range in formats used, including traditional paper and elementary digital representations. When a plant owner decides to consolidate this information – for example, to prepare a modernization process – bringing this eclectic documentation into a single,

accessible and up-to-date format can require a gargantuan effort. ABB has explored means of efficiently extracting models from engineering documents in an automated and consistent manner. A joint research project by ABB and the Helmut Schmidt University (HSU) in Hamburg, Germany, resulted in a method based on optical recognition and semantic analysis that converts piping and instrumentation diagrams (P&IDs) into object-oriented models.

1 Excerpt of a P&ID

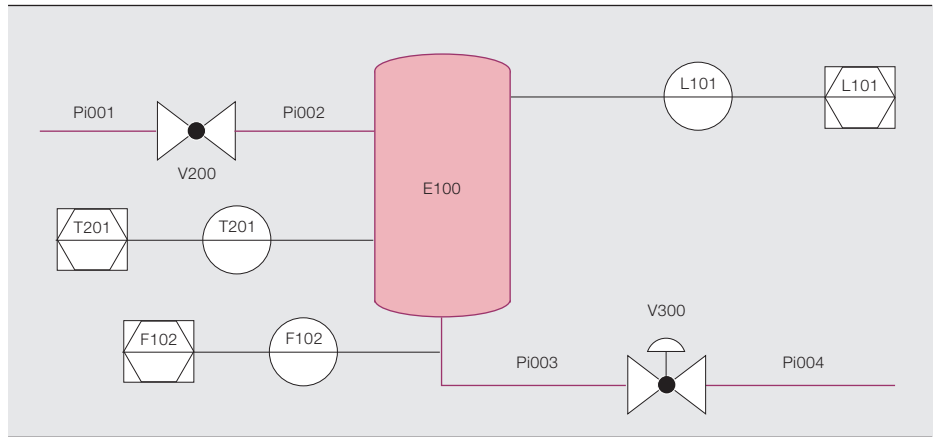

tion with HSU, devised methods for the extraction of object-oriented (OO) representations from existing design documents, specifically P&IDs [2].

Previous research has shown that the use of P&IDs can support different tasks along the plant's life-cycle such as automated HAZOP (hazard and operability) studies [3], detection of design patterns [4], derivation of simulation models [5] and fault detection and diagnosis [6]. Existing approaches are all based on the prerequisite that P&IDs must be described in OO formats (eg, IEC 62424 CAEX/AutomationML [7,8] or ISO 15926 [9]). Unfortunately, this is not typically the case in existing process facilities as most P&IDs are filed in non-computer-interpretable forms.

From pixels to meaning

The method extracts OO models from mixed text-graphics documents, concretely P&IDs → 1, recognizing text, symbolic forms and connection topologies. The approach relies on the fact that input documents are composed of four fundamental artifacts, namely parametric forms, nonparametric forms, text annotations and underlying semantic content → 2.

The conversion process assumes that P&IDs are stored in pdf files (pdf/bitmap or pdf/SVG) from which raster images can be extracted. In some cases, however, preliminary process steps are required so that a raster image can be subsequently obtained, particularly when dealing with lega-

cy papers or CAD files → 3. From here, the method executes three procedures for the generation of the computer-interpretable model, namely:

- Optical recognition: OSR and OCR → 4 for the identification of symbols and text annotations.
- Semantic analysis: Interpretation of the functional connotation of graphical forms for the enhancement of the recognition procedure and the improvement of expression capabilities for the model description.

Input documents are composed of four fundamental artifacts, namely parametric forms, nonparametric forms, text annotations, and underlying semantic content.

- Representation and verification: Description of captured information as an OO model followed by visual inspection.

Optical recognition (OR)

OR deploys sound image processing techniques for the identification of geometric forms and text identifiers. The process is executed through the recursive application of two methods: OSR and OCR.

Optical symbol recognition

As the first step of OSR, nonparametric symbols (ie, multi-curve forms) such as “vessel E100” and “valve V300” shown in → 1 are localized and matched against predefined libraries of templates. A library

The sheer size and complexity of process-industry plants combined with the numerous modifications and additions effected throughout their life-cycles results in vast amounts of legacy documentation. This includes structural models, functional descriptions, P&IDs and equipment specifications. Although these documents embody a rich source of information that should be exploited in planning and operational activities, this is currently hindered by the challenges entailed by their timely localization and data extraction [1].

In current industrial practice, existing engineering documentation is digitized manually by scanning, storing and indexing. The resulting files contain unstructured information that cannot be fully exploited for automation tasks as their underlying content does not take the form of a data model. Addressing this, ABB has, in coopera-

Title picture

Documentation in process industries can take various formats, including paper and primitive electronic formats. How can all this be translated to a modern object-oriented standard?

2 Composition of a typical P&ID

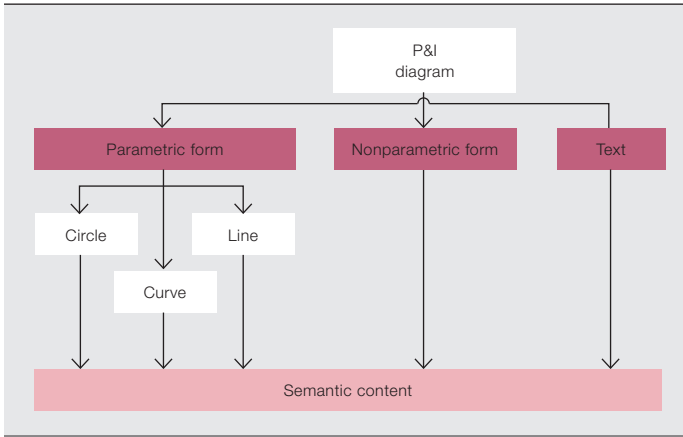

can represent, for instance, plant asset catalogs or sets of symbols commonly used to embody specific devices or processes within P&IDs. The definition of libraries allows for not only modularity, which in turn results in more efficient search procedures, but also effective capture and reuse of structural knowledge within projects. The matching criterion employed is based on the structural features of the examined forms. Three key geometric properties → 5 are supported to guarantee an exhaustive search of possible matches – namely, rotation, scaling and occlusion.

Scores quantifying the extent of resemblance between identified candidates and templates are used to define levels of con-

and thereby avoid the misinterpretation of characters as symbols. As with the non-parametric symbols, the reliability of the recognition process can be adjusted based on calculated matching scores. Again, the position coordinates of objects found are suppressed to ease the identification of further artifacts.

Optical character recognition

Based on the notion that the text identifier of an object is located in its surroundings or within the object, the coordinates of identified forms are used to generate search windows → 6. The size of a window is typically proportional to the dimensions of the analyzed image. It can also be defined by the user. An OCR algorithm searches for text within the defined win-

3 Overview of the digitalization workflow

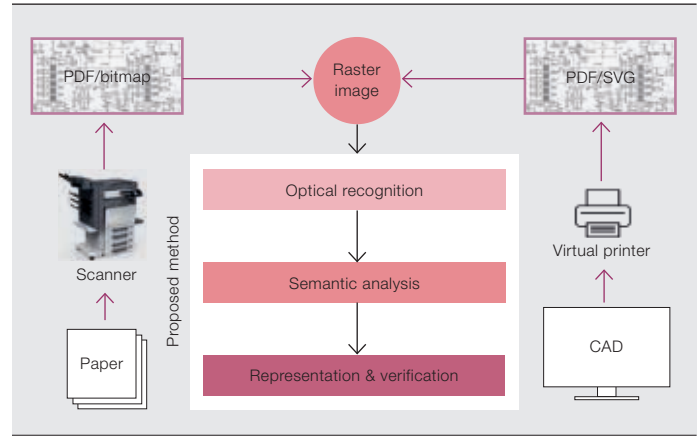

4 Glossary of terms

AML	AutomationML
CAD	Computer-aided design
CAEX	Computer-aided engineering exchange
PDF	Portable document format
P&ID	Piping & instrumentation diagram
OCR	Optical character recognition
OO	Object oriented
OR	Optical recognition
OSR	Optical symbol recognition
SA	Semantic analysis
SVG	Scalable vector graphics

A semantic rule might state, for instance, that a pipeline can be connected at most to two other elements, one at each termination.

fidence within the recognition method. Successfully matched objects are suppressed from the image to facilitate the recognition of further artifacts.

In a second step, parametric symbols (ie, mathematically described forms such as circles or lines), eg, “pipe Pi002” and “sensor L101” in → 1, are identified. Recognition methods used within this procedure are capable of identifying possible candidates regardless of their size and orientation. Thresholds can be set to define the minimum dimensions of parametric forms

touching characters) are referred to the user for manual resolution.

Semantic analysis (SA)

In the context of the developed method, SA refers to the incorporation of domain-specific knowledge, particularly functional and structural content, within the recognition of graphical forms and their interrelations. Among other purposes, SA is exploited for connectivity detection and enhancing modeling expression capabilities through the definition of specific interface types.

Beyond connectivity detection, further rules are tested so that mistaken detections can be automatically corrected and/or the user warned.

5 Supported features of the geometric matching process

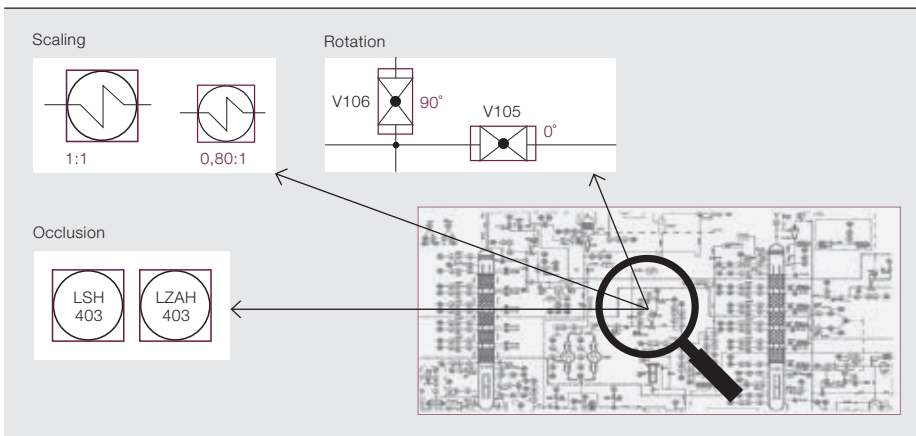

6 Search windows and allocation of tag identifiers

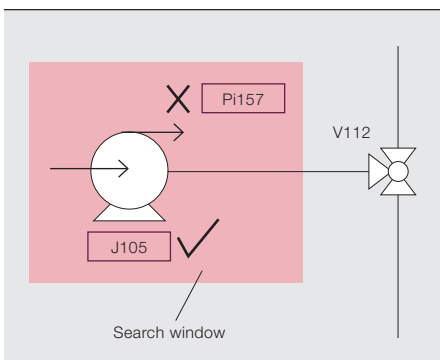

7 Specific interface types

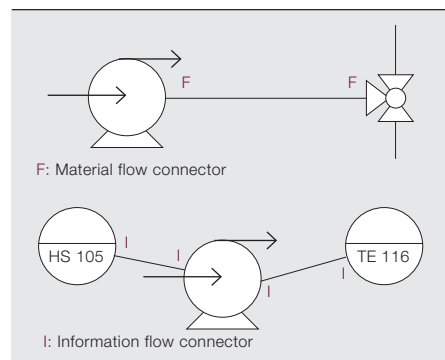

Boosting connectivity detection

Characteristic connections within engineering diagrams are based on polyline arrangements. Hence, connectivity detection requires as a first step the unification of contiguous lines to single linking artifacts. The proximity of such artifacts to structural forms is analyzed and the underlying connectivity of the diagram derived. Semantic rules are applied to enforce the consistency of links. A semantic rule might state, for instance, that a pipeline can be connected to at most two other elements, one at each termination. Where potential instances violate such statements, further rules are tested so that mistaken detections can be automatically corrected and/or the user can be warned.

Definition of interface types

The generation of detailed OO models requires distinguishing between different types of connectivity. For instance, the semantics (function and physics) of a vessel-sensor connection is intrinsically different to that of a vessel-pipe link → 1. The former transmits information and is typically implemented by wires, while the latter carries material and is commonly realized through flow couplings.

8 Example of connectivity matrix

	Vessel E100	Pipe Pi002	Sensor L101
Vessel E100		F	I
Pipe Pi002	F		
Sensor L101	I		

9 Example of table of coordinates

Plant asset	P&ID coordinates (X,Y)	Dimensions (L,W)
Vessel E100	(81,123)	(123, 57)
Pipe Pi002	(59,142)	(22,1)
Sensor L101	(105, 126)	(18,18)

This distinction is fundamental in several use cases such as in fault detection and diagnosis in which root cause analysis is highly dependent on the propagation media of plant disturbances → 7.

Representation and verification (R&V)

Within the R&V phase, information inferred by the image processing algorithms is transferred to an intermediate structural description and ultimately to an OO model. The process concludes with a visual inspection in which the user is presented with an interface to verify the consistency of digitized artifacts.

Intermediate structural description

In order to provide a first representation of gathered information, the connectivity, position and dimensions of the elements found are stored respectively in a connectivity matrix and a table of coordinates.

The connectivity matrix → 8 has as first row and column the list of recognized elements. These are referred to by their class and tag identifier, eg, vessel E100. The inner entries of the matrix represent the connectivity between elements (row, column). Connection types are indicated by distinctive names: F for material flow and I for information flow.

10 Example of derived OO model

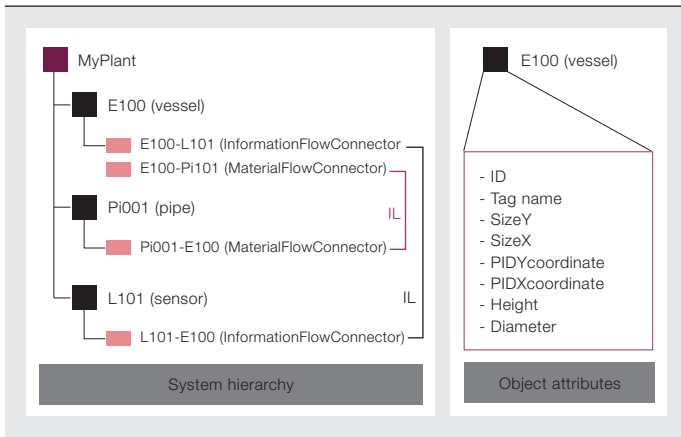

The table of coordinates → 9 stores the position of the given objects and their respective dimensions.

Intermediate structural descriptions can be codified as spreadsheets (eg, using Microsoft Excel or data tables in C# Windows Forms) and recursively accessed for the derivation of the targeted OO models. Additionally, they can be used for basic tasks such as generation of part lists or solving queries about the presence of a specific item or item type.

OO Modeling

An OO model, specifically a CAEX/AutomationML model compliant with IEC 62424 [7,8], is derived from the collected data. The procedure starts by creating an object for every entry within the first column of the connectivity matrix. Subsequently, interfaces are added. For example, for vessel E100, two interfaces are created – one of type MaterialFlow (F) and one of type InformationFlow (I) → 10. The process concludes by assigning attributes (eg, position and dimensions). Thus an OO model describing the connectivity and semantic information of the P&ID is obtained.

Visual inspection

Finally, a graphical depiction of the inferred information is generated → 11. The representation overlays the original black and white P&ID with colored forms representing the identified objects. Users can visualize these objects and compare them with the original diagram, effecting changes where necessary. Corrections carried out in the graphical interface have a direct effect on the OO model, thus avoiding the need for additional engineering tools. Previously generated warnings can be used to prioritize the cross-checking procedure.

11 Visual inspection process

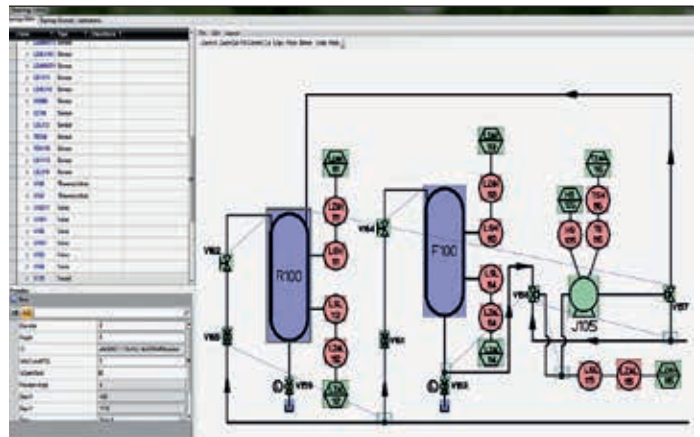

Making the most of documentation

The improved exploitation of existing documentation and automated transfer to digital plant models enables increased efficiency of (re)engineering tasks in greenfield and brownfield projects. It can be applied in a number of industries, including chemical, pharmaceutical, oil and gas, water, and power generation.

Esteban Arroyo

Alexander Fay

Helmut Schmidt University
Hamburg, Germany
esteban.arroyo@hsu-hh.de
alexander.fay@hsu-hh.de

Mario Hoernicke

Pablo Rodríguez

ABB Corporate Research
Ladenburg, Germany
mario.hoernicke@de.abb.com
pablo.rodriguez@de.abb.com

Steve Royston

ABB Process Automation,
Oil, Gas & Chemicals
St. Neots, United Kingdom
steve.royston@gb.abb.com

References

- [1] E. Arroyo *et al.*, "Integrating Plant and Process Information as a Basis for Automated Plant Diagnosis Tasks," IEEE International Conference on Emerging Technologies and Factory Automation (ETFA), Barcelona, Spain, 2014.
- [2] *Diagrams for the chemical and petrochemical industry*, DIN EN ISO 10628:2001.
- [3] A. Fay *et al.*, "Knowledge-based support of HAZOP studies using a CAEX plant model," *Inside Functional Safety*, vol. 2, pp. 5–15, 2009.
- [4] R. Drath *et al.*, "Computer-aided design and implementation of interlocking control code," in *IEEE International Symposium on Computer Aided Control Systems Design (CACSD)*, 2006, pp. 2653–2658.
- [5] M. Barth *et al.*, "Object-oriented engineering data exchange as a base for automatic generation of simulation models," IEEE Industrial Electronics Society (IECON), Porto, Portugal, 2009.
- [6] S.Y. Yim *et al.*, "Using process topology in plant-wide control loop performance assessment," *Computers and Chemical Engineering*, vol. 31, pp. 86–99, 2006.
- [7] *Representation of process control engineering – Requests in P&ID diagrams and data exchange between P&ID tools and PCE-CAE tools*, IEC 62424 (2008-08).
- [8] R. Drath, *Datenaustausch in der Anlagenplanung mit AutomationML*, Germany: Springer Verlag Berlin Heidelberg, 2010.
- [9] T. Holm *et al.*, "ISO 15926 vs. IEC 62424 – Comparison of Plant Structure Modeling Concepts," IEEE International Conference on Emerging Technologies and Factory Automation (ETFA), Kraków, Poland, 2012.

Our readers have spoken

Presenting the results of our readership survey

In ABB Review 3/2015, readers were invited to take part in a survey, the results of which are being shared below → 1–7. The ABB Review editorial team would like to thank all those who participated in this survey. Five winners were drawn from the participants, and

are each receiving a Solar Impulse backpack and cap. Congratulations to Isidro Fraga Hurtado from Cuba, John Grant and Nasos Bardis from the United States, Tamer Mahmoud from Egypt and Walter Heinrich from Germany.

1 Do you read ABB Review articles that are outside your area(s) of expertise?

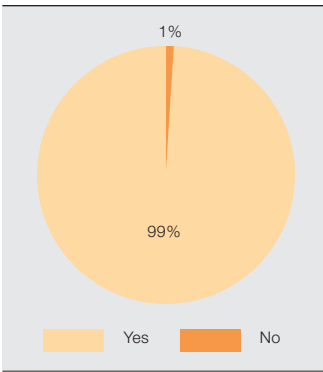

2 Would you recommend ABB Review to a colleague?

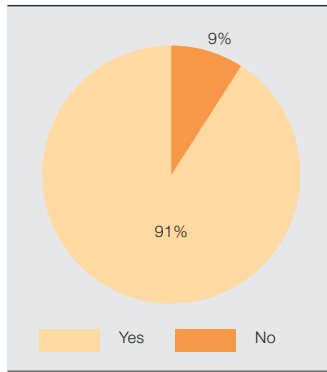

3 How do you receive your copy of ABB Review?

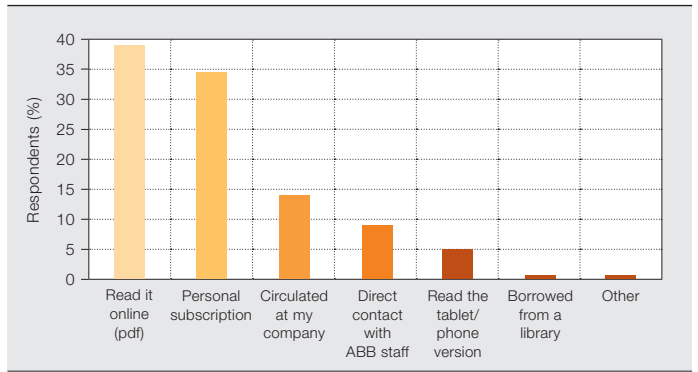

4 How do you use ABB Review? (Multiple responses permitted)

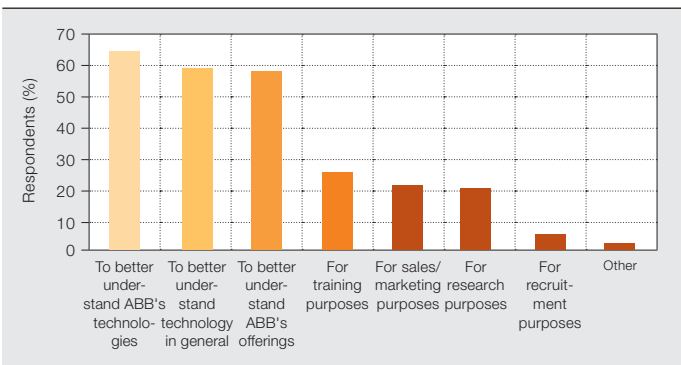

5 Are you aware that ABB Review is available as a tablet/phone version?

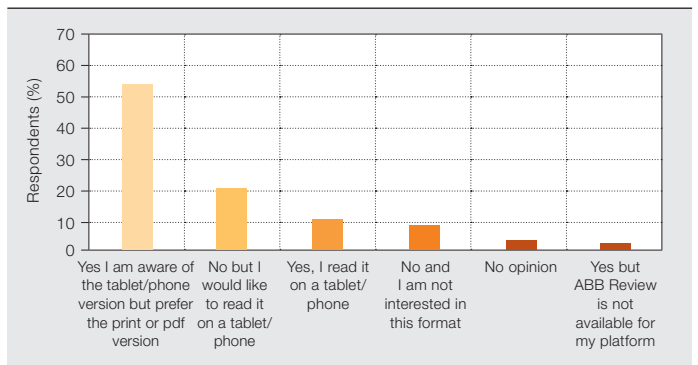

6 How satisfied are you with the number of articles per edition of ABB Review?

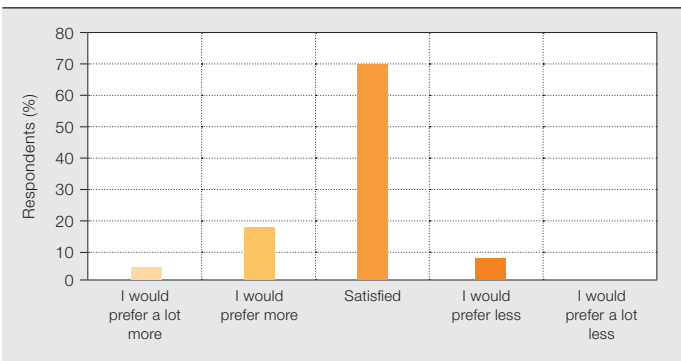

7 How satisfied are you with the level of technical content in ABB Review articles?

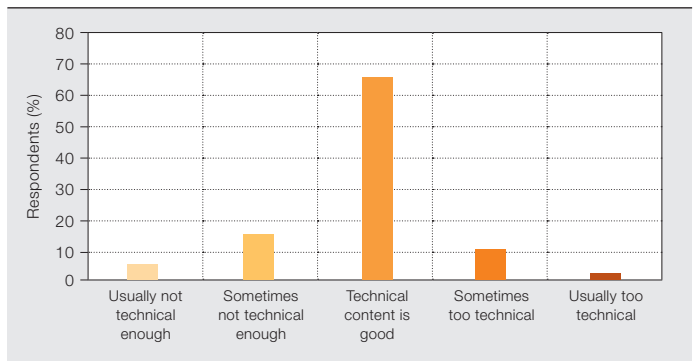

Editorial Board

Bazmi Husain

Chief Technology Officer
Group R&D and Technology

Ron Popper

Head of Corporate Responsibility

Christoph Sieder

Head of Corporate Communications

Ernst Scholtz

R&D Strategy Manager
Group R&D and Technology

Andreas Moglestue

Chief Editor, ABB Review
andreas.moglestue@ch.abb.com

Publisher

ABB Review is published by ABB Group R&D and Technology.

ABB Technology Ltd.
ABB Review
Affolternstrasse 44
CH-8050 Zurich
Switzerland
abb.review@ch.abb.com

ABB Review is published four times a year in English, French, German and Spanish. ABB Review is free of charge to those with an interest in ABB's technology and objectives. For a subscription, please contact your nearest ABB representative or subscribe online at www.abb.com/abbreview

Partial reprints or reproductions are permitted subject to full acknowledgement. Complete reprints require the publisher's written consent.

Publisher and copyright ©2016
ABB Technology Ltd.
Zurich/Switzerland

Printer

Vorarlberger Verlagsanstalt GmbH
AT-6850 Dornbirn/Austria

Layout

DAVILLA AG
Zurich/Switzerland

Disclaimer

The information contained herein reflects the views of the authors and is for informational purposes only. Readers should not act upon the information contained herein without seeking professional advice. We make publications available with the understanding that the authors are not rendering technical or other professional advice or opinions on specific facts or matters and assume no liability whatsoever in connection with their use. The companies of the ABB Group do not make any warranty or guarantee, or promise, expressed or implied, concerning the content or accuracy of the views expressed herein.

ISSN: 1013-3119

<http://www.abb.com/abbreview>

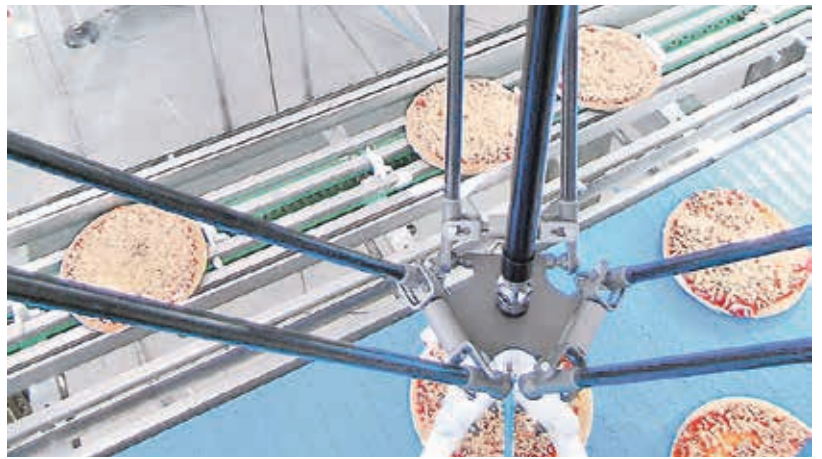

Preview 2116

Food and beverage

ABB Review has over the years discussed many topics that are central to human existence, including energy supply, manufacturing, mining and transportation. The topic of food and beverage is concerned with human needs even more directly and immediately than any of these, but is maybe not one that most readers will immediately associate with ABB.

ABB products and technologies play an important part in the production of many foods and beverages. ABB's involvement ranges from individual instruments to plant-wide control systems as well as handling equipment such as motors and robots. In fact food and beverage is identified as one of the strategic target growth areas by the company.

Read more about ABB's contributions to food and beverage in ABB Review 2/2016.

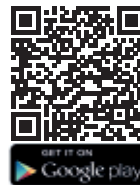

Tablet edition

ABB Review is also available for your tablet. Please visit <http://www.abb.com/abbreviewapp>



Stay informed . . .

Have you ever missed a copy of ABB Review? Sign up for the email alert at <http://www.abb.com/abbreview> and never miss another edition.

Please note that when you register for this alert, you will receive an email with a confirmation link. Please ensure that you have confirmed your registration.



Fully loaded
Searchable content,
in four languages

Offline access
For when you don't have an Internet
connection – like in the train, the plane
or at the top of the Kilimanjaro

Rich media
A picture is worth a thousand words –
but sometimes that's not enough.
Watch movies and animations, and
zoom in on your favorite pictures
in the picture galleries.

Right at your fingertips.
Whenever you need it,
wherever you want it.

Check out our ABB Review app with lots of handy functions. Available in four languages, it features interactive functionality for your tablet and smartphone, fully searchable content, integration of picture galleries, movies and animations. Get it in an app store of your trust.
<http://www.abb.com/abbreviewapp>

