

---

# Molecular Electronics: Interfacing the Nano-and Micro-Worlds

---

Study Leader:  
N. Lewis

Study Contributors:  
C. Callan  
W. Dally  
A. Despain  
W. Happer  
J. Katz  
S. Koonin  
H. Levine  
R. Westervelt  
E. Williams  
C. Young

May 2000

JSR-99-120

Approved for public release; distribution unlimited.

JASON  
The MITRE Corporation  
1820 Dolley Madison Boulevard  
McLean, Virginia 22102-3481  
(703) 883-6997

20000706 030

DTIC QUALITY INSPECTED 4

# REPORT DOCUMENTATION PAGE

*Form Approved*  
OMB No. 0704-0188

Public reporting burden for this collection of information estimated to average 1 hour per response, including the time for review instructions, searching existing data sources, gathering and maintaining the data needed, and completing and reviewing the collection of information. Send comments regarding this burden estimate or any other aspect of this collection of information, including suggestions for reducing this burden, to Washington Headquarters Services, Directorate for Information Operations and Reports, 1215 Jefferson Davis Highway, Suite 1204, Arlington, VA 22202-4302, and to the Office of Management and Budget, Paperwork Reduction Project (0704-0188), Washington, DC 20503.

<b>1. AGENCY USE ONLY (Leave blank)</b>		<b>2. REPORT DATE</b> May 17, 2000	<b>3. REPORT TYPE AND DATES COVERED</b>	
<b>4. TITLE AND SUBTITLE</b>  Molecular Electronics: Interfacing the Nano- and Micro-Worlds			<b>5. FUNDING NUMBERS</b>  13-988534-A4	
<b>6. AUTHOR(S)</b>  N. Lewis, et al				
<b>7. PERFORMING ORGANIZATION NAME(S) AND ADDRESS(ES)</b>  The MITRE Corporation JASON Program Office 1820 Dolley Madison Blvd McLean, Virginia 22102			<b>8. PERFORMING ORGANIZATION REPORT NUMBER</b>  JSR-99-120	
<b>9. SPONSORING/MONITORING AGENCY NAME(S) AND ADDRESS(ES)</b>  Defense Advanced Research Projects Agency 3701 North Fairfax Drive Arlington, Va. 22203-1714			<b>10. SPONSORING/MONITORING AGENCY REPORT NUMBER</b>  JSR-99-120	
<b>11. SUPPLEMENTARY NOTES</b>				
<b>12a. DISTRIBUTION/AVAILABILITY STATEMENT</b>  Approved for public release; distribution unlimited.			<b>12b. DISTRIBUTION CODE</b>	
<b>13. ABSTRACT (Maximum 200 words)</b>  This JASON study was charged to define the study topics in relation to the broad field that is encompassed by the terms Molecular Electronics.				
<b>14. SUBJECT TERMS</b>			<b>15. NUMBER OF PAGES</b>	
			<b>16. PRICE CODE</b>	
<b>17. SECURITY CLASSIFICATION OF REPORT</b>  Unclassified	<b>18. SECURITY CLASSIFICATION OF THIS PAGE</b>  Unclassified	<b>19. SECURITY CLASSIFICATION OF ABSTRACT</b>  Unclassified	<b>20. LIMITATION OF ABSTRACT</b>  SAR	

## Molecular Electronics

---

- Study Participants
- Briefers

JASON Molecular Electronics Study

This JASON study was on the general topic of Molecular Electronics. The contributors included: Curt Callan, Princeton; Bill Dally, Stanford; Alvin Despain, University of Southern California; Will Happer, Princeton; Jonathan Katz, Washington University, St. Louis; Steven Koonin, Caltech; Herbie Levine, University of California San Diego; Robert Westervelt, Harvard; Ellen Williams, University of Maryland; and Carl Young with the U.S. Government. The briefers included: Paul Alivisatos, Department of Chemistry at UC Berkeley; Paul Mceuen, Department of Physics at UC Berkeley; Charles Marcus, Stanford; T. Sanofsky, the Salk Institute; and Ned Seeman, NYU.

## What is Molecular Electronics?

---

- Single (Electron)ics
  - ◆ Si or GaAs, usually low T
- Quantum Dots, Wells
- Trapped Atoms
- Carbon Nanotubes
- Molecular Wires (DNA, polypyrrole, etc.)
- Molecular Switches (Science)
- DNA as a Structural and/or Computational Element
- New Options Monthly

JASON Molecular Electronics Study

Our first charge was to define the study topic in relation to the broad field that is encompassed by the terms “Molecular Electronics”. In its broadest definition, this field encompasses single electron-based electronic circuits, quantum dots and quantum wells, quantum computers using trapped atoms for example, carbon nanotubes, transistors made from organic materials such as polypyrrole, DNA computing, and electrical and structural elements fabricated from DNA or other structure-directing template molecules. Our eventual definition of a molecular electronics device is: “a device that requires an isolable molecular species in either its construction or operation”.

## How Much Room Is There *Really* Left at the Bottom?

---

- 1 Gigabit/cm<sup>2</sup> Memories Exist Now
- Probably Factor of 20-50 Pushing Current Methods
- Another Factor of 10 Going to 2 1/2 Dimensions
- So Moore's Law Will Take us to 200-500 Gbit/cm<sup>2</sup> Memories in 5-10 years
- 10<sup>12</sup> bits/cm<sup>2</sup> is 100 nm<sup>2</sup>/bit
- Need Terabit/cm<sup>2</sup> Possibilities to be Exciting

JASON Molecular Electronics Study

It is important to establish some technological benchmarks that any new technology would have to meet in order to compete successfully with the expected performance improvement of existing technology. To paraphrase Richard Feynman, in benchmarking what might be done in a new technology relative to existing microelectronics capabilities, one has to evaluate exactly how much room there is now left at the bottom. One can already purchase memory with densities of 750 Mb/cm<sup>2</sup>, so Gb/cm<sup>2</sup> storage devices are certainly within reach. It is also not unreasonable to suppose that improvements in planar technology will probably result in a factor of 10 areal density increase over the next 5-10 years. In addition, another factor of 10 will probably be obtained as the third dimension is exploited from 5 metal layers to 50-100 layers. Using Moore's law as a guide, then it is not unreasonable to expect that storage densities of 100-500 Gb/cm<sup>2</sup> will be available in the next 5-10 year period. In this vein, we conclude that Tb/cm<sup>2</sup> storage densities are required in order to have an exciting new technological approach. The exact number is not of concern, but the spirit of the discussion is that a new technology must ultimately offer the promise of either unique computational capabilities or significant improvement in performance metrics relative to these anticipated capabilities from existing technology.

## Molecular Electronics

---

- Electrical Devices That are Physically on the 1-50 nm Scale
- “Bottom Up” vs “Top Down” Device Fabrication Processes
- Use Isolable Molecular Species Somewhere in Their Construction or Operation

JASON Molecular Electronics Study

Another constraint is how one would consider fabrication of such structures on a cost-effective basis. At sizes above 100 nm in dimension, feature design is readily imposed through physical processes, as in the implementation of conventional optical lithography methods. Below this feature scale, however, new materials and processes will be needed to achieve the required masking, etching, and feature definition steps and the difficulty and expense of bringing a macroscopic method to ever smaller length scales becomes of concern.

## Molecular Species Facilitate Self-Assembly

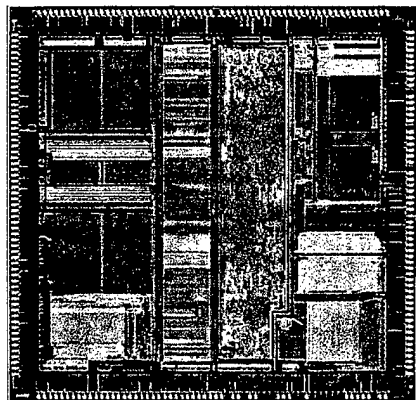

Above 100 nm, impose design through physical processes

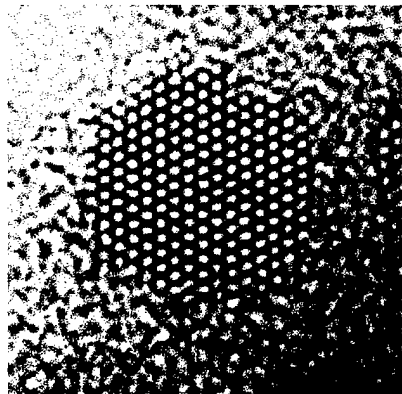

(65Å)

Below 100 nm, atoms and molecules self-assemble

JASON Molecular Electronics Study

Another approach, that is well-suited to implementation on the <100 nm length scale, involves “bottom-up” fabrication methods. Self-assembly methods are traditionally very expensive methods of constructing materials on large length scales because of the high purity and controlled growth conditions that are required to avoid deleterious defects in the material of interest. However, self-assembly is a very inexpensive method of obtaining features on the <100 nm size regime, for which the top-down methods become much more costly. As two examples, consider the TEM of a CdSe nanocrystal, depicted in the figure above, from Paul Alivisatos’ laboratory at Berkeley. This is an atomically perfect particle that is (65Å) in diameter and which was formed through a chemically-controlled crystallization process. This assembly is far beyond capabilities of top-down lithographic methods as presently practiced.

## Molecular Self-Assembly

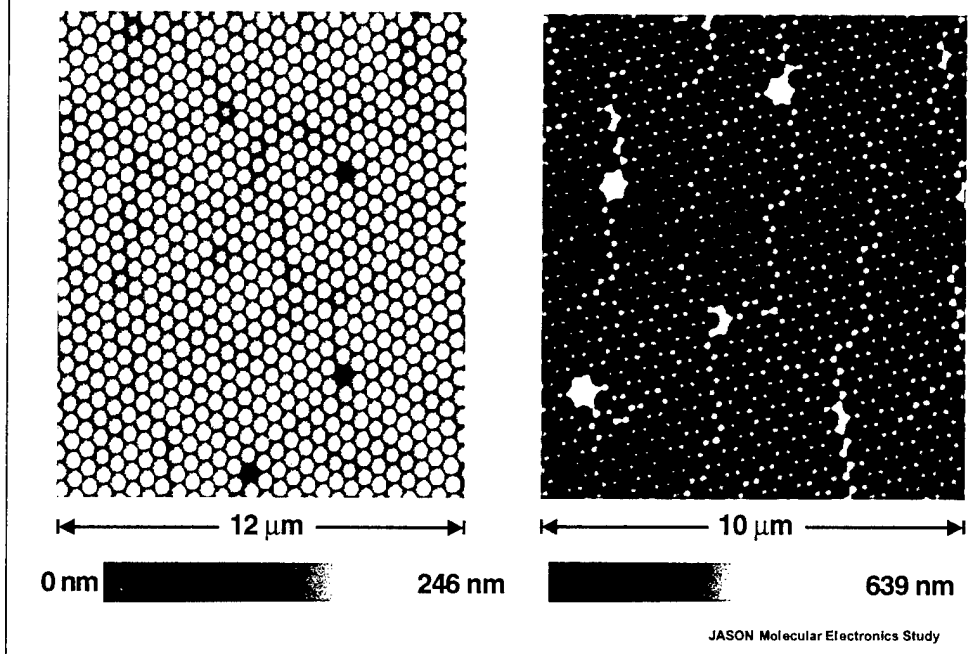

Another example is provided in this figure, which used two layers of hexagonally-close-packed latex spheres to form a mask that allowed formation of a regular, templated set of semiconductor/metal contacts having features of 40 nm in dimension or less. This structure could have been made by electron beam lithography, but the cost to cover a 1 cm<sup>2</sup> area with such features would have exceeded \$100,000 at current prices. In contrast, the natural lithography method was performed on a benchtop in a few hours by one person and with a raw materials cost of <\$100.

The other point that these figures emphasize is that one is going to have to learn, in general, how to deal with, adapt to, and program around, defects. Certainly this adaptation is possible, as evidenced by neuronal memory and processing architectures in biological systems. Such strategies seem especially warranted for materials that are synthesized from self-assembly as opposed to templated lithography.



## **What Would One Do With Molecular Electronics?**

---

- Ultrahigh Density Memory
- Highly Parallel (Slow) Processings
  - “Brain-like processing”:
    - ◆ Target Recognition
    - ◆ Change Detection
    - ◆ Local Gain Control
    - ◆ Data Compression
    - ◆ Data Fusion
- Processing Imbedded with Memory?
- Learn to Program Around Defects?

JASON Molecular Electronics Study

The initial implementation of such a technology most likely will focus on memory devices, as opposed to computation. However, with such systems, even relatively slow computation could be exploited in a highly parallel fashion for many applications of interest to DARPA and the DoD, including target recognition, change detection, data compression and data fusion. Perhaps embedding the processor with a memory, which is a very different architecture from what one does with conventional electronics, is also a fruitful avenue for exploration.

## Issues Addressed in Study

---

- What Types of Components?
- How to Build One Device?
- How to Wire Them Up Into a Circuit?
- How to Talk to These Circuits From the Macroscopic World?
- **WARNING: Don't throw away your Pentium V just yet!!**

JASON Molecular Electronics Study

With that in mind, the questions of interest become: “What types of components would be required in order to build a molecular electronic device? The more difficult question is, “How does one actually wire these devices up into a circuit? And yet a still more difficult question is, “How does one talk to these circuits from the outside, macroscopic world?” This last question was the main focus of concern for this particular study.

## Si FET vs Carbon Nanotube FET

---

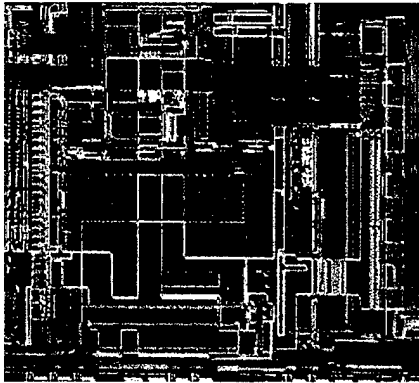

1999

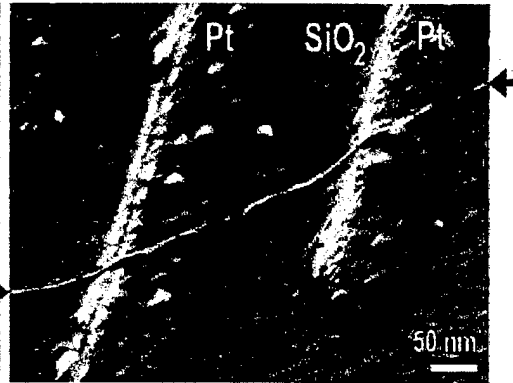

1999

JASON Molecular Electronics Study

As a caveat to this discussion, we emphasize that we do not believe that any of the avenues discussed in this study will displace existing CMOS technology in the foreseeable future. For example, the first silicon transistor was made in 1947; Intel was not founded until the mid-1960's, and the technology started to mature only 35 years after its invention. With that in mind, we can still develop a list of "parts" that are needed in order to assemble a molecular computational device even though we do not expect it to replace Si technology any time soon. One certainly needs nonlinear elements, gain, wires, a means to template and assemble the structures, and finally, a method to interface the nanoscale world to the micron or macroscale world in order to communicate with the 100 or so wires that lead off of a chip.

## Exemplary Parts List

---

- Single Electronics
  - ◆ Si or GaAs, usually low T
  - ◆ Quantum Dots, Wells
- Carbon Nanotubes (Nonlinear Elements at 300 K)
- Molecular Systems (HP/UCLA, MIT, JHU)
- Molecular Wires (Ag plated DNA)
- DNA as a Prototype Assembly Tool

JASON Molecular Electronics Study

What components might be used to construct such a device? Prototypical systems that are illustrative would include: a single electronics silicon- or gallium arsenide-based device, carbon nanotubes, organic semiconductors, and/or DNA-based wires. We discuss some of the interesting features of these systems below.

## Carbon Nanotube-based Transistor

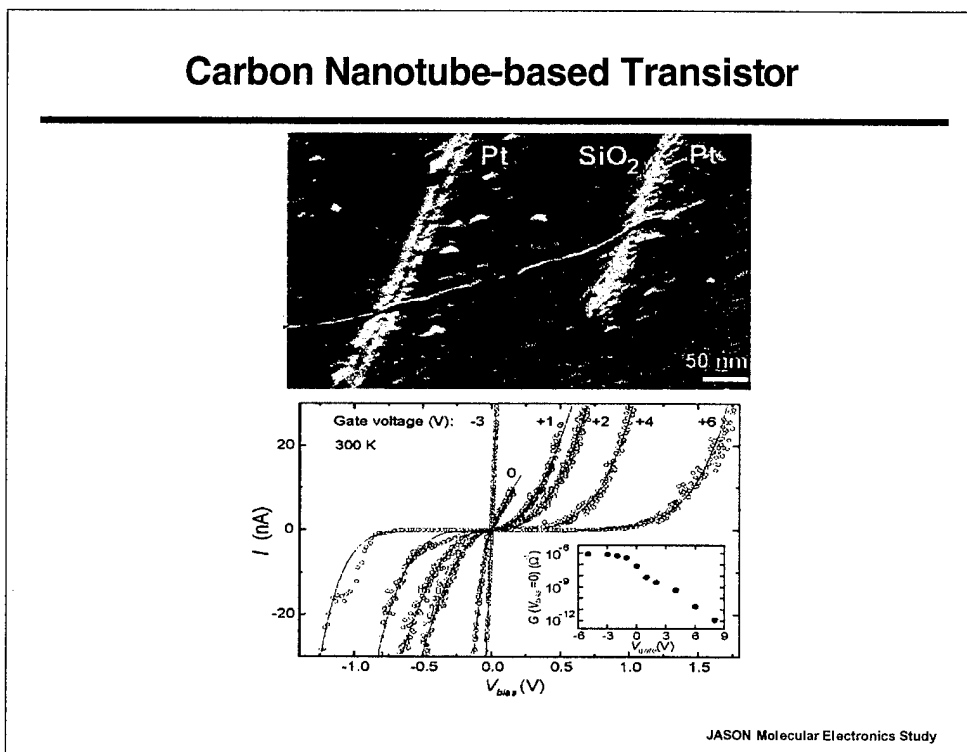

Consider the results from C. Dekker's laboratory, shown in this figure. This displays a carbon nanotube-based transistor. This nanotube is about 1.4 nm in diameter, is electrically isolated from the Si substrate through an intervening oxide, and certainly does not make a good gate contact by CMOS technology standards. Nevertheless, one can apply a voltage to the silicon gate and thereby manipulate the conductance between the two platinum leads that bridge the nanotube. At very negative gate voltages electrons are injected into the nanotube and the tube becomes very conductive. At zero bias, the tube becomes less conductive, and finally at a positive bias electrons are removed from the system and the conductance reaches a minimum. The nanotube over metal with intervening oxide, 1.4 nm wide, therefore forms a nonlinear element. Notice that although the behavior is not in accord with a conventional FET current-voltage curve, it is still an acceptable nonlinear element. Perhaps the most important feature of this device is that, unlike the silicon or gallium arsenide-based single electron devices or quantum wells developed to date, this nm-sized feature exhibited its electrical rectification properties at room temperature. The reason for this is that the structure is quantized in the radial dimension of that tube. N-type and p-type doping of these structures is also being developed.

## Carbon Nanotubes: Twist Angles

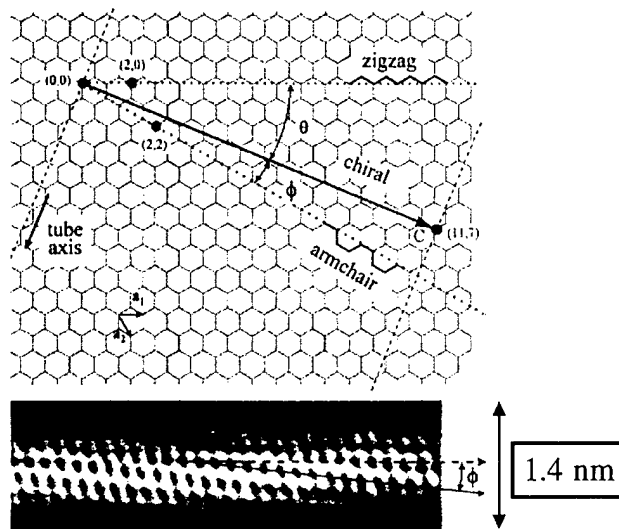

JASON Molecular Electronics Study

A very interesting feature of these nanotubes is that their band structure is sensitive to the structural arrangement of the atoms that comprise that tube. Theoretical predictions suggested that the electronic structure would depend critically on the chiral angle at which the tube atoms propagated with respect the long axis of the tube.

## Carbon Nanotubes: Twist Angles

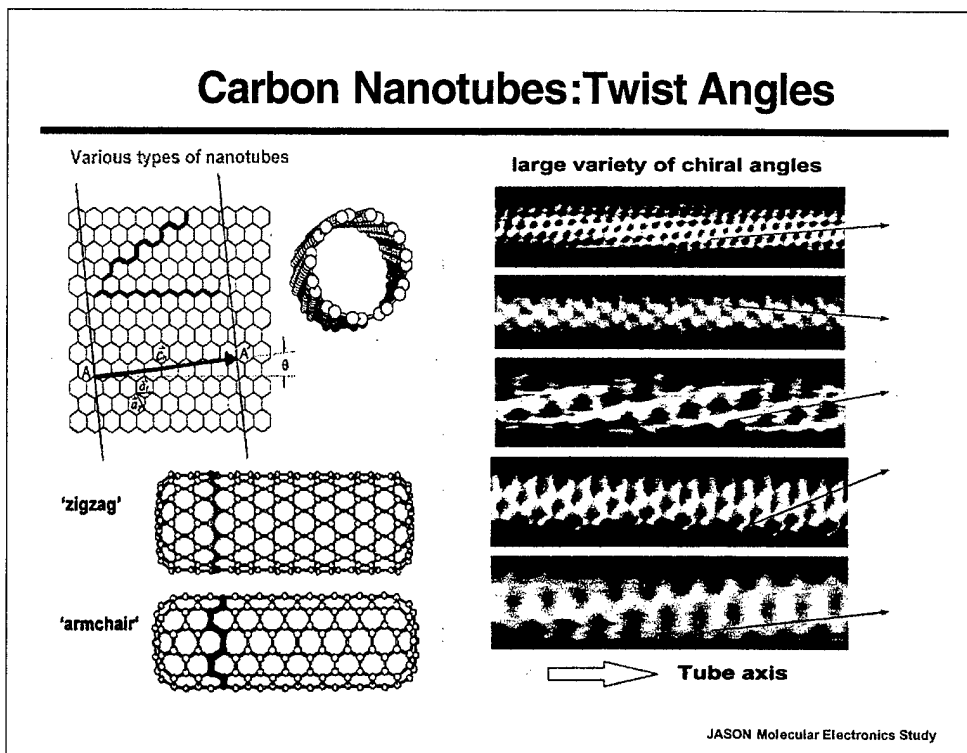

This prediction has been observed experimentally, as exemplified in the figure above. This figure displays scanning tunneling microscopy data for various carbon nanotubes, showing the different chiral propagation angles. The following figure also displays the current-voltage properties of each individual type of nanotube. Indeed the band gaps of tubes of differing chirality show the variation in electronic structure that was predicted theoretically. Another important feature is that the band gaps are in the range of 0.7-1.7 eV, which is an excellent range for potential use in electronic devices at room temperature.

## Band Gap vs Twist Angle

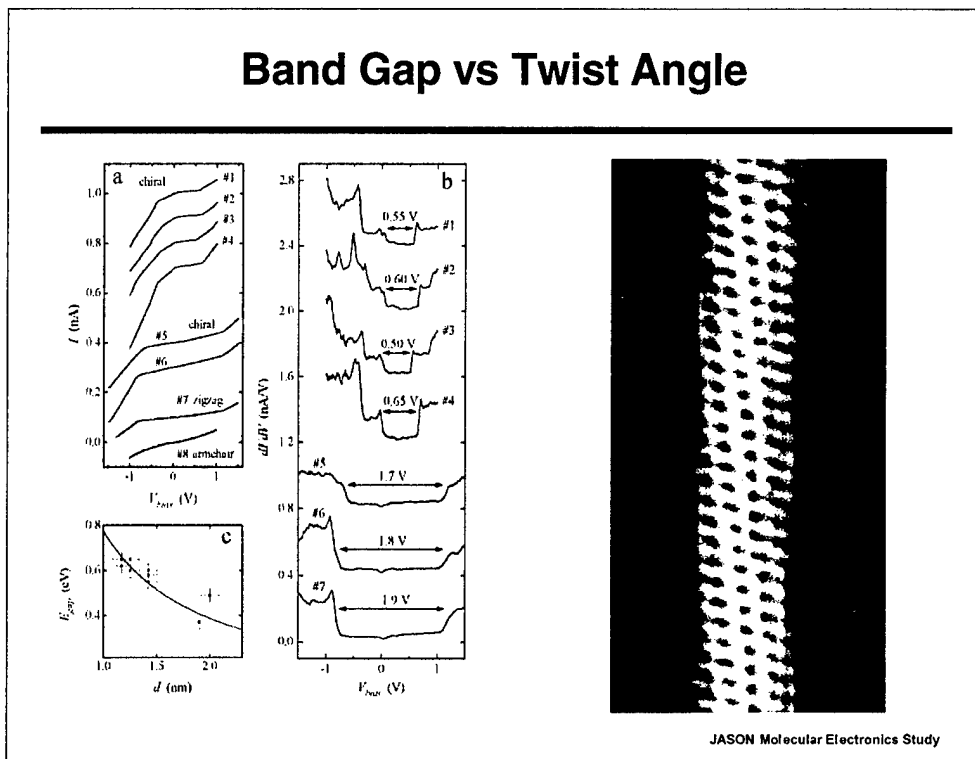

A great deal more development would of course be required before these materials could be even considered as the foundation of a viable technology. One does not yet know how to separate these various different types of tubes. As people learn to put functional groups on the ends of the tubes, they can most likely be separated chemically by their differing retention times on a chiral chromatography column. However, we have at least established the proof of principle that it is possible to fabricate nonlinear elements out of distinct molecular species on the nm scale.



## Rotaxane Monolayer Fuse

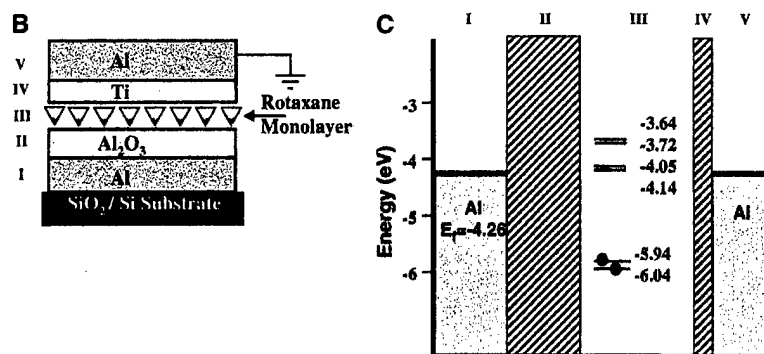

C. Collins et. al, *Science*, July 16, 1999

JASON Molecular Electronics Study

We now turn to another example of a nonlinear element. This work, in fact, received much attention in the popular press during the course of this particular JASON study. Work by Jim Heath from UCLA and Phil Keuches and Stan Williams from Hewlett Packard utilized a device in which a monomolecular layer of a rotaxane was deposited using Langmuir-Blodgett methods onto an oxidized Al electrode. The monolayer was then contacted with Ti metal, and the current-voltage properties of the resulting structure were measured.

## Rotaxane Monolayer Fuse

---

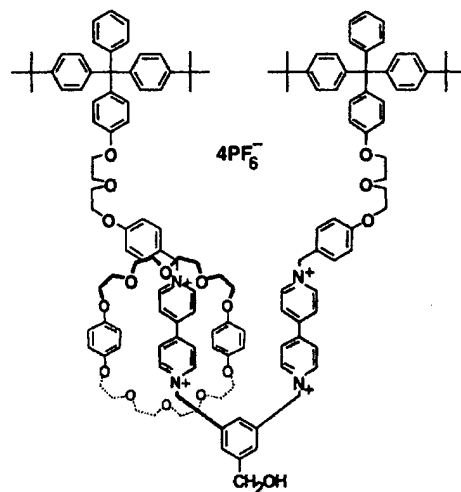

JASON Molecular Electronics Study

Rotaxane has an aromatic backbone and a clathrate around a viologen unit. This molecule was chosen apparently because solutions of the viologen unit can be reduced and because these units show some asymmetry in their electrochemistry.

## Rotaxane Monolayer Fuse

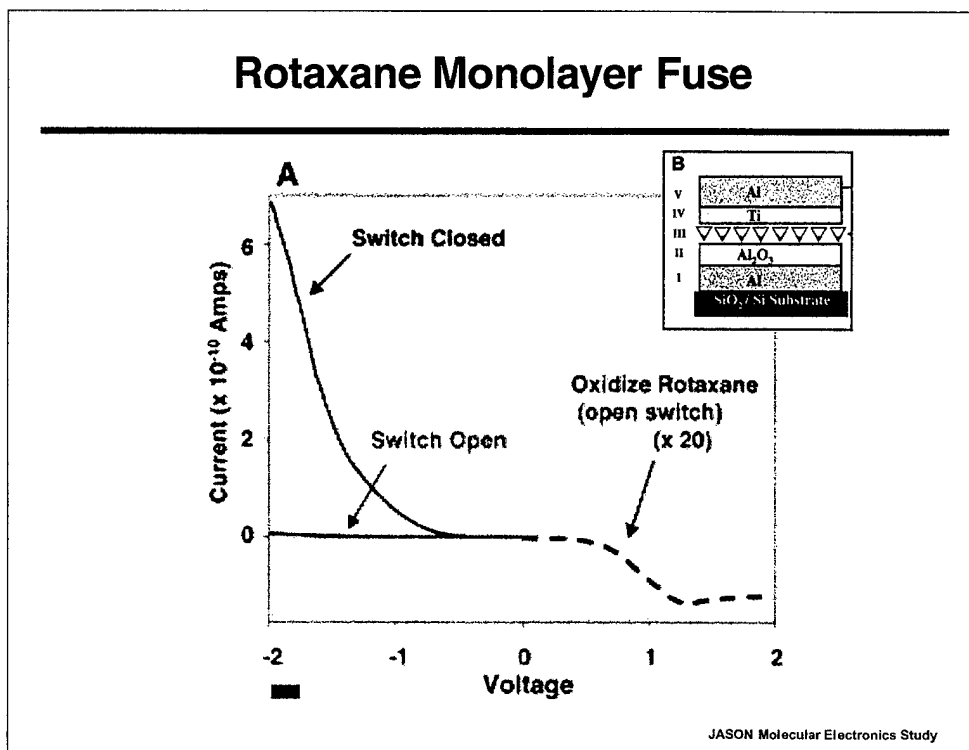

The experimental observation on this system is that when the voltage is of one polarity, the current increases with increasing voltage and this I-V characteristic can be repeated numerous times as long as the voltage is maintained in that polarity. However, when the polarity is reversed, the conductance irreversibly decreases, by a factor of over 10-20. Thus, this system acts as a monolayer-based electrical fuse into which a bit can be switched one time and its state read out many times.

A significant point of interest is the origin of the asymmetry of the device with respect to the applied bias. The anisotropic orientation of the molecular layer is one possible source of this asymmetry, although another possible source is the difference in chemical composition between the Al bottom metal layer and the top Ti metal layer. In the presence of water, titanium will oxidize to TiO<sub>2</sub>, which would create an insulating layer when the Ti electrode is under positive bias. Further experiments are required to determine whether the device properties arise primarily from the characteristics of the molecular layer or from the metallurgy and chemistry of the contacts themselves. Other very interesting studies of molecularly-based devices, including wires and nonlinear elements, can be found in the work of J. Tour (South Carolina, M. Reed (Yale), R. Metzger (Alabama), and J. Ellenbogen (MITRE), amongst others.

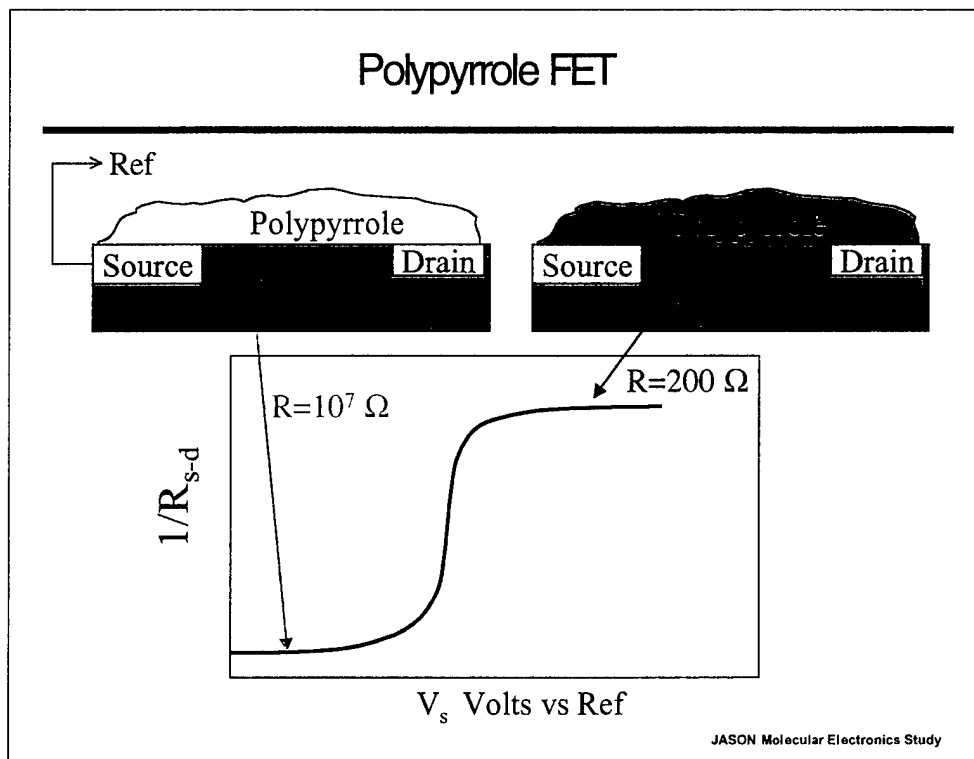

A third example of a molecular device can be found in the work of Mark Wrighton and co-workers at MIT. This work utilized an organic semiconductor, polypyrrole, as a chemically-switchable resistive element. Polypyrrole is a member of a class of organic materials that conduct electricity in one form and which are insulators in another form. Note that these bulk organic materials can, in principle, preserve their electrical properties on the nm scale provided that the correlation length for the physical phenomenon, in this case, electrical conduction, is sufficiently small, as seems to be the case of many of the conducting organic polymers. The MIT group demonstrated that through potential control one could manipulate reversibly the conductivity of the film and therefore manipulate the source/drain current. Interesting features of this system are that the control electrode need not be provided with each nonlinear element because the absolute potential of the source electrode could control whether the chemical transformation can occur. In addition, many different states of conductivity (i.e., several different bits) can in principle be written into the same material and into the same physical region of the device. Chemically different conducting polymers can also be synthesized so that the storage density could in principle be improved in that fashion as well. The switching was fully reversible and involved a change in source/drain conductance of over  $10^5$  between the two states of the polymer. A potential drawback is that the doping/undoping process involves physical ion flow through the material, so that the switching time is not likely to approach that of contemporary electronic devices, although it may still be very useful in moderate speed, highly parallelized computational architectures.

## Bistable Switch from CuTCNQ

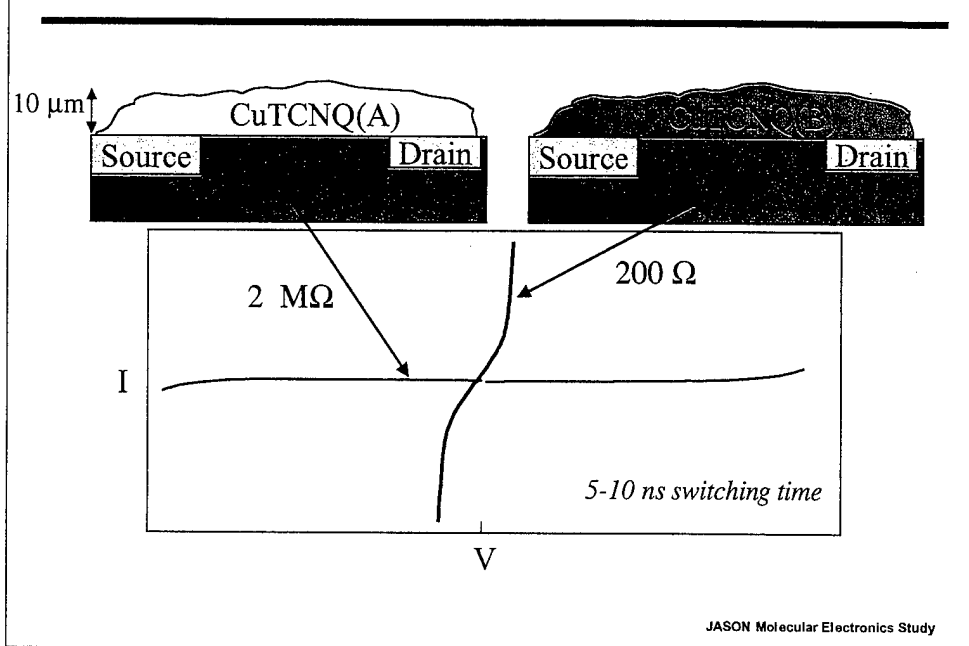

A fourth example of a molecular electronic device is a bistable switch that was formed from copper TCNQ. TCNQ is a well-known organic material that undergoes charge transfer and thus becomes electrically conductive when it reacts with copper. The resistance in the initial state is approximately 2 M ohm. However, if a critical field strength is exceeded, the resistance decreased to approximately 200 ohm, in a switching time of 5-10 ns. The mechanism of this interconversion is not yet known, nor is the long term durability of the switch established. Interesting features of this system are the fact that switching involves electronic motion as opposed to ionic motion, and thereby produces rapid switching times, and also that the change in conductance can exceed 5 orders of magnitude in a relatively simple molecular system.

## Toolkit Requirements

---

- *Nonlinear Elements*
- *Gain*
- **Wires**
- Directed Assembly
- Interface to Macroscopic World

JASON Molecular Electronics Study

As described above, there are a variety of methods that are emerging in which nonlinear elements can be obtained. However, a molecular electronic device cannot be fabricated from isolated nonlinear elements. Wires are also needed, as well as gain. In principle, there are at least two general approaches to obtain connections between the various molecular scale devices of interest.

## Nanometer Metal Contacts: Bring The Device to the Wires

---

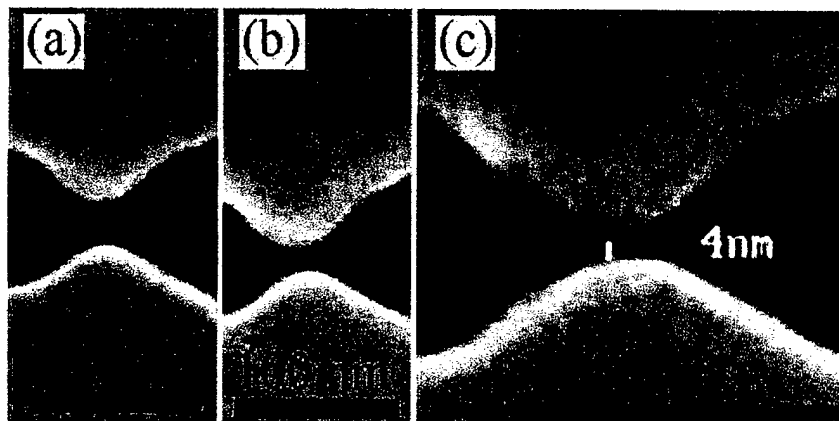

JASON Molecular Electronics Study

One method is illustrated from Charlie Marcus' lab at Stanford. This work has shown that it is possible to reproducibly fabricate and control the gaps between two metal lines such that the gap width is on the order of 1-4 nm. This is accomplished by electrodepositing the metal while monitoring the conductance between the two metal leads; when the conductance sharply increases, the sign of the plating current is reversed and the gap opened up slightly, to produce the desired interelectrode spacing.

## Electrostatic Particle Trapping

---

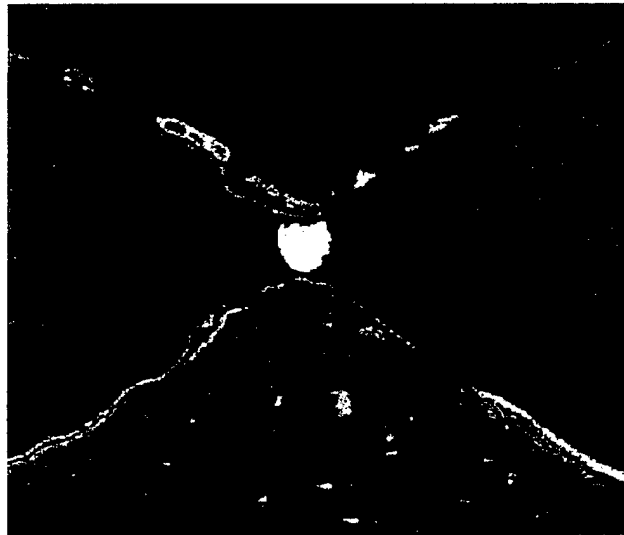

JASON Molecular Electronics Study

Single element molecular devices can be made between these small metal spacings. For example, a single platinum colloidal particle was trapped between these electrodes. This of course decreases the gap conductance and forms a nm-scale switch.



## Metallic Nanotubes

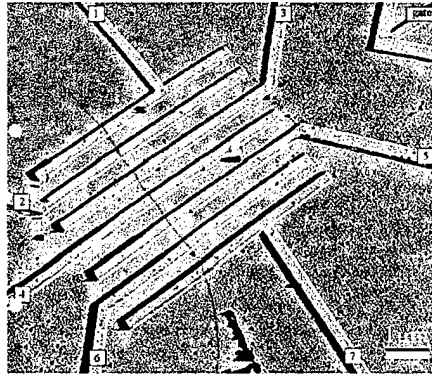

Resistance = 10 kohm in 1  $\mu\text{m}$   
Claim is transport is ballistic so resistance independent of distance  
(at least to 1  $\mu\text{m}$ )  
Compare to Cu  $\rho = 10^{-8}$  ohm-m; C tubes  $\rho = 10^{-7}$  ohm-m

JASON Molecular Electronics Study

Another method is to bring the devices to the contacts. This approach is depicted above, in which a carbon nanotube approximately 1.9 nm in diameter and approximately 1 micron in length randomly bridges micron-wide metal lines allowing a 4-point probe conductivity measurement to be performed. The important feature of this experiment is that the resistance is only 10 k $\Omega$  over the 1  $\mu\text{m}$  interelectrode gap, because the transport is ballistic in these nearly-defect free nanotubes. It is not yet known if this ballistic transport persists for much longer distances, but such an observation would be very significant because the transit time over large distances determines the latency in a processor or memory device. At present this limit on interconnect speed is a concern even for copper wire when interconnects become only a few nm in cross section. The resistivity of Cu is  $\rho = 10^{-8}$  ohm-m whereas the resistance to 100 kohm for the nanotube translates into a resistivity of  $10^{-7}$  ohm-m.

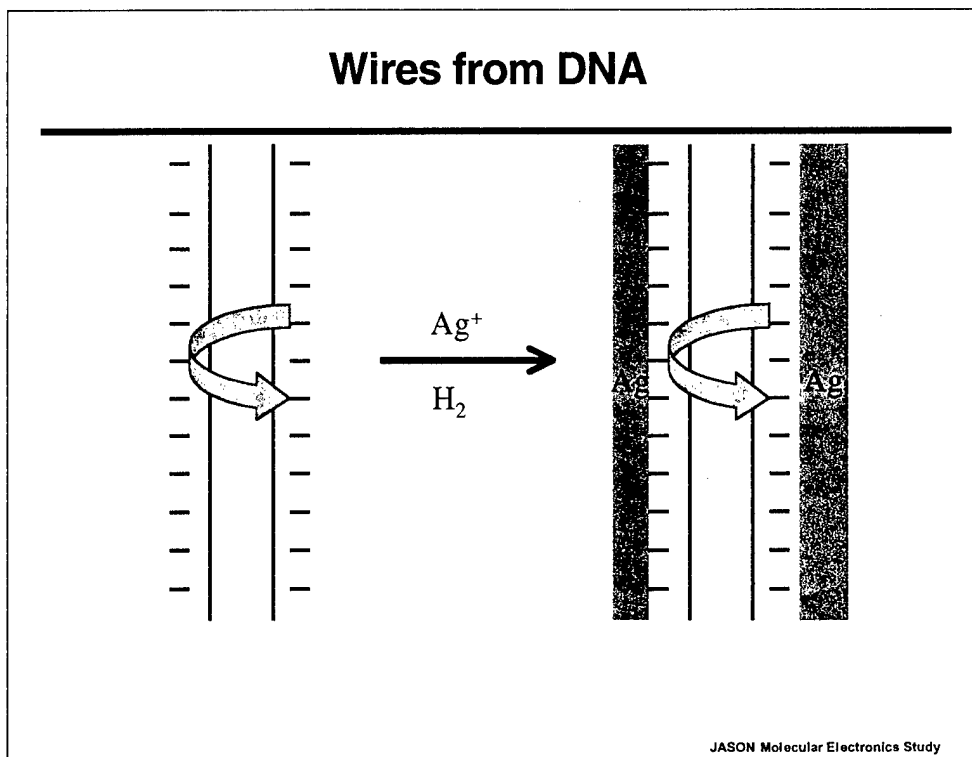

Another method to make wires on the nm scale might involve use of a templating material, for example DNA. In this mode, the DNA itself would not be the wire, but it would form the structural template for the wire material. DNA is a polyanionic species, and if exposed to silver cations and then to a reducing agent, silver can be plated along the DNA strand. This might prove to be a very versatile approach to constructing wires along pre-defined spatial directions.

## Micro/Nano Interface

---

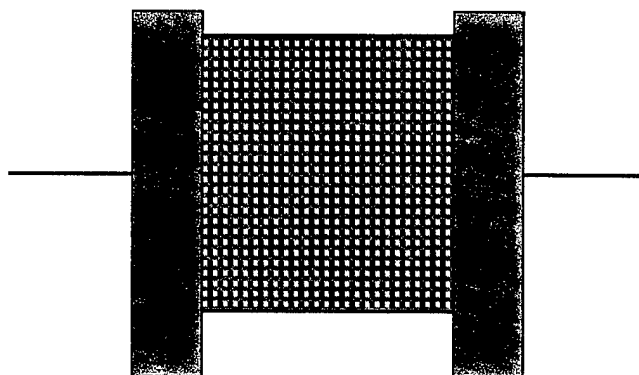

The need to have a micro/nano interface precludes direct connections to every individual device

JASON Molecular Electronics Study

Even after one has constructed a single device, one needs to link such devices together in order to achieve a functional unit cell that can store a bit of information. We desire to ultimately link these components into functional, repeatable structures on the nanometer scale that then can be strung together, with the entire assembly addressed from the micron scale. Based on the above arguments, self-assembly seems the most appropriate method for fabricating the devices on the required length scale.

## DNA as a Structural Tool

---

- Rigid on <50 nm lengths
- Already developed cut, join, splice ops
- Can specify connectivity of joints
- Thermodynamics optimal to come together, go apart, and form the specified joints

JASON Molecular Electronics Study

One method of achieving the desired directed self-assembly process might be to use DNA. DNA, is rigid on 50 nm lengths. Recombinant DNA technology has already provided the methodology to cut pieces, join pieces, and to splice pieces into a plethora of different combinations. The connectivity of the joints can also be specified, using sticky ends. An equally important point is that the DNA hybridization thermodynamics are nearly optimal to self anneal, so that the units do not come together too quickly and make chemical bonds only under kinetic control and not lead to the thermodynamic product. Ned Seeman at NYU is in fact working on this approach using branched DNA.

## Branched DNA

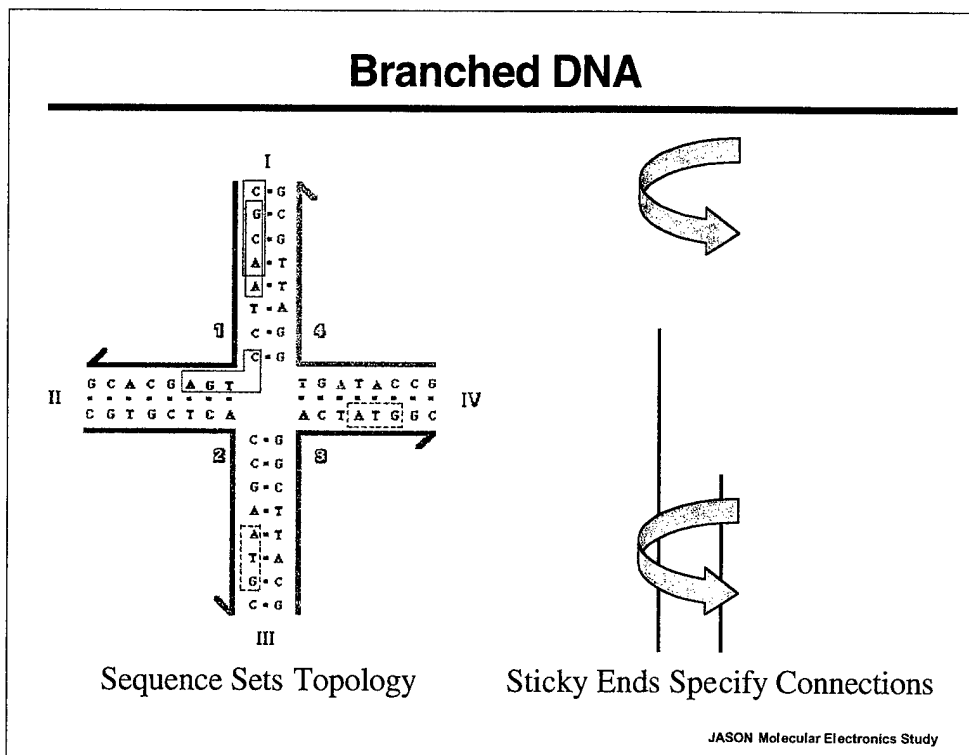

In branched DNA, instead of the b-DNA form, the base pairs are arranged so that the topology of a branchpoint is imposed. Including sticky ends on the strands, one can start to assemble structural motifs using this approach. The junction shown is composed of four strands of DNA, labeled with Arabic numerals and drawn in four colors, red (1), green (2), magenta (3) and cyan (4). The 3' end of each strand is indicated by the half-arrows. Each strand is paired with two other strands to form a double helical arm; the arms are numbered with Roman numerals. The hydrogen bonded base pairing that forms the double helices is indicated by the dots between the bases. The sequence of this junction has been optimized to minimize symmetry and non-Watson-Crick base pairing. Because there is no homologous twofold sequence symmetry flanking the central branch point, this junction cannot undergo the branch migration isomerization reaction. The molecule is designed by minimizing sequence symmetry; this means that all short segments of sequences (tetramers here) are unique. At the upper part of arm I, two of the 52 unique tetrameric elements in this complex are boxed; these are C.G.C.A and G.C.A.A. At the corner of strand 1, the sequence C.T.G.A is boxed. This is one of twelve sequences in the complex (3 on each strand) that span a junction. The complements to each of these 12 sequences are not present. Whereas tetrameric elements have been used to assign the sequence of this molecule, there is redundancy in the molecule amongst trimers, such as the A.T.G sequences shown in dotted boxes.

## Directed Synthesis of a DNA-Based Cube

---

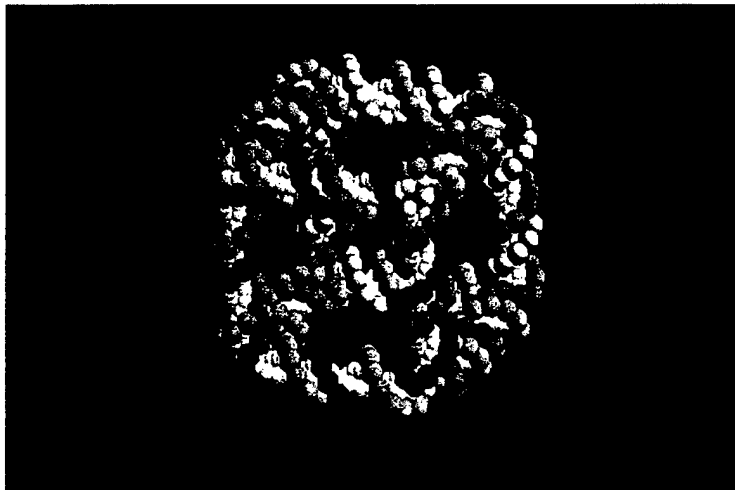

JASON Molecular Electronics Study

Including sticky ends on the strands, one can start to assemble structural motifs using this approach. For example, the figure above shows a DNA-based cube. The joints are then converted to normal double helical DNA through use of ligase. This representation of a DNA cube shows that it contains six different cyclic strands. Their backbones are shown in red (front), green (right), yellow (back), magenta (left), cyan (top) and dark blue (bottom). Each nucleotide is represented by a single colored dot for the backbone and a single white dot representing the base.

## Example Shift Register

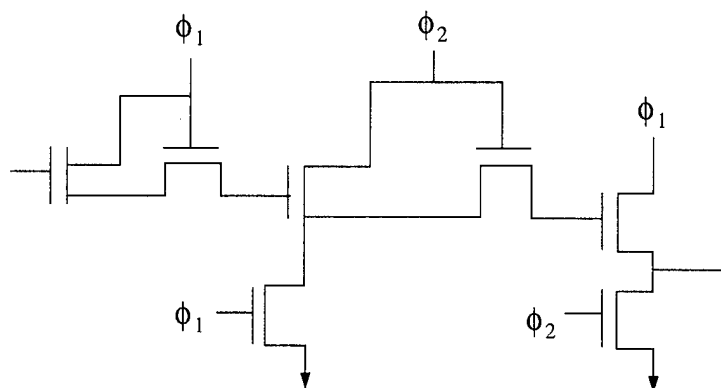

JASON Molecular Electronics Study

The shift register structure shown above can be mapped onto the layout in the next Figure. In this layout, dashed lines are, for example purposes, carbon nanotubes, which serve as the nonlinear elements in the system. The gates are solid lines that run perpendicular to, and intersect in the middle of, the dashed lines that represent the tubes. An attractive feature of this architecture is that repetition of that unit cell is sufficient to provide the shift register function on a macroscopic length scale.

## Example Shift Register

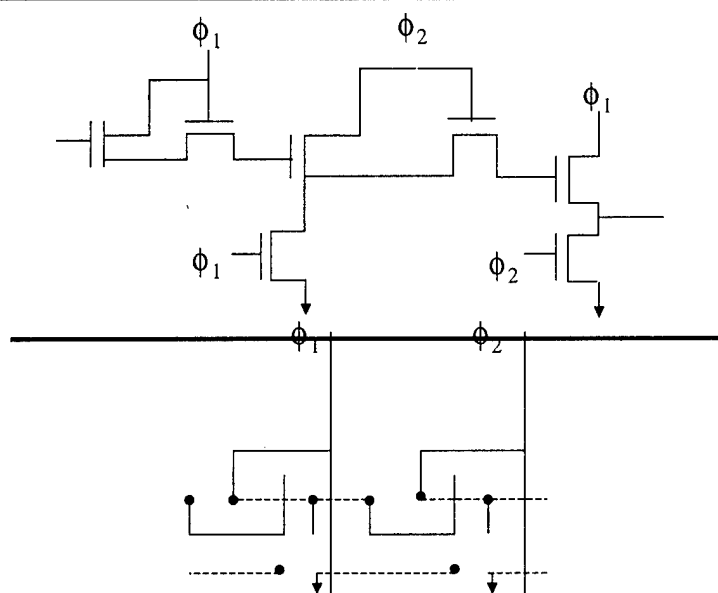

JASON Molecular Electronics Study



## Example Shift Register

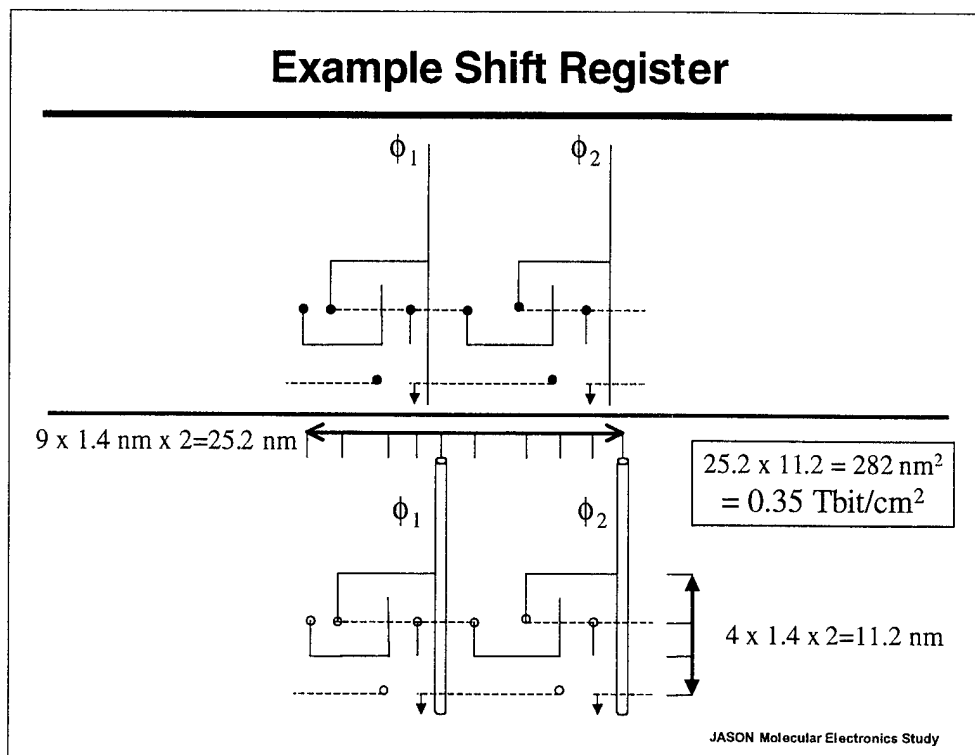

It is illuminating to compute the density of close-packed devices of this type. For an upper bound on the density, we assume that carbon nanotubes comprise the transistors, and that the wires are Ag-coated DNA. We then only separate the nanotube from the next nanotube by a distance equal to 1 nanotube diameter. This unit cell is therefore 25.2 nm wide and 11 nm high, or 282 nm<sup>2</sup>. In a planar structure, this structure would therefore become a 0.35 Tbit/cm<sup>2</sup> memory device, if the devices were close packed onto the entire surface.

## How Small is Small Enough?

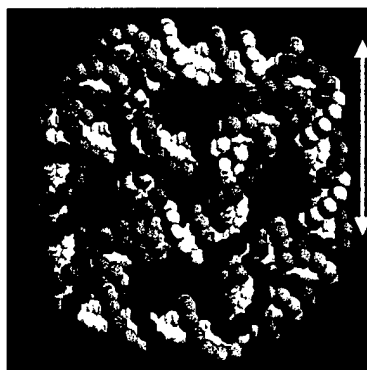

5.4 nm

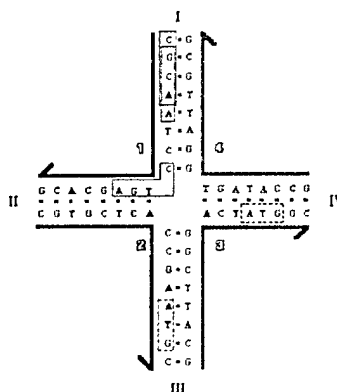

- Shift register has 10-20 “parts”/bit
- Footprint of the cube is 30 nm<sup>2</sup>; if planar then 3 Tbits/cm<sup>2</sup>
- Density of diamond 1.77 atoms/cm<sup>3</sup>; 10 nm<sup>2</sup> is ca. 200 C atoms
- This cube has just “assembly” parts and no active components
- Use the third dimension too and/or develop another structural manifold assembly capability

JASON Molecular Electronics Study

This is a large number, but in the context of the discussion above, it is not necessarily revolutionary in and of itself. Thus, one of the messages is that even DNA is not a small molecule on the scale that is needed to compete with projected advances in Si technology. Every nucleic acid has a molecular weight of several hundred a.m.u., and many base pairs are required to specify a branch in DNA. The length of one side of the cube displayed above, which does not have any active elements in it, is in the order of 5.4 nm, (two turns of the DNA double helix). This requires an area of 30 nm<sup>2</sup>, for a density of 3 Tbits/cm<sup>2</sup>, if the entire unit cell could be fabricated only within the constraints of this cube. The message is clearly that one is going to have to learn how to use the third dimension in this structure as well and/or develop another structural manifold assembly capability if one is to achieve Tb/cm<sup>2</sup> densities out of such a technology. This example serves to illustrate the difficulty of the ultimate problem; even using molecularly-based components, it is difficult (but not impossible of course) to envision constructing a device that would have a order-of-magnitude or more improvement in storage density if the system is primarily functioning in two dimensions: the third dimension must be effectively utilized in molecular systems to make them truly exciting from this particular viewpoint.

## Programmable Gate Array using DNA Lattice

---

- DNA assembles 3-D lattice of repeated unit cells
- Shift register programs each cell
  - ◆ 1-from left, 2-from bottom, 3-NAND, 4-crossover, 5-turn
- Realizes arbitrary logic circuit (e.g., exclusive-or)

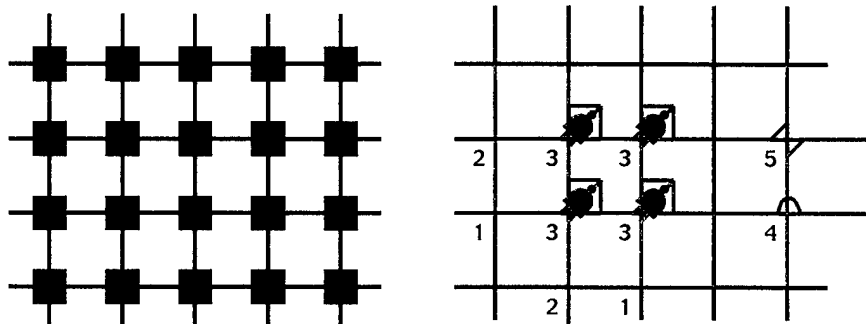

JASON Molecular Electronics Study

Arbitrary combinational and sequential logic functions may be realized by constructing a programmable gate array using a DNA lattice. A 3-D DNA lattice assembles a repeated array of unit cells. Each cell consists of three shift-register bits, and a programmable cell.

The unit cell treats the signals from below and from the left as inputs and generates outputs up and to the right. Depending on the contents of the shift-register bits, the unit cell can realize a copy function (copying from the left or from below), a 2-input NAND function, or a wiring function (crossover or turn). These five combinations allow the construction of any combinational logic function within one plane of the 3-D lattice structure. The remaining 3 combinations are used for wiring between the planes.

Sequential logic circuits may be realized by constructing adjacent planes of logic in opposite directions: even planes propagate signals up and to the right while odd planes propagate signals down and to the left. Feedback paths for sequential logic may then be realized by routing a signal to an adjacent plane.

Alternatively sequential logic circuits may be realized in a single plane by allowing additional wiring functions in the unit cell (e.g., all six two-point connections, and all four tees).

## **Directed Nanoscale Assembly**

---

- Molecular Electronics Program is really a Directed Nanoscale Component Assembly program
- Parts can come from anywhere: bucky tubes, polypyrrole, metal coated DNA, quantum dots, etc.
- Connect some number of pieces in a predesigned pattern, in one step
- Put them together into a functional unit cell

JASON Molecular Electronics Study

With this in mind, it is reasonable to propose that the emphasis moving forward on molecular electronics should be directed towards learning how to build the parts from the bottom up. In fact, one could envision establishing a directed nanoscale component assembly program, as opposed simply to a molecular electronics program. The goals of the two are different, and the former will focus on the assembly of a functional system as opposed to components of it. The components could, in principle, be comprised of carbon nanotubes, polypyrrole, metal coated DNA, quantum dots, etc. The goal, however, is to connect some number of pieces in a predesigned pattern in one synthetic step using simple chemical processes. With that in mind, we outline the basic milestones and capabilities that would need to be demonstrated in such a program.

## Directed Nanoscale Assembly

---

- Connect a conducting element to a nonlinear element



- Connect two different conducting elements to a nonlinear element

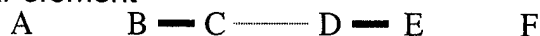

- Contact two different types of conducting elements to two metal lines, one type to one line, the other type to the other line



- Connect a conducting element to another conducting element in at least two different, predictable angles

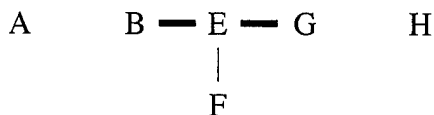

JASON Molecular Electronics Study

One goal is to demonstrate that one can connect a conducting element, say B and C, to a nonlinear element. The connections can be between a wire and a nonlinear element, a carbon nanotube, a quantum dot, or another feature. The important milestone is to specify the connectivity chemically. The next goal would be to connect two different conducting elements to a nonlinear element. The third goal is to connect not only same type of conducting elements, but to connect two different types of conducting elements to two metal lines. One type to one line, and the other type to the other line. Another goal is to demonstrate the ability to have a 90° angle connection.

## Directed Nanoscale Assembly

---

- Framing the problem in this fashion will focus the thinking of the people doing the science
- Won't find out what the real properties are until some circuits are built
- NSF, DOE, Services won't do this now or maybe ever
- Put the challenge out there and good science/technology will likely result
- Not unlike semiconductors in 1920's: know good things will come but don't know quite how or what

JASON Molecular Electronics Study

Framing the problem in this fashion will focus the thinking of the investigators doing the science. A related issue is that one will never find out what the properties are of these circuits until someone actually builds them. In many respects, this field is not unlike the field of semiconductors in the 1920's: one reasonably suspects that important advances are going to be made, but the end result is probably not going to be a computer like the ones known now.

## Si FET vs Carbon Nanotube FET

---

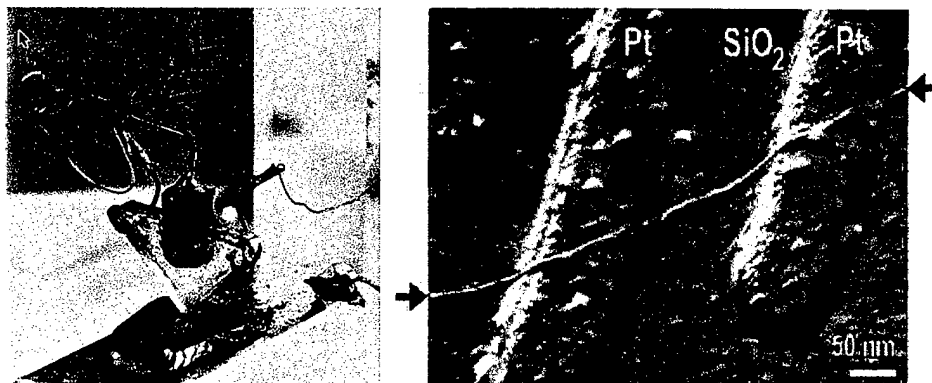

JASON Molecular Electronics Study

Certainly this type of directed nanoscale assembly program will produce good science, will probably produce enabling technology in some arena, and is the forward-looking type of program that DARPA is known for fostering and culturing.

## DISTRIBUTION LIST

Director of Space and SDI Programs  
SAF/AQSC  
1060 Air Force Pentagon  
Washington, DC 20330-1060

CMDR & Program Executive Officer  
U S Army/CSSD-ZA  
Strategic Defense Command  
PO Box 15280  
Arlington, VA 22215-0150

Superintendent  
Code 1424  
Attn Documents Librarian  
Naval Postgraduate School  
Monterey, CA 93943

DTIC [2]  
8725 John Jay Kingman Road  
Suite 0944  
Fort Belvoir, VA 22060-6218

Dr. A. Michael Andrews  
Director of Technology  
SARD-TT  
Room 3E480  
Research Development Acquisition  
103 Army Pentagon  
Washington, DC 20301-0103

Dr. Albert Brandenstein  
Chief Scientist  
Office of Nat'l Drug Control Policy  
Executive Office of the President  
Washington, DC 20500

Dr. H. Lee Buchanan, III  
Assistant Secretary of the Navy  
(Research, Development & Acquisition)  
3701 North Fairfax Drive  
1000 Navy Pentagon  
Washington, DC 20350-1000

Dr. Collier  
Chief Scientist  
U S Army Strategic Defense Command  
PO Box 15280  
Arlington, VA 22215-0280

D A R P A Library  
3701 North Fairfax Drive  
Arlington, VA 22209-2308

Dr. Victor Demarines, Jr.  
President and Chief Exec Officer  
The MITRE Corporation  
A210  
202 Burlington Road  
Bedford, MA 01730-1420

Mr. Frank Fernandez  
Director  
DARPA/DIRO  
3701 North Fairfax Drive  
Arlington, VA 22203-1714

Mr. Dan Flynn [5]  
Deputy Chief  
OSWR  
CDT/OWTP  
4P07, NHB  
Washington, DC 20505

Dr. Paris Genalis  
Deputy Director  
OUSD(A&T)/S&TS/NW  
The Pentagon, Room 3D1048  
Washington, DC 20301

Dr. Lawrence K. Gershwin  
NIO/S&T  
2E42, OHB  
Washington, DC 20505

General Thomas F. Gioconda [5]  
Assistant Secretary for Defense  
US Department of Energy  
DP-1, Room 4A019  
Mailstop 4A-028  
1000 Independence Ave, SW  
Washington, DC 20585

Mr. David Havlik  
Manager  
Weapons Program Coordination Office  
MS 9006  
Sandia National Laboratories  
PO Box 969  
Livermore, CA 94551-0969



## DISTRIBUTION LIST

Dr. Helmut Hellwig  
Deputy Asst Secretary  
(Science, Technology and Engineering)  
SAF/AQR  
1060 Air Force Pentagon  
Washington, DC 20330-1060

Dr. Robert G. Henderson  
Director  
JASON Program Office  
The MITRE Corporation  
1820 Dolley Madison Blvd  
Mailstop W553  
McLean, VA 22102

J A S O N Library [5]  
The MITRE Corporation  
Mail Stop W002  
1820 Dolley Madison Blvd  
McLean, VA 22102

Mr. O' Dean P. Judd  
Los Alamos National Laboratory  
Mailstop F650  
Los Alamos, NM 87545

Dr. Bobby R. Junker  
Office of Naval Research  
Code 111  
800 North Quincy Street  
Arlington, VA 22217

Dr. Martha Krebs  
Director  
Energy Research, ER-1, Rm 7B-058  
1000 Independence Ave, SW  
Washington, DC 20858

Lt Gen, Howard W. Leaf, ( Retired)  
Director, Test and Evaluation  
HQ USAF/TE  
1650 Air Force Pentagon  
Washington, DC 20330-1650

Dr. Arthur Manfredi  
ZETA Associates  
10300 Eaton Drive  
Suite 500  
Fairfax VA 22030-2239

Dr. George Mayer  
Scientific Director  
Army Research Office  
4015 Wilson Blvd  
Tower 3, Suite 216  
Arlington, VA 22203-2529

Ms. M. Jill Mc Master  
Editor  
Journal of Intelligence Community Research  
and Development (JICRD)  
Investment Program Office (IPO)  
1041 Electric Avenue  
Vienna, VA 20180

Dr. Thomas Meyer  
DARPA/DIRO  
3701 N. Fairfax Drive  
Arlington, VA 22203

Dr. Bill Murphy  
ACIS  
6014 Martins Landing Lane  
Burke VA 22015

Dr. Julian C. Nall  
Institute for Defense Analyses  
1801 North Beauregard Street  
Alexandria, VA 22311

Dr. Ari Patrinos [5]  
Associate Director  
Biological and Environmental Research  
SC-70  
US Department of Energy  
19901 Germantown Road  
Germantown, MD 207874-1290

Dr. Bruce Pierce  
USD(A)D S  
The Pentagon, Room 3D136  
Washington, DC 20301-3090

Mr. John Rausch [2]  
Division Head 06 Department  
NAVOPINTCEN  
4301 Suitland Road  
Washington, DC 20390

## DISTRIBUTION LIST

Records Resource  
The MITRE Corporation  
Mailstop W115  
1820 Dolley Madison Blvd  
McLean, VA 22102

Dr. Peter D. Zimmerman  
Science Advisor  
ACDA  
320 21st Street, NW  
Washington, DC 20451

Dr. Fred E. Saalfeld  
Director  
Office of Naval Research  
800 North Quincy Street  
Arlington, VA 22217-5000

Dr. Dan Schuresko  
O/DDS&T  
OSA/ATG  
Room 23F20N, WF-2  
Washington, DC 20505

Dr. John Schuster  
Submarine Warfare Division  
Submarine, Security & Tech  
Head (N875)  
2000 Navy Pentagon Room 4D534  
Washington, DC 20350-2000

Dr. Richard Spinrad  
US Naval Observatory  
Naval Oceanographers Office  
3450 Massachusetts Ave, NW  
Washington, DC 20392-5421

Dr. Michael A. Stroschio  
US Army Research Office  
P. O. Box 12211  
Research Triangle Park, NC 27709-2211

Dr. George W. Ullrich [3]  
ODUSD(S&T)  
Director for Weapons Systems  
3080 Defense Pentagon  
Washington, DC 20301-3080

Dr. David Whelan  
Director  
DARPA/TTO  
3701 North Fairfax Drive  
Arlington, VA 22203-1714