Amazon Redshift
Database Developer Guide
API Version 2012-12-01



Amazon Redshift: Database Developer Guide

Copyright © 2016 Amazon Web Services, Inc. and/or its affiliates. All rights reserved.

Amazon's trademarks and trade dress may not be used in connection with any product or service that is not Amazon's, in any manner that is likely to cause confusion among customers, or in any manner that disparages or discredits Amazon. All other trademarks not owned by Amazon are the property of their respective owners, who may or may not be affiliated with, connected to, or sponsored by Amazon.

Table of Contents

Welcome	1
Are You a First-Time Amazon Redshift User?	1
Are You a Database Developer?	2
Prerequisites	3
Amazon Redshift System Overview	4
Data Warehouse System Architecture	4
Performance	6
Columnar Storage	8
Internal Architecture and System Operation	9
Workload Management	10
Using Amazon Redshift with Other Services	11
Moving Data Between Amazon Redshift and Amazon S3	11
Using Amazon Redshift with Amazon DynamoDB	11
Importing Data from Remote Hosts over SSH	11
Automating Data Loads Using AWS Data Pipeline	11
Getting Started Using Databases	12
Step 1: Create a Database	12
Step 2: Create a Database User	13
Delete a Database User	13
Step 3: Create a Database Table	13
Insert Data Rows into a Table	14
Select Data from a Table	14
Step 4: Load Sample Data	15
Step 5: Query the System Tables	15
View a List of Table Names	15
View Database Users	16
View Recent Queries	17
Determine the Process ID of a Running Query	17
Step 6: Cancel a Query	18
Cancel a Query from Another Session	19
Cancel a Query Using the Superuser Queue	19
Step 7: Clean Up Your Resources	19
Amazon Redshift Best Practices	21
Best Practices for Designing Tables	21
Take the Tuning Table Design Tutorial	22
Choose the Best Sort Key	22
Choose the Best Distribution Style	22
Use Automatic Compression	23
Define Constraints	23
Use the Smallest Possible Column Size	24
Using Date/Time Data Types for Date Columns	24
Best Practices for Loading Data	24
Take the Loading Data Tutorial	24
Take the Tuning Table Design Tutorial	25
Use a COPY Command to Load Data	25
Use a Single COPY Command	25
Split Your Load Data into Multiple Files	25
Compress Your Data Files	25
Use a Manifest File	25
Verify Data Files Before and After a Load	26
Use a Multi-Row Insert	26
Use a Bulk Insert	26
Load Data in Sort Key Order	26
Load Data in Sequential Blocks	27
Use Time-Series Tables	27

Use a Staging Table to Perform a Merge	27
Schedule Around Maintenance Windows	27
Best Practices for Designing Queries	28
Tutorial: Tuning Table Design	30
Prerequisites	30
Steps	30
Step 1: Create a Test Data Set	30
To Create a Test Data Set	31
Next Step	34
Step 2: Establish a Baseline	34
To Test System Performance to Establish a Baseline	35
Next Step	37
Step 3: Select Sort Keys	38
To Select Sort Keys	38
Next Step	38
Step 4: Select Distribution Styles	39
Distribution Styles	39
To Select Distribution Styles	40
Next Step	42
Step 5: Review Compression Encodings	42
To Review Compression Encodings	42
Next Step	45
Step 6: Recreate the Test Data Set	45
To Recreate the Test Data Set	45
Next Step	48
Step 7: Retest System Performance After Tuning	48
To Retest System Performance After Tuning	48
Next Step	52
Step 8: Evaluate the Results	52
Next Step	54
Step 9: Clean Up Your Resources	54
Next Step	54
Summary	54
Next Step	55
Tutorial: Loading Data from Amazon S3	56
Prerequisites	56
Overview	57
Steps	57
Step 1: Launch a Cluster	57
Next Step	58
Step 2: Download the Data Files	58
Next Step	59
Step 3: Upload the Files to an Amazon S3 Bucket	59
.....	59
Next Step	60
Step 4: Create the Sample Tables	60
Next Step	62
Step 5: Run the COPY Commands	62
COPY Command Syntax	62
Loading the SSB Tables	64
Step 6: Vacuum and Analyze the Database	74
Next Step	75
Step 7: Clean Up Your Resources	75
Next	75
Summary	75
Next Step	76
Tutorial: Configuring WLM Queues to Improve Query Processing	77
Overview	77

Prerequisites	77
Sections	78
Section 1: Understanding the Default Queue Processing Behavior	78
Step 1: Create the WLM_QUEUE_STATE_VW View	78
Step 2: Create the WLM_QUERY_STATE_VW View	79
Step 3: Run Test Queries	80
Section 2: Modifying the WLM Query Queue Configuration	82
Step 1: Create a Parameter Group	82
Step 2: Configure WLM	82
Step 3: Associate the Parameter Group with Your Cluster	84
Section 3: Routing Queries to Queues Based on User Groups and Query Groups	86
Step 1: View Query Queue Configuration in the Database	86
Step 2: Run a Query Using the Query Group Queue	87
Step 3: Create a Database User and Group	88
Step 4: Run a Query Using the User Group Queue	88
Section 4: Using wlm_query_slot_count to Temporarily Override Concurrency Level in a Queue	90
Step 1: Override the Concurrency Level Using wlm_query_slot_count	90
Step 2: Run Queries from Different Sessions	91
Section 5: Cleaning Up Your Resources	92
Managing Database Security	93
Amazon Redshift Security Overview	93
Default Database User Privileges	94
Superusers	94
Users	95
Creating, Altering, and Deleting Users	95
Groups	96
Creating, Altering, and Deleting Groups	96
Schemas	96
Creating, Altering, and Deleting Schemas	96
Search Path	97
Schema-Based Privileges	97
Example for Controlling User and Group Access	97
Designing Tables	100
Choosing a Column Compression Type	100
Compression Encodings	101
Testing Compression Encodings	107
Example: Choosing Compression Encodings for the CUSTOMER Table	109
Choosing a Data Distribution Style	110
Data Distribution Concepts	111
Distribution Styles	112
Viewing Distribution Styles	112
Evaluating Query Patterns	113
Designating Distribution Styles	113
Evaluating the Query Plan	114
Query Plan Example	116
Distribution Examples	120
Choosing Sort Keys	122
Compound Sort Key	123
Interleaved Sort Key	123
Comparing Sort Styles	124
Defining Constraints	127
Analyzing Table Design	128
Loading Data	130
Using COPY to Load Data	130
Credentials and Access Permissions	131
Preparing Your Input Data	132
Loading Data from Amazon S3	133
Loading Data from Amazon EMR	141

Loading Data from Remote Hosts	145
Loading from Amazon DynamoDB	151
Verifying That the Data Was Loaded Correctly	153
Validating Input Data	154
Automatic Compression	154
Optimizing for Narrow Tables	156
Default Values	156
Troubleshooting	157
Updating with DML	161
Updating and Inserting	161
Merge Method 1: Replacing Existing Rows	162
Merge Method 2: Specifying a Column List	162
Creating a Temporary Staging Table	162
Performing a Merge Operation by Replacing Existing Rows	163
Performing a Merge Operation by Specifying a Column List	163
Merge Examples	165
Performing a Deep Copy	167
Analyzing Tables	169
ANALYZE Command History	171
Automatic Analysis	171
Vacuuming Tables	172
VACUUM Frequency	172
Sort Stage and Merge Stage	173
Vacuum Threshold	173
Vacuum Types	173
Managing Vacuum Times	174
Vacuum Column Limit Exceeded Error	180
Managing Concurrent Write Operations	181
Serializable Isolation	181
Write and Read-Write Operations	182
Concurrent Write Examples	183
Unloading Data	185
Unloading Data to Amazon S3	185
Unloading Encrypted Data Files	188
Unloading Data in Delimited or Fixed-Width Format	189
Reloading Unloaded Data	190
Creating User-Defined Functions	192
UDF Constraints	192
UDF Security and Privileges	192
UDF Data Types	193
ANYELEMENT Data Type	193
Naming UDFs	194
Overloading Function Names	194
Preventing UDF Naming Conflicts	194
Creating a Scalar UDF	194
Scalar Function Example	195
Python Language Support	195
Importing Custom Python Library Modules	196
Tuning Query Performance	199
Query Processing	199
Query Planning And Execution Workflow	200
Reviewing Query Plan Steps	201
Query Plan	202
Factors Affecting Query Performance	208
Analyzing and Improving Queries	209
Query Analysis Workflow	209
Reviewing Query Alerts	210
Analyzing the Query Plan	211

Analyzing the Query Summary	212
Improving Query Performance	216
Diagnostic Queries for Query Tuning	219
Implementing Workload Management	222
Defining Query Queues	223
Modifying the WLM Configuration	226
WLM Queue Assignment Rules	226
Assigning Queries to Queues	229
Dynamic and Static Properties	230
Monitoring Workload Management	232
Troubleshooting Queries	233
Connection Fails	234
Query Hangs	234
Query Takes Too Long	235
Load Fails	236
Load Takes Too Long	236
Load Data Is Incorrect	236
Setting the JDBC Fetch Size Parameter	237
SQL Reference	238
Amazon Redshift SQL	238
SQL Functions Supported on the Leader Node	238
Amazon Redshift and PostgreSQL	239
Using SQL	245
SQL Reference Conventions	245
Basic Elements	245
Expressions	269
Conditions	273
SQL Commands	290
ABORT	291
ALTER DATABASE	292
ALTER DEFAULT PRIVILEGES	294
ALTER GROUP	296
ALTER SCHEMA	297
ALTER TABLE	297
ALTER TABLE APPEND	303
ALTER USER	306
ANALYZE	309
ANALYZE COMPRESSION	310
BEGIN	312
CANCEL	313
CLOSE	315
COMMENT	316
COMMIT	317
COPY	317
CREATE DATABASE	371
CREATE FUNCTION	372
CREATE GROUP	374
CREATE LIBRARY	375
CREATE SCHEMA	377
CREATE TABLE	378
CREATE TABLE AS	389
CREATE USER	397
CREATE VIEW	400
DEALLOCATE	401
DECLARE	401
DELETE	404
DROP DATABASE	405
DROP FUNCTION	406

DROP GROUP	406
DROP LIBRARY	407
DROP SCHEMA	407
DROP TABLE	408
DROP USER	411
DROP VIEW	412
END	413
EXECUTE	414
EXPLAIN	415
FETCH	419
GRANT	420
INSERT	424
LOCK	428
PREPARE	429
RESET	430
REVOKE	431
ROLLBACK	434
SELECT	435
SELECT INTO	465
SET	465
SET SESSION AUTHORIZATION	468
SET SESSION CHARACTERISTICS	469
SHOW	469
START TRANSACTION	470
TRUNCATE	470
UNLOAD	471
UPDATE	483
VACUUM	488
SQL Functions Reference	491
Leader Node-Only Functions	492
Aggregate Functions	493
Bit-Wise Aggregate Functions	503
Window Functions	508
Conditional Expressions	552
Date and Time Functions	561
Math Functions	594
String Functions	617
JSON Functions	654
Data Type Formatting Functions	657
System Administration Functions	667
System Information Functions	670
Reserved Words	681
System Tables Reference	685
System Tables and Views	685
Types of System Tables and Views	686
Visibility of Data in System Tables and Views	686
Filtering System-Generated Queries	686
STL Tables for Logging	687
STL_AGGR	688
STL_ALERT_EVENT_LOG	690
STL_ANALYZE	691
STL_BCAST	693
STL_COMMIT_STATS	694
STL_CONNECTION_LOG	695
STL_DDLTEXT	696
STL_DELETE	698
STL_DIST	700
STL_ERROR	701

STL_EXPLAIN	702
STL_FILE_SCAN	704
STL_HASH	705
STL_HASHJOIN	706
STL_INSERT	708
STL_LIMIT	709
STL_LOAD_COMMITS	711
STL_LOAD_ERRORS	713
STL_LOADERROR_DETAIL	715
STL_MERGE	716
STL_MERGEJOIN	717
STL_NESTLOOP	718
STL_PARSE	719
STL_PLAN_INFO	720
STL_PROJECT	722
STL_QUERY	724
STL_QUERYTEXT	726
STL_REPLACEMENTS	727
STL_RESTARTED_SESSIONS	728
STL_RETURN	729
STL_S3CLIENT	730
STL_S3CLIENT_ERROR	731
STL_SAVE	732
STL_SCAN	734
STL_SESSIONS	736
STL_SORT	737
STL_SSHCLIENT_ERROR	738
STL_STREAM_SEGS	738
STL_TR_CONFLICT	739
STL_UNDONE	740
STL_UNIQUE	741
STL_UNLOAD_LOG	742
STL_USERLOG	743
STL_UTILITYTEXT	744
STL_VACUUM	746
STL_WARNING	748
STL_WINDOW	749
STL_WLM_ERROR	750
STL_WLM_QUERY	750
STV Tables for Snapshot Data	752
STV_ACTIVE_CURSORS	753
STV_BLOCKLIST	753
STV_CURSOR_CONFIGURATION	756
STV_EXEC_STATE	756
STV_INFLIGHT	758
STV_LOAD_STATE	759
STV_LOCKS	760
STV_PARTITIONS	761
STV_RECENTS	762
STV_SESSIONS	764
STV_SLICES	764
STV_STARTUP_RECOVERY_STATE	765
STV_TBL_PERM	766
STV_TBL_TRANS	768
STV_WLM_CLASSIFICATION_CONFIG	769
STV_WLM_QUERY_QUEUE_STATE	770
STV_WLM_QUERY_STATE	771
STV_WLM_QUERY_TASK_STATE	772

STV_WLM_SERVICE_CLASS_CONFIG	773
STV_WLM_SERVICE_CLASS_STATE	775
System Views	776
SVL_COMPILE	777
SVV_DISKUSAGE	778
SVV_INTERLEAVED_COLUMNS	780
SVL_QERROR	781
SVL_QLOG	781
SVV_QUERY_INFLIGHT	782
SVL_QUERY_QUEUE_INFO	783
SVL_QUERY_REPORT	784
SVV_QUERY_STATE	786
SVL_QUERY_SUMMARY	788
SVL_STATEMENTTEXT	790
SVV_TABLE_INFO	791
SVV_TRANSACTIONS	793
SVL_UDF_LOG	795
SVV_VACUUM_PROGRESS	796
SVV_VACUUM_SUMMARY	797
SVL_VACUUM_PERCENTAGE	798
System Catalog Tables	799
PG_DEFAULT_ACL	799
PG_LIBRARY	801
PG_STATISTIC_INDICATOR	801
PG_TABLE_DEF	802
Querying the Catalog Tables	804
Configuration Reference	809
Modifying the Server Configuration	809
analyze_threshold_percent	810
Values (Default in Bold)	810
Description	810
Example	810
datestyle	810
Values (Default in Bold)	810
Description	810
Example	810
extra_float_digits	811
Values (Default in Bold)	811
Description	811
max_cursor_result_set_size	811
Values (Default in Bold)	811
Description	811
query_group	811
Values (Default in Bold)	811
Description	811
search_path	812
Values (Default in Bold)	812
Description	812
Example	812
statement_timeout	813
Values (Default in Bold)	813
Description	813
Example	814
timezone	814
Values (Default in Bold)	814
Syntax	814
Description	814
Time Zone Formats	814

Examples	816
wlm_query_slot_count	816
Values (Default in Bold)	816
Description	816
Examples	817
Sample Database	818
CATEGORY Table	819
DATE Table	820
EVENT Table	820
VENUE Table	820
USERS Table	821
LISTING Table	821
SALES Table	822
Time Zone Names and Abbreviations	823
Time Zone Names	823
Time Zone Abbreviations	833
Document History	838

Welcome

Topics

- [Are You a First-Time Amazon Redshift User? \(p. 1\)](#)
- [Are You a Database Developer? \(p. 2\)](#)
- [Prerequisites \(p. 3\)](#)

This is the *Amazon Redshift Database Developer Guide*.

Amazon Redshift is an enterprise-level, petabyte scale, fully managed data warehousing service.

This guide focuses on using Amazon Redshift to create and manage a data warehouse. If you work with databases as a designer, software developer, or administrator, it gives you the information you need to design, build, query, and maintain your data warehouse.

Are You a First-Time Amazon Redshift User?

If you are a first-time user of Amazon Redshift, we recommend that you begin by reading the following sections.

- Service Highlights and Pricing – The [product detail page](#) provides the Amazon Redshift value proposition, service highlights, and pricing.
- Getting Started – [Amazon Redshift Getting Started](#) includes an example that walks you through the process of creating an Amazon Redshift data warehouse cluster, creating database tables, uploading data, and testing queries.

After you complete the Getting Started guide, we recommend that you explore one of the following guides:

- [Amazon Redshift Cluster Management Guide](#) – The Cluster Management guide shows you how to create and manage Amazon Redshift clusters.

If you are an application developer, you can use the Amazon Redshift Query API to manage clusters programmatically. Additionally, the AWS SDK libraries that wrap the underlying Amazon Redshift API can help simplify your programming tasks. If you prefer a more interactive way of managing clusters, you can use the Amazon Redshift console and the AWS command line interface (AWS CLI). For information about the API and CLI, go to the following manuals:

- [API Reference](#)
- [CLI Reference](#)
- Amazon Redshift Database Developer Guide (*this document*) – If you are a database developer, the Database Developer Guide explains how to design, build, query, and maintain the databases that make up your data warehouse.

If you are transitioning to Amazon Redshift from another relational database system or data warehouse application, you should be aware of important differences in how Amazon Redshift is implemented. For a summary of the most important considerations for designing tables and loading data, see [Best Practices for Designing Tables \(p. 21\)](#) and [Best Practices for Loading Data \(p. 24\)](#). Amazon Redshift is based on PostgreSQL 8.0.2. For a detailed list of the differences between Amazon Redshift and PostgreSQL, see [Amazon Redshift and PostgreSQL \(p. 239\)](#).

Are You a Database Developer?

If you are a database user, database designer, database developer, or database administrator, the following table will help you find what you're looking for.

If you want to ...	We recommend
Quickly start using Amazon Redshift	<p>Begin by following the steps in Amazon Redshift Getting Started to quickly deploy a cluster, connect to a database, and try out some queries.</p> <p>When you are ready to build your database, load data into tables, and write queries to manipulate data in the data warehouse, return here to the Database Developer Guide.</p>
Learn about the internal architecture of the Amazon Redshift data warehouse.	<p>The Amazon Redshift System Overview (p. 4) gives a high-level overview of Amazon Redshift's internal architecture.</p> <p>If you want a broader overview of the Amazon Redshift web service, go to the Amazon Redshift product detail page.</p>
Create databases, tables, users, and other database objects.	<p>Getting Started Using Databases (p. 12) is a quick introduction to the basics of SQL development.</p> <p>The Amazon Redshift SQL (p. 238) has the syntax and examples for Amazon Redshift SQL commands and functions and other SQL elements.</p> <p>Best Practices for Designing Tables (p. 21) provides a summary of our recommendations for choosing sort keys, distribution keys, and compression encodings.</p>
Learn how to design tables for optimum performance.	<p>Designing Tables (p. 100) details considerations for applying compression to the data in table columns and choosing distribution and sort keys.</p>
Load data.	<p>Loading Data (p. 130) explains the procedures for loading large datasets from Amazon DynamoDB tables or from flat files stored in Amazon S3 buckets.</p> <p>Best Practices for Loading Data (p. 24) provides for tips for loading your data quickly and effectively.</p>
Manage users, groups, and database security.	<p>Managing Database Security (p. 93) covers database security topics.</p>

If you want to ...	We recommend
Monitor and optimize system performance.	<p>The System Tables Reference (p. 685) details system tables and views that you can query for the status of the database and monitor queries and processes.</p> <p>You should also consult the Amazon Redshift Cluster Management Guide to learn how to use the AWS Management Console to check the system health, monitor metrics, and back up and restore clusters.</p>
Analyze and report information from very large datasets.	<p>Many popular software vendors are certifying Amazon Redshift with their offerings to enable you to continue to use the tools you use today. For more information, see the Amazon Redshift partner page.</p> <p>The SQL Reference (p. 238) has all the details for the SQL expressions, commands, and functions Amazon Redshift supports.</p>

Prerequisites

Before you use this guide, you should complete these tasks.

- Install a SQL client.
- Launch an Amazon Redshift cluster.
- Connect your SQL client to the cluster master database.

For step-by-step instructions, see [Amazon Redshift Getting Started](#).

You should also know how to use your SQL client and should have a fundamental understanding of the SQL language.

Amazon Redshift System Overview

Topics

- [Data Warehouse System Architecture \(p. 4\)](#)
- [Performance \(p. 6\)](#)
- [Columnar Storage \(p. 8\)](#)
- [Internal Architecture and System Operation \(p. 9\)](#)
- [Workload Management \(p. 10\)](#)
- [Using Amazon Redshift with Other Services \(p. 11\)](#)

An Amazon Redshift data warehouse is an enterprise-class relational database query and management system.

Amazon Redshift supports client connections with many types of applications, including business intelligence (BI), reporting, data, and analytics tools.

When you execute analytic queries, you are retrieving, comparing, and evaluating large amounts of data in multiple-stage operations to produce a final result.

Amazon Redshift achieves efficient storage and optimum query performance through a combination of massively parallel processing, columnar data storage, and very efficient, targeted data compression encoding schemes. This section presents an introduction to the Amazon Redshift system architecture.

Data Warehouse System Architecture

This section introduces the elements of the Amazon Redshift data warehouse architecture as shown in the following figure.

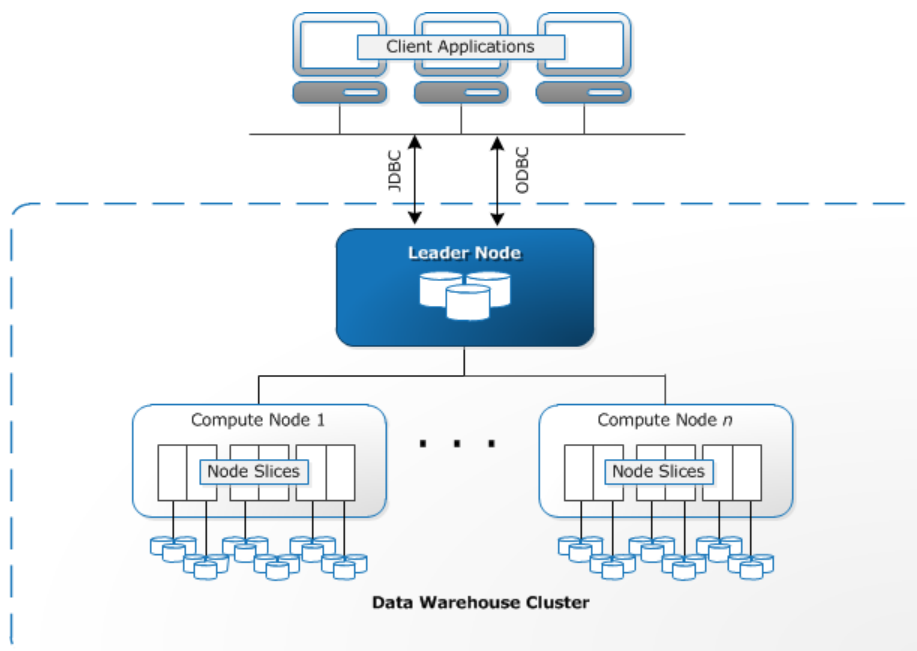

Client applications

Amazon Redshift integrates with various data loading and ETL (extract, transform, and load) tools and business intelligence (BI) reporting, data mining, and analytics tools. Amazon Redshift is based on industry-standard PostgreSQL, so most existing SQL client applications will work with only minimal changes. For information about important differences between Amazon Redshift SQL and PostgreSQL, see [Amazon Redshift and PostgreSQL \(p. 239\)](#).

Connections

Amazon Redshift communicates with client applications by using industry-standard PostgreSQL JDBC and ODBC drivers. For more information, see [Amazon Redshift and PostgreSQL JDBC and ODBC \(p. 240\)](#).

Clusters

The core infrastructure component of an Amazon Redshift data warehouse is a *cluster*.

A cluster is composed of one or more *compute nodes*. If a cluster is provisioned with two or more compute nodes, an additional *leader node* coordinates the compute nodes and handles external communication. Your client application interacts directly only with the leader node. The compute nodes are transparent to external applications.

Leader node

The leader node manages communications with client programs and all communication with compute nodes. It parses and develops execution plans to carry out database operations, in particular, the series of steps necessary to obtain results for complex queries. Based on the execution plan, the leader node compiles code, distributes the compiled code to the compute nodes, and assigns a portion of the data to each compute node.

The leader node distributes SQL statements to the compute nodes only when a query references tables that are stored on the compute nodes. All other queries run exclusively on the leader node. Amazon Redshift is designed to implement certain SQL functions only on the leader node. A query that uses any of these functions will return an error if it references tables that reside on the compute nodes. For more information, see [SQL Functions Supported on the Leader Node \(p. 238\)](#).

Compute nodes

The leader node compiles code for individual elements of the execution plan and assigns the code to individual compute nodes. The compute nodes execute the compiled code and send intermediate results back to the leader node for final aggregation.

Each compute node has its own dedicated CPU, memory, and attached disk storage, which are determined by the node type. As your workload grows, you can increase the compute capacity and storage capacity of a cluster by increasing the number of nodes, upgrading the node type, or both.

Amazon Redshift provides two node types; dense storage nodes and dense compute nodes. Each node provides two storage choices. You can start with a single 160 GB node and scale up to multiple 16 TB nodes to support a petabyte of data or more.

For a more detailed explanation of data warehouse clusters and nodes, see [Internal Architecture and System Operation \(p. 9\)](#).

Node slices

A compute node is partitioned into slices. Each slice is allocated a portion of the node's memory and disk space, where it processes a portion of the workload assigned to the node. The leader node manages distributing data to the slices and apportions the workload for any queries or other database operations to the slices. The slices then work in parallel to complete the operation.

The number of slices per node is determined by the node size of the cluster. For more information about the number of slices for each node size, go to [About Clusters and Nodes](#) in the *Amazon Redshift Cluster Management Guide*.

When you create a table, you can optionally specify one column as the distribution key. When the table is loaded with data, the rows are distributed to the node slices according to the distribution key that is defined for a table. Choosing a good distribution key enables Amazon Redshift to use parallel processing to load data and execute queries efficiently. For information about choosing a distribution key, see [Choose the Best Distribution Style \(p. 22\)](#).

Internal network

Amazon Redshift takes advantage of high-bandwidth connections, close proximity, and custom communication protocols to provide private, very high-speed network communication between the leader node and compute nodes. The compute nodes run on a separate, isolated network that client applications never access directly.

Databases

A cluster contains one or more databases. User data is stored on the compute nodes. Your SQL client communicates with the leader node, which in turn coordinates query execution with the compute nodes.

Amazon Redshift is a relational database management system (RDBMS), so it is compatible with other RDBMS applications. Although it provides the same functionality as a typical RDBMS, including online transaction processing (OLTP) functions such as inserting and deleting data, Amazon Redshift is optimized for high-performance analysis and reporting of very large datasets.

Amazon Redshift is based on PostgreSQL 8.0.2. Amazon Redshift and PostgreSQL have a number of very important differences that you need to take into account as you design and develop your data warehouse applications. For information about how Amazon Redshift SQL differs from PostgreSQL, see [Amazon Redshift and PostgreSQL \(p. 239\)](#).

Performance

Amazon Redshift achieves extremely fast query execution by employing these performance features:

- Massively parallel processing
- Columnar data storage
- Data compression
- Query optimization
- Compiled code

Massively parallel processing

Massively parallel processing (MPP) enables fast execution of the most complex queries operating on large amounts of data. Multiple compute nodes handle all query processing leading up to final result aggregation, with each core of each node executing the same compiled query segments on portions of the entire data.

Amazon Redshift distributes the rows of a table to the compute nodes so that the data can be processed in parallel. By selecting an appropriate distribution key for each table, you can optimize the distribution of data to balance the workload and minimize movement of data from node to node. For more information, see [Choose the Best Distribution Style \(p. 22\)](#).

Loading data from flat files takes advantage of parallel processing by spreading the workload across multiple nodes while simultaneously reading from multiple files. For more information about how to load data into tables, see [Best Practices for Loading Data \(p. 24\)](#).

Columnar data storage

Columnar storage for database tables drastically reduces the overall disk I/O requirements and is an important factor in optimizing analytic query performance. Storing database table information in a columnar fashion reduces the number of disk I/O requests and reduces the amount of data you need to load from disk. Loading less data into memory enables Amazon Redshift to perform more in-memory processing when executing queries. See [Columnar Storage \(p. 8\)](#) for a more detailed explanation.

When columns are sorted appropriately, the query processor is able to rapidly filter out a large subset of data blocks. For more information, see [Choose the Best Sort Key \(p. 22\)](#).

Data compression

Data compression reduces storage requirements, thereby reducing disk I/O, which improves query performance. When you execute a query, the compressed data is read into memory, then uncompressed during query execution. Loading less data into memory enables Amazon Redshift to allocate more memory to analyzing the data. Because columnar storage stores similar data sequentially, Amazon Redshift is able to apply adaptive compression encodings specifically tied to columnar data types. The best way to enable data compression on table columns is by allowing Amazon Redshift to apply optimal compression encodings when you load the table with data. To learn more about using automatic data compression, see [Loading Tables with Automatic Compression \(p. 154\)](#).

Query optimizer

The Amazon Redshift query execution engine incorporates a query optimizer that is MPP-aware and also takes advantage of the columnar-oriented data storage. The Amazon Redshift query optimizer implements significant enhancements and extensions for processing complex analytic queries that often include multi-table joins, subqueries, and aggregation. To learn more about optimizing queries, see [Tuning Query Performance \(p. 199\)](#).

Compiled code

The leader node distributes fully optimized compiled code across all of the nodes of a cluster. Compiling the query eliminates the overhead associated with an interpreter and therefore increases the execution speed, especially for complex queries. The compiled code is cached and shared across

sessions on the same cluster, so subsequent executions of the same query will be faster, often even with different parameters.

The execution engine compiles different code for the JDBC connection protocol and for ODBC and psql (libq) connection protocols, so two clients using different protocols will each incur the first-time cost of compiling the code. Other clients that use the same protocol, however, will benefit from sharing the cached code.

Columnar Storage

Columnar storage for database tables is an important factor in optimizing analytic query performance because it drastically reduces the overall disk I/O requirements and reduces the amount of data you need to load from disk.

The following series of illustrations describe how columnar data storage implements efficiencies and how that translates into efficiencies when retrieving data into memory.

This first illustration shows how records from database tables are typically stored into disk blocks by row.

SSN	Name	Age	Addr	City	St
101259797	SMITH	88	899 FIRST ST	JUNO	AL
892375862	CHIN	37	16137 MAIN ST	POMONA	CA
318370701	HANDU	12	42 JUNE ST	CHICAGO	IL



In a typical relational database table, each row contains field values for a single record. In row-wise database storage, data blocks store values sequentially for each consecutive column making up the entire row. If block size is smaller than the size of a record, storage for an entire record may take more than one block. If block size is larger than the size of a record, storage for an entire record may take less than one block, resulting in an inefficient use of disk space. In online transaction processing (OLTP) applications, most transactions involve frequently reading and writing all of the values for entire records, typically one record or a small number of records at a time. As a result, row-wise storage is optimal for OLTP databases.

The next illustration shows how with columnar storage, the values for each column are stored sequentially into disk blocks.

SSN	Name	Age	Addr	City	St
101259797	SMITH	88	899 FIRST ST	JUNO	AL
892375862	CHIN	37	16137 MAIN ST	POMONA	CA
318370701	HANDU	12	42 JUNE ST	CHICAGO	IL



Using columnar storage, each data block stores values of a single column for multiple rows. As records enter the system, Amazon Redshift transparently converts the data to columnar storage for each of the columns.

In this simplified example, using columnar storage, each data block holds column field values for as many as three times as many records as row-based storage. This means that reading the same number of column field values for the same number of records requires a third of the I/O operations compared to row-wise storage. In practice, using tables with very large numbers of columns and very large row counts, storage efficiency is even greater.

An added advantage is that, since each block holds the same type of data, block data can use a compression scheme selected specifically for the column data type, further reducing disk space and I/O. For more information about compression encodings based on data types, see [Compression Encodings \(p. 101\)](#).

The savings in space for storing data on disk also carries over to retrieving and then storing that data in memory. Since many database operations only need to access or operate on one or a small number of columns at a time, you can save memory space by only retrieving blocks for columns you actually need for a query. Where OLTP transactions typically involve most or all of the columns in a row for a small number of records, data warehouse queries commonly read only a few columns for a very large number of rows. This means that reading the same number of column field values for the same number of rows requires a fraction of the I/O operations and uses a fraction of the memory that would be required for processing row-wise blocks. In practice, using tables with very large numbers of columns and very large row counts, the efficiency gains are proportionally greater. For example, suppose a table contains 100 columns. A query that uses five columns will only need to read about five percent of the data contained in the table. This savings is repeated for possibly billions or even trillions of records for large databases. In contrast, a row-wise database would read the blocks that contain the 95 unneeded columns as well.

Typical database block sizes range from 2 KB to 32 KB. Amazon Redshift uses a block size of 1 MB, which is more efficient and further reduces the number of I/O requests needed to perform any database loading or other operations that are part of query execution.

Internal Architecture and System Operation

The following diagram shows a high level view of internal components and functionality of the Amazon Redshift data warehouse.

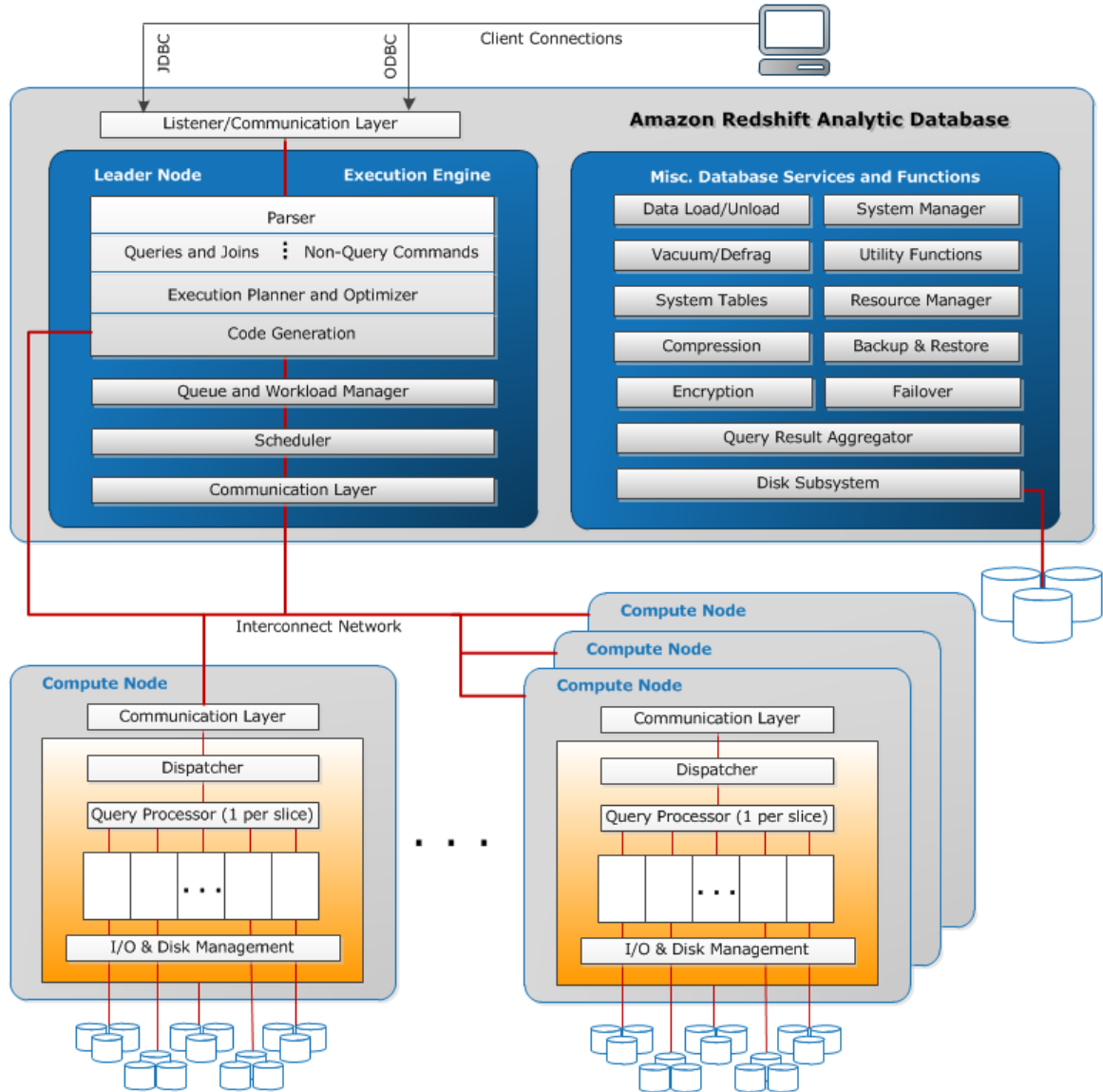

Workload Management

Amazon Redshift workload management (WLM) enables users to flexibly manage priorities within workloads so that short, fast-running queries won't get stuck in queues behind long-running queries.

Amazon Redshift WLM creates query queues at runtime according to *service classes*, which define the configuration parameters for various types of queues, including internal system queues and user-accessible queues. From a user perspective, a user-accessible service class and a queue are functionally equivalent. For consistency, this documentation uses the term *queue* to mean a user-accessible service class as well as a runtime queue.

When you run a query, WLM assigns the query to a queue according to the user's user group or by matching a query group that is listed in the queue configuration with a query group label that the user sets at runtime.

By default, Amazon Redshift configures one queue with a *concurrency level* of five, which enables up to five queries to run concurrently, plus one predefined Superuser queue, with a concurrency level of

one. You can define up to eight queues. Each queue can be configured with a maximum concurrency level of 50. The maximum total concurrency level for all user-defined queues (not including the Superuser queue) is 50.

The easiest way to modify the WLM configuration is by using the Amazon Redshift Management Console. You can also use the Amazon Redshift command line interface (CLI) or the Amazon Redshift API.

For more information about implementing and using workload management, see [Implementing Workload Management \(p. 222\)](#).

Using Amazon Redshift with Other Services

Amazon Redshift integrates with other AWS services to enable you to move, transform, and load your data quickly and reliably, using data security features.

Moving Data Between Amazon Redshift and Amazon S3

Amazon Simple Storage Service (Amazon S3) is a web service that stores data in the cloud. Amazon Redshift leverages parallel processing to read and load data from multiple data files stored in Amazon S3 buckets. For more information, see [Loading Data from Amazon S3 \(p. 133\)](#).

You can also use parallel processing to export data from your Amazon Redshift data warehouse to multiple data files on Amazon S3. For more information, see [Unloading Data \(p. 185\)](#).

Using Amazon Redshift with Amazon DynamoDB

Amazon DynamoDB is a fully managed NoSQL database service. You can use the COPY command to load an Amazon Redshift table with data from a single Amazon DynamoDB table. For more information, see [Loading Data from an Amazon DynamoDB Table \(p. 151\)](#).

Importing Data from Remote Hosts over SSH

You can use the COPY command in Amazon Redshift to load data from one or more remote hosts, such as Amazon EMR clusters, Amazon EC2 instances, or other computers. COPY connects to the remote hosts using SSH and executes commands on the remote hosts to generate data. Amazon Redshift supports multiple simultaneous connections. The COPY command reads and loads the output from multiple host sources in parallel. For more information, see [Loading Data from Remote Hosts \(p. 145\)](#).

Automating Data Loads Using AWS Data Pipeline

You can use AWS Data Pipeline to automate data movement and transformation into and out of Amazon Redshift. By using the built-in scheduling capabilities of AWS Data Pipeline, you can schedule and execute recurring jobs without having to write your own complex data transfer or transformation logic. For example, you can set up a recurring job to automatically copy data from Amazon DynamoDB into Amazon Redshift. For a tutorial that walks you through the process of creating a pipeline that periodically moves data from Amazon S3 to Amazon Redshift, see [Copy Data to Amazon Redshift Using AWS Data Pipeline](#) in the AWS Data Pipeline Developer Guide.

Getting Started Using Databases

Topics

- [Step 1: Create a Database](#) (p. 12)
- [Step 2: Create a Database User](#) (p. 13)
- [Step 3: Create a Database Table](#) (p. 13)
- [Step 4: Load Sample Data](#) (p. 15)
- [Step 5: Query the System Tables](#) (p. 15)
- [Step 6: Cancel a Query](#) (p. 18)
- [Step 7: Clean Up Your Resources](#) (p. 19)

This section describes the basic steps to begin using the Amazon Redshift database.

The examples in this section assume you have signed up for the Amazon Redshift data warehouse service, created a cluster, and established a connection to the cluster from your SQL query tool. For information about these tasks, see [Amazon Redshift Getting Started](#).

Important

The cluster that you deployed for this exercise will be running in a live environment. As long as it is running, it will accrue charges to your AWS account. For more pricing information, go to [the Amazon Redshift pricing page](#).

To avoid unnecessary charges, you should delete your cluster when you are done with it. The final step of the exercise explains how to do so.

Step 1: Create a Database

After you have verified that your cluster is up and running, you can create your first database. This database is where you will actually create tables, load data, and run queries. A single cluster can host multiple databases. For example, you can have a TICKET database and an ORDERS database on the same cluster.

After you connect to the initial cluster database, the database you created when you launched the cluster, you use the initial database as the base for creating a new database.

For example, to create a database named `ticket`, issue the following command:

```
create database ticket;
```

For this exercise, we'll accept the defaults. For information about more command options, see [CREATE DATABASE \(p. 371\)](#) in the SQL Command Reference.

After you have created the TICKIT database, you can connect to the new database from your SQL client. Use the same connection parameters as you used for your current connection, but change the database name to `tickit`.

You do not need to change the database to complete the remainder of this tutorial. If you prefer not to connect to the TICKIT database, you can try the rest of the examples in this section using the default database.

Step 2: Create a Database User

By default, only the master user that you created when you launched the cluster has access to the initial database in the cluster. To grant other users access, you must create one or more user accounts. Database user accounts are global across all the databases in a cluster; they do not belong to individual databases.

Use the `CREATE USER` command to create a new database user. When you create a new user, you specify the name of the new user and a password. A password is required. It must have between 8 and 64 characters, and it must include at least one uppercase letter, one lowercase letter, and one numeral.

For example, to create a user named `GUEST` with password `ABCd4321`, issue the following command:

```
create user guest password 'ABCd4321';
```

For information about other command options, see [CREATE USER \(p. 397\)](#) in the SQL Command Reference.

Delete a Database User

You won't need the `GUEST` user account for this tutorial, so you can delete it. If you delete a database user account, the user will no longer be able to access any of the cluster databases.

Issue the following command to drop the `GUEST` user:

```
drop user guest;
```

The master user you created when you launched your cluster continues to have access to the database.

Important

Amazon Redshift strongly recommends that you do not delete the master user.

For information about command options, see [DROP USER \(p. 411\)](#) in the SQL Reference.

Step 3: Create a Database Table

After you create your new database, you create tables to hold your database data. You specify any column information for the table when you create the table.

For example, to create a table named `testtable` with a single column named `testcol` for an integer data type, issue the following command:

```
create table testtable (testcol int);
```

The `PG_TABLE_DEF` system table contains information about all the tables in the cluster. To verify the result, issue the following `SELECT` command to query the `PG_TABLE_DEF` system table.

```
select * from pg_table_def where tablename = 'testtable';
```

The query result should look something like this:

```
schemaname|tablename|column | type  | encoding|distkey|sortkey | notnull
-----+-----+-----+-----+-----+-----+-----+-----
public   |testtable|testcol|integer|none     |f       |0       |f
(1 row)
```

By default, new database objects, such as tables, are created in a schema named "public". For more information about schemas, see [Schemas \(p. 96\)](#) in the Managing Database Security section.

The `encoding`, `distkey`, and `sortkey` columns are used by Amazon Redshift for parallel processing. For more information about designing tables that incorporate these elements, see [Best Practices for Designing Tables \(p. 21\)](#).

Insert Data Rows into a Table

After you create a table, you can insert rows of data into that table.

Note

The [INSERT \(p. 424\)](#) command inserts individual rows into a database table. For standard bulk loads, use the [COPY \(p. 317\)](#) command. For more information, see [Use a COPY Command to Load Data \(p. 25\)](#).

For example, to insert a value of 100 into the `testtable` table (which contains a single column), issue the following command:

```
insert into testtable values (100);
```

Select Data from a Table

After you create a table and populate it with data, use a `SELECT` statement to display the data contained in the table. The `SELECT *` statement returns all the column names and row values for all of the data in a table and is a good way to verify that recently added data was correctly inserted into the table.

To view the data that you entered in the `testtable` table, issue the following command:

```
select * from testtable;
```

The result will look like this:

```
testcol
-----
100
(1 row)
```

For more information about using the SELECT statement to query tables, see [SELECT \(p. 435\)](#) in the SQL Command Reference.

Step 4: Load Sample Data

Most of the examples in this guide use the TICKIT sample database. If you want to follow the examples using your SQL query tool, you will need to load the sample data for the TICKIT database.

The sample data for this tutorial is provided in Amazon S3 buckets that give read access to all authenticated AWS users, so any valid AWS credentials that permit access to Amazon S3 will work.

To load the sample data for the TICKIT database, you will first create the tables, then use the COPY command to load the tables with sample data that is stored in an Amazon S3 bucket. For steps to create tables and load sample data, see [Amazon Redshift Getting Started Guide](#).

Step 5: Query the System Tables

In addition to the tables that you create, your database contains a number of system tables. These system tables contain information about your installation and about the various queries and processes that are running on the system. You can query these system tables to collect information about your database.

Note

The description for each table in the System Tables Reference indicates whether a table is visible to all users or visible only to superusers. You must be logged in as a superuser to query tables that are visible only to superusers.

Amazon Redshift provides access to the following types of system tables:

- [STL Tables for Logging \(p. 687\)](#)

These system tables are generated from Amazon Redshift log files to provide a history of the system. Logging tables have an STL prefix.

- [STV Tables for Snapshot Data \(p. 752\)](#)

These tables are virtual system tables that contain snapshots of the current system data. Snapshot tables have an STV prefix.

- [System Views \(p. 776\)](#)

System views contain a subset of data found in several of the STL and STV system tables. System views have an SVV or SVL prefix.

- [System Catalog Tables \(p. 799\)](#)

The system catalog tables store schema metadata, such as information about tables and columns. System catalog tables have a PG prefix.

You may need to specify the process ID associated with a query to retrieve system table information about that query. For information, see [Determine the Process ID of a Running Query \(p. 17\)](#).

View a List of Table Names

For example, to view a list of all tables in the public schema, you can query the PG_TABLE_DEF system catalog table.

```
select distinct(tablename) from pg_table_def where schemaname = 'public';
```

The result will look something like this:

```
tablename
-----
category
date
event
listing
sales
testtable
users
venue
```

View Database Users

You can query the PG_USER catalog to view a list of all database users, along with the user ID (USESYSID) and user privileges.

```
select * from pg_user;
 username | usesysid | usecreatedb | usesuper | usecatupd | passwd |
 valuntil | useconfig
-----+-----+-----+-----+-----+-----+
 rdsdb    |         1 | t           | t         | t         | ***** |
 |
 masteruser |       100 | t           | t         | f         | ***** |
 |
 dwuser    |       101 | f           | f         | f         | ***** |
 |
 simpleuser |       102 | f           | f         | f         | ***** |
 |
 poweruser |       103 | f           | t         | f         | ***** |
 |
 dbuser    |       104 | t           | f         | f         | ***** |
 |
(6 rows)
```

The user name `rdsdb` is used internally by Amazon Redshift to perform routine administrative and maintenance tasks. You can filter your query to show only user-defined user names by adding `where usesysid > 1` to your select statement.

```
select * from pg_user
where usesysid > 1;

 username | usesysid | usecreatedb | usesuper | usecatupd | passwd |
 valuntil | useconfig
-----+-----+-----+-----+-----+-----+
 masteruser |       100 | t           | t         | f         | ***** |
 |
 dwuser    |       101 | f           | f         | f         | ***** |
 |
```

```

simpleuser |      102 | f      | f      | f      | ***** |
|
poweruser |      103 | f      | t      | f      | ***** |
|
dbuser    |      104 | t      | f      | f      | ***** |
|
(5 rows)

```

View Recent Queries

In the previous example, you found that the user ID (USESYSID) for masteruser is 100. To list the five most recent queries executed by masteruser, you can query the SVL_QLOG view. The SVL_QLOG view is a friendlier subset of information from the STL_QUERY table. You can use this view to find the query ID (QUERY) or process ID (PID) for a recently run query or to see how long it took a query to complete. SVL_QLOG includes the first 60 characters of the query string (SUBSTRING) to help you locate a specific query. Use the LIMIT clause with your SELECT statement to limit the results to five rows.

```

select query, pid, elapsed, substring from svl_qlog
where userid = 100
order by starttime desc
limit 5;

```

The result will look something like this:

```

query | pid | elapsed | substring
-----+-----+-----+-----
+-----+-----+-----+-----
187752 | 18921 | 18465685 | select query, elapsed, substring from svl_qlog
order by query
204168 | 5117 | 59603 | insert into testtable values (100);
187561 | 17046 | 1003052 | select * from pg_table_def where tablename =
'testtable';
187549 | 17046 | 1108584 | select * from STV_WLM_SERVICE_CLASS_CONFIG
187468 | 17046 | 5670661 | select * from pg_table_def where schemaname =
'public';
(5 rows)

```

Determine the Process ID of a Running Query

In the previous example you learned how to obtain the query ID and process ID (PID) for a completed query from the SVL_QLOG view.

You might need to find the PID for a query that is still running. For example, you will need the PID if you need to cancel a query that is taking too long to run. You can query the STV_RECENTS system table to obtain a list of process IDs for running queries, along with the corresponding query string. If your query returns multiple PIDs, you can look at the query text to determine which PID you need.

To determine the PID of a running query, issue the following SELECT statement:

```

select pid, user_name, starttime, query
from stv_recents
where status='Running';

```

Step 6: Cancel a Query

If a user issues a query that is taking too long or is consuming excessive cluster resources, you might need to cancel the query. For example, a user might want to create a list of ticket sellers that includes the seller's name and quantity of tickets sold. The following query selects data from the SALES table USERS table and joins the two tables by matching SELLERID and USERID in the WHERE clause.

```
select sellerid, firstname, lastname, sum(qtysold)
from sales, users
where sales.sellerid = users.userid
group by sellerid, firstname, lastname
order by 4 desc;
```

Note

This is a complex query. For this tutorial, you don't need to worry about how this query is constructed.

The previous query runs in seconds and returns 2,102 rows.

Suppose the user forgets to put in the WHERE clause.

```
select sellerid, firstname, lastname, sum(qtysold)
from sales, users
group by sellerid, firstname, lastname
order by 4 desc;
```

The result set will include all of the rows in the SALES table multiplied by all the rows in the USERS table (49989*3766). This is called a Cartesian join, and it is not recommended. The result is over 188 million rows and takes a long time to run.

To cancel a running query, use the CANCEL command with the query's PID.

To find the process ID, query the STV_RECENTS table, as shown in the previous step. The following example shows how you can make the results more readable by using the TRIM function to trim trailing spaces and by showing only the first 20 characters of the query string.

```
select pid, trim(user_name), starttime, substring(query,1,20)
from stv_recents
where status='Running';
```

The result looks something like this:

pid	btrim	starttime	substring
18764	masteruser	2013-03-28 18:39:49.355918	select sellerid, fir

(1 row)

To cancel the query with PID 18764, issue the following command:

```
cancel 18764;
```

Note

The CANCEL command will not abort a transaction. To abort or roll back a transaction, you must use the ABORT or ROLLBACK command. To cancel a query associated with a transaction, first cancel the query then abort the transaction.

If the query that you canceled is associated with a transaction, use the `ABORT` or `ROLLBACK` command to cancel the transaction and discard any changes made to the data:

```
abort ;
```

Unless you are signed on as a superuser, you can cancel only your own queries. A superuser can cancel all queries.

Cancel a Query from Another Session

If your query tool does not support running queries concurrently, you will need to start another session to cancel the query. For example, SQLWorkbench, which is the query tool we use in the Amazon Redshift Getting Started, does not support multiple concurrent queries. To start another session using SQLWorkbench, select File, New Window and connect using the same connection parameters. Then you can find the PID and cancel the query.

Cancel a Query Using the Superuser Queue

If your current session has too many queries running concurrently, you might not be able to run the `CANCEL` command until another query finishes. In that case, you will need to issue the `CANCEL` command using a different workload management query queue.

Workload management enables you to execute queries in different query queues so that you don't need to wait for another query to complete. The workload manager creates a separate queue, called the Superuser queue, that you can use for troubleshooting. To use the Superuser queue, you must be logged on a superuser and set the query group to 'superuser' using the `SET` command. After running your commands, reset the query group using the `RESET` command.

To cancel a query using the Superuser queue, issue these commands:

```
set query_group to 'superuser';  
cancel 18764;  
reset query_group;
```

For information about managing query queues, see [Implementing Workload Management \(p. 222\)](#).

Step 7: Clean Up Your Resources

If you deployed a cluster in order to complete this exercise, when you are finished with the exercise, you should delete the cluster so that it will stop accruing charges to your AWS account.

To delete the cluster, follow the steps in [Deleting a Cluster](#) in the Amazon Redshift Cluster Management Guide.

If you want to keep the cluster, you might want to keep the sample data for reference. Most of the examples in this guide use the tables you created in this exercise. The size of the data will not have any significant effect on your available storage.

If you want to keep the cluster, but want to clean up the sample data, you can run the following command to drop the TICKIT database:

```
drop database tickit;
```

If you didn't create a TICKIT database, or if you don't want to drop the database, run the following commands to drop just the tables:

```
drop table testtable;  
drop table users;  
drop table venue;  
drop table category;  
drop table date;  
drop table event;  
drop table listing;  
drop table sales;
```

Amazon Redshift Best Practices

Topics

- [Amazon Redshift Best Practices for Designing Tables \(p. 21\)](#)
- [Amazon Redshift Best Practices for Loading Data \(p. 24\)](#)
- [Amazon Redshift Best Practices for Designing Queries \(p. 28\)](#)

This chapter presents best practices for designing tables, loading data into tables, and writing queries.

Amazon Redshift is not the same as other SQL database systems. To fully realize the benefits of the Amazon Redshift architecture, you must specifically design, build, and load your tables to leverage massively parallel processing, columnar data storage, and columnar data compression. If your data loading and query execution times are longer than you expect, or longer than you want, you might be overlooking key information.

If you are an experienced SQL database developer, we strongly recommend that you review this chapter before you begin developing your Amazon Redshift data warehouse.

If you are new to developing SQL databases, this is not the best place to start. We recommend that you begin by reading [Getting Started Using Databases \(p. 12\)](#) and trying the examples yourself.

This chapter provides an overview of the most important development principles, along with specific tips, examples, and best practices for implementing those principles. No single practice can apply to every application. You should evaluate all of your options before finalizing a database design. For more information, see [Designing Tables \(p. 100\)](#), [Loading Data \(p. 130\)](#), [Tuning Query Performance \(p. 199\)](#), and the reference chapters.

Amazon Redshift Best Practices for Designing Tables

Topics

- [Take the Tuning Table Design Tutorial \(p. 22\)](#)
- [Choose the Best Sort Key \(p. 22\)](#)
- [Choose the Best Distribution Style \(p. 22\)](#)
- [Let COPY Choose Compression Encodings \(p. 23\)](#)
- [Define Primary Key and Foreign Key Constraints \(p. 23\)](#)

- [Use the Smallest Possible Column Size \(p. 24\)](#)
- [Use Date/Time Data Types for Date Columns \(p. 24\)](#)

As you plan your database, there are key table design decisions that will heavily influence overall query performance. These design choices also have a significant effect on storage requirements, which in turn affects query performance by reducing the number of I/O operations and minimizing the memory required to process queries.

This section summarizes the most important design decisions and presents best practices for optimizing query performance. [Designing Tables \(p. 100\)](#) provides more detailed explanations and examples of table design options.

Take the Tuning Table Design Tutorial

[Tutorial: Tuning Table Design \(p. 30\)](#) walks you step-by-step through the process of choosing sort keys, distribution styles, and compression encodings, and shows you how to compare system performance before and after tuning.

Choose the Best Sort Key

Amazon Redshift stores your data on disk in sorted order according to the sort key. The Amazon Redshift query optimizer uses sort order when it determines optimal query plans.

- **If recent data is queried most frequently, specify the timestamp column as the leading column for the sort key.**

Queries will be more efficient because they can skip entire blocks that fall outside the time range.

- **If you do frequent range filtering or equality filtering on one column, specify that column as the sort key.**

Amazon Redshift can skip reading entire blocks of data for that column because it keeps track of the minimum and maximum column values stored on each block and can skip blocks that don't apply to the predicate range.

- **If you frequently join a table, specify the join column as both the sort key and the distribution key.**

This enables the query optimizer to choose a sort merge join instead of a slower hash join. Because the data is already sorted on the join key, the query optimizer can bypass the sort phase of the sort merge join.

For more information about choosing and specifying sort keys, see [Tutorial: Tuning Table Design \(p. 30\)](#) and [Choosing Sort Keys \(p. 122\)](#).

Choose the Best Distribution Style

When you execute a query, the query optimizer redistributes the rows to the compute nodes as needed to perform any joins and aggregations. The goal in selecting a table distribution style is to minimize the impact of the redistribution step by locating the data where it needs to be before the query is executed.

1. **Distribute the fact table and one dimension table on their common columns.**

Your fact table can have only one distribution key. Any tables that join on another key will not be colocated with the fact table. Choose one dimension to colocate based on how frequently it is joined and the size of the joining rows. Designate both the dimension table's primary key and the fact table's corresponding foreign key as the DISTKEY.

2. Choose the largest dimension based on the size of the filtered data set.

Only the rows that are used in the join need to be distributed, so consider the size of the of the data set after filtering, not the size of the table.

3. Choose a column with high cardinality in the filtered result set.

If you distribute a sales table on a date column, for example, you will probably get fairly even data distribution, unless most of your sales are seasonal. However, if you commonly use a range-restricted predicate to filter for a narrow date period, most of the filtered rows will be on a limited set of slices and the query workload will be skewed.

4. Change some dimension tables to use ALL distribution.

If a dimension table cannot be colocated with the fact table or other important joining tables, you can improve query performance significantly by distributing the entire table to all of the nodes. Using ALL distribution multiplies storage space requirements and increases load times and maintenance operations, so you should weigh all factors before choosing ALL distribution.

For more information about choosing distribution styles, see [Tutorial: Tuning Table Design \(p. 30\)](#) and [Choosing a Data Distribution Style \(p. 110\)](#).

Let COPY Choose Compression Encodings

You can specify compression encodings when you create a table, but in most cases, automatic compression produces the best results.

The COPY command will analyze your data and apply compression encodings to an empty table automatically as part of the load operation.

Automatic compression balances overall performance when choosing compression encodings. Range-restricted scans might perform poorly if sort key columns are compressed much more highly than other columns in the same query. As a result, automatic compression will choose a less efficient compression encoding to keep the sort key columns balanced with other columns.

If your table's sort key is a date or timestamp and the table uses many large varchar columns, you might get better performance by not compressing the sort key column at all. Run the [ANALYZE COMPRESSION \(p. 310\)](#) command on the table, then use the encodings to create a new table, but leave out the compression encoding for the sort key.

There is a performance cost for automatic compression encoding, but only if the table is empty and does not already have compression encoding. For short-lived tables and tables that you create frequently, such as staging tables, load the table once with automatic compression or run the ANALYZE COMPRESSION command, then use those encodings to create new tables. You can add the encodings to the CREATE TABLE statement, or use CREATE TABLE LIKE to create a new table with the same encoding.

For more information, see [Tutorial: Tuning Table Design \(p. 30\)](#) and [Loading Tables with Automatic Compression \(p. 154\)](#).

Define Primary Key and Foreign Key Constraints

Define primary key and foreign key constraints between tables wherever appropriate. Even though they are informational only, the query optimizer uses those constraints to generate more efficient query plans.

Do not define primary key and foreign key constraints unless your application enforces the constraints. Amazon Redshift does not enforce unique, primary-key, and foreign-key constraints.

See [Defining Constraints \(p. 127\)](#) for additional information about how Amazon Redshift uses constraints.

Use the Smallest Possible Column Size

Don't make it a practice to use the maximum column size for convenience.

Instead, consider the largest values you are likely to store in a VARCHAR column, for example, and size your columns accordingly. Because Amazon Redshift compresses column data very effectively, creating columns much larger than necessary has minimal impact on the size of data tables. During processing for complex queries, however, intermediate query results might need to be stored in temporary tables. Because temporary tables are not compressed, unnecessarily large columns consume excessive memory and temporary disk space, which can affect query performance.

Use Date/Time Data Types for Date Columns

Amazon Redshift stores DATE and TIMESTAMP data more efficiently than CHAR or VARCHAR, which results in better query performance. Use the DATE or TIMESTAMP data type, depending on the resolution you need, rather than a character type when storing date/time information. For more information, see [Datetime Types \(p. 259\)](#).

Amazon Redshift Best Practices for Loading Data

Topics

- [Take the Loading Data Tutorial \(p. 24\)](#)
- [Take the Tuning Table Design Tutorial \(p. 25\)](#)
- [Use a COPY Command to Load Data \(p. 25\)](#)
- [Use a Single COPY Command to Load from Multiple Files \(p. 25\)](#)
- [Split Your Load Data into Multiple Files \(p. 25\)](#)
- [Compress Your Data Files \(p. 25\)](#)
- [Use a Manifest File \(p. 25\)](#)
- [Verify Data Files Before and After a Load \(p. 26\)](#)
- [Use a Multi-Row Insert \(p. 26\)](#)
- [Use a Bulk Insert \(p. 26\)](#)
- [Load Data in Sort Key Order \(p. 26\)](#)
- [Load Data in Sequential Blocks \(p. 27\)](#)
- [Use Time-Series Tables \(p. 27\)](#)
- [Use a Staging Table to Perform a Merge \(Upsert\) \(p. 27\)](#)
- [Schedule Around Maintenance Windows \(p. 27\)](#)

Loading very large data sets can take a long time and consume a lot of computing resources. How your data is loaded can also affect query performance. This section presents best practices for loading data efficiently using COPY commands, bulk inserts, and staging tables.

Take the Loading Data Tutorial

[Tutorial: Loading Data from Amazon S3 \(p. 56\)](#) walks you beginning to end through the steps to upload data to an Amazon S3 bucket and then use the COPY command to load the data into your tables. The tutorial includes help with troubleshooting load errors and compares the performance difference between loading from a single file and loading from multiple files.

Take the Tuning Table Design Tutorial

Data loads are heavily influenced by table design, especially compression encodings and distribution styles. [Tutorial: Tuning Table Design \(p. 30\)](#) walks you step-by-step through the process of choosing sort keys, distribution styles, and compression encodings, and shows you how to compare system performance before and after tuning.

Use a COPY Command to Load Data

The COPY command loads data in parallel from Amazon S3, Amazon EMR, Amazon DynamoDB, or multiple data sources on remote hosts. COPY loads large amounts of data much more efficiently than using INSERT statements, and stores the data more effectively as well.

For more information about using the COPY command, see [Loading Data from Amazon S3 \(p. 133\)](#) and [Loading Data from an Amazon DynamoDB Table \(p. 151\)](#).

Use a Single COPY Command to Load from Multiple Files

Amazon Redshift automatically loads in parallel from multiple data files.

If you use multiple concurrent COPY commands to load one table from multiple files, Amazon Redshift is forced to perform a serialized load, which is much slower and requires a VACUUM at the end if the table has a sort column defined. For more information about using COPY to load data in parallel, see [Loading Data from Amazon S3 \(p. 133\)](#).

Split Your Load Data into Multiple Files

The COPY command loads the data in parallel from multiple files, dividing the workload among the nodes in your cluster. When you load all the data from a single large file, Amazon Redshift is forced to perform a serialized load, which is much slower. Split your load data files so that the files are about equal size, between 1 MB and 1 GB after compression. The number of files should be a multiple of the number of slices in your cluster. For more information about how to split your data into files and examples of using COPY to load data, see [Loading Data from Amazon S3 \(p. 133\)](#).

Compress Your Data Files

We strongly recommend that you individually compress your load files using gzip, lzop, or bzip2 when you have large datasets.

Specify the GZIP, LZOP, or BZIP2 option with the COPY command. This example loads the TIME table from a pipe-delimited lzop file.

```
copy time
from 's3://mybucket/data/timerows.lzo'
credentials '<aws-auth-args>'
lzop
delimiter '|';
```

Use a Manifest File

Amazon S3 provides eventual consistency for some operations, so it is possible that new data will not be available immediately after the upload, which could result in an incomplete data load or

loading stale data. You can manage data consistency by using a manifest file to load data. For more information, see [Managing Data Consistency](#) (p. 135).

Verify Data Files Before and After a Load

When you load data from Amazon S3, first upload your files to your Amazon S3 bucket, then verify that the bucket contains all the correct files, and only those files. For more information, see [Verifying That the Correct Files Are Present in Your Bucket](#) (p. 137).

After the load operation is complete, query the [STL_LOAD_COMMITS](#) (p. 711) system table to verify that the expected files were loaded. For more information, see [Verifying That the Data Was Loaded Correctly](#) (p. 153).

Use a Multi-Row Insert

If a COPY command is not an option and you require SQL inserts, use a multi-row insert whenever possible. Data compression is inefficient when you add data only one row or a few rows at a time.

Multi-row inserts improve performance by batching up a series of inserts. The following example inserts three rows into a four-column table using a single INSERT statement. This is still a small insert, shown simply to illustrate the syntax of a multi-row insert.

```
insert into category_stage values
(default, default, default, default),
(20, default, 'Country', default),
(21, 'Concerts', 'Rock', default);
```

See [INSERT](#) (p. 424) for more details and examples.

Use a Bulk Insert

Use a bulk insert operation with a SELECT clause for high performance data insertion.

Use the [INSERT](#) (p. 424) and [CREATE TABLE AS](#) (p. 389) commands when you need to move data or a subset of data from one table into another.

For example, the following INSERT statement selects all of the rows from the CATEGORY table and inserts them into the CATEGORY_STAGE table.

```
insert into category_stage
(select * from category);
```

The following example creates CATEGORY_STAGE as a copy of CATEGORY and inserts all of the rows in CATEGORY into CATEGORY_STAGE.

```
create table category_stage as
select * from category;
```

Load Data in Sort Key Order

Load your data in sort key order to avoid needing to vacuum.

As long as each batch of new data follows the existing rows in your table, your data will be properly stored in sort order, and you will not need to run a vacuum. You don't need to presort the rows in each load because COPY sorts each batch of incoming data as it loads.

For example, suppose you load data every day based on the current day's activity. If your sort key is a timestamp column, your data is stored in sort order because the current day's data is always appended at the end of the previous day's data. For more information, see [Loading Your Data in Sort Key Order](#) (p. 178)

Load Data in Sequential Blocks

If you need to add a large quantity of data, load the data in sequential blocks according to sort order to eliminate the need to vacuum.

For example, suppose you need to load a table with events from January, 2012 to December, 2012. Load the rows for January, then February, and so on. Your table will be completely sorted when your load completes and you will not need to run a vacuum. For more information, see [Use Time-Series Tables](#) (p. 27).

When loading very large data sets, the space required to sort might exceed the total available space. By loading data in smaller blocks, you'll use much less intermediate sort space during each load. In addition, loading smaller blocks will make it easier to restart if the COPY fails and is rolled back.

Use Time-Series Tables

If your data has a fixed retention period, we strongly recommend that you organize your data as a sequence of time-series tables, where each table is identical but contains data for different time ranges.

You can easily remove old data simply by executing a DROP TABLE on the corresponding tables, which is much faster than running a large scale DELETE, and also saves you from having to run a subsequent VACUUM to reclaim space. You can create a UNION ALL view to hide the fact that the data is stored in different tables. When you delete old data, simply refine your UNION ALL view to remove the dropped tables. Similarly, as you load new time periods into new tables, add the new tables to the view.

If you use time-series tables with a timestamp column for the sort key, you effectively load your data in sort key order, which eliminates the need to vacuum to resort the data. For more information, see [Load Data in Sort Key Order](#) (p. 26).

Use a Staging Table to Perform a Merge (Upsert)

You can efficiently update and insert new data by loading your data into a staging table first.

While Amazon Redshift does not support a single *merge* statement (update or insert, also known as an *upsert*) to insert and update data from a single data source, you can effectively perform a merge operation by loading your data into a staging table and then joining the staging table with your target table for an UPDATE statement and an INSERT statement. For instructions, see [Updating and Inserting New Data](#) (p. 161).

Schedule Around Maintenance Windows

If a scheduled maintenance occurs while a query is running, the query is terminated and rolled back and you will need to restart it. Schedule long-running operations, such as large data loads or VACUUM operation, to avoid maintenance windows. You can also minimize the risk, and make restarts easier when they are needed, by performing data loads in smaller increments and managing the size of

your VACUUM operations. For more information, see [Load Data in Sequential Blocks \(p. 27\)](#) and [Vacuuming Tables \(p. 172\)](#).

Amazon Redshift Best Practices for Designing Queries

To maximize query performance, follow these recommendations when creating queries.

- Design tables according to best practices to provide a solid foundation for query performance. For more information, see [Best Practices for Designing Tables \(p. 21\)](#).
- Avoid using `select *`. Include only the columns you specifically need.
- Use a [CASE Expression \(p. 552\)](#) to perform complex aggregations instead of selecting from the same table multiple times.
- Don't use cross-joins unless absolutely necessary. These joins without a join condition result in the Cartesian product of two tables. Cross-joins are typically executed as nested-loop joins, which are the slowest of the possible join types.
- Use subqueries in cases where one table in the query is used only for predicate conditions. This situation is a form of a cross-join and again results in an expensive nested-loop join.
- Use predicates to restrict the dataset as much as possible.
- In the predicate, use the least expensive operators that you can. [Comparison Condition \(p. 273\)](#) operators are preferable to [LIKE \(p. 278\)](#) operators. LIKE operators are still preferable to [SIMILAR TO \(p. 281\)](#) or [POSIX Operators \(p. 283\)](#).
- Avoid using functions in query predicates. Using them can drive up the cost of the query by requiring large numbers of rows to resolve the intermediate steps of the query.
- If possible, use a WHERE clause based on the primary sort column of the largest table in the query to restrict the dataset. The query planner can then use row order to help determine which records match the criteria, so it can skip scanning large numbers of disk blocks. Without this, the query execution engine must scan the entire table.
- Add predicates to filter tables that participate in joins, even if the predicates apply the same filters. The query returns the same result set, but Amazon Redshift is able to filter the join tables before the scan step and can then efficiently skip scanning blocks from those tables.

For example, suppose you want to join `SALES` and `LISTING` to find ticket sales for tickets listed after December, grouped by seller. Both tables are sorted by date. The following query joins the tables on their common key and filters for `listing.listtime` values greater than December 1.

```
select listing.sellerid, sum(sales.qtysold)
from sales, listing
where sales.salesid = listing.listid
and listing.listtime > '2008-12-01'
group by 1 order by 1;
```

The WHERE clause doesn't include a predicate for `sales.saletime`, so the execution engine is forced to scan the entire `SALES` table. If you know the filter would result in fewer rows participating in the join, then add that filter as well. The following example cuts execution time significantly.

```
select listing.sellerid, sum(sales.qtysold)
from sales, listing
where sales.salesid = listing.listid
and listing.listtime > '2008-12-01'
and sales.saletime > '2008-12-01'
```



```
group by 1 order by 1;
```

- Use sort keys in the GROUP BY clause so the query planner can use more efficient aggregation. A query might qualify for one-phase aggregation when its GROUP BY list contains only sort key columns, one of which is also the distribution key. The sort key columns in the GROUP BY list must include the first sort key, then other sort keys that you want to use in sort key order. For example, it is valid to use the first sort key, the first and second sort keys, the first, second and third sort keys, and so on. It is not valid to use the first and third sort keys.

You can confirm the use of one-phase aggregation by running the [EXPLAIN \(p. 415\)](#) command and looking for `XN GroupAggregate` in the aggregation step of the query.

- If you use both GROUP BY and ORDER BY clauses, make sure you put the columns in the same order in both. That is, use the following approach:

```
group by a, b, c  
order by a, b, c
```

Don't use this approach:

```
group by b, c, a  
order by a, b, c
```

Tutorial: Tuning Table Design

In this tutorial, you will learn how to optimize the design of your tables. You will start by creating tables based on the Star Schema Benchmark (SSB) schema without sort keys, distribution styles, and compression encodings. You will load the tables with test data and test system performance. Next, you will apply best practices to recreate the tables using sort keys and distribution styles. You will load the tables with test data using automatic compression and then you will test performance again so that you can compare the performance benefits of well-designed tables.

Estimated time: 60 minutes

Estimated cost: \$1.00 per hour for the cluster

Prerequisites

You will need your AWS credentials (access key ID and secret access key) to load test data from Amazon S3. If you need to create new access keys, go to [Administering Access Keys for IAM Users](#).

Steps

- [Step 1: Create a Test Data Set \(p. 30\)](#)
- [Step 2: Test System Performance to Establish a Baseline \(p. 34\)](#)
- [Step 3: Select Sort Keys \(p. 38\)](#)
- [Step 4: Select Distribution Styles \(p. 39\)](#)
- [Step 5: Review Compression Encodings \(p. 42\)](#)
- [Step 6: Recreate the Test Data Set \(p. 45\)](#)
- [Step 7: Retest System Performance After Tuning \(p. 48\)](#)
- [Step 8: Evaluate the Results \(p. 52\)](#)
- [Step 9: Clean Up Your Resources \(p. 54\)](#)
- [Summary \(p. 54\)](#)

Step 1: Create a Test Data Set

Data warehouse databases commonly use a star schema design, in which a central fact table contains the core data for the database and several dimension tables provide descriptive attribute information for the fact table. The fact table joins each dimension table on a foreign key that matches the dimension's primary key.

Star Schema Benchmark (SSB)

For this tutorial, you will use a set of five tables based on the Star Schema Benchmark (SSB) schema. The following diagram shows the SSB data model.

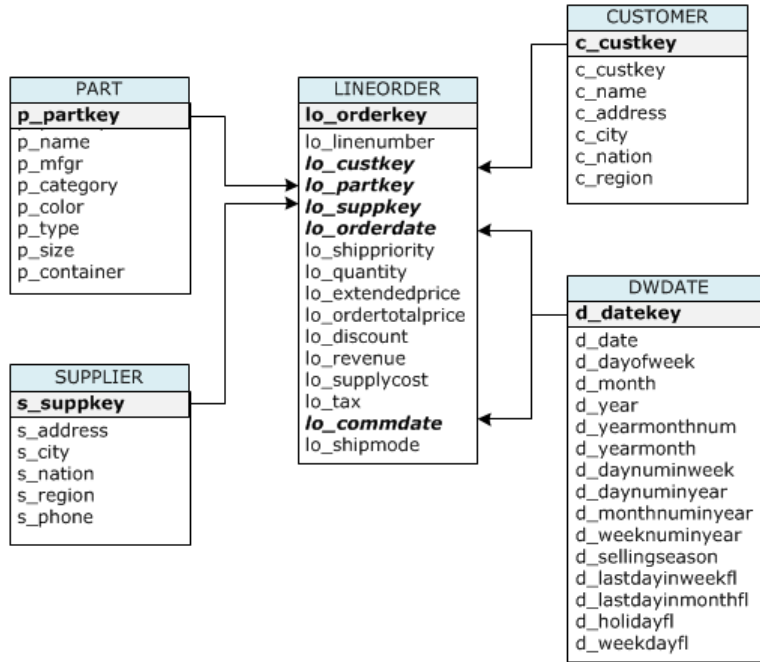

To Create a Test Data Set

You will create a set of tables without sort keys, distribution styles, or compression encodings. Then you will load the tables with data from the SSB data set.

1. (Optional) Launch a cluster.

If you already have a cluster that you want to use, you can skip this step. Your cluster should have at least two nodes. For the exercises in this tutorial, you will use a four-node cluster.

To launch a dc1.large cluster with four nodes, follow the steps in [Amazon Redshift Getting Started](#), but select **Multi Node** for **Cluster Type** and set **Number of Compute Nodes** to **4**.

Follow the steps to connect to your cluster from a SQL client and test a connection. You do not need to complete the remaining steps to create tables, upload data, and try example queries.

2. Create the SSB test tables using minimum attributes.

Note

If the SSB tables already exist in the current database, you will need to drop the tables first. See [Step 6: Recreate the Test Data Set \(p. 45\)](#) for the DROP TABLE commands.

For the purposes of this tutorial, the first time you create the tables, they will not have sort keys, distribution styles, or compression encodings.

Execute the following CREATE TABLE commands.

```

CREATE TABLE part
(
  p_partkey    INTEGER NOT NULL,
  p_name       VARCHAR(22) NOT NULL,

```

```
p_mfgr          VARCHAR(6) NOT NULL,
p_category      VARCHAR(7) NOT NULL,
p_brand1        VARCHAR(9) NOT NULL,
p_color         VARCHAR(11) NOT NULL,
p_type          VARCHAR(25) NOT NULL,
p_size          INTEGER NOT NULL,
p_container     VARCHAR(10) NOT NULL
);

CREATE TABLE supplier
(
  s_suppkey      INTEGER NOT NULL,
  s_name         VARCHAR(25) NOT NULL,
  s_address      VARCHAR(25) NOT NULL,
  s_city         VARCHAR(10) NOT NULL,
  s_nation       VARCHAR(15) NOT NULL,
  s_region       VARCHAR(12) NOT NULL,
  s_phone        VARCHAR(15) NOT NULL
);

CREATE TABLE customer
(
  c_custkey      INTEGER NOT NULL,
  c_name         VARCHAR(25) NOT NULL,
  c_address      VARCHAR(25) NOT NULL,
  c_city         VARCHAR(10) NOT NULL,
  c_nation       VARCHAR(15) NOT NULL,
  c_region       VARCHAR(12) NOT NULL,
  c_phone        VARCHAR(15) NOT NULL,
  c_mktsegment   VARCHAR(10) NOT NULL
);

CREATE TABLE dwdate
(
  d_datekey      INTEGER NOT NULL,
  d_date         VARCHAR(19) NOT NULL,
  d_dayofweek    VARCHAR(10) NOT NULL,
  d_month        VARCHAR(10) NOT NULL,
  d_year         INTEGER NOT NULL,
  d_yearmonthnum INTEGER NOT NULL,
  d_yearmonth    VARCHAR(8) NOT NULL,
  d_daynuminweek INTEGER NOT NULL,
  d_daynuminmonth INTEGER NOT NULL,
  d_daynuminyear INTEGER NOT NULL,
  d_monthnuminyear INTEGER NOT NULL,
  d_weeknuminyear INTEGER NOT NULL,
  d_sellingseason VARCHAR(13) NOT NULL,
  d_lastdayinweekfl VARCHAR(1) NOT NULL,
  d_lastdayinmonthfl VARCHAR(1) NOT NULL,
  d_holidayfl    VARCHAR(1) NOT NULL,
  d_weekdayfl    VARCHAR(1) NOT NULL
);

CREATE TABLE lineorder
(
  lo_orderkey    INTEGER NOT NULL,
  lo_linenumber  INTEGER NOT NULL,
  lo_custkey     INTEGER NOT NULL,
  lo_partkey     INTEGER NOT NULL,
  lo_suppkey     INTEGER NOT NULL,
```

```
lo_orderdate          INTEGER NOT NULL,  
lo_orderpriority     VARCHAR(15) NOT NULL,  
lo_shippriority      VARCHAR(1) NOT NULL,  
lo_quantity          INTEGER NOT NULL,  
lo_extendedprice     INTEGER NOT NULL,  
lo_ordertotalprice   INTEGER NOT NULL,  
lo_discount          INTEGER NOT NULL,  
lo_revenue           INTEGER NOT NULL,  
lo_supplycost        INTEGER NOT NULL,  
lo_tax               INTEGER NOT NULL,  
lo_commitdate        INTEGER NOT NULL,  
lo_shipmode          VARCHAR(10) NOT NULL  
);
```

3. Load the tables using SSB sample data.

The sample data for this tutorial is provided in an Amazon S3 buckets that give read access to all authenticated AWS users, so any valid AWS credentials that permit access to Amazon S3 will work.

a. Create a new text file named `loadssb.sql` containing the following SQL.

```
copy customer from 's3://awssampleduswest2/ssbgz/customer'  
credentials 'aws_access_key_id=<Your-Access-Key-  
ID>;aws_secret_access_key=<Your-Secret-Access-Key>'  
gzip compupdate off region 'us-west-2';  
  
copy dwdate from 's3://awssampleduswest2/ssbgz/dwdate'  
credentials 'aws_access_key_id=<Your-Access-Key-  
ID>;aws_secret_access_key=<Your-Secret-Access-Key>'  
gzip compupdate off region 'us-west-2';  
  
copy lineorder from 's3://awssampleduswest2/ssbgz/lineorder'  
credentials 'aws_access_key_id=<Your-Access-Key-  
ID>;aws_secret_access_key=<Your-Secret-Access-Key>'  
gzip compupdate off region 'us-west-2';  
  
copy part from 's3://awssampleduswest2/ssbgz/part'  
credentials 'aws_access_key_id=<Your-Access-Key-  
ID>;aws_secret_access_key=<Your-Secret-Access-Key>'  
gzip compupdate off region 'us-west-2';  
  
copy supplier from 's3://awssampleduswest2/ssbgz/supplier'  
credentials 'aws_access_key_id=<Your-Access-Key-  
ID>;aws_secret_access_key=<Your-Secret-Access-Key>'  
gzip compupdate off region 'us-west-2';
```

- b. Replace `<Your-Access-Key-ID>` and `<Your-Secret-Access-Key>` with your own AWS account credentials. The segment of the credentials string that is enclosed in single quotes must not contain any spaces or line breaks.
- c. Execute the COPY commands either by running the SQL script or by copying and pasting the commands into your SQL client.

Note

The load operation will take about 10 to 15 minutes for all five tables.

Your results should look similar to the following.

```
Load into table 'customer' completed, 3000000 record(s) loaded
successfully.

0 row(s) affected.
copy executed successfully

Execution time: 10.28s
(Statement 1 of 5 finished)
...
...
Script execution finished
Total script execution time: 9m 51s
```

4. Sum the execution time for all five tables, or else note the total script execution time. You'll record that number as the load time in the benchmarks table in Step 2, following.
5. To verify that each table loaded correctly, execute the following commands.

```
select count(*) from LINEORDER;
select count(*) from PART;
select count(*) from CUSTOMER;
select count(*) from SUPPLIER;
select count(*) from DWDATE;
```

The following results table shows the number of rows for each SSB table.

Table Name	Rows
LINEORDER	600,037,902
PART	1,400,000
CUSTOMER	3,000,000
SUPPLIER	1,000,000
DWDATE	2,556

Next Step

[Step 2: Test System Performance to Establish a Baseline \(p. 34\)](#)

Step 2: Test System Performance to Establish a Baseline

As you test system performance before and after tuning your tables, you will record the following details:

- Load time
- Storage use
- Query performance

The examples in this tutorial are based on using a four-node dw2.large cluster. Your results will be different, even if you use the same cluster configuration. System performance is influenced by many factors, and no two systems will perform exactly the same.

You will record your results using the following benchmarks table.

Benchmark	Before	After
Load time (five tables)		
Storage Use		
LINEORDER		
PART		
CUSTOMER		
DWDATE		
SUPPLIER		
Total storage		
Query execution time		
Query 1		
Query 2		
Query 3		
Total execution time		

To Test System Performance to Establish a Baseline

1. Note the cumulative load time for all five tables and enter it in the benchmarks table in the Before column.

This is the value you noted in the previous step.

2. Record storage use.

Determine how many 1 MB blocks of disk space are used for each table by querying the STV_BLOCKLIST table and record the results in your benchmarks table.

```
select stv_tbl_perm.name as table, count(*) as mb
from stv_blocklist, stv_tbl_perm
where stv_blocklist.tbl = stv_tbl_perm.id
and stv_blocklist.slice = stv_tbl_perm.slice
and stv_tbl_perm.name in
('lineorder', 'part', 'customer', 'dwdate', 'supplier')
group by stv_tbl_perm.name
order by 1 asc;
```

Your results should look similar to this:

table	mb
customer	384
dwwdate	160
lineorder	51024
part	200
supplier	152

3. Test query performance.

The first time you run a query, Amazon Redshift compiles the code, and then sends compiled code to the compute nodes. When you compare the execution times for queries, you should not use the results for the first time you execute the query. Instead, compare the times for the second execution of each query. For more information, see [Factors Affecting Query Performance](#) (p. 208).

Run the following queries twice to eliminate compile time. Record the second time for each query in the benchmarks table.

```
-- Query 1
-- Restrictions on only one dimension.
select sum(lo_extendedprice*lo_discount) as revenue
from lineorder, dwwdate
where lo_orderdate = d_datekey
and d_year = 1997
and lo_discount between 1 and 3
and lo_quantity < 24;

-- Query 2
-- Restrictions on two dimensions

select sum(lo_revenue), d_year, p_brand1
from lineorder, dwwdate, part, supplier
where lo_orderdate = d_datekey
and lo_partkey = p_partkey
and lo_suppkey = s_suppkey
and p_category = 'MFGR#12'
and s_region = 'AMERICA'
group by d_year, p_brand1
order by d_year, p_brand1;

-- Query 3
-- Drill down in time to just one month

select c_city, s_city, d_year, sum(lo_revenue) as revenue
from customer, lineorder, supplier, dwwdate
where lo_custkey = c_custkey
and lo_suppkey = s_suppkey
and lo_orderdate = d_datekey
and (c_city='UNITED KI1' or
c_city='UNITED KI5')
and (s_city='UNITED KI1' or
s_city='UNITED KI5')
and d_yearmonth = 'Dec1997'
group by c_city, s_city, d_year
order by d_year asc, revenue desc;
```

Your results for the second time will look something like this:

```
SELECT executed successfully

Execution time: 6.97s
(Statement 1 of 3 finished)

SELECT executed successfully

Execution time: 12.81s
(Statement 2 of 3 finished)

SELECT executed successfully

Execution time: 13.39s
(Statement 3 of 3 finished)

Script execution finished
Total script execution time: 33.17s
```

The following benchmarks table shows the example results for the cluster used in this tutorial.

Benchmark	Before	After
Load time (five tables)	10m 23s	
Storage Use		
LINEORDER	51024	
PART	200	
CUSTOMER	384	
DWDATE	160	
SUPPLIER	152	
Total storage	51920	
Query execution time		
Query 1	6.97	
Query 2	12.81	
Query 3	13.39	
Total execution time	33.17	

Next Step

[Step 3: Select Sort Keys \(p. 38\)](#)

Step 3: Select Sort Keys

When you create a table, you can specify one or more columns as the sort key. Amazon Redshift stores your data on disk in sorted order according to the sort key. How your data is sorted has an important effect on disk I/O, columnar compression, and query performance.

In this step, you choose sort keys for the SSB tables based on these best practices:

- If recent data is queried most frequently, specify the timestamp column as the leading column for the sort key.
- If you do frequent range filtering or equality filtering on one column, specify that column as the sort key.
- If you frequently join a (dimension) table, specify the join column as the sort key.

To Select Sort Keys

1. Evaluate your queries to find timestamp columns that are used to filter the results.

For example, LINEORDER frequently uses equality filters using `lo_orderdate`.

```
where lo_orderdate = d_datekey and d_year = 1997
```

2. Look for columns that are used in range filters and equality filters. For example, LINEORDER also uses `lo_orderdate` for range filtering.

```
where lo_orderdate = d_datekey and d_year >= 1992 and d_year <= 1997
```

3. Based on the first two best practices, `lo_orderdate` is a good choice for sort key.

In the tuning table, specify `lo_orderdate` as the sort key for LINEORDER.

4. The remaining tables are dimensions, so, based on the third best practice, specify their primary keys as sort keys.

The following tuning table shows the chosen sort keys. You fill in the Distribution Style column in [Step 4: Select Distribution Styles \(p. 39\)](#).

Table name	Sort Key	Distribution Style
LINEORDER	lo_orderdate	
PART	p_partkey	
CUSTOMER	c_custkey	
SUPPLIER	s_suppkey	
DWDATE	d_datekey	

Next Step

[Step 4: Select Distribution Styles \(p. 39\)](#)

Step 4: Select Distribution Styles

When you load data into a table, Amazon Redshift distributes the rows of the table to each of the node slices according to the table's distribution style. The number of slices per node depends on the node size of the cluster. For example, the dc1.large cluster that you are using in this tutorial has four nodes with two slices each, so the cluster has a total of eight slices. The nodes all participate in parallel query execution, working on data that is distributed across the slices.

When you execute a query, the query optimizer redistributes the rows to the compute nodes as needed to perform any joins and aggregations. Redistribution might involve either sending specific rows to nodes for joining or broadcasting an entire table to all of the nodes.

You should assign distribution styles to achieve these goals.

- Collocate the rows from joining tables

When the rows for joining columns are on the same slices, less data needs to be moved during query execution.

- Distribute data evenly among the slices in a cluster.

If data is distributed evenly, workload can be allocated evenly to all the slices.

These goals may conflict in some cases, and you will need to evaluate which strategy is the best choice for overall system performance. For example, even distribution might place all matching values for a column on the same slice. If a query uses an equality filter on that column, the slice with those values will carry a disproportionate share of the workload. If tables are collocated based on a distribution key, the rows might be distributed unevenly to the slices because the keys are distributed unevenly through the table.

In this step, you evaluate the distribution of the SSB tables with respect to the goals of data distribution, and then select the optimum distribution styles for the tables.

Distribution Styles

When you create a table, you designate one of three distribution styles: KEY, ALL, or EVEN.

KEY distribution

The rows are distributed according to the values in one column. The leader node will attempt to place matching values on the same node slice. If you distribute a pair of tables on the joining keys, the leader node collocates the rows on the slices according to the values in the joining columns so that matching values from the common columns are physically stored together.

ALL distribution

A copy of the entire table is distributed to every node. Where EVEN distribution or KEY distribution place only a portion of a table's rows on each node, ALL distribution ensures that every row is collocated for every join that the table participates in.

EVEN distribution

The rows are distributed across the slices in a round-robin fashion, regardless of the values in any particular column. EVEN distribution is appropriate when a table does not participate in joins or when there is not a clear choice between KEY distribution and ALL distribution. EVEN distribution is the default distribution style.

For more information, see [Distribution Styles \(p. 112\)](#).

To Select Distribution Styles

When you execute a query, the query optimizer redistributes the rows to the compute nodes as needed to perform any joins and aggregations. By locating the data where it needs to be before the query is executed, you can minimize the impact of the redistribution step.

The first goal is to distribute the data so that the matching rows from joining tables are collocated, which means that the matching rows from joining tables are located on the same node slice.

1. To look for redistribution steps in the query plan, execute an EXPLAIN command followed by the query. This example uses Query 2 from our set of test queries.

```
explain
select sum(lo_revenue), d_year, p_brand1
from lineorder, dwdate, part, supplier
where lo_orderdate = d_datekey
and lo_partkey = p_partkey
and lo_suppkey = s_suppkey
and p_category = 'MFGR#12'
and s_region = 'AMERICA'
group by d_year, p_brand1
order by d_year, p_brand1;
```

The following shows a portion of the query plan. Look for labels that begin with *DS_BCAST* or *DS_DIST* labels

```
QUERY PLAN
XN Merge (cost=1038007224737.84..1038007224738.54 rows=280 width=20)
  Merge Key: dwdate.d_year, part.p_brand1
  -> XN Network (cost=1038007224737.84..1038007224738.54 rows=280
width=20)
    Send to leader
    -> XN Sort (cost=1038007224737.84..1038007224738.54 rows=280
width=20)
      Sort Key: dwdate.d_year, part.p_brand1
      -> XN HashAggregate (cost=38007224725.76..38007224726.46
rows=280)
        -> XN Hash Join DS_BCAST_INNER
(cost=30674.95..38007188507.46)
          Hash Cond: ("outer".lo_orderdate =
"inner".d_datekey)
            -> XN Hash Join DS_BCAST_INNER
(cost=30643.00..37598119820.65)
              Hash Cond: ("outer".lo_suppkey =
"inner".s_suppkey)
                -> XN Hash Join DS_BCAST_INNER
Hash Cond: ("outer".lo_partkey =
"inner".p_partkey)
                  -> XN Seq Scan on lineorder
                  -> XN Hash
(cost=17500.00..17500.00 rows=56000)
                    -> XN Seq Scan on part
(cost=0.00..17500.00)
                      Filter:
((p_category)::text =
-> XN Hash (cost=12500.00..12500.00
rows=201200)
```

```

                                -> XN Seq Scan on supplier
(cost=0.00..12500.00
                                Filter: ((s_region)::text =
'AMERICA'::text)
                                -> XN Hash  (cost=25.56..25.56 rows=2556
width=8)
                                -> XN Seq Scan on dwdate
(cost=0.00..25.56 rows=2556

```

DS_BCAST_INNER indicates that the inner join table was broadcast to every slice. A DS_DIST_BOTH label, if present, would indicate that both the outer join table and the inner join table were redistributed across the slices. Broadcasting and redistribution can be expensive steps in terms of query performance. You want to select distribution strategies that reduce or eliminate broadcast and distribution steps. For more information about evaluating the EXPLAIN plan, see [Evaluating Query Patterns \(p. 113\)](#).

2. Distribute the fact table and one dimension table on their common columns.

The following diagram shows the relationships between the fact table, LINEORDER, and the dimension tables in the SSB schema.

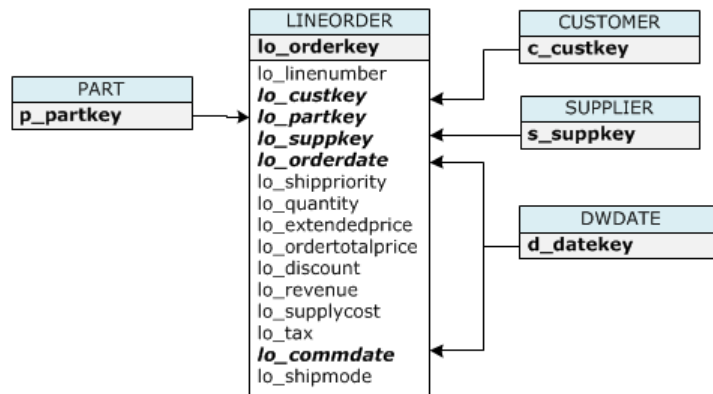

Each table can have only one distribution key, which means that only one pair of tables in the schema can be collocated on their common columns. The central fact table is the clear first choice. For the second table in the pair, choose the largest dimension that commonly joins the fact table. In this design, LINEORDER is the fact table, and PART is the largest dimension. PART joins LINEORDER on its primary key, p_partkey.

Designate lo_partkey as the distribution key for LINEORDER and p_partkey as the distribution key for PART so that the matching values for the joining keys will be collocated on the same slices when the data is loaded.

3. Change some dimension tables to use ALL distribution.

If a dimension table cannot be collocated with the fact table or other important joining tables, you can often improve query performance significantly by distributing the entire table to all of the nodes. ALL distribution guarantees that the joining rows will be collocated on every slice. You should weigh all factors before choosing ALL distribution. Using ALL distribution multiplies storage space requirements and increases load times and maintenance operations.

CUSTOMER, SUPPLIER, and DWDATE also join the LINEORDER table on their primary keys; however, LINEORDER will be collocated with PART, so you will set the remaining tables to use DISTSTYLE ALL. Because the tables are relatively small and are not updated frequently, using ALL distribution will have minimal impact on storage and load times.

4. Use EVEN distribution for the remaining tables.

All of the tables have been assigned with DISTKEY or ALL distribution styles, so you won't assign EVEN to any tables. After evaluating your performance results, you might decide to change some tables from ALL to EVEN distribution.

The following tuning table shows the chosen distribution styles.

Table name	Sort Key	Distribution Style
LINEORDER	lo_orderdate	lo_partkey
PART	p_partkey	p_partkey
CUSTOMER	c_custkey	ALL
SUPPLIER	s_suppkey	ALL
DWDATE	d_datekey	ALL

For more information, see [Choose the Best Distribution Style \(p. 22\)](#).

Next Step

[Step 5: Review Compression Encodings \(p. 42\)](#)

Step 5: Review Compression Encodings

Compression is a column-level operation that reduces the size of data when it is stored. Compression conserves storage space and reduces the size of data that is read from storage, which reduces the amount of disk I/O and therefore improves query performance.

By default, Amazon Redshift stores data in its raw, uncompressed format. When you create tables in an Amazon Redshift database, you can define a compression type, or encoding, for the columns. For more information, see [Compression Encodings \(p. 101\)](#).

You can apply compression encodings to columns in tables manually when you create the tables, or you can use the COPY command to analyze the load data and apply compression encodings automatically.

To Review Compression Encodings

1. Find how much space each column uses.

Query the STV_BLOCKLIST system view to find the number of 1 MB blocks each column uses. The MAX aggregate function returns the highest block number for each column. This example uses `col < 17` in the WHERE clause to exclude system-generated columns.

Execute the following command.

```
select col, max(blocknum)
from stv_blocklist b, stv_tbl_perm p
where (b.tbl=p.id) and name = 'lineorder'
and col < 17
group by name, col
order by col;
```

Your results will look similar to the following.

```
col | max
-----+-----
 0 | 572
 1 | 572
 2 | 572
 3 | 572
 4 | 572
 5 | 572
 6 | 1659
 7 | 715
 8 | 572
 9 | 572
10 | 572
11 | 572
12 | 572
13 | 572
14 | 572
15 | 572
16 | 1185
(17 rows)
```

2. Experiment with the different encoding methods.

In this step, you create a table with identical columns, except that each column uses a different compression encoding. Then you insert a large number of rows, using data from the `p_name` column in the `PART` table, so that every column has the same data. Finally, you will examine the table to compare the effects of the different encodings on column sizes.

- a. Create a table with the encodings that you want to compare.

```
create table encodingshipmode (
  moderaw varchar(22) encode raw,
  modebytedict varchar(22) encode bytedict,
  modelzo varchar(22) encode lzo,
  moderunlength varchar(22) encode runlength,
  modetext255 varchar(22) encode text255,
  modetext32k varchar(22) encode text32k);
```

- b. Insert the same data into all of the columns using an `INSERT` statement with a `SELECT` clause. The command will take a couple minutes to execute.

```
insert into encodingshipmode
select lo_shipmode as moderaw, lo_shipmode as modebytedict,
  lo_shipmode as modelzo,
  lo_shipmode as moderunlength, lo_shipmode as modetext255,
  lo_shipmode as modetext32k
from lineorder where lo_orderkey < 200000000;
```

- c. Query the `STV_BLOCKLIST` system table to compare the number of 1 MB disk blocks used by each column.

```
select col, max(blocknum)
from stv_blocklist b, stv_tbl_perm p
where (b.tbl=p.id) and name = 'encodingshipmode'
and col < 6
```

```
group by name, col
order by col;
```

The query returns results similar to the following. Depending on how your cluster is configured, your results will be different, but the relative sizes should be similar.

col	max
0	221
1	26
2	61
3	192
4	54
5	105

(6 rows)

The columns show the results for the following encodings:

- Raw
- Bytedict
- LZO
- Runlength
- Text255
- Text32K

You can see that Bytedict encoding on the second column produced the best results for this data set, with a compression ratio of better than 8:1. Different data sets will produce different results, of course.

3. Use the ANALYZE COMPRESSION command to view the suggested encodings for an existing table.

Execute the following command.

```
analyze compression lineorder;
```

Your results should look similar to the following.

Table	Column	Encoding
lineorder	lo_orderkey	delta
lineorder	lo_linenummer	delta
lineorder	lo_custkey	raw
lineorder	lo_partkey	raw
lineorder	lo_suppkey	raw
lineorder	lo_orderdate	delta32k
lineorder	lo_orderpriority	bytedict
lineorder	lo_shippriority	runlength
lineorder	lo_quantity	delta
lineorder	lo_extendedprice	lzo
lineorder	lo_ordertotalprice	lzo
lineorder	lo_discount	delta
lineorder	lo_revenue	lzo
lineorder	lo_supplycost	delta32k
lineorder	lo_tax	delta

```
lineorder    lo_commitdate    delta32k
lineorder    lo_shipmode      bytedict
```

Notice that ANALYZE COMPRESSION chose BYTEDICT encoding for the `lo_shipmode` column.

For an example that walks through choosing manually applied compression encodings, see [Example: Choosing Compression Encodings for the CUSTOMER Table \(p. 109\)](#).

4. Apply automatic compression to the SSB tables.

By default, the COPY command automatically applies compression encodings when you load data into an empty table that has no compression encodings other than RAW encoding. For this tutorial, you will let the COPY command automatically select and apply optimal encodings for the tables as part of the next step, Recreate the test data set.

For more information, see [Loading Tables with Automatic Compression \(p. 154\)](#).

Next Step

[Step 6: Recreate the Test Data Set \(p. 45\)](#)

Step 6: Recreate the Test Data Set

Now that you have chosen the sort keys and distribution styles for each of the tables, you can create the tables using those attributes and reload the data. You will allow the COPY command to analyze the load data and apply compression encodings automatically.

To Recreate the Test Data Set

1. You need to drop the SSB tables before you run the CREATE TABLE commands.

Execute the following commands.

```
drop table part cascade;
drop table supplier cascade;
drop table customer cascade;
drop table dwwdate cascade;
drop table lineorder cascade;
```

2. Create the tables with sort keys and distribution styles.

Execute the following set of SQL CREATE TABLE commands.

```
CREATE TABLE part (
  p_partkey    integer      not null sortkey distkey,
  p_name       varchar(22)  not null,
  p_mfgr       varchar(6)   not null,
  p_category   varchar(7)   not null,
  p_brand1     varchar(9)   not null,
  p_color      varchar(11)  not null,
  p_type       varchar(25)  not null,
  p_size       integer      not null,
  p_container  varchar(10)  not null
);
```

Amazon Redshift Database Developer Guide
To Recreate the Test Data Set

```
CREATE TABLE supplier (  
  s_suppkey      integer      not null sortkey,  
  s_name         varchar(25)   not null,  
  s_address      varchar(25)   not null,  
  s_city         varchar(10)   not null,  
  s_nation       varchar(15)   not null,  
  s_region       varchar(12)   not null,  
  s_phone        varchar(15)   not null)  
diststyle all;  
  
CREATE TABLE customer (  
  c_custkey      integer      not null sortkey,  
  c_name         varchar(25)   not null,  
  c_address      varchar(25)   not null,  
  c_city         varchar(10)   not null,  
  c_nation       varchar(15)   not null,  
  c_region       varchar(12)   not null,  
  c_phone        varchar(15)   not null,  
  c_mktsegment   varchar(10)   not null)  
diststyle all;  
  
CREATE TABLE dwwdate (  
  d_datekey      integer      not null sortkey,  
  d_date         varchar(19)   not null,  
  d_dayofweek    varchar(10)   not null,  
  d_month        varchar(10)   not null,  
  d_year         integer      not null,  
  d_yearmonthnum integer      not null,  
  d_yearmonth    varchar(8)   not null,  
  d_daynuminweek integer      not null,  
  d_daynuminmonth integer     not null,  
  d_daynuminyear integer     not null,  
  d_monthnuminyear integer     not null,  
  d_weeknuminyear integer     not null,  
  d_sellingseason varchar(13)  not null,  
  d_lastdayinweekfl varchar(1)  not null,  
  d_lastdayinmonthfl varchar(1)  not null,  
  d_holidayfl    varchar(1)  not null,  
  d_weekdayfl    varchar(1)  not null)  
diststyle all;  
  
CREATE TABLE lineorder (  
  lo_orderkey    integer      not null,  
  lo_linenumber  integer      not null,  
  lo_custkey     integer      not null,  
  lo_partkey     integer      not null distkey,  
  lo_suppkey     integer      not null,  
  lo_orderdate   integer      not null sortkey,  
  lo_orderpriority varchar(15)  not null,  
  lo_shippriority varchar(1)   not null,  
  lo_quantity    integer      not null,  
  lo_extendedprice integer     not null,  
  lo_ordertotalprice integer     not null,  
  lo_discount    integer      not null,  
  lo_revenue     integer      not null,  
  lo_supplycost  integer      not null,  
  lo_tax         integer      not null,  
  lo_commitdate  integer      not null,  
  lo_shipmode    varchar(10)  not null
```

```
);
```

3. Load the tables using the same sample data.
 - a. Open the `loadssb.sql` script that you created in the previous step.
 - b. Delete `compupdate off` from each COPY statement. This time, you will allow COPY to apply compression encodings.

For reference, the edited script should look like the following:

```
copy customer from 's3://awssampleduswest2/ssbgz/customer'
credentials 'aws_access_key_id=<Your-Access-Key-ID>;aws_secret_access_key=<Your-Secret-Access-Key>'
gzip region 'us-west-2';

copy dwdate from 's3://awssampleduswest2/ssbgz/dwdate'
credentials 'aws_access_key_id=<Your-Access-Key-ID>;aws_secret_access_key=<Your-Secret-Access-Key>'
gzip region 'us-west-2';

copy lineorder from 's3://awssampleduswest2/ssbgz/lineorder'
credentials 'aws_access_key_id=<Your-Access-Key-ID>;aws_secret_access_key=<Your-Secret-Access-Key>'
gzip region 'us-west-2';

copy part from 's3://awssampleduswest2/ssbgz/part'
credentials 'aws_access_key_id=<Your-Access-Key-ID>;aws_secret_access_key=<Your-Secret-Access-Key>'
gzip region 'us-west-2';

copy supplier from 's3://awssampleduswest2/ssbgz/supplier'
credentials 'aws_access_key_id=<Your-Access-Key-ID>;aws_secret_access_key=<Your-Secret-Access-Key>'
gzip region 'us-west-2';
```

- c. Save the file.
- d. Execute the COPY commands either by running the SQL script or by copying and pasting the commands into your SQL client.

Note

The load operation will take about 10 to 15 minutes. This might be a good time to get another cup of tea or feed the fish.

Your results should look similar to the following.

```
Warnings:
Load into table 'customer' completed, 3000000 record(s) loaded
successfully.
...
...
Script execution finished
Total script execution time: 12m 15s
```

- e. Record the load time in the benchmarks table.

Benchmark	Before	After
Load time (five tables)	10m 23s	12m 15s

Benchmark	Before	After
Storage Use		
LINEORDER	51024	
PART	384	
CUSTOMER	200	
DWDATE	160	
SUPPLIER	152	
Total storage	51920	
Query execution time		
Query 1	6.97	
Query 2	12.81	
Query 3	13.39	
Total execution time	33.17	

Next Step

[Step 7: Retest System Performance After Tuning \(p. 48\)](#)

Step 7: Retest System Performance After Tuning

After recreating the test data set with the selected sort keys, distribution styles, and compressions encodings, you will retest the system performance.

To Retest System Performance After Tuning

1. Record storage use.

Determine how many 1 MB blocks of disk space are used for each table by querying the STV_BLOCKLIST table and record the results in your benchmarks table.

```
select stv_tbl_perm.name as "table", count(*) as "blocks (mb)"
from stv_blocklist, stv_tbl_perm
where stv_blocklist.tbl = stv_tbl_perm.id
and stv_blocklist.slice = stv_tbl_perm.slice
and stv_tbl_perm.name in ('customer', 'part', 'supplier', 'dwdate',
'lineorder')
group by stv_tbl_perm.name
order by 1 asc;
```

Your results will look similar to this:

```
table      | blocks (mb)
-----+-----
```

customer	604
dwwdate	160
lineorder	27152
part	200
supplier	236

2. Check for distribution skew.

Uneven distribution, or data distribution skew, forces some nodes to do more work than others, which limits query performance.

To check for distribution skew, query the SVV_DISKUSAGE system view. Each row in SVV_DISKUSAGE records the statistics for one disk block. The num_values column gives the number of rows in that disk block, so sum(num_values) returns the number of rows on each slice.

Execute the following query to see the distribution for all of the tables in the SSB database.

```
select trim(name) as table, slice, sum(num_values) as rows, min(minvalue),
       max(maxvalue)
from svv_diskusage
where name in ('customer', 'part', 'supplier', 'dwwdate', 'lineorder')
and col =0
group by name, slice
order by name, slice;
```

Your results will look something like this:

table	slice	rows	min	max
customer	0	3000000	1	3000000
customer	2	3000000	1	3000000
customer	4	3000000	1	3000000
customer	6	3000000	1	3000000
dwwdate	0	2556	19920101	19981230
dwwdate	2	2556	19920101	19981230
dwwdate	4	2556	19920101	19981230
dwwdate	6	2556	19920101	19981230
lineorder	0	75029991	3	599999975
lineorder	1	75059242	7	600000000
lineorder	2	75238172	1	599999975
lineorder	3	75065416	1	599999973
lineorder	4	74801845	3	599999975
lineorder	5	75177053	1	599999975
lineorder	6	74631775	1	600000000
lineorder	7	75034408	1	599999974
part	0	175006	15	1399997
part	1	175199	1	1399999
part	2	175441	4	1399989
part	3	175000	3	1399995
part	4	175018	5	1399979
part	5	175091	11	1400000
part	6	174253	2	1399969
part	7	174992	13	1399996
supplier	0	1000000	1	1000000
supplier	2	1000000	1	1000000
supplier	4	1000000	1	1000000
supplier	6	1000000	1	1000000

(28 rows)

The following chart illustrates the distribution of the three largest tables. (The columns are not to scale.) Notice that because CUSTOMER uses ALL distribution, it was distributed to only one slice per node.

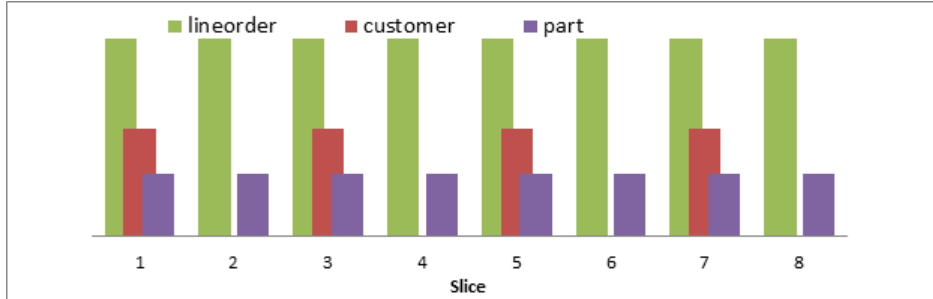

The distribution is relatively even, so you don't need to adjust for distribution skew.

3. Run an EXPLAIN command with each query to view the query plans.

The following example shows the EXPLAIN command with Query 2.

```
explain
select sum(lo_revenue), d_year, p_brand1
from lineorder, ddate, part, supplier
where lo_orderdate = d_datekey
and lo_partkey = p_partkey
and lo_suppkey = s_suppkey
and p_category = 'MFGR#12'
and s_region = 'AMERICA'
group by d_year, p_brand1
order by d_year, p_brand1;
```

In the EXPLAIN plan for Query 2, notice that the DS_BCAST_INNER labels have been replaced by DS_DIST_ALL_NONE and DS_DIST_NONE, which means that no redistribution was required for those steps, and the query should run much more quickly.

```
QUERY PLAN
XN Merge (cost=1000014243538.45..1000014243539.15 rows=280 width=20)
  Merge Key: ddate.d_year, part.p_brand1
  -> XN Network (cost=1000014243538.45..1000014243539.15 rows=280
width=20)
    Send to leader
    -> XN Sort (cost=1000014243538.45..1000014243539.15 rows=280
width=20)
      Sort Key: ddate.d_year, part.p_brand1
      -> XN HashAggregate (cost=14243526.37..14243527.07
rows=280 width=20)
        -> XN Hash Join DS_DIST_ALL_NONE
(cost=30643.30..14211277.03 rows=4299912
Hash Cond: ("outer".lo_orderdate =
"inner".d_datekey)
        -> XN Hash Join DS_DIST_ALL_NONE
(cost=30611.35..14114497.06
Hash Cond: ("outer".lo_suppkey =
"inner".s_suppkey)
```

```

                                -> XN Hash Join DS_DIST_NONE
(cost=17640.00..13758507.64
                                Hash Cond: ("outer".lo_partkey =
"inner".p_partkey)
                                -> XN Seq Scan on lineorder
(cost=0.00..6000378.88
                                -> XN Hash
(cost=17500.00..17500.00 rows=56000 width=16)
                                -> XN Seq Scan on part
(cost=0.00..17500.00
                                Filter:
((p_category)::text = 'MFGR#12'::text)
                                -> XN Hash (cost=12500.00..12500.00
rows=188541 width=4)
                                -> XN Seq Scan on supplier
(cost=0.00..12500.00
                                Filter: ((s_region)::text =
'AMERICA'::text)
                                -> XN Hash (cost=25.56..25.56 rows=2556
width=8)
                                -> XN Seq Scan on dwdate
(cost=0.00..25.56 rows=2556 width=8)

```

4. Run the same test queries again.

As you did earlier, run the following queries twice to eliminate compile time. Record the second time for each query in the benchmarks table.

```

-- Query 1
-- Restrictions on only one dimension.
select sum(lo_extendedprice*lo_discount) as revenue
from lineorder, dwdate
where lo_orderdate = d_datekey
and d_year = 1997
and lo_discount between 1 and 3
and lo_quantity < 24;

-- Query 2
-- Restrictions on two dimensions

select sum(lo_revenue), d_year, p_brand1
from lineorder, dwdate, part, supplier
where lo_orderdate = d_datekey
and lo_partkey = p_partkey
and lo_suppkey = s_suppkey
and p_category = 'MFGR#12'
and s_region = 'AMERICA'
group by d_year, p_brand1
order by d_year, p_brand1;

-- Query 3
-- Drill down in time to just one month

select c_city, s_city, d_year, sum(lo_revenue) as revenue
from customer, lineorder, supplier, dwdate
where lo_custkey = c_custkey
and lo_suppkey = s_suppkey
and lo_orderdate = d_datekey
and (c_city='UNITED KI1' or

```

```
c_city='UNITED KI5')
and (s_city='UNITED KI1' or
s_city='UNITED KI5')
and d_yearmonth = 'Dec1997'
group by c_city, s_city, d_year
order by d_year asc, revenue desc;
```

The following benchmarks table shows the results based on the cluster used in this example. Your results will vary based on a number of factors, but the relative results should be similar.

Benchmark	Before	After
Load time (five tables)	10m 23s	12m 15s
Storage Use		
LINEORDER	51024	27152
PART	200	200
CUSTOMER	384	604
DWDATE	160	160
SUPPLIER	152	236
Total storage	51920	28352
Query execution time		
Query 1	6.97	3.19
Query 2	12.81	9.02
Query 3	13.39	10.54
Total execution time	33.17	22.75

Next Step

[Step 8: Evaluate the Results \(p. 52\)](#)

Step 8: Evaluate the Results

You tested load times, storage requirements, and query execution times before and after tuning the tables, and recorded the results.

The following table shows the example results for the cluster that was used for this tutorial. Your results will be different, but should show similar improvements.

Benchmark	Before	After	Change	%
Load time (five tables)	623	732	109	17.5%
Storage Use				

Benchmark	Before	After	Change	%
LINEORDER	51024	27152	-23872	-46.8%
PART	200	200	0	0%
CUSTOMER	384	604	220	57.3%
DWDATE	160	160	0	0%
SUPPLIER	152	236	84	55.3%
Total storage	51920	28352	-23568	-45.4%
Query execution time				
Query 1	6.97	3.19	-3.78	-54.2%
Query 2	12.81	9.02	-3.79	-29.6%
Query 3	13.39	10.54	-2.85	-21.3%
Total execution time	33.17	22.75	-10.42	-31.4%

Load time

Load time increased by 17.5%.

Sorting, compression, and distribution increase load time. In particular, in this case, you used automatic compression, which increases the load time for empty tables that don't already have compression encodings. Subsequent loads to the same tables would be faster. You also increased load time by using ALL distribution. You could reduce load time by using EVEN or DISTKEY distribution instead for some of the tables, but that decision needs to be weighed against query performance.

Storage requirements

Storage requirements were reduced by 45.4%.

Some of the storage improvement from using columnar compression was offset by using ALL distribution on some of the tables. Again, you could improve storage use by using EVEN or DISTKEY distribution instead for some of the tables, but that decision needs to be weighed against query performance.

Distribution

You verified that there is no distribution skew as a result of your distribution choices.

By checking the EXPLAIN plan, you saw that data redistribution was eliminated for the test queries.

Query execution time

Total query execution time was reduced by 31.4%.

The improvement in query performance was due to a combination of optimizing sort keys, distribution styles, and compression. Often, query performance can be improved even further by rewriting queries and configuring workload management (WLM). For more information, see [Tuning Query Performance \(p. 199\)](#).

Next Step

[Step 9: Clean Up Your Resources \(p. 54\)](#)

Step 9: Clean Up Your Resources

Your cluster continues to accrue charges as long as it is running. When you have completed this tutorial, you should return your environment to the previous state by following the steps in [Step 5: Revoke Access and Delete Your Sample Cluster](#) in the *Amazon Redshift Getting Started*.

If you want to keep the cluster, but recover the storage used by the SSB tables, execute the following commands.

```
drop table part cascade;  
drop table supplier cascade;  
drop table customer cascade;  
drop table dwdate cascade;  
drop table lineorder cascade;
```

Next Step

[Summary \(p. 54\)](#)

Summary

In this tutorial, you learned how to optimize the design of your tables by applying table design best practices.

You chose sort keys for the SSB tables based on these best practices:

- If recent data is queried most frequently, specify the timestamp column as the leading column for the sort key.
- If you do frequent range filtering or equality filtering on one column, specify that column as the sort key.
- If you frequently join a (dimension) table, specify the join column as the sort key.

You applied the following best practices to improve the distribution of the tables.

- Distribute the fact table and one dimension table on their common columns
- Change some dimension tables to use ALL distribution

You evaluated the effects of compression on a table and determined that using automatic compression usually produces the best results.

For more information, see the following links:

- [Best Practices for Designing Tables \(p. 21\)](#)
- [Choose the Best Sort Key \(p. 22\)](#)
- [Choosing a Data Distribution Style \(p. 110\)](#)
- [Choosing a Column Compression Type \(p. 100\)](#)

- [Analyzing Table Design \(p. 128\)](#)

Next Step

For your next step, if you haven't done so already, we recommend taking [Tutorial: Loading Data from Amazon S3 \(p. 56\)](#).

Tutorial: Loading Data from Amazon S3

In this tutorial, you will walk through the process of loading data into your Amazon Redshift database tables from data files in an Amazon Simple Storage Service (Amazon S3) bucket from beginning to end.

In this tutorial, you will:

- Download data files that use CSV, character-delimited, and fixed width formats.
- Create an Amazon S3 bucket and then upload the data files to the bucket.
- Launch an Amazon Redshift cluster and create database tables.
- Use COPY commands to load the tables from the data files on Amazon S3.
- Troubleshoot load errors and modify your COPY commands to correct the errors.

Estimated time: 60 minutes

Estimated cost: \$1.00 per hour for the cluster

Prerequisites

You will need the following prerequisites:

- An AWS account to launch an Amazon Redshift cluster and to create a bucket in Amazon S3.
- Your AWS credentials (an access key ID and secret access key) to load test data from Amazon S3. If you need to create new access keys, go to [Administering Access Keys for IAM Users](#).

This tutorial is designed so that it can be taken by itself. In addition to this tutorial, we recommend completing the following tutorials to gain a more complete understanding of how to design and use Amazon Redshift databases:

- [Amazon Redshift Getting Started](#) walks you through the process of creating an Amazon Redshift cluster and loading sample data.
- [Tutorial: Tuning Table Design \(p. 30\)](#) walks you step by step through the process of designing and tuning tables, including choosing sort keys, distribution styles, and compression encodings, and evaluating system performance before and after tuning.

Overview

You can add data to your Amazon Redshift tables either by using an INSERT command or by using a COPY command. At the scale and speed of an Amazon Redshift data warehouse, the COPY command is many times faster and more efficient than INSERT commands.

The COPY command uses the Amazon Redshift massively parallel processing (MPP) architecture to read and load data in parallel from multiple data sources. You can load from data files on Amazon S3, Amazon EMR, or any remote host accessible through a Secure Shell (SSH) connection, or you can load directly from an Amazon DynamoDB table.

In this tutorial, you will use the COPY command to load data from Amazon S3. Many of the principles presented here apply to loading from other data sources as well.

To learn more about using the COPY command, see these resources:

- [Best Practices for Loading Data \(p. 24\)](#)
- [Loading Data from Amazon EMR \(p. 141\)](#)
- [Loading Data from Remote Hosts \(p. 145\)](#)
- [Loading Data from an Amazon DynamoDB Table \(p. 151\)](#)

Steps

- [Step 1: Launch a Cluster \(p. 57\)](#)
- [Step 2: Download the Data Files \(p. 58\)](#)
- [Step 3: Upload the Files to an Amazon S3 Bucket \(p. 59\)](#)
- [Step 4: Create the Sample Tables \(p. 60\)](#)
- [Step 5: Run the COPY Commands \(p. 62\)](#)
- [Step 6: Vacuum and Analyze the Database \(p. 74\)](#)
- [Step 7: Clean Up Your Resources \(p. 75\)](#)

Step 1: Launch a Cluster

If you already have a cluster that you want to use, you can skip this step.

For the exercises in this tutorial, you will use a four-node cluster. Follow the steps in [Amazon Redshift Getting Started](#), but select **Multi Node** for **Cluster Type** and set **Number of Compute Nodes** to **4**.

CLUSTER DETAILS **NODE CONFIGURATION** ADDITIONAL CONFIGURATION REVIEW

Choose a number of nodes and Node Type below. Number of Compute Nodes is required for multi-node clusters.

Node Type Specifies the compute, memory, storage, and I/O capacity of the cluster's nodes.

CPU 7 EC2 Compute Units (2 virtual cores) per node

Memory 15 GiB per node

Storage 160GB SSD storage per node

I/O Performance Moderate

Cluster Type

Number of Compute Nodes* Compute nodes store your data and execute your queries. In addition to your compute nodes, a leader node will be added to your cluster, free of charge. The leader node is the access point for ODBC/JDBC and generates the query plans executed on the compute nodes.

Maximum 32

Minimum 2

Follow the Getting Started steps to connect to your cluster from a SQL client and test a connection. You do not need to complete the remaining Getting Started steps to create tables, upload data, and try example queries.

Next Step

[Step 2: Download the Data Files \(p. 58\)](#)

Step 2: Download the Data Files

In this step, you will download a set of sample data files to your computer. In the next step, you will upload the files to an Amazon S3 bucket.

To download the data files

1. Download the zipped file from the following link: [LoadingDataSampleFiles.zip](#)
2. Extract the files to a folder on your computer.
3. Verify that your folder contains the following files.

```
customer-fw-manifest
customer-fw.tbl-000
customer-fw.tbl-000.bak
customer-fw.tbl-001
customer-fw.tbl-002
customer-fw.tbl-003
customer-fw.tbl-004
customer-fw.tbl-005
customer-fw.tbl-006
customer-fw.tbl-007
customer-fw.tbl.log
dwdate-tab.tbl-000
dwdate-tab.tbl-001
```

```
dwdate-tab.tbl-002  
dwdate-tab.tbl-003  
dwdate-tab.tbl-004  
dwdate-tab.tbl-005  
dwdate-tab.tbl-006  
dwdate-tab.tbl-007  
part-csv.tbl-000  
part-csv.tbl-001  
part-csv.tbl-002  
part-csv.tbl-003  
part-csv.tbl-004  
part-csv.tbl-005  
part-csv.tbl-006  
part-csv.tbl-007
```

Next Step

[Step 3: Upload the Files to an Amazon S3 Bucket \(p. 59\)](#)

Step 3: Upload the Files to an Amazon S3 Bucket

In this step, you create an Amazon S3 bucket and upload the data files to the bucket.

To upload the files to an Amazon S3 bucket

1. Create a bucket in Amazon S3.
 1. Sign in to the AWS Management Console and open the Amazon S3 console at <https://console.aws.amazon.com/s3/>.
 2. Click **Create Bucket**.
 3. In the **Bucket Name** box of the **Create a Bucket** dialog box, type a bucket name.

The bucket name you choose must be unique among all existing bucket names in Amazon S3. One way to help ensure uniqueness is to prefix your bucket names with the name of your organization. Bucket names must comply with certain rules. For more information, go to [Bucket Restrictions and Limitations](#) in the *Amazon Simple Storage Service Developer Guide*.
 4. Select a region.

Create the bucket in the same region as your cluster. If your cluster is in the Oregon region, click **Oregon**.
 5. Click **Create**.

When Amazon S3 successfully creates your bucket, the console displays your empty bucket in the **Buckets** panel.
2. Create a folder.
 1. Click the name of the new bucket.
 2. Click the **Actions** button, and click **Create Folder** in the drop-down list.
 3. Name the new folder **load**.

Note

The bucket that you created is not in a sandbox. In this exercise, you will add objects to a real bucket, and you will be charged a nominal amount for the time that you store

the objects in the bucket. For more information about Amazon S3 pricing, go to the [Amazon S3 Pricing](#) page.

3. Upload the data files the new Amazon S3 bucket.
 1. Click the name of the data folder.
 2. In the Upload - Select Files wizard, click **Add Files**.

A file selection dialog box opens.
 3. Select all of the files you downloaded and extracted, and then click **Open**.
 4. Click **Start Upload**.

User Credentials

The Amazon Redshift COPY command must have access to read the file objects in the Amazon S3 bucket. If you use the same user credentials to create the Amazon S3 bucket and to run the Amazon Redshift COPY command, the COPY command will have all necessary permissions. If you want to use different user credentials, you can grant access by using the Amazon S3 access controls. The Amazon Redshift COPY command requires at least ListBucket and GetObject permissions to access the file objects in the Amazon S3 bucket. For more information about controlling access to Amazon S3 resources, go to [Managing Access Permissions to Your Amazon S3 Resources](#).

Next Step

[Step 4: Create the Sample Tables \(p. 60\)](#)

Step 4: Create the Sample Tables

For this tutorial, you will use a set of five tables based on the Star Schema Benchmark (SSB) schema. The following diagram shows the SSB data model.

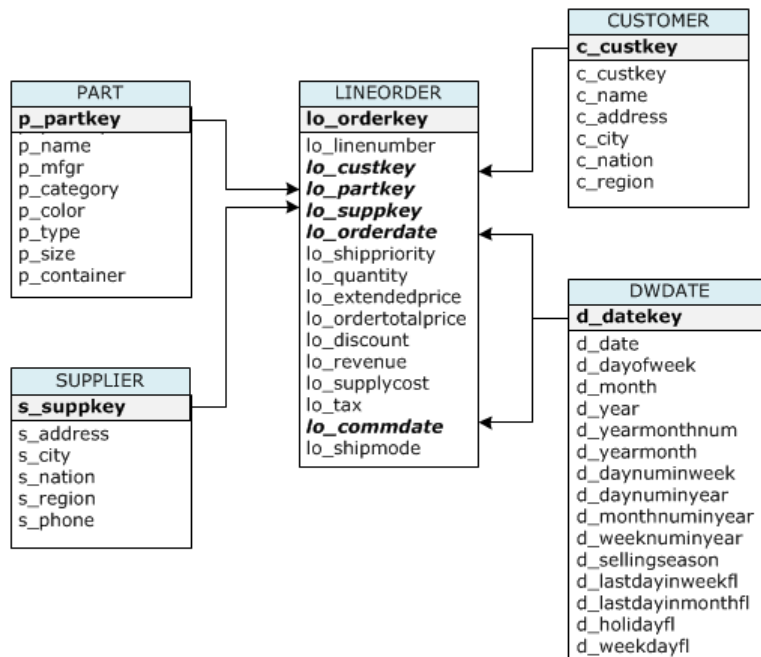

If the SSB tables already exist in the current database, you will need to drop the tables to remove them from the database before you create them using the CREATE TABLE commands in the next step. The tables used in this tutorial might have different attributes than the existing tables.

To create the sample tables

1. To drop the SSB tables, execute the following commands.

```
drop table part cascade;
drop table supplier;
drop table customer;
drop table dwdate;
drop table lineorder;
```

2. Execute the following CREATE TABLE commands.

```
CREATE TABLE part
(
  p_partkey      INTEGER NOT NULL,
  p_name         VARCHAR(22) NOT NULL,
  p_mfgr         VARCHAR(6),
  p_category     VARCHAR(7) NOT NULL,
  p_brand1       VARCHAR(9) NOT NULL,
  p_color        VARCHAR(11) NOT NULL,
  p_type         VARCHAR(25) NOT NULL,
  p_size         INTEGER NOT NULL,
  p_container    VARCHAR(10) NOT NULL
);

CREATE TABLE supplier
(
  s_suppkey      INTEGER NOT NULL,
  s_name         VARCHAR(25) NOT NULL,
  s_address      VARCHAR(25) NOT NULL,
  s_city         VARCHAR(10) NOT NULL,
  s_nation       VARCHAR(15) NOT NULL,
  s_region       VARCHAR(12) NOT NULL,
  s_phone        VARCHAR(15) NOT NULL
);

CREATE TABLE customer
(
  c_custkey      INTEGER NOT NULL,
  c_name         VARCHAR(25) NOT NULL,
  c_address      VARCHAR(25) NOT NULL,
  c_city         VARCHAR(10) NOT NULL,
  c_nation       VARCHAR(15) NOT NULL,
  c_region       VARCHAR(12) NOT NULL,
  c_phone        VARCHAR(15) NOT NULL,
  c_mktsegment   VARCHAR(10) NOT NULL
);

CREATE TABLE dwdate
(
  d_datekey      INTEGER NOT NULL,
  d_date         VARCHAR(19) NOT NULL,
  d_dayofweek    VARCHAR(10) NOT NULL,
  d_month        VARCHAR(10) NOT NULL,
```

```
d_year          INTEGER NOT NULL,
d_yearmonthnum INTEGER NOT NULL,
d_yearmonth    VARCHAR(8) NOT NULL,
d_daynuminweek INTEGER NOT NULL,
d_daynuminmonth INTEGER NOT NULL,
d_daynuminyear INTEGER NOT NULL,
d_monthnuminyear INTEGER NOT NULL,
d_weeknuminyear INTEGER NOT NULL,
d_sellingseason VARCHAR(13) NOT NULL,
d_lastdayinweekfl VARCHAR(1) NOT NULL,
d_lastdayinmonthfl VARCHAR(1) NOT NULL,
d_holidayfl    VARCHAR(1) NOT NULL,
d_weekdayfl    VARCHAR(1) NOT NULL
);
CREATE TABLE lineorder
(
  lo_orderkey      INTEGER NOT NULL,
  lo_linenumbers  INTEGER NOT NULL,
  lo_custkey       INTEGER NOT NULL,
  lo_partkey       INTEGER NOT NULL,
  lo_suppkey       INTEGER NOT NULL,
  lo_orderdate     INTEGER NOT NULL,
  lo_orderpriority VARCHAR(15) NOT NULL,
  lo_shippriority  VARCHAR(1) NOT NULL,
  lo_quantity      INTEGER NOT NULL,
  lo_extendedprice INTEGER NOT NULL,
  lo_ordertotalprice INTEGER NOT NULL,
  lo_discount      INTEGER NOT NULL,
  lo_revenue       INTEGER NOT NULL,
  lo_supplycost    INTEGER NOT NULL,
  lo_tax           INTEGER NOT NULL,
  lo_commitdate    INTEGER NOT NULL,
  lo_shipmode      VARCHAR(10) NOT NULL
);
```

Next Step

[Step 5: Run the COPY Commands \(p. 62\)](#)

Step 5: Run the COPY Commands

You will run COPY commands to load each of the tables in the SSB schema. The COPY command examples demonstrate loading from different file formats, using several COPY command options, and troubleshooting load errors.

Topics

- [COPY Command Syntax \(p. 62\)](#)
- [Loading the SSB Tables \(p. 64\)](#)

COPY Command Syntax

The basic [COPY \(p. 317\)](#) command syntax is as follows.

```
COPY table_name [ column_list ] FROM data_source CREDENTIALS
  access_credentials [options]
```

To execute a COPY command, you provide the following values.

Table name

The target table for the COPY command. The table must already exist in the database. The table can be temporary or persistent. The COPY command appends the new input data to any existing rows in the table.

Column list

By default, COPY loads fields from the source data to the table columns in order. You can optionally specify a *column list*, that is a comma-separated list of column names, to map data fields to specific columns. You will not use column lists in this tutorial. For more information, see [Column List \(p. 332\)](#) in the COPY command reference.

Data source

You can use the COPY command to load data from an Amazon S3 bucket, an Amazon EMR cluster, a remote host using an SSH connection, or an Amazon DynamoDB table. For this tutorial, you will load from data files in an Amazon S3 bucket. When loading from Amazon S3, you must provide the name of the bucket and the location of the data files, by providing either an object path for the data files or the location of a manifest file that explicitly lists each data file and its location.

- Key prefix

An object stored in Amazon S3 is uniquely identified by an object key, which includes the bucket name, folder names, if any, and the object name. A *key prefix* refers to a set of objects with the same prefix. The object path is a key prefix that the COPY command uses to load all objects that share the key prefix. For example, the key prefix `custdata.txt` can refer to a single file or to a set of files, including `custdata.txt.001`, `custdata.txt.002`, and so on.

- Manifest file

If you need to load files with different prefixes, for example, from multiple buckets or folders, or if you need to exclude files that share a prefix, you can use a manifest file. A *manifest file* explicitly lists each load file and its unique object key. You will use a manifest file to load the PART table later in this tutorial.

Credentials

To access the AWS resources that contain the data to load, you must provide AWS access credentials (that is, an access key ID and a secret access key) for an AWS user or an IAM user with sufficient privileges. To load data from Amazon S3, the credentials must include ListBucket and GetObject permissions. Additional credentials are required if your data is encrypted or if you are using temporary access credentials. For more information, see [the section called "Credentials" \(p. 330\)](#) in the COPY command reference. For more information about managing access, go to [Managing Access Permissions to Your Amazon S3 Resources](#). If you do not have an access key ID and secret access key, you will need to get them. For more information, go to [Administering Access Keys for IAM Users](#).

Options

You can specify a number of parameters with the COPY command to specify file formats, manage data formats, manage errors, and control other features. In this tutorial, you will use the following COPY command options and features:

- [Key Prefix \(p. 65\)](#)
- [CSV Format \(p. 65\)](#)

- [NULL AS](#) (p. 66)
- [REGION](#) (p. 67)
- [Fixed-Width Format](#) (p. 68)
- [MAXERROR](#) (p. 69)
- [ACCEPTINVCHARS](#) (p. 71)
- [MANIFEST](#) (p. 71)
- [DATEFORMAT](#) (p. 72)
- [GZIP, LZOP and BZIP2](#) (p. 73)
- [COMPUPDATE](#) (p. 73)
- [Multiple Files](#) (p. 73)

Loading the SSB Tables

You will use the following COPY commands to load each of the tables in the SSB schema. The command to each table demonstrates different COPY options and troubleshooting techniques.

To load the SSB tables, follow these steps:

1. [Replace the Bucket Name and AWS Credentials](#) (p. 64)
2. [Load the PART Table Using NULL AS](#) (p. 64)
3. [Load the SUPPLIER table Using REGION](#) (p. 67)
4. [Load the CUSTOMER Table Using MANIFEST](#) (p. 68)
5. [Load the DWDATE Table Using DATEFORMAT](#) (p. 72)
6. [Load the LINEORDER Table Using Multiple Files](#) (p. 72)

Replace the Bucket Name and AWS Credentials

The COPY commands in this tutorial are presented in the following format.

```
copy table from 's3://<your-bucket-name>/load/key_prefix'  
credentials 'aws_access_key_id=<Your-Access-Key-  
ID>;aws_secret_access_key=<Your-Secret-Access-Key>'  
options;
```

For each COPY command, do the following:

1. Replace *<your-bucket-name>* with the name of a bucket in the same region as your cluster.

This step assumes the bucket and the cluster are in the same region. Alternatively, you can specify the region using the [REGION](#) (p. 324) option with the COPY command.
2. Replace *<Your-Access-Key-ID>* and *<Your-Secret-Access-Key>* with your own AWS IAM account credentials. The segment of the credentials string that is enclosed in single quotation marks must not contain any spaces or line breaks.

Load the PART Table Using NULL AS

In this step, you will use the CSV and NULL AS options to load the PART table.

The COPY command can load data from multiple files in parallel, which is much faster than loading from a single file. To demonstrate this principle, the data for each table in this tutorial is split into eight files, even though the files are very small. In a later step, you will compare the time difference between

loading from a single file and loading from multiple files. For more information, see [Split Your Load Data into Multiple Files \(p. 25\)](#).

Key Prefix

You can load from multiple files by specifying a key prefix for the file set, or by explicitly listing the files in a manifest file. In this step, you will use a key prefix. In a later step, you will use a manifest file. The key prefix 's3://mybucket/load/part-csv.tbl' loads the following set of the files in the load folder.

```
part-csv.tbl-000
part-csv.tbl-001
part-csv.tbl-002
part-csv.tbl-003
part-csv.tbl-004
part-csv.tbl-005
part-csv.tbl-006
part-csv.tbl-007
```

CSV Format

CSV, which stands for comma separated values, is a common format used for importing and exporting spreadsheet data. CSV is more flexible than comma-delimited format because it enables you to include quoted strings within fields. The default quote character for COPY from CSV format is a double quotation mark ("), but you can specify another quote character by using the QUOTE AS option. When you use the quote character within the field, escape the character with an additional quote character.

The following excerpt from a CSV-formatted data file for the PART table shows strings enclosed in double quotation marks ("LARGE ANODIZED BRASS") and a string enclosed in two double quotation marks within a quoted string ("MEDIUM " "BURNISHED" " TIN").

```
15,dark sky,MFGR#3,MFGR#47,MFGR#3438,indigo,"LARGE ANODIZED BRASS",45,LG CASE
22,floral beige,MFGR#4,MFGR#44,MFGR#4421,medium,"PROMO, POLISHED BRASS",19,LG
DRUM
23,bisque slate,MFGR#4,MFGR#41,MFGR#4137,firebrick,"MEDIUM " "BURNISHED" "
TIN",42,JUMBO JAR
```

The data for the PART table contains characters that will cause COPY to fail. In this exercise, you will troubleshoot the errors and correct them.

To load data that is in CSV format, add `csv` to your COPY command. Execute the following command to load the PART table.

```
copy part from 's3://<your-bucket-name>/load/part-csv.tbl'
credentials 'aws_access_key_id=<Your-Access-Key-
ID>;aws_secret_access_key=<Your-Secret-Access-Key>'
csv;
```

You should get an error message similar to the following.

```
An error occurred when executing the SQL command:
copy part from 's3://mybucket/load/part-csv.tbl'
credentials' ...

ERROR: Load into table 'part' failed. Check 'stl_load_errors' system table
for details. [SQL State=XX000]
```

```
Execution time: 1.46s  
  
1 statement(s) failed.  
1 statement(s) failed.
```

To get more information about the error, query the `STL_LOAD_ERRORS` table. The following query uses the `SUBSTRING` function to shorten columns for readability and uses `LIMIT 10` to reduce the number of rows returned. You can adjust the values in `substring(filename,22,25)` to allow for the length of your bucket name.

```
select query, substring(filename,22,25) as filename,line_number as line,  
substring(colname,0,12) as column, type, position as pos,  
substring(raw_line,0,30) as line_text,  
substring(raw_field_value,0,15) as field_text,  
substring(err_reason,0,45) as reason  
from stl_load_errors  
order by query desc  
limit 10;
```

query	filename	line	column	type	pos
333765	part-csv.tbl-000	1			0
line_text	field_text			reason	
15,NUL next,			Missing newline: Unexpected character 0x2c f		

NULL AS

The `part-csv.tbl` data files use the NUL terminator character (`\x000` or `\x0`) to indicate NULL values.

Note

Despite very similar spelling, NUL and NULL are not the same. NUL is a UTF-8 character with codepoint `x000` that is often used to indicate end of record (EOR). NULL is a SQL value that represents an absence of data.

By default, COPY treats a NUL terminator character as an EOR character and terminates the record, which often results in unexpected results or an error. Because there is no single standard method of indicating NULL in text data, the `NULL AS COPY` command option enables you to specify which character to substitute with NULL when loading the table. In this example, you want COPY to treat the NUL terminator character as a NULL value.

Note

The table column that receives the NULL value must be configured as *nullable*. That is, it must not include the NOT NULL constraint in the CREATE TABLE specification.

To load PART using the NULL AS option, execute the following COPY command.

```
copy part from 's3://<your-bucket-name>/load/part-csv.tbl'  
credentials 'aws_access_key_id=<Your-Access-Key-  
ID>;aws_secret_access_key=<Your-Secret-Access-Key>'  
csv  
null as '\000';
```

To verify that COPY loaded NULL values, execute the following command to select only the rows that contain NULL.

```
select p_partkey, p_name, p_mfgr, p_category from part where p_mfgr is null;
```

p_partkey	p_name	p_mfgr	p_category
15	NUL next		MFGR#47
81	NUL next		MFGR#23
133	NUL next		MFGR#44

(2 rows)

Load the SUPPLIER table Using REGION

In this step you will use the DELIMITER and REGION options to load the SUPPLIER table.

Note

The files for loading the SUPPLIER table are provided in an AWS sample bucket. You don't need to upload files for this step.

Character-Delimited Format

The fields in a character-delimited file are separated by a specific character, such as a pipe character (|), a comma (,), or a tab (\t). Character-delimited files can use any single ASCII character, including one of the nonprinting ASCII characters, as the delimiter. You specify the delimiter character by using the DELIMITER option. The default delimiter is a pipe character (|).

The following excerpt from the data for the SUPPLIER table uses pipe-delimited format.

```
1|1|257368|465569|41365|19950218|2-HIGH|0|17|2608718|9783671|4|2504369|92072|
2|19950331|TRUCK
1|2|257368|201928|8146|19950218|2-HIGH|0|36|6587676|9783671|9|5994785|109794|
6|19950416|MAIL
```

REGION

Whenever possible, you should locate your load data in the same AWS region as your Amazon Redshift cluster. If your data and your cluster are in the same region, you reduce latency, minimize eventual consistency issues, and avoid cross-region data transfer costs. For more information, see [Best Practices for Loading Data \(p. 24\)](#)

If you must load data from a different AWS region, use the REGION option to specify the AWS region in which the load data is located. If you specify a region, all of the load data, including manifest files, must be in the named region. For more information, see [REGION \(p. 324\)](#).

If your cluster is in the US East (N. Virginia) region, execute the following command to load the SUPPLIER table from pipe-delimited data in an Amazon S3 bucket located in the US West (Oregon) region. For this example, do not change the bucket name.

```
copy supplier from 's3://awssampleduswest2/ssbgz/supplier.tbl'
credentials 'aws_access_key_id=<Your-Access-Key-
ID>;aws_secret_access_key=<Your-Secret-Access-Key>'
delimiter '|'
gzip
region 'us-west-2';
```

If your cluster is *not* in the US East (N. Virginia) region, execute the following command to load the SUPPLIER table from pipe-delimited data in an Amazon S3 bucket located in the US East (N. Virginia) region. For this example, do not change the bucket name.

```
copy supplier from 's3://awssampledbs/bgz/supplier.tbl'  
credentials 'aws_access_key_id=<Your-Access-Key-  
ID>;aws_secret_access_key=<Your-Secret-Access-Key>'  
delimiter '|'   
gzip  
region 'us-east-1';
```

Load the CUSTOMER Table Using MANIFEST

In this step, you will use the FIXEDWIDTH, MAXERROR, ACCEPTINVCHARS, and MANIFEST options to load the CUSTOMER table.

The sample data for this exercise contains characters that will cause errors when COPY attempts to load them. You will use the MAXERRORS option and the STL_LOAD_ERRORS system table to troubleshoot the load errors and then use the ACCEPTINVCHARS and MANIFEST options to eliminate the errors.

Fixed-Width Format

Fixed-width format defines each field as a fixed number of characters, rather than separating fields with a delimiter. The following excerpt from the data for the CUSTOMER table uses fixed-width format.

```
1 Customer#000000001 IVhzIApeRb MOROCCO 0MOROCCO AFRICA  
25-705  
2 Customer#000000002 XSTf4,NCwDVaWNe6tE JORDAN 6JORDAN MIDDLE EAST  
23-453  
3 Customer#000000003 MG9kdTD ARGENTINA5ARGENTINAAMERICA  
11-783
```

The order of the label/width pairs must match the order of the table columns exactly. For more information, see [FIXEDWIDTH \(p. 334\)](#).

The fixed-width specification string for the CUSTOMER table data is as follows.

```
fixedwidth 'c_custkey:10, c_name:25, c_address:25, c_city:10, c_nation:15,  
c_region :12, c_phone:15,c_mktsegment:10'
```

To load the CUSTOMER table from fixed-width data, execute the following command.

```
copy customer  
from 's3://<your-bucket-name>/load/customer-fw.tbl'  
credentials 'aws_access_key_id=<Your-Access-Key-  
ID>;aws_secret_access_key=<Your-Secret-Access-Key>'  
fixedwidth 'c_custkey:10, c_name:25, c_address:25, c_city:10, c_nation:15,  
c_region :12, c_phone:15,c_mktsegment:10';
```

You should get an error message, similar to the following.

```
An error occurred when executing the SQL command:  
copy customer  
from 's3://mybucket/load/customer-fw.tbl'  
credentials'aws_access_key_id=...  
  
ERROR: Load into table 'customer' failed. Check 'stl_load_errors' system  
table for details. [SQL State=XX000]
```



```
Execution time: 2.95s
1 statement(s) failed.
```

MAXERROR

By default, the first time COPY encounters an error, the command fails and returns an error message. To save time during testing, you can use the MAXERROR option to instruct COPY to skip a specified number of errors before it fails. Because we expect errors the first time we test loading the CUSTOMER table data, add `maxerror 10` to the COPY command.

To test using the FIXEDWIDTH and MAXERROR options, execute the following command.

```
copy customer
from 's3://<your-bucket-name>/load/customer-fw.tbl'
credentials 'aws_access_key_id=<Your-Access-Key-ID>;aws_secret_access_key=<Your-Secret-Access-Key>'
fixedwidth 'c_custkey:10, c_name:25, c_address:25, c_city:10, c_nation:15,
c_region :12, c_phone:15,c_mktsegment:10'
maxerror 10;
```

This time, instead of an error message, you get a warning message similar to the following.

```
Warnings:
Load into table 'customer' completed, 112497 record(s) loaded successfully.
Load into table 'customer' completed, 7 record(s) could not be loaded. Check
'stl_load_errors' system table for details.
```

The warning indicates that COPY encountered seven errors. To check the errors, query the STL_LOAD_ERRORS table, as shown in the following example.

```
select query, substring(filename,22,25) as filename,line_number as line,
substring(colname,0,12) as column, type, position as pos,
substring(raw_line,0,30) as line_text,
substring(raw_field_value,0,15) as field_text,
substring(err_reason,0,45) as error_reason
from stl_load_errors
order by query desc, filename
limit 7;
```

The results of the STL_LOAD_ERRORS query should look similar to the following.

query	filename	line	column	type	pos
line_text	field_text	error_reason			
334489	customer-fw.tbl.log	2	c_custkey	int4	-1
customer-fw.tbl	customer-f	Invalid digit, Value 'c', Pos 0, Type: Integ			
334489	customer-fw.tbl.log	6	c_custkey	int4	-1
Complete	Complete	Invalid digit, Value 'C', Pos 0, Type: Integ			
334489	customer-fw.tbl.log	3	c_custkey	int4	-1
#Total rows	#Total row	Invalid digit, Value '#', Pos 0, Type: Integ			

```

334489 | customer-fw.tbl.log          |      5 | c_custkey | int4          | -1 |
#Status                                | #Status    | Invalid digit, Value '#', Pos
0, Type: Integ
334489 | customer-fw.tbl.log          |      1 | c_custkey | int4          | -1 |
#Load file                              | #Load file | Invalid digit, Value '#', Pos
0, Type: Integ
334489 | customer-fw.tbl000          |      1 | c_address | varchar       | 34
| 1      Customer#000000001    | .Mayag.ezR | String contains invalid or
unsupported UTF8
334489 | customer-fw.tbl000          |      1 | c_address | varchar       | 34
| 1      Customer#000000001    | .Mayag.ezR | String contains invalid or
unsupported UTF8
(7 rows)

```

By examining the results, you can see that there are two messages in the `error_reasons` column:

- Invalid digit, Value '#', Pos 0, Type: Integ
- String contains invalid or unsupported UTF8

These errors are caused by the `customer-fw.tbl.log` file. The problem is that it is a log file, not a data file, and should not be loaded. You can use a manifest file to avoid loading the wrong file.

Another problem with the load is more difficult to detect—the load produced unexpected results. To investigate this problem, execute the following command to query the `CUSTOMER` table.

```

select c_custkey, c_name, c_address
from customer
order by c_custkey
limit 10;

```

c_custkey	c_name	c_address
2	Customer#000000002	XSTf4,NCwDVaWNe6tE
2	Customer#000000002	XSTf4,NCwDVaWNe6tE
3	Customer#000000003	MG9kdTD
3	Customer#000000003	MG9kdTD
4	Customer#000000004	XxVSJsL
4	Customer#000000004	XxVSJsL
5	Customer#000000005	KvpyuHCplrB84WgAi
5	Customer#000000005	KvpyuHCplrB84WgAi
6	Customer#000000006	sKZz0CsnMD7mp4Xd0YrBvx
6	Customer#000000006	sKZz0CsnMD7mp4Xd0YrBvx

(10 rows)

The rows should be unique, but there are duplicates.

Another way to check for unexpected results is to verify the number of rows that were loaded. In our case, 100000 rows should have been loaded, but the load message reported loading 112497 records. The extra rows were loaded because the `COPY` loaded an extraneous file, `customer-fw.tbl0000.bak`.

In this exercise, you will use a manifest file to avoid loading the wrong files.

ACCEPTINVCHARS

By default, when COPY encounters a character that is not supported by the column's data type, it skips the row and returns an error. For information about invalid UTF-8 characters, see [Multibyte Character Load Errors](#) (p. 159).

You could use the MAXERRORS option to ignore errors and continue loading, then query STL_LOAD_ERRORS to locate the invalid characters, and then fix the data files. However, MAXERRORS is best used for troubleshooting load problems and should generally not be used in a production environment.

The ACCEPTINVCHARS option is usually a better choice for managing invalid characters. ACCEPTINVCHARS instructs COPY to replace each invalid character with a specified valid character and continue with the load operation. You can specify any valid ASCII character, except NULL, as the replacement character. The default replacement character is a question mark (?). COPY replaces multibyte characters with a replacement string of equal length. For example, a 4-byte character would be replaced with '????'.

COPY returns the number of rows that contained invalid UTF-8 characters, and it adds an entry to the STL_REPLACEMENTS system table for each affected row, up to a maximum of 100 rows per node slice. Additional invalid UTF-8 characters are also replaced, but those replacement events are not recorded.

ACCEPTINVCHARS is valid only for VARCHAR columns.

For this step, you will add the ACCEPTINVCHARS with the replacement character '^'.

MANIFEST

When you COPY from Amazon S3 using a key prefix, there is a risk that you will load unwanted tables. For example, the 's3://mybucket/load/' folder contains eight data files that share the key prefix customer-fw.tbl: customer-fw.tbl0000, customer-fw.tbl0001, and so on. However, the same folder also contains the extraneous files customer-fw.tbl.log and customer-fw.tbl-0001.bak.

To ensure that you load all of the correct files, and only the correct files, use a manifest file. The manifest is a text file in JSON format that explicitly lists the unique object key for each source file to be loaded. The file objects can be in different folders or different buckets, but they must be in the same region. For more information, see [MANIFEST](#) (p. 323).

The following shows the customer-fw-manifest text.

```
{
  "entries": [
    {"url": "s3://<your-bucket-name>/load/customer-fw.tbl-000"},
    {"url": "s3://<your-bucket-name>/load/customer-fw.tbl-001"},
    {"url": "s3://<your-bucket-name>/load/customer-fw.tbl-002"},
    {"url": "s3://<your-bucket-name>/load/customer-fw.tbl-003"},
    {"url": "s3://<your-bucket-name>/load/customer-fw.tbl-004"},
    {"url": "s3://<your-bucket-name>/load/customer-fw.tbl-005"},
    {"url": "s3://<your-bucket-name>/load/customer-fw.tbl-006"},
    {"url": "s3://<your-bucket-name>/load/customer-fw.tbl-007"}
  ]
}
```

To load the data for the CUSTOMER table using the manifest file

1. Open the file customer-fw-manifest in a text editor.
2. Replace <your-bucket-name> with the name of your bucket.

3. Save the file.
4. Upload the file to the load folder on your bucket.
5. Execute the following COPY command.

```
copy customer from 's3://<your-bucket-name>/load/customer-fw-manifest'  
credentials 'aws_access_key_id=<Your-Access-Key-  
ID>;aws_secret_access_key=<Your-Secret-Access-Key>'  
fixedwidth 'c_custkey:10, c_name:25, c_address:25, c_city:10, c_nation:15,  
c_region :12, c_phone:15,c_mktsegment:10'  
maxerror 10  
acceptinvchars as '^'  
manifest;
```

Load the DWDATE Table Using DATEFORMAT

In this step, you will use the DELIMITER and DATEFORMAT options to load the DWDATE table.

When loading DATE and TIMESTAMP columns, COPY expects the default format, which is YYYY-MM-DD for dates and YYYY-MM-DD HH:MI:SS for time stamps. If the load data does not use a default format, you can use DATEFORMAT and TIMEFORMAT to specify the format.

The following excerpt shows date formats in the DWDATE table. Notice that the date formats in column two are inconsistent.

```
19920104 1992-01-04          Sunday  January 1992 199201 Jan1992 1 4 4 1...  
19920112 January 12, 1992 Monday  January 1992 199201 Jan1992 2 12 12 1...  
19920120 January 20, 1992 Tuesday   January 1992 199201 Jan1992 3 20 20  
1...
```

DATEFORMAT

You can specify only one date format. If the load data contains inconsistent formats, possibly in different columns, or if the format is not known at load time, you use DATEFORMAT with the 'auto' argument. When 'auto' is specified, COPY will recognize any valid date or time format and convert it to the default format. The 'auto' option recognizes several formats that are not supported when using a DATEFORMAT and TIMEFORMAT string. For more information, see [Using Automatic Recognition with DATEFORMAT and TIMEFORMAT \(p. 355\)](#).

To load the DWDATE table, execute the following COPY command.

```
copy dwdate from 's3://<your-bucket-name>/load/dwdate-tab.tbl'  
credentials 'aws_access_key_id=<Your-Access-Key-  
ID>;aws_secret_access_key=<Your-Secret-Access-Key>'  
delimiter '\t'  
dateformat 'auto';
```

Load the LINEORDER Table Using Multiple Files

This step uses the GZIP and COMPUPDATE options to load the LINEORDER table.

In this exercise, you will load the LINEORDER table from a single data file, and then load it again from multiple files in order to compare the load times for the two methods.

Note

The files for loading the LINEORDER table are provided in an AWS sample bucket. You don't need to upload files for this step.

GZIP, LZOP and BZIP2

You can compress your files using either gzip, lzop, or bzip2 compression formats. When loading from compressed files, COPY uncompresses the files during the load process. Compressing your files saves storage space and shortens upload times.

COMPUPDATE

When COPY loads an empty table with no compression encodings, it analyzes the load data to determine the optimal encodings. It then alters the table to use those encodings before beginning the load. This analysis process takes time, but it occurs, at most, once per table. To save time, you can skip this step by turning COMPUPDATE off. To enable an accurate evaluation of COPY times, you will turn COMPUPDATE off for this step.

Multiple Files

The COPY command can load data very efficiently when it loads from multiple files in parallel instead of loading from a single file. If you split your data into files so that the number of files is a multiple of the number of slices in your cluster, Amazon Redshift divides the workload and distributes the data evenly among the slices. The number of slices per node depends on the node size of the cluster. For more information about the number of slices that each node size has, go to [About Clusters and Nodes](#) in the *Amazon Redshift Cluster Management Guide*.

For example, the dc1.large compute nodes used in this tutorial have two slices each, so the four-node cluster has eight slices. In previous steps, the load data was contained in eight files, even though the files are very small. In this step, you will compare the time difference between loading from a single large file and loading from multiple files.

The files you will use for this tutorial contain about 15 million records and occupy about 1.2 GB. These files are very small in Amazon Redshift scale, but sufficient to demonstrate the performance advantage of loading from multiple files. The files are large enough that the time required to download them and then upload them to Amazon S3 is excessive for this tutorial, so you will load the files directly from an AWS sample bucket.

The following screenshot shows the data files for LINEORDER.

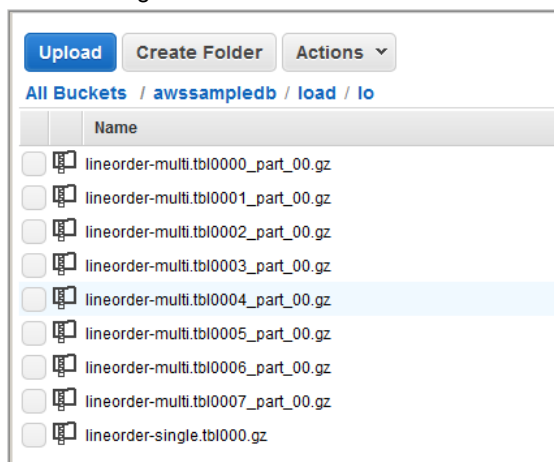

To evaluate the performance of COPY with multiple files

1. Execute the following command to COPY from a single file. Do not change the bucket name.

```
copy lineorder from 's3://awssampled/load/lo/lineorder-single.tbl'  
credentials 'aws_access_key_id=<Your-Access-Key-  
ID>;aws_secret_access_key=<Your-Secret-Access-Key>'  
gzip
```

```
compupdate off  
region 'us-east-1';
```

- Your results should be similar to the following. Note the execution time.

```
Warnings:  
Load into table 'lineorder' completed, 14996734 record(s) loaded  
successfully.  
  
0 row(s) affected.  
copy executed successfully  
  
Execution time: 51.56s
```

- Execute the following command to COPY from multiple files. Do not change the bucket name.

```
copy lineorder from 's3://awssampledload/load/lo/lineorder-multi.tbl'  
credentials 'aws_access_key_id=<Your-Access-Key-  
ID>;aws_secret_access_key=<Your-Secret-Access-Key>'  
gzip  
compupdate off  
region 'us-east-1';
```

- Your results should be similar to the following. Note the execution time.

```
Warnings:  
Load into table 'lineorder' completed, 14996734 record(s) loaded  
successfully.  
  
0 row(s) affected.  
copy executed successfully  
  
Execution time: 17.7s
```

- Compare execution times.

In our example, the time to load 15 million records decreased from 51.56 seconds to 17.7 seconds, a reduction of 65.7 percent.

These results are based on using a four-node cluster. If your cluster has more nodes, the time savings is multiplied. For typical Amazon Redshift clusters, with tens to hundreds of nodes, the difference is even more dramatic. If you have a single node cluster, there is little difference between the execution times.

Next Step

[Step 6: Vacuum and Analyze the Database \(p. 74\)](#)

Step 6: Vacuum and Analyze the Database

Whenever you add, delete, or modify a significant number of rows, you should run a VACUUM command and then an ANALYZE command. A *vacuum* recovers the space from deleted rows and restores the sort order. The ANALYZE command updates the statistics metadata, which enables the query optimizer to generate more accurate query plans. For more information, see [Vacuuming Tables \(p. 172\)](#).

If you load the data in sort key order, a vacuum is fast. In this tutorial, you added a significant number of rows, but you added them to empty tables. That being the case, there is no need to resort, and you didn't delete any rows. COPY automatically updates statistics after loading an empty table, so your statistics should be up-to-date. However, as a matter of good housekeeping, you will complete this tutorial by vacuuming and analyzing your database.

To vacuum and analyze the database, execute the following commands.

```
vacuum;  
analyze;
```

Next Step

[Step 7: Clean Up Your Resources \(p. 75\)](#)

Step 7: Clean Up Your Resources

Your cluster continues to accrue charges as long as it is running. When you have completed this tutorial, you should return your environment to the previous state by following the steps in [Step 5: Revoke Access and Delete Your Sample Cluster](#) in the *Amazon Redshift Getting Started*.

If you want to keep the cluster, but recover the storage used by the SSB tables, execute the following commands.

```
drop table part;  
drop table supplier;  
drop table customer;  
drop table dwwdate;  
drop table lineorder;
```

Next

[Summary \(p. 75\)](#)

Summary

In this tutorial, you uploaded data files to Amazon S3 and then used COPY commands to load the data from the files into Amazon Redshift tables.

You loaded data using the following formats:

- Character-delimited
- CSV
- Fixed-width

You used the STL_LOAD_ERRORS system table to troubleshoot load errors, and then used the REGION, MANIFEST, MAXERROR, ACCEPTINVCHARS, DATEFORMAT, and NULL AS options to resolve the errors.

You applied the following best practices for loading data:

- [Use a COPY Command to Load Data \(p. 25\)](#)
- [Split Your Load Data into Multiple Files \(p. 25\)](#)
- [Use a Single COPY Command to Load from Multiple Files \(p. 25\)](#)
- [Compress Your Data Files \(p. 25\)](#)
- [Use a Manifest File \(p. 25\)](#)
- [Verify Data Files Before and After a Load \(p. 26\)](#)

For more information about Amazon Redshift best practices, see the following links:

- [Best Practices for Loading Data \(p. 24\)](#)
- [Best Practices for Designing Tables \(p. 21\)](#)
- [Best Practices for Designing Queries \(p. 28\)](#)

Next Step

For your next step, if you haven't done so already, we recommend taking [Tutorial: Tuning Table Design \(p. 30\)](#).

Tutorial: Configuring Workload Management (WLM) Queues to Improve Query Processing

Overview

This tutorial walks you through the process of configuring workload management (WLM) in Amazon Redshift. By configuring WLM, you can improve query performance and resource allocation in your cluster.

Amazon Redshift routes user queries to queues for processing. WLM defines how those queries are routed to the queues. By default, Amazon Redshift has two queues available for queries: one for superusers, and one for users. The superuser queue cannot be configured and can only process one query at a time. You should reserve this queue for troubleshooting purposes only. The user queue can process up to five queries at a time, but you can configure this by changing the concurrency level of the queue if needed.

When you have several users running queries against the database, you might find another configuration to be more efficient. For example, if some users run resource-intensive operations, such as VACUUM, these might have a negative impact on less-intensive queries, such as reports. You might consider adding additional queues and configuring them for different workloads.

Estimated time: 75 minutes

Estimated cost: 50 cents

Prerequisites

You will need an Amazon Redshift cluster, the sample TICKIT database, and the psql client tool. If you do not already have these set up, go to [Amazon Redshift Getting Started](#) and [Connect to Your Cluster by Using the psql Tool](#).

Sections

- [Section 1: Understanding the Default Queue Processing Behavior \(p. 78\)](#)
- [Section 2: Modifying the WLM Query Queue Configuration \(p. 82\)](#)
- [Section 3: Routing Queries to Queues Based on User Groups and Query Groups \(p. 86\)](#)
- [Section 4: Using wlm_query_slot_count to Temporarily Override Concurrency Level in a Queue \(p. 90\)](#)
- [Section 5: Cleaning Up Your Resources \(p. 92\)](#)

Section 1: Understanding the Default Queue Processing Behavior

Before you start to configure WLM, it's useful to understand the default behavior of queue processing in Amazon Redshift. In this section, you'll create two database views that return information from several system tables. Then you'll run some test queries to see how queries are routed by default. For more information about system tables, see [System Tables Reference \(p. 685\)](#).

Step 1: Create the WLM_QUEUE_STATE_VW View

In this step, you'll create a view called WLM_QUEUE_STATE_VW. This view returns information from the following system tables.

- [STV_WLM_CLASSIFICATION_CONFIG \(p. 769\)](#)
- [STV_WLM_SERVICE_CLASS_CONFIG \(p. 773\)](#)
- [STV_WLM_SERVICE_CLASS_STATE \(p. 775\)](#)

You'll use this view throughout the tutorial to monitor what happens to queues after you change the WLM configuration. The following table describes the data that the WLM_QUEUE_STATE_VW view returns.

Column	Description
queue	The number associated with the row that represents a queue. Queue number determines the order of the queues in the database.
description	A value that describes whether the queue is available only to certain user groups, to certain query groups, or all types of queries.
slots	The number of slots allocated to the queue.
mem	The amount of memory, in MB per slot, allocated to the queue.
max_execution_time	The amount of time a query is allowed to run before it is terminated.
user_*	A value that indicates whether wildcard characters are allowed in the WLM configuration to match user groups.
query_*	A value that indicates whether wildcard characters are allowed in the WLM configuration to match query groups.
queued	The number of queries that are waiting in the queue to be processed.
executing	The number of queries that are currently executing.

Column	Description
executed	The number of queries that have executed.

To Create the WLM_QUEUE_STATE_VW View

1. Open psql and connect to your TICKIT sample database. If you do not have this database, see [Prerequisites \(p. 77\)](#).
2. Run the following query to create the WLM_QUEUE_STATE_VW view.

```
create view WLM_QUEUE_STATE_VW as
select (config.service_class-5) as queue
, trim (class.condition) as description
, config.num_query_tasks as slots
, config.query_working_mem as mem
, config.max_execution_time as max_time
, config.user_group_wild_card as "user_*"
, config.query_group_wild_card as "query_*"
, state.num_queued_queries queued
, state.num_executing_queries executing
, state.num_executed_queries executed
from
STV_WLM_CLASSIFICATION_CONFIG class,
STV_WLM_SERVICE_CLASS_CONFIG config,
STV_WLM_SERVICE_CLASS_STATE state
where
class.action_service_class = config.service_class
and class.action_service_class = state.service_class
and config.service_class > 4
order by config.service_class;
```

3. Run the following query to see the information that the view contains.

```
select * from wlm_queue_state_vw;
```

The following is an example result.

queue	description	slots	mem	max_time	user_*	query_*	queued	executing	executed
0	(super user) and (query group: superuser)	1	357		0 false	false	0	0	0
1	(querytype: any)	5	836		0 false	false	0	1	160

Step 2: Create the WLM_QUERY_STATE_VW View

In this step, you'll create a view called WLM_QUERY_STATE_VW. This view returns information from the [STV_WLM_QUERY_STATE \(p. 771\)](#) system table.

You'll use this view throughout the tutorial to monitor the queries that are running. The following table describes the data that the WLM_QUERY_STATE_VW view returns.

Column	Description
query	The query ID.
queue	The queue number.

Column	Description
slot_count	The number of slots allocated to the query.
start_time	The time that the query started.
state	The state of the query, such as executing.
queue_time	The number of microseconds that the query has spent in the queue.
exec_time	The number of microseconds that the query has been executing.

To Create the WLM_QUERY_STATE_VW View

1. In psql, run the following query to create the WLM_QUERY_STATE_VW view.

```
create view WLM_QUERY_STATE_VW as
select query, (service_class-5) as queue, slot_count, trim(wlm_start_time)
  as start_time, trim(state) as state, trim(queue_time) as queue_time,
  trim(exec_time) as exec_time
from stv_wlm_query_state;
```

2. Run the following query to see the information that the view contains.

```
select * from wlm_query_state_vw;
```

The following is an example result.

query	queue	slot_count	start_time	state	queue_time	exec_time
1249	1	1	2014-09-24 22:19:16	Executing	0	516

Step 3: Run Test Queries

In this step, you'll run queries from multiple connections in psql and review the system tables to determine how the queries were routed for processing.

For this step, you will need two psql windows open:

- In psql window 1, you'll run queries that monitor the state of the queues and queries using the views you already created in this tutorial.
- In psql window 2, you'll run long-running queries to change the results you find in psql window 1.

To Run the Test Queries

1. Open two psql windows. If you already have one window open, you only need to open a second window. You can use the same user account for both of these connections.
2. In psql window 1, run the following query.

```
select * from wlm_query_state_vw;
```

The following is an example result.

query	queue	slot_count	start_time	state	queue_time	exec_time
1258	1	1	2014-09-24 22:21:03	Executing	0	549

This query returns a self-referential result. The query that is currently executing is the SELECT statement from this view. A query on this view will always return at least one result. You'll compare this result with the result that occurs after starting the long-running query in the next step.

- In psql window 2, run the following query from the TICKIT sample database.

```
select avg(l.priceperticket*s.qtysold) from listing l, sales s where
l.listid <40000;
```

Note

This query should run for approximately a minute so that you have time to explore the results of the WLM_QUEUE_STATE_VW view and the WLM_QUERY_STATE_VW view that you created earlier. If you find that the query does not run long enough for you to query both views, you can increase the value of l.listid to make it run longer.

- In psql window 1, query WLM_QUEUE_STATE_VW and WLM_QUERY_STATE_VW and compare the results to your earlier results.

```
select * from wlm_queue_state_vw;
select * from wlm_query_state_vw;
```

The following are example results.

queue	description	slots	mem	max_time	user_*	query_*	queued	executing	executed
0	(super user) and (query group: superuser)	1	357		0 false	false	0	0	0
1	(querytype: any)	5	836		0 false	false	0	2	163

query	queue	slot_count	start_time	state	queue_time	exec_time
1267	1	1	2014-09-24 22:22:30	Executing	0	684
1265	1	1	2014-09-24 22:22:26	Executing	0	4080859

Note the following differences between your previous queries and the results in this step:

- There are two rows now in WLM_QUERY_STATE_VW. One result is the self-referential query for running a SELECT operation on this view. The second result is the long-running query from the previous step.
- The executing column in WLM_QUEUE_STATE_VW has increased from 1 to 2. This column entry means that there are two queries running in the queue.
- The executed column is incremented each time you run a query in the queue.

The WLM_QUEUE_STATE_VW view is useful for getting an overall view of the queues and how many queries are being processed in each queue. The WLM_QUERY_STATE_VW view is useful for getting a more detailed view of the individual queries that are currently running.

Section 2: Modifying the WLM Query Queue Configuration

Now that you understand how queues work by default, you will learn how to configure query queues in WLM. In this section, you'll create and configure a new parameter group for your cluster. You'll create two additional user queues and configure them to accept queries based on the queries' user group or query group labels. Any queries that do not get routed to one of these two queues will be routed to the default queue at run time.

Step 1: Create a Parameter Group

In this step, we'll create a new parameter group to use to configure WLM for this tutorial.

To Create a Parameter Group

1. Sign in to the AWS Management Console and open the Amazon Redshift console at <https://console.aws.amazon.com/redshift/>.
2. In the navigation pane, click **Parameter Groups**.
3. Click **Create Cluster Parameter Group**.
4. In the **Create Cluster Parameter Group** dialog box, type `wlmtutorial` in the **Parameter Group Name** box and type `WLM tutorial` in the **Description** box. You can leave the **Parameter Group Family** setting as is. Then click **Create**.

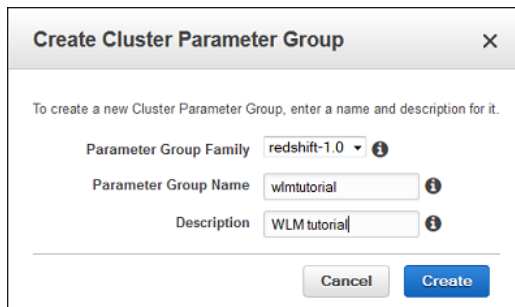

Step 2: Configure WLM

In this step, you'll modify the default settings of your new parameter group. You'll add two new query queues to the WLM configuration and specify different settings for each queue.

To Modify Parameter Group Settings

1. On the **Parameter Groups** page of the Amazon Redshift console, click the magnifying glass icon next to `wlmtutorial`. Doing this opens up the **Parameters** tab for `wlmtutorial`.

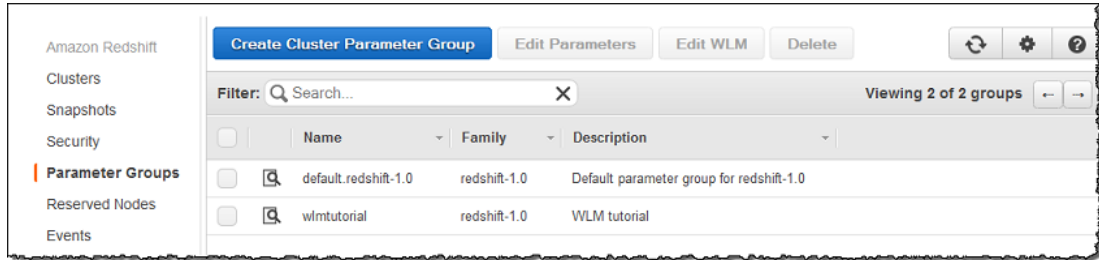

- On the **Parameters** tab, review the parameters and values. At this point, all of the settings will have default values. The **wlm_json_configuration** parameter is the one that will be modified when you configure WLM in this tutorial.

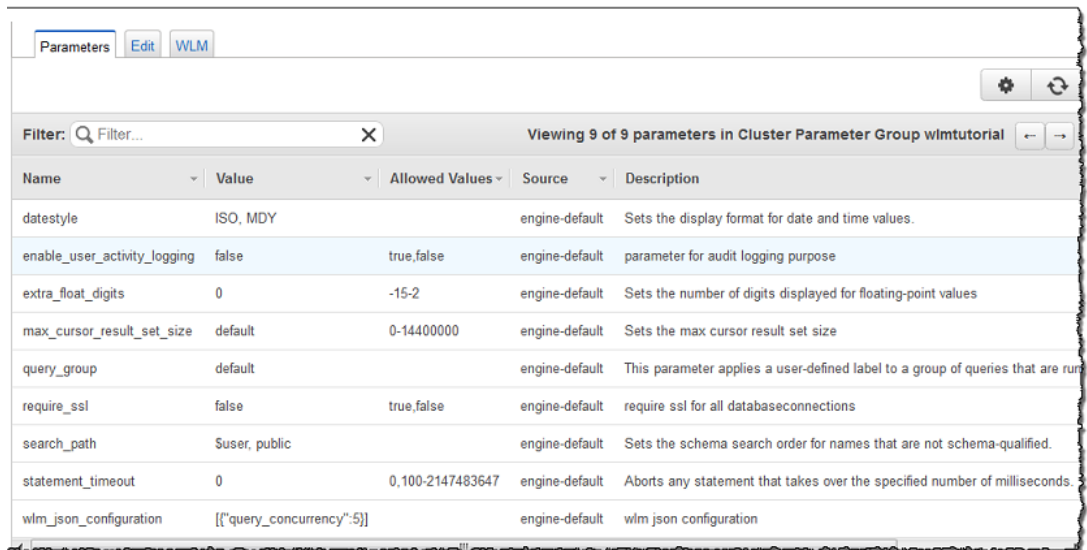

- Click the **WLM** tab. Click **Add New Queue** twice to add two new queues to this parameter group. Configure the queues with the following values.
 - For queue 1, type 2 in the **Concurrency** box, `test` in the **Query Groups** box, and 30 in the **% Memory** box. Leave the other boxes empty.

Note

You can ignore the warning about invalid memory allocation. After you specify memory values to total 100 percent for all of the queues, the message will disappear.

- For queue 2, type 3 in the **Concurrency** box, `admin` in the **User Groups** box, and 40 in the **% Memory** box. Leave the other boxes empty.
- For queue 3, type 30 in the **% Memory** box. Leave the other boxes empty.

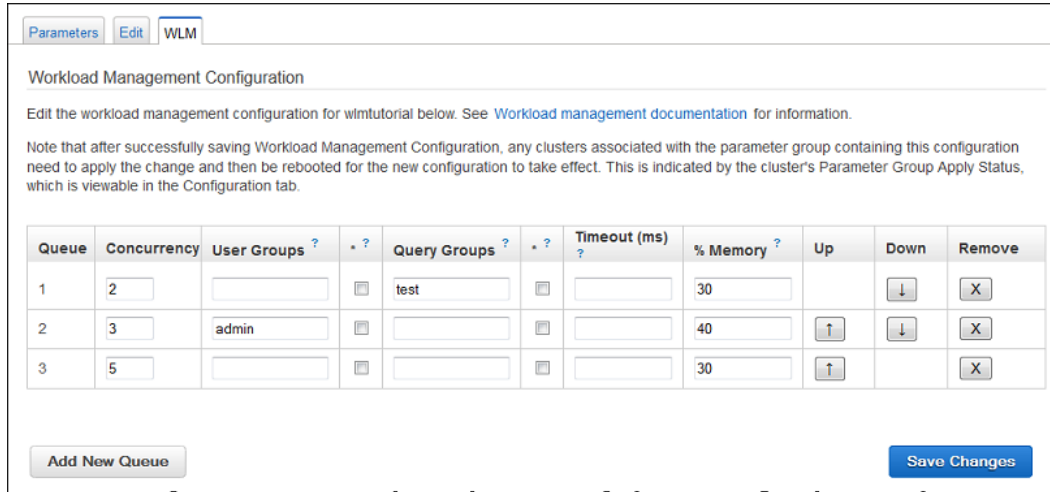

4. Click **Save Changes**.

Step 3: Associate the Parameter Group with Your Cluster

In this step, you'll open your sample cluster and associate it with the new parameter group. After you do this, you'll reboot the cluster so that Amazon Redshift can apply the new settings to the database.

To Associate the Parameter Group with Your Cluster

1. In the navigation pane, click **Clusters**, and then click your cluster to open it. If you are using the same cluster from *Amazon Redshift Getting Started*, your cluster will be named `examplecluster`.

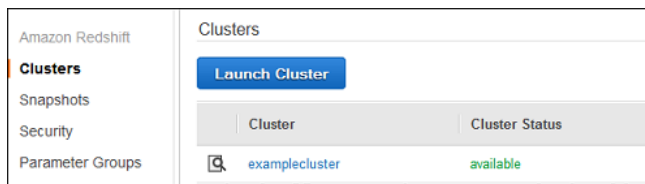

2. On the **Configuration** tab, click **Modify** in the **Cluster** menu.

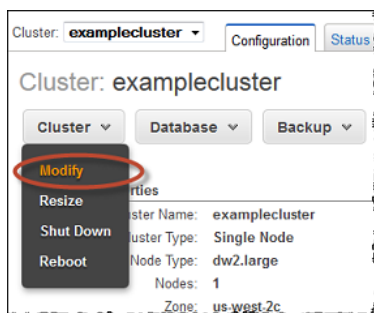

3. In the **Modify Cluster** dialog box, select `wlmtutorial` from the **Cluster Parameter Group** menu, and then click **Modify**.

Modify Cluster

Cluster Identifier: examplecluster

Cluster Parameter Group: default.redshift-1.0

Parameter Group Description: wlmutorial

Cluster Security Groups: default, wlmutorial

Master User Password: [Empty]

Allow Version Upgrade: Yes

Automated Snapshot Retention Period: 1 days

Maintenance Window Start: Thursday 09:00 UTC

Maintenance Window End: Thursday 09:30 UTC

Buttons: Cancel, Modify

The statuses shown in the **Cluster Parameter Group** and **Parameter Group Apply Status** will change from **in-sync** to **applying** as shown in the following.

Cluster: examplecluster

Cluster Properties

- Cluster Name: examplecluster
- Cluster Type: Single Node
- Node Type: dw2.large
- Nodes: 1
- Zone: us-west-2b
- Created Time: September 24, 2014 11:04:33 AM UTC-7
- Cluster Version: 1.0.829
- Cluster Security Groups: default (active)
- Cluster Parameter Group: wlmutorial (applying)

Cluster Status

- Cluster Status: available
- Database Health: healthy
- In Maintenance Mode: no
- Parameter Group Apply Status: applying
- Pending Modified Values: none

After the new parameter group is applied to the cluster, the **Cluster Properties** and **Cluster Status** show the new parameter group that you associated with the cluster. You need to reboot the cluster so that these settings can be applied to the database also.

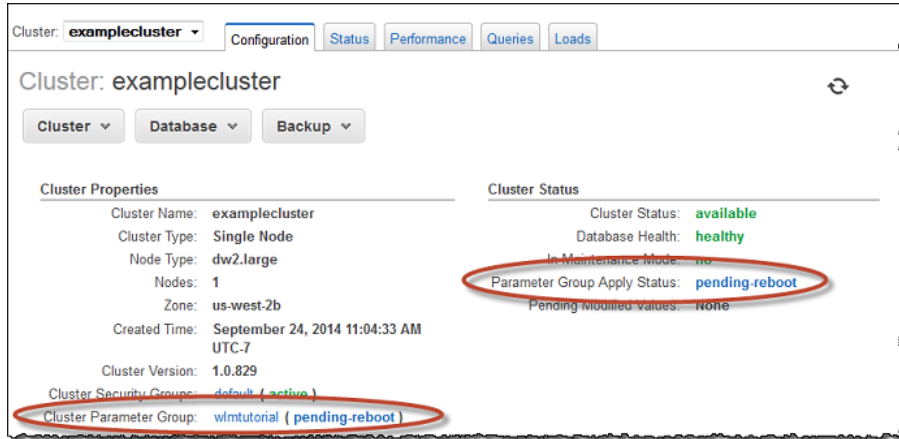

4. In the **Cluster** menu, click **Reboot**. The status shown in **Cluster Status** will change from **available** to **rebooting**. After the cluster is rebooted, the status will return to **available**.

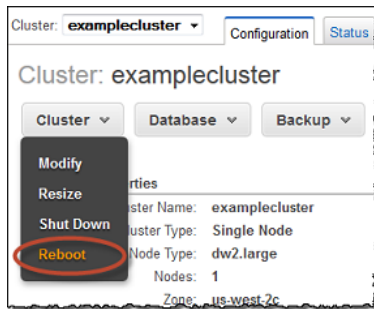

Section 3: Routing Queries to Queues Based on User Groups and Query Groups

Now that you have your cluster associated with a new parameter group, and you have configured WLM, you'll run some queries to see how Amazon Redshift routes queries into queues for processing.

Step 1: View Query Queue Configuration in the Database

First, verify that the database has the WLM configuration that you expect.

To View the Query Queue Configuration

1. Open psql and run the following query. The query uses the WLM_QUEUE_STATE_VW view you created in [Step 1: Create the WLM_QUEUE_STATE_VW View \(p. 78\)](#). If you already had a session connected to the database prior to the cluster reboot, you'll need to reconnect.

```
select * from wlm_queue_state_vw;
```

The following is an example result.

queue	description	slots	mem	max_time	user_*	query_*	queued	executing	executed
0	(super user) and (query group: superuser)	1	357	0	false	false	0	0	0
1	(query group: test)	2	627	0	false	false	0	0	0
2	(user group: admin)	3	557	0	false	false	0	0	0
3	(querytype: any)	5	250	0	false	false	0	1	0

Compare these results to the results you received in [Step 1: Create the WLM_QUEUE_STATE_VW View \(p. 78\)](#). Notice that there are now two additional queues. Queue 1 is now the queue for the test query group, and queue 2 is the queue for the admin user group.

Queue 3 is now the default queue. The last queue in the list is always the default queue, and that is the queue to which queries are routed by default if no user group or query group is specified in a query.

2. Run the following query to confirm that your query now runs in queue 3.

```
select * from wlm_query_state_vw;
```

The following is an example result.

query	queue	slot_count	start_time	state	queue_time	exec_time
2144	3	1	2014-09-24 23:49:59	Executing	0	550430

Step 2: Run a Query Using the Query Group Queue

To Run a Query Using the Query Group Queue

1. Run the following query to route it to the `test` query group.

```
set query_group to test;
select avg(l.priceperticket*s.qtysold) from listing l, sales s where
  l.listid <40000;
```

2. From the other psql window, run the following query.

```
select * from wlm_query_state_vw;
```

The following is an example result.

query	queue	slot_count	start_time	state	queue_time	exec_time
2168	1	1	2014-09-24 23:54:18	Executing	0	6343309
2170	3	1	2014-09-24 23:54:24	Executing	0	847

The query was routed to the test query group, which is queue 1 now.

3. Select all from the other view as shown following, and you'll see a result similar to the following.

```
select * from wlm_queue_state_vw;
```

queue	description	slots	mem	max_time	user_*	query_*	queued	executing	executed
0	(super user) and (query group: superuser)	1	357	0	false	false	0	0	0
1	(query group: test)	2	627	0	false	false	0	1	0
2	(user group: admin)	3	557	0	false	false	0	0	0
3	(querytype: any)	5	250	0	false	false	0	1	3

4. Now, reset the query group and run the long query again:

```
reset query_group;  
select avg(l.priceperticket*s.qtysold) from listing l, sales s where  
l.listid <40000;
```

5. Run the queries against the views to see the results.

```
select * from wlm_queue_state_vw;  
select * from wlm_query_state_vw;
```

The following are example results.

queue	description	slots	mem	max_time	user_*	query_*	queued	executing	executed
0	(super user) and (query group: superuser)	1	357		0 false	false	0	0	0
1	(query group: test)	2	627		0 false	false	0	0	1
2	(user group: admin)	3	557		0 false	false	0	0	0
3	(querytype: any)	5	250		0 false	false	0	2	5

query	queue	slot_count	start_time	state	queue_time	exec_time
2186	3	1	2014-09-24 23:57:52	Executing	0	649
2184	3	1	2014-09-24 23:57:48	Executing	0	4137349

The result should be that the query is now running in queue 3 again.

Step 3: Create a Database User and Group

In [Step 1: Create a Parameter Group \(p. 82\)](#), you configured one of your query queues with a user group named `admin`. Before you can run any queries in this queue, you need to create the user group in the database and add a user to the group. Then you'll log into `psql` using the new user's credentials and run queries. You need to run queries as a superuser, such as the `masteruser`, to create database users.

To Create a New Database User and User Group

1. In the database, create a new database user named `adminwlm` by running the following command in a `psql` window.

```
create user adminwlm createuser password '123Admin';
```

2. Then, run the following commands to create the new user group and add your new `adminwlm` user to it.

```
create group admin;  
alter group admin add user adminwlm;
```

Step 4: Run a Query Using the User Group Queue

Next you'll run a query and route it to the user group queue. You do this when you want to route your query to a queue that is configured to handle the type of query you want to run.

To Run a Query Using the User Group Queue

1. In `psql` window 2, run the following queries to switch to the `adminwlm` account and run a query as that user.

```
set session authorization 'adminwlm';
select avg(l.priceperticket*s.qtysold) from listing l, sales s where
l.listid <40000;
```

2. In psql window 1, run the following query to see the query queue that the queries are routed to.

```
select * from wlm_query_state_vw;
select * from wlm_queue_state_vw;
```

The following are example results.

queue	description	slots	mem	max_time	user_*	query_*	queued	executing	executed
0	(super user) and (query group: superuser)	1	357		0 false	false	0	0	0
1	(query group: test)	2	627		0 false	false	0	0	1
2	(user group: admin)	3	557		0 false	false	0	1	0
3	(querytype: any)	5	250		0 false	false	0	1	8

query	queue	slot_count	start_time	state	queue_time	exec_time
2202	2	1	2014-09-25 00:01:38	Executing	0	4885796
2204	3	1	2014-09-25 00:01:43	Executing	0	650

Note that the queue this query ran in is queue 2, the admin user queue. Any time you run queries logged in as this user, they will run in queue 2 unless you specify a different query group to use.

3. Now run the following query from psql window 2.

```
set query_group to test;
select avg(l.priceperticket*s.qtysold) from listing l, sales s where
l.listid <40000;
```

4. In psql window 1, run the following query to see the query queue that the queries are routed to.

```
select * from wlm_queue_state_vw;
select * from wlm_query_state_vw;
```

The following are example results.

queue	description	slots	mem	max_time	user_*	query_*	queued	executing	executed
0	(super user) and (query group: superuser)	1	357		0 false	false	0	0	0
1	(query group: test)	2	627		0 false	false	0	1	1
2	(user group: admin)	3	557		0 false	false	0	0	1
3	(querytype: any)	5	250		0 false	false	0	1	10

query	queue	slot_count	start_time	state	queue_time	exec_time
2218	1	1	2014-09-25 00:04:30	Executing	0	4819666
2220	3	1	2014-09-25 00:04:35	Executing	0	685

5. When you're done, reset the query group.

```
reset query_group;
```

Section 4: Using wlm_query_slot_count to Temporarily Override Concurrency Level in a Queue

Sometimes, users might temporarily need more resources for a particular query. If so, they can use the `wlm_query_slot_count` configuration setting to temporarily override the way slots are allocated in a query queue. *Slots* are units of memory and CPU that are used to process queries. You might override the slot count when you have occasional queries that take a lot of resources in the cluster, such as when you perform a `VACUUM` operation in the database.

If you find that users often need to set `wlm_query_slot_count` for certain types of queries, you should consider adjusting the WLM configuration and giving users a queue that better suits the needs of their queries. For more information about temporarily overriding the concurrency level by using slot count, see [wlm_query_slot_count](#) (p. 816).

Step 1: Override the Concurrency Level Using wlm_query_slot_count

For the purposes of this tutorial, we'll run the same long-running `SELECT` query. We'll run it as the `adminwlm` user using `wlm_query_slot_count` to increase the number of slots available for the query.

To Override the Concurrency Level Using wlm_query_slot_count

1. Increase the limit on the query to make sure that you have enough time to query the `WLM_QUERY_STATE_VW` view and see a result.

```
set wlm_query_slot_count to 3;
select avg(l.priceperticket*s.qtysold) from listing l, sales s where
l.listid <40000;
```

2. Now, query `WLM_QUERY_STATE_VW` use the masteruser account to see how the query is running.

```
select * from wlm_query_state_vw;
```

The following is an example result.

query	queue	slot_count	start_time	state	queue_time	exec_time
2240	2	3	2014-09-25 00:08:45	Executing	0	3731414
2242	3	1	2014-09-25 00:08:49	Executing	0	596

Notice that the slot count for the query is 3. This count means that the query is using all three slots to process the query, allocating all of the resources in the queue to that query.

3. Now, run the following query.

```
select * from WLM_QUEUE_STATE_VW;
```

The following is an example result.

queue	description	slots	mem	max_time	user_*	query_*	queued	executing	executed
0	(super user) and (query group: superuser)	1	357	0	false	false	0	0	0
1	(query group: test)	2	627	0	false	false	0	0	4
2	(user group: admin)	3	557	0	false	false	0	1	3
3	(querytype: any)	5	250	0	false	false	0	1	25

The `wlm_query_slot_count` configuration setting is valid for the current session only. If that session expires, or another user runs a query, the WLM configuration is used.

4. Reset the slot count and rerun the test.

```
reset wlm_query_slot_count;  
select avg(l.priceperticket*s.qtysold) from listing l, sales s where  
l.listid <40000;
```

The following are example results.

queue	description	slots	mem	max_time	user_*	query_*	queued	executing	executed
0	(super user) and (query group: superuser)	1	357	0	false	false	0	0	0
1	(query group: test)	2	627	0	false	false	0	0	2
2	(user group: admin)	3	557	0	false	false	0	1	2
3	(querytype: any)	5	250	0	false	false	0	1	14

query	queue	slot_count	start_time	state	queue_time	exec_time
2260	2	1	2014-09-25 00:12:11	Executing	0	4042618
2262	3	1	2014-09-25 00:12:15	Executing	0	680

Step 2: Run Queries from Different Sessions

Next, run queries from different sessions.

To Run Queries from Different Sessions

1. In psql window 1 and 2, run the following to use the test query group.

```
set query_group to test;
```

2. In psql window 1, run the following long-running query.

```
select avg(l.priceperticket*s.qtysold) from listing l, sales s where  
l.listid <40000;
```

3. As the long-running query is still going in psql window 1, run the following to increase the slot count to use all the slots for the queue and then start running the long-running query.

```
set wlm_query_slot_count to 2;  
select avg(l.priceperticket*s.qtysold) from listing l, sales s where  
l.listid <40000;
```

4. Open a third psql window and query the views to see the results.

```
select * from wlm_queue_state_vw;  
select * from wlm_query_state_vw;
```

The following are example results.

queue	description	slots	mem	max_time	user_*	query_*	queued	executing	executed
0	(super user) and (query group: superuser)	1	357	0	false	false	0	0	0
1	(query group: test)	2	627	0	false	false	1	1	2
2	(user group: admin)	3	557	0	false	false	0	0	3
3	(querytype: any)	5	250	0	false	false	0	1	18

query	queue	slot_count	start_time	state	queue_time	exec_time
2286	1	2	2014-09-25 00:16:48	QueuedWaiting	3758950	0
2282	1	1	2014-09-25 00:16:33	Executing	0	19335850
2288	3	1	2014-09-25 00:16:52	Executing	0	666

Notice that the first query is using one of the slots allocated to queue 1 to run the query, and that there is one query that is waiting in the queue (where `queued` is 1 and `state` is `QueuedWaiting`). Once the first query completes, the second one will begin executing. This execution happens because both queries are routed to the `test` query group, and the second query must wait for enough slots to begin processing.

Section 5: Cleaning Up Your Resources

Your cluster continues to accrue charges as long as it is running. When you have completed this tutorial, you should return your environment to the previous state by following the steps in [Step 6: Find Additional Resources and Reset Your Environment in Amazon Redshift Getting Started](#).

For more information about WLM, see [Implementing Workload Management \(p. 222\)](#).

Managing Database Security

Topics

- [Amazon Redshift Security Overview \(p. 93\)](#)
- [Default Database User Privileges \(p. 94\)](#)
- [Superusers \(p. 94\)](#)
- [Users \(p. 95\)](#)
- [Groups \(p. 96\)](#)
- [Schemas \(p. 96\)](#)
- [Example for Controlling User and Group Access \(p. 97\)](#)

You manage database security by controlling which users have access to which database objects.

Access to database objects depends on the privileges that you grant to user accounts or groups. The following guidelines summarize how database security works:

- By default, privileges are granted only to the object owner.
- Amazon Redshift database users are named user accounts that can connect to a database. A user account is granted privileges explicitly, by having those privileges assigned directly to the account, or implicitly, by being a member of a group that is granted privileges.
- Groups are collections of users that can be collectively assigned privileges for easier security maintenance.
- Schemas are collections of database tables and other database objects. Schemas are similar to operating system directories, except that schemas cannot be nested. Users can be granted access to a single schema or to multiple schemas.

For examples of security implementation, see [Example for Controlling User and Group Access \(p. 97\)](#).

Amazon Redshift Security Overview

Amazon Redshift database security is distinct from other types of Amazon Redshift security. In addition to database security, which is described in this section, Amazon Redshift provides these features to manage security:

- **Sign-in credentials** — Access to your Amazon Redshift Management Console is controlled by your AWS account privileges. For more information, see [Sign-In Credentials](#).
- **Access management** — To control access to specific Amazon Redshift resources, you define AWS Identity and Access Management (IAM) accounts. For more information, see [Controlling Access to Amazon Redshift Resources](#).
- **Cluster security groups** — To grant other users inbound access to an Amazon Redshift cluster, you define a cluster security group and associate it with a cluster. For more information, see [Amazon Redshift Cluster Security Groups](#).
- **VPC** — To protect access to your cluster by using a virtual networking environment, you can launch your cluster in an Amazon Virtual Private Cloud (VPC). For more information, see [Managing Clusters in Virtual Private Cloud \(VPC\)](#).
- **Cluster encryption** — To encrypt the data in all your user-created tables, you can enable cluster encryption when you launch the cluster. For more information, see [Amazon Redshift Clusters](#).
- **SSL connections** — To encrypt the connection between your SQL client and your cluster, you can use secure sockets layer (SSL) encryption. For more information, see [Connect to Your Cluster Using SSL](#).
- **Load data encryption** — To encrypt your table load data files when you upload them to Amazon S3, you can use either server-side encryption or client-side encryption. When you load from server-side encrypted data, Amazon S3 handles decryption transparently. When you load from client-side encrypted data, the Amazon Redshift COPY command decrypts the data as it loads the table. For more information, see [Uploading Encrypted Data to Amazon S3 \(p. 135\)](#).
- **Data in transit** — To protect your data in transit within the AWS cloud, Amazon Redshift uses hardware accelerated SSL to communicate with Amazon S3 or Amazon DynamoDB for COPY, UNLOAD, backup, and restore operations.

Default Database User Privileges

When you create a database object, you are its owner. By default, only a superuser or the owner of an object can query, modify, or grant privileges on the object. For users to use an object, you must grant the necessary privileges to the user or the group that contains the user. Database superusers have the same privileges as database owners.

Amazon Redshift supports the following privileges: SELECT, INSERT, UPDATE, DELETE, REFERENCES, CREATE, TEMPORARY, and USAGE. Different privileges are associated with different object types. For information on database object privileges supported by Amazon Redshift, see the [GRANT \(p. 420\)](#) command.

The right to modify or destroy an object is always the privilege of the owner only.

To revoke a privilege that was previously granted, use the [REVOKE \(p. 431\)](#) command. The privileges of the object owner, such as DROP, GRANT, and REVOKE privileges, are implicit and cannot be granted or revoked. Object owners can revoke their own ordinary privileges, for example, to make a table read-only for themselves as well as others. Superusers retain all privileges regardless of GRANT and REVOKE commands.

Superusers

Database superusers have the same privileges as database owners for all databases.

The *masteruser*, which is the user you created when you launched the cluster, is a superuser.

You must be a superuser to create a superuser.

Amazon Redshift system tables and system views are either visible only to superusers or visible to all users. Only superusers can query system tables and system views that are designated "visible to superusers." For information, see [System Tables and Views \(p. 685\)](#).

Superusers can view all PostgreSQL catalog tables. For information, see [System Catalog Tables \(p. 799\)](#).

A database superuser bypasses all permission checks. Be very careful when using a superuser role. We recommend that you do most of your work as a role that is not a superuser. Superusers retain all privileges regardless of GRANT and REVOKE commands.

To create a new database superuser, log on to the database as a superuser and issue a CREATE USER command or an ALTER USER command with the CREATEUSER privilege.

```
create user adminuser createuser password '1234Admin';  
alter user adminuser createuser;
```

Users

Amazon Redshift user accounts can only be created and dropped by a database superuser. Users are authenticated when they login to Amazon Redshift. They can own databases and database objects (for example, tables) and can grant privileges on those objects to users, groups, and schemas to control who has access to which object. Users with CREATE DATABASE rights can create databases and grant privileges to those databases. Superusers have database ownership privileges for all databases.

Creating, Altering, and Deleting Users

Database users accounts are global across a data warehouse cluster (and not per individual database).

- To create a user use the [CREATE USER \(p. 397\)](#) command.
- To create a superuser use the [CREATE USER \(p. 397\)](#) command with the CREATEUSER option.
- To remove an existing user, use the [DROP USER \(p. 411\)](#) command.
- To make changes to a user account, such as changing a password, use the [ALTER USER \(p. 306\)](#) command.
- To view a list of users, query the PG_USER catalog table:

```
select * from pg_user;
```

username valuntil	usesysid useconfig	usecreatedb	usesuper	usecatupd	passwd
rdsdb	1	t	t	t	*****
masteruser	100	t	t	f	*****
dwuser	101	f	f	f	*****
simpleuser	102	f	f	f	*****
poweruser	103	f	t	f	*****
dbuser	104	t	f	f	*****

```
(6 rows)
```

Groups

Groups are collections of users who are all granted whatever privileges are associated with the group. You can use groups to assign privileges by role. For example, you can create different groups for sales, administration, and support and give the users in each group the appropriate access to the data they require for their work. You can grant or revoke privileges at the group level, and those changes will apply to all members of the group, except for superusers.

To view all user groups, query the PG_GROUP system catalog table:

```
select * from pg_group;
```

Creating, Altering, and Deleting Groups

Only a superuser can create, alter, or drop groups.

You can perform the following actions:

- To create a group, use the [CREATE GROUP \(p. 374\)](#) command.
- To add users to or remove users from an existing group, use the [ALTER GROUP \(p. 296\)](#) command.
- To delete a group, use the [DROP GROUP \(p. 406\)](#) command. This command only drops the group, not its member users.

Schemas

A database contains one or more named schemas. Each schema in a database contains tables and other kinds of named objects. By default, a database has a single schema, which is named PUBLIC. You can use schemas to group database objects under a common name. Schemas are similar to operating system directories, except that schemas cannot be nested.

Identical database object names can be used in different schemas in the same database without conflict. For example, both MY_SCHEMA and YOUR_SCHEMA can contain a table named MYTABLE. Users with the necessary privileges can access objects across multiple schemas in a database.

By default, an object is created within the first schema in the search path of the database. For information, see [Search Path \(p. 97\)](#) later in this section.

Schemas can help with organization and concurrency issues in a multi-user environment in the following ways:

- To allow many developers to work in the same database without interfering with each other.
- To organize database objects into logical groups to make them more manageable.
- To give applications the ability to put their objects into separate schemas so that their names will not collide with the names of objects used by other applications.

Creating, Altering, and Deleting Schemas

Any user can create groups and alter or drop groups they own.

You can perform the following actions:

- To create a schema, use the [CREATE SCHEMA \(p. 377\)](#) command.
- To change the owner of a schema, use the [ALTER SCHEMA \(p. 297\)](#) command.
- To delete a schema and its objects, use the [DROP SCHEMA \(p. 407\)](#) command.
- To create a table within a schema, create the table with the format *schema_name.table_name*.

To view a list of all schemas, query the PG_NAMESPACE system catalog table:

```
select * from pg_namespace;
```

To view a list of tables that belong to a schema, query the PG_TABLE_DEF system catalog table. For example, the following query returns a list of tables in the PG_CATALOG schema.

```
select distinct(tablename) from pg_table_def  
where schemaname = 'pg_catalog';
```

Search Path

The search path is defined in the `search_path` parameter with a comma-separated list of schema names. The search path specifies the order in which schemas are searched when an object, such as a table or function, is referenced by a simple name that does not include a schema qualifier.

If an object is created without specifying a target schema, the object is added to the first schema that is listed in search path. When objects with identical names exist in different schemas, an object name that does not specify a schema will refer to the first schema in the search path that contains an object with that name.

To change the default schema for the current session, use the [SET \(p. 465\)](#) command.

For more information, see the [search_path \(p. 812\)](#) description in the Configuration Reference.

Schema-Based Privileges

Schema-based privileges are determined by the owner of the schema:

- By default, all users have CREATE and USAGE privileges on the PUBLIC schema of a database. To disallow users from creating objects in the PUBLIC schema of a database, use the [REVOKE \(p. 431\)](#) command to remove that privilege.
- Unless they are granted the USAGE privilege by the object owner, users cannot access any objects in schemas they do not own.
- If users have been granted the CREATE privilege to a schema that was created by another user, those users can create objects in that schema.

Example for Controlling User and Group Access

This example creates user groups and user accounts and then grants them various privileges for an Amazon Redshift database that connects to a web application client. This example assumes three groups of users: regular users of a web application, power users of a web application, and web developers.

1. Create the groups where the user accounts will be assigned. The following set of commands creates three different user groups:

```
create group webappusers;  
  
create group webpowerusers;  
  
create group webdevusers;
```

2. Create several database user accounts with different privileges and add them to the groups.
 - a. Create two users and add them to the WEBAPPUSERS group:

```
create user webappuser1 password 'webAppuser1pass'  
in group webappusers;  
  
create user webappuser2 password 'webAppuser2pass'  
in group webappusers;
```

- b. Create an account for a web developer and adds it to the WEBDEVUSERS group:

```
create user webdevuser1 password 'webDevuser2pass'  
in group webdevusers;
```

- c. Create a superuser account. This user will have administrative rights to create other users:

```
create user webappadmin password 'webAppadminpass1'  
createuser;
```

3. Create a schema to be associated with the database tables used by the web application, and grant the various user groups access to this schema:

- a. Create the WEBAPP schema:

```
create schema webapp;
```

- b. Grant USAGE privileges to the WEBAPPUSERS group:

```
grant usage on schema webapp to group webappusers;
```

- c. Grant USAGE privileges to the WEBPOWERUSERS group:

```
grant usage on schema webapp to group webpowerusers;
```

- d. Grant ALL privileges to the WEBDEVUSERS group:

```
grant all on schema webapp to group webdevusers;
```

The basic users and groups are now set up. You can now make changes to alter the users and groups.

4. For example, the following command alters the search_path parameter for the WEBAPPUSER1.

```
alter user webappuser1 set search_path to webapp, public;
```

The SEARCH_PATH specifies the schema search order for database objects, such as tables and functions, when the object is referenced by a simple name with no schema specified.

5. You can also add users to a group after creating the group, such as adding WEBAPPUSER2 to the WEBPOWERUSERS group:

```
alter group webpowerusers add user webappuser2;
```

Designing Tables

Topics

- [Choosing a Column Compression Type \(p. 100\)](#)
- [Choosing a Data Distribution Style \(p. 110\)](#)
- [Choosing Sort Keys \(p. 122\)](#)
- [Defining Constraints \(p. 127\)](#)
- [Analyzing Table Design \(p. 128\)](#)

A data warehouse system has very different design goals as compared to a typical transaction-oriented relational database system. An online transaction processing (OLTP) application is focused primarily on single row transactions, inserts, and updates. Amazon Redshift is optimized for very fast execution of complex analytic queries against very large data sets. Because of the massive amount of data involved in data warehousing, you must specifically design your database to take full advantage of every available performance optimization.

This section explains how to choose and implement compression encodings, data distribution keys, sort keys, and table constraints, and it presents best practices for making these design decisions.

Choosing a Column Compression Type

Topics

- [Compression Encodings \(p. 101\)](#)
- [Testing Compression Encodings \(p. 107\)](#)
- [Example: Choosing Compression Encodings for the CUSTOMER Table \(p. 109\)](#)

Compression is a column-level operation that reduces the size of data when it is stored. Compression conserves storage space and reduces the size of data that is read from storage, which reduces the amount of disk I/O and therefore improves query performance.

By default, Amazon Redshift stores data in its raw, uncompressed format. You can apply a compression type, or *encoding*, to the columns in a table manually when you create the table, or you can use the COPY command to analyze and apply compression automatically. For details about applying automatic compression, see [Loading Tables with Automatic Compression \(p. 154\)](#).

Note

We strongly recommend using the COPY command to apply automatic compression.

You might choose to apply compression encodings manually if the new table shares the same data characteristics as another table, or if in testing you discover that the compression encodings that are applied during automatic compression are not the best fit for your data. If you choose to apply compression encodings manually, you can run the [ANALYZE COMPRESSION \(p. 310\)](#) command against an already populated table and use the results to choose compression encodings.

To apply compression manually, you specify compression encodings for individual columns as part of the CREATE TABLE statement. The syntax is as follows:

```
CREATE TABLE table_name (column_name
    data_type ENCODE encoding-type)[, ...]
```

Where *encoding-type* is taken from the keyword table in the following section.

For example, the following statement creates a two-column table, PRODUCT. When data is loaded into the table, the PRODUCT_ID column is not compressed, but the PRODUCT_NAME column is compressed, using the byte dictionary encoding (BYTEDICT).

```
create table product(
product_id int,
product_name char(20) encode bytedict);
```

You cannot change the compression encoding for a column after the table is created. You can specify the encoding for a column when it is added to a table using the ALTER TABLE command.

```
ALTER TABLE table-name ADD [ COLUMN ] column_name column_type
```

Compression Encodings

Topics

- [Raw Encoding \(p. 102\)](#)
- [Byte-Dictionary Encoding \(p. 102\)](#)
- [Delta Encoding \(p. 103\)](#)
- [LZO Encoding \(p. 104\)](#)
- [Mostly Encoding \(p. 104\)](#)
- [Runlength Encoding \(p. 106\)](#)
- [Text255 and Text32k Encodings \(p. 106\)](#)

A compression encoding specifies the type of compression that is applied to a column of data values as rows are added to a table.

The following table identifies the supported compression encodings and the data types that support the encoding.

Encoding type	Keyword in CREATE TABLE and ALTER TABLE	Data types
Raw (no compression)	RAW	All
Byte dictionary	BYTEDICT	All except BOOLEAN
Delta	DELTA	SMALLINT, INT, BIGINT, DATE, TIMESTAMP, DECIMAL

Encoding type	Keyword in CREATE TABLE and ALTER TABLE	Data types
	DELTA32K	INT, BIGINT, DATE, TIMESTAMP, DECIMAL
LZO	LZO	All except BOOLEAN, REAL, and DOUBLE PRECISION
Mostlyn	MOSTLY8	SMALLINT, INT, BIGINT, DECIMAL
	MOSTLY16	INT, BIGINT, DECIMAL
	MOSTLY32	BIGINT, DECIMAL
Run-length	RUNLENGTH	All
Text	TEXT255	VARCHAR only
	TEXT32K	VARCHAR only

Raw Encoding

Raw encoding is the default storage method. With raw encoding, data is stored in raw, uncompressed form.

Byte-Dictionary Encoding

In byte dictionary encoding, a separate dictionary of unique values is created for each block of column values on disk. (An Amazon Redshift disk block occupies 1 MB.) The dictionary contains up to 256 one-byte values that are stored as indexes to the original data values. If more than 256 values are stored in a single block, the extra values are written into the block in raw, uncompressed form. The process repeats for each disk block.

This encoding is very effective when a column contains a limited number of unique values. This encoding is optimal when the data domain of a column is fewer than 256 unique values. Byte-dictionary encoding is especially space-efficient if a CHAR column holds long character strings.

Note

Byte-dictionary encoding is not always effective when used with VARCHAR columns. Using BYTEDICT with large VARCHAR columns might cause excessive disk usage. We strongly recommend using a different encoding, such as LZO, for VARCHAR columns.

Suppose a table has a COUNTRY column with a CHAR(30) data type. As data is loaded, Amazon Redshift creates the dictionary and populates the COUNTRY column with the index value. The dictionary contains the indexed unique values, and the table itself contains only the one-byte subscripts of the corresponding values.

Note

Trailing blanks are stored for fixed-length character columns. Therefore, in a CHAR(30) column, every compressed value saves 29 bytes of storage when you use the byte-dictionary encoding.

The following table represents the dictionary for the COUNTRY column:

Unique data value	Dictionary index	Size (fixed length, 30 bytes per value)
England	0	30

Unique data value	Dictionary index	Size (fixed length, 30 bytes per value)
United States of America	1	30
Venezuela	2	30
Sri Lanka	3	30
Argentina	4	30
Japan	5	30
Total		180

The following table represents the values in the COUNTRY column:

Original data value	Original size (fixed length, 30 bytes per value)	Compressed value (index)	New size (bytes)
England	30	0	1
England	30	0	1
United States of America	30	1	1
United States of America	30	1	1
Venezuela	30	2	1
Sri Lanka	30	3	1
Argentina	30	4	1
Japan	30	5	1
Sri Lanka	30	3	1
Argentina	30	4	1
Totals	300		10

The total compressed size in this example is calculated as follows: 6 different entries are stored in the dictionary ($6 * 30 = 180$), and the table contains 10 1-byte compressed values, for a total of 190 bytes.

Delta Encoding

Delta encodings are very useful for datetime columns.

Delta encoding compresses data by recording the difference between values that follow each other in the column. This difference is recorded in a separate dictionary for each block of column values on disk. (An Amazon Redshift disk block occupies 1 MB.) For example, if the column contains 10 integers in sequence from 1 to 10, the first will be stored as a 4-byte integer (plus a 1-byte flag), and the next 9 will each be stored as a byte with the value 1, indicating that it is one greater than the previous value.

Delta encoding comes in two variations:

- DELTA records the differences as 1-byte values (8-bit integers)
- DELTA32K records differences as 2-byte values (16-bit integers)

If most of the values in the column could be compressed by using a single byte, the 1-byte variation is very effective; however, if the deltas are larger, this encoding, in the worst case, is somewhat less effective than storing the uncompressed data. Similar logic applies to the 16-bit version.

If the difference between two values exceeds the 1-byte range (DELTA) or 2-byte range (DELTA32K), the full original value is stored, with a leading 1-byte flag. The 1-byte range is from -127 to 127, and the 2-byte range is from -32K to 32K.

The following table shows how a delta encoding works for a numeric column:

Original data value	Original size (bytes)	Difference (delta)	Compressed value	Compressed size (bytes)
1	4		1	1+4 (flag + actual value)
5	4	4	4	1
50	4	45	45	1
200	4	150	150	1+4 (flag + actual value)
185	4	-15	-15	1
220	4	35	35	1
221	4	1	1	1
Totals	28			15

LZO Encoding

LZO encoding provides a very high compression ratio with good performance. LZO encoding works especially well for CHAR and VARCHAR columns that store very long character strings, especially free form text, such as product descriptions, user comments, or JSON strings.

Note

COPY with automatic compression currently supports LZO encoding only for CHAR and VARCHAR; however, [ANALYZE COMPRESSION \(p. 310\)](#) fully supports LZO encoding. For more information, see [Loading Tables with Automatic Compression \(p. 154\)](#).

Mostly Encoding

Mostly encodings are useful when the data type for a column is larger than most of the stored values require. By specifying a mostly encoding for this type of column, you can compress the majority of the values in the column to a smaller standard storage size. The remaining values that cannot be compressed are stored in their raw form. For example, you can compress a 16-bit column, such as an INT2 column, to 8-bit storage.

In general, the mostly encodings work with the following data types:

- SMALLINT/INT2 (16-bit)
- INTEGER/INT (32-bit)
- BIGINT/INT8 (64-bit)

- DECIMAL/NUMERIC (64-bit)

Choose the appropriate variation of the mostly encoding to suit the size of the data type for the column. For example, apply MOSTLY8 to a column that is defined as a 16-bit integer column. Applying MOSTLY16 to a column with a 16-bit data type or MOSTLY32 to a column with a 32-bit data type is disallowed.

Mostly encodings might be less effective than no compression when a relatively high number of the values in the column cannot be compressed. Before applying one of these encodings to a column, check that *most* of the values that you are going to load now (and are likely to load in the future) fit into the ranges shown in the following table.

Encoding	Compressed Storage Size	Range of values that can be compressed (values outside the range are stored raw)
MOSTLY8	1 byte (8 bits)	-128 to 127
MOSTLY16	2 bytes (16 bits)	-32768 to 32767
MOSTLY32	4 bytes (32 bits)	-2147483648 to +2147483647

Note

For decimal values, ignore the decimal point to determine whether the value fits into the range. For example, 1,234.56 is treated as 123,456 and can be compressed in a MOSTLY32 column.

For example, the VENUEID column in the VENUE table is defined as a raw integer column, which means that its values consume 4 bytes of storage. However, the current range of values in the column is 0 to 309. Therefore, re-creating and reloading this table with MOSTLY16 encoding for VENUEID would reduce the storage of every value in that column to 2 bytes.

If the VENUEID values referenced in another table were mostly in the range of 0 to 127, it might make sense to encode that foreign-key column as MOSTLY8. Before making the choice, you would have to run some queries against the referencing table data to find out whether the values mostly fall into the 8-bit, 16-bit, or 32-bit range.

The following table shows compressed sizes for specific numeric values when the MOSTLY8, MOSTLY16, and MOSTLY32 encodings are used:

Original value	Original INT or BIGINT size (bytes)	MOSTLY8 compressed size (bytes)	MOSTLY16 compressed size (bytes)	MOSTLY32 compressed size (bytes)
1	4	1	2	4
10	4	1	2	4
100	4	1	2	4
1000	4	Same as raw data size	2	4
10000	4		2	4
20000	4		2	4
40000	8	Same as raw data size	Same as raw data size	4
100000	8			4

Original value	Original INT or BIGINT size (bytes)	MOSTLY8 compressed size (bytes)	MOSTLY16 compressed size (bytes)	MOSTLY32 compressed size (bytes)
2000000000	8			4

Runlength Encoding

Runlength encoding replaces a value that is repeated consecutively with a token that consists of the value and a count of the number of consecutive occurrences (the length of the run). A separate dictionary of unique values is created for each block of column values on disk. (An Amazon Redshift disk block occupies 1 MB.) This encoding is best suited to a table in which data values are often repeated consecutively, for example, when the table is sorted by those values.

For example, if a column in a large dimension table has a predictably small domain, such as a COLOR column with fewer than 10 possible values, these values are likely to fall in long sequences throughout the table, even if the data is not sorted.

We do not recommend applying runlength encoding on any column that is designated as a sort key. Range-restricted scans perform better when blocks contain similar numbers of rows. If sort key columns are compressed much more highly than other columns in the same query, range-restricted scans might perform poorly.

The following table uses the COLOR column example to show how the runlength encoding works:

Original data value	Original size (bytes)	Compressed value (token)	Compressed size (bytes)
Blue	4	{2,Blue}	5
Blue	4		0
Green	5	{3,Green}	6
Green	5		0
Green	5		0
Blue	4	{1,Blue}	5
Yellow	6	{4,Yellow}	7
Yellow	6		0
Yellow	6		0
Yellow	6		0
Totals	51		23

Text255 and Text32k Encodings

Text255 and text32k encodings are useful for compressing VARCHAR columns in which the same words recur often. A separate dictionary of unique words is created for each block of column values on disk. (An Amazon Redshift disk block occupies 1 MB.) The dictionary contains the first 245 unique words in the column. Those words are replaced on disk by a one-byte index value representing one of the 245 values, and any words that are not represented in the dictionary are stored uncompressed.

The process repeats for each 1 MB disk block. If the indexed words occur frequently in the column, the column will yield a high compression ratio.

For the text32k encoding, the principle is the same, but the dictionary for each block does not capture a specific number of words. Instead, the dictionary indexes each unique word it finds until the combined entries reach a length of 32K, minus some overhead. The index values are stored in two bytes.

For example, consider the VENUENAME column in the VENUE table. Words such as **Arena**, **Center**, and **Theatre** recur in this column and are likely to be among the first 245 words encountered in each block if text255 compression is applied. If so, this column will benefit from compression because every time those words appear, they will occupy only 1 byte of storage (instead of 5, 6, or 7 bytes, respectively).

Testing Compression Encodings

If you decide to manually specify column encodings, you might want to test different encodings with your data.

Note

We recommend that you use the COPY command to load data whenever possible, and allow the COPY command to choose the optimal encodings based on your data. Alternatively, you can use the [ANALYZE COMPRESSION \(p. 310\)](#) command to view the suggested encodings for existing data. For details about applying automatic compression, see [Loading Tables with Automatic Compression \(p. 154\)](#).

To perform a meaningful test of data compression, you need a large number of rows. For this example, we will create a table by using a CREATE TABLE AS statement that selects from two tables; VENUE and LISTING. We will leave out the WHERE clause that would normally join the two tables; the result is that *each* row in the VENUE table is joined to *all* of the rows in the LISTING table, for a total of over 32 million rows. This is known as a Cartesian join and normally is not recommended, but for this purpose, it is a convenient method of creating a lot of rows. If you have an existing table with data that you want to test, you can skip this step.

After we have a table with sample data, we create a table with six columns, each with a different compression encoding: raw, bytedict, lzo, runlength, text255, and text32k. We populate each column with exactly the same data by executing an INSERT command that selects the data from the first table.

To test compression encodings:

1. (Optional) First, we'll create a table with a large number of rows. Skip this step if you want to test an existing table.

```
create table reallybigvenue as
select venueid, venueName, venueCity, venueState, venueSeats
from venue, listing;
```

2. Next, create a table with the encodings that you want to compare.

```
create table encodingvenue (
venueRaw varchar(100) encode raw,
venueBytedict varchar(100) encode bytedict,
venueLzo varchar(100) encode lzo,
venueRunlength varchar(100) encode runlength,
venueText255 varchar(100) encode text255,
venueText32k varchar(100) encode text32k);
```

3. Insert the same data into all of the columns using an INSERT statement with a SELECT clause.

```
insert into encodingvenue
```

```
select venueid as venueraw, venueid as venuebytedict, venueid as
venueunlength, venueid as venuetext32k, venueid as venuetext255
from reallybigvenue;
```

4. Verify the number of rows in the new table.

```
select count(*) from encodingvenue

count
-----
38884394
(1 row)
```

5. Query the [STV_BLOCKLIST \(p. 753\)](#) system table to compare the number of 1 MB disk blocks used by each column.

The MAX aggregate function returns the highest block number for each column. The STV_BLOCKLIST table includes details for three system-generated columns. This example uses col < 6 in the WHERE clause to exclude the system-generated columns.

```
select col, max(blocknum)
from stv_blocklist b, stv_tbl_perm p
where (b.tbl=p.id) and name = 'encodingvenue'
and col < 6
group by name, col
order by col;
```

The query returns the following results. The columns are numbered beginning with zero. Depending on how your cluster is configured, your result might have different numbers, but the relative sizes should be similar. You can see that BYTEDICT encoding on the second column produced the best results for this data set, with a compression ratio of better than 20:1. LZO encoding also produced excellent results. Different data sets will produce different results, of course. When a column contains longer text strings, LZO often produces the best compression results.

```
col | max
----+----
0 | 203
1 | 10
2 | 22
3 | 204
4 | 56
5 | 72
(6 rows)
```

If you have data in an existing table, you can use the [ANALYZE COMPRESSION \(p. 310\)](#) command to view the suggested encodings for the table. For example, the following example shows the recommended encoding for a copy of the VENUE table, REALLYBIGVENUE, that contains 38 million rows. Notice that ANALYZE COMPRESSION recommends BYTEDICT encoding for the VENUEID column, which agrees with the results of our previous test.

```
analyze compression reallybigvenue;
```

Table	Column	Encoding	Est_reduction_pct
reallybigvenue	venueid	lzo	97.54
reallybigvenue	venueid	lzo	91.71

```
reallybigvenue | venuecity | lzo | 96.01
reallybigvenue | venuestate | lzo | 97.68
reallybigvenue | venueseats | lzo | 98.21
```

Example: Choosing Compression Encodings for the CUSTOMER Table

The following statement creates a CUSTOMER table that has columns with various data types. This CREATE TABLE statement shows one of many possible combinations of compression encodings for these columns.

```
create table customer(
custkey int encode delta,
custname varchar(30) encode raw,
gender varchar(7) encode text255,
address varchar(200) encode text255,
city varchar(30) encode text255,
state char(2) encode raw,
zipcode char(5) encode bytedict,
start_date date encode delta32k);
```

The following table shows the column encodings that were chosen for the CUSTOMER table and gives an explanation for the choices:

Column	Data Type	Encoding	Explanation
CUSTKEY	int	delta	CUSTKEY consists of unique, consecutive integer values. Since the differences will be one byte, DELTA is a good choice.
CUSTNAME	varchar(30)	raw	CUSTNAME has a large domain with few repeated values. Any compression encoding would probably be ineffective.
GENDER	varchar(7)	text255	GENDER is very small domain with many repeated values. Text255 works well with VARCHAR columns in which the same words recur.
ADDRESS	varchar(200)	text255	ADDRESS is a large domain, but contains many repeated words, such as Street Avenue, North, South, and so on. Text 255 and text 32k are useful for compressing

Column	Data Type	Encoding	Explanation
			VARCHAR columns in which the same words recur. The column length is short, so text255 is a good choice.
CITY	varchar(30)	text255	CITY is a large domain, with some repeated values. Certain city names are used much more commonly than others. Text255 is a good choice for the same reasons as ADDRESS.
STATE	char(2)	raw	In the United States, STATE is a precise domain of 50 two-character values. Bytedict encoding would yield some compression, but because the column size is only two characters, compression might not be worth the overhead of uncompressing the data.
ZIPCODE	char(5)	bytedict	ZIPCODE is a known domain of fewer than 50,000 unique values. Certain zip codes occur much more commonly than others. Bytedict encoding is very effective when a column contains a limited number of unique values.
START_DATE	date	delta32k	Delta encodings are very useful for datetime columns, especially if the rows are loaded in date order.

Choosing a Data Distribution Style

Topics

- [Data Distribution Concepts \(p. 111\)](#)

- [Distribution Styles](#) (p. 112)
- [Viewing Distribution Styles](#) (p. 112)
- [Evaluating Query Patterns](#) (p. 113)
- [Designating Distribution Styles](#) (p. 113)
- [Evaluating the Query Plan](#) (p. 114)
- [Query Plan Example](#) (p. 116)
- [Distribution Examples](#) (p. 120)

When you load data into a table, Amazon Redshift distributes the rows of the table to each of the compute nodes according to the table's distribution style. When you execute a query, the query optimizer redistributes the rows to the compute nodes as needed to perform any joins and aggregations. The goal in selecting a table distribution style is to minimize the impact of the redistribution step by locating the data where it needs to be before the query is executed.

This section will introduce you to the principles of data distribution in an Amazon Redshift database and give you a methodology to choose the best distribution style for each of your tables.

Data Distribution Concepts

Nodes and slices

An Amazon Redshift cluster is a set of nodes. Each node in the cluster has its own operating system, dedicated memory, and dedicated disk storage. One node is the *leader node*, which manages the distribution of data and query processing tasks to the *compute nodes*.

The disk storage for a compute node is divided into a number of *slices*. The number of slices per node depends on the node size of the cluster. For example, each DS1.XL compute node has two slices, and each DS1.8XL compute node has 16 slices. The nodes all participate in parallel query execution, working on data that is distributed as evenly as possible across the slices. For more information about the number of slices that each node size has, go to [About Clusters and Nodes](#) in the *Amazon Redshift Cluster Management Guide*.

Data redistribution

When you load data into a table, Amazon Redshift distributes the rows of the table to each of the node slices according to the table's distribution style. As part of a query plan, the optimizer determines where blocks of data need to be located to best execute the query. The data is then physically moved, or redistributed, during execution. Redistribution might involve either sending specific rows to nodes for joining or broadcasting an entire table to all of the nodes.

Data redistribution can account for a substantial portion of the cost of a query plan, and the network traffic it generates can affect other database operations and slow overall system performance. To the extent that you anticipate where best to locate data initially, you can minimize the impact of data redistribution.

Data distribution goals

When you load data into a table, Amazon Redshift distributes the table's rows to the compute nodes and slices according to the distribution style that you chose when you created the table. Data distribution has two primary goals:

- To distribute the workload uniformly among the nodes in the cluster. Uneven distribution, or data distribution skew, forces some nodes to do more work than others, which impairs query performance.
- To minimize data movement during query execution. If the rows that participate in joins or aggregates are already colocated on the nodes with their joining rows in other tables, the optimizer does not need to redistribute as much data during query execution.

The distribution strategy that you choose for your database has important consequences for query performance, storage requirements, data loading, and maintenance. By choosing the best distribution style for each table, you can balance your data distribution and significantly improve overall system performance.

Distribution Styles

When you create a table, you designate one of three distribution styles; EVEN, KEY, or ALL.

Even distribution

The leader node distributes the rows across the slices in a round-robin fashion, regardless of the values in any particular column. EVEN distribution is appropriate when a table does not participate in joins or when there is not a clear choice between KEY distribution and ALL distribution. EVEN distribution is the default distribution style.

Key distribution

The rows are distributed according to the values in one column. The leader node will attempt to place matching values on the same node slice. If you distribute a pair of tables on the joining keys, the leader node collocates the rows on the slices according to the values in the joining columns so that matching values from the common columns are physically stored together.

ALL distribution

A copy of the entire table is distributed to every node. Where EVEN distribution or KEY distribution place only a portion of a table's rows on each node, ALL distribution ensures that every row is collocated for every join that the table participates in.

ALL distribution multiplies the storage required by the number of nodes in the cluster, and so it takes much longer to load, update, or insert data into multiple tables. ALL distribution is appropriate only for relatively slow moving tables; that is, tables that are not updated frequently or extensively. Small dimension tables do not benefit significantly from ALL distribution, because the cost of redistribution is low.

Note

After you have specified a distribution style for a column, Amazon Redshift handles data distribution at the cluster level. Amazon Redshift does not require or support the concept of partitioning data within database objects. You do not need to create table spaces or define partitioning schemes for tables.

Viewing Distribution Styles

To view the distribution style of a table, query the PG_CLASS system catalog table. The RELDISTSTYLE column indicates the distribution style for the table. The following table gives the distribution style for each value in PG_CLASS:

RELDISTSTYLE	Distribution style
0	EVEN
1	KEY
8	ALL

The following example creates three tables using the three distribution styles and then queries PG_CLASS to view the distribution styles.

```
create table alldiststyle (col1 int)
```

```
diststyle all;

create table evendiststyle (coll int)
diststyle even;

create table keydiststyle (coll int)
diststyle key distkey (coll);

select relname, reldiststyle from pg_class
where relname like '%diststyle';
```

relname	reldiststyle
evendiststyle	0
keydiststyle	1
alldiststyle	8

Evaluating Query Patterns

Choosing distribution styles is just one aspect of database design. You should consider distribution styles only within the context of the entire system, balancing distribution with other important factors such as cluster size, compression encoding methods, sort keys, and table constraints.

Test your system with data that is as close to real data as possible.

In order to make good choices for distribution styles, you need to understand the query patterns for your Amazon Redshift application. Identify the most costly queries in your system and base your initial database design on the demands of those queries. Factors that determine the total cost of a query are how long the query takes to execute, how much computing resources it consumes, how often it is executed, and how disruptive it is to other queries and database operations.

Identify the tables that are used by the most costly queries, and evaluate their role in query execution. Consider how the tables are joined and aggregated.

Use the guidelines in this section to choose a distribution style for each table. When you have done so, create the tables, load them with data that is as close as possible to real data, and then test the tables for the types of queries that you expect to use. You can evaluate the query explain plans to identify tuning opportunities. Compare load times, storage space, and query execution times in order to balance your system's overall requirements.

Designating Distribution Styles

The considerations and recommendations for designating distribution styles in this section use a star schema as an example. Your database design might be based on a star schema, some variant of a star schema, or an entirely different schema. Amazon Redshift is designed to work effectively with whatever schema design you choose. The principles in this section can be applied to any design schema.

1. Specify the primary key and foreign keys for all your tables.

Amazon Redshift does not enforce primary key and foreign key constraints, but the query optimizer uses them when it generates query plans. If you set primary keys and foreign keys, your application must maintain the validity of the keys.

2. Distribute the fact table and its largest dimension table on their common columns.

Choose the largest dimension based on the size of data set that participates in the most common join, not just the size of the table. If a table is commonly filtered, using a WHERE clause, only

a portion of its rows participate in the join. Such a table has less impact on redistribution than a smaller table that contributes more data. Designate both the dimension table's primary key and the fact table's corresponding foreign key as DISTKEY. If multiple tables use the same distribution key, they will also be collocated with the fact table. Your fact table can have only one distribution key. Any tables that join on another key will not be collocated with the fact table.

3. Designate distribution keys for the other dimension tables.

Distribute the tables on their primary keys or their foreign keys, depending on how they most commonly join with other tables.

4. Evaluate whether to change some of the dimension tables to use ALL distribution.

If a dimension table cannot be collocated with the fact table or other important joining tables, you can improve query performance significantly by distributing the entire table to all of the nodes. Using ALL distribution multiplies storage space requirements and increases load times and maintenance operations, so you should weigh all factors before choosing ALL distribution. The following section explains how to identify candidates for ALL distribution by evaluating the EXPLAIN plan.

5. Use EVEN distribution for the remaining tables.

If a table is largely denormalized and does not participate in joins, or if you don't have a clear choice for another distribution style, use EVEN distribution (the default).

You cannot change the distribution style of a table after it is created. To use a different distribution style, you can recreate the table and populate the new table with a deep copy. For more information, see [Performing a Deep Copy](#) (p. 167).

Evaluating the Query Plan

You can use query plans to identify candidates for optimizing the distribution style.

After making your initial design decisions, create your tables, load them with data, and test them. Use a test data set that is as close as possible to the real data. Measure load times to use as a baseline for comparisons.

Evaluate queries that are representative of the most costly queries you expect to execute; specifically, queries that use joins and aggregations. Compare execution times for various design options. When you compare execution times, do not count the first time the query is executed, because the first run time includes the compilation time.

DS_DIST_NONE

No redistribution is required, because corresponding slices are collocated on the compute nodes. You will typically have only one DS_DIST_NONE step, the join between the fact table and one dimension table.

DS_DIST_ALL_NONE

No redistribution is required, because the inner join table used DISTSTYLE ALL. The entire table is located on every node.

DS_DIST_INNER

The inner table is redistributed.

DS_BCAST_INNER

A copy of the entire inner table is broadcast to all the compute nodes.

DS_DIST_ALL_INNER

The entire inner table is redistributed to a single slice because the outer table uses DISTSTYLE ALL.

DS_DIST_BOTH

Both tables are redistributed.

DS_DIST_NONE and DS_DIST_ALL_NONE are good. They indicate that no distribution was required for that step because all of the joins are collocated.

DS_DIST_INNER means that the step will probably have a relatively high cost because the inner table is being redistributed to the nodes. DS_DIST_INNER indicates that the outer table is already properly distributed on the join key. Set the inner table's distribution key to the join key to convert this to DS_DIST_NONE. If distributing the inner table on the join key is not possible because the outer table is not distributed on the join key, evaluate whether to use ALL distribution for the inner table. If the table is relatively slow moving, that is, it is not updated frequently or extensively, and it is large enough to carry a high redistribution cost, change the distribution style to ALL and test again. ALL distribution causes increased load times, so when you retest, include the load time in your evaluation factors.

DS_DIST_ALL_INNER is not good. It means the entire inner table is redistributed to a single slice because the outer table uses DISTSTYLE ALL, so that a copy of the entire outer table is located on each node. This results in inefficient serial execution of the join on a single node instead taking advantage of parallel execution using all of the nodes. DISTSTYLE ALL is meant to be used only for the inner join table. Instead, specify a distribution key or use even distribution for the outer table.

DS_BCAST_INNER and DS_DIST_BOTH are not good. Usually these redistributions occur because the tables are not joined on their distribution keys. If the fact table does not already have a distribution key, specify the joining column as the distribution key for both tables. If the fact table already has a distribution key on another column, you should evaluate whether changing the distribution key to collocate this join will improve overall performance. If changing the distribution key of the outer table is not an optimal choice, you can achieve collocation by specifying DISTSTYLE ALL for the inner table.

The following example shows a portion of a query plan with DS_BCAST_INNER and DS_DIST_NONE labels.

```
-> XN Hash Join DS_BCAST_INNER (cost=112.50..3272334142.59 rows=170771
width=84)
    Hash Cond: ("outer".venueid = "inner".venueid)
    -> XN Hash Join DS_BCAST_INNER (cost=109.98..3167290276.71
rows=172456 width=47)
        Hash Cond: ("outer".eventid = "inner".eventid)
        -> XN Merge Join DS_DIST_NONE (cost=0.00..6286.47 rows=172456
width=30)
            Merge Cond: ("outer".listid = "inner".listid)
            -> XN Seq Scan on listing (cost=0.00..1924.97
rows=192497 width=14)
            -> XN Seq Scan on sales (cost=0.00..1724.56 rows=172456
width=24)
```

After changing the dimension tables to use DISTSTYLE ALL, the query plan for the same query shows DS_DIST_ALL_NONE in place of DS_BCAST_INNER. Also, there is a dramatic change in the relative cost for the join steps.

```
-> XN Hash Join DS_DIST_ALL_NONE (cost=112.50..14142.59 rows=170771
width=84)
    Hash Cond: ("outer".venueid = "inner".venueid)
    -> XN Hash Join DS_DIST_ALL_NONE (cost=109.98..10276.71 rows=172456
width=47)
        Hash Cond: ("outer".eventid = "inner".eventid)
        -> XN Merge Join DS_DIST_NONE (cost=0.00..6286.47 rows=172456
width=30)
            Merge Cond: ("outer".listid = "inner".listid)
            -> XN Seq Scan on listing (cost=0.00..1924.97
rows=192497 width=14)
```

```
-> XN Seq Scan on sales (cost=0.00..1724.56 rows=172456  
width=24)
```

Query Plan Example

This example shows how to evaluate a query plan to find opportunities to optimize the distribution.

Run the following query with an EXPLAIN command to produce a query plan.

```
explain  
select lastname, catname, venuevenue, venuecity, venuestate, eventname,  
month, sum(pricepaid) as buyerprice, max(totalprice) as maxtotalprice  
from category join event on category.catid = event.catid  
join venue on venue.venueid = event.venueid  
join sales on sales.eventid = event.eventid  
join listing on sales.listid = listing.listid  
join date on sales.dateid = date.dateid  
join users on users.userid = sales.buyerid  
group by lastname, catname, venuevenue, venuecity, venuestate, eventname,  
month  
having sum(pricepaid)>9999  
order by catname, buyerprice desc;
```

In the TICKIT database, SALES is a fact table and LISTING is its largest dimension. In order to collocate the tables, SALES is distributed on the LISTID, which is the foreign key for LISTING, and LISTING is distributed on its primary key, LISTID. The following example shows the CREATE TABLE commands for SALES and LISTING.

```
create table sales(  
salesid integer not null,  
listid integer not null distkey,  
sellerid integer not null,  
buyerid integer not null,  
eventid integer not null encode mostly16,  
dateid smallint not null,  
qtysold smallint not null encode mostly8,  
pricepaid decimal(8,2) encode delta32k,  
commission decimal(8,2) encode delta32k,  
saletime timestamp,  
primary key(salesid),  
foreign key(listid) references listing(listid),  
foreign key(sellerid) references users(userid),  
foreign key(buyerid) references users(userid),  
foreign key(dateid) references date(dateid))  
sortkey(listid,sellerid);  
  
create table listing(  
listid integer not null distkey sortkey,  
sellerid integer not null,  
eventid integer not null encode mostly16,  
dateid smallint not null,  
numtickets smallint not null encode mostly8,  
priceperticket decimal(8,2) encode bytedict,  
totalprice decimal(8,2) encode mostly32,  
listtime timestamp,  
primary key(listid),
```



```
foreign key(sellerid) references users(userid),
foreign key(eventid) references event(eventid),
foreign key(dateid) references date(dateid));
```

In the following query plan, the Merge Join step for the join on SALES and LISTING shows DS_DIST_NONE, which indicates that no redistribution is required for the step. However, moving up the query plan, the other inner joins show DS_BCAST_INNER, which indicates that the inner table is broadcast as part of the query execution. Because only one pair of tables can be colocated using key distribution, five tables need to be rebroadcast.

```
QUERY PLAN
XN Merge (cost=1015345167117.54..1015345167544.46 rows=1000 width=103)
  Merge Key: category.catname, sum(sales.pricepaid)
  -> XN Network (cost=1015345167117.54..1015345167544.46 rows=170771
width=103)
    Send to leader
    -> XN Sort (cost=1015345167117.54..1015345167544.46 rows=170771
width=103)
      Sort Key: category.catname, sum(sales.pricepaid)
      -> XN HashAggregate (cost=15345150568.37..15345152276.08
rows=170771 width=103)
        Filter: (sum(pricepaid) > 9999.00)
        -> XN Hash Join DS_BCAST_INNER
(cost=742.08..15345146299.10 rows=170771 width=103)
          Hash Cond: ("outer".catid = "inner".catid)
          -> XN Hash Join DS_BCAST_INNER
(cost=741.94..15342942456.61 rows=170771 width=97)
            Hash Cond: ("outer".dateid = "inner".dateid)
            -> XN Hash Join DS_BCAST_INNER
(cost=737.38..15269938609.81 rows=170766 width=90)
              Hash Cond: ("outer".buyerid =
"inner".userid)
              -> XN Hash Join DS_BCAST_INNER
(cost=112.50..3272334142.59 rows=170771 width=84)
                Hash Cond: ("outer".venueid =
"inner".venueid)
                -> XN Hash Join DS_BCAST_INNER
(cost=109.98..3167290276.71 rows=172456 width=47)
                  Hash Cond:
("outer".eventid = "inner".eventid)
                  -> XN Merge Join
DS_DIST_NONE (cost=0.00..6286.47 rows=172456 width=30)
                    Merge Cond:
("outer".listid = "inner".listid)
                    -> XN Seq Scan on
listing (cost=0.00..1924.97 rows=192497 width=14)
                    -> XN Seq Scan on
sales (cost=0.00..1724.56 rows=172456 width=24)
                    -> XN Hash
(cost=87.98..87.98 rows=8798 width=25)
                    -> XN Seq Scan on
event (cost=0.00..87.98 rows=8798 width=25)
                    -> XN Hash (cost=2.02..2.02
rows=202 width=41)
                    -> XN Seq Scan on venue
(cost=0.00..2.02 rows=202 width=41)
                    -> XN Hash (cost=499.90..499.90
rows=49990 width=14)
```

```
                                -> XN Seq Scan on users
(cost=0.00..499.90 rows=49990 width=14)
                                -> XN Hash  (cost=3.65..3.65 rows=365
width=11)
                                -> XN Seq Scan on date
(cost=0.00..3.65 rows=365 width=11)
                                -> XN Hash  (cost=0.11..0.11 rows=11 width=10)
                                -> XN Seq Scan on category
(cost=0.00..0.11 rows=11 width=10)
```

One solution is to recreate the tables with `DISTSTYLE ALL`. You cannot change a table's distribution style after it is created. To recreate tables with a different distribution style, use a deep copy.

First, rename the tables.

```
alter table users rename to userscopy;
alter table venue rename to venuecopy;
alter table category rename to categorycopy;
alter table date rename to datecopy;
alter table event rename to eventcopy;
```

Run the following script to recreate `USERS`, `VENUE`, `CATEGORY`, `DATE`, `EVENT`. Don't make any changes to `SALES` and `LISTING`.

```
create table users(
    userid integer not null sortkey,
    username char(8),
    firstname varchar(30),
    lastname varchar(30),
    city varchar(30),
    state char(2),
    email varchar(100),
    phone char(14),
    likesports boolean,
    liketheatre boolean,
    likeconcerts boolean,
    likejazz boolean,
    likeclassical boolean,
    likeopera boolean,
    likerock boolean,
    likevegas boolean,
    likebroadway boolean,
    likemusicals boolean,
    primary key(userid)) diststyle all;

create table venue(
    venueid smallint not null sortkey,
    venue name varchar(100),
    venue city varchar(30),
    venue state char(2),
    venue seats integer,
    primary key(venueid)) diststyle all;

create table category(
    catid smallint not null,
    catgroup varchar(10),
    catname varchar(10),
    catdesc varchar(50),
```

```
primary key(catid)) diststyle all;

create table date(
  dateid smallint not null sortkey,
  caldate date not null,
  day character(3) not null,
  week smallint not null,
  month character(5) not null,
  qtr character(5) not null,
  year smallint not null,
  holiday boolean default('N'),
  primary key (dateid)) diststyle all;

create table event(
  eventid integer not null sortkey,
  venueid smallint not null,
  catid smallint not null,
  dateid smallint not null,
  eventname varchar(200),
  starttime timestamp,
  primary key(eventid),
  foreign key(venueid) references venue(venueid),
  foreign key(catid) references category(catid),
  foreign key(dateid) references date(dateid)) diststyle all;
```

Insert the data back into the tables and run an ANALYZE command to update the statistics.

```
insert into users select * from userscopy;
insert into venue select * from venuecopy;
insert into category select * from categorycopy;
insert into date select * from datecopy;
insert into event select * from eventcopy;

analyze;
```

Finally, drop the copies.

```
drop table userscopy;
drop table venuecopy;
drop table categorycopy;
drop table datecopy;
drop table eventcopy;
```

Run the same query with EXPLAIN again, and examine the new query plan. The joins now show DS_DIST_ALL_NONE, indicating that no redistribution is required because the data was distributed to every node using DISTSTYLE ALL.

```
QUERY PLAN
XN Merge (cost=1000000047117.54..1000000047544.46 rows=1000 width=103)
  Merge Key: category.catname, sum(sales.pricepaid)
  -> XN Network (cost=1000000047117.54..1000000047544.46 rows=170771
width=103)
    Send to leader
    -> XN Sort (cost=1000000047117.54..1000000047544.46 rows=170771
width=103)
      Sort Key: category.catname, sum(sales.pricepaid)
```

```

-> XN HashAggregate (cost=30568.37..32276.08 rows=170771
width=103)
    Filter: (sum(pricepaid) > 9999.00)
    -> XN Hash Join DS_DIST_ALL_NONE (cost=742.08..26299.10
rows=170771 width=103)
        Hash Cond: ("outer".buyerid = "inner".userid)
        -> XN Hash Join DS_DIST_ALL_NONE
(cost=117.20..21831.99 rows=170766 width=97)
            Hash Cond: ("outer".dateid = "inner".dateid)
            -> XN Hash Join DS_DIST_ALL_NONE
(cost=112.64..17985.08 rows=170771 width=90)
                Hash Cond: ("outer".catid =
"inner".catid)
                -> XN Hash Join DS_DIST_ALL_NONE
(cost=112.50..14142.59 rows=170771 width=84)
                    Hash Cond: ("outer".venueid =
"inner".venueid)
                    -> XN Hash Join DS_DIST_ALL_NONE
(cost=109.98..10276.71 rows=172456 width=47)
                        Hash Cond: ("outer".eventid
= "inner".eventid)
                        -> XN Merge Join
DS_DIST_NONE (cost=0.00..6286.47 rows=172456 width=30)
                            Merge Cond:
("outer".listid = "inner".listid)
                            -> XN Seq Scan on
listing (cost=0.00..1924.97 rows=192497 width=14)
                            -> XN Seq Scan on
sales (cost=0.00..1724.56 rows=172456 width=24)
                            -> XN Hash
(cost=87.98..87.98 rows=8798 width=25)
                            -> XN Seq Scan on
event (cost=0.00..87.98 rows=8798 width=25)
                            -> XN Hash (cost=2.02..2.02
rows=202 width=41)
                            -> XN Seq Scan on venue
(cost=0.00..2.02 rows=202 width=41)
                            -> XN Hash (cost=0.11..0.11 rows=11
width=10)
                            -> XN Seq Scan on category
(cost=0.00..0.11 rows=11 width=10)
                            -> XN Hash (cost=3.65..3.65 rows=365
width=11)
                            -> XN Seq Scan on date
(cost=0.00..3.65 rows=365 width=11)
                            -> XN Hash (cost=499.90..499.90 rows=49990
width=14)
                            -> XN Seq Scan on users (cost=0.00..499.90
rows=49990 width=14)

```

Distribution Examples

The following examples show how data is distributed according to the options that you define in the CREATE TABLE statement.

DISTKEY Examples

Look at the schema of the USERS table in the TICKIT database. USERID is defined as the SORTKEY column and the DISTKEY column:

```
select "column", type, encoding, distkey, sortkey
from pg_table_def where tablename = 'users';
```

column	type	encoding	distkey	sortkey
userid	integer	none	t	1
username	character(8)	none	f	0
firstname	character varying(30)	text32k	f	0
...				

USERID is a good choice for the distribution column on this table. If you query the SVV_DISKUSAGE system view, you can see that the table is very evenly distributed. Column numbers are zero-based, so USERID is column 0.

```
select slice, col, num_values as rows, minvalue, maxvalue
from svv_diskusage
where name='users' and col=0 and rows>0
order by slice, col;
```

slice	col	rows	minvalue	maxvalue
0	0	12496	4	49987
1	0	12498	1	49988
2	0	12497	2	49989
3	0	12499	3	49990
(4 rows)				

The table contains 49,990 rows. The rows (num_values) column shows that each slice contains about the same number of rows. The minvalue and maxvalue columns show the range of values on each slice. Each slice includes nearly the entire range of values, so there's a good chance that every slice will participate in executing a query that filters for a range of user IDs.

This example demonstrates distribution on a small test system. The total number of slices is typically much higher.

If you commonly join or group using the STATE column, you might choose to distribute on the STATE column. The following examples shows that if you create a new table with the same data as the USERS table, but you set the DISTKEY to the STATE column, the distribution will not be as even. Slice 0 (13,587 rows) holds approximately 30% more rows than slice 3 (10,150 rows). In a much larger table, this amount of distribution skew could have an adverse impact on query processing.

```
create table userskey distkey(state) as select * from users;
```

```
select slice, col, num_values as rows, minvalue, maxvalue from svv_diskusage
where name = 'userskey' and col=0 and rows>0
order by slice, col;
```

slice	col	rows	minvalue	maxvalue
0	0	13587	5	49989

```
1 | 0 | 11245 | 2 | 49990
2 | 0 | 15008 | 1 | 49976
3 | 0 | 10150 | 4 | 49986
(4 rows)
```

DISTSTYLE EVEN Example

If you create a new table with the same data as the USERS table but set the DISTSTYLE to EVEN, rows are always evenly distributed across slices.

```
create table userseven diststyle even as
select * from users;

select slice, col, num_values as rows, minvalue, maxvalue from svv_diskusage
where name = 'userseven' and col=0 and rows>0
order by slice, col;
```

slice	col	rows	minvalue	maxvalue
0	0	12497	4	49990
1	0	12498	8	49984
2	0	12498	2	49988
3	0	12497	1	49989

(4 rows)

However, because distribution is not based on a specific column, query processing can be degraded, especially if the table is joined to other tables. The lack of distribution on a joining column often influences the type of join operation that can be performed efficiently. Joins, aggregations, and grouping operations are optimized when both tables are distributed and sorted on their respective joining columns.

DISTSTYLE ALL Example

If you create a new table with the same data as the USERS table but set the DISTSTYLE to ALL, all the rows are distributed to the first slice of each node.

```
select slice, col, num_values as rows, minvalue, maxvalue from svv_diskusage
where name = 'usersall' and col=0 and rows > 0
order by slice, col;
```

slice	col	rows	minvalue	maxvalue
0	0	49990	4	49990
2	0	49990	2	49990

(4 rows)

Choosing Sort Keys

When you create a table, you can define one or more of its columns as *sort keys*. When data is initially loaded into the empty table, the rows are stored on disk in sorted order. Information about sort key columns is passed to the query planner, and the planner uses this information to construct plans that exploit the way that the data is sorted.

Sorting enables efficient handling of range-restricted predicates. Amazon Redshift stores columnar data in 1 MB disk blocks. The min and max values for each block are stored as part of the metadata. If a query uses a range-restricted predicate, the query processor can use the min and max values to rapidly skip over large numbers of blocks during table scans. For example, if a table stores five years of data sorted by date and a query specifies a date range of one month, up to 98 percent of the disk blocks can be eliminated from the scan. If the data is not sorted, more of the disk blocks (possibly all of them) have to be scanned.

You can specify either a compound or interleaved sort key. A compound sort key is more efficient when query predicates use a *prefix*, which is a subset of the sort key columns in order. An interleaved sort key gives equal weight to each column in the sort key, so query predicates can use any subset of the columns that make up the sort key, in any order. For examples of using compound sort keys and interleaved sort keys, see [Comparing Sort Styles \(p. 124\)](#).

To understand the impact of the chosen sort key on query performance, use the [EXPLAIN \(p. 415\)](#) command. For more information, see [Query Planning And Execution Workflow \(p. 200\)](#)

To define a sort type, use either the `INTERLEAVED` or `COMPOUND` keyword with your `CREATE TABLE` or `CREATE TABLE AS` statement. The default is `COMPOUND`. An `INTERLEAVED` sort key can use a maximum of eight columns.

To view the sort keys for a table, query the [SVV_TABLE_INFO \(p. 791\)](#) system view.

Topics

- [Compound Sort Key \(p. 123\)](#)
- [Interleaved Sort Key \(p. 123\)](#)
- [Comparing Sort Styles \(p. 124\)](#)

Compound Sort Key

A compound key is made up of all of the columns listed in the sort key definition, in the order they are listed. A compound sort key is most useful when a query's filter applies conditions, such as filters and joins, that use a prefix of the sort keys. The performance benefits of compound sorting decrease when queries depend only on secondary sort columns, without referencing the primary columns. `COMPOUND` is the default sort type.

Compound sort keys might speed up joins, `GROUP BY` and `ORDER BY` operations, and window functions that use `PARTITION BY` and `ORDER BY`. For example, a merge join, which is often faster than a hash join, is feasible when the data is distributed and presorted on the joining columns. Compound sort keys also help improve compression.

As you add rows to a sorted table that already contains data, the unsorted region grows, which has a significant effect on performance. The effect is greater when the table uses interleaved sorting, especially when the sort columns include data that increases monotonically, such as date or timestamp columns. You should run a `VACUUM` operation regularly, especially after large data loads, to re-sort and re-analyze the data. For more information, see [Managing the Size of the Unsorted Region \(p. 175\)](#). After vacuuming to resort the data, it's a good practice to run an `ANALYZE` command to update the statistical metadata for the query planner. For more information, see [Analyzing Tables \(p. 169\)](#).

Interleaved Sort Key

An interleaved sort gives equal weight to each column, or subset of columns, in the sort key. If multiple queries use different columns for filters, then you can often improve performance for those queries by using an interleaved sort style. When a query uses restrictive predicates on secondary sort columns, interleaved sorting significantly improves query performance as compared to compound sorting.

The performance improvements you gain by implementing an interleaved sort key should be weighed against increased load and vacuum times.

Interleaved sorts are most effective with highly selective queries that filter on one or more of the sort key columns in the WHERE clause, for example `select c_name from customer where c_region = 'ASIA'`. The benefits of interleaved sorting increase with the number of sorted columns that are restricted.

An interleaved sort is more effective with large tables. Sorting is applied on each slice, so an interleaved sort is most effective when a table is large enough to require multiple 1 MB blocks per slice and the query processor is able to skip a significant proportion of the blocks using restrictive predicates. To view the number of blocks a table uses, query the [STV_BLOCKLIST \(p. 753\)](#) system view.

When sorting on a single column, an interleaved sort might give better performance than a compound sort if the column values have a long common prefix. For example, URLs commonly begin with "http://www". Compound sort keys use a limited number of characters from the prefix, which results in a lot of duplication of keys. Interleaved sorts use an internal compression scheme for zone map values that enables them to better discriminate among column values that have a long common prefix.

VACUUM REINDEX

As you add rows to a sorted table that already contains data, performance might deteriorate over time. This deterioration occurs for both compound and interleaved sorts, but it has a greater effect on interleaved tables. A VACUUM restores the sort order, but the operation can take longer for interleaved tables because merging new interleaved data might involve modifying every data block.

When tables are initially loaded, Amazon Redshift analyzes the distribution of the values in the sort key columns and uses that information for optimal interleaving of the sort key columns. As a table grows, the distribution of the values in the sort key columns can change, or skew, especially with date or timestamp columns. If the skew becomes too large, performance might be affected. To re-analyze the sort keys and restore performance, run the VACUUM command with the REINDEX key word. Because it needs to take an extra analysis pass over the data, VACUUM REINDEX can take longer than a standard VACUUM for interleaved tables. To view information about key distribution skew and last reindex time, query the [SVV_INTERLEAVED_COLUMNS \(p. 780\)](#) system view.

For more information about how to determine how to run VACUUM and when to run a VACUUM REINDEX, see [Deciding Whether to Reindex \(p. 174\)](#).

Comparing Sort Styles

This section compares the performance differences when using a single-column sort key, a compound sort key, and an interleaved sort key for different types of queries.

For this example, you'll create a denormalized table named CUST_SALES, using data from the CUSTOMER and LINEORDER tables. CUSTOMER and LINEORDER are part of the SSB data set, which is used in the [Tutorial: Tuning Table Design \(p. 30\)](#).

The new CUST_SALES table has 480 million rows, which is not large by Amazon Redshift standards, but it is large enough to show the performance differences. Larger tables will tend to show greater differences, especially for interleaved sorting.

To compare the three sort methods, perform the following steps:

1. Create the SSB data set.
2. Create the CUST_SALES_DATE table.
3. Create three tables to compare sort styles.
4. Execute queries and compare the results.

Create the SSB Data Set

If you haven't already done so, follow the steps in [Step 1: Create a Test Data Set \(p. 30\)](#) in the Tuning Table Design tutorial to create the tables in the SSB data set and load them with data. The data load will take about 10 to 15 minutes.

The example in the Tuning Table Design tutorial uses a four-node cluster. The comparisons in this example use a two-node cluster. Your results will vary with different cluster configurations.

Create the CUST_SALES_DATE Table

The CUST_SALES_DATE table is a denormalized table that contains data about customers and revenues. To create the CUST_SALES_DATE table, execute the following statement.

```
create table cust_sales_date as
(select c_custkey, c_nation, c_region, c_mktsegment, d_date::date, lo_revenue
from customer, lineorder, dwdate
where lo_custkey = c_custkey
and lo_orderdate = dwdate.d_datekey
and lo_revenue > 0);
```

The following query shows the row count for CUST_SALES.

```
select count(*) from cust_sales_date;

      count
-----
480027069
(1 row)
```

Execute the following query to view the first row of the CUST_SALES table.

```
select * from cust_sales_date limit 1;

c_custkey | c_nation | c_region | c_mktsegment | d_date      | lo_revenue
-----+-----+-----+-----+-----+-----
          1 | MOROCCO | AFRICA   | BUILDING     | 1994-10-28 | 1924330
```

Create Tables for Comparing Sort Styles

To compare the sort styles, create three tables. The first will use a single-column sort key; the second will use a compound sort key; the third will use an interleaved sort key. The single-column sort will use the `c_custkey` column. The compound sort and the interleaved sort will both use the `c_custkey`, `c_nation`, and `c_region` columns.

To create the tables for comparison, execute the following CREATE TABLE statements.

```
create table cust_sales_date_single
sortkey (c_custkey)
as select * from cust_sales_date;

create table cust_sales_date_compound
compound sortkey (c_custkey, c_region, c_mktsegment, d_date)
as select * from cust_sales_date;
```

```
create table cust_sales_date_interleaved
interleaved sortkey (c_custkey, c_region, c_mktsegment, d_date)
as select * from cust_sales_date;
```

Execute Queries and Compare the Results

Execute the same queries against each of the tables to compare execution times for each table. To eliminate differences due to compile time, run each of the queries twice, and record the second time.

1. Test a query that restricts on the `c_custkey` column, which is the first column in the sort key for each table. Execute the following queries.

```
-- Query 1

select max(lo_revenue), min(lo_revenue)
from cust_sales_date_single
where c_custkey < 100000;

select max(lo_revenue), min(lo_revenue)
from cust_sales_date_compound
where c_custkey < 100000;

select max(lo_revenue), min(lo_revenue)
from cust_sales_date_interleaved
where c_custkey < 100000;
```

2. Test a query that restricts on the `c_region` column, which is the second column in the sort key for the compound and interleaved keys. Execute the following queries.

```
-- Query 2

select max(lo_revenue), min(lo_revenue)
from cust_sales_date_single
where c_region = 'ASIA'
and c_mktsegment = 'FURNITURE';

select max(lo_revenue), min(lo_revenue)
from cust_sales_date_compound
where c_region = 'ASIA'
and c_mktsegment = 'FURNITURE';

select max(lo_revenue), min(lo_revenue)
from cust_sales_date_interleaved
where c_region = 'ASIA'
and c_mktsegment = 'FURNITURE';
```

3. Test a query that restricts on both the `c_region` column and the `c_mktsegment` column. Execute the following queries.

```
-- Query 3

select max(lo_revenue), min(lo_revenue)
from cust_sales_date_single
where d_date between '01/01/1996' and '01/14/1996'
and c_mktsegment = 'FURNITURE'
and c_region = 'ASIA';
```

```
select max(lo_revenue), min(lo_revenue)
from cust_sales_date_compound
where d_date between '01/01/1996' and '01/14/1996'
and c_mktsegment = 'FURNITURE'
and c_region = 'ASIA';

select max(lo_revenue), min(lo_revenue)
from cust_sales_date_interleaved
where d_date between '01/01/1996' and '01/14/1996'
and c_mktsegment = 'FURNITURE'
and c_region = 'ASIA';
```

4. Evaluate the results.

The following table summarizes the performance of the three sort styles.

Important

These results show relative performance for the two-node cluster that was used for these examples. Your results will vary, depending on multiple factors, such as your node type, number of nodes, and other concurrent operations contending for resources.

Sort Style	Query 1	Query 2	Query 3
Single	0.25 s	18.37 s	30.04 s
Compound	0.27 s	18.24 s	30.14 s
Interleaved	0.94 s	1.46 s	0.80 s

In Query 1, the results for all three sort styles are very similar, because the WHERE clause restricts only on the first column. There is a small overhead cost for accessing an interleaved table.

In Query 2, there is no benefit to the single-column sort key because that column is not used in the WHERE clause. There is no performance improvement for the compound sort key, because the query was restricted using the second and third columns in the sort key. The query against the interleaved table shows the best performance because interleaved sorting is able to efficiently filter on secondary columns in the sort key.

In Query 3, the interleaved sort is much faster than the other styles because it is able to filter on the combination of the `d_date`, `c_mktsegment`, and `c_region` columns.

This example uses a relatively small table, by Amazon Redshift standards, with 480 million rows. With larger tables, containing billions of rows and more, interleaved sorting can improve performance by an order of magnitude or more for certain types of queries.

Defining Constraints

Uniqueness, primary key, and foreign key constraints are informational only; *they are not enforced by Amazon Redshift*. Nonetheless, primary keys and foreign keys are used as planning hints and they should be declared if your ETL process or some other process in your application enforces their integrity.

For example, the query planner uses primary and foreign keys in certain statistical computations, to infer uniqueness and referential relationships that affect subquery decorrelation techniques, to order large numbers of joins, and to eliminate redundant joins.

The planner leverages these key relationships, but it assumes that all keys in Amazon Redshift tables are valid as loaded. If your application allows invalid foreign keys or primary keys, some queries could return incorrect results. For example, a `SELECT DISTINCT` query might return duplicate rows if the primary key is not unique. Do not define key constraints for your tables if you doubt their validity. On the other hand, you should always declare primary and foreign keys and uniqueness constraints when you know that they are valid.

Amazon Redshift *does* enforce NOT NULL column constraints.

Analyzing Table Design

As you have seen in the previous sections, specifying sort keys, distribution keys, and column encodings can significantly improve storage, I/O, and query performance. This section provides a SQL script that you can run to help you identify tables where these options are missing or performing poorly.

Copy and paste the following code to create a SQL script named `table_inspector.sql`, then execute the script in your SQL client application as superuser.

```
SELECT SCHEMA schemaname,
       "table" tablename,
       table_id tableid,
       size size_in_mb,
       CASE
         WHEN diststyle NOT IN ('EVEN','ALL') THEN 1
         ELSE 0
       END has_dist_key,
       CASE
         WHEN sortkey1 IS NOT NULL THEN 1
         ELSE 0
       END has_sort_key,
       CASE
         WHEN encoded = 'Y' THEN 1
         ELSE 0
       END has_col_encoding,
       CAST(max_blocks_per_slice - min_blocks_per_slice AS FLOAT) /
       GREATEST(NVL (min_blocks_per_slice,0)::int,1) ratio_skew_across_slices,
       CAST(100*dist_slice AS FLOAT) / (SELECT COUNT(DISTINCT slice) FROM
       stv_slices) pct_slices_populated
FROM svv_table_info ti
JOIN (SELECT tbl,
            MIN(c) min_blocks_per_slice,
            MAX(c) max_blocks_per_slice,
            COUNT(DISTINCT slice) dist_slice
      FROM (SELECT b.tbl,
                  b.slice,
                  COUNT(*) AS c
            FROM STV_BLOCKLIST b
            GROUP BY b.tbl,
                  b.slice)
      WHERE tbl IN (SELECT table_id FROM svv_table_info)
      GROUP BY tbl) iq ON iq.tbl = ti.table_id;
```

The following sample shows the results of running the script with two sample tables, SKEW1 and SKEW2, that demonstrate the effects of data skew.

schemaname	tablename	tableid	size_ in_mb	has_ dist_ key	has_ sort_ key	has_ col_ encoding	ratio_skew_ _across_ slices	pct_ slices_ populated
public	category	100553	28	1	1	0	0	100
public	date	100555	44	1	1	0	0	100
public	event	100558	36	1	1	1	0	100
public	listing	100560	44	1	1	1	0	100
public	nation	100563	175	0	0	0	0	39.06
public	region	100566	30	0	0	0	0	7.81
public	sales	100562	52	1	1	0	0	100
public	skew1	100547	18978	0	0	0	.15	50
public	skew2	100548	353	1	0	0	0	1.56
public	venue	100551	32	1	1	0	0	100
public	users	100549	82	1	1	1	0	100
public	venue	100551	32	1	1	0	0	100

The following list describes the TEMP_TABLES_REPORT columns:

has_dist_key

Indicates whether the table has distribution key. 1 indicates a key exists; 0 indicates there is no key. For example, `nation` does not have a distribution key .

has_sort_key

Indicates whether the table has a sort key. 1 indicates a key exists; 0 indicates there is no key. For example, `nation` does not have a sort key.

has_column_encoding

Indicates whether the table has any compression encodings defined for any of the columns. 1 indicates at least one column has an encoding. 0 indicates there is no encoding. For example, `region` has no compression encoding.

ratio_skew_across_slices

An indication of the data distribution skew. A smaller value is good.

pct_slices_populated

The percentage of slices populated. A larger value is good.

Tables for which there is significant data distribution skew will have either a large value in the `ratio_skew_across_slices` column or a small value in the `pct_slices_populated` column. This indicates that you have not chosen an appropriate distribution key column. In the example above, the `SKEW1` table has a .15 skew ratio across slices, but that's not necessarily a problem. What's more significant is the 1.56% value for the slices populated for the `SKEW2` table. The small value is an indication that the `SKEW2` table has the wrong distribution key.

Run the `table_inspector.sql` script whenever you add new tables to your database or whenever you have significantly modified your tables.

Loading Data

Topics

- [Using a COPY Command to Load Data \(p. 130\)](#)
- [Updating Tables with DML Commands \(p. 161\)](#)
- [Updating and Inserting New Data \(p. 161\)](#)
- [Performing a Deep Copy \(p. 167\)](#)
- [Analyzing Tables \(p. 169\)](#)
- [Vacuuming Tables \(p. 172\)](#)
- [Managing Concurrent Write Operations \(p. 181\)](#)

A COPY command is the most efficient way to load a table. You can also add data to your tables using INSERT commands, though it is much less efficient than using COPY. The COPY command is able to read from multiple data files or multiple data streams simultaneously. Amazon Redshift allocates the workload to the cluster nodes and performs the load operations in parallel, including sorting the rows and distributing data across node slices.

To access data on other AWS resources, your cluster must have permission to access those resources and to perform the necessary actions to access the data. You can use Identity and Resource Management (IAM) to limit the access users have to your cluster resources and data.

After your initial data load, if you add, modify, or delete a significant amount of data, you should follow up by running a VACUUM command to reorganize your data and reclaim space after deletes. You should also run an ANALYZE command to update table statistics.

This section explains how to load data and troubleshoot data loads and presents best practices for loading data.

Using a COPY Command to Load Data

Topics

- [Credentials and Access Permissions \(p. 131\)](#)
- [Preparing Your Input Data \(p. 132\)](#)
- [Loading Data from Amazon S3 \(p. 133\)](#)
- [Loading Data from Amazon EMR \(p. 141\)](#)

- [Loading Data from Remote Hosts \(p. 145\)](#)
- [Loading Data from an Amazon DynamoDB Table \(p. 151\)](#)
- [Verifying That the Data Was Loaded Correctly \(p. 153\)](#)
- [Validating Input Data \(p. 154\)](#)
- [Loading Tables with Automatic Compression \(p. 154\)](#)
- [Optimizing Storage for Narrow Tables \(p. 156\)](#)
- [Loading Default Column Values \(p. 156\)](#)
- [Troubleshooting Data Loads \(p. 157\)](#)

The COPY command leverages the Amazon Redshift massively parallel processing (MPP) architecture to read and load data in parallel from files on Amazon S3, from a DynamoDB table, or from text output from one or more remote hosts.

Note

We strongly recommend using the COPY command to load large amounts of data. Using individual INSERT statements to populate a table might be prohibitively slow. Alternatively, if your data already exists in other Amazon Redshift database tables, use INSERT INTO ... SELECT or CREATE TABLE AS to improve performance. For information, see [INSERT \(p. 424\)](#) or [CREATE TABLE AS \(p. 389\)](#).

To load data from another AWS resource, your cluster must have permission to access the resource and perform the necessary actions.

To grant or revoke privilege to load data into a table using a COPY command, grant or revoke the INSERT privilege.

Your data needs to be in the proper format for loading into your Amazon Redshift table. This section presents guidelines for preparing and verifying your data before the load and for validating a COPY statement before you execute it.

To protect the information in your files, you can encrypt the data files before you upload them to your Amazon S3 bucket; COPY will decrypt the data as it performs the load. You can also limit access to your load data by providing temporary security credentials to users. Temporary security credentials provide enhanced security because they have short life spans and cannot be reused after they expire.

You can compress the files using gzip, lzop, or bzip2 to save time uploading the files. COPY can then speed up the load process by uncompressing the files as they are read.

To help keep your data secure in transit within the AWS cloud, Amazon Redshift uses hardware accelerated SSL to communicate with Amazon S3 or Amazon DynamoDB for COPY, UNLOAD, backup, and restore operations.

When you load your table directly from an Amazon DynamoDB table, you have the option to control the amount of Amazon DynamoDB provisioned throughput you consume.

You can optionally let COPY analyze your input data and automatically apply optimal compression encodings to your table as part of the load process.

Credentials and Access Permissions

To load or unload data using another AWS resource, such as Amazon S3, Amazon DynamoDB, Amazon EMR, or Amazon EC2, your cluster must have permission to access the resource and perform the necessary actions to access the data. For example, to load data from Amazon S3, COPY must have LIST access to the bucket and GET access for the bucket objects.

To obtain authorization to access a resource, your cluster must be authenticated. You can choose either role-based access control or key-based access control. This section presents an overview

of the two methods. For complete details and examples, see [Permissions to Access Other AWS Resources](#) (p. 348).

Role-Based Access Control

With role-based access control, your cluster temporarily assumes an AWS Identity and Access Management (IAM) role on your behalf. Then, based on the authorizations granted to the role, your cluster can access the required AWS resources.

We recommend using role-based access control because it provides more secure, fine-grained control of access to AWS resources and sensitive user data, in addition to safeguarding your AWS credentials.

To use role-based access control, you must first create an IAM role using the Amazon Redshift service role type, and then attach the role to your cluster. The role must have, at a minimum, the permissions listed in [IAM Permissions for COPY, UNLOAD, and CREATE LIBRARY](#) (p. 351). For steps to create an IAM role and attach it to your cluster, see [Creating an IAM Role to Allow Your Amazon Redshift Cluster to Access AWS Services](#) in the *Amazon Redshift Cluster Management Guide*.

You can add a role to a cluster or view the roles associated with a cluster by using the Amazon Redshift Management Console, CLI, or API. For more information, see [Authorizing COPY and UNLOAD Operations Using IAM Roles](#) in the *Amazon Redshift Cluster Management Guide*.

When you create an IAM role, IAM returns an Amazon Resource Name (ARN) for the role. To execute a COPY command using an IAM role, provide the role ARN in the CREDENTIALS parameter string. The following COPY command example uses the role `MyRedshiftRole` for authentication.

```
copy customer from 's3://mybucket/mydata'  
credentials  
'aws_iam_role=arn:aws:iam::12345678901:role/MyRedshiftRole';
```

Key-Based Access Control

With key-based access control, you provide the access key ID and secret access key for an IAM user that is authorized to access the AWS resources that contain the data.

Note

We strongly recommend using an IAM role for authentication instead of supplying a plain-text access key ID and secret access key. If you choose key-based access control, never use your AWS account (root) credentials. Always create an IAM user and provide that user's access key ID and secret access key. For steps to create an IAM user, see [Creating an IAM User in Your AWS Account](#).

To authenticate using IAM user credentials, replace `<access-key-id>` and `<secret-access-key>` with an authorized user's access key ID and full secret access key in the CREDENTIALS `aws-auth-args` string as shown following.

```
CREDENTIALS  
'aws_access_key_id=<access-key-id>;aws_secret_access_key=<secret-access-key>;
```

The AWS IAM user must have, at a minimum, the permissions listed in [IAM Permissions for COPY, UNLOAD, and CREATE LIBRARY](#) (p. 351).

Preparing Your Input Data

If your input data is not compatible with the table columns that will receive it, the COPY command will fail.

Use the following guidelines to help ensure that your input data is valid:

- Your data can only contain UTF-8 characters up to four bytes long.
- Verify that CHAR and VARCHAR strings are no longer than the lengths of the corresponding columns. VARCHAR strings are measured in bytes, not characters, so, for example, a four-character string of Chinese characters that occupy four bytes each requires a VARCHAR(16) column.
- Multibyte characters can only be used with VARCHAR columns. Verify that multibyte characters are no more than four bytes long.
- Verify that data for CHAR columns only contains single-byte characters.
- Do not include any special characters or syntax to indicate the last field in a record. This field can be a delimiter.
- If your data includes null terminators, also referred to as NUL (UTF-8 0000) or binary zero (0x000), you can load these characters as NULLS into CHAR or VARCHAR columns by using the NULL AS option in the COPY command: `null as '\0'` or `null as '\000'`. If you do not use NULL AS, null terminators will cause your COPY to fail.
- If your strings contain special characters, such as delimiters and embedded newlines, use the ESCAPE option with the [COPY \(p. 317\)](#) command.
- Verify that all single and double quotes are appropriately matched.
- Verify that floating-point strings are in either standard floating-point format, such as 12.123, or an exponential format, such as 1.0E4.
- Verify that all timestamp and date strings follow the specifications for [DATEFORMAT and TIMEFORMAT Strings \(p. 354\)](#). The default timestamp format is YYYY-MM-DD hh:mm:ss, and the default date format is YYYY-MM-DD.
- For more information about boundaries and limitations on individual data types, see [Data Types \(p. 247\)](#). For information about multibyte character errors, see [Multibyte Character Load Errors \(p. 159\)](#).

Loading Data from Amazon S3

Topics

- [Splitting Your Data into Multiple Files \(p. 134\)](#)
- [Uploading Files to Amazon S3 \(p. 134\)](#)
- [Using the COPY Command to Load from Amazon S3 \(p. 137\)](#)

The COPY command leverages the Amazon Redshift massively parallel processing (MPP) architecture to read and load data in parallel from files in an Amazon S3 bucket. You can take maximum advantage of parallel processing by splitting your data into multiple files and by setting distribution keys on your tables. For more information about distribution keys, see [Choosing a Data Distribution Style \(p. 110\)](#).

Data from the files is loaded into the target table, one line per row. The fields in the data file are matched to table columns in order, left to right. Fields in the data files can be fixed-width or character delimited; the default delimiter is a pipe (|). By default, all the table columns are loaded, but you can optionally define a comma-separated list of columns. If a table column is not included in the column list specified in the COPY command, it is loaded with a default value. For more information, see [Loading Default Column Values \(p. 156\)](#).

Follow this general process to load data from Amazon S3:

1. Split your data into multiple files.
2. Upload your files to Amazon S3.
3. Run a COPY command to load the table.
4. Verify that the data was loaded correctly.

The rest of this section explains these steps in detail.

Splitting Your Data into Multiple Files

You can load table data from a single file, or you can split the data for each table into multiple files. The `COPY` command can load data from multiple files in parallel. You can load multiple files by specifying a common prefix, or *prefix key*, for the set, or by explicitly listing the files in a manifest file.

Note

We strongly recommend that you divide your data into multiple files to take advantage of parallel processing.

Split your data into files so that the number of files is a multiple of the number of slices in your cluster. That way Amazon Redshift can divide the data evenly among the slices. The number of slices per node depends on the node size of the cluster. For example, each DS1.XL compute node has two slices, and each DS1.8XL compute node has 32 slices. For more information about the number of slices that each node size has, go to [About Clusters and Nodes](#) in the *Amazon Redshift Cluster Management Guide*.

The nodes all participate in parallel query execution, working on data that is distributed as evenly as possible across the slices. If you have a cluster with two DS1.XL nodes, you might split your data into four files or some multiple of four. Amazon Redshift does not take file size into account when dividing the workload, so you need to ensure that the files are roughly the same size, between 1 MB and 1 GB after compression.

If you intend to use object prefixes to identify the load files, name each file with a common prefix. For example, the `venue.txt` file might be split into four files, as follows:

```
venue.txt.1  
venue.txt.2  
venue.txt.3  
venue.txt.4
```

If you put multiple files in a folder in your bucket, you can specify the folder name as the prefix and `COPY` will load all of the files in the folder. If you explicitly list the files to be loaded by using a manifest file, the files can reside in different buckets or folders.

Uploading Files to Amazon S3

Topics

- [Managing Data Consistency \(p. 135\)](#)
- [Uploading Encrypted Data to Amazon S3 \(p. 135\)](#)
- [Verifying That the Correct Files Are Present in Your Bucket \(p. 137\)](#)

After splitting your files, you can upload them to your bucket. You can optionally compress or encrypt the files before you load them.

Create an Amazon S3 bucket to hold your data files, and then upload the data files to the bucket. For information about creating buckets and uploading files, see [Working with Amazon S3 Buckets](#) in the *Amazon Simple Storage Service Developer Guide*.

Amazon S3 provides eventual consistency for some operations, so it is possible that new data will not be available immediately after the upload. For more information see, [Managing Data Consistency \(p. 135\)](#)

Important

The Amazon S3 bucket that holds the data files must be created in the same region as your cluster unless you use the [REGION \(p. 324\)](#) option to specify the region in which the Amazon S3 bucket is located.

You can create an Amazon S3 bucket in a specific region either by selecting the region when you create the bucket by using the Amazon S3 console, or by specifying an endpoint when you create the bucket using the Amazon S3 API or CLI.

Following the data load, verify that the correct files are present on Amazon S3.

Managing Data Consistency

Amazon S3 provides eventual consistency for some operations, so it is possible that new data will not be available immediately after the upload, which could result in an incomplete data load or loading stale data. COPY operations where the cluster and the bucket are in different regions are eventually consistent. All regions provide read-after-write consistency for uploads of new objects with unique object keys. For more information about data consistency, see [Amazon S3 Data Consistency Model](#) in the *Amazon Simple Storage Service Developer Guide*.

To ensure that your application loads the correct data, we recommend the following practices:

- Create new object keys.

Amazon S3 provides eventual consistency in all regions for overwrite operations. Creating new file names, or object keys, in Amazon S3 for each data load operation provides strong consistency in all regions.

- Use a manifest file with your COPY operation.

The manifest explicitly names the files to be loaded. Using a manifest file enforces strong consistency.

The rest of this section explains these steps in detail.

Creating New Object Keys

Because of potential data consistency issues, we strongly recommend creating new files with unique Amazon S3 object keys for each data load operation. If you overwrite existing files with new data, and then issue a COPY command immediately following the upload, it is possible for the COPY operation to begin loading from the old files before all of the new data is available. For more information about eventual consistency, see [Amazon S3 Data Consistency Model](#) in the *Amazon S3 Developer Guide*.

Using a Manifest File

You can explicitly specify which files to load by using a manifest file. When you use a manifest file, COPY enforces strong consistency by searching secondary servers if it does not find a listed file on the primary server. The manifest file can be configured with an optional `mandatory` flag. If `mandatory` is `true` and the file is not found, COPY returns an error.

For more information about using a manifest file, see the [copy_from_s3_manifest_file \(p. 323\)](#) option for the COPY command and [Using a Manifest to Specify Data Files \(p. 358\)](#) in the COPY examples.

Because Amazon S3 provides eventual consistency for overwrites in all regions, it is possible to load stale data if you overwrite existing objects with new data. As a best practice, never overwrite existing files with new data.

Uploading Encrypted Data to Amazon S3

Amazon S3 supports both server-side encryption and client-side encryption. This topic discusses the differences between the server-side and client-side encryption and describes the steps to use client-side encryption with Amazon Redshift. Server-side encryption is transparent to Amazon Redshift.

Server-Side Encryption

Server-side encryption is data encryption at rest—that is, Amazon S3 encrypts your data as it uploads it and decrypts it for you when you access it. When you load tables using a COPY command, there is

no difference in the way you load from server-side encrypted or unencrypted objects on Amazon S3. For more information about server-side encryption, see [Using Server-Side Encryption](#) in the *Amazon Simple Storage Service Developer Guide*.

Client-Side Encryption

In client-side encryption, your client application manages encryption of your data, the encryption keys, and related tools. You can upload data to an Amazon S3 bucket using client-side encryption, and then load the data using the COPY command with the ENCRYPTED option and a private encryption key to provide greater security.

You encrypt your data using envelope encryption. With *envelope encryption*, your application handles all encryption exclusively. Your private encryption keys and your unencrypted data are never sent to AWS, so it's very important that you safely manage your encryption keys. If you lose your encryption keys, you won't be able to unencrypt your data, and you can't recover your encryption keys from AWS. Envelope encryption combines the performance of fast symmetric encryption while maintaining the greater security that key management with asymmetric keys provides. A one-time-use symmetric key (the envelope symmetric key) is generated by your Amazon S3 encryption client to encrypt your data, then that key is encrypted by your master key and stored alongside your data in Amazon S3. When Amazon Redshift accesses your data during a load, the encrypted symmetric key is retrieved and decrypted with your real key, then the data is decrypted.

To work with Amazon S3 client-side encrypted data in Amazon Redshift, follow the steps outlined in [Protecting Data Using Client-Side Encryption](#) in the *Amazon Simple Storage Service Developer Guide*, with the additional requirements that you use:

- **Symmetric encryption** – The AWS SDK for Java `AmazonS3EncryptionClient` class uses envelope encryption, described preceding, which is based on symmetric key encryption. Use this class to create an Amazon S3 client to upload client-side encrypted data.
- **A 256-bit AES master symmetric key** – A master key encrypts the envelope key. You pass the master key to your instance of the `AmazonS3EncryptionClient` class. Save this key, because you will need it to copy data into Amazon Redshift.
- **Object metadata to store encrypted envelope key** – By default, Amazon S3 stores the envelope key as object metadata for the `AmazonS3EncryptionClient` class. The encrypted envelope key that is stored as object metadata is used during the decryption process.

Note

If you get a cipher encryption error message when you use the encryption API for the first time, your version of the JDK may have a Java Cryptography Extension (JCE) jurisdiction policy file that limits the maximum key length for encryption and decryption transformations to 128 bits. For information about addressing this issue, go to [Specifying Client-Side Encryption Using the AWS SDK for Java](#) in the *Amazon Simple Storage Service Developer Guide*.

For information about loading client-side encrypted files into your Amazon Redshift tables using the COPY command, see [Loading Encrypted Data Files from Amazon S3](#) (p. 141).

Example: Uploading Client-Side Encrypted Data

For an example of how to use the AWS SDK for Java to upload client-side encrypted data, go to [Example 1: Encrypt and Upload a File Using a Client-Side Symmetric Master Key](#) in the *Amazon Simple Storage Service Developer Guide*.

The example shows the choices you must make during client-side encryption so that the data can be loaded in Amazon Redshift. Specifically, the example shows using object metadata to store the encrypted envelope key and the use of a 256-bit AES master symmetric key.

This example provides example code using the AWS SDK for Java to create a 256-bit AES symmetric master key and save it to a file. Then the example upload an object to Amazon S3 using an S3

encryption client that first encrypts sample data on the client-side. The example also downloads the object and verifies that the data is the same.

Verifying That the Correct Files Are Present in Your Bucket

After you upload your files to your Amazon S3 bucket, we recommend listing the contents of the bucket to verify that all of the correct files are present and that no unwanted files are present. For example, if the bucket `mybucket` holds a file named `venue.txt.back`, that file will be loaded, perhaps unintentionally, by the following command:

```
copy venue from 's3://mybucket/venue' ... ;
```

If you want to control specifically which files are loaded, you can use a manifest file to explicitly list the data files. For more information about using a manifest file, see the [copy_from_s3_manifest_file \(p. 323\)](#) option for the COPY command and [Using a Manifest to Specify Data Files \(p. 358\)](#) in the COPY examples.

For more information about listing the contents of the bucket, see [Listing Object Keys](#) in the *Amazon S3 Developer Guide*.

Using the COPY Command to Load from Amazon S3

Topics

- [Using a Manifest to Specify Data Files \(p. 139\)](#)
- [Loading Compressed Data Files from Amazon S3 \(p. 139\)](#)
- [Loading Fixed-Width Data from Amazon S3 \(p. 139\)](#)
- [Loading Multibyte Data from Amazon S3 \(p. 140\)](#)
- [Loading Encrypted Data Files from Amazon S3 \(p. 141\)](#)

Use the [COPY \(p. 317\)](#) command to load a table in parallel from data files on Amazon S3. You can specify the files to be loaded by using an Amazon S3 object prefix or by using a manifest file.

The syntax to specify the files to be loaded by using a prefix is as follows:

```
copy <table_name> from 's3://<bucket_name>/<object_prefix>'
credentials '<aws-auth-args>';
```

The manifest file is a JSON-formatted file that lists the data files to be loaded. The syntax to specify the files to be loaded by using a manifest file is as follows:

```
copy <table_name> from 's3://<bucket_name>/<manifest_file>'
credentials '<aws-auth-args>'
manifest;
```

Note

Do not include line breaks or spaces in your `aws-auth-args` string.

The table to be loaded must already exist in the database. For information about creating a table, see [CREATE TABLE \(p. 378\)](#) in the SQL Reference.

The values for '`aws-auth-args`' are the AWS credentials needed to access the Amazon S3 objects.

You can specify either [Role-Based Access Control \(p. 348\)](#) or [Key-Based Access Control \(p. 349\)](#). In either case, the IAM role or IAM user must have the permissions required to access the specified

AWS resources. For more information, see [IAM Permissions for COPY, UNLOAD, and CREATE LIBRARY](#) (p. 351).

To specify role-based access control, provide the *aws-auth-args* string in the following format:

```
'aws_iam_role=arn:aws:iam::<aws-account-id>:role/<role-name>'
```

To specify key-based access control, provide the *aws-auth-args* in the following format:

```
'aws_access_key_id=<access-key-id>;aws_secret_access_key=<secret-access-key>'
```

To use temporary token credentials, you must provide the temporary access key ID, the temporary secret access key, and the temporary token. To load data using temporary access credentials, use the following syntax:

```
copy <table_name> from 's3://<bucket_name>/<object_prefix>'
credentials 'aws_access_key_id=<temporary-access-key-
id>;aws_secret_access_key=<temporary-secret-access-key>;token=<temporary-
token>';
```

Important

The temporary security credentials must be valid for the entire duration of the COPY statement. If the temporary security credentials expire during the load process, the COPY will fail and the transaction will be rolled back. For example, if temporary security credentials expire after 15 minutes and the COPY requires one hour, the COPY will fail before it completes.

If you want to validate your data without actually loading the table, use the NOLOAD option with the [COPY](#) (p. 317) command.

The following example shows the first few rows of a pipe-delimited data in a file named `venue.txt`.

```
1|Toyota Park|Bridgeview|IL|0
2|Columbus Crew Stadium|Columbus|OH|0
3|RFK Stadium|Washington|DC|0
```

Before uploading the file to Amazon S3, split the file into multiple files so that the COPY command can load it using parallel processing. The number of files should be a multiple of the number of slices in your cluster. Split your load data files so that the files are about equal size, between 1 MB and 1 GB after compression. For more information, see [Splitting Your Data into Multiple Files](#) (p. 134).

For example, the `venue.txt` file might be split into four files, as follows:

```
venue.txt.1
venue.txt.2
venue.txt.3
venue.txt.4
```

The following COPY command loads the VENUE table using the pipe-delimited data in the data files with the prefix 'venue' in the Amazon S3 bucket `mybucket`.

Note

The Amazon S3 bucket `mybucket` in the following examples does not exist. For sample COPY commands that use real data in an existing Amazon S3 bucket, see [Step 4: Load Sample Data](#) (p. 15).

```
copy venue from 's3://mybucket/venue'
```

```
credentials '<aws-auth-args>'
delimiter '|';
```

If no Amazon S3 objects with the key prefix 'venue' exist, the load fails.

Using a Manifest to Specify Data Files

You can use a manifest to ensure that the COPY command loads all of the required files, and only the required files, for a data load. Instead of supplying an object path for the COPY command, you supply the name of a JSON-formatted text file that explicitly lists the files to be loaded. The URL in the manifest must specify the bucket name and full object path for the file, not just a prefix. You can use a manifest to load files from different buckets or files that do not share the same prefix. The following example shows the JSON to load files from different buckets and with file names that begin with date stamps.

```
{
  "entries": [
    {"url": "s3://mybucket-alpha/2013-10-04-custdata", "mandatory": true},
    {"url": "s3://mybucket-alpha/2013-10-05-custdata", "mandatory": true},
    {"url": "s3://mybucket-beta/2013-10-04-custdata", "mandatory": true},
    {"url": "s3://mybucket-beta/2013-10-05-custdata", "mandatory": true}
  ]
}
```

The optional `mandatory` flag specifies whether COPY should return an error if the file is not found. The default of `mandatory` is `false`. Regardless of any mandatory settings, COPY will terminate if no files are found.

The following example runs the COPY command with the manifest in the previous example, which is named `cust.manifest`.

```
copy customer
from 's3://mybucket/cust.manifest'
credentials '<aws-auth-args>'
manifest;
```

For more information, see [Using a Manifest to Specify Data Files \(p. 358\)](#).

Loading Compressed Data Files from Amazon S3

To load data files that are compressed using gzip, lzop, or bzip2, include the corresponding option: GZIP, LZOP, or BZIP2.

COPY does not support files compressed using the lzop `--filter` option.

For example, the following command loads from files that were compressing using lzop.

```
copy customer from 's3://mybucket/customer.lzo'
credentials '<aws-auth-args>'
delimiter '|' lzop;
```

Loading Fixed-Width Data from Amazon S3

Fixed-width data files have uniform lengths for each column of data. Each field in a fixed-width data file has exactly the same length and position. For character data (CHAR and VARCHAR) in a fixed-width data file, you must include leading or trailing spaces as placeholders in order to keep the width uniform. For integers, you must use leading zeros as placeholders. A fixed-width data file has no delimiter to separate columns.

To load a fixed-width data file into an existing table, USE the FIXEDWIDTH parameter in the COPY command. Your table specifications must match the value of fixedwidth_spec in order for the data to load correctly.

To load fixed-width data from a file to a table, issue the following command:

```
copy table_name from 's3://mybucket/prefix'  
credentials '<aws-auth-args>'  
fixedwidth 'fixedwidth_spec';
```

The *fixedwidth_spec* parameter is a string that contains an identifier for each column and the width of each column, separated by a colon. The `column:width` pairs are delimited by commas. The identifier can be anything that you choose: numbers, letters, or a combination of the two. The identifier has no relation to the table itself, so the specification must contain the columns in the same order as the table.

The following two examples show the same specification, with the first using numeric identifiers and the second using string identifiers:

```
'0:3,1:25,2:12,3:2,4:6'
```

```
'venueid:3,venueid:25,venueid:12,venueid:2,venueid:6'
```

The following example shows fixed-width sample data that could be loaded into the VENUE table using the above specifications:

```
1 Toyota Park           Bridgeview  IL0  
2 Columbus Crew Stadium Columbus    OH0  
3 RFK Stadium           Washington  DC0  
4 CommunityAmerica Ballpark Kansas City KS0  
5 Gillette Stadium       Foxborough  MA68756
```

The following COPY command loads this data set into the VENUE table:

```
copy venue  
from 's3://mybucket/data/venue_fw.txt'  
credentials '<aws-auth-args>'  
fixedwidth 'venueid:3,venueid:25,venueid:12,venueid:2,venueid:6';
```

Loading Multibyte Data from Amazon S3

If your data includes non-ASCII multibyte characters (such as Chinese or Cyrillic characters), you must load the data to VARCHAR columns. The VARCHAR data type supports four-byte UTF-8 characters, but the CHAR data type only accepts single-byte ASCII characters. You cannot load five-byte or longer characters into Amazon Redshift tables. For more information about CHAR and VARCHAR, see [Data Types \(p. 247\)](#).

To check which encoding an input file uses, use the Linux `file` command:

```
$ file ordersdata.txt  
ordersdata.txt: ASCII English text  
$ file uni_ordersdata.dat  
uni_ordersdata.dat: UTF-8 Unicode text
```

Loading Encrypted Data Files from Amazon S3

You can use the COPY command to load data files that were uploaded to Amazon S3 using server-side encryption with AWS-managed encryption keys (SSE-S3 or SSE-KMS), client-side encryption, or both. COPY does not support Amazon S3 server-side encryption with a customer-supplied key (SSE-C). For more information, go to [Protecting Data Using Server-Side Encryption](#).

SSE encryption is transparent to Amazon Redshift. If you want to provide your own encryption key, you can use client-side encryption.

With client-side encryption, the files are encrypted using a base64 encoded AES 128-bit or AES 256-bit envelope key that you specify, and then uploaded to Amazon S3. You will need to provide that key value with your COPY command credentials when you load the encrypted files. For more information, see [Uploading Encrypted Data to Amazon S3 \(p. 135\)](#).

To load client-side encrypted data files, add the master key value to the credentials string and include the ENCRYPTED option.

```
copy customer from 's3://mybucket/encrypted/customer'  
credentials '<aws-auth-args>;master_symmetric_key=<master_key>'  
delimiter '|' encrypted;
```

To load encrypted data files that are gzip, lzop, or bzip2 compressed, include the GZIP, LZOP, or BZIP2 option along with the master key value and the ENCRYPTED option.

```
copy customer from 's3://mybucket/encrypted/customer'  
credentials '<aws-auth-args>;master_symmetric_key=<master_key>'  
delimiter '|' encrypted gzip;
```

Loading Data from Amazon EMR

You can use the COPY command to load data in parallel from an Amazon EMR cluster configured to write text files to the cluster's Hadoop Distributed File System (HDFS) in the form of fixed-width files, character-delimited files, CSV files, or JSON-formatted files.

Loading Data From Amazon EMR Process

This section walks you through the process of loading data from an Amazon EMR cluster. The following sections provide the details you need to accomplish each step.

- **Step 1: Configure IAM Permissions (p. 142)**

The users that create the Amazon EMR cluster and run the Amazon Redshift COPY command must have the necessary permissions.

- **Step 2: Create an Amazon EMR Cluster (p. 142)**

Configure the cluster to output text files to the Hadoop Distributed File System (HDFS). You will need the Amazon EMR cluster ID and the cluster's master public DNS (the endpoint for the Amazon EC2 instance that hosts the cluster).

- **Step 3: Retrieve the Amazon Redshift Cluster Public Key and Cluster Node IP Addresses (p. 143)**

The public key enables the Amazon Redshift cluster nodes to establish SSH connections to the hosts. You will use the IP address for each cluster node to configure the host security groups to permit access from your Amazon Redshift cluster using these IP addresses.

- **Step 4: Add the Amazon Redshift Cluster Public Key to Each Amazon EC2 Host's Authorized Keys File (p. 144)**

You add the Amazon Redshift cluster public key to the host's authorized keys file so that the host will recognize the Amazon Redshift cluster and accept the SSH connection.

- [Step 5: Configure the Hosts to Accept All of the Amazon Redshift Cluster's IP Addresses \(p. 145\)](#)

Modify the Amazon EMR instance's security groups to add ingress rules to accept the Amazon Redshift IP addresses.

- [Step 6: Run the COPY Command to Load the Data \(p. 145\)](#)

From an Amazon Redshift database, run the COPY command to load the data into an Amazon Redshift table.

Step 1: Configure IAM Permissions

The users that create the Amazon EMR cluster and run the Amazon Redshift COPY command must have the necessary permissions.

To configure IAM permissions

1. Add the following permissions for the IAM user that will create the Amazon EMR cluster.

```
ec2:DescribeSecurityGroups
ec2:RevokeSecurityGroupIngress
ec2:AuthorizeSecurityGroupIngress
redshift:DescribeClusters
```

2. Add the following permission for the IAM user that will execute the COPY command.

```
elasticmapreduce:ListInstances
```

3. Add the following permission to the Amazon EMR cluster's IAM role.

```
redshift:DescribeClusters
```

Step 2: Create an Amazon EMR Cluster

The COPY command loads data from files on the Amazon EMR Hadoop Distributed File System (HDFS). When you create the Amazon EMR cluster, configure the cluster to output data files to the cluster's HDFS.

To create an Amazon EMR cluster

1. Create an Amazon EMR cluster in the same AWS region as the Amazon Redshift cluster.

If the Amazon Redshift cluster is in a VPC, the Amazon EMR cluster must be in the same VPC group. If the Amazon Redshift cluster uses EC2-Classic mode (that is, it is not in a VPC), the Amazon EMR cluster must also use EC2-Classic mode. For more information, see [Managing Clusters in Virtual Private Cloud \(VPC\)](#) in the *Amazon Redshift Cluster Management Guide*.

2. Configure the cluster to output data files to the cluster's HDFS. The HDFS file names must not include asterisks (*) or question marks (?).

Important

The file names must not include asterisks (*) or question marks (?).

3. Specify **No** for the **Auto-terminate** option in the Amazon EMR cluster configuration so that the cluster remains available while the COPY command executes.

Important

If any of the data files are changed or deleted before the COPY completes, you might have unexpected results, or the COPY operation might fail.

4. Note the cluster ID and the master public DNS (the endpoint for the Amazon EC2 instance that hosts the cluster). You will use that information in later steps.

Step 3: Retrieve the Amazon Redshift Cluster Public Key and Cluster Node IP Addresses

To retrieve the Amazon Redshift cluster public key and cluster node IP addresses for your cluster using the console

1. Access the Amazon Redshift Management Console.
2. Click the **Clusters** link in the left navigation pane.
3. Select your cluster from the list.
4. Locate the **SSH Ingestion Settings** group.

Note the **Cluster Public Key** and **Node IP addresses**. You will use them in later steps.

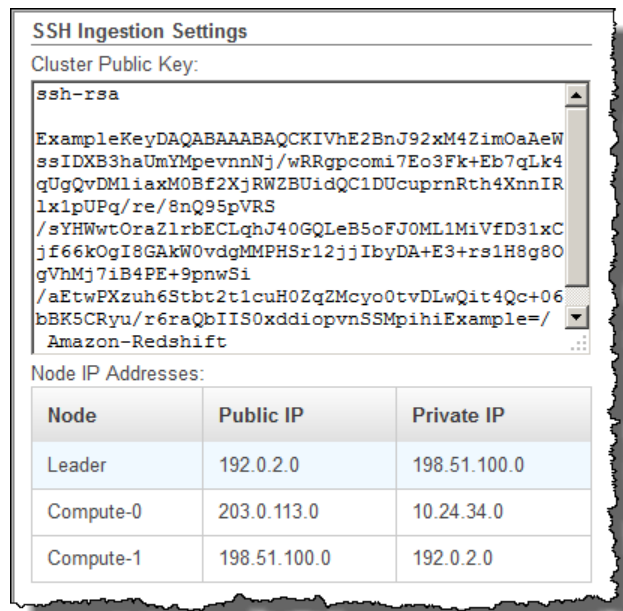

You will use the Private IP addresses in Step 3 to configure the Amazon EC2 host to accept the connection from Amazon Redshift.

To retrieve the cluster public key and cluster node IP addresses for your cluster using the Amazon Redshift CLI, execute the describe-clusters command. For example:

```
aws redshift describe-clusters --cluster-identifier <cluster-identifier>
```

The response will include a ClusterPublicKey value and the list of private and public IP addresses, similar to the following:

```
{
  "Clusters": [
    {
      "VpcSecurityGroups": [],
      "ClusterStatus": "available",
      "ClusterNodes": [
        {
          "PrivateIPAddress": "10.nnn.nnn.nnn",
          "NodeRole": "LEADER",
          "PublicIPAddress": "10.nnn.nnn.nnn"
        },
        {
          "PrivateIPAddress": "10.nnn.nnn.nnn",
          "NodeRole": "COMPUTE-0",
          "PublicIPAddress": "10.nnn.nnn.nnn"
        },
        {
          "PrivateIPAddress": "10.nnn.nnn.nnn",
          "NodeRole": "COMPUTE-1",
          "PublicIPAddress": "10.nnn.nnn.nnn"
        }
      ],
      "AutomatedSnapshotRetentionPeriod": 1,
      "PreferredMaintenanceWindow": "wed:05:30-wed:06:00",
      "AvailabilityZone": "us-east-1a",
      "NodeType": "ds1.xlarge",
      "ClusterPublicKey": "ssh-rsa AAAABexamplepublickey...Y3TAl
Amazon-Redshift",
      ...
    }
  ]
}
```

To retrieve the cluster public key and cluster node IP addresses for your cluster using the Amazon Redshift API, use the `DescribeClusters` action. For more information, see [describe-clusters](#) in the *Amazon Redshift CLI Guide* or [DescribeClusters](#) in the Amazon Redshift API Guide.

Step 4: Add the Amazon Redshift Cluster Public Key to Each Amazon EC2 Host's Authorized Keys File

You add the cluster public key to each host's authorized keys file for all of the Amazon EMR cluster nodes so that the hosts will recognize Amazon Redshift and accept the SSH connection.

To add the Amazon Redshift cluster public key to the host's authorized keys file

1. Access the host using an SSH connection.

For information about connecting to an instance using SSH, see [Connect to Your Instance](#) in the *Amazon EC2 User Guide*.

2. Copy the Amazon Redshift public key from the console or from the CLI response text.
3. Copy and paste the contents of the public key into the `/home/<ssh_username>/.ssh/authorized_keys` file on the host. Include the complete string, including the prefix `"ssh-rsa "` and suffix `"Amazon-Redshift"`. For example:

```
ssh-rsa AAAACTP3isxgGzVWoIWpbVvRCOzYdVifMrh... uA70BnMHCaMiRdmvsDOedZDOedZ
Amazon-Redshift
```

Step 5: Configure the Hosts to Accept All of the Amazon Redshift Cluster's IP Addresses

To allow inbound traffic to the host instances, edit the security group and add one Inbound rule for each Amazon Redshift cluster node. For **Type**, select SSH with TCP protocol on Port 22. For **Source**, enter the Amazon Redshift cluster node Private IP addresses you retrieved in [Step 3: Retrieve the Amazon Redshift Cluster Public Key and Cluster Node IP Addresses \(p. 143\)](#). For information about adding rules to an Amazon EC2 security group, see [Authorizing Inbound Traffic for Your Instances](#) in the *Amazon EC2 User Guide*.

Step 6: Run the COPY Command to Load the Data

Run a [COPY \(p. 317\)](#) command to connect to the Amazon EMR cluster and load the data into an Amazon Redshift table. The Amazon EMR cluster must continue running until the COPY command completes. For example, do not configure the cluster to auto-terminate.

Important

If any of the data files are changed or deleted before the COPY completes, you might have unexpected results, or the COPY operation might fail.

In the COPY command, specify the Amazon EMR cluster ID and the HDFS file path and file name.

```
copy sales
from 'emr://myemrclusterid/myoutput/part*' credentials
'aws_access_key_id=<access-key-id>;aws_secret_access_key=<secret-access-
key>';
```

You can use the wildcard characters asterisk (*) and question mark (?) as part of the file name argument. For example, `part*` loads the files `part-0000`, `part-0001`, and so on. If you specify only a folder name, COPY attempts to load all files in the folder.

Important

If you use wildcard characters or use only the folder name, verify that no unwanted files will be loaded or the COPY command will fail. For example, some processes might write a log file to the output folder.

Loading Data from Remote Hosts

You can use the COPY command to load data in parallel from one or more remote hosts, such as Amazon EC2 instances or other computers. COPY connects to the remote hosts using SSH and executes commands on the remote hosts to generate text output.

The remote host can be an Amazon EC2 Linux instance or another Unix or Linux computer configured to accept SSH connections. This guide assumes your remote host is an Amazon EC2 instance. Where the procedure is different for another computer, the guide will point out the difference.

Amazon Redshift can connect to multiple hosts, and can open multiple SSH connections to each host. Amazon Redshift sends a unique command through each connection to generate text output to the host's standard output, which Amazon Redshift then reads as it would a text file.

Before You Begin

Before you begin, you should have the following in place:

- One or more host machines, such as Amazon EC2 instances, that you can connect to using SSH.
- Data sources on the hosts.

You will provide commands that the Amazon Redshift cluster will run on the hosts to generate the text output. After the cluster connects to a host, the COPY command runs the commands, reads the text from the hosts' standard output, and loads the data in parallel into an Amazon Redshift table. The text output must be in a form that the COPY command can ingest. For more information, see [Preparing Your Input Data \(p. 132\)](#)

- Access to the hosts from your computer.

For an Amazon EC2 instance, you will use an SSH connection to access the host. You will need to access the host to add the Amazon Redshift cluster's public key to the host's authorized keys file.

- A running Amazon Redshift cluster.

For information about how to launch a cluster, see [Amazon Redshift Getting Started](#).

Loading Data Process

This section walks you through the process of loading data from remote hosts. The following sections provide the details you need to accomplish each step.

- **[Step 1: Retrieve the Cluster Public Key and Cluster Node IP Addresses \(p. 147\)](#)**

The public key enables the Amazon Redshift cluster nodes to establish SSH connections to the remote hosts. You will use the IP address for each cluster node to configure the host security groups or firewall to permit access from your Amazon Redshift cluster using these IP addresses.

- **[Step 2: Add the Amazon Redshift Cluster Public Key to the Host's Authorized Keys File \(p. 148\)](#)**

You add the Amazon Redshift cluster public key to the host's authorized keys file so that the host will recognize the Amazon Redshift cluster and accept the SSH connection.

- **[Step 3: Configure the Host to Accept All of the Amazon Redshift Cluster's IP Addresses \(p. 149\)](#)**

For Amazon EC2, modify the instance's security groups to add ingress rules to accept the Amazon Redshift IP addresses. For other hosts, modify the firewall so that your Amazon Redshift nodes are able to establish SSH connections to the remote host.

- **[Step 4: Get the Public Key for the Host \(p. 149\)](#)**

You can optionally specify that Amazon Redshift should use the public key to identify the host. You will need to locate the public key and copy the text into your manifest file.

- **[Step 5: Create a Manifest File \(p. 149\)](#)**

The manifest is a JSON-formatted text file with the details Amazon Redshift needs to connect to the hosts and fetch the data.

- **[Step 6: Upload the Manifest File to an Amazon S3 Bucket \(p. 151\)](#)**

Amazon Redshift reads the manifest and uses that information to connect to the remote host. If the Amazon S3 bucket does not reside in the same region as your Amazon Redshift cluster, you must use the [REGION \(p. 324\)](#) option to specify the region in which the data is located.

- **[Step 7: Run the COPY Command to Load the Data \(p. 151\)](#)**

From an Amazon Redshift database, run the COPY command to load the data into an Amazon Redshift table.

Step 1: Retrieve the Cluster Public Key and Cluster Node IP Addresses

To retrieve the cluster public key and cluster node IP addresses for your cluster using the console

1. Access the Amazon Redshift Management Console.
2. Click the **Clusters** link in the left navigation pane.
3. Select your cluster from the list.
4. Locate the **Copy from SSH Setting** group.

Note the **Cluster Public Key** and **Node IP addresses**. You will use them in later steps.

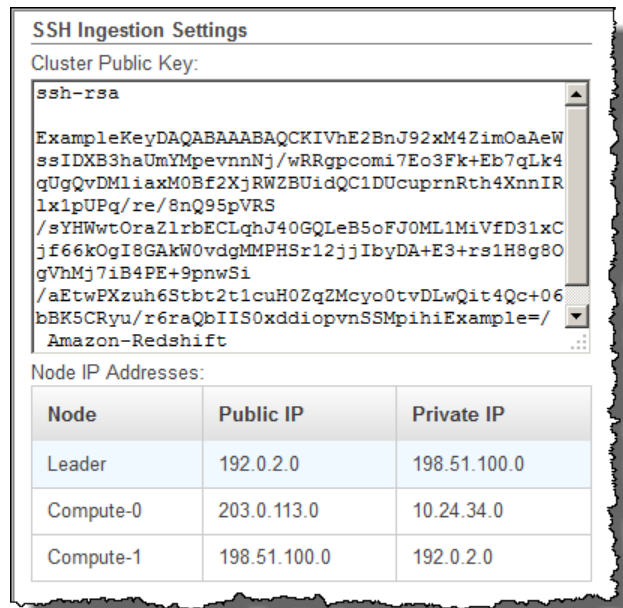

You will use the IP addresses in Step 3 to configure the host to accept the connection from Amazon Redshift. Depending on what type of host you connect to and whether it is in a VPC, you will use either the public IP addresses or the private IP addresses.

To retrieve the cluster public key and cluster node IP addresses for your cluster using the Amazon Redshift CLI, execute the describe-clusters command.

For example:

```
aws redshift describe-clusters --cluster-identifier <cluster-identifier>
```

The response will include the ClusterPublicKey and the list of Private and Public IP addresses, similar to the following:

```
{
  "Clusters": [
    {
      "VpcSecurityGroups": [],
      "ClusterStatus": "available",
```

```
    "ClusterNodes": [
      {
        "PrivateIPAddress": "10.nnn.nnn.nnn",
        "NodeRole": "LEADER",
        "PublicIPAddress": "10.nnn.nnn.nnn"
      },
      {
        "PrivateIPAddress": "10.nnn.nnn.nnn",
        "NodeRole": "COMPUTE-0",
        "PublicIPAddress": "10.nnn.nnn.nnn"
      },
      {
        "PrivateIPAddress": "10.nnn.nnn.nnn",
        "NodeRole": "COMPUTE-1",
        "PublicIPAddress": "10.nnn.nnn.nnn"
      }
    ],
    "AutomatedSnapshotRetentionPeriod": 1,
    "PreferredMaintenanceWindow": "wed:05:30-wed:06:00",
    "AvailabilityZone": "us-east-1a",
    "NodeType": "ds1.xlarge",
    "ClusterPublicKey": "ssh-rsa AAAABexamplepublickey...Y3TAl
Amazon-Redshift",
    ...
  }
```

To retrieve the cluster public key and cluster node IP addresses for your cluster using the Amazon Redshift API, use the `DescribeClusters` action. For more information, see [describe-clusters](#) in the *Amazon Redshift CLI Guide* or [DescribeClusters](#) in the Amazon Redshift API Guide.

Step 2: Add the Amazon Redshift Cluster Public Key to the Host's Authorized Keys File

You add the cluster public key to each host's authorized keys file so that the host will recognize Amazon Redshift and accept the SSH connection.

To add the Amazon Redshift cluster public key to the host's authorized keys file

1. Access the host using an SSH connection.

You will add the user name you log in with to the "username" field in the manifest file you create in Step 5. For information about connecting to an instance using SSH, see [Connect to Your Instance](#) in the *Amazon EC2 User Guide*.

2. Copy the Amazon Redshift public key from the console or from the CLI response text.
3. Copy and paste the contents of the public key into the `/home/<ssh_username>/.ssh/authorized_keys` file on the remote host. The `<ssh_username>` must match the value for the "username" field in the manifest file. Include the complete string, including the prefix "ssh-rsa" and suffix "Amazon-Redshift". For example:

```
ssh-rsa AAAACTP3isxgGzVWoIWpbVvRCOzYdVifMrh... uA70BnMHCaMiRdmvsDOedZDOedZ
Amazon-Redshift
```

Step 3: Configure the Host to Accept All of the Amazon Redshift Cluster's IP Addresses

If you are working with an Amazon EC2 instance or an Amazon EMR cluster, add Inbound rules to the host's security group to allow traffic from each Amazon Redshift cluster node. For **Type**, select SSH with TCP protocol on Port 22. For **Source**, enter the Amazon Redshift cluster node IP addresses you retrieved in [Step 1: Retrieve the Cluster Public Key and Cluster Node IP Addresses \(p. 147\)](#). For information about adding rules to an Amazon EC2 security group, see [Authorizing Inbound Traffic for Your Instances](#) in the *Amazon EC2 User Guide*.

Use the Private IP addresses when:

- You have an Amazon Redshift cluster that is not in a Virtual Private Cloud (VPC), and an Amazon EC2 -Classic instance, both of which are in the same AWS region.
- You have an Amazon Redshift cluster that is in a VPC, and an Amazon EC2 -VPC instance, both of which are in the same AWS region and in the same VPC.

Otherwise, use the Public IP addresses.

For more information about using Amazon Redshift in a VPC, see [Managing Clusters in Virtual Private Cloud \(VPC\)](#) in the *Amazon Redshift Cluster Management Guide*.

Step 4: Get the Public Key for the Host

You can optionally provide the host's public key in the manifest file so that Amazon Redshift can identify the host. The COPY command does not require the host public key but, for security reasons, we strongly recommend using a public key to help prevent 'man-in-the-middle' attacks.

You can find the host's public key in the following location, where `<ssh_host_rsa_key_name>` is the unique name for the host's public key:

```
: /etc/ssh/<ssh_host_rsa_key_name>.pub
```

Note

Amazon Redshift only supports RSA keys. We do not support DSA keys.

When you create your manifest file in Step 5, you will paste the text of the public key into the "Public Key" field in the manifest file entry.

Step 5: Create a Manifest File

The COPY command can connect to multiple hosts using SSH, and can create multiple SSH connections to each host. COPY executes a command through each host connection, and then loads the output from the commands in parallel into the table. The manifest file is a text file in JSON format that Amazon Redshift uses to connect to the host. The manifest file specifies the SSH host endpoints and the commands that will be executed on the hosts to return data to Amazon Redshift. Optionally, you can include the host public key, the login user name, and a mandatory flag for each entry.

The manifest file is in the following format:

```
{
  "entries": [
    {
      "endpoint": "<ssh_endpoint_or_IP>",
      "command": "<remote_command>",

```

```
    "mandatory":true,  
    "publickey": "<public_key>",  
    "username": "<host_user_name>",  
  {"endpoint": "<ssh_endpoint_or_IP>",  
   "command": "<remote_command>",  
   "mandatory":true,  
   "publickey": "<public_key>",  
   "username": "host_user_name"}  
  ]  
}
```

The manifest file contains one "entries" construct for each SSH connection. Each entry represents a single SSH connection. You can have multiple connections to a single host or multiple connections to multiple hosts. The double quotes are required as shown, both for the field names and the values. The only value that does not need double quotes is the Boolean value `true` or `false` for the mandatory field.

The following table describes the fields in the manifest file.

endpoint

The URL address or IP address of the host. For example, "ec2-111-222-333.compute-1.amazonaws.com" or "22.33.44.56"

command

The command that will be executed by the host to generate text or binary (gzip, lzip, or bzip2) output. The command can be any command that the user "host_user_name" has permission to run. The command can be as simple as printing a file, or it could query a database or launch a script. The output (text file, gzip binary file, lzip binary file, or bzip2 binary file) must be in a form the Amazon Redshift COPY command can ingest. For more information, see [Preparing Your Input Data](#) (p. 132).

publickey

(Optional) The public key of the host. If provided, Amazon Redshift will use the public key to identify the host. If the public key is not provided, Amazon Redshift will not attempt host identification. For example, if the remote host's public key is: `ssh-rsa AbcCbaxxx...xxxDHKJ root@amazon.com` enter the following text in the publickey field: `AbcCbaxxx...xxxDHKJ`.

mandatory

(Optional) Indicates whether the COPY command should fail if the connection fails. The default is `false`. If Amazon Redshift does not successfully make at least one connection, the COPY command fails.

username

(Optional) The username that will be used to log in to the host system and execute the remote command. The user login name must be the same as the login that was used to add the public key to the host's authorized keys file in Step 2. The default username is "redshift".

The following example shows a completed manifest to open four connections to the same host and execute a different command through each connection:

```
{  
  "entries": [  
    {"endpoint": "ec2-184-72-204-112.compute-1.amazonaws.com",  
     "command": "cat loaddata1.txt",  
     "mandatory":true,  
     "publickey": "ec2publickeyportionoftheec2keypair",  
     "username": "ec2-user"},  
    {"endpoint": "ec2-184-72-204-112.compute-1.amazonaws.com",  
     "command": "cat loaddata2.txt",  
     "mandatory":true,  
     "publickey": "ec2publickeyportionoftheec2keypair",  
     "username": "ec2-user"}  
  ]  
}
```

```
    "publickey": "ec2publickeyportionoftheec2keypair",  
    "username": "ec2-user"},  
  {"endpoint": "ec2-184-72-204-112.compute-1.amazonaws.com",  
   "command": "cat loaddata3.txt",  
   "mandatory": true,  
   "publickey": "ec2publickeyportionoftheec2keypair",  
   "username": "ec2-user"},  
  {"endpoint": "ec2-184-72-204-112.compute-1.amazonaws.com",  
   "command": "cat loaddata4.txt",  
   "mandatory": true,  
   "publickey": "ec2publickeyportionoftheec2keypair",  
   "username": "ec2-user"}  
  ]  
}
```

Step 6: Upload the Manifest File to an Amazon S3 Bucket

Upload the manifest file to an Amazon S3 bucket. If the Amazon S3 bucket does not reside in the same region as your Amazon Redshift cluster, you must use the [REGION \(p. 324\)](#) option to specify the region in which the manifest is located. For information about creating an Amazon S3 bucket and uploading a file, see [Amazon Simple Storage Service Getting Started Guide](#).

Step 7: Run the COPY Command to Load the Data

Run a [COPY \(p. 317\)](#) command to connect to the host and load the data into an Amazon Redshift table. In the COPY command, specify the explicit Amazon S3 object path for the manifest file and include the SSH option. For example,

```
copy sales  
from 's3://mybucket/ssh_manifest' credentials  
'aws_access_key_id=<access-key-id>;aws_secret_access_key=<secret-access-key>'   
delimiter '|'   
ssh;
```

Note

If you use automatic compression, the COPY command performs two data reads, which means it will execute the remote command twice. The first read is to provide a sample for compression analysis, then the second read actually loads the data. If executing the remote command twice might cause a problem because of potential side effects, you should disable automatic compression. To disable automatic compression, run the COPY command with the COMPUPDATE option set to OFF. For more information, see [Loading Tables with Automatic Compression \(p. 154\)](#).

Loading Data from an Amazon DynamoDB Table

You can use the COPY command to load a table with data from a single Amazon DynamoDB table.

Important

The Amazon DynamoDB table that provides the data must be created in the same region as your cluster unless you use the [REGION \(p. 324\)](#) option to specify the region in which the Amazon DynamoDB table is located.

The COPY command leverages the Amazon Redshift massively parallel processing (MPP) architecture to read and load data in parallel from an Amazon DynamoDB table. You can take maximum advantage of parallel processing by setting distribution styles on your Amazon Redshift tables. For more information, see [Choosing a Data Distribution Style \(p. 110\)](#).

Important

When the COPY command reads data from the Amazon DynamoDB table, the resulting data transfer is part of that table's provisioned throughput.

To avoid consuming excessive amounts of provisioned read throughput, we recommend that you not load data from Amazon DynamoDB tables that are in production environments. If you do load data from production tables, we recommend that you set the READRATIO option much lower than the average percentage of unused provisioned throughput. A low READRATIO setting will help minimize throttling issues. To use the entire provisioned throughput of an Amazon DynamoDB table, set READRATIO to 100.

The COPY command matches attribute names in the items retrieved from the DynamoDB table to column names in an existing Amazon Redshift table by using the following rules:

- Amazon Redshift table columns are case-insensitively matched to Amazon DynamoDB item attributes. If an item in the DynamoDB table contains multiple attributes that differ only in case, such as Price and PRICE, the COPY command will fail.
- Amazon Redshift table columns that do not match an attribute in the Amazon DynamoDB table are loaded as either NULL or empty, depending on the value specified with the EMPTYASNULL option in the [COPY \(p. 317\)](#) command.
- Amazon DynamoDB attributes that do not match a column in the Amazon Redshift table are discarded. Attributes are read before they are matched, and so even discarded attributes consume part of that table's provisioned throughput.
- Only Amazon DynamoDB attributes with scalar STRING and NUMBER data types are supported. The Amazon DynamoDB BINARY and SET data types are not supported. If a COPY command tries to load an attribute with an unsupported data type, the command will fail. If the attribute does not match an Amazon Redshift table column, COPY does not attempt to load it, and it does not raise an error.

The COPY command uses the following syntax to load data from an Amazon DynamoDB table:

```
copy <redshift_tablename> from 'dynamodb://<dynamodb_table_name>'
credentials '<aws-auth-args>'
readratio '<integer>';
```

The values for *<your-access-key-id>* and *<your-secret-access-key>* are the AWS credentials needed to access the Amazon DynamoDB table. If these credentials correspond to an IAM user, that IAM user must have permission to SCAN and DESCRIBE the Amazon DynamoDB table that is being loaded.

You can limit the access users have to your data by using temporary security credentials. Temporary security credentials provide enhanced security because they have short life spans and cannot be reused after they expire. A user who has these temporary security credentials can access your resources only until the credentials expire. For more information, see [Temporary Security Credentials \(p. 350\)](#). To load data using temporary access credentials, use the following syntax:

```
copy <redshift_tablename> from 'dynamodb://<dynamodb_table_name>'
credentials 'aws_access_key_id=<temporary-access-key-
id>;aws_secret_access_key=<temporary-secret-access-key>;token=<temporary-
token>';
```

Important

The temporary security credentials must be valid for the entire duration of the COPY statement. If the temporary security credentials expire during the load process, the COPY will fail and the transaction will be rolled back. For example, if temporary security credentials expire after 15 minutes and the COPY requires one hour, the COPY will fail before it completes.

If you want to validate your data without actually loading the table, use the NOLOAD option with the COPY (p. 317) command.

The following example loads the FAVORITEMOVIES table with data from the DynamoDB table my-favorite-movies-table. The read activity can consume up to 50% of the provisioned throughput.

```
copy favoritemovies from 'dynamodb://my-favorite-movies-table'  
credentials '<aws-auth-args>'  
readratio 50;
```

To maximize throughput, the COPY command loads data from an Amazon DynamoDB table in parallel across the compute nodes in the cluster.

Provisioned Throughput with Automatic Compression

By default, the COPY command applies automatic compression whenever you specify an empty target table with no compression encoding. The automatic compression analysis initially samples a large number of rows from the Amazon DynamoDB table. The sample size is based on the value of the COMPROWS parameter. The default is 100,000 rows per slice.

After sampling, the sample rows are discarded and the entire table is loaded. As a result, many rows are read twice. For more information about how automatic compression works, see [Loading Tables with Automatic Compression \(p. 154\)](#).

Important

When the COPY command reads data from the Amazon DynamoDB table, including the rows used for sampling, the resulting data transfer is part of that table's provisioned throughput.

Loading Multibyte Data from Amazon DynamoDB

If your data includes non-ASCII multibyte characters (such as Chinese or Cyrillic characters), you must load the data to VARCHAR columns. The VARCHAR data type supports four-byte UTF-8 characters, but the CHAR data type only accepts single-byte ASCII characters. You cannot load five-byte or longer characters into Amazon Redshift tables. For more information about CHAR and VARCHAR, see [Data Types \(p. 247\)](#).

Verifying That the Data Was Loaded Correctly

After the load operation is complete, query the STL_LOAD_COMMITS (p. 711) system table to verify that the expected files were loaded. You should execute the COPY command and load verification within the same transaction so that if there is problem with the load you can roll back the entire transaction.

The following query returns entries for loading the tables in the TICKIT database:

```
select query, trim(filename) as filename, curtime, status  
from stl_load_commits  
where filename like '%ticket%' order by query;
```

query	btrim	curtime	status
22475	ticket/allusers_pipe.txt	2013-02-08 20:58:23.274186	1
22478	ticket/venue_pipe.txt	2013-02-08 20:58:25.070604	1
22480	ticket/category_pipe.txt	2013-02-08 20:58:27.333472	1
22482	ticket/date2008_pipe.txt	2013-02-08 20:58:28.608305	1
22485	ticket/allevnts_pipe.txt	2013-02-08 20:58:29.99489	1
22487	ticket/listings_pipe.txt	2013-02-08 20:58:37.632939	1
22489	ticket/sales_tab.txt	2013-02-08 20:58:37.632939	1

(6 rows)

Validating Input Data

To validate the data in the Amazon S3 input files or Amazon DynamoDB table before you actually load the data, use the NOLOAD option with the [COPY \(p. 317\)](#) command. Use NOLOAD with the same COPY commands and options you would use to actually load the data. NOLOAD checks the integrity of all of the data without loading it into the database. The NOLOAD option displays any errors that would occur if you had attempted to load the data.

For example, if you specified the incorrect Amazon S3 path for the input file, Amazon Redshift would display the following error:

```
ERROR: No such file or directory
DETAIL:
-----
Amazon Redshift error: The specified key does not exist
code:                2
context:             S3 key being read :
location:            step_scan.cpp:1883
process:             xenmaster [pid=22199]
-----
```

To troubleshoot error messages, see the [Load Error Reference \(p. 160\)](#).

Loading Tables with Automatic Compression

Topics

- [How Automatic Compression Works \(p. 154\)](#)
- [Automatic Compression Example \(p. 155\)](#)

You can apply compression encodings to columns in tables manually, based on your own evaluation of the data, or you can use the COPY command to analyze and apply compression automatically. We strongly recommend using the COPY command to apply automatic compression.

You can use automatic compression when you create and load a brand new table. The COPY command will perform a compression analysis. You can also perform a compression analysis without loading data or changing the compression on a table by running the [ANALYZE COMPRESSION \(p. 310\)](#) command against an already populated table. For example, you can run the ANALYZE COMPRESSION command when you want to analyze compression on a table for future use, while preserving the existing DDL.

Automatic compression balances overall performance when choosing compression encodings. Range-restricted scans might perform poorly if sort key columns are compressed much more highly than other columns in the same query. As a result, automatic compression will choose a less efficient compression encoding to keep the sort key columns balanced with other columns. However, ANALYZE COMPRESSION does not take sort keys into account, so it might recommend a different encoding for the sort key than what automatic compression would choose. If you use ANALYZE COMPRESSION, consider changing the encoding to RAW for sort keys.

How Automatic Compression Works

By default, the COPY command applies automatic compression whenever you run the COPY command with an empty target table and all of the table columns either have RAW encoding or no encoding.

To apply automatic compression to an empty table, regardless of its current compression encodings, run the COPY command with the COMPUPDATE option set to ON. To disable automatic compression, run the COPY command with the COMPUPDATE option set to OFF.

You cannot apply automatic compression to a table that already contains data.

Note

Automatic compression analysis requires enough rows in the load data (at least 100,000 rows per slice) to generate a meaningful sample.

Automatic compression performs these operations in the background as part of the load transaction:

1. An initial sample of rows is loaded from the input file. Sample size is based on the value of the COMPROWS parameter. The default is 100,000.
2. Compression options are chosen for each column.
3. The sample rows are removed from the table.
4. The table is recreated with the chosen compression encodings.
5. The entire input file is loaded and compressed using the new encodings.

After you run the COPY command, the table is fully loaded, compressed, and ready for use. If you load more data later, appended rows are compressed according to the existing encoding.

If you only want to perform a compression analysis, run ANALYZE COMPRESSION, which is more efficient than running a full COPY. Then you can evaluate the results to decide whether to use automatic compression or recreate the table manually.

Automatic compression is supported only for the COPY command. Alternatively, you can manually apply compression encoding when you create the table. For information about manual compression encoding, see [Choosing a Column Compression Type \(p. 100\)](#).

Automatic Compression Example

In this example, assume that the TICKIT database contains a copy of the LISTING table called BIGLIST, and you want to apply automatic compression to this table when it is loaded with approximately 3 million rows.

To load and automatically compress the table

1. Ensure that the table is empty. You can apply automatic compression only to an empty table:

```
truncate biglist;
```

2. Load the table with a single COPY command. Although the table is empty, some earlier encoding might have been specified. To ensure that Amazon Redshift performs a compression analysis, set the COMPUPDATE parameter to ON.

```
copy biglist from 's3://mybucket/biglist.txt'  
credentials '<aws-auth-args>'  
delimiter '|' COMPUPDATE ON;
```

Because no COMPROWS option is specified, the default and recommended sample size of 100,000 rows per slice is used.

3. Look at the new schema for the BIGLIST table in order to review the automatically chosen encoding schemes.

```
select "column", type, encoding
```



```
from pg_table_def where tablename = 'biglist';
```

Column	Type	Encoding
listid	integer	delta
sellerid	integer	delta32k
eventid	integer	delta32k
dateid	smallint	delta
+numtickets	smallint	delta
priceperticket	numeric(8,2)	delta32k
totalprice	numeric(8,2)	mostly32
listtime	timestamp without time zone	none

4. Verify that the expected number of rows were loaded:

```
select count(*) from biglist;
```

```
count  
-----  
3079952  
(1 row)
```

When rows are later appended to this table using COPY or INSERT statements, the same compression encodings will be applied.

Optimizing Storage for Narrow Tables

If you have a table with very few columns but a very large number of rows, the three hidden metadata identity columns (INSERT_XID, DELETE_XID, ROW_ID) will consume a disproportionate amount of the disk space for the table.

In order to optimize compression of the hidden columns, load the table in a single COPY transaction where possible. If you load the table with multiple separate COPY commands, the INSERT_XID column will not compress well. You will need to perform a vacuum operation if you use multiple COPY commands, but it will not improve compression of INSERT_XID.

Loading Default Column Values

You can optionally define a column list in your COPY command. If a column in the table is omitted from the column list, COPY will load the column with either the value supplied by the DEFAULT option that was specified in the CREATE TABLE command, or with NULL if the DEFAULT option was not specified.

If COPY attempts to assign NULL to a column that is defined as NOT NULL, the COPY command fails. For information about assigning the DEFAULT option, see [CREATE TABLE \(p. 378\)](#).

When loading from data files on Amazon S3, the columns in the column list must be in the same order as the fields in the data file. If a field in the data file does not have a corresponding column in the column list, the COPY command fails.

When loading from Amazon DynamoDB table, order does not matter. Any fields in the Amazon DynamoDB attributes that do not match a column in the Amazon Redshift table are discarded.

The following restrictions apply when using the COPY command to load DEFAULT values into a table:

- If an [IDENTITY \(p. 381\)](#) column is included in the column list, the EXPLICIT_IDS option must also be specified in the [COPY \(p. 317\)](#) command, or the COPY command will fail. Similarly, if an

IDENTITY column is omitted from the column list, and the EXPLICIT_IDS option is specified, the COPY operation will fail.

- Because the evaluated DEFAULT expression for a given column is the same for all loaded rows, a DEFAULT expression that uses a RANDOM() function will assign the same value to all the rows.
- DEFAULT expressions that contain CURRENT_DATE or SYSDATE are set to the timestamp of the current transaction.

For an example, see "Load data from a file with default values" in [COPY Examples \(p. 356\)](#).

Troubleshooting Data Loads

Topics

- [S3ServiceException Errors \(p. 157\)](#)
- [System Tables for Troubleshooting Data Loads \(p. 158\)](#)
- [Multibyte Character Load Errors \(p. 159\)](#)
- [Load Error Reference \(p. 160\)](#)

This section provides information about identifying and resolving data loading errors.

S3ServiceException Errors

The most common s3ServiceException errors are caused by an improperly formatted or incorrect credentials string, having your cluster and your bucket in different regions, and insufficient Amazon S3 privileges.

The section provides troubleshooting information for each type of error.

Invalid Credentials String

If your credentials string was improperly formatted, you will receive the following error message:

```
ERROR: Invalid credentials. Must be of the format: credentials
'aws_access_key_id=<access-key-id>;aws_secret_access_key=<secret-access-key>
[;token=<temporary-session-token>]'
```

Verify that the credentials string does not contain any spaces or line breaks, and is enclosed in single quotes.

Invalid Access Key ID

If your access key id does not exist, you will receive the following error message:

```
[Amazon](500310) Invalid operation: S3ServiceException:The AWS Access Key Id
you provided does not exist in our records.
```

This is often a copy and paste error. Verify that the access key ID was entered correctly.

Invalid Secret Access Key

If your secret access key is incorrect, you will receive the following error message:

```
[Amazon](500310) Invalid operation: S3ServiceException:The request signature
we calculated does not match the signature you provided.
```

```
Check your key and signing method.,Status 403,Error SignatureDoesNotMatch
```

This is often a copy and paste error. Verify that the secret access key was entered correctly and that it is the correct key for the access key ID.

Bucket is in a Different Region

The Amazon S3 bucket specified in the COPY command must be in the same region as the cluster. If your Amazon S3 bucket and your cluster are in different regions, you will receive an error similar to the following:

```
ERROR: S3ServiceException:The bucket you are attempting to access must be addressed using the specified endpoint.
```

You can create an Amazon S3 bucket in a specific region either by selecting the region when you create the bucket by using the Amazon S3 Management Console, or by specifying an endpoint when you create the bucket using the Amazon S3 API or CLI. For more information, see [Uploading Files to Amazon S3 \(p. 134\)](#).

For more information about Amazon S3 regions, see [Accessing a Bucket](#) in the *Amazon Simple Storage Service Developer Guide*.

Alternatively, you can specify the region using the [REGION \(p. 324\)](#) option with the COPY command.

Access Denied

The user account identified by the credentials must have LIST and GET access to the Amazon S3 bucket. If the user does not have sufficient privileges, you will receive the following error message:

```
ERROR: S3ServiceException:Access Denied,Status 403,Error AccessDenied
```

For information about managing user access to buckets, see [Access Control](#) in the *Amazon S3 Developer Guide*.

System Tables for Troubleshooting Data Loads

The following Amazon Redshift system tables can be helpful in troubleshooting data load issues:

- Query [STL_LOAD_ERRORS \(p. 713\)](#) to discover the errors that occurred during specific loads.
- Query [STL_FILE_SCAN \(p. 704\)](#) to view load times for specific files or to see if a specific file was even read.

To find and diagnose load errors

1. Create a view or define a query that returns details about load errors. The following example joins the STL_LOAD_ERRORS table to the STV_TBL_PERM table to match table IDs with actual table names.

```
create view loadview as
(select distinct tbl, trim(name) as table_name, query, starttime,
trim(filename) as input, line_number, colname, err_code,
trim(err_reason) as reason
from stl_load_errors sl, stv_tbl_perm sp
where sl.tbl = sp.id);
```

2. Set the MAXERRORS option in your COPY command to a large enough value to enable COPY to return useful information about your data. If the COPY encounters errors, an error message directs you to consult the STL_LOAD_ERRORS table for details.
3. Query the LOADVIEW view to see error details. For example:

```
select * from loadview where table_name='venue';
```

```
tbl | table_name | query | starttime
-----+-----+-----+-----
100551 | venue | 20974 | 2013-01-29 19:05:58.365391

| input | line_number | colname | err_code | reason
-----+-----+-----+-----+-----
| venue_pipe.txt | 1 | 0 | 1214 | Delimiter not found
```

4. Fix the problem in the input file or the load script, based on the information that the view returns. Some typical load errors to watch for include:
 - Mismatch between data types in table and values in input data fields.
 - Mismatch between number of columns in table and number of fields in input data.
 - Mismatched quotes. Amazon Redshift supports both single and double quotes; however, these quotes must be balanced appropriately.
 - Incorrect format for date/time data in input files.
 - Out-of-range values in input files (for numeric columns).
 - Number of distinct values for a column exceeds the limitation for its compression encoding.

Multibyte Character Load Errors

Columns with a CHAR data type only accept single-byte UTF-8 characters, up to byte value 127, or 7F hex, which is also the ASCII character set. VARCHAR columns accept multibyte UTF-8 characters, to a maximum of four bytes. For more information, see [Character Types \(p. 256\)](#).

If a line in your load data contains a character that is invalid for the column data type, COPY returns an error and logs a row in the STL_LOAD_ERRORS system log table with error number 1220. The ERR_REASON field includes the byte sequence, in hex, for the invalid character.

An alternative to fixing invalid characters in your load data is to replace the invalid characters during the load process. To replace invalid UTF-8 characters, specify the ACCEPTINVCHARS option with the COPY command. For more information, see [ACCEPTINVCHARS \(p. \)](#).

The following example shows the error reason when COPY attempts to load UTF-8 character e0 a1 c7a4 into a CHAR column:

```
Multibyte character not supported for CHAR
(Hint: Try using VARCHAR). Invalid char: e0 a1 c7a4
```

If the error is related to a VARCHAR datatype, the error reason includes an error code as well as the invalid UTF-8 hex sequence. The following example shows the error reason when COPY attempts to load UTF-8 a4 into a VARCHAR field:

```
String contains invalid or unsupported UTF-8 codepoints.
Bad UTF-8 hex sequence: a4 (error 3)
```

The following table lists the descriptions and suggested workarounds for VARCHAR load errors. If one of these errors occurs, replace the character with a valid UTF-8 code sequence or remove the character.

Error code	Description
1	The UTF-8 byte sequence exceeds the four-byte maximum supported by VARCHAR.
2	The UTF-8 byte sequence is incomplete. COPY did not find the expected number of continuation bytes for a multibyte character before the end of the string.
3	The UTF-8 single-byte character is out of range. The starting byte must not be 254, 255 or any character between 128 and 191 (inclusive).
4	The value of the trailing byte in the byte sequence is out of range. The continuation byte must be between 128 and 191 (inclusive).
5	The UTF-8 character is reserved as a surrogate. Surrogate code points (U+D800 through U+DFFF) are invalid.
6	The character is not a valid UTF-8 character (code points 0xFDD0 to 0xFDEF).
7	The character is not a valid UTF-8 character (code points 0xFFFE and 0xFFFF).
8	The byte sequence exceeds the maximum UTF-8 code point.
9	The UTF-8 byte sequence does not have a matching code point.

Load Error Reference

If any errors occur while loading data from a file, query the [STL_LOAD_ERRORS \(p. 713\)](#) table to identify the error and determine the possible explanation. The following table lists all error codes that might occur during data loads:

Load Error Codes

Error code	Description
1200	Unknown parse error. Contact support.
1201	Field delimiter was not found in the input file.
1202	Input data had more columns than were defined in the DDL.
1203	Input data had fewer columns than were defined in the DDL.
1204	Input data exceeded the acceptable range for the data type.
1205	Date format is invalid. See DATEFORMAT and TIMEFORMAT Strings (p. 354) for valid formats.
1206	Timestamp format is invalid. See DATEFORMAT and TIMEFORMAT Strings (p. 354) for valid formats.
1207	Data contained a value outside of the expected range of 0-9.
1208	FLOAT data type format error.
1209	DECIMAL data type format error.
1210	BOOLEAN data type format error.

Error code	Description
1211	Input line contained no data.
1212	Load file was not found.
1213	A field specified as NOT NULL contained no data.
1214	Delimiter not found.
1215	CHAR field error.
1216	Invalid input line.
1217	Invalid identity column value.
1218	When using NULL AS '\0', a field containing a null terminator (NUL, or UTF-8 0000) contained more than one byte.
1219	UTF-8 hexadecimal contains an invalid digit.
1220	String contains invalid or unsupported UTF-8 codepoints.
1221	Encoding of the file is not the same as that specified in the COPY command.

Updating Tables with DML Commands

Amazon Redshift supports standard Data Manipulation Language (DML) commands (INSERT, UPDATE, and DELETE) that you can use to modify rows in tables. You can also use the TRUNCATE command to do fast bulk deletes.

Note

We strongly encourage you to use the [COPY \(p. 317\)](#) command to load large amounts of data. Using individual INSERT statements to populate a table might be prohibitively slow. Alternatively, if your data already exists in other Amazon Redshift database tables, use SELECT INTO ... INSERT or CREATE TABLE AS to improve performance. For information, see [INSERT \(p. 424\)](#) or [CREATE TABLE AS \(p. 389\)](#).

If you insert, update, or delete a significant number of rows in a table, relative to the number of rows before the changes, run the ANALYZE and VACUUM commands against the table when you are done. If a number of small changes accumulate over time in your application, you might want to schedule the ANALYZE and VACUUM commands to run at regular intervals. For more information, see [Analyzing Tables \(p. 169\)](#) and [Vacuuming Tables \(p. 172\)](#).

Updating and Inserting New Data

You can efficiently add new data to an existing table by using a combination of updates and inserts from a staging table. While Amazon Redshift does not support a single *merge*, or *upsert*, command to update a table from a single data source, you can perform a merge operation by creating a staging table and then using one of the methods described in this section to update the target table from the staging table.

Topics

- [Merge Method 1: Replacing Existing Rows \(p. 162\)](#)
- [Merge Method 2: Specifying a Column List \(p. 162\)](#)
- [Creating a Temporary Staging Table \(p. 162\)](#)

- [Performing a Merge Operation by Replacing Existing Rows \(p. 163\)](#)
- [Performing a Merge Operation by Specifying a Column List \(p. 163\)](#)
- [Merge Examples \(p. 165\)](#)

Note

You should run the entire merge operation, except for creating and dropping the temporary staging table, in a single transaction so that the transaction will roll back if any step fails. Using a single transaction also reduces the number of commits, which saves time and resources.

Merge Method 1: Replacing Existing Rows

If you are overwriting all of the columns in the target table, the fastest method for performing a merge is by replacing the existing rows because it scans the target table only once, by using an inner join to delete rows that will be updated. After the rows are deleted, they are replaced along with new rows by a single insert operation from the staging table.

Use this method if all of the following are true:

- Your target table and your staging table contain the same columns.
- You intend to replace all of the data in the target table columns with all of the staging table columns.
- You will use all of the rows in the staging table in the merge.

If any of these criteria do not apply, use Merge Method 2: Specifying a column list, described in the following section.

If you will not use all of the rows in the staging table, you can filter the DELETE and INSERT statements by using a WHERE clause to leave out rows that are not actually changing. However, if most of the rows in the staging table will not participate in the merge, we recommend performing an UPDATE and an INSERT in separate steps, as described later in this section.

Merge Method 2: Specifying a Column List

Use this method to update specific columns in the target table instead of overwriting entire rows. This method takes longer than the previous method because it requires an extra update step. Use this method if any of the following are true:

- Not all of the columns in the target table are to be updated.
- Most rows in the staging table will not be used in the updates.

Creating a Temporary Staging Table

The *staging table* is a temporary table that holds all of the data that will be used to make changes to the *target table*, including both updates and inserts.

A merge operation requires a join between the staging table and the target table. To collocate the joining rows, set the staging table's distribution key to the same column as the target table's distribution key. For example, if the target table uses a foreign key column as its distribution key, use the same column for the staging table's distribution key. If you create the staging table by using a [CREATE TABLE LIKE \(p. 382\)](#) statement, the staging table will inherit the distribution key from the parent table. If you use a CREATE TABLE AS statement, the new table does not inherit the distribution key. For more information, see [Choosing a Data Distribution Style \(p. 110\)](#)

If the distribution key is not the same as the primary key and the distribution key is not updated as part of the merge operation, add a redundant join predicate on the distribution key columns to enable a collocated join. For example:

```
where target.primarykey = stage.primarykey  
and target.distkey = stage.distkey
```

To verify that the query will use a collocated join, run the query with [EXPLAIN \(p. 415\)](#) and check for DS_DIST_NONE on all of the joins. For more information, see [Evaluating the Query Plan \(p. 114\)](#)

Performing a Merge Operation by Replacing Existing Rows

To perform a merge operation by replacing existing rows

1. Create a staging table, and then populate it with data to be merged, as shown in the following pseudocode.

```
create temp table stage (like target);  
  
insert into stage  
select * from source  
where source.filter = 'filter_expression';
```

2. Use an inner join with the staging table to delete the rows from the target table that are being updated.

Put the delete and insert operations in a single transaction block so that if there is a problem, everything will be rolled back.

```
begin transaction;  
  
delete from target  
using stage  
where target.primarykey = stage.primarykey;
```

3. Insert all of the rows from the staging table.

```
insert into target  
select * from stage;  
  
end transaction;
```

4. Drop the staging table.

```
drop table stage;
```

Performing a Merge Operation by Specifying a Column List

To perform a merge operation by specifying a column list

1. Put the entire operation in a single transaction block so that if there is a problem, everything will be rolled back.

```
begin transaction;
```

```
...  
end transaction;
```

2. Create a staging table, and then populate it with data to be merged, as shown in the following pseudocode.

```
create temp table stage (like target);  
insert into stage  
select * from source  
where source.filter = 'filter_expression';
```

3. Update the target table by using an inner join with the staging table.
 - In the UPDATE clause, explicitly list the columns to be updated.
 - Perform an inner join with the staging table.
 - If the distribution key is different from the primary key and the distribution key is not being updated, add a redundant join on the distribution key. To verify that the query will use a collocated join, run the query with [EXPLAIN \(p. 415\)](#) and check for DS_DIST_NONE on all of the joins. For more information, see [Evaluating the Query Plan \(p. 114\)](#)
 - If your target table is sorted by time stamp, add a predicate to take advantage of range-restricted scans on the target table. For more information, see [Best Practices for Designing Queries \(p. 28\)](#).
 - If you will not use all of the rows in the merge, add a clause to filter the rows that need to be changed. For example, add an inequality filter on one or more columns to exclude rows that have not changed.
 - Put the update, delete, and insert operations in a single transaction block so that if there is a problem, everything will be rolled back.

For example:

```
begin transaction;  
  
update target  
set col1 = stage.col1,  
col2 = stage.col2,  
col3 = 'expression'  
from stage  
where target.primarykey = stage.primarykey  
and target.distkey = stage.distkey  
and target.col3 > 'last_update_time'  
and (target.col1 != stage.col1  
or target.col2 != stage.col2  
or target.col3 = 'filter_expression');
```

4. Delete unneeded rows from the staging table by using an inner join with the target table. Some rows in the target table already match the corresponding rows in the staging table, and others were updated in the previous step. In either case, they are not needed for the insert.

```
delete from stage  
using target  
where stage.primarykey = target.primarykey;
```

5. Insert the remaining rows from the staging table. Use the same column list in the VALUES clause that you used in the UPDATE statement in step two.

```
insert into target
(select coll1, col2, 'expression'
from stage
where primarykey = stage.primarykey
and distkey = stage.distkey
and col3 = 'filter_expression');

end transaction;
```

6. Drop the staging table.

```
drop table stage;
```

Merge Examples

The following examples perform a merge to update the SALES table. The first example uses the simpler method of deleting from the target table and then inserting all of the rows from the staging table. The second example requires updating on select columns in the target table, so it includes an extra update step.

Sample merge data source

The examples in this section need a sample data source that includes both updates and inserts. For the examples, we will create a sample table named SALES_UPDATE that uses data from the SALES table. We'll populate the new table with random data that represents new sales activity for December. We will use the SALES_UPDATE sample table to create the staging table in the examples that follow.

```
-- Create a sample table as a copy of the SALES table
create table sales_update as
select * from sales;

-- Change every fifth row so we have updates

update sales_update
set qtysold = qtysold*2,
pricepaid = pricepaid*0.8,
commission = commission*1.1
where saletime > '2008-11-30'
and mod(sellerid, 5) = 0;

-- Add some new rows so we have insert examples
-- This example creates a duplicate of every fourth row

insert into sales_update
select (salesid + 172456) as salesid, listid, sellerid, buyerid, eventid,
dateid, qtysold, pricepaid, commission, getdate() as saletime
from sales_update
where saletime > '2008-11-30'
and mod(sellerid, 4) = 0;
```

Example of a merge that replaces existing rows

The following script uses the SALES_UPDATE table to perform a merge operation on the SALES table with new data for December sales activity. This example deletes rows in the SALES table that have updates so they can be replaced with the updated rows in the staging table. The staging table should

contain only rows that will participate in the merge, so the CREATE TABLE statement includes a filter to exclude rows that have not changed.

```
-- Create a staging table and populate it with updated rows from
SALES_UPDATE

create temp table stagesales as
select * from sales_update
where sales_update.saletime > '2008-11-30'
and sales_update.salesid = (select sales.salesid from sales
where sales.salesid = sales_update.salesid
and sales.listid = sales_update.listid
and (sales_update.qtysold != sales.qtysold
or sales_update.pricepaid != sales.pricepaid));

-- Start a new transaction
begin transaction;

-- Delete any rows from SALES that exist in STAGESALES, because they are
updates
-- The join includes a redundant predicate to collocate on the distribution
key
-- A filter on saletime enables a range-restricted scan on SALES

delete from sales
using stagesales
where sales.salesid = stagesales.salesid
and sales.listid = stagesales.listid
and sales.saletime > '2008-11-30';

-- Insert all the rows from the staging table into the target table
insert into sales
select * from stagesales;

-- End transaction and commit
end transaction;

-- Drop the staging table
drop table stagesales;
```

Example of a merge that specifies a column list

The following example performs a merge operation to update SALES with new data for December sales activity. We need sample data that includes both updates and inserts, along with rows that have not changed. For this example, we want to update the QTYSOLD and PRICEPAID columns but leave COMMISSION and SALETIME unchanged. The following script uses the SALES_UPDATE table to perform a merge operation on the SALES table.

```
-- Create a staging table and populate it with rows from SALES_UPDATE for Dec
create temp table stagesales as select * from sales_update
where saletime > '2008-11-30';

-- Start a new transaction
begin transaction;

-- Update the target table using an inner join with the staging table
-- The join includes a redundant predicate to collocate on the distribution
key -- A filter on saletime enables a range-restricted scan on SALES
```

```
update sales
set qtysold = stagesales.qtysold,
pricepaid = stagesales.pricepaid
from stagesales
where sales.salesid = stagesales.salesid
and sales.listid = stagesales.listid
and stagesales.saletime > '2008-11-30'
and (sales.qtysold != stagesales.qtysold
or sales.pricepaid != stagesales.pricepaid);

-- Delete matching rows from the staging table
-- using an inner join with the target table

delete from stagesales
using sales
where sales.salesid = stagesales.salesid
and sales.listid = stagesales.listid;

-- Insert the remaining rows from the staging table into the target table
insert into sales
select * from stagesales;

-- End transaction and commit
end transaction;

-- Drop the staging table
drop table stagesales;
```

Performing a Deep Copy

A deep copy recreates and repopulates a table by using a bulk insert, which automatically sorts the table. If a table has a large unsorted region, a deep copy is much faster than a vacuum. The trade off is that you cannot make concurrent updates during a deep copy operation, which you can do during a vacuum.

You can choose one of four methods to create a copy of the original table:

- Use the original table DDL.

If the CREATE TABLE DDL is available, this is the fastest and preferred method. If you create a new table, you can specify all table and column attributes, including primary key and foreign keys.

Note

If the original DDL is not available, you might be able to recreate the DDL by running a script called `v_generate_tbl_ddl`. You can download the script from [amazon-redshift-utils](#), which is part of the [Amazon Web Services - Labs](#) git hub repository.

- Use CREATE TABLE LIKE.

If the original DDL is not available, you can use CREATE TABLE LIKE to recreate the original table. The new table inherits the encoding, distkey, sortkey, and notnull attributes of the parent table. The new table doesn't inherit the primary key and foreign key attributes of the parent table, but you can add them using [ALTER TABLE](#) (p. 297).

- Create a temporary table and truncate the original table.

If you need to retain the primary key and foreign key attributes of the parent table, or if the parent table has dependencies, you can use CTAS to create a temporary table, then truncate the original table and populate it from the temporary table.

Using a temporary table improves performance significantly compared to using a permanent table, but there is a risk of losing data. A temporary table is automatically dropped at the end of the session in which it is created. TRUNCATE commits immediately, even if it is inside a transaction block. If the TRUNCATE succeeds but the session terminates before the subsequent INSERT completes, the data is lost. If data loss is unacceptable, use a permanent table.

To perform a deep copy using the original table DDL

1. (Optional) Recreate the table DDL by running a script called `v_generate_tbl_ddl`.
2. Create a copy of the table using the original CREATE TABLE DDL.
3. Use an INSERT INTO ... SELECT statement to populate the copy with data from the original table.
4. Drop the original table.
5. Use an ALTER TABLE statement to rename the copy to the original table name.

The following example performs a deep copy on the SALES table using a duplicate of SALES named SALESCOPY.

```
create table salescopy ( ... );
insert into salescopy (select * from sales);
drop table sales;
alter table salescopy rename to sales;
```

To perform a deep copy using CREATE TABLE LIKE

1. Create a new table using CREATE TABLE LIKE.
2. Use an INSERT INTO ... SELECT statement to copy the rows from the current table to the new table.
3. Drop the current table.
4. Use an ALTER TABLE statement to rename the new table to the original table name.

The following example performs a deep copy on the SALES table using CREATE TABLE LIKE.

```
create table likesales (like sales);
insert into likesales (select * from sales);
drop table sales;
alter table likesales rename to sales;
```

To perform a deep copy by creating a temporary table and truncating the original table

1. Use CREATE TABLE AS to create a temporary table with the rows from the original table.
2. Truncate the current table.
3. Use an INSERT INTO ... SELECT statement to copy the rows from the temporary table to the original table.
4. Drop the temporary table.

The following example performs a deep copy on the SALES table by creating a temporary table and truncating the original table:

```
create temp table salestemp as select * from sales;  
truncate sales;  
insert into sales (select * from salestemp);  
drop table salestemp;
```

Analyzing Tables

We recommend that at regular intervals you update the statistical metadata that the query planner uses to build and choose optimal plans. To do so, you analyze your tables.

You can analyze a table explicitly by running the [ANALYZE \(p. 309\)](#) command.

Topics

- [ANALYZE Command History \(p. 171\)](#)
- [Automatic Analysis of New Tables \(p. 171\)](#)

Overview

When you load data with the COPY command, you can perform an analysis automatically by setting the STATUPDATE option to ON. By default, the COPY command performs an analysis after it loads data into an empty table. You can force an analysis regardless of whether a table is empty by setting STATUPDATE ON. If you specify STATUPDATE OFF, no analysis is performed.

Only the table owner or a superuser can run the ANALYZE command or run the COPY command with STATUPDATE set to ON.

If you run a query against a new table that was not analyzed after its data was initially loaded, a warning message is displayed; however, no warning occurs when you query a table after a subsequent update or load. The same behavior occurs when you run the EXPLAIN command on a query that contains tables that have not been analyzed.

Whenever adding data to a nonempty table significantly changes the size of the table, we recommend that you update statistics either by running an ANALYZE command or by using the STATUPDATE ON option with the COPY command. To view details about the number of rows that have been inserted or deleted since the last ANALYZE, query the [PG_STATISTIC_INDICATOR \(p. 801\)](#) system catalog table.

If performance degradation occurs that might be the result of inefficient data storage or a significant change in the statistical profile of the data, run the analysis to see if the updated statistics solve the problem.

To build or update statistics, run the [ANALYZE \(p. 309\)](#) command against one of the following:

- The entire current database
- A single table
- One or more specific columns in a single table

The ANALYZE command obtains a sample of rows from the table, does some calculations, and saves resulting column statistics. By default, Amazon Redshift runs a sample pass for the DISTKEY column and another sample pass for all of the other columns in the table. If you want to generate statistics for a subset of columns, you can specify a comma-separated column list.

ANALYZE operations are resource intensive, so run them only on tables and columns that actually require statistics updates. You don't need to analyze all columns in all tables regularly or on the

same schedule. If the data changes substantially, analyze the columns that are frequently used in the following:

- Sorting and grouping operations
- Joins
- Query predicates

To reduce processing time and improve overall system performance, Amazon Redshift skips analyze for any table that has a low percentage of changed rows, as determined by the [analyze_threshold_percent](#) (p. 810) parameter. By default, the analyze threshold is set to 10 percent. You can change the analyze threshold for the current session by executing a [SET](#) (p. 465) command.

Columns that are less likely to require frequent analysis are those that represent facts and measures and any related attributes that are never actually queried, such as large VARCHAR columns. For example, consider the LISTING table in the TICKIT database:

```
select "column", type, encoding, distkey, sortkey
from pg_table_def where tablename = 'listing';
```

column	type	encoding	distkey	sortkey
listid	integer	none	t	1
sellerid	integer	none	f	0
eventid	integer	mostly16	f	0
dateid	smallint	none	f	0
numtickets	smallint	mostly8	f	0
priceperticket	numeric(8,2)	bytedict	f	0
totalprice	numeric(8,2)	mostly32	f	0
listtime	timestamp with...	none	f	0

If this table is loaded every day with a large number of new records, the LISTID column, which is frequently used in queries as a join key, would need to be analyzed regularly. If TOTALPRICE and LISTTIME are the frequently used constraints in queries, you could analyze those columns and the distribution key on every weekday:

```
analyze listing(listid, totalprice, listtime);
```

If the sellers and events in the application are much more static, and the date IDs refer to a fixed set of days covering only two or three years, the unique values for these columns will not change significantly, although the number of instances of each unique value will increase steadily. In addition, if the NUMTICKETS and PRICEPERTICKET measures are queried infrequently compared to the TOTALPRICE column, you could run the ANALYZE command on the whole table once every weekend to update statistics for the five columns that are not analyzed daily:

```
analyze listing;
```

To maintain current statistics for tables, do the following:

- Run the ANALYZE command before running queries.
- Run the ANALYZE command against the database routinely at the end of every regular load or update cycle.
- Run the ANALYZE command against any new tables that you create and any existing tables or columns that undergo significant change.
- Consider running ANALYZE operations on different schedules for different types of tables and columns, depending on their use in queries and their propensity to change.

ANALYZE Command History

It is useful to know when the last ANALYZE command was run on a table or database. When an ANALYZE command is run, Amazon Redshift executes multiple queries that look like this:

```
padb_fetch_sample: select * from table_name
```

To find out when ANALYZE commands were run, you can query system tables and views such as STL_QUERY and SVL_STATEMENTTEXT and include a restriction on padb_fetch_sample. For example, to find out when the SALES table was last analyzed, run this query:

```
select query, rtrim(querytxt), starttime
from stl_query
where querytxt like 'padb_fetch_sample%' and querytxt like '%sales%'
order by query desc;
```

query	rtrim	starttime
81	padb_fetch_sample: select * from sales	2012-04-18 12:...
80	padb_fetch_sample: select * from sales	2012-04-18 12:...
79	padb_fetch_sample: select count(*) from sales	2012-04-18 12:...

(3 rows)

Alternatively, you can run a more complex query that returns all the statements that ran in every completed transaction that included an ANALYZE command:

```
select xid, to_char(starttime, 'HH24:MM:SS.MS') as starttime,
date_diff('sec',starttime,endtime ) as secs, substring(text, 1, 40)
from svl_statementtext
where sequence = 0
and xid in (select xid from svl_statementtext s where s.text like
'padb_fetch_sample%' )
order by xid desc, starttime;
```

xid	starttime	secs	substring
1338	12:04:28.511	4	Analyze date
1338	12:04:28.511	1	padb_fetch_sample: select count(*) from
1338	12:04:29.443	2	padb_fetch_sample: select * from date
1338	12:04:31.456	1	padb_fetch_sample: select * from date
1337	12:04:24.388	1	padb_fetch_sample: select count(*) from
1337	12:04:24.388	4	Analyze sales
1337	12:04:25.322	2	padb_fetch_sample: select * from sales
1337	12:04:27.363	1	padb_fetch_sample: select * from sales
...			

Automatic Analysis of New Tables

Amazon Redshift automatically analyzes tables that you create with the following commands:

- CREATE TABLE AS (CTAS)
- CREATE TEMP TABLE AS
- SELECT INTO

You do not need to run the ANALYZE command on these tables when they are first created. If you modify them, you should analyze them in the same way as other tables.

Vacuuming Tables

Topics

- [VACUUM Frequency \(p. 172\)](#)
- [Sort Stage and Merge Stage \(p. 173\)](#)
- [Vacuum Threshold \(p. 173\)](#)
- [Vacuum Types \(p. 173\)](#)
- [Managing Vacuum Times \(p. 174\)](#)
- [Vacuum Column Limit Exceeded Error \(p. 180\)](#)

To clean up tables after a bulk delete, a load, or a series of incremental updates, you need to run the [VACUUM \(p. 488\)](#) command, either against the entire database or against individual tables.

Note

Only the table owner or a superuser can effectively vacuum a table. If you do not have owner or superuser privileges for a table, a VACUUM that specifies a single table will fail. If you run a VACUUM of the entire database, without specifying a table name, the operation completes successfully but has no effect on tables for which you do not have owner or superuser privileges. For this reason, and because vacuuming the entire database is potentially an expensive operation, we recommend vacuuming individual tables as needed.

Amazon Redshift does not automatically reclaim and reuse space that is freed when you delete rows and update rows. To perform an update, Amazon Redshift deletes the original row and appends the updated row, so every update is effectively a delete followed by an insert. When you perform a delete, the rows are marked for deletion, but not removed. The query processor needs to scan the deleted rows as well as undeleted rows, so too many deleted rows can cost unnecessary processing. You should vacuum following a significant number of deletes or updates to reclaim space and improve query performance.

For tables with a sort key, the VACUUM command ensures that new data in tables is fully sorted on disk. When data is initially loaded into a table that has a sort key, the data is sorted according to the SORTKEY specification in the [CREATE TABLE \(p. 378\)](#) statement. However, when you update the table, using COPY, INSERT, or UPDATE statements, new rows are stored in a separate unsorted region on disk, then sorted on demand for queries as required. If large numbers of rows remain unsorted on disk, query performance might be degraded for operations that rely on sorted data, such as range-restricted scans or merge joins. The VACUUM command merges new rows with existing sorted rows, so range-restricted scans are more efficient and the execution engine doesn't need to sort rows on demand during query execution.

When a table is sorted using an interleaved sort key, Amazon Redshift analyzes the distribution of values in the sort key columns to determine the optimal sort strategy. Over time, that distribution can change, or skew, which might degrade performance. Run a [VACUUM REINDEX \(p. 489\)](#) to re-analyze the sort key distribution and restore performance. For more information, see [Interleaved Sort Key \(p. 123\)](#).

VACUUM Frequency

You should vacuum as often as you need to in order to maintain consistent query performance. Consider these factors when determining how often to run your VACUUM command.

- Run VACUUM during time periods when you expect minimal activity on the cluster, such as evenings or during designated database administration windows.

- A large unsorted region results in longer vacuum times. If you delay vacuuming, the vacuum will take longer because more data has to be reorganized.
- VACUUM is an I/O intensive operation, so the longer it takes for your vacuum to complete, the more impact it will have on concurrent queries and other database operations running on your cluster.
- VACUUM takes longer for tables that use interleaved sorting. To evaluate whether interleaved tables need to be resorted, query the [SVV_INTERLEAVED_COLUMNS](#) (p. 780) view.

Sort Stage and Merge Stage

Amazon Redshift performs a vacuum operation in two stages: first, it sorts the rows in the unsorted region, then, if necessary, it merges the newly sorted rows at the end of the table with the existing rows. When vacuuming a large table, the vacuum operation proceeds in a series of steps consisting of incremental sorts followed by merges. If the operation fails or if Amazon Redshift goes off line during the vacuum, the partially vacuumed table or database will be in a consistent state, but you will need to manually restart the vacuum operation. Incremental sorts are lost, but merged rows that were committed before the failure do not need to be vacuumed again. If the unsorted region is large, the lost time might be significant. For more information about the sort and merge stages, see [Managing the Volume of Merged Rows](#) (p. 175).

Users can access tables while they are being vacuumed. You can perform queries and write operations while a table is being vacuumed, but when DML and a vacuum run concurrently, both might take longer. If you execute UPDATE and DELETE statements during a vacuum, system performance might be reduced. Incremental merges temporarily block concurrent UPDATE and DELETE operations, and UPDATE and DELETE operations in turn temporarily block incremental merge steps on the affected tables. DDL operations, such as ALTER TABLE, are blocked until the vacuum operation finishes with the table.

Vacuum Threshold

By default, VACUUM skips the sort phase for any table where more than 95 percent of the table's rows are already sorted. Skipping the sort phase can significantly improve VACUUM performance. In addition, in the delete phase VACUUM reclaims space such that at least 95 percent of the remaining rows are not marked for deletion. Because VACUUM can often skip rewriting many blocks that contain only a few rows marked for deletion, it usually needs much less time for the delete phase compared to reclaiming 100 percent of deleted rows. To change the default sort threshold for a single table, include the table name and the TO *threshold* PERCENT parameter when you run the VACUUM command.

Vacuum Types

You can run a full vacuum, a delete only vacuum, a sort only vacuum, or a reindex with full vacuum.

- **VACUUM FULL**

We recommend a full vacuum for most applications where reclaiming space and resorting rows are equally important. It's more efficient to run a full vacuum than to run back-to-back DELETE ONLY and SORT ONLY vacuum operations. VACUUM FULL is the same as VACUUM. Full vacuum is the default vacuum operation.

- **VACUUM DELETE ONLY**

A DELETE ONLY vacuum is the same as a full vacuum except that it skips the sort. A DELETE ONLY vacuum saves time when reclaiming disk space is important but resorting new rows is not. For example, you might perform a DELETE ONLY vacuum operation if you don't need to resort rows to optimize query performance.

- **VACUUM SORT ONLY**

A SORT ONLY vacuum saves some time by not reclaiming disk space, but in most cases there is little benefit compared to a full vacuum.

- **VACUUM REINDEX**

Use VACUUM REINDEX for tables that use interleaved sort keys. REINDEX reanalyzes the distribution of the values in the table's sort key columns, then performs a full VACUUM operation. VACUUM REINDEX takes significantly longer than VACUUM FULL because it needs to take an extra analysis pass over the data, and because merging in new interleaved data can involve touching all the data blocks.

If a VACUUM REINDEX operation terminates before it completes, the next VACUUM resumes the reindex operation before performing the vacuum.

Managing Vacuum Times

Depending on the nature of your data, we recommend following the practices in this section to minimize vacuum times.

Topics

- [Deciding Whether to Reindex \(p. 174\)](#)
- [Managing the Size of the Unsorted Region \(p. 175\)](#)
- [Managing the Volume of Merged Rows \(p. 175\)](#)
- [Loading Your Data in Sort Key Order \(p. 178\)](#)
- [Using Time Series Tables \(p. 179\)](#)

Deciding Whether to Reindex

You can often significantly improve query performance by using an interleaved sort style, but over time performance might degrade if the distribution of the values in the sort key columns changes.

The query engine is able to use sort order to efficiently select which data blocks need to be scanned to process a query. For an interleaved sort, Amazon Redshift analyzes the sort key column values to determine the optimal sort order. If the distribution of key values changes, or skews, as rows are added, the sort strategy will no longer be optimal, and the performance benefit of sorting will degrade. To reanalyze the sort key distribution you can run a VACUUM REINDEX. The reindex operation is time consuming, so to decide whether a table will benefit from a reindex, query the [SVV_INTERLEAVED_COLUMNS \(p. 780\)](#) view.

For example, the following query shows details for tables that use interleaved sort keys.

```
select tbl as tbl_id, stv_tbl_perm.name as table_name,
col, interleaved_skew, last_reindex
from svv_interleaved_columns, stv_tbl_perm
where svv_interleaved_columns.tbl = stv_tbl_perm.id
and interleaved_skew is not null;
```

tbl_id	table_name	col	interleaved_skew	last_reindex
100048	customer	0	3.65	2015-04-22 22:05:45
100068	lineorder	1	2.65	2015-04-22 22:05:45
100072	part	0	1.65	2015-04-22 22:05:45
100077	supplier	1	1.00	2015-04-22 22:05:45

(4 rows)

The value for `interleaved_skew` is a ratio that indicates the amount of skew. A value of 1 means there is no skew. If the skew is greater than 1.4, a `VACUUM REINDEX` will usually improve performance unless the skew is inherent in the underlying set.

You can use the date value in `last_reindex` to determine how long it has been since the last reindex.

Managing the Size of the Unsorted Region

The unsorted region grows when you load large amounts of new data into tables that already contain data or when you do not vacuum tables as part of your routine maintenance operations. To avoid long-running vacuum operations, use the following practices:

- Run vacuum operations on a regular schedule.

If you load your tables in small increments (such as daily updates that represent a small percentage of the total number of rows in the table), running `VACUUM` regularly will help ensure that individual vacuum operations go quickly.

- Run the largest load first.

If you need to load a new table with multiple `COPY` operations, run the largest load first. When you run an initial load into a new or truncated table, all of the data is loaded directly into the sorted region, so no vacuum is required.

- Truncate a table instead of deleting all of the rows.

Deleting rows from a table does not reclaim the space that the rows occupied until you perform a vacuum operation; however, truncating a table empties the table and reclaims the disk space, so no vacuum is required. Alternatively, drop the table and re-create it.

- Truncate or drop test tables.

If you are loading a small number of rows into a table for test purposes, don't delete the rows when you are done. Instead, truncate the table and reload those rows as part of the subsequent production load operation.

- Perform a deep copy.

A deep copy recreates and repopulates a table by using a bulk insert, which automatically resorts the table. If a table has a large unsorted region, a deep copy is much faster than a vacuum. The trade off is that you cannot make concurrent updates during a deep copy operation, which you can do during a vacuum. For more information, see [Best Practices for Designing Queries \(p. 28\)](#).

Managing the Volume of Merged Rows

If a vacuum operation needs to merge new rows into a table's sorted region, the time required for a vacuum will increase as the table grows larger. You can improve vacuum performance by reducing the number of rows that must be merged.

Prior to a vacuum, a table consists of a sorted region at the head of the table, followed by an unsorted region, which grows whenever rows are added or updated. When a set of rows is added by a `COPY` operation, the new set of rows is sorted on the sort key as it is added to the unsorted region at the end of the table. The new rows are ordered within their own set, but not within the unsorted region.

The following diagram illustrates the unsorted region after two successive `COPY` operations, where the sort key is `CUSTID`. For simplicity, this example shows a compound sort key, but the same principles apply to interleaved sort keys, except that the impact of the unsorted region is greater for interleaved tables.

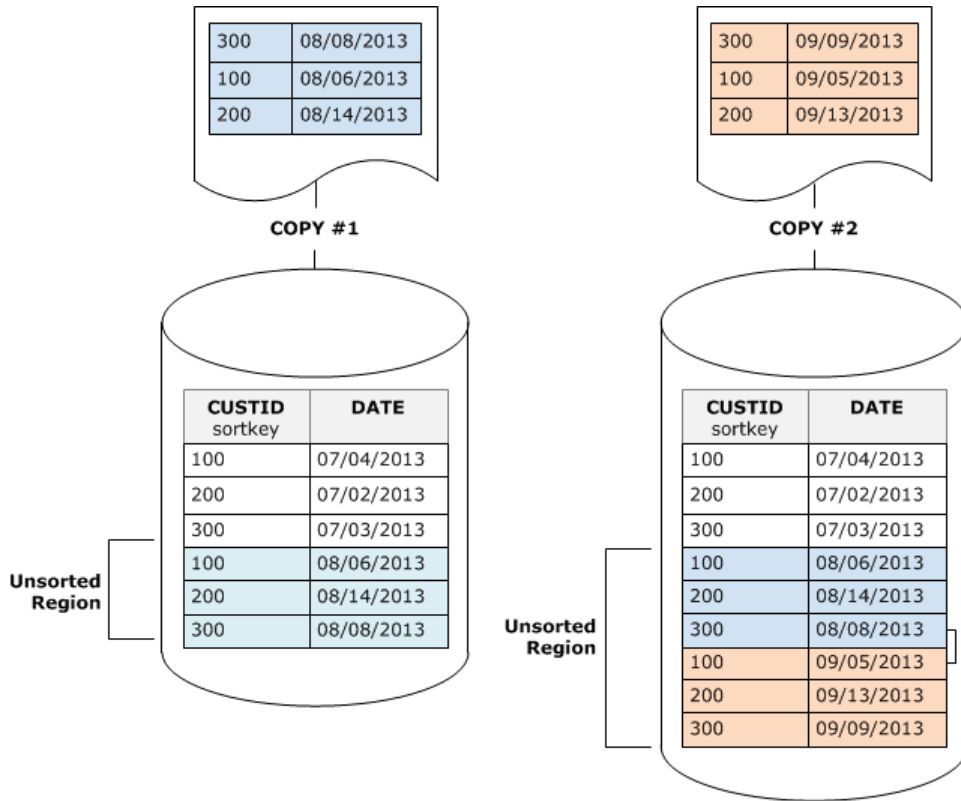

A vacuum restores the table's sort order in two stages:

1. Sort the unsorted region into a newly-sorted region.

The first stage is relatively cheap, because only the unsorted region is rewritten. If the range of sort key values of the newly-sorted region is higher than the existing range, only the new rows need to be rewritten, and the vacuum is complete. For example, if the sorted region contains ID values 1 to 500 and subsequent copy operations add key values greater than 500, then only the unsorted region only needs to be rewritten.

2. Merge the newly-sorted region with the previously-sorted region.

If the keys in the newly sorted region overlap the keys in the sorted region, then VACUUM needs to merge the rows. Starting at the beginning of the newly-sorted region (at the lowest sort key), the vacuum writes the merged rows from the previously sorted region and the newly sorted region into a new set of blocks.

The extent to which the new sort key range overlaps the existing sort keys determines the extent to which the previously-sorted region will need to be rewritten. If the unsorted keys are scattered throughout the existing sort range, a vacuum might need to rewrite existing portions of the table.

The following diagram shows how a vacuum would sort and merge rows that are added to a table where CUSTID is the sort key. Because each copy operation adds a new set of rows with key values that overlap the existing keys, almost the entire table needs to be rewritten. The diagram shows single sort and merge, but in practice, a large vacuum consists of a series of incremental sort and merge steps.

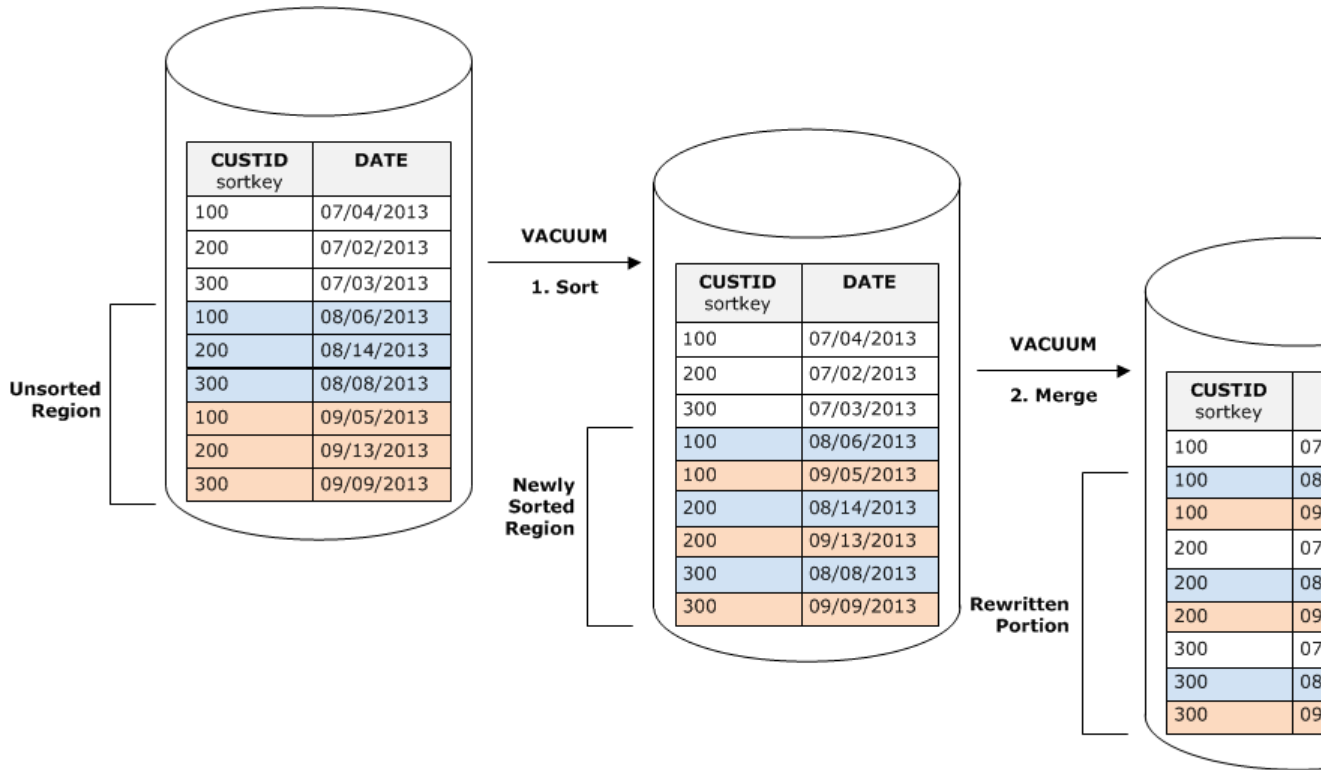

If the range of sort keys in a set of new rows overlaps the range of existing keys, the cost of the merge stage continues to grow in proportion to the table size as the table grows while the cost of the sort stage remains proportional to the size of the unsorted region. In such a case, the cost of the merge stage overshadows the cost of the sort stage, as the following diagram shows.

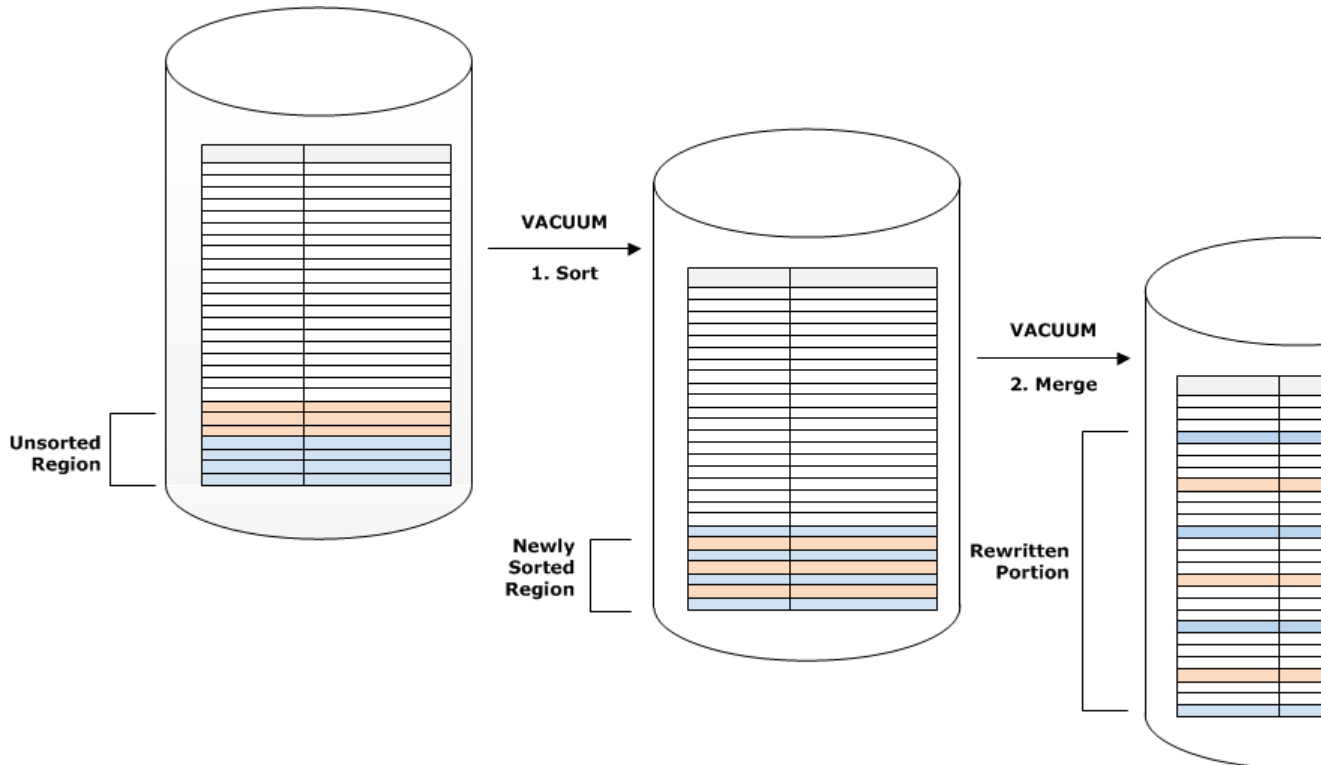

To determine what proportion of a table was remerged, query SVV_VACUUM_SUMMARY after the vacuum operation completes. The following query shows the effect of six successive vacuums as CUSTSALES grew larger over time.

```
select * from svv_vacuum_summary
where table_name = 'custsales';
```

table_name	xid	sort_	merge_	elapsed_	row_
sortedrow_	block_	max_merge_			
		partitions	increments	time	delta
	delta	partitions			delta
custsales	7072	3	2	143918314	0
88297472	1524	47			
custsales	7122	3	3	164157882	0
88297472	772	47			
custsales	7212	3	4	187433171	0
88297472	767	47			
custsales	7289	3	4	255482945	0
88297472	770	47			
custsales	7420	3	5	316583833	0
88297472	769	47			
custsales	9007	3	6	306685472	0
88297472	772	47			

(6 rows)

The merge_increments column gives an indication of the amount of data that was merged for each vacuum operation. If the number of merge increments over consecutive vacuums increases in proportion to the growth in table size, that is an indication that each vacuum operation is remerging an increasing number of rows in the table because the existing and newly sorted regions overlap.

Loading Your Data in Sort Key Order

If you load your data in sort key order, you might reduce or even eliminate the need to vacuum.

COPY automatically adds new rows to the table's sorted region when all of the following are true:

- The table uses a compound sort key with only one sort column.
- The sort column is NOT NULL.
- The table is 100 percent sorted or empty.
- All the new rows are higher in sort order than the existing rows, including rows marked for deletion. In this instance, Amazon Redshift uses the first eight bytes of the sort key to determine sort order.

For example, suppose you have a table that records customer events using a customer ID and time. If you sort on customer ID, it's likely that the sort key range of new rows added by incremental loads will overlap the existing range, as shown in the previous example, leading to an expensive vacuum operation.

If you set your sort key to a timestamp column, your new rows will be appended in sort order at the end of the table, as the following diagram shows, reducing or even eliminating the need to vacuum.

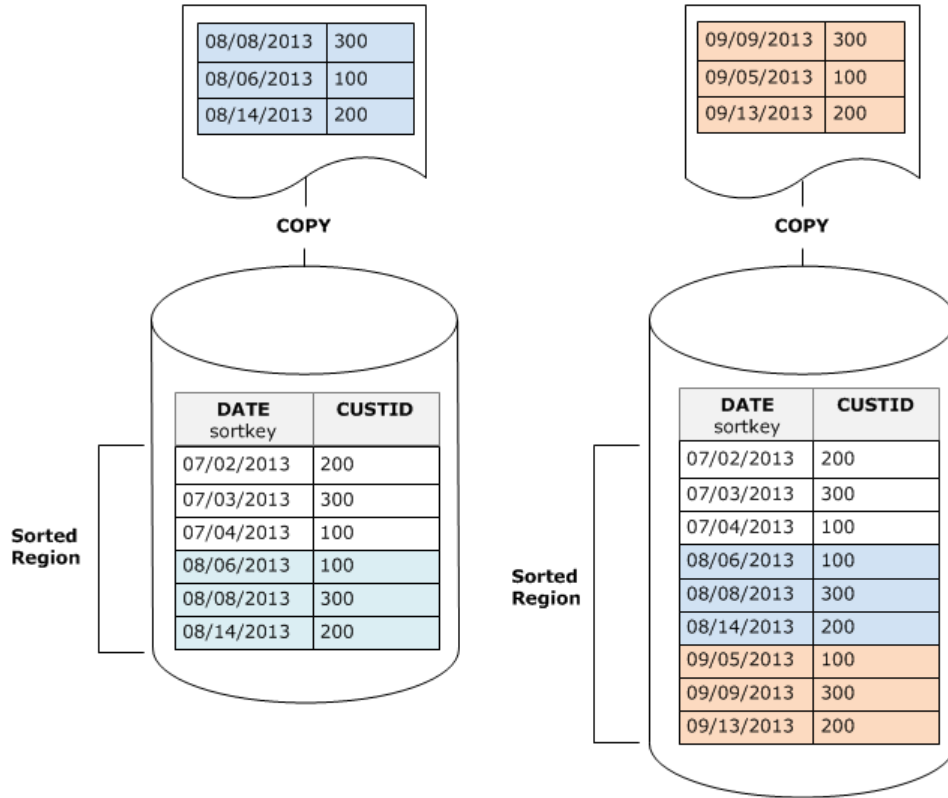

Using Time Series Tables

If you maintain data for a rolling time period, use a series of tables, as the following diagram illustrates.

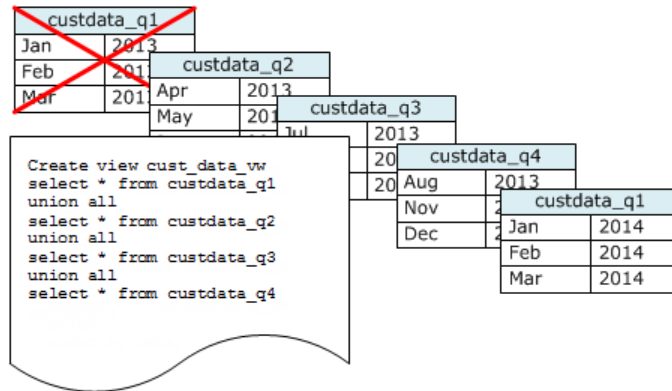

Create a new table each time you add a set of data, then delete the oldest table in the series. You gain a double benefit:

- You avoid the added cost of deleting rows, because a DROP TABLE operation is much more efficient than a mass DELETE.
- If the tables are sorted by timestamp, no vacuum is needed. If each table contains data for one month, a vacuum will at most have to rewrite one month's worth of data, even if the tables are not sorted by timestamp.

You can create a UNION ALL view for use by reporting queries that hides the fact that the data is stored in multiple tables. If a query filters on the sort key, the query planner can efficiently skip all the

tables that aren't used. A UNION ALL can be less efficient for other types of queries, so you should evaluate query performance in the context of all queries that use the tables.

Vacuum Column Limit Exceeded Error

If your vacuum fails with the message `ERROR: 1036 DETAIL: Vacuum column limit exceeded`, your table has more columns than VACUUM can process with the available memory. The vacuum column limit is less than the maximum number of columns for a table, which is 1600. The actual column limit for a vacuum varies depending on your cluster's configuration. For example, on clusters with DC1 or DS1 node types, you can generally VACUUM tables with up to about 500 columns. With the DS2 node type, the limit could be as high as 750 columns for DS2.xlarge or 1,000 columns for a DS2.8xlarge cluster.

You can increase the vacuum column limit by increasing the value of `wlm_query_slot_count` (p. 816), which increases the amount of memory available for the query. The maximum value for `wlm_query_slot_count` is limited to the concurrency value for the queue. For more information, see [Best Practices for Designing Queries](#) (p. 28).

If increasing the value of `wlm_query_slot_count` is not an option, or if it doesn't solve the problem, you can avoid needing to vacuum by performing a deep copy. To perform a deep copy, you create a copy of the table, insert the rows from the original table into the copy, drop the original table, and then rename the copy. A deep copy is often much faster than a vacuum. For more information, see [Performing a Deep Copy](#) (p. 167).

For example, suppose the table `calendardays` has 365 columns. After a load operation, you perform a vacuum and the vacuum fails, as the following example shows.

```
vacuum calendardays;  
  
An error occurred when executing the SQL command:  
vacuum calendardays;  
  
ERROR: 1036  
DETAIL: Vacuum column limit exceeded for table calendardays  
HINT: Increase the value of wlm_query_slot_count or perform a deep copy  
instead of a vacuum.
```

The following example sets `wlm_query_slot_count` to 10, performs a vacuum, and then resets `wlm_query_slot_count` to 1. With the higher slot count, the vacuum succeeds.

```
set wlm_query_slot_count to 10;  
vacuum calendardays;  
set wlm_query_slot_count to 1;  
  
vacuum executed successfully
```

You can perform a deep copy instead of a vacuum. The following example uses CREATE TABLE LIKE to perform a deep copy.

```
create table likecalendardays (like calendardays);  
insert into likecalendardays (select * from calendardays);  
drop table calendardays;  
alter table likecalendardays rename to calendardays;
```

Performing a deep copy using CREATE TABLE AS (CTAS) is faster than using CREATE TABLE LIKE, but CTAS does not preserve the sort key, encoding, distkey, and notnull attributes of the parent table. For a comparison of different deep copy methods, see [Performing a Deep Copy](#) (p. 167).

Managing Concurrent Write Operations

Topics

- [Serializable Isolation \(p. 181\)](#)
- [Write and Read-Write Operations \(p. 182\)](#)
- [Concurrent Write Examples \(p. 183\)](#)

Amazon Redshift allows tables to be read while they are being incrementally loaded or modified.

In some traditional data warehousing and business intelligence applications, the database is available to users only when the nightly load is complete. In such cases, no updates are allowed during regular work hours, when analytic queries are run and reports are generated; however, an increasing number of applications remain live for long periods of the day or even all day, making the notion of a load window obsolete.

Amazon Redshift supports these types of applications by allowing tables to be read while they are being incrementally loaded or modified. Queries simply see the latest committed version, or *snapshot*, of the data, rather than waiting for the next version to be committed. If you want a particular query to wait for a commit from another write operation, you have to schedule it accordingly.

The following topics describe some of the key concepts and use cases that involve transactions, database snapshots, updates, and concurrent behavior.

Serializable Isolation

Some applications require not only concurrent querying and loading, but also the ability to write to multiple tables or the same table concurrently. In this context, *concurrently* means overlapping, not scheduled to run at precisely the same time. Two transactions are considered to be concurrent if the second one starts before the first commits. Concurrent operations can originate from different sessions that are controlled either by the same user or by different users.

Note

Amazon Redshift supports a default *automatic commit* behavior in which each separately-executed SQL command commits individually. If you enclose a set of commands in a transaction block (defined by [BEGIN \(p. 312\)](#) and [END \(p. 413\)](#) statements), the block commits as one transaction, so you can roll it back if necessary. An exception to this behavior is the TRUNCATE command, which automatically commits all outstanding changes made in the current transaction without requiring an END statement.

Concurrent write operations are supported in Amazon Redshift in a protective way, using write locks on tables and the principle of *serializable isolation*. Serializable isolation preserves the illusion that a transaction running against a table is the only transaction that is running against that table. For example, two concurrently running transactions, T1 and T2, must produce the same results as at least one of the following:

- T1 and T2 run serially in that order
- T2 and T1 run serially in that order

Concurrent transactions are invisible to each other; they cannot detect each other's changes. Each concurrent transaction will create a snapshot of the database at the beginning of the transaction. A database snapshot is created within a transaction on the first occurrence of most SELECT statements, DML commands such as COPY, DELETE, INSERT, UPDATE, and TRUNCATE, and the following DDL commands :

- ALTER TABLE (to add or drop columns)

- CREATE TABLE
- DROP TABLE
- TRUNCATE TABLE

If *any* serial execution of the concurrent transactions would produce the same results as their concurrent execution, those transactions are deemed "serializable" and can be run safely. If no serial execution of those transactions would produce the same results, the transaction that executes a statement that would break serializability is aborted and rolled back.

System catalog tables (PG) and other Amazon Redshift system tables (STL and STV) are not locked in a transaction; therefore, changes to database objects that arise from DDL and TRUNCATE operations are visible on commit to any concurrent transactions.

For example, suppose that table A exists in the database when two concurrent transactions, T1 and T2, start. If T2 returns a list of tables by selecting from the PG_TABLES catalog table, and then T1 drops table A and commits, and then T2 lists the tables again, table A is no longer listed. If T2 tries to query the dropped table, Amazon Redshift returns a "relation does not exist" error. The catalog query that returns the list of tables to T2 or checks that table A exists is not subject to the same isolation rules as operations against user tables.

Transactions for updates to these tables run in a *read committed* isolation mode. PG-prefix catalog tables do not support snapshot isolation.

Serializable Isolation for System Tables and Catalog Tables

A database snapshot is also created in a transaction for any SELECT query that references a user-created table or Amazon Redshift system table (STL or STV). SELECT queries that do not reference any table will not create a new transaction database snapshot, nor will any INSERT, DELETE, or UPDATE statements that operate solely on system catalog tables (PG).

Write and Read-Write Operations

You can manage the specific behavior of concurrent write operations by deciding when and how to run different types of commands. The following commands are relevant to this discussion:

- COPY commands, which perform loads (initial or incremental)
- INSERT commands that append one or more rows at a time
- UPDATE commands, which modify existing rows
- DELETE commands, which remove rows

COPY and INSERT operations are pure write operations, but DELETE and UPDATE operations are read-write operations. (In order for rows to be deleted or updated, they have to be read first.) The results of concurrent write operations depend on the specific commands that are being run concurrently. COPY and INSERT operations against the same table are held in a wait state until the lock is released, then they proceed as normal.

UPDATE and DELETE operations behave differently because they rely on an initial table read before they do any writes. Given that concurrent transactions are invisible to each other, both UPDATES and DELETES have to read a snapshot of the data from the last commit. When the first UPDATE or DELETE releases its lock, the second UPDATE or DELETE needs to determine whether the data that it is going to work with is potentially stale. It will not be stale, because the second transaction does not obtain its snapshot of data until after the first transaction has released its lock.

Potential Deadlock Situation for Concurrent Write Transactions

Whenever transactions involve updates of more than one table, there is always the possibility of concurrently running transactions becoming deadlocked when they both try to write to the same set of tables. A transaction releases all of its table locks at once when it either commits or rolls back; it does not relinquish locks one at a time.

For example, suppose that transactions T1 and T2 start at roughly the same time. If T1 starts writing to table A and T2 starts writing to table B, both transactions can proceed without conflict; however, if T1 finishes writing to table A and needs to start writing to table B, it will not be able to proceed because T2 still holds the lock on B. Conversely, if T2 finishes writing to table B and needs to start writing to table A, it will not be able to proceed either because T1 still holds the lock on A. Because neither transaction can release its locks until all its write operations are committed, neither transaction can proceed.

In order to avoid this kind of deadlock, you need to schedule concurrent write operations carefully. For example, you should always update tables in the same order in transactions and, if specifying locks, lock tables in the same order before you perform any DML operations.

Concurrent Write Examples

The following pseudo-code examples demonstrate how transactions either proceed or abort and roll back when they are run concurrently.

Concurrent COPY Operations into the Same Table

Transaction 1 copies rows into the LISTING table:

```
begin;
copy listing from ...;
end;
```

Transaction 2 starts concurrently in a separate session and attempts to copy more rows into the LISTING table. Transaction 2 must wait until transaction 1 releases the write lock on the LISTING table, then it can proceed.

```
begin;
[waits]
copy listing from ;
end;
```

The same behavior would occur if one or both transactions contained an INSERT command instead of a COPY command.

Concurrent DELETE Operations from the Same Table

Transaction 1 deletes rows from a table:

```
begin;
delete from listing where ...;
end;
```

Transaction 2 starts concurrently and attempts to delete rows from the same table. It will succeed because it waits for transaction 1 to complete before attempting to delete rows.

```
begin
```

```
[waits]
delete from listing where ;
end;
```

The same behavior would occur if one or both transactions contained an UPDATE command to the same table instead of a DELETE command.

Concurrent Transactions with a Mixture of Read and Write Operations

In this example, transaction 1 deletes rows from the USERS table, reloads the table, runs a COUNT(*) query, and then ANALYZE, before committing:

```
begin;
delete one row from USERS table;
copy ;
select count(*) from users;
analyze ;
end;
```

Meanwhile, transaction 2 starts. This transaction attempts to copy additional rows into the USERS table, analyze the table, and then run the same COUNT(*) query as the first transaction:

```
begin;
[waits]
copy users from ...;
select count(*) from users;
analyze;
end;
```

The second transaction will succeed because it must wait for the first to complete. Its COUNT query will return the count based on the load it has completed.

Unloading Data

Topics

- [Unloading Data to Amazon S3 \(p. 185\)](#)
- [Unloading Encrypted Data Files \(p. 188\)](#)
- [Unloading Data in Delimited or Fixed-Width Format \(p. 189\)](#)
- [Reloading Unloaded Data \(p. 190\)](#)

To unload data from database tables to a set of files in an Amazon S3 bucket, you can use the [UNLOAD \(p. 471\)](#) command with a SELECT statement. You can unload text data in either delimited format or fixed-width format, regardless of the data format that was used to load it. You can also specify whether to create compressed GZIP files.

You can limit the access users have to your Amazon S3 bucket by using temporary security credentials.

Important

The Amazon S3 bucket where Amazon Redshift will write the output files must be created in the same region as your cluster.

Unloading Data to Amazon S3

Amazon Redshift splits the results of a select statement across a set of files, one or more files per node slice, to simplify parallel reloading of the data. Alternatively, you can specify that [UNLOAD \(p. 471\)](#) should write the results serially to one or more files by adding the PARALLEL OFF option. UNLOAD automatically encrypts data files using Amazon S3 server-side encryption (SSE-S3).

You can use any select statement in the UNLOAD command that Amazon Redshift supports, except for a select that uses a LIMIT clause in the outer select. For example, you can use a select statement that includes specific columns or that uses a where clause to join multiple tables. If your query contains quotes (enclosing literal values, for example), you need to escape them in the query text (\'). For more information, see the [SELECT \(p. 435\)](#) command reference. For more information about using a LIMIT clause, see the [Usage Notes \(p. 475\)](#) for the UNLOAD command.

For example, the following UNLOAD command sends the contents of the VENUE table to the Amazon S3 bucket `s3://mybucket/ticket/unload/`.

```
unload ('select * from venue')  
to 's3://mybucket/ticket/unload/' credentials
```

```
'<aws-auth-args>';
```

If you include a prefix in the Amazon S3 path string, UNLOAD will use that prefix for the file names.

```
unload ('select * from venue')  
to 's3://mybucket/ticket/unload/venue_' credentials  
'<aws-auth-args>;
```

The file names created by the previous example include the prefix 'venue_'.

```
venue_0000_part_00  
venue_0001_part_00  
venue_0002_part_00  
venue_0003_part_00
```

By default, UNLOAD writes data in parallel to multiple files, according to the number of slices in the cluster. To write data to a single file, specify PARALLEL OFF. UNLOAD writes the data serially, sorted absolutely according to the ORDER BY clause, if one is used. The maximum size for a data file is 6.2 GB. If the data size is greater than the maximum, UNLOAD creates additional files, up to 6.2 GB each.

The following example writes the contents VENUE to a single file. Only one file is required because the file size is less than 6.2 GB.

```
unload ('select * from venue')  
to 's3://mybucket/ticket/unload/venue_' credentials  
'<aws-auth-args>'  
parallel off;
```

Note

The UNLOAD command is designed to use parallel processing. We recommend leaving PARALLEL enabled for most cases, especially if the files will be used to load tables using a COPY command.

You can limit the access users have to your data by using temporary security credentials. Temporary security credentials provide enhanced security because they have short life spans and cannot be reused after they expire. A user who has these temporary security credentials can access your resources only until the credentials expire. For more information, see [Temporary Security Credentials](#) (p. 350). To unload data using temporary access credentials, use the following syntax:

```
unload ('select * from venue')  
to 's3://mybucket/ticket/venue_' credentials  
'aws_access_key_id=<temporary-access-key-  
id>;aws_secret_access_key=<temporary-secret-access-key>;token=<temporary-  
token>';
```

Important

The temporary security credentials must be valid for the entire duration of the COPY statement. If the temporary security credentials expire during the load process, the COPY will fail and the transaction will be rolled back. For example, if temporary security credentials expire after 15 minutes and the COPY requires one hour, the COPY will fail before it completes.

You can create a manifest file that lists the unload files by specifying the MANIFEST option in the UNLOAD command. The manifest is a text file in JSON format that explicitly lists the URL of each file that was written to Amazon S3.

The following example includes the manifest option.

```
unload ('select * from venue')
to 's3://mybucket/ticket/venue_' credentials
'<aws-auth-args>'
manifest;
```

The following example shows a manifest for four unload files.

```
{
  "entries": [
    {"url": "s3://mybucket/ticket/venue_0000_part_00"},
    {"url": "s3://mybucket/ticket/venue_0001_part_00"},
    {"url": "s3://mybucket/ticket/venue_0002_part_00"},
    {"url": "s3://mybucket/ticket/venue_0003_part_00"}
  ]
}
```

The manifest file can be used to load the same files by using a COPY with the MANIFEST option. For more information, see [Using a Manifest to Specify Data Files \(p. 139\)](#).

After you complete an UNLOAD operation, confirm that the data was unloaded correctly by navigating to the Amazon S3 bucket where UNLOAD wrote the files. You will see one or more numbered files per slice, starting with the number zero. If you specified the MANIFEST option, you will also see a file ending with 'manifest'. For example:

```
mybucket/ticket/venue_0000_part_00
mybucket/ticket/venue_0001_part_00
mybucket/ticket/venue_0002_part_00
mybucket/ticket/venue_0003_part_00
mybucket/ticket/venue_manifest
```

You can programmatically get a list of the files that were written to Amazon S3 by calling an Amazon S3 list operation after the UNLOAD completes; however, depending on how quickly you issue the call, the list might be incomplete because an Amazon S3 list operation is eventually consistent. To get a complete, authoritative list immediately, query STL_UNLOAD_LOG.

The following query returns the pathname for files that were created by an UNLOAD. The [PG_LAST_QUERY_ID\(\)](#) (p. 679) function returns the most recent query.

```
select query, substring(path,0,40) as path
from stl_unload_log
where query=2320
order by path;
```

query	path
2320	s3://my-bucket/venue0000_part_00
2320	s3://my-bucket/venue0001_part_00
2320	s3://my-bucket/venue0002_part_00
2320	s3://my-bucket/venue0003_part_00

(4 rows)

If the amount of data is very large, Amazon Redshift might split the files into multiple parts per slice. For example:

```
venue_0000_part_00  
venue_0000_part_01  
venue_0000_part_02  
venue_0001_part_00  
venue_0001_part_01  
venue_0001_part_02  
...
```

The following UNLOAD command includes a quoted string in the select statement, so the quotes are escaped (=\'OH\').

```
unload ('select venuevenue, venuecity from venue where venuestate=\'OH\' ')  
to 's3://mybucket/ticket/venue/ ' credentials  
'<aws-auth-args>';
```

By default, UNLOAD will fail rather than overwrite existing files in the destination bucket. To overwrite the existing files, including the manifest file, specify the ALLOWOVERWRITE option.

```
unload ('select * from venue')  
to 's3://mybucket/venue_pipe_' credentials  
'<aws-auth-args>'  
manifest  
allowoverwrite;
```

Unloading Encrypted Data Files

UNLOAD automatically creates files using Amazon S3 server-side encryption with AWS-managed encryption keys (SSE-S3). UNLOAD does not support Amazon S3 server-side encryption with encryption keys from SSE-KMS or a customer-supplied key (SSE-C). For more information, go to [Protecting Data Using Server-Side Encryption](#).

If you want to provide your own encryption key, you can create client-side encrypted data files in Amazon S3 by using the UNLOAD command with the ENCRYPTED option. UNLOAD uses the same envelope encryption process that Amazon S3 client-side encryption uses. You can then use the COPY command with the ENCRYPTED option to load the encrypted files.

The process works like this:

1. You create a base64 encoded 256-bit AES key that you will use as your private encryption key, or *master symmetric key*.
2. You issue an UNLOAD command that includes your master symmetric key and the ENCRYPTED option.
3. UNLOAD generates a one-time-use symmetric key (called the *envelope symmetric key*) and an initialization vector (IV), which it uses to encrypt your data.
4. UNLOAD encrypts the envelope symmetric key using your master symmetric key.
5. UNLOAD then stores the encrypted data files in Amazon S3 and stores the encrypted envelope key and IV as object metadata with each file. The encrypted envelope key is stored as object metadata `x-amz-meta-x-amz-key` and the IV is stored as object metadata `x-amz-meta-x-amz-iv`.

For more information about the envelope encryption process, see the [Client-Side Data Encryption with the AWS SDK for Java and Amazon S3](#) article.

To unload encrypted data files, add the master key value to the credentials string and include the ENCRYPTED option.

Note

If you use the MANIFEST option, the manifest file is not encrypted.

```
unload ('select venuename, venuecity from venue')
to 's3://mybucket/encrypted/venue_'
credentials 'aws_access_key_id=<access-key-id>;aws_secret_access_key=<secret-
access-key>;master_symmetric_key=<master_key>'
manifest
encrypted;
```

To unload encrypted data files that are GZIP compressed, include the GZIP option along with the master key value and the ENCRYPTED option.

```
unload ('select venuename, venuecity from venue')
to 's3://mybucket/encrypted/venue_'
credentials 'aws_access_key_id=<access-key-id>;aws_secret_access_key=<secret-
access-key>;master_symmetric_key=<master_key>'
encrypted gzip;
```

To load the encrypted data files, add the same master key value to the credentials string and include the ENCRYPTED option.

```
copy venue from 's3://mybucket/encrypted/venue_'
credentials 'aws_access_key_id=<access-key-id>;aws_secret_access_key=<secret-
access-key>;master_symmetric_key=<master_key>'
encrypted;
```

Unloading Data in Delimited or Fixed-Width Format

You can unload data in delimited format or fixed-width format. The default output is pipe-delimited (using the '|' character).

The following example specifies a comma as the delimiter:

```
unload ('select * from venue')
to 's3://mybucket/ticket/venue/comma'
credentials '<aws-auth-args>'
delimiter ',';
```

The resulting output files look like this:

```
20,Air Canada Centre,Toronto,ON,0
60,Rexall Place,Edmonton,AB,0
100,U.S. Cellular Field,Chicago,IL,40615
200,Al Hirschfeld Theatre,New York City,NY,0
240,San Jose Repertory Theatre,San Jose,CA,0
300,Kennedy Center Opera House,Washington,DC,0
...
```

To unload the same result set to a tab-delimited file, issue the following command:

```
unload ('select * from venue')
to 's3://mybucket/ticket/venue/tab'
credentials '<aws-auth-args>'
delimiter as '\t';
```

Alternatively, you can use a FIXEDWIDTH specification. This specification consists of an identifier for each table column and the width of the column (number of characters). The UNLOAD command will fail rather than truncate data, so specify a width that is at least as long as the longest entry for that column. Unloading fixed-width data works similarly to unloading delimited data, except that the resulting output contains no delimiting characters. For example:

```
unload ('select * from venue')
to 's3://mybucket/ticket/venue/fw'
credentials '<aws-auth-args>'
fixedwidth '0:3,1:100,2:30,3:2,4:6';
```

The fixed-width output looks like this:

```
20 Air Canada Centre           Toronto      ONO
60 Rexall Place                Edmonton    ABO
100U.S. Cellular Field         Chicago     IL40615
200Al Hirschfeld Theatre       New York CityNYO
240San Jose Repertory Theatre  San Jose    CAO
300Kennedy Center Opera House  Washington  DC0
```

For more details about FIXEDWIDTH specifications, see the [COPY \(p. 317\)](#) command.

Reloading Unloaded Data

To reload the results of an unload operation, you can use a COPY command.

The following example shows a simple case in which the VENUE table is unloaded using a manifest file, truncated, and reloaded.

```
unload ('select * from venue order by venueid')
to 's3://mybucket/ticket/venue/reload_' credentials
'<aws-auth-args>'
manifest
delimiter '|';

truncate venue;

copy venue
from 's3://mybucket/ticket/venue/reload_manifest' credentials
'<aws-auth-args>'
manifest
delimiter '|';
```

After it is reloaded, the VENUE table looks like this:

```
select * from venue order by venueid limit 5;
```

Amazon Redshift Database Developer Guide
Reloading Unloaded Data

venueid	venue name	venue city	venue state	venue seats
1	Toyota Park	Bridgeview	IL	0
2	Columbus Crew Stadium	Columbus	OH	0
3	RFK Stadium	Washington	DC	0
4	CommunityAmerica Ballpark	Kansas City	KS	0
5	Gillette Stadium	Foxborough	MA	68756

(5 rows)

Creating User-Defined Functions

You can create a custom user-defined scalar function (UDF) to implement non-SQL processing based on a Python program. The new function is stored in the database and is available for any user with sufficient privileges to run, in much the same way as you run existing Amazon Redshift functions. In addition to using the standard Python functionality, you can import your own custom Python modules. For more information, see [Python Language Support for UDFs \(p. 195\)](#).

To create a UDF, you must have USAGE privilege for the Python language. The UDF owner or a superuser can execute UDFs; other users must be granted privileges for each function. For more information about privileges, see [UDF Security and Privileges \(p. 192\)](#).

Topics

- [UDF Constraints \(p. 192\)](#)
- [UDF Security and Privileges \(p. 192\)](#)
- [UDF Data Types \(p. 193\)](#)
- [Naming UDFs \(p. 194\)](#)
- [Creating a Scalar UDF \(p. 194\)](#)
- [Python Language Support for UDFs \(p. 195\)](#)

UDF Constraints

Within the constraints listed in this topic, you can use UDFs anywhere you use the Amazon Redshift built-in scalar functions. For more information, see [SQL Functions Reference \(p. 491\)](#).

Amazon Redshift UDFs have the following constraints:

- UDFs cannot access the network or write to the file system.
- The total size of user-installed libraries cannot exceed 100 MB.
- The number of UDFs that can run concurrently per cluster is limited to one-fourth of the total concurrency level for the cluster. For example, if the cluster is configured with a concurrency of 15, a maximum of three UDFs can run concurrently. After the limit is reached, UDFs are queued for execution within workload management queues. For more information, see [Implementing Workload Management \(p. 222\)](#).

UDF Security and Privileges

Superusers have all privileges by default. Users must have the following privileges to work with UDFs:

- To create a UDF or a UDF library, you must have `USAGE ON LANGUAGE plpythonu`.
- To replace or drop a UDF or library, you must be the owner or a superuser.
- To execute a UDF, you must have `EXECUTE ON FUNCTION` for each function. By default, the `PUBLIC` user group has execute permission for new UDFs. To restrict usage, revoke `EXECUTE` from `PUBLIC`, then grant the privilege to specific individuals or groups.

For more information, see [GRANT \(p. 420\)](#) and [REVOKE \(p. 431\)](#).

UDF Data Types

UDFs can use any standard Amazon Redshift data type for the input arguments and the function's return value. In addition to the standard data types, UDFs support the data type `ANYELEMENT`, which Amazon Redshift automatically converts to a standard data type based on the arguments supplied at run time. Scalar UDFs can return a data type of `ANYELEMENT`. For more information, see [ANYELEMENT Data Type \(p. 193\)](#).

During execution, Amazon Redshift converts the arguments from Amazon Redshift data types to Python data types for processing, and then converts the return value from the Python data type to the corresponding Amazon Redshift data type. For more information about Amazon Redshift data types, see [Data Types \(p. 247\)](#).

The following table maps Amazon Redshift data types to Python data types.

Amazon Redshift Data Type	Python Data Type
smallint	int
integer	
bigint	
short	
long	
decimal or numeric	decimal
double	float
real	
boolean	bool
char	string
varchar	
timestamp	datetime

ANYELEMENT Data Type

`ANYELEMENT` is a *polymorphic data type*, which means that if a function is declared using `ANYELEMENT` for an argument's data type, the function can accept any standard Amazon Redshift data type as input for that argument when the function is called. The `ANYELEMENT` argument is set to the data type actually passed to it when the function is called.

If a function uses multiple ANYELEMENT data types, they must all resolve to the same actual data type when the function is called. All ANYELEMENT argument data types are set to the actual data type of the first argument passed to an ANYELEMENT. For example, a function declared as `f_equal(anyelement, anyelement)` will take any two input values, so long as they are of the same data type.

If the return value of a function is declared as ANYELEMENT, at least one input argument must be ANYELEMENT. The actual data type for the return value will be the same as the actual data type supplied for the ANYELEMENT input argument.

Naming UDFs

You can avoid potential conflicts and unexpected results considering your UDF naming conventions before implementation. Because function names can be overloaded, they can collide with existing and future Amazon Redshift function names. This topic discusses overloading and presents a strategy for avoiding conflict.

Overloading Function Names

A function is identified by its name and *signature*, which is the number of input arguments and the data types of the arguments. Two functions in the same schema can have the same name if they have different signatures. In other words, the function names can be *overloaded*.

When you execute a query, the query engine determines which function to call based on the number of arguments you provide and the data types of the arguments. You can use overloading to simulate functions with a variable number of arguments, up to the limit allowed by the [CREATE FUNCTION \(p. 372\)](#) command.

Preventing UDF Naming Conflicts

We recommend that you name all UDFs using the prefix `f_`. Amazon Redshift reserves the `f_` prefix exclusively for UDFs and by prefixing your UDF names with `f_`, you ensure that your UDF name won't conflict with any existing or future Amazon Redshift built-in SQL function names. For example, by naming a new UDF `f_sum`, you avoid conflict with the Amazon Redshift SUM function. Similarly, if you name a new function `f_fibonacci`, you avoid conflict if Amazon Redshift adds a function named FIBONACCI in a future release.

You can create a UDF with the same name and signature as an existing Amazon Redshift built-in SQL function without the function name being overloaded if the UDF and the built-in function exist in different schemas. Because built-in functions exist in the system catalog schema, `pg_catalog`, you can create a UDF with the same name in another schema, such as `public` or a user-defined schema. When you call a function that is not explicitly qualified with a schema name, Amazon Redshift searches the `pg_catalog` schema first by default, so a built-in function will run before a new UDF with the same name.

You can change this behavior by setting the search path to place `pg_catalog` at the end so that your UDFs take precedence over built-in functions, but the practice can cause unexpected results. Adopting a unique naming strategy, such as using the reserved prefix `f_`, is a more reliable practice. For more information, see [SET \(p. 465\)](#) and [search_path \(p. 812\)](#).

Creating a Scalar UDF

A scalar UDF incorporates a Python program that executes when the function is called and returns a single value. The [CREATE FUNCTION \(p. 372\)](#) command defines the following parameters:

- (Optional) Input arguments. Each argument must have a name and a data type.
- One return data type.
- One executable Python program.

The CREATE FUNCTION syntax is as follows:

```
CREATE [ OR REPLACE ] FUNCTION f_function_name
( [ argument_name arg_type [ , ... ] ] )
RETURNS data_type
{ VOLATILE | STABLE | IMMUTABLE }
AS $$
    python_program
$$ LANGUAGE plpythonu;
```

When an Amazon Redshift query calls a scalar UDF, the following steps occur at run time.

1. The function converts the input arguments to Python data types.

For a mapping of Amazon Redshift data types to Python data types, see [UDF Data Types \(p. 193\)](#).

2. The function executes the Python program, passing the converted input arguments.
3. The Python code returns a single value. The data type of the return value must correspond to the RETURNS data type specified by the function definition.
4. The function converts the Python return value to the specified Amazon Redshift data type, then returns that value to the query.

Scalar Function Example

The following example creates a function that compares two numbers and returns the larger value. Note that the indentation of the code between the double dollar signs (\$\$) is a Python requirement. For more information, see [CREATE FUNCTION \(p. 372\)](#).

```
create function f_greater (a float, b float)
    returns float
stable
as $$
    if a > b:
        return a
    return b
$$ language plpythonu;
```

The following query calls the new `f_greater` function to query the SALES table and return either COMMISSION or 20 percent of PRICEPAID, whichever is greater:

```
select f_greater (commission, pricepaid*0.20) from sales;
```

Python Language Support for UDFs

You can create a custom UDF based on the Python programming language. The [Python 2.7 Standard Library](#) is available for use in UDFs, with the exception of the following modules:

- ScrolledText
- Tix
- Tkinter
- tk
- turtle
- smtpd

In addition to the Python Standard Library, the following modules are part of the Amazon Redshift implementation:

- [numpy 1.8.2](#)
- [pandas 0.14.1](#)
- [python-dateutil 2.2](#)
- [pytz 2015.7](#)
- [scipy 0.12.1](#)
- [six 1.3.0](#)
- [wsgiref 0.1.2](#)

You can also import your own custom Python modules and make them available for use in UDFs by executing a [CREATE LIBRARY \(p. 375\)](#) command. For more information, see [Importing Custom Python Library Modules \(p. 196\)](#).

Important

Amazon Redshift blocks all network access and write access to the file system through UDFs.

Importing Custom Python Library Modules

You define scalar functions using Python language syntax. In addition to the native Python Standard Library modules and Amazon Redshift preinstalled modules, you can create your own custom Python library modules and import the libraries into your clusters, or use existing libraries provided by Python or third parties.

You cannot create a library that contains a module with the same name as a Python Standard Library module or an Amazon Redshift preinstalled Python module. If an existing user-installed library uses the same Python package as a library you create, you must drop the existing library before installing the new library.

You must be a superuser or have `USAGE ON LANGUAGE plpythonu` privilege to install custom libraries; however, any user with sufficient privileges to create functions can use the installed libraries. You can query the [PG_LIBRARY \(p. 801\)](#) system catalog to view information about the libraries installed on your cluster.

Note

Amazon Redshift does not support importing Python modules from Microsoft Windows.

To Import a Custom Python Module into Your Cluster

This section provides an example of importing a custom Python module into your cluster. To perform the steps in this section, you must have an Amazon S3 bucket, where you upload the library package. You then install the package in your cluster. For more information about creating buckets, go to [Creating a Bucket](#) in the *Amazon Simple Storage Service Console User Guide*.

In this example, let's suppose that you create UDFs to work with positions and distances in your data. Connect to your Amazon Redshift cluster from a SQL client tool, and run the following commands to create the functions.

```
CREATE FUNCTION f_distance (x1 float, y1 float, x2 float, y2 float) RETURNS
float IMMUTABLE as $$
  def distance(x1, y1, x2, y2):
    import math
    return math.sqrt((y2 - y1) ** 2 + (x2 - x1) ** 2)

  return distance(x1, y1, x2, y2)
$$ LANGUAGE plpythonu;

CREATE FUNCTION f_within_range (x1 float, y1 float, x2 float, y2 float)
RETURNS bool IMMUTABLE as $$
  def distance(x1, y1, x2, y2):
    import math
    return math.sqrt((y2 - y1) ** 2 + (x2 - x1) ** 2)

  return distance(x1, y1, x2, y2) < 20
$$ LANGUAGE plpythonu;
```

Note that a few lines of code are duplicated in the previous functions. This duplication is necessary because a UDF cannot reference the contents of another UDF, and both functions require the same functionality. However, instead of duplicating code in multiple functions, you can create a custom library and configure your functions to use it.

To do so, first create the library package by following these steps:

1. Create a folder named **geometry**. This folder is the top level package of the library.
2. In the **geometry** folder, create a file named `__init__.py`. Note that the file name contains two double underscore characters. This file indicates to Python that the package can be initialized.
3. Also in the **geometry** folder, create a folder named **trig**. This folder is the subpackage of the library.
4. In the **trig** folder, create another file named `__init__.py` and a file named `line.py`. In this folder, `__init__.py` indicates to Python that the subpackage can be initialized and that `line.py` is the file that contains library code.

Your folder and file structure should be the same as the following:

```
geometry/
  __init__.py
  trig/
    __init__.py
    line.py
```

For more information about package structure, go to [Modules](#) in the Python tutorial on the Python website.

5. The following code contains a class and member functions for the library. Copy and paste it into `line.py`.

```
class LineSegment:
  def __init__(self, x1, y1, x2, y2):
    self.x1 = x1
    self.y1 = y1
    self.x2 = x2
    self.y2 = y2
  def angle(self):
    import math
    return math.atan2(self.y2 - self.y1, self.x2 - self.x1)
  def distance(self):
```

```
import math
return math.sqrt((self.y2 - self.y1) ** 2 + (self.x2 - self.x1) ** 2)
```

After you have created the package, do the following to prepare the package and upload it to Amazon S3.

1. Compress the contents of the **geometry** folder into a .zip file named **geometry.zip**. Do not include the **geometry** folder itself; only include the contents of the folder as shown following:

```
geometry.zip
  __init__.py
  trig/
    __init__.py
    line.py
```

2. Upload **geometry.zip** to your Amazon S3 bucket.
3. From your SQL client tool, run the following command to install the library. Replace *<bucket_name>* with the name of your bucket, and replace *<access key id>* and *<secret key>* with an access key and secret access key from your AWS Identity and Access Management (IAM) user credentials.

```
CREATE LIBRARY geometry LANGUAGE plpythonu FROM 's3://<bucket_name>/
geometry.zip' CREDENTIALS 'aws_access_key_id=<access key
id>;aws_secret_access_key=<secret key>';
```

After you install the library in your cluster, you need to configure your functions to use the library. To do this, run the following commands.

```
CREATE OR REPLACE FUNCTION f_distance (x1 float, y1 float, x2 float, y2
float) RETURNS float IMMUTABLE as $$
  from trig.line import LineSegment

  return LineSegment(x1, y1, x2, y2).distance()
$$ LANGUAGE plpythonu;

CREATE OR REPLACE FUNCTION f_within_range (x1 float, y1 float, x2 float, y2
float) RETURNS bool IMMUTABLE as $$
  from trig.line import LineSegment

  return LineSegment(x1, y1, x2, y2).distance() < 20
$$ LANGUAGE plpythonu;
```

In the preceding commands, `import trig/line` eliminates the duplicated code from the original functions in this section. You can reuse the functionality provided by this library in multiple UDFs. Note that to import the module, you only need to specify the path to the subpackage and module name (`trig/line`).

Tuning Query Performance

Amazon Redshift uses queries based on structured query language (SQL) to interact with data and objects in the system. Data manipulation language (DML) is the subset of SQL that you use to view, add, change, and delete data. Data definition language (DDL) is the subset of SQL that you use to add, change, and delete database objects such as tables and views.

Once your system is set up, you will typically work with DML the most, especially the [SELECT \(p. 435\)](#) command for retrieving and viewing data. To write effective data retrieval queries in Amazon Redshift, become familiar with SELECT and apply the tips outlined in [Best Practices for Designing Tables \(p. 21\)](#) to maximize query efficiency.

To understand how Amazon Redshift processes queries, use the [Query Processing \(p. 199\)](#) and [Analyzing and Improving Queries \(p. 209\)](#) sections. Then you can apply this information in combination with diagnostic tools to identify and eliminate issues in query performance.

You can use query queues to manage query execution and avoid performance bottlenecks. You can use the Workload Management (WLM) feature in Amazon Redshift to define multiple query queues and route queries to the appropriate queues at run time. For more information, see [Implementing Workload Management \(p. 222\)](#).

To identify and address some of the most common and most serious issues you are likely to encounter with Amazon Redshift queries, use the [Troubleshooting Queries \(p. 233\)](#) section.

Topics

- [Query Processing \(p. 199\)](#)
- [Analyzing and Improving Queries \(p. 209\)](#)
- [Implementing Workload Management \(p. 222\)](#)
- [Troubleshooting Queries \(p. 233\)](#)

Query Processing

Amazon Redshift routes a submitted SQL query through the parser and optimizer to develop a query plan. The execution engine then translates the query plan into code and sends that code to the compute nodes for execution.

Topics

- [Query Planning And Execution Workflow \(p. 200\)](#)

- [Reviewing Query Plan Steps](#) (p. 201)
- [Query Plan](#) (p. 202)
- [Factors Affecting Query Performance](#) (p. 208)

Query Planning And Execution Workflow

The following illustration provides a high-level view of the query planning and execution workflow.

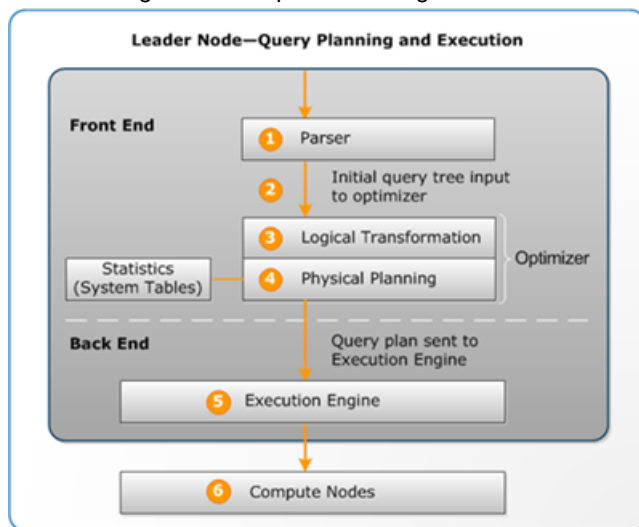

The query planning and execution workflow follows these steps:

1. The leader node receives the query and parses the SQL.
2. The parser produces an initial query tree that is a logical representation of the original query. Amazon Redshift then inputs this query tree into the query optimizer.
3. The optimizer evaluates and if necessary rewrites the query to maximize its efficiency. This process sometimes results in creating multiple related queries to replace a single one.
4. The optimizer generates a query plan (or several, if the previous step resulted in multiple queries) for the execution with the best performance. The query plan specifies execution options such as join types, join order, aggregation options, and data distribution requirements.

You can use the [EXPLAIN](#) (p. 415) command to view the query plan. The query plan is a fundamental tool for analyzing and tuning complex queries. For more information, see [Query Plan](#) (p. 202).

5. The execution engine translates the query plan into *steps*, *segments* and *streams*:

Step

Each step is an individual operation needed during query execution. Steps can be combined to allow compute nodes to perform a query, join, or other database operation.

Segment

A combination of several steps that can be done by a single process, also the smallest compilation unit executable by a compute node slice. A *slice* is the unit of parallel processing in Amazon Redshift. The segments in a stream run in parallel.

Stream

A collection of segments to be parceled out over the available compute node slices.

The execution engine generates compiled C++ code based on steps, segments, and streams. Compiled code executes faster than interpreted code and uses less compute capacity. This compiled code is then broadcast to the compute nodes.

Note

When benchmarking your queries, you should always compare the times for the second execution of a query, because the first execution time includes the overhead of compiling the code. For more information, see [Factors Affecting Query Performance \(p. 208\)](#).

6. The compute node slices execute the query segments in parallel. As part of this process, Amazon Redshift takes advantage of optimized network communication, memory, and disk management to pass intermediate results from one query plan step to the next, which also helps to speed query execution.

Steps 5 and 6 happen once for each stream. The engine creates the executable segments for one stream and sends them to the compute nodes. When the segments of that stream are complete, the engine generates the segments for the next stream. In this way, the engine can analyze what happened in the prior stream (for example, whether operations were disk-based) to influence the generation of segments in the next stream.

When the compute nodes are done, they return the query results to the leader node for final processing. The leader node merges the data into a single result set and addresses any needed sorting or aggregation. The leader node then returns the results to the client.

Note

The compute nodes might return some data to the leader node during query execution if necessary. For example, if you have a subquery with a LIMIT clause, the limit is applied on the leader node before data is redistributed across the cluster for further processing.

Reviewing Query Plan Steps

You can see the steps in a query plan by running the EXPLAIN command. The following example shows a SQL query and the query plan that the EXPLAIN command produces for it. Reading the query plan from the bottom up, you can see each of the logical operations needed to perform the query. For more information, see [Query Plan \(p. 202\)](#).

```
explain
select eventname, sum(pricepaid) from sales, event
where sales.eventid = event.eventid
group by eventname
order by 2 desc;
```

```
XN Merge (cost=1002815366604.92..1002815366606.36 rows=576 width=27)
  Merge Key: sum(sales.pricepaid)
  -> XN Network (cost=1002815366604.92..1002815366606.36 rows=576 width=27)
      Send to leader
      -> XN Sort (cost=1002815366604.92..1002815366606.36 rows=576
width=27)
          Sort Key: sum(sales.pricepaid)
          -> XN HashAggregate (cost=2815366577.07..2815366578.51
rows=576 width=27)
              -> XN Hash Join DS_BCAST_INNER
(cost=109.98..2815365714.80 rows=172456 width=27)
                  Hash Cond: ("outer".eventid = "inner".eventid)
                  -> XN Seq Scan on sales (cost=0.00..1724.56
rows=172456 width=14)
                      -> XN Hash (cost=87.98..87.98 rows=8798 width=21)
                          -> XN Seq Scan on event (cost=0.00..87.98
rows=8798 width=21)
```

The following illustration uses the preceding query and associated query plan to show how those query operations are mapped to steps, segments, and streams. Each query plan operation maps to multiple steps within the segments, and sometimes to multiple segments within the streams.



Query Plan

You can use the query plan to get information on the individual operations required to execute a query. Before you work with a query plan, we recommend you first understand how Amazon Redshift handles processing queries and creating query plans. For more information, see [Query Planning And Execution Workflow \(p. 200\)](#).

To create a query plan, run the [EXPLAIN \(p. 415\)](#) command followed by the actual query text. The query plan gives you the following information:

- What operations the execution engine will perform, reading the results from bottom to top.
- What type of step each operation performs.
- Which tables and columns are used in each operation.
- How much data is processed in each operation, in terms of number of rows and data width in bytes.
- The relative cost of the operation. *Cost* is a measure that compares the relative execution times of the steps within a plan. Cost does not provide any precise information about actual execution times

or memory consumption, nor does it provide a meaningful comparison between execution plans. It does give you an indication of which operations in a query are consuming the most resources.

The EXPLAIN command doesn't actually run the query. It only shows the plan that Amazon Redshift will execute if the query is run under current operating conditions. If you change the schema or data for a table and run [ANALYZE \(p. 309\)](#) again to update the statistical metadata, the query plan might be different.

The query plan output by EXPLAIN is a simplified, high-level view of query execution. It doesn't illustrate the details of parallel query processing. To see detailed information, you need to run the query itself, and then get query summary information from the SVL_QUERY_SUMMARY or SVL_QUERY_REPORT view. For more information about using these views, see [Analyzing the Query Summary \(p. 212\)](#).

The following example shows the EXPLAIN output for a simple GROUP BY query on the EVENT table:

```
explain select eventname, count(*) from event group by eventname;

                                QUERY PLAN
-----
XN HashAggregate (cost=131.97..133.41 rows=576 width=17)
->  XN Seq Scan on event (cost=0.00..87.98 rows=8798 width=17)
```

EXPLAIN returns the following metrics for each operation:

Cost

A relative value that is useful for comparing operations within a plan. Cost consists of two decimal values separated by two periods, for example `cost=131.97..133.41`. The first value, in this case 131.97, provides the relative cost of returning the first row for this operation. The second value, in this case 133.41, provides the relative cost of completing the operation. The costs in the query plan are cumulative as you read up the plan, so the HashAggregate cost in this example (131.97..133.41) includes the cost of the Seq Scan below it (0.00..87.98).

Rows

The estimated number of rows to return. In this example, the scan is expected to return 8798 rows. The HashAggregate operator on its own is expected to return 576 rows (after duplicate event names are discarded from the result set).

Note

The rows estimate is based on the available statistics generated by the ANALYZE command. If ANALYZE has not been run recently, the estimate will be less reliable.

Width

The estimated width of the average row, in bytes. In this example, the average row is expected to be 17 bytes wide.

EXPLAIN Operators

This section briefly describes the operators that you see most often in the EXPLAIN output. For a complete list of operators, see [EXPLAIN \(p. 415\)](#) in the SQL Commands section.

Sequential Scan Operator

The sequential scan operator (Seq Scan) indicates a table scan. Seq Scan scans each column in the table sequentially from beginning to end and evaluates query constraints (in the WHERE clause) for every row.

Join Operators

Amazon Redshift selects join operators based on the physical design of the tables being joined, the location of the data required for the join, and the specific requirements of the query itself.

- **Nested Loop**

The least optimal join, a nested loop is used mainly for cross-joins (Cartesian products) and some inequality joins.

- **Hash Join and Hash**

Typically faster than a nested loop join, a hash join and hash are used for inner joins and left and right outer joins. These operators are used when joining tables where the join columns are not both distribution keys *and* sort keys. The hash operator creates the hash table for the inner table in the join; the hash join operator reads the outer table, hashes the joining column, and finds matches in the inner hash table.

- **Merge Join**

Typically the fastest join, a merge join is used for inner and outer joins. This operator is used when joining tables where the join columns are both distribution keys *and* sort keys, and when less than 20 percent of the joining tables are unsorted. It reads two sorted tables in order and finds the matching rows. To view the percent of unsorted rows, query the [SVV_TABLE_INFO \(p. 791\)](#) system table.

Aggregate Operators

The query plan uses the following operators in queries that involve aggregate functions and GROUP BY operations.

- **Aggregate**

Operator for scalar aggregate functions such as AVG and SUM.

- **HashAggregate**

Operator for unsorted grouped aggregate functions.

- **GroupAggregate**

Operator for sorted grouped aggregate functions.

Sort Operators

The query plan uses the following operators when queries have to sort or merge result sets.

- **Sort**

Evaluates the ORDER BY clause and other sort operations, such as sorts required by UNION queries and joins, SELECT DISTINCT queries, and window functions.

- **Merge**

Produces final sorted results according to intermediate sorted results that derive from parallel operations.

UNION, INTERSECT, and EXCEPT Operators

The query plan uses the following operators for queries that involve set operations with UNION, INTERSECT, and EXCEPT.

- **Subquery**

Used to run UNION queries.

- **Hash Intersect Distinct and Hash Intersect All**

Used to run INTERSECT and INTERSECT ALL queries.

- **SetOp Except**

Used to run EXCEPT (or MINUS) queries.

Other Operators

The following operators also appear frequently in EXPLAIN output for routine queries.

- **Unique**

Eliminates duplicates for SELECT DISTINCT queries and UNION queries.

- **Limit**

Processes the LIMIT clause.

- **Window**

Runs window functions.

- **Result**

Runs scalar functions that do not involve any table access.

- **Subplan**

Used for certain subqueries.

- **Network**

Sends intermediate results to the leader node for further processing.

- **Materialize**

Saves rows for input to nested loop joins and some merge joins.

Joins in EXPLAIN

The query optimizer uses different join types to retrieve table data, depending on the structure of the query and the underlying tables. The EXPLAIN output references the join type, the tables used, and the way the table data is distributed across the cluster to describe how the query is processed.

Join Type Examples

The following examples show the different join types that the query optimizer can use. The join type used in the query plan depends on the physical design of the tables involved.

Example: Hash Join Two Tables

The following query joins EVENT and CATEGORY on the CATID column. CATID is the distribution and sort key for CATEGORY but not for EVENT. A hash join is performed with EVENT as the outer table and CATEGORY as the inner table. Because CATEGORY is the smaller table, the planner broadcasts a copy of it to the compute nodes during query processing by using DS_BCAST_INNER. The join cost in this example accounts for most of the cumulative cost of the plan.

```
explain select * from category, event where category.catid=event.catid;
```

QUERY PLAN

```
-----  
XN Hash Join DS_BCAST_INNER (cost=0.14..6600286.07 rows=8798 width=84)  
  Hash Cond: ("outer".catid = "inner".catid)  
    -> XN Seq Scan on event (cost=0.00..87.98 rows=8798 width=35)  
    -> XN Hash (cost=0.11..0.11 rows=11 width=49)  
      -> XN Seq Scan on category (cost=0.00..0.11 rows=11 width=49)
```

Note

Aligned indents for operators in the EXPLAIN output sometimes indicate that those operations do not depend on each other and can start in parallel. In the preceding example, although the scan on the EVENT table and the hash operation are aligned, the EVENT scan must wait until the hash operation has fully completed.

[Example: Merge Join Two Tables](#)

The following query also uses SELECT *, but it joins SALES and LISTING on the LISTID column, where LISTID has been set as both the distribution and sort key for both tables. A merge join is chosen, and no redistribution of data is required for the join (DS_DIST_NONE).

```
explain select * from sales, listing where sales.listid = listing.listid;  
QUERY PLAN
```

```
-----  
XN Merge Join DS_DIST_NONE (cost=0.00..6285.93 rows=172456 width=97)  
  Merge Cond: ("outer".listid = "inner".listid)  
    -> XN Seq Scan on listing (cost=0.00..1924.97 rows=192497 width=44)  
    -> XN Seq Scan on sales (cost=0.00..1724.56 rows=172456 width=53)
```

The following example demonstrates the different types of joins within the same query. As in the previous example, SALES and LISTING are merge joined, but the third table, EVENT, must be hash joined with the results of the merge join. Again, the hash join incurs a broadcast cost.

```
explain select * from sales, listing, event  
where sales.listid = listing.listid and sales.eventid = event.eventid;  
QUERY PLAN
```

```
-----  
XN Hash Join DS_BCAST_INNER (cost=109.98..3871130276.17 rows=172456  
width=132)  
  Hash Cond: ("outer".eventid = "inner".eventid)  
    -> XN Merge Join DS_DIST_NONE (cost=0.00..6285.93 rows=172456 width=97)  
      Merge Cond: ("outer".listid = "inner".listid)  
        -> XN Seq Scan on listing (cost=0.00..1924.97 rows=192497 width=44)  
        -> XN Seq Scan on sales (cost=0.00..1724.56 rows=172456 width=53)  
    -> XN Hash (cost=87.98..87.98 rows=8798 width=35)  
      -> XN Seq Scan on event (cost=0.00..87.98 rows=8798 width=35)
```

[Example: Join, Aggregate, and Sort](#)

The following query executes a hash join of the SALES and EVENT tables, followed by aggregation and sort operations to account for the grouped SUM function and the ORDER BY clause. The initial Sort operator runs in parallel on the compute nodes. Then the Network operator sends the results to the leader node, where the Merge operator produces the final sorted results.

```
explain select eventname, sum(pricepaid) from sales, event  
where sales.eventid=event.eventid group by eventname
```

```
order by 2 desc;
```

QUERY PLAN

```
-----
XN Merge (cost=1002815366604.92..1002815366606.36 rows=576 width=27)
  Merge Key: sum(sales.pricepaid)
  -> XN Network (cost=1002815366604.92..1002815366606.36 rows=576 width=27)
      Send to leader
      -> XN Sort (cost=1002815366604.92..1002815366606.36 rows=576
width=27)
          Sort Key: sum(sales.pricepaid)
          -> XN HashAggregate (cost=2815366577.07..2815366578.51
rows=576 width=27)
              -> XN Hash Join DS_BCAST_INNER
(cost=109.98..2815365714.80 rows=172456 width=27)
                  Hash Cond: ("outer".eventid = "inner".eventid)
                  -> XN Seq Scan on sales (cost=0.00..1724.56
rows=172456 width=14)
                      -> XN Hash (cost=87.98..87.98 rows=8798 width=21)
                          -> XN Seq Scan on event (cost=0.00..87.98
rows=8798 width=21)
```

Data Redistribution

The EXPLAIN output for joins also specifies a method for how data will be moved around a cluster to facilitate the join. This data movement can be either a broadcast or a redistribution. In a broadcast, the data values from one side of a join are copied from each compute node to every other compute node, so that every compute node ends up with a complete copy of the data. In a redistribution, participating data values are sent from their current slice to a new slice (possibly on a different node). Data is typically redistributed to match the distribution key of the other table participating in the join if that distribution key is one of the joining columns. If neither of the tables has distribution keys on one of the joining columns, either both tables are distributed or the inner table is broadcast to every node.

The EXPLAIN output also references inner and outer tables. The inner table is scanned first, and appears nearer the bottom of the query plan. The inner table is the table that is probed for matches. It is usually held in memory, is usually the source table for hashing, and if possible, is the smaller table of the two being joined. The outer table is the source of rows to match against the inner table. It is usually read from disk. The query optimizer chooses the inner and outer table based on database statistics from the latest run of the ANALYZE command. The order of tables in the FROM clause of a query doesn't determine which table is inner and which is outer.

Use the following attributes in query plans to identify how data will be moved to facilitate a query:

- **DS_BCAST_INNER**

A copy of the entire inner table is broadcast to all compute nodes.

- **DS_DIST_ALL_NONE**

No redistribution is required, because the inner table has already been distributed to every node using DISTSTYLE ALL.

- **DS_DIST_NONE**

No tables are redistributed. Collocated joins are possible because corresponding slices are joined without moving data between nodes.

- **DS_DIST_INNER**

The inner table is redistributed.

- **DS_DIST_ALL_INNER**

The entire inner table is redistributed to a single slice because the outer table uses `DISTSTYLE ALL`.

- **DS_DIST_BOTH**

Both tables are redistributed.

Factors Affecting Query Performance

A number of factors can affect query performance. The following aspects of your data, cluster, and database operations all play a part in how quickly your queries process.

- **Number of nodes, processors, or slices** – A compute node is partitioned into slices. More nodes means more processors and more slices, which enables your queries to process faster by running portions of the query concurrently across the slices. However, more nodes also means greater expense, so you will need to find the balance of cost and performance that is appropriate for your system. For more information on Amazon Redshift cluster architecture, see [Data Warehouse System Architecture](#) (p. 4).
- **Node types** – An Amazon Redshift cluster can use either dense storage or dense compute nodes. The dense storage node types are recommended for substantial data storage needs, while dense compute node types are optimized for performance-intensive workloads. Each node type offers different sizes and limits to help you scale your cluster appropriately. The node size determines the storage capacity, memory, CPU, and price of each node in the cluster. For more information on node types, see [Amazon Redshift Pricing](#).
- **Data distribution** – Amazon Redshift stores table data on the compute nodes according to a table's distribution style. When you execute a query, the query optimizer redistributes the data to the compute nodes as needed to perform any joins and aggregations. Choosing the right distribution style for a table helps minimize the impact of the redistribution step by locating the data where it needs to be before the joins are performed. For more information, see [Choosing a Data Distribution Style](#) (p. 110).
- **Data sort order** – Amazon Redshift stores table data on disk in sorted order according to a table's sort keys. The query optimizer and the query processor use the information about where the data is located to reduce the number of blocks that need to be scanned and thereby improve query speed. For more information, see [Choosing Sort Keys](#) (p. 122).
- **Dataset size** – A higher volume of data in the cluster can slow query performance for queries, because more rows need to be scanned and redistributed. You can mitigate this effect by regular vacuuming and archiving of data, and by using a predicate to restrict the query dataset.
- **Concurrent operations** – Running multiple operations at once can affect query performance. Each operation takes one or more slots in an available query queue and uses the memory associated with those slots. If other operations are running, enough query queue slots might not be available. In this case, the query will have to wait for slots to open before it can begin processing. For more information about creating and configuring query queues, see [Implementing Workload Management](#) (p. 222).
- **Query structure** – How your query is written will affect its performance. As much as possible, write queries to process and return as little data as will meet your needs. For more information, see [Best Practices for Designing Queries](#) (p. 28).
- **Code compilation** – Amazon Redshift generates and compiles code for each query execution plan. The compiled code segments are stored in a least recently used (LRU) cache and shared across sessions in a cluster. Thus, subsequent executions of the same query, even in different sessions and often even with different query parameters, will run faster because they can skip the initial generation and compilation steps. The LRU cache persists through cluster reboots, but is wiped by maintenance upgrades.

The compiled code executes faster because it eliminates the overhead of using an interpreter. You always have some overhead cost the first time code is generated and compiled. As a result,

the performance of a query the first time you run it can be misleading. The overhead cost might be especially noticeable when you run one-off (ad hoc) queries. You should always run a query a second time to determine its typical performance.

Similarly, be careful about comparing the performance of the same query sent from different clients. The execution engine generates different code for the JDBC connection protocols and ODBC and psql (libpq) connection protocols. If two clients use different protocols, each client will incur the first-time cost of generating compiled code, even for the same query. Other clients that use the same protocol, however, will benefit from sharing the cached code. A client that uses ODBC and a client running psql with libpq can share the same compiled code.

Analyzing and Improving Queries

Retrieving information from an Amazon Redshift data warehouse involves executing complex queries on extremely large amounts of data, which can take a long time to process. To ensure queries process as quickly as possible, there are a number of tools you can use to identify potential performance issues.

Topics

- [Query Analysis Workflow](#) (p. 209)
- [Reviewing Query Alerts](#) (p. 210)
- [Analyzing the Query Plan](#) (p. 211)
- [Analyzing the Query Summary](#) (p. 212)
- [Improving Query Performance](#) (p. 216)
- [Diagnostic Queries for Query Tuning](#) (p. 219)

Query Analysis Workflow

If a query is taking longer than expected, use the following steps to identify and correct issues that might be negatively affecting the query's performance. If you aren't sure what queries in your system might benefit from performance tuning, start by running the diagnostic query in [Identifying Queries That Are Top Candidates for Tuning](#) (p. 220).

1. Make sure your tables are designed according to best practices. For more information, see [Best Practices for Designing Tables](#) (p. 21).
2. See if you can delete or archive any unneeded data in your tables. For example, suppose your queries always target the last 6 months' worth of data but you have the last 18 months' worth in your tables. In this case, you can delete or archive the older data to reduce the number of records that need to be scanned and distributed.
3. Run the [VACUUM](#) (p. 488) command on the tables in the query to reclaim space and re-sort rows. Running VACUUM helps if the unsorted region is large and the query uses the sort key in a join or in the predicate.
4. Run the [ANALYZE](#) (p. 309) command on the tables in the query to make sure statistics are up to date. Running ANALYZE helps if any of the tables in the query have recently changed a lot in size. If running a full ANALYZE command will take too long, run ANALYZE on a single column to reduce processing time. This approach will still update the table size statistics; table size is a significant factor in query planning.
5. Make sure your query has been run once for each type of client (based on what type of connection protocol the client uses) so that the query is compiled and cached. This approach will speed up subsequent runs of the query. For more information, see [Factors Affecting Query Performance](#) (p. 208).

6. Check the [STL_ALERT_EVENT_LOG](#) (p. 690) table to identify and correct possible issues with your query. For more information, see [Reviewing Query Alerts](#) (p. 210).
7. Run the [EXPLAIN](#) (p. 415) command to get the query plan and use it to optimize the query. For more information, see [Analyzing the Query Plan](#) (p. 211).
8. Use the [SVL_QUERY_SUMMARY](#) (p. 788) and [SVL_QUERY_REPORT](#) (p. 784) views to get summary information and use it to optimize the query. For more information, see [Analyzing the Query Summary](#) (p. 212).

Sometimes a query that should execute quickly is forced to wait until another, longer-running query finishes. In that case, you might have nothing to improve in the query itself, but you can improve overall system performance by creating and using query queues for different types of queries. To get an idea of queue wait time for your queries, see [Reviewing Queue Wait Times for Queries](#) (p. 221). For more information about configuring query queues, see [Implementing Workload Management](#) (p. 222).

Reviewing Query Alerts

To use the [STL_ALERT_EVENT_LOG](#) (p. 690) system table to identify and correct potential performance issues with your query, follow these steps:

1. Run the following to determine your query ID:

```
select query, elapsed, substring
from svl_qlog
order by query
desc limit 5;
```

Examine the truncated query text in the `substring` field to determine which `query` value to select. If you have run the query more than once, use the `query` value from the row with the lower `elapsed` value. That is the row for the compiled version. If you have been running many queries, you can raise the value used by the `LIMIT` clause used to make sure your query is included.

2. Select rows from `STL_ALERT_EVENT_LOG` for your query:

```
Select * from stl_alert_event_log where query = MyQueryID;
```

userid	query	slice	segment	step	pid	xid	event	solution	event_time
100	32359	4	0	0	8780	71195	Very selective query filter:ratio=rows(2)/r	Review the choice of sort key to enable...	2015-02-10 17:40:50
100	32359	5	0	0	8781	71195	Very selective query filter:ratio=rows(2)/r	Review the choice of sort key to enable...	2015-02-10 17:40:50
100	109142	4	0	0	8780	302411	Very selective query filter:ratio=rows(2)/r	Review the choice of sort key to enable...	2015-02-24 20:32:28
100	109142	5	0	0	8781	302411	Very selective query filter:ratio=rows(2)/r	Review the choice of sort key to enable...	2015-02-24 20:32:28
100	109828	4	1	0	8746	304543	Very selective query filter:ratio=rows(3)/r	Review the choice of sort key to enable...	2015-02-24 23:27:52
100	109828	5	1	0	8747	304543	Very selective query filter:ratio=rows(3)/r	Review the choice of sort key to enable...	2015-02-24 23:27:52
100	109829	4	1	0	8760	304543	Very selective query filter:ratio=rows(3)/r	Review the choice of sort key to enable...	2015-02-24 23:28:01
100	109829	5	1	0	8761	304543	Very selective query filter:ratio=rows(3)/r	Review the choice of sort key to enable...	2015-02-24 23:28:01
100	113910	4	1	0	8774	316848	Very selective query filter:ratio=rows(3)/r	Review the choice of sort key to enable...	2015-02-25 17:14:58

3. Evaluate the results for your query. Use the following table to locate potential solutions for any issues that you have identified.

Note

Not all queries will have rows in `STL_ALERT_EVENT_LOG`, only those with identified issues.

Issue	Event Value	Solution Value	Recommended Solution
Statistics for the tables in the query are missing or out of date.	Missing query planner statistics	Run the ANALYZE command	See Table Statistics

Issue	Event Value	Solution Value	Recommended Solution
			Missing or Out of Date (p. 217) .
There is a nested loop join (the least optimal join) in the query plan.	Nested Loop Join in the query plan	Review the join predicates to avoid Cartesian products	See Nested Loop (p. 217) .
The scan skipped a relatively large number of rows that are marked as deleted but not vacuumed, or rows that have been inserted but not committed.	Scanned a large number of deleted rows	Run the VACUUM command to reclaim deleted space	See Ghost Rows or Uncommitted Rows (p. 218) .
More than 1,000,000 rows were redistributed for a hash join or aggregation.	Distributed a large number of rows across the network: RowCount rows were distributed in order to process the aggregation	Review the choice of distribution key to collocate the join or aggregation	See Suboptimal Data Distribution (p. 218) .
More than 1,000,000 rows were broadcast for a hash join.	Broadcasted a large number of rows across the network	Review the choice of distribution key to collocate the join and consider using distributed tables	See Suboptimal Data Distribution (p. 218) .
A DS_DIST_ALL_INNER redistribution style was indicated in the query plan, which forces serial execution because the entire inner table was redistributed to a single node.	DS_DIST_ALL_INNER for Hash Join in the query plan	Review the choice of distribution strategy to distribute the inner, rather than outer, table	See Suboptimal Data Distribution (p. 218) .

Analyzing the Query Plan

Before analyzing the query plan, you should be familiar with how to read it. If you are unfamiliar with reading a query plan, we recommend that you read [Query Plan \(p. 202\)](#) before proceeding.

Run the [EXPLAIN \(p. 415\)](#) command to get a query plan. To analyze the data provided by the query plan, follow these steps:

1. Identify the steps with the highest cost. Concentrate on optimizing those when proceeding through the remaining steps.
2. Look at the join types:
 - **Nested Loop:** Such joins usually occur because a join condition was omitted. For recommended solutions, see [Nested Loop \(p. 217\)](#).
 - **Hash and Hash Join:** Hash joins are used when joining tables where the join columns are not distribution keys and also not sort keys. For recommended solutions, see [Hash Join \(p. 217\)](#).

- **Merge Join:** No change is needed.
3. Notice which table is used for the inner join, and which for the outer join. The query engine generally chooses the smaller table for the inner join, and the larger table for the outer join. If such a choice doesn't occur, your statistics are likely out of date. For recommended solutions, see [Table Statistics Missing or Out of Date \(p. 217\)](#).
 4. See if there are any high-cost sort operations. If there are, see [Unsorted or Missorted Rows \(p. 218\)](#) for recommended solutions.
 5. Look for the following broadcast operators where there are high-cost operations:
 - **DS_BCAST_INNER:** Indicates the table is broadcast to all the compute nodes, which is fine for a small table but not ideal for a larger table.
 - **DS_DIST_ALL_INNER:** Indicates that all of the workload is on a single slice.
 - **DS_DIST_BOTH:** Indicates heavy redistribution.
- For recommended solutions for these situations, see [Suboptimal Data Distribution \(p. 218\)](#).

Analyzing the Query Summary

To get execution steps and statistics in more detail than in the query plan than [EXPLAIN \(p. 415\)](#) produces, use the [SVL_QUERY_SUMMARY \(p. 788\)](#) and [SVL_QUERY_REPORT \(p. 784\)](#) system views.

[SVL_QUERY_SUMMARY](#) provides query statistics by stream. You can use the information it provides to identify issues with expensive steps, long-running steps, and steps that write to disk.

The [SVL_QUERY_REPORT](#) system view allows you to see information similar to that for [SVL_QUERY_SUMMARY](#), only by compute node slice rather than by stream. You can use the slice-level information for detecting uneven data distribution across the cluster (also known as data distribution skew), which forces some nodes to do more work than others and impairs query performance.

Topics

- [Using the SVL_QUERY_SUMMARY View \(p. 212\)](#)
- [Using the SVL_QUERY_REPORT View \(p. 214\)](#)
- [Mapping the Query Plan to the Query Summary \(p. 215\)](#)

Using the SVL_QUERY_SUMMARY View

To analyze query summary information by stream, do the following:

1. Run the following query to determine your query ID:

```
select query, elapsed, substring
from svl_qlog
order by query
desc limit 5;
```

Examine the truncated query text in the `substring` field to determine which `query` value represents your query. If you have run the query more than once, use the `query` value from the row with the lower `elapsed` value. That is the row for the compiled version. If you have been running many queries, you can raise the value used by the `LIMIT` clause used to make sure your query is included.

2. Select rows from [SVL_QUERY_SUMMARY](#) for your query. Order the results by stream, segment, and step:

```
select * from svl_query_summary where query = MyQueryID order by stm, seg,
step;
```

userid	query	stm	seg	step	maxtime	avgtime	rows	bytes	rate_row	rate_byte	label	is_diskbased	workmem	is_rrscan	is_delayed_scan	rows_pre_filter
1	249059	0	0	0	58	27	4	192			scan tbl=246 name=Internal Worktable	f		0 f	f	0
1	249059	0	0	1	58	27	4	0			project	f		0 f	f	0
1	249059	0	0	2	58	27	4	64			save tbl=249	f	481296384 f	f	f	0
1	249059	1	1	0	20	20	1	48			scan tbl=250 name=Internal Worktable	f		0 f	f	0
1	249059	1	1	1	20	20	1	0			dist	f		0 f	f	0
1	249059	1	2	0	2275	1350	1	48			scan tbl=19221 name=Internal Worktable	f		0 f	f	0
1	249059	1	2	1	2275	1350	1	0			project	f		0 f	f	0
1	249059	1	2	2	2275	1350	1	16			save tbl=249	f	475004928 f	f	f	0
1	249059	2	3	0	1640	792	5	80			scan tbl=249 name=Internal Worktable	f		0 f	f	0
1	249059	2	3	1	1640	792	5	80			sort tbl=248	f	468713472 f	f	f	0
1	249059	3	4	0	26	9	5	80			scan tbl=248 name=Internal Worktable	f		0 f	f	0
1	249059	3	4	1	26	9	5	0			return	f		0 f	f	0
1	249059	3	5	0	49	49	0	0			merge	f		0 f	f	0
1	249059	3	5	1	49	49	5	0			project	f		0 f	f	0
1	249059	3	5	2	49	49	0	0			return	f		0 f	f	0

- Map the steps to the operations in the query plan using the information in [Mapping the Query Plan to the Query Summary](#) (p. 215). They should have approximately the same values for rows and bytes (rows * width from the query plan). If they don't, see [Table Statistics Missing or Out of Date](#) (p. 217) for recommended solutions.
- See if the `is_diskbased` field has a value of `t` (true) for any step. Hashes, aggregates, and sorts are the operators that are likely to write data to disk if the system doesn't have enough memory allocated for query processing.

If `is_diskbased` is true, see [Insufficient Memory Allocated to the Query](#) (p. 218) for recommended solutions.

- Review the `label` field values and see if there is an AGG-DIST-AGG sequence anywhere in the steps. Its presence indicates two-step aggregation, which is expensive. To fix this, change the GROUP BY clause to use the distribution key (the first key, if there are multiple ones).
- Review the `maxtime` value for each segment (it is the same across all steps in the segment). Identify the segment with the highest `maxtime` value and review the steps in this segment for the following operators.

Note

A high `maxtime` value doesn't necessarily indicate a problem with the segment. Despite a high value, the segment might not have taken a long time to process. All segments in a stream start getting timed in unison. However, some downstream segments might not be able to run until they get data from upstream ones. This effect might make them seem to have taken a long time because their `maxtime` value will include both their waiting time and their processing time.

- BCAST or DIST:** In these cases, the high `maxtime` value might be the result of redistributing a large number of rows. For recommended solutions, see [Suboptimal Data Distribution](#) (p. 218).
- HJOIN (hash join):** If the step in question has a very high value in the `rows` field compared to the `rows` value in the final RETURN step in the query, see [Hash Join](#) (p. 217) for recommended solutions.
- SCAN/SORT:** Look for a SCAN, SORT, SCAN, MERGE sequence of steps just prior to a join step. This pattern indicates that unsorted data is being scanned, sorted, and then merged with the sorted area of the table.

See if the rows value for the SCAN step has a very high value compared to the rows value in the final RETURN step in the query. This pattern indicates that the execution engine is scanning rows that are later discarded, which is inefficient. For recommended solutions, see [Insufficiently Restrictive Predicate](#) (p. 219).

If the `maxtime` value for the SCAN step is high, see [Suboptimal WHERE Clause](#) (p. 219) for recommended solutions.

If the `rows` value for the SORT step is not zero, see [Unsorted or Missorted Rows \(p. 218\)](#) for recommended solutions.

- Review the `rows` and `bytes` values for the 5–10 steps that precede the final RETURN step to get an idea of the amount of data that is being returned to the client. This process can be a bit of an art.

For example, in the following query summary, you can see that the third PROJECT step provides a `rows` value but not a `bytes` value. By looking through the preceding steps for one with the same `rows` value, you find the SCAN step that provides both rows and bytes information:

userid	query	stm	seg	step	maxtime	avgttime	rows	bytes	rate_row	rate_byte	label	is_diskbased	workmem
1	187435	2	5	2	14307	12797	0	0			hash tbl=256	f	46871347
1	187435	3	6	0	531	308	387	229104			scan tbl=242 name=Internal Worktable	f	
1	187435	3	6	1	531	308	387	0			project	f	
1	187435	3	6	2	531	308	387	222912			save tbl=245	f	38063308
1	187435	4	7	0	390	390	0	0			scan tbl=238 name=Internal Worktable	f	
1	187435	4	7	1	390	390	0	0			dist	f	
1	187435	4	8	0	1218	1066	0	0			scan tbl=134954 name=Internal Worktable	f	
1	187435	4	8	1	1218	1066	0	0			project	f	
1	187435	4	8	2	1218	1066	0	0			save tbl=245	f	37434163
1	187435	5	9	0	171	83	387	222912			scan tbl=245 name=Internal Worktable	f	
1	187435	5	9	1	171	83	387	60120			dist	f	
1	187435	5	10	0	3579	3383	387	222912			scan tbl=134955 name=Internal Worktable	f	
1	187435	5	10	1	3579	3383	387	0			project	f	
1	187435	5	10	2	3579	3383	0	0			hjoin tbl=256	f	
1	187435	5	10	3	3579	3383	0	0			project	f	
1	187435	5	10	4	3579	3383	0	0			sort tbl=259	f	36805017
1	187435	6	11	0	10	7	0	0			scan tbl=259 name=Internal Worktable	f	
1	187435	6	11	1	10	7	0	0			return	f	
1	187435	6	12	0	9	9	0	0			merge	f	
1	187435	6	12	1	9	9	0	0			project	f	
1	187435	6	12	2	9	9	0	0			return	f	

If you are returning an unusually large volume of data, see [Very Large Result Set \(p. 219\)](#) for recommended solutions.

- See if the `bytes` value is high relative to the `rows` value for any step, in comparison to other steps. This pattern can indicate that you are selecting a lot of columns. For recommended solutions, see [Large SELECT List \(p. 219\)](#).

Using the SVL_QUERY_REPORT View

To analyze query summary information by slice, do the following:

- Run the following to determine your query ID:

```
select query, elapsed, substring
from svl_qlog
order by query
desc limit 5;
```

Examine the truncated query text in the `substring` field to determine which `query` value represents your query. If you have run the query more than once, use the `query` value from the row with the lower `elapsed` value. That is the row for the compiled version. If you have been running many queries, you can raise the value used by the LIMIT clause used to make sure your query is included.

- Select rows from SVL_QUERY_REPORT for your query. Order the results by segment, elapsed_time, and rows:

```
select * from svl_query_report where query = MyQueryID order by segment,
step, elapsed_time, rows;
```

- For each step, check to see that all slices are processing approximately the same number of rows:

userid	query	slice	segment	step	start_time	end_time	elapsed_time	rows	bytes	label
100	141696	2	0	0	2014-09-12 18:45:33	2014-09-12 18:45:33	2109	1150	33300	bcast
100	141696	5	0	2	2014-09-12 18:45:33	2014-09-12 18:45:33	420	1100	31700	bcast
100	141696	1	0	2	2014-09-12 18:45:33	2014-09-12 18:45:33	437	1099	31812	bcast
100	141696	3	0	2	2014-09-12 18:45:33	2014-09-12 18:45:33	490	1066	30108	bcast
100	141696	6	0	2	2014-09-12 18:45:33	2014-09-12 18:45:33	576	1108	32316	bcast
100	141696	4	0	2	2014-09-12 18:45:33	2014-09-12 18:45:33	583	1128	32484	bcast
100	141696	0	0	2	2014-09-12 18:45:33	2014-09-12 18:45:33	726	1079	30804	bcast
100	141696	7	0	2	2014-09-12 18:45:33	2014-09-12 18:45:33	2109	1150	33300	bcast
100	141696	2	0	2	2014-09-12 18:45:33	2014-09-12 18:45:33	2406	1068	31056	bcast
100	141696	2	1	0	2014-09-12 18:45:33	2014-09-12 18:45:33	3441	8798	253580	scan

Also check to see that all slices are taking approximately the same amount of time:

userid	query	slice	segment	step	start_time	end_time	elapsed_time	rows	bytes	label
100	141696	2	0	0	2014-09-12 18:45:33	2014-09-12 18:45:33	2109	1150	33300	bcast
100	141696	5	0	2	2014-09-12 18:45:33	2014-09-12 18:45:33	420	1100	31700	bcast
100	141696	1	0	2	2014-09-12 18:45:33	2014-09-12 18:45:33	437	1099	31812	bcast
100	141696	3	0	2	2014-09-12 18:45:33	2014-09-12 18:45:33	490	1066	30108	bcast
100	141696	6	0	2	2014-09-12 18:45:33	2014-09-12 18:45:33	576	1108	32316	bcast
100	141696	4	0	2	2014-09-12 18:45:33	2014-09-12 18:45:33	583	1128	32484	bcast
100	141696	0	0	2	2014-09-12 18:45:33	2014-09-12 18:45:33	726	1079	30804	bcast
100	141696	7	0	2	2014-09-12 18:45:33	2014-09-12 18:45:33	2109	1150	33300	bcast
100	141696	2	0	2	2014-09-12 18:45:33	2014-09-12 18:45:33	2406	1068	31056	bcast
100	141696	2	1	0	2014-09-12 18:45:33	2014-09-12 18:45:33	3441	8798	253580	scan

Large discrepancies in these values can indicate data distribution skew due to a suboptimal distribution style for this particular query. For recommended solutions, see [Suboptimal Data Distribution](#) (p. 218).

Mapping the Query Plan to the Query Summary

It helps to map the operations from the query plan to the steps (identified by the label field values) in the query summary to get further details on them:

Query Plan Operation	Label Field Value	Description
Aggregate	AGGR	Evaluates aggregate functions and GROUP BY conditions.
HashAggregate		
GroupAggregate		
DS_BCAST_INNER	BCAST (broadcast)	Broadcasts an entire table or some set of rows (such as a filtered set of rows from a table) to all nodes.
Doesn't appear in query plan	DELETE	Deletes rows from tables.
DS_DIST_NONE	DIST (distribute)	Distributes rows to nodes for parallel joining purposes or other parallel processing.
DS_DIST_ALL_NONE		
DS_DIST_INNER		
DS_DIST_ALL_INNER		

Query Plan Operation	Label Field Value	Description
DS_DIST_ALL_BOTH		
HASH	HASH	Builds hash table for use in hash joins.
Hash Join	HJOIN (hash join)	Executes a hash join of two tables or intermediate result sets.
Doesn't appear in query plan	INSERT	Inserts rows into tables.
Limit	LIMIT	Applies a LIMIT clause to result sets.
Merge	MERGE	Merges rows derived from parallel sort or join operations.
Merge Join	MJOIN (merge join)	Executes a merge join of two tables or intermediate result sets.
Nested Loop	NLOOP (nested loop)	Executes a nested loop join of two tables or intermediate result sets.
Doesn't appear in query plan	PARSE	Parses strings into binary values for loading.
Project	PROJECT	Evaluates expressions.
Network	RETURN	Returns rows to the leader or the client.
Doesn't appear in query plan	SAVE	Materializes rows for use in the next processing step.
Seq Scan	SCAN	Scans tables or intermediate result sets.
Sort	SORT	Sorts rows or intermediate result sets as required by other subsequent operations (such as joins or aggregations) or to satisfy an ORDER BY clause.
Unique	UNIQUE	Applies a SELECT DISTINCT clause or removes duplicates as required by other operations.
Window	WINDOW	Computes aggregate and ranking window functions.

Improving Query Performance

Following are some common issues that affect query performance, with instructions on ways to diagnose and resolve them.

Topics

- [Table Statistics Missing or Out of Date \(p. 217\)](#)
- [Nested Loop \(p. 217\)](#)
- [Hash Join \(p. 217\)](#)
- [Ghost Rows or Uncommitted Rows \(p. 218\)](#)
- [Unsorted or Missorted Rows \(p. 218\)](#)
- [Suboptimal Data Distribution \(p. 218\)](#)
- [Insufficient Memory Allocated to the Query \(p. 218\)](#)
- [Suboptimal WHERE Clause \(p. 219\)](#)
- [Insufficiently Restrictive Predicate \(p. 219\)](#)
- [Very Large Result Set \(p. 219\)](#)
- [Large SELECT List \(p. 219\)](#)

Table Statistics Missing or Out of Date

If table statistics are missing or out of date, you might see the following:

- A warning message in EXPLAIN command results.
- A missing statistics alert event in STL_ALERT_EVENT_LOG. For more information, see [Reviewing Query Alerts \(p. 210\)](#).

To fix this issue, run [ANALYZE \(p. 309\)](#).

Nested Loop

If a nested loop is present, you might see a nested loop alert event in STL_ALERT_EVENT_LOG. You can also identify this type of event by running the query at [Identifying Queries with Nested Loops \(p. 221\)](#). For more information, see [Reviewing Query Alerts \(p. 210\)](#).

To fix this, review your query for cross-joins and remove them if possible. Cross-joins are joins without a join condition that result in the Cartesian product of two tables. They are typically executed as nested loop joins, which are the slowest of the possible join types.

Hash Join

If a hash join is present, you might see the following:

- Hash and hash join operations in the query plan. For more information, see [Analyzing the Query Plan \(p. 211\)](#).
- An HJOIN step in the segment with the highest maxtime value in SVL_QUERY_SUMMARY. For more information, see [Using the SVL_QUERY_SUMMARY View \(p. 212\)](#).

To fix this issue, you can take a couple of approaches:

- Rewrite the query to use a merge join if possible. You can do this by specifying join columns that are both distribution keys and sort keys.
- If the HJOIN step in SVL_QUERY_SUMMARY has a very high value in the rows field compared to the rows value in the final RETURN step in the query, check whether you can rewrite the query to join on a unique column. When a query does not join on a unique column, such as a primary key, that increases the number of rows involved in the join.

Ghost Rows or Uncommitted Rows

If ghost rows or uncommitted rows are present, you might see an alert event in `STL_ALERT_EVENT_LOG` that indicates excessive ghost rows. For more information, see [Reviewing Query Alerts \(p. 210\)](#).

To fix this issue, you can take a couple of approaches:

- Check the **Loads** tab of your Amazon Redshift console for active load operations on any of the query tables. If you see active load operations, wait for those to complete before taking action.
- If there are no active load operations, run [VACUUM \(p. 488\)](#) on the query tables to remove deleted rows.

Unsorted or Missorted Rows

If unsorted or missorted rows are present, you might see a very selective filter alert event in `STL_ALERT_EVENT_LOG`. For more information, see [Reviewing Query Alerts \(p. 210\)](#).

You can also check to see if any of the tables in your query have large unsorted areas by running the query in [Identifying Tables with Data Skew or Unsorted Rows \(p. 220\)](#).

To fix this issue, you can take a couple of approaches:

- Run [VACUUM \(p. 488\)](#) on the query tables to re-sort the rows.
- Review the sort keys on the query tables to see if any improvements can be made. Remember to weigh the performance of this query against the performance of other important queries and the system overall before making any changes. For more information, see [Choosing Sort Keys \(p. 122\)](#).

Suboptimal Data Distribution

If data distribution is suboptimal, you might see the following:

- A serial execution, large broadcast, or large distribution alert event appears in `STL_ALERT_EVENT_LOG`. For more information, see [Reviewing Query Alerts \(p. 210\)](#).
- Slices are not processing approximately the same number of rows for a given step. For more information, see [Using the SVL_QUERY_REPORT View \(p. 214\)](#).
- Slices are not taking approximately the same amount of time for a given step. For more information, see [Using the SVL_QUERY_REPORT View \(p. 214\)](#).

If none of the preceding is true, you can also see if any of the tables in your query have data skew by running the query in [Identifying Tables with Data Skew or Unsorted Rows \(p. 220\)](#).

To fix this issue, take another look at the distribution styles for the tables in the query and see if any improvements can be made. Remember to weigh the performance of this query against the performance of other important queries and the system overall before making any changes. For more information, see [Choosing a Data Distribution Style \(p. 110\)](#).

Insufficient Memory Allocated to the Query

If insufficient memory is allocated to your query, you might see a step in `SVL_QUERY_SUMMARY` that has an `is_diskbased` value of true. For more information, see [Using the SVL_QUERY_SUMMARY View \(p. 212\)](#).

To fix this issue, allocate more memory to the query by temporarily increasing the number of query slots it uses. Workload Management (WLM) reserves slots in a query queue equivalent to the

concurrency level set for the queue. For example, a queue with a concurrency level of 5 has 5 slots. Memory assigned to the queue is allocated equally to each slot. Assigning several slots to one query gives that query access to the memory for all of those slots. For more information on how to temporarily increase the slots for a query, see [wlm_query_slot_count](#) (p. 816).

Suboptimal WHERE Clause

If your WHERE clause causes excessive table scans, you might see a SCAN step in the segment with the highest `maxtime` value in `SVL_QUERY_SUMMARY`. For more information, see [Using the SVL_QUERY_SUMMARY View](#) (p. 212).

To fix this issue, add a WHERE clause to the query based on the primary sort column of the largest table. This approach will help minimize scanning time. For more information, see [Best Practices for Designing Tables](#) (p. 21).

Insufficiently Restrictive Predicate

If your query has an insufficiently restrictive predicate, you might see a SCAN step in the segment with the highest `maxtime` value in `SVL_QUERY_SUMMARY` that has a very high `rows` value compared to the `rows` value in the final RETURN step in the query. For more information, see [Using the SVL_QUERY_SUMMARY View](#) (p. 212).

To fix this issue, try adding a predicate to the query or making the existing predicate more restrictive to narrow the output.

Very Large Result Set

If your query returns a very large result set, consider rewriting the query to use [UNLOAD](#) (p. 471) to write the results to Amazon S3. This approach will improve the performance of the RETURN step by taking advantage of parallel processing. For more information on checking for a very large result set, see [Using the SVL_QUERY_SUMMARY View](#) (p. 212).

Large SELECT List

If your query has an unusually large SELECT list, you might see a `bytes` value that is high relative to the `rows` value for any step (in comparison to other steps) in `SVL_QUERY_SUMMARY`. This high `bytes` value can be an indicator that you are selecting a lot of columns. For more information, see [Using the SVL_QUERY_SUMMARY View](#) (p. 212).

To fix this issue, review the columns you are selecting and see if any can be removed.

Diagnostic Queries for Query Tuning

Use the following queries to identify issues with queries or underlying tables that can affect query performance. We recommend using these queries in conjunction with the query tuning processes discussed in [Analyzing and Improving Queries](#) (p. 209).

Topics

- [Identifying Queries That Are Top Candidates for Tuning](#) (p. 220)
- [Identifying Tables with Data Skew or Unsorted Rows](#) (p. 220)
- [Identifying Queries with Nested Loops](#) (p. 221)
- [Reviewing Queue Wait Times for Queries](#) (p. 221)
- [Reviewing Query Alerts by Table](#) (p. 222)
- [Identifying Tables with Missing Statistics](#) (p. 222)

Identifying Queries That Are Top Candidates for Tuning

The following query identifies the top 50 most time-consuming statements that have been executed in the last 7 days. You can use the results to identify queries that are taking unusually long, and also to identify queries that are run frequently (those that appear more than once in the result set). These queries are frequently good candidates for tuning to improve system performance.

This query also provides a count of the alert events associated with each query identified. These alerts provide details that you can use to improve the query's performance. For more information, see [Reviewing Query Alerts \(p. 210\)](#).

```
select trim(database) as db, count(query) as n_qry,
max(substring (qrytext,1,80)) as qrytext,
min(run_minutes) as "min" ,
max(run_minutes) as "max",
avg(run_minutes) as "avg", sum(run_minutes) as total,
max(query) as max_query_id,
max(starttime)::date as last_run,
sum(alerts) as alerts, aborted
from (select userid, label, stl_query.query,
trim(database) as database,
trim(querytxt) as qrytext,
md5(trim(querytxt)) as qry_md5,
starttime, endtime,
(datediff(seconds, starttime,endtime)::numeric(12,2))/60 as run_minutes,
alrt.num_events as alerts, aborted
from stl_query
left outer join
(select query, 1 as num_events from stl_alert_event_log group by query ) as
alrt
on alrt.query = stl_query.query
where userid <> 1 and starttime >= dateadd(day, -7, current_date))
group by database, label, qry_md5, aborted
order by total desc limit 50;
```

Identifying Tables with Data Skew or Unsorted Rows

The following query identifies tables that have uneven data distribution (data skew) or a high percentage of unsorted rows.

A low `skew` value indicates that table data is properly distributed. If a table has a `skew` value of 4.00 or higher, consider modifying its data distribution style. For more information, see [Suboptimal Data Distribution \(p. 218\)](#).

If a table has a `pct_unsorted` value greater than 20 percent, consider running the `VACUUM (p. 488)` command. For more information, see [Unsorted or Missorted Rows \(p. 218\)](#).

You should also review the `mbytes` and `pct_of_total` values for each table. These columns identify the size of the table and what percentage of raw disk space the table consumes. The raw disk space includes space that is reserved by Amazon Redshift for internal use, so it is larger than the nominal disk capacity, which is the amount of disk space available to the user. Use this information to ensure that you have free disk space equal to at least 2.5 times the size of your largest table. Having this space available enables the system to write intermediate results to disk when processing complex queries.

```
select trim(pgn.nspname) as schema,
trim(a.name) as table, id as tableid,
```



```
decode(pgc.reldiststyle,0, 'even',1,det.distkey ,8,'all') as distkey,
dist_ratio.ratio::decimal(10,4) as skew,
det.head_sort as "sortkey",
det.n_sortkeys as "#sks", b.mbytes,
decode(b.mbytes,0,0,((b.mbytes/part.total::decimal)*100)::decimal(5,2)) as
pct_of_total,
decode(det.max_enc,0,'n','y') as enc, a.rows,
decode( det.n_sortkeys, 0, null, a.unsorted_rows ) as unsorted_rows ,
decode( det.n_sortkeys, 0, null, decode( a.rows,0,0,
(a.unsorted_rows::decimal(32)/a.rows)*100) )::decimal(5,2) as pct_unsorted
from (select db_id, id, name, sum(rows) as rows,
sum(rows)-sum(sorted_rows) as unsorted_rows
from stv_tbl_perm a
group by db_id, id, name) as a
join pg_class as pgc on pgc.oid = a.id
join pg_namespace as pgn on pgn.oid = pgc.relnamespace
left outer join (select tbl, count(*) as mbytes
from stv_blocklist group by tbl) b on a.id=b.tbl
inner join (select attrelid,
min(case attisdistkey when 't' then attname else null end) as "distkey",
min(case attsortkeyord when 1 then attname else null end ) as head_sort ,
max(attsortkeyord) as n_sortkeys,
max(attencodingtype) as max_enc
from pg_attribute group by 1) as det
on det.attrelid = a.id
inner join ( select tbl, max(mbytes)::decimal(32)/min(mbytes) as ratio
from (select tbl, trim(name) as name, slice, count(*) as mbytes
from svv_diskusage group by tbl, name, slice )
group by tbl, name ) as dist_ratio on a.id = dist_ratio.tbl
join ( select sum(capacity) as total
from stv_partitions where part_begin=0 ) as part on 1=1
where mbytes is not null
order by mbytes desc;
```

Identifying Queries with Nested Loops

The following query identifies queries that have had alert events logged for nested loops. For information on how to fix the nested loop condition, see [Nested Loop \(p. 217\)](#).

```
select query, trim(querytxt) as SQL, starttime
from stl_query
where query in (
select distinct query
from stl_alert_event_log
where event like 'Nested Loop Join in the query plan%')
order by starttime desc;
```

Reviewing Queue Wait Times for Queries

The following query shows how long recent queries waited for an open slot in a query queue before being executed. If you see a trend of high wait times, you might want to modify your query queue configuration for better throughput. For more information, see [Defining Query Queues \(p. 223\)](#).

```
select trim(database) as DB , w.query,
substring(q.querytxt, 1, 100) as querytxt, w.queue_start_time,
w.service_class as class, w.slot_count as slots,
```

```
w.total_queue_time/1000000 as queue_seconds,  
w.total_exec_time/1000000 exec_seconds, (w.total_queue_time  
+w.total_Exec_time)/1000000 as total_seconds  
from stl_wlm_query w  
left join stl_query q on q.query = w.query and q.userid = w.userid  
where w.queue_start_Time >= dateadd(day, -7, current_Date)  
and w.total_queue_Time > 0 and w.userid >1  
and q.starttime >= dateadd(day, -7, current_Date)  
order by w.total_queue_time desc, w.queue_start_time desc limit 35;
```

Reviewing Query Alerts by Table

The following query identifies tables that have had alert events logged for them, and also identifies what type of alerts are most frequently raised.

If the `minutes` value for a row with an identified table is high, check that table to see if it needs routine maintenance such as having [ANALYZE \(p. 309\)](#) or [VACUUM \(p. 488\)](#) run against it.

If the `count` value is high for a row but the `table` value is null, run a query against `STL_ALERT_EVENT_LOG` for the associated `event` value to investigate why that alert is getting raised so often.

```
select trim(s.perm_table_name) as table,  
(sum(abs(datediff(seconds, s.starttime, s.endtime)))/60)::numeric(24,0) as  
minutes, trim(split_part(l.event,':',1)) as event, trim(l.solution) as  
solution,  
max(l.query) as sample_query, count(*)  
from stl_alert_event_log as l  
left join stl_scan as s on s.query = l.query and s.slice = l.slice  
and s.segment = l.segment and s.step = l.step  
where l.event_time >= dateadd(day, -7, current_Date)  
group by 1,3,4  
order by 2 desc,6 desc;
```

Identifying Tables with Missing Statistics

The following query provides a count of the queries that you are running against tables that are missing statistics. If this query returns any rows, look at the `plannode` value to determine the affected table, and then run [ANALYZE \(p. 309\)](#) on it.

```
select substring(trim(plannode),1,100) as plannode, count(*)  
from stl_explain  
where plannode like '%missing statistics%'  
group by plannode  
order by 2 desc;
```

Implementing Workload Management

You can use workload management (WLM) to define multiple query queues and to route queries to the appropriate queues at runtime.

When you have multiple sessions or users running queries at the same time, some queries might consume cluster resources for long periods of time and affect the performance of other queries. For

example, suppose one group of users submits occasional complex, long-running queries that select and sort rows from several large tables. Another group frequently submits short queries that select only a few rows from one or two tables and run in a few seconds. In this situation, the short-running queries might have to wait in a queue for a long-running query to complete.

You can improve system performance and your users' experience by modifying your WLM configuration to create separate queues for the long-running queries and the short-running queries. At run time, you can route queries to these queues according to user groups or query groups.

You can configure up to eight query queues and set the number of queries that can run in each of those queues concurrently, up to a maximum concurrency level of 50 across all of the queues. You can set up rules to route queries to particular queues based on the user running the query or labels that you specify. You can also configure the amount of memory allocated to each queue, so that large queries run in queues with more memory than other queues. You can also configure the WLM timeout property to limit long-running queries.

Topics

- [Defining Query Queues \(p. 223\)](#)
- [Modifying the WLM Configuration \(p. 226\)](#)
- [WLM Queue Assignment Rules \(p. 226\)](#)
- [Assigning Queries to Queues \(p. 229\)](#)
- [WLM Dynamic and Static Configuration Properties \(p. 230\)](#)
- [Monitoring Workload Management \(p. 232\)](#)

Defining Query Queues

When users run queries in Amazon Redshift, the queries are routed to query queues. Each query queue contains a number of query slots. Each queue is allocated a portion of the cluster's available memory. A queue's memory is divided among the queue's query slots. You can configure WLM properties for each query queue to specify the way that memory is allocated among slots, how queries can be routed to specific queues at run time, and when to cancel long-running queries. You can also use the `wlm_query_slot_count` parameter, which is separate from the WLM properties, to temporarily enable queries to use more memory by allocating multiple slots.

By default, Amazon Redshift configures the following query queues:

- **One superuser queue.**

The superuser queue is reserved for superusers only and it can't be configured. You should only use this queue when you need to run queries that affect the system or for troubleshooting purposes. For example, use this queue when you need to cancel a user's long-running query or to add users to the database. You should not use it to perform routine queries. The queue does not appear in the console, but it does appear in the system tables in the database as the fifth queue. To run a query in the superuser queue, a user must be logged in as a superuser, and must run the query using the predefined `superuser` query group.

- **One default user queue.**

The default queue is initially configured to run five queries concurrently. You can change the concurrency, timeout, and memory allocation properties for the default queue, but you cannot specify user groups or query groups. The default queue must be the last queue in the WLM configuration. Any queries that are not routed to other queues run in the default queue.

Query queues are defined in the WLM configuration. The WLM configuration is an editable parameter (`wlm_json_configuration`) in a parameter group, which can be associated with one or more clusters. For more information, see [Modifying the WLM Configuration \(p. 226\)](#).

You can add additional query queues to the default WLM configuration, up to a total of eight user queues. You can configure the following for each query queue:

- Concurrency level
- User groups
- Query groups
- WLM memory percent to use
- WLM timeout

Concurrency Level

Queries in a queue run concurrently until they reach the *concurrency* level defined for that queue. Subsequent queries then wait in the queue. Each queue can be configured to run up to 50 queries concurrently. The maximum total concurrency level for all user-defined queues is 50. The limit includes the default queue, but does not include the reserved Superuser queue, Amazon Redshift allocates, by default, an equal, fixed share of available memory to each queue, and an equal, fixed share of a queue's memory to each query slot in the queue. The proportion of memory allocated to each queue is defined in the WLM configuration using the `memory_percent_to_use` property. At run time, you can temporarily override the amount of memory assigned to a query by setting the `wlm_query_slot_count` parameter to specify the number of slots allocated to the query.

By default, WLM queues have a concurrency level of 5. Your workload might benefit from a higher concurrency level in certain cases, such as the following:

- If many small queries are forced to wait for long-running queries, create a separate queue with a higher concurrency level and assign the smaller queries to that queue. A queue with a higher concurrency level has less memory allocated to each query slot, but the smaller queries require less memory.
- If you have multiple queries that each access data on a single slice, set up a separate WLM queue to execute those queries concurrently. Amazon Redshift will assign concurrent queries to separate slices, which allows multiple queries to execute in parallel on multiple slices. For example, if a query is a simple aggregate with a predicate on the distribution key, the data for the query will be located on a single slice.

As a best practice, we recommend using a concurrency level of 15 or lower. All of the compute nodes in a cluster, and all of the slices on the nodes, participate in parallel query execution. By increasing concurrency, you increase the contention for system resources and limit the overall throughput.

The memory that is allocated to each queue is divided among the query slots in that queue. The amount of memory available to a query is the memory allocated to the query slot in which the query is running, regardless of the number of queries that are actually running concurrently. A query that can run entirely in memory when the concurrency level is 5 might need to write intermediate results to disk if the concurrency level is increased to 20. The additional disk I/O could degrade performance.

If a specific query needs more memory than is allocated to a single query slot, you can increase the available memory by increasing the `wlm_query_slot_count` (p. 816) parameter. The following example sets `wlm_query_slot_count` to 10, performs a vacuum, and then resets `wlm_query_slot_count` to 1.

```
set wlm_query_slot_count to 10;  
vacuum;  
set wlm_query_slot_count to 1;
```

For more information, see [Improving Query Performance](#) (p. 216).

User Groups

You can assign a set of user groups to a queue by specify each user group name or by using wildcards. When a member of a listed user group runs a query, that query runs in the corresponding queue. There is no set limit on the number of user groups that can be assigned to a queue. For more information, see [Wildcards \(p. 225\)](#)

Query Groups

You can assign a set of query groups to a queue by specify each user group name or by using wildcards. A query group is simply a label. At run time, you can assign the query group label to a series of queries. Any queries that are assigned to a listed query group will run in the corresponding queue. There is no set limit to the number of query groups that can be assigned to a queue. For more information, see [Wildcards \(p. 225\)](#)

Wildcards

If wildcards are enabled in the WLM queue configuration, you can assign user groups and query groups to a queue either individually or by using Unix shell-style wildcards. The pattern matching is case insensitive. For example, the '*' wildcard character matches any number of characters, so if you add `dba_*` to the list of user groups for a queue, then any query that is run by a user that belongs to a group with a name that begins with `dba_`, such as `dba_admin` or `DBA_primary`, is assigned to that queue. The '?' wildcard character matches any single character, so if the queue includes user-group `dba?1`, then user groups named `dba11` and `dba21` would match, but `dba12` would not match. Wildcards are disabled by default.

WLM Memory Percent to Use

To specify the amount of available memory that is allocated to a query, you can set the *WLM Memory Percent to Use* parameter. By default, each user-defined queue is allocated an equal portion of the memory that is available for user-defined queries. For example, if you have four user-defined queues, each queue is allocated 25 percent of the available memory. The superuser queue has its own allocated memory and cannot be modified. To change the allocation, you assign an integer percentage of memory to each queue, up to a total of 100 percent. Any unallocated memory is managed by Amazon Redshift and can be temporarily given to a queue if the queue requests additional memory for processing.

For example, if you configure four queues, you can allocate memory as follows: 20 percent, 30 percent, 15 percent, 15 percent. The remaining 20 percent is unallocated and managed by the service.

WLM Timeout

To limit the amount of time that queries in a given WLM queue are permitted to use, you can set the WLM timeout value for each queue. The timeout parameter specifies the amount of time, in milliseconds, that Amazon Redshift waits for a query to execute before canceling the query. The timeout is based on query execution time and doesn't include time spent waiting in a queue.

The function of WLM timeout is similar to the [statement_timeout \(p. 813\)](#) configuration parameter, except that, where the *statement_timeout* configuration parameter applies to the entire cluster, WLM timeout is specific to a single queue in the WLM configuration.

WLM Query Queue Hopping

If a read-only query, such as a SELECT statement, is canceled due to a WLM timeout, WLM attempts to route the query to the next matching queue based on the WLM Queue Assignment Rules. If the

query doesn't match any other queue definition, the query is canceled; it is not assigned to the default queue. A user-defined function (UDF) or any query that writes to the database cannot be rerouted and is simply canceled. Such queries include data manipulation language (DML) statements, data definition language (DDL) statements, and commands that change the database, such as VACUUM.

Modifying the WLM Configuration

The easiest way to modify the WLM configuration is by using the Amazon Redshift management console. You can also use the Amazon Redshift command line interface (CLI) or the Amazon Redshift API.

For information about modifying WLM configurations, see [Configuring Workload Management](#) in the Amazon Redshift Cluster Management Guide

Important

You might need to reboot the cluster after changing the WLM configuration. For more information, see [WLM Dynamic and Static Configuration Properties \(p. 230\)](#).

WLM Queue Assignment Rules

When a user runs a query, WLM assigns the query to the first matching queue, based on these rules.

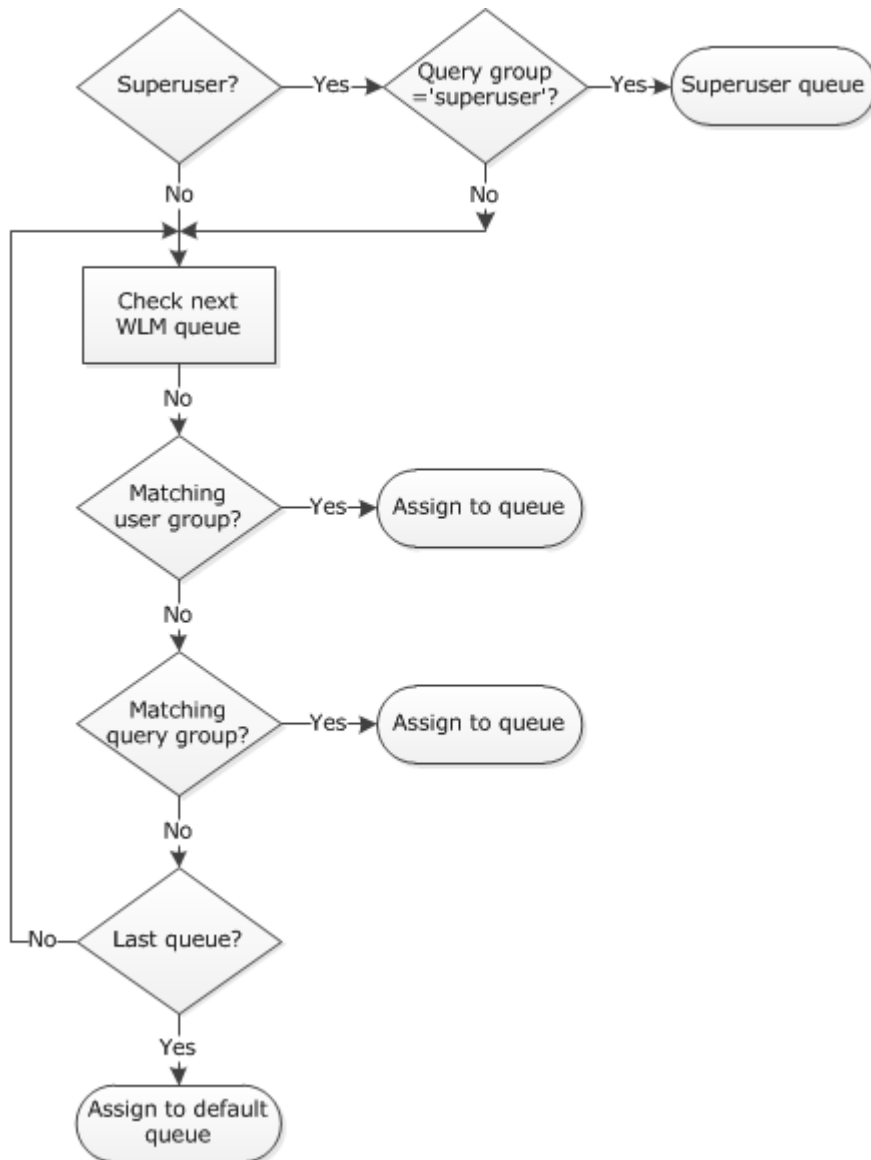

1. If a user is logged in as a superuser and runs a query in the query group labeled superuser, the query is assigned to the Superuser queue.
2. If a user belongs to a listed user group or if a user runs a query within a listed query group, the query is assigned to the first matching queue.
3. If a query does not meet any criteria, the query is assigned to the default queue, which is the last queue defined in the WLM configuration.

The following table shows a WLM configuration with the Superuser queue and four user-defined queues.

Queue	Concurrency	User Groups	Query Groups
Superuser	1		superuser
1	5	UG1	
2	5		QGB
3	5	UG3	QGC
Default	5		

Queue Assignments Example

The following example shows how queries are assigned to the queues in the previous example according to user groups and query groups. For information about how to assign queries to user groups and query groups at run time, see [Assigning Queries to Queues \(p. 229\)](#) later in this section.

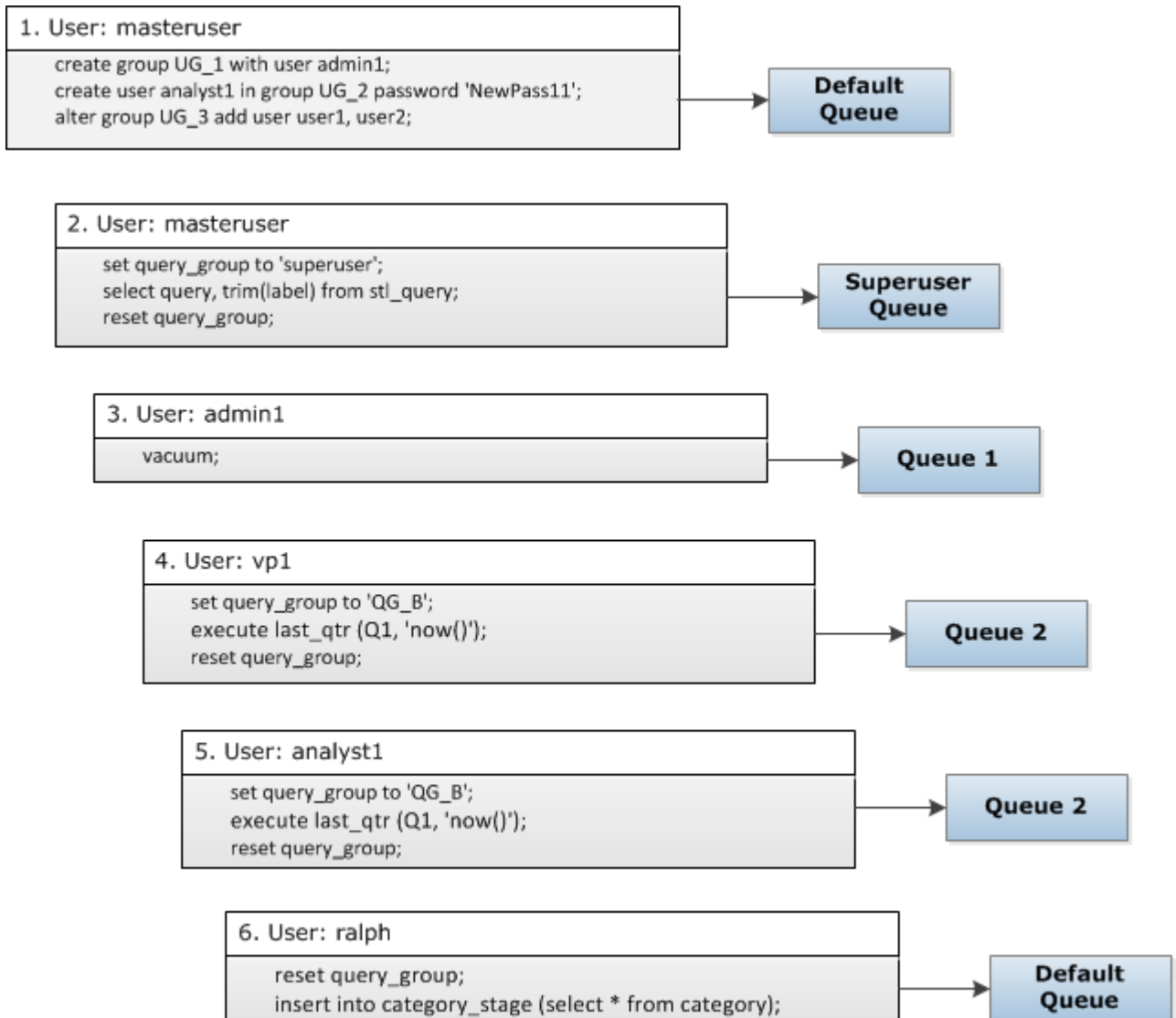

In this example, WLM makes the following assignments:

1. The first set of statements shows three ways to assign users to user groups. The statements are executed by the user `masteruser`, which is not a member of a user group listed in any WLM queue. No query group is set, so the statements are routed to the default queue.
2. The user `masteruser` is a superuser and the query group is set to `'superuser'`, so the query is assigned to the superuser queue.
3. The user `admin1` is a member of the user group listed in queue 1, so the query is assigned to queue 1.
4. The user `vp1` is not a member of any listed user group. The query group is set to `'QG_B'`, so the query is assigned to queue 2.
5. The user `analyst1` is a member of the user group listed in queue 3, but `'QG_B'` matches queue 2, so the query is assigned to queue 2.
6. The user `ralph` is not a member of any listed user group and the query group was reset, so there is no matching queue. The query is assigned to the default queue.

Assigning Queries to Queues

The following examples assign queries to queues according to user groups and query groups.

Assigning Queries to Queues Based on User Groups

If a user group name is listed in a queue definition, queries run by members of that user group will be assigned to the corresponding queue. The following example creates user groups and adds users to groups by using the SQL commands [CREATE USER \(p. 397\)](#), [CREATE GROUP \(p. 374\)](#), and [ALTER GROUP \(p. 296\)](#).

```
create group admin_group with user admin246, admin135, sec555;  
create user vp1234 in group ad_hoc_group password 'vpPass1234';  
alter group admin_group add user analyst44, analyst45, analyst46;
```

Assigning a Query to a Query Group

You can assign a query to a queue at run time by assigning your query to the appropriate query group. Use the `SET` command to begin a query group.

```
SET query_group TO group_label
```

Here, *group_label* is a query group label that is listed in the WLM configuration.

All queries that you run after the `SET query_group` command will run as members of the specified query group until you either reset the query group or end your current login session. For information about setting and resetting Amazon Redshift objects, see [SET \(p. 465\)](#) and [RESET \(p. 430\)](#) in the SQL Command Reference.

The query group labels that you specify must be included in the current WLM configuration; otherwise, the `SET query_group` command has no effect on query queues.

The label defined in the `TO` clause is captured in the query logs so that you can use the label for troubleshooting. For information about the `query_group` configuration parameter, see [query_group \(p. 811\)](#) in the Configuration Reference.

The following example runs two queries as part of the query group 'priority' and then resets the query group.

```
set query_group to 'priority';
select count(*)from stv_blocklist;
select query, elapsed, substring from svl_qlog order by query desc limit 5;
reset query_group;
```

Assigning Queries to the Superuser Queue

To assign a query to the Superuser queue, log in to Amazon Redshift as a superuser and then run the query in the superuser group. When you are done, reset the query group so that subsequent queries do not run in the Superuser queue.

The following example assigns two commands to run in the Superuser queue.

```
set query_group to 'superuser';

analyze;
vacuum;
reset query_group;
```

To view a list of superusers, query the PG_USER system catalog table.

```
select * from pg_user where usesuper = 'true';
```

WLM Dynamic and Static Configuration Properties

The WLM configuration properties are either dynamic or static. If you change any of the dynamic properties, you don't need to reboot your cluster for the changes to take effect. If you add or remove query queues or change any of the static properties, you must restart your cluster before any WLM parameter changes, including changes to dynamic properties, take effect.

The following WLM properties are static:

- User groups
- User group wildcard
- Query groups
- Query group wildcard

The following WLM properties are dynamic:

- Concurrency
- Percent of memory to use
- Timeout

If the timeout value is changed, the new value is applied to any query that begins execution after the value is changed. If the concurrency or percent of memory to use are changed, Amazon Redshift transitions to the new configuration dynamically so that currently running queries are not affected by the change. For more information, see [WLM Dynamic Memory Allocation \(p. 231\)](#).

Topics

- [WLM Dynamic Memory Allocation \(p. 231\)](#)
- [Dynamic WLM Example \(p. 231\)](#)

WLM Dynamic Memory Allocation

In each queue, WLM creates a number of query slots equal to the queue's concurrency level. The amount of memory allocated to a query slot equals the percentage of memory allocated to the queue divided by the slot count. If you change the memory allocation or concurrency, Amazon Redshift dynamically manages the transition to the new WLM configuration so that active queries can run to completion using the currently allocated amount of memory, at the same time ensuring that total memory usage never exceeds 100 percent of available memory.

The workload manager uses the following process to manage the transition.

1. WLM recalculates the memory allocation for each new query slot.
2. If a query slot is not actively being used by a running query, WLM removes the slot, which makes that memory available for new slots.
3. If a query slot is actively in use, WLM waits for the query to finish.
4. As active queries complete, the empty slots are removed and the associated memory is freed.
5. As enough memory becomes available to add one or more slots, new slots are added.
6. When all queries that were running at the time of the change finish, the slot count equals the new concurrency level, and the transition to the new WLM configuration is complete.

In effect, queries that are running when the change takes place continue to use the original memory allocation, and queries that are queued when the change takes place are routed to new slots as they become available.

If the WLM dynamic properties are changed during the transition process, WLM immediately begins to transition to the new configuration, starting from the current state. To view the status of the transition, query the [STV_WLM_SERVICE_CLASS_CONFIG](#) (p. 773) system table.

Dynamic WLM Example

Suppose your cluster WLM is configured with two queues, using the following dynamic properties.

Queue	Concurrency	% Memory to Use
1	4	50%
2	4	50%

Now suppose your cluster has 200 GB of memory available for query processing. (This number is arbitrary and used for illustration only.) As the following equation shows, each slot is allocated 25 GB.

$$(200 \text{ GB} * 50\%) / 4 \text{ slots} = 25 \text{ GB}$$

Next, you change your WLM to use the following dynamic properties.

Queue	Concurrency	% Memory to Use
1	3	75%
2	4	25%

As the following equation shows, the new memory allocation for each slot in queue 1 is 50 GB.

$$(200 \text{ GB} * 75\%) / 3 \text{ slots} = 50 \text{ GB}$$

Suppose queries A1, A2, A3, and A4 are running when the new configuration is applied, and queries B1, B2, B3, and B4 are queued. WLM dynamically reconfigures the query slots as follows.

Step	Queries Running	Current Slot Count	Target Slot Count	Allocated Memory	Available Memory
1	A1, A2, A3, A4	4	0	100 GB	50 GB
2	A2, A3, A4	3	0	75 GB	75 GB
3	A3, A4	2	0	50 GB	100 GB
4	A3, A4, B1	2	1	100 GB	50 GB
5	A4, B1	1	1	75 GB	75 GB
6	A4, B1, B2	1	2	125 GB	25 GB
7	B1, B2	0	2	100 GB	50 GB
8	B1, B2, B3	0	3	150 GB	0 GB

1. WLM recalculates the memory allocation for each query slot. Originally, queue 1 was allocated 100 GB. The new queue has a total allocation of 150 GB, so the new queue immediately has 50 GB available. Queue 1 is now using four slots, and the new concurrency level is three slots, so no new slots are added.
2. When one query finishes, the slot is removed and 25 GB is freed. Queue 1 now has three slots and 75 GB of available memory. The new configuration needs 50 GB for each new slot, but the new concurrency level is three slots, so no new slots are added.
3. When a second query finishes, the slot is removed, and 25 GB is freed. Queue 1 now has two slots and 100 GB of free memory.
4. A new slot is added using 50 GB of the free memory. Queue 1 now has three slots, and 50 GB free memory. Queued queries can now be routed to the new slot.
5. When a third query finishes, the slot is removed, and 25 GB is freed. Queue 1 now has two slots, and 75 GB of free memory.
6. A new slot is added using 50 GB of the free memory. Queue 1 now has three slots, and 25 GB free memory. Queued queries can now be routed to the new slot.
7. When the fourth query finishes, the slot is removed, and 25 GB is freed. Queue 1 now has two slots and 50 GB of free memory.
8. A new slot is added using the 50 GB of free memory. Queue 1 now has three slots with 50 GB each and all available memory has been allocated.

The transition is complete and all query slots are available to queued queries.

Monitoring Workload Management

WLM configures query queues according to internally-defined WLM *service classes*. Amazon Redshift creates several internal queues according to these service classes along with the queues defined in the WLM configuration. The terms *queue* and *service class* are often used interchangeably in the system tables. The superuser queue uses service class 5. User-defined queues use service class 6 and greater.

You can view the status of queries, queues, and service classes by using WLM-specific system tables. Query the following system tables to do the following:

- View which queries are being tracked and what resources are allocated by the workload manager.

- See which queue a query has been assigned to.
- View the status of a query that is currently being tracked by the workload manager.

Table Name	Description
STL_WLM_ERROR (p. 750)	Contains a log of WLM-related error events.
STL_WLM_QUERY (p. 750)	Lists queries that are being tracked by WLM.
STV_WLM_CLASSIFICATION_CONFIG (p. 769)	Shows the current classification rules for WLM.
STV_WLM_QUERY_QUEUE_STATE (p. 770)	Records the current state of the query queues.
STV_WLM_QUERY_STATE (p. 771)	Provides a snapshot of the current state of queries that are being tracked by WLM.
STV_WLM_QUERY_TASK_STATE (p. 771)	Contains the current state of query tasks.
STV_WLM_SERVICE_CLASS_CONFIG (p. 772)	Records the service class configurations for WLM.
STV_WLM_SERVICE_CLASS_STATE (p. 772)	Contains the current state of the service classes.

You use the task ID to track a query in the system tables. The following example shows how to obtain the task ID of the most recently submitted user query:

```
select task from stl_wlm_query where exec_start_time =(select
  max(exec_start_time) from stl_wlm_query);

task
-----
137
(1 row)
```

The following example displays queries that are currently executing or waiting in various service classes (queues). This query is useful in tracking the overall concurrent workload for Amazon Redshift:

```
select * from stv_wlm_query_state order by query;

xid | task | query | service_ | wlm_start_ | state | queue_ | exec_
   |     |      | class    | time       |      | time   | time
-----+-----+-----+-----+-----+-----+-----+-----
2645 | 84  | 98   | 3        | 2010-10-... | Returning | 0      | 3438369
2650 | 85  | 100  | 3        | 2010-10-... | Waiting   | 0      | 1645879
2660 | 87  | 101  | 2        | 2010-10-... | Executing | 0      | 916046
2661 | 88  | 102  | 1        | 2010-10-... | Executing | 0      | 13291
(4 rows)
```

Troubleshooting Queries

This section provides a quick reference for identifying and addressing some of the most common and most serious issues you are likely to encounter with Amazon Redshift queries.

Topics

- [Connection Fails](#) (p. 234)
- [Query Hangs](#) (p. 234)
- [Query Takes Too Long](#) (p. 235)
- [Load Fails](#) (p. 236)
- [Load Takes Too Long](#) (p. 236)
- [Load Data Is Incorrect](#) (p. 236)
- [Setting the JDBC Fetch Size Parameter](#) (p. 237)

These suggestions give you a starting point for troubleshooting. You can also refer to the following resources for more detailed information.

- [Accessing Amazon Redshift Clusters and Databases](#)
- [Designing Tables](#) (p. 100)
- [Loading Data](#) (p. 130)
- [Tutorial: Tuning Table Design](#) (p. 30)
- [Tutorial: Loading Data from Amazon S3](#) (p. 56)

Connection Fails

Your query connection can fail for the following reasons; we suggest the following troubleshooting approaches.

Client Cannot Connect to Server

If you are using SSL or server certificates, first remove this complexity while you troubleshoot the connection issue. Then add SSL or server certificates back when you have found a solution. For more information, go to [Configure Security Options for Connections](#) in the *Amazon Redshift Cluster Management Guide*.

Connection Is Refused

Generally, when you receive an error message indicating that there is a failure to establish a connection, it means that there is an issue with the permission to access the cluster. For more information, go to [The connection is refused or fails](#) in the *Amazon Redshift Cluster Management Guide*.

Query Hangs

Your query can hang, or stop responding, for the following reasons; we suggest the following troubleshooting approaches.

Connection to the Database Is Dropped

Reduce the size of maximum transmission unit (MTU). The MTU size determines the maximum size, in bytes, of a packet that can be transferred in one Ethernet frame over your network connection. For more information, go to [The connection to the database is dropped](#) in the *Amazon Redshift Cluster Management Guide*.

Connection to the Database Times Out

Your client connection to the database appears to hang or timeout when running long queries, such as a COPY command. In this case, you might observe that the Amazon Redshift console displays that the query has completed, but the client tool itself still appears to be running the query. The results of the query might be missing or incomplete depending on when the connection stopped. This effect happens when idle connections are terminated by an intermediate network component. For more information, go to [Firewall Timeout Issue](#) in the *Amazon Redshift Cluster Management Guide*.

Client-Side Out-of-Memory Error Occurs with ODBC

If your client application uses an ODBC connection and your query creates a result set that is too large to fit in memory, you can stream the result set to your client application by using a cursor. For more information, see [DECLARE \(p. 401\)](#) and [Performance Considerations When Using Cursors \(p. 403\)](#).

Client-Side Out-of-Memory Error Occurs with JDBC

When you attempt to retrieve large result sets over a JDBC connection, you might encounter client-side out-of-memory errors. For more information, see [Setting the JDBC fetch size parameter](#).

There Is a Potential Deadlock

If there is a potential deadlock, try the following:

- View the [STV_LOCKS \(p. 760\)](#) and [STL_TR_CONFLICT \(p. 739\)](#) system tables to find conflicts involving updates to more than one table.
- Use the [PG_CANCEL_BACKEND \(p. 668\)](#) function to cancel one or more conflicting queries.
- Use the [PG_TERMINATE_BACKEND \(p. 669\)](#) function to terminate a session, which forces any currently running transactions in the terminated session to release all locks and roll back the transaction.
- Schedule concurrent write operations carefully. For more information, see [Managing Concurrent Write Operations \(p. 181\)](#).

Query Takes Too Long

Your query can take too long for the following reasons; we suggest the following troubleshooting approaches.

Tables Are Not Optimized

Set the sort key, distribution style, and compression encoding of the tables to take full advantage of parallel processing. For more information, see [Designing Tables \(p. 100\)](#) and [Tutorial: Tuning Table Design \(p. 30\)](#).

Query Is Writing to Disk

Your queries might be writing to disk for at least part of the query execution. For more information, see [Improving Query Performance \(p. 216\)](#).

Query Must Wait for Other Queries to Finish

You might be able to improve overall system performance by creating query queues and assigning different types of queries to the appropriate queues. For more information, see [Implementing Workload Management \(p. 222\)](#).

Queries Are Not Optimized

Analyze the explain plan to find opportunities for rewriting queries or optimizing the database. For more information, see [Query Plan \(p. 202\)](#).

Query Needs More Memory to Run

If a specific query needs more memory, you can increase the available memory by increasing the [wlm_query_slot_count](#) (p. 816).

Database Requires a VACUUM Command to Be Run

Run the VACUUM command whenever you add, delete, or modify a large number of rows, unless you load your data in sort key order. The VACUUM command reorganizes your data to maintain the sort order and restore performance. For more information, see [Vacuuming Tables](#) (p. 172).

Load Fails

Your data load can fail for the following reasons; we suggest the following troubleshooting approaches.

Data Source Is in a Different Region

By default, the Amazon S3 bucket or Amazon DynamoDB table specified in the COPY command must be in the same region as the cluster. If your data and your cluster are in different regions, you will receive an error similar to the following:

```
The bucket you are attempting to access must be addressed using the specified endpoint.
```

If at all possible, make sure your cluster and your data source are the same region. You can specify a different region by using the [REGION](#) (p. 324) option with the COPY command.

Note

If your cluster and your data source are in different AWS regions, you will incur data transfer costs. You will also have higher latency and more issues with eventual consistency.

COPY Command Fails

Query `STL_LOAD_ERRORS` to discover the errors that occurred during specific loads. For more information, see [STL_LOAD_ERRORS](#) (p. 713).

Load Takes Too Long

Your load operation can take too long for the following reasons; we suggest the following troubleshooting approaches.

COPY Loads Data from a Single File

Split your load data into multiple files. When you load all the data from a single large file, Amazon Redshift is forced to perform a serialized load, which is much slower. The number of files should be a multiple of the number of slices in your cluster, and the files should be about equal size, between 1 MB and 1 GB after compression. For more information, see [Best Practices for Designing Queries](#) (p. 28).

Load Operation Uses Multiple COPY Commands

If you use multiple concurrent COPY commands to load one table from multiple files, Amazon Redshift is forced to perform a serialized load, which is much slower. In this case, use a single COPY command.

Load Data Is Incorrect

Your COPY operation can load incorrect data in the following ways; we suggest the following troubleshooting approaches.

Not All Files Are Loaded

Eventual consistency can cause a discrepancy in some cases between the files listed using an Amazon S3 ListBuckets action and the files available to the COPY command. For more information, see [Verifying That the Data Was Loaded Correctly \(p. 153\)](#).

Wrong Files Are Loaded

Using an object prefix to specify data files can cause unwanted files to be read. Instead, use a manifest file to specify exactly which files to load. For more information, see the [copy_from_s3_manifest_file \(p. 323\)](#) option for the COPY command and [Example: COPY from Amazon S3 using a manifest \(p. 358\)](#) in the COPY examples.

Setting the JDBC Fetch Size Parameter

By default, the JDBC driver collects all the results for a query at one time. As a result, when you attempt to retrieve a large result set over a JDBC connection, you might encounter a client-side out-of-memory error. To enable your client to retrieve result sets in batches instead of in a single all-or-nothing fetch, set the JDBC fetch size parameter in your client application.

Note

Fetch size is not supported for ODBC.

For the best performance, set the fetch size to the highest value that does not lead to out of memory errors. A lower fetch size value results in more server trips, which prolongs execution times. The server reserves resources, including the WLM query slot and associated memory, until the client retrieves the entire result set or the query is canceled. When you tune the fetch size appropriately, those resources are released more quickly, making them available to other queries.

Note

If you need to extract large datasets, we recommend using an [UNLOAD \(p. 471\)](#) statement to transfer the data to Amazon S3. When you use UNLOAD, the compute nodes work in parallel to speed up the transfer of data.

For more information about setting the JDBC fetch size parameter, go to [Getting results based on a cursor](#) in the PostgreSQL documentation.

SQL Reference

Topics

- [Amazon Redshift SQL \(p. 238\)](#)
- [Using SQL \(p. 245\)](#)
- [SQL Commands \(p. 290\)](#)
- [SQL Functions Reference \(p. 491\)](#)
- [Reserved Words \(p. 681\)](#)

Amazon Redshift SQL

Topics

- [SQL Functions Supported on the Leader Node \(p. 238\)](#)
- [Amazon Redshift and PostgreSQL \(p. 239\)](#)

Amazon Redshift is built around industry-standard SQL, with added functionality to manage very large datasets and support high-performance analysis and reporting of those data.

Note

The maximum size for a single Amazon Redshift SQL statement is 16 MB.

SQL Functions Supported on the Leader Node

Some Amazon Redshift queries are distributed and executed on the compute nodes, and other queries execute exclusively on the leader node.

The leader node distributes SQL to the compute nodes whenever a query references user-created tables or system tables (tables with an STL or STV prefix and system views with an SVL or SVV prefix). A query that references only catalog tables (tables with a PG prefix, such as PG_TABLE_DEF, which reside on the leader node) or that does not reference any tables, runs exclusively on the leader node.

Some Amazon Redshift SQL functions are supported only on the leader node and are not supported on the compute nodes. A query that uses a leader-node function must execute exclusively on the leader node, not on the compute nodes, or it will return an error.

The documentation for each function that must run exclusively on the leader node includes a note stating that the function will return an error if it references user-defined tables or Amazon Redshift system tables. See [Leader Node–Only Functions \(p. 492\)](#) for a list of functions that run exclusively on the leader node.

Examples

The `CURRENT_SCHEMA` function is a leader-node only function. In this example, the query does not reference a table, so it runs exclusively on the leader node.

```
select current_schema();
```

The result is as follows.

```
current_schema
-----
public
(1 row)
```

In the next example, the query references a system catalog table, so it runs exclusively on the leader node.

```
select * from pg_table_def
where schemaname = current_schema() limit 1;

 schemaname | tablename | column | type   | encoding | distkey | sortkey |
notnull
-----+-----+-----+-----+-----+-----+-----
+-----+
public     | category | catid  | smallint | none     | t       |          |
t
(1 row)
```

In the next example, the query references an Amazon Redshift system table that resides on the compute nodes, so it returns an error.

```
select current_schema(), userid from users;

INFO:  Function "current_schema()" not supported.
ERROR: Specified types or functions (one per INFO message) not supported on
Amazon Redshift tables.
```

Amazon Redshift and PostgreSQL

Topics

- [Amazon Redshift and PostgreSQL JDBC and ODBC \(p. 240\)](#)
- [Features That Are Implemented Differently \(p. 240\)](#)
- [Unsupported PostgreSQL Features \(p. 241\)](#)
- [Unsupported PostgreSQL Data Types \(p. 242\)](#)

- [Unsupported PostgreSQL Functions \(p. 243\)](#)

Amazon Redshift is based on PostgreSQL 8.0.2. Amazon Redshift and PostgreSQL have a number of very important differences that you must be aware of as you design and develop your data warehouse applications.

Amazon Redshift is specifically designed for online analytic processing (OLAP) and business intelligence (BI) applications, which require complex queries against large datasets. Because it addresses very different requirements, the specialized data storage schema and query execution engine that Amazon Redshift uses are completely different from the PostgreSQL implementation. For example, where online transaction processing (OLTP) applications typically store data in rows, Amazon Redshift stores data in columns, using specialized data compression encodings for optimum memory usage and disk I/O. Some PostgreSQL features that are suited to smaller-scale OLTP processing, such as secondary indexes and efficient single-row data manipulation operations, have been omitted to improve performance.

See [Amazon Redshift System Overview \(p. 4\)](#) for a detailed explanation of the Amazon Redshift data warehouse system architecture.

PostgreSQL 9.x includes some features that are not supported in Amazon Redshift. In addition, there are important differences between Amazon Redshift SQL and PostgreSQL 8.0.2 that you must be aware of. This section highlights the differences between Amazon Redshift and PostgreSQL 8.0.2 and provides guidance for developing a data warehouse that takes full advantage of the Amazon Redshift SQL implementation.

Amazon Redshift and PostgreSQL JDBC and ODBC

Because Amazon Redshift is based on PostgreSQL, we previously recommended using JDBC4 Postgresql driver version 8.4.703 and psqLODBC version 9.x drivers; if you are currently using those drivers, we recommend moving to the new Amazon Redshift-specific drivers going forward. For more information about drivers and configuring connections, see [JDBC and ODBC Drivers for Amazon Redshift](#) in the *Amazon Redshift Cluster Management Guide*.

To avoid client-side out-of-memory errors when retrieving large data sets using JDBC, you can enable your client to fetch data in batches by setting the JDBC fetch size parameter. For more information, see [Setting the JDBC Fetch Size Parameter \(p. 237\)](#).

Amazon Redshift does not recognize the JDBC maxRows parameter. Instead, specify a [LIMIT \(p. 460\)](#) clause to restrict the result set. You can also use an [OFFSET \(p. 460\)](#) clause to skip to a specific starting point in the result set.

Features That Are Implemented Differently

Many Amazon Redshift SQL language elements have different performance characteristics and use syntax and semantics and that are quite different from the equivalent PostgreSQL implementation.

Important

Do not assume that the semantics of elements that Amazon Redshift and PostgreSQL have in common are identical. Make sure to consult the *Amazon Redshift Developer Guide* [SQL Commands \(p. 290\)](#) to understand the often subtle differences.

One example in particular is the [VACUUM \(p. 488\)](#) command, which is used to clean up and reorganize tables. VACUUM functions differently and uses a different set of parameters than the PostgreSQL version. See [Vacuuming Tables \(p. 172\)](#) for more about information about using VACUUM in Amazon Redshift.

Often, database management and administration features and tools are different as well. For example, Amazon Redshift maintains a set of system tables and views that provide information about how the system is functioning. See [System Tables and Views \(p. 685\)](#) for more information.

The following list includes some examples of SQL features that are implemented differently in Amazon Redshift.

- [CREATE TABLE \(p. 378\)](#)

Amazon Redshift does not support tablespaces, table partitioning, inheritance, and certain constraints. The Amazon Redshift implementation of CREATE TABLE enables you to define the sort and distribution algorithms for tables to optimize parallel processing.

- [ALTER TABLE \(p. 297\)](#)

ALTER COLUMN actions are not supported.

ADD COLUMN supports adding only one column in each ALTER TABLE statement.

- [COPY \(p. 317\)](#)

The Amazon Redshift COPY command is highly specialized to enable the loading of data from Amazon S3 buckets and Amazon DynamoDB tables and to facilitate automatic compression. See the [Loading Data \(p. 130\)](#) section and the COPY command reference for details.

- [SELECT \(p. 435\)](#)

ORDER BY ... NULLS FIRST/LAST is not supported.

- [INSERT \(p. 424\)](#), [UPDATE \(p. 483\)](#), and [DELETE \(p. 404\)](#)

WITH is not supported.

- [VACUUM \(p. 488\)](#)

The parameters for VACUUM are entirely different. For example, the default VACUUM operation in PostgreSQL simply reclaims space and makes it available for re-use; however, the default VACUUM operation in Amazon Redshift is VACUUM FULL, which reclaims disk space and resorts all rows.

- Trailing spaces in VARCHAR values are ignored when string values are compared. For more information, see [Significance of Trailing Blanks \(p. 258\)](#).

Unsupported PostgreSQL Features

These PostgreSQL features are not supported in Amazon Redshift.

Important

Do not assume that the semantics of elements that Amazon Redshift and PostgreSQL have in common are identical. Make sure to consult the *Amazon Redshift Developer Guide SQL Commands (p. 290)* to understand the often subtle differences.

- Only the 8.x version of the PostgreSQL query tool *psql* is supported.
- Table partitioning (range and list partitioning)
- Tablespaces
- Constraints
 - Unique
 - Foreign key
 - Primary key
 - Check constraints
 - Exclusion constraints

Unique, primary key, and foreign key constraints are permitted, but they are informational only. They are not enforced by the system, but they are used by the query planner.

- Inheritance
- Postgres system columns

Amazon Redshift SQL does not implicitly define system columns. However, the PostgreSQL system column names cannot be used as names of user-defined columns. See <http://www.postgresql.org/docs/8.0/static/ddl-system-columns.html>

- Indexes
- NULLS clause in Window functions
- Collations

Amazon Redshift does not support locale-specific or user-defined collation sequences. See [Collation Sequences \(p. 269\)](#).

- Value expressions
 - Subscripted expressions
 - Array constructors
 - Row constructors
- Stored procedures
- Triggers
- Management of External Data (SQL/MED)
- Table functions
- VALUES list used as constant tables
- Recursive common table expressions
- Sequences
- Full text search

Unsupported PostgreSQL Data Types

Generally, if a query attempts to use an unsupported data type, including explicit or implicit casts, it will return an error. However, some queries that use unsupported data types will run on the leader node but not on the compute nodes. See [SQL Functions Supported on the Leader Node \(p. 238\)](#).

For a list of the supported data types, see [Data Types \(p. 247\)](#).

These PostgreSQL data types are not supported in Amazon Redshift.

- Arrays
- BIT, BIT VARYING
- BYTEA
- Composite Types
- Date/Time Types
 - INTERVAL
 - TIME
- Enumerated Types
- Geometric Types
- JSON
- Network Address Types
- Numeric Types
 - SERIAL, BIGSERIAL, SMALLSERIAL
 - MONEY
- Object Identifier Types

- Pseudo-Types
- Range Types
- Text Search Types
- TXID_SNAPSHOT
- UUID
- XML

Unsupported PostgreSQL Functions

Many functions that are not excluded have different semantics or usage. For example, some supported functions will run only on the leader node. Also, some unsupported functions will not return an error when run on the leader node. The fact that these functions do not return an error in some cases should not be taken to indicate that the function is supported by Amazon Redshift.

Important

Do not assume that the semantics of elements that Amazon Redshift and PostgreSQL have in common are identical. Make sure to consult the *Amazon Redshift Database Developer Guide SQL Commands* (p. 290) to understand the often subtle differences.

For more information, see [SQL Functions Supported on the Leader Node](#) (p. 238).

These PostgreSQL functions are not supported in Amazon Redshift.

- Access privilege inquiry functions
- Advisory lock functions
- Aggregate functions
 - STRING_AGG()
 - ARRAY_AGG()
 - EVERY()
 - XML_AGG()
 - CORR()
 - COVAR_POP()
 - COVAR_SAMP()
 - REGR_AVGX(), REGR_AVGY()
 - REGR_COUNT()
 - REGR_INTERCEPT()
 - REGR_R2()
 - REGR_SLOPE()
 - REGR_SXX(), REGR_SXY(), REGR_SYY()
- Array functions and operators
- Backup control functions
- Comment information functions
- Database object location functions
- Database object size functions
- Date/Time functions and operators
 - CLOCK_TIMESTAMP()
 - JUSTIFY_DAYS(), JUSTIFY_HOURS(), JUSTIFY_INTERVAL()
 - PG_SLEEP()
 - TRANSACTION_TIMESTAMP()
- Data type formatting functions

- TO_TIMESTAMP()
- ENUM support functions
- Geometric functions and operators
- Generic file access functions
- IS DISTINCT FROM
- Network address functions and operators
- Mathematical functions
 - DIV()
 - SETSEED()
 - WIDTH_BUCKET()
- Set returning functions
 - GENERATE_SERIES()
 - GENERATE_SUBSCRIPTS()
- Range functions and operators
- Recovery control functions
- Recovery information functions
- ROLLBACK TO SAVEPOINT function
- Schema visibility inquiry functions
- Server signaling functions
- Snapshot synchronization functions
- Sequence manipulation functions
- String functions
 - BIT_LENGTH()
 - OVERLAY()
 - CONVERT(), CONVERT_FROM(), CONVERT_TO()
 - ENCODE()
 - FORMAT()
 - QUOTE_NULLABLE()
 - REGEXP_MATCHES()
 - REGEXP_SPLIT_TO_ARRAY()
 - REGEXP_SPLIT_TO_TABLE()
 - SUBSTR()
 - TRANSLATE()
- System catalog information functions
- System information functions
 - CURRENT_CATALOG CURRENT_QUERY()
 - INET_CLIENT_ADDR()
 - INET_CLIENT_PORT()
 - INET_SERVER_ADDR() INET_SERVER_PORT()
 - PG_CONF_LOAD_TIME()
 - PG_IS_OTHER_TEMP_SCHEMA()
 - PG_LISTENING_CHANNELS()
 - PG_MY_TEMP_SCHEMA()
 - PG_POSTMASTER_START_TIME()
 - PG_TRIGGER_DEPTH()
- Text search functions and operators

- Transaction IDs and snapshots functions
- Trigger functions
- XML functions

Using SQL

Topics

- [SQL Reference Conventions \(p. 245\)](#)
- [Basic Elements \(p. 245\)](#)
- [Expressions \(p. 269\)](#)
- [Conditions \(p. 273\)](#)

The SQL language consists of commands and functions that you use to work with databases and database objects. The language also enforces rules regarding the use of data types, expressions, and literals.

SQL Reference Conventions

This section explains the conventions that are used to write the syntax for the SQL expressions, commands, and functions described in the SQL reference section.

Character	Description
CAPS	Words in capital letters are key words.
[]	Square brackets denote optional arguments. Multiple arguments in square brackets indicate that you can choose any number of the arguments. In addition, arguments in brackets on separate lines indicate that the Amazon Redshift parser expects the arguments to be in the order that they are listed in the syntax. For an example, see SELECT (p. 435) .
{ }	Braces indicate that you are required to choose one of the arguments inside the braces.
	Pipes indicate that you can choose between the arguments.
<i>italics</i>	Words in italics indicate placeholders. You must insert the appropriate value in place of the word in italics.
...	An ellipsis indicates that you can repeat the preceding element.
'	Words in single quotes indicate that you must type the quotes.

Basic Elements

Topics

- [Names and Identifiers \(p. 246\)](#)
- [Literals \(p. 247\)](#)
- [Nulls \(p. 247\)](#)
- [Data Types \(p. 247\)](#)
- [Collation Sequences \(p. 269\)](#)

This section covers the rules for working with database object names, literals, nulls, and data types.

Names and Identifiers

Names identify database objects, including tables and columns, as well as users and passwords. The terms *name* and *identifier* can be used interchangeably. There are two types of identifiers, standard identifiers and quoted or delimited identifiers. Standard and delimited identifiers are case-insensitive and are folded to lower case. Identifiers must consist of only UTF-8 printable characters.

Standard Identifiers

Standard SQL identifiers adhere to a set of rules and must:

- Contain only UTF-8 characters.
- Begin with a UTF-8 printable character.
- Be between 1 and 127 bytes in length, not including quotes for delimited identifiers.
- Contain no quotation marks and no spaces.
- Not be a reserved SQL key word.

Delimited Identifiers

Delimited identifiers (also known as quoted identifiers) begin and end with double quotation marks ("). If you use a delimited identifier, you must use the double quotation marks for every reference to that object. The identifier can contain any standard UTF-8 printable characters other than the double quote itself. Therefore, you can create column or table names that include otherwise illegal characters, such as spaces or the percent symbol.

Delimited identifiers are case-insensitive, and are folded to lower case. To use a double quote in a string, you must precede it with another double quote character.

Examples

This table shows examples of delimited identifiers, the resulting output, and a discussion:

Syntax	Result	Discussion
"group"	group	GROUP is a reserved word, so usage of it within an identifier requires double quotes.
""WHERE""	"where"	WHERE is also a reserved word. To include quotation marks in the string, escape each double quote character with additional double quote characters.
"This name"	this name	Double quotes are required in order to preserve the space.
"This ""IS IT""	this "is it"	The quotes surrounding IS IT must each be preceded by an extra quote in order to become part of the name.

To create a table named group with a column named this "is it":

```
create table "group" (
  "This ""IS IT"" char(10));
```

The following queries return the same result:

```
select "This ""IS IT""
from "group";

this "is it"
-----
(0 rows)
```

```
select "this ""is it""
from "group";

this "is it"
-----
(0 rows)
```

The following fully qualified `table.column` syntax also returns the same result:

```
select "group"."this ""is it""
from "group";

this "is it"
-----
(0 rows)
```

Literals

A literal or constant is a fixed data value, composed of a sequence of characters or a numeric constant. Amazon Redshift supports several types of literals, including:

- Numeric literals for integer, decimal, and floating-point numbers. For more information, see [Integer and Floating-Point Literals \(p. 254\)](#).
- Character literals, also referred to as strings, character strings, or character constants
- Datetime and interval literals, used with datetime data types. For more information, see [Date and Timestamp Literals \(p. 261\)](#) and [Interval Literals \(p. 263\)](#).

Nulls

If a column in a row is missing, unknown, or not applicable, it is a null value or is said to contain null. Nulls can appear in fields of any data type that are not restricted by primary key or NOT NULL constraints. A null is not equivalent to the value zero or to an empty string.

Any arithmetic expression containing a null always evaluates to a null. All operators except concatenation return a null when given a null argument or operand.

To test for nulls, use the comparison conditions IS NULL and IS NOT NULL. Because null represents a lack of data, a null is not equal or unequal to any value or to another null.

Data Types

Topics

- [Multibyte Characters \(p. 248\)](#)
- [Numeric Types \(p. 249\)](#)
- [Character Types \(p. 256\)](#)

- [Datetime Types \(p. 259\)](#)
- [Boolean Type \(p. 264\)](#)
- [Type Compatibility and Conversion \(p. 266\)](#)

Each value that Amazon Redshift stores or retrieves has a data type with a fixed set of associated properties. Data types are declared when tables are created. A data type constrains the set of values that a column or argument can contain.

The following table lists the data types that you can use in Amazon Redshift tables.

Data Type	Aliases	Description
SMALLINT	INT2	Signed two-byte integer
INTEGER	INT, INT4	Signed four-byte integer
BIGINT	INT8	Signed eight-byte integer
DECIMAL	NUMERIC	Exact numeric of selectable precision
REAL	FLOAT4	Single precision floating-point number
DOUBLE PRECISION	FLOAT8, FLOAT	Double precision floating-point number
BOOLEAN	BOOL	Logical Boolean (true/false)
CHAR	CHARACTER, NCHAR, BPCHAR	Fixed-length character string
VARCHAR	CHARACTER VARYING, NVARCHAR, TEXT	Variable-length character string with a user-defined limit
DATE		Calendar date (year, month, day)
TIMESTAMP	TIMESTAMP WITHOUT TIME ZONE	Date and time (without time zone)
TIMESTAMPTZ	TIMESTAMP WITH TIME ZONE	Date and time (with time zone)

Multibyte Characters

The VARCHAR data type supports UTF-8 multibyte characters up to a maximum of four bytes. Five-byte or longer characters are not supported. To calculate the size of a VARCHAR column that contains multibyte characters, multiply the number of characters by the number of bytes per character. For example, if a string has four Chinese characters, and each character is three bytes long, then you will need a VARCHAR(12) column to store the string.

VARCHAR does not support the following invalid UTF-8 codepoints:

- 0xD800 - 0xDFFF
(Byte sequences: ED A0 80 - ED BF BF)
- 0xFDD0 - 0xFDEF, 0xFFFE, and 0xFFFF

(Byte sequences: EF B7 90 - EF B7 AF, EF BF BE, and EF BF BF)

The CHAR data type does not support multibyte characters.

Numeric Types

Topics

- [Integer Types \(p. 249\)](#)
- [DECIMAL or NUMERIC Type \(p. 249\)](#)
- [Notes About Using 128-bit DECIMAL or NUMERIC Columns \(p. 250\)](#)
- [Floating-Point Types \(p. 250\)](#)
- [Computations with Numeric Values \(p. 251\)](#)
- [Integer and Floating-Point Literals \(p. 254\)](#)
- [Examples with Numeric Types \(p. 255\)](#)

Numeric data types include integers, decimals, and floating-point numbers.

Integer Types

Use the SMALLINT, INTEGER, and BIGINT data types to store whole numbers of various ranges. You cannot store values outside of the allowed range for each type.

Name	Storage	Range
SMALLINT or INT2	2 bytes	-32768 to +32767
INTEGER, INT, or INT4	4 bytes	-2147483648 to +2147483647
BIGINT or INT8	8 bytes	-9223372036854775808 to 9223372036854775807

DECIMAL or NUMERIC Type

Use the DECIMAL or NUMERIC data type to store values with a *user-defined precision*. The DECIMAL and NUMERIC keywords are interchangeable. In this document, *decimal* is the preferred term for this data type. The term *numeric* is used generically to refer to integer, decimal, and floating-point data types.

Storage	Range
Variable, up to 128 bits for uncompressed DECIMAL types.	128-bit signed integers with up to 38 digits of precision.

Define a DECIMAL column in a table by specifying a *precision* and *scale*:

```
decimal(precision, scale)
```

precision

The total number of significant digits in the whole value: the number of digits on both sides of the decimal point. For example, the number 48.2891 has a precision of 6 and a scale of 4. The default precision, if not specified, is 18. The maximum precision is 38.

If the number of digits to the left of the decimal point in an input value exceeds the precision of the column minus its scale, the value cannot be copied into the column (or inserted or updated). This rule applies to any value that falls outside the range of the column definition. For example, the allowed range of values for a `numeric(5,2)` column is `-999.99` to `999.99`.

scale

The number of decimal digits in the fractional part of the value, to the right of the decimal point. Integers have a scale of zero. In a column specification, the scale value must be less than or equal to the precision value. The default scale, if not specified, is 0. The maximum scale is 37.

If the scale of an input value that is loaded into a table is greater than the scale of the column, the value is rounded to the specified scale. For example, the `PRICEPAID` column in the `SALES` table is a `DECIMAL(8,2)` column. If a `DECIMAL(8,4)` value is inserted into the `PRICEPAID` column, the value is rounded to a scale of 2.

```
insert into sales
values (0, 8, 1, 1, 2000, 14, 5, 4323.8951, 11.00, null);

select pricepaid, salesid from sales where salesid=0;

pricepaid | salesid
-----+-----
4323.90 |      0
(1 row)
```

However, results of explicit casts of values selected from tables are not rounded.

Note

The maximum positive value that you can insert into a `DECIMAL(19,0)` column is `9223372036854775807` ($2^{63} - 1$). The maximum negative value is `-9223372036854775807`. For example, an attempt to insert the value `9999999999999999999` (19 nines) will cause an overflow error. Regardless of the placement of the decimal point, the largest string that Amazon Redshift can represent as a `DECIMAL` number is `9223372036854775807`. For example, the largest value that you can load into a `DECIMAL(19,18)` column is `9.223372036854775807`. These rules derive from the internal storage of `DECIMAL` values as 8-byte integers. Amazon Redshift recommends that you do not define `DECIMAL` values with 19 digits of precision unless that precision is necessary.

[Notes About Using 128-bit DECIMAL or NUMERIC Columns](#)

Note the following restrictions on using `DECIMAL` or `NUMERIC` columns with a precision that is greater than 19:

- Amazon Redshift does not implicitly convert 64-bit `DECIMAL` values to 128-bit values. You must explicitly convert 64-bit values to a higher precision by using functions such as the [CAST and CONVERT Functions](#) (p. 658).
- Do not arbitrarily assign maximum precision to `DECIMAL` columns unless you are certain that your application requires that precision. 128-bit values use twice as much disk space as 64-bit values and can slow down query execution time.

[Floating-Point Types](#)

Use the `REAL` and `DOUBLE PRECISION` data types to store numeric values with *variable precision*. These types are *inexact* types, meaning that some values are stored as approximations, such that storing and returning a specific value may result in slight discrepancies. If you require exact storage and calculations (such as for monetary amounts), use the `DECIMAL` data type.

Name	Storage	Range
REAL or FLOAT4	4 bytes	6 significant digits of precision
DOUBLE PRECISION, FLOAT8, or FLOAT	8 bytes	15 significant digits of precision

For example, note the results of the following inserts into a REAL column:

```
create table reall(realcol real);

insert into reall values(12345.12345);

insert into reall values(123456.12345);

select * from reall;
realcol
-----
123456
12345.1
(2 rows)
```

These inserted values are truncated to meet the limitation of 6 significant digits of precision for REAL columns.

Computations with Numeric Values

In this context, *computation* refers to binary mathematical operations: addition, subtraction, multiplication, and division. This section describes the expected return types for these operations, as well as the specific formula that is applied to determine precision and scale when DECIMAL data types are involved.

When numeric values are computed during query processing, you might encounter cases where the computation is impossible and the query returns a numeric overflow error. You might also encounter cases where the scale of computed values varies or is unexpected. For some operations, you can use explicit casting (type promotion) or Amazon Redshift configuration parameters to work around these problems.

For information about the results of similar computations with SQL functions, see [Aggregate Functions \(p. 493\)](#).

Return Types for Computations

Given the set of numeric data types supported in Amazon Redshift, the following table shows the expected return types for addition, subtraction, multiplication, and division operations. The first column on the left side of the table represents the first operand in the calculation, and the top row represents the second operand.

	INT2	INT4	INT8	DECIMAL	FLOAT4	FLOAT8
INT2	INT2	INT4	INT8	DECIMAL	FLOAT8	FLOAT8
INT4	INT4	INT4	INT8	DECIMAL	FLOAT8	FLOAT8
INT8	INT8	INT8	INT8	DECIMAL	FLOAT8	FLOAT8
DECIMAL	DECIMAL	DECIMAL	DECIMAL	DECIMAL	FLOAT8	FLOAT8

FLOAT4	FLOAT8	FLOAT8	FLOAT8	FLOAT8	FLOAT4	FLOAT8
FLOAT8	FLOAT8	FLOAT8	FLOAT8	FLOAT8	FLOAT8	FLOAT8

Precision and Scale of Computed DECIMAL Results

The following table summarizes the rules for computing resulting precision and scale when mathematical operations return DECIMAL results. In this table, p_1 and s_1 represent the precision and scale of the first operand in a calculation and p_2 and s_2 represent the precision and scale of the second operand. (Regardless of these calculations, the maximum result precision is 38, and the maximum result scale is 38.)

Operation	Result Precision and Scale
+ or -	Scale = $\max(s_1, s_2)$ Precision = $\max(p_1 - s_1, p_2 - s_2) + 1 + \text{scale}$
*	Scale = $s_1 + s_2$ Precision = $p_1 + p_2 + 1$
/	Scale = $\max(4, s_1 + p_2 - s_2 + 1)$ Precision = $p_1 - s_1 + s_2 + \text{scale}$

For example, the PRICEPAID and COMMISSION columns in the SALES table are both DECIMAL(8,2) columns. If you divide PRICEPAID by COMMISSION (or vice versa), the formula is applied as follows:

```
Precision = 8-2 + 2 + max(4, 2+8-2+1)
= 6 + 2 + 9 = 17

Scale = max(4, 2+8-2+1) = 9

Result = DECIMAL(17,9)
```

The following calculation is the general rule for computing the resulting precision and scale for operations performed on DECIMAL values with set operators such as UNION, INTERSECT, and EXCEPT or functions such as COALESCE and DECODE:

```
Scale = max(s1, s2)
Precision = min(max(p1-s1, p2-s2)+scale, 19)
```

For example, a DEC1 table with one DECIMAL(7,2) column is joined with a DEC2 table with one DECIMAL(15,3) column to create a DEC3 table. The schema of DEC3 shows that the column becomes a NUMERIC(15,3) column.

```
create table dec3 as select * from dec1 union select * from dec2;
```

Result

```
select "column", type, encoding, distkey, sortkey
from pg_table_def where tablename = 'dec3';
```

column	type	encoding	distkey	sortkey
c1	numeric(15,3)	none	f	0

In the above example, the formula is applied as follows:

```
Precision = min(max(7-2,15-3) + max(2,3), 19)
            = 12 + 3 = 15

Scale = max(2,3) = 3

Result = DECIMAL(15,3)
```

Notes on Division Operations

For division operations, divide-by-zero conditions return errors.

The scale limit of 100 is applied after the precision and scale are calculated. If the calculated result scale is greater than 100, division results are scaled as follows:

- Precision = precision - (scale - max_scale)
- Scale = max_scale

If the calculated precision is greater than the maximum precision (38), the precision is reduced to 38, and the scale becomes the result of: $\max(38 + \text{scale} - \text{precision}, \min(4, 100))$

Overflow Conditions

Overflow is checked for all numeric computations. DECIMAL data with a precision of 19 or less is stored as 64-bit integers. DECIMAL data with a precision that is greater than 19 is stored as 128-bit integers. The maximum precision for all DECIMAL values is 38, and the maximum scale is 37. Overflow errors occur when a value exceeds these limits, which apply to both intermediate and final result sets:

- Explicit casting results in run-time overflow errors when specific data values do not fit the requested precision or scale specified by the cast function. For example, you cannot cast all values from the PRICEPAID column in the SALES table (a DECIMAL(8,2) column) and return a DECIMAL(7,3) result:

```
select pricepaid::decimal(7,3) from sales;
ERROR: Numeric data overflow (result precision)
```

This error occurs because *some* of the larger values in the PRICEPAID column cannot be cast.

- Multiplication operations produce results in which the result scale is the sum of the scale of each operand. If both operands have a scale of 4, for example, the result scale is 8, leaving only 10 digits for the left side of the decimal point. Therefore, it is relatively easy to run into overflow conditions when multiplying two large numbers that both have significant scale.
- Implicitly casting 64-bit DECIMAL values to a higher precision causes numeric overflow errors. To avoid overflow errors, explicitly cast 64-bit DECIMAL values to a higher precision by using functions such as the [CAST and CONVERT Functions \(p. 658\)](#). For example, the PRICEPAID column in the SALES table is a DECIMAL(8,2) column. To multiply the values in this column by a value that increases the precision to greater than 19 digits, such as 10000000000000000000, cast the expression as follows:

```
select salesid, pricepaid::decimal(38,2) * 10000000000000000000
as value from sales where salesid=2;
```

```
salesid |          value
-----+-----
         2 | 76000000000000000000.00
(1 row)
```

Numeric Calculations with INTEGER and DECIMAL Types

When one of the operands in a calculation has an INTEGER data type and the other operand is DECIMAL, the INTEGER operand is implicitly cast as a DECIMAL:

- INT2 (SMALLINT) is cast as DECIMAL(5,0)
- INT4 (INTEGER) is cast as DECIMAL(10,0)
- INT8 (BIGINT) is cast as DECIMAL(19,0)

For example, if you multiply SALES.COMMISSION, a DECIMAL(8,2) column, and SALES.QTYSOLD, a SMALLINT column, this calculation is cast as:

```
DECIMAL(8,2) * DECIMAL(5,0)
```

Integer and Floating-Point Literals

Literals or constants that represent numbers can be integer or floating-point.

Integer Literals

An integer constant is a sequence of the digits 0-9, with an optional positive (+) or negative (-) sign preceding the digits.

Syntax

```
[ + | - ] digit ...
```

Examples

Valid integers include the following:

```
23
-555
+17
```

Floating-Point Literals

Floating-point literals (also referred to as decimal, numeric, or fractional literals) are sequences of digits that can include a decimal point, and optionally the exponent marker (e).

Syntax

```
[ + | - ] digit ... [ . ] [ digit ... ]
[ e | E [ + | - ] digit ... ]
```

Arguments

e | E

e or E indicates that the number is specified in scientific notation.

Examples

Valid floating-point literals include the following:

```
3.14159  
-37.  
2.0e19  
-2E-19
```

Examples with Numeric Types

CREATE TABLE Statement

The following CREATE TABLE statement demonstrates the declaration of different numeric data types:

```
create table film (  
  film_id integer,  
  language_id smallint,  
  original_language_id smallint,  
  rental_duration smallint default 3,  
  rental_rate numeric(4,2) default 4.99,  
  length smallint,  
  replacement_cost real default 25.00);
```

Attempt to Insert an Integer That is Out of Range

The following example attempts to insert the value 33000 into an INT column.

```
insert into film(language_id) values(33000);
```

The range for INT is -32768 to +32767, so Amazon Redshift returns an error.

```
An error occurred when executing the SQL command:  
insert into film(language_id) values(33000)  
  
ERROR: smallint out of range [SQL State=22003]
```

Insert a Decimal Value into an Integer Column

The following example inserts the a decimal value into an INT column.

```
insert into film(language_id) values(1.5);
```

This value is inserted but rounded up to the integer value 2.

Insert a Decimal That Succeeds Because Its Scale Is Rounded

The following example inserts a decimal value that has higher precision than the column.

```
insert into film(rental_rate) values(35.512);
```

In this case, the value 35.51 is inserted into the column.

Attempt to Insert a Decimal Value That Is Out of Range

In this case, the value 350.10 is out of range. The number of digits for values in DECIMAL columns is equal to the column's precision minus its scale (4 minus 2 for the RENTAL_RATE column). In other words, the allowed range for a DECIMAL(4,2) column is -99.99 through 99.99.

```
insert into film(rental_rate) values (350.10);
ERROR: numeric field overflow
DETAIL: The absolute value is greater than or equal to 10^2 for field with
precision 4, scale 2.
```

Insert Variable-Precision Values into a REAL Column

The following example inserts variable-precision values into a REAL column.

```
insert into film(replacement_cost) values(1999.99);

insert into film(replacement_cost) values(19999.99);

select replacement_cost from film;
replacement_cost
-----
20000
1999.99
...
```

The value 19999.99 is converted to 20000 to meet the 6-digit precision requirement for the column. The value 1999.99 is loaded as is.

Character Types

Topics

- [Storage and Ranges \(p. 256\)](#)
- [CHAR or CHARACTER \(p. 257\)](#)
- [VARCHAR or CHARACTER VARYING \(p. 257\)](#)
- [NCHAR and NVARCHAR Types \(p. 257\)](#)
- [TEXT and BPCHAR Types \(p. 257\)](#)
- [Significance of Trailing Blanks \(p. 258\)](#)
- [Examples with Character Types \(p. 258\)](#)

Character data types include CHAR (character) and VARCHAR (character varying).

Storage and Ranges

CHAR and VARCHAR data types are defined in terms of bytes, not characters. A CHAR column can only contain single-byte characters, so a CHAR(10) column can contain a string with a maximum length of 10 bytes. A VARCHAR can contain multibyte characters, up to a maximum of four bytes per character. For example, a VARCHAR(12) column can contain 12 single-byte characters, 6 two-byte characters, 4 three-byte characters, or 3 four-byte characters.

Name	Storage	Range (Width of Column)
CHAR, CHARACTER or NCHAR	Length of string, including trailing blanks (if any)	4096 bytes

Name	Storage	Range (Width of Column)
VARCHAR, CHARACTER VARYING, or NVARCHAR	4 bytes + total bytes for characters, where each character can be 1 to 4 bytes.	65535 bytes (64K -1)
BPCHAR	Converted to fixed-length CHAR(256).	256 bytes
TEXT	Converted to VARCHAR(256).	260 bytes

Note

The CREATE TABLE syntax supports the MAX keyword for character data types. For example:

```
create table test(coll varchar(max));
```

The MAX setting defines the width of the column as 4096 bytes for CHAR or 65535 bytes for VARCHAR.

CHAR or CHARACTER

Use a CHAR or CHARACTER column to store fixed-length strings. These strings are padded with blanks, so a CHAR(10) column always occupies 10 bytes of storage.

```
char(10)
```

A CHAR column without a length specification results in a CHAR(1) column.

VARCHAR or CHARACTER VARYING

Use a VARCHAR or CHARACTER VARYING column to store variable-length strings with a fixed limit. These strings are not padded with blanks, so a VARCHAR(120) column consists of a maximum of 120 single-byte characters, 60 two-byte characters, 40 three-byte characters, or 30 four-byte characters.

```
varchar(120)
```

If you use the VARCHAR data type without a length specifier, the default length is 256.

NCHAR and NVARCHAR Types

You can create columns with the NCHAR and NVARCHAR types (also known as NATIONAL CHARACTER and NATIONAL CHARACTER VARYING types). These types are converted to CHAR and VARCHAR types, respectively, and are stored in the specified number of bytes.

An NCHAR column without a length specification is converted to a CHAR(1) column.

An NVARCHAR column without a length specification is converted to a VARCHAR(256) column.

TEXT and BPCHAR Types

You can create an Amazon Redshift table with a TEXT column, but it is converted to a VARCHAR(256) column that accepts variable-length values with a maximum of 256 characters.

You can create an Amazon Redshift column with a BPCHAR (blank-padded character) type, which Amazon Redshift converts to a fixed-length CHAR(256) column.

Significance of Trailing Blanks

Both CHAR and VARCHAR data types store strings up to n bytes in length. An attempt to store a longer string into a column of these types results in an error, unless the extra characters are all spaces (blanks), in which case the string is truncated to the maximum length. If the string is shorter than the maximum length, CHAR values are padded with blanks, but VARCHAR values store the string without blanks.

Trailing blanks in CHAR values are always semantically insignificant. They are disregarded when you compare two CHAR values, not included in LENGTH calculations, and removed when you convert a CHAR value to another string type.

Trailing spaces in VARCHAR and CHAR values are treated as semantically insignificant when values are compared.

Length calculations return the length of VARCHAR character strings with trailing spaces included in the length. Trailing blanks are not counted in the length for fixed-length character strings.

Examples with Character Types

CREATE TABLE Statement

The following CREATE TABLE statement demonstrates the use of VARCHAR and CHAR data types:

```
create table address(  
  address_id integer,  
  address1 varchar(100),  
  address2 varchar(50),  
  district varchar(20),  
  city_name char(20),  
  state char(2),  
  postal_code char(5)  
);
```

The following examples use this table.

Trailing Blanks in Variable-Length Character Strings

Because ADDRESS1 is a VARCHAR column, the trailing blanks in the second inserted address are semantically insignificant. In other words, these two inserted addresses *match*.

```
insert into address(address1) values('9516 Magnolia Boulevard');  
  
insert into address(address1) values('9516 Magnolia Boulevard ');
```

```
select count(*) from address  
where address1='9516 Magnolia Boulevard';  
  
count  
-----  
2  
(1 row)
```

If the ADDRESS1 column were a CHAR column and the same values were inserted, the COUNT(*) query would recognize the character strings as the same and return 2.

Results of the LENGTH Function

The LENGTH function recognizes trailing blanks in VARCHAR columns:

```
select length(address1) from address;

length
-----
23
25
(2 rows)
```

A value of `Augusta` in the `CITY_NAME` column, which is a CHAR column, would always return a length of 7 characters, regardless of any trailing blanks in the input string.

Values That Exceed the Length of the Column

Character strings are not truncated to fit the declared width of the column:

```
insert into address(city_name) values('City of South San Francisco');
ERROR: value too long for type character(20)
```

A workaround for this problem is to cast the value to the size of the column:

```
insert into address(city_name)
values('City of South San Francisco'::char(20));
```

In this case, the first 20 characters of the string (`City of South San Fr`) would be loaded into the column.

Datetime Types

Topics

- [Storage and Ranges \(p. 259\)](#)
- [DATE \(p. 260\)](#)
- [TIMESTAMP \(p. 260\)](#)
- [TIMESTAMPTZ \(p. 260\)](#)
- [Examples with Datetime Types \(p. 261\)](#)
- [Date and Timestamp Literals \(p. 261\)](#)
- [Interval Literals \(p. 263\)](#)

Datetime data types include DATE, TIMESTAMP, and TIMESTAMPTZ.

Storage and Ranges

Name	Storage	Range	Resolution
DATE	4 bytes	4713 BC to 294276 AD	1 day
TIMESTAMP	8 bytes	4713 BC to 294276 AD	1 microsecond
TIMESTAMPTZ	8 bytes	4713 BC to 294276 AD	1 microsecond

DATE

Use the DATE data type to store simple calendar dates without time stamps.

TIMESTAMP

TIMESTAMP is an alias of TIMESTAMP WITHOUT TIME ZONE.

Use the TIMESTAMP data type to store complete time stamp values that include the date and the time of day.

TIMESTAMP columns store values with up to a maximum of 6 digits of precision for fractional seconds.

If you insert a date into a TIMESTAMP column, or a date with a partial time stamp value, the value is implicitly converted into a full time stamp value with default values (00) for missing hours, minutes, and seconds. Time zone values in input strings are ignored.

By default, TIMESTAMP values are Coordinated Universal Time (UTC) in both user tables and Amazon Redshift system tables.

TIMESTAMPTZ

TIMESTAMPTZ is an alias of TIMESTAMP WITH TIME ZONE.

Use the TIMESTAMPTZ data type to input complete time stamp values that include the date, the time of day, and a time zone. When an input value includes a time zone, Amazon Redshift uses the time zone to convert the value to Coordinated Universal Time (UTC) and stores the UTC value.

To view a list of supported time zone names, execute the following command.

```
select pg_timezone_names();
```

To view a list of supported time zone abbreviations, execute the following command.

```
select pg_timezone_abbrevs();
```

You can also find current information about time zones in the [IANA Time Zone Database](#).

The following table has examples of time zone formats.

Format	Example
day mon hh:mm:ss yyyy tz	17 Dec 07:37:16 1997 PST
mm/dd/yyyy hh:mm:ss.ss tz	12/17/1997 07:37:16.00 PST
mm/dd/yyyy hh:mm:ss.ss tz	12/17/1997 07:37:16.00 US/Pacific
yyyy-mm-dd hh:mm:ss+/-tz	1997-12-17 07:37:16-08
dd.mm.yyyy hh:mm:ss tz	17.12.1997 07:37:16.00 PST

TIMESTAMPTZ columns store values with up to a maximum of 6 digits of precision for fractional seconds.

If you insert a date into a TIMESTAMPTZ column, or a date with a partial time stamp, the value is implicitly converted into a full time stamp value with default values (00) for missing hours, minutes, and seconds.

TIMESTAMPTZ values are UTC in user tables.

Examples with Datetime Types

Date Examples

Insert dates that have different formats and display the output:

```
create table datetable (start_date date, end_date date);
```

```
insert into datetable values ('2008-06-01','2008-12-31');  
insert into datetable values ('Jun 1,2008','20081231');
```

```
select * from datetable order by 1;  
  
start_date | end_date  
-----  
2008-06-01 | 2008-12-31  
2008-06-01 | 2008-12-31
```

If you insert a time stamp value into a DATE column, the time portion is ignored and only the date loaded.

Time Stamp Examples

If you insert a date into a TIMESTAMP or TIMESTAMPTZ column, the time defaults to midnight. For example, if you insert the literal 20081231, the stored value is 2008-12-31 00:00:00.

To change the time zone for the current session, use the [SET \(p. 465\)](#) command to set the [timezone \(p. 814\)](#) configuration parameter.

Insert timestamps that have different formats and display the output:

```
create table tstamp(timeofday timestamp, timeofdaytz timestamptz);  
  
insert into tstamp values('Jun 1,2008 09:59:59', 'Jun 1,2008 09:59:59  
EST' );  
insert into tstamp values('Dec 31,2008 18:20','Dec 31,2008 18:20');  
insert into tstamp values('Jun 1,2008 09:59:59 EST', 'Jun 1,2008 09:59:59');  
  
timeofday  
-----  
2008-06-01 09:59:59  
2008-12-31 18:20:00  
(2 rows)
```

Date and Timestamp Literals

Dates

The following input dates are all valid examples of literal date values that you can load into Amazon Redshift tables. The default MDY DateStyle mode is assumed to be in effect, which means that the month value precedes the day value in strings such as 1999-01-08 and 01/02/00.

Note

A date or time stamp literal must be enclosed in quotes when you load it into a table.

Input date	Full Date
January 8, 1999	January 8, 1999
1999-01-08	January 8, 1999
1/8/1999	January 8, 1999
01/02/00	January 2, 2000
2000-Jan-31	January 31, 2000
Jan-31-2000	January 31, 2000
31-Jan-2000	January 31, 2000
20080215	February 15, 2008
080215	February 15, 2008
2008.366	December 31, 2008 (3-digit part of date must be between 001 and 366)

Timestamps

The following input timestamps are all valid examples of literal time values that you can load into Amazon Redshift tables. All of the valid date literals can be combined with the following time literals.

Input Timestamps (Concatenated Dates and Times)	Description (of Time Part)
20080215 04:05:06.789	4:05 am and 6.789 seconds
20080215 04:05:06	4:05 am and 6 seconds
20080215 04:05	4:05 am exactly
20080215 040506	4:05 am and 6 seconds
20080215 04:05 AM	4:05 am exactly; AM is optional
20080215 04:05 PM	4:05 pm exactly; hour value must be < 12.
20080215 16:05	4:05 05 pm exactly
20080215	Midnight (by default)

Special Datetime Values

The following special values can be used as datetime literals and as arguments to date functions. They require single quotes and are converted to regular timestamp values during query processing.

	Description
now	Evaluates to the start time of the current transaction and returns a timestamp with microsecond precision.
today	Evaluates to the appropriate date and returns a timestamp with zeroes for the timeparts.

	Description
tomorrow	
yesterday	

The following examples show how `now` and `today` work in conjunction with the `DATEADD` function:

```
select dateadd(day,1,'today');

date_add
-----
2009-11-17 00:00:00
(1 row)

select dateadd(day,1,'now');

date_add
-----
2009-11-17 10:45:32.021394
(1 row)
```

Interval Literals

Use an interval literal to identify specific periods of time, such as 12 hours or 6 weeks. You can use these interval literals in conditions and calculations that involve datetime expressions.

Note

You cannot use the `INTERVAL` data type for columns in Amazon Redshift tables.

An interval is expressed as a combination of the `INTERVAL` keyword with a numeric quantity and a supported datepart; for example: `INTERVAL '7 days'` or `INTERVAL '59 minutes'`. Several quantities and units can be connected to form a more precise interval; for example: `INTERVAL '7 days, 3 hours, 59 minutes'`. Abbreviations and plurals of each unit are also supported; for example: 5 s, 5 second, and 5 seconds are equivalent intervals.

If you do not specify a datepart, the interval value represents seconds. You can specify the quantity value as a fraction (for example: 0.5 days).

Examples

The following examples show a series of calculations with different interval values.

Add 1 second to the specified date:

```
select caldate + interval '1 second' as dateplus from date
where caldate='12-31-2008';
dateplus
-----
2008-12-31 00:00:01
(1 row)
```

Add 1 minute to the specified date:

```
select caldate + interval '1 minute' as dateplus from date
where caldate='12-31-2008';
dateplus
-----
```

```
2008-12-31 00:01:00
(1 row)
```

Add 3 hours and 35 minutes to the specified date:

```
select caldate + interval '3 hours, 35 minutes' as dateplus from date
where caldate='12-31-2008';
dateplus
-----
2008-12-31 03:35:00
(1 row)
```

Add 52 weeks to the specified date:

```
select caldate + interval '52 weeks' as dateplus from date
where caldate='12-31-2008';
dateplus
-----
2009-12-30 00:00:00
(1 row)
```

Add 1 week, 1 hour, 1 minute, and 1 second to the specified date:

```
select caldate + interval '1w, 1h, 1m, 1s' as dateplus from date
where caldate='12-31-2008';
dateplus
-----
2009-01-07 01:01:01
(1 row)
```

Add 12 hours (half a day) to the specified date:

```
select caldate + interval '0.5 days' as dateplus from date
where caldate='12-31-2008';
dateplus
-----
2008-12-31 12:00:00
(1 row)
```

Boolean Type

Use the BOOLEAN data type to store true and false values in a single-byte column. The following table describes the three possible states for a Boolean value and the literal values that result in that state. Regardless of the input string, a Boolean column stores and outputs "t" for true and "f" for false.

State	Valid Literal Values	Storage
True	TRUE 't' 'true' 'y' 'yes' '1'	1 byte
False	FALSE 'f' 'false' 'n' 'no' '0'	1 byte

State	Valid Literal Values	Storage
Unknown	NULL	1 byte

Examples

You could use a `BOOLEAN` column to store an "Active/Inactive" state for each customer in a `CUSTOMER` table:

```
create table customer(
custid int,
active_flag boolean default true
);
```

```
insert into customer values(100, default);
```

```
select * from customer;
custid | active_flag
-----
100 | t
```

If no default value (`true` or `false`) is specified in the `CREATE TABLE` statement, inserting a default value means inserting a null.

In this example, the query selects users from the `USERS` table who like sports but do not like theatre:

```
select firstname, lastname, likesports, liketheatre
from users
where likesports is true and liketheatre is false
order by userid limit 10;
```

```
firstname | lastname | likesports | liketheatre
-----+-----+-----+-----
Lars      | Ratliff  | t          | f
Mufutau   | Watkins  | t          | f
Scarlett  | Mayer    | t          | f
Shafira   | Glenn    | t          | f
Winifred  | Cherry   | t          | f
Chase     | Lamb     | t          | f
Liberty   | Ellison  | t          | f
Aladdin   | Haney    | t          | f
Tashya    | Michael  | t          | f
Lucian    | Montgomery | t          | f
(10 rows)
```

This example selects users from the `USERS` table for whom is it unknown whether they like rock music:

```
select firstname, lastname, likerock
from users
where likerock is unknown
order by userid limit 10;
```

```
firstname | lastname | likerock
```

-----+-----	
Rafael	Taylor
Vladimir	Humphrey
Barry	Roy
Tamekah	Juarez
Mufutau	Watkins
Naida	Calderon
Anika	Huff
Bruce	Beck
Mallory	Farrell
Scarlett	Mayer
(10 rows)	

Type Compatibility and Conversion

Following, you can find a discussion about how type conversion rules and data type compatibility work in Amazon Redshift.

Compatibility

Data type matching and matching of literal values and constants to data types occurs during various database operations, including the following:

- Data manipulation language (DML) operations on tables
- UNION, INTERSECT, and EXCEPT queries
- CASE expressions
- Evaluation of predicates, such as LIKE and IN
- Evaluation of SQL functions that do comparisons or extractions of data
- Comparisons with mathematical operators

The results of these operations depend on type conversion rules and data type compatibility. *Compatibility* implies that a one-to-one matching of a certain value and a certain data type is not always required. Because some data types are *compatible*, an implicit conversion, or *coercion*, is possible (for more information, see [Implicit Conversion Types \(p. 267\)](#)). When data types are incompatible, you can sometimes convert a value from one data type to another by using an explicit conversion function.

General Compatibility and Conversion Rules

Note the following compatibility and conversion rules:

- In general, data types that fall into the same type category (such as different numeric data types) are compatible and can be implicitly converted.

For example, with implicit conversion you can insert a decimal value into an integer column. The decimal is rounded to produce a whole number. Or you can extract a numeric value, such as 2008, from a date and insert that value into an integer column.

- Numeric data types enforce overflow conditions that occur when you attempt to insert out-of-range values. For example, a decimal value with a precision of 5 does not fit into a decimal column that was defined with a precision of 4. An integer or the whole part of a decimal is never truncated; however, the fractional part of a decimal can be rounded up or down, as appropriate.
- Different types of character strings are compatible; VARCHAR column strings containing single-byte data and CHAR column strings are comparable and implicitly convertible. VARCHAR strings that contain multibyte data are not comparable. Also, you can convert a character string to a date, timestamp, or numeric value if the string is an appropriate literal value; any leading or trailing spaces are ignored. Conversely, you can convert a date, timestamp, or numeric value to a fixed-length or variable-length character string.

Note

A character string that you want to cast to a numeric type must contain a character representation of a number. For example, you can cast the strings '1.0' or '5.9' to decimal values, but you cannot cast the string 'ABC' to any numeric type.

- If you compare numeric values with character strings, the numeric values are converted to character strings. To enforce the opposite conversion (converting character strings to numeric values), use an explicit function, such as [CAST and CONVERT \(p. 658\)](#).
- To convert 64-bit DECIMAL or NUMERIC values to a higher precision, you must use an explicit conversion function such as the CAST or CONVERT functions.
- When converting DATE or TIMESTAMP to TIMESTAMPTZ, DATE or TIMESTAMP are assumed to use the current session time zone. The session time zone is UTC by default. For more information about setting the session time zone, see [timezone \(p. 814\)](#).
- Similarly, TIMESTAMPTZ is converted to DATE or TIMESTAMP based on the current session time zone. The session time zone is UTC by default. After the conversion, time zone information is dropped.
- Character strings that represent a time stamp with time zone specified are converted to TIMESTAMPTZ using the specified time zone. If the time zone is omitted, the current session time zone is used, which is UTC by default.

Implicit Conversion Types

There are two types of implicit conversions:

- Implicit conversions in assignments, such as setting values in INSERT or UPDATE commands.
- Implicit conversions in expressions, such as performing comparisons in the WHERE clause.

The table following lists the data types that can be converted implicitly in assignments or expressions. You can also use an explicit conversion function to perform these conversions.

From Type	To Type
BIGINT (INT8)	BOOLEAN
	CHAR
	DECIMAL (NUMERIC)
	DOUBLE PRECISION (FLOAT8)
	INTEGER (INT, INT4)
	REAL (FLOAT4)
	SMALLINT (INT2)
	VARCHAR
CHAR	VARCHAR
DATE	CHAR
	VARCHAR
	TIMESTAMP
	TIMESTAMPTZ

From Type	To Type
DECIMAL (NUMERIC)	BIGINT (INT8)
	CHAR
	DOUBLE PRECISION (FLOAT8)
	INTEGER (INT, INT4)
	REAL (FLOAT4)
	SMALLINT (INT2)
	VARCHAR
DOUBLE PRECISION (FLOAT8)	BIGINT (INT8)
	CHAR
	DECIMAL (NUMERIC)
	INTEGER (INT, INT4)
	REAL (FLOAT4)
	SMALLINT (INT2)
	VARCHAR
INTEGER (INT, INT4)	BIGINT (INT8)
	BOOLEAN
	CHAR
	DECIMAL (NUMERIC)
	DOUBLE PRECISION (FLOAT8)
	REAL (FLOAT4)
	SMALLINT (INT2)
	VARCHAR
REAL (FLOAT4)	BIGINT (INT8)
	CHAR
	DECIMAL (NUMERIC)
	INTEGER (INT, INT4)
	SMALLINT (INT2)
	VARCHAR
SMALLINT (INT2)	BIGINT (INT8)
	BOOLEAN
	CHAR

From Type	To Type
	DECIMAL (NUMERIC)
	DOUBLE PRECISION (FLOAT8)
	INTEGER (INT, INT4)
	REAL (FLOAT4)
	VARCHAR
TIMESTAMP	CHAR
	DATE
	VARCHAR
	TIMESTAMPTZ
TIMESTAMPTZ	CHAR
	DATE
	VARCHAR
	TIMESTAMP

Note

Implicit conversions between TIMESTAMPTZ, TIMESTAMP, DATE, or character strings use the current session time zone. For information about setting the current time zone, see [timezone \(p. 814\)](#).

Collation Sequences

Amazon Redshift does not support locale-specific or user-defined collation sequences. In general, the results of any predicate in any context could be affected by the lack of locale-specific rules for sorting and comparing data values. For example, ORDER BY expressions and functions such as MIN, MAX, and RANK return results based on binary UTF8 ordering of the data that does not take locale-specific characters into account.

Expressions

Topics

- [Simple Expressions \(p. 269\)](#)
- [Compound Expressions \(p. 270\)](#)
- [Expression Lists \(p. 271\)](#)
- [Scalar Subqueries \(p. 272\)](#)
- [Function Expressions \(p. 272\)](#)

An expression is a combination of one or more values, operators, or functions that evaluate to a value. The data type of an expression is generally that of its components.

Simple Expressions

A simple expression is one of the following:

- A constant or literal value
- A column name or column reference
- A scalar function
- An aggregate (set) function
- A window function
- A scalar subquery

Examples of simple expressions include:

```
5+12
dateid
sales.qtysold * 100
sqrt (4)
max (qtysold)
(select max (qtysold) from sales)
```

Compound Expressions

A compound expression is a series of simple expressions joined by arithmetic operators. A simple expression used in a compound expression must return a numeric value.

Syntax

```
expression
operator
expression | (compound_expression)
```

Arguments

expression

A simple expression that evaluates to a value.

operator

A compound arithmetic expression can be constructed using the following operators, in this order of precedence:

- () : parentheses to control the order of evaluation
- + , - : positive and negative sign/operator
- ^ , |/, ||/ : exponentiation, square root, cube root
- * , / , % : multiplication, division, and modulo operators
- @ : absolute value
- + , - : addition and subtraction
- & , |, #, ~, <<, >> : AND, OR, XOR, NOT, shift left, shift right bitwise operators
- ||: concatenation

(*compound_expression*)

Compound expressions may be nested using parentheses.

Examples

Examples of compound expressions include:

```
('SMITH' || 'JONES')
```

```
sum(x) / y
sqrt(256) * avg(column)
rank() over (order by qtysold) / 100
(select (pricepaid - commission) from sales where dateid = 1882) * (qtysold)
```

Some functions can also be nested within other functions. For example, any scalar function can nest within another scalar function. The following example returns the sum of the absolute values of a set of numbers:

```
sum(abs(qtysold))
```

Window functions cannot be used as arguments for aggregate functions or other window functions. The following expression would return an error:

```
avg(rank() over (order by qtysold))
```

Window functions can have a nested aggregate function. The following expression sums sets of values and then ranks them:

```
rank() over (order by sum(qtysold))
```

Expression Lists

An expression list is a combination of expressions, and can appear in membership and comparison conditions (WHERE clauses) and in GROUP BY clauses.

Syntax

```
expression , expression , ... | (expression , expression , ...)
```

Arguments

expression

A simple expression that evaluates to a value. An expression list can contain one or more comma-separated expressions or one or more sets of comma-separated expressions. When there are multiple sets of expressions, each set must contain the same number of expressions, and be separated by parentheses. The number of expressions in each set must match the number of expressions before the operator in the condition.

Examples

The following are examples of expression lists in conditions:

```
(1, 5, 10)
('THESE', 'ARE', 'STRINGS')
(('one', 'two', 'three'), ('blue', 'yellow', 'green'))
```

The number of expressions in each set must match the number in the first part of the statement:

```
select * from venue
where (venuecity, venuestate) in (('Miami', 'FL'), ('Tampa', 'FL'))
order by venueid;
```

venueid	venueName	venueCity	venueState	venueSeats
28	American Airlines Arena	Miami	FL	0
54	St. Pete Times Forum	Tampa	FL	0
91	Raymond James Stadium	Tampa	FL	65647

(3 rows)

Scalar Subqueries

A scalar subquery is a regular SELECT query in parentheses that returns exactly one value: one row with one column. The query is executed and the returned value is used in the outer query. If the subquery returns zero rows, the value of the subquery expression is null. If it returns more than one row, Amazon Redshift returns an error. The subquery can refer to variables from the parent query, which will act as constants during any one invocation of the subquery.

You can use scalar subqueries in most statements that call for an expression. Scalar subqueries are not valid expressions in the following cases:

- As default values for expressions
- In GROUP BY and HAVING clauses

Example

The following subquery computes the average price paid per sale across the entire year of 2008, then the outer query uses that value in the output to compare against the average price per sale per quarter:

```
select qtr, avg(pricepaid) as avg_saleprice_per_qtr,
(select avg(pricepaid)
from sales join date on sales.dateid=date.dateid
where year = 2008) as avg_saleprice_yearly
from sales join date on sales.dateid=date.dateid
where year = 2008
group by qtr
order by qtr;
```

qtr	avg_saleprice_per_qtr	avg_saleprice_yearly
1	647.64	642.28
2	646.86	642.28
3	636.79	642.28
4	638.26	642.28

(4 rows)

Function Expressions

Syntax

Any built-in can be used as an expression. The syntax for a function call is the name of a function followed by its argument list in parentheses.

```
function ( [expression [, expression...]] )
```

Arguments

function

Any built-in function.

expression

Any expression(s) matching the data type and parameter count expected by the function.

Examples

```
abs (variable)
select avg (qtysold + 3) from sales;
select dateadd (day,30,caldate) as plus30days from date;
```

Conditions

Topics

- [Syntax \(p. 273\)](#)
- [Comparison Condition \(p. 273\)](#)
- [Logical Conditions \(p. 275\)](#)
- [Pattern-Matching Conditions \(p. 278\)](#)
- [BETWEEN Range Condition \(p. 286\)](#)
- [Null Condition \(p. 287\)](#)
- [EXISTS Condition \(p. 288\)](#)
- [IN Condition \(p. 289\)](#)

A condition is a statement of one or more expressions and logical operators that evaluates to true, false, or unknown. Conditions are also sometimes referred to as predicates.

Note

All string comparisons and LIKE pattern matches are case-sensitive. For example, 'A' and 'a' do not match. However, you can do a case-insensitive pattern match by using the ILIKE predicate.

Syntax

```
comparison_condition
| logical_condition
| range_condition
| pattern_matching_condition
| null_condition
| EXISTS_condition
| IN_condition
```

Comparison Condition

Comparison conditions state logical relationships between two values. All comparison conditions are binary operators with a Boolean return type. Amazon Redshift supports the comparison operators described in the following table:

Operator	Syntax	Description
<	a < b	Value a is less than value b.
>	a > b	Value a is greater than value b.
<=	a <= b	Value a is less than or equal to value b.

Operator	Syntax	Description
>=	a >= b	Value a is greater than or equal to value b.
=	a = b	Value a is equal to value b.
<> or !=	a <> b or a != b	Value a is not equal to value b.
ANY SOME	a = ANY (subquery)	Value a is equal to any value returned by the subquery.
ALL	a <> ALL or != ALL(subquery)	Value a is not equal to any value returned by the subquery.
IS TRUE FALSE UNKNOWN	a IS TRUE	Value a is Boolean TRUE.

Usage Notes

= ANY | SOME

The ANY and SOME keywords are synonymous with the *IN* condition, and return true if the comparison is true for at least one value returned by a subquery that returns one or more values. Amazon Redshift supports only the = (equals) condition for ANY and SOME. Inequality conditions are not supported.

Note

The ALL predicate is not supported.

<> ALL

The ALL keyword is synonymous with NOT IN (see [IN Condition \(p. 289\)](#) condition) and returns true if the expression is not included in the results of the subquery. Amazon Redshift supports only the <> or != (not equals) condition for ALL. Other comparison conditions are not supported.

IS TRUE/FALSE/UNKNOWN

Non-zero values equate to TRUE, 0 equates to FALSE, and null equates to UNKNOWN. See the [Boolean Type \(p. 264\)](#) data type.

Examples

Here are some simple examples of comparison conditions:

```
a = 5
a < b
min(x) >= 5
qtysold = any (select qtysold from sales where dateid = 1882)
```

The following query returns venues with more than 10000 seats from the VENUE table:

```
select venueid, venuename, venueseats from venue
where venueseats > 10000
order by venueseats desc;
```

venueid	venuename	venueseats
83	FedExField	91704
6	New York Giants Stadium	80242
79	Arrowhead Stadium	79451

```

78 | INVESCO Field | 76125
69 | Dolphin Stadium | 74916
67 | Ralph Wilson Stadium | 73967
76 | Jacksonville Municipal Stadium | 73800
89 | Bank of America Stadium | 73298
72 | Cleveland Browns Stadium | 73200
86 | Lambeau Field | 72922
...
(57 rows)

```

This example selects the users (USERID) from the USERS table who like rock music:

```

select userid from users where likerock = 't' order by 1 limit 5;

userid
-----
3
5
6
13
16
(5 rows)

```

This example selects the users (USERID) from the USERS table where it is unknown whether they like rock music:

```

select firstname, lastname, likerock
from users
where likerock is unknown
order by userid limit 10;

firstname | lastname | likerock
-----+-----+-----
Rafael    | Taylor   |
Vladimir | Humphrey |
Barry     | Roy      |
Tamekah   | Juarez   |
Mufutau   | Watkins  |
Naida     | Calderon |
Anika     | Huff     |
Bruce     | Beck     |
Mallory   | Farrell  |
Scarlett  | Mayer    |
(10 rows)

```

Logical Conditions

Logical conditions combine the result of two conditions to produce a single result. All logical conditions are binary operators with a Boolean return type.

Syntax

```

expression
{ AND | OR }
expression
NOT expression

```

Logical conditions use a three-valued Boolean logic where the null value represents an unknown relationship. The following table describes the results for logical conditions, where `E1` and `E2` represent expressions:

E1	E2	E1 AND E2	E1 OR E2	NOT E2
TRUE	TRUE	TRUE	TRUE	FALSE
TRUE	FALSE	FALSE	TRUE	TRUE
TRUE	UNKNOWN	UNKNOWN	TRUE	UNKNOWN
FALSE	TRUE	FALSE	TRUE	
FALSE	FALSE	FALSE	FALSE	
FALSE	UNKNOWN	FALSE	UNKNOWN	
UNKNOWN	TRUE	UNKNOWN	TRUE	
UNKNOWN	FALSE	FALSE	UNKNOWN	
UNKNOWN	UNKNOWN	UNKNOWN	UNKNOWN	

The NOT operator is evaluated before AND, and the AND operator is evaluated before the OR operator. Any parentheses used may override this default order of evaluation.

Examples

The following example returns USERID and USERNAME from the USERS table where the user likes both Las Vegas and sports:

```
select userid, username from users
where likevegas = 1 and likesports = 1
order by userid;
```

```
userid | username
-----+-----
1 | JSG99FHE
67 | TWU10MZT
87 | DUF19VXU
92 | HYP36WEQ
109 | FPL38HZK
120 | DMJ24GUZ
123 | QZR22XGQ
130 | ZQC82ALK
133 | LBN45WCH
144 | UCX04JKN
165 | TEY68OEB
169 | AYQ83HGO
184 | TVX65AZX
...
(2128 rows)
```

The next example returns the USERID and USERNAME from the USERS table where the user likes Las Vegas, or sports, or both. This query returns all of the output from the previous example plus the users who like only Las Vegas or sports.

```
select userid, username from users
```



```
where likevegas = 1 or likesports = 1
order by userid;
```

```
userid | username
-----+-----
1 | JSG99FHE
2 | PGL08LJI
3 | IFT66TXU
5 | AEB55QTM
6 | NDQ15VBM
9 | MSD36KVR
10 | WKW41AIW
13 | QTF33MCG
15 | OWU78MTR
16 | ZMG93CDD
22 | RHT62AGI
27 | KOY02CVE
29 | HUH27PKK
...
(18968 rows)
```

The following query uses parentheses around the OR condition to find venues in New York or California where Macbeth was performed:

```
select distinct venuename, venuecity
from venue join event on venue.venueid=event.venueid
where (venuestate = 'NY' or venuestate = 'CA') and eventname='Macbeth'
order by 2,1;
```

```
venuename | venuecity
-----+-----
Geffen Playhouse | Los Angeles
Greek Theatre | Los Angeles
Royce Hall | Los Angeles
American Airlines Theatre | New York City
August Wilson Theatre | New York City
Belasco Theatre | New York City
Bernard B. Jacobs Theatre | New York City
...
```

Removing the parentheses in this example changes the logic and results of the query.

The following example uses the NOT operator:

```
select * from category
where notcatid=1
order by 1;
```

```
catid | catgroup | catname | catdesc
-----+-----+-----+-----
2 | Sports | NHL | National Hockey League
3 | Sports | NFL | National Football League
4 | Sports | NBA | National Basketball Association
5 | Sports | MLS | Major League Soccer
...
```

The following example uses a NOT condition followed by an AND condition:

```
select * from category
where (not catid=1) and catgroup='Sports'
order by catid;
```

catid	catgroup	catname	catdesc
2	Sports	NHL	National Hockey League
3	Sports	NFL	National Football League
4	Sports	NBA	National Basketball Association
5	Sports	MLS	Major League Soccer

(4 rows)

Pattern-Matching Conditions

Topics

- [LIKE \(p. 278\)](#)
- [SIMILAR TO \(p. 281\)](#)
- [POSIX Operators \(p. 283\)](#)

A pattern-matching operator searches a string for a pattern specified in the conditional expression and returns true or false depend on whether it finds a match. Amazon Redshift uses three methods for pattern matching:

- LIKE expressions

The LIKE operator compares a string expression, such as a column name, with a pattern that uses the wildcard characters % (percent) and _ (underscore). LIKE pattern matching always covers the entire string. LIKE performs a case-sensitive match and ILIKE performs a case-insensitive match.

- SIMILAR TO regular expressions

The SIMILAR TO operator matches a string expression with a SQL standard regular expression pattern, which can include a set of pattern-matching metacharacters that includes the two supported by the LIKE operator. SIMILAR TO matches the entire string and performs a case-sensitive match.

- POSIX-style regular expressions

POSIX regular expressions provide a more powerful means for pattern matching than the LIKE and SIMILAR TO operators. POSIX regular expression patterns can match any portion of the string and performs a case-sensitive match.

Regular expression matching, using SIMILAR TO or POSIX operators, is computationally expensive. We recommend using LIKE whenever possible, especially when processing a very large number of rows. For example, the following queries are functionally identical, but the query that uses LIKE executes several times faster than the query that uses a regular expression:

```
select count(*) from event where eventname SIMILAR TO '%(Ring|Die)%';
select count(*) from event where eventname LIKE '%Ring%' OR eventname LIKE '%Die%';
```

LIKE

The LIKE operator compares a string expression, such as a column name, with a pattern that uses the wildcard characters % (percent) and _ (underscore). LIKE pattern matching always covers the entire string. To match a sequence anywhere within a string, the pattern must start and end with a percent sign.

LIKE is case-sensitive; ILIKE is case-insensitive.

Syntax

```
expression [ NOT ] LIKE | ILIKE pattern [ ESCAPE 'escape_char' ]
```

Arguments

expression

A valid UTF-8 character expression, such as a column name.

LIKE | ILIKE

LIKE performs a case-sensitive pattern match. ILIKE performs a case-insensitive pattern match for single-byte characters. Both LIKE and ILIKE perform a case-insensitive pattern match for multibyte characters.

pattern

A valid UTF-8 character expression with the pattern to be matched.

escape_char

A character expression that will escape metacharacters characters in the pattern. The default is two backslashes ('\').

If *pattern* does not contain metacharacters, then the pattern only represents the string itself; in that case LIKE acts the same as the equals operator.

Either of the character expressions can be CHAR or VARCHAR data types. If they differ, Amazon Redshift converts *pattern* to the data type of *expression*.

LIKE supports the following pattern-matching metacharacters:

Operator	Description
%	Matches any sequence of zero or more characters.
_	Matches any single character.

Examples

The following table shows examples of pattern matching using LIKE:

Expression	Returns
'abc' LIKE 'abc'	True
'abc' LIKE 'a%'	True
'abc' LIKE '_B_'	False
'abc' ILIKE '_B_'	True
'abc' LIKE 'c%'	False

The following example finds all cities whose names start with "E":

```
select distinct city from users
where city like 'E%' order by city;
city
-----
```

```
East Hartford
East Lansing
East Rutherford
East St. Louis
Easthampton
Easton
Eatontown
Eau Claire
...
```

The following example finds users whose last name contains "ten" :

```
select distinct lastname from users
where lastname like '%ten%' order by lastname;
lastname
-----
Christensen
Wooten
...
```

The following example finds cities whose third and fourth characters are "ea". The command uses ILIKE to demonstrate case insensitivity:

```
select distinct city from users where city ilike '__EA%' order by city;
city
-----
Brea
Clearwater
Great Falls
Ocean City
Olean
Wheaton
(6 rows)
```

The following example uses the default escape string (\\) to search for strings that include "_":

```
select tablename, "column" from pg_table_def
where "column" like '%start\\_%'
limit 5;
```

tablename	column
stl_s3client	start_time
stl_tr_conflict	xact_start_ts
stl_undone	undo_start_ts
stl_unload_log	start_time
stl_vacuum_detail	start_row

(5 rows)

The following example specifies '^' as the escape character, then uses the escape character to search for strings that include "_":

```
select tablename, "column" from pg_table_def
where "column" like '%start^_%' escape '^'
limit 5;
```

tablename	column
stl_s3client	start_time
stl_tr_conflict	xact_start_ts
stl_undone	undo_start_ts
stl_unload_log	start_time
stl_vacuum_detail	start_row

(5 rows)

SIMILAR TO

The SIMILAR TO operator matches a string expression, such as a column name, with a SQL standard regular expression pattern. A SQL regular expression pattern can include a set of pattern-matching metacharacters, including the two supported by the [LIKE \(p. 278\)](#) operator.

The SIMILAR TO operator returns true only if its pattern matches the entire string, unlike POSIX regular expression behavior, where the pattern can match any portion of the string.

SIMILAR TO performs a case-sensitive match.

Note

Regular expression matching using SIMILAR TO is computationally expensive. We recommend using LIKE whenever possible, especially when processing a very large number of rows. For example, the following queries are functionally identical, but the query that uses LIKE executes several times faster than the query that uses a regular expression:

```
select count(*) from event where eventname SIMILAR TO '%(Ring|Die)%';
select count(*) from event where eventname LIKE '%Ring%' OR eventname
LIKE '%Die%';
```

Syntax

```
expression [ NOT ] SIMILAR TO pattern [ ESCAPE 'escape_char' ]
```

Arguments

expression

A valid UTF-8 character expression, such as a column name.

SIMILAR TO

SIMILAR TO performs a case-sensitive pattern match for the entire string in *expression*.

pattern

A valid UTF-8 character expression representing a SQL standard regular expression pattern.

escape_char

A character expression that will escape metacharacters in the pattern. The default is two backslashes ('\').

If *pattern* does not contain metacharacters, then the pattern only represents the string itself.

Either of the character expressions can be CHAR or VARCHAR data types. If they differ, Amazon Redshift converts *pattern* to the data type of *expression*.

SIMILAR TO supports the following pattern-matching metacharacters:

Operator	Description
%	Matches any sequence of zero or more characters.

Operator	Description
–	Matches any single character.
	Denotes alternation (either of two alternatives).
*	Repeat the previous item zero or more times.
+	Repeat the previous item one or more times.
?	Repeat the previous item zero or one time.
{m}	Repeat the previous item exactly <i>m</i> times.
{m, }	Repeat the previous item <i>m</i> or more times.
{m,n}	Repeat the previous item at least <i>m</i> and not more than <i>n</i> times.
()	Parentheses group items into a single logical item.
[...]	A bracket expression specifies a character class, just as in POSIX regular expressions.

Examples

The following table shows examples of pattern matching using SIMILAR TO:

Expression	Returns
'abc' SIMILAR TO 'abc'	True
'abc' SIMILAR TO '_b_'	True
'abc' SIMILAR TO '_A_'	False
'abc' SIMILAR TO '%(b d)%'	True
'abc' SIMILAR TO '(b c)%'	False
'AbcAbcdefgfg12efgfg12' SIMILAR TO '((Ab)?c)+d((efg)+(12))+'	True
'aaaaaab11111xy' SIMILAR TO 'a{6}_[0-9]{5}(x y){2}'	True
'\$0.87' SIMILAR TO '\$[0-9]+(.[0-9][0-9])?'	True

The following example finds all cities whose names contain "E" or "H":

```
select distinct city from users
where city similar to '%E%|H%' order by city;
      city
-----
Agoura Hills
Auburn Hills
Benton Harbor
Beverly Hills
Chicago Heights
Chino Hills
```

```
Citrus Heights
East Hartford
```

The following example uses the default escape string ('\\') to search for strings that include "_":

```
select tablename, "column" from pg_table_def
where "column" similar to '%start\\_%'
limit 5;
  tablename      | column
-----+-----
 stl_s3client    | start_time
 stl_tr_conflict | xact_start_ts
 stl_undone      | undo_start_ts
 stl_unload_log  | start_time
 stl_vacuum_detail | start_row
(5 rows)
```

The following example specifies '^' as the escape string, then uses the escape string to search for strings that include "_":

```
select tablename, "column" from pg_table_def
where "column" similar to '%start^_%' escape '^'
limit 5;
  tablename      | column
-----+-----
 stl_s3client    | start_time
 stl_tr_conflict | xact_start_ts
 stl_undone      | undo_start_ts
 stl_unload_log  | start_time
 stl_vacuum_detail | start_row
(5 rows)
```

POSIX Operators

POSIX regular expressions provide a more powerful means for pattern matching than the [LIKE \(p. 278\)](#) and [SIMILAR TO \(p. 281\)](#) operators. POSIX regular expression patterns can match any portion of a string, unlike the SIMILAR TO operator, which returns true only if its pattern matches the entire string.

Note

Regular expression matching using POSIX operators is computationally expensive. We recommend using LIKE whenever possible, especially when processing a very large number of rows. For example, the following queries are functionally identical, but the query that uses LIKE executes several times faster than the query that uses a regular expression:

```
select count(*) from event where eventname ~ '.*(Ring|Die).*';
select count(*) from event where eventname LIKE '%Ring%' OR eventname
LIKE '%Die%';
```

Syntax

```
expression [ ! ] ~ pattern
```

Arguments

expression

A valid UTF-8 character expression, such as a column name.

!
Negation operator.

~
Perform a case-sensitive match for any substring of *expression*.

pattern
A string literal that represents a SQL standard regular expression pattern.

If *pattern* does not contain wildcard characters, then the pattern only represents the string itself.

To search for strings that include metacharacters, such as `.`, `*`, `|`, `?`, `^`, and so on, escape the character using two backslashes (`' \\ '`). Unlike `SIMILAR TO` and `LIKE`, POSIX regular expression syntax does not support a user-defined escape character.

Either of the character expressions can be `CHAR` or `VARCHAR` data types. If they differ, Amazon Redshift converts *pattern* to the data type of *expression*.

All of the character expressions can be `CHAR` or `VARCHAR` data types. If the expressions differ in data type, Amazon Redshift converts them to the data type of *expression*.

POSIX pattern matching supports the following metacharacters:

POSIX	Description
.	Matches any single character.
*	Matches zero or more occurrences.
+	Matches one or more occurrences.
?	Matches zero or one occurrence.
	Specifies alternative matches; for example, <code>E H</code> means <code>E</code> or <code>H</code> .
^	Matches the beginning-of-line character.
\$	Matches the end-of-line character.
\$	Matches the end of the string.
[]	Brackets specify a matching list, that should match one expression in the list. A caret (^) precedes a nonmatching list, which matches any character except for the expressions represented in the list.
()	Parentheses group items into a single logical item.
{m}	Repeat the previous item exactly <i>m</i> times.
{m, }	Repeat the previous item <i>m</i> or more times.
{m, n}	Repeat the previous item at least <i>m</i> and not more than <i>n</i> times.
[: :]	Matches any character within a POSIX character class. In the following character classes, Amazon Redshift supports only ASCII characters: [:alnum:], [:alpha:], [:lower:], [:upper:]

Amazon Redshift supports the following POSIX character classes.

Character Class	Description
[[:alnum:]]	All ASCII alphanumeric characters

Character Class	Description
<code>[[:alpha:]]</code>	All ASCII alphabetic characters
<code>[[:blank:]]</code>	All blank space characters
<code>[[:cntrl:]]</code>	All control characters (nonprinting)
<code>[[:digit:]]</code>	All numeric digits
<code>[[:lower:]]</code>	All lowercase ASCII alphabetic characters
<code>[[:punct:]]</code>	All punctuation characters
<code>[[:space:]]</code>	All space characters (nonprinting)
<code>[[:upper:]]</code>	All uppercase ASCII alphabetic characters
<code>[[:xdigit:]]</code>	All valid hexadecimal characters

Amazon Redshift supports the following Perl-influenced operators in regular expressions. Escape the operator using two backslashes (`\\`).

Operator	Description	Equivalent character class expression
<code>\\d</code>	A digit character	<code>[[:digit:]]</code>
<code>\\D</code>	A nondigit character	<code>[^[:digit:]]</code>
<code>\\w</code>	A word character	<code>[[:word:]]</code>
<code>\\W</code>	A nonword character	<code>[^[:word:]]</code>
<code>\\s</code>	A white space character	<code>[[:space:]]</code>
<code>\\S</code>	A non–white space character	<code>[^[:space:]]</code>

Examples

The following table shows examples of pattern matching using POSIX operators:

Expression	Returns
<code>'abc' ~ 'abc'</code>	True
<code>'abc' ~ 'a'</code>	True
<code>'abc' ~ 'A'</code>	False
<code>'abc' ~ '.*(b d).*'</code>	True
<code>'abc' ~ '(b c).*'</code>	True
<code>'AbcAbcdefgfg12efgfg12' ~ '((Ab)?c)+d((efg)+(12))+'</code>	True
<code>'aaaaaab11111xy' ~ 'a{6}.[1]{5}(x y){2}'</code>	True
<code>'\$0.87' ~ '\\\\\$[0-9]+(\\. [0-9][0-9])?'</code>	True

Expression	Returns
'ab c' ~ '[:space:]'	True
'ab c' ~ '\\s'	True
' ' ~ '\\s'	False

The following example finds all cities whose names contain *E* or *H*:

```
select distinct city from users
where city ~ '.*E.*|.*H.*' order by city;
      city
-----
Agoura Hills
Auburn Hills
Benton Harbor
Beverly Hills
Chicago Heights
Chino Hills
Citrus Heights
East Hartford
```

The following example uses the escape string ('\\') to search for strings that include a period.

```
select venue name from venue
where venue name ~ '.*\\. .*';
      venue name
-----
Bernard B. Jacobs Theatre
E.J. Nutter Center
Hubert H. Humphrey Metrodome
Jobing.com Arena
St. James Theatre
St. Pete Times Forum
Superpages.com Center
U.S. Cellular Field
```

BETWEEN Range Condition

A **BETWEEN** condition tests expressions for inclusion in a range of values, using the keywords **BETWEEN** and **AND**.

Syntax

```
expression [ NOT ] BETWEEN expression AND expression
```

Expressions can be numeric, character, or datetime data types, but they must be compatible. The range is inclusive.

Examples

The first example counts how many transactions registered sales of either 2, 3, or 4 tickets:

```
select count(*) from sales
where qtysold between 2 and 4;

count
-----
104021
(1 row)
```

The range condition includes the begin and end values.

```
select min(dateid), max(dateid) from sales
where dateid between 1900 and 1910;

min | max
-----+-----
1900 | 1910
```

The first expression in a range condition must be the lesser value and the second expression the greater value. The following example will always return zero rows due to the values of the expressions:

```
select count(*) from sales
where qtysold between 4 and 2;

count
-----
0
(1 row)
```

However, applying the NOT modifier will invert the logic and produce a count of all rows:

```
select count(*) from sales
where qtysold not between 4 and 2;

count
-----
172456
(1 row)
```

The following query returns a list of venues with 20000 to 50000 seats:

```
select venueid, venuename, venueseats from venue
where venueseats between 20000 and 50000
order by venueseats desc;

venueid |          venuename          | venueseats
-----+-----+-----
116 | Busch Stadium                |      49660
106 | Rangers BallPark in Arlington |      49115
96  | Oriole Park at Camden Yards  |      48876
...
(22 rows)
```

Null Condition

The null condition tests for nulls, when a value is missing or unknown.

Syntax

```
expression IS [ NOT ] NULL
```

Arguments

expression

Any expression such as a column.

IS NULL

Is true when the expression's value is null and false when it has a value.

IS NOT NULL

Is false when the expression's value is null and true when it has a value.

Example

This example indicates how many times the SALES table contains null in the QTYSOLD field:

```
select count(*) from sales
where qtysold is null;
count
-----
0
(1 row)
```

EXISTS Condition

EXISTS conditions test for the existence of rows in a subquery, and return true if a subquery returns at least one row. If NOT is specified, the condition returns true if a subquery returns no rows.

Syntax

```
[ NOT ] EXISTS (table_subquery)
```

Arguments

EXISTS

Is true when the *table_subquery* returns at least one row.

NOT EXISTS

Is true when the *table_subquery* returns no rows.

table_subquery

A subquery that evaluates to a table with one or more columns and one or more rows.

Example

This example returns all date identifiers, one time each, for each date that had a sale of any kind:

```
select dateid from date
where exists (
select 1 from sales
where date.dateid = sales.dateid
```

```
)
order by dateid;

dateid
-----
1827
1828
1829
...
```

IN Condition

An IN condition tests a value for membership in a set of values or in a subquery.

Syntax

```
expression [ NOT ] IN (expr_list | table_subquery)
```

Arguments

expression

A numeric, character, or datetime expression that is evaluated against the *expr_list* or *table_subquery* and must be compatible with the data type of that list or subquery.

expr_list

One or more comma-delimited expressions, or one or more sets of comma-delimited expressions bounded by parentheses.

table_subquery

A subquery that evaluates to a table with one or more rows, but is limited to only one column in its select list.

IN | NOT IN

IN returns true if the expression is a member of the expression list or query. NOT IN returns true if the expression is not a member. IN and NOT IN return NULL and no rows are returned in the following cases: If *expression* yields null; or if there are no matching *expr_list* or *table_subquery* values and at least one of these comparison rows yields null.

Examples

The following conditions are true only for those values listed:

```
qtysold in (2, 4, 5)
date.day in ('Mon', 'Tues')
date.month not in ('Oct', 'Nov', 'Dec')
```

Optimization for Large IN Lists

To optimize query performance, an IN list that includes more than 10 values is internally evaluated as a scalar array. IN lists with fewer than 10 values are evaluated as a series of OR predicates. This optimization is supported for all data types except DECIMAL.

Look at the EXPLAIN output for the query to see the effect of this optimization. For example:

```
explain select * from sales
where salesid in (1,2,3,4,5,6,7,8,9,10,11);
```

QUERY PLAN

```
-----  
XN Seq Scan on sales (cost=0.00..6035.96 rows=86228 width=53)  
Filter: (salesid = ANY ('{1,2,3,4,5,6,7,8,9,10,11}'::integer[]))  
(2 rows)
```

SQL Commands

Topics

- [ABORT](#) (p. 291)
- [ALTER DATABASE](#) (p. 292)
- [ALTER DEFAULT PRIVILEGES](#) (p. 294)
- [ALTER GROUP](#) (p. 296)
- [ALTER SCHEMA](#) (p. 297)
- [ALTER TABLE](#) (p. 297)
- [ALTER TABLE APPEND](#) (p. 303)
- [ALTER USER](#) (p. 306)
- [ANALYZE](#) (p. 309)
- [ANALYZE COMPRESSION](#) (p. 310)
- [BEGIN](#) (p. 312)
- [CANCEL](#) (p. 313)
- [CLOSE](#) (p. 315)
- [COMMENT](#) (p. 316)
- [COMMIT](#) (p. 317)
- [COPY](#) (p. 317)
- [CREATE DATABASE](#) (p. 371)
- [CREATE FUNCTION](#) (p. 372)
- [CREATE GROUP](#) (p. 374)
- [CREATE LIBRARY](#) (p. 375)
- [CREATE SCHEMA](#) (p. 377)
- [CREATE TABLE](#) (p. 378)
- [CREATE TABLE AS](#) (p. 389)
- [CREATE USER](#) (p. 397)
- [CREATE VIEW](#) (p. 400)
- [DEALLOCATE](#) (p. 401)
- [DECLARE](#) (p. 401)
- [DELETE](#) (p. 404)
- [DROP DATABASE](#) (p. 405)
- [DROP FUNCTION](#) (p. 406)
- [DROP GROUP](#) (p. 406)
- [DROP LIBRARY](#) (p. 407)
- [DROP SCHEMA](#) (p. 407)
- [DROP TABLE](#) (p. 408)

- [DROP USER](#) (p. 411)
- [DROP VIEW](#) (p. 412)
- [END](#) (p. 413)
- [EXECUTE](#) (p. 414)
- [EXPLAIN](#) (p. 415)
- [FETCH](#) (p. 419)
- [GRANT](#) (p. 420)
- [INSERT](#) (p. 424)
- [LOCK](#) (p. 428)
- [PREPARE](#) (p. 429)
- [RESET](#) (p. 430)
- [REVOKE](#) (p. 431)
- [ROLLBACK](#) (p. 434)
- [SELECT](#) (p. 435)
- [SELECT INTO](#) (p. 465)
- [SET](#) (p. 465)
- [SET SESSION AUTHORIZATION](#) (p. 468)
- [SET SESSION CHARACTERISTICS](#) (p. 469)
- [SHOW](#) (p. 469)
- [START TRANSACTION](#) (p. 470)
- [TRUNCATE](#) (p. 470)
- [UNLOAD](#) (p. 471)
- [UPDATE](#) (p. 483)
- [VACUUM](#) (p. 488)

The SQL language consists of commands that you use to create and manipulate database objects, run queries, load tables, and modify the data in tables.

Note

Amazon Redshift is based on PostgreSQL 8.0.2. Amazon Redshift and PostgreSQL have a number of very important differences that you must be aware of as you design and develop your data warehouse applications. For more information about how Amazon Redshift SQL differs from PostgreSQL, see [Amazon Redshift and PostgreSQL](#) (p. 239).

Note

The maximum size for a single SQL statement is 16 MB.

ABORT

Aborts the currently running transaction and discards all updates made by that transaction. ABORT has no effect on already completed transactions.

This command performs the same function as the ROLLBACK command. See [ROLLBACK](#) (p. 434) for more detailed documentation.

Syntax

```
ABORT [ WORK | TRANSACTION ]
```

Parameters

WORK

Optional keyword.

TRANSACTION

Optional keyword; WORK and TRANSACTION are synonyms.

Example

The following example creates a table then starts a transaction where data is inserted into the table. The ABORT command then rolls back the data insertion to leave the table empty.

The following command creates an example table called MOVIE_GROSS:

```
create table movie_gross( name varchar(30), gross bigint );
```

The next set of commands starts a transaction that inserts two data rows into the table:

```
begin;
insert into movie_gross values ( 'Raiders of the Lost Ark', 23400000);
insert into movie_gross values ( 'Star Wars', 10000000 );
```

Next, the following command selects the data from the table to show that it was successfully inserted:

```
select * from movie_gross;
```

The command output shows that both rows are successfully inserted:

```
name          | gross
-----+-----
Raiders of the Lost Ark | 23400000
Star Wars      | 10000000
(2 rows)
```

This command now rolls back the data changes to where the transaction began:

```
abort;
```

Selecting data from the table now shows an empty table:

```
select * from movie_gross;

name | gross
-----+-----
(0 rows)
```

ALTER DATABASE

Changes the attributes of a database.

Syntax

```
ALTER DATABASE database_name  
| RENAME TO new_name  
| OWNER TO new_owner  
| CONNECTION LIMIT { limit | UNLIMITED } ]
```

Parameters

database_name

Name of the database to alter. Typically, you alter a database that you are not currently connected to; in any case, the changes take effect only in subsequent sessions. You can change the owner of the current database, but you cannot rename it:

```
alter database tickit rename to newtickit;  
ERROR:  current database may not be renamed
```

RENAME TO

Renames the specified database. For more information about valid names, see [Names and Identifiers \(p. 246\)](#). You cannot rename the dev, padb_harvest, template0, or template1 databases, and you cannot rename the current database. Only the database owner or a [superuser \(p. 94\)](#) can rename a database; non-superuser owners must also have the CREATEDB privilege.

new_name

New database name.

OWNER TO

Changes the owner of the specified database. You can change the owner of the current database or some other database. Only a superuser can change the owner.

new_owner

New database owner. The new owner must be an existing database user with write privileges. See [GRANT \(p. 420\)](#) for more information about user privileges.

CONNECTION LIMIT { *limit* | UNLIMITED }

The maximum number of database connections users are permitted to have open concurrently. The limit is not enforced for super users. Use the UNLIMITED keyword to permit the maximum number of concurrent connections. The limit of concurrent connections for each cluster is 500. A limit on the number of connections for each user might also apply. For more information, see [CREATE USER \(p. 371\)](#). The default is UNLIMITED. To view current connections, query the [STV_SESSIONS \(p. 764\)](#) system view.

Note

If both user and database connection limits apply, an unused connection slot must be available that is within both limits when a user attempts to connect.

Usage Notes

ALTER DATABASE commands apply to subsequent sessions not current sessions. You need to reconnect to the altered database to see the effect of the change.

Examples

The following example renames a database named TICKIT_SANDBOX to TICKIT_TEST:

```
alter database tickit_sandbox rename to tickit_test;
```

The following example changes the owner of the TICKIT database (the current database) to DWUSER:

```
alter database tickit owner to dwuser;
```

ALTER DEFAULT PRIVILEGES

Defines the default set of access privileges to be applied to objects that are created in the future by the specified user. By default, users can change only their own default access privileges. Only a superuser can specify default privileges for other users.

You can apply default privileges to users or user groups. You can set default privileges globally for all objects created in the current database, or for objects created only in the specified schemas.

Default privileges apply only to new objects. Running ALTER DEFAULT PRIVILEGES doesn't change privileges on existing objects.

For more information about privileges, see [GRANT \(p. 420\)](#).

To view information about the default privileges for database users, query the [PG_DEFAULT_ACL \(p. 799\)](#) system catalog table.

Syntax

```
ALTER DEFAULT PRIVILEGES
  [ FOR USER target_user [, ...] ]
  [ IN SCHEMA schema_name [, ...] ]
  grant_or_revoke_clause

where grant_or_revoke_clause is one of:

GRANT { { SELECT | INSERT | UPDATE | DELETE | REFERENCES } [,...] | ALL
  [ PRIVILEGES ] }
  ON TABLES
  TO { user_name [ WITH GRANT OPTION ] | GROUP group_name | PUBLIC } [, ...]

GRANT { EXECUTE | ALL [ PRIVILEGES ] }
  ON FUNCTIONS
  TO { user_name [ WITH GRANT OPTION ] | GROUP group_name | PUBLIC } [, ...]

REVOKE [ GRANT OPTION FOR ] { { SELECT | INSERT | UPDATE | DELETE |
  REFERENCES } [,...] | ALL [ PRIVILEGES ] }
  ON TABLES
  FROM user_name [, ...] [ CASCADE | RESTRICT ]

REVOKE { { SELECT | INSERT | UPDATE | DELETE | REFERENCES } [,...] | ALL
  [ PRIVILEGES ] }
  ON TABLES
  FROM { GROUP group_name | PUBLIC } [, ...] [ CASCADE | RESTRICT ]

REVOKE [ GRANT OPTION FOR ] { EXECUTE | ALL [ PRIVILEGES ] }
  ON FUNCTIONS
  FROM user_name [, ...] [ CASCADE | RESTRICT ]

REVOKE { EXECUTE | ALL [ PRIVILEGES ] }
  ON FUNCTIONS
  FROM { GROUP group_name | PUBLIC } [, ...] [ CASCADE | RESTRICT ]
```

Parameters

FOR USER *target_user*

Optional. The name of the user for which default privileges are defined. Only a superuser can specify default privileges for other users. The default value is the current user.

IN SCHEMA *schema_name*

Optional. If an IN SCHEMA clause appears, the specified default privileges are applied to new objects created in the specified by *schema_name*. In this case, the user or user group that is the target of ALTER DEFAULT PRIVILEGES must have CREATE privilege for the specified schema. Default privileges that are specific to a schema are added to existing global default privileges. By default, default privileges are applied globally to the entire database.

GRANT

The set of privileges to grant to the specified users or groups for all new tables or functions created by the specified user. You can set the same privileges and options with the GRANT clause that you can with the [GRANT \(p. 420\)](#) command.

WITH GRANT OPTION

A clause that indicates that the user receiving the privileges can in turn grant the same privileges to others. You cannot grant WITH GRANT OPTION to a group or to PUBLIC.

TO *user_name* | GROUP *group_name*

The name of the user or user group to which the specified default privileges will be applied.

REVOKE

The set of privileges to revoke from the specified users or groups for all new tables or functions created by the specified user. You can set the same privileges and options with the REVOKE clause that you can with the [REVOKE \(p. 431\)](#) command.

GRANT OPTION FOR

A clause that revokes only the option to grant a specified privilege to other users and doesn't revoke the privilege itself. You cannot revoke GRANT OPTION from a group or from PUBLIC.

FROM *user_name* | GROUP *group_name*

The name of the user or user group from which the specified privileges will be revoked by default.

Examples

Suppose that you want to allow any user in the user group `report_readers` to view all tables created by the user `report_admin`. In this case, execute the following command as a superuser.

```
alter default privileges for user report_admin grant select on tables to
group report_readers;
```

In the following example, the first command grants SELECT privileges on all new tables you create.

```
alter default privileges grant select on tables to public;
```

The following example grants INSERT privilege to the `sales_admin` user group for all new tables and views that you create in the `sales` schema.

```
alter default privileges in schema sales grant insert on tables to group
sales_admin;
```

The following example reverses the ALTER DEFAULT PRIVILEGES command in the preceding example.

```
alter default privileges in schema sales revoke insert on tables from group
sales_admin;
```

By default, the PUBLIC user group has EXECUTE permission for all new user-defined functions. To revoke `public` EXECUTE permissions for your new functions and then grant EXECUTE permission only to the `dev_test` user group, execute the following commands.

```
alter default privileges revoke execute on functions from public;
alter default privileges grant execute on functions to group dev_test;
```

ALTER GROUP

Changes a user group. Use this command to add users to the group, drop users from the group, or rename the group.

Syntax

```
ALTER GROUP group_name
{
  ADD USER username [, ... ] |
  DROP USER username [, ... ] |
  RENAME TO new_name
}
```

Parameters

group_name

Name of the user group to modify.

ADD

Adds a user to a user group.

DROP

Removes a user from a user group.

username

Name of the user to add to the group or drop from the group.

RENAME TO

Renames the user group. Group names beginning with two underscores are reserved for Amazon Redshift internal use. For more information about valid names, see [Names and Identifiers \(p. 246\)](#).

new_name

New name of the user group.

Examples

The following example adds a user named DWUSER to the ADMIN_GROUP group:

```
alter group admin_group
add user dwuser;
```

The following example renames the group ADMIN_GROUP to ADMINISTRATORS:

```
alter group admin_group  
rename to administrators;
```

ALTER SCHEMA

Changes the definition of an existing schema. Use this command to rename or change the owner of a schema.

For example, rename an existing schema to preserve a backup copy of that schema when you plan to create a newer version of that schema. See [CREATE SCHEMA \(p. 377\)](#) for more information about schemas.

Syntax

```
ALTER SCHEMA schema_name  
{  
  RENAME TO new_name |  
  OWNER TO new_owner  
}
```

Parameters

schema_name

Name of the database schema to be altered.

RENAME TO

Renames the schema.

new_name

The new name of the schema. For more information about valid names, see [Names and Identifiers \(p. 246\)](#).

OWNER TO

Changes the owner of the schema.

new_owner

The new owner of the schema.

Examples

The following example renames the SALES schema to US_SALES:

```
alter schema sales  
rename to us_sales;
```

The following example gives ownership of the US_SALES schema to the user DWUSER:

```
alter schema us_sales  
owner to dwuser;
```

ALTER TABLE

Topics

- [Syntax \(p. 298\)](#)
- [Parameters \(p. 298\)](#)
- [ALTER TABLE Examples \(p. 300\)](#)
- [ALTER TABLE ADD and DROP COLUMN Examples \(p. 301\)](#)

Changes the definition of a database table. This command updates the values and properties set by CREATE TABLE.

Note

ALTER TABLE locks the table for reads and writes until the operation completes.

Syntax

```
ALTER TABLE table_name
{
ADD table_constraint |
DROP CONSTRAINT constraint_name [ RESTRICT | CASCADE ] |
OWNER TO new_owner |
RENAME TO new_name |
RENAME COLUMN column_name TO new_name |
ADD [ COLUMN ] column_name column_type
[ DEFAULT default_expr ]
[ ENCODE encoding ]
[ NOT NULL | NULL ] |
DROP [ COLUMN ] column_name [ RESTRICT | CASCADE ] }
```

where *table_constraint* is:

```
[ CONSTRAINT constraint_name ]
{ UNIQUE ( column_name [, ... ] ) |
PRIMARY KEY ( column_name [, ... ] ) |
FOREIGN KEY ( column_name [, ... ] )
REFERENCES reftable [ ( refcolumn ) ] }
```

Parameters

table_name

Name of the table to alter. Specify either just the name of the table, or use the format *schema_name.table_name* to use a specific schema. You can also specify a view name if you are using the ALTER TABLE statement to rename a view or change its owner. The maximum length for the table name is 127 bytes; longer names are truncated to 127 bytes. You can use UTF-8 multibyte characters up to a maximum of four bytes. For more information about valid names, see [Names and Identifiers \(p. 246\)](#).

ADD *table_constraint*

Adds the specified constraint to the table. See [CREATE TABLE \(p. 378\)](#) for descriptions of valid *table_constraint* values.

Note

You cannot add a primary-key constraint to a nullable column. If the column was originally created with the NOT NULL constraint, you can add the primary-key constraint.

DROP CONSTRAINT *constraint_name*

Drops the named constraint from the table. To drop a constraint, specify the constraint name, not the constraint type. To view table constraint names, run the following query.

```
select constraint_name, constraint_type
```

```
from information_schema.table_constraints;
```

RESTRICT

Removes only that constraint. Option for DROP CONSTRAINT. Cannot be used with CASCADE.

CASCADE

Removes constraint and anything dependent on that constraint. Option for DROP CONSTRAINT. Cannot be used with RESTRICT.

OWNER TO *new_owner*

Changes the owner of the table (or view) to the *new_owner* value.

RENAME TO *new_name*

Renames a table (or view) to the value specified in *new_name*. The maximum table name length is 127 characters; longer names are truncated to 127 bytes.

You cannot rename a permanent table to a name that begins with '#'. A table name beginning with '#' indicates a temporary table.

RENAME COLUMN *column_name* TO *new_name*

Renames a column to the value specified in *new_name*. The maximum column name length is 127 bytes; longer names are truncated to 127 bytes. For more information about valid names, see [Names and Identifiers \(p. 246\)](#).

ADD [COLUMN] *column_name*

Adds a column with the specified name to the table. You can add only one column in each ALTER TABLE statement.

You cannot add a column that is the distribution key (DISTKEY) or a sort key (SORTKEY) of the table.

You cannot use an ALTER TABLE ADD COLUMN command to modify the following table and column attributes:

- UNIQUE
- PRIMARY KEY
- REFERENCES (foreign key)
- IDENTITY

The maximum column name length is 127 bytes; longer names are truncated to 127 bytes. The maximum number of columns you can define in a single table is 1,600.

column_type

The data type of the column being added. For CHAR and VARCHAR columns, you can use the MAX keyword instead of declaring a maximum length. MAX sets the maximum length to 4096 bytes for CHAR or 65535 bytes for VARCHAR. Amazon Redshift supports the following [data types \(p. 247\)](#)

- SMALLINT (INT2)
- INTEGER (INT, INT4)
- BIGINT (INT8)
- DECIMAL (NUMERIC)
- REAL (FLOAT4)
- DOUBLE PRECISION (FLOAT8)
- BOOLEAN (BOOL)
- CHAR (CHARACTER)
- VARCHAR (CHARACTER VARYING)
- DATE
- TIMESTAMP

- TIMESTAMPTZ

DEFAULT *default_expr*

Clause that assigns a default data value for the column. The data type of *default_expr* must match the data type of the column. The DEFAULT value must be a variable-free expression. Subqueries, cross-references to other columns in the current table, and user-defined functions are not allowed.

The *default_expr* is used in any INSERT operation that doesn't specify a value for the column. If no default value is specified, the default value for the column is null.

If a COPY operation encounters a null field on a column that has a DEFAULT value and a NOT NULL constraint, the COPY command inserts the value of the *default_expr*.

ENCODE *encoding*

Compression encoding for a column. RAW is the default, if no compression is selected. The following [Compression Encodings \(p. 101\)](#) are supported:

- BYTEDICT
- DELTA
- DELTA32K
- LZO
- MOSTLY8
- MOSTLY16
- MOSTLY32
- RAW (no compression, the default setting)
- RUNLENGTH
- TEXT255
- TEXT32K

NOT NULL | NULL

NOT NULL specifies that the column is not allowed to contain null values. NULL, the default, specifies that the column accepts null values.

DROP [COLUMN] *column_name*

Name of the column to delete from the table.

You cannot drop a column that is the distribution key (DISTKEY) or a sort key (SORTKEY) of the table. The default behavior for DROP COLUMN is RESTRICT if the column has any dependent objects, such as a view, primary key, foreign key, or UNIQUE restriction.

RESTRICT

When used with DROP COLUMN, RESTRICT means that if a defined view references the column that is being dropped, or if a foreign key references the column, or if the column takes part in a multi-part key, then the column will not be dropped. Cannot be used with CASCADE.

CASCADE

When used with DROP COLUMN, removes the specified column and anything dependent on that column. Cannot be used with RESTRICT.

ALTER TABLE Examples

The following examples demonstrate basic usage of the ALTER TABLE command.

Rename a Table

The following command renames the USERS table to USERS_BKUP:

```
alter table users
```



```
rename to users_bkup;
```

You can also use this type of command to rename a view.

Change the Owner of a Table or View

The following command changes the VENUE table owner to the user DWUSER:

```
alter table venue  
owner to dwuser;
```

The following commands create a view, then change its owner:

```
create view vdate as select * from date;  
alter table vdate owner to vuser;
```

Rename a Column

The following command renames the VENUESEATS column in the VENUE table to VENUESIZE:

```
alter table venue  
rename column venuesseats to venuesize;
```

Drop a Table Constraint

To drop a table constraint, such as a primary key, foreign key, or unique constraint, first find the internal name of the constraint, then specify the constraint name in the ALTER TABLE command. The following example finds the constraints for the CATEGORY table, then drops the primary key with the name category_pkey.

```
select constraint_name, constraint_type  
from information_schema.table_constraints  
where constraint_schema = 'public'  
and table_name = 'category';  
  
constraint_name | constraint_type  
-----+-----  
category_pkey   | PRIMARY KEY  
  
alter table category  
drop constraint category_pkey;
```

ALTER TABLE ADD and DROP COLUMN Examples

The following examples demonstrate how to use ALTER TABLE to add and then drop a basic table column and also how to drop a column with a dependent object.

ADD Then DROP a Basic Column

The following example adds a standalone FEEDBACK_SCORE column to the USERS table. This column simply contains an integer, and the default value for this column is NULL (no feedback score).

First, query the PG_TABLE_DEF catalog table to view the USERS table:

```
select "column", type, encoding, distkey, sortkey
from pg_table_def where tablename = 'users';
```

column	type	encoding	distkey	sortkey
userid	integer	none	t	1
username	character(8)	none	f	0
firstname	character varying(30)	text32k	f	0
lastname	character varying(30)	text32k	f	0
city	character varying(30)	text32k	f	0
state	character(2)	none	f	0
email	character varying(100)	text255	f	0
phone	character(14)	none	f	0
likesports	boolean	none	f	0
liketheatre	boolean	none	f	0
likeconcerts	boolean	none	f	0
likejazz	boolean	none	f	0
likeclassical	boolean	none	f	0
likeopera	boolean	none	f	0
likerock	boolean	none	f	0
likevegas	boolean	none	f	0
likebroadway	boolean	none	f	0
likemusicals	boolean	none	f	0
(18 rows)				

Now add the feedback_score column:

```
alter table users
add column feedback_score int
default NULL;
```

Select the FEEDBACK_SCORE column from USERS to verify that it was added:

```
select feedback_score from users limit 5;

feedback_score
-----
(5 rows)
```

Drop the column to reinstate the original DDL:

```
alter table users drop column feedback_score;
```

DROPPING a Column with a Dependent Object

This example drops a column that has a dependent object. As a result, the dependent object is also dropped.

To start, add the FEEDBACK_SCORE column to the USERS table again:

```
alter table users
add column feedback_score int
default NULL;
```

Next, create a view from the USERS table called USERS_VIEW:

```
create view users_view as select * from users;
```

Now, try to drop the FEEDBACK_SCORE column from the USERS table. This DROP statement uses the default behavior (RESTRICT):

```
alter table users drop column feedback_score;
```

Amazon Redshift displays an error message that the column cannot be dropped because another object depends on it.

Try dropping the FEEDBACK_SCORE column again, this time specifying CASCADE to drop all dependent objects:

```
alter table users  
drop column feedback_score cascade;
```

ALTER TABLE APPEND

Appends rows to a target table by moving data from an existing source table. Data in the source table is moved to matching columns in the target table. Column order doesn't matter. After data is successfully appended to the target table, the source table is empty. ALTER TABLE APPEND is usually much faster than a similar CREATE TABLE AS (p. 389) or INSERT (p. 424) INTO operation because data is moved, not duplicated.

Columns with the same names must also have identical column attributes. If either the source table or the target table contains columns that don't exist in the other table, use the IGNOREEXTRA or FILLTARGET parameters to specify how extra columns should be managed.

You cannot append an identity column. If both tables include an identity column, the command fails. If only one table has an identity column, include the FILLTARGET or IGNOREEXTRA parameter. For more information, see ALTER TABLE APPEND Usage Notes (p. 304).

Both the source table and the target table must be permanent tables. Both tables must use the same distribution style and distribution key, if one was defined. If the tables are sorted, both tables must use the same sort style and define the same columns as sort keys.

An ALTER TABLE APPEND command automatically commits immediately upon completion of the operation. It cannot be rolled back. You cannot run ALTER TABLE APPEND within a transaction block (BEGIN ... END).

Syntax

```
ALTER TABLE target_table_name APPEND FROM source_table_name  
[ IGNOREEXTRA | FILLTARGET ]
```

Parameters

target_table_name

The name of the table to which rows will be appended. Either specify just the name of the table or use the format *schema_name.table_name* to use a specific schema. The target table must be an existing permanent table.

FROM source_table_name

The name of the table that provides the rows to be appended. Either specify just the name of the table or use the format *schema_name.table_name* to use a specific schema. The source table must be an existing permanent table.

IGNOREEXTRA

A keyword that specifies that if the source table includes columns that are not present in the target table, data in the extra columns should be discarded. You cannot use IGNOREEXTRA with FILLTARGET.

FILLTARGET

A keyword that specifies that if the target table includes columns that are not present in the source table, the columns should be filled with the [DEFAULT \(p. 381\)](#) column value, if one was defined, or NULL. You cannot use IGNOREEXTRA with FILLTARGET.

ALTER TABLE APPEND Usage Notes

ALTER TABLE APPEND moves only identical columns from the source table to the target table. Column order doesn't matter.

If either the source table or the target tables contains extra columns, use either FILLTARGET or IGNOREEXTRA according to the following rules:

- If the source table contains columns that don't exist in the target table, include IGNOREEXTRA. The command ignores the extra columns in the source table.
- If the target table contains columns that don't exist in the source table, include FILLTARGET. The command fills the extra columns in the source table with either the default column value or IDENTITY value, if one was defined, or NULL.
- If both the source table and the target table contain extra columns, the command fails. You cannot use both FILLTARGET and IGNOREEXTRA.

If a column with the same name but different attributes exists in both tables, the command fails. Like-named columns must have the following attributes in common:

- Data type
- Column size
- Compression encoding
- Not null
- Sort style
- Sort key columns
- Distribution style
- Distribution key columns

You cannot append an identity column. If both the source table and the target table have identity columns, the command fails. If only the source table has an identity column, include the IGNOREEXTRA parameter so that the identity column is ignored. If only the target table has an identity column, include the FILLTARGET parameter so that the identity column is populated according to the IDENTITY clause defined for the table. For more information, see [DEFAULT \(p. 381\)](#).

ALTER TABLE APPEND Examples

Suppose your organization maintains a table, SALES_MONTHLY, to capture current sales transactions. You want to move data from the transaction table to the SALES table, every month.

You can use the following INSERT INTO and TRUNCATE commands to accomplish the task.

```
insert into sales (select * from sales_monthly);
truncate sales_monthly;
```

However, you can perform the same operation much more efficiently by using an ALTER TABLE APPEND command.

First, query the [PG_TABLE_DEF](#) (p. 802) system catalog table to verify that both tables have the same columns with identical column attributes.

```
select trim(tablename) as table, "column", trim(type) as type,
encoding, distkey, sortkey, "notnull"
from pg_table_def where tablename like 'sales%';
```

table notnull	column	type	encoding	distkey	sortkey
sales t	salesid	integer	delta32k	f	0
sales t	listid	integer	delta32k	t	0
sales t	sellerid	integer	delta32k	f	0
sales t	buyerid	integer	delta32k	f	0
sales t	eventid	integer	delta32k	f	0
sales t	dateid	smallint	delta	f	1
sales t	qtysold	smallint	delta	f	0
sales f	pricepaid	numeric(8,2)	mostly32	f	0
sales f	commission	numeric(8,2)	delta32k	f	0
sales f	saletime	timestamp	none	f	0
sales_month t	salesid	integer	delta32k	f	0
sales_month t	listid	integer	delta32k	t	0
sales_month t	sellerid	integer	delta32k	f	0
sales_month t	buyerid	integer	delta32k	f	0
sales_month t	eventid	integer	delta32k	f	0
sales_month t	dateid	smallint	delta	f	1
sales_month t	qtysold	smallint	delta	f	0
sales_month f	pricepaid	numeric(8,2)	mostly32	f	0
sales_month f	commission	numeric(8,2)	delta32k	f	0
sales_month f	saletime	timestamp	none	f	0

Next, look at the size of each table.

```
select count(*) from sales_monthly;
count
-----
    2000
(1 row)

select count(*) from sales;
count
-----
 412,214
(1 row)
```

Now execute the following ALTER TABLE APPEND command.

```
alter table sales append from sales_monthly;
```

Look at the size of each table again. The SALES_MONTHLY table now has 0 rows, and the SALES table has grown by 2000 rows.

```
select count(*) from sales_monthly;
count
-----
     0
(1 row)

select count(*) from sales;
count
-----
 414214
(1 row)
```

If the source table has more columns than the target table, specify the IGNOREEXTRA parameter. The following example uses the IGNOREEXTRA parameter to ignore extra columns in the SALES_LISTING table when appending to the SALES table.

```
alter table sales append from sales_listing ignoreextra;
```

If the target table has more columns than the source table, specify the FILLTARGET parameter. The following example uses the FILLTARGET parameter to populate columns in the SALES_REPORT table that don't exist in the SALES_MONTH table.

```
alter table sales_report append from sales_month filltarget;
```

ALTER USER

Changes a database user account. If you are the current user, you can change your own password. For all other options, you must be a database superuser to execute this command.

Syntax

```
ALTER USER username [ WITH ] option [, ... ]
```

where *option* is

```
CREATEDB | NOCREATEDB
| CREATEUSER | NOCREATEUSER
| PASSWORD { 'password' | 'md5hash' }
[ VALID UNTIL 'expiration_date' ]
| RENAME TO new_name |
| CONNECTION LIMIT { limit | UNLIMITED }
| SET parameter { TO | = } { value | DEFAULT }
| RESET parameter
```

Parameters

username

Name of the user account.

WITH

Optional keyword.

CREATEDB | NOCREATEDB

The CREATEDB option allows the user to create new databases. NOCREATEDB is the default.

CREATEUSER | NOCREATEUSER

The CREATEUSER option creates a superuser with all database privileges, including CREATE USER. The default is NOCREATEUSER. For more information, see [Superusers \(p. 94\)](#).

PASSWORD { 'password' | 'md5hash' }

Sets the user's password.

You can specify the password in clear text or as an MD5 hash string.

For clear text, the password must meet the following constraints:

- It must be 8 to 64 characters in length.
- It must contain at least one uppercase letter, one lowercase letter, and one number.
- It can use any printable ASCII characters (ASCII code 33 to 126) except ' (single quote), " (double quote), \, /, @, or space.

As a more secure alternative to passing the CREATE USER password parameter as clear text, you can specify an MD5 hash of a string that includes the password and user name.

Note

When you specify an MD5 hash string, the ALTER USER command checks for a valid MD5 hash string, but it doesn't validate the password portion of the string. It is possible in this case to create a password, such as an empty string, that you can't use to log on to the database.

To specify an MD5 password, follow these steps:

1. Concatenate the password and user name.

For example, for password *ez* and user *user1*, the concatenated string is *ezuser1*.

2. Convert the concatenated string into a 32-character MD5 hash string. You can use any MD5 utility to create the hash string. The following example uses the Amazon Redshift [MD5 Function \(p. 634\)](#) and the concatenation operator (`||`) to return a 32-character MD5-hash string.

```
select md5('ez' || 'user1');
md5
-----
```

```
37af65b44378ac7a5a1fb187a1969c71
```

- Concatenate 'md5' in front of the MD5 hash string and provide the concatenated string as the *md5hash* argument.

```
create user user1 password 'md537af65b44378ac7a5a1fb187a1969c71';
```

- Log on to the database using the user name and password.

For this example, log on as `user1` with password `ez`.

VALID UNTIL '*expiration_date*'

Specifies that the password has an expiration date. Use the value '*infinity*' to avoid having an expiration date. The valid data type for this parameter is timestamp.

RENAME TO

Renames the user account.

new_name

New name of the user. For more information about valid names, see [Names and Identifiers \(p. 246\)](#).

Important

When you rename a user, you must also change the user's password. The user name is used as part of the password encryption, so when a user is renamed, the password is cleared. The user will not be able to log in until the password is reset. For example:

```
alter user newuser password 'EXAMPLENewPassword11';
```

CONNECTION LIMIT { *limit* | UNLIMITED }

The maximum number of database connections the user is permitted to have open concurrently. The limit is not enforced for super users. Use the UNLIMITED keyword to permit the maximum number of concurrent connections. The limit of concurrent connections for each cluster is 500. A limit on the number of connections for each database might also apply. For more information, see [CREATE DATABASE \(p. 371\)](#). The default is UNLIMITED. To view current connections, query the [STV_SESSIONS \(p. 764\)](#) system view.

Note

If both user and database connection limits apply, an unused connection slot must be available that is within both limits when a user attempts to connect.

SET

Sets a configuration parameter to a new default value for all sessions run by the specified user.

RESET

Resets a configuration parameter to the original default value for the specified user.

parameter

Name of the parameter to set or reset.

value

New value of the parameter.

DEFAULT

Sets the configuration parameter to the default value for all sessions run by the specified user.

Usage Notes

When you set the [search_path \(p. 812\)](#) parameter with the ALTER USER command, the modification takes effect on the specified user's next login. If you want to change the search_path for the current user and session, use a SET command.

Examples

The following example gives the user ADMIN the privilege to create databases:

```
alter user admin createdb;
```

The following example sets the password of the user ADMIN to `adminPass9` and sets an expiration date and time for the password:

```
alter user admin password 'adminPass9'  
valid until '2017-12-31 23:59';
```

The following example renames the user ADMIN to SYSADMIN:

```
alter user admin rename to sysadmin;
```

ANALYZE

Updates table statistics for use by the query planner.

Syntax

```
ANALYZE [ VERBOSE ]  
[ [ table_name ]  
[ ( column_name [, ...] ) ] ]
```

Parameters

VERBOSE

Returns progress information messages about the ANALYZE operation. This option is useful when you don't specify a table.

table_name

You can analyze specific tables, including temporary tables. You can qualify the table with its schema name. You can optionally specify a *table_name* to analyze a single table. You cannot specify more than one *table_name* with a single ANALYZE *table_name* statement. If you don't specify a *table_name*, all of the tables in the currently connected database are analyzed, including the persistent tables in the system catalog. Amazon Redshift skips analyzing a table if the percentage of rows that have changed since the last ANALYZE is lower than the analyze threshold. For more information, see [Analyze Threshold \(p. 310\)](#).

You don't need to analyze Amazon Redshift system tables (STL and STV tables).

column_name

If you specify a *table_name*, you can also specify one or more columns in the table (as a column-separated list within parentheses).

Usage Notes

Amazon Redshift automatically runs ANALYZE on tables that you create with the following commands:

- CREATE TABLE AS

- CREATE TEMP TABLE AS
- SELECT INTO

You do not need to run the ANALYZE command on these tables when they are first created. If you modify them, you should analyze them in the same way as other tables.

Analyze Threshold

To reduce processing time and improve overall system performance, Amazon Redshift skips analyzing a table if the percentage of rows that have changed since the last ANALYZE command run is lower than the analyze threshold specified by the [analyze_threshold_percent \(p. 810\)](#) parameter. By default, `analyze_threshold_percent` is 10. To change `analyze_threshold_percent` for the current session, execute the [SET \(p. 465\)](#) command. The following example changes `analyze_threshold_percent` to 20 percent.

```
set analyze_threshold_percent to 20;
```

If ANALYZE skips a table because it doesn't meet the analyze threshold, Amazon Redshift returns the following message.

```
ANALYZE SKIP
```

To view the results of ANALYZE operations, query the [STL_ANALYZE \(p. 691\)](#) system table.

For more information about analyzing tables, see [Analyzing Tables \(p. 169\)](#).

Examples

Analyze all of the tables in the TICKIT database and return progress information.

```
analyze verbose;
```

Analyze the LISTING table only.

```
analyze listing;
```

Analyze the VENUEID and VENUENAME columns in the VENUE table.

```
analyze venue(venueid, venueid);
```

ANALYZE COMPRESSION

Performs compression analysis and produces a report with the suggested compression encoding for the tables analyzed. For each column, the report includes an estimate of the potential reduction in disk space compared to the current encoding.

Syntax

```
ANALYZE COMPRESSION
```

```
[ [ table_name ]  
[ ( column_name [, ...] ) ] ]  
[COMPROWS numrows]
```

Parameters

table_name

You can analyze compression for specific tables, including temporary tables. You can qualify the table with its schema name. You can optionally specify a *table_name* to analyze a single table. If you do not specify a *table_name*, all of the tables in the currently connected database are analyzed. You cannot specify more than one *table_name* with a single ANALYZE COMPRESSION statement.

column_name

If you specify a *table_name*, you can also specify one or more columns in the table (as a column-separated list within parentheses).

COMPROWS

Number of rows to be used as the sample size for compression analysis. The analysis is run on rows from each data slice. For example, if you specify COMPROWS 1000000 (1,000,000) and the system contains 4 total slices, no more than 250,000 rows per slice are read and analyzed. If COMPROWS is not specified, the sample size defaults to 100,000 per slice. Values of COMPROWS lower than the default of 100,000 rows per slice are automatically upgraded to the default value. However, compression analysis will not produce recommendations if the amount of data in the table is insufficient to produce a meaningful sample. If the COMPROWS number is greater than the number of rows in the table, the ANALYZE COMPRESSION command still proceeds and runs the compression analysis against all of the available rows.

numrows

Number of rows to be used as the sample size for compression analysis. The accepted range for *numrows* is a number between 1000 and 1000000000 (1,000,000,000).

Usage Notes

Run ANALYZE COMPRESSION to get recommendations for column encoding schemes, based on a sample of the table's contents. ANALYZE COMPRESSION is an advisory tool and doesn't modify the column encodings of the table. The suggested encoding can be applied by recreating the table, or creating a new table with the same schema. Recreating an uncompressed table with appropriate encoding schemes can significantly reduce its on-disk footprint, saving disk space and improving query performance for IO-bound workloads.

ANALYZE COMPRESSION doesn't consider [Runlength Encoding \(p. 106\)](#) encoding on any column that is designated as a SORTKEY because range-restricted scans might perform poorly when SORTKEY columns are compressed much more highly than other columns.

ANALYZE COMPRESSION acquires an exclusive table lock, which prevents concurrent reads and writes against the table. Only run the ANALYZE COMPRESSION command when the table is idle.

Examples

Analyze the LISTING table only:

```
analyze compression listing;
```

Table	Column	Encoding	Est_reduction_pct
listing	listid	delta32k	0.00

listing	sellerid	delta32k	0.00
listing	eventid	delta32k	0.00
listing	dateid	lzo	96.94
listing	numtickets	delta	0.00
listing	priceperticket	lzo	15.74
listing	totalprice	lzo	18.06
listing	listtime	lzo	20.98

Analyze the QTYSOLD, COMMISSION, and SALETIME columns in the SALES table:

```
analyze compression sales(qtysold, commission, saletime);
```

Table	Column	Encoding	Est_reduction_pct
sales	salesid	N/A	0.00
sales	listid	N/A	0.00
sales	sellerid	N/A	0.00
sales	buyerid	N/A	0.00
sales	eventid	N/A	0.00
sales	dateid	N/A	0.00
sales	qtysold	lzo	17.49
sales	pricepaid	N/A	0.00
sales	commission	delta32k	0.00
sales	saletime	lzo	20.99

BEGIN

Starts a transaction. Synonymous with START TRANSACTION.

A transaction is a single, logical unit of work, whether it consists of one command or multiple commands. In general, all commands in a transaction execute on a snapshot of the database whose starting time is determined by the value set for the `transaction_snapshot_begin` system configuration parameter.

By default, individual Amazon Redshift operations (queries, DDL statements, loads) are automatically committed to the database. If you want to suspend the commit for an operation until subsequent work is completed, you need to open a transaction with the BEGIN statement, then run the required commands, then close the transaction with a COMMIT statement. If necessary, you can use a ROLLBACK statement to abort a transaction that is in progress. An exception to this behavior is the [TRUNCATE \(p. 470\)](#) command, which commits the transaction in which it is run and cannot be rolled back.

Syntax

```
BEGIN [ WORK | TRANSACTION ] [ ISOLATION LEVEL option ] [ READ WRITE | READ ONLY ]
```

```
START TRANSACTION [ ISOLATION LEVEL option ] [ READ WRITE | READ ONLY ]
```

Where *option* is

```
SERIALIZABLE
| READ UNCOMMITTED
| READ COMMITTED
| REPEATABLE READ
```

Note: READ UNCOMMITTED, READ COMMITTED, and REPEATABLE READ have no operational impact and map to SERIALIZABLE in Amazon Redshift.

Parameters

WORK

Optional keyword.

TRANSACTION

Optional keyword; WORK and TRANSACTION are synonyms.

ISOLATION LEVEL SERIALIZABLE

Serializable isolation is supported by default, so the behavior of the transaction is the same whether or not this syntax is included in the statement. See [Managing Concurrent Write Operations](#) (p. 181). No other isolation levels are supported.

Note

The SQL standard defines four levels of transaction isolation to prevent *dirty reads* (where a transaction reads data written by a concurrent uncommitted transaction), *nonrepeatable reads* (where a transaction re-reads data it read previously and finds that data was changed by another transaction that committed since the initial read), and *phantom reads* (where a transaction re-executes a query, returns a set of rows that satisfy a search condition, and then finds that the set of rows has changed because of another recently-committed transaction):

- Read uncommitted: Dirty reads, nonrepeatable reads, and phantom reads are possible.
- Read committed: Nonrepeatable reads and phantom reads are possible.
- Repeatable read: Phantom reads are possible.
- Serializable: Prevents dirty reads, nonrepeatable reads, and phantom reads. Though you can use any of the four transaction isolation levels, Amazon Redshift processes all isolation levels as serializable.

READ WRITE

Gives the transaction read and write permissions.

READ ONLY

Gives the transaction read-only permissions.

Examples

The following example starts a serializable transaction block:

```
begin;
```

The following example starts the transaction block with a serializable isolation level and read and write permissions:

```
begin read write;
```

CANCEL

Cancels a database query that is currently running.

The CANCEL command requires the process ID of the running query and displays a confirmation message to verify that the query was cancelled.

Syntax

```
CANCEL process_id [ 'message' ]
```

Parameters

process_id

Process ID corresponding to the query that you want to cancel.

'*message*'

An optional confirmation message that displays when the query cancellation completes. If you do not specify a message, Amazon Redshift displays the default message as verification. You must enclose the message in single quotes.

Usage Notes

You can't cancel a query by specifying a *query ID*; you must specify the query's *process ID* (PID). You can only cancel queries currently being run by your user. Superusers can cancel all queries.

If queries in multiple sessions hold locks on the same table, you can use the [PG_TERMINATE_BACKEND](#) (p. 669) function to terminate one of the sessions, which forces any currently running transactions in the terminated session to release all locks and roll back the transaction. Query the [STV_LOCKS](#) (p. 760) system table to view currently held locks.

Following certain internal events, Amazon Redshift might restart an active session and assign a new PID. If the PID has changed, you might receive the following error message:

```
Session <PID> does not exist. The session PID might have changed. Check the
stl_restarted_sessions system table for details.
```

To find the new PID, query the [STL_RESTARTED_SESSIONS](#) (p. 728) system table and filter on the `oldpid` column.

```
select oldpid, newpid from stl_restarted_sessions where oldpid = 1234;
```

Examples

To cancel a currently running query, first retrieve the process ID for the query that you want to cancel. To determine the process IDs for all currently running queries, type the following command:

```
select pid, starttime, duration,
trim(user_name) as user,
trim (query) as querytxt
from stv_recents
where status = 'Running';
```

```
pid |                starttime                | duration | user | querytxt
-----+-----+-----+-----+-----
802 | 2008-10-14 09:19:03.550885 |      132 | dwuser | select
venue name from venue where venuestate='FL', where venuecity not in
('Miami' , 'Orlando');
834 | 2008-10-14 08:33:49.473585 | 1250414 | dwuser | select *
from listing;
```

```
964 | 2008-10-14 08:30:43.290527 | 326179 | dwuser | select  
sellerid from sales where qtysold in (8, 10);
```

Check the query text to determine which process id (PID) corresponds to the query that you want to cancel.

Type the following command to use PID 802 to cancel that query:

```
cancel 802;
```

The session where the query was running displays the following message:

```
ERROR: Query (168) cancelled on user's request
```

where 168 is the query ID (not the process ID used to cancel the query).

Alternatively, you can specify a custom confirmation message to display instead of the default message. To specify a custom message, include your message in quotes at the end of the CANCEL command:

```
cancel 802 'Long-running query';
```

The session where the query was running displays the following message:

```
ERROR: Long-running query
```

CLOSE

(Optional) Closes all of the free resources that are associated with an open cursor. [COMMIT \(p. 317\)](#), [END \(p. 413\)](#), and [ROLLBACK \(p. 434\)](#) automatically close the cursor, so it is not necessary to use the CLOSE command to explicitly close the cursor.

For more information, see [DECLARE \(p. 401\)](#), [FETCH \(p. 419\)](#).

Syntax

```
CLOSE cursor
```

Parameters

cursor

Name of the cursor to close.

CLOSE Example

The following commands close the cursor and perform a commit, which ends the transaction:

```
close movie_cursor;  
commit;
```

COMMENT

Creates or changes a comment about a database object.

Syntax

```
COMMENT ON
{
TABLE object_name |
COLUMN object_name.column_name |
CONSTRAINT constraint_name ON table_name |
DATABASE object_name |
VIEW object_name
}
IS 'text'
```

Parameters

object_name

Name of the database object being commented on. You can add a comment to the following objects:

- TABLE
- COLUMN (also takes a *column_name*).
- CONSTRAINT (also takes a *constraint_name* and *table_name*).
- DATABASE
- VIEW

IS '*text*'

The text of the comment that you want to apply to the specified object. Enclose the comment in single quotation marks.

column_name

Name of the column being commented on. Parameter of COLUMN. Follows a table specified in *object_name*.

constraint_name

Name of the constraint that is being commented on. Parameter of CONSTRAINT.

table_name

Name of a table containing the constraint. Parameter of CONSTRAINT.

arg1_type, arg2_type, ...

Data types of the arguments for a function. Parameter of FUNCTION.

Usage Notes

Comments on databases may only be applied to the current database. A warning message is displayed if you attempt to comment on a different database. The same warning is displayed for comments on databases that do not exist.

Comments cannot be retrieved directly by using SQL commands. Comments can be viewed by using the PostgreSQL `psql` tool, using the `\d` family of commands.

Example

The following example adds a descriptive comment to the EVENT table:

```
comment on table
event is 'Contains listings of individual events.';
```

The following example uses the `psql \dd` command to view the comments. Amazon Redshift does not support `psql` directly. You must execute `psql` commands from the PostgreSQL `psql` client.

```
\dd event

Object descriptions
schema | name | object | description
-----+-----+-----+-----
public | event | table | Contains listings of individual events.
(1 row)
```

COMMIT

Commits the current transaction to the database. This command makes the database updates from the transaction permanent.

Syntax

```
COMMIT [ WORK | TRANSACTION ]
```

Parameters

WORK

Optional keyword.

TRANSACTION

Optional keyword; WORK and TRANSACTION are synonyms.

Examples

Each of the following examples commits the current transaction to the database:

```
commit;
```

```
commit work;
```

```
commit transaction;
```

COPY

Loads data into a table from data files or from an Amazon DynamoDB table. The files can be located in an Amazon Simple Storage Service (Amazon S3) bucket, an Amazon EMR (Amazon EMR) cluster, or a remote host that is accessed using a Secure Shell (SSH) connection.

The COPY command appends the new input data to any existing rows in the table.

The maximum size of a single input row from any source is 4 MB.

Note

To use the COPY command, you must have [INSERT \(p. 421\)](#) privilege for the Amazon Redshift table.

Topics

- [COPY Syntax \(p. 318\)](#)
- [COPY Syntax Overview \(p. 318\)](#)
- [COPY Parameter Reference \(p. 321\)](#)
- [Usage Notes \(p. 348\)](#)
- [COPY Examples \(p. 356\)](#)

COPY Syntax

```
COPY table-name
[ column-list ]
FROM data_source
[ WITH ] CREDENTIALS [ AS ] 'aws-auth-args'
[ [ FORMAT ] [ AS ] data_format ]
[ [ parameter [ argument ] [, ... ] ] ]
```

COPY Syntax Overview

You can perform a COPY operation as few as three parameters: a table name, a data source, and authorization to access the data.

Amazon Redshift extends the functionality of the COPY command to enable you to load data in several data formats from multiple data sources, control access to load data, manage data transformations, and manage the load operation.

This section presents the required COPY command parameters and groups the optional parameters by function. Subsequent topics describe each parameter and explain how various options work together. You can also go directly to a parameter description by using the alphabetical parameter list.

Required Parameters

The COPY command requires only three parameters:

- [Table Name \(p. 319\)](#)
- [Data Source \(p. 319\)](#)
- [Credentials \(p. 319\)](#)

The simplest COPY command uses the following format.

```
COPY table-name
FROM data-source
CREDENTIALS 'aws-auth-args';
```

The following example creates a table named CATDEMO, and then loads the data with sample data from a data file in Amazon S3 named `category_pipe.txt`.

```
create table catdemo(catid smallint, catgroup varchar(10), catname
varchar(10), catdesc varchar(50));
```

In the follow example, the data source for the COPY command is a data file named `category_pipe.txt` in the `ticket` folder of an Amazon S3 bucket named `awssampledbuswest2`. The COPY command is authorized to access the Amazon S3 bucket through an AWS Identity and Access Management (IAM) role. If your cluster has an existing IAM role with permission to access Amazon S3 attached, you can substitute your role's Amazon Resource Name (ARN) in the following COPY command and execute it.

```
copy catdemo
from 's3://awssampledbuswest2/ticket/category_pipe.txt'
credentials 'aws_iam_role=arn:aws:iam:<aws-account-id>:role/<role-name>'
region 'us-west-2';
```

For steps to create an IAM role, see [Step 2: Create an IAM Role](#) . For complete instructions on how to use COPY commands to load sample data, including instructions for loading data from other AWS regions, see [Step 4: Load Sample Data \(p. 15\)](#).

table-name

The name of the target table for the COPY command. The table must already exist in the database. The table can be temporary or persistent. The COPY command appends the new input data to any existing rows in the table.

FROM *data-source*

The location of the source data to be loaded into the target table.

The most commonly used data repository is an Amazon S3 bucket. You can also load from data files located in an Amazon EMR cluster, an Amazon EC2 instance, or a remote host that your cluster can access using an SSH connection, or you can load directly from a DynamoDB table.

- [COPY from Amazon S3 \(p. 322\)](#)
- [COPY from Amazon EMR \(p. 325\)](#)
- [COPY from Remote Host \(SSH\) \(p. 326\)](#)
- [COPY from Amazon DynamoDB \(p. 329\)](#)

CREDENTIALS '*aws-auth-args*'

A clause that indicates the method that your cluster will use for authentication and authorization to access other AWS resources. The COPY command needs authorization to access data in another AWS resource, including Amazon S3, Amazon EMR, Amazon DynamoDB, and Amazon EC2. You can provide that authorization by referencing an IAM role that is attached to your cluster or by providing the access key ID and secret access key for an IAM user.

If your data is encrypted on Amazon S3 using client-side encryption, you supply the encryption as part of the *aws-auth-args* parameter string.

- [Credentials \(p. 330\)](#)
- [Role-Based Access Control \(p. 348\)](#)
- [Key-Based Access Control \(p. 349\)](#)
- [Temporary Security Credentials \(p. 350\)](#)

Optional Parameters

You can optionally specify how COPY will map field data to columns in the target table, define source data attributes to enable the COPY command to correctly read and parse the source data, and manage which operations the COPY command performs during the load process.

- [Column Mapping Options \(p. 332\)](#)
- [Data Format Parameters \(p. 320\)](#)
- [Data Conversion Parameters \(p. 320\)](#)

- [Data Load Operations \(p. 321\)](#)

Column Mapping

By default, COPY inserts field values into the target table's columns in the same order as the fields occur in the data files. If the default column order will not work, you can specify a column list or use JSONPath expressions to map source data fields to the target columns.

- [Column List \(p. 332\)](#)
- [JSONPaths File \(p. 332\)](#)

Data Format Parameters

You can load data from text files in fixed-width, character-delimited, comma-separated values (CSV), or JSON format, or from Avro files.

By default, the COPY command expects the source data to be in character-delimited UTF-8 text files. The default delimiter is a pipe character (|). If the source data is in another format, use the following parameters to specify the data format.

- [FORMAT \(p. 333\)](#)
- [CSV \(p. 333\)](#)
- [DELIMITER \(p. 333\)](#)
- [FIXEDWIDTH \(p. 334\)](#)
- [AVRO \(p. 334\)](#)
- [JSON \(p. 335\)](#)
- [BZIP2 \(p. 341\)](#)
- [GZIP \(p. 341\)](#)
- [LZOP \(p. 341\)](#)

Data Conversion Parameters

As it loads the table, COPY attempts to implicitly convert the strings in the source data to the data type of the target column. If you need to specify a conversion that is different from the default behavior, or if the default conversion results in errors, you can manage data conversions by specifying the following parameters.

- [ACCEPTANYDATE \(p. 341\)](#)
- [ACCEPTINVCHARS \(p. 342\)](#)
- [BLANKSASNULL \(p. 342\)](#)
- [DATEFORMAT \(p. 342\)](#)
- [EMPTYASNULL \(p. 342\)](#)
- [ENCODING \(p. 342\)](#)
- [ESCAPE \(p. 343\)](#)
- [EXPLICIT_IDS \(p. 344\)](#)
- [FILLRECORD \(p. 344\)](#)
- [IGNOREBLANKLINES \(p. 344\)](#)
- [IGNOREHEADER \(p. 344\)](#)
- [NULL AS \(p. 344\)](#)
- [REMOVEQUOTES \(p. 345\)](#)

- [ROUNDEC](#) (p. 345)
- [TIMEFORMAT](#) (p. 345)
- [TRIMBLANKS](#) (p. 346)
- [TRUNCATECOLUMNS](#) (p. 346)

Data Load Operations

Manage the default behavior of the load operation for troubleshooting or to reduce load times by specifying the following parameters.

- [COMPROWS](#) (p. 346)
- [COMPUPDATE](#) (p. 346)
- [MAXERROR](#) (p. 346)
- [NOLOAD](#) (p. 347)
- [STATUPDATE](#) (p. 347)

Using the COPY Command

For more information about how to use the COPY command, see the following topics:

- [COPY Examples](#) (p. 356)
- [Usage Notes](#) (p. 348)
- [Tutorial: Loading Data from Amazon S3](#) (p. 56)
- [Best Practices for Loading Data](#) (p. 24)
- [Using a COPY Command to Load Data](#) (p. 130)
 - [Loading Data from Amazon S3](#) (p. 133)
 - [Loading Data from Amazon EMR](#) (p. 141)
 - [Loading Data from Remote Hosts](#) (p. 145)
 - [Loading Data from an Amazon DynamoDB Table](#) (p. 151)
- [Troubleshooting Data Loads](#) (p. 157)

COPY Parameter Reference

Topics

- [Data Sources](#) (p. 321)
- [Credentials](#) (p. 330)
- [Column Mapping Options](#) (p. 332)
- [Data Format Parameters](#) (p. 333)
- [Data Conversion Parameters](#) (p. 341)
- [Data Load Operations](#) (p. 346)
- [Alphabetical Parameter List](#) (p. 347)

Data Sources

You can load data from text files in an Amazon S3 bucket, in an Amazon EMR cluster, or on a remote host that your cluster can access using an SSH connection. You can also load data directly from a DynamoDB table.

The maximum size of a single input row from any source is 4 MB.

To export data from a table to a set of files in an Amazon S3, use the [UNLOAD \(p. 471\)](#) command.

Topics

- [COPY from Amazon S3 \(p. 322\)](#)
- [COPY from Amazon EMR \(p. 325\)](#)
- [COPY from Remote Host \(SSH\) \(p. 326\)](#)
- [COPY from Amazon DynamoDB \(p. 329\)](#)

COPY from Amazon S3

To load data from files located in one or more S3 buckets, use the FROM clause to indicate how COPY will locate the files in Amazon S3. You can provide the object path to the data files as part of the FROM clause, or you can provide the location of a manifest file that contains a list of Amazon S3 object paths. COPY from Amazon S3 uses an HTTPS connection.

Important

If the Amazon S3 buckets that hold the data files do not reside in the same region as your cluster, you must use the [REGION \(p. 324\)](#) parameter to specify the region in which the data is located.

Topics

- [Syntax \(p. 322\)](#)
- [Examples \(p. 322\)](#)
- [Optional Parameters \(p. 324\)](#)
- [Unsupported Parameters \(p. 325\)](#)

Syntax

```
FROM { 's3://objectpath' | 's3://manifest_file' }  
CREDENTIALS 'aws-auth-args'  
| MANIFEST  
| ENCRYPTED  
| REGION [AS] 'aws-region'  
| optional-parameters
```

Examples

The following example uses an object path to load data from Amazon S3.

```
copy customer  
from 's3://mybucket/customer'  
credentials '<aws-auth-args>';
```

The following example uses a manifest file to load data from Amazon S3.

```
copy customer  
from 's3://mybucket/cust.manifest'  
credentials '<aws-auth-args>'  
manifest;
```

Parameters

FROM

The source of the data to be loaded.

`'s3://copy_from_s3_objectpath'`

Specifies the path to the Amazon S3 objects that contain the data—for example, `'s3://mybucket/custdata.txt'`. The `s3://copy_from_s3_objectpath` parameter can reference a single file or a set of objects or folders that have the same key prefix. For example, the name `custdata.txt` is a key prefix that refers to a number of physical files: `custdata.txt`, `custdata.txt.1`, `custdata.txt.2`, `custdata.txt.bak`, and so on. The key prefix can also reference a number of folders. For example, `'s3://mybucket/custfolder'` refers to the folders `custfolder`, `custfolder_1`, `custfolder_2`, and so on. If a key prefix references multiple folders, all of the files in the folders will be loaded. If a key prefix matches a file as well as a folder, such as `custfolder.log`, COPY attempts to load the file also. If a key prefix might result in COPY attempting to load unwanted files, use a manifest file. For more information, see [copy_from_s3_manifest_file](#) (p. 323), following.

Important

If the S3 bucket that holds the data files does not reside in the same region as your cluster, you must use the [REGION](#) (p. 324) parameter to specify the region in which the data is located.

For more information, see [Loading Data from Amazon S3](#) (p. 133).

`'s3://copy_from_s3_manifest_file'`

Specifies the Amazon S3 object key for a manifest file that lists the data files to be loaded. The `'s3://copy_from_s3_manifest_file'` argument must explicitly reference a single file—for example, `'s3://mybucket/manifest.txt'`. It cannot reference a key prefix.

The manifest is a text file in JSON format that lists the URL of each file that is to be loaded from Amazon S3. The URL includes the bucket name and full object path for the file. The files that are specified in the manifest can be in different buckets, but all the buckets must be in the same region as the Amazon Redshift cluster. If a file is listed twice, the file is loaded twice. The following example shows the JSON for a manifest that loads three files.

```
{
  "entries": [
    { "url": "s3://mybucket-alpha/custdata.1", "mandatory": true },
    { "url": "s3://mybucket-alpha/custdata.2", "mandatory": true },
    { "url": "s3://mybucket-beta/custdata.1", "mandatory": false }
  ]
}
```

The double quote characters are required, and must be simple quotation marks (0x22), not slanted or "smart" quotes. Each entry in the manifest can optionally include a `mandatory` flag. If `mandatory` is set to `true`, COPY terminates if it does not find the file for that entry; otherwise, COPY will continue. The default value for `mandatory` is `false`.

The manifest file must not be encrypted or compressed, even if the `ENCRYPTED`, `GZIP`, `LZOP`, or `BZIP2` options are specified. COPY returns an error if the specified manifest file is not found or the manifest file is not properly formed.

If a manifest file is used, the `MANIFEST` parameter must be specified with the COPY command. If the `MANIFEST` parameter is not specified, COPY assumes that the file specified with `FROM` is a data file.

For more information, see [Loading Data from Amazon S3](#) (p. 133).

MANIFEST

Specifies that a manifest is used to identify the data files to be loaded from Amazon S3. If the `MANIFEST` parameter is used, COPY loads data from the files listed in the manifest referenced by

's3://copy_from_s3_manifest_file'. If the manifest file is not found, or is not properly formed, COPY fails. For more information, see [Using a Manifest to Specify Data Files \(p. 139\)](#).

ENCRYPTED

Specifies that the input files on Amazon S3 are encrypted using client-side encryption. For more information, see [Loading Encrypted Data Files from Amazon S3 \(p. 141\)](#). If the input files are encrypted using Amazon S3 server-side encryption, COPY reads the files automatically. If the encrypted files are in compressed format, add the GZIP, LZOP, or BZIP2 parameter.

REGION [AS] 'aws-region'

Specifies the AWS region where the source data is located. REGION is required for COPY from an Amazon S3 bucket or an DynamoDB table when the AWS resource that contains the data is not in the same region as the Amazon Redshift cluster.

The value for *aws_region* must match a region listed in the following table.

Region Name	Region
US East (N. Virginia)	us-east-1
US West (N. California)	us-west-1
US West (Oregon)	us-west-2
EU (Ireland)	eu-west-1
EU (Frankfurt)	eu-central-1
Asia Pacific (Singapore)	ap-southeast-1
Asia Pacific (Sydney)	ap-southeast-2
Asia Pacific (Tokyo)	ap-northeast-1
Asia Pacific (Seoul)	ap-northeast-2
South America (São Paulo)	sa-east-1
China (Beijing)	cn-north-1
AWS GovCloud (US)	us-gov-west-1

If the REGION parameter is specified, all resources, including a manifest file or multiple Amazon S3 buckets, must be located in the specified region.

Note

Transferring data across regions incurs additional charges against the Amazon S3 bucket or the DynamoDB table that contains the data. For more information about pricing, see **Data Transfer OUT From Amazon S3 To Another AWS Region** on the [Amazon S3 Pricing](#) page and **Data Transfer OUT** on the [Amazon DynamoDB Pricing](#) page.

By default, COPY assumes that the data is located in the same region as the Amazon Redshift cluster.

Optional Parameters

You can optionally specify the following parameters with COPY from Amazon S3:

- [Column Mapping Options \(p. 332\)](#)
- [Parameters \(p. 333\)](#)
- [Data Conversion Parameters \(p. 341\)](#)

- [Data Load Operations \(p. 346\)](#)

Unsupported Parameters

You cannot use the following parameters with COPY from Amazon S3:

- SSH
- READRATIO

COPY from Amazon EMR

You can use the COPY command to load data in parallel from an Amazon EMR cluster configured to write text files to the cluster's Hadoop Distributed File System (HDFS) in the form of fixed-width files, character-delimited files, CSV files, JSON-formatted files, or Avro files.

Topics

- [Syntax \(p. 325\)](#)
- [Example \(p. 325\)](#)
- [Parameters \(p. 325\)](#)
- [Supported Parameters \(p. 326\)](#)
- [Unsupported Parameters \(p. 326\)](#)

Syntax

```
FROM 'emr://emr_cluster_id/hdfs_filepath'  
CREDENTIALS '<aws-auth-args>'  
| optional_parameters
```

Example

The following example loads data from an Amazon EMR cluster.

```
copy sales  
from 'emr://j-SAMPLE2B500FC/myoutput/part-*'  
credentials '<aws-auth-args>';
```

Parameters

FROM

The source of the data to be loaded.

'emr://emr_cluster_id/hdfs_file_path'

The unique identifier for the Amazon EMR cluster and the HDFS file path that references the data files for the COPY command. The HDFS data file names must not contain the wildcard characters asterisk (*) and question mark (?).

Note

The Amazon EMR cluster must continue running until the COPY operation completes. If any of the HDFS data files are changed or deleted before the COPY operation completes, you might have unexpected results, or the COPY operation might fail.

You can use the wildcard characters asterisk (*) and question mark (?) as part of the *hdfs_file_path* argument to specify multiple files to be loaded. For example, 'emr://j-SAMPLE2B500FC/myoutput/part*' identifies the files `part-0000`, `part-0001`, and so on. If

the file path does not contain wildcard characters, it is treated as a string literal. If you specify only a folder name, COPY attempts to load all files in the folder.

Important

If you use wildcard characters or use only the folder name, verify that no unwanted files will be loaded. For example, some processes might write a log file to the output folder.

For more information, see [Loading Data from Amazon EMR \(p. 141\)](#).

Supported Parameters

You can optionally specify the following parameters with COPY from Amazon EMR:

- [Column Mapping Options \(p. 332\)](#)
- [Parameters \(p. 333\)](#)
- [Data Conversion Parameters \(p. 341\)](#)
- [Data Load Operations \(p. 346\)](#)

Unsupported Parameters

You cannot use the following parameters with COPY from Amazon EMR:

- ENCRYPTED
- MANIFEST
- REGION
- READRATIO
- SSH

COPY from Remote Host (SSH)

You can use the COPY command to load data in parallel from one or more remote hosts, such as Amazon Elastic Compute Cloud (Amazon EC2) instances or other computers. COPY connects to the remote hosts using Secure Shell (SSH) and executes commands on the remote hosts to generate text output. The remote host can be an EC2 Linux instance or another Unix or Linux computer configured to accept SSH connections. Amazon Redshift can connect to multiple hosts, and can open multiple SSH connections to each host. Amazon Redshift sends a unique command through each connection to generate text output to the host's standard output, which Amazon Redshift then reads as it does a text file.

Use the FROM clause to specify the Amazon S3 object key for the manifest file that provides the information COPY will use to open SSH connections and execute the remote commands.

Topics

- [Syntax \(p. 326\)](#)
- [Examples \(p. 327\)](#)
- [Parameters \(p. 327\)](#)
- [Optional Parameters \(p. 328\)](#)
- [Unsupported Parameters \(p. 329\)](#)

Syntax

```
FROM 's3://'ssh_manifest_file' }
```

```
CREDENTIALS '<aws-auth-args>'
SSH
| optional-parameters
```

Examples

The following example uses a manifest file to load data from a remote host using SSH.

```
copy sales
from 's3://mybucket/ssh_manifest'
credentials '<aws-auth-args>'
ssh;
```

Parameters

FROM

The source of the data to be loaded.

's3://copy_from_ssh_manifest_file'

The COPY command can connect to multiple hosts using SSH, and can create multiple SSH connections to each host. COPY executes a command through each host connection, and then loads the output from the commands in parallel into the table. The `s3://copy_from_ssh_manifest_file` argument specifies the Amazon S3 object key for the manifest file that provides the information COPY will use to open SSH connections and execute the remote commands.

The `s3://copy_from_ssh_manifest_file` argument must explicitly reference a single file; it cannot be a key prefix. The following shows an example:

```
's3://mybucket/ssh_manifest.txt'
```

The manifest file is a text file in JSON format that Amazon Redshift uses to connect to the host. The manifest file specifies the SSH host endpoints and the commands that will be executed on the hosts to return data to Amazon Redshift. Optionally, you can include the host public key, the login user name, and a mandatory flag for each entry. The following example shows a manifest file that creates two SSH connections:

```
{
  "entries": [
    {
      "endpoint": "<ssh_endpoint_or_IP>",
      "command": "<remote_command>",
      "mandatory": true,
      "publickey": "<public_key>",
      "username": "<host_user_name>"
    },
    {
      "endpoint": "<ssh_endpoint_or_IP>",
      "command": "<remote_command>",
      "mandatory": true,
      "publickey": "<public_key>",
      "username": "<host_user_name>"
    }
  ]
}
```

The manifest file contains one "entries" construct for each SSH connection. You can have multiple connections to a single host or multiple connections to multiple hosts. The double quote characters are required as shown, both for the field names and the values. The quote characters must be simple quotation marks (0x22), not slanted or "smart" quotation marks. The

only value that does not need double quote characters is the Boolean value *true* or *false* for the "mandatory" field.

The following list describes the fields in the manifest file.

endpoint

The URL address or IP address of the host—for example, "ec2-111-222-333.compute-1.amazonaws.com", or "198.51.100.0".

command

The command to be executed by the host to generate text output or binary output in gzip, lzop, or bzip2 format. The command can be any command that the user "*host_user_name*" has permission to run. The command can be as simple as printing a file, or it can query a database or launch a script. The output (text file, gzip binary file, lzop binary file, or bzip2 binary file) must be in a form that the Amazon Redshift COPY command can ingest. For more information, see [Preparing Your Input Data \(p. 132\)](#).

publickey

(Optional) The public key of the host. If provided, Amazon Redshift will use the public key to identify the host. If the public key is not provided, Amazon Redshift will not attempt host identification. For example, if the remote host's public key is `ssh-rsa AbcCbaxxx...Example root@amazon.com`, type the following text in the public key field: "AbcCbaxxx...Example"

mandatory

(Optional) A clause that indicates whether the COPY command should fail if the connection attempt fails. The default is *false*. If Amazon Redshift doesn't successfully make at least one connection, the COPY command fails.

username

(Optional) The user name that will be used to log in to the host system and execute the remote command. The user login name must be the same as the login that was used to add the Amazon Redshift cluster's public key to the host's authorized keys file. The default username is `redshift`.

For more information about creating a manifest file, see [Loading Data Process \(p. 146\)](#).

To COPY from a remote host, the SSH parameter must be specified with the COPY command. If the SSH parameter is not specified, COPY assumes that the file specified with FROM is a data file and will fail.

If you use automatic compression, the COPY command performs two data read operations, which means it will execute the remote command twice. The first read operation is to provide a data sample for compression analysis, then the second read operation actually loads the data. If executing the remote command twice might cause a problem, you should disable automatic compression. To disable automatic compression, run the COPY command with the COMPUPDATE parameter set to OFF. For more information, see [Loading Tables with Automatic Compression \(p. 154\)](#).

For detailed procedures for using COPY from SSH, see [Loading Data from Remote Hosts \(p. 145\)](#).

SSH

A clause that specifies that data is to be loaded from a remote host using the SSH protocol. If you specify SSH, you must also provide a manifest file using the `s3://copy_from_ssh_manifest_file` (p. 327) argument.

Optional Parameters

You can optionally specify the following parameters with COPY from SSH:

- [Column Mapping Options \(p. 332\)](#)
- [Parameters \(p. 333\)](#)
- [Data Conversion Parameters \(p. 341\)](#)

- [Data Load Operations \(p. 346\)](#)

Unsupported Parameters

You cannot use the following parameters with COPY from SSH:

- ENCRYPTED
- MANIFEST
- READRATIO
- REGION

COPY from Amazon DynamoDB

To load data from an existing DynamoDB table, use the FROM clause to specify the DynamoDB table name.

Topics

- [Syntax \(p. 329\)](#)
- [Examples \(p. 329\)](#)
- [Optional Parameters \(p. 330\)](#)
- [Unsupported Parameters \(p. 330\)](#)

Syntax

```
FROM 'dynamodb://table-name'  
CREDENTIALS '<aws-auth-args>'  
READRATIO ratio  
| REGION [AS] 'aws_region'  
| optional-parameters
```

Examples

The following example loads data from a DynamoDB table.

```
copy favoritemovies from 'dynamodb://ProductCatalog'  
credentials '<aws-auth-args>'  
readratio 50;
```

Parameters

FROM

The source of the data to be loaded.

'dynamodb://table-name'

The name of the DynamoDB table that contains the data, for example 'dynamodb://ProductCatalog'. For details about how DynamoDB attributes are mapped to Amazon Redshift columns, see [Loading Data from an Amazon DynamoDB Table \(p. 151\)](#).

A DynamoDB table name is unique to an AWS account, which is identified by the AWS access credentials.

READRATIO [AS] *ratio*

The percentage of the DynamoDB table's provisioned throughput to use for the data load.

READRATIO is required for COPY from DynamoDB. It cannot be used with COPY from Amazon

S3. We highly recommend setting the ratio to a value less than the average unused provisioned throughput. Valid values are integers 1–200.

Important

Setting READRATIO to 100 or higher will enable Amazon Redshift to consume the entirety of the DynamoDB table's provisioned throughput, which will seriously degrade the performance of concurrent read operations against the same table during the COPY session. Write traffic will be unaffected. Values higher than 100 are allowed to troubleshoot rare scenarios when Amazon Redshift fails to fulfill the provisioned throughput of the table. If you load data from DynamoDB to Amazon Redshift on an ongoing basis, consider organizing your DynamoDB tables as a time series to separate live traffic from the COPY operation.

Optional Parameters

You can optionally specify the following parameters with COPY from Amazon DynamoDB:

- [Column Mapping Options \(p. 332\)](#)
- The following data conversion parameters are supported:
 - [ACCEPTANYDATE \(p. 341\)](#)
 - [BLANKSASNULL \(p. 342\)](#)
 - [DATEFORMAT \(p. 342\)](#)
 - [EMPTYASNULL \(p. 342\)](#)
 - [ROUNDEC \(p. 345\)](#)
 - [TIMEFORMAT \(p. 345\)](#)
 - [TRIMBLANKS \(p. 346\)](#)
 - [TRUNCATECOLUMNS \(p. 346\)](#)
- [Data Load Operations \(p. 346\)](#)

Unsupported Parameters

You cannot use the following parameters with COPY from DynamoDB:

- All data format parameters
- ESCAPE
- FILLRECORD
- IGNOREBLANKLINES
- IGNOREHEADER
- NULL
- REMOVEQUOTES
- ACCEPTINVCHARS
- MANIFEST
- ENCRYPTED
- MANIFEST
- ENCRYPTED

Credentials

The COPY command needs authorization to access data in another AWS resource, including Amazon S3, Amazon EMR, Amazon DynamoDB, and Amazon EC2. You can provide that authorization by

referencing an [AWS Identity and Access Management \(IAM\) role](#) that is attached to your cluster (*role-based access control*) or by providing the access credentials for an IAM user (*key-based access control*). For increased security and flexibility, we recommend using IAM role-based access control. COPY can also use temporary credentials to limit access to your load data, and you can encrypt your load data on Amazon S3.

[WITH] CREDENTIALS [AS] '*aws-auth-args*'

A clause that indicates the method your cluster will use when accessing other AWS resources that contain data files or manifest files.

Optionally, if the [ENCRYPTED](#) (p. 324) parameter is used, the *aws-auth-args* string also provides the encryption key.

The *aws-auth-args* string is case-sensitive and must not contain spaces.

The keywords WITH and AS are optional and are ignored.

You can specify either [Role-Based Access Control](#) (p. 348) or [Key-Based Access Control](#) (p. 349). In either case, the IAM role or IAM user must have the permissions required to access the specified AWS resources. For more information, see [IAM Permissions for COPY, UNLOAD, and CREATE LIBRARY](#) (p. 351)

Note

To safeguard your AWS credentials and protect sensitive data, we strongly recommend using role-based access control.

To specify role-based access control, provide the *aws-auth-args* string in the following format:

```
'aws_iam_role=arn:aws:iam::<aws-account-id>:role/<role-name>'
```

To specify key-based access control, provide the *aws-auth-args* in the following format:

```
'aws_access_key_id=<access-key-id>;aws_secret_access_key=<secret-access-key>'
```

To use temporary token credentials, you must provide the temporary access key ID, the temporary secret access key, and the temporary token. The *aws-auth-args* string is in the following format:

```
WITH CREDENTIALS AS  
'aws_access_key_id=<temporary-access-key-id>;aws_secret_access_key=<temporary-secret-access-key>;token=<temporary-token>'
```

For more information, see [Temporary Security Credentials](#) (p. 350)

If the [ENCRYPTED](#) (p. 324) parameter is used, the *aws-auth-args* string is in the following format, where, *<master-key>* is the value of the master key that was used to encrypt the files.

```
WITH CREDENTIALS AS  
'<aws-auth-args>;master_symmetric_key=<master-key>'
```

For example, the following COPY command uses role-based access control with an encryption key.

```
copy customer from 's3://mybucket/mydata'
```

```
credentials
'aws_iam_role=arn:aws:iam::<account-id>:role/<role-
name>;master_symmetric_key=<master-key>'
```

The following COPY command shows key-based access control with an encryption key.

```
copy customer from 's3://mybucket/mydata'
credentials
'aws_access_key_id=<access-key-id>;aws_secret_access_key=<secret-access-
key>;master_symmetric_key=<master-key>'
```

The following topics provide more details and examples of authentication options.

- [IAM Permissions for COPY, UNLOAD, and CREATE LIBRARY](#) (p. 351)
- [Role-Based Access Control](#) (p. 348)
- [Key-Based Access Control](#) (p. 349)

Column Mapping Options

By default, COPY inserts values into the target table's columns in the same order as fields occur in the data files. If the default column order will not work, you can specify a column list or use JSONPath expressions to map source data fields to the target columns.

- [Column List](#) (p. 332)
- [JSONPaths File](#) (p. 332)

Column List

You can specify a comma-separated list of column names to load source data fields into specific target columns. The columns can be in any order in the COPY statement, but when loading from flat files, such as in an Amazon S3 bucket, their order must match the order of the source data. Order does not matter when loading from an Amazon DynamoDB table.

The format for a column list is as follows.

```
COPY tablename (column1 [,column2, ...])
```

If a column in the target table is omitted from the column list, then COPY loads the target column's [DEFAULT](#) (p. 381) expression.

If the target column does not have a default, then COPY attempts to load NULL.

If COPY attempts to assign NULL to a column that is defined as NOT NULL, the COPY command fails.

If an [IDENTITY](#) (p. 381) column is included in the column list, then [EXPLICIT_IDS](#) (p. 344) must also be specified; if an IDENTITY column is omitted, then EXPLICIT_IDS cannot be specified. If no column list is specified, the command behaves as if a complete, in-order column list was specified, with IDENTITY columns omitted if EXPLICIT_IDS was also not specified.

JSONPaths File

When loading from data files in JSON or Avro format, COPY automatically maps the data elements in the JSON or Avro source data to the columns in the target table by matching field names in the Avro schema to column names in the target table or column list.

If your column names and field names don't match, or to map to deeper levels in the data hierarchy, you can use a JSONPaths file to explicitly map JSON or Avro data elements to columns.

For more information, see [JSONPaths file](#) (p. 337).

Data Format Parameters

By default, the COPY command expects the source data to be character-delimited UTF-8 text. The default delimiter is a pipe character (|). If the source data is in another format, use the following parameters to specify the data format.

- [FORMAT](#) (p. 333)
- [CSV](#) (p. 333)
- [DELIMITER](#) (p. 333)
- [FIXEDWIDTH](#) (p. 334)
- [AVRO](#) (p. 334)
- [JSON](#) (p. 335)
- [BZIP2](#) (p. 341)
- [GZIP](#) (p. 341)
- [LZOP](#) (p. 341)

Parameters

FORMAT [AS]

Optional. Identifies data format keywords.

CSV [QUOTE [AS] '*quote_character*']

Enables use of CSV format in the input data. To automatically escape delimiters, newline characters, and carriage returns, enclose the field in the character specified by the QUOTE parameter. The default quote character is a double quotation mark ("). When the quote character is used within a field, escape the character with an additional quote character. For example, if the quote character is a double quotation mark, to insert the string A "quoted" word the input file should include the string "A " "quoted" " word". When the CSV parameter is used, the default delimiter is a comma (,). You can specify a different delimiter by using the DELIMITER parameter.

When a field is enclosed in quotes, white space between the delimiters and the quote characters is ignored. If the delimiter is a white space character, such as a tab, the delimiter is not treated as white space.

CSV cannot be used with FIXEDWIDTH, REMOVEQUOTES, or ESCAPE.

QUOTE [AS] '*quote_character*'

Optional. Specifies the character to be used as the quote character when using the CSV parameter. The default is a double quotation mark ("). If you use the QUOTE parameter to define a quote character other than double quotation mark, you don't need to escape double quotation marks within the field. The QUOTE parameter can be used only with the CSV parameter. The AS keyword is optional.

DELIMITER [AS] [*delimiter_char*]

Specifies the single ASCII character that is used to separate fields in the input file, such as a pipe character (|), a comma (,), or a tab (\t). Non-printing ASCII characters are supported. ASCII characters can also be represented in octal, using the format 'ddd', where 'd' is an octal digit (0–7). The default delimiter is a pipe character (|), unless the CSV parameter is used, in which case the default delimiter is a comma (,). The AS keyword is optional. DELIMITER cannot be used with FIXEDWIDTH.

FIXEDWIDTH '*fixedwidth_spec*'

Loads the data from a file where each column width is a fixed length, rather than columns being separated by a delimiter. The *fixedwidth_spec* is a string that specifies a user-defined column label and column width. The column label can be either a text string or an integer, depending on what the user chooses. The column label has no relation to the column name. The order of the label/width pairs must match the order of the table columns exactly. FIXEDWIDTH cannot be used with CSV or DELIMITER. In Amazon Redshift, the length of CHAR and VARCHAR columns is expressed in bytes, so be sure that the column width that you specify accommodates the binary length of multibyte characters when preparing the file to be loaded. For more information, see [Character Types \(p. 256\)](#).

The format for *fixedwidth_spec* is shown following:

```
'colLabel1:colWidth1,colLabel:colWidth2, ...'
```

AVRO [AS] '*avro_option*'

Specifies that the source data is in Avro format.

Avro format is supported for COPY from these services and protocols:

- Amazon S3
- Amazon EMR
- Remote hosts (SSH)

Avro is not supported for COPY from DynamoDB.

Avro is a data serialization protocol. An Avro source file includes a schema that defines the structure of the data. The Avro schema type must be `record`. COPY accepts Avro files creating using the default uncompressed codec as well as the `deflate` and `snappy` compression codecs. For more information about Avro, go to [Apache Avro](#).

Valid values for *avro_option* are as follows:

- 'auto'
- 's3://jsonpaths_file'

The default is 'auto'.

'auto'

COPY automatically maps the data elements in the Avro source data to the columns in the target table by matching field names in the Avro schema to column names in the target table. The matching is case-sensitive. Column names in Amazon Redshift tables are always lowercase, so when you use the 'auto' option, matching field names must also be lowercase. If the field names are not all lowercase, you can use a [JSONPaths file \(p. 337\)](#) to explicitly map column names to Avro field names. With the default 'auto' argument, COPY recognizes only the first level of fields, or *outer fields*, in the structure.

By default, COPY attempts to match all columns in the target table to Avro field names. To load a subset of the columns, you can optionally specify a column list.

If a column in the target table is omitted from the column list, then COPY loads the target column's [DEFAULT \(p. 381\)](#) expression. If the target column does not have a default, then COPY attempts to load NULL.

If a column is included in the column list and COPY does not find a matching field in the Avro data, then COPY attempts to load NULL to the column.

If COPY attempts to assign NULL to a column that is defined as NOT NULL, the COPY command fails.

's3://jsonpaths_file'

To explicitly map Avro data elements to columns, you can use an *JSONPaths* file. For more information about using a *JSONPaths* file to map Avro data, see [JSONPaths file \(p. 337\)](#).

Avro Schema

An Avro source data file includes a schema that defines the structure of the data. COPY reads the schema that is part of the Avro source data file to map data elements to target table columns. The following example shows an Avro schema.

```
{
  "name": "person",
  "type": "record",
  "fields": [
    {"name": "id", "type": "int"},
    {"name": "guid", "type": "string"},
    {"name": "name", "type": "string"},
    {"name": "address", "type": "string"}
  ]
}
```

The Avro schema is defined using JSON format. The top-level JSON object contains three name/value pairs with the names, or *keys*, "name", "type", and "fields".

The "fields" key pairs with an array of objects that define the name and data type of each field in the data structure. By default, COPY automatically matches the field names to column names. Column names are always lowercase, so matching field names must also be lowercase. Any field names that don't match a column name are ignored. Order does not matter. In the previous example, COPY maps to the column names `id`, `guid`, `name`, and `address`.

With the default 'auto' argument, COPY matches only the first-level objects to columns. To map to deeper levels in the schema, or if field names and column names don't match, use a *JSONPaths* file to define the mapping. For more information, see [JSONPaths file \(p. 337\)](#).

If the value associated with a key is a complex Avro data type such as byte, array, record, map, or link, COPY loads the value as a string, where the string is the JSON representation of the data. COPY loads Avro enum data types as strings, where the content is the name of the type. For an example, see [COPY from JSON Format \(p. 352\)](#).

The maximum size of the Avro file header, which includes the schema and file metadata, is 1 MB.

The maximum size of a single Avro data block is 4 MB. This is distinct from the maximum row size. If the maximum size of a single Avro data block is exceeded, even if the resulting row size is less than the 4 MB row-size limit, the COPY command fails.

In calculating row size, Amazon Redshift internally counts pipe characters (|) twice. If your input data contains a very large number of pipe characters, it is possible for row size to exceed 4 MB even if the data block is less than 4 MB.

JSON [AS] 'json_option'

The source data is in JSON format.

JSON format is supported for COPY from these services and protocols:

- Amazon S3
- COPY from Amazon EMR
- COPY from SSH

JSON is not supported for COPY from DynamoDB.

Valid values for *json_option* are as follows :

- 'auto'
- 's3://jsonpaths_file'

The default is 'auto'.

'auto'

COPY maps the data elements in the JSON source data to the columns in the target table by matching *object keys*, or names, in the source name/value pairs to the names of columns in the target table. The matching is case-sensitive. Column names in Amazon Redshift tables are always lowercase, so when you use the 'auto' option, matching JSON field names must also be lowercase. If the JSON field name keys are not all lowercase, you can use a [JSONPaths file \(p. 337\)](#) to explicitly map column names to JSON field name keys.

By default, COPY attempts to match all columns in the target table to JSON field name keys. To load a subset of the columns, you can optionally specify a column list.

If a column in the target table is omitted from the column list, then COPY loads the target column's [DEFAULT \(p. 381\)](#) expression. If the target column does not have a default, then COPY attempts to load NULL.

If a column is included in the column list and COPY does not find a matching field in the JSON data, then COPY attempts to load NULL to the column.

If COPY attempts to assign NULL to a column that is defined as NOT NULL, the COPY command fails.

's3://jsonpaths_file'

COPY uses the named JSONPaths file to map the data elements in the JSON source data to the columns in the target table. The `s3://jsonpaths_file` argument must be an Amazon S3 object key that explicitly references a single file, such as `s3://mybucket/jsonpaths.txt`; it cannot be a key prefix. For more information about using a JSONPaths file, see [JSONPaths file \(p. 337\)](#).

Note

If the file specified by `jsonpaths_file` has the same prefix as the path specified by `copy_from_s3_objectpath` for the data files, COPY reads the JSONPaths file as a data file and returns errors. For example, if your data files use the object path `s3://mybucket/my_data.json` and your JSONPaths file is `s3://mybucket/my_data.jsonpaths`, COPY attempts to load `my_data.jsonpaths` as a data file.

JSON Data File

The JSON data file contains a set of either objects or arrays. COPY loads each JSON object or array into one row in the target table. Each object or array corresponding to a row must be a stand-alone, root-level structure; that is, it must not be a member of another JSON structure.

A JSON *object* begins and ends with braces (`{ }`) and contains an unordered collection of name/value pairs. Each paired name and value are separated by a colon, and the pairs are separated by commas. By default, the *object key*, or name, in the name/value pairs must match the name of the corresponding column in the table. Column names in Amazon Redshift tables are always lowercase, so matching JSON field name keys must also be lowercase. If your column names and JSON keys don't match, use a [JSONPaths file \(p. 337\)](#) to explicitly map columns to keys.

Order in a JSON object does not matter. Any names that don't match a column name are ignored. The following shows the structure of a simple JSON object.

```
{
  "column1": "value1",
  "column2": value2,
  "notacolumn" : "ignore this value"
```

```
}
```

A JSON *array* begins and ends with brackets ([]), and contains an ordered collection of values separated by commas. If your data files use arrays, you must specify a JSONPaths file to match the values to columns. The following shows the structure of a simple JSON array.

```
["value1", value2]
```

The JSON must be well-formed. For example, the objects or arrays cannot be separated by commas or any other characters except white space. Strings must be enclosed in double quote characters. Quote characters must be simple quotation marks (0x22), not slanted or "smart" quotation marks.

The maximum size of a single JSON object or array, including braces or brackets, is 4 MB. This is distinct from the maximum row size. If the maximum size of a single JSON object or array is exceeded, even if the resulting row size is less than the 4 MB row-size limit, the COPY command fails.

In calculating row size, Amazon Redshift internally counts pipe characters (|) twice. If your input data contains a very large number of pipe characters, it is possible for row size to exceed 4 MB even if the object size is less than 4 MB.

COPY loads `\n` as a newline character and loads `\t` as a tab character. To load a backslash, escape it with a backslash (`\\`).

COPY searches the specified JSON source for a well-formed, valid JSON object or array. If COPY encounters any non-white space characters before locating a usable JSON structure, or between valid JSON objects or arrays, COPY returns an error for each instance. These errors count toward the MAXERROR error count. When the error count equals or exceeds MAXERROR, COPY fails.

For each error, Amazon Redshift records a row in the STL_LOAD_ERRORS system table. The LINE_NUMBER column records the last line of the JSON object that caused the error.

If IGNOREHEADER is specified, COPY ignores the specified number of lines in the JSON data. Newline characters in the JSON data are always counted for IGNOREHEADER calculations.

COPY loads empty strings as empty fields by default. If EMPTYASNULL is specified, COPY loads empty strings for CHAR and VARCHAR fields as NULL. Empty strings for other data types, such as INT, are always loaded with NULL.

The following options are not supported with JSON:

- CSV
- DELIMITER
- ESCAPE
- FILLRECORD
- FIXEDWIDTH
- IGNOREBLANKLINES
- NULL AS
- READRATIO
- REMOVEQUOTES

For more information, see [COPY from JSON Format \(p. 352\)](#). For more information about JSON data structures, go to www.json.org.

JSONPaths file

If you are loading from JSON-formatted or Avro source data, by default COPY maps the first-level data elements in the source data to the columns in the target table by matching each name, or object key, in a name/value pair to the name of a column in the target table.

If your column names and object keys don't match, or to map to deeper levels in the data hierarchy, you can use a JSONPaths file to explicitly map JSON or Avro data elements to columns. The JSONPaths file maps JSON data elements to columns by matching the column order in the target table or column list.

The JSONPaths file must contain only a single JSON object (not an array). The JSON object is a name/value pair. The *object key*, which is the name in the name/value pair, must be "jsonpaths". The *value* in the name/value pair is an array of *JSONPath expressions*. Each JSONPath expression references a single element in the JSON data hierarchy or Avro schema, similarly to how an XPath expression refers to elements in an XML document. For more information, see [JSONPath Expressions \(p. 338\)](#).

To use a JSONPaths file, add the JSON or AVRO keyword to the COPY command and specify the S3 bucket name and object path of the JSONPaths file, using the following format.

```
COPY tablename
FROM 'data_source'
CREDENTIALS 'aws-auth-args'
FORMAT AS { AVRO | JSON } 's3://jsonpaths_file';
```

The `s3://jsonpaths_file` argument must be an Amazon S3 object key that explicitly references a single file, such as `'s3://mybucket/jsonpaths.txt'`; it cannot be a key prefix.

Note

If you are loading from Amazon S3 and the file specified by `jsonpaths_file` has the same prefix as the path specified by `copy_from_s3_objectpath` for the data files, COPY reads the JSONPaths file as a data file and returns errors. For example, if your data files use the object path `s3://mybucket/my_data.json` and your JSONPaths file is `s3://mybucket/my_data.jsonpaths`, COPY attempts to load `my_data.jsonpaths` as a data file.

Note

If the key name is any string other than "jsonpaths", the COPY command does not return an error, but it ignores `jsonpaths_file` and uses the 'auto' argument instead.

If any of the following occurs, the COPY command fails:

- The JSON is malformed.
- There is more than one JSON object.
- Any characters except white space exist outside the object.
- An array element is an empty string or is not a string.

MAXERROR does not apply to the JSONPaths file.

If the [ENCRYPTED \(p. 324\)](#) parameter is used with COPY, the JSONPaths file is not encrypted.

For more information, see [COPY from JSON Format \(p. 352\)](#).

JSONPath Expressions

The JSONPaths file uses JSONPath expressions to map data fields to target columns. Each JSONPath expression corresponds to one column in the Amazon Redshift target table. The order of the JSONPath array elements must match the order of the columns in the target table or the column list, if a column list is used.

The double quote characters are required as shown, both for the field names and the values. The quote characters must be simple quotation marks (0x22), not slanted or "smart" quotation marks.

If an object element referenced by a JSONPath expression is not found in the JSON data, COPY attempts to load a NULL value. If the referenced object is malformed, COPY returns a load error.

If an array element referenced by a JSONPath expression is not found in the JSON or Avro data, COPY fails with the following error: `Invalid JSONPath format: Not an array or index out of range`. Remove any array elements from the JSONPaths that don't exist in the source data and verify that the arrays in the source data are well formed.

The JSONPath expressions can use either bracket notation or dot notation, but you cannot mix notations. The following example shows JSONPath expressions using bracket notation.

```
{
  "jsonpaths": [
    "$['venueName']",
    "$['venueCity']",
    "$['venueState']",
    "$['venueSeats']"
  ]
}
```

The following example shows JSONPath expressions using dot notation.

```
{
  "jsonpaths": [
    "$.venueName",
    "$.venueCity",
    "$.venueState",
    "$.venueSeats"
  ]
}
```

In the context of Amazon Redshift COPY syntax, a JSONPath expression must specify the explicit path to a single name element in a JSON or Avro hierarchical data structure. Amazon Redshift does not support any JSONPath elements, such as wildcard characters or filter expressions, that might resolve to an ambiguous path or multiple name elements.

For more information, see [COPY from JSON Format \(p. 352\)](#).

Using JSONPaths with Avro Data

The following example shows an Avro schema with multiple levels.

```
{
  "name": "person",
  "type": "record",
  "fields": [
    {"name": "id", "type": "int"},
    {"name": "guid", "type": "string"},
    {"name": "isActive", "type": "boolean"},
    {"name": "age", "type": "int"},
    {"name": "name", "type": "string"},
    {"name": "address", "type": "string"},
    {"name": "latitude", "type": "double"},
    {"name": "longitude", "type": "double"},
    {
```

```

        "name": "tags",
        "type": {
            "type" : "array",
            "name" : "inner_tags",
            "items" : "string"
        }
    },
    {
        "name": "friends",
        "type": {
            "type" : "array",
            "name" : "inner_friends",
            "items" : {
                "name" : "friends_record",
                "type" : "record",
                "fields" : [
                    {"name" : "id", "type" :
"int"},
                    {"name" : "name",
"type" : "string"}
                ]
            }
        }
    },
    {"name": "randomArrayItem", "type": "string"}
]
}

```

The following example shows a JSONPaths file that uses AvroPath expressions to reference the previous schema.

```

{
  "jsonpaths": [
    "$.id",
    "$.guid",
    "$.address",
    "$.friends[0].id"
  ]
}

```

The JSONPaths example includes the following elements:

`jsonpaths`

The name of the JSON object that contains the AvroPath expressions.

`[...]`

Brackets enclose the JSON array that contains the path elements.

`$`

The dollar sign refers to the root element in the Avro schema, which is the `fields` array.

`$.id`,

The target of the AvroPath expression. In this instance, the target is the element in the `fields` array with the name `id`. The expressions are separated by commas.

`$.friends[0].id`

Brackets indicate an array index. JSONPath expressions use zero-based indexing, so this expression references the first element in the `friends` array with the name `id`.

The Avro schema syntax requires using *inner fields* to define the structure of record and array data types. The inner fields are ignored by the AvroPath expressions. For example, the field

"friends" defines an array named "inner_friends", which in turn defines a record named "friends_record". The AvroPath expression to reference the field "id" can ignore the extra fields to reference the target field directly. The following AvroPath expressions reference the two fields that belong to the "friends" array.

```
$.friends[0].id  
$.friends[0].name
```

BZIP2

A value that specifies that the input file or files are in compressed bzip2 format (.bz2 files). The COPY operation reads each compressed file and uncompresses the data as it loads.

GZIP

A value that specifies that the input file or files are in compressed gzip format (.gz files). The COPY operation reads each compressed file and uncompresses the data as it loads.

LZOP

A value that specifies that the input file or files are in compressed lzop format (.lzo files). The COPY operation reads each compressed file and uncompresses the data as it loads.

Note

COPY does not support files that are compressed using the lzop *--filter* option.

Data Conversion Parameters

As it loads the table, COPY attempts to implicitly convert the strings in the source data to the data type of the target column. If you need to specify a conversion that is different from the default behavior, or if the default conversion results in errors, you can manage data conversions by specifying the following parameters.

- [ACCEPTANYDATE](#) (p. 341)
- [ACCEPTINVCHARS](#) (p. 342)
- [BLANKSASNULL](#) (p. 342)
- [DATEFORMAT](#) (p. 342)
- [EMPTYASNULL](#) (p. 342)
- [ENCODING](#) (p. 342)
- [ESCAPE](#) (p. 343)
- [EXPLICIT_IDS](#) (p. 344)
- [FILLRECORD](#) (p. 344)
- [IGNOREBLANKLINES](#) (p. 344)
- [IGNOREHEADER](#) (p. 344)
- [NULL AS](#) (p. 344)
- [REMOVEQUOTES](#) (p. 345)
- [ROUNDEC](#) (p. 345)
- [TIMEFORMAT](#) (p. 345)
- [TRIMBLANKS](#) (p. 346)
- [TRUNCATECOLUMNS](#) (p. 346)

Parameters

ACCEPTANYDATE

Allows any date format, including invalid formats such as 00/00/00 00:00:00, to be loaded without generating an error. This parameter applies only to `TIMESTAMP` and `DATE` columns.

Always use ACCEPTANYDATE with the DATEFORMAT parameter. If the date format for the data does not match the DATEFORMAT specification, Amazon Redshift inserts a NULL value into that field.

ACCEPTINVCHARS [AS] [*replacement_char*]

Enables loading of data into VARCHAR columns even if the data contains invalid UTF-8 characters. When ACCEPTINVCHARS is specified, COPY replaces each invalid UTF-8 character with a string of equal length consisting of the character specified by *replacement_char*. For example, if the replacement character is '^', an invalid three-byte character will be replaced with '^'^'^'.

The replacement character can be any ASCII character except NULL. The default is a question mark (?). For information about invalid UTF-8 characters, see [Multibyte Character Load Errors \(p. 159\)](#).

COPY returns the number of rows that contained invalid UTF-8 characters, and it adds an entry to the [STL_REPLACEMENTS \(p. 727\)](#) system table for each affected row, up to a maximum of 100 rows for each node slice. Additional invalid UTF-8 characters are also replaced, but those replacement events are not recorded.

If ACCEPTINVCHARS is not specified, COPY returns an error whenever it encounters an invalid UTF-8 character.

ACCEPTINVCHARS is valid only for VARCHAR columns.

BLANKSASNULL

Loads blank fields, which consist of only white space characters, as NULL. This option applies only to CHAR and VARCHAR columns. Blank fields for other data types, such as INT, are always loaded with NULL. For example, a string that contains three space characters in succession (and no other characters) is loaded as a NULL. The default behavior, without this option, is to load the space characters as is.

DATEFORMAT [AS] {*dateformat_string* | 'auto' }

If no DATEFORMAT is specified, the default format is 'YYYY-MM-DD'. For example, an alternative valid format is 'MM-DD-YYYY'.

If the COPY command does not recognize the format of your date or time values, or if your date or time values use different formats, use the 'auto' argument with the DATEFORMAT or TIMEFORMAT parameter. The 'auto' argument recognizes several formats that are not supported when using a DATEFORMAT and TIMEFORMAT string. The 'auto' keyword is case-sensitive. For more information, see [Using Automatic Recognition with DATEFORMAT and TIMEFORMAT \(p. 355\)](#).

The date format can include time information (hour, minutes, seconds), but this information is ignored. The AS keyword is optional. For more information, see [DATEFORMAT and TIMEFORMAT Strings \(p. 354\)](#).

EMPTYASNULL

Indicates that Amazon Redshift should load empty CHAR and VARCHAR fields as NULL. Empty fields for other data types, such as INT, are always loaded with NULL. Empty fields occur when data contains two delimiters in succession with no characters between the delimiters. EMPTYASNULL and NULL AS " (empty string) produce the same behavior.

ENCODING [AS] *file_encoding*

Specifies the encoding type of the load data. The COPY command converts the data from the specified encoding into UTF-8 during loading.

Valid values for *file_encoding* are as follows:

- UTF8
- UTF16
- UTF16LE

- UTF16BE

The default is UTF8.

Source file names must use UTF-8 encoding.

The following files must use UTF-8 encoding, even if a different encoding is specified for the load data:

- Manifest files
- JSONPaths files

The argument strings provided with the following parameters must use UTF-8:

- FIXEDWIDTH '*fixedwidth_spec*'
- ACCEPTINVCHARS '*replacement_char*'
- DATEFORMAT '*dateformat_string*'
- TIMEFORMAT '*timeformat_string*'
- NULL AS '*null_string*'

Fixed-width data files must use UTF-8 encoding because field widths are based on the size of UTF-8 characters.

All load data must use the specified encoding. If COPY encounters a different encoding, it skips the file and returns an error.

If you specify UTF16, then your data must have a byte order mark (BOM). If you know whether your UTF-16 data is little-endian (LE) or big-endian (BE), you can use UTF16LE or UTF16BE, regardless of the presence of a BOM.

ESCAPE

When this parameter is specified, the backslash character (\) in input data is treated as an escape character. The character that immediately follows the backslash character is loaded into the table as part of the current column value, even if it is a character that normally serves a special purpose. For example, you can use this parameter to escape the delimiter character, a quotation mark, an embedded newline character, or the escape character itself when any of these characters is a legitimate part of a column value.

If you specify the ESCAPE parameter in combination with the REMOVEQUOTES parameter, you can escape and retain quotation marks (' or ") that might otherwise be removed. The default null string, \N, works as is, but it can also be escaped in the input data as \\N. As long as you don't specify an alternative null string with the NULL AS parameter, \N and \\N produce the same results.

Note

The control character 0x00 (NUL) cannot be escaped and should be removed from the input data or converted. This character is treated as an end of record (EOR) marker, causing the remainder of the record to be truncated.

You cannot use the ESCAPE parameter for FIXEDWIDTH loads, and you cannot specify the escape character itself; the escape character is always the backslash character. Also, you must ensure that the input data contains the escape character in the appropriate places.

Here are some examples of input data and the resulting loaded data when the ESCAPE parameter is specified. The result for row 4 assumes that the REMOVEQUOTES parameter is also specified. The input data consists of two pipe-delimited fields:

```
1|The quick brown fox\[newline]
jumped over the lazy dog.
```

```
2| A\\B\\C
3| A \\ | B \\ | C
4| 'A Midsummer Night\'s Dream'
```

The data loaded into column 2 looks like this:

```
The quick brown fox
jumped over the lazy dog.
A\\B\\C
A|B|C
A Midsummer Night's Dream
```

Note

Applying the escape character to the input data for a load is the responsibility of the user. One exception to this requirement is when you reload data that was previously unloaded with the ESCAPE parameter. In this case, the data will already contain the necessary escape characters.

The ESCAPE parameter does not interpret octal, hex, Unicode, or other escape sequence notation. For example, if your source data contains the octal line feed value (`\012`) and you try to load this data with the ESCAPE parameter, Amazon Redshift loads the value `012` into the table and does not interpret this value as a line feed that is being escaped.

In order to escape newline characters in data that originates from Microsoft Windows platforms, you might need to use two escape characters: one for the carriage return and one for the line feed. Alternatively, you can remove the carriage returns before loading the file (for example, by using the `dos2unix` utility).

EXPLICIT_IDS

Use EXPLICIT_IDS with tables that have IDENTITY columns if you want to override the autogenerated values with explicit values from the source data files for the tables. If the command includes a column list, that list must include the IDENTITY columns to use this parameter. The data format for EXPLICIT_IDS values must match the IDENTITY format specified by the CREATE TABLE definition.

FILLRECORD

Allows data files to be loaded when contiguous columns are missing at the end of some of the records. The missing columns are filled with either zero-length strings or NULLs, as appropriate for the data types of the columns in question. If the EMPTYASNULL parameter is present in the COPY command and the missing column is a VARCHAR column, NULLs are loaded; if EMPTYASNULL is not present and the column is a VARCHAR, zero-length strings are loaded. NULL substitution only works if the column definition allows NULLs.

For example, if the table definition contains four nullable CHAR columns, and a record contains the values `apple, orange, banana, mango`, the COPY command could load and fill in a record that contains only the values `apple, orange`. The missing CHAR values would be loaded as NULL values.

IGNOREBLANKLINES

Ignores blank lines that only contain a line feed in a data file and does not try to load them.

IGNOREHEADER [AS] *number_rows*

Treats the specified *number_rows* as a file header and does not load them. Use IGNOREHEADER to skip file headers in all files in a parallel load.

NULL AS '*null_string*'

Loads fields that match *null_string* as NULL, where *null_string* can be any string. If your data includes a null terminator, also referred to as NUL (UTF-8 0000) or binary zero (0x000), COPY treats it as an end of record (EOR) and terminates the record. If a field contains only NUL, you can use NULL AS to replace the null terminator with NULL by specifying `'\0'` or `'\000'`—for example, `NULL AS '\0'` or `NULL AS '\000'`. If a field contains a string that ends with NUL and

NULL AS is specified, the string is inserted with NUL at the end. Do not use '\n' (newline) for the *null_string* value. Amazon Redshift reserves '\n' for use as a line delimiter. The default *null_string* is '\N'.

Note

If you attempt to load nulls into a column defined as NOT NULL, the COPY command will fail.

REMOVEQUOTES

Removes surrounding quotation marks from strings in the incoming data. All characters within the quotation marks, including delimiters, are retained. If a string has a beginning single or double quotation mark but no corresponding ending mark, the COPY command fails to load that row and returns an error. The following table shows some simple examples of strings that contain quotes and the resulting loaded values.

Input String	Loaded Value with REMOVEQUOTES Option
"The delimiter is a pipe () character"	The delimiter is a pipe () character
'Black'	Black
"White"	White
Blue'	Blue'
'Blue	<i>Value not loaded: error condition</i>
"Blue	<i>Value not loaded: error condition</i>
' 'Black' '	'Black'
' '	<white space>

ROUNDEC

Rounds up numeric values when the scale of the input value is greater than the scale of the column. By default, COPY truncates values when necessary to fit the scale of the column. For example, if a value of 20.259 is loaded into a DECIMAL(8,2) column, COPY truncates the value to 20.25 by default. If ROUNDEC is specified, COPY rounds the value to 20.26. The INSERT command always rounds values when necessary to match the column's scale, so a COPY command with the ROUNDEC parameter behaves the same as an INSERT command.

TIMEFORMAT [AS] {*timeformat_string* | 'auto' | 'epochsecs' | 'epochmilliseconds' }

Specifies the time format. If no TIMEFORMAT is specified, the default format is YYYY-MM-DD HH:MI:SS for TIMESTAMP columns or YYYY-MM-DD HH:MI:SSOF for TIMESTAMPTZ columns, where OF is the offset from Coordinated Universal Time (UTC). You can't include a time zone specifier in the *timeformat_string*. To load TIMESTAMPTZ data that is in a format different from the default format, specify 'auto'; for more information, see [Using Automatic Recognition with DATEFORMAT and TIMEFORMAT \(p. 355\)](#). For more information about *timeformat_string*, see [DATEFORMAT and TIMEFORMAT Strings \(p. 354\)](#).

The 'auto' argument recognizes several formats that are not supported when using a DATEFORMAT and TIMEFORMAT string. If the COPY command does not recognize the format of your date or time values, or if your date and time values use formats different from each other, use the 'auto' argument with the DATEFORMAT or TIMEFORMAT parameter. For more information, see [Using Automatic Recognition with DATEFORMAT and TIMEFORMAT \(p. 355\)](#).

If your source data is represented as epoch time, that is the number of seconds or milliseconds since January 1, 1970, 00:00:00 UTC, specify 'epochsecs' or 'epochmilliseconds'.

The 'auto', 'epochsecs', and 'epochmilliseconds' keywords are case-sensitive.

The AS keyword is optional.

TRIMBLANKS

Removes the trailing white space characters from a VARCHAR string. This parameter applies only to columns with a VARCHAR data type.

TRUNCATECOLUMNS

Truncates data in columns to the appropriate number of characters so that it fits the column specification. Applies only to columns with a VARCHAR or CHAR data type, and rows 4 MB or less in size.

Data Load Operations

Manage the default behavior of the load operation for troubleshooting or to reduce load times by specifying the following parameters.

- [COMPROWS](#) (p. 346)
- [COMPUPDATE](#) (p. 346)
- [MAXERROR](#) (p. 346)
- [NOLOAD](#) (p. 347)
- [STATUPDATE](#) (p. 347)

Parameters

COMPROWS *numrows*

Specifies the number of rows to be used as the sample size for compression analysis. The analysis is run on rows from each data slice. For example, if you specify `COMPROWS 1000000` (1,000,000) and the system contains four total slices, no more than 250,000 rows for each slice are read and analyzed.

If `COMPROWS` is not specified, the sample size defaults to 100,000 for each slice. Values of `COMPROWS` lower than the default of 100,000 rows for each slice are automatically upgraded to the default value. However, automatic compression will not take place if the amount of data being loaded is insufficient to produce a meaningful sample.

If the `COMPROWS` number is greater than the number of rows in the input file, the `COPY` command still proceeds and runs the compression analysis on all of the available rows. The accepted range for this argument is a number between 1000 and 1000000000 (1,000,000,000).

COMPUPDATE [{ ON | TRUE } | { OFF | FALSE }]

Controls whether compression encodings are automatically applied during a `COPY`.

The `COPY` command will automatically choose the optimal compression encodings for each column in the target table based on a sample of the input data. For more information, see [Loading Tables with Automatic Compression](#) (p. 154).

If `COMPUPDATE` is omitted, `COPY` applies automatic compression only if the target table is empty and all the table columns either have RAW encoding or no encoding. This behavior is the default.

With `COMPUPDATE ON` (or `TRUE`), `COPY` applies automatic compression if the table is empty, even if the table columns already have encodings other than RAW. Existing encodings are replaced. If `COMPUPDATE` is specified, this behavior is the default.

With `COMPUPDATE OFF` (or `FALSE`), automatic compression is disabled.

MAXERROR [AS] *error_count*

If the load returns the *error_count* number of errors or greater, the load fails. If the load returns fewer errors, it continues and returns an INFO message that states the number of rows that could not be loaded. Use this parameter to allow loads to continue when certain rows fail to load into the table because of formatting errors or other inconsistencies in the data.

Set this value to 0 or 1 if you want the load to fail as soon as the first error occurs. The AS keyword is optional. The MAXERROR default value is 0 and the limit is 100000.

The actual number of errors reported might be greater than the specified MAXERROR because of the parallel nature of Amazon Redshift. If any node in the Amazon Redshift cluster detects that MAXERROR has been exceeded, each node reports all of the errors it has encountered.

NOLOAD

Checks the validity of the data file without actually loading the data. Use the NOLOAD parameter to make sure that your data file will load without any errors before running the actual data load. Running COPY with the NOLOAD parameter is much faster than loading the data because it only parses the files.

STATUPDATE [{ ON | TRUE } | { OFF | FALSE }]

Governs automatic computation and refresh of optimizer statistics at the end of a successful COPY command. By default, if the STATUPDATE parameter is not used, statistics are updated automatically if the table is initially empty.

Whenever ingesting data into a nonempty table significantly changes the size of the table, we recommend updating statistics either by running an [ANALYZE \(p. 309\)](#) command or by using the STATUPDATE ON argument.

With STATUPDATE ON (or TRUE), statistics are updated automatically regardless of whether the table is initially empty. If STATUPDATE is used, the current user must be either the table owner or a superuser. If STATUPDATE is not specified, only INSERT permission is required.

With STATUPDATE OFF (or FALSE), statistics are never updated.

For additional information, see [Analyzing Tables \(p. 169\)](#).

Alphabetical Parameter List

The following list provides links to each COPY command parameter description, sorted alphabetically.

- [ACCEPTANYDATE \(p. 341\)](#)
- [ACCEPTINVCHARS \(p. 342\)](#)
- [AVRO \(p. 334\)](#)
- [BLANKSASNULL \(p. 342\)](#)
- [BZIP2 \(p. 341\)](#)
- [COMPROWS \(p. 346\)](#)
- [COMPUPDATE \(p. 346\)](#)
- [Credentials \(p. 330\)](#)
- [CSV \(p. 333\)](#)
- [DATEFORMAT \(p. 342\)](#)
- [DELIMITER \(p. 333\)](#)
- [EMPTYASNULL \(p. 342\)](#)
- [ENCODING \(p. 342\)](#)
- [ENCRYPTED \(p. 324\)](#)
- [ESCAPE \(p. 343\)](#)
- [EXPLICIT_IDS \(p. 344\)](#)
- [FILLRECORD \(p. 344\)](#)
- [FIXEDWIDTH \(p. 334\)](#)
- [FORMAT \(p. 333\)](#)
- [FROM \(p. 323\)](#)
- [GZIP \(p. 341\)](#)

- [IGNOREBLANKLINES](#) (p. 344)
- [IGNOREHEADER](#) (p. 344)
- [JSON](#) (p. 335)
- [LZOP](#) (p. 341)
- [MANIFEST](#) (p. 323)
- [MAXERROR](#) (p. 346)
- [NOLOAD](#) (p. 347)
- [NULL AS](#) (p. 344)
- [READRATIO](#) (p. 329)
- [REGION](#) (p. 324)
- [REMOVEQUOTES](#) (p. 345)
- [ROUNDEC](#) (p. 345)
- [SSH](#) (p. 328)
- [STATUPDATE](#) (p. 347)
- [TIMEFORMAT](#) (p. 345)
- [TRIMBLANKS](#) (p. 346)
- [TRUNCATECOLUMNS](#) (p. 346)

Usage Notes

Topics

- [Permissions to Access Other AWS Resources](#) (p. 348)
- [Loading Multibyte Data from Amazon S3](#) (p. 351)
- [Errors When Reading Multiple Files](#) (p. 351)
- [COPY from JSON Format](#) (p. 352)
- [DATEFORMAT and TIMEFORMAT Strings](#) (p. 354)
- [Using Automatic Recognition with DATEFORMAT and TIMEFORMAT](#) (p. 355)

Permissions to Access Other AWS Resources

To move data between your cluster and another AWS resource, such as Amazon S3, Amazon DynamoDB, Amazon EMR, or Amazon EC2, your cluster must have permission to access the resource and perform the necessary actions. For example, to load data from Amazon S3, COPY must have LIST access to the bucket and GET access for the bucket objects. For information about minimum permissions, see [IAM Permissions for COPY, UNLOAD, and CREATE LIBRARY](#) (p. 351).

To obtain authorization to access the resource, your cluster must be authenticated. You can choose either of the following authentication methods:

- [Role-Based Access Control](#) (p. 348)—For role-based access control, you specify an IAM role that your cluster uses for authentication and authorization. To safeguard your AWS credentials and sensitive data, we strongly recommend using role-based authentication.
- [Key-Based Access Control](#) (p. 349)—For key-based access control, you provide the AWS access credentials (access key ID and secret access key) for an IAM user as plain text.

Role-Based Access Control

With role-based access control, your cluster temporarily assumes an AWS Identity and Access Management (IAM) role on your behalf. Then, based on the authorizations granted to the role, your cluster can access the required AWS resources.

An IAM *role* is similar to an IAM user, in that it is an AWS identity with permission policies that determine what the identity can and cannot do in AWS. However, instead of being uniquely associated with one user, a role is intended to be assumable by any entity that needs it. Also, a role doesn't have any credentials (a password or access keys) associated with it. Instead, if a role is associated with a cluster, access keys are created dynamically and provided to the cluster.

We recommend using role-based access control because it provides more secure, fine-grained control of access to AWS resources and sensitive user data, in addition to safeguarding your AWS credentials.

Role-based authentication delivers the following benefits:

- You can use AWS standard IAM tools to define an IAM role and associate the role with multiple clusters. When you modify the access policy for a role, the changes are applied automatically to all clusters that use the role.
- You can define fine-grained IAM policies that grant permissions for specific clusters and database users to access specific AWS resources and actions.
- Your cluster obtains temporary session credentials at run time and refreshes the credentials as needed until the operation completes. If you use key-based temporary credentials, the operation fails if the temporary credentials expire before it completes.
- Your access key ID and secret access key ID are not stored or transmitted in your SQL code.

To use role-based access control, you must first create an IAM role using the Amazon Redshift service role type, and then attach the role to your cluster. The role must have, at a minimum, the permissions listed in [IAM Permissions for COPY, UNLOAD, and CREATE LIBRARY \(p. 351\)](#). For steps to create an IAM role and attach it to your cluster, see [Authorizing Amazon Redshift to Access Other AWS Services On Your Behalf](#) in the *Amazon Redshift Cluster Management Guide*.

You can add a role to a cluster or view the roles associated with a cluster by using the Amazon Redshift Management Console, CLI, or API. For more information, see [Associating an IAM Role With a Cluster](#) in the *Amazon Redshift Cluster Management Guide*.

When you create an IAM role, IAM returns an Amazon Resource Name (ARN) for the role. To specify an IAM role, provide the role ARN in the CREDENTIALS *auth-args*. Alternatively, you can replace `<account-id>` with your account number and replace `<role-name>` with the role name as shown in the following CREDENTIALS string as follows:

```
CREDENTIALS
'aws_iam_role=arn:aws:iam::<aws-account-id>:role/<role-name>'
```

For example, suppose the following role is attached to the cluster.

```
"IamRoleArn": "arn:aws:iam::0123456789012:role/MyRedshiftRole"
```

The following COPY command example uses the ARN in the previous example for authentication and access to Amazon S3.

```
copy customer from 's3://mybucket/mydata'
credentials
'aws_iam_role=arn:aws:iam:arn:aws:iam::0123456789012:role/MyRedshiftRole';
```

Key-Based Access Control

With key-based access control, you provide the access key ID and secret access key for an IAM user that is authorized to access the AWS resources that contain the data.

To authenticate using IAM user credentials, replace `<access-key-id>` and `<secret-access-key>` with an authorized user's access key ID and full secret access key in the CREDENTIALS `aws-auth-args` string as shown following.

```
CREDENTIALS
'aws_access_key_id=<access-key-id>;aws_secret_access_key=<secret-access-key>';
```

Note

We strongly recommend using an IAM role for authentication instead of supplying a plain-text access key ID and secret access key. If you choose key-based access control, never use your AWS account (root) credentials. Always create an IAM user and provide that user's access key ID and secret access key. For steps to create an IAM user, see [Creating an IAM User in Your AWS Account](#).

The AWS IAM user must have, at a minimum, the permissions listed in [IAM Permissions for COPY, UNLOAD, and CREATE LIBRARY](#) (p. 351).

Temporary Security Credentials

If you are using key-based access control, you can further limit the access users have to your data by using temporary security credentials. Role-based authentication automatically uses temporary credentials. Temporary security credentials provide enhanced security because they have short lifespans and cannot be reused after they expire. The access key ID and secret access key generated with the token cannot be used without the token, and a user who has these temporary security credentials can access your resources only until the credentials expire.

To grant users temporary access to your resources, you call AWS Security Token Service (AWS STS) API operations. The AWS STS API operations return temporary security credentials consisting of a security token, an access key ID, and a secret access key. You issue the temporary security credentials to the users who need temporary access to your resources. These users can be existing IAM users, or they can be non-AWS users. For more information about creating temporary security credentials, see [Using Temporary Security Credentials](#) in the IAM User Guide.

To use temporary security credentials with a COPY, UNLOAD, or CREATE LIBRARY command, include `token=<temporary-token>` in the credentials string. You must also supply the access key ID and secret access key that were provided with the token.

The syntax for a COPY command with temporary security credentials is shown following.

```
copy table-name
from 's3://objectpath'
credentials
'aws_access_key_id=<temporary-access-key-id>;aws_secret_access_key=<temporary-secret-access-key>;token=<temporary-token>';
```

The following example loads the LISTING table using temporary credentials and file encryption:

```
copy listing
from 's3://mybucket/data/listings_pipe.txt'
credentials
'aws_access_key_id=<temporary-access-key-id>;aws_secret_access_key=<temporary-secret-access-key>;token=<temporary-token>;master_symmetric_key=<master-key>';
encrypted;
```

Important

The temporary security credentials must be valid for the entire duration of the COPY or UNLOAD operation. If the temporary security credentials expire during the operation, the command will fail and the transaction will be rolled back. For example, if temporary security credentials expire after 15 minutes and the COPY requires one hour, the COPY will fail before it completes. If you use role-based access, the temporary security credentials are automatically refreshed until the operation completes.

IAM Permissions for COPY, UNLOAD, and CREATE LIBRARY

The IAM user role or IAM user referenced by the CREDENTIALS parameter must have, at a minimum, the following permissions:

- For COPY from Amazon S3, permission to LIST the Amazon S3 bucket and GET the Amazon S3 objects that are being loaded, and the manifest file, if one is used.
- For COPY from Amazon S3, Amazon EMR, and remote hosts (SSH) with JSON-formatted data, permission to LIST and GET the JSONPaths file on Amazon S3, if one is used.
- For COPY from DynamoDB, permission to SCAN and DESCRIBE the DynamoDB table that is being loaded.
- For COPY from an Amazon EMR cluster, permission for the ListInstances action on the Amazon EMR cluster.
- For UNLOAD to Amazon S3, READ and WRITE permission for the Amazon S3 bucket to which the data files are being unloaded.
- For CREATE LIBRARY from Amazon S3, permission to LIST the Amazon S3 bucket and GET the Amazon S3 objects being imported.

Note

If you receive the error message `S3ServiceException: Access Denied`, when running a COPY, UNLOAD, or CREATE LIBRARY command, your cluster doesn't have proper access permissions for proper access permissions for Amazon S3.

You can manage IAM user permissions by attaching an IAM policy to an IAM role that is attached to your cluster, to your IAM user, or to the group to which your IAM user belongs. For example, the `AmazonS3ReadOnlyAccess` managed policy grants LIST and GET permissions to Amazon S3 resources. For more information about IAM policies, see [Working with Managed Policies](#) in *IAM User Guide*.

Loading Multibyte Data from Amazon S3

If your data includes non-ASCII multibyte characters (such as Chinese or Cyrillic characters), you must load the data to VARCHAR columns. The VARCHAR data type supports four-byte UTF-8 characters, but the CHAR data type only accepts single-byte ASCII characters. You cannot load five-byte or longer characters into Amazon Redshift tables. For more information, see [Multibyte Characters](#) (p. 248).

Errors When Reading Multiple Files

The COPY command is atomic and transactional. In other words, even when the COPY command reads data from multiple files, the entire process is treated as a single transaction. If COPY encounters an error reading a file, it automatically retries until the process times out (see [statement_timeout](#) (p. 813)) or if data cannot be download from Amazon S3 for a prolonged period of time (between 15 and 30 minutes), ensuring that each file is loaded only once. If the COPY command fails, the entire transaction is aborted and all changes are rolled back. For more information about handling load errors, see [Troubleshooting Data Loads](#) (p. 157).

After a COPY command is successfully initiated, it does not fail if the session terminates, for example when the client disconnects. However, if the COPY command is within a BEGIN ... END transaction

block that does not complete because the session terminates, the entire transaction, including the COPY, is rolled back. For more information about transactions, see [BEGIN \(p. 312\)](#).

COPY from JSON Format

The JSON data structure is made up of a set of *objects* or *arrays*. A JSON *object* begins and ends with braces, and contains an unordered collection of name/value pairs. Each name and value are separated by a colon, and the pairs are separated by commas. The name is a string in double quotation marks. The quote characters must be simple quotation marks (0x22), not slanted or "smart" quotes.

A JSON *array* begins and ends with brackets, and contains an ordered collection of values separated by commas. A value can be a string in double quotation marks, a number, a Boolean true or false, null, a JSON object, or an array.

JSON objects and arrays can be nested, enabling a hierarchical data structure. The following example shows a JSON data structure with two valid objects.

```
{
  "id": 1006410,
  "title": "Amazon Redshift Database Developer Guide"
}
{
  "id": 100540,
  "name": "Amazon Simple Storage Service Developer Guide"
}
```

The following shows the same data as two JSON arrays.

```
[
  1006410,
  "Amazon Redshift Database Developer Guide"
]
[
  100540,
  "Amazon Simple Storage Service Developer Guide"
]
```

You can let COPY automatically load fields from the JSON file by specifying the 'auto' option, or you can specify a JSONPaths file that COPY will use to parse the JSON source data. A *JSONPaths file* is a text file that contains a single JSON object with the name "jsonpaths" paired with an array of JSONPath expressions. If the name is any string other than "jsonpaths", COPY uses the 'auto' argument instead of using the JSONPaths file.

In the Amazon Redshift COPY syntax, a JSONPath expression specifies the explicit path to a single name element in a JSON hierarchical data structure, using either bracket notation or dot notation. Amazon Redshift does not support any JSONPath elements, such as wildcard characters or filter expressions, that might resolve to an ambiguous path or multiple name elements. As a result, Amazon Redshift can't parse complex, multi-level data structures.

The following is an example of a JSONPaths file with JSONPath expressions using bracket notation. The dollar sign (\$) represents the root-level structure.

```
{
  "jsonpaths": [
    "${'id'}",
    "${'store']['book']['title'}",
  ]
}
```

```
"$['location'][0]"
  ]
}
```

In the previous example, `$['location'][0]` references the first element in an array. JSON uses zero-based array indexing. Array indices must be positive integers (greater than or equal to zero).

The following example shows the previous JSONPaths file using dot notation.

```
{
  "jsonpaths": [
    "$.id",
    "$.store.book.title",
    "$.location[0]"
  ]
}
```

You cannot mix bracket notation and dot notation in the `jsonpaths` array. Brackets can be used in both bracket notation and dot notation to reference an array element.

When using dot notation, the JSONPath expressions must not contain the following characters:

- Single straight quotation mark (')
- Period, or dot (.)
- Brackets ([]) unless used to reference an array element

If the value in the name/value pair referenced by a JSONPath expression is an object or an array, the entire object or array is loaded as a string, including the braces or brackets. For example, suppose your JSON data contains the following object.

```
{
  "id": 0,
  "guid": "84512477-fa49-456b-b407-581d0d851c3c",
  "isActive": true,
  "tags": [
    "nisi",
    "culpa",
    "ad",
    "amet",
    "voluptate",
    "reprehenderit",
    "veniam"
  ],
  "friends": [
    {
      "id": 0,
      "name": "Carmella Gonzales"
    },
    {
      "id": 1,
      "name": "Renaldo"
    }
  ]
}
```

The JSONPath expression `$['tags']` then returns the following value.

```
"["nisi", "culpa", "ad", "amet", "voluptate", "reprehenderit", "veniam"]"
```

The JSONPath expression `$('#friends')[1]` then returns the following value.

```
"{"id": 1, "name": "Renaldo}"
```

Each JSONPath expression in the `jsonpaths` array corresponds to one column in the Amazon Redshift target table. The order of the `jsonpaths` array elements must match the order of the columns in the target table or the column list, if a column list is used.

For examples that show how to load data using either the `'auto'` argument or a JSONPaths file, and using either JSON objects or arrays, see [Copy from JSON Examples \(p. 364\)](#).

Escape Characters in JSON

COPY loads `\n` as a newline character and loads `\t` as a tab character. To load a backslash, escape it with a backslash (`\\`).

For example, suppose you have the following JSON in a file named `escape.json` in the bucket `s3://mybucket/json/`.

```
{
  "backslash": "This is a backslash: \\",
  "newline": "This sentence\n is on two lines.",
  "tab": "This sentence \t contains a tab."
}
```

Execute the following commands to create the ESCAPES table and load the JSON.

```
create table escapes (backslash varchar(25), newline varchar(35), tab
  varchar(35));

copy escapes from 's3://mybucket/json/escape.json' with
credentials '<aws-auth-args>'
format as json 'auto';
```

Query the ESCAPES table to view the results.

```
select * from escapes;

      backslash      |      newline      |      tab
-----+-----+-----
This is a backslash: \ | This sentence      | This sentence      contains a
tab.                  | : is on two lines.

(1 row)
```

DATEFORMAT and TIMEFORMAT Strings

The DATEFORMAT and TIMEFORMAT options in the COPY command take format strings. These strings can contain datetime separators (such as '-', '/', or ':') and the following "dateparts" and "timeparts".

Note

If the COPY command does not recognize the format of your date or time values, or if your date and time values use formats different from each other, use the 'auto' argument with the TIMEFORMAT parameter. The 'auto' argument recognizes several formats that are not supported when using a DATEFORMAT and TIMEFORMAT string.

Datepart or Timepart	Meaning
YY	Year without century
YYYY	Year with century
MM	Month as a number
MON	Month as a name (abbreviated name or full name)
DD	Day of month as a number
HH or HH24	Hour (24-hour clock)
HH12	Hour (12-hour clock)
MI	Minutes
SS	Seconds
AM or PM	Meridian indicator (for 12-hour clock)

The default date format is YYYY-MM-DD. The default time stamp without time zone (TIMESTAMP) format is YYYY-MM-DD HH:MI:SS. The default time stamp with time zone (TIMESTAMPTZ) format is YYYY-MM-DD HH:MI:SSOF, where OF is the offset from UTC (for example, -8:00. You can't include a time zone specifier (TZ, tz, or OF) in the timeformat_string. The seconds (SS) field also supports fractional seconds up to a microsecond level of detail. To load TIMESTAMPTZ data that is in a format different from the default format, specify 'auto'. For more information, see [Using Automatic Recognition with DATEFORMAT and TIMEFORMAT \(p. 355\)](#).

For example, the following DATEFORMAT and TIMEFORMAT strings are valid.

COPY Syntax	Example of Valid Input String
DATEFORMAT AS 'MM/DD/YYYY'	03/31/2003
DATEFORMAT AS 'MON DD, YYYY'	March 31, 2003
TIMEFORMAT AS 'MM.DD.YYYY HH:MI:SS'	03.31.2003 18:45:05 03.31.2003 18:45:05.123456

Using Automatic Recognition with DATEFORMAT and TIMEFORMAT

If you specify 'auto' as the argument for the DATEFORMAT or TIMEFORMAT parameter, Amazon Redshift will automatically recognize and convert the date format or time format in your source data. The following shows an example.

```
copy favoritemovies from 'dynamodb://ProductCatalog'
```

```
credentials '<aws-auth-args>'
dateformat 'auto';
```

When used with the 'auto' argument for DATEFORMAT and TIMEFORMAT, COPY recognizes and converts the date and time formats listed in the table in [DATEFORMAT and TIMEFORMAT Strings \(p. 354\)](#). In addition, the 'auto' argument recognizes the following formats that are not supported when using a DATEFORMAT and TIMEFORMAT string.

Format	Example of Valid Input String
Julian	J2451187
BC	Jan-08-95 BC
YYYYMMDD HHMISS	19960108 040809
YYMMDD HHMISS	960108 040809
YYYY.DDD	1996.008
YYYY-MM-DD HH:MI:SS.SSS	1996-01-08 04:05:06.789
DD Mon HH:MM:SS YYYY TZ	17 Dec 07:37:16 1997 PST
MM/DD/YYYY HH:MM:SS.SS TZ	12/17/1997 07:37:16.00 PST
YYYY-MM-DD HH:MM:SS +/-TZ	1997-12-17 07:37:16-08
DD.MM.YYYY HH:MM:SS TZ	12.17.1997 07:37:16.00 PST

Automatic recognition does not support epochsecs and epochmillisecs.

To test whether a date or timestamp value will be automatically converted, use a CAST function to attempt to convert the string to a date or timestamp value. For example, the following commands test the timestamp value 'J2345678 04:05:06.789':

```
create table formattest (test char(16));
insert into formattest values('J2345678 04:05:06.789');
select test, cast(test as timestamp) as timestamp, cast(test as date) as date
from formattest;
```

test	timestamp	date
J2345678 04:05:06.789	1710-02-23 04:05:06	1710-02-23

If the source data for a DATE column includes time information, the time component is truncated. If the source data for a TIMESTAMP column omits time information, 00:00:00 is used for the time component.

COPY Examples

Note

These examples contain line breaks for readability. Do not include line breaks or spaces in your *aws-auth-args* string.

Topics

- [Load FAVORITEMOVIES from an DynamoDB Table \(p. 357\)](#)
- [Load LISTING from an Amazon S3 Bucket \(p. 357\)](#)
- [Load LISTING from an Amazon EMR Cluster \(p. 357\)](#)
- [Using a Manifest to Specify Data Files \(p. 358\)](#)
- [Load LISTING from a Pipe-Delimited File \(Default Delimiter\) \(p. 359\)](#)
- [Load LISTING Using Temporary Credentials \(p. 359\)](#)
- [Load EVENT with Options \(p. 359\)](#)
- [Load VENUE from a Fixed-Width Data File \(p. 360\)](#)
- [Load CATEGORY from a CSV File \(p. 360\)](#)
- [Load VENUE with Explicit Values for an IDENTITY Column \(p. 361\)](#)
- [Load TIME from a Pipe-Delimited GZIP File \(p. 361\)](#)
- [Load a Timestamp or Datestamp \(p. 361\)](#)
- [Load Data from a File with Default Values \(p. 362\)](#)
- [COPY Data with the ESCAPE Option \(p. 364\)](#)
- [Copy from JSON Examples \(p. 364\)](#)
- [Copy from Avro Examples \(p. 367\)](#)
- [Preparing Files for COPY with the ESCAPE Option \(p. 369\)](#)

Load FAVORITEMOVIES from an DynamoDB Table

The AWS SDKs include a simple example of creating a DynamoDB table called *my-favorite-movies-table*. (For this example, see [AWS SDK for Java](#).) The following example loads the Amazon Redshift FAVORITEMOVIES table with data from the DynamoDB table. The Amazon Redshift table must already exist in the database.

```
copy favoritemovies from 'dynamodb://ProductCatalog'  
credentials '<aws-auth-args>'  
readratio 50;
```

Load LISTING from an Amazon S3 Bucket

The following example loads LISTING from an Amazon S3 bucket. The COPY command loads all of the files in the `/data/listing/` folder.

```
copy listing  
from 's3://mybucket/data/listing/'  
credentials '<aws-auth-args>';
```

Load LISTING from an Amazon EMR Cluster

The following example loads the SALES table with tab-delimited data from lzop-compressed files in an Amazon EMR cluster. COPY will load every file in the `myoutput/` folder that begins with `part-`.

```
copy sales  
from 'emr://j-SAMPLE2B500FC/myoutput/part-*'  
credentials '<aws-auth-args>'  
delimiter '\t' lzop;
```

The following example loads the SALES table with JSON formatted data in an Amazon EMR cluster. COPY will load every file in the `myoutput/json/` folder.

```
copy sales
from 'emr://j-SAMPLE2B500FC/myoutput/json/'
credentials '<aws-auth-args>'
JSON 's3://mybucket/jsonpaths.txt';
```

Using a Manifest to Specify Data Files

You can use a manifest to ensure that your COPY command loads all of the required files, and only the required files, from Amazon S3. You can also use a manifest when you need to load multiple files from different buckets or files that do not share the same prefix.

For example, suppose you need to load the following three files: `custdata1.txt`, `custdata2.txt`, and `custdata3.txt`. You could use the following command to load all of the files in `mybucket` that begin with `custdata` by specifying a prefix:

```
copy category
from 's3://mybucket/custdata'
credentials '<aws-auth-args>';
```

If only two of the files exist because of an error, COPY will load only those two files and finish successfully, resulting in an incomplete data load. If the bucket also contains an unwanted file that happens to use the same prefix, such as a file named `custdata.backup` for example, COPY will load that file as well, resulting in unwanted data being loaded.

To ensure that all of the required files are loaded and to prevent unwanted files from being loaded, you can use a manifest file. The manifest is a JSON-formatted text file that lists the files to be processed by the COPY command. For example, the following manifest loads the three files in the previous example.

```
{
  "entries": [
    {"url": "s3://mybucket/custdata.1", "mandatory": true},
    {"url": "s3://mybucket/custdata.2", "mandatory": true},
    {"url": "s3://mybucket/custdata.3", "mandatory": true}
  ]
}
```

The optional `mandatory` flag indicates whether COPY should terminate if the file does not exist. The default is `false`. Regardless of any mandatory settings, COPY will terminate if no files are found. In this example, COPY will return an error if any of the files is not found. Unwanted files that might have been picked up if you specified only a key prefix, such as `custdata.backup`, are ignored, because they are not on the manifest.

The following example uses the manifest in the previous example, which is named `cust.manifest`.

```
copy customer
from 's3://mybucket/cust.manifest'
credentials '<aws-auth-args>'
manifest;
```

You can use a manifest to load files from different buckets or files that do not share the same prefix. The following example shows the JSON to load data with files whose names begin with a date stamp.

```
{
  "entries": [
    {"url": "s3://mybucket/2013-10-04-custdata.txt", "mandatory": true},
    {"url": "s3://mybucket/2013-10-05-custdata.txt", "mandatory": true},
    {"url": "s3://mybucket/2013-10-06-custdata.txt", "mandatory": true},
    {"url": "s3://mybucket/2013-10-07-custdata.txt", "mandatory": true}
  ]
}
```

The manifest can list files that are in different buckets, as long as the buckets are in the same region as the cluster.

```
{
  "entries": [
    {"url": "s3://mybucket-alpha/custdata1.txt", "mandatory": false},
    {"url": "s3://mybucket-beta/custdata1.txt", "mandatory": false},
    {"url": "s3://mybucket-beta/custdata2.txt", "mandatory": false}
  ]
}
```

Load LISTING from a Pipe-Delimited File (Default Delimiter)

The following example is a very simple case in which no options are specified and the input file contains the default delimiter, a pipe character (|).

```
copy listing
from 's3://mybucket/data/listings_pipe.txt'
credentials '<aws-auth-args>';
```

Load LISTING Using Temporary Credentials

The following example uses the TOKEN parameter to specify temporary session credentials:

```
copy listing
from 's3://mybucket/data/listings_pipe.txt'
credentials 'aws_access_key_id=<temporary-access-key-id>;aws_secret_access_key=<temporary-secret-access-key>;token=<temporary-token>';
```

Load EVENT with Options

The following example loads pipe-delimited data into the EVENT table and applies the following rules:

- If pairs of quotation marks are used to surround any character strings, they are removed.
- Both empty strings and strings that contain blanks are loaded as NULL values.
- The load will fail if more than 5 errors are returned.
- Timestamp values must comply with the specified format; for example, a valid timestamp is 2008-09-26 05:43:12.

```
copy event
from 's3://mybucket/data/allevnts_pipe.txt'
credentials '<aws-auth-args>';
```

```
removequotes
emptyasnull
blanksasnull
maxerror 5
delimiter '|'
timeformat 'YYYY-MM-DD HH:MI:SS';
```

Load VENUE from a Fixed-Width Data File

```
copy venue
from 's3://mybucket/data/venue_fw.txt'
credentials '<aws-auth-args>'
fixedwidth 'venueid:3,venueid:25,venueid:12,venueid:2,venueid:6';
```

The preceding example assumes a data file formatted in the same way as the sample data shown. In the sample following, spaces act as placeholders so that all of the columns are the same width as noted in the specification:

```
1 Toyota Park           Bridgeview  IL0
2 Columbus Crew Stadium Columbus    OH0
3 RFK Stadium           Washington  DC0
4 CommunityAmerica BallparkKansas City  KS0
5 Gillette Stadium      Foxborough  MA68756
```

Load CATEGORY from a CSV File

Suppose you want to load the CATEGORY with the values shown in the following table.

catid	catgroup	catname	catdesc
12	Shows	Musicals	Musical theatre
13	Shows	Plays	All "non-musical" theatre
14	Shows	Opera	All opera, light, and "rock" opera
15	Concerts	Classical	All symphony, concerto, and choir concerts

The following example shows the contents of a text file with the field values separated by commas.

```
12,Shows,Musicals,Musical theatre
13,Shows,Plays,All "non-musical" theatre
14,Shows,Opera,All opera, light, and "rock" opera
15,Concerts,Classical,All symphony, concerto, and choir concerts
```

If you load the file using the DELIMITER parameter to specify comma-delimited input, the COPY command will fail because some input fields contain commas. You can avoid that problem by using the CSV parameter and enclosing the fields that contain commas in quote characters. If the quote character appears within a quoted string, you need to escape it by doubling the quote character. The default quote character is a double quotation mark, so you will need to escape each double quotation mark with an additional double quotation mark. Your new input file will look something like this.

```
12,Shows,Musicals,Musical theatre
```

```
13,Shows,Plays,"All "non-musical" theatre"  
14,Shows,Opera,"All opera, light, and "rock" opera"  
15,Concerts,Classical,"All symphony, concerto, and choir concerts"
```

Assuming the file name is `category_csv.txt`, you can load the file by using the following COPY command:

```
copy category  
from 's3://mybucket/data/category_csv.txt'  
credentials '<aws-auth-args>'  
csv;
```

Alternatively, to avoid the need to escape the double quotation marks in your input, you can specify a different quote character by using the QUOTE AS parameter. For example, the following version of `category_csv.txt` uses `'%'` as the quote character:

```
12,Shows,Musicals,Musical theatre  
13,Shows,Plays,%All "non-musical" theatre%  
14,Shows,Opera,%All opera, light, and "rock" opera%  
15,Concerts,Classical,%All symphony, concerto, and choir concerts%
```

The following COPY command uses QUOTE AS to load `category_csv.txt`:

```
copy category  
from 's3://mybucket/data/category_csv.txt'  
credentials '<aws-auth-args>'  
csv quote as '%';
```

Load VENUE with Explicit Values for an IDENTITY Column

The following example assumes that when the VENUE table was created that at least one column (such as the `venueid` column) was specified to be an IDENTITY column. This command overrides the default IDENTITY behavior of auto-generating values for an IDENTITY column and instead loads the explicit values from the `venue.txt` file.

```
copy venue  
from 's3://mybucket/data/venue.txt'  
credentials '<aws-auth-args>'  
explicit_ids;
```

Load TIME from a Pipe-Delimited GZIP File

The following example loads the TIME table from a pipe-delimited GZIP file:

```
copy time  
from 's3://mybucket/data/timerows.gz'  
credentials '<aws-auth-args>'  
gzip  
delimiter '|';
```

Load a Timestamp or Datestamp

The following example loads data with a formatted timestamp.

Note

The TIMEFORMAT of HH:MI:SS can also support fractional seconds beyond the SS to a microsecond level of detail. The file `time.txt` used in this example contains one row, 2009-01-12 14:15:57.119568.

```
copy timestamp1
from 's3://mybucket/data/time.txt'
credentials '<aws-auth-args>'
timeformat 'YYYY-MM-DD HH:MI:SS';
```

The result of this copy is as follows:

```
select * from timestamp1;
c1
-----
2009-01-12 14:15:57.119568
(1 row)
```

Load Data from a File with Default Values

The following example uses a variation of the VENUE table in the TICKIT database. Consider a VENUE_NEW table defined with the following statement:

```
create table venue_new(
venueid smallint not null,
venuename varchar(100) not null,
venuecity varchar(30),
venuestate char(2),
venueseats integer not null default '1000');
```

Consider a `venue_noseats.txt` data file that contains no values for the VENUESEATS column, as shown in the following example:

```
1|Toyota Park|Bridgeview|IL|
2|Columbus Crew Stadium|Columbus|OH|
3|RFK Stadium|Washington|DC|
4|CommunityAmerica Ballpark|Kansas City|KS|
5|Gillette Stadium|Foxborough|MA|
6|New York Giants Stadium|East Rutherford|NJ|
7|BMO Field|Toronto|ON|
8|The Home Depot Center|Carson|CA|
9|Dick's Sporting Goods Park|Commerce City|CO|
10|Pizza Hut Park|Frisco|TX|
```

The following COPY statement will successfully load the table from the file and apply the DEFAULT value ('1000') to the omitted column:

```
copy venue_new(venueid, venuename, venuecity, venuestate)
from 's3://mybucket/data/venue_noseats.txt'
credentials '<aws-auth-args>'
delimiter '|';
```

Now view the loaded table:

```
select * from venue_new order by venueid;
venueid |          venuename          |   venuecity   |   venuestate |
venueseats
-----+-----+-----+-----+-----
+-----+
1 | Toyota Park                | Bridgeview    | IL           |          1000
2 | Columbus Crew Stadium      | Columbus      | OH           |          1000
3 | RFK Stadium                | Washington    | DC           |          1000
4 | CommunityAmerica Ballpark | Kansas City   | KS           |          1000
5 | Gillette Stadium           | Foxborough    | MA           |          1000
6 | New York Giants Stadium    | East Rutherford | NJ           |          1000
7 | BMO Field                  | Toronto       | ON           |          1000
8 | The Home Depot Center      | Carson        | CA           |          1000
9 | Dick's Sporting Goods Park | Commerce City | CO           |          1000
10 | Pizza Hut Park             | Frisco        | TX           |          1000
(10 rows)
```

For the following example, in addition to assuming that no VENUESEATS data is included in the file, also assume that no VENUENAME data is included:

```
1 | Bridgeview | IL |
2 | Columbus  | OH |
3 | Washington | DC |
4 | Kansas City | KS |
5 | Foxborough | MA |
6 | East Rutherford | NJ |
7 | Toronto    | ON |
8 | Carson     | CA |
9 | Commerce City | CO |
10 | Frisco    | TX |
```

Using the same table definition, the following COPY statement will fail because no DEFAULT value was specified for VENUENAME, and VENUENAME is a NOT NULL column:

```
copy venue(venueid, venuecity, venuestate)
from 's3://mybucket/data/venue_pipe.txt'
credentials '<aws-auth-args>'
delimiter '|';
```

Now consider a variation of the VENUE table that uses an IDENTITY column:

```
create table venue_identity(
venueid int identity(1,1),
venue_name varchar(100) not null,
venuecity varchar(30),
venuestate char(2),
venue_seats integer not null default '1000');
```

As with the previous example, assume that the VENUESEATS column has no corresponding values in the source file. The following COPY statement will successfully load the table, including the predefined IDENTITY data values instead of autogenerating those values:

```
copy venue(venueid, venue_name, venuecity, venuestate)
from 's3://mybucket/data/venue_pipe.txt'
credentials '<aws-auth-args>'
```

```
delimiter '|' explicit_ids;
```

This statement fails because it does not include the IDENTITY column (VENUEID is missing from the column list) yet includes an EXPLICIT_IDS parameter:

```
copy venue(venueid, venueid, venueid, venueid)
from 's3://mybucket/data/venue_pipe.txt'
credentials '<aws-auth-args>'
delimiter '|' explicit_ids;
```

This statement fails because it does not include an EXPLICIT_IDS parameter:

```
copy venue(venueid, venueid, venueid, venueid)
from 's3://mybucket/data/venue_pipe.txt'
credentials '<aws-auth-args>'
delimiter '|';
```

COPY Data with the ESCAPE Option

The following example shows how to load characters that match the delimiter character (in this case, the pipe character). In the input file, make sure that all of the pipe characters (|) that you want to load are escaped with the backslash character (\). Then load the file with the ESCAPE parameter.

```
$ more redshiftinfo.txt
1|public\|event\|dwuser
2|public\|sales\|dwuser

create table redshiftinfo(
  infoid int,
  tableinfo varchar(50));

copy redshiftinfo from 's3://mybucket/data/redshiftinfo.txt'
credentials '<aws-auth-args>'
delimiter '|' escape;

select * from redshiftinfo order by 1;
infoid |      tableinfo
-----+-----
1      | public|event|dwuser
2      | public|sales|dwuser
(2 rows)
```

Without the ESCAPE parameter, this COPY command fails with an `Extra column(s) found error`.

Important

If you load your data using a COPY with the ESCAPE parameter, you must also specify the ESCAPE parameter with your UNLOAD command to generate the reciprocal output file. Similarly, if you UNLOAD using the ESCAPE parameter, you will need to use ESCAPE when you COPY the same data.

Copy from JSON Examples

In the following examples, you will load the CATEGORY table with the following data.

CATID	CATGROUP	CATNAME	CATDESC
1	Sports	MLB	Major League Baseball
2	Sports	NHL	National Hockey League

CATID	CATGROUP	CATNAME	CATDESC
3	Sports	NFL	National Football League
4	Sports	NBA	National Basketball Association
5	Concerts	Classical	All symphony, concerto, and choir concerts

Topics

- [Load from JSON Data Using the 'auto' Option \(p. 365\)](#)
- [Load from JSON Data Using a JSONPaths file \(p. 366\)](#)
- [Load from JSON Arrays Using a JSONPaths file \(p. 367\)](#)

Load from JSON Data Using the 'auto' Option

To load from JSON data using the 'auto' argument, the JSON data must consist of a set of objects. The key names must match the column names, but in this case, order does not matter. The following shows the contents of a file named `category_object_auto.json`.

```
{
  "catdesc": "Major League Baseball",
  "catid": 1,
  "catgroup": "Sports",
  "catname": "MLB"
}
{
  "catgroup": "Sports",
  "catid": 2,
  "catname": "NHL",
  "catdesc": "National Hockey League"
}
{
  "catid": 3,
  "catname": "NFL",
  "catgroup": "Sports",
  "catdesc": "National Football League"
}
{
  "bogus": "Bogus Sports LLC",
  "catid": 4,
  "catgroup": "Sports",
  "catname": "NBA",
  "catdesc": "National Basketball Association"
}
{
  "catid": 5,
  "catgroup": "Shows",
  "catname": "Musicals",
  "catdesc": "All symphony, concerto, and choir concerts"
}
```

To load from the JSON data file in the previous example, execute the following COPY command.

```
copy category
from 's3://mybucket/category_object_auto.json'
```

```
credentials '<aws-auth-args>'
json 'auto';
```

Load from JSON Data Using a JSONPaths file

If the JSON data objects don't correspond directly to column names, you can use a JSONPaths file to map the JSON elements to columns. Again, the order does not matter in the JSON source data, but the order of the JSONPaths file expressions must match the column order. Suppose you have the following data file, named `category_object_paths.json`.

```
{
  "one": 1,
  "two": "Sports",
  "three": "MLB",
  "four": "Major League Baseball"
}
{
  "three": "NHL",
  "four": "National Hockey League",
  "one": 2,
  "two": "Sports"
}
{
  "two": "Sports",
  "three": "NFL",
  "one": 3,
  "four": "National Football League"
}
{
  "one": 4,
  "two": "Sports",
  "three": "NBA",
  "four": "National Basketball Association"
}
{
  "one": 6,
  "two": "Shows",
  "three": "Musicals",
  "four": "All symphony, concerto, and choir concerts"
}
```

The following JSONPaths file, named `category_jsonpath.json`, maps the source data to the table columns.

```
{
  "jsonpaths": [
    "${'one'}",
    "${'two'}",
    "${'three'}",
    "${'four'}"
  ]
}
```

To load from the JSON data file in the previous example, execute the following COPY command.

```
copy category
```

```
from 's3://mybucket/category_object_paths.json'  
credentials '<aws-auth-args>'  
json 's3://mybucket/category_jsonpath.json';
```

Load from JSON Arrays Using a JSONPaths file

To load from JSON data that consists of a set of arrays, you must use a JSONPaths file to map the array elements to columns. Suppose you have the following data file, named `category_array_data.json`.

```
[1,"Sports","MLB","Major League Baseball"]  
[2,"Sports","NHL","National Hockey League"]  
[3,"Sports","NFL","National Football League"]  
[4,"Sports","NBA","National Basketball Association"]  
[5,"Concerts","Classical","All symphony, concerto, and choir concerts"]
```

The following JSONPaths file, named `category_array_jsonpath.json`, maps the source data to the table columns.

```
{  
  "jsonpaths": [  
    "$[0]",  
    "$[1]",  
    "$[2]",  
    "$[3]"  
  ]  
}
```

To load from the JSON data file in the previous example, execute the following COPY command.

```
copy category  
from 's3://mybucket/category_array_data.json'  
credentials '<aws-auth-args>'  
json 's3://mybucket/category_array_jsonpath.json';
```

Copy from Avro Examples

In the following examples, you will load the CATEGORY table with the following data.

CATID	CATGROUP	CATNAME	CATDESC
1	Sports	MLB	Major League Baseball
2	Sports	NHL	National Hockey League
3	Sports	NFL	National Football League
4	Sports	NBA	National Basketball Association
5	Concerts	Classical	All symphony, concerto, and choir concerts

Topics

- [Load from Avro Data Using the 'auto' Option \(p. 368\)](#)
- [Load from Avro Data Using a JSONPaths File \(p. 368\)](#)

Load from Avro Data Using the 'auto' Option

To load from Avro data using the 'auto' argument, field names in the Avro schema must match the column names. However, when using the 'auto' argument, order does not matter. The following shows the schema for a file named `category_auto.avro`.

```
{
  "name": "category",
  "type": "record",
  "fields": [
    {"name": "catid", "type": "int"},
    {"name": "catdesc", "type": "string"},
    {"name": "catname", "type": "string"},
    {"name": "catgroup", "type": "string"},
  ]
}
```

The data in an Avro file is in binary format, so it is not human-readable. The following shows a JSON representation of the data in the `category_auto.avro` file.

```
{
  "catid": 1,
  "catdesc": "Major League Baseball",
  "catname": "MLB",
  "catgroup": "Sports"
}
{
  "catid": 2,
  "catdesc": "National Hockey League",
  "catname": "NHL",
  "catgroup": "Sports"
}
{
  "catid": 3,
  "catdesc": "National Basketball Association",
  "catname": "NBA",
  "catgroup": "Sports"
}
{
  "catid": 4,
  "catdesc": "All symphony, concerto, and choir concerts",
  "catname": "Classical",
  "catgroup": "Concerts"
}
```

To load from the Avro data file in the previous example, execute the following COPY command.

```
copy category
from 's3://mybucket/category_auto.avro'
credentials '<aws-auth-args>'
format as avro 'auto';
```

Load from Avro Data Using a JSONPaths File

If the field names in the Avro schema don't correspond directly to column names, you can use a JSONPaths file to map the schema elements to columns. The order of the JSONPaths file expressions must match the column order.

Suppose you have a data file named `category_paths.avro` that contains the same data as in the previous example, but with the following schema.

```
{
  "name": "category",
  "type": "record",
  "fields": [
    {"name": "id", "type": "int"},
    {"name": "desc", "type": "string"},
    {"name": "name", "type": "string"},
    {"name": "group", "type": "string"},
    {"name": "region", "type": "string"}
  ]
}
```

The following JSONPaths file, named `category_path.avropath`, maps the source data to the table columns.

```
{
  "jsonpaths": [
    "${'id'}",
    "${'group'}",
    "${'name'}",
    "${'desc'}"
  ]
}
```

To load from the Avro data file in the previous example, execute the following COPY command.

```
copy category
from 's3://mybucket/category_object_paths.avro'
credentials '<aws-auth-args>'
format avro 's3://mybucket/category_path.avropath ';
```

Preparing Files for COPY with the ESCAPE Option

The following example describes how you might prepare data to "escape" newline characters before importing the data into an Amazon Redshift table using the COPY command with the ESCAPE parameter. Without preparing the data to delimit the newline characters, Amazon Redshift will return load errors when you run the COPY command, because the newline character is normally used as a record separator.

For example, consider a file or a column in an external table that you want to copy into an Amazon Redshift table. If the file or column contains XML-formatted content or similar data, you will need to make sure that all of the newline characters (`\n`) that are part of the content are escaped with the backslash character (`\`).

A good thing about a file or table containing embedded newlines characters is that it provides a relatively easy pattern to match. Each embedded newline character most likely always follows a `>` character with potentially some white space characters (`' '` or tab) in between, as you can see in the following example of a text file named `nlTest1.txt`.

```
$ cat nlTest1.txt
<xml start>
<newline characters provide>
```

```
<line breaks at the end of each>
<line in content>
</xml>|1000
<xml>
</xml>|2000
```

With the following example, you can run a text-processing utility to pre-process the source file and insert escape characters where needed. (The | character is intended to be used as delimiter to separate column data when copied into an Amazon Redshift table.)

```
$ sed -e ':a;N;$!ba;s/>[[:space:]]*\n/>\\n/g' nlTest1.txt > nlTest2.txt
```

Similarly, you can use Perl to perform a similar operation:

```
cat nlTest1.txt | perl -p -e 's/>\s*\n/>\\n/g' > nlTest2.txt
```

To accommodate loading the data from the `nlTest2.txt` file into Amazon Redshift, we created a two-column table in Amazon Redshift. The first column `c1`, is a character column that will hold XML-formatted content from the `nlTest2.txt` file. The second column `c2` holds integer values loaded from the same file.

After running the `sed` command, you can correctly load data from the `nlTest2.txt` file into an Amazon Redshift table using the `ESCAPE` parameter.

Note

When you include the `ESCAPE` parameter with the `COPY` command, it escapes a number of special characters that include the backslash character (including newline).

```
copy t2 from 's3://mybucket/data/nlTest2.txt'
credentials '<aws-auth-args>'
escape
delimiter as '|';

select * from t2 order by 2;

c1          | c2
-----+-----
<xml start>
<newline characters provide>
<line breaks at the end of each>
<line in content>
</xml>
| 1000
<xml>
</xml>    | 2000
(2 rows)
```

You can prepare data files exported from external databases in a similar way. For example, with an Oracle database, you can use the `REPLACE` function on each affected column in a table that you want to copy into Amazon Redshift.

```
SELECT c1, REPLACE(c2, \n',\\n' ) as c2 from my_table_with_xml
```

In addition, many database export and extract, transform, load (ETL) tools that routinely process large amounts of data provide options to specify escape and delimiter characters.

CREATE DATABASE

Creates a new database.

Syntax

```
CREATE DATABASE database_name [ WITH ]  
[ OWNER [=] db_owner ]  
[ CONNECTION LIMIT { limit | UNLIMITED } ]
```

Parameters

database_name

Name of the new database. For more information about valid names, see [Names and Identifiers \(p. 246\)](#).

WITH

Optional keyword.

OWNER

Specifies a database owner.

=

Optional character.

db_owner

Username for the database owner.

CONNECTION LIMIT { *limit* | UNLIMITED }

The maximum number of database connections users are permitted to have open concurrently. The limit is not enforced for super users. Use the UNLIMITED keyword to permit the maximum number of concurrent connections. The limit of concurrent connections for each cluster is 500. A limit on the number of connections for each user might also apply. For more information, see [CREATE USER \(p. 371\)](#). The default is UNLIMITED. To view current connections, query the [STV_SESSIONS \(p. 764\)](#) system view.

Note

If both user and database connection limits apply, an unused connection slot must be available that is within both limits when a user attempts to connect.

CREATE DATABASE Limits

Amazon Redshift enforces these limits for databases.

- Maximum of 60 user-defined databases per cluster.
- Maximum of 127 bytes for a database name.
- Cannot be a reserved word.

Examples

The following example creates a database named TICKIT and gives ownership to the user DWUSER:

```
create database tickit  
with owner dwuser;
```

Query the PG_DATABASE_INFO catalog table to view details about databases.

```
select datname, datdba, datconlimit
from pg_database_info
where datdba > 1;
```

datname	datdba	datconlimit
admin	100	UNLIMITED
reports	100	100
ticket	100	100

CREATE FUNCTION

Creates a new scalar user-defined function (UDF).

Syntax

```
CREATE [ OR REPLACE ] FUNCTION f_function_name
( [argument_name data_type [ , ... ] ] )
RETURNS data_type
{VOLATILE | STABLE | IMMUTABLE }
AS $$
    python_program
$$ LANGUAGE plpythonu;
```

Parameters

OR REPLACE

Specifies that if a function with the same name and input argument data types, or *signature*, as this one already exists, the existing function is replaced. You can only replace a function with a new function that defines an identical set of data types. You must be a superuser to replace a function.

If you define a function with the same name as an existing function but a different signature, you will create a new function. In other words, the function name will be overloaded. For more information, see [Overloading Function Names \(p. 194\)](#).

f_function_name

The name of the function. If you specify a schema name (such as `myschema.myfunction`), the function is created using the specified schema. Otherwise, the function is created in the current schema. For more information about valid names, see [Names and Identifiers \(p. 246\)](#).

We recommend that you prefix all UDF names with `f_`. Amazon Redshift reserves the `f_` prefix for UDF names, so by using the `f_` prefix, you ensure that your UDF name will not conflict with any existing or future Amazon Redshift built-in SQL function names. For more information, see [Naming UDFs \(p. 194\)](#).

You can define more than one function with the same function name if the data types for the input arguments are different. In other words, the function name will be overloaded. For more information, see [Overloading Function Names \(p. 194\)](#).

argument_name data_type

A list of input argument names and data types. A UDF can implement any standard Amazon Redshift data type. In addition, UDFs support a data type of ANYELEMENT, which is automatically converted to a standard data type based on the data type of the corresponding argument supplied at run time. If multiple arguments use ANYELEMENT, they will all resolve to the same data type

at run time, based on the first ANYELEMENT argument in the list. For more information, see [UDF Data Types \(p. 193\)](#) and [Data Types \(p. 247\)](#).

You can specify a maximum of 32 arguments.

RETURNS *data_type*

The data type of the value returned by the function. The RETURNS data type can be any standard Amazon Redshift data type. In addition, UDFs can use a data type of ANYELEMENT, which is automatically converted to a standard data type based on the argument supplied at run time. If you specify ANYELEMENT for the return data type, at least one argument must use ANYELEMENT. The actual return data type will match the data type supplied for the ANYELEMENT argument when the function is called. For more information, see [UDF Data Types \(p. 193\)](#).

VOLATILE | STABLE | IMMUTABLE

Informs the query optimizer about the volatility of the function.

You will get the best optimization if you label your function with the strictest volatility category that is valid for it. On the other hand, if the category is too strict, there is a risk that the optimizer will erroneously skip some calls, resulting in an incorrect result set. In order of strictness, beginning with the least strict, the volatility categories are:

- VOLATILE
- STABLE
- IMMUTABLE

VOLATILE

Given the same arguments, the function can return different results on successive calls, even for the rows in a single statement. The query optimizer cannot make any assumptions about the behavior of a volatile function, so a query that uses a volatile function must reevaluate the function for every input row.

STABLE

Given the same arguments, the function is guaranteed to return the same results for all rows processed within a single statement. The function can return different results when called in different statements. This category allows the optimizer to optimize multiple calls of the function within a single statement to a single call for the statement.

IMMUTABLE

Given the same arguments, the function always returns the same result, forever. When a query calls an IMMUTABLE function with constant arguments, the optimizer pre-evaluates the function.

AS \$\$... \$\$ LANGUAGE *plpythonu*

A construct that encloses the statement to be executed and a keyword showing the language in which the statement is written. The literal keywords AS \$\$ and \$\$ LANGUAGE *plpythonu* are required.

Amazon Redshift requires you to enclose the statement in your function by using a format called *dollar quoting*. Anything within the enclosure is passed exactly as is. You don't need to escape any special characters because the contents of the string are written literally.

With dollar quoting, you use a pair of dollar signs (\$\$) to signify the start and the end of the statement to execute, as shown in the following example.

```
$$ my statement $$
```

Optionally, between the dollar signs in each pair, you can specify a string to help identify the statement. The string that you use must be the same in both the start and the end of the enclosure

pairs. This string is case-sensitive, and it follows the same constraints as an unquoted identifier except that it cannot contain dollar signs. The following example uses the string `test`.

```
$test$ my statement $test$
```

For more information about dollar quoting, see *Dollar-quoted String Constants* in the [Lexical Structure](#) section of the PostgreSQL manual.

The statement that you pass in with the function must conform to indentation requirements as specified in the [Style Guide for Python Code](#) on the Python website. Python (`plpythonu`) is the only supported language.

python_program

A valid executable Python program that returns a value. For more information, see [Python Language Support for UDFs \(p. 195\)](#).

Examples

The following example creates a function that compares two integers and returns the larger value:

```
create function f_greater (a float, b float)
  returns float
stable
as $$
  if a > b:
    return a
  return b
$$ language plpythonu;
```

The following example queries the SALES table and calls the new `f_greater` function to return either COMMISSION or 20 percent of PRICEPAID, whichever is greater:

```
select f_greater (commission, pricepaid*0.20) from sales;
```

CREATE GROUP

Defines a new user group. Only a superuser can create a group.

Syntax

```
CREATE GROUP group_name
[ [ WITH ] [ USER username ] [, ...] ]
```

Parameters

group_name

Name of the new user group. Group names beginning with two underscores are reserved for Amazon Redshift internal use. For more information about valid names, see [Names and Identifiers \(p. 246\)](#).

WITH

Optional syntax to indicate additional parameters for CREATE GROUP.

USER

Add one or more users to the group.

username

Name of the user to add to the group.

Examples

The following example creates a user group named ADMIN_GROUP with a single user ADMIN:

```
create group admin_group with user admin;
```

CREATE LIBRARY

Installs a Python library, which will be available for users to incorporate when creating a user-defined function (UDF) with the [CREATE FUNCTION \(p. 372\)](#) command. The total size of user-installed libraries cannot exceed 100 MB. CREATE LIBRARY cannot be run inside a transaction block (BEGIN ... END). For more information, see [Importing Custom Python Library Modules \(p. 196\)](#).

Amazon Redshift supports Python version 2.7. For more information, go to www.python.org.

Syntax

```
CREATE [ OR REPLACE ] LIBRARY library_name LANGUAGE plpythonu
FROM
{ 'https://file_url'
| 's3://bucketname/file_name'
  [ WITH ] CREDENTIALS [AS] 'aws-auth-args'
  [ REGION [AS] 'aws_region' ]
}
```

Parameters

OR REPLACE

Specifies that if a library with the same name as this one already exists, the existing library is replaced. REPLACE commits immediately. If a UDF that depends on the library is running concurrently, the UDF might fail or return unexpected results, even if the UDF is running within a transaction. You must be the owner or a superuser to replace a library.

library_name

The name of the library to be installed. You cannot create a library that contains a module with the same name as a Python Standard Library module or an Amazon Redshift preinstalled Python module. If an existing user-installed library uses the same Python package as the library to be installed, you must drop the existing library before installing the new library. For more information, see [Python Language Support for UDFs \(p. 195\)](#).

LANGUAGE plpythonu

The language to use. Python (plpythonu) is the only supported language. Amazon Redshift supports Python version 2.7. For more information, go to www.python.org.

FROM

The location of the library file. You can specify an Amazon S3 bucket and object name, or you can specify a URL to download the file from a public website. The library must be packaged in the form of a .zip file. For more information, go to [Building and Installing Python Modules](#) in the Python documentation.

`https://file_url`

The URL to download the file from a public website. The URL can contain up to three redirects. The following is an example of a file URL.

```
'https://www.example.com/pylib.zip'
```

`s3://bucket_name/file_name`

The path to a single Amazon S3 object that contains the library file. The following is an example of an Amazon S3 object path.

```
's3://mybucket/my-pylib.zip'
```

If you specify an Amazon S3 bucket, you must also provide credentials for an AWS user that has permission to download the file.

Important

If the Amazon S3 bucket does not reside in the same region as your Amazon Redshift cluster, you must use the `REGION` option to specify the region in which the data is located. The value for `aws_region` must match a region listed in the table in the [REGION \(p. 324\)](#) parameter description for the `COPY` command.

[WITH] CREDENTIALS [AS] *aws-auth-args*

A clause that indicates the method your cluster will use for authentication and authorization to access the Amazon S3 bucket that contains the library file. Your cluster must have permission to access the Amazon S3 with the `LIST` and `GET` actions.

The syntax for the `CREDENTIALS` parameter is the same as for the `COPY` command `CREDENTIALS` parameter. For more information, see [Credentials \(p. 330\)](#).

The *aws-auth-args* string is case-sensitive and must not contain spaces. The keywords `WITH` and `AS` are optional and are ignored.

To specify an IAM role, replace *<account-id>* and *<role-name>* with the account ID and role name in the `CREDENTIALS` *aws-auth-args* string, as shown following:

```
'aws_iam_role=arn:aws:iam::<aws-account-id>:role/<role-name>'
```

Optionally, if the Amazon S3 bucket uses server-side encryption, provide the encryption key in the *aws-auth-args* string. If you use temporary security credentials, provide the temporary token in the *aws-auth-args* string.

To specify key-based access control, provide the *aws-auth-args* in the following format:

```
'aws_access_key_id=<access-key-id>;aws_secret_access_key=<secret-access-key>'
```

To use temporary token credentials, you must provide the temporary access key ID, the temporary secret access key, and the temporary token. The *aws-auth-args* string is in the following format:

```
WITH CREDENTIALS AS  
'aws_access_key_id=<temporary-access-key-id>;aws_secret_access_key=<temporary-secret-access-key>;token=<temporary-token>'
```

For more information, see [Temporary Security Credentials \(p. 350\)](#)

REGION [AS] *aws_region*

The AWS region where the Amazon S3 bucket is located. REGION is required when the Amazon S3 bucket is not in the same region as the Amazon Redshift cluster. The value for *aws_region* must match a region listed in the table in the [REGION \(p. 324\)](#) parameter description for the COPY command.

By default, CREATE LIBRARY assumes that the Amazon S3 bucket is located in the same region as the Amazon Redshift cluster.

Examples

The following two examples install the [urlparse](#) Python module, which is packaged in a file named `urlparse3-1.0.3.zip`.

The following command installs a UDF library named `f_urlparse` from a package that has been uploaded to an Amazon S3 bucket located in the US East region.

```
create library f_urlparse
language plpythonu
from 's3://mybucket/urlparse3-1.0.3.zip'
credentials 'aws_access_key_id=<access-key-id>;aws_secret_access_key=<secret-
access-key>'
region as 'us-east-1';
```

The following example installs a library named `f_urlparse` from a library file on a website.

```
create library f_urlparse
language plpythonu
from 'https://example.com/packages/urlparse3-1.0.3.zip';
```

CREATE SCHEMA

Defines a new schema for the current database.

Syntax

```
CREATE SCHEMA [ IF NOT EXISTS ] schema_name [ AUTHORIZATION username ]
[ schema_element [ ... ] ]

CREATE SCHEMA AUTHORIZATION username [ schema_element [ ... ] ]
```

Parameters

IF NOT EXISTS

Clause that indicates that if the specified schema already exists, the command should make no changes and return a message that the schema exists, rather than terminating with an error.

This clause is useful when scripting, so the script doesn't fail if CREATE SCHEMA tries to create a schema that already exists.

schema_name

Name of the new schema. For more information about valid names, see [Names and Identifiers \(p. 246\)](#).

Note

The list of schemas in the [search_path](#) (p. 812) configuration parameter determines the precedence of identically named objects when they are referenced without schema names.

AUTHORIZATION

Clause that gives ownership to a specified user.

username

Name of the schema owner.

schema_element

Definition for one or more objects to be created within the schema.

Limits

Amazon Redshift enforces the following limits for schemas.

- There is a maximum of 256 schemas per database.
- The schema name cannot be a reserved word.

Examples

The following example creates a schema named US_SALES and gives ownership to the user DWUSER:

```
create schema us_sales authorization dwuser;
```

To view the new schema, query the PG_NAMESPACE catalog table as shown following:

```
select nspname as schema, username as owner
from pg_namespace, pg_user
where pg_namespace.nspowner = pg_user.usesysid
and pg_user.username = 'dwuser';
```

```
 name | owner
-----+-----
 us_sales | dwuser
(1 row)
```

The following example either creates the US_SALES schema, or does nothing and returns a message if it already exists:

```
create schema if not exists us_sales;
```

CREATE TABLE

Topics

- [Syntax](#) (p. 379)
- [Parameters](#) (p. 379)
- [Usage Notes](#) (p. 384)
- [Examples](#) (p. 385)

Creates a new table in the current database. The owner of this table is the issuer of the CREATE TABLE command.

Syntax

```
CREATE [ [LOCAL ] { TEMPORARY | TEMP } ] TABLE
[ IF NOT EXISTS ] table_name
( { column_name data_type [column_attributes] [column_constraints]
  | table_constraints
  | LIKE parent_table [ { INCLUDING | EXCLUDING } DEFAULTS ] }
[ , ... ] )
[ BACKUP { YES | NO } ]
[table_attribute]

where column_attributes are:
  [ DEFAULT default_expr ]
  [ IDENTITY ( seed, step ) ]
  [ ENCODE encoding ]
  [ DISTKEY ]
  [ SORTKEY ]

and column_constraints are:
  [ { NOT NULL | NULL } ]
  [ { UNIQUE | PRIMARY KEY } ]
  [ REFERENCES reftable [ ( refcolumn ) ] ]

and table_constraints are:
  [ UNIQUE ( column_name [ , ... ] ) ]
  [ PRIMARY KEY ( column_name [ , ... ] ) ]
  [ FOREIGN KEY ( column_name [ , ... ] ) REFERENCES reftable [ ( refcolumn
    ) ] ]

and table_attributes are:
  [ DISTSTYLE { EVEN | KEY | ALL } ]
  [ DISTKEY ( column_name ) ]
  [ [COMPOUND | INTERLEAVED ] SORTKEY ( column_name [ , ... ] ) ]
```

Parameters

LOCAL

Optional. Although this keyword is accepted in the statement, it has no effect in Amazon Redshift.

TEMPORARY | TEMP

Keyword that creates a temporary table that is visible only within the current session. The table is automatically dropped at the end of the session in which it is created. The temporary table can have the same name as a permanent table. The temporary table is created in a separate, session-specific schema. (You cannot specify a name for this schema.) This temporary schema becomes the first schema in the search path, so the temporary table will take precedence over the permanent table unless you qualify the table name with the schema name to access the permanent table. For more information about schemas and precedence, see [search_path](#) (p. 812).

Note

By default, users have permission to create temporary tables by their automatic membership in the PUBLIC group. To deny this privilege to a user, revoke the TEMP privilege from the PUBLIC group, and then explicitly grant the TEMP privilege only to specific users or groups of users.

IF NOT EXISTS

Clause that indicates that if the specified table already exists, the command should make no changes and return a message that the table exists, rather than terminating with an error. Note that the existing table might be nothing like the one that would have been created; only the table name is used for comparison.

This clause is useful when scripting, so the script doesn't fail if CREATE TABLE tries to create a table that already exists.

table_name

Name of the table to be created.

Important

If you specify a table name that begins with '#', the table will be created as a temporary table. The following is an example:

```
create table #newtable (id int);
```

The maximum length for the table name is 127 bytes; longer names are truncated to 127 bytes. You can use UTF-8 multibyte characters up to a maximum of four bytes. Amazon Redshift enforces a limit of 9,900 tables per cluster, including user-defined temporary tables and temporary tables created by Amazon Redshift during query processing or system maintenance. Optionally, the table name can be qualified with the database and schema name. In the following example, the database name is `tickit`, the schema name is `public`, and the table name is `test`.

```
create table tickit.public.test (c1 int);
```

If the database or schema does not exist, the table is not created, and the statement returns an error. You cannot create tables or views in the system databases `template0`, `template1`, and `padb_harvest`.

If a schema name is given, the new table is created in that schema (assuming the creator has access to the schema). The table name must be a unique name for that schema. If no schema is specified, the table is created by using the current database schema. If you are creating a temporary table, you cannot specify a schema name, because temporary tables exist in a special schema.

Multiple temporary tables with the same name can exist at the same time in the same database if they are created in separate sessions because the tables are assigned to different schemas. For more information about valid names, see [Names and Identifiers \(p. 246\)](#).

column_name

Name of a column to be created in the new table. The maximum length for the column name is 127 bytes; longer names are truncated to 127 bytes. You can use UTF-8 multibyte characters up to a maximum of four bytes. The maximum number of columns you can define in a single table is 1,600. For more information about valid names, see [Names and Identifiers \(p. 246\)](#).

Note

If you are creating a "wide table," take care that your list of columns does not exceed row-width boundaries for intermediate results during loads and query processing. For more information, see [Usage Notes \(p. 384\)](#).

data_type

The data type of the column being created. For CHAR and VARCHAR columns, you can use the MAX keyword instead of declaring a maximum length. MAX sets the maximum length to 4096 bytes for CHAR or 65535 bytes for VARCHAR. The following [data types \(p. 247\)](#) are supported:

- SMALLINT (INT2)
- INTEGER (INT, INT4)

- BIGINT (INT8)
- DECIMAL (NUMERIC)
- REAL (FLOAT4)
- DOUBLE PRECISION (FLOAT8)
- BOOLEAN (BOOL)
- CHAR (CHARACTER)
- VARCHAR (CHARACTER VARYING)
- DATE
- TIMESTAMP
- TIMESTAMP

DEFAULT *default_expr*

Clause that assigns a default data value for the column. The data type of *default_expr* must match the data type of the column. The DEFAULT value must be a variable-free expression. Subqueries, cross-references to other columns in the current table, and user-defined functions are not allowed.

The *default_expr* expression is used in any INSERT operation that does not specify a value for the column. If no default value is specified, the default value for the column is null.

If a COPY operation with a defined column list omits a column that has a DEFAULT value, the COPY command inserts the value of *default_expr*.

IDENTITY(*seed*, *step*)

Clause that specifies that the column is an IDENTITY column. An IDENTITY column contains unique auto-generated values. These values start with the value specified as *seed* and increment by the number specified as *step*. The data type for an IDENTITY column must be either INT or BIGINT.

ENCODE *encoding*

Compression encoding for a column. RAW is the default, if no compression is selected. The following [Compression Encodings \(p. 101\)](#) are supported:

- BYTEDICT
- DELTA
- DELTA32K
- LZO
- MOSTLY8
- MOSTLY16
- MOSTLY32
- RAW (no compression, the default setting)
- RUNLENGTH
- TEXT255
- TEXT32K

DISTKEY

Keyword that specifies that the column is the distribution key for the table. Only one column in a table can be the distribution key. You can use the DISTKEY keyword after a column name or as part of the table definition by using the DISTKEY (*column_name*) syntax. Either method has the same effect. For more information, see the DISTSTYLE parameter later in this topic.

SORTKEY

Keyword that specifies that the column is the sort key for the table. When data is loaded into the table, the data is sorted by one or more columns that are designated as sort keys. You can use the SORTKEY keyword after a column name to specify a single-column sort key, or you can specify one or more columns as sort key columns for the table by using the SORTKEY (*column_name* [, ...]) syntax. Only compound sort keys are created with this syntax.

If you do not specify any sort keys, the table is not sorted. You can define a maximum of 400 SORTKEY columns per table.

NOT NULL | NULL

NOT NULL specifies that the column is not allowed to contain null values. NULL, the default, specifies that the column accepts null values. IDENTITY columns are declared NOT NULL by default.

UNIQUE

Keyword that specifies that the column can contain only unique values. The behavior of the unique table constraint is the same as that for column constraints, with the additional capability to span multiple columns. To define a unique table constraint, use the UNIQUE (*column_name* [, ...]) syntax.

Important

Unique constraints are informational and are not enforced by the system.

PRIMARY KEY

Keyword that specifies that the column is the primary key for the table. Only one column can be defined as the primary key by using a column definition. To define a table constraint with a multiple-column primary key, use the PRIMARY KEY (*column_name* [, ...]) syntax.

Identifying a column as the primary key provides metadata about the design of the schema. A primary key implies that other tables can rely on this set of columns as a unique identifier for rows. One primary key can be specified for a table, whether as a column constraint or a table constraint. The primary key constraint should name a set of columns that is different from other sets of columns named by any unique constraint defined for the same table.

Important

Primary key constraints are informational only. They are not enforced by the system, but they are used by the planner.

References *reftable* [(*refcolumn*)]

Clause that specifies a foreign key constraint, which implies that the column must contain only values that match values in the referenced column of some row of the referenced table. The referenced columns should be the columns of a unique or primary key constraint in the referenced table.

Important

Foreign key constraints are informational only. They are not enforced by the system, but they are used by the planner.

LIKE *parent_table* [{ INCLUDING | EXCLUDING } DEFAULTS]

A clause that specifies an existing table from which the new table automatically copies column names, data types, and NOT NULL constraints. The new table and the parent table are decoupled, and any changes made to the parent table are not applied to the new table. Default expressions for the copied column definitions are copied only if INCLUDING DEFAULTS is specified. The default behavior is to exclude default expressions, so that all columns of the new table have null defaults.

Tables created with the LIKE option don't inherit primary and foreign key constraints. Distribution style, sort keys, BACKUP, and NULL properties are inherited by LIKE tables, but you cannot explicitly set them in the CREATE TABLE ... LIKE statement.

BACKUP { YES | NO }

A clause that specifies whether the table should be included in automated and manual cluster snapshots. For tables, such as staging tables, that won't contain critical data, specify BACKUP NO to save processing time when creating snapshots and restoring from snapshots and to reduce storage space on Amazon Simple Storage Service. The BACKUP NO setting has no effect on automatic replication of data to other nodes within the cluster, so tables with BACKUP NO specified are restored in a node failure. The default is BACKUP YES.

DISTSTYLE { EVEN | KEY | ALL }

Keyword that defines the data distribution style for the whole table. Amazon Redshift distributes the rows of a table to the compute nodes according the distribution style specified for the table.

The distribution style that you select for tables affects the overall performance of your database. For more information, see [Choosing a Data Distribution Style \(p. 110\)](#). Possible distribution styles are as follows:

- **EVEN:** The data in the table is spread evenly across the nodes in a cluster in a round-robin distribution. Row IDs are used to determine the distribution, and roughly the same number of rows are distributed to each node. This distribution method is the default.
- **KEY:** The data is distributed by the values in the DISTKEY column. When you set the joining columns of joining tables as distribution keys, the joining rows from both tables are collocated on the compute nodes. When data is collocated, the optimizer can perform joins more efficiently. If you specify DISTSTYLE KEY, you must name a DISTKEY column, either for the table or as part of the column definition. For more information, see the DISTKEY parameter earlier in this topic.
- **ALL:** A copy of the entire table is distributed to every node. This distribution style ensures that all the rows required for any join are available on every node, but it multiplies storage requirements and increases the load and maintenance times for the table. ALL distribution can improve execution time when used with certain dimension tables where KEY distribution is not appropriate, but performance improvements must be weighed against maintenance costs.

DISTKEY (*column_name*)

Constraint that specifies the column to be used as the distribution key for the table. You can use the DISTKEY keyword after a column name or as part of the table definition, by using the DISTKEY (*column_name*) syntax. Either method has the same effect. For more information, see the DISTSTYLE parameter earlier in this topic.

[{ COMPOUND | INTERLEAVED }] SORTKEY (*column_name* [...])

Specifies one or more sort keys for the table. When data is loaded into the table, the data is sorted by the columns that are designated as sort keys. You can use the SORTKEY keyword after a column name to specify a single-column sort key, or you can specify one or more columns as sort key columns for the table by using the SORTKEY (*column_name* [, ...]) syntax.

You can optionally specify COMPOUND or INTERLEAVED sort style. The default is COMPOUND. For more information, see [Choosing Sort Keys \(p. 122\)](#).

If you do not specify any sort keys, the table is not sorted by default. You can define a maximum of 400 COMPOUND SORTKEY columns or 8 INTERLEAVED SORTKEY columns per table.

COMPOUND

Specifies that the data is sorted using a compound key made up of all of the listed columns, in the order they are listed. A compound sort key is most useful when a query scans rows according to the order of the sort columns. The performance benefits of sorting with a compound key decrease when queries rely on secondary sort columns. You can define a maximum of 400 COMPOUND SORTKEY columns per table.

INTERLEAVED

Specifies that the data is sorted using an interleaved sort key. A maximum of eight columns can be specified for an interleaved sort key.

An interleaved sort gives equal weight to each column, or subset of columns, in the sort key, so queries do not depend on the order of the columns in the sort key. When a query uses one or more secondary sort columns, interleaved sorting significantly improves query performance. Interleaved sorting carries a small overhead cost for data loading and vacuuming operations.

UNIQUE (*column_name* [...])

Constraint that specifies that a group of one or more columns of a table can contain only unique values. The behavior of the unique table constraint is the same as that for column constraints, with the additional capability to span multiple columns. In the context of unique constraints, null values are not considered equal. Each unique table constraint must name a set of columns that is different from the set of columns named by any other unique or primary key constraint defined for the table.

Important

Unique constraints are informational and are not enforced by the system.

PRIMARY KEY (*column_name* [,...])

Constraint that specifies that a column or a number of columns of a table can contain only unique (nonduplicate) non-null values. Identifying a set of columns as the primary key also provides metadata about the design of the schema. A primary key implies that other tables can rely on this set of columns as a unique identifier for rows. One primary key can be specified for a table, whether as a single column constraint or a table constraint. The primary key constraint should name a set of columns that is different from other sets of columns named by any unique constraint defined for the same table.

Important

Primary key constraints are informational only. They are not enforced by the system, but they are used by the planner.

FOREIGN KEY (*column_name* [, ...]) REFERENCES *reftable* [(*refcolumn*)]

Constraint that specifies a foreign key constraint, which requires that a group of one or more columns of the new table must only contain values that match values in the referenced column(s) of some row of the referenced table. If *refcolumn* is omitted, the primary key of *reftable* is used. The referenced columns must be the columns of a unique or primary key constraint in the referenced table.

Important

Foreign key constraints are informational only. They are not enforced by the system, but they are used by the planner.

Usage Notes

Limits

Amazon Redshift enforces a maximum limit of 9,900 permanent tables per cluster.

The maximum number of characters for a table name is 127.

The maximum number of columns you can define in a single table is 1,600.

The maximum number of SORTKEY columns you can define in a single table is 400.

Summary of Column-Level Settings and Table-Level Settings

Several attributes and settings can be set at the column level or at the table level. In some cases, setting an attribute or constraint at the column level or at the table level has the same effect. In other cases, they produce different results.

The following list summarizes column-level and table-level settings:

DISTKEY

There is no difference in effect whether set at the column level or at the table level.

If DISTKEY is set, either at the column level or at the table level, DISTSTYLE must be set to KEY or not set at all. DISTSTYLE can be set only at the table level.

SORTKEY

If set at the column level, SORTKEY must be a single column. If SORTKEY is set at the table level, one or more columns can make up a compound or interleaved composite sort key.

UNIQUE

At the column level, one or more keys can be set to UNIQUE; the UNIQUE constraint applies to each column individually. If UNIQUE is set at the table level, one or more columns can make up a composite UNIQUE constraint.

PRIMARY KEY

If set at the column level, PRIMARY KEY must be a single column. If PRIMARY KEY is set at the table level, one or more columns can make up a composite primary key .

FOREIGN KEY

There is no difference in effect whether FOREIGN KEY is set at the column level or at the table level. At the column level, the syntax is simply `REFERENCES reftable [(refcolumn)]`.

Distribution of Incoming Data

When the hash distribution scheme of the incoming data matches that of the target table, no physical distribution of the data is actually necessary when the data is loaded. For example, if a distribution key is set for the new table and the data is being inserted from another table that is distributed on the same key column, the data is loaded in place, using the same nodes and slices. However, if the source and target tables are both set to EVEN distribution, data is redistributed into the target table.

Wide Tables

You might be able to create a very wide table but be unable to perform query processing, such as INSERT or SELECT statements, on the table. The maximum width of a table with fixed width columns, such as CHAR, is 64KB - 1 (or 65535 bytes). If a table includes VARCHAR columns, the table can have a larger declared width without returning an error because VARCHARS columns do not contribute their full declared width to the calculated query-processing limit. The effective query-processing limit with VARCHAR columns will vary based on a number of factors.

If a table is too wide for inserting or selecting, you will receive the following error.

```
ERROR:  8001
DETAIL:  The combined length of columns processed in the SQL statement
exceeded the query-processing limit of 65535 characters (pid:7627)
```

Examples

The following examples demonstrate various column and table attributes in Amazon Redshift CREATE TABLE statements.

Create a Table with a Distribution Key, a Compound Sort Key, and Compression

The following example creates a SALES table in the TICKIT database with compression defined for several columns. LISTID is declared as the distribution key, and LISTID and SELLERID are declared as a multicolumn compound sort key. Primary key and foreign key constraints are also defined for the table.

```
create table sales(
salesid integer not null,
listid integer not null,
sellerid integer not null,
buyerid integer not null,
eventid integer not null encode mostly16,
dateid smallint not null,
qtysold smallint not null encode mostly8,
pricepaid decimal(8,2) encode delta32k,
commission decimal(8,2) encode delta32k,
saletime timestamp,
primary key(salesid),
foreign key(listid) references listing(listid),
foreign key(sellerid) references users(userid),
foreign key(buyerid) references users(userid),
foreign key(dateid) references date(dateid))
```

```
distkey(listid)
compound sortkey(listid,sellerid);
```

The result is as follows:

```
select "column", type, encoding, distkey, sortkey
from pg_table_def where tablename = 'sales';
```

column	type	encoding	distkey	sortkey
salesid	integer	none	f	0
listid	integer	none	t	1
sellerid	integer	none	f	2
buyerid	integer	none	f	0
eventid	integer	mostly16	f	0
dateid	smallint	none	f	0
qtysold	smallint	mostly8	f	0
pricepaid	numeric(8,2)	delta32k	f	0
commission	numeric(8,2)	delta32k	f	0
saletime	timestamp without time zone	none	f	0

(10 rows)

Create a Table Using an Interleaved Sort Key

The following example creates the CUSTOMER table with an interleaved sort key.

```
create table customer_interleaved (
  c_custkey      integer      not null,
  c_name         varchar(25)  not null,
  c_address      varchar(25)  not null,
  c_city         varchar(10)  not null,
  c_nation       varchar(15)  not null,
  c_region       varchar(12)  not null,
  c_phone        varchar(15)  not null,
  c_mktsegment   varchar(10)  not null)
diststyle all
interleaved sortkey (c_custkey, c_city, c_mktsegment);
```

Create a Table Using IF NOT EXISTS

The following example either creates the CITIES table, or does nothing and returns a message if it already exists:

```
create table if not exists cities(
cityid integer not null,
city varchar(100) not null,
state char(2) not null);
```

Create a Table with ALL Distribution

The following example creates the VENUE table with ALL distribution.

```
create table venue(
venueid smallint not null,
venue name varchar(100),
```

```
venuecity varchar(30),
venuestate char(2),
venue seats integer,
primary key(venueid)
diststyle all;
```

Create a Table with Default EVEN Distribution

The following example creates a table called MYEVENT with three columns.

```
create table myevent(
eventid int,
eventname varchar(200),
eventcity varchar(30));
```

By default, the table is distributed evenly and is not sorted. The table has no declared DISTKEY or SORTKEY columns.

```
select "column", type, encoding, distkey, sortkey
from pg_table_def where tablename = 'myevent';
```

column	type	encoding	distkey	sortkey
eventid	integer	none	f	0
eventname	character varying(200)	none	f	0
eventcity	character varying(30)	none	f	0

(3 rows)

Create a Temporary Table That Is LIKE Another Table

The following example creates a temporary table called TEMPEVENT, which inherits its columns from the EVENT table.

```
create temp table tempevent(like event);
```

This table also inherits the DISTKEY and SORTKEY attributes of its parent table:

```
select "column", type, encoding, distkey, sortkey
from pg_table_def where tablename = 'tempevent';
```

column	type	encoding	distkey	sortkey
eventid	integer	none	t	1
venueid	smallint	none	f	0
catid	smallint	none	f	0
dateid	smallint	none	f	0
eventname	character varying(200)	none	f	0
starttime	timestamp without time zone	none	f	0

(6 rows)

Create a Table with an IDENTITY Column

The following example creates a table named VENUE_IDENT, which has an IDENTITY column named VENUEID. This column starts with 0 and increments by 1 for each record. VENUEID is also declared as the primary key of the table.

```
create table venue_ident(venueid bigint identity(0, 1),
venueid varchar(100),
venuecity varchar(30),
venuestate char(2),
venuestate integer,
primary key(venueid));
```

Create a Table with DEFAULT Column Values

The following example creates a CATEGORYDEF table that declares default values for each column:

```
create table categorydef(
catid smallint not null default 0,
catgroup varchar(10) default 'Special',
catname varchar(10) default 'Other',
catdesc varchar(50) default 'Special events',
primary key(catid));

insert into categorydef values(default,default,default,default);

select * from categorydef;
```

catid	catgroup	catname	catdesc
0	Special	Other	Special events

(1 row)

DISTSTYLE, DISTKEY, and SORTKEY Options

The following example shows how the DISTKEY, SORTKEY, and DISTSTYLE options work. In this example, COL1 is the distribution key; therefore, the distribution style must be either set to KEY or not set. By default, the table has no sort key and so is not sorted:

```
create table t1(col1 int distkey, col2 int) diststyle key;
```

The result is as follows:

```
select "column", type, encoding, distkey, sortkey
from pg_table_def where tablename = 't1';
```

column	type	encoding	distkey	sortkey
col1	integer	none	t	0
col2	integer	none	f	0

In the following example, the same column is defined as the distribution key and the sort key. Again, the distribution style must be either set to KEY or not set.

```
create table t2(col1 int distkey sortkey, col2 int);
```

The result is as follows:

```
select "column", type, encoding, distkey, sortkey
from pg_table_def where tablename = 't2';
```

column	type	encoding	distkey	sortkey
col1	integer	none	t	1
col2	integer	none	f	0

In the following example, no column is set as the distribution key, COL2 is set as the sort key, and the distribution style is set to ALL:

```
create table t3(col1 int, col2 int sortkey) diststyle all;
```

The result is as follows:

```
select "column", type, encoding, distkey, sortkey
from pg_table_def where tablename = 't3';
```

Column	Type	Encoding	DistKey	SortKey
col1	integer	none	f	0
col2	integer	none	f	1

In the following example, the distribution style is set to EVEN and no sort key is defined explicitly; therefore the table is distributed evenly but is not sorted.

```
create table t4(col1 int, col2 int) diststyle even;
```

The result is as follows:

```
select "column", type, encoding, distkey, sortkey
from pg_table_def where tablename = 't4';
```

column	type	encoding	distkey	sortkey
col1	integer	none	f	0
col2	integer	none	f	0

CREATE TABLE AS

Topics

- [Syntax \(p. 389\)](#)
- [Parameters \(p. 390\)](#)
- [CTAS Usage Notes \(p. 392\)](#)
- [CTAS Examples \(p. 395\)](#)

Creates a new table based on a query. The owner of this table is the user that issues the command.

The new table is loaded with data defined by the query in the command. The table columns have names and data types associated with the output columns of the query. The CREATE TABLE AS (CTAS) command creates a new table and evaluates the query to load the new table.

Syntax

```
CREATE [ [LOCAL ] { TEMPORARY | TEMP } ]
```

```
TABLE table_name
[ ( column_name [, ... ] ) ]
[ table_attributes ]
[ BACKUP { YES | NO } ]
AS query

where table_attributes are:
[ DISTSTYLE { EVEN | ALL | KEY } ]
[ DISTKEY ( distkey_identifier ) ]
[ [ { COMPOUND | INTERLEAVED } ] SORTKEY ( column_name [, ...] ) ]
```

Parameters

LOCAL

Although this optional keyword is accepted in the statement, it has no effect in Amazon Redshift.

TEMPORARY | TEMP

Creates a temporary table. A temporary table is automatically dropped at the end of the session in which it was created.

table_name

The name of the table to be created.

Important

If you specify a table name that begins with '#', the table will be created as a temporary table. For example:

```
create table #newtable (id) as select * from oldtable;
```

The maximum table name length is 127 bytes; longer names are truncated to 127 bytes. Amazon Redshift enforces a maximum limit of 9,900 permanent tables per cluster. The table name can be qualified with the database and schema name, as the following table shows.

```
create table tickit.public.test (c1) as select * from oldtable;
```

In this example, `tickit` is the database name and `public` is the schema name. If the database or schema does not exist, the statement returns an error.

If a schema name is given, the new table is created in that schema (assuming the creator has access to the schema). The table name must be a unique name for that schema. If no schema is specified, the table is created using the current database schema. If you are creating a temporary table, you cannot specify a schema name, since temporary tables exist in a special schema.

Multiple temporary tables with the same name are allowed to exist at the same time in the same database if they are created in separate sessions. These tables are assigned to different schemas.

column_name

The name of a column in the new table. If no column names are provided, the column names are taken from the output column names of the query. Default column names are used for expressions.

DISTSTYLE { EVEN | KEY | ALL }

Defines the data distribution style for the whole table. Amazon Redshift distributes the rows of a table to the compute nodes according the distribution style specified for the table.

The distribution style that you select for tables affects the overall performance of your database. For more information, see [Choosing a Data Distribution Style \(p. 110\)](#).

- **EVEN:** The data in the table is spread evenly across the nodes in a cluster in a round-robin distribution. Row IDs are used to determine the distribution, and roughly the same number of rows are distributed to each node. This is the default distribution method.

- **KEY:** The data is distributed by the values in the DISTKEY column. When you set the joining columns of joining tables as distribution keys, the joining rows from both tables are collocated on the compute nodes. When data is collocated, the optimizer can perform joins more efficiently. If you specify DISTSTYLE KEY, you must name a DISTKEY column.
- **ALL:** A copy of the entire table is distributed to every node. This distribution style ensures that all the rows required for any join are available on every node, but it multiplies storage requirements and increases the load and maintenance times for the table. ALL distribution can improve execution time when used with certain dimension tables where KEY distribution is not appropriate, but performance improvements must be weighed against maintenance costs.

DISTKEY (*column*)

Specifies a column name or positional number for the distribution key. Use the name specified in either the optional column list for the table or the select list of the query. Alternatively, use a positional number, where the first column selected is 1, the second is 2, and so on. Only one column in a table can be the distribution key:

- If you declare a column as the DISTKEY column, DISTSTYLE must be set to KEY or not set at all.
- If you do not declare a DISTKEY column, you can set DISTSTYLE to EVEN.
- If you don't specify DISTKEY or DISTSTYLE, CTAS determines the distribution style for the new table based on the query plan for the SELECT clause. For more information, see [Inheritance of Column and Table Attributes \(p. 392\)](#).

You can define the same column as the distribution key and the sort key; this approach tends to accelerate joins when the column in question is a joining column in the query.

[{ COMPOUND | INTERLEAVED }] SORTKEY (*column_name* [, ...])

Specifies one or more sort keys for the table. When data is loaded into the table, the data is sorted by the columns that are designated as sort keys.

You can optionally specify COMPOUND or INTERLEAVED sort style. The default is COMPOUND. For more information, see [Choosing Sort Keys \(p. 122\)](#).

You can define a maximum of 400 COMPOUND SORTKEY columns or 8 INTERLEAVED SORTKEY columns per table.

If you don't specify SORTKEY, CTAS determines the sort keys for the new table based on the query plan for the SELECT clause. For more information, see [Inheritance of Column and Table Attributes \(p. 392\)](#).

COMPOUND

Specifies that the data is sorted using a compound key made up of all of the listed columns, in the order they are listed. A compound sort key is most useful when a query scans rows according to the order of the sort columns. The performance benefits of sorting with a compound key decrease when queries rely on secondary sort columns. You can define a maximum of 400 COMPOUND SORTKEY columns per table.

INTERLEAVED

Specifies that the data is sorted using an interleaved sort key. A maximum of eight columns can be specified for an interleaved sort key.

An interleaved sort gives equal weight to each column, or subset of columns, in the sort key, so queries do not depend on the order of the columns in the sort key. When a query uses one or more secondary sort columns, interleaved sorting significantly improves query performance. Interleaved sorting carries a small overhead cost for data loading and vacuuming operations.

BACKUP { YES | NO }

A clause that specifies whether the table should be included in automated and manual cluster snapshots. For tables, such as staging tables, that won't contain critical data, specify BACKUP NO to save processing time when creating snapshots and restoring from snapshots and to reduce storage space on Amazon Simple Storage Service. The BACKUP NO setting has no effect on automatic replication of data to other nodes within the cluster, so tables with BACKUP NO specified are restored in the event of a node failure. The default is BACKUP YES.

AS query

Any query (SELECT statement) that Amazon Redshift supports.

CTAS Usage Notes

Limits

Amazon Redshift enforces a maximum limit of 9,900 permanent tables.

The maximum number of characters for a table name is 127.

The maximum number of columns you can define in a single table is 1,600.

Inheritance of Column and Table Attributes

CREATE TABLE AS (CTAS) tables don't inherit constraints, identity columns, default column values, or the primary key from the table that they were created from.

You can't specify column compression encodings for CTAS tables. Amazon Redshift automatically assigns compression encoding as follows:

- Columns that are defined as sort keys are assigned RAW compression.
- Columns that are defined as BOOLEAN, REAL, or DOUBLE PRECISION data types are assigned RAW compression.
- All other columns are assigned LZO compression.

For more information, see [Compression Encodings \(p. 101\)](#) and [Data Types \(p. 247\)](#).

To explicitly assign column encodings, use [CREATE TABLE \(p. 378\)](#)

CTAS determines distribution style and sort key for the new table based on the query plan for the SELECT clause.

If the SELECT clause is a simple select operation from a single table, without a limit clause, order by clause, or group by clause, then CTAS uses the source table's distribution style and sort key.

For complex queries, such as queries that include joins, aggregations, an order by clause, or a limit clause, CTAS makes a best effort to choose the optimal distribution style and sort key based on the query plan.

Note

For best performance with large data sets or complex queries, we recommend testing using typical data sets.

You can often predict which distribution key and sort key CTAS will choose by examining the query plan to see which columns, if any, the query optimizer chooses for sorting and distributing data. If the top node of the query plan is a simple sequential scan from a single table (XN Seq Scan), then CTAS generally uses the source table's distribution style and sort key. If the top node of the query plan is anything other a sequential scan (such as XN Limit, XN Sort, XN HashAggregate, and so on), CTAS makes a best effort to choose the optimal distribution style and sort key based on the query plan.

For example, suppose you create five tables using the following types of SELECT clauses:

- A simple select statement
- A limit clause
- An order by clause using LISTID

- An order by clause using QTYSOLD
- A SUM aggregate function with a group by clause.

The following examples show the query plan for each CTAS statement.

```
explain create table sales1_simple as select listid, dateid, qtysold from
sales;
          QUERY PLAN
-----
XN Seq Scan on sales  (cost=0.00..1724.56 rows=172456 width=8)
(1 row)

explain create table sales2_limit as select listid, dateid, qtysold from
sales limit 100;
          QUERY PLAN
-----
XN Limit  (cost=0.00..1.00 rows=100 width=8)
-> XN Seq Scan on sales  (cost=0.00..1724.56 rows=172456 width=8)
(2 rows)

explain create table sales3_orderbylistid as select listid, dateid, qtysold
from sales order by listid;
          QUERY PLAN
-----
XN Sort  (cost=1000000016724.67..1000000017155.81 rows=172456 width=8)
  Sort Key: listid
  -> XN Seq Scan on sales  (cost=0.00..1724.56 rows=172456 width=8)
(3 rows)

explain create table sales4_orderbyqty as select listid, dateid, qtysold from
sales order by qtysold;
          QUERY PLAN
-----
XN Sort  (cost=1000000016724.67..1000000017155.81 rows=172456 width=8)
  Sort Key: qtysold
  -> XN Seq Scan on sales  (cost=0.00..1724.56 rows=172456 width=8)
(3 rows)

explain create table sales5_groupby as select listid, dateid, sum(qtysold)
from sales group by listid, dateid;
          QUERY PLAN
-----
XN HashAggregate  (cost=3017.98..3226.75 rows=83509 width=8)
-> XN Seq Scan on sales  (cost=0.00..1724.56 rows=172456 width=8)
(2 rows)
```

To view the distribution key and sortkey for each table, query the PG_TABLE_DEF system catalog table, as shown following.

```
select * from pg_table_def where tablename like 'sales%';

  tablename      | column      | distkey | sortkey
-----+-----+-----+-----
```

sales	salesid	f	0
sales	listid	t	0
sales	sellerid	f	0
sales	buyerid	f	0
sales	eventid	f	0
sales	dateid	f	1
sales	qtysold	f	0
sales	pricepaid	f	0
sales	commission	f	0
sales	saletime	f	0
sales1_simple	listid	t	0
sales1_simple	dateid	f	1
sales1_simple	qtysold	f	0
sales2_limit	listid	f	0
sales2_limit	dateid	f	0
sales2_limit	qtysold	f	0
sales3_orderbylistid	listid	t	1
sales3_orderbylistid	dateid	f	0
sales3_orderbylistid	qtysold	f	0
sales4_orderbyqty	listid	t	0
sales4_orderbyqty	dateid	f	0
sales4_orderbyqty	qtysold	f	1
sales5_groupby	listid	f	0
sales5_groupby	dateid	f	0
sales5_groupby	sum	f	0

The following table summarizes the results. For simplicity, we omit cost, rows, and width details from the explain plan.

Table	CTAS Select Statement	Explain Plan Top Node	Dist Key	Sort Key
S1_SIMPLE	select listid, dateid, qtysold from sales	XN Seq Scan on sales ...	LISTID	DATEID
S2_LIMIT	select listid, dateid, qtysold from sales limit 100	XN Limit ...	None (EVEN)	None
S3_ORDERBYLISTID	select listid, dateid, qtysold from sales order by listid	XN Sort ... Sort Key: listid	LISTID	LISTID
S4_ORDERBYQTY	select listid, dateid, qtysold from sales order by qtysold	XN Sort ... Sort Key: qtysold	LISTID	QTYSOLD
S5_GROUPBY	select listid, dateid, sum(qtysold) from sales group by listid, dateid	XN HashAggregate ...	None (EVEN)	None

You can explicitly specify distribution style and sort key in the CTAS statement. For example, the following statement creates a table using EVEN distribution and specifies SALESID as the sort key.

```
create table sales_disteven
```

```
diststyle even
sortkey (salesid)
as
select eventid, venueid, dateid, eventname
from event;
```

Distribution of Incoming Data

When the hash distribution scheme of the incoming data matches that of the target table, no physical distribution of the data is actually necessary when the data is loaded. For example, if a distribution key is set for the new table and the data is being inserted from another table that is distributed on the same key column, the data is loaded in place, using the same nodes and slices. However, if the source and target tables are both set to EVEN distribution, data is redistributed into the target table.

Automatic ANALYZE Operations

Amazon Redshift automatically analyzes tables that you create with CTAS commands. You do not need to run the ANALYZE command on these tables when they are first created. If you modify them, you should analyze them in the same way as other tables.

CTAS Examples

The following example creates a table called EVENT_BACKUP for the EVENT table:

```
create table event_backup as select * from event;
```

The resulting table inherits the distribution and sort keys from the EVENT table.

```
select "column", type, encoding, distkey, sortkey
from pg_table_def where tablename = 'event_backup';
```

column	type	encoding	distkey	sortkey
catid	smallint	none	false	0
dateid	smallint	none	false	1
eventid	integer	none	true	0
eventname	character varying(200)	none	false	0
starttime	timestamp without time zone	none	false	0
venueid	smallint	none	false	0

The following command creates a new table called EVENTDISTSORT by selecting four columns from the EVENT table. The new table is distributed by EVENTID and sorted by EVENTID and DATEID:

```
create table eventdistsort
distkey (1)
sortkey (1,3)
as
select eventid, venueid, dateid, eventname
from event;
```

The result is as follows:

```
select "column", type, encoding, distkey, sortkey
from pg_table_def where tablename = 'eventdistsort';
```

column	type	encoding	distkey	sortkey
eventid	integer	none	t	1
venueid	smallint	none	f	0
dateid	smallint	none	f	2
eventname	character varying(200)	none	f	0

You could create exactly the same table by using column names for the distribution and sort keys. For example:

```
create table eventdistsort1
distkey (eventid)
sortkey (eventid, dateid)
as
select eventid, venueid, dateid, eventname
from event;
```

The following statement applies even distribution to the table but does not define an explicit sort key:

```
create table eventdisteven
diststyle even
as
select eventid, venueid, dateid, eventname
from event;
```

The table does not inherit the sort key from the EVENT table (EVENTID) because EVEN distribution is specified for the new table. The new table has no sort key and no distribution key.

```
select "column", type, encoding, distkey, sortkey
from pg_table_def where tablename = 'eventdisteven';
```

column	type	encoding	distkey	sortkey
eventid	integer	none	f	0
venueid	smallint	none	f	0
dateid	smallint	none	f	0
eventname	character varying(200)	none	f	0

The following statement applies even distribution and defines a sort key:

```
create table eventdistevensort diststyle even sortkey (venueid)
as select eventid, venueid, dateid, eventname from event;
```

The resulting table has a sort key but no distribution key.

```
select "column", type, encoding, distkey, sortkey
from pg_table_def where tablename = 'eventdistevensort';
```

column	type	encoding	distkey	sortkey
eventid	integer	none	f	0
venueid	smallint	none	f	1
dateid	smallint	none	f	0

```
eventname | character varying(200) | none | f | 0
```

The following statement redistributes the EVENT table on a different key column from the incoming data, which is sorted on the EVENTID column, and defines no SORTKEY column; therefore the table is not sorted.

```
create table venuedistevent distkey(venueid)
as select * from event;
```

The result is as follows:

```
select "column", type, encoding, distkey, sortkey
from pg_table_def where tablename = 'venuedistevent';
```

column	type	encoding	distkey	sortkey
eventid	integer	none	f	0
venueid	smallint	none	t	0
catid	smallint	none	f	0
dateid	smallint	none	f	0
eventname	character varying(200)	none	f	0
starttime	timestamp without time zone	none	f	0

CREATE USER

Creates a new database user account. You must be a database superuser to execute this command.

Syntax

```
CREATE USER name
[ [ WITH] option [ ... ] ]

where option can be:

CREATEDB | NOCREATEDB
| CREATEUSER | NOCREATEUSER
| IN GROUP groupname [ , ... ]
| PASSWORD { 'password' | 'md5hash' }
| VALID UNTIL 'abstime'
| CONNECTION LIMIT { limit | UNLIMITED }
```

Parameters

name

The name of the user account to create. For more information about valid names, see [Names and Identifiers \(p. 246\)](#).

CREATEDB | NOCREATEDB

The CREATEDB option allows the new user account to create databases. The default is NOCREATEDB.

CREATEUSER | NOCREATEUSER

The CREATEUSER option creates a superuser with all database privileges, including CREATE USER. The default is NOCREATEUSER. For more information, see [Superusers \(p. 94\)](#).

IN GROUP *groupname*

Specifies the name of an existing group that the user belongs to. Multiple group names may be listed.

PASSWORD { *'password' | 'md5hash'* }

Sets the user's password.

You can specify the password in clear text or as an MD5 hash string.

Note

When you launch a new cluster using the AWS Management Console, AWS CLI, or Amazon Redshift API, you must supply a clear text password for the master database user. You can change the password later by using [ALTER USER](#) (p. 306).

For clear text, the password must meet the following constraints:

- It must be 8 to 64 characters in length.
- It must contain at least one uppercase letter, one lowercase letter, and one number.
- It can use any printable ASCII characters (ASCII code 33 to 126) except ' (single quote), " (double quote), \, /, @, or space.

As a more secure alternative to passing the CREATE USER password parameter as clear text, you can specify an MD5 hash of a string that includes the password and user name.

Note

When you specify an MD5 hash string, the CREATE USER command checks for a valid MD5 hash string, but it doesn't validate the password portion of the string. It is possible in this case to create a password, such as an empty string, that you can't use to log on to the database.

To specify an MD5 password, follow these steps:

1. Concatenate the password and user name.

For example, for password `ez` and user `user1`, the concatenated string is `ezuser1`.

2. Convert the concatenated string into a 32-character MD5 hash string. You can use any MD5 utility to create the hash string. The following example uses the Amazon Redshift [MD5 Function](#) (p. 634) and the concatenation operator (`||`) to return a 32-character MD5-hash string.

```
select md5('ez' || 'user1');
md5
-----
37af65b44378ac7a5a1fb187a1969c71
```

3. Concatenate 'md5' in front of the MD5 hash string and provide the concatenated string as the *md5hash* argument.

```
create user user1 password 'md537af65b44378ac7a5a1fb187a1969c71';
```

4. Log on to the database using the user name and password.

For this example, log on as `user1` with password `ez`.

VALID UNTIL *abstime*

The VALID UNTIL option sets an absolute time after which the user account password is no longer valid. By default the password has no time limit.

CONNECTION LIMIT { *limit* | UNLIMITED }

The maximum number of database connections the user is permitted to have open concurrently. The limit is not enforced for super users. Use the UNLIMITED keyword to permit the maximum

number of concurrent connections. The limit of concurrent connections for each cluster is 500. A limit on the number of connections for each database might also apply. For more information, see [CREATE DATABASE \(p. 371\)](#). The default is UNLIMITED. To view current connections, query the [STV_SESSIONS \(p. 764\)](#) system view.

Note

If both user and database connection limits apply, an unused connection slot must be available that is within both limits when a user attempts to connect.

Usage Notes

By default, all users have CREATE and USAGE privileges on the PUBLIC schema. To disallow users from creating objects in the PUBLIC schema of a database, use the REVOKE command to remove that privilege.

Examples

The following command creates a user account named danny, with the password "abcD1234", database connection privileges, and a connection limit of 30.

```
create user dbuser with password 'abcD1234' createdb connection limit 30;
```

Query the PG_USER_INFO catalog table to view details about a database user.

```
select * from pg_user_info;
username | usesysid | usecreatedb | usesuper | usecatupd | passwd |
valuntil | useconfig | useconlimit
-----+-----+-----+-----+-----+-----+
+-----+-----+-----+-----+-----+-----+
rdsdb   |         1 | true        | true     | true      | ***** |
infinity |         |            |          |           |          |
adminuser |       100 | true        | true     | false     | ***** |
|         | UNLIMITED |          |           |          |          |
danny   |       102 | true        | false    | false     | ***** |
|         | 30         |          |           |          |          |
```

In the following example, the account password is valid until June 10, 2017.

```
create user dbuser with password 'abcD1234' valid until '2017-06-10';
```

The following example creates a user with a case-sensitive password that contains special characters.

```
create user newman with password '@AbC4321!';
```

To use a backslash (\) in your MD5 password, escape the backslash with a backslash in your source string. The following example creates a user named slashpass with a single backslash (\) as the password.

```
select md5('\\' || 'slashpass');
md5
-----
0c983d1a624280812631c5389e60d48c
```

```
create user slashpass password 'md50c983d1a624280812631c5389e60d48c';
```

CREATE VIEW

Creates a view in a database. The view is not physically materialized; the query that defines the view is run every time the view is referenced in a query.

Syntax

```
CREATE [ OR REPLACE ] VIEW name [ ( column_name [, ...] ) ] AS query
```

Parameters

OR REPLACE

If a view of the same name already exists, the view is replaced. You can only replace a view with a new query that generates the identical set of columns, using the same column names and data types. CREATE OR REPLACE VIEW locks the view for reads and writes until the operation completes.

name

The name of the view. If a schema name is given (such as `myschema.myview`) the view is created using the specified schema. Otherwise, the view is created in the current schema. The view name must be different from the name of any other view or table in the same schema.

If you specify a view name that begins with '#', the view will be created as a temporary view that is visible only in the current session.

For more information about valid names, see [Names and Identifiers \(p. 246\)](#). You cannot create tables or views in the system databases `template0`, `template1`, and `padb_harvest`.

column_name

Optional list of names to be used for the columns in the view. If no column names are given, the column names are derived from the query. The maximum number of columns you can define in a single view is 1,600.

query

A query (in the form of a SELECT statement) that evaluates to a table. This table defines the columns and rows in the view.

Note

You cannot update, insert into, or delete from a view.

Usage Notes

Having ownership of a view, or having privileges granted on a view, does not imply access to the underlying tables. You need to grant access to the underlying tables explicitly.

Examples

The following command creates a view called *myevent* from a table called `EVENT`:

```
create view myevent as select eventname from event
where eventname = 'LeAnn Rimes';
```

The following command creates a view called *myuser* from a table called *USERS*:

```
create view myuser as select lastname from users;
```

DEALLOCATE

Deallocates a prepared statement.

Syntax

```
DEALLOCATE [PREPARE] plan_name
```

Parameters

PREPARE

This keyword is optional and is ignored.

plan_name

The name of the prepared statement to deallocate.

Usage Notes

DEALLOCATE is used to deallocate a previously prepared SQL statement. If you do not explicitly deallocate a prepared statement, it is deallocated when the current session ends. For more information on prepared statements, see [PREPARE \(p. 429\)](#).

See Also

[EXECUTE \(p. 414\)](#), [PREPARE \(p. 429\)](#)

DECLARE

Defines a new cursor. Use a cursor to retrieve a few rows at a time from the result set of a larger query.

When the first row of a cursor is fetched, the entire result set is materialized on the leader node, in memory or on disk, if needed. Because of the potential negative performance impact of using cursors with large result sets, we recommend using alternative approaches whenever possible. For more information, see [Performance Considerations When Using Cursors \(p. 403\)](#).

You must declare a cursor within a transaction block. Only one cursor at a time can be open per session.

For more information, see [FETCH \(p. 419\)](#), [CLOSE \(p. 315\)](#).

Syntax

```
DECLARE cursor_name CURSOR FOR query
```

Parameters

cursor_name

Name of the new cursor.

query

A SELECT statement that populates the cursor.

DECLARE CURSOR Usage Notes

If your client application uses an ODBC connection and your query creates a result set that is too large to fit in memory, you can stream the result set to your client application by using a cursor. When you use a cursor, the entire result set is materialized on the leader node, and then your client can fetch the results incrementally.

Note

To enable cursors in ODBC for Microsoft Windows, enable the **Use Declare/Fetch** option in the ODBC DSN you use for Amazon Redshift. We recommend setting the ODBC cache size, using the **Cache Size** field in the ODBC DSN options dialog, to 4,000 or greater on multi-node clusters to minimize round trips. On a single-node cluster, set Cache Size to 1,000.

Because of the potential negative performance impact of using cursors, we recommend using alternative approaches whenever possible. For more information, see [Performance Considerations When Using Cursors \(p. 403\)](#).

Amazon Redshift cursors are supported with the following limitations:

- Only one cursor at a time can be open per session.
- Cursors must be used within a transaction (BEGIN ... END).
- The maximum cumulative result set size for all cursors is constrained based on the cluster node type. If you need larger result sets, you can resize to an XL or 8XL node configuration.

For more information, see [Cursor Constraints \(p. 402\)](#).

Cursor Constraints

When the first row of a cursor is fetched, the entire result set is materialized on the leader node. If the result set does not fit in memory, it is written to disk as needed. To protect the integrity of the leader node, Amazon Redshift enforces constraints on the size of all cursor result sets, based on the cluster's node type.

The following table shows the maximum total result set size for each cluster node type. Maximum result set sizes are in megabytes.

Node type	Maximum result set per cluster (MB)
DS1 or DS2 XL single node	64000
DS1 or DS2 XL multiple nodes	1800000
DS1 or DS2 8XL multiple nodes	14400000
DC1 Large single node	16000
DC1 Large multiple nodes	384000
DC1 8XL multiple nodes	3000000

To view the active cursor configuration for a cluster, query the [STV_CURSOR_CONFIGURATION \(p. 756\)](#) system table as a superuser. To view the state of active cursors, query the [STV_ACTIVE_CURSORS \(p. 753\)](#) system table. Only the rows for a user's own cursors are visible to the user, but a superuser can view all cursors.

Performance Considerations When Using Cursors

Because cursors materialize the entire result set on the leader node before beginning to return results to the client, using cursors with very large result sets can have a negative impact on performance. We strongly recommend against using cursors with very large result sets. In some cases, such as when your application uses an ODBC connection, cursors might be the only feasible solution. If possible, we recommend using these alternatives:

- Use [UNLOAD \(p. 471\)](#) to export a large table. When you use UNLOAD, the compute nodes work in parallel to transfer the data directly to data files on Amazon Simple Storage Service. For more information, see [Unloading Data \(p. 185\)](#).
- Set the JDBC fetch size parameter in your client application. If you use a JDBC connection and you are encountering client-side out-of-memory errors, you can enable your client to retrieve result sets in smaller batches by setting the JDBC fetch size parameter. For more information, see [Setting the JDBC Fetch Size Parameter \(p. 237\)](#).

DECLARE CURSOR Example

The following example declares a cursor named LOLLAPALOOZA to select sales information for the Lollapalooza event, and then fetches rows from the result set using the cursor:

```
-- Begin a transaction
begin;

-- Declare a cursor
declare lollapalooza cursor for
select eventname, starttime, pricepaid/qtysold as costperticket, qtysold
from sales, event
where sales.eventid = event.eventid
and eventname='Lollapalooza';

-- Fetch the first 5 rows in the cursor lollapalooza:
fetch forward 5 from lollapalooza;

 eventname |          starttime          | costperticket | qtysold
-----+-----+-----+-----
Lollapalooza | 2008-05-01 19:00:00 | 92.00000000 | 3
Lollapalooza | 2008-11-15 15:00:00 | 222.00000000 | 2
Lollapalooza | 2008-04-17 15:00:00 | 239.00000000 | 3
Lollapalooza | 2008-04-17 15:00:00 | 239.00000000 | 4
Lollapalooza | 2008-04-17 15:00:00 | 239.00000000 | 1
(5 rows)

-- Fetch the next row:
fetch next from lollapalooza;

 eventname |          starttime          | costperticket | qtysold
-----+-----+-----+-----
Lollapalooza | 2008-10-06 14:00:00 | 114.00000000 | 2

-- Close the cursor and end the transaction:
close lollapalooza;
```

```
commit;
```

DELETE

Deletes rows from tables.

Note

The maximum size for a single SQL statement is 16 MB.

Syntax

```
DELETE [ FROM ] table_name  
[ { USING } table_name, ... ]  
[ WHERE condition ]
```

Parameters

FROM

The FROM keyword is optional, except when the USING clause is specified. The statements `delete from event;` and `delete event;` are equivalent operations that remove all of the rows from the EVENT table.

Note

To delete all the rows from a table, [TRUNCATE \(p. 470\)](#) the table. TRUNCATE is much more efficient than DELETE and does not require a VACUUM and ANALYZE. However, be aware that TRUNCATE commits the transaction in which it is run.

table_name

A temporary or persistent table. Only the owner of the table or a user with DELETE privilege on the table may delete rows from the table.

Consider using the TRUNCATE command for fast unqualified delete operations on large tables; see [TRUNCATE \(p. 470\)](#).

Note

After deleting a large number of rows from a table:

- Vacuum the table to reclaim storage space and resort rows.
- Analyze the table to update statistics for the query planner.

USING *table_name*, ...

The USING keyword is used to introduce a table list when additional tables are referenced in the WHERE clause condition. For example, the following statement deletes all of the rows from the EVENT table that satisfy the join condition over the EVENT and SALES tables. The SALES table must be explicitly named in the FROM list:

```
delete from event using sales where event.eventid=sales.eventid;
```

If you repeat the target table name in the USING clause, the DELETE operation runs a self-join. You can use a subquery in the WHERE clause instead of the USING syntax as an alternative way to write the same query.

WHERE *condition*

Optional clause that limits the deletion of rows to those that match the condition. For example, the condition can be a restriction on a column, a join condition, or a condition based on the result of a query. The query can reference tables other than the target of the DELETE command. For example:

```
delete from t1
```



```
where col1 in(select col2 from t2);
```

If no condition is specified, all of the rows in the table are deleted.

Examples

Delete all of the rows from the CATEGORY table:

```
delete from category;
```

Delete rows with CATID values between 0 and 9 from the CATEGORY table:

```
delete from category
where catid between 0 and 9;
```

Delete rows from the LISTING table whose SELLERID values do not exist in the SALES table:

```
delete from listing
where listing.sellerid not in(select sales.sellerid from sales);
```

The following two queries both delete one row from the CATEGORY table, based on a join to the EVENT table and an additional restriction on the CATID column:

```
delete from category
using event
where event.catid=category.catid and category.catid=9;
```

```
delete from category
where catid in
(select category.catid from category, event
where category.catid=event.catid and category.catid=9);
```

DROP DATABASE

Drops a database.

Syntax

```
DROP DATABASE database_name
```

Parameters

database_name

Name of the database to be dropped. You cannot drop the dev, padb_harvest, template0, or template1 databases, and you cannot drop the current database.

Examples

The following example drops a database named TICKIT_TEST:

```
drop database tickit_test;
```

DROP FUNCTION

Removes a user-defined function (UDF) from the database. The function's signature, or list of argument data types, must be specified because multiple functions can exist with the same name but different signatures. You cannot drop an Amazon Redshift built-in function.

This command is not reversible.

Syntax

```
DROP FUNCTION name  
( [arg_name] arg_type [, ...] )  
[ CASCADE | RESTRICT ]
```

Parameters

name

The name of the function to be removed.

arg_name

The name of an input argument. DROP FUNCTION ignores argument names, because only the argument data types are needed to determine the function's identity.

arg_type

The data type of the input argument. You can supply a comma-separated list with a maximum of 32 data types.

CASCADE

Keyword specifying to automatically drop objects that depend on the function.

RESTRICT

Keyword specifying that if any objects depend on the function, do not drop the function and return a message. This action is the default.

Examples

The following example drops the function named `f_sqrt`:

```
drop function f_sqrt(int);
```

To remove a function that has dependencies, use the CASCADE option, as shown in the following example:

```
drop function f_sqrt(int) cascade;
```

DROP GROUP

Deletes a user group. This command is not reversible. This command does not delete the individual users in a group.

See DROP USER to delete an individual user.

Syntax

```
DROP GROUP name
```

Parameter

name

Name of the user group to delete.

Example

The following example deletes the GUEST user group:

```
drop group guests;
```

You cannot drop a group if the group has any privileges on an object. If you attempt to drop such a group, you will receive the following error.

```
ERROR: group "guest" cannot be dropped because the group has a privilege on  
some object
```

If the group has privileges for an object, first revoke the privileges before dropping the group. The following example revokes all privileges on all tables in the `public` schema from the `GUEST` user group, and then drops the group.

```
revoke all on all tables in schema public from group guest;  
drop group guests;
```

DROP LIBRARY

Removes a custom Python library from the database. Only the library owner or a superuser can drop a library. `DROP LIBRARY` cannot be run inside a transaction block (`BEGIN ... END`). For more information, see [CREATE LIBRARY \(p. 375\)](#).

This command is not reversible. The `DROP LIBRARY` command commits immediately. If a UDF that depends on the library is running concurrently, the UDF might fail, even if the UDF is running within a transaction.

Syntax

```
DROP LIBRARY library_name
```

Parameters

library_name

The name of the library.

DROP SCHEMA

Deletes a schema. This command is not reversible.

Syntax

```
DROP SCHEMA [ IF EXISTS ] name [ , ... ] [ CASCADE | RESTRICT ]
```

Parameters

IF EXISTS

Clause that indicates that if the specified schema doesn't exist, the command should make no changes and return a message that the schema doesn't exist, rather than terminating with an error.

This clause is useful when scripting, so the script doesn't fail if DROP SCHEMA runs against a nonexistent schema.

name

Name of the schema to drop.

CASCADE

Keyword that indicates to automatically drop all objects in the schema, such as tables and functions.

RESTRICT

Keyword that indicates not to drop the schema if it contains any objects. This action is the default.

Example

The following example deletes a schema named S_SALES. This example uses RESTRICT as a safety mechanism so that the schema will not be deleted if it contains any objects. In this case, you would need to delete the schema objects before deleting the schema:

```
drop schema s_sales restrict;
```

The following example deletes a schema named S_SALES and all objects that depend on that schema:

```
drop schema s_sales cascade;
```

The following example either drops the S_SALES schema if it exists, or does nothing and returns a message if it does not:

```
drop schema if exists s_sales;
```

DROP TABLE

Removes a table from a database. Only the owner of the table, the schema owner, or a superuser can drop a table.

If you are trying to empty a table of rows, without removing the table, use the DELETE or TRUNCATE command.

DROP TABLE removes constraints that exist on the target table. Multiple tables can be removed with a single DROP TABLE command.

Syntax

```
DROP TABLE [ IF EXISTS ] name [, ...] [ CASCADE | RESTRICT ]
```

Parameters

IF EXISTS

Clause that indicates that if the specified table doesn't exist, the command should make no changes and return a message that the table doesn't exist, rather than terminating with an error.

This clause is useful when scripting, so the script doesn't fail if DROP TABLE runs against a nonexistent table.

name

Name of the table to drop.

CASCADE

Clause that indicates to automatically drop objects that depend on the table, such as views.

RESTRICT

Clause that indicates not to drop the table if any objects depend on it. This action is the default.

Examples

Dropping a Table with No Dependencies

The following example creates and drops a table called FEEDBACK that has no dependencies:

```
create table feedback(a int);  
  
drop table feedback;
```

If a table contains any columns that are references to other tables, Amazon Redshift displays a message such as the following, advising you to use the CASCADE option to also drop dependent objects:

```
ERROR: cannot drop table category because other objects depend on it  
HINT: Use DROP ... CASCADE to drop the dependent objects too.
```

Dropping Two Tables Simultaneously

The following command set creates a FEEDBACK table and a BUYERS table and then drops both tables with a single command:

```
create table feedback(a int);  
  
create table buyers(a int);  
  
drop table feedback, buyers;
```

Dropping a Table with a Dependency

The following steps show how to drop a table called FEEDBACK using the CASCADE switch.

First, create a simple table called FEEDBACK using the CREATE TABLE command:

```
create table feedback(a int);
```

Next, use the CREATE VIEW command to create a view called FEEDBACK_VIEW that relies on the table FEEDBACK:

```
create view feedback_view as select * from feedback;
```

The following example drops the table FEEDBACK and also drops the view FEEDBACK_VIEW, because FEEDBACK_VIEW is dependent on the table FEEDBACK:

```
drop table feedback cascade;
```

Viewing the Dependencies for a Table

You can create a view that holds the dependency information for all of the tables in a database. Before dropping a given table, query this view to determine if the table has dependencies.

Type the following command to create a FIND_DEPEND view, which joins dependencies with object references:

```
create view find_depend as
select distinct c_p.oid as tbloid,
n_p.nspname as schemaname, c_p.relname as name,
n_c.nspname as refbyschemaname, c_c.relname as refbyname,
c_c.oid as viewoid
from pg_catalog.pg_class c_p
join pg_catalog.pg_depend d_p
on c_p.relfilenode = d_p.refobjid
join pg_catalog.pg_depend d_c
on d_p.objid = d_c.objid
join pg_catalog.pg_class c_c
on d_c.refobjid = c_c.relfilenode
left outer join pg_namespace n_p
on c_p.relnamespace = n_p.oid
left outer join pg_namespace n_c
on c_c.relnamespace = n_c.oid
where d_c.deptype = 'i'::"char"
and c_c.relkind = 'v'::"char";
```

Now create a SALES_VIEW from the SALES table:

```
create view sales_view as select * from sales;
```

Now query the FIND_DEPEND view to view dependencies in the database. Limit the scope of the query to the PUBLIC schema, as shown in the following code:

```
select * from find_depend
where refbyschemaname='public'
order by name;
```

This query returns the following dependencies, showing that the SALES_VIEW view is also dropped by using the CASCADE option when dropping the SALES table:

tbloid	schemaname	name	viewoid	refbyschemaname	refbyname
100241	public	find_depend	100241	public	find_depend
100203	public	sales	100245	public	sales_view
100245	public	sales_view	100245	public	sales_view

(3 rows)

Dropping a Table Using IF EXISTS

The following example either drops the FEEDBACK table if it exists, or does nothing and returns a message if it does not:

```
drop table if exists feedback;
```

DROP USER

Drops a user from a database. Multiple users can be dropped with a single DROP USER command. You must be a database superuser to execute this command.

Syntax

```
DROP USER [ IF EXISTS ] name [, ... ]
```

Parameters

IF EXISTS

Clause that indicates that if the specified user account doesn't exist, the command should make no changes and return a message that the user account doesn't exist, rather than terminating with an error.

This clause is useful when scripting, so the script doesn't fail if DROP USER runs against a nonexistent user account.

name

Name of the user account to remove. You can specify multiple user accounts, with a comma separating each account name from the next.

Usage Notes

You cannot drop a user if the user owns any database object, such as a schema, database, table, or view, or if the user has any privileges on a table, database, or group. If you attempt to drop such a user, you will receive one of the following errors.

```
ERROR: user "username" cannot be dropped because the user owns some object
[SQL State=55006]
```

```
ERROR: user "username" cannot be dropped because the user has a privilege on
some object [SQL State=55006]
```

Note

Amazon Redshift checks only the current database before dropping a user. DROP USER doesn't return an error if the user owns database objects or has any privileges on objects in

another database. If you drop a user that owns objects in another database, the owner for those objects is changed to 'unknown'.

If a user owns an object, first drop the object or change its ownership to another user before dropping the original user. If the user has privileges for an object, first revoke the privileges before dropping the user. The following example shows dropping an object, changing ownership, and revoking privileges before dropping the user.

```
drop database dwdatabase;  
alter schema owner to dwadmin;  
revoke all on table dwtable from dwuser;  
drop user dwuser;
```

Examples

The following example drops a user account called danny:

```
drop user danny;
```

The following example drops two user accounts, danny and billybob:

```
drop user danny, billybob;
```

The following example drops the user account danny if it exists, or does nothing and returns a message if it does not:

```
drop user if exists danny;
```

DROP VIEW

Removes a view from the database. Multiple views can be dropped with a single DROP VIEW command. This command is not reversible.

Syntax

```
DROP VIEW [ IF EXISTS ] name [, ... ] [ CASCADE | RESTRICT ]
```

Parameters

IF EXISTS

Clause that indicates that if the specified view doesn't exist, the command should make no changes and return a message that the view doesn't exist, rather than terminating with an error.

This clause is useful when scripting, so the script doesn't fail if DROP VIEW runs against a nonexistent view.

name

Name of the view to be removed.

CASCADE

Clause that indicates to automatically drop objects that depend on the view, such as other views.

RESTRICT

Clause that indicates not to drop the view if any objects depend on it. This action is the default.

Examples

The following example drops the view called *event*:

```
drop view event;
```

To remove a view that has dependencies, use the `CASCADE` option. For example, say we start with a table called `EVENT`. We then create the `eventview` view of the `EVENT` table, using the `CREATE VIEW` command, as shown in the following example:

```
create view eventview as
select dateid, eventname, catid
from event where catid = 1;
```

Now, we create a second view called *myeventview*, that is based on the first view *eventview*:

```
create view myeventview as
select eventname, catid
from eventview where eventname <> ' ';
```

At this point, two views have been created: *eventview* and *myeventview*.

The *myeventview* view is a child view with *eventview* as its parent.

To delete the *eventview* view, the obvious command to use is the following:

```
drop view eventview;
```

Notice that if you run this command in this case, you will get the following error:

```
drop view eventview;
ERROR: cannot drop view eventview because other objects depend on it
HINT: Use DROP ... CASCADE to drop the dependent objects too.
```

To remedy this, execute the following command (as suggested in the error message):

```
drop view eventview cascade;
```

Both *eventview* and *myeventview* have now been dropped successfully.

The following example either drops the *eventview* view if it exists, or does nothing and returns a message if it does not:

```
drop view if exists eventview;
```

END

Commits the current transaction. Performs exactly the same function as the `COMMIT` command.

See [COMMIT \(p. 317\)](#) for more detailed documentation.

Syntax

```
END [ WORK | TRANSACTION ]
```

Parameters

WORK

Optional keyword.

TRANSACTION

Optional keyword; WORK and TRANSACTION are synonyms.

Examples

The following examples all end the transaction block and commit the transaction:

```
end;
```

```
end work;
```

```
end transaction;
```

After any of these commands, Amazon Redshift ends the transaction block and commits the changes.

EXECUTE

Executes a previously prepared statement.

Syntax

```
EXECUTE plan_name [ (parameter [, ...]) ]
```

Parameters

plan_name

Name of the prepared statement to be executed.

parameter

The actual value of a parameter to the prepared statement. This must be an expression yielding a value of a type compatible with the data type specified for this parameter position in the PREPARE command that created the prepared statement.

Usage Notes

EXECUTE is used to execute a previously prepared statement. Since prepared statements only exist for the duration of a session, the prepared statement must have been created by a PREPARE statement executed earlier in the current session.

If the previous PREPARE statement specified some parameters, a compatible set of parameters must be passed to the EXECUTE statement, or else Amazon Redshift will return an error. Unlike functions,

prepared statements are not overloaded based on the type or number of specified parameters; the name of a prepared statement must be unique within a database session.

When an EXECUTE command is issued for the prepared statement, Amazon Redshift may optionally revise the query execution plan (to improve performance based on the specified parameter values) before executing the prepared statement. Also, for each new execution of a prepared statement, Amazon Redshift may revise the query execution plan again based on the different parameter values specified with the EXECUTE statement. To examine the query execution plan that Amazon Redshift has chosen for any given EXECUTE statements, use the [EXPLAIN \(p. 415\)](#) command.

For examples and more information on the creation and usage of prepared statements, see [PREPARE \(p. 429\)](#).

See Also

[DEALLOCATE \(p. 401\)](#), [PREPARE \(p. 429\)](#)

EXPLAIN

Displays the execution plan for a query statement without running the query.

Syntax

```
EXPLAIN [ VERBOSE ] query
```

Parameters

VERBOSE

Displays the full query plan instead of just a summary.

query

Query statement to explain. The query can be a SELECT, INSERT, CREATE TABLE AS, UPDATE, or DELETE statement.

Usage Notes

EXPLAIN performance is sometimes influenced by the time it takes to create temporary tables. For example, a query that uses the common subexpression optimization requires temporary tables to be created and analyzed in order to return the EXPLAIN output. The query plan depends on the schema and statistics of the temporary tables. Therefore, the EXPLAIN command for this type of query might take longer to run than expected.

You can use EXPLAIN only for the following commands:

- SELECT
- SELECT INTO
- CREATE TABLE AS
- INSERT
- UPDATE
- DELETE

The EXPLAIN command will fail if you use it for other SQL commands, such as data definition language (DDL) or database operations.

Query Planning and Execution Steps

The execution plan for a specific Amazon Redshift query statement breaks down execution and calculation of a query into a discrete sequence of steps and table operations that will eventually produce a final result set for the query. The following table provides a summary of steps that Amazon Redshift can use in developing an execution plan for any query a user submits for execution.

EXPLAIN Operators	Query Execution Steps	Description
SCAN:		
Sequential Scan	scan	Amazon Redshift relation scan or table scan operator or step. Scans whole table sequentially from beginning to end; also evaluates query constraints for every row (Filter) if specified with WHERE clause. Also used to run INSERT, UPDATE, and DELETE statements.
JOINS: Amazon Redshift uses different join operators based on the physical design of the tables being joined, the location of the data required for the join, and specific attributes of the query itself. Subquery Scan -- Subquery scan and append are used to run UNION queries.		
Nested Loop	nloop	Least optimal join; mainly used for cross-joins (Cartesian products; without a join condition) and some inequality joins.
Hash Join	hjoin	Also used for inner joins and left and right outer joins and typically faster than a nested loop join. Hash Join reads the outer table, hashes the joining column, and finds matches in the inner hash table. Step can spill to disk. (Inner input of hjoin is hash step which can be disk-based.)
Merge Join	mjoin	Also used for inner joins and outer joins (for join tables that are both distributed and sorted on the joining columns). Typically the fastest Amazon Redshift join algorithm, not including other cost considerations.
AGGREGATION: Operators and steps used for queries that involve aggregate functions and GROUP BY operations.		
Aggregate	aggr	Operator/step for scalar aggregate functions.
HashAggregate	aggr	Operator/step for grouped aggregate functions. Can operate from disk by virtue of hash table spilling to disk.
GroupAggregate	aggr	Operator sometimes chosen for grouped aggregate queries if the Amazon Redshift configuration setting for force_hash_grouping setting is off.
SORT: Operators and steps used when queries have to sort or merge result sets.		
Sort	sort	Sort performs the sorting specified by the ORDER BY clause as well as other operations such as UNIONS and joins. Can operate from disk.

EXPLAIN Operators	Query Execution Steps	Description
Merge	merge	Produces final sorted results of a query based on intermediate sorted results derived from operations performed in parallel.
EXCEPT, INTERSECT, and UNION operations:		
SetOp Except [Distinct]	hjoin	Used for EXCEPT queries. Can operate from disk based on virtue of fact that input hash can be disk-based.
Hash Intersect [Distinct]	hjoin	Used for INTERSECT queries. Can operate from disk based on virtue of fact that input hash can be disk-based.
Append [All Distinct]	save	Append used with Subquery Scan to implement UNION and UNION ALL queries. Can operate from disk based on virtue of "save".
Miscellaneous/Other:		
Hash	hash	Used for inner joins and left and right outer joins (provides input to a hash join). The Hash operator creates the hash table for the inner table of a join. (The inner table is the table that is checked for matches and, in a join of two tables, is usually the smaller of the two.)
Limit	limit	Evaluates the LIMIT clause.
Materialize	save	Materialize rows for input to nested loop joins and some merge joins. Can operate from disk.
--	parse	Used to parse textual input data during a load.
--	project	Used to rearrange columns and compute expressions, that is, project data.
Result	--	Run scalar functions that do not involve any table access.
--	return	Return rows to the leader or client.
Subplan	--	Used for certain subqueries.
Unique	unique	Eliminates duplicates from SELECT DISTINCT and UNION queries.
Window	window	Compute aggregate and ranking window functions. Can operate from disk.
Network Operations:		
Network (Broadcast)	bcast	Broadcast is also an attribute of Join Explain operators and steps.
Network (Distribute)	dist	Distribute rows to compute nodes for parallel processing by data warehouse cluster.

EXPLAIN Operators	Query Execution Steps	Description
Network (Send to Leader)	return	Sends results back to the leader for further processing.
DML Operations (operators that modify data):		
Insert (using Result)	insert	Inserts data.
Delete (Scan + Filter)	delete	Deletes data. Can operate from disk.
Update (Scan + Filter)	delete, insert	Implemented as delete and Insert.

Examples

Note

For these examples, the sample output might vary depending on Amazon Redshift configuration.

The following example returns the query plan for a query that selects the EVENTID, EVENTNAME, VENUEID, and VENUENAME from the EVENT and VENUE tables:

```
explain
select eventid, eventname, event.venueid, venueid
from event, venue
where event.venueid = venue.venueid;
```

```

-----
QUERY PLAN
-----
XN Hash Join DS_DIST_OUTER (cost=2.52..58653620.93 rows=8712 width=43)
Hash Cond: ("outer".venueid = "inner".venueid)
-> XN Seq Scan on event (cost=0.00..87.98 rows=8798 width=23)
-> XN Hash (cost=2.02..2.02 rows=202 width=22)
-> XN Seq Scan on venue (cost=0.00..2.02 rows=202 width=22)
(5 rows)

```

The following example returns the query plan for the same query with verbose output:

```
explain verbose
select eventid, eventname, event.venueid, venueid
from event, venue
where event.venueid = venue.venueid;
```

```

-----
QUERY PLAN
-----
{HASHJOIN
:startup_cost 2.52
:total_cost 58653620.93
:plan_rows 8712
:plan_width 43
:best_pathkeys <>
:dist_info DS_DIST_OUTER
:dist_info.dist_keys (
TARGETENTRY

```

```
{
VAR
:varno 2
:varattno 1
...

XN Hash Join DS_DIST_OUTER (cost=2.52..58653620.93 rows=8712 width=43)
Hash Cond: ("outer".venueid = "inner".venueid)
-> XN Seq Scan on event (cost=0.00..87.98 rows=8798 width=23)
-> XN Hash (cost=2.02..2.02 rows=202 width=22)
-> XN Seq Scan on venue (cost=0.00..2.02 rows=202 width=22)
(519 rows)
```

The following example returns the query plan for a CREATE TABLE AS (CTAS) statement:

```
explain create table venue_nonulls as
select * from venue
where venueseats is not null;
```

QUERY PLAN

```
-----
XN Seq Scan on venue (cost=0.00..2.02 rows=187 width=45)
Filter: (venueseats IS NOT NULL)
(2 rows)
```

FETCH

Retrieves rows using a cursor. For information about declaring a cursor, see [DECLARE \(p. 401\)](#).

FETCH retrieves rows based on the current position within the cursor. When a cursor is created, it is positioned before the first row. After a FETCH, the cursor is positioned on the last row retrieved. If FETCH runs off the end of the available rows, such as following a FETCH ALL, the cursor is left positioned after the last row.

FORWARD 0 fetches the current row without moving the cursor; that is, it fetches the most recently fetched row. If the cursor is positioned before the first row or after the last row, no row is returned.

When the first row of a cursor is fetched, the entire result set is materialized on the leader node, in memory or on disk, if needed. Because of the potential negative performance impact of using cursors with large result sets, we recommend using alternative approaches whenever possible. For more information, see [Performance Considerations When Using Cursors \(p. 403\)](#).

For more information, see [DECLARE \(p. 401\)](#), [CLOSE \(p. 315\)](#).

Syntax

```
FETCH [ NEXT | ALL | {FORWARD [ count | ALL ] } ] FROM cursor
```

Parameters

NEXT

Fetches the next row. This is the default.

ALL

Fetches all remaining rows. (Same as FORWARD ALL.) ALL is not supported for single-node clusters.

FORWARD [*count* | ALL]

Fetches the next *count* rows, or all remaining rows. FORWARD 0 fetches the current row. For single-node clusters, the maximum value for count is 1000. FORWARD ALL is not supported for single-node clusters.

cursor

Name of the new cursor.

FETCH Example

The following example declares a cursor named LOLLAPALOOZA to select sales information for the Lollapalooza event, and then fetches rows from the result set using the cursor:

```
-- Begin a transaction
begin;

-- Declare a cursor
declare lollapalooza cursor for
select eventname, starttime, pricepaid/qtysold as costperticket, qtysold
from sales, event
where sales.eventid = event.eventid
and eventname='Lollapalooza';

-- Fetch the first 5 rows in the cursor lollapalooza:
fetch forward 5 from lollapalooza;
```

eventname	starttime	costperticket	qtysold
Lollapalooza	2008-05-01 19:00:00	92.00000000	3
Lollapalooza	2008-11-15 15:00:00	222.00000000	2
Lollapalooza	2008-04-17 15:00:00	239.00000000	3
Lollapalooza	2008-04-17 15:00:00	239.00000000	4
Lollapalooza	2008-04-17 15:00:00	239.00000000	1

```
(5 rows)

-- Fetch the next row:
fetch next from lollapalooza;
```

eventname	starttime	costperticket	qtysold
Lollapalooza	2008-10-06 14:00:00	114.00000000	2

```
-- Close the cursor and end the transaction:
close lollapalooza;
commit;
```

GRANT

Defines access privileges for a user or user group.

Privileges include access options such as being able to read data in tables and views, write data, and create tables. Use this command to give specific privileges for a table, database, schema, or function. To revoke privileges from a database object, use the [REVOKE \(p. 431\)](#) command.

Syntax

```
GRANT { { SELECT | INSERT | UPDATE | DELETE | REFERENCES } [,...] | ALL
  [ PRIVILEGES ] }
  ON { [ TABLE ] table_name [, ...] | ALL TABLES IN SCHEMA schema_name
  [, ...] }
  TO { username [ WITH GRANT OPTION ] | GROUP group_name | PUBLIC } [, ...]

GRANT { { CREATE | TEMPORARY | TEMP } [,...] | ALL [ PRIVILEGES ] }
  ON DATABASE db_name [, ...]
  TO { username [ WITH GRANT OPTION ] | GROUP group_name | PUBLIC } [, ...]

GRANT { { CREATE | USAGE } [,...] | ALL [ PRIVILEGES ] }
  ON SCHEMA schema_name [, ...]
  TO { username [ WITH GRANT OPTION ] | GROUP group_name | PUBLIC } [, ...]

GRANT EXECUTE
  ON { [ FUNCTION ] function_name ( [ [ argname ] argtype [, ...] ] )
  [, ...] | ALL FUNCTIONS IN SCHEMA schema_name [, ...] }
  TO { username [ WITH GRANT OPTION ] | GROUP group_name | PUBLIC } [, ...]

GRANT USAGE
  ON LANGUAGE language_name [, ...]
  TO { username [ WITH GRANT OPTION ] | GROUP group_name | PUBLIC } [, ...]
```

Parameters

SELECT

Grants privilege to select data from a table or view using a SELECT statement. The SELECT privilege is also required to reference existing column values for UPDATE or DELETE operations.

INSERT

Grants privilege to load data into a table using an INSERT statement or a COPY statement.

UPDATE

Grants privilege to update a table column using an UPDATE statement. UPDATE operations also require the SELECT privilege, because they must reference table columns to determine which rows to update, or to compute new values for columns.

DELETE

Grants privilege to delete a data row from a table. DELETE operations also require the SELECT privilege, because they must reference table columns to determine which rows to delete.

REFERENCES

Grants privilege to create a foreign key constraint. You need to grant this privilege on both the referenced table and the referencing table; otherwise, the user cannot create the constraint.

ALL [PRIVILEGES]

Grants all available privileges at once to the specified user or user group. The PRIVILEGES keyword is optional.

ON [TABLE] *table_name*

Grants the specified privileges on a table or a view. The TABLE keyword is optional. You can list multiple tables and views in one statement.

ON ALL TABLES IN SCHEMA *schema_name*

Grants the specified privileges on all tables and views in the referenced schema.

TO *username*

Indicates the user receiving the privileges.

WITH GRANT OPTION

Indicates that the user receiving the privileges can in turn grant the same privileges to others.

WITH GRANT OPTION can not be granted to a group or to PUBLIC.

GROUP *group_name*

Grants the privileges to a user group.

PUBLIC

Grants the specified privileges to all users, including users created later. PUBLIC represents a group that always includes all users. An individual user's privileges consist of the sum of privileges granted to PUBLIC, privileges granted to any groups that the user belongs to, and any privileges granted to the user individually.

CREATE

Depending on the database object, grants the following privileges to the user or user group:

- For databases, CREATE allows users to create schemas within the database.
- For schemas, CREATE allows users to create objects within a schema. To rename an object, the user must have the CREATE privilege and own the object to be renamed.

TEMPORARY | TEMP

Grants the privilege to create temporary tables in the specified database.

Note

By default, users are granted permission to create temporary tables by their automatic membership in the PUBLIC group. To remove the privilege for any users to create temporary tables, revoke the TEMP permission from the PUBLIC group and then explicitly grant the permission to create temporary tables to specific users or groups of users.

ON DATABASE *db_name*

Grants the specified privileges on a database.

USAGE

Grants USAGE privilege on a specific schema, which makes objects in that schema accessible to users. Specific actions on these objects must be granted separately (for example, SELECT or UPDATE privileges on tables). By default, all users have CREATE and USAGE privileges on the PUBLIC schema.

ON SCHEMA *schema_name*

Grants the specified privileges on a schema.

EXECUTE ON [FUNCTION] *function_name*

Grants the EXECUTE privilege on a specific function. Because function names can be overloaded, you must include the argument list for the function. For more information, see [UDF Security and Privileges \(p. 192\)](#).

EXECUTE ON ALL FUNCTIONS IN SCHEMA *schema_name*

Grants the specified privileges on all functions in the referenced schema.

USAGE ON LANGUAGE *language_name*

Grants the USAGE privilege on a language. The USAGE ON LANGUAGE privilege is required to create UDFs by executing the [CREATE FUNCTION \(p. 372\)](#) command. For more information, see [UDF Security and Privileges \(p. 192\)](#).

UDFs and libraries are implemented in the Python language, so *language_name* must be ppythonu.

Usage Notes

To grant privileges on an object, you must meet one of the following criteria:

- Be the object owner.
- Be a superuser.

- Have a grant privilege for that object and privilege.

For example, the following command gives the user HR the ability both to perform SELECT commands on the employees table and to grant and revoke the same privilege for other users:

```
grant select on table employees to HR with grant option;
```

Note that HR cannot grant privileges for any operation other than SELECT, or on any other table than employees.

Having privileges granted on a view does not imply having privileges on the underlying tables. Similarly, having privileges granted on a schema does not imply having privileges on the tables in the schema. You need to grant access to the underlying tables explicitly.

Superusers can access all objects regardless of GRANT and REVOKE commands that set object privileges.

Examples

The following example grants the SELECT privilege on the SALES table to the user fred.

```
grant select on table sales to fred;
```

The following example grants the SELECT privilege on all tables in the QA_TICKIT schema to the user fred.

```
grant select on all tables in schema qa_tickit to fred;
```

The following example grants all schema privileges on the schema QA_TICKIT to the user group QA_USERS. Schema privileges are CREATE and USAGE. USAGE grants users access to the objects in the schema, but does not grant privileges such as INSERT or SELECT on those objects. Privileges must be granted on each object separately.

```
create group qa_users;  
grant all on schema qa_tickit to group qa_users;
```

The following example grants all privileges on the SALES table in the QA_TICKIT schema to all users in the group QA_USERS.

```
grant all on table qa_tickit.sales to group qa_users;
```

The following sequence of commands shows how access to a schema does not grant privileges on a table in the schema.

```
create user schema_user in group qa_users password 'Abcd1234';  
create schema qa_tickit;  
create table qa_tickit.test (col1 int);  
grant all on schema qa_tickit to schema_user;  
  
set session authorization schema_user;  
select current_user;  
  
current_user  
-----
```

```

schema_user
(1 row)

select count(*) from qa_tickit.test;

ERROR: permission denied for relation test [SQL State=42501]

set session authorization dw_user;
grant select on table qa_tickit.test to schema_user;
set session authorization schema_user;
select count(*) from qa_tickit.test;

count
-----
0
(1 row)

```

The following sequence of commands shows how access to a view does not imply access to its underlying tables. The user called VIEW_USER cannot select from the DATE table, although this user has been granted all privileges on VIEW_DATE.

```

create user view_user password 'Abcd1234';
create view view_date as select * from date;
grant all on view_date to view_user;
set session authorization view_user;
select current_user;

current_user
-----
view_user
(1 row)

select count(*) from view_date;
count
-----
365
(1 row)

select count(*) from date;
ERROR: permission denied for relation date

```

INSERT

Topics

- [Syntax \(p. 425\)](#)
- [Parameters \(p. 425\)](#)
- [Usage Notes \(p. 426\)](#)
- [INSERT Examples \(p. 426\)](#)

Inserts new rows into a table. You can insert a single row with the VALUES syntax, multiple rows with the VALUES syntax, or one or more rows defined by the results of a query (INSERT INTO...SELECT).

Note

We strongly encourage you to use the [COPY \(p. 317\)](#) command to load large amounts of data. Using individual INSERT statements to populate a table might be prohibitively slow.

Alternatively, if your data already exists in other Amazon Redshift database tables, use INSERT INTO SELECT or [CREATE TABLE AS \(p. 389\)](#) to improve performance. For more information about using the COPY command to load tables, see [Loading Data \(p. 130\)](#).

Note

The maximum size for a single SQL statement is 16 MB.

Syntax

```
INSERT INTO table_name [ ( column [, ...] ) ]  
{DEFAULT VALUES |  
VALUES ( { expression | DEFAULT } [, ...] )  
[, ( { expression | DEFAULT } [, ...] )  
[, ...] ] |  
query }
```

Parameters

table_name

A temporary or persistent table. Only the owner of the table or a user with INSERT privilege on the table can insert rows. If you use the *query* clause to insert rows, you must have SELECT privilege on the tables named in the query.

column

You can insert values into one or more columns of the table. You can list the target column names in any order. If you do not specify a column list, the values to be inserted must correspond to the table columns in the order in which they were declared in the CREATE TABLE statement. If the number of values to be inserted is less than the number of columns in the table, the first *n* columns are loaded.

Either the declared default value or a null value is loaded into any column that is not listed (implicitly or explicitly) in the INSERT statement.

DEFAULT VALUES

If the columns in the table were assigned default values when the table was created, use these keywords to insert a row that consists entirely of default values. If any of the columns do not have default values, nulls are inserted into those columns. If any of the columns are declared NOT NULL, the INSERT statement returns an error.

VALUES

Use this keyword to insert one or more rows, each row consisting of one or more values. The VALUES list for each row must align with the column list. To insert multiple rows, use a comma delimiter between each list of expressions. Do not repeat the VALUES keyword. All VALUES lists for a multiple-row INSERT statement must contain the same number of values.

expression

A single value or an expression that evaluates to a single value. Each value must be compatible with the data type of the column where it is being inserted. If possible, a value whose data type does not match the column's declared data type is automatically converted to a compatible data type. For example:

- A decimal value 1.1 is inserted into an INT column as 1.
- A decimal value 100.8976 is inserted into a DEC(5,2) column as 100.90.

You can explicitly convert a value to a compatible data type by including type cast syntax in the expression. For example, if column COL1 in table T1 is a CHAR(3) column:

```
insert into t1(col1) values('Incomplete'::char(3));
```

This statement inserts the value Inc into the column.

For a single-row INSERT VALUES statement, you can use a scalar subquery as an expression. The result of the subquery is inserted into the appropriate column.

Note

Subqueries are not supported as expressions for multiple-row INSERT VALUES statements.

DEFAULT

Use this keyword to insert the default value for a column, as defined when the table was created. If no default value exists for a column, a null is inserted. You cannot insert a default value into a column that has a NOT NULL constraint if that column does not have an explicit default value assigned to it in the CREATE TABLE statement.

query

Insert one or more rows into the table by defining any query. All of the rows that the query produces are inserted into the table. The query must return a column list that is compatible with the columns in the table, but the column names do not have to match.

Usage Notes

Note

We strongly encourage you to use the [COPY \(p. 317\)](#) command to load large amounts of data. Using individual INSERT statements to populate a table might be prohibitively slow. Alternatively, if your data already exists in other Amazon Redshift database tables, use INSERT INTO SELECT or [CREATE TABLE AS \(p. 389\)](#) to improve performance. For more information about using the COPY command to load tables, see [Loading Data \(p. 130\)](#).

The data format for the inserted values must match the data format specified by the CREATE TABLE definition.

After inserting a large number of new rows into a table:

- Vacuum the table to reclaim storage space and resort rows.
- Analyze the table to update statistics for the query planner.

When values are inserted into DECIMAL columns and they exceed the specified scale, the loaded values are rounded up as appropriate. For example, when a value of 20.259 is inserted into a DECIMAL(8,2) column, the value that is stored is 20.26.

INSERT Examples

The CATEGORY table in the TICKIT database contains the following rows:

catid	catgroup	catname	catdesc
1	Sports	MLB	Major League Baseball
2	Sports	NHL	National Hockey League
3	Sports	NFL	National Football League
4	Sports	NBA	National Basketball Association
5	Sports	MLS	Major League Soccer
6	Shows	Musicals	Musical theatre
7	Shows	Plays	All non-musical theatre
8	Shows	Opera	All opera and light opera
9	Concerts	Pop	All rock and pop music concerts
10	Concerts	Jazz	All jazz singers and bands
11	Concerts	Classical	All symphony, concerto, and choir concerts

(11 rows)

Create a CATEGORY_STAGE table with a similar schema to the CATEGORY table but define default values for the columns:

```
create table category_stage
(catid smallint default 0,
catgroup varchar(10) default 'General',
catname varchar(10) default 'General',
catdesc varchar(50) default 'General');
```

The following INSERT statement selects all of the rows from the CATEGORY table and inserts them into the CATEGORY_STAGE table.

```
insert into category_stage
(select * from category);
```

The parentheses around the query are optional.

This command inserts a new row into the CATEGORY_STAGE table with a value specified for each column in order:

```
insert into category_stage values
(12, 'Concerts', 'Comedy', 'All stand-up comedy performances');
```

You can also insert a new row that combines specific values and default values:

```
insert into category_stage values
(13, 'Concerts', 'Other', default);
```

Run the following query to return the inserted rows:

```
select * from category_stage
where catid in(12,13) order by 1;
```

catid	catgroup	catname	catdesc
12	Concerts	Comedy	All stand-up comedy performances
13	Concerts	Other	General

(2 rows)

The following examples show some multiple-row INSERT VALUES statements. The first example inserts specific CATID values for two rows and default values for the other columns in both rows.

```
insert into category_stage values
(14, default, default, default),
(15, default, default, default);
```

```
select * from category_stage where catid in(14,15) order by 1;
```

catid	catgroup	catname	catdesc
14	General	General	General
15	General	General	General

(2 rows)

The next example inserts three rows with various combinations of specific and default values:

```
insert into category_stage values
(default, default, default, default),
(20, default, 'Country', default),
(21, 'Concerts', 'Rock', default);

select * from category_stage where catid in(0,20,21) order by 1;
catid | catgroup | catname | catdesc
-----+-----+-----+-----
0 | General  | General | General
20 | General  | Country | General
21 | Concerts | Rock    | General
(3 rows)
```

The first set of VALUES in this example produce the same results as specifying DEFAULT VALUES for a single-row INSERT statement.

The following examples show INSERT behavior when a table has an IDENTITY column. First, create a new version of the CATEGORY table, then insert rows into it from CATEGORY:

```
create table category_ident
(catid int identity not null,
catgroup varchar(10) default 'General',
catname varchar(10) default 'General',
catdesc varchar(50) default 'General');

insert into category_ident(catgroup,catname,catdesc)
select catgroup,catname,catdesc from category;
```

Note that you cannot insert specific integer values into the CATID IDENTITY column. IDENTITY column values are automatically generated.

The following example demonstrates that subqueries cannot be used as expressions in multiple-row INSERT VALUES statements:

```
insert into category(catid) values
((select max(catid)+1 from category)),
((select max(catid)+2 from category));

ERROR: cannot use subqueries in multi-row VALUES
```

LOCK

Restricts access to a database table. This command is only meaningful when it is run inside a transaction block.

The LOCK command obtains a table-level lock in "ACCESS EXCLUSIVE" mode, waiting if necessary for any conflicting locks to be released. Explicitly locking a table in this way causes reads and writes on the table to wait when they are attempted from other transactions or sessions. An explicit table lock created by one user temporarily prevents another user from selecting data from that table or loading data into it. The lock is released when the transaction that contains the LOCK command completes.

Less restrictive table locks are acquired implicitly by commands that refer to tables, such as write operations. For example, if a user tries to read data from a table while another user is updating the table, the data that is read will be a snapshot of the data that has already been committed. (In some

cases, queries will abort if they violate serializable isolation rules.) See [Managing Concurrent Write Operations \(p. 181\)](#).

Some DDL operations, such as DROP TABLE and TRUNCATE, create exclusive locks. These operations prevent data reads.

If a lock conflict occurs, Amazon Redshift displays an error message to alert the user who started the transaction in conflict. The transaction that received the lock conflict is aborted. Every time a lock conflict occurs, Amazon Redshift writes an entry to the [STL_TR_CONFLICT \(p. 739\)](#) table.

Syntax

```
LOCK [ TABLE ] table_name [ , ... ]
```

Parameters

TABLE

Optional keyword.

table_name

Name of the table to lock. You can lock more than one table by using a comma-delimited list of table names. You cannot lock views.

Example

```
begin;

lock event, sales;

...
```

PREPARE

Prepare a statement for execution.

PREPARE creates a prepared statement. When the PREPARE statement is executed, the specified statement (SELECT, INSERT, UPDATE, or DELETE) is parsed, rewritten, and planned. When an EXECUTE command is then issued for the prepared statement, Amazon Redshift may optionally revise the query execution plan (to improve performance based on the specified parameter values) before executing the prepared statement.

Syntax

```
PREPARE plan_name [ (datatype [ , ... ] ) ] AS statement
```

Parameters

plan_name

An arbitrary name given to this particular prepared statement. It must be unique within a single session and is subsequently used to execute or deallocate a previously prepared statement.

datatype

The data type of a parameter to the prepared statement. To refer to the parameters in the prepared statement itself, use \$1, \$2, and so on.

statement

Any SELECT, INSERT, UPDATE, or DELETE statement.

Usage Notes

Prepared statements can take parameters: values that are substituted into the statement when it is executed. To include parameters in a prepared statement, supply a list of data types in the PREPARE statement, and, in the statement to be prepared itself, refer to the parameters by position using the notation \$1, \$2, ... When executing the statement, specify the actual values for these parameters in the EXECUTE statement. See [EXECUTE \(p. 414\)](#) for more details.

Prepared statements only last for the duration of the current session. When the session ends, the prepared statement is discarded, so it must be re-created before being used again. This also means that a single prepared statement cannot be used by multiple simultaneous database clients; however, each client can create its own prepared statement to use. The prepared statement can be manually removed using the DEALLOCATE command.

Prepared statements have the largest performance advantage when a single session is being used to execute a large number of similar statements. As mentioned, for each new execution of a prepared statement, Amazon Redshift may revise the query execution plan to improve performance based on the specified parameter values. To examine the query execution plan that Amazon Redshift has chosen for any specific EXECUTE statements, use the [EXPLAIN \(p. 415\)](#) command.

For more information on query planning and the statistics collected by Amazon Redshift for query optimization, see the [ANALYZE \(p. 309\)](#) command.

Examples

Create a temporary table, prepare INSERT statement and then execute it:

```
DROP TABLE IF EXISTS prep1;
CREATE TABLE prep1 (c1 int, c2 char(20));
PREPARE prep_insert_plan (int, char)
AS insert into prep1 values ($1, $2);
EXECUTE prep_insert_plan (1, 'one');
EXECUTE prep_insert_plan (2, 'two');
EXECUTE prep_insert_plan (3, 'three');
DEALLOCATE prep_insert_plan;
```

Prepare a SELECT statement and then execute it:

```
PREPARE prep_select_plan (int)
AS select * from prep1 where c1 = $1;
EXECUTE prep_select_plan (2);
EXECUTE prep_select_plan (3);
DEALLOCATE prep_select_plan;
```

See Also

[DEALLOCATE \(p. 401\)](#), [EXECUTE \(p. 414\)](#)

RESET

Restores the value of a configuration parameter to its default value.

You can reset either a single specified parameter or all parameters at once. To set a parameter to a specific value, use the [SET \(p. 465\)](#) command. To display the current value of a parameter, use the [SHOW \(p. 469\)](#) command.

Syntax

```
RESET { parameter_name | ALL }
```

Parameters

parameter_name

Name of the parameter to reset. See [Modifying the Server Configuration \(p. 809\)](#) for more documentation about parameters.

ALL

Resets all run-time parameters.

Examples

The following example resets the `query_group` parameter to its default value:

```
reset query_group;
```

The following example resets all run-time parameters to their default values:

```
reset all;
```

REVOKE

Removes access privileges, such as privileges to create or update tables, from a user or user group.

Specify in the REVOKE statement the privileges that you want to remove. To give privileges, use the [GRANT \(p. 420\)](#) command.

Syntax

```
REVOKE [ GRANT OPTION FOR ]  
{ { SELECT | INSERT | UPDATE | DELETE | REFERENCES } [,...] | ALL  
  [ PRIVILEGES ] }  
ON { [ TABLE ] table_name [, ...] | ALL TABLES IN SCHEMA schema_name  
    [, ...] }  
FROM { username | GROUP group_name | PUBLIC } [, ...]  
    [ CASCADE | RESTRICT ]  
  
REVOKE [ GRANT OPTION FOR ]  
{ { CREATE | TEMPORARY | TEMP } [,...] | ALL [ PRIVILEGES ] }  
ON DATABASE db_name [, ...]  
FROM { username | GROUP group_name | PUBLIC } [, ...]  
    [ CASCADE | RESTRICT ]  
  
REVOKE [ GRANT OPTION FOR ]  
{ { CREATE | USAGE } [,...] | ALL [ PRIVILEGES ] }
```

```

ON SCHEMA schema_name [, ...]
FROM { username | GROUP group_name | PUBLIC } [, ...]
[ CASCADE | RESTRICT ]

REVOKE [ GRANT OPTION FOR ]
EXECUTE
    ON FUNCTION function_name ( [ [ argname ] argtype [, ...] ] ) [, ...]
    FROM { username | GROUP group_name | PUBLIC } [, ...]
[ CASCADE | RESTRICT ]

REVOKE [ GRANT OPTION FOR ]
USAGE
    ON LANGUAGE language_name [, ...]
    FROM { username | GROUP group_name | PUBLIC } [, ...]
[ CASCADE | RESTRICT ]

```

Parameters

GRANT OPTION FOR

Revokes only the option to grant a specified privilege to other users and does not revoke the privilege itself. GRANT OPTION can not be revoked from a group or from PUBLIC.

SELECT

Revokes the privilege to select data from a table or a view using a SELECT statement.

INSERT

Revokes the privilege to load data into a table using an INSERT statement or a COPY statement.

UPDATE

Revokes the privilege to update a table column using an UPDATE statement.

DELETE

Revokes the privilege to delete a data row from a table.

REFERENCES

Revokes the privilege to create a foreign key constraint. You should revoke this privilege on both the referenced table and the referencing table.

ALL [PRIVILEGES]

Revokes all available privileges at once from the specified user or group. The PRIVILEGES keyword is optional.

ON [TABLE] *table_name*

Revokes the specified privileges on a table or a view. The TABLE keyword is optional.

ON ALL TABLES IN SCHEMA *schema_name*

Revokes the specified privileges on all tables in the referenced schema.

GROUP *group_name*

Revokes the privileges from the specified user group.

PUBLIC

Revokes the specified privileges from all users. PUBLIC represents a group that always includes all users. An individual user's privileges consist of the sum of privileges granted to PUBLIC, privileges granted to any groups that the user belongs to, and any privileges granted to the user individually.

CREATE

Depending on the database object, revokes the following privileges from the user or group:

- For databases, using the CREATE clause for REVOKE prevents users from creating schemas within the database.
- For schemas, using the CREATE clause for REVOKE prevents users from creating objects within a schema. To rename an object, the user must have the CREATE privilege and own the object to be renamed.

Note

By default, all users have CREATE and USAGE privileges on the PUBLIC schema.

TEMPORARY | TEMP

Revokes the privilege to create temporary tables in the specified database.

Note

By default, users are granted permission to create temporary tables by their automatic membership in the PUBLIC group. To remove the privilege for any users to create temporary tables, revoke the TEMP permission from the PUBLIC group and then explicitly grant the permission to create temporary tables to specific users or groups of users.

ON DATABASE *db_name*

Revokes the privileges on the specified database.

USAGE

Revokes USAGE privileges on objects within a specific schema, which makes these objects inaccessible to users. Specific actions on these objects must be revoked separately (such as the EXECUTE privilege on functions).

Note

By default, all users have CREATE and USAGE privileges on the PUBLIC schema.

ON SCHEMA *schema_name*

Revokes the privileges on the specified schema. You can use schema privileges to control the creation of tables; the CREATE privilege for a database only controls the creation of schemas.

CASCADE

If a user holds a privilege with grant option and has granted the privilege to other users, the privileges held by those other users are *dependent privileges*. If the privilege or the grant option held by the first user is being revoked and dependent privileges exist, those dependent privileges are also revoked if CASCADE is specified; otherwise, the revoke action fails.

For example, if user A has granted a privilege with grant option to user B, and user B has granted the privilege to user C, user A can revoke the grant option from user B and use the CASCADE option to in turn revoke the privilege from user C.

RESTRICT

Revokes only those privileges that the user directly granted. This behavior is the default.

EXECUTE ON FUNCTION *function_name*

Revokes the EXECUTE privilege on a specific function or aggregate. Because function names can be overloaded, you must include the argument list for the function. For more information, see [UDF Security and Privileges \(p. 192\)](#).

USAGE ON LANGUAGE *language_name*

Revokes the USAGE privilege on a language. For more information, see [UDF Security and Privileges \(p. 192\)](#).

UDFs and libraries implement the Python language, so *language_name* must be ppythonu.

Usage Notes

To revoke privileges from an object, you must meet one of the following criteria:

- Be the object owner.
- Be a superuser.
- Have a grant privilege for that object and privilege.

For example, the following command gives the user HR the ability both to perform SELECT commands on the employees table and to grant and revoke the same privilege for other users:

```
grant select on table employees to HR with grant option;
```

Note that HR cannot revoke privileges for any operation other than SELECT, or on any other table than employees.

Superusers can access all objects regardless of GRANT and REVOKE commands that set object privileges.

Examples

The following example revokes INSERT privileges on the SALES table from the GUESTS user group. This command prevents members of GUESTS from being able to load data into the SALES table by using the INSERT command:

```
revoke insert on table sales from group guests;
```

The following example revokes the SELECT privilege on all tables in the QA_TICKIT schema from the user fred:

```
revoke select on all tables in schema qa_tickit from fred;
```

The following example revokes the privilege to select from a view for user bobr:

```
revoke select on table eventview from bobr;
```

The following example revokes the privilege to create temporary tables in the TICKIT database from all users:

```
revoke temporary on database tickit from public;
```

The following example controls table creation privileges in the PUBLIC schema. Subsequent to this command, users will be denied permission to create tables in the PUBLIC schema of the TICKIT database. (By default, all users have CREATE and USAGE privileges on the PUBLIC schema.)

```
revoke create on schema public from public;
```

ROLLBACK

Aborts the current transaction and discards all updates made by that transaction.

This command performs the same function as the [ABORT \(p. 291\)](#) command.

Syntax

```
ROLLBACK [ WORK | TRANSACTION ]
```

Parameters

WORK
Optional keyword.

TRANSACTION

Optional keyword; WORK and TRANSACTION are synonyms.

Example

The following example creates a table then starts a transaction where data is inserted into the table. The ROLLBACK command then rolls back the data insertion to leave the table empty.

The following command creates an example table called MOVIE_GROSS:

```
create table movie_gross( name varchar(30), gross bigint );
```

The next set of commands starts a transaction that inserts two data rows into the table:

```
begin;
insert into movie_gross values ( 'Raiders of the Lost Ark', 23400000);
insert into movie_gross values ( 'Star Wars', 10000000 );
```

Next, the following command selects the data from the table to show that it was successfully inserted:

```
select * from movie_gross;
```

The command output shows that both rows successfully inserted:

```
name          | gross
-----+-----
Raiders of the Lost Ark | 23400000
Star Wars      | 10000000
(2 rows)
```

This command now rolls back the data changes to where the transaction began:

```
rollback;
```

Selecting data from the table now shows an empty table:

```
select * from movie_gross;

name | gross
-----+-----
(0 rows)
```

SELECT

Topics

- [Syntax \(p. 436\)](#)
- [WITH Clause \(p. 436\)](#)

- [SELECT List](#) (p. 440)
- [FROM Clause](#) (p. 442)
- [WHERE Clause](#) (p. 444)
- [GROUP BY Clause](#) (p. 449)
- [HAVING Clause](#) (p. 450)
- [UNION, INTERSECT, and EXCEPT](#) (p. 451)
- [ORDER BY Clause](#) (p. 459)
- [Join Examples](#) (p. 461)
- [Subquery Examples](#) (p. 462)
- [Correlated Subqueries](#) (p. 463)

Returns rows from tables, views, and user-defined functions.

Note

The maximum size for a single SQL statement is 16 MB.

Syntax

```
[ WITH with_subquery [, ...] ]  
SELECT  
[ TOP number | [ ALL | DISTINCT ]  
* | expression [ AS output_name ] [, ...] ]  
[ FROM table_reference [, ...] ]  
[ WHERE condition ]  
[ GROUP BY expression [, ...] ]  
[ HAVING condition ]  
[ { UNION | ALL | INTERSECT | EXCEPT | MINUS } query ]  
[ ORDER BY expression  
[ ASC | DESC ]  
[ LIMIT { number | ALL } ]  
[ OFFSET start ]
```

WITH Clause

A WITH clause is an optional clause that precedes the SELECT list in a query. The WITH clause defines one or more subqueries. Each subquery defines a temporary table, similar to a view definition. These temporary tables can be referenced in the FROM clause and are used only during the execution of the query to which they belong. Each subquery in the WITH clause specifies a table name, an optional list of column names, and a query expression that evaluates to a table (a SELECT statement).

WITH clause subqueries are an efficient way of defining tables that can be used throughout the execution of a single query. In all cases, the same results can be achieved by using subqueries in the main body of the SELECT statement, but WITH clause subqueries may be simpler to write and read. Where possible, WITH clause subqueries that are referenced multiple times are optimized as common subexpressions; that is, it may be possible to evaluate a WITH subquery once and reuse its results. (Note that common subexpressions are not limited to those defined in the WITH clause.)

Syntax

```
[ WITH with_subquery [, ...] ]
```

where *with_subquery* is:

```
with_subquery_table_name [ ( column_name [, ...] ) ] AS ( query )
```

Parameters

with_subquery_table_name

A unique name for a temporary table that defines the results of a WITH clause subquery. You cannot use duplicate names within a single WITH clause. Each subquery must be given a table name that can be referenced in the [FROM Clause \(p. 442\)](#).

column_name

An optional list of output column names for the WITH clause subquery, separated by commas. The number of column names specified must be equal to or less than the number of columns defined by the subquery.

query

Any SELECT query that Amazon Redshift supports. See [SELECT \(p. 435\)](#).

Usage Notes

You can use a WITH clause in the following SQL statements:

- SELECT (including subqueries within SELECT statements)
- SELECT INTO
- CREATE TABLE AS
- CREATE VIEW
- DECLARE
- EXPLAIN
- INSERT INTO...SELECT
- PREPARE
- UPDATE (within a WHERE clause subquery)

If the FROM clause of a query that contains a WITH clause does not reference any of the tables defined by the WITH clause, the WITH clause is ignored and the query executes as normal.

A table defined by a WITH clause subquery can be referenced only in the scope of the SELECT query that the WITH clause begins. For example, you can reference such a table in the FROM clause of a subquery in the SELECT list, WHERE clause, or HAVING clause. You cannot use a WITH clause in a subquery and reference its table in the FROM clause of the main query or another subquery. This query pattern results in an error message of the form `relation table_name does not exist for the WITH clause table`.

You cannot specify another WITH clause inside a WITH clause subquery.

You cannot make forward references to tables defined by WITH clause subqueries. For example, the following query returns an error because of the forward reference to table W2 in the definition of table W1:

```
with w1 as (select * from w2), w2 as (select * from w1)
select * from sales;
ERROR: relation "w2" does not exist
```

A WITH clause subquery may not consist of a SELECT INTO statement; however, you can use a WITH clause in a SELECT INTO statement.

Examples

The following example shows the simplest possible case of a query that contains a WITH clause. The WITH query named VENUECOPY selects all of the rows from the VENUE table. The main query in turn selects all of the rows from VENUECOPY. The VENUECOPY table exists only for the duration of this query.

```
with venuecopy as (select * from venue)
select * from venuecopy order by 1 limit 10;
```

venueid venueseats	venue name	venuecity	venuestate	
1	Toyota Park	Bridgeview	IL	0
2	Columbus Crew Stadium	Columbus	OH	0
3	RFK Stadium	Washington	DC	0
4	CommunityAmerica Ballpark	Kansas City	KS	0
5	Gillette Stadium	Foxborough	MA	68756
6	New York Giants Stadium	East Rutherford	NJ	80242
7	BMO Field	Toronto	ON	0
8	The Home Depot Center	Carson	CA	0
9	Dick's Sporting Goods Park	Commerce City	CO	0
v 10	Pizza Hut Park	Frisco	TX	0

(10 rows)

The following example shows a WITH clause that produces two tables, named VENUE_SALES and TOP_VENUES. The second WITH query table selects from the first. In turn, the WHERE clause of the main query block contains a subquery that constrains the TOP_VENUES table.

```
with venue_sales as
(select venue name, venuecity, sum(pricepaid) as venue name_sales
from sales, venue, event
where venue.venueid=event.venueid and event.eventid=sales.eventid
group by venue name, venuecity),

top_venues as
(select venue name
from venue_sales
where venue name_sales > 800000)

select venue name, venuecity, venuestate,
sum(qtysold) as venue_qty,
sum(pricepaid) as venue_sales
from sales, venue, event
where venue.venueid=event.venueid and event.eventid=sales.eventid
and venue name in(select venue name from top_venues)
group by venue name, venuecity, venuestate
order by venue name;
```

venue name	venuecity	venuestate	venue_qty
venue_sales			

```

August Wilson Theatre | New York City | NY | 3187 |
1032156.00
Biltmore Theatre | New York City | NY | 2629 |
828981.00
Charles Playhouse | Boston | MA | 2502 |
857031.00
Ethel Barrymore Theatre | New York City | NY | 2828 |
891172.00
Eugene O'Neill Theatre | New York City | NY | 2488 |
828950.00
Greek Theatre | Los Angeles | CA | 2445 |
838918.00
Helen Hayes Theatre | New York City | NY | 2948 |
978765.00
Hilton Theatre | New York City | NY | 2999 |
885686.00
Imperial Theatre | New York City | NY | 2702 |
877993.00
Lunt-Fontanne Theatre | New York City | NY | 3326 |
1115182.00
Majestic Theatre | New York City | NY | 2549 |
894275.00
Nederlander Theatre | New York City | NY | 2934 |
936312.00
Pasadena Playhouse | Pasadena | CA | 2739 |
820435.00
Winter Garden Theatre | New York City | NY | 2838 |
939257.00
(14 rows)

```

The following two examples demonstrate the rules for the scope of table references based on WITH clause subqueries. The first query runs, but the second fails with an expected error. The first query has WITH clause subquery inside the SELECT list of the main query. The table defined by the WITH clause (HOLIDAYS) is referenced in the FROM clause of the subquery in the SELECT list:

```

select caldate, sum(pricepaid) as daysales,
(with holidays as (select * from date where holiday = 't'))
select sum(pricepaid)
from sales join holidays on sales.dateid=holidays.dateid
where caldate='2008-12-25') as dec25sales
from sales join date on sales.dateid=date.dateid
where caldate in('2008-12-25','2008-12-31')
group by caldate
order by caldate;

caldate | daysales | dec25sales
-----+-----+-----
2008-12-25 | 70402.00 | 70402.00
2008-12-31 | 12678.00 | 70402.00
(2 rows)

```

The second query fails because it attempts to reference the HOLIDAYS table in the main query as well as in the SELECT list subquery. The main query references are out of scope.

```

select caldate, sum(pricepaid) as daysales,
(with holidays as (select * from date where holiday = 't'))
select sum(pricepaid)

```

```
from sales join holidays on sales.dateid=holidays.dateid
where caldate='2008-12-25') as dec25sales
from sales join holidays on sales.dateid=holidays.dateid
where caldate in('2008-12-25','2008-12-31')
group by caldate
order by caldate;
```

```
ERROR: relation "holidays" does not exist
```

SELECT List

Topics

- [Syntax \(p. 440\)](#)
- [Parameters \(p. 440\)](#)
- [Usage Notes \(p. 441\)](#)
- [Examples with TOP \(p. 441\)](#)
- [SELECT DISTINCT Examples \(p. 442\)](#)

The SELECT list names the columns, functions, and expressions that you want the query to return. The list represents the output of the query.

Syntax

```
SELECT
[ TOP number ]
[ ALL | DISTINCT ] * | expression [ AS column_alias ] [, ...]
```

Parameters

TOP *number*

TOP takes a positive integer as its argument, which defines the number of rows that are returned to the client. The behavior with the TOP clause is the same as the behavior with the LIMIT clause. The number of rows that is returned is fixed, but the set of rows is not; to return a consistent set of rows, use TOP or LIMIT in conjunction with an ORDER BY clause.

ALL

A redundant keyword that defines the default behavior if you do not specify DISTINCT. `SELECT ALL * means the same as SELECT *` (select all rows for all columns and retain duplicates).

DISTINCT

Option that eliminates duplicate rows from the result set, based on matching values in one or more columns.

* (asterisk)

Returns the entire contents of the table (all columns and all rows).

expression

An expression formed from one or more columns that exist in the tables referenced by the query. An expression can contain SQL functions. For example:

```
avg(datediff(day, listtime, saletime))
```

AS *column_alias*

A temporary name for the column that will be used in the final result set. The AS keyword is optional. For example:

```
avg(datediff(day, listtime, saletime)) as avgwait
```

If you do not specify an alias for an expression that is not a simple column name, the result set applies a default name to that column.

Note

The alias is not recognized until the entire target list has been parsed, which means that you cannot refer to the alias elsewhere within the target list. For example, the following statement will fail:

```
select (qtysold + 1) as q, sum(q) from sales group by 1;  
ERROR: column "q" does not exist
```

You must use the same expression that was aliased to `q`:

```
select (qtysold + 1) as q, sum(qtysold + 1) from sales group by 1;  
q | sum  
---+-----  
8 | 368  
...
```

Usage Notes

TOP is a SQL extension; it provides an alternative to the LIMIT behavior. You cannot use TOP and LIMIT in the same query.

Examples with TOP

Return any 10 rows from the SALES table. Because no ORDER BY clause is specified, the set of rows that this query returns is unpredictable.

```
select top 10 *  
from sales;
```

The following query is functionally equivalent, but uses a LIMIT clause instead of a TOP clause:

```
select *  
from sales  
limit 10;
```

Return the first 10 rows from the SALES table, ordered by the QTYSOLD column in descending order.

```
select top 10 qtysold, sellerid  
from sales  
order by qtysold desc, sellerid;  
  
qtysold | sellerid  
-----+-----  
8 | 518  
8 | 520  
8 | 574  
8 | 718
```

```
8 |      868
8 |     2663
8 |     3396
8 |     3726
8 |     5250
8 |     6216
(10 rows)
```

Return the first two QTYSOLD and SELLERID values from the SALES table, ordered by the QTYSOLD column:

```
select top 2 qtysold, sellerid
from sales
order by qtysold desc, sellerid;

qtysold | sellerid
-----+-----
8 |      518
8 |      520
(2 rows)
```

SELECT DISTINCT Examples

Return a list of different category groups from the CATEGORY table:

```
select distinct catgroup from category
order by 1;

catgroup
-----
Concerts
Shows
Sports
(3 rows)
```

Return the distinct set of week numbers for December 2008:

```
select distinct week, month, year
from date
where month='DEC' and year=2008
order by 1, 2, 3;

week | month | year
-----+-----+-----
49 | DEC   | 2008
50 | DEC   | 2008
51 | DEC   | 2008
52 | DEC   | 2008
53 | DEC   | 2008
(5 rows)
```

FROM Clause

The FROM clause in a query lists the table references (tables, views, and subqueries) that data is selected from. If multiple table references are listed, the tables must be joined, using appropriate

syntax in either the FROM clause or the WHERE clause. If no join criteria are specified, the system processes the query as a cross-join (Cartesian product).

Syntax

```
FROM table_reference [, ...]
```

where *table_reference* is one of the following:

```
with_subquery_table_name [ [ AS ] alias [ ( column_alias [, ...] ) ] ]
 [ * ] [ [ AS ] alias [ ( column_alias [, ...] ) ] ]
( subquery ) [ AS ] alias [ ( column_alias [, ...] ) ]
 [ NATURAL ] join_type table_reference
[ ON join_condition | USING ( join_column [, ...] ) ]
```

Parameters

with_subquery_table_name

A table defined by a subquery in the [WITH Clause \(p. 436\)](#).

table_name

Name of a table or view.

alias

Temporary alternative name for a table or view. An alias must be supplied for a table derived from a subquery. In other table references, aliases are optional. The AS keyword is always optional.

Table aliases provide a convenient shortcut for identifying tables in other parts of a query, such as the WHERE clause. For example:

```
select * from sales s, listing l
where s.listid=l.listid
```

column_alias

Temporary alternative name for a column in a table or view.

subquery

A query expression that evaluates to a table. The table exists only for the duration of the query and is typically given a name or *alias*; however, an alias is not required. You can also define column names for tables that derive from subqueries. Naming column aliases is important when you want to join the results of subqueries to other tables and when you want to select or constrain those columns elsewhere in the query.

A subquery may contain an ORDER BY clause, but this clause may have no effect if a LIMIT or OFFSET clause is not also specified.

NATURAL

Defines a join that automatically uses all pairs of identically named columns in the two tables as the joining columns. No explicit join condition is required. For example, if the CATEGORY and EVENT tables both have columns named CATID, a natural join of those tables is a join over their CATID columns.

Note

If a NATURAL join is specified but no identically named pairs of columns exist in the tables to be joined, the query defaults to a cross-join.

join_type

Specify one of the following types of join:

- [INNER] JOIN
- LEFT [OUTER] JOIN

- RIGHT [OUTER] JOIN
- FULL [OUTER] JOIN
- CROSS JOIN

ON *join_condition*

Type of join specification where the joining columns are stated as a condition that follows the ON keyword. For example:

```
sales join listing
on sales.listid=listing.listid and sales.eventid=listing.eventid
```

USING (*join_column* [, ...])

Type of join specification where the joining columns are listed in parentheses. If multiple joining columns are specified, they are delimited by commas. The USING keyword must precede the list. For example:

```
sales join listing
using (listid,eventid)
```

Join Types

Cross-joins are unqualified joins; they return the Cartesian product of the two tables.

Inner and outer joins are qualified joins. They are qualified either implicitly (in natural joins); with the ON or USING syntax in the FROM clause; or with a WHERE clause condition.

An inner join returns matching rows only, based on the join condition or list of joining columns. An outer join returns all of the rows that the equivalent inner join would return plus non-matching rows from the "left" table, "right" table, or both tables. The left table is the first-listed table, and the right table is the second-listed table. The non-matching rows contain NULL values to fill the gaps in the output columns.

Usage Notes

Joining columns must have comparable data types.

A NATURAL or USING join retains only one of each pair of joining columns in the intermediate result set.

A join with the ON syntax retains both joining columns in its intermediate result set.

See also [WITH Clause \(p. 436\)](#).

WHERE Clause

The WHERE clause contains conditions that either join tables or apply predicates to columns in tables. Tables can be inner-joined by using appropriate syntax in either the WHERE clause or the FROM clause. Outer join criteria must be specified in the FROM clause.

Syntax

```
[ WHERE condition ]
```

condition

Any search condition with a Boolean result, such as a join condition or a predicate on a table column. The following examples are valid join conditions:

```
sales.listid=listing.listid
sales.listid<>listing.listid
```

The following examples are valid conditions on columns in tables:

```
catgroup like 'S%'
venueseats between 20000 and 50000
eventname in('Jersey Boys','Spamalot')
year=2008
length(catdesc)>25
date_part(month, caldate)=6
```

Conditions can be simple or complex; for complex conditions, you can use parentheses to isolate logical units. In the following example, the join condition is enclosed by parentheses.

```
where (category.catid=event.catid) and category.catid in(6,7,8)
```

Usage Notes

You can't use aliases in the WHERE clause to reference select list expressions.

You can't restrict the results of aggregate functions in the WHERE clause; use the HAVING clause for this purpose.

Columns that are restricted in the WHERE clause must derive from table references in the FROM clause.

Example

The following query uses a combination of different WHERE clause restrictions, including a join condition for the SALES and EVENT tables, a predicate on the EVENTNAME column, and two predicates on the STARTTIME column.

```
select eventname, starttime, pricepaid/qtysold as costperticket, qtysold
from sales, event
where sales.eventid = event.eventid
and eventname='Hannah Montana'
and date_part(quarter, starttime) in(1,2)
and date_part(year, starttime) = 2008
order by 3 desc, 4, 2, 1 limit 10;
```

eventname	starttime	costperticket	qtysold
Hannah Montana	2008-06-07 14:00:00	1706.00000000	2
Hannah Montana	2008-05-01 19:00:00	1658.00000000	2
Hannah Montana	2008-06-07 14:00:00	1479.00000000	1
Hannah Montana	2008-06-07 14:00:00	1479.00000000	3
Hannah Montana	2008-06-07 14:00:00	1163.00000000	1
Hannah Montana	2008-06-07 14:00:00	1163.00000000	2
Hannah Montana	2008-06-07 14:00:00	1163.00000000	4
Hannah Montana	2008-05-01 19:00:00	497.00000000	1
Hannah Montana	2008-05-01 19:00:00	497.00000000	2
Hannah Montana	2008-05-01 19:00:00	497.00000000	4

(10 rows)

Oracle-Style Outer Joins in the WHERE Clause

For Oracle compatibility, Amazon Redshift supports the Oracle outer-join operator (+) in WHERE clause join conditions. This operator is intended for use only in defining outer-join conditions; do not try to use it in other contexts. Other uses of this operator are silently ignored in most cases.

An outer join returns all of the rows that the equivalent inner join would return, plus non-matching rows from one or both tables. In the FROM clause, you can specify left, right, and full outer joins. In the WHERE clause, you can specify left and right outer joins only.

To outer join tables TABLE1 and TABLE2 and return non-matching rows from TABLE1 (a left outer join), specify TABLE1 LEFT OUTER JOIN TABLE2 in the FROM clause or apply the (+) operator to all joining columns from TABLE2 in the WHERE clause. For all rows in TABLE1 that have no matching rows in TABLE2, the result of the query contains nulls for any select list expressions that contain columns from TABLE2.

To produce the same behavior for all rows in TABLE2 that have no matching rows in TABLE1, specify TABLE1 RIGHT OUTER JOIN TABLE2 in the FROM clause or apply the (+) operator to all joining columns from TABLE1 in the WHERE clause.

Basic Syntax

```
[ WHERE {  
[ table1.column1 = table2.column1(+) ]  
[ table1.column1(+) = table2.column1 ]  
}
```

The first condition is equivalent to:

```
from table1 left outer join table2  
on table1.column1=table2.column1
```

The second condition is equivalent to:

```
from table1 right outer join table2  
on table1.column1=table2.column1
```

Note

The syntax shown here covers the simple case of an equijoin over one pair of joining columns. However, other types of comparison conditions and multiple pairs of joining columns are also valid.

For example, the following WHERE clause defines an outer join over two pairs of columns. The (+) operator must be attached to the same table in both conditions:

```
where table1.col1 > table2.col1(+)  
and table1.col2 = table2.col2(+)
```

Usage Notes

Where possible, use the standard FROM clause OUTER JOIN syntax instead of the (+) operator in the WHERE clause. Queries that contain the (+) operator are subject to the following rules:

- You can only use the (+) operator in the WHERE clause, and only in reference to columns from tables or views.

- You cannot apply the (+) operator to expressions. However, an expression can contain columns that use the (+) operator. For example, the following join condition returns a syntax error:

```
event.eventid*10(+)=category.catid
```

However, the following join condition is valid:

```
event.eventid(+)*10=category.catid
```

- You cannot use the (+) operator in a query block that also contains FROM clause join syntax.
- If two tables are joined over multiple join conditions, you must use the (+) operator in all or none of these conditions. A join with mixed syntax styles executes as an inner join, without warning.
- The (+) operator does not produce an outer join if you join a table in the outer query with a table that results from an inner query.
- To use the (+) operator to outer-join a table to itself, you must define table aliases in the FROM clause and reference them in the join condition:

```
select count(*)
from event a, event b
where a.eventid(+)=b.catid;
```

```
count
-----
8798
(1 row)
```

- You cannot combine a join condition that contains the (+) operator with an OR condition or an IN condition. For example:

```
select count(*) from sales, listing
where sales.listid(+)=listing.listid or sales.salesid=0;
ERROR: Outer join operator (+) not allowed in operand of OR or IN.
```

- In a WHERE clause that outer-joins more than two tables, the (+) operator can be applied only once to a given table. In the following example, the SALES table cannot be referenced with the (+) operator in two successive joins.

```
select count(*) from sales, listing, event
where sales.listid(+)=listing.listid and sales.dateid(+)=date.dateid;
ERROR: A table may be outer joined to at most one other table.
```

- If the WHERE clause outer-join condition compares a column from TABLE2 with a constant, apply the (+) operator to the column. If you do not include the operator, the outer-joined rows from TABLE1, which contain nulls for the restricted column, are eliminated. See the Examples section below.

Examples

The following join query specifies a left outer join of the SALES and LISTING tables over their LISTID columns:

```
select count(*)
from sales, listing
where sales.listid = listing.listid(+);
```

```
count
-----
172456
(1 row)
```

The following equivalent query produces the same result but uses FROM clause join syntax:

```
select count(*)
from sales left outer join listing on sales.listid = listing.listid;

count
-----
172456
(1 row)
```

The SALES table does not contain records for all listings in the LISTING table because not all listings result in sales. The following query outer-joins SALES and LISTING and returns rows from LISTING even when the SALES table reports no sales for a given list ID. The PRICE and COMM columns, derived from the SALES table, contain nulls in the result set for those non-matching rows.

```
select listing.listid, sum(pricepaid) as price,
sum(commission) as comm
from listing, sales
where sales.listid(+) = listing.listid and listing.listid between 1 and 5
group by 1 order by 1;

listid | price | comm
-----+-----+-----
1 | 728.00 | 109.20
2 |      | 
3 |      | 
4 | 76.00 | 11.40
5 | 525.00 | 78.75
(5 rows)
```

Note that when the WHERE clause join operator is used, the order of the tables in the FROM clause does not matter.

An example of a more complex outer join condition in the WHERE clause is the case where the condition consists of a comparison between two table columns *and* a comparison with a constant:

```
where category.catid=event.catid(+) and eventid(+)=796;
```

Note that the (+) operator is used in two places: first in the equality comparison between the tables and second in the comparison condition for the EVENTID column. The result of this syntax is the preservation of the outer-joined rows when the restriction on EVENTID is evaluated. If you remove the (+) operator from the EVENTID restriction, the query treats this restriction as a filter, not as part of the outer-join condition. In turn, the outer-joined rows that contain nulls for EVENTID are eliminated from the result set.

Here is a complete query that illustrates this behavior:

```
select catname, catgroup, eventid
from category, event
where category.catid=event.catid(+) and eventid(+)=796;
```

```

catname | catgroup | eventid
-----+-----
Classical | Concerts |
Jazz | Concerts |
MLB | Sports |
MLS | Sports |
Musicals | Shows | 796
NBA | Sports |
NFL | Sports |
NHL | Sports |
Opera | Shows |
Plays | Shows |
Pop | Concerts |
(11 rows)

```

The equivalent query using FROM clause syntax is as follows:

```

select catname, catgroup, eventid
from category left join event
on category.catid=event.catid and eventid=796;

```

If you remove the second (+) operator from the WHERE clause version of this query, it returns only 1 row (the row where eventid=796).

```

select catname, catgroup, eventid
from category, event
where category.catid=event.catid(+) and eventid=796;

catname | catgroup | eventid
-----+-----
Musicals | Shows | 796
(1 row)

```

GROUP BY Clause

The GROUP BY clause identifies the grouping columns for the query. Grouping columns must be declared when the query computes aggregates with standard functions such as SUM, AVG, and COUNT.

```
GROUP BY expression [, ...]
```

expression

The list of columns or expressions must match the list of non-aggregate expressions in the select list of the query. For example, consider the following simple query:

```

select listid, eventid, sum(pricepaid) as revenue,
count(qtysold) as numtix
from sales
group by listid, eventid
order by 3, 4, 2, 1
limit 5;

listid | eventid | revenue | numtix

```

```
-----+-----+-----+-----  
89397 |      47 |   20.00 |      1  
106590 |      76 |   20.00 |      1  
124683 |     393 |   20.00 |      1  
103037 |     403 |   20.00 |      1  
147685 |     429 |   20.00 |      1  
(5 rows)
```

In this query, the select list consists of two aggregate expressions. The first uses the SUM function and the second uses the COUNT function. The remaining two columns, LISTID and EVENTID, must be declared as grouping columns.

Expressions in the GROUP BY clause can also reference the select list by using ordinal numbers. For example, the previous example could be abbreviated as follows:

```
select listid, eventid, sum(pricepaid) as revenue,  
count(qtysold) as numtix  
from sales  
group by 1,2  
order by 3, 4, 2, 1  
limit 5;  
  
listid | eventid | revenue | numtix  
-----+-----+-----+-----  
89397 |      47 |   20.00 |      1  
106590 |      76 |   20.00 |      1  
124683 |     393 |   20.00 |      1  
103037 |     403 |   20.00 |      1  
147685 |     429 |   20.00 |      1  
(5 rows)
```

HAVING Clause

The HAVING clause applies a condition to the intermediate grouped result set that a query returns.

Syntax

```
[ HAVING condition ]
```

For example, you can restrict the results of a SUM function:

```
having sum(pricepaid) >10000
```

The HAVING condition is applied after all WHERE clause conditions are applied and GROUP BY operations are completed.

The condition itself takes the same form as any WHERE clause condition.

Usage Notes

- Any column that is referenced in a HAVING clause condition must be either a grouping column or a column that refers to the result of an aggregate function.
- In a HAVING clause, you cannot specify:
 - An alias that was defined in the select list. You must repeat the original, unaliased expression.

- An ordinal number that refers to a select list item. Only the GROUP BY and ORDER BY clauses accept ordinal numbers.

Examples

The following query calculates total ticket sales for all events by name, then eliminates events where the total sales were less than \$800,000. The HAVING condition is applied to the results of the aggregate function in the select list: `sum(pricepaid)`.

```
select eventname, sum(pricepaid)
from sales join event on sales.eventid = event.eventid
group by 1
having sum(pricepaid) > 800000
order by 2 desc, 1;
```

eventname	sum
Mamma Mia!	1135454.00
Spring Awakening	972855.00
The Country Girl	910563.00
Macbeth	862580.00
Jersey Boys	811877.00
Legally Blonde	804583.00

(6 rows)

The following query calculates a similar result set. In this case, however, the HAVING condition is applied to an aggregate that is not specified in the select list: `sum(qtysold)`. Events that did not sell more than 2,000 tickets are eliminated from the final result.

```
select eventname, sum(pricepaid)
from sales join event on sales.eventid = event.eventid
group by 1
having sum(qtysold) >2000
order by 2 desc, 1;
```

eventname	sum
Mamma Mia!	1135454.00
Spring Awakening	972855.00
The Country Girl	910563.00
Macbeth	862580.00
Jersey Boys	811877.00
Legally Blonde	804583.00
Chicago	790993.00
Spamalot	714307.00

(8 rows)

UNION, INTERSECT, and EXCEPT

Topics

- [Syntax \(p. 452\)](#)
- [Parameters \(p. 452\)](#)
- [Order of Evaluation for Set Operators \(p. 453\)](#)
- [Usage Notes \(p. 453\)](#)

- [Example UNION Queries \(p. 454\)](#)
- [Example UNION ALL Query \(p. 456\)](#)
- [Example INTERSECT Queries \(p. 457\)](#)
- [Example EXCEPT Query \(p. 458\)](#)

The UNION, INTERSECT, and EXCEPT *set operators* are used to compare and merge the results of two separate query expressions. For example, if you want to know which users of a website are both buyers and sellers but their user names are stored in separate columns or tables, you can find the *intersection* of these two types of users. If you want to know which website users are buyers but not sellers, you can use the EXCEPT operator to find the *difference* between the two lists of users. If you want to build a list of all users, regardless of role, you can use the UNION operator.

Syntax

```
query
{ UNION [ ALL ] | INTERSECT | EXCEPT | MINUS }
query
```

Parameters

query

A query expression that corresponds, in the form of its select list, to a second query expression that follows the UNION, INTERSECT, or EXCEPT operator. The two expressions must contain the same number of output columns with compatible data types; otherwise, the two result sets cannot be compared and merged. Set operations do not allow implicit conversion between different categories of data types; for more information, see [Type Compatibility and Conversion \(p. 266\)](#).

You can build queries that contain an unlimited number of query expressions and link them with UNION, INTERSECT, and EXCEPT operators in any combination. For example, the following query structure is valid, assuming that the tables T1, T2, and T3 contain compatible sets of columns:

```
select * from t1
union
select * from t2
except
select * from t3
order by c1;
```

UNION

Set operation that returns rows from two query expressions, regardless of whether the rows derive from one or both expressions.

INTERSECT

Set operation that returns rows that derive from two query expressions. Rows that are not returned by both expressions are discarded.

EXCEPT | MINUS

Set operation that returns rows that derive from one of two query expressions. To qualify for the result, rows must exist in the first result table but not the second. MINUS and EXCEPT are exact synonyms.

ALL

The ALL keyword retains any duplicate rows that are produced by UNION. The default behavior when the ALL keyword is not used is to discard these duplicates. INTERSECT ALL, EXCEPT ALL, and MINUS ALL are not supported.

Order of Evaluation for Set Operators

The UNION and EXCEPT set operators are left-associative. If parentheses are not specified to influence the order of precedence, a combination of these set operators is evaluated from left to right. For example, in the following query, the UNION of T1 and T2 is evaluated first, then the EXCEPT operation is performed on the UNION result:

```
select * from t1
union
select * from t2
except
select * from t3
order by c1;
```

The INTERSECT operator takes precedence over the UNION and EXCEPT operators when a combination of operators is used in the same query. For example, the following query will evaluate the intersection of T2 and T3, then union the result with T1:

```
select * from t1
union
select * from t2
intersect
select * from t3
order by c1;
```

By adding parentheses, you can enforce a different order of evaluation. In the following case, the result of the union of T1 and T2 is intersected with T3, and the query is likely to produce a different result.

```
(select * from t1
union
select * from t2)
intersect
(select * from t3)
order by c1;
```

Usage Notes

- The column names returned in the result of a set operation query are the column names (or aliases) from the tables in the first query expression. Because these column names are potentially misleading, in that the values in the column derive from tables on either side of the set operator, you might want to provide meaningful aliases for the result set.
- A query expression that precedes a set operator should not contain an ORDER BY clause. An ORDER BY clause produces meaningful sorted results only when it is used at the end of a query that contains set operators. In this case, the ORDER BY clause applies to the final results of all of the set operations. The outermost query can also contain standard LIMIT and OFFSET clauses.
- The LIMIT and OFFSET clauses are not supported as a means of restricting the number of rows returned by an intermediate result of a set operation. For example, the following query returns an error:

```
(select listid from listing
limit 10)
intersect
select listid from sales;
ERROR: LIMIT may not be used within input to set operations.
```

- When set operator queries return decimal results, the corresponding result columns are promoted to return the same precision and scale. For example, in the following query, where T1.REVENUE is a DECIMAL(10,2) column and T2.REVENUE is a DECIMAL(8,4) column, the decimal result is promoted to DECIMAL(12,4):

```
select t1.revenue union select t2.revenue;
```

The scale is 4 because that is the maximum scale of the two columns. The precision is 12 because T1.REVENUE requires 8 digits to the left of the decimal point (12 - 4 = 8). This type promotion ensures that all values from both sides of the UNION fit in the result. For 64-bit values, the maximum result precision is 19 and the maximum result scale is 18. For 128-bit values, the maximum result precision is 38 and the maximum result scale is 37.

If the resulting data type exceeds Amazon Redshift precision and scale limits, the query returns an error.

- For set operations, two rows are treated as identical if, for each corresponding pair of columns, the two data values are either *equal* or *both NULL*. For example, if tables T1 and T2 both contain one column and one row, and that row is NULL in both tables, an INTERSECT operation over those tables returns that row.

Example UNION Queries

In the following UNION query, rows in the SALES table are merged with rows in the LISTING table. Three compatible columns are selected from each table; in this case, the corresponding columns have the same names and data types.

The final result set is ordered by the first column in the LISTING table and limited to the 5 rows with the highest LISTID value.

```
select listid, sellerid, eventid from listing
union select listid, sellerid, eventid from sales
order by listid, sellerid, eventid desc limit 5;
```

```
listid | sellerid | eventid
-----+-----+-----
1 | 36861 | 7872
2 | 16002 | 4806
3 | 21461 | 4256
4 | 8117 | 4337
5 | 1616 | 8647
(5 rows)
```

The following example shows how you can add a literal value to the output of a UNION query so you can see which query expression produced each row in the result set. The query identifies rows from the first query expression as "B" (for buyers) and rows from the second query expression as "S" (for sellers).

The query identifies buyers and sellers for ticket transactions that cost \$10,000 or more. The only difference between the two query expressions on either side of the UNION operator is the joining column for the SALES table.

```
select listid, lastname, firstname, username,
pricepaid as price, 'S' as buyorsell
from sales, users
where sales.sellerid=users.userid
and pricepaid >=10000
```

```
union
select listid, lastname, firstname, username, pricepaid,
'B' as buyorsell
from sales, users
where sales.buyerid=users.userid
and pricepaid >=10000
order by 1, 2, 3, 4, 5;
```

listid	lastname	firstname	username	price	buyorsell
209658	Lamb	Colette	VOR15LYI	10000.00	B
209658	West	Kato	ELU81XAA	10000.00	S
212395	Greer	Harlan	GXO71KOC	12624.00	S
212395	Perry	Cora	YWR73YNZ	12624.00	B
215156	Banks	Patrick	ZNQ69CLT	10000.00	S
215156	Hayden	Malachi	BBG56AKU	10000.00	B

(6 rows)

The following example uses a UNION ALL operator because duplicate rows, if found, need to be retained in the result. For a specific series of event IDs, the query returns 0 or more rows for each sale associated with each event, and 0 or 1 row for each listing of that event. Event IDs are unique to each row in the LISTING and EVENT tables, but there might be multiple sales for the same combination of event and listing IDs in the SALES table.

The third column in the result set identifies the source of the row. If it comes from the SALES table, it is marked "Yes" in the SALESROW column. (SALESROW is an alias for SALES.LISTID.) If the row comes from the LISTING table, it is marked "No" in the SALESROW column.

In this case, the result set consists of three sales rows for listing 500, event 7787. In other words, three different transactions took place for this listing and event combination. The other two listings, 501 and 502, did not produce any sales, so the only row that the query produces for these list IDs comes from the LISTING table (SALESROW = 'No').

```
select eventid, listid, 'Yes' as salesrow
from sales
where listid in(500,501,502)
union all
select eventid, listid, 'No'
from listing
where listid in(500,501,502)
order by listid asc;
```

eventid	listid	salesrow
7787	500	No
7787	500	Yes
7787	500	Yes
7787	500	Yes
6473	501	No
5108	502	No

(6 rows)

If you run the same query without the ALL keyword, the result retains only one of the sales transactions.

```
select eventid, listid, 'Yes' as salesrow
from sales
where listid in(500,501,502)
```

```
union
select eventid, listid, 'No'
from listing
where listid in(500,501,502)
order by listid asc;
```

```
eventid | listid | salesrow
-----+-----+-----
7787 | 500 | No
7787 | 500 | Yes
6473 | 501 | No
5108 | 502 | No
(4 rows)
```

Example UNION ALL Query

The following example uses a UNION ALL operator because duplicate rows, if found, need to be retained in the result. For a specific series of event IDs, the query returns 0 or more rows for each sale associated with each event, and 0 or 1 row for each listing of that event. Event IDs are unique to each row in the LISTING and EVENT tables, but there might be multiple sales for the same combination of event and listing IDs in the SALES table.

The third column in the result set identifies the source of the row. If it comes from the SALES table, it is marked "Yes" in the SALESROW column. (SALESROW is an alias for SALES.LISTID.) If the row comes from the LISTING table, it is marked "No" in the SALESROW column.

In this case, the result set consists of three sales rows for listing 500, event 7787. In other words, three different transactions took place for this listing and event combination. The other two listings, 501 and 502, did not produce any sales, so the only row that the query produces for these list IDs comes from the LISTING table (SALESROW = 'No').

```
select eventid, listid, 'Yes' as salesrow
from sales
where listid in(500,501,502)
union all
select eventid, listid, 'No'
from listing
where listid in(500,501,502)
order by listid asc;
```

```
eventid | listid | salesrow
-----+-----+-----
7787 | 500 | No
7787 | 500 | Yes
7787 | 500 | Yes
7787 | 500 | Yes
6473 | 501 | No
5108 | 502 | No
(6 rows)
```

If you run the same query without the ALL keyword, the result retains only one of the sales transactions.

```
select eventid, listid, 'Yes' as salesrow
from sales
where listid in(500,501,502)
union
```

```
select eventid, listid, 'No'
from listing
where listid in(500,501,502)
order by listid asc;
```

```
eventid | listid | salesrow
-----+-----+-----
7787 | 500 | No
7787 | 500 | Yes
6473 | 501 | No
5108 | 502 | No
(4 rows)
```

Example INTERSECT Queries

Compare the following example with the first UNION example. The only difference between the two examples is the set operator that is used, but the results are very different. Only one of the rows is the same:

```
235494 | 23875 | 8771
```

This is the only row in the limited result of 5 rows that was found in both tables.

```
select listid, sellerid, eventid from listing
intersect
select listid, sellerid, eventid from sales
order by listid desc, sellerid, eventid
limit 5;
```

```
listid | sellerid | eventid
-----+-----+-----
235494 | 23875 | 8771
235482 | 1067 | 2667
235479 | 1589 | 7303
235476 | 15550 | 793
235475 | 22306 | 7848
(5 rows)
```

The following query finds events (for which tickets were sold) that occurred at venues in both New York City and Los Angeles in March. The difference between the two query expressions is the constraint on the VENUECITY column.

```
select distinct eventname from event, sales, venue
where event.eventid=sales.eventid and event.venueid=venue.venueid
and date_part(month,starttime)=3 and venuecity='Los Angeles'
intersect
select distinct eventname from event, sales, venue
where event.eventid=sales.eventid and event.venueid=venue.venueid
and date_part(month,starttime)=3 and venuecity='New York City'
order by eventname asc;
```

```
eventname
-----
A Streetcar Named Desire
Dirty Dancing
Electra
```

```
Running with Annalise  
Hairspray  
Mary Poppins  
November  
Oliver!  
Return To Forever  
Rhinoceros  
South Pacific  
The 39 Steps  
The Bacchae  
The Caucasian Chalk Circle  
The Country Girl  
Wicked  
Woyzeck  
(16 rows)
```

Example EXCEPT Query

The CATEGORY table in the TICKIT database contains the following 11 rows:

catid	catgroup	catname	catdesc
1	Sports	MLB	Major League Baseball
2	Sports	NHL	National Hockey League
3	Sports	NFL	National Football League
4	Sports	NBA	National Basketball Association
5	Sports	MLS	Major League Soccer
6	Shows	Musicals	Musical theatre
7	Shows	Plays	All non-musical theatre
8	Shows	Opera	All opera and light opera
9	Concerts	Pop	All rock and pop music concerts
10	Concerts	Jazz	All jazz singers and bands
11	Concerts	Classical	All symphony, concerto, and choir concerts

(11 rows)

Assume that a CATEGORY_STAGE table (a staging table) contains one additional row:

catid	catgroup	catname	catdesc
1	Sports	MLB	Major League Baseball
2	Sports	NHL	National Hockey League
3	Sports	NFL	National Football League
4	Sports	NBA	National Basketball Association
5	Sports	MLS	Major League Soccer
6	Shows	Musicals	Musical theatre
7	Shows	Plays	All non-musical theatre
8	Shows	Opera	All opera and light opera
9	Concerts	Pop	All rock and pop music concerts
10	Concerts	Jazz	All jazz singers and bands
11	Concerts	Classical	All symphony, concerto, and choir concerts
12	Concerts	Comedy	All stand up comedy performances

(12 rows)

Return the difference between the two tables. In other words, return rows that are in the CATEGORY_STAGE table but not in the CATEGORY table:

```
select * from category_stage
```

```
except
select * from category;

catid | catgroup | catname |          catdesc
-----+-----+-----+-----
12 | Concerts | Comedy | All stand up comedy performances
(1 row)
```

The following equivalent query uses the synonym MINUS.

```
select * from category_stage
minus
select * from category;

catid | catgroup | catname |          catdesc
-----+-----+-----+-----
12 | Concerts | Comedy | All stand up comedy performances
(1 row)
```

If you reverse the order of the SELECT expressions, the query returns no rows.

ORDER BY Clause

Topics

- [Syntax \(p. 459\)](#)
- [Parameters \(p. 459\)](#)
- [Usage Notes \(p. 460\)](#)
- [Examples with ORDER BY \(p. 460\)](#)

The ORDER BY clause sorts the result set of a query.

Syntax

```
[ ORDER BY expression
[ ASC | DESC ]
[ NULLS FIRST | NULLS LAST ]
[ LIMIT { count | ALL } ]
[ OFFSET start ]
```

Parameters

expression

Expression that defines the sort order of the query result set, typically by specifying one or more columns in the select list. Results are returned based on binary UTF-8 ordering. You can also specify the following:

- Columns that are not in the select list
- Expressions formed from one or more columns that exist in the tables referenced by the query
- Ordinal numbers that represent the position of select list entries (or the position of columns in the table if no select list exists)
- Aliases that define select list entries

When the ORDER BY clause contains multiple expressions, the result set is sorted according to the first expression, then the second expression is applied to rows that have matching values from the first expression, and so on.

ASC | DESC

Option that defines the sort order for the expression, as follows:

- **ASC**: ascending (for example, low to high for numeric values and 'A' to 'Z' for character strings). If no option is specified, data is sorted in ascending order by default.
- **DESC**: descending (high to low for numeric values; 'Z' to 'A' for strings).

NULLS FIRST | NULLS LAST

Option that specifies whether NULL values should be ordered first, before non-null values, or last, after non-null values. By default, NULL values are sorted and ranked last in ASC ordering, and sorted and ranked first in DESC ordering.

LIMIT *number* | ALL

Option that controls the number of sorted rows that the query returns. The LIMIT number must be a positive integer; the maximum value is 2147483647.

LIMIT 0 returns no rows. You can use this syntax for testing purposes: to check that a query runs (without displaying any rows) or to return a column list from a table. An ORDER BY clause is redundant if you are using LIMIT 0 to return a column list. The default is LIMIT ALL.

OFFSET *start*

Option that specifies to skip the number of rows before *start* before beginning to return rows. The OFFSET number must be a positive integer; the maximum value is 2147483647. When used with the LIMIT option, OFFSET rows are skipped before starting to count the LIMIT rows that are returned. If the LIMIT option is not used, the number of rows in the result set is reduced by the number of rows that are skipped. The rows skipped by an OFFSET clause still have to be scanned, so it might be inefficient to use a large OFFSET value.

Usage Notes

Note the following expected behavior with ORDER BY clauses:

- NULL values are considered "higher" than all other values. With the default ascending sort order, NULL values sort at the end. To change this behavior, use the NULLS FIRST option.
- When a query doesn't contain an ORDER BY clause, the system returns result sets with no predictable ordering of the rows. The same query executed twice might return the result set in a different order.
- The LIMIT and OFFSET options can be used without an ORDER BY clause; however, to return a consistent set of rows, use these options in conjunction with ORDER BY.
- In any parallel system like Amazon Redshift, when ORDER BY does not produce a unique ordering, the order of the rows is nondeterministic. That is, if the ORDER BY expression produces duplicate values, the return order of those rows might vary from other systems or from one run of Amazon Redshift to the next.

Examples with ORDER BY

Return all 11 rows from the CATEGORY table, ordered by the second column, CATGROUP. For results that have the same CATGROUP value, order the CATDESC column values by the length of the character string. The other two columns, CATID and CATNAME, do not influence the order of results.

```
select * from category order by 2, length(catdesc), 1, 3;
```

catid	catgroup	catname	catdesc
10	Concerts	Jazz	All jazz singers and bands
9	Concerts	Pop	All rock and pop music concerts

```

11 | Concerts | Classical | All symphony, concerto, and choir conce
6 | Shows | Musicals | Musical theatre
7 | Shows | Plays | All non-musical theatre
8 | Shows | Opera | All opera and light opera
5 | Sports | MLS | Major League Soccer
1 | Sports | MLB | Major League Baseball
2 | Sports | NHL | National Hockey League
3 | Sports | NFL | National Football League
4 | Sports | NBA | National Basketball Association
(11 rows)

```

Return selected columns from the SALES table, ordered by the highest QTYSOLD values. Limit the result to the top 10 rows:

```

select salesid, qtysold, pricepaid, commission, saletime from sales
order by qtysold, pricepaid, commission, salesid, saletime desc
limit 10;

```

salesid	qtysold	pricepaid	commission	saletime
15401	8	272.00	40.80	2008-03-18 06:54:56
61683	8	296.00	44.40	2008-11-26 04:00:23
90528	8	328.00	49.20	2008-06-11 02:38:09
74549	8	336.00	50.40	2008-01-19 12:01:21
130232	8	352.00	52.80	2008-05-02 05:52:31
55243	8	384.00	57.60	2008-07-12 02:19:53
16004	8	440.00	66.00	2008-11-04 07:22:31
489	8	496.00	74.40	2008-08-03 05:48:55
4197	8	512.00	76.80	2008-03-23 11:35:33
16929	8	568.00	85.20	2008-12-19 02:59:33

(10 rows)

Return a column list and no rows by using LIMIT 0 syntax:

```

select * from venue limit 0;
venueid | venue name | venue city | venue state | venue seats
-----+-----+-----+-----+-----
(0 rows)

```

Join Examples

The following query is an outer join. Left and right outer joins retain values from one of the joined tables when no match is found in the other table. The left and right tables are the first and second tables listed in the syntax. NULL values are used to fill the "gaps" in the result set.

This query matches LISTID column values in LISTING (the left table) and SALES (the right table). The results show that listings 2, 3, and 5 did not result in any sales.

```

select listing.listid, sum(pricepaid) as price, sum(commission) as comm
from listing left outer join sales on sales.listid = listing.listid
where listing.listid between 1 and 5
group by 1
order by 1;

```

listid	price	comm
1		
2		
3		
4		
5		

```
1 | 728.00 | 109.20
2 |      | 
3 |      | 
4 |  76.00 |  11.40
5 | 525.00 |  78.75
(5 rows)
```

The following query is an inner join of two subqueries in the FROM clause. The query finds the number of sold and unsold tickets for different categories of events (concerts and shows):

```
select catgroup1, sold, unsold
from
(select catgroup, sum(qtysold) as sold
from category c, event e, sales s
where c.catid = e.catid and e.eventid = s.eventid
group by catgroup) as a(catgroup1, sold)
join
(select catgroup, sum(numtickets)-sum(qtysold) as unsold
from category c, event e, sales s, listing l
where c.catid = e.catid and e.eventid = s.eventid
and s.listid = l.listid
group by catgroup) as b(catgroup2, unsold)
on a.catgroup1 = b.catgroup2
order by 1;

catgroup1 | sold | unsold
-----+-----+-----
Concerts  | 195444 | 1067199
Shows     | 149905 | 817736
(2 rows)
```

These FROM clause subqueries are *table* subqueries; they can return multiple columns and rows.

Subquery Examples

The following examples show different ways in which subqueries fit into SELECT queries. See [Join Examples \(p. 461\)](#) for another example of the use of subqueries.

SELECT List Subquery

The following example contains a subquery in the SELECT list. This subquery is *scalar*: it returns only one column and one value, which is repeated in the result for each row that is returned from the outer query. The query compares the Q1SALES value that the subquery computes with sales values for two other quarters (2 and 3) in 2008, as defined by the outer query.

```
select qtr, sum(pricepaid) as qtrsales,
(select sum(pricepaid)
from sales join date on sales.dateid=date.dateid
where qtr='1' and year=2008) as q1sales
from sales join date on sales.dateid=date.dateid
where qtr in('2','3') and year=2008
group by qtr
order by qtr;

qtr | qtrsales | q1sales
-----+-----+-----
```

```
2      | 30560050.00 | 24742065.00
3      | 31170237.00 | 24742065.00
(2 rows)
```

WHERE Clause Subquery

The following example contains a table subquery in the WHERE clause. This subquery produces multiple rows. In this case, the rows contain only one column, but table subqueries can contain multiple columns and rows, just like any other table.

The query finds the top 10 sellers in terms of maximum tickets sold. The top 10 list is restricted by the subquery, which removes users who live in cities where there are ticket venues. This query can be written in different ways; for example, the subquery could be rewritten as a join within the main query.

```
select firstname, lastname, city, max(qtysold) as maxsold
from users join sales on users.userid=sales.sellerid
where users.city not in(select venuecity from venue)
group by firstname, lastname, city
order by maxsold desc, city desc
limit 10;
```

firstname	lastname	city	maxsold
Noah	Guerrero	Worcester	8
Isadora	Moss	Winooski	8
Kieran	Harrison	Westminster	8
Heidi	Davis	Warwick	8
Sara	Anthony	Waco	8
Bree	Buck	Valdez	8
Evangeline	Sampson	Trenton	8
Kendall	Keith	Stillwater	8
Bertha	Bishop	Stevens Point	8
Patricia	Anderson	South Portland	8

(10 rows)

WITH Clause Subqueries

See [WITH Clause \(p. 436\)](#).

Correlated Subqueries

The following example contains a *correlated subquery* in the WHERE clause; this kind of subquery contains one or more correlations between its columns and the columns produced by the outer query. In this case, the correlation is where `s.listid=l.listid`. For each row that the outer query produces, the subquery is executed to qualify or disqualify the row.

```
select salesid, listid, sum(pricepaid) from sales s
where qtysold=
(select max(numtickets) from listing l
where s.listid=l.listid)
group by 1,2
order by 1,2
limit 5;
```

salesid	listid	sum
---------	--------	-----

-----+-----+-----

```
27 |      28 | 111.00
81 |     103 | 181.00
142 |     149 | 240.00
146 |     152 | 231.00
194 |     210 | 144.00
(5 rows)
```

Correlated Subquery Patterns That Are Not Supported

The query planner uses a query rewrite method called subquery decorrelation to optimize several patterns of correlated subqueries for execution in an MPP environment. A few types of correlated subqueries follow patterns that Amazon Redshift cannot decorrelate and does not support. Queries that contain the following correlation references return errors:

- Correlation references that skip a query block, also known as "skip-level correlation references." For example, in the following query, the block containing the correlation reference and the skipped block are connected by a NOT EXISTS predicate:

```
select event.eventname from event
where not exists
(select * from listing
where not exists
(select * from sales where event.eventid=sales.eventid));
```

The skipped block in this case is the subquery against the LISTING table. The correlation reference correlates the EVENT and SALES tables.

- Correlation references from a subquery that is part of an ON clause in an outer join:

```
select * from category
left join event
on category.catid=event.catid and eventid =
(select max(eventid) from sales where sales.eventid=event.eventid);
```

The ON clause contains a correlation reference from SALES in the subquery to EVENT in the outer query.

- Null-sensitive correlation references to an Amazon Redshift system table. For example:

```
select attrelid
from stv_locks sl, pg_attribute
where sl.table_id=pg_attribute.attrelid and 1 not in
(select 1 from pg_opclass where sl.lock_owner = opowner);
```

- Correlation references from within a subquery that contains a window function.

```
select listid, qtysold
from sales s
where qtysold not in
(select sum(numtickets) over() from listing l where s.listid=l.listid);
```

- References in a GROUP BY column to the results of a correlated subquery. For example:

```
select listing.listid,
(select count (sales.listid) from sales where sales.listid=listing.listid)
as list
from listing
```

```
group by list, listing.listid;
```

- Correlation references from a subquery with an aggregate function and a GROUP BY clause, connected to the outer query by an IN predicate. (This restriction does not apply to MIN and MAX aggregate functions.) For example:

```
select * from listing where listid in
(select sum(qtysold)
from sales
where numtickets>4
group by salesid);
```

SELECT INTO

Selects rows defined by any query and inserts them into a new temporary or persistent table.

Syntax

```
[ WITH with_subquery [, ...] ]
SELECT
[ TOP number ] [ ALL | DISTINCT ]
* | expression [ AS output_name ] [, ...]
INTO [ TEMPORARY | TEMP ] [ TABLE ] new_table
[ FROM table_reference [, ...] ]
[ WHERE condition ]
[ GROUP BY expression [, ...] ]
[ HAVING condition [, ...] ]
[ { UNION | INTERSECT | { EXCEPT | MINUS } } [ ALL ] query ]
[ ORDER BY expression
[ ASC | DESC ]
[ LIMIT { number | ALL } ]
[ OFFSET start ]
```

For details about the parameters of this command, see [SELECT \(p. 435\)](#).

Examples

Select all of the rows from the EVENT table and create a NEWEVENT table:

```
select * into newevent from event;
```

Select the result of an aggregate query into a temporary table called PROFITS:

```
select username, lastname, sum(pricepaid-commission) as profit
into temp table profits
from sales, users
where sales.sellerid=users.userid
group by 1, 2
order by 3 desc;
```

SET

Sets the value of a server configuration parameter.

Use the [RESET \(p. 430\)](#) command to return a parameter to its default value. See [Modifying the Server Configuration \(p. 809\)](#) for more information about parameters.

Syntax

```
SET { [ SESSION | LOCAL ]  
parameter_name { TO | = }  
{ value | 'value' | DEFAULT } |  
SEED TO value }
```

Parameters

SESSION

Specifies that the setting is valid for the current session. Default value.

LOCAL

Specifies that the setting is valid for the current transaction.

SEED TO *value*

Sets an internal seed to be used by the RANDOM function for random number generation.

SET SEED takes a numeric *value* between 0 and 1, and multiplies this number by $(2^{31}-1)$ for use with the [RANDOM Function \(p. 610\)](#) function. If you use SET SEED before making multiple RANDOM calls, RANDOM generates numbers in a predictable sequence.

parameter_name

Name of the parameter to set. See [Modifying the Server Configuration \(p. 809\)](#) for information about parameters.

value

New parameter value. Use single quotes to set the value to a specific string. If using SET SEED, this parameter contains the SEED value.

DEFAULT

Sets the parameter to the default value.

Examples

Changing a Parameter for the Current Session

The following example sets the datestyle:

```
set datestyle to 'SQL,DMY';
```

Setting a Query Group for Workload Management

If query groups are listed in a queue definition as part of the cluster's WLM configuration, you can set the QUERY_GROUP parameter to a listed query group name. Subsequent queries are assigned to the associated query queue. The QUERY_GROUP setting remains in effect for the duration of the session or until a RESET QUERY_GROUP command is encountered.

This example runs two queries as part of the query group 'priority', then resets the query group.

```
set query_group to 'priority';  
select tbl, count(*) from stv_blocklist;  
select query, elapsed, substring from svl_qlog order by query desc limit 5;  
reset query_group;
```

See [Implementing Workload Management \(p. 222\)](#)

Setting a Label for a Group of Queries

The QUERY_GROUP parameter defines a label for one or more queries that are executed in the same session after a SET command. In turn, this label is logged when queries are executed and can be used to constrain results returned from the STL_QUERY and STV_INFLIGHT system tables and the SVL_QLOG view.

```

show query_group;
query_group
-----
unset
(1 row)

set query_group to '6 p.m.';

show query_group;
query_group
-----
6 p.m.
(1 row)

select * from sales where salesid=500;
salesid | listid | sellerid | buyerid | eventid | dateid | ...
-----+-----+-----+-----+-----+-----+-----
500 | 504 | 3858 | 2123 | 5871 | 2052 | ...
(1 row)

reset query_group;

select query, trim(label) querygroup, pid, trim(querytxt) sql
from stl_query
where label = '6 p.m.';
query | querygroup | pid | sql
-----+-----+-----+-----
57 | 6 p.m. | 30711 | select * from sales where salesid=500;
(1 row)

```

Query group labels are a useful mechanism for isolating individual queries or groups of queries that are run as part of scripts. You do not need to identify and track queries by their IDs; you can track them by their labels.

Setting a Seed Value for Random Number Generation

The following example uses the SEED option with SET to cause the RANDOM function to generate numbers in a predictable sequence.

First, return three RANDOM integers without setting the SEED value first:

```

select cast (random() * 100 as int);
int4
-----
6
(1 row)

select cast (random() * 100 as int);
int4
-----
68

```

```
(1 row)

select cast (random() * 100 as int);
int4
-----
56
(1 row)
```

Now, set the SEED value to .25, and return three more RANDOM numbers:

```
set seed to .25;

select cast (random() * 100 as int);
int4
-----
21
(1 row)

select cast (random() * 100 as int);
int4
-----
79
(1 row)

select cast (random() * 100 as int);
int4
-----
12
(1 row)
```

Finally, reset the SEED value to .25, and verify that RANDOM returns the same results as the previous three calls:

```
set seed to .25;

select cast (random() * 100 as int);
int4
-----
21
(1 row)

select cast (random() * 100 as int);
int4
-----
79
(1 row)

select cast (random() * 100 as int);
int4
-----
12
(1 row)
```

SET SESSION AUTHORIZATION

Sets the user name for the current session.

You can use the SET SESSION AUTHORIZATION command, for example, to test database access by temporarily running a session or transaction as an unprivileged user.

Syntax

```
SET [ SESSION | LOCAL ] SESSION AUTHORIZATION { user_name | DEFAULT }
```

Parameters

SESSION

Specifies that the setting is valid for the current session. Default value.

LOCAL

Specifies that the setting is valid for the current transaction.

user_name

Name of the user to set. The user name may be written as an identifier or a string literal.

DEFAULT

Sets the session user name to the default value.

Examples

The following example sets the user name for the current session to `dwuser`:

```
SET SESSION AUTHORIZATION 'dwuser';
```

The following example sets the user name for the current transaction to `dwuser`:

```
SET LOCAL SESSION AUTHORIZATION 'dwuser';
```

This example sets the user name for the current session to the default user name:

```
SET SESSION AUTHORIZATION DEFAULT;
```

SET SESSION CHARACTERISTICS

This command is deprecated.

SHOW

Displays the current value of a server configuration parameter. This value may be specific to the current session if a SET command is in effect. For a list of configuration parameters, see [Configuration Reference \(p. 809\)](#).

Syntax

```
SHOW { parameter_name | ALL }
```

Parameters

parameter_name

Displays the current value of the specified parameter.

ALL

Displays the current values of all of the parameters.

Examples

The following example displays the value for the `query_group` parameter:

```
show query_group;

query_group

unset
(1 row)
```

The following example displays a list of all parameters and their values:

```
show all;
name          | setting
-----+-----
datestyle     | ISO, MDY
extra_float_digits | 0
query_group   | unset
search_path   | $user,public
statement_timeout | 0
```

START TRANSACTION

Synonym of the `BEGIN` function.

See [BEGIN](#) (p. 312).

TRUNCATE

Deletes all of the rows from a table without doing a table scan: this operation is a faster alternative to an unqualified `DELETE` operation. To execute a `TRUNCATE` command, you must be the owner of the table or a superuser.

Syntax

```
TRUNCATE [ TABLE ] table_name
```

Parameters

TABLE

Optional keyword.

table_name

A temporary or persistent table. Only the owner of the table or a superuser may truncate it.

You can truncate any table, including tables that are referenced in foreign-key constraints.

After truncating a table, run the `ANALYZE` command against the table. You do not need to vacuum a table after truncating it.

Usage Notes

The TRUNCATE command commits the transaction in which it is run; therefore, you cannot roll back a TRUNCATE operation, and a TRUNCATE command may commit other operations when it commits itself.

Examples

Use the TRUNCATE command to delete all of the rows from the CATEGORY table:

```
truncate category;
```

Attempt to roll back a TRUNCATE operation:

```
begin;

truncate date;

rollback;

select count(*) from date;
count
-----
0
(1 row)
```

The DATE table remains empty after the ROLLBACK command because the TRUNCATE command committed automatically.

UNLOAD

Unloads the result of a query to one or more files on Amazon Simple Storage Service(Amazon S3), using Amazon S3 server-side encryption (SSE).

Syntax

```
UNLOAD ('select-statement')
TO 's3://object-path/name-prefix'
[ WITH ] CREDENTIALS [AS] 'aws-auth-args'
[ option [ ... ] ]

where option is

{ MANIFEST
| DELIMITER [ AS ] 'delimiter-char'
| FIXEDWIDTH [ AS ] 'fixedwidth-spec' }
| ENCRYPTED
| BZIP2
| GZIP
| ADDQUOTES
| NULL [ AS ] 'null-string'
| ESCAPE
| ALLOWOVERWRITE
| PARALLEL [ { ON | TRUE } | { OFF | FALSE } ]
```

Parameters

(*'select-statement'*)

A SELECT query. The results of the query are unloaded. In most cases, it is worthwhile to unload data in sorted order by specifying an ORDER BY clause in the query; this approach saves the time required to sort the data when it is reloaded.

The query must be enclosed in single quotes as shown following:

```
('select * from venue order by venueid')
```

Note

If your query contains quotes (enclosing literal values, for example), or backslashes (\), you need to escape them in the query text as shown following:

```
('select * from venue where venuestate=\'NV\')
```

TO *'s3://object-path/name-prefix'*

The full path, including bucket name, to the location on Amazon S3 where Amazon Redshift will write the output file objects, including the manifest file if MANIFEST is specified. The object names are prefixed with *name-prefix*. For added security, UNLOAD connects to Amazon S3 using an HTTPS connection. By default, UNLOAD writes one or more files per slice. UNLOAD appends a slice number and part number to the specified name prefix as follows:

```
<object-path>/<name-prefix><slice-number>_part_<part-number>.
```

If MANIFEST is specified, the manifest file is written as follows:

```
<object_path>/<name_prefix>.
```

UNLOAD automatically creates encrypted files using Amazon S3 server-side encryption (SSE). The COPY command automatically reads server-side encrypted files during the load operation. You can transparently download server-side encrypted files from your bucket using either the Amazon S3 management console or APIs. For more information, go to [Protecting Data Using Server-Side Encryption](#).

To use Amazon S3 client-side encryption, specify the ENCRYPTED option.

Important

The Amazon S3 bucket where Amazon Redshift will write the output files must reside in the same region as your cluster.

[WITH] CREDENTIALS [AS] *'aws-auth-args'*

A clause that indicates the method your cluster will use for authentication and authorization to access the Amazon S3 bucket where UNLOAD will write the output files. Optionally, if you use the [ENCRYPTED \(p. 474\)](#) parameter, provide the encryption key in the *aws-auth-args* string.

The *aws-auth-args* string must not contain spaces.

The keywords WITH and AS are optional and are ignored.

You can specify either [Role-Based Access Control \(p. 132\)](#) or [Key-Based Access Control \(p. 132\)](#). In either case, the IAM role or user must have the permissions required to access the specified AWS resources.

Note

To protect your AWS credentials and sensitive data, we strongly recommend using role-based access control.

To specify role-based access control, provide the role ARN in the *aws-auth-args* string in the following format.

```
'aws_iam_role=arn:aws:iam::<account-id>:role/<role-name>'
```

To specify key-based access control, provide the access key ID and the secret access key in the *aws-auth-args* string in the following format.

```
'aws_access_key_id=<access-key-id>;aws_secret_access_key=<secret-access-key>'
```

To further limit user access with key-based access control, you can provide temporary access credentials. For more information, see [Temporary Security Credentials \(p. 350\)](#) in Usage notes for the COPY command.

To encrypt your data files on Amazon S3 using client-side encryption, include the [ENCRYPTED \(p. 474\)](#) parameter and add the master symmetric encryption key to the *aws-auth-args* string in the following format. The master key must be a base-64 encoded symmetric key in 256-bit Advanced Encryption Standard (AES) format.

If the ENCRYPTED parameter is used, the *aws-auth-args* string is in the format, where *<master-key>* is the value of the master key that UNLOAD will use to encrypt the files.

```
'aws_access_key_id=<access-key-id>;aws_secret_access_key=<secret-access-key>;master_symmetric_key=<master-key>'
```

For example, the following UNLOAD command uses role-based access control with an encryption key.

```
unload ('select * from venue')
to 's3://mybucket/unload/'
credentials
'aws_iam_role=arn:aws:iam::<account-id>:role/<role-
name>;master_symmetric_key=<master-key>'
encrypted;
```

The following topics provide more details and examples of authentication options.

- [IAM Permissions for COPY, UNLOAD, and CREATE LIBRARY \(p. 351\)](#)
- [Role-Based Access Control \(p. 348\)](#)
- [Key-Based Access Control \(p. 349\)](#)

MANIFEST

Creates a manifest file that explicitly lists the data files that are created by the UNLOAD process. The manifest is a text file in JSON format that lists the URL of each file that was written to Amazon S3. The manifest file is written to the same Amazon S3 path prefix as the unload files in the format *<object_path_prefix>manifest*. For example, if the UNLOAD specifies the Amazon S3 path prefix *'s3://mybucket/venue_'*, the manifest file location will be *'s3://mybucket/venue_manifest'*.

DELIMITER AS '*delimiter_character*'

Single ASCII character that is used to separate fields in the output file, such as a pipe character (|), a comma (,), or a tab (\t). The default delimiter is a pipe character. The AS keyword is optional. DELIMITER cannot be used with FIXEDWIDTH. If the data contains the delimiter character, you will need to specify the ESCAPE option to escape the delimiter, or use ADDQUOTES to enclose the data in double quotes. Alternatively, specify a delimiter that is not contained in the data.

FIXEDWIDTH '*fixedwidth_spec*'

Unloads the data to a file where each column width is a fixed length, rather than separated by a delimiter. The *fixedwidth_spec* is a string that specifies the number of columns and the width of the columns. The AS keyword is optional. FIXEDWIDTH cannot be used with DELIMITER. Because FIXEDWIDTH does not truncate data, the specification for each column in the UNLOAD statement needs to be at least as long as the length of the longest entry for that column. The format for *fixedwidth_spec* is shown below:

```
'colID1:colWidth1,colID2:colWidth2, ...'
```

ENCRYPTED

Specifies that the output files on Amazon S3 will be encrypted using Amazon S3 client-side encryption. For more information, see [Unloading Encrypted Data Files \(p. 188\)](#). UNLOAD automatically creates encrypted files using Amazon S3 server-side encryption with AWS-managed encryption keys (SSE). UNLOAD does not support Amazon S3 server-side encryption with a customer-supplied key (SSE-C). To unload to encrypted compressed files, add the GZIP or BZIP2 option.

BZIP2

Unloads data to one or more bzip2-compressed files per slice. Each resulting file is appended with a .bz2 extension.

GZIP

Unloads data to one or more gzip-compressed files per slice. Each resulting file is appended with a .gz extension.

ADDQUOTES

Places quotation marks around each unloaded data field, so that Amazon Redshift can unload data values that contain the delimiter itself. For example, if the delimiter is a comma, you could unload and reload the following data successfully:

```
"1","Hello, World"
```

Without the added quotes, the string `Hello, World` would be parsed as two separate fields.

If you use ADDQUOTES, you must specify REMOVEQUOTES in the COPY if you reload the data.

NULL AS '*null-string*'

Specifies a string that represents a null value in unload files. If this option is used, all output files contain the specified string in place of any null values found in the selected data. If this option is not specified, null values are unloaded as:

- Zero-length strings for delimited output
- Whitespace strings for fixed-width output

If a null string is specified for a fixed-width unload and the width of an output column is less than the width of the null string, the following behavior occurs:

- An empty field is output for non-character columns
- An error is reported for character columns

ESCAPE

For CHAR and VARCHAR columns in delimited unload files, an escape character (\) is placed before every occurrence of the following characters:

- Linefeed: \n
- Carriage return: \r
- The delimiter character specified for the unloaded data.
- The escape character: \
- A quote character: " or ' (if both ESCAPE and ADDQUOTES are specified in the UNLOAD command).

Important

If you loaded your data using a COPY with the ESCAPE option, you must also specify the ESCAPE option with your UNLOAD command to generate the reciprocal output file. Similarly, if you UNLOAD using the ESCAPE option, you will need to use ESCAPE when you COPY the same data.

ALLOWOVERWRITE

By default, UNLOAD fails if it finds files that it would possibly overwrite. If ALLOWOVERWRITE is specified, UNLOAD will overwrite existing files, including the manifest file.

PARALLEL

By default, UNLOAD writes data in parallel to multiple files, according to the number of slices in the cluster. The default option is ON or TRUE. If PARALLEL is OFF or FALSE, UNLOAD writes to one or more data files serially, sorted absolutely according to the ORDER BY clause, if one is used. The maximum size for a data file is 6.2 GB. So, for example, if you unload 13.4 GB of data, UNLOAD creates the following three files.

```
s3://mybucket/key000    6.2 GB
s3://mybucket/key001    6.2 GB
s3://mybucket/key002    1.0 GB
```

Note

The UNLOAD command is designed to use parallel processing. We recommend leaving PARALLEL enabled for most cases, especially if the files will be used to load tables using a COPY command.

Usage Notes

Using ESCAPE for All Delimited UNLOAD Operations

When you UNLOAD using a delimiter and there is any possibility that your data includes the delimiter or any of the characters listed in the ESCAPE option description, you must use the ESCAPE option with the UNLOAD statement. If you do not use the ESCAPE option with the UNLOAD, subsequent COPY operations using the unloaded data might fail.

Important

We strongly recommend that you always use ESCAPE with both UNLOAD and COPY statements unless you are certain that your data does not contain any delimiters or other characters that might need to be escaped.

Loss of Floating-Point Precision

You might encounter loss of precision for floating-point data that is successively unloaded and reloaded.

Limit Clause

The SELECT query cannot use a LIMIT clause in the outer SELECT. For example, the following UNLOAD statement will fail:

```
unload ('select * from venue limit 10')
to 's3://mybucket/venue_pipe_' credentials
'<aws-auth-args>;
```

Instead, use a nested LIMIT clause. For example:

```
unload ('select * from venue where venueid in
```

```
(select venueid from venue order by venueid desc limit 10)')  
to 's3://mybucket/venue_pipe_' credentials  
'<aws-auth-args>';
```

Alternatively, you could populate a table using `SELECT...INTO` or `CREATE TABLE AS` using a `LIMIT` clause, then unload from that table.

UNLOAD Examples

Unload VENUE to a Pipe-Delimited File (Default Delimiter)

Note

These examples contain line breaks for readability. Do not include line breaks or spaces in your `aws-auth-args` string.

The following example unloads the `VENUE` table and writes the data to `s3://mybucket/unload/`:

```
unload ('select * from venue')  
to 's3://mybucket/unload/' credentials  
'<aws-auth-args>';
```

By default, `UNLOAD` writes one or more files per slice. Assuming a two-node cluster with two slices per node, the previous example creates these files in `mybucket`:

```
unload/0000_part_00  
unload/0001_part_00  
unload/0002_part_00  
unload/0003_part_00
```

To better differentiate the output files, you can include a prefix in the location. The following example unloads the `VENUE` table and writes the data to `s3://mybucket/venue_pipe_`:

```
unload ('select * from venue')  
to 's3://mybucket/unload/venue_pipe_' credentials  
'<aws-auth-args>';
```

The result is these four files in the `unload` folder, again assuming four slices.

```
venue_pipe_0000_part_00  
venue_pipe_0001_part_00  
venue_pipe_0002_part_00  
venue_pipe_0003_part_00
```

Unload VENUE Serially

To unload serially, specify `PARALLEL OFF`. `UNLOAD` will then write one file at a time, up to a maximum of 6.2 GB per file.

The following example unloads the `VENUE` table and writes the data serially to `s3://mybucket/unload/`.

```
unload ('select * from venue')  
to 's3://mybucket/unload/venue_serial_' credentials
```



```
'aws_access_key_id=<access-key-id>;aws_secret_access_key=<secret-access-key>'
parallel off;
```

The result is one file named `venue_serial_000`.

If the unload data is larger than 6.2 GB, UNLOAD creates a new file for each 6.2 GB data segment. The following example unloads the `LINEORDER` table and writes the data serially to `s3://mybucket/unload/`.

```
unload ('select * from lineorder')
to 's3://mybucket/unload/lineorder_serial_' credentials
'aws_access_key_id=<access-key-id>;aws_secret_access_key=<secret-access-key>'
parallel off gzip;
```

The result is the following series of files.

```
lineorder_serial_0000.gz
lineorder_serial_0001.gz
lineorder_serial_0002.gz
lineorder_serial_0003.gz
```

To better differentiate the output files, you can include a prefix in the location. The following example unloads the `VENUE` table and writes the data to `s3://mybucket/venue_pipe_`:

```
unload ('select * from venue')
to 's3://mybucket/unload/venue_pipe_' credentials
'<aws-auth-args>;'
```

The result is these four files in the `unload` folder, again assuming four slices.

```
venue_pipe_0000_part_00
venue_pipe_0001_part_00
venue_pipe_0002_part_00
venue_pipe_0003_part_00
```

Unload VENUE with a Manifest File

To create a manifest file, include the `MANIFEST` option. The following example unloads the `VENUE` table and writes a manifest file along with the data files to `s3://mybucket/venue_pipe_`:

Important

If you unload files with the `MANIFEST` option, you should use the `MANIFEST` option with the `COPY` command when you load the files. If you use the same prefix to load the files and do not specify the `MANIFEST` option, `COPY` will fail because it assumes the manifest file is a data file.

```
unload ('select * from venue')
to 's3://mybucket/venue_pipe_' credentials
'<aws-auth-args>'
manifest;
```

The result is these five files:

```
s3://mybucket/venue_pipe_0000_part_00
```

```
s3://mybucket/venue_pipe_0001_part_00
s3://mybucket/venue_pipe_0002_part_00
s3://mybucket/venue_pipe_0003_part_00
s3://mybucket/venue_pipe_manifest
```

Load VENUE from Unload Files

To load a table from a set of unload files, simply reverse the process by using a COPY command. The following example creates a new table, LOADVENUE, and loads the table from the data files created in the previous example.

```
create table loadvenue (like venue);

copy loadvenue from 's3://mybucket/venue_pipe_' credentials
'<aws-auth-args>';
```

If you used the MANIFEST option to create a manifest file with your unload files, you can load the data using the same manifest file with a COPY command with the MANIFEST option. The following example loads data using a manifest file.

```
copy loadvenue
from 's3://mybucket/venue_pipe_manifest' credentials
'<aws-auth-args>'
manifest;
```

Unload VENUE to Encrypted Files

The following example unloads the VENUE table to a set of encrypted files. If you specify a manifest file with the ENCRYPTED option, the manifest file is not encrypted. For more information, see [Unloading Encrypted Data Files \(p. 188\)](#)

```
unload ('select * from venue')
to 's3://mybucket/venue_encrypt_' credentials
'aws_access_key_id=<your-access-key-id>;aws_secret_access_key=<your-
secret-access-key>;master_symmetric_key=EXAMPLEMASTERKEYtkbjk/OpCwtYSx/M4/
t7DMCDIK722'
manifest
encrypted;
```

Load VENUE from Encrypted Files

To load tables from a set of files that were created by using UNLOAD with the ENCRYPT option, reverse the process by using a COPY command with the ENCRYPTED option and specify the same master symmetric key that was used for the UNLOAD command. The following example loads the LOADVENUE table from the encrypted data files created in the previous example.

```
create table loadvenue (like venue);

copy loadvenue
from 's3://mybucket/venue_encrypt_manifest' credentials
'aws_access_key_id=<your-access-key-id>;aws_secret_access_key=<your-
secret-access-key>;master_symmetric_key=EXAMPLEMASTERKEYtkbjk/OpCwtYSx/M4/
t7DMCDIK722'
manifest
```

```
encrypted;
```

Unload VENUE Data to a Tab-Delimited File

```
unload ('select venueid, venuename, venueseats from venue')
to 's3://mybucket/venue_tab_' credentials
'<aws-auth-args>'
delimiter as '\t';
```

The output data files look like this:

```
1 Toyota Park Bridgeview IL 0
2 Columbus Crew Stadium Columbus OH 0
3 RFK Stadium Washington DC 0
4 CommunityAmerica Ballpark Kansas City KS 0
5 Gillette Stadium Foxborough MA 68756
...
```

Unload VENUE Using Temporary Credentials

You can limit the access users have to your data by using temporary security credentials. Temporary security credentials provide enhanced security because they have short life spans and cannot be reused after they expire. A user who has these temporary security credentials can access your resources only until the credentials expire. For more information, see [Temporary Security Credentials \(p. 350\)](#) in the usage notes for the COPY command.

The following example unloads the LISTING table using temporary credentials:

```
unload ('select venueid, venuename, venueseats from venue')
to 's3://mybucket/venue_tab' credentials
'aws_access_key_id=<temporary-access-key-
id>;aws_secret_access_key=<temporary-secret-access-key>;token=<temporary-
token>'
delimiter as '\t';
```

Important

The temporary security credentials must be valid for the entire duration of the UNLOAD statement. If the temporary security credentials expire during the load process, the UNLOAD will fail and the transaction will be rolled back. For example, if temporary security credentials expire after 15 minutes and the UNLOAD requires one hour, the UNLOAD will fail before it completes.

Unload VENUE to a Fixed-Width Data File

```
unload ('select * from venue')
to 's3://mybucket/venue_fw_'
credentials '<aws-auth-args>'
fixedwidth as
'venueid:3,venuename:39,venuecity:16,venuestate:2,venueseats:6';
```

The output data files will look like the following:

```
1 Toyota Park           Bridgeview  IL0
2 Columbus Crew Stadium Columbus    OH0
```

```
3 RFK Stadium Washington DC0
4 CommunityAmerica BallparkKansas City KS0
5 Gillette Stadium Foxborough MA68756
...
```

Unload VENUE to a Set of Tab-Delimited GZIP-Compressed Files

```
unload ('select * from venue')
to 's3://mybucket/venue_tab_'
credentials '<aws-auth-args>'
delimiter as '\t'
gzip;
```

Unload Data That Contains a Delimiter

This example uses the ADDQUOTES option to unload comma-delimited data where some of the actual data fields contain a comma.

First, create a table that contains quotes.

```
create table location (id int, location char(64));

insert into location values (1,'Phoenix, AZ'),(2,'San Diego, CA'),
(3,'Chicago, IL');
```

Then, unload the data using the ADDQUOTES option.

```
unload ('select id, location from location')
to 's3://mybucket/location_'
credentials '<aws-auth-args>'
delimiter ',' addquotes;
```

The unloaded data files look like this:

```
1,"Phoenix, AZ"
2,"San Diego, CA"
3,"Chicago, IL"
...
```

Unload the Results of a Join Query

The following example unloads the results of a join query that contains a window function.

```
unload ('select venuecity, venuestate, caldate, pricepaid,
sum(pricepaid) over(partition by venuecity, venuestate
order by caldate rows between 3 preceding and 3 following) as winsum
from sales join date on sales.dateid=date.dateid
join event on event.eventid=sales.eventid
join venue on event.venueid=venue.venueid
order by 1,2')
to 's3://mybucket/ticket/winsum'
credentials '<aws-auth-args>';
```

The output files look like this:

```
Atlanta|GA|2008-01-04|363.00|1362.00
Atlanta|GA|2008-01-05|233.00|2030.00
Atlanta|GA|2008-01-06|310.00|3135.00
Atlanta|GA|2008-01-08|166.00|8338.00
Atlanta|GA|2008-01-11|268.00|7630.00
...
```

Unload Using NULL AS

UNLOAD outputs null values as empty strings by default. The following examples show how to use NULL AS to substitute a text string for nulls.

For these examples, we will add some null values to the VENUE table.

```
update venue set venuestate = NULL
where venuecity = 'Cleveland';
```

Select from VENUE where VENUESTATE is null to verify that the columns contain NULL.

```
select * from venue where venuestate is null;
```

venueid	venue name	venuecity	venuestate	venue seats
22	Quicken Loans Arena	Cleveland		0
101	Progressive Field	Cleveland		43345
72	Cleveland Browns Stadium	Cleveland		73200

(3 rows)

Now, UNLOAD the VENUE table using the NULL AS option to replace null values with the character string 'fred'.

```
unload ('select * from venue')
to 's3://mybucket/nulls/'
credentials '<aws-auth-args>'
null as 'fred';
```

The following sample from the unload file shows that null values were replaced with `fred`. It turns out that some values for VENUESEATS were also null and were replaced with `fred`. Even though the data type for VENUESEATS is integer, UNLOAD converts the values to text in the unload files, and then COPY converts them back to integer. If you are unloading to a fixed-width file, the NULL AS string must not be larger than the field width.

```
248|Charles Playhouse|Boston|MA|0
251|Paris Hotel|Las Vegas|NV|fred
258|Tropicana Hotel|Las Vegas|NV|fred
300|Kennedy Center Opera House|Washington|DC|0
306|Lyric Opera House|Baltimore|MD|0
308|Metropolitan Opera|New York City|NY|0
  5|Gillette Stadium|Foxborough|MA|5
  22|Quicken Loans Arena|Cleveland|fred|0
101|Progressive Field|Cleveland|fred|43345
...
```

To load a table from the unload files, use a COPY command with the same NULL AS option.

Note

If you attempt to load nulls into a column defined as NOT NULL, the COPY command will fail.

```
create table loadvenueNULLs (like venue);

copy loadvenueNULLs from 's3://mybucket/nulls/'
credentials '<aws-auth-args>'
null as 'fred';
```

To verify that the columns contain null, not just empty strings, select from LOADVENUENULLS and filter for null.

```
select * from loadvenueNULLs where venuestate is null or venueseats is null;
```

venueid	venueName	venuecity	venuestate	venueseats
72	Cleveland Browns Stadium	Cleveland		73200
253	Mirage Hotel	Las Vegas	NV	
255	Venetian Hotel	Las Vegas	NV	
22	Quicken Loans Arena	Cleveland		0
101	Progressive Field	Cleveland		43345
251	Paris Hotel	Las Vegas	NV	

...

You can UNLOAD a table that contains nulls using the default NULL AS behavior and then COPY the data back into a table using the default NULL AS behavior; however, any non-numeric fields in the target table will contain empty strings, not nulls. By default UNLOAD converts nulls to empty strings (white space or zero-length). COPY converts empty strings to NULL for numeric columns, but inserts empty strings into non-numeric columns. The following example shows how to perform an UNLOAD followed by a COPY using the default NULL AS behavior.

```
unload ('select * from venue')
to 's3://mybucket/nulls/'
credentials '<aws-auth-args>' allowoverwrite;

truncate loadvenueNULLs;
copy loadvenueNULLs from 's3://mybucket/nulls/'
credentials '<aws-auth-args>';
```

In this case, when you filter for nulls, only the rows where VENUESEATS contained nulls. Where VENUESTATE contained nulls in the table (VENUE), VENUESTATE in the target table (LOADVENUENULLS) contains empty strings.

```
select * from loadvenueNULLs where venuestate is null or venueseats is null;
```

venueid	venueName	venuecity	venuestate	venueseats
253	Mirage Hotel	Las Vegas	NV	
255	Venetian Hotel	Las Vegas	NV	
251	Paris Hotel	Las Vegas	NV	

...

To load empty strings to non-numeric columns as NULL, include the EMPTYASNULL or BLANKSASNULL options. It's OK to use both.

```
unload ('select * from venue')
to 's3://mybucket/nulls/'
credentials '<aws-auth-args>' allowoverwrite;

truncate loadvenuenuLLs;
copy loadvenuenuLLs from 's3://mybucket/nulls/'
credentials '<aws-auth-args>' EMPTYASNULL;
```

To verify that the columns contain NULL, not just whitespace or empty, select from LOADVENUENUALLS and filter for null.

```
select * from loadvenuenuLLs where venuestate is null or venueseats is null;
```

venueid	venueName	venueCity	venueState	venueseats
72	Cleveland Browns Stadium	Cleveland		73200
253	Mirage Hotel	Las Vegas	NV	
255	Venetian Hotel	Las Vegas	NV	
22	Quicken Loans Arena	Cleveland		0
101	Progressive Field	Cleveland		43345
251	Paris Hotel	Las Vegas	NV	
...				

ALLOWOVERWRITE Example

By default, UNLOAD will not overwrite existing files in the destination bucket. For example, if you run the same UNLOAD statement twice without modifying the files in the destination bucket, the second UNLOAD will fail. To overwrite the existing files, including the manifest file, specify the ALLOWOVERWRITE option.

```
unload ('select * from venue')
to 's3://mybucket/venue_pipe_'
credentials '<aws-auth-args>'
manifest allowoverwrite;
```

UPDATE

Topics

- [Syntax \(p. 483\)](#)
- [Parameters \(p. 484\)](#)
- [Usage Notes \(p. 484\)](#)
- [Examples of UPDATE Statements \(p. 484\)](#)

Updates values in one or more table columns when a condition is satisfied.

Note

The maximum size for a single SQL statement is 16 MB.

Syntax

```
UPDATE table_name SET column = { expression | DEFAULT } [,...]
[ FROM fromlist ]
```

```
[ WHERE condition ]
```

Parameters

table_name

A temporary or persistent table. Only the owner of the table or a user with UPDATE privilege on the table may update rows. If you use the FROM clause or select from tables in an expression or condition, you must have SELECT privilege on those tables. You cannot give the table an alias here; however, you can specify an alias in the FROM clause.

SET *column* =

One or more columns that you want to modify. Columns that are not listed retain their current values. Do not include the table name in the specification of a target column. For example, UPDATE tab SET tab.col = 1 is invalid.

expression

An expression that defines the new value for the specified column.

DEFAULT

Updates the column with the default value that was assigned to the column in the CREATE TABLE statement.

FROM *tablelist*

You can update a table by referencing information in other tables. List these other tables in the FROM clause or use a subquery as part of the WHERE condition. Tables listed in the FROM clause can have aliases. If you need to include the target table of the UPDATE statement in the list, use an alias.

WHERE *condition*

Optional clause that restricts updates to rows that match a condition. When the condition returns true, the specified SET columns are updated. The condition can be a simple predicate on a column or a condition based on the result of a subquery.

You can name any table in the subquery, including the target table for the UPDATE.

Usage Notes

After updating a large number of rows in a table:

- Vacuum the table to reclaim storage space and resort rows.
- Analyze the table to update statistics for the query planner.

Left, right, and full outer joins are not supported in the FROM clause of an UPDATE statement; they return the following error:

```
ERROR: Target table must be part of an equijoin predicate
```

If you need to specify an outer join, use a subquery in the WHERE clause of the UPDATE statement.

If your UPDATE statement requires a self-join to the target table, you need to specify the join condition as well as the WHERE clause criteria that qualify rows for the update operation. In general, when the target table is joined to itself or another table, a best practice is to use a subquery that clearly separates the join conditions from the criteria that qualify rows for updates.

Examples of UPDATE Statements

The CATEGORY table in the TICKIT database contains the following rows:

catid	catgroup	catname	catdesc
1	Sports	MLB	Major League Baseball
2	Sports	NHL	National Hockey League
3	Sports	NFL	National Football League
4	Sports	NBA	National Basketball Association
5	Sports	MLS	Major League Soccer
6	Shows	Musicals	Musical theatre
7	Shows	Plays	All non-musical theatre
8	Shows	Opera	All opera and light opera
9	Concerts	Pop	All rock and pop music concerts
10	Concerts	Jazz	All jazz singers and bands
11	Concerts	Classical	All symphony, concerto, and choir concerts

(11 rows)

Updating a Table Based on a Range of Values

Update the CATGROUP column based on a range of values in the CATID column.

```
update category
set catgroup='Theatre'
where catid between 6 and 8;
```

```
select * from category
where catid between 6 and 8;
```

catid	catgroup	catname	catdesc
6	Theatre	Musicals	Musical theatre
7	Theatre	Plays	All non-musical theatre
8	Theatre	Opera	All opera and light opera

(3 rows)

Updating a Table Based on a Current Value

Update the CATNAME and CATDESC columns based on their current CATGROUP value:

```
update category
set catdesc=default, catname='Shows'
where catgroup='Theatre';
```

```
select * from category
where catname='Shows';
```

catid	catgroup	catname	catdesc
6	Theatre	Shows	
7	Theatre	Shows	
8	Theatre	Shows	

(3 rows)

In this case, the CATDESC column was set to null because no default value was defined when the table was created.

Run the following commands to set the CATEGORY table data back to the original values:

```
truncate category;

copy category from
's3://mybucket/data/category_pipe.txt'
credentials '<aws-auth-args>'
delimiter '|';
```

Updating a Table Based on the Result of a WHERE Clause Subquery

Update the CATEGORY table based on the result of a subquery in the WHERE clause:

```
update category
set catdesc='Broadway Musical'
where category.catid in
(select category.catid from category
join event on category.catid = event.catid
join venue on venue.venueid = event.venueid
join sales on sales.eventid = event.eventid
where venuecity='New York City' and catname='Musicals');
```

View the updated table:

```
select * from category order by 1;
```

catid	catgroup	catname	catdesc
1	Sports	MLB	Major League Baseball
2	Sports	NHL	National Hockey League
3	Sports	NFL	National Football League
4	Sports	NBA	National Basketball Association
5	Sports	MLS	Major League Soccer
6	Shows	Musicals	Broadway Musical
7	Shows	Plays	All non-musical theatre
8	Shows	Opera	All opera and light opera
9	Concerts	Pop	All rock and pop music concerts
10	Concerts	Jazz	All jazz singers and bands
11	Concerts	Classical	All symphony, concerto, and choir concerts

(11 rows)

Updating a Table Based on the Result of a Join Condition

Update the original 11 rows in the CATEGORY table based on matching CATID rows in the EVENT table:

```
update category set catid=100
from event
where event.catid=category.catid;
```

```
select * from category order by 1;
```

catid	catgroup	catname	catdesc
1	Sports	MLB	Major League Baseball
2	Sports	NHL	National Hockey League
3	Sports	NFL	National Football League
4	Sports	NBA	National Basketball Association
5	Sports	MLS	Major League Soccer

```

10 | Concerts | Jazz      | All jazz singers and bands
11 | Concerts | Classical | All symphony, concerto, and choir concerts
100 | Shows   | Opera    | All opera and light opera
100 | Shows   | Musicals | Musical theatre
100 | Concerts | Pop      | All rock and pop music concerts
100 | Shows   | Plays    | All non-musical theatre
(11 rows)

```

Note that the EVENT table is listed in the FROM clause and the join condition to the target table is defined in the WHERE clause. Only four rows qualified for the update. These four rows are the rows whose CATID values were originally 6, 7, 8, and 9; only those four categories are represented in the EVENT table:

```

select distinct catid from event;
catid
-----
9
8
6
7
(4 rows)

```

Update the original 11 rows in the CATEGORY table by extending the previous example and adding another condition to the WHERE clause. Because of the restriction on the CATGROUP column, only one row qualifies for the update (although four rows qualify for the join).

```

update category set catid=100
from event
where event.catid=category.catid
and catgroup='Concerts';

select * from category where catid=100;

catid | catgroup | catname | catdesc
-----+-----+-----+-----
100 | Concerts | Pop      | All rock and pop music concerts
(1 row)

```

An alternative way to write this example is as follows:

```

update category set catid=100
from event join category cat on event.catid=cat.catid
where cat.catgroup='Concerts';

```

The advantage to this approach is that the join criteria are clearly separated from any other criteria that qualify rows for the update. Note the use of the alias CAT for the CATEGORY table in the FROM clause.

Updates with Outer Joins in the FROM Clause

The previous example showed an inner join specified in the FROM clause of an UPDATE statement. The following example returns an error because the FROM clause does not support outer joins to the target table:

```

update category set catid=100

```

```
from event left join category cat on event.catid=cat.catid
where cat.catgroup='Concerts';
ERROR: Target table must be part of an equijoin predicate
```

If the outer join is required for the UPDATE statement, you can move the outer join syntax into a subquery:

```
update category set catid=100
from
(select event.catid from event left join category cat on
 event.catid=cat.catid) eventcat
where category.catid=eventcat.catid
and catgroup='Concerts';
```

VACUUM

Reclaims space and resorts rows in either a specified table or all tables in the current database.

Note

Only the table owner or a superuser can effectively vacuum a table. If VACUUM is run without the necessary table privileges, the operation completes successfully but has no effect.

By default, VACUUM skips the sort phase for any table where more than 95 percent of the table's rows are already sorted. Skipping the sort phase can significantly improve VACUUM performance. In addition, in the delete phase VACUUM reclaims space such that at least 95 percent of the remaining rows are not marked for deletion. Because VACUUM is often able to skip rewriting many blocks that contain only a few rows marked for deletion, it usually needs much less time for the delete phase compared to reclaiming 100 percent of deleted rows. To change the default sort or delete threshold for a single table, include the table name and the TO *threshold* PERCENT parameter when you run VACUUM.

Note

The Amazon Redshift VACUUM command syntax and behavior are substantially different from the PostgreSQL VACUUM operation. For example, the default VACUUM operation in Amazon Redshift is VACUUM FULL, which reclaims disk space and resorts all rows. In contrast, the default VACUUM operation in PostgreSQL simply reclaims space and makes it available for reuse.

For more information, see [Vacuuming Tables \(p. 172\)](#).

Syntax

```
VACUUM [ FULL | SORT ONLY | DELETE ONLY | REINDEX ]
[ [ table_name ] [ TO threshold PERCENT ] ]
```

Parameters

FULL

Sorts the specified table (or all tables in the current database) and reclaims disk space occupied by rows that were marked for deletion by previous UPDATE and DELETE operations. A full vacuum doesn't perform a reindex for interleaved tables. To reindex interleaved tables followed by a full vacuum, use the [VACUUM REINDEX \(p. 489\)](#) option.

By default, VACUUM FULL skips the sort phase for any table that is already at least 95 percent sorted. If VACUUM is able to skip the sort phase, it performs a DELETE ONLY and reclaims space

in the delete phase such that at least 95 percent of the remaining rows are not marked for deletion.

If the sort threshold is not met (for example, if 90 percent of rows are sorted) and VACUUM performs a full sort, then it also performs a complete delete operation, recovering space from 100 percent of deleted rows.

You can change the default vacuum threshold only for a single table. To change the default vacuum threshold for a single table, include the table name and the TO *threshold* PERCENT parameter.

SORT ONLY

Sorts the specified table (or all tables in the current database) without reclaiming space freed by deleted rows. This option is useful when reclaiming disk space is not important but resorting new rows is important. A SORT ONLY vacuum reduces the elapsed time for vacuum operations when the unsorted region doesn't contain a large number of deleted rows and doesn't span the entire sorted region. Applications that don't have disk space constraints but do depend on query optimizations associated with keeping table rows sorted can benefit from this kind of vacuum.

By default, VACUUM SORT ONLY skips any table that is already at least 95 percent sorted. To change the default sort threshold for a single table, include the table name and the TO *threshold* PERCENT parameter when you run VACUUM.

DELETE ONLY

Reclaims disk space occupied by rows that were marked for deletion by previous UPDATE and DELETE operations, and compacts the table to free up the consumed space. A DELETE ONLY vacuum operation doesn't sort table data. This option reduces the elapsed time for vacuum operations when reclaiming disk space is important but resorting new rows is not important. This option can also be useful when your query performance is already optimal, and resorting rows to optimize query performance is not a requirement.

By default, VACUUM DELETE ONLY reclaims space such that at least 95 percent of the remaining rows are not marked for deletion. To change the default delete threshold for a single table, include the table name and the TO *threshold* PERCENT parameter when you run VACUUM.

REINDEX

Analyzes the distribution of the values in interleaved sort key columns, then performs a full VACUUM operation. VACUUM REINDEX takes significantly longer than VACUUM FULL because it makes an additional pass to analyze the interleaved sort keys. The sort and merge operation can take longer for interleaved tables because the interleaved sort might need to rearrange more rows than a compound sort.

If a VACUUM REINDEX operation terminates before it completes, the next VACUUM resumes the reindex operation before performing the full vacuum operation.

VACUUM REINDEX is not supported with TO *threshold* PERCENT.

table_name

The name of a table to vacuum. If you don't specify a table name, the vacuum operation applies to all tables in the current database. You can specify any permanent or temporary user-created table. The command is not meaningful for other objects, such as views and system tables.

If you include the TO *threshold* PERCENT parameter, a table name is required.

TO *threshold* PERCENT

A clause that specifies the threshold above which VACUUM skips the sort phase and the target threshold for reclaiming space in the delete phase. The *sort threshold* is the percentage of total rows that are already in sort order for the specified table prior to vacuuming. The *delete threshold* is the minimum percentage of total rows not marked for deletion after vacuuming.

Because VACUUM resorts the rows only when the percent of sorted rows in a table is less than the sort threshold, Amazon Redshift can often reduce VACUUM times significantly. Similarly, when

VACUUM is not constrained to reclaim space from 100 percent of rows marked for deletion, it is often able to skip rewriting blocks that contain only a few deleted rows.

For example, if you specify 75 for *threshold*, VACUUM skips the sort phase if 75 percent or more of the table's rows are already in sort order. For the delete phase, VACUUMS sets a target of reclaiming disk space such that at least 75 percent of the table's rows are not marked for deletion following the vacuum. The *threshold* value must be an integer between 0 and 100. The default is 95. If you specify a value of 100, VACUUM always sorts the table unless it's already fully sorted and reclaims space from all rows marked for deletion. If you specify a value of 0, VACUUM never sorts the table and never reclaims space.

If you include the TO *threshold* PERCENT parameter, you must also specify a table name. If a table name is omitted, VACUUM fails.

The TO *threshold* PERCENT parameter can't be used with REINDEX.

Usage Notes

For most Amazon Redshift applications, a full vacuum is recommended. For more information, see [Vacuuming Tables \(p. 172\)](#).

Before running a vacuum operation, note the following behavior:

- You cannot run VACUUM within a transaction block (BEGIN ... END).
- You can run only one VACUUM command a cluster at any given time. If you attempt to run multiple vacuum operations concurrently, Amazon Redshift returns an error.
- Some amount of table growth might occur when tables are vacuumed. This behavior is expected when there are no deleted rows to reclaim or the new sort order of the table results in a lower ratio of data compression.
- During vacuum operations, some degree of query performance degradation is expected. Normal performance resumes as soon as the vacuum operation is complete.
- Concurrent write operations proceed during vacuum operations, but we don't recommend performing write operations while vacuuming. It's more efficient to complete write operations before running the vacuum. Also, any data that is written after a vacuum operation has been started cannot be vacuumed by that operation; in this case, a second vacuum operation will be necessary.
- A vacuum operation might not be able to start if a load or insert operation is already in progress. Vacuum operations temporarily require exclusive access to tables in order to start. This exclusive access is required briefly, so vacuum operations don't block concurrent loads and inserts for any significant period of time.
- Vacuum operations are skipped when there is no work to do for a particular table; however, there is some overhead associated with discovering that the operation can be skipped. If you know that a table is pristine or doesn't meet the vacuum threshold, don't run a vacuum operation against it.
- A DELETE ONLY vacuum operation on a small table might not reduce the number of blocks used to store the data, especially when the table has a large number of columns or the cluster uses a large number of slices per node. These vacuum operations add one block per column per slice to account for concurrent inserts into the table, and there is potential for this overhead to outweigh the reduction in block count from the reclaimed disk space. For example, if a 10-column table on an 8-node cluster occupies 1000 blocks before a vacuum, the vacuum will not reduce the actual block count unless more than 80 blocks of disk space are reclaimed because of deleted rows. (Each data block uses 1 MB.)

Examples

Reclaim space and database and resort rows in all tables based on the default 95 percent vacuum threshold.

```
vacuum;
```

Reclaim space and resort rows in the SALES table based on the default 95 percent threshold.

```
vacuum sales;
```

Always reclaim space and resort rows in the SALES table.

```
vacuum sales to 100 percent;
```

Resort rows in the SALES table only if fewer than 75 percent of rows are already sorted.

```
vacuum sort only sales to 75 percent;
```

Reclaim space in the SALES table such that at least 75 percent of the remaining rows are not marked for deletion following the vacuum.

```
vacuum delete only sales to 75 percent;
```

Reindex and then vacuum the LISTING table.

```
vacuum reindex listing;
```

The following command returns an error.

```
vacuum reindex listing to 75 percent;
```

SQL Functions Reference

Topics

- [Leader Node–Only Functions](#) (p. 492)
- [Aggregate Functions](#) (p. 493)
- [Bit-Wise Aggregate Functions](#) (p. 503)
- [Window Functions](#) (p. 508)
- [Conditional Expressions](#) (p. 552)
- [Date and Time Functions](#) (p. 561)
- [Math Functions](#) (p. 594)
- [String Functions](#) (p. 617)
- [JSON Functions](#) (p. 654)
- [Data Type Formatting Functions](#) (p. 657)
- [System Administration Functions](#) (p. 667)
- [System Information Functions](#) (p. 670)

Amazon Redshift supports a number of functions that are extensions to the SQL standard, as well as standard aggregate functions, scalar functions, and window functions.

Note

Amazon Redshift is based on PostgreSQL 8.0.2. Amazon Redshift and PostgreSQL have a number of very important differences that you must be aware of as you design and develop your data warehouse applications. For more information about how Amazon Redshift SQL differs from PostgreSQL, see [Amazon Redshift and PostgreSQL \(p. 239\)](#).

Leader Node–Only Functions

Some Amazon Redshift queries are distributed and executed on the compute nodes; other queries execute exclusively on the leader node.

The leader node distributes SQL to the compute nodes when a query references user-created tables or system tables (tables with an STL or STV prefix and system views with an SVL or SVV prefix). A query that references only catalog tables (tables with a PG prefix, such as PG_TABLE_DEF) or that does not reference any tables, runs exclusively on the leader node.

Some Amazon Redshift SQL functions are supported only on the leader node and are not supported on the compute nodes. A query that uses a leader-node function must execute exclusively on the leader node, not on the compute nodes, or it will return an error.

The documentation for each leader-node only function includes a note stating that the function will return an error if it references user-defined tables or Amazon Redshift system tables.

For more information, see [SQL Functions Supported on the Leader Node \(p. 238\)](#).

The following SQL functions are leader-node only functions and are not supported on the compute nodes:

System information functions

- CURRENT_SCHEMA
- CURRENT_SCHEMAS
- HAS_DATABASE_PRIVILEGE
- HAS_SCHEMA_PRIVILEGE
- HAS_TABLE_PRIVILEGE

The following leader-node only functions are deprecated:

Date functions

- AGE
- CURRENT_TIME
- CURRENT_TIMESTAMP
- LOCALTIME
- ISFINITE
- NOW

String functions

- ASCII
- GET_BIT
- GET_BYTE
- OCTET_LENGTH

- [SET_BIT](#)
- [SET_BYTE](#)
- [TO_ASCII](#)

Aggregate Functions

Topics

- [AVG Function \(p. 493\)](#)
- [COUNT Function \(p. 495\)](#)
- [LISTAGG Function \(p. 496\)](#)
- [MAX Function \(p. 498\)](#)
- [MIN Function \(p. 499\)](#)
- [STDDEV_SAMP and STDDEV_POP Functions \(p. 500\)](#)
- [SUM Function \(p. 501\)](#)
- [VAR_SAMP and VAR_POP Functions \(p. 502\)](#)

Aggregate functions compute a single result value from a set of input values. The aggregate functions supported by Amazon Redshift include AVG, COUNT, MAX, MIN, and SUM.

SELECT statements using any of these aggregate functions can include two optional clauses: GROUP BY and HAVING. The syntax for these clauses is as follows (using the COUNT function as an example):

```
SELECT count (*) expression FROM table_reference
WHERE condition [GROUP BY expression ] [ HAVING condition ]
```

The GROUP BY clause aggregates and groups results by the unique values in a specified column or columns. The HAVING clause restricts the results returned to rows where a particular aggregate condition is true, such as count (*) > 1. The HAVING clause is used in the same way as WHERE to restrict rows based on the value of a column.

See the COUNT function description for an example of these additional clauses.

AVG Function

The AVG function returns the average (arithmetic mean) of the input expression values. The AVG function works with numeric values and ignores NULL values.

Syntax

```
AVG ( [ DISTINCT | ALL ] expression )
```

Arguments

expression

The target column or expression that the function operates on.

DISTINCT | ALL

With the argument DISTINCT, the function eliminates all duplicate values from the specified expression before calculating the average. With the argument ALL, the function retains all duplicate values from the expression for calculating the average. ALL is the default.

Data Types

The argument types supported by the AVG function are SMALLINT, INTEGER, BIGINT, NUMERIC, DECIMAL, REAL, and DOUBLE PRECISION.

The return types supported by the AVG function are:

- NUMERIC for any integer type argument
- DOUBLE PRECISION for a floating point argument

The default precision for an AVG function result with a 64-bit NUMERIC or DECIMAL argument is 19. The default precision for a result with a 128-bit NUMERIC or DECIMAL argument is 38. The scale of the result is the same as the scale of the argument. For example, an AVG of a DEC(5,2) column returns a DEC(19,2) data type.

Examples

Find the average quantity sold per transaction from the SALES table:

```
select avg(qtysold)from sales;

avg
-----
 2
(1 row)
```

Find the average total price listed for all listings:

```
select avg(numtickets*priceperticket) as avg_total_price from listing;

avg_total_price
-----
3034.41
(1 row)
```

Find the average price paid, grouped by month in descending order:

```
select avg(pricepaid) as avg_price, month
from sales, date
where sales.dateid = date.dateid
group by month
order by avg_price desc;

avg_price | month
-----+-----
659.34 | MAR
655.06 | APR
645.82 | JAN
643.10 | MAY
642.72 | JUN
642.37 | SEP
640.72 | OCT
640.57 | DEC
635.34 | JUL
635.24 | FEB
634.24 | NOV
```

```
632.78 | AUG  
(12 rows)
```

COUNT Function

The COUNT function counts the rows defined by the expression.

The COUNT function has three variations. COUNT (*) counts all the rows in the target table whether they include nulls or not. COUNT (*expression*) computes the number of rows with non-NULL values in a specific column or expression. COUNT (DISTINCT *expression*) computes the number of distinct non-NULL values in a column or expression.

Syntax

```
[ APPROXIMATE ] COUNT ( [ DISTINCT | ALL ] * | expression )
```

Arguments

expression

The target column or expression that the function operates on.

DISTINCT | ALL

With the argument DISTINCT, the function eliminates all duplicate values from the specified expression before doing the count. With the argument ALL, the function retains all duplicate values from the expression for counting. ALL is the default.

APPROXIMATE

When used with APPROXIMATE, a COUNT (DISTINCT *expression*) function uses a HyperLogLog algorithm to approximate the number of distinct non-NULL values in a column or expression. Queries that use the APPROXIMATE keyword execute much faster, with a low relative error of around 2%. Approximation is warranted for queries that return a large number of distinct values, in the millions or more per query, or per group, if there is a group by clause. For smaller sets of distinct values, in the thousands, approximation might be slower than a precise count. APPROXIMATE can only be used with COUNT (DISTINCT).

Data Types

The COUNT function supports all argument data types.

The COUNT function returns BIGINT.

Examples

Count all of the users from the state of Florida:

```
select count ( * ) from users where state='FL';  
  
count  
-----  
510  
(1 row)
```

Count all of the unique venue IDs from the EVENT table:

```
select count (distinct venueid) as venues from event;  
  
venues
```

```
-----  
204  
(1 row)
```

Count the number of times each seller listed batches of more than four tickets for sale. Group the results by seller ID:

```
select count(*), sellerid from listing  
group by sellerid  
having min(numtickets)>4  
order by 1 desc, 2;
```

```
count | sellerid  
-----+-----  
12 | 17304  
11 | 25428  
11 | 48950  
11 | 49585  
...  
(16840 rows)
```

The following examples compare the return values and execution times for COUNT and APPROXIMATE COUNT.

```
select count(distinct pricepaid) from sales;  
count
```

```
-----  
4528  
(1 row)
```

Time: 48.048 ms

```
select approximate count(distinct pricepaid) from sales;  
count
```

```
-----  
4541  
(1 row)
```

Time: 21.728 ms

LISTAGG Function

For each group in a query, the LISTAGG aggregate function orders the rows for each group according to the ORDER BY expression, then concatenates the values into a single string.

Syntax

```
LISTAGG(aggregate_expression [, 'delimiter' ] )  
[ WITHIN GROUP (ORDER BY order_list) ]
```

Arguments

aggregate_expression

Any valid expression (such as a column name) that provides the values to aggregate. NULL values and empty strings are ignored. LISTAGG does not support DISTINCT expressions.

delimiter

Optional. The string constant that will separate the concatenated values. The default is NULL.

WITHIN GROUP (ORDER BY order_list)

Optional. Specifies the sort order of the aggregated values.

Returns

VARCHAR(MAX). If the result set is larger than the maximum VARCHAR size (64K – 1, or 65535), then LISTAGG returns the following error:

```
Invalid operation: Result size exceeds LISTAGG limit
```

Usage Notes

If a statement includes multiple LISTAGG functions that use WITHIN GROUP clauses, each WITHIN GROUP clause must use the same ORDER BY values.

For example, the following statement will return an error.

```
select listagg(sellerid)
within group (order by dateid) as sellers,
listagg(dateid)
within group (order by sellerid) as dates
from winsales;
```

The following statements will execute successfully.

```
select listagg(sellerid)
within group (order by dateid) as sellers,
listagg(dateid)
within group (order by dateid) as dates
from winsales;

select listagg(sellerid)
within group (order by dateid) as sellers,
listagg(dateid) as dates
from winsales;
```

Examples

The following example aggregates seller IDs, ordered by seller ID.

```
select listagg(sellerid)
within group (order by sellerid)
from winsales;

  listagg
-----
11122333344
```

The following example aggregates seller IDs in date order.

```
select listagg(sellerid)
within group (order by dateid)
from winsales;
```

```
listagg
-----
31141242333
```

The following example returns a pipe-separated list of sales dates for buyer B.

```
select listagg(dateid, '|')
within group (order by sellerid desc, salesid asc)
from winsales
where buyerid = 'b';

           listagg
-----
2003-08-02|2004-04-18|2004-04-18|2004-02-12
```

The following example returns a comma-separated list of sales IDs for each buyer ID.

```
select buyerid,
listagg(salesid, ',')
within group (order by salesid) as sales_id
from winsales
group by buyerid
order by buyerid;

buyerid | sales_id
-----+-----
a       | 10005,40001,40005
b       | 20001,30001,30004,30003
c       | 10001,20002,30007,10006
```

MAX Function

The MAX function returns the maximum value in a set of rows. DISTINCT or ALL may be used but do not affect the result.

Syntax

```
MAX ( [ DISTINCT | ALL ] expression )
```

Arguments

expression

The target column or expression that the function operates on.

DISTINCT | ALL

With the argument DISTINCT, the function eliminates all duplicate values from the specified expression before calculating the maximum. With the argument ALL, the function retains all duplicate values from the expression for calculating the maximum. ALL is the default.

Data Types

Accepts any data type except Boolean as input. Returns the same data type as *expression*. The Boolean equivalent of the MIN function is the [BOOL_AND Function \(p. 506\)](#), and the Boolean equivalent of MAX is the [BOOL_OR Function \(p. 506\)](#).

Examples

Find the highest price paid from all sales:

```
select max(pricepaid) from sales;

max
-----
12624.00
(1 row)
```

Find the highest price paid per ticket from all sales:

```
select max(pricepaid/qtysold) as max_ticket_price
from sales;

max_ticket_price
-----
2500.000000000
(1 row)
```

MIN Function

The MIN function returns the minimum value in a set of rows. DISTINCT or ALL may be used but do not affect the result.

Syntax

```
MIN ( [ DISTINCT | ALL ] expression )
```

Arguments

expression

The target column or expression that the function operates on.

DISTINCT | ALL

With the argument DISTINCT, the function eliminates all duplicate values from the specified expression before calculating the minimum. With the argument ALL, the function retains all duplicate values from the expression for calculating the minimum. ALL is the default.

Data Types

Accepts any data type except Boolean as input. Returns the same data type as *expression*. The Boolean equivalent of the MIN function is [BOOL_AND Function \(p. 506\)](#), and the Boolean equivalent of MAX is [BOOL_OR Function \(p. 506\)](#).

Examples

Find the lowest price paid from all sales:

```
select min(pricepaid)from sales;

max
```

```
-----  
20.00  
(1 row)
```

Find the lowest price paid per ticket from all sales:

```
select min(pricepaid/qtysold)as min_ticket_price  
from sales;  
  
min_ticket_price  
-----  
20.00000000  
(1 row)
```

STDDEV_SAMP and STDDEV_POP Functions

The STDDEV_SAMP and STDDEV_POP functions return the sample and population standard deviation of a set of numeric values (integer, decimal, or floating-point). The result of the STDDEV_SAMP function is equivalent to the square root of the sample variance of the same set of values. STDDEV_SAMP and STDDEV are synonyms for the same function.

STDDEV_SAMP and STDDEV are synonyms for the same function.

Syntax

```
STDDEV_SAMP | STDDEV ( [ DISTINCT | ALL ] expression )  
STDDEV_POP ( [ DISTINCT | ALL ] expression )
```

The expression must have an integer, decimal, or floating-point data type. Regardless of the data type of the expression, the return type of this function is a double precision number.

Note

Standard-deviation is calculated using floating-point arithmetic, which might result in slight imprecision.

Usage Notes

When the sample standard deviation (STDDEV or STDDEV_SAMP) is calculated for an expression that consists of a single value, the result of the function is NULL not 0.

Examples

The following query returns the average of the values in the VENUESEATS column of the VENUE table, followed by the sample standard deviation and population standard deviation of the same set of values. VENUESEATS is an INTEGER column. The scale of the result is reduced to 2 digits.

```
select avg(venueseats),  
cast(stddev_samp(venueseats) as dec(14,2)) stddevsamp,  
cast(stddev_pop(venueseats) as dec(14,2)) stddevpop  
from venue;  
  
avg | stddevsamp | stddevpop  
-----+-----+-----  
17503 | 27847.76 | 27773.20
```



```
(1 row)
```

The following query returns the sample standard deviation for the COMMISSION column in the SALES table. COMMISSION is a DECIMAL column. The scale of the result is reduced to 10 digits.

```
select cast(stddev(commission) as dec(18,10))
from sales;

stddev
-----
130.3912659086
(1 row)
```

The following query casts the sample standard deviation for the COMMISSION column as an integer.

```
select cast(stddev(commission) as integer)
from sales;

stddev
-----
130
(1 row)
```

The following query returns both the sample standard deviation and the square root of the sample variance for the COMMISSION column. The results of these calculations are the same.

```
select
cast(stddev_samp(commission) as dec(18,10)) stddevsamp,
cast(sqrt(var_samp(commission)) as dec(18,10)) sqrtvarsamp
from sales;

stddevsamp | sqrtvarsamp
-----+-----
130.3912659086 | 130.3912659086
(1 row)
```

SUM Function

The SUM function returns the sum of the input column or expression values. The SUM function works with numeric values and ignores NULL values.

Syntax

```
SUM ( [ DISTINCT | ALL ] expression )
```

Arguments

expression

The target column or expression that the function operates on.

DISTINCT | ALL

With the argument DISTINCT, the function eliminates all duplicate values from the specified expression before calculating the sum. With the argument ALL, the function retains all duplicate values from the expression for calculating the sum. ALL is the default.

Data Types

The argument types supported by the SUM function are SMALLINT, INTEGER, BIGINT, NUMERIC, DECIMAL, REAL, and DOUBLE PRECISION.

The return types supported by the SUM function are

- BIGINT for BIGINT, SMALLINT, and INTEGER arguments
- NUMERIC for NUMERIC arguments
- DOUBLE PRECISION for floating point arguments

The default precision for a SUM function result with a 64-bit NUMERIC or DECIMAL argument is 19. The default precision for a result with a 128-bit NUMERIC or DECIMAL argument is 38. The scale of the result is the same as the scale of the argument. For example, a SUM of a DEC(5,2) column returns a DEC(19,2) data type.

Examples

Find the sum of all commissions paid from the SALES table:

```
select sum(commission) from sales;

sum
-----
16614814.65
(1 row)
```

Find the number of seats in all venues in the state of Florida:

```
select sum(venueseats) from venue
where venuestate = 'FL';

sum
-----
250411
(1 row)
```

Find the number of seats sold in May:

```
select sum(qtysold) from sales, date
where sales.dateid = date.dateid and date.month = 'MAY';

sum
-----
32291
(1 row)
```

VAR_SAMP and VAR_POP Functions

The VAR_SAMP and VAR_POP functions return the sample and population variance of a set of numeric values (integer, decimal, or floating-point). The result of the VAR_SAMP function is equivalent to the squared sample standard deviation of the same set of values.

VAR_SAMP and VARIANCE are synonyms for the same function.

Syntax

```
VAR_SAMP | VARIANCE ( [ DISTINCT | ALL ] expression)  
VAR_POP ( [ DISTINCT | ALL ] expression)
```

The expression must have an integer, decimal, or floating-point data type. Regardless of the data type of the expression, the return type of this function is a double precision number.

Note

The results of these functions might vary across data warehouse clusters, depending on the configuration of the cluster in each case.

Usage Notes

When the sample variance (VARIANCE or VAR_SAMP) is calculated for an expression that consists of a single value, the result of the function is NULL not 0.

Examples

The following query returns the rounded sample and population variance of the NUMTICKETS column in the LISTING table.

```
select avg(numtickets),  
round(var_samp(numtickets)) varsamp,  
round(var_pop(numtickets)) varpop  
from listing;
```

```
avg | varsamp | varpop  
-----+-----+-----  
10 |      54 |      54  
(1 row)
```

The following query runs the same calculations but cast the results to decimal values.

```
select avg(numtickets),  
cast(var_samp(numtickets) as dec(10,4)) varsamp,  
cast(var_pop(numtickets) as dec(10,4)) varpop  
from listing;
```

```
avg | varsamp | varpop  
-----+-----+-----  
10 | 53.6291 | 53.6288  
(1 row)
```

Bit-Wise Aggregate Functions

Topics

- [BIT_AND and BIT_OR \(p. 504\)](#)
- [BOOL_AND and BOOL_OR \(p. 504\)](#)
- [NULLs in Bit-Wise Aggregations \(p. 505\)](#)
- [DISTINCT Support for Bit-Wise Aggregations \(p. 505\)](#)
- [BIT_AND Function \(p. 505\)](#)

- [BIT_OR Function \(p. 505\)](#)
- [BOOL_AND Function \(p. 506\)](#)
- [BOOL_OR Function \(p. 506\)](#)
- [Bit-Wise Function Examples \(p. 506\)](#)

Amazon Redshift supports the following bit-wise aggregate functions:

- BIT_AND
- BIT_OR
- BOOL_AND
- BOOL_OR

BIT_AND and BIT_OR

The BIT_AND and BIT_OR functions run bit-wise AND and OR operations on all of the values in a single integer column or expression. These functions aggregate each bit of each binary value that corresponds to each integer value in the expression.

The BIT_AND function returns a result of 0 if none of the bits is set to 1 across all of the values. If one or more bits is set to 1 across all values, the function returns an integer value. This integer is the number that corresponds to the binary value for the those bits.

For example, a table contains four integer values in a column: 3, 7, 10, and 22. These integers are represented in binary form as follows:

Integer	Binary value
3	11
7	111
10	1010
22	10110

A BIT_AND operation on this dataset finds that all bits are set to 1 in the second-to-last position only. The result is a binary value of 00000010, which represents the integer value 2; therefore, the BIT_AND function returns 2.

If you apply the BIT_OR function to the same set of integer values, the operation looks for *any* value in which a 1 is found in each position. In this case, a 1 exists in the last five positions for at least one of the values, yielding a binary result of 00011111; therefore, the function returns 31 (or $16 + 8 + 4 + 2 + 1$).

BOOL_AND and BOOL_OR

The BOOL_AND and BOOL_OR functions operate on a single Boolean or integer column or expression. These functions apply similar logic to the BIT_AND and BIT_OR functions. For these functions, the return type is a Boolean value (`true` or `false`):

- If all values in a set are `true`, the BOOL_AND function returns `true` (t). If all values are `false`, the function returns `false` (f).
- If any value in a set is `true`, the BOOL_OR function returns `true` (t). If no value in a set is `true`, the function returns `false` (f).

NULLs in Bit-Wise Aggregations

When a bit-wise function is applied to a column that is nullable, any NULL values are eliminated before the function result is calculated. If no rows qualify for aggregation, the bit-wise function returns NULL. The same behavior applies to regular aggregate functions. For example:

```
select sum(venueseats), bit_and(venueseats) from venue
where venueseats is null;

sum | bit_and
-----+-----
null |      null
(1 row)
```

DISTINCT Support for Bit-Wise Aggregations

Like other aggregate functions, bit-wise functions support the DISTINCT keyword. However, using DISTINCT with these functions has no impact on the results. The first instance of a value is sufficient to satisfy bitwise AND or OR operations, and it makes no difference if duplicate values are present in the expression being evaluated. Because the DISTINCT processing is likely to incur some query execution overhead, do not use DISTINCT with these functions.

BIT_AND Function

Syntax

```
BIT_AND ( [DISTINCT | ALL] expression )
```

Arguments

expression

The target column or expression that the function operates on. This expression must have an INT, INT2, or INT8 data type. The function returns an equivalent INT, INT2, or INT8 data type.

DISTINCT | ALL

With the argument DISTINCT, the function eliminates all duplicate values for the specified expression before calculating the result. With the argument ALL, the function retains all duplicate values. ALL is the default. See [DISTINCT Support for Bit-Wise Aggregations \(p. 505\)](#).

BIT_OR Function

Syntax

```
BIT_OR ( [DISTINCT | ALL] expression )
```

Arguments

expression

The target column or expression that the function operates on. This expression must have an INT, INT2, or INT8 data type. The function returns an equivalent INT, INT2, or INT8 data type.

DISTINCT | ALL

With the argument DISTINCT, the function eliminates all duplicate values for the specified expression before calculating the result. With the argument ALL, the function retains all duplicate values. ALL is the default. See [DISTINCT Support for Bit-Wise Aggregations \(p. 505\)](#).

BOOL_AND Function

Syntax

```
BOOL_AND ( [DISTINCT | ALL] expression )
```

Arguments

expression

The target column or expression that the function operates on. This expression must have a BOOLEAN or integer data type. The return type of the function is BOOLEAN.

DISTINCT | ALL

With the argument DISTINCT, the function eliminates all duplicate values for the specified expression before calculating the result. With the argument ALL, the function retains all duplicate values. ALL is the default. See [DISTINCT Support for Bit-Wise Aggregations \(p. 505\)](#).

BOOL_OR Function

Syntax

```
BOOL_OR ( [DISTINCT | ALL] expression )
```

Arguments

expression

The target column or expression that the function operates on. This expression must have a BOOLEAN or integer data type. The return type of the function is BOOLEAN.

DISTINCT | ALL

With the argument DISTINCT, the function eliminates all duplicate values for the specified expression before calculating the result. With the argument ALL, the function retains all duplicate values. ALL is the default. See [DISTINCT Support for Bit-Wise Aggregations \(p. 505\)](#).

Bit-Wise Function Examples

The USERS table in the TICKIT sample database contains several Boolean columns that indicate whether each user is known to like different types of events, such as sports, theatre, opera, and so on. For example:

```
select userid, username, lastname, city, state,
likesports, liketheatre
from users limit 10;
```

userid	username	lastname	city	state	likesports	liketheatre
1	JSG99FHE	Taylor	Kent	WA	t	t
9	MSD36KVR	Watkins	Port Orford	MD	t	f

Assume that a new version of the USERS table is built in a different way, with a single integer column that defines (in binary form) eight types of events that each user likes or dislikes. In this design, each

bit position represents a type of event, and a user who likes all eight types has all eight bits set to 1 (as in the first row of the following table). A user who does not like any of these events has all eight bits set to 0 (see second row). A user who likes only sports and jazz is represented in the third row:

	SPORTS	THEATRE	JAZZ	OPERA	ROCK	VEGAS	BROADW	CLASSICAL
User 1	1	1	1	1	1	1	1	1
User 2	0	0	0	0	0	0	0	0
User 3	1	0	1	0	0	0	0	0

In the database table, these binary values could be stored in a single LIKES column as integers:

User	Binary value	Stored value (integer)
User 1	11111111	255
User 2	00000000	0
User 3	10100000	160

BIT_AND and BIT_OR Examples

Given that meaningful business information is stored in integer columns, you can use bit-wise functions to extract and aggregate that information. The following query applies the BIT_AND function to the LIKES column in a table called USERLIKES and groups the results by the CITY column.

```
select city, bit_and(likes) from userlikes group by city
order by city;
city      | bit_and
-----+-----
Los Angeles |      0
Sacramento |      0
San Francisco |      0
San Jose   |     64
Santa Barbara |    192
(5 rows)
```

These results can be interpreted as follows:

- The integer value 192 for Santa Barbara translates to the binary value 11000000. In other words, all users in this city like sports and theatre, but not all users like any other type of event.
- The integer 64 translates to 01000000, so for users in San Jose, the only type of event that they all like is theatre.
- The values of 0 for the other three cities indicate that no "likes" are shared by all users in those cities.

If you apply the BIT_OR function to the same data, the results are as follows:

```
select city, bit_or(likes) from userlikes group by city
order by city;
city      | bit_or
-----+-----
Los Angeles |    127
```

```
Sacramento | 255
San Francisco | 255
San Jose | 255
Santa Barbara | 255
(5 rows)
```

For four of the cities listed, all of the event types are liked by at least one user (255=11111111). For Los Angeles, all of the event types except sports are liked by at least one user (127=01111111).

BOOL_AND and BOOL_OR Examples

You can use the Boolean functions against either Boolean expressions or integer expressions. For example, the following query return results from the standard USERS table in the TICKIT database, which has several Boolean columns.

The BOOL_OR function returns `true` for all five rows. At least one user in each of those states likes sports. The BOOL_AND function returns `false` for all five rows. Not all users in each of those states likes sports.

```
select state, bool_or(likesports), bool_and(likesports) from users
group by state order by state limit 5;
```

```
state | bool_or | bool_and
-----+-----
AB    | t       | f
AK    | t       | f
AL    | t       | f
AZ    | t       | f
BC    | t       | f
(5 rows)
```

Window Functions

Topics

- [Window Function Syntax Summary \(p. 510\)](#)
- [AVG Window Function \(p. 512\)](#)
- [COUNT Window Function \(p. 513\)](#)
- [CUME_DIST Window Function \(p. 514\)](#)
- [DENSE_RANK Window Function \(p. 515\)](#)
- [FIRST_VALUE and LAST_VALUE Window Functions \(p. 516\)](#)
- [LAG Window Function \(p. 517\)](#)
- [LEAD Window Function \(p. 518\)](#)
- [LISTAGG Window Function \(p. 519\)](#)
- [MAX Window Function \(p. 519\)](#)
- [MEDIAN Window Function \(p. 520\)](#)
- [MIN Window Function \(p. 521\)](#)
- [NTH_VALUE Window Function \(p. 522\)](#)
- [NTILE Window Function \(p. 523\)](#)
- [PERCENT_RANK Window Function \(p. 524\)](#)
- [PERCENTILE_CONT Window Function \(p. 525\)](#)
- [PERCENTILE_DISC Window Function \(p. 526\)](#)

- [RANK Window Function \(p. 527\)](#)
- [RATIO_TO_REPORT Window Function \(p. 528\)](#)
- [ROW_NUMBER Window Function \(p. 529\)](#)
- [STDDEV_SAMP and STDDEV_POP Window Functions \(p. 529\)](#)
- [SUM Window Function \(p. 530\)](#)
- [VAR_SAMP and VAR_POP Window Functions \(p. 531\)](#)
- [Window Function Examples \(p. 532\)](#)

Window functions provide application developers the ability to create analytic business queries more efficiently. Window functions operate on a partition or "window" of a result set, and return a value for every row in that window. In contrast, nonwindowed functions perform their calculations with respect to every row in the result set. Unlike group functions that aggregate result rows, all rows in the table expression are retained.

The values returned are calculated by utilizing values from the sets of rows in that window. The window defines, for each row in the table, a set of rows that is used to compute additional attributes. A window is defined using a window specification (the `OVER` clause), and is based on three main concepts:

- *Window partitioning*, which forms groups of rows (`PARTITION` clause)
- *Window ordering*, which defines an order or sequence of rows within each partition (`ORDER BY` clause)
- *Window frames*, which are defined relative to each row to further restrict the set of rows (`ROWS` specification)

Window functions are the last set of operations performed in a query except for the final `ORDER BY` clause. All joins and all `WHERE`, `GROUP BY`, and `HAVING` clauses are completed before the window functions are processed. Therefore, window functions can appear only in the select list or `ORDER BY` clause. Multiple window functions can be used within a single query with different frame clauses. Window functions may be present in other scalar expressions, such as `CASE`.

Amazon Redshift supports two types of window functions: aggregate and ranking.

These are the supported aggregate functions:

- `AVG`
- `COUNT`
- `CUME_DIST`
- `FIRST_VALUE`
- `LAG`
- `LAST_VALUE`
- `LEAD`
- `MAX`
- `MEDIAN`
- `MIN`
- `NTH_VALUE`
- `PERCENTILE_CONT`
- `PERCENTILE_DISC`
- `RATIO_TO_REPORT`
- `STDDEV_POP`
- `STDDEV_SAMP` (synonym for `STDDEV`)
- `SUM`

- VAR_POP
- VAR_SAMP (synonym for VARIANCE)

These are the supported ranking functions:

- DENSE_RANK
- NTILE
- PERCENT_RANK
- RANK
- ROW_NUMBER

Window Function Syntax Summary

Standard window function syntax is as follows:

```
function (expression) OVER (  
[ PARTITION BY expr_list ]  
[ ORDER BY order_list [ frame_clause ] ] )
```

where *function* is one of the functions described in this section and *expr_list* is:

```
expression | column_name [, expr_list ]
```

and *order_list* is:

```
expression | column_name [ ASC | DESC ]  
[ NULLS FIRST | NULLS LAST ]  
[, order_list ]
```

and *frame_clause* is:

```
ROWS  
{ UNBOUNDED PRECEDING | unsigned_value PRECEDING | CURRENT ROW } |  
  
{ BETWEEN  
{ UNBOUNDED PRECEDING | unsigned_value { PRECEDING | FOLLOWING } |  
CURRENT ROW }  
AND  
{ UNBOUNDED FOLLOWING | unsigned_value { PRECEDING | FOLLOWING } |  
CURRENT ROW }}
```

Note

STDDEV_SAMP and VAR_SAMP are synonyms for STDDEV and VARIANCE, respectively.

Arguments

function

For details, see the individual function descriptions.

OVER

Clause that defines the window specification. The OVER clause is mandatory for window functions and differentiates window functions from other SQL functions.

PARTITION BY *expr_list*

Optional. The PARTITION BY clause subdivides the result set into partitions, much like the GROUP BY clause. If a partition clause is present, the function is calculated for the rows in each partition. If no partition clause is specified, a single partition contains the entire table, and the function is computed for that complete table.

The ranking functions, DENSE_RANK, NTILE, RANK, and ROW_NUMBER, require a global comparison of all the rows in the result set. When a PARTITION BY clause is used, the query optimizer can execute each aggregation in parallel by spreading the workload across multiple slices according to the partitions. If the PARTITION BY clause is not present, the aggregation step must be executed serially on a single slice, which can have a significant negative impact on performance, especially for large clusters.

ORDER BY *order_list*

Optional. The window function is applied to the rows within each partition sorted according to the order specification in ORDER BY. This ORDER BY clause is distinct from and completely unrelated to an ORDER BY clause in a nonwindow function (outside of the OVER clause). The ORDER BY clause can be used without the PARTITION BY clause.

For the ranking functions, the ORDER BY clause identifies the measures for the ranking values. For aggregation functions, the partitioned rows must be ordered before the aggregate function is computed for each frame. For more about window function types, see [Window Functions \(p. 508\)](#).

Column identifiers or expressions that evaluate to column identifiers are required in the order list. Neither constants nor constant expressions can be used as substitutes for column names.

NULLS values are treated as their own group, sorted and ranked according to the NULLS FIRST or NULLS LAST option. By default, NULL values are sorted and ranked last in ASC ordering, and sorted and ranked first in DESC ordering.

If the ORDER BY clause is omitted, the order of the rows is nondeterministic.

Note

In any parallel system such as Amazon Redshift, when an ORDER BY clause does not produce a unique and total ordering of the data, the order of the rows is nondeterministic. That is, if the ORDER BY expression produces duplicate values (a partial ordering), the return order of those rows might vary from one run of Amazon Redshift to the next. In turn, window functions might return unexpected or inconsistent results. For more information, see [Unique Ordering of Data for Window Functions \(p. 551\)](#).

column_name

Name of a column to be partitioned by or ordered by.

ASC | DESC

Option that defines the sort order for the expression, as follows:

- ASC: ascending (for example, low to high for numeric values and 'A' to 'Z' for character strings). If no option is specified, data is sorted in ascending order by default.
- DESC: descending (high to low for numeric values; 'Z' to 'A' for strings).

NULLS FIRST | NULLS LAST

Option that specifies whether NULLS should be ordered first, before non-null values, or last, after non-null values. By default, NULLS are sorted and ranked last in ASC ordering, and sorted and ranked first in DESC ordering.

frame_clause

For aggregate functions, the frame clause further refines the set of rows in a function's window when using ORDER BY. It provides the ability to include or exclude sets of rows within the ordered result. The frame clause consists of the ROWS keyword and associated specifiers.

The frame clause does not apply to ranking functions and is not required when no ORDER BY clause is used in the OVER clause for an aggregate function. If an ORDER BY clause is used for an aggregate function, an explicit frame clause is required.

When no ORDER BY clause is specified, the implied frame is unbounded: equivalent to ROWS BETWEEN UNBOUNDED PRECEDING AND UNBOUNDED FOLLOWING.

ROWS

This clause defines the window frame by specifying a physical offset from the current row.

This clause specifies the rows in the current window or partition that the value in the current row is to be combined with. It uses arguments that specify row position, which can be before or after the current row. The reference point for all window frames is the current row. Each row becomes the current row in turn as the window frame slides forward in the partition.

The frame can be a simple set of rows up to and including the current row:

```
{UNBOUNDED PRECEDING | offset PRECEDING | CURRENT ROW}
```

or it can be a set of rows between two boundaries:

```
BETWEEN  
{UNBOUNDED PRECEDING | offset { PRECEDING | FOLLOWING }  
 | CURRENT ROW}  
AND  
{UNBOUNDED FOLLOWING | offset { PRECEDING | FOLLOWING }  
 | CURRENT ROW}
```

UNBOUNDED PRECEDING indicates that the window starts at the first row of the partition; *offset* PRECEDING indicates that the window starts a number of rows equivalent to the value of *offset* before the current row. UNBOUNDED PRECEDING is the default.

CURRENT ROW indicates the window begins or ends at the current row. RANGE CURRENT ROW includes all rows that have the same value as the current row according to the ORDER BY expression.

UNBOUNDED FOLLOWING indicates that the window ends at the last row of the partition; *offset* FOLLOWING indicates that the window ends a number of rows equivalent to the value of *offset* after the current row.

offset identifies a physical number of rows before or after the current row. In this case, *offset* must be a constant or expression that evaluates to a positive numeric value. For example, 5 FOLLOWING will end the frame 5 rows after the current row.

Where BETWEEN is not specified, the frame is implicitly bounded by the current row. For example ROWS 5 PRECEDING is equal to ROWS BETWEEN 5 PRECEDING AND CURRENT ROW, and ROWS UNBOUNDED FOLLOWING is equal to ROWS BETWEEN CURRENT ROW AND UNBOUNDED FOLLOWING.

Note

You cannot specify a frame in which the starting boundary is greater than the ending boundary. For example, you cannot specify any of these frames:

```
between 5 following and 5 preceding  
between current row and 2 preceding  
between 3 following and current row
```

AVG Window Function

The AVG window function returns the average (arithmetic mean) of the input expression values. The AVG function works with numeric values and ignores NULL values.

Syntax

```
AVG ( [ALL ] expression ) OVER  
(  
[ PARTITION BY expr_list ]  
[ ORDER BY order_list frame_clause ]  
)
```

Arguments

expression

The target column or expression that the function operates on.

ALL

With the argument ALL, the function retains all duplicate values from the expression for counting. ALL is the default. DISTINCT is not supported.

OVER

Specifies the window clauses for the aggregation functions. The OVER clause distinguishes window aggregation functions from normal set aggregation functions.

PARTITION BY *expr_list*

Defines the window for the AVG function in terms of one or more expressions.

ORDER BY *order_list*

Sorts the rows within each partition. If no PARTITION BY is specified, ORDER BY uses the entire table.

frame_clause

If an ORDER BY clause is used for an aggregate function, an explicit frame clause is required. The frame clause refines the set of rows in a function's window, including or excluding sets of rows within the ordered result. The frame clause consists of the ROWS keyword and associated specifiers. See [Window Function Syntax Summary \(p. 510\)](#).

Data Types

The argument types supported by the AVG function are SMALLINT, INTEGER, BIGINT, NUMERIC, DECIMAL, REAL, and DOUBLE PRECISION.

The return types supported by the AVG function are:

- BIGINT for SMALLINT or INTEGER arguments
- NUMERIC for BIGINT arguments
- DOUBLE PRECISION for floating point arguments

Examples

See [AVG Window Function Examples \(p. 534\)](#).

COUNT Window Function

The COUNT window function counts the rows defined by the expression.

The COUNT function has two variations. COUNT(*) counts all the rows in the target table whether they include nulls or not. COUNT(expression) computes the number of rows with non-NULL values in a specific column or expression.

Syntax

```
COUNT ( * | [ ALL ] expression) OVER
(
[ PARTITION BY expr_list ]
[ ORDER BY order_list
frame_clause ]
)
```

Arguments

expression

The target column or expression that the function operates on.

ALL

With the argument ALL, the function retains all duplicate values from the expression for counting. ALL is the default. DISTINCT is not supported.

OVER

Specifies the window clauses for the aggregation functions. The OVER clause distinguishes window aggregation functions from normal set aggregation functions.

PARTITION BY *expr_list*

Defines the window for the COUNT function in terms of one or more expressions.

ORDER BY *order_list*

Sorts the rows within each partition. If no PARTITION BY is specified, ORDER BY uses the entire table.

frame_clause

If an ORDER BY clause is used for an aggregate function, an explicit frame clause is required. The frame clause refines the set of rows in a function's window, including or excluding sets of rows within the ordered result. The frame clause consists of the ROWS keyword and associated specifiers. See [Window Function Syntax Summary \(p. 510\)](#).

Data Types

The COUNT function supports all argument data types.

The return type supported by the COUNT function is BIGINT.

Examples

See [COUNT Window Function Examples \(p. 534\)](#).

CUME_DIST Window Function

Calculates the cumulative distribution of a value within a window or partition. Assuming ascending ordering, the cumulative distribution is determined using this formula:

$$\text{count of rows with values } \leq x / \text{count of rows in the window or partition}$$

where x equals the value in the current row of the column specified in the ORDER BY clause. The following dataset illustrates use of this formula:

Row#	Value	Calculation	CUME_DIST
1	2500	(1)/(5)	0.2
2	2600	(2)/(5)	0.4
3	2800	(3)/(5)	0.6

4	2900	(4)/(5)	0.8
5	3100	(5)/(5)	1.0

The return value range is >0 to 1, inclusive.

Syntax

```
CUME_DIST (  
OVER (  
[ PARTITION BY partition_expression ]  
[ ORDER BY order_list ]  
)
```

Arguments

OVER

A clause that specifies the window partitioning. The OVER clause cannot contain a window frame specification.

PARTITION BY *partition_expression*

Optional. An expression that sets the range of records for each group in the OVER clause.

ORDER BY *order_list*

The expression on which to calculate cumulative distribution. The expression must have either a numeric data type or be implicitly convertible to one. If ORDER BY is omitted, the return value is 1 for all rows.

If ORDER BY does not produce a unique ordering, the order of the rows is nondeterministic. For more information, see [Unique Ordering of Data for Window Functions \(p. 551\)](#).

Return Type

FLOAT8

Example

See [CUME_DIST Window Function Examples \(p. 535\)](#).

DENSE_RANK Window Function

The DENSE_RANK window function determines the rank of a value in a group of values, based on the ORDER BY expression in the OVER clause. If the optional PARTITION BY clause is present, the rankings are reset for each group of rows. Rows with equal values for the ranking criteria receive the same rank. The DENSE_RANK function differs from RANK in one respect: If two or more rows tie, there is no gap in the sequence of ranked values. For example, if two rows are ranked 1, the next rank is 2.

You can have ranking functions with different PARTITION BY and ORDER BY clauses in the same query.

Syntax

```
DENSE_RANK ( ) OVER  
(  
[ PARTITION BY expr_list ]  
[ ORDER BY order_list ]
```

```
)
```

Arguments

()

The function takes no arguments, but the empty parentheses are required.

OVER

The window clauses for the DENSE_RANK function.

PARTITION BY *expr_list*

Optional. One or more expressions that define the window.

ORDER BY *order_list*

Optional. The expression on which the ranking values are based. If no PARTITION BY is specified, ORDER BY uses the entire table. If ORDER BY is omitted, the return value is 1 for all rows.

If ORDER BY does not produce a unique ordering, the order of the rows is nondeterministic. For more information, see [Unique Ordering of Data for Window Functions \(p. 551\)](#).

Return Type

INTEGER

Examples

See [DENSE_RANK Window Function Examples \(p. 535\)](#).

FIRST_VALUE and LAST_VALUE Window Functions

Given an ordered set of rows, FIRST_VALUE returns the value of the specified expression with respect to the first row in the window frame. The LAST_VALUE function returns the value of the expression with respect to the last row in the frame.

Syntax

```
FIRST_VALUE | LAST_VALUE  
( expression [ IGNORE NULLS | RESPECT NULLS ] ) OVER  
(  
[ PARTITION BY expr_list ]  
[ ORDER BY order_list frame_clause ]  
)
```

Arguments

expression

The target column or expression that the function operates on.

IGNORE NULLS

When this option is used with FIRST_VALUE, the function returns the first value in the frame that is not NULL (or NULL if all values are NULL). When this option is used with LAST_VALUE, the function returns the last value in the frame that is not NULL (or NULL if all values are NULL).

RESPECT NULLS

Indicates that Amazon Redshift should include null values in the determination of which row to use. RESPECT NULLS is supported by default if you do not specify IGNORE NULLS.

OVER

Introduces the window clauses for the function.

PARTITION BY *expr_list*

Defines the window for the function in terms of one or more expressions.

ORDER BY *order_list*

Sorts the rows within each partition. If no **PARTITION BY** clause is specified, **ORDER BY** sorts the entire table. If you specify an **ORDER BY** clause, you must also specify a *frame_clause*.

The results of the **FIRST_VALUE** and **LAST_VALUE** functions depend on the ordering of the data. The results are nondeterministic in the following cases:

- When no **ORDER BY** clause is specified and a partition contains two different values for an expression
- When the expression evaluates to different values that correspond to the same value in the **ORDER BY** list.

frame_clause

If an **ORDER BY** clause is used for an aggregate function, an explicit frame clause is required. The frame clause refines the set of rows in a function's window, including or excluding sets of rows in the ordered result. The frame clause consists of the **ROWS** keyword and associated specifiers.

See [Window Function Syntax Summary \(p. 510\)](#).

Data Types

These functions support expressions that use any of the Amazon Redshift data types. The return type is the same as the type of the *expression*.

Examples

See [FIRST_VALUE and LAST_VALUE Window Function Examples \(p. 536\)](#).

LAG Window Function

The **LAG** window function returns the values for a row at a given offset above (before) the current row in the partition.

Syntax

```
LAG (value_expr [, offset ])  
[ IGNORE NULLS | RESPECT NULLS ]  
OVER ( [ PARTITION BY window_partition ] ORDER BY window_ordering )
```

Arguments

value_expr

The target column or expression that the function operates on.

offset

An optional parameter that specifies the number of rows before the current row to return values for. The offset can be a constant integer or an expression that evaluates to an integer. If you do not specify an offset, Amazon Redshift uses 1 as the default value. An offset of 0 indicates the current row.

IGNORE NULLS

An optional specification that indicates that Amazon Redshift should skip null values in the determination of which row to use. Null values are included if **IGNORE NULLS** is not listed.

Note

You can use an **NVL** or **COALESCE** expression to replace the null values with another value. For more information, see [NVL Expression \(p. 557\)](#).

RESPECT NULLS

Indicates that Amazon Redshift should include null values in the determination of which row to use. RESPECT NULLS is supported by default if you do not specify IGNORE NULLS.

OVER

Specifies the window partitioning and ordering. The OVER clause cannot contain a window frame specification.

PARTITION BY *window_partition*

An optional argument that sets the range of records for each group in the OVER clause.

ORDER BY *window_ordering*

Sorts the rows within each partition.

The LAG window function supports expressions that use any of the Amazon Redshift data types. The return type is the same as the type of the *value_expr*.

Examples

See [LAG Window Function Examples \(p. 539\)](#).

LEAD Window Function

The LEAD window function returns the values for a row at a given offset below (after) the current row in the partition.

Syntax

```
LEAD (value_expr [, offset ])  
[ IGNORE NULLS | RESPECT NULLS ]  
OVER ( [ PARTITION BY window_partition ] ORDER BY window_ordering )
```

Arguments

value_expr

The target column or expression that the function operates on.

offset

An optional parameter that specifies the number of rows below the current row to return values for. The offset can be a constant integer or an expression that evaluates to an integer. If you do not specify an offset, Amazon Redshift uses 1 as the default value. An offset of 0 indicates the current row.

IGNORE NULLS

An optional specification that indicates that Amazon Redshift should skip null values in the determination of which row to use. Null values are included if IGNORE NULLS is not listed.

Note

You can use an NVL or COALESCE expression to replace the null values with another value. For more information, see [NVL Expression \(p. 557\)](#).

RESPECT NULLS

Indicates that Amazon Redshift should include null values in the determination of which row to use. RESPECT NULLS is supported by default if you do not specify IGNORE NULLS.

OVER

Specifies the window partitioning and ordering. The OVER clause cannot contain a window frame specification.

PARTITION BY *window_partition*

An optional argument that sets the range of records for each group in the OVER clause.

ORDER BY *window_ordering*

Sorts the rows within each partition.

The LEAD window function supports expressions that use any of the Amazon Redshift data types. The return type is the same as the type of the *value_expr*.

Examples

See [LEAD Window Function Examples \(p. 539\)](#).

LISTAGG Window Function

For each group in a query, the LISTAGG window function orders the rows for each group according to the ORDER BY expression, then concatenates the values into a single string.

Syntax

```
LISTAGG(expression [, 'delimiter' ] )  
[ WITHIN GROUP (ORDER BY order_list) ]  
OVER ( [PARTITION BY partition_expression] )
```

Arguments

aggregate_expression

Any valid expression (such as a column name) that provides the values to aggregate. NULL values and empty strings are ignored.

delimiter

Optional. The string constant that will separate the concatenated values. The default is NULL.

WITHIN GROUP (ORDER BY *order_list*)

Optional. Specifies the sort order of the aggregated values. Deterministic only if ORDER BY provides unique ordering. The default is to aggregate all rows and return a single value.

OVER

A clause that specifies the window partitioning. The OVER clause cannot contain a window ordering or window frame specification.

PARTITION BY *partition_expression*

Optional. Sets the range of records for each group in the OVER clause.

Returns

VARCHAR(MAX). If the result set is larger than the maximum VARCHAR size (64K – 1, or 65535), then LISTAGG returns the following error:

```
Invalid operation: Result size exceeds LISTAGG limit
```

Examples

See [LISTAGG Window Function Examples \(p. 540\)](#).

MAX Window Function

The MAX window function returns the maximum of the input expression values. The MAX function works with numeric values and ignores NULL values.

Syntax

```
MAX ( [ ALL ] expression ) OVER  
(
```

```
[ PARTITION BY expr_list ]  
[ ORDER BY order_list frame_clause ]  
)
```

Arguments

expression

The target column or expression that the function operates on.

ALL

With the argument ALL, the function retains all duplicate values from the expression. ALL is the default. DISTINCT is not supported.

OVER

A clause that specifies the window clauses for the aggregation functions. The OVER clause distinguishes window aggregation functions from normal set aggregation functions.

PARTITION BY *expr_list*

Defines the window for the MAX function in terms of one or more expressions.

ORDER BY *order_list*

Sorts the rows within each partition. If no PARTITION BY is specified, ORDER BY uses the entire table.

frame_clause

If an ORDER BY clause is used for an aggregate function, an explicit frame clause is required. The frame clause refines the set of rows in a function's window, including or excluding sets of rows within the ordered result. The frame clause consists of the ROWS keyword and associated specifiers. See [Window Function Syntax Summary \(p. 510\)](#).

Data Types

Accepts any data type as input. Returns the same data type as *expression*.

Examples

See [MAX Window Function Examples \(p. 541\)](#).

MEDIAN Window Function

Calculates the median value for the range of values in a window or partition. NULL values in the range are ignored.

MEDIAN is an inverse distribution function that assumes a continuous distribution model.

Syntax

```
MEDIAN ( median_expression )  
OVER ( [ PARTITION BY partition_expression ] )
```

Arguments

median_expression

An expression, such as a column name, that provides the values for which to determine the median. The expression must have either a numeric or datetime data type or be implicitly convertible to one.

OVER

A clause that specifies the window partitioning. The OVER clause cannot contain a window ordering or window frame specification.

PARTITION BY *partition_expression*

Optional. An expression that sets the range of records for each group in the OVER clause.

Data Types

The return type is determined by the data type of *median_expression*. The following table shows the return type for each *median_expression* data type.

Input Type	Return Type
INT2, INT4, INT8, NUMERIC, DECIMAL	DECIMAL
FLOAT, DOUBLE	DOUBLE
DATE	DATE

Usage Notes

If the *median_expression* argument is a DECIMAL data type defined with the maximum precision of 38 digits, it is possible that MEDIAN will return either an inaccurate result or an error. If the return value of the MEDIAN function exceeds 38 digits, the result is truncated to fit, which causes a loss of precision. If, during interpolation, an intermediate result exceeds the maximum precision, a numeric overflow occurs and the function returns an error. To avoid these conditions, we recommend either using a data type with lower precision or casting the *median_expression* argument to a lower precision.

For example, a SUM function with a DECIMAL argument returns a default precision of 38 digits. The scale of the result is the same as the scale of the argument. So, for example, a SUM of a DECIMAL(5,2) column returns a DECIMAL(38,2) data type.

The following example uses a SUM function in the *median_expression* argument of a MEDIAN function. The data type of the PRICEPAID column is DECIMAL (8,2), so the SUM function returns DECIMAL(38,2).

```
select salesid, sum(pricepaid), median(sum(pricepaid))
over() from sales where salesid < 10 group by salesid;
```

To avoid a potential loss of precision or an overflow error, cast the result to a DECIMAL data type with lower precision, as the following example shows.

```
select salesid, sum(pricepaid), median(sum(pricepaid)::decimal(30,2))
over() from sales where salesid < 10 group by salesid;
```

Examples

See [MEDIAN Window Function Examples \(p. 542\)](#).

MIN Window Function

The MIN window function returns the minimum of the input expression values. The MIN function works with numeric values and ignores NULL values.

Syntax

```
MIN ( [ ALL ] expression ) OVER
```

```
(  
[ PARTITION BY expr_list ]  
[ ORDER BY order_list frame_clause ]  
)
```

Arguments

expression

The target column or expression that the function operates on.

ALL

With the argument ALL, the function retains all duplicate values from the expression. ALL is the default. DISTINCT is not supported.

OVER

Specifies the window clauses for the aggregation functions. The OVER clause distinguishes window aggregation functions from normal set aggregation functions.

PARTITION BY *expr_list*

Defines the window for the MIN function in terms of one or more expressions.

ORDER BY *order_list*

Sorts the rows within each partition. If no PARTITION BY is specified, ORDER BY uses the entire table.

frame_clause

If an ORDER BY clause is used for an aggregate function, an explicit frame clause is required. The frame clause refines the set of rows in a function's window, including or excluding sets of rows within the ordered result. The frame clause consists of the ROWS keyword and associated specifiers. See [Window Function Syntax Summary \(p. 510\)](#).

Data Types

Accepts any data type as input. Returns the same data type as *expression*.

Examples

See [MIN Window Function Examples \(p. 542\)](#).

NTH_VALUE Window Function

The NTH_VALUE window function returns the expression value of the specified row of the window frame relative to the first row of the window.

Syntax

```
NTH_VALUE (expr, offset)  
[ IGNORE NULLS | RESPECT NULLS ]  
OVER  
( [ PARTITION BY window_partition ]  
[ ORDER BY window_ordering  
                  frame_clause ] )
```

Arguments

expr

The target column or expression that the function operates on.

offset

Determines the row number relative to the first row in the window for which to return the expression. The *offset* can be a constant or an expression and must be a positive integer that is greater than 0.

IGNORE NULLS

An optional specification that indicates that Amazon Redshift should skip null values in the determination of which row to use. Null values are included if IGNORE NULLS is not listed.

RESPECT NULLS

Indicates that Amazon Redshift should include null values in the determination of which row to use. RESPECT NULLS is supported by default if you do not specify IGNORE NULLS.

OVER

Specifies the window partitioning, ordering, and window frame.

PARTITION BY *window_partition*

Sets the range of records for each group in the OVER clause.

ORDER BY *window_ordering*

Sorts the rows within each partition. If ORDER BY is omitted, the default frame consists of all rows in the partition.

frame_clause

If an ORDER BY clause is used for an aggregate function, an explicit frame clause is required. The frame clause refines the set of rows in a function's window, including or excluding sets of rows in the ordered result. The frame clause consists of the ROWS keyword and associated specifiers. See [Window Function Syntax Summary \(p. 510\)](#).

The NTH_VALUE window function supports expressions that use any of the Amazon Redshift data types. The return type is the same as the type of the *expr*.

Examples

See [NTH_VALUE Window Function Examples \(p. 543\)](#).

NTILE Window Function

The NTILE window function divides ordered rows in the partition into the specified number of ranked groups of as equal size as possible and returns the group that a given row falls into.

Syntax

```
NTILE (expr)  
OVER (  
[ PARTITION BY expression_list ]  
[ ORDER BY order_list ]  
)
```

Arguments

expr

The number of ranking groups and must result in a positive integer value (greater than 0) for each partition. The *expr* argument must not be nullable.

OVER

A clause that specifies the window partitioning and ordering. The OVER clause cannot contain a window frame specification.

PARTITION BY *window_partition*

Optional. The range of records for each group in the OVER clause.

ORDER BY *window_ordering*

Optional. An expression that sorts the rows within each partition. If the ORDER BY clause is omitted, the ranking behavior is the same.

If ORDER BY does not produce a unique ordering, the order of the rows is nondeterministic. For more information, see [Unique Ordering of Data for Window Functions \(p. 551\)](#).

Return Type

BIGINT

Examples

See [NTILE Window Function Examples \(p. 544\)](#).

PERCENT_RANK Window Function

Calculates the percent rank of a given row. The percent rank is determined using this formula:

$$(x - 1) / (\text{the number of rows in the window or partition} - 1)$$

where x is the rank of the current row. The following dataset illustrates use of this formula:

Row#	Value	Rank	Calculation	PERCENT_RANK
1	15	1	(1-1)/(7-1)	0.0000
2	20	2	(2-1)/(7-1)	0.1666
3	20	2	(2-1)/(7-1)	0.1666
4	20	2	(2-1)/(7-1)	0.1666
5	30	5	(5-1)/(7-1)	0.6666
6	30	5	(5-1)/(7-1)	0.6666
7	40	7	(7-1)/(7-1)	1.0000

The return value range is 0 to 1, inclusive. The first row in any set has a PERCENT_RANK of 0.

Syntax

```
PERCENT_RANK ( )
OVER (
[ PARTITION BY partition_expression ]
[ ORDER BY order_list ]
)
```

Arguments

()

The function takes no arguments, but the empty parentheses are required.

OVER

A clause that specifies the window partitioning. The OVER clause cannot contain a window frame specification.

PARTITION BY *partition_expression*

Optional. An expression that sets the range of records for each group in the OVER clause.

ORDER BY *order_list*

Optional. The expression on which to calculate percent rank. The expression must have either a numeric data type or be implicitly convertible to one. If ORDER BY is omitted, the return value is 0 for all rows.

If ORDER BY does not produce a unique ordering, the order of the rows is nondeterministic. For more information, see [Unique Ordering of Data for Window Functions \(p. 551\)](#).

Return Type

FLOAT8

Examples

See [PERCENT_RANK Window Function Examples \(p. 544\)](#).

PERCENTILE_CONT Window Function

PERCENTILE_CONT is an inverse distribution function that assumes a continuous distribution model. It takes a percentile value and a sort specification, and returns an interpolated value that would fall into the given percentile value with respect to the sort specification.

PERCENTILE_CONT computes a linear interpolation between values after ordering them. Using the percentile value (P) and the number of not null rows (N) in the aggregation group, the function computes the row number after ordering the rows according to the sort specification. This row number (RN) is computed according to the formula $RN = (1 + (P * (N - 1)))$. The final result of the aggregate function is computed by linear interpolation between the values from rows at row numbers $CRN = \text{CEILING}(RN)$ and $FRN = \text{FLOOR}(RN)$.

The final result will be as follows.

If ($CRN = FRN = RN$) then the result is (value of expression from row at RN)

Otherwise the result is as follows:

$(CRN - RN) * (\text{value of expression for row at } FRN) + (RN - FRN) * (\text{value of expression for row at } CRN)$.

You can specify only the PARTITION clause in the OVER clause. If PARTITION is specified, for each row, PERCENTILE_CONT returns the value that would fall into the specified percentile among a set of values within a given partition.

Syntax

```
PERCENTILE_CONT ( percentile )  
WITHIN GROUP (ORDER BY expr)  
OVER ( [ PARTITION BY expr_list ] )
```

Arguments

percentile

Numeric constant between 0 and 1. Nulls are ignored in the calculation.

WITHIN GROUP (ORDER BY *expr*)

Specifies numeric or date/time values to sort and compute the percentile over.

OVER

Specifies the window partitioning. The OVER clause cannot contain a window ordering or window frame specification.

PARTITION BY *expr*

Optional argument that sets the range of records for each group in the OVER clause.

Returns

The return type is determined by the data type of the ORDER BY expression in the WITHIN GROUP clause. The following table shows the return type for each ORDER BY expression data type.

Input Type	Return Type
INT2, INT4, INT8, NUMERIC, DECIMAL	DECIMAL
FLOAT, DOUBLE	DOUBLE
DATE	DATE
TIMESTAMP	TIMESTAMP

Usage Notes

If the ORDER BY expression is a DECIMAL data type defined with the maximum precision of 38 digits, it is possible that PERCENTILE_CONT will return either an inaccurate result or an error. If the return value of the PERCENTILE_CONT function exceeds 38 digits, the result is truncated to fit, which causes a loss of precision. If, during interpolation, an intermediate result exceeds the maximum precision, a numeric overflow occurs and the function returns an error. To avoid these conditions, we recommend either using a data type with lower precision or casting the ORDER BY expression to a lower precision.

For example, a SUM function with a DECIMAL argument returns a default precision of 38 digits. The scale of the result is the same as the scale of the argument. So, for example, a SUM of a DECIMAL(5,2) column returns a DECIMAL(38,2) data type.

The following example uses a SUM function in the ORDER BY clause of a PERCENTILE_CONT function. The data type of the PRICEPAID column is DECIMAL (8,2), so the SUM function returns DECIMAL(38,2).

```
select salesid, sum(pricepaid), percentile_cont(0.6)
within group (order by sum(pricepaid) desc) over()
from sales where salesid < 10 group by salesid;
```

To avoid a potential loss of precision or an overflow error, cast the result to a DECIMAL data type with lower precision, as the following example shows.

```
select salesid, sum(pricepaid), percentile_cont(0.6)
within group (order by sum(pricepaid)::decimal(30,2) desc) over()
from sales where salesid < 10 group by salesid;
```

Examples

See [PERCENTILE_CONT Window Function Examples \(p. 545\)](#).

PERCENTILE_DISC Window Function

PERCENTILE_DISC is an inverse distribution function that assumes a discrete distribution model. It takes a percentile value and a sort specification and returns an element from the given set.

For a given percentile value P, PERCENTILE_DISC sorts the values of the expression in the ORDER BY clause and returns the value with the smallest cumulative distribution value (with respect to the same sort specification) that is greater than or equal to P.

You can specify only the PARTITION clause in the OVER clause.

Syntax

```
PERCENTILE_DISC ( percentile )  
WITHIN GROUP (ORDER BY expr)  
OVER ( [ PARTITION BY expr_list ] )
```

Arguments

percentile

Numeric constant between 0 and 1. Nulls are ignored in the calculation.

WITHIN GROUP (ORDER BY *expr*)

Specifies numeric or date/time values to sort and compute the percentile over.

OVER

Specifies the window partitioning. The OVER clause cannot contain a window ordering or window frame specification.

PARTITION BY *expr*

Optional argument that sets the range of records for each group in the OVER clause.

Returns

The same data type as the ORDER BY expression in the WITHIN GROUP clause.

Examples

See [PERCENTILE_DISC Window Function Examples \(p. 546\)](#).

RANK Window Function

The RANK window function determines the rank of a value in a group of values, based on the ORDER BY expression in the OVER clause. If the optional PARTITION BY clause is present, the rankings are reset for each group of rows. Rows with equal values for the ranking criteria receive the same rank. Amazon Redshift adds the number of tied rows to the tied rank to calculate the next rank and thus the ranks might not be consecutive numbers. For example, if two rows are ranked 1, the next rank is 3.

RANK differs from the [DENSE_RANK Window Function \(p. 515\)](#) in one respect: For DENSE_RANK, if two or more rows tie, there is no gap in the sequence of ranked values. For example, if two rows are ranked 1, the next rank is 2.

You can have ranking functions with different PARTITION BY and ORDER BY clauses in the same query.

Syntax

```
RANK ( ) OVER  
(  
[ PARTITION BY expr_list ]  
[ ORDER BY order_list ]  
)
```

Arguments

()

The function takes no arguments, but the empty parentheses are required.

OVER

The window clauses for the RANK function.

PARTITION BY *expr_list*

Optional. One or more expressions that define the window.

ORDER BY *order_list*

Optional. Defines the columns on which the ranking values are based. If no PARTITION BY is specified, ORDER BY uses the entire table. If ORDER BY is omitted, the return value is 1 for all rows.

If ORDER BY does not produce a unique ordering, the order of the rows is nondeterministic. For more information, see [Unique Ordering of Data for Window Functions \(p. 551\)](#).

Return Type

INTEGER

Examples

See [RANK Window Function Examples \(p. 547\)](#).

RATIO_TO_REPORT Window Function

Calculates the ratio of a value to the sum of the values in a window or partition. The ratio to report value is determined using the formula:

```
value of ratio_expression argument for the current row / sum of ratio_expression argument for the window or partition
```

The following dataset illustrates use of this formula:

Row#	Value	Calculation	RATIO_TO_REPORT
1	2500	(2500)/(13900)	0.1798
2	2600	(2600)/(13900)	0.1870
3	2800	(2800)/(13900)	0.2014
4	2900	(2900)/(13900)	0.2086
5	3100	(3100)/(13900)	0.2230

The return value range is 0 to 1, inclusive. If *ratio_expression* is NULL, then the return value is NULL.

Syntax

```
RATIO_TO_REPORT ( ratio_expression )  
OVER ( [ PARTITION BY partition_expression ] )
```

Arguments

ratio_expression

An expression, such as a column name, that provides the value for which to determine the ratio. The expression must have either a numeric data type or be implicitly convertible to one.

You cannot use any other analytic function in *ratio_expression*.

OVER

A clause that specifies the window partitioning. The OVER clause cannot contain a window ordering or window frame specification.

PARTITION BY *partition_expression*

Optional. An expression that sets the range of records for each group in the OVER clause.

Return Type

FLOAT8

Examples

See [RATIO_TO_REPORT Window Function Examples \(p. 548\)](#).

ROW_NUMBER Window Function

Determines the ordinal number of the current row within a group of rows, counting from 1, based on the ORDER BY expression in the OVER clause. If the optional PARTITION BY clause is present, the ordinal numbers are reset for each group of rows. Rows with equal values for the ORDER BY expressions receive the different row numbers nondeterministically.

Syntax

```
ROW_NUMBER ( ) OVER  
(  
[ PARTITION BY expr_list ]  
[ ORDER BY order_list ]  
)
```

Arguments

()

The function takes no arguments, but the empty parentheses are required.

OVER

The window clauses for the ROW_NUMBER function.

PARTITION BY *expr_list*

Optional. One or more expressions that define the ROW_NUMBER function.

ORDER BY *order_list*

Optional. The expression that defines the columns on which the row numbers are based. If no PARTITION BY is specified, ORDER BY uses the entire table. If ORDER BY is omitted, the return value is 1 through the total number of rows.

If ORDER BY does not produce a unique ordering, the order of the rows is nondeterministic. For more information, see [Unique Ordering of Data for Window Functions \(p. 551\)](#).

Return Type

INTEGER

Examples

See [ROW_NUMBER Window Function Example \(p. 549\)](#).

STDDEV_SAMP and STDDEV_POP Window Functions

The STDDEV_SAMP and STDDEV_POP window functions return the sample and population standard deviation of a set of numeric values (integer, decimal, or floating-point). See also [STDDEV_SAMP and STDDEV_POP Functions \(p. 500\)](#).

STDDEV_SAMP and STDDEV are synonyms for the same function.

Syntax

```
STDDEV_SAMP | STDDEV | STDDEV_POP  
( [ ALL ] expression ) OVER  
(  
  [ PARTITION BY expr_list ]  
  [ ORDER BY order_list  
    frame_clause ]  
)
```

Arguments

expression

The target column or expression that the function operates on.

ALL

With the argument ALL, the function retains all duplicate values from the expression. ALL is the default. DISTINCT is not supported.

OVER

Specifies the window clauses for the aggregation functions. The OVER clause distinguishes window aggregation functions from normal set aggregation functions.

PARTITION BY *expr_list*

Defines the window for the function in terms of one or more expressions.

ORDER BY *order_list*

Sorts the rows within each partition. If no PARTITION BY is specified, ORDER BY uses the entire table.

frame_clause

If an ORDER BY clause is used for an aggregate function, an explicit frame clause is required. The frame clause refines the set of rows in a function's window, including or excluding sets of rows within the ordered result. The frame clause consists of the ROWS keyword and associated specifiers. See [Window Function Syntax Summary \(p. 510\)](#).

Data Types

The argument types supported by the STDDEV functions are SMALLINT, INTEGER, BIGINT, NUMERIC, DECIMAL, REAL, and DOUBLE PRECISION.

Regardless of the data type of the expression, the return type of a STDDEV function is a double precision number.

Examples

See [STDDEV_POP and VAR_POP Window Function Examples \(p. 549\)](#).

SUM Window Function

The SUM window function returns the sum of the input column or expression values. The SUM function works with numeric values and ignores NULL values.

Syntax

```
SUM ( [ ALL ] expression ) OVER  
(
```

```
[ PARTITION BY expr_list ]  
[ ORDER BY order_list  
           frame_clause ]  
)
```

Arguments

expression

The target column or expression that the function operates on.

ALL

With the argument ALL, the function retains all duplicate values from the expression. ALL is the default. DISTINCT is not supported.

OVER

Specifies the window clauses for the aggregation functions. The OVER clause distinguishes window aggregation functions from normal set aggregation functions.

PARTITION BY *expr_list*

Defines the window for the SUM function in terms of one or more expressions.

ORDER BY *order_list*

Sorts the rows within each partition. If no PARTITION BY is specified, ORDER BY uses the entire table.

frame_clause

If an ORDER BY clause is used for an aggregate function, an explicit frame clause is required. The frame clause refines the set of rows in a function's window, including or excluding sets of rows within the ordered result. The frame clause consists of the ROWS keyword and associated specifiers. See [Window Function Syntax Summary \(p. 510\)](#).

Data Types

The argument types supported by the SUM function are SMALLINT, INTEGER, BIGINT, NUMERIC, DECIMAL, REAL, and DOUBLE PRECISION.

The return types supported by the SUM function are:

- BIGINT for SMALLINT or INTEGER arguments
- NUMERIC for BIGINT arguments
- DOUBLE PRECISION for floating-point arguments

Examples

See [SUM Window Function Examples \(p. 550\)](#).

VAR_SAMP and VAR_POP Window Functions

The VAR_SAMP and VAR_POP window functions return the sample and population variance of a set of numeric values (integer, decimal, or floating-point). See also [VAR_SAMP and VAR_POP Functions \(p. 502\)](#).

VAR_SAMP and VARIANCE are synonyms for the same function.

Syntax

```
VAR_SAMP | VARIANCE | VAR_POP  
( [ ALL ] expression ) OVER
```

```
(  
  [ PARTITION BY expr_list ]  
  [ ORDER BY order_list  
                                frame_clause ]  
)
```

Arguments

expression

The target column or expression that the function operates on.

ALL

With the argument ALL, the function retains all duplicate values from the expression. ALL is the default. DISTINCT is not supported.

OVER

Specifies the window clauses for the aggregation functions. The OVER clause distinguishes window aggregation functions from normal set aggregation functions.

PARTITION BY *expr_list*

Defines the window for the function in terms of one or more expressions.

ORDER BY *order_list*

Sorts the rows within each partition. If no PARTITION BY is specified, ORDER BY uses the entire table.

frame_clause

If an ORDER BY clause is used for an aggregate function, an explicit frame clause is required. The frame clause refines the set of rows in a function's window, including or excluding sets of rows within the ordered result. The frame clause consists of the ROWS keyword and associated specifiers. See [Window Function Syntax Summary \(p. 510\)](#).

Data Types

The argument types supported by the VARIANCE functions are SMALLINT, INTEGER, BIGINT, NUMERIC, DECIMAL, REAL, and DOUBLE PRECISION.

Regardless of the data type of the expression, the return type of a VARIANCE function is a double precision number.

Window Function Examples

Topics

- [AVG Window Function Examples \(p. 534\)](#)
- [COUNT Window Function Examples \(p. 534\)](#)
- [CUME_DIST Window Function Examples \(p. 535\)](#)
- [DENSE_RANK Window Function Examples \(p. 535\)](#)
- [FIRST_VALUE and LAST_VALUE Window Function Examples \(p. 536\)](#)
- [LAG Window Function Examples \(p. 539\)](#)
- [LEAD Window Function Examples \(p. 539\)](#)
- [LISTAGG Window Function Examples \(p. 540\)](#)
- [MAX Window Function Examples \(p. 541\)](#)
- [MEDIAN Window Function Examples \(p. 542\)](#)
- [MIN Window Function Examples \(p. 542\)](#)
- [NTH_VALUE Window Function Examples \(p. 543\)](#)
- [NTILE Window Function Examples \(p. 544\)](#)

- [PERCENT_RANK Window Function Examples \(p. 544\)](#)
- [PERCENTILE_CONT Window Function Examples \(p. 545\)](#)
- [PERCENTILE_DISC Window Function Examples \(p. 546\)](#)
- [RANK Window Function Examples \(p. 547\)](#)
- [RATIO_TO_REPORT Window Function Examples \(p. 548\)](#)
- [ROW_NUMBER Window Function Example \(p. 549\)](#)
- [STDDEV_POP and VAR_POP Window Function Examples \(p. 549\)](#)
- [SUM Window Function Examples \(p. 550\)](#)
- [Unique Ordering of Data for Window Functions \(p. 551\)](#)

This section provides examples for using the window functions.

Some of the window function examples in this section use a table named WINSALES, which contains 11 rows:

SALESID	DATEID	SELLERID	BUYERID	QTY	QTY_SHIPPED
30001	8/2/2003	3	B	10	10
10001	12/24/2003	1	C	10	10
10005	12/24/2003	1	A	30	
40001	1/9/2004	4	A	40	
10006	1/18/2004	1	C	10	
20001	2/12/2004	2	B	20	20
40005	2/12/2004	4	A	10	10
20002	2/16/2004	2	C	20	20
30003	4/18/2004	3	B	15	
30004	4/18/2004	3	B	20	
30007	9/7/2004	3	C	30	

The following script creates and populates the sample WINSALES table.

```
create table winsales(
salesid int,
dateid date,
sellerid int,
buyerid char(10),
qty int,
qty_shipped int);

insert into winsales values
(30001, '8/2/2003', 3, 'b', 10, 10),
(10001, '12/24/2003', 1, 'c', 10, 10),
(10005, '12/24/2003', 1, 'a', 30, null),
(40001, '1/9/2004', 4, 'a', 40, null),
(10006, '1/18/2004', 1, 'c', 10, null),
(20001, '2/12/2004', 2, 'b', 20, 20),
(40005, '2/12/2004', 4, 'a', 10, 10),
```

```
(20002, '2/16/2004', 2, 'c', 20, 20),
(30003, '4/18/2004', 3, 'b', 15, null),
(30004, '4/18/2004', 3, 'b', 20, null),
(30007, '9/7/2004', 3, 'c', 30, null);
```

AVG Window Function Examples

Compute a rolling average of quantities sold by date; order the results by date ID and sales ID:

```
select salesid, dateid, sellerid, qty,
avg(qty) over
(order by dateid, salesid rows unbounded preceding) as avg
from winsales
order by 2,1;
```

salesid	dateid	sellerid	qty	avg
30001	2003-08-02	3	10	10
10001	2003-12-24	1	10	10
10005	2003-12-24	1	30	16
40001	2004-01-09	4	40	22
10006	2004-01-18	1	10	20
20001	2004-02-12	2	20	20
40005	2004-02-12	4	10	18
20002	2004-02-16	2	20	18
30003	2004-04-18	3	15	18
30004	2004-04-18	3	20	18
30007	2004-09-07	3	30	19

(11 rows)

For a description of the WINSALES table, see [Window Function Examples \(p. 532\)](#).

COUNT Window Function Examples

Show the sales ID, quantity, and count of all rows from the beginning of the data window:

```
select salesid, qty,
count(*) over (order by salesid rows unbounded preceding) as count
from winsales
order by salesid;
```

salesid	qty	count
10001	10	1
10005	30	2
10006	10	3
20001	20	4
20002	20	5
30001	10	6
30003	15	7
30004	20	8
30007	30	9
40001	40	10
40005	10	11

(11 rows)

For a description of the WINSALES table, see [Window Function Examples \(p. 532\)](#).

Show the sales ID, quantity, and count of non-null rows from the beginning of the data window. (In the WINDSALES table, the QTY_SHIPPED column contains some NULLs.)

```
select salesid, qty, qty_shipped,
count(qty_shipped)
over (order by salesid rows unbounded preceding) as count
from winsales
order by salesid;
```

salesid	qty	qty_shipped	count
10001	10	10	1
10005	30		1
10006	10		1
20001	20	20	2
20002	20	20	3
30001	10	10	4
30003	15		4
30004	20		4
30007	30		4
40001	40		4
40005	10	10	5

(11 rows)

CUME_DIST Window Function Examples

The following example calculates the cumulative distribution of the quantity for each seller:

```
select sellerid, qty, cume_dist()
over (partition by sellerid order by qty)
from winsales;
```

sellerid	qty	cume_dist
1	10.00	0.33
1	10.64	0.67
1	30.37	1
3	10.04	0.25
3	15.15	0.5
3	20.75	0.75
3	30.55	1
2	20.09	0.5
2	20.12	1
4	10.12	0.5
4	40.23	1

For a description of the WINDSALES table, see [Window Function Examples \(p. 532\)](#).

DENSE_RANK Window Function Examples

Dense Ranking with ORDER BY

Order the table by the quantity sold (in descending order), and assign both a dense rank and a regular rank to each row. The results are sorted after the window function results are applied.

```
select salesid, qty,
dense_rank() over(order by qty desc) as d_rnk,
```

```
rank() over(order by qty desc) as rnk
from winsales
order by 2,1;
```

salesid	qty	d_rnk	rnk
10001	10	5	8
10006	10	5	8
30001	10	5	8
40005	10	5	8
30003	15	4	7
20001	20	3	4
20002	20	3	4
30004	20	3	4
10005	30	2	2
30007	30	2	2
40001	40	1	1

(11 rows)

Note the difference in rankings assigned to the same set of rows when the DENSE_RANK and RANK functions are used side by side in the same query. For a description of the WINSALES table, see [Window Function Examples \(p. 532\)](#).

Dense Ranking with PARTITION BY and ORDER BY

Partition the table by SELLERID and order each partition by the quantity (in descending order) and assign a dense rank to each row. The results are sorted after the window function results are applied.

```
select salesid, sellerid, qty,
dense_rank() over(partition by sellerid order by qty desc) as d_rnk
from winsales
order by 2,3,1;
```

salesid	sellerid	qty	d_rnk
10001	1	10	2
10006	1	10	2
10005	1	30	1
20001	2	20	1
20002	2	20	1
30001	3	10	4
30003	3	15	3
30004	3	20	2
30007	3	30	1
40005	4	10	2
40001	4	40	1

(11 rows)

For a description of the WINSALES table, see [Window Function Examples \(p. 532\)](#).

FIRST_VALUE and LAST_VALUE Window Function Examples

The following example returns the seating capacity for each venue in the VENUE table, with the results ordered by capacity (high to low). The FIRST_VALUE function is used to select the name of the venue that corresponds to the first row in the frame: in this case, the row with the highest number of seats. The results are partitioned by state, so when the VENUESTATE value changes, a new first value is selected. The window frame is unbounded so the same first value is selected for each row in each partition.

For California, Qualcomm Stadium has the highest number of seats (70561), so this name is the first value for all of the rows in the CA partition.

```
select venuestate, venueseats, venueename,
first_value(venueename)
over(partition by venuestate
order by venueseats desc
rows between unbounded preceding and unbounded following)
from (select * from venue where venueseats >0)
order by venuestate;
```

venuestate	venueseats	venueename	first_value
CA	70561	Qualcomm Stadium	Qualcomm Stadium
CA	69843	Monster Park	Qualcomm Stadium
CA	63026	McAfee Coliseum	Qualcomm Stadium
CA	56000	Dodger Stadium	Qualcomm Stadium
CA	45050	Angel Stadium of Anaheim	Qualcomm Stadium
CA	42445	PETCO Park	Qualcomm Stadium
CA	41503	AT&T Park	Qualcomm Stadium
CA	22000	Shoreline Amphitheatre	Qualcomm Stadium
CO	76125	INVESCO Field	INVESCO Field
CO	50445	Coors Field	INVESCO Field
DC	41888	Nationals Park	Nationals Park
FL	74916	Dolphin Stadium	Dolphin Stadium
FL	73800	Jacksonville Municipal Stadium	Dolphin Stadium
FL	65647	Raymond James Stadium	Dolphin Stadium
FL	36048	Tropicana Field	Dolphin Stadium
...			

The next example uses the LAST_VALUE function instead of FIRST_VALUE; otherwise, the query is the same as the previous example. For California, Shoreline Amphitheatre is returned for every row in the partition because it has the lowest number of seats (22000).

```
select venuestate, venueseats, venueename,
last_value(venueename)
over(partition by venuestate
order by venueseats desc
rows between unbounded preceding and unbounded following)
from (select * from venue where venueseats >0)
order by venuestate;
```

venuestate	venueseats	venueename	last_value
CA	70561	Qualcomm Stadium	Shoreline Amphitheatre
CA	69843	Monster Park	Shoreline Amphitheatre
CA	63026	McAfee Coliseum	Shoreline Amphitheatre
CA	56000	Dodger Stadium	Shoreline Amphitheatre
CA	45050	Angel Stadium of Anaheim	Shoreline Amphitheatre

CA Amphitheatre	42445	PETCO Park	Shoreline
CA Amphitheatre	41503	AT&T Park	Shoreline
CA Amphitheatre	22000	Shoreline Amphitheatre	Shoreline
CO	76125	INVESCO Field	Coors Field
CO	50445	Coors Field	Coors Field
DC	41888	Nationals Park	Nationals Park
FL	74916	Dolphin Stadium	Tropicana Field
FL	73800	Jacksonville Municipal Stadium	Tropicana Field
FL	65647	Raymond James Stadium	Tropicana Field
FL	36048	Tropicana Field	Tropicana Field
...			

The following example shows the use of the IGNORE NULLS option and relies on the addition of a new row to the VENUE table:

```
insert into venue values(2000,null,'Stanford','CA',90000);
```

This new row contains a NULL value for the VENUENAME column. Now repeat the FIRST_VALUE query that was shown earlier in this section:

```
select venuestate, venueseats, venuename,
first_value(venuename)
over(partition by venuestate
order by venueseats desc
rows between unbounded preceding and unbounded following)
from (select * from venue where venueseats >0)
order by venuestate;
```

venuestate	venueseats	venuename	first_value
CA	90000		
CA	70561	Qualcomm Stadium	
CA	69843	Monster Park	
...			

Because the new row contains the highest VENUESEATS value (90000) and its VENUENAME is NULL, the FIRST_VALUE function returns NULL for the CA partition. To ignore rows like this in the function evaluation, add the IGNORE NULLS option to the function argument:

```
select venuestate, venueseats, venuename,
first_value(venuename ignore nulls)
over(partition by venuestate
order by venueseats desc
rows between unbounded preceding and unbounded following)
from (select * from venue where venuestate='CA')
order by venuestate;
```

venuestate	venueseats	venuename	first_value
CA	90000		Qualcomm Stadium
CA	70561	Qualcomm Stadium	Qualcomm Stadium
CA	69843	Monster Park	Qualcomm Stadium
...			

LAG Window Function Examples

The following example shows the quantity of tickets sold to the buyer with a buyer ID of 3 and the time that buyer 3 bought the tickets. To compare each sale with the previous sale for buyer 3, the query returns the previous quantity sold for each sale. Since there is no purchase before 1/16/2008, the first previous quantity sold value is null:

```
select buyerid, saletime, qtysold,
lag(qtysold,1) over (order by buyerid, saletime) as prev_qtysold
from sales where buyerid = 3 order by buyerid, saletime;
```

buyerid	saletime	qtysold	prev_qtysold
3	2008-01-16 01:06:09	1	
3	2008-01-28 02:10:01	1	1
3	2008-03-12 10:39:53	1	1
3	2008-03-13 02:56:07	1	1
3	2008-03-29 08:21:39	2	1
3	2008-04-27 02:39:01	1	2
3	2008-08-16 07:04:37	2	1
3	2008-08-22 11:45:26	2	2
3	2008-09-12 09:11:25	1	2
3	2008-10-01 06:22:37	1	1
3	2008-10-20 01:55:51	2	1
3	2008-10-28 01:30:40	1	2

(12 rows)

LEAD Window Function Examples

The following example provides the commission for events in the SALES table for which tickets were sold on January 1, 2008 and January 2, 2008 and the commission paid for ticket sales for the subsequent sale.

```
select eventid, commission, saletime,
lead(commission, 1) over (order by saletime) as next_comm
from sales where saletime between '2008-01-01 00:00:00' and '2008-01-02
12:59:59'
order by saletime;
```

eventid	commission	saletime	next_comm
6213	52.05	2008-01-01 01:00:19	106.20
7003	106.20	2008-01-01 02:30:52	103.20
8762	103.20	2008-01-01 03:50:02	70.80
1150	70.80	2008-01-01 06:06:57	50.55
1749	50.55	2008-01-01 07:05:02	125.40
8649	125.40	2008-01-01 07:26:20	35.10
2903	35.10	2008-01-01 09:41:06	259.50
6605	259.50	2008-01-01 12:50:55	628.80
6870	628.80	2008-01-01 12:59:34	74.10
6977	74.10	2008-01-02 01:11:16	13.50
4650	13.50	2008-01-02 01:40:59	26.55
4515	26.55	2008-01-02 01:52:35	22.80
5465	22.80	2008-01-02 02:28:01	45.60
5465	45.60	2008-01-02 02:28:02	53.10
7003	53.10	2008-01-02 02:31:12	70.35
4124	70.35	2008-01-02 03:12:50	36.15
1673	36.15	2008-01-02 03:15:00	1300.80

```
...  
(39 rows)
```

LISTAGG Window Function Examples

The following examples uses the WINDSALES table. For a description of the WINDSALES table, see [Window Function Examples \(p. 532\)](#).

The following example returns a list of seller IDs, ordered by seller ID.

```
select listagg(sellerid)  
within group (order by sellerid)  
over() from winsales;
```

```
listagg  
-----  
11122333344  
...  
...  
11122333344  
11122333344  
(11 rows)
```

The following example returns a list of seller IDs for buyer B, ordered by date.

```
select listagg(sellerid)  
within group (order by dateid)  
over () as seller  
from winsales  
where buyerid = 'b' ;
```

```
seller  
-----  
3233  
3233  
3233  
3233  
(4 rows)
```

The following example returns a comma-separated list of sales dates for buyer B.

```
select listagg(dateid,',')  
within group (order by sellerid desc,salesid asc)  
over () as dates  
from winsales  
where buyerid = 'b';
```

```
dates  
-----  
2003-08-02,2004-04-18,2004-04-18,2004-02-12  
2003-08-02,2004-04-18,2004-04-18,2004-02-12  
2003-08-02,2004-04-18,2004-04-18,2004-02-12  
2003-08-02,2004-04-18,2004-04-18,2004-02-12  
(4 rows)
```

The following example returns a comma-separated list of sales IDs for each buyer ID.

```
select buyerid,
listagg(salesid,',' )
within group (order by salesid)
over (partition by buyerid) as sales_id
from winsales
order by buyerid;
```

buyerid	sales_id
a	10005,40001,40005
a	10005,40001,40005
a	10005,40001,40005
b	20001,30001,30004,30003
b	20001,30001,30004,30003
b	20001,30001,30004,30003
b	20001,30001,30004,30003
c	10001,20002,30007,10006
c	10001,20002,30007,10006
c	10001,20002,30007,10006
c	10001,20002,30007,10006

(11 rows)

MAX Window Function Examples

Show the sales ID, quantity, and maximum quantity from the beginning of the data window:

```
select salesid, qty,
max(qty) over (order by salesid rows unbounded preceding) as max
from winsales
order by salesid;
```

salesid	qty	max
10001	10	10
10005	30	30
10006	10	30
20001	20	30
20002	20	30
30001	10	30
30003	15	30
30004	20	30
30007	30	30
40001	40	40
40005	10	40

(11 rows)

For a description of the WINSALES table, see [Window Function Examples \(p. 532\)](#).

Show the salesid, quantity, and maximum quantity in a restricted frame:

```
select salesid, qty,
max(qty) over (order by salesid rows between 2 preceding and 1 preceding) as
max
from winsales
order by salesid;
```

```
salesid | qty | max
-----+-----+-----
10001 | 10 |
10005 | 30 | 10
10006 | 10 | 30
20001 | 20 | 30
20002 | 20 | 20
30001 | 10 | 20
30003 | 15 | 20
30004 | 20 | 15
30007 | 30 | 20
40001 | 40 | 30
40005 | 10 | 40
(11 rows)
```

MEDIAN Window Function Examples

The following example calculates the median sales quantity for each seller:

```
select sellerid, qty, median(qty)
over (partition by sellerid)
from winsales
order by sellerid;
```

```
sellerid qty median
-----+-----+-----
1 10 10.0
1 10 10.0
1 30 10.0
2 20 20.0
2 20 20.0
3 10 17.5
3 15 17.5
3 20 17.5
3 30 17.5
4 10 25.0
4 40 25.0
```

For a description of the WINSALES table, see [Window Function Examples \(p. 532\)](#).

MIN Window Function Examples

Show the sales ID, quantity, and minimum quantity from the beginning of the data window:

```
select salesid, qty,
min(qty) over
(order by salesid rows unbounded preceding)
from winsales
order by salesid;
```

```
salesid | qty | min
-----+-----+-----
10001 | 10 | 10
10005 | 30 | 10
10006 | 10 | 10
```

```
20001 | 20 | 10
20002 | 20 | 10
30001 | 10 | 10
30003 | 15 | 10
30004 | 20 | 10
30007 | 30 | 10
40001 | 40 | 10
40005 | 10 | 10
(11 rows)
```

For a description of the WINSALES table, see [Window Function Examples \(p. 532\)](#).

Show the sales ID, quantity, and minimum quantity in a restricted frame:

```
select salesid, qty,
min(qty) over
(order by salesid rows between 2 preceding and 1 preceding) as min
from winsales
order by salesid;

salesid | qty | min
-----+-----+-----
10001 | 10 |
10005 | 30 | 10
10006 | 10 | 10
20001 | 20 | 10
20002 | 20 | 10
30001 | 10 | 20
30003 | 15 | 10
30004 | 20 | 10
30007 | 30 | 15
40001 | 40 | 20
40005 | 10 | 30
(11 rows)
```

NTH_VALUE Window Function Examples

The following example shows the number of seats in the third largest venue in California, Florida, and New York compared to the number of seats in the other venues in those states:

```
select venuestate, venuename, venueseats,
nth_value(venueseats, 3)
ignore nulls
over(partition by venuestate order by venueseats desc
rows between unbounded preceding and unbounded following)
as third_most_seats
from (select * from venue where venueseats > 0 and
venuestate in('CA', 'FL', 'NY'))
order by venuestate;

venuestate | venuename | venueseats | third_most_seats
-----+-----+-----+-----
CA | Qualcomm Stadium | 70561 | 63026
CA | Monster Park | 69843 | 63026
CA | McAfee Coliseum | 63026 | 63026
CA | Dodger Stadium | 56000 | 63026
CA | Angel Stadium of Anaheim | 45050 | 63026
```

CA	PETCO Park	42445	63026
CA	AT&T Park	41503	63026
CA	Shoreline Amphitheatre	22000	63026
FL	Dolphin Stadium	74916	65647
FL	Jacksonville Municipal Stadium	73800	65647
FL	Raymond James Stadium	65647	65647
FL	Tropicana Field	36048	65647
NY	Ralph Wilson Stadium	73967	20000
NY	Yankee Stadium	52325	20000
NY	Madison Square Garden	20000	20000

(15 rows)

NTILE Window Function Examples

The following example ranks into four ranking groups the price paid for Hamlet tickets on August 26, 2008. The result set is 17 rows, divided almost evenly among the rankings 1 through 4:

```
select eventname, caldate, pricepaid, ntile(4)
over(order by pricepaid desc) from sales, event, date
where sales.eventid=event.eventid and event.dateid=date.dateid and
eventname='Hamlet'
and caldate='2008-08-26'
order by 4;
```

eventname	caldate	pricepaid	ntile
Hamlet	2008-08-26	1883.00	1
Hamlet	2008-08-26	1065.00	1
Hamlet	2008-08-26	589.00	1
Hamlet	2008-08-26	530.00	1
Hamlet	2008-08-26	472.00	1
Hamlet	2008-08-26	460.00	2
Hamlet	2008-08-26	355.00	2
Hamlet	2008-08-26	334.00	2
Hamlet	2008-08-26	296.00	2
Hamlet	2008-08-26	230.00	3
Hamlet	2008-08-26	216.00	3
Hamlet	2008-08-26	212.00	3
Hamlet	2008-08-26	106.00	3
Hamlet	2008-08-26	100.00	4
Hamlet	2008-08-26	94.00	4
Hamlet	2008-08-26	53.00	4
Hamlet	2008-08-26	25.00	4

(17 rows)

PERCENT_RANK Window Function Examples

The following example calculates the percent rank of the sales quantities for each seller:

```
select sellerid, qty, percent_rank()
over (partition by sellerid order by qty)
from winsales;
```

sellerid	qty	percent_rank
1	10.00	0.0
1	10.64	0.5

```

1 30.37 1.0
3 10.04 0.0
3 15.15 0.33
3 20.75 0.67
3 30.55 1.0
2 20.09 0.0
2 20.12 1.0
4 10.12 0.0
4 40.23 1.0

```

For a description of the WINSALES table, see [Window Function Examples \(p. 532\)](#).

PERCENTILE_CONT Window Function Examples

The following examples uses the WINSALES table. For a description of the WINSALES table, see [Window Function Examples \(p. 532\)](#).

```

select sellerid, qty, percentile_cont(0.5)
within group (order by qty)
over() as median from winsales;

```

sellerid	qty	median
1	10	20.0
1	10	20.0
3	10	20.0
4	10	20.0
3	15	20.0
2	20	20.0
3	20	20.0
2	20	20.0
3	30	20.0
1	30	20.0
4	40	20.0

(11 rows)

```

select sellerid, qty, percentile_cont(0.5)
within group (order by qty)
over(partition by sellerid) as median from winsales;

```

sellerid	qty	median
2	20	20.0
2	20	20.0
4	10	25.0
4	40	25.0
1	10	10.0
1	10	10.0
1	30	10.0
3	10	17.5
3	15	17.5
3	20	17.5
3	30	17.5

(11 rows)

The following example calculates the PERCENTILE_CONT and PERCENTILE_DISC of the ticket sales for sellers in Washington state.

```
SELECT sellerid, state, sum(qtysold*pricepaid) sales,
percentile_cont(0.6) within group (order by
  sum(qtysold*pricepaid::decimal(14,2) ) desc) over(),
percentile_disc(0.6) within group (order by
  sum(qtysold*pricepaid::decimal(14,2) ) desc) over()
from sales s, users u
where s.sellerid = u.userid and state = 'WA' and sellerid < 1000
group by sellerid, state;
```

sellerid	state	sales	percentile_cont	percentile_disc
127	WA	6076.00	2044.20	1531.00
787	WA	6035.00	2044.20	1531.00
381	WA	5881.00	2044.20	1531.00
777	WA	2814.00	2044.20	1531.00
33	WA	1531.00	2044.20	1531.00
800	WA	1476.00	2044.20	1531.00
1	WA	1177.00	2044.20	1531.00

(7 rows)

PERCENTILE_DISC Window Function Examples

The following examples uses the WINDSALES table. For a description of the WINDSALES table, see [Window Function Examples \(p. 532\)](#).

```
select sellerid, qty, percentile_disc(0.5)
within group (order by qty)
over() as median from winsales;
```

sellerid	qty	median
1	10	20
3	10	20
1	10	20
4	10	20
3	15	20
2	20	20
2	20	20
3	20	20
1	30	20
3	30	20
4	40	20

(11 rows)

```
select sellerid, qty, percentile_disc(0.5)
within group (order by qty)
over(partition by sellerid) as median from winsales;
```

sellerid	qty	median
2	20	20
2	20	20
4	10	10
4	40	10
1	10	10
1	10	10

```
1 | 30 | 10
3 | 10 | 15
3 | 15 | 15
3 | 20 | 15
3 | 30 | 15
(11 rows)
```

RANK Window Function Examples

Ranking with ORDER BY

Order the table by the quantity sold (default ascending), and assign a rank to each row. The results are sorted after the window function results are applied:

```
select salesid, qty,
rank() over (order by qty) as rnk
from winsales
order by 2,1;
```

```
salesid | qty | rnk
-----+-----+-----
10001 | 10 | 1
10006 | 10 | 1
30001 | 10 | 1
40005 | 10 | 1
30003 | 15 | 5
20001 | 20 | 6
20002 | 20 | 6
30004 | 20 | 6
10005 | 30 | 9
30007 | 30 | 9
40001 | 40 | 11
(11 rows)
```

Note that the outer ORDER BY clause in this example includes columns 2 and 1 to make sure that Amazon Redshift returns consistently sorted results each time this query is run. For example, rows with sales IDs 10001 and 10006 have identical QTY and RNK values. Ordering the final result set by column 1 ensures that row 10001 always falls before 10006. For a description of the WINSALES table, see [Window Function Examples \(p. 532\)](#).

Ranking with PARTITION BY and ORDER BY

In this example, the ordering is reversed for the window function (`order by qty desc`). Now the highest rank value applies to the highest QTY value.

```
select salesid, qty,
rank() over (order by qty desc) as rank
from winsales
order by 2,1;
```

```
salesid | qty | rank
-----+-----+-----
10001 | 10 | 8
10006 | 10 | 8
30001 | 10 | 8
40005 | 10 | 8
30003 | 15 | 7
```

```

20001 | 20 | 4
20002 | 20 | 4
30004 | 20 | 4
10005 | 30 | 2
30007 | 30 | 2
40001 | 40 | 1
(11 rows)

```

For a description of the WINSALES table, see [Window Function Examples \(p. 532\)](#).

Partition the table by SELLERID and order each partition by the quantity (in descending order) and assign a rank to each row. The results are sorted after the window function results are applied.

```

select salesid, sellerid, qty, rank() over
(partition by sellerid
order by qty desc) as rank
from winsales
order by 2,3,1;

```

```

salesid | sellerid | qty | rank
-----+-----+----+----
 10001 |         | 10 |  2
 10006 |         | 10 |  2
 10005 |         | 30 |  1
 20001 |         | 20 |  1
 20002 |         | 20 |  1
 30001 |         | 10 |  4
 30003 |         | 15 |  3
 30004 |         | 20 |  2
 30007 |         | 30 |  1
 40005 |         | 10 |  2
 40001 |         | 40 |  1
(11 rows)

```

RATIO_TO_REPORT Window Function Examples

The following example calculates the ratios of the sales quantities for each seller:

```

select sellerid, qty, ratio_to_report(qty)
over (partition by sellerid)
from winsales;

```

```

sellerid qty  ratio_to_report
-----+-----+-----
 2  20.12312341      0.5
 2  20.08630000      0.5
 4  10.12414400      0.2
 4  40.23000000      0.8
 1  30.37262000      0.6
 1  10.64000000      0.21
 1  10.00000000      0.2
 3  10.03500000      0.13
 3  15.14660000      0.2
 3  30.54790000      0.4
 3  20.74630000      0.27

```

For a description of the WINSALES table, see [Window Function Examples \(p. 532\)](#).

ROW_NUMBER Window Function Example

The following example partitions the table by SELLERID and orders each partition by QTY (in ascending order), then assigns a row number to each row. The results are sorted after the window function results are applied.

```
select salesid, sellerid, qty,
row_number() over
(partition by sellerid
 order by qty asc) as row
from winsales
order by 2,4;
```

salesid	sellerid	qty	row
10006	1	10	1
10001	1	10	2
10005	1	30	3
20001	2	20	1
20002	2	20	2
30001	3	10	1
30003	3	15	2
30004	3	20	3
30007	3	30	4
40005	4	10	1
40001	4	40	2

(11 rows)

For a description of the WINSALES table, see [Window Function Examples \(p. 532\)](#).

STDDEV_POP and VAR_POP Window Function Examples

The following example shows how to use STDDEV_POP and VAR_POP functions as window functions. The query computes the population variance and population standard deviation for PRICEPAID values in the SALES table.

```
select salesid, dateid, pricepaid,
round(stddev_pop(pricepaid) over
(order by dateid, salesid rows unbounded preceding)) as stddevpop,
round(var_pop(pricepaid) over
(order by dateid, salesid rows unbounded preceding)) as varpop
from sales
order by 2,1;
```

salesid	dateid	pricepaid	stddevpop	varpop
33095	1827	234.00	0	0
65082	1827	472.00	119	14161
88268	1827	836.00	248	61283
97197	1827	708.00	230	53019
110328	1827	347.00	223	49845
110917	1827	337.00	215	46159
150314	1827	688.00	211	44414
157751	1827	1730.00	447	199679
165890	1827	4192.00	1185	1403323
...				

The sample standard deviation and variance functions can be used in the same way.

SUM Window Function Examples

Cumulative Sums (Running Totals)

Create a cumulative (rolling) sum of sales quantities ordered by date and sales ID:

```
select salesid, dateid, sellerid, qty,
sum(qty) over (order by dateid, salesid rows unbounded preceding) as sum
from winsales
order by 2,1;
```

salesid	dateid	sellerid	qty	sum
30001	2003-08-02	3	10	10
10001	2003-12-24	1	10	20
10005	2003-12-24	1	30	50
40001	2004-01-09	4	40	90
10006	2004-01-18	1	10	100
20001	2004-02-12	2	20	120
40005	2004-02-12	4	10	130
20002	2004-02-16	2	20	150
30003	2004-04-18	3	15	165
30004	2004-04-18	3	20	185
30007	2004-09-07	3	30	215

(11 rows)

For a description of the WINSALES table, see [Window Function Examples \(p. 532\)](#).

Create a cumulative (rolling) sum of sales quantities by date, partition the results by seller ID, and order the results by date and sales ID within the partition:

```
select salesid, dateid, sellerid, qty,
sum(qty) over (partition by sellerid
order by dateid, salesid rows unbounded preceding) as sum
from winsales
order by 2,1;
```

salesid	dateid	sellerid	qty	sum
30001	2003-08-02	3	10	10
10001	2003-12-24	1	10	10
10005	2003-12-24	1	30	40
40001	2004-01-09	4	40	40
10006	2004-01-18	1	10	50
20001	2004-02-12	2	20	20
40005	2004-02-12	4	10	50
20002	2004-02-16	2	20	40
30003	2004-04-18	3	15	25
30004	2004-04-18	3	20	45
30007	2004-09-07	3	30	75

(11 rows)

Number Rows Sequentially

Number all of the rows in the result set, ordered by the SELLERID and SALESID columns:

```
select salesid, sellerid, qty,
sum(1) over (order by sellerid, salesid rows unbounded preceding) as rownum
```

```
from winsales
order by 2,1;

salesid | sellerid | qty | rownum
-----+-----+-----+-----
10001 |      1 |  10 |      1
10005 |      1 |  30 |      2
10006 |      1 |  10 |      3
20001 |      2 |  20 |      4
20002 |      2 |  20 |      5
30001 |      3 |  10 |      6
30003 |      3 |  15 |      7
30004 |      3 |  20 |      8
30007 |      3 |  30 |      9
40001 |      4 |  40 |     10
40005 |      4 |  10 |     11
(11 rows)
```

For a description of the WINSALES table, see [Window Function Examples \(p. 532\)](#).

Number all rows in the result set, partition the results by SELLERID, and order the results by SELLERID and SALESID within the partition:

```
select salesid, sellerid, qty,
sum(1) over (partition by sellerid
order by sellerid, salesid rows unbounded preceding) as rownum
from winsales
order by 2,1;

salesid | sellerid | qty | rownum
-----+-----+-----+-----
10001 |      1 |  10 |      1
10005 |      1 |  30 |      2
10006 |      1 |  10 |      3
20001 |      2 |  20 |      1
20002 |      2 |  20 |      2
30001 |      3 |  10 |      1
30003 |      3 |  15 |      2
30004 |      3 |  20 |      3
30007 |      3 |  30 |      4
40001 |      4 |  40 |      1
40005 |      4 |  10 |      2
(11 rows)
```

Unique Ordering of Data for Window Functions

If an ORDER BY clause for a window function does not produce a unique and total ordering of the data, the order of the rows is nondeterministic. If the ORDER BY expression produces duplicate values (a partial ordering), the return order of those rows may vary in multiple runs and window functions may return unexpected or inconsistent results.

For example, the following query returns different results over multiple runs because `order by dateid` does not produce a unique ordering of the data for the SUM window function.

```
select dateid, pricepaid,
sum(pricepaid) over(order by dateid rows unbounded preceding) as sumpaid
from sales
group by dateid, pricepaid;
```

```
dateid | pricepaid |   sumpaid
-----+-----+-----
1827 |    1730.00 |    1730.00
1827 |     708.00 |    2438.00
1827 |     234.00 |    2672.00
...

select dateid, pricepaid,
sum(pricepaid) over(order by dateid rows unbounded preceding) as sumpaid
from sales
group by dateid, pricepaid;
```

```
dateid | pricepaid |   sumpaid
-----+-----+-----
1827 |     234.00 |     234.00
1827 |     472.00 |     706.00
1827 |     347.00 |    1053.00
...
```

In this case, adding a second ORDER BY column to the window function may solve the problem:

```
select dateid, pricepaid,
sum(pricepaid) over(order by dateid, pricepaid rows unbounded preceding) as
sumpaid
from sales
group by dateid, pricepaid;
```

```
dateid | pricepaid | sumpaid
-----+-----+-----
1827 |     234.00 |  234.00
1827 |     337.00 |  571.00
1827 |     347.00 |  918.00
...
```

Conditional Expressions

Topics

- [CASE Expression \(p. 552\)](#)
- [COALESCE \(p. 554\)](#)
- [DECODE Expression \(p. 554\)](#)
- [GREATEST and LEAST \(p. 556\)](#)
- [NVL Expression \(p. 557\)](#)
- [NVL2 Expression \(p. 558\)](#)
- [NULLIF Expression \(p. 559\)](#)

Amazon Redshift supports some conditional expressions that are extensions to the SQL standard.

CASE Expression

Syntax

The CASE expression is a conditional expression, similar to if/then/else statements found in other languages. CASE is used to specify a result when there are multiple conditions.

There are two types of CASE expressions: simple and searched.

In simple CASE expressions, an expression is compared with a value. When a match is found, the specified action in the THEN clause is applied. If no match is found, the action in the ELSE clause is applied.

In searched CASE expressions, each CASE is evaluated based on a Boolean expression, and the CASE statement returns the first matching CASE. If no matching CASEs are found among the WHEN clauses, the action in the ELSE clause is returned.

Simple CASE statement used to match conditions:

```
CASE expression
WHEN value THEN result
[WHEN ...]
[ELSE result]
END
```

Searched CASE statement used to evaluate each condition:

```
CASE
WHEN boolean condition THEN result
[WHEN ...]
[ELSE result]
END
```

Arguments

expression

A column name or any valid expression.

value

Value that the expression is compared with, such as a numeric constant or a character string.

result

The target value or expression that is returned when an expression or Boolean condition is evaluated.

Boolean condition

A Boolean condition is valid or true when the value is equal to the constant. When true, the result specified following the THEN clause is returned. If a condition is false, the result following the ELSE clause is returned. If the ELSE clause is omitted and no condition matches, the result is null.

Examples

Use a simple CASE expression to replace *New York City* with *Big Apple* in a query against the VENUE table. Replace all other city names with *other*.

```
select venuecity,
case venuecity
when 'New York City'
then 'Big Apple' else 'other'
end from venue
order by venueid desc;
```

venuecity	case
Los Angeles	other
New York City	Big Apple

```
San Francisco | other
Baltimore    | other
...
(202 rows)
```

Use a searched CASE expression to assign group numbers based on the PRICEPAID value for individual ticket sales:

```
select pricepaid,
case when pricepaid <10000 then 'group 1'
when pricepaid >10000 then 'group 2'
else 'group 3'
end from sales
order by 1 desc;
```

```
pricepaid | case
-----+-----
12624.00 | group 2
10000.00 | group 3
10000.00 | group 3
9996.00  | group 1
9988.00  | group 1
...
(172456 rows)
```

COALESCE

Synonym of the NVL expression.

See [NVL Expression \(p. 557\)](#).

DECODE Expression

A DECODE expression replaces a specific value with either another specific value or a default value, depending on the result of an equality condition. This operation is equivalent to the operation of a simple CASE expression or an IF-THEN-ELSE statement.

Syntax

```
DECODE ( expression, search, result [, search, result ]... [ ,default ] )
```

This type of expression is useful for replacing abbreviations or codes that are stored in tables with meaningful business values that are needed for reports.

Parameters

expression

The source of the value that you want to compare, such as a column in a table.

search

The target value that is compared against the source expression, such as a numeric value or a character string. The search expression must evaluate to a single fixed value. You cannot specify an expression that evaluates to a range of values, such as *age between 20 and 29*; you need to specify separate search/result pairs for each value that you want to replace.

The data type of all instances of the search expression must be the same or compatible. The *expression* and *search* parameters must also be compatible.

result

The replacement value that query returns when the expression matches the search value. You must include at least one search/result pair in the DECODE expression.

The data types of all instances of the result expression must be the same or compatible. The *result* and *default* parameters must also be compatible.

default

An optional default value that is used for cases when the search condition fails. If you do not specify a default value, the DECODE expression returns NULL.

Usage Notes

If the *expression* value and the *search* value are both NULL, the DECODE result is the corresponding *result* value. For an illustration of this use of the function, see the Examples section.

When used this way, DECODE is similar to [NVL2 Expression \(p. 558\)](#), but there are some differences. For a description of these differences, see the NVL2 usage notes.

Examples

When the value 2008-06-01 exists in the START_DATE column of DATETABLE, the following example replaces it with June 1st, 2008. The example replaces all other START_DATE values with NULL.

```
select decode(caldate, '2008-06-01', 'June 1st, 2008')
from date where month='JUN' order by caldate;

case
-----
June 1st, 2008

...
(30 rows)
```

The following example uses a DECODE expression to convert the five abbreviated CATNAME columns in the CATEGORY table to full names and convert other values in the column to Unknown.

```
select catid, decode(catname,
'NHL', 'National Hockey League',
'MLB', 'Major League Baseball',
'MLS', 'Major League Soccer',
'NFL', 'National Football League',
'NBA', 'National Basketball Association',
'Unknown')
from category
order by catid;

catid | case
-----+-----
1      | Major League Baseball
2      | National Hockey League
3      | National Football League
4      | National Basketball Association
5      | Major League Soccer
6      | Unknown
7      | Unknown
8      | Unknown
```

```
9      | Unknown
10     | Unknown
11     | Unknown
(11 rows)
```

Use a DECODE expression to find venues in Colorado and Nevada with NULL in the VENUESEATS column; convert the NULLs to zeroes. If the VENUESEATS column is not NULL, return 1 as the result.

```
select venue, venuestate, decode(venue, null, 0, 1)
from venue
where venuestate in ('NV', 'CO')
order by 2, 3, 1;
```

venue	venuestate	case
Coors Field	CO	1
Dick's Sporting Goods Park	CO	1
Ellie Caulkins Opera House	CO	1
INVESCO Field	CO	1
Pepsi Center	CO	1
Ballys Hotel	NV	0
Bellagio Hotel	NV	0
Caesars Palace	NV	0
Harrahs Hotel	NV	0
Hilton Hotel	NV	0
...		

(20 rows)

GREATEST and LEAST

Returns the largest or smallest value from a list of any number of expressions.

Syntax

```
GREATEST (value [, ...])
LEAST (value [, ...])
```

Parameters

expression_list

A comma-separated list of expressions, such as column names. The expressions must all be convertible to a common data type. NULL values in the list are ignored. If all of the expressions evaluate to NULL, the result is NULL.

Returns

Returns the data type of the expressions.

Example

The following example returns the highest value alphabetically for `firstname` or `lastname`.

```
select firstname, lastname, greatest(firstname, lastname) from users
where userid < 10
order by 3;
```



```

  firstname | lastname | greatest
-----+-----+-----
Lars       | Ratliff  | Ratliff
Reagan    | Hodge   | Reagan
Colton    | Roy     | Roy
Barry     | Roy     | Roy
Tamekah   | Juarez  | Tamekah
Rafael    | Taylor  | Taylor
Victor    | Hernandez| Victor
Vladimir | Humphrey| Vladimir
Mufutau   | Watkins | Watkins
(9 rows)
```

NVL Expression

An NVL expression is identical to a COALESCE expression. NVL and COALESCE are synonyms.

Syntax

```
NVL | COALESCE ( expression, expression, ... )
```

An NVL or COALESCE expression returns the value of the first expression in the list that is not null. If all expressions are null, the result is null. When a non-null value is found, the remaining expressions in the list are not evaluated.

This type of expression is useful when you want to return a backup value for something when the preferred value is missing or null. For example, a query might return one of three phone numbers (cell, home, or work, in that order), whichever is found first in the table (not null).

Examples

Create a table with START_DATE and END_DATE columns, insert some rows that include null values, then apply an NVL expression to the two columns.

```
create table datetable (start_date date, end_date date);
```

```
insert into datetable values ('2008-06-01','2008-12-31');
insert into datetable values (null,'2008-12-31');
insert into datetable values ('2008-12-31',null);
```

```
select nvl(start_date, end_date)
from datetable
order by 1;

coalesce
-----
2008-06-01
2008-12-31
2008-12-31
```

The default column name for an NVL expression is COALESCE. The following query would return the same results:

```
select coalesce(start_date, end_date)
```

```
from datetable  
order by 1;
```

If you expect a query to return null values for certain functions or columns, you can use an NVL expression to replace the nulls with some other value. For example, aggregate functions, such as SUM, return null values instead of zeroes when they have no rows to evaluate. You can use an NVL expression to replace these null values with 0.0:

```
select nvl(sum(sales), 0.0) as sumresult, ...
```

NVL2 Expression

Returns one of two values based on whether a specified expression evaluates to NULL or NOT NULL.

Syntax

```
NVL2 ( expression, not_null_return_value, null_return_value )
```

Arguments

expression

An expression, such as a column name, to be evaluated for null status.

not_null_return_value

The value returned if *expression* evaluates to NOT NULL. The *not_null_return_value* value must either have the same data type as *expression* or be implicitly convertible to that data type.

null_return_value

The value returned if *expression* evaluates to NULL. The *null_return_value* value must either have the same data type as *expression* or be implicitly convertible to that data type.

Return Type

The NVL2 return type is determined as follows:

- If either *not_null_return_value* or *null_return_value* is null, the data type of the not-null expression is returned.

If both *not_null_return_value* and *null_return_value* are not null:

- If *not_null_return_value* and *null_return_value* have the same data type, that data type is returned.
- If *not_null_return_value* and *null_return_value* have different numeric data types, the smallest compatible numeric data type is returned.
- If *not_null_return_value* and *null_return_value* have different datetime data types, a timestamp data type is returned.
- If *not_null_return_value* and *null_return_value* have different character data types, the data type of *not_null_return_value* is returned.
- If *not_null_return_value* and *null_return_value* have mixed numeric and non-numeric data types, the data type of *not_null_return_value* is returned.

Important

In the last two cases where the data type of *not_null_return_value* is returned, *null_return_value* is implicitly cast to that data type. If the data types are incompatible, the function fails.

Usage Notes

[DECODE Expression \(p. 554\)](#) can be used in a similar way to NVL2 when the *expression* and *search* parameters are both null. The difference is that for DECODE, the return will have both the value and the data type of the *result* parameter. In contrast, for NVL2, the return will have the value of either the *not_null_return_value* or *null_return_value* parameter, whichever is selected by the function, but will have the data type of *not_null_return_value*.

For example, assuming column1 is NULL, the following queries will return the same value. However, the DECODE return value data type will be INTEGER and the NVL2 return value data type will be VARCHAR.

```
select decode(column1, null, 1234, '2345');
select nvl2(column1, '2345', 1234);
```

Example

The following example modifies some sample data, then evaluates two fields to provide appropriate contact information for users:

```
update users set email = null where firstname = 'Aphrodite' and lastname =
'Acevedo';
```

```
select (firstname + ' ' + lastname) as name,
nvl2(email, email, phone) AS contact_info
from users
where state = 'WA'
and lastname like 'A%'
order by lastname, firstname;
```

```
name          contact_info
-----+-----
Aphrodite Acevedo (906) 632-4407
Caldwell Acevedo Nunc.sollicitudin@Duisac.ca
Quinn Adams vel@adipiscingligulaAenean.com
Kamal Aguilar quis@vulputaterisusa.com
Samson Alexander hendrerit.neque@indolorFusce.ca
Hall Alford ac.mattis@vitaediamProin.edu
Lane Allen et.netus@risusDonec.org
Xander Allison ac.facilisis.facilisis@Infaucibus.com
Amaya Alvarado dui.nec.tempus@euui.edu
Vera Alvarez at.arcu.Vestibulum@pellentesque.edu
Yetta Anthony enim.sit@risus.org
Violet Arnold ad.litora@at.com
August Ashley consectetuer.euismod@Phasellus.com
Karyn Austin ipsum.primis.in@Maurisblanditenim.org
Lucas Ayers at@elitpretiumet.com
```

NULLIF Expression

Syntax

The NULLIF expression compares two arguments and returns null if the arguments are equal. If they are not equal, the first argument is returned. This expression is the inverse of the NVL or COALESCE expression.

```
NULLIF ( expression1, expression2 )
```

Arguments

expression1, *expression2*

The target columns or expressions that are compared. The return type is the same as the type of the first expression. The default column name of the NULLIF result is the column name of the first expression.

Examples

In the following example, the query returns null when the LISTID and SALESID values match:

```
select nullif(listid,salesid), salesid
from sales where salesid<10 order by 1, 2 desc;
```

listid	salesid
4	2
5	4
5	3
6	5
10	9
10	8
10	7
10	6
	1

(9 rows)

You can use NULLIF to ensure that empty strings are always returned as nulls. In the example below, the NULLIF expression returns either a null value or a string that contains at least one character.

```
insert into category
values(0,'','Special','Special');

select nullif(catgroup,'') from category
where catdesc='Special';
```

```
catgroup
-----
null
(1 row)
```

NULLIF ignores trailing spaces. If a string is not empty but contains spaces, NULLIF still returns null:

```
create table nulliftest(c1 char(2), c2 char(2));

insert into nulliftest values ('a','a ');
insert into nulliftest values ('b','b');

select nullif(c1,c2) from nulliftest;
c1
-----
```

```
null
null
(2 rows)
```

Date and Time Functions

In this section, you can find information about the date and time scalar functions that Amazon Redshift supports.

Summary of Date and Time Functions

Function	Syntax	Returns
ADD_MONTHS (p. 564) Adds the specified number of months to a date or time stamp.	ADD_MONTHS ({date timestamp}, integer)	TIMESTAMP
AT TIME ZONE (p. 565) Specifies which time zone to use with a TIMESTAMP or TIMESTAMPTZ expression.	AT TIME ZONE 'timezone'	TIMESTAMP
CONVERT_TIMEZONE (p. 566) Converts a time stamp from one time zone to another.	CONVERT_TIMEZONE (['timezone',] 'timezone', timestamp)	TIMESTAMP
CURRENT_DATE (p. 568) Returns a date in UTC for the start of the current transaction.	CURRENT_DATE	DATE
DATE_CMP (p. 569) Compares two dates and returns 0 if the dates are identical, 1 if <i>date1</i> is greater, and -1 if <i>date2</i> is greater.	DATE_CMP (date1, date2)	INTEGER
DATE_CMP_TIMESTAMP (p. 570) Compares a date to a time and returns 0 if the values are identical, 1 if <i>date</i> is greater and -1 if <i>timestamp</i> is greater.	DATE_CMP_TIMESTAMP (date, timestamp)	INTEGER
DATE_CMP_TIMESTAMPTZ (p. 571) Compares a date and a time stamp with time zone and returns 0 if the values are identical, 1 if <i>date</i> is greater and -1 if <i>timestamptz</i> is greater.	DATE_CMP_TIMESTAMPTZ (date, timestamptz)	INTEGER
DATE_PART_YEAR (p. 571) Extracts the year from a date.	DATE_PART_YEAR (date)	INTEGER
DATEADD (p. 572) Increments a date or time by a specified interval.	DATEADD (datepart, interval, {date timestamp})	TIMESTAMP

Function	Syntax	Returns
<p>DATEDIFF (p. 574)</p> <p>Returns the difference between two dates or times for a given date part, such as a day or month.</p>	<p>DATEDIFF (<i>datepart</i>, {<i>date</i> <i>timestamp</i>}, {<i>date</i> <i>time</i>})</p>	INTEGER
<p>DATE_PART (p. 575)</p> <p>Extracts a date part value from a date or time.</p>	<p>DATE_PART (<i>datepart</i>, {<i>date</i> <i>timestamp</i>})</p>	DOUBLE
<p>DATE_TRUNC (p. 577)</p> <p>Truncates a time stamp based on a date part.</p>	<p>DATE_TRUNC ('<i>datepart</i>', <i>timestamp</i>)</p>	TIMESTAMP
<p>EXTRACT (p. 577)</p> <p>Extracts a date part from a timestamp or literal.</p>	<p>EXTRACT (<i>datepart</i> FROM {TIMESTAMP '<i>literal</i>' <i>timestamp</i>})</p>	DOUBLE
<p>GETDATE (p. 578)</p> <p>Returns the current date and time in UTC. The parentheses are required.</p>	<p>GETDATE()</p>	TIMESTAMP
<p>INTERVAL_CMP (p. 579)</p> <p>Compares two intervals and returns 0 if the intervals are equal, 1 if <i>interval1</i> is greater, and -1 if <i>interval2</i> is greater.</p>	<p>INTERVAL_CMP (<i>interval1</i>, <i>interval2</i>)</p>	INTEGER
<p>LAST_DAY (p. 580)</p> <p>Returns the date of the last day of the month that contains <i>date</i>.</p>	<p>LAST_DAY(<i>date</i>)</p>	DATE
<p>MONTHS_BETWEEN (p. 580)</p> <p>Returns the number of months between two dates.</p>	<p>MONTHS_BETWEEN (<i>date</i>, <i>date</i>)</p>	FLOAT8
<p>NEXT_DAY (p. 582)</p> <p>Returns the date of the first instance of <i>day</i> that is later than <i>date</i>.</p>	<p>NEXT_DAY (<i>date</i>, <i>day</i>)</p>	DATE
<p>SYSDATE (p. 583)</p> <p>Returns the date and time in UTC for the start of the current transaction.</p>	<p>SYSDATE</p>	TIMESTAMP
<p>TIMEOFDAY (p. 584)</p> <p>Returns the current weekday, date, and time in UTC as a string value.</p>	<p>TIMEOFDAY()</p>	VARCHAR
<p>TIMESTAMP_CMP (p. 584)</p> <p>Compares two timestamps and returns 0 if the timestamps are equal, 1 if <i>interval1</i> is greater, and -1 if <i>interval2</i> is greater.</p>	<p>TIMESTAMP_CMP (<i>timestamp1</i>, <i>timestamp2</i>)</p>	INTEGER

Function	Syntax	Returns
TIMESTAMP_CMP_DATE (p. 586) Compares a timestamp to a date and returns 0 if the values are identical, 1 if <i>timestamp</i> is greater, and -1 if <i>date</i> is greater.	TIMESTAMP_CMP_DATE (<i>timestamp</i> , <i>date</i>)	INTEGER
TIMESTAMP_CMP_TIMESTAMPTZ (p. 586) Compares a timestamp with a time stamp with time zone and returns 0 if the values are equal, 1 if <i>timestamp</i> is greater, and -1 if <i>timestamptz</i> is greater.	TIMESTAMP_CMP_TIMESTAMPTZ (<i>timestamp</i> , <i>timestamptz</i>)	INTEGER
TIMESTAMPTZ_CMP (p. 587) Compares two timestamp with time zone values and returns 0 if the values are equal, 1 if <i>timestamptz1</i> is greater, and -1 if <i>timestamptz2</i> is greater.	TIMESTAMPTZ_CMP (<i>timestamptz1</i> , <i>timestamptz2</i>)	INTEGER
TIMESTAMPTZ_CMP_DATE (p. 587) Compares the value of a time stamp with time zone and a date and returns 0 if the values are equal, 1 if <i>timestamptz</i> is greater, and -1 if <i>date</i> is greater.	TIMESTAMPTZ_CMP_DATE (<i>timestamptz</i> , <i>date</i>)	INTEGER
TIMESTAMPTZ_CMP_TIMESTAMP (p. 588) Compares a timestamp with time zone with a time stamp and returns 0 if the values are equal, 1 if <i>timestamptz</i> is greater, and -1 if <i>timestamp</i> is greater.	TIMESTAMPTZ_CMP_TIMESTAMP (<i>timestamptz</i> , <i>timestamp</i>)	INTEGER
TIMEZONE (p. 588) Returns a time stamp for the specified time zone and time stamp value.	TIMEZONE (' <i>timezone</i> ' { <i>timestamp</i> <i>timestamptz</i>)	INTEGER
TO_TIMESTAMP (p. 589) Returns a time stamp with time zone for the specified time stamp and time zone format.	TO_TIMESTAMP (' <i>timestamp</i> ', ' <i>format</i> ')	INTEGER
TRUNC (p. 589) Truncates a time stamp and returns a date.	TRUNC(<i>timestamp</i>)	DATE

Note

Leap seconds are not considered in elapsed-time calculations.

Date and Time Functions in Transactions

When you execute the following functions within a transaction block (BEGIN ... END), the function returns the start date or time of the current transaction, not the start of the current statement.

- SYSDATE

- `TIMESTAMP`
- `CURRENT_DATE`

The following functions always return the start date or time of the current statement, even when they are within a transaction block.

- `GETDATE`
- `TIMEOFDAY`

Deprecated Leader Node-Only Functions

The following date functions are deprecated because they execute only on the leader node. For more information, see [Leader Node–Only Functions \(p. 492\)](#).

- `AGE`. Use [DATEDIFF Function \(p. 574\)](#) instead.
- `CURRENT_TIME`. Use [GETDATE Function \(p. 578\)](#) or [SYSDATE \(p. 583\)](#) instead.
- `CURRENT_TIMESTAMP`. Use [GETDATE Function \(p. 578\)](#) or [SYSDATE \(p. 583\)](#) instead.
- `LOCALTIME`. Use [GETDATE Function \(p. 578\)](#) or [SYSDATE \(p. 583\)](#) instead.
- `LOCALTIMESTAMP`. Use [GETDATE Function \(p. 578\)](#) or [SYSDATE \(p. 583\)](#) instead.
- `ISFINITE`
- `NOW`. Use [GETDATE Function \(p. 578\)](#) or [SYSDATE \(p. 583\)](#) instead.

ADD_MONTHS Function

`ADD_MONTHS` adds the specified number of months to a date or time stamp value or expression. The [DATEADD \(p. 572\)](#) function provides similar functionality.

Syntax

```
ADD_MONTHS( {date | timestamp}, integer)
```

Arguments

date | timestamp

A date or timestamp column or an expression that implicitly converts to a date or time stamp. If the date is the last day of the month, or if the resulting month is shorter, the function returns the last day of the month in the result. For other dates, the result contains the same day number as the date expression.

integer

A positive or negative integer. Use a negative number to subtract months from dates.

Return Type

`TIMESTAMP`

Example

The following query uses the `ADD_MONTHS` function inside a `TRUNC` function. The `TRUNC` function removes the time of day from the result of `ADD_MONTHS`. The `ADD_MONTHS` function adds 12 months to each value from the `CALDATE` column.

```
select distinct trunc(add_months(caldate, 12)) as calplus12,  
trunc(caldate) as cal  
from date  
order by 1 asc;
```

calplus12	cal
2009-01-01	2008-01-01
2009-01-02	2008-01-02
2009-01-03	2008-01-03
...	

(365 rows)

The following examples demonstrate the behavior when the ADD_MONTHS function operates on dates with months that have different numbers of days.

```
select add_months('2008-03-31',1);
```

```
add_months  
-----  
2008-04-30 00:00:00  
(1 row)
```

```
select add_months('2008-04-30',1);
```

```
add_months  
-----  
2008-05-31 00:00:00  
(1 row)
```

AT TIME ZONE Function

AT TIME ZONE specifies which time zone to use with a TIMESTAMP or TIMESTAMPTZ expression.

Syntax

```
AT TIME ZONE 'timezone'
```

Arguments

timezone

The time zone for the return value. The time zone can be specified as a time zone name (such as '**Africa/Kampala**' or '**Singapore**') or as a time zone abbreviation (such as '**UTC**' or '**PDT**').

To view a list of supported time zone names, execute the following command.

```
select pg_timezone_names();
```

To view a list of supported time zone abbreviations, execute the following command.

```
select pg_timezone_abbrevs();
```

For more information and examples, see [Time Zone Usage Notes \(p. 566\)](#).

Return Type

TIMESTAMPTZ when used with a TIMESTAMP expression. TIMESTAMP when used with a TIMESTAMPTZ expression.

Examples

The following example converts a time stamp value without time zone and interprets it as MST time (UTC-7), which is then converted to PST (UTC-8) for display.

```
SELECT TIMESTAMP '2001-02-16 20:38:40' AT TIME ZONE 'MST';

   timestampz
-----
'2001-02-16 19:38:40-08'
```

The following example takes an input time stamp with a time zone value where the specified time zone is UTC-5 (EST) and converts it to MST (UTC-7).

```
SELECT TIMESTAMP WITH TIME ZONE '2001-02-16 20:38:40-05' AT TIME ZONE 'MST';

   timestamp
-----
'2001-02-16 19:38:40'
```

CONVERT_TIMEZONE Function

CONVERT_TIMEZONE converts a time stamp from one time zone to another.

Syntax

```
CONVERT_TIMEZONE ( ['source_timezone',] 'target_timezone', 'timestamp')
```

Arguments

source_timezone

(Optional) The time zone of the current time stamp. The default is UTC. For more information, see [Time Zone Usage Notes \(p. 566\)](#).

target_timezone

The time zone for the new time stamp. For more information, see [Time Zone Usage Notes \(p. 566\)](#).

timestamp

A timestamp column or an expression that implicitly converts to a time stamp.

Return Type

TIMESTAMP

Time Zone Usage Notes

Either *source_timezone* or *target_timezone* can be specified as a time zone name (such as 'Africa/Kampala' or 'Singapore') or as a time zone abbreviation (such as 'UTC' or 'PDT').

To view a list of supported time zone names, execute the following command.

```
select pg_timezone_names();
```

To view a list of supported time zone abbreviations, execute the following command.

```
select pg_timezone_abbrevs();
```

Using a Time Zone Name

If you specify a time zone using a time zone name, `CONVERT_TIMEZONE` automatically adjusts for Daylight Saving Time (DST), or any other local seasonal protocol, such as Summer Time, Standard Time, or Winter Time, that is in force for that time zone during the date and time specified by *'timestamp'*. For example, 'Europe/London' represents UTC in the winter and UTC+1 in the summer.

Using a Time Zone Abbreviation

Time zone abbreviations represent a fixed offset from UTC. If you specify a time zone using a time zone abbreviation, `CONVERT_TIMEZONE` uses the fixed offset from UTC and does not adjust for any local seasonal protocol. For example, ADT (Atlantic Daylight Time) always represents UTC-03, even in winter.

You can specify an offset from UTC for either *source_zone* or *target_zone* by using the format *'name+offset'*, where *name* is any string of three or more alphabetic characters, and *offset* is a time value, using the format *hh:mm:ss*. The offset can be positive or negative.

`CONVERT_TIMEZONE` interprets the offset as the time *from* UTC. For example, an offset of +2 is equivalent to UTC-2, and an offset of -2 is equivalent to UTC+2. `CONVERT_TIMEZONE` does not use the prefix string when calculating the offset, even if the string represents a valid time zone. For example, 'NEWZONE+2', 'PDT+2', and 'GMT+2' all have the same result. If a string does not include an offset, then it must represent a valid time zone or `CONVERT_TIMEZONE` returns an error.

Examples

The following example converts the time stamp value in the `LISTTIME` column from the default UTC time zone to PST. Even though the time stamp is within the daylight time period, it is converted to standard time because the target time zone is specified as an abbreviation (PST).

```
select listtime, convert_timezone('PST', listtime) from listing
where listid = 16;
```

listtime	convert_timezone
2008-08-24 09:36:12	2008-08-24 01:36:12

The following example converts a timestamp `LISTTIME` column from the default UTC time zone to US/Pacific time zone. The target time zone uses a time zone name, and the time stamp is within the daylight time period, so the function returns the daylight time.

```
select listtime, convert_timezone('US/Pacific', listtime) from listing
where listid = 16;
```

listtime	convert_timezone
----------	------------------

```
2008-08-24 09:36:12 | 2008-08-24 02:36:12
```

The following example converts a time stamp string from EST to PST:

```
select convert_timezone('EST', 'PST', '20080305 12:25:29');

convert_timezone
-----
2008-03-05 09:25:29
```

The following example converts a time stamp to US Eastern Standard Time because the target time zone uses a time zone name (America/New_York) and the time stamp is within the standard time period.

```
select convert_timezone('America/New_York', '2013-02-01 08:00:00');

convert_timezone
-----
2013-02-01 03:00:00
(1 row)
```

The following example converts the time stamp to US Eastern Daylight Time because the target time zone uses a time zone name (America/New_York) and the time stamp is within the daylight time period.

```
select convert_timezone('America/New_York', '2013-06-01 08:00:00');

convert_timezone
-----
2013-06-01 04:00:00
(1 row)
```

The following example demonstrates the use of offsets.

```
SELECT CONVERT_TIMEZONE('GMT', 'NEWZONE +2', '2014-05-17 12:00:00') as
newzone_plus_2,
CONVERT_TIMEZONE('GMT', 'NEWZONE-2:15', '2014-05-17 12:00:00') as
newzone_minus_2_15,
CONVERT_TIMEZONE('GMT', 'America/Los_Angeles+2', '2014-05-17 12:00:00') as
la_plus_2,
CONVERT_TIMEZONE('GMT', 'GMT+2', '2014-05-17 12:00:00') as gmt_plus_2;

newzone_plus_2 | newzone_minus_2_15 | la_plus_2 |
gmt_plus_2
-----+-----+-----+-----
2014-05-17 10:00:00 | 2014-05-17 14:15:00 | 2014-05-17 10:00:00 | 2014-05-17
10:00:00
(1 row)
```

CURRENT_DATE Function

CURRENT_DATE returns a date in UTC in the default format: YYYY-MM-DD.

Note

CURRENT_DATE returns the start date for the current transaction, not for the start of the current statement.

Syntax

```
CURRENT_DATE
```

Return Type

DATE

Examples

Return the current date:

```
select current_date;
   date
-----
2008-10-01
(1 row)
```

DATE_CMP Function

DATE_CMP compares two dates. The function returns 0 if the dates are identical, 1 if *date1* is greater, and -1 if *date2* is greater.

Syntax

```
DATE_CMP(date1, date2)
```

Arguments

date1

A date or timestamp column or an expression that implicitly converts to a date or time stamp.

date2

A date or timestamp column or an expression that implicitly converts to a date or time stamp.

Return Type

INTEGER

Example

The following query compares the CALDATE column to the date January 4, 2008 and returns whether the value in CALDATE is before (-1), equal to (0), or after (1) January 4, 2008:

```
select caldate, '2008-01-04',
       date_cmp(caldate, '2008-01-04')
from date
order by dateid
```

```
limit 10;

 caldate      | ?column? | date_cmp
-----+-----+-----
2008-01-01 | 2008-01-04 |      -1
2008-01-02 | 2008-01-04 |      -1
2008-01-03 | 2008-01-04 |      -1
2008-01-04 | 2008-01-04 |       0
2008-01-05 | 2008-01-04 |       1
2008-01-06 | 2008-01-04 |       1
2008-01-07 | 2008-01-04 |       1
2008-01-08 | 2008-01-04 |       1
2008-01-09 | 2008-01-04 |       1
2008-01-10 | 2008-01-04 |       1
(10 rows)
```

DATE_CMP_TIMESTAMP Function

Compares a date to a time stamp and returns 0 if the values are identical, 1 if *date* is greater alphabetically and -1 if *timestamp* is greater.

Syntax

```
DATE_CMP_TIMESTAMP(date, timestamp)
```

Arguments

date

A date column or an expression that implicitly converts to a date.

timestamp

A timestamp column or an expression that implicitly converts to a time stamp.

Return Type

INTEGER

Examples

The following example compares the date 2008-06-18 to LISTTIME. Listings made before this date return 1; listings made after this date return -1.

```
select listid, '2008-06-18', listtime,
date_cmp_timestamp('2008-06-18', listtime)
from listing
order by 1, 2, 3, 4
limit 10;
```

listid	?column?	listtime	date_cmp_timestamp
1	2008-06-18	2008-01-24 06:43:29	1
2	2008-06-18	2008-03-05 12:25:29	1
3	2008-06-18	2008-11-01 07:35:33	-1
4	2008-06-18	2008-05-24 01:18:37	1
5	2008-06-18	2008-05-17 02:29:11	1

6		2008-06-18		2008-08-15 02:08:13		-1
7		2008-06-18		2008-11-15 09:38:15		-1
8		2008-06-18		2008-11-09 05:07:30		-1
9		2008-06-18		2008-09-09 08:03:36		-1
10		2008-06-18		2008-06-17 09:44:54		1

(10 rows)

DATE_CMP_TIMESTAMPTZ Function

DATE_CMP_TIMESTAMPTZ compares a date to a time stamp with time zone. If the date and time stamp values are identical, the function returns 0. If the date is greater alphabetically, the function returns 1. If the time stamp is greater, the function returns -1.

Syntax

```
DATE_CMP_TIMESTAMPTZ(date, timestampz)
```

Arguments

date

A DATE column or an expression that implicitly converts to a date.

timestampz

A TIMESTAMPTZ column or an expression that implicitly converts to a time stamp with a time zone.

Return Type

INTEGER

DATE_PART_YEAR Function

The DATE_PART_YEAR function extracts the year from a date.

Syntax

```
DATE_PART_YEAR(date)
```

Argument

date

A date or timestamp column or an expression that implicitly converts to a date or time stamp.

Return Type

INTEGER

Examples

The following example extracts the year from the CALDATE column:

```
select caldate, date_part_year(caldate)
```

```
from date
order by
dateid limit 10;
```

caldate	date_part_year
2008-01-01	2008
2008-01-02	2008
2008-01-03	2008
2008-01-04	2008
2008-01-05	2008
2008-01-06	2008
2008-01-07	2008
2008-01-08	2008
2008-01-09	2008
2008-01-10	2008

(10 rows)

DATEADD Function

Increments a date or time stamp value by a specified interval.

Syntax

```
DATEADD( datepart, interval, {date|timestamp} )
```

This function returns a time stamp data type.

Arguments

datepart

The date part (year, month, or day, for example) that the function operates on. See [Dateparts for Date or Time Stamp Functions \(p. 590\)](#).

interval

An integer that specified the interval (number of days, for example) to add to the target expression. A negative integer subtracts the interval.

date|*timestamp*

A date or timestamp column or an expression that implicitly converts to a date or time stamp. The date or time stamp expression must contain the specified date part.

Return Type

TIMESTAMP

Examples

Add 30 days to each date in November that exists in the DATE table:

```
select dateadd(day,30,caldate) as novplus30
from date
where month='NOV'
order by dateid;

novplus30
```



```
-----  
2008-12-01 00:00:00  
2008-12-02 00:00:00  
2008-12-03 00:00:00  
...  
(30 rows)
```

Add 18 months to a literal date value:

```
select dateadd(month,18,'2008-02-28');  
  
date_add  
-----  
2009-08-28 00:00:00  
(1 row)
```

The default column name for a DATEADD function is DATE_ADD. The default time stamp for a date value is 00:00:00.

Add 30 minutes to a date value that does not specify a time stamp:

```
select dateadd(m,30,'2008-02-28');  
  
date_add  
-----  
2008-02-28 00:30:00  
(1 row)
```

You can name dateparts in full or abbreviate them; in this case, *m* stands for minutes, not months.

Usage Notes

The DATEADD(month, ...) and ADD_MONTHS functions handle dates that fall at the ends of months differently.

- **ADD_MONTHS:** If the date you are adding to is the last day of the month, the result is always the last day of the result month, regardless of the length of the month. For example, April 30th + 1 month is May 31st:

```
select add_months('2008-04-30',1);  
  
add_months  
-----  
2008-05-31 00:00:00  
(1 row)
```

- **DATEADD:** If there are fewer days in the date you are adding to than in the result month, the result will be the corresponding day of the result month, not the last day of that month. For example, April 30th + 1 month is May 30th:

```
select dateadd(month,1,'2008-04-30');  
  
date_add  
-----  
2008-05-30 00:00:00
```

```
(1 row)
```

The DATEADD function handles the leap year date 02-29 differently when using dateadd(month, 12, ...) or dateadd(year, 1, ...).

```
select dateadd(month,12,'2016-02-29');
date_add
-----
2017-02-28 00:00:00

select dateadd(year, 1, '2016-02-29');
date_add
-----
2017-03-01 00:00:00
```

DATEDIFF Function

DATEDIFF returns the difference between the date parts of two date or time expressions.

Syntax

```
DATEDIFF ( datepart, {date|timestamp}, {date|timestamp} )
```

Arguments

datepart

The specific part of the date value (year, month, or day, for example) that the function operates on. For more information, see [Dateparts for Date or Time Stamp Functions \(p. 590\)](#).

Specifically, DATEDIFF determines the number of *datepart boundaries* that are crossed between two expressions. For example, if you are calculating the difference in years between two dates, 12-31-2008 and 01-01-2009, the function returns 1 year despite the fact that these dates are only one day apart. If you are finding the difference in hours between two time stamps, 01-01-2009 8:30:00 and 01-01-2009 10:00:00, the result is 2 hours.

date|timestamp

A date or timestamp columns or expressions that implicitly convert to a date or time stamp. The expressions must both contain the specified date part. If the second date or time is later than the first date or time, the result is positive. If the second date or time is earlier than the first date or time, the result is negative.

Return Type

BIGINT

Examples

Find the difference, in number of weeks, between two literal date values:

```
select datediff(week,'2009-01-01','2009-12-31') as numweeks;

numweeks
-----
```

```
52  
(1 row)
```

Find the difference, in number of quarters, between a literal value in the past and today's date. This example assumes that the current date is June 5, 2008. You can name dateparts in full or abbreviate them. The default column name for the DATEDIFF function is DATE_DIFF.

```
select datediff(qtr, '1998-07-01', current_date);  
  
date_diff  
-----  
40  
(1 row)
```

This example joins the SALES and LISTING tables to calculate how many days after they were listed any tickets were sold for listings 1000 through 1005. The longest wait for sales of these listings was 15 days, and the shortest was less than one day (0 days).

```
select priceperticket,  
datediff(day, listtime, saletime) as wait  
from sales, listing where sales.listid = listing.listid  
and sales.listid between 1000 and 1005  
order by wait desc, priceperticket desc;  
  
priceperticket | wait  
-----+-----  
96.00          | 15  
123.00         | 11  
131.00         | 9  
123.00         | 6  
129.00         | 4  
96.00          | 4  
96.00          | 0  
(7 rows)
```

This example calculates the average number of hours sellers waited for all ticket sales.

```
select avg(datediff(hours, listtime, saletime)) as avgwait  
from sales, listing  
where sales.listid = listing.listid;  
  
avgwait  
-----  
465  
(1 row)
```

DATE_PART Function

DATE_PART extracts datepart values from an expression. DATE_PART is a synonym of the PGDATE_PART function.

Syntax

```
DATE_PART ( datepart, {date|timestamp} )
```

Arguments

datepart

The specific part of the date value (year, month, or day, for example) that the function operates on. For more information, see [Dateparts for Date or Time Stamp Functions \(p. 590\)](#).

{date|timestamp}

A date or timestamp column or an expression that implicitly converts to a date or time stamp. The expression must be a date or time stamp expression that contains the specified datepart.

Return Type

DOUBLE

Examples

Apply the DATE_PART function to a column in a table:

```
select date_part(w, listtime) as weeks, listtime
from listing where listid=10;
```

weeks	listtime
25	2008-06-17 09:44:54

(1 row)

You can name dateparts in full or abbreviate them; in this case, *w* stands for weeks.

The day of week datepart returns an integer from 0-6, starting with Sunday. Use DATE_PART with *dow* (DAYOFWEEK) to view events on a Saturday.

```
select date_part(dow, starttime) as dow,
starttime from event
where date_part(dow, starttime)=6
order by 2,1;
```

dow	starttime
6	2008-01-05 14:00:00
6	2008-01-05 14:00:00
6	2008-01-05 14:00:00
6	2008-01-05 14:00:00
...	

(1147 rows)

Apply the DATE_PART function to a literal date value:

```
select date_part(minute, '2009-01-01 02:08:01');
```

pgdate_part
8

(1 row)

The default column name for the DATE_PART function is PGDATE_PART.

DATE_TRUNC Function

The DATE_TRUNC function truncates a time stamp expression or literal based on the date part that you specify, such as hour, week, or month. DATE_TRUNC returns the first day of the specified year, the first day of the specified month, or the Monday of the specified week.

Syntax

```
DATE_TRUNC('datepart', timestamp)
```

Arguments

datepart

The date part to which to truncate the time stamp value. See [Dateparts for Date or Time Stamp Functions \(p. 590\)](#) for valid formats.

timestamp

A timestamp column or an expression that implicitly converts to a time stamp.

Return Type

TIMESTAMP

Example

In the following example, the DATE_TRUNC function uses the 'week' datepart to return the date for the Monday of each week.

```
select date_trunc('week', saletime), sum(pricepaid) from sales where
saletime like '2008-09%' group by date_trunc('week', saletime) order by 1;
date_trunc |      sum
-----+-----
2008-09-01 | 2474899.00
2008-09-08 | 2412354.00
2008-09-15 | 2364707.00
2008-09-22 | 2359351.00
2008-09-29 |  705249.00
(5 rows)
```

EXTRACT Function

The EXTRACT function returns a date part, such as a day, month, or year, from a time stamp value or expression.

Syntax

```
EXTRACT ( datepart FROM { TIMESTAMP 'literal' | timestamp } )
```

Arguments

datepart

For possible values, see [Dateparts for Date or Time Stamp Functions \(p. 590\)](#).

literal

A time stamp value, enclosed in single quotation marks and preceded by the `TIMESTAMP` keyword.

timestamp

A `TIMESTAMP` or `TIMESTAMPTZ` column, or an expression that implicitly converts to a time stamp or time stamp with time zone.

Return Type

INTEGER

Examples

Determine the week numbers for sales in which the price paid was \$10,000 or more.

```
select salesid, extract(week from saletime) as weeknum
from sales where pricepaid > 9999 order by 2;
```

salesid	weeknum
159073	6
160318	8
161723	26

(3 rows)

Return the minute value from a literal time stamp value.

```
select extract(minute from timestamp '2009-09-09 12:08:43');
date_part
-----
8
(1 row)
```

GETDATE Function

`GETDATE` returns the current date and time in UTC.

Syntax

```
GETDATE()
```

The parentheses are required.

Return Type

TIMESTAMP

Examples

The following example uses the `GETDATE()` function to return the full time stamp for the current date:

```
select getdate();
```

```
timestamp
-----
2008-12-04 16:10:43
(1 row)
```

The following example uses the GETDATE() function inside the TRUNC function to return the current date without the time:

```
select trunc(getdate());

trunc
-----
2008-12-04
(1 row)
```

INTERVAL_CMP Function

INTERVAL_CMP compares two intervals and returns 1 if the first interval is greater, -1 if the second interval is greater, and 0 if the intervals are equal. For more information, see [Interval Literals \(p. 263\)](#).

Syntax

```
INTERVAL_CMP(interval1, interval2)
```

Arguments

interval1
An interval literal value.

interval2
An interval literal value.

Return Type

INTEGER

Examples

The following example compares the value of "3 days" to "1 year":

```
select interval_cmp('3 days', '1 year');

interval_cmp
-----
-1
```

This example compares the value "7 days" to "1 week":

```
select interval_cmp('7 days', '1 week');

interval_cmp
-----
0
```

```
(1 row)
```

LAST_DAY Function

LAST_DAY returns the date of the last day of the month that contains *date*. The return type is always DATE, regardless of the data type of the *date* argument.

Syntax

```
LAST_DAY ( { date | timestamp } )
```

Arguments

date | *timestamp*

A date or timestamp column or an expression that implicitly converts to a date or time stamp.

Return Type

DATE

Examples

The following example returns the date of the last day in the current month:

```
select last_day(sysdate);

 last_day
-----
2014-01-31
(1 row)
```

The following example returns the number of tickets sold for each of the last 7 days of the month:

```
select datediff(day, saletime, last_day(saletime)) as "Days Remaining",
       sum(qtysold)
from sales
where datediff(day, saletime, last_day(saletime)) < 7
group by 1
order by 1;

 days remaining | sum
-----+-----
                0 | 10140
                1 | 11187
                2 | 11515
                3 | 11217
                4 | 11446
                5 | 11708
                6 | 10988
(7 rows)
```

MONTHS_BETWEEN Function

MONTHS_BETWEEN determines the number of months between two dates.

If the first date is later than the second date, the result is positive; otherwise, the result is negative.

If either argument is null, the result is NULL.

Syntax

```
MONTHS_BETWEEN ( date1, date2 )
```

Arguments

date1

An expression, such as a column name, that evaluates to a valid date or time stamp value.

date2

An expression, such as a column name, that evaluates to a valid date or time stamp value.

Return Type

FLOAT8

The whole number portion of the result is based on the difference between the year and month values of the dates. The fractional portion of the result is calculated from the day and timestamp values of the dates and assumes a 31-day month.

If *date1* and *date2* both contain the same date within a month (for example, 1/15/14 and 2/15/14) or the last day of the month (for example, 8/31/14 and 9/30/14), then the result is a whole number based on the year and month values of the dates, regardless of whether the timestamp portion matches, if present.

Examples

The following example returns the months between 1/18/1969 and 3/18/1969:

```
select months_between('1969-01-18', '1969-03-18')
as months;

months
-----
-2
```

The following example returns the months between the first and last showings of an event:

```
select eventname,
min(starttime) as first_show,
max(starttime) as last_show,
months_between(max(starttime),min(starttime)) as month_diff
from event
group by eventname
order by eventname
limit 5;
```

eventname	first_show	last_show	month_diff
.38 Special	2008-01-21 19:30:00.0	2008-12-25 15:00:00.0	11.12
3 Doors Down	2008-01-03 15:00:00.0	2008-12-01 19:30:00.0	10.94
70s Soul Jam	2008-01-16 19:30:00.0	2008-12-07 14:00:00.0	10.7

```
A Bronx Tale      2008-01-21 19:00:00.0  2008-12-15 15:00:00.0  10.8  
A Catered Affair  2008-01-08 19:30:00.0  2008-12-19 19:00:00.0  11.35
```

NEXT_DAY Function

NEXT_DAY returns the date of the first instance of the specified day that is later than the given date.

If the *day* value is the same day of the week as *given_date*, the next occurrence of that day is returned.

Syntax

```
NEXT_DAY ( { date | timestamp }, day )
```

Arguments

date | *timestamp*

A date or timestamp column or an expression that implicitly converts to a date or time stamp.

day

A string containing the name of any day. Capitalization does not matter.

Valid values are as follows:

Day	Values
Sunday	Su, Sun, Sunday
Monday	M, Mo, Mon, Monday
Tuesday	Tu, Tues, Tuesday
Wednesday	W, We Wed, Wednesday
Thursday	Th, Thu, Thurs, Thursday
Friday	F, Fr, Fri, Friday
Saturday	Sa, Sat, Saturday

Return Type

DATE

Examples

The following example returns the date of the first Tuesday after 8/20/2014.

```
select next_day('2014-08-20', 'Tuesday');  
  
next_day  
-----  
2014-08-26
```

The following example gets target marketing dates for the third quarter:

```
select username, (firstname || ' ' || lastname) as name,
```

```
eventname, caldate, next_day (caldate, 'Monday') as marketing_target
from sales, date, users, event
where sales.buyerid = users.userid
and sales.eventid = event.eventid
and event.dateid = date.dateid
and date.qtr = 3
order by marketing_target, eventname, name;
```

username	name	eventname	caldate
marketing_target			
MBO26QSG	Callum Atkinson	.38 Special	2008-07-06 2008-07-07
WCR50YIU	Erasmus Alvarez	A Doll's House	2008-07-03 2008-07-07
CKT700IE	Hadassah Adkins	Ana Gabriel	2008-07-06 2008-07-07
VVG07OUE	Nathan Abbott	Armando Manzanero	2008-07-04 2008-07-07
GEW77SII	Scarlet Avila	August: Osage County	2008-07-06 2008-07-07
ECR71CVS	Caryn Adkins	Ben Folds	2008-07-03 2008-07-07
KUW82CYU	Kaden Aguilar	Bette Midler	2008-07-01 2008-07-07
WZE78DJZ	Kay Avila	Bette Midler	2008-07-01 2008-07-07
HXY04NVE	Dante Austin	Britney Spears	2008-07-02 2008-07-07
URY81YWF	Wilma Anthony	Britney Spears	2008-07-02 2008-07-07

SYSDATE Function

SYSDATE returns the current date and time in UTC.

Note

SYSDATE returns the start date and time for the current transaction, not for the start of the current statement.

Syntax

```
SYSDATE
```

This function requires no arguments.

Return Type

TIMESTAMP

Examples

The following example uses the SYSDATE function to return the full time stamp for the current date:

```
select sysdate;

timestamp
-----
2008-12-04 16:10:43.976353
(1 row)
```

The following example uses the SYSDATE function inside the TRUNC function to return the current date without the time:

```
select trunc(sysdate);
```

```
trunc
-----
2008-12-04
(1 row)
```

The following query returns sales information for dates that fall between the date when the query is issued and whatever date is 120 days earlier:

```
select salesid, pricepaid, trunc(saletime) as saletime, trunc(sysdate) as now
from sales
where saletime between trunc(sysdate)-120 and trunc(sysdate)
order by saletime asc;
```

salesid	pricepaid	saletime	now
91535	670.00	2008-08-07	2008-12-05
91635	365.00	2008-08-07	2008-12-05
91901	1002.00	2008-08-07	2008-12-05
...			

TIMEOFDAY Function

TIMEOFDAY is a special alias used to return the weekday, date, and time as a string value.

Syntax

```
TIMEOFDAY()
```

Return Type

VARCHAR

Examples

Return the current date and time by using the TIMEOFDAY function:

```
select timeofday();
timeofday
-----
Thu Sep 19 22:53:50.333525 2013 UTC
(1 row)
```

TIMESTAMP_CMP Function

Compares the value of two time stamps and returns an integer. If the time stamps are identical, the function returns 0. If the first time stamp is greater alphabetically, the function returns 1. If the second time stamp is greater, the function returns -1.

Syntax

```
TIMESTAMP_CMP(timestamp1, timestamp2)
```

Arguments

timestamp1

A `TIMESTAMP` column or an expression that implicitly converts to a time stamp.

timestamp2

A `TIMESTAMP` column or an expression that implicitly converts to a time stamp.

Return Type

INTEGER

Examples

The following example compares the `LISTTIME` and `SALETIME` for a listing. Note that the value for `TIMESTAMP_CMP` is -1 for all listings because the time stamp for the sale is after the time stamp for the listing:

```
select listing.listid, listing.listtime,
sales.saletime, timestamp_cmp(listing.listtime, sales.saletime)
from listing, sales
where listing.listid=sales.listid
order by 1, 2, 3, 4
limit 10;
```

listid	listtime	saletime	timestamp_cmp
1	2008-01-24 06:43:29	2008-02-18 02:36:48	-1
4	2008-05-24 01:18:37	2008-06-06 05:00:16	-1
5	2008-05-17 02:29:11	2008-06-06 08:26:17	-1
5	2008-05-17 02:29:11	2008-06-09 08:38:52	-1
6	2008-08-15 02:08:13	2008-08-31 09:17:02	-1
10	2008-06-17 09:44:54	2008-06-26 12:56:06	-1
10	2008-06-17 09:44:54	2008-07-10 02:12:36	-1
10	2008-06-17 09:44:54	2008-07-16 11:59:24	-1
10	2008-06-17 09:44:54	2008-07-22 02:23:17	-1
12	2008-07-25 01:45:49	2008-08-04 03:06:36	-1

(10 rows)

This example shows that `TIMESTAMP_CMP` returns a 0 for identical time stamps:

```
select listid, timestamp_cmp(listtime, listtime)
from listing
order by 1 , 2
limit 10;
```

listid	timestamp_cmp
1	0
2	0
3	0
4	0
5	0
6	0
7	0
8	0
9	0
10	0

(10 rows)

TIMESTAMP_CMP_DATE Function

TIMESTAMP_CMP_DATE compares the value of a time stamp and a date. If the time stamp and date values are identical, the function returns 0. If the time stamp is greater alphabetically, the function returns 1. If the date is greater, the function returns -1.

Syntax

```
TIMESTAMP_CMP_DATE(timestamp, date)
```

Arguments

timestamp

A timestamp column or an expression that implicitly converts to a time stamp.

date

A date column or an expression that implicitly converts to a date.

Return Type

INTEGER

Examples

The following example compares LISTTIME to the date 2008-06-18. Listings made after this date return 1; listings made before this date return -1.

```
select listid, listtime,  
timestamp_cmp_date(listtime, '2008-06-18')  
from listing  
order by 1, 2, 3  
limit 10;
```

listid	listtime	timestamp_cmp_date
1	2008-01-24 06:43:29	-1
2	2008-03-05 12:25:29	-1
3	2008-11-01 07:35:33	1
4	2008-05-24 01:18:37	-1
5	2008-05-17 02:29:11	-1
6	2008-08-15 02:08:13	1
7	2008-11-15 09:38:15	1
8	2008-11-09 05:07:30	1
9	2008-09-09 08:03:36	1
10	2008-06-17 09:44:54	-1

(10 rows)

TIMESTAMP_CMP_TIMESTAMPTZ Function

TIMESTAMP_CMP_TIMESTAMPTZ compares the value of a time stamp expression with a time stamp with time zone expression. If the time stamp and time stamp with time zone values are identical, the function returns 0. If the time stamp is greater alphabetically, the function returns 1. If the time stamp with time zone is greater, the function returns -1.

Syntax

```
TIMESTAMP_CMP_TIMESTAMPZ(timestamp, timestamptz)
```

Arguments

timestamp

A TIMESTAMP column or an expression that implicitly converts to a time stamp.

timestamptz

A TIMESTAMP column or an expression that implicitly converts to a time stamp with a time zone.

Return Type

INTEGER

TIMESTAMPTZ_CMP Function

TIMESTAMPTZ_CMP compares the value of two time stamp with time zone values and returns an integer. If the time stamps are identical, the function returns 0. If the first time stamp is greater alphabetically, the function returns 1. If the second time stamp is greater, the function returns -1.

Syntax

```
TIMESTAMPTZ_CMP(timestamptz1, timestamptz2)
```

Arguments

timestamp1

A TIMESTAMPTZ column or an expression that implicitly converts to a time stamp with time zone.

timestamp2

A TIMESTAMPTZ column or an expression that implicitly converts to a time stamp with time zone.

Return Type

INTEGER

TIMESTAMPTZ_CMP_DATE Function

TIMESTAMPTZ_CMP_DATE compares the value of a time stamp and a date. If the time stamp and date values are identical, the function returns 0. If the time stamp is greater alphabetically, the function returns 1. If the date is greater, the function returns -1.

Syntax

```
TIMESTAMPTZ_CMP_DATE(timestamptz, date)
```

Arguments

timestamptz

A TIMESTAMPTZ column or an expression that implicitly converts to a time stamp with a time zone.

date

A date column or an expression that implicitly converts to a date.

Return Type

INTEGER

TIMESTAMPTZ_CMP_TIMESTAMP Function

TIMESTAMPTZ_CMP_TIMESTAMP compares the value of a time stamp with time zone expression with a time stamp expression. If the time stamp with time zone and time stamp values are identical, the function returns 0. If the time stamp with time zone is greater alphabetically, the function returns 1. If the time stamp is greater, the function returns -1.

Syntax

```
TIMESTAMPTZ_CMP_TIMESTAMP(timestamptz, timestamp)
```

Arguments

timestamptz

A TIMESTAMPTZ column or an expression that implicitly converts to a time stamp with a time zone.

timestamp

A TIMESTAMP column or an expression that implicitly converts to a time stamp.

Return Type

INTEGER

TIMEZONE Function

TIMEZONE returns a time stamp for the specified time zone and time stamp value.

Syntax

```
TIMEZONE ('timezone' { timestamp | timestamptz })
```

Arguments

timezone

The time zone for the return value. The time zone can be specified as a time zone name (such as '**Africa/Kampala**' or '**Singapore**') or as a time zone abbreviation (such as '**UTC**' or '**PDT**'). To view a list of supported time zone names, execute the following command.

```
select pg_timezone_names();
```

To view a list of supported time zone abbreviations, execute the following command.

```
select pg_timezone_abbrevs();
```

For more information and examples, see [Time Zone Usage Notes \(p. 566\)](#).

timestamp

An expression that results in a TIMESTAMP type, or a value that can implicitly be coerced to a time stamp.

timestampz

An expression that results in a TIMESTAMPTZ type, or a value that can implicitly be coerced to a time stamp with time zone.

Return Type

TIMESTAMPTZ when used with a TIMESTAMP expression.

TIMESTAMP when used with a TIMESTAMPTZ expression.

TO_TIMESTAMP Function

TO_TIMESTAMP converts a TIMESTAMP string to TIMESTAMPTZ.

Syntax

```
to_timestamp ('timestamp', 'format')
```

Arguments

timestamp

A string that represents a time stamp value in the format specified by *format*.

format

The format for the *timestamp* value. Formats that include a time zone (**tz**, **tz**, or **of**) are not supported as input. For valid time stamp formats, see [Datetime Format Strings \(p. 665\)](#).

Return Type

TIMESTAMPTZ

TRUNC Date Function

Truncates a time stamp and returns a date.

Syntax

```
TRUNC (timestamp)
```

Arguments

timestamp

A timestamp column or an expression that implicitly converts to a time stamp.

To return a time stamp value with 00:00:00 as the time, cast the function result to a TIMESTAMP.

Return Type

DATE

Examples

Return the date portion from the result of the SYSDATE function (which returns a time stamp):

```
select sysdate;

timestamp
-----
2011-07-21 10:32:38.248109
(1 row)

select trunc(sysdate);

trunc
-----
2011-07-21
(1 row)
```

Apply the TRUNC function to a TIMESTAMP column. The return type is a date.

```
select trunc(starttime) from event
order by eventid limit 1;

trunc
-----
2008-01-25
(1 row)
```

Dateparts for Date or Time Stamp Functions

The following table identifies the datepart and timepart names and abbreviations that are accepted as arguments to the following functions:

- DATEADD
- DATEDIFF
- DATE_PART
- DATE_TRUNC
- EXTRACT

Datepart or Timepart	Abbreviations
millennium, millennia	mil, mils
century, centuries	c, cent, cents
decade, decades	dec, decs
epoch	epoch (supported by the DATE_PART (p. 575) and the EXTRACT (p. 577))
year, years	y, yr, yrs
quarter, quarters	qtr, qtrs
month, months	mon, mons
week, weeks	w When used with the DATE_TRUNC (p. 577) , returns the date for the most recent Monday.

Datepart or Timepart	Abbreviations
day of week	<p>dayofweek, dow, dw, weekday (supported by the DATE_PART (p. 575) and the EXTRACT Function (p. 577))</p> <p>Returns an integer from 0–6, starting with Sunday.</p> <p>Note The DOW datepart behaves differently from the day of week (D) date part used for datetime format strings. D is based on integers 1–7, where Sunday is 1. For more information, see Datetime Format Strings (p. 665).</p>
day of year	dayofyear, doy, dy, yearday (supported by the DATE_PART (p. 575) and the EXTRACT (p. 577))
day, days	d
hour, hours	h, hr, hrs
minute, minutes	m, min, mins
second, seconds	s, sec, secs
millisecond, milliseconds	ms, msec, msecs, msecond, mseconds, millisec, millisecs, millisecond
microsecond, microseconds	microsec, microsecs, microsecond, usecond, useconds, us, usec, usecs
timezone, timezone_hour, timezone_minute	Supported by the DATE_TRUNC (p. 577) function and the EXTRACT (p. 577) for time stamp with time zone (TIMESTAMPTZ) only.

Variations in Results with Seconds, Milliseconds, and Microseconds

Minor differences in query results occur when different date functions specify seconds, milliseconds, or microseconds as dateparts:

- The EXTRACT function return integers for the specified datepart only, ignoring higher- and lower-level dateparts. If the specified datepart is seconds, milliseconds and microseconds are not included in the result. If the specified datepart is milliseconds, seconds and microseconds are not included. If the specified datepart is microseconds, seconds and milliseconds are not included.
- The DATE_PART function returns the complete seconds portion of the time stamp, regardless of the specified datepart, returning either a decimal value or an integer as required.

For example, compare the results of the following queries:

```
create table seconds(micro timestamp);

insert into seconds values('2009-09-21 11:10:03.189717');

select extract(sec from micro) from seconds;
date_part
-----
3
(1 row)

select date_part(sec, micro) from seconds;
```

```
pgdate_part
-----
3.189717
(1 row)
```

CENTURY, EPOCH, DECADE, and MIL Notes

CENTURY or CENTURIES

Amazon Redshift interprets a CENTURY to start with year ###1 and end with year ###0:

```
select extract (century from timestamp '2000-12-16 12:21:13');
date_part
-----
20
(1 row)

select extract (century from timestamp '2001-12-16 12:21:13');
date_part
-----
21
(1 row)
```

EPOCH

The Amazon Redshift implementation of EPOCH is relative to 1970-01-01 00:00:00.000000 independent of the time zone where the server resides. You might need to offset the results by the difference in hours depending on the time zone where the server is located.

The following example demonstrates the following:

1. Creates a table called EVENT_EXAMPLE based on the EVENT table. This CREATE AS command uses the DATE_PART function to create a date column (called PGDATE_PART by default) to store the epoch value for each event.
2. Selects the column and data type of EVENT_EXAMPLE from PG_TABLE_DEF.
3. Selects EVENTNAME, STARTTIME, and PGDATE_PART from the EVENT_EXAMPLE table to view the different date and time formats.
4. Selects EVENTNAME and STARTTIME from EVENT_EXAMPLE as is. Converts epoch values in PGDATE_PART using a 1 second interval to a timestamp without time zone, and returns the results in a column called CONVERTED_TIMESTAMP.

```
create table event_example
as select eventname, starttime, date_part(epoch, starttime) from event;

select "column", type from pg_table_def where tablename='event_example';

   column   |          type
-----+-----
eventname   | character varying(200)
starttime   | timestamp without time zone
pgdate_part | double precision
(3 rows)
```

```
select eventname, starttime, pgdate_part from event_example;

   eventname   |          starttime          | pgdate_part
-----+-----+-----
Mamma Mia!    | 2008-01-01 20:00:00        | 1199217600
```

Spring Awakening	2008-01-01 15:00:00	1199199600
Nas	2008-01-01 14:30:00	1199197800
Hannah Montana	2008-01-01 19:30:00	1199215800
K.D. Lang	2008-01-01 15:00:00	1199199600
Spamalot	2008-01-02 20:00:00	1199304000
Macbeth	2008-01-02 15:00:00	1199286000
The Cherry Orchard	2008-01-02 14:30:00	1199284200
Macbeth	2008-01-02 19:30:00	1199302200
Demi Lovato	2008-01-02 19:30:00	1199302200

```
select eventname,
starttime,
timestamp with time zone 'epoch' + pgdate_part * interval '1 second' AS
converted_timestamp
from event_example;
```

eventname	starttime	converted_timestamp
-----+-----+-----		
Mamma Mia!	2008-01-01 20:00:00	2008-01-01 20:00:00
Spring Awakening	2008-01-01 15:00:00	2008-01-01 15:00:00
Nas	2008-01-01 14:30:00	2008-01-01 14:30:00
Hannah Montana	2008-01-01 19:30:00	2008-01-01 19:30:00
K.D. Lang	2008-01-01 15:00:00	2008-01-01 15:00:00
Spamalot	2008-01-02 20:00:00	2008-01-02 20:00:00
Macbeth	2008-01-02 15:00:00	2008-01-02 15:00:00
The Cherry Orchard	2008-01-02 14:30:00	2008-01-02 14:30:00
Macbeth	2008-01-02 19:30:00	2008-01-02 19:30:00
Demi Lovato	2008-01-02 19:30:00	2008-01-02 19:30:00
...		

DECADE or DECADES

Amazon Redshift interprets the DECADE or DECADES DATEPART based on the common calendar. For example, because the common calendar starts from the year 1, the first decade (decade 1) is 0001-01-01 through 0009-12-31, and the second decade (decade 2) is 0010-01-01 through 0019-12-31. For example, decade 201 spans from 2000-01-01 to 2009-12-31:

```
select extract(decade from timestamp '1999-02-16 20:38:40');
date_part
-----
200
(1 row)

select extract(decade from timestamp '2000-02-16 20:38:40');
date_part
-----
201
(1 row)

select extract(decade from timestamp '2010-02-16 20:38:40');
date_part
-----
202
(1 row)
```

MIL or MILS

Amazon Redshift interprets a MIL to start with the first day of year #001 and end with the last day of year #000:

```
select extract (mil from timestamp '2000-12-16 12:21:13');
date_part
-----
2
(1 row)

select extract (mil from timestamp '2001-12-16 12:21:13');
date_part
-----
3
(1 row)
```

Math Functions

Topics

- [Mathematical Operator Symbols \(p. 595\)](#)
- [ABS Function \(p. 596\)](#)
- [ACOS Function \(p. 597\)](#)
- [ASIN Function \(p. 597\)](#)
- [ATAN Function \(p. 598\)](#)
- [ATAN2 Function \(p. 599\)](#)
- [CBRT Function \(p. 600\)](#)
- [CEILING \(or CEIL\) Function \(p. 600\)](#)
- [CHECKSUM Function \(p. 601\)](#)
- [COS Function \(p. 601\)](#)
- [COT Function \(p. 602\)](#)
- [DEGREES Function \(p. 603\)](#)
- [DEXP Function \(p. 603\)](#)
- [DLOG1 Function \(p. 604\)](#)
- [DLOG10 Function \(p. 604\)](#)
- [EXP Function \(p. 605\)](#)
- [FLOOR Function \(p. 605\)](#)
- [LN Function \(p. 606\)](#)
- [LOG Function \(p. 607\)](#)
- [MOD Function \(p. 608\)](#)
- [PI Function \(p. 608\)](#)
- [POWER Function \(p. 609\)](#)
- [RADIANS Function \(p. 610\)](#)
- [RANDOM Function \(p. 610\)](#)
- [ROUND Function \(p. 612\)](#)
- [SIN Function \(p. 613\)](#)
- [SIGN Function \(p. 614\)](#)
- [SQRT Function \(p. 614\)](#)
- [TAN Function \(p. 615\)](#)
- [TRUNC Function \(p. 616\)](#)

This section describes the mathematical operators and functions supported in Amazon Redshift.

Mathematical Operator Symbols

The following table lists the supported mathematical operators.

Supported Operators

Operator	Description	Example	Result
+	addition	2 + 3	5
-	subtraction	2 - 3	-1
*	multiplication	2 * 3	6
/	division	4 / 2	2
%	modulo	5 % 4	1
^	exponentiation	2.0 ^ 3.0	8
/	square root	/ 25.0	5
/	cube root	/ 27.0	3
@	absolute value	@ -5.0	5
<<	bitwise shift left	1 << 4	16
>>	bitwise shift right	8 >> 2	2

Examples

Calculate the commission paid plus a \$2.00 handling for a given transaction:

```
select commission, (commission + 2.00) as comm
from sales where salesid=10000;

commission | comm
-----+-----
28.05 | 30.05
(1 row)
```

Calculate 20 percent of the sales price for a given transaction:

```
select pricepaid, (pricepaid * .20) as twentypct
from sales where salesid=10000;

pricepaid | twentypct
-----+-----
187.00 | 37.400
(1 row)
```

Forecast ticket sales based on a continuous growth pattern. In this example, the subquery returns the number of tickets sold in 2008. That result is multiplied exponentially by a continuous growth rate of 5% over 10 years.

```
select (select sum(qtysold) from sales, date
```

```
where sales.dateid=date.dateid and year=2008)
^ ((5::float/100)*10) as qty10years;

qty10years
-----
587.664019657491
(1 row)
```

Find the total price paid and commission for sales with a date ID that is greater than or equal to 2000. Then subtract the total commission from the total price paid.

```
select sum (pricepaid) as sum_price, dateid,
sum (commission) as sum_comm, (sum (pricepaid) - sum (commission)) as value
from sales where dateid >= 2000
group by dateid order by dateid limit 10;
```

sum_price	dateid	sum_comm	value
364445.00	2044	54666.75	309778.25
349344.00	2112	52401.60	296942.40
343756.00	2124	51563.40	292192.60
378595.00	2116	56789.25	321805.75
328725.00	2080	49308.75	279416.25
349554.00	2028	52433.10	297120.90
249207.00	2164	37381.05	211825.95
285202.00	2064	42780.30	242421.70
320945.00	2012	48141.75	272803.25
321096.00	2016	48164.40	272931.60

(10 rows)

ABS Function

ABS calculates the absolute value of a number, where that number can be a literal or an expression that evaluates to a number.

Syntax

```
ABS (number)
```

Arguments

number

Number or expression that evaluates to a number.

Return Type

ABS returns the same data type as its argument.

Examples

Calculate the absolute value of -38:

```
select abs (-38);
abs
```



```
-----  
38  
(1 row)
```

Calculate the absolute value of (14-76):

```
select abs (14-76);  
abs  
-----  
62  
(1 row)
```

ACOS Function

ACOS is a trigonometric function that returns the arc cosine of a number. The return value is in radians and is between $\pi/2$ and $-\pi/2$.

Syntax

```
ACOS(number)
```

Arguments

number

The input parameter is a double precision number.

Return Type

The ACOS function returns a double precision number.

Examples

The following example returns the arc cosine of -1:

```
select acos(-1);  
acos  
-----  
3.14159265358979  
(1 row)
```

The following example converts the arc cosine of .5 to the equivalent number of degrees:

```
select (acos(.5) * 180/(select pi())) as degrees;  
degrees  
-----  
60  
(1 row)
```

ASIN Function

ASIN is a trigonometric function that returns the arc sine of a number. The return value is in radians and is between $\pi/2$ and $-\pi/2$.

Syntax

```
ASIN(number)
```

Argument

number

The input parameter is a double precision number.

Return Type

The ASIN function returns a double precision number.

Examples

The following example returns the arc sine of 1 and multiples it by 2:

```
select asin(1)*2 as pi;
pi
-----
3.14159265358979
(1 row)
```

The following example converts the arc sine of .5 to the equivalent number of degrees:

```
select (asin(.5) * 180/(select pi())) as degrees;
degrees
-----
30
(1 row)
```

ATAN Function

ATAN is a trigonometric function that returns the arc tangent of a number. The return value is in radians and is between $\pi/2$ and $-\pi/2$.

Syntax

```
ATAN(number)
```

Argument

number

The input parameter is a double precision number.

Return Type

The ATAN function returns a double precision number.

Examples

The following example returns the arc tangent of 1 and multiplies it by 4:

```
select atan(1) * 4 as pi;
pi
-----
3.14159265358979
(1 row)
```

The following example converts the arc tangent of 1 to the equivalent number of degrees:

```
select (atan(1) * 180/(select pi())) as degrees;
degrees
-----
45
(1 row)
```

ATAN2 Function

ATAN2 is a trigonometric function that returns the arc tangent of a one number divided by another number. The return value is in radians and is between $\pi/2$ and $-\pi/2$.

Syntax

```
ATAN2(number1, number2)
```

Arguments

number1

The first input parameter is a double precision number.

number2

The second parameter is a double precision number.

Return Type

The ATAN2 function returns a double precision number.

Examples

The following example returns the arc tangent of 2/2 and multiplies it by 4:

```
select atan2(2,2) * 4 as pi;
pi
-----
3.14159265358979
(1 row)
```

The following example converts the arc tangent of 1/0 (or 0) to the equivalent number of degrees:

```
select (atan2(1,0) * 180/(select pi())) as degrees;
degrees
-----
90
(1 row)
```

CBRT Function

The CBRT function is a mathematical function that calculates the cube root of a number.

Syntax

```
CBRT (number)
```

Argument

CBRT takes a DOUBLE PRECISION number as an argument.

Return Type

CBRT returns a DOUBLE PRECISION number.

Examples

Calculate the cube root of the commission paid for a given transaction:

```
select cbrt(commission) from sales where salesid=10000;

cbrt
-----
3.03839539048843
(1 row)
```

CEILING (or CEIL) Function

The CEILING or CEIL function is used to round a number up to the next whole number. (The [FLOOR Function \(p. 605\)](#) rounds a number down to the next whole number.)

Syntax

```
CEIL | CEILING(number)
```

Arguments

number
DOUBLE PRECISION number to be rounded.

Return Type

CEILING and CEIL return an integer.

Example

Calculate the ceiling of the commission paid for a given sales transaction:

```
select ceiling(commission) from sales
where salesid=10000;
```

```
ceiling
-----
29
(1 row)
```

CHECKSUM Function

Computes a checksum value for building a hash index.

Syntax

```
CHECKSUM(expression)
```

Argument

expression

The input expression must be a VARCHAR, INTEGER, or DECIMAL data type.

Return Type

The CHECKSUM function returns an integer.

Example

The following example computes a checksum value for the COMMISSION column:

```
select checksum(commission)
from sales
order by salesid
limit 10;

checksum
-----
10920
1140
5250
2625
2310
5910
11820
2955
8865
975
(10 rows)
```

COS Function

COS is a trigonometric function that returns the cosine of a number. The return value is in radians and is between $\pi/2$ and $-\pi/2$.

Syntax

```
COS(double_precision)
```

Argument

number

The input parameter is a double precision number.

Return Type

The COS function returns a double precision number.

Examples

The following example returns cosine of 0:

```
select cos(0);
cos
-----
1
(1 row)
```

The following example returns the cosine of PI:

```
select cos(pi());
cos
-----
-1
(1 row)
```

COT Function

COT is a trigonometric function that returns the cotangent of a number. The input parameter must be nonzero.

Syntax

```
COT(number)
```

Argument

number

The input parameter is a double precision number.

Return Type

The COT function returns a double precision number.

Examples

The following example returns the cotangent of 1:

```
select cot(1);
cot
-----
```

```
0.642092615934331
(1 row)
```

DEGREES Function

Converts an angle in radians to its equivalent in degrees.

Syntax

```
DEGREES(number)
```

Argument

number

The input parameter is a double precision number.

Return Type

The DEGREES function returns a double precision number.

Examples

The following example returns the degree equivalent of .5 radians:

```
select degrees(.5);
degrees
-----
28.6478897565412
(1 row)
```

The following example converts PI radians to degrees:

```
select degrees(pi());
degrees
-----
180
(1 row)
```

DEXP Function

The DEXP function returns the exponential value in scientific notation for a double precision number. The only difference between the DEXP and EXP functions is that the parameter for DEXP must be a double precision.

Syntax

```
DEXP(number)
```

Argument

number

The input parameter is a double precision number.

Return Type

The DEXP function returns a double precision number.

Example

Use the DEXP function to forecast ticket sales based on a continuous growth pattern. In this example, the subquery returns the number of tickets sold in 2008. That result is multiplied by the result of the DEXP function, which specifies a continuous growth rate of 7% over 10 years.

```
select (select sum(qtysold) from sales, date
where sales.dateid=date.dateid
and year=2008) * dexp((7::float/100)*10) qty2010;

qty2010
-----
695447.483772222
(1 row)
```

DLOG1 Function

The DLOG1 function returns the natural logarithm of the input parameter. Synonym for the LN function.

Synonym of [LN Function \(p. 606\)](#).

DLOG10 Function

The DLOG10 returns the base 10 logarithm of the input parameter. Synonym of the LOG function.

Synonym of [LOG Function \(p. 607\)](#).

Syntax

```
DLOG10(number)
```

Argument

number

The input parameter is a double precision number.

Return Type

The DLOG10 function returns a double precision number.

Example

The following example returns the base 10 logarithm of the number 100:

```
select dlog10(100);

dlog10
-----
2
```



```
(1 row)
```

EXP Function

The EXP function returns the exponential value in scientific notation for a numeric expression.

Syntax

```
EXP (expression)
```

Argument

expression

The expression must be an INTEGER, DECIMAL, or DOUBLE PRECISION data type.

Return Type

EXP returns a DOUBLE PRECISION number.

Example

Use the EXP function to forecast ticket sales based on a continuous growth pattern. In this example, the subquery returns the number of tickets sold in 2008. That result is multiplied by the result of the EXP function, which specifies a continuous growth rate of 7% over 10 years.

```
select (select sum(qtysold) from sales, date
where sales.dateid=date.dateid
and year=2008) * exp((7::float/100)*10) qty2010;

qty2010
-----
695447.483772222
(1 row)
```

FLOOR Function

The FLOOR function rounds a number down to the next whole number.

Syntax

```
FLOOR (number)
```

Argument

number

DOUBLE PRECISION number to be rounded down.

Return Type

FLOOR returns an integer.

Example

Calculate the floor of the commission paid for a given sales transaction:

```
select floor(commission) from sales
where salesid=10000;

floor
-----
28
(1 row)
```

LN Function

Returns the natural logarithm of the input parameter. Synonym of the DLOG1 function.

Synonym of [DLOG1 Function \(p. 604\)](#).

Syntax

```
LN(expression)
```

Argument

expression

The target column or expression that the function operates on.

Note

This function returns an error for some data types if the expression references an Amazon Redshift user-created table or an Amazon Redshift STL or STV system table.

Expressions with the following data types produce an error if they reference a user-created or system table. Expressions with these data types run exclusively on the leader node:

- BOOLEAN
- CHAR
- DATE
- DECIMAL or NUMERIC
- TIMESTAMP
- VARCHAR

Expressions with the following data types run successfully on user-created tables and STL or STV system tables:

- BIGINT
- DOUBLE PRECISION
- INTEGER
- REAL
- SMALLINT

Return Type

The LN function returns the same type as the expression.

Example

The following example returns the natural logarithm, or base e logarithm, of the number 2.718281828:

```
select ln(2.718281828);
ln
-----
0.9999999998311267
(1 row)
```

Note that the answer is nearly equal to 1.

This example returns the natural logarithm of the values in the USERID column in the USERS table:

```
select username, ln(userid) from users order by userid limit 10;

username |          ln
-----+-----
JSG99FHE |          0
PGL08LJI | 0.693147180559945
IFT66TXU | 1.09861228866811
XDZ38RDD | 1.38629436111989
AEB55QTM | 1.6094379124341
NDQ15VBM | 1.79175946922805
OWY35QYB | 1.94591014905531
AZG78YIP | 2.07944154167984
MSD36KVR | 2.19722457733622
WKW41AIW | 2.30258509299405
(10 rows)
```

LOG Function

Returns the base 10 logarithm of a number.

Synonym of [DLOG10 Function \(p. 604\)](#).

Syntax

```
LOG(number)
```

Argument

number

The input parameter is a double precision number.

Return Type

The LOG function returns a double precision number.

Example

The following example returns the base 10 logarithm of the number 100:

```
select log(100);
```

```
dlog10
-----
2
(1 row)
```

MOD Function

The MOD function returns a numeric result that is the remainder of two numeric parameters. The first parameter is divided by the second parameter.

Syntax

```
MOD(number1, number2)
```

Arguments

number1

The first input parameter is an INTEGER, SMALLINT, BIGINT, or DECIMAL number. If either parameter is a DECIMAL type, the other parameter must also be a DECIMAL type. If either parameter is an INTEGER, the other parameter can be an INTEGER, SMALLINT, or BIGINT. Both parameters can also be SMALLINT or BIGINT, but one parameter cannot be a SMALLINT if the other is a BIGINT.

number2

The second parameter is an INTEGER, SMALLINT, BIGINT, or DECIMAL number. The same data type rules apply to *number2* as to *number1*.

Return Type

Valid return types are DECIMAL, INT, SMALLINT, and BIGINT. The return type of the MOD function is the same numeric type as the input parameters, if both input parameters are the same type. If either input parameter is an INTEGER, however, the return type will also be an INTEGER.

Example

The following example returns information for odd-numbered categories in the CATEGORY table:

```
select catid, catname
from category
where mod(catid,2)=1
order by 1,2;

catid | catname
-----+-----
1 | MLB
3 | NFL
5 | MLS
7 | Plays
9 | Pop
11 | Classical
(6 rows)
```

PI Function

The PI function returns the value of PI to 14 decimal places.

Syntax

```
PI()
```

Return Type

PI returns a DOUBLE PRECISION number.

Examples

Return the value of pi:

```
select pi();

pi
-----
3.14159265358979
(1 row)
```

POWER Function

Syntax

The POWER function is an exponential function that raises a numeric expression to the power of a second numeric expression. For example, 2 to the third power is calculated as `power(2,3)`, with a result of 8.

```
POW | POWER (expression1, expression2)
```

POW and POWER are synonyms.

Arguments

expression1

Numeric expression to be raised. Must be an integer, decimal, or floating-point data type.

expression2

Power to raise *expression1*. Must be an integer, decimal, or floating-point data type.

Return Type

POWER returns a DOUBLE PRECISION number.

Examples

In the following example, the POWER function is used to forecast what ticket sales will look like in the next 10 years, based on the number of tickets sold in 2008 (the result of the subquery). The growth rate is set at 7% per year in this example.

```
select (select sum(qtysold) from sales, date
where sales.dateid=date.dateid
and year=2008) * pow((1+7::float/100),10) qty2010;
```

```
qty2010
-----
679353.754088594
(1 row)
```

The following example is a variation on the previous example, with the growth rate at 7% per year but the interval set to months (120 months over 10 years):

```
select (select sum(qtysold) from sales, date
where sales.dateid=date.dateid
and year=2008) * pow((1+7::float/100/12),120) qty2010;

qty2010
-----
694034.54678046
(1 row)
```

RADIANS Function

Converts an angle in degrees to its equivalent in radians.

Syntax

```
RADIANS(number)
```

Argument

string

The input parameter is a double precision number.

Return Type

The RADIANS function returns a double precision number.

Examples

The following example returns the radian equivalent of 180 degrees:

```
select radians(180);
radians
-----
3.14159265358979
(1 row)
```

RANDOM Function

The RANDOM function generates a random value between 0.0 and 1.0.

Syntax

```
RANDOM( )
```

Return Type

RANDOM returns a DOUBLE PRECISION number.

Usage Notes

Call RANDOM after setting a seed value with the [SET \(p. 465\)](#) command to cause RANDOM to generate numbers in a predictable sequence.

Examples

Compute a random value between 0 and 99. If the random number is 0 to 1, this query produces a random number from 0 to 100:

```
select cast (random() * 100 as int);
int4
-----
24
(1 row)
```

This example uses the [SET \(p. 465\)](#) command to set a SEED value so that RANDOM generates a predictable sequence of numbers.

First, return three RANDOM integers without setting the SEED value first:

```
select cast (random() * 100 as int);
int4
-----
6
(1 row)

select cast (random() * 100 as int);
int4
-----
68
(1 row)

select cast (random() * 100 as int);
int4
-----
56
(1 row)
```

Now, set the SEED value to .25, and return three more RANDOM numbers:

```
set seed to .25;
select cast (random() * 100 as int);
int4
-----
21
(1 row)

select cast (random() * 100 as int);
int4
-----
79
```

```
(1 row)

select cast (random() * 100 as int);
int4
-----
12
(1 row)
```

Finally, reset the SEED value to .25, and verify that RANDOM returns the same results as the previous three calls:

```
set seed to .25;
select cast (random() * 100 as int);
int4
-----
21
(1 row)

select cast (random() * 100 as int);
int4
-----
79
(1 row)

select cast (random() * 100 as int);
int4
-----
12
(1 row)
```

ROUND Function

The ROUND function rounds numbers to the nearest integer or decimal.

The ROUND function can optionally include a second argument: an integer to indicate the number of decimal places for rounding, in either direction. If the second argument is not provided, the function rounds to the nearest whole number; if the second argument *n* is specified, the function rounds to the nearest number with *n* decimal places of precision.

Syntax

```
ROUND ( number [ , integer ] )
```

Argument

number

INTEGER, DECIMAL, and FLOAT data types are supported.

If the first argument is an integer, the parser converts the integer into a decimal data type prior to processing. If the first argument is a decimal number, the parser processes the function without conversion, resulting in better performance.

Return Type

ROUND returns the same numeric data type as the input argument(s).

Examples

Round the commission paid for a given transaction to the nearest whole number.

```
select commission, round(commission)
from sales where salesid=10000;
```

```
commission | round
-----+-----
      28.05 |    28
(1 row)
```

Round the commission paid for a given transaction to the first decimal place.

```
select commission, round(commission, 1)
from sales where salesid=10000;
```

```
commission | round
-----+-----
      28.05 |   28.1
(1 row)
```

For the same query, extend the precision in the opposite direction.

```
select commission, round(commission, -1)
from sales where salesid=10000;
```

```
commission | round
-----+-----
      28.05 |    30
(1 row)
```

SIN Function

SIN is a trigonometric function that returns the sine of a number. The return value is in radians and is between $\pi/2$ and $-\pi/2$.

Syntax

```
SIN(number)
```

Argument

number

The input parameter is a double precision number.

Return Type

The SIN function returns a double precision number.

Examples

The following example returns the sine of π :

```
select sin(-pi());

sin
-----
-1.22464679914735e-16
(1 row)
```

SIGN Function

The SIGN function returns the sign (positive or negative) of a numeric value. The result of the SIGN function will either be a 1 or a -1, indicating the sign of the argument.

Syntax

```
SIGN (numeric)
```

Argument

numeric
Numeric value to be evaluated.

Return Type

The SIGN function returns an integer.

Examples

Determine the sign of the commission paid for a given transaction:

```
select commission, sign (commission)
from sales where salesid=10000;

commission | sign
-----+-----
         28.05 |      1
(1 row)
```

SQRT Function

The SQRT function returns the square root of a numeric value.

Syntax

```
SQRT (expression)
```

Argument

expression
The expression must have an integer, decimal, or floating-point data type.

Return Type

SQRT returns a DOUBLE PRECISION number.

Examples

The following example returns the square root for some COMMISSION values from the SALES table. The COMMISSION column is a DECIMAL column.

```
select sqrt(commission)
from sales where salesid <10 order by salesid;

sqrt
-----
10.4498803820905
3.37638860322683
7.24568837309472
5.1234753829798
...
```

The following query returns the rounded square root for the same set of COMMISSION values.

```
select salesid, commission, round(sqrt(commission))
from sales where salesid <10 order by salesid;

salesid | commission | round
-----+-----+-----
1 | 109.20 | 10
2 | 11.40 | 3
3 | 52.50 | 7
4 | 26.25 | 5
...
```

TAN Function

TAN is a trigonometric function that returns the tangent of a number. The input parameter must be a non-zero number (in radians).

Syntax

```
TAN(number)
```

Argument

number

The input parameter is a double precision number.

Return Type

The TAN function returns a double precision number.

Examples

The following example returns the tangent of 0:

```
select tan(0);
tan
```

```
-----  
0  
(1 row)
```

TRUNC Function

The TRUNC function truncates a number and right-fills it with zeros from the position specified. This function also truncates a time stamp and returns a date.

Syntax

```
TRUNC(number [ , integer ] |  
timestamp )
```

Arguments

number

Numeric data type to be truncated. SMALLINT, INTEGER, BIGINT, DECIMAL, REAL, and DOUBLE PRECISION data types are supported.

integer (optional)

An integer that indicates the number of decimal places of precision, in either direction. If no integer is provided, the number is truncated as a whole number; if an integer is specified, the number is truncated to the specified decimal place.

timestamp

The function can also return the date from a time stamp. (To return a time stamp value with 00:00:00 as the time, cast the function result to a time stamp.)

Return Type

TRUNC returns the same numeric data type as the first input argument. For time stamps, TRUNC returns a date.

Examples

Truncate the commission paid for a given sales transaction.

```
select commission, trunc(commission)
from sales where salesid=784;

commission | trunc
-----+-----
      111.15 |    111
(1 row)
```

Truncate the same commission value to the first decimal place.

```
select commission, trunc(commission,1)
from sales where salesid=784;

commission | trunc
-----+-----
      111.15 |   111.1
```

```
(1 row)
```

Truncate the commission with a negative value for the second argument; 111.15 is rounded down to 110.

```
select commission, trunc(commission,-1)
from sales where salesid=784;
```

```
commission | trunc
-----+-----
      111.15 |    110
(1 row)
```

Return the date portion from the result of the SYSDATE function (which returns a time stamp):

```
select sysdate;
```

```
timestamp
-----
2011-07-21 10:32:38.248109
(1 row)
```

```
select trunc(sysdate);
```

```
trunc
-----
2011-07-21
(1 row)
```

Apply the TRUNC function to a TIMESTAMP column. The return type is a date.

```
select trunc(starttime) from event
order by eventid limit 1;
```

```
trunc
-----
2008-01-25
(1 row)
```

String Functions

Topics

- [|| \(Concatenation\) Operator \(p. 619\)](#)
- [BPCHARCMP Function \(p. 620\)](#)
- [BTRIM Function \(p. 621\)](#)
- [BTTEXT_PATTERN_CMP Function \(p. 622\)](#)
- [CHAR_LENGTH Function \(p. 622\)](#)
- [CHARACTER_LENGTH Function \(p. 622\)](#)
- [CHARINDEX Function \(p. 622\)](#)
- [CHR Function \(p. 624\)](#)
- [CONCAT \(Oracle Compatibility Function\) \(p. 624\)](#)

- [CRC32 Function \(p. 626\)](#)
- [FUNC_SHA1 Function \(p. 627\)](#)
- [INITCAP Function \(p. 627\)](#)
- [LEFT and RIGHT Functions \(p. 629\)](#)
- [LEN Function \(p. 630\)](#)
- [LENGTH Function \(p. 631\)](#)
- [LOWER Function \(p. 631\)](#)
- [LPAD and RPAD Functions \(p. 632\)](#)
- [LTRIM Function \(p. 633\)](#)
- [MD5 Function \(p. 634\)](#)
- [POSITION Function \(p. 634\)](#)
- [QUOTE_IDENT Function \(p. 636\)](#)
- [QUOTE_LITERAL Function \(p. 636\)](#)
- [REGEXP_COUNT Function \(p. 637\)](#)
- [REGEXP_INSTR Function \(p. 638\)](#)
- [REGEXP_REPLACE Function \(p. 639\)](#)
- [REGEXP_SUBSTR Function \(p. 641\)](#)
- [REPEAT Function \(p. 641\)](#)
- [REPLACE Function \(p. 642\)](#)
- [REPLICATE Function \(p. 643\)](#)
- [REVERSE Function \(p. 643\)](#)
- [RTRIM Function \(p. 644\)](#)
- [SPLIT_PART Function \(p. 645\)](#)
- [STRPOS Function \(p. 646\)](#)
- [STRTOL Function \(p. 647\)](#)
- [SUBSTRING Function \(p. 648\)](#)
- [TEXTLEN Function \(p. 651\)](#)
- [TO_HEX Function \(p. 651\)](#)
- [TRANSLATE Function \(p. 651\)](#)
- [TRIM Function \(p. 653\)](#)
- [UPPER Function \(p. 654\)](#)

String functions process and manipulate character strings or expressions that evaluate to character strings. When the *string* argument in these functions is a literal value, it must be enclosed in single quotes. Supported data types include CHAR and VARCHAR.

The following section provides the function names, syntax, and descriptions for supported functions. All offsets into strings are 1-based.

Deprecated Leader Node-Only Functions

The following string functions are deprecated because they execute only on the leader node. For more information, see [Leader Node-Only Functions \(p. 492\)](#)

- ASCII
- GET_BIT

- GET_BYTE
- OCTET_LENGTH
- SET_BIT
- SET_BYTE
- TO_ASCII

|| (Concatenation) Operator

Concatenates two strings on either side of the || symbol and returns the concatenated string.

Similar to [CONCAT \(Oracle Compatibility Function\) \(p. 624\)](#).

Note

For both the CONCAT function and the concatenation operator, if one or both strings is null, the result of the concatenation is null.

Syntax

```
string1 || string2
```

Arguments

string1, *string2*

Both arguments can be fixed-length or variable-length character strings or expressions.

Return Type

The || operator returns a string. The type of string is the same as the input arguments.

Example

The following example concatenates the FIRSTNAME and LASTNAME fields from the USERS table:

```
select firstname || ' ' || lastname
from users
order by 1
limit 10;
```

?column?

```
-----
Aaron Banks
Aaron Booth
Aaron Browning
Aaron Burnett
Aaron Casey
Aaron Cash
Aaron Castro
Aaron Dickerson
Aaron Dixon
Aaron Dotson
(10 rows)
```

To concatenate columns that might contain nulls, use the [NVL Expression \(p. 557\)](#) expression. The following example uses NVL to return a 0 whenever NULL is encountered.

```
select venuename || ' seats ' || nvl(venueseats, 0)
from venue where venuestate = 'NV' or venuestate = 'NC'
order by 1
limit 10;

seating
-----
Ballys Hotel seats 0
Bank of America Stadium seats 73298
Bellagio Hotel seats 0
Caesars Palace seats 0
Harrahs Hotel seats 0
Hilton Hotel seats 0
Luxor Hotel seats 0
Mandalay Bay Hotel seats 0
Mirage Hotel seats 0
New York New York seats 0
```

BPCHARCMP Function

Compares the value of two strings and returns an integer. If the strings are identical, returns 0. If the first string is "greater" alphabetically, returns 1. If the second string is "greater", returns -1.

For multibyte characters, the comparison is based on the byte encoding.

Synonym of [BTTEXT_PATTERN_CMP Function \(p. 622\)](#).

Syntax

```
BPCHARCMP(string1, string2)
```

Arguments

string1

The first input parameter is a CHAR or VARCHAR string.

string2

The second parameter is a CHAR or VARCHAR string.

Return Type

The BPCHARCMP function returns an integer.

Examples

The following example determines whether a user's first name is alphabetically greater than the user's last name for the first ten entries in USERS:

```
select userid, firstname, lastname,
bpcharcmp(firstname, lastname)
from users
order by 1, 2, 3, 4
```



```
limit 10;
```

This example returns the following sample output:

userid	firstname	lastname	bpcharcmp
1	Rafael	Taylor	-1
2	Vladimir	Humphrey	1
3	Lars	Ratliff	-1
4	Barry	Roy	-1
5	Reagan	Hodge	1
6	Victor	Hernandez	1
7	Tamekah	Juarez	1
8	Colton	Roy	-1
9	Mufutau	Watkins	-1
10	Naida	Calderon	1

(10 rows)

You can see that for entries where the string for the FIRSTNAME is later alphabetically than the LASTNAME, BPCHARCMP returns 1. If the LASTNAME is alphabetically later than FIRSTNAME, BPCHARCMP returns -1.

This example returns all entries in the USER table whose FIRSTNAME is identical to their LASTNAME:

```
select userid, firstname, lastname,
bpcharcmp(firstname, lastname)
from users where bpcharcmp(firstname, lastname)=0
order by 1, 2, 3, 4;
```

userid	firstname	lastname	bpcharcmp
62	Chase	Chase	0
4008	Whitney	Whitney	0
12516	Graham	Graham	0
13570	Harper	Harper	0
16712	Cooper	Cooper	0
18359	Chase	Chase	0
27530	Bradley	Bradley	0
31204	Harding	Harding	0

(8 rows)

BTRIM Function

The BTRIM function trims a string by removing leading and trailing blanks or by removing characters that match an optional specified string.

Syntax

```
BTRIM(string [, matching_string ] )
```

Arguments

string

The first input parameter is a VARCHAR string.

matching_string

The second parameter, if present, is a VARCHAR string.

Return Type

The BTRIM function returns a VARCHAR string.

Examples

The following example trims leading and trailing blanks from the string ' abc ':

```
select '   abc   ' as untrim, btrim('   abc   ') as trim;

untrim   | trim
-----+-----
   abc   | abc
(1 row)
```

The following example removes the leading and trailing 'xyz' strings from the string 'xyzaxyzbxyzcxyz'.

```
select 'xyzaxyzbxyzcxyz' as untrim,
btrim('xyzaxyzbxyzcxyz', 'xyz') as trim;

      untrim      | trim
-----+-----
xyzaxyzbxyzcxyz | axyzbxyzc
(1 row)
```

Note that the leading and trailing occurrences of 'xyz' were removed, but that occurrences that were internal within the string were not removed.

BTTEXT_PATTERN_CMP Function

Synonym for the BPCHARCMP function.

See [BPCHARCMP Function \(p. 620\)](#) for details.

CHAR_LENGTH Function

Synonym of the LEN function.

See [LEN Function \(p. 630\)](#)

CHARACTER_LENGTH Function

Synonym of the LEN function.

See [LEN Function \(p. 630\)](#)

CHARINDEX Function

Returns the location of the specified substring within a string. Synonym of the STRPOS function.

Syntax

```
CHARINDEX( substring, string )
```

Arguments

substring

The substring to search for within the *string*.

string

The string or column to be searched.

Return Type

The CHARINDEX function returns an integer corresponding to the position of the substring (one-based, not zero-based). The position is based on the number of characters, not bytes, so that multi-byte characters are counted as single characters.

Usage Notes

CHARINDEX returns 0 if the substring is not found within the *string*:

```
select charindex('dog', 'fish');

charindex
-----
0
(1 row)
```

Examples

The following example shows the position of the string *fish* within the word *dogfish*:

```
select charindex('fish', 'dogfish');

charindex
-----
4
(1 row)
```

The following example returns the number of sales transactions with a COMMISSION over 999.00 from the SALES table:

```
select distinct charindex('.', commission), count (charindex('.',
commission))
from sales where charindex('.', commission) > 4 group by charindex('.',
commission)
order by 1,2;

charindex | count
-----+-----
5 | 629
(1 row)
```

See [STRPOS Function \(p. 646\)](#) for details.

CHR Function

The CHR function returns the character that matches the ASCII code point value specified by of the input parameter.

Syntax

```
CHR ( number )
```

Argument

number

The input parameter is an integer that represents an ASCII code point value.

Return Type

The CHR function returns a CHAR string if an ASCII character matches the input value. If the input number has no ASCII match, the function returns null.

Example

The following example returns event names that begin with a capital A (ASCII code point 65):

```
select distinct eventname from event
where substr(eventname, 1, 1)=chr(65);

eventname
-----
Adriana Lecouvreur
A Man For All Seasons
A Bronx Tale
A Christmas Carol
Allman Brothers Band
...
```

CONCAT (Oracle Compatibility Function)

The CONCAT function concatenates two character strings and returns the resulting string. To concatenate more than two strings, use nested CONCAT functions. The concatenation operator (||) between two strings produces the same results as the CONCAT function.

Note

For both the CONCAT function and the concatenation operator, if one or both strings is null, the result of the concatenation is null.

Syntax

```
CONCAT ( string1, string2 )
```

Arguments

string1, *string2*

Both arguments can be fixed-length or variable-length character strings or expressions.

Return Type

CONCAT returns a string. The data type of the string is the same type as the input arguments.

Examples

The following example concatenates two character literals:

```
select concat('December 25, ', '2008');

concat
-----
December 25, 2008
(1 row)
```

The following query, using the || operator instead of CONCAT, produces the same result:

```
select 'December 25, ' || '2008';

?column?
-----
December 25, 2008
(1 row)
```

The following example uses two CONCAT functions to concatenate three character strings:

```
select concat('Thursday, ', concat('December 25, ', '2008'));

concat
-----
Thursday, December 25, 2008
(1 row)
```

To concatenate columns that might contain nulls, use the [NVL Expression \(p. 557\)](#). The following example uses NVL to return a 0 whenever NULL is encountered.

```
select concat(venueName, concat(' seats ', nvl(venueSeats, 0))) as seating
from venue where venueState = 'NV' or venueState = 'NC'
order by 1
limit 5;

seating
-----
Ballys Hotel seats 0
Bank of America Stadium seats 73298
Bellagio Hotel seats 0
Caesars Palace seats 0
Harrahs Hotel seats 0
(5 rows)
```

The following query concatenates CITY and STATE values from the VENUE table:

```
select concat(venueCity, venueState)
from venue
where venueSeats > 75000
```

```
order by venueseats;

concat
-----
DenverCO
Kansas CityMO
East RutherfordNJ
LandoverMD
(4 rows)
```

The following query uses nested CONCAT functions. The query concatenates CITY and STATE values from the VENUE table but delimits the resulting string with a comma and a space:

```
select concat(concat(venuecity, ', '), venuestate)
from venue
where venueseats > 75000
order by venueseats;

concat
-----
Denver, CO
Kansas City, MO
East Rutherford, NJ
Landover, MD
(4 rows)
```

CRC32 Function

CRC32 is an error-detecting function that uses a CRC32 algorithm to detect changes between source and target data. The CRC32 function converts a variable-length string into an 8-character string that is a text representation of the hexadecimal value of a 32-bit-binary sequence.

Syntax

```
CRC32(string)
```

Arguments

string
A variable-length string.

Return Type

The CRC32 function returns an 8-character string that is a text representation of the hexadecimal value of a 32-bit binary sequence. The Amazon Redshift CRC32 function is based on the CRC-32C polynomial.

Example

The following example shows the 32-bit value for the string 'Amazon Redshift':

```
select crc32('Amazon Redshift');
crc32
-----
```

```
f2726906  
(1 row)
```

FUNC_SHA1 Function

The FUNC_SHA1 function uses the SHA1 cryptographic hash function to convert a variable-length string into a 40-character string that is a text representation of the hexadecimal value of a 160-bit checksum.

Syntax

```
FUNC_SHA1(string)
```

Arguments

string

A variable-length string.

Return Type

The FUNC_SHA1 function returns a 40-character string that is a text representation of the hexadecimal value of a 160-bit checksum.

Example

The following example returns the 160-bit value for the word 'Amazon Redshift':

```
select func_sha1('Amazon Redshift');
```

INITCAP Function

Capitalizes the first letter of each word in a specified string. INITCAP supports UTF-8 multibyte characters, up to a maximum of four bytes per character.

Syntax

```
INITCAP(string)
```

Argument

string

The input parameter is a CHAR or VARCHAR string.

Return Type

The INITCAP function returns a VARCHAR string.

Usage Notes

The INITCAP function makes the first letter of each word in a string uppercase, and any subsequent letters are made (or left) lowercase. Therefore, it is important to understand which characters

(other than space characters) function as word separators. A *word separator* character is any non-alphanumeric character, including punctuation marks, symbols, and control characters. All of the following characters are word separators:

```
! " # $ % & ' ( ) * + , - . / : ; < = > ? @ [ \ ] ^ _ ` { | } ~
```

Tabs, newline characters, form feeds, line feeds, and carriage returns are also word separators.

Examples

The following example capitalizes the initials of each word in the CATDESC column:

```
select catid, catdesc, initcap(catdesc)
from category
order by 1, 2, 3;
```

catid	catdesc	initcap
1	Major League Baseball	Major League Baseball
2	National Hockey League	National Hockey League
3	National Football League	National Football League
4	National Basketball Association	National Basketball Association
5	Major League Soccer	Major League Soccer
6	Musical theatre	Musical Theatre
7	All non-musical theatre	All Non-Musical Theatre
8	All opera and light opera	All Opera And Light Opera
9	All rock and pop music concerts	All Rock And Pop Music Concerts
10	All jazz singers and bands	All Jazz Singers And Bands
11	All symphony, concerto, and choir concerts	All Symphony, Concerto, And Choir Concerts

(11 rows)

The following example shows that the INITCAP function does not preserve uppercase characters when they do not begin words. For example, MLB becomes Mlb.

```
select initcap(catname)
from category
order by catname;
```

```
initcap
-----
Classical
Jazz
Mlb
Mls
Musicals
Nba
Nfl
Nhl
Opera
Plays
Pop
(11 rows)
```

The following example shows that non-alphanumeric characters other than spaces function as word separators, causing uppercase characters to be applied to several letters in each string:

```
select email, initcap(email)
from users
order by userid desc limit 5;
```

email	initcap
urna.Ut@egetdictumplacerat.edu	Urna.Ut@Egetdictumplacerat.Edu
nibh.enim@egestas.ca	Nibh.Enim@Egestas.Ca
in@Donecat.ca	In@Donecat.Ca
sodales@blanditviverraDonec.ca	Sodales@Blanditviverradonec.Ca
sociis.natoque.penatibus@vitae.org	Sociis.Natoque.Penatibus@Vitae.Org

(5 rows)

LEFT and RIGHT Functions

These functions return the specified number of leftmost or rightmost characters from a character string.

The number is based on the number of characters, not bytes, so that multibyte characters are counted as single characters.

Syntax

```
LEFT ( string, integer )
RIGHT ( string, integer )
```

Arguments

string

Any character string or any expression that evaluates to a character string.

integer

A positive integer.

Return Type

LEFT and RIGHT return a VARCHAR string.

Example

The following example returns the leftmost 5 and rightmost 5 characters from event names that have IDs between 1000 and 1005:

```
select eventid, eventname,
left(eventname,5) as left_5,
right(eventname,5) as right_5
from event
where eventid between 1000 and 1005
order by 1;
```

eventid	eventname	left_5	right_5
1000	Gypsy	Gypsy	Gypsy

```
1001 | Chicago          | Chica | icago
1002 | The King and I   | The K | and I
1003 | Pal Joey         | Pal J | Joey
1004 | Grease           | Greas | rease
1005 | Chicago          | Chica | icago
(6 rows)
```

LEN Function

Returns the length of the specified string.

Syntax

LEN is a synonym of [LENGTH Function \(p. 631\)](#), [CHAR_LENGTH Function \(p. 622\)](#), [CHARACTER_LENGTH Function \(p. 622\)](#), and [TEXTLEN Function \(p. 651\)](#).

```
LEN(expression)
```

Argument

expression

The input parameter is a CHAR or VARCHAR text string.

Return Type

The LEN function returns an integer indicating the number of characters in the input string. The LEN function returns the actual number of characters in multi-byte strings, not the number of bytes. For example, a VARCHAR(12) column is required to store three four-byte Chinese characters. The LEN function will return 3 for that same string.

Usage Notes

Length calculations do not count trailing spaces for fixed-length character strings but do count them for variable-length strings.

Example

The following example returns the number of characters in the strings `cat` with no trailing spaces and `cat` with three trailing spaces:

```
select len('cat'), len('cat   ');
len | len
-----+-----
3  |   6
(1 row)
```

The following example returns the ten longest VENUENAME entries in the VENUE table:

```
select venue, len(venue)
from venue
order by 2 desc, 1
limit 10;

venue | len
```

Saratoga Springs Performing Arts Center	39
Lincoln Center for the Performing Arts	38
Nassau Veterans Memorial Coliseum	33
Jacksonville Municipal Stadium	30
Rangers BallPark in Arlington	29
University of Phoenix Stadium	29
Circle in the Square Theatre	28
Hubert H. Humphrey Metrodome	28
Oriole Park at Camden Yards	27
Dick's Sporting Goods Park	26
(10 rows)	

LENGTH Function

Synonym of the LEN function.

See [LEN Function \(p. 630\)](#)

LOWER Function

Converts a string to lower case. LOWER supports UTF-8 multibyte characters, up to a maximum of four bytes per character.

Syntax

```
LOWER(string)
```

Argument

string

The input parameter is a CHAR or VARCHAR string.

Return Type

The LOWER function returns a character string that is the same data type as the input string (CHAR or VARCHAR).

Examples

The following example converts the CATNAME field to lower case:

```
select catname, lower(catname) from category order by 1,2;
```

catname	lower
Classical	classical
Jazz	jazz
MLB	mlb
MLS	mls
Musicals	musicals
NBA	nba
NFL	nfl
NHL	nhl
Opera	opera

```
Plays      | plays
Pop        | pop
(11 rows)
```

LPAD and RPAD Functions

These functions prepend or append characters to a string, based on a specified length.

Syntax

```
LPAD (string1, length, [ string2 ])
```

```
RPAD (string1, length, [ string2 ])
```

Arguments

string1

A character string or an expression that evaluates to a character string, such as the name of a character column.

length

An integer that defines the length of the result of the function. The length of a string is based on the number of characters, not bytes, so that multi-byte characters are counted as single characters. If *string1* is longer than the specified length, it is truncated (on the right). If *length* is a negative number, the result of the function is an empty string.

string2

One or more characters that are prepended or appended to *string1*. This argument is optional; if it is not specified, spaces are used.

Return Type

These functions return a VARCHAR data type.

Examples

Truncate a specified set of event names to 20 characters and prepend the shorter names with spaces:

```
select lpad(eventname,20) from event
where eventid between 1 and 5 order by 1;

lpad
-----
Salome
Il Trovatore
Boris Godunov
Gotterdammerung
La Cenerentola (Cind
(5 rows)
```

Truncate the same set of event names to 20 characters but append the shorter names with 0123456789.

```
select rpad(eventname,20,'0123456789') from event
```

```
where eventid between 1 and 5 order by 1;
```

```
rpad
-----
Boris Godunov0123456
Gotterdammerung01234
Il Trovatore01234567
La Cenerentola (Cind
Salome01234567890123
(5 rows)
```

LTRIM Function

The LTRIM function trims a specified set of characters from the beginning of a string.

Syntax

```
LTRIM( string, 'trim_chars' )
```

Arguments

string

The string column or expression to be trimmed.

trim_chars

A string column or expression representing the characters to be trimmed from the beginning of *string*.

Return Type

The LTRIM function returns a character string that is the same data type as the input string (CHAR or VARCHAR).

Example

The following example trims the year from LISTTIME:

```
select listid, listtime, ltrim(listtime, '2008-')
from listing
order by 1, 2, 3
limit 10;
```

listid	listtime	ltrim
1	2008-01-24 06:43:29	1-24 06:43:29
2	2008-03-05 12:25:29	3-05 12:25:29
3	2008-11-01 07:35:33	11-01 07:35:33
4	2008-05-24 01:18:37	5-24 01:18:37
5	2008-05-17 02:29:11	5-17 02:29:11
6	2008-08-15 02:08:13	15 02:08:13
7	2008-11-15 09:38:15	11-15 09:38:15
8	2008-11-09 05:07:30	11-09 05:07:30
9	2008-09-09 08:03:36	9-09 08:03:36
10	2008-06-17 09:44:54	6-17 09:44:54

(10 rows)

LTRIM removes any of the characters in *trim_chars* when they appear at the beginning of *string*. The following example trims the characters 'C', 'D', and 'G' when they appear at the beginning of VENUENAME.

```
select venueid, venuename, trim(venueid, 'CDG')
from venue
where venueid like '%Park'
order by 2
limit 7;
```

venueid	venueid	btrim
121	ATT Park	ATT Park
109	Citizens Bank Park	itizens Bank Park
102	Comerica Park	omerica Park
9	Dick's Sporting Goods Park	ick's Sporting Goods Park
97	Fenway Park	Fenway Park
112	Great American Ball Park	reat American Ball Park
114	Miller Park	Miller Park

MD5 Function

Uses the MD5 cryptographic hash function to convert a variable-length string into a 32-character string that is a text representation of the hexadecimal value of a 128-bit checksum.

Syntax

```
MD5(string)
```

Arguments

string
A variable-length string.

Return Type

The MD5 function returns a 32-character string that is a text representation of the hexadecimal value of a 128-bit checksum.

Examples

The following example shows the 128-bit value for the string 'Amazon Redshift':

```
select md5('Amazon Redshift');
md5
-----
f7415e33f972c03abd4f3fed36748f7a
(1 row)
```

POSITION Function

Returns the location of the specified substring within a string.

Synonym of the [STRPOS Function \(p. 646\)](#) function.

Syntax

```
POSITION(substring IN string )
```

Arguments

substring

The substring to search for within the *string*.

string

The string or column to be searched.

Return Type

The POSITION function returns an integer corresponding to the position of the substring (one-based, not zero-based). The position is based on the number of characters, not bytes, so that multi-byte characters are counted as single characters.

Usage Notes

POSITION returns 0 if the substring is not found within the string:

```
select position('dog' in 'fish');

position
-----
0
(1 row)
```

Examples

The following example shows the position of the string `fish` within the word `dogfish`:

```
select position('fish' in 'dogfish');

position
-----
4
(1 row)
```

The following example returns the number of sales transactions with a COMMISSION over 999.00 from the SALES table:

```
select distinct position('.') in commission, count (position('.') in
  commission)
from sales where position('.') in commission) > 4 group by position('.') in
  commission)
order by 1,2;

position | count
-----+-----
5 | 629
```

```
(1 row)
```

QUOTE_IDENT Function

The QUOTE_IDENT function returns the specified string as a double quoted string so that it can be used as an identifier in a SQL statement. Appropriately doubles any embedded double quotes.

Syntax

```
QUOTE_IDENT(string)
```

Argument

string

The input parameter can be a CHAR or VARCHAR string.

Return Type

The QUOTE_IDENT function returns the same type string as the input parameter.

Example

The following example returns the CATNAME column surrounded by quotes:

```
select catid, quote_ident(catname)
from category
order by 1,2;
```

```
catid | quote_ident
-----+-----
1 | "MLB"
2 | "NHL"
3 | "NFL"
4 | "NBA"
5 | "MLS"
6 | "Musicals"
7 | "Plays"
8 | "Opera"
9 | "Pop"
10 | "Jazz"
11 | "Classical"
(11 rows)
```

QUOTE_LITERAL Function

The QUOTE_LITERAL function returns the specified string as a quoted string so that it can be used as a string literal in a SQL statement. If the input parameter is a number, QUOTE_LITERAL treats it as a string. Appropriately doubles any embedded single quotes and backslashes.

Syntax

```
QUOTE_LITERAL(string)
```

Argument

string

The input parameter is a CHAR or VARCHAR string.

Return Type

The QUOTE_LITERAL function returns a string that is the same data type as the input string (CHAR or VARCHAR).

Example

The following example returns the CATID column surrounded by quotes. Note that the ordering now treats this column as a string:

```
select quote_literal(catid), catname
from category
order by 1,2;
```

quote_literal	catname
'1'	MLB
'10'	Jazz
'11'	Classical
'2'	NHL
'3'	NFL
'4'	NBA
'5'	MLS
'6'	Musicals
'7'	Plays
'8'	Opera
'9'	Pop

(11 rows)

REGEXP_COUNT Function

Searches a string for a regular expression pattern and returns an integer that indicates the number of times the pattern occurs in the string. If no match is found, then the function returns 0. For more information about regular expressions, see [POSIX Operators \(p. 283\)](#).

Syntax

```
REGEXP_COUNT ( source_string, pattern [, position ] )
```

Arguments

source_string

A string expression, such as a column name, to be searched.

pattern

A string literal that represents a SQL standard regular expression pattern.

position

A positive integer that indicates the position within *source_string* to begin searching. The position is based on the number of characters, not bytes, so that multibyte characters are counted as single characters. The default is 1. If *position* is less than 1, the search begins at the first character of *source_string*. If *position* is greater than the number of characters in *source_string*, the result is 0.

Return Type

Integer

Example

The following example counts the number of times a three-letter sequence occurs.

```
select regexp_count('abcdefghijklmnopqrstuvwxy', '[a-z]{3}');

regexp_count
-----
8
(1 row)
```

The following example counts the number of times the top-level domain name is either `org` or `edu`.

```
select email, regexp_count(email, '@[^\.]*\.\.(org|edu)')
from users limit 5;
```

email	regexp_count
elementum@semperpretiumneque.ca	0
Integer.mollis.Integer@tristiquealiquet.org	1
lorem.ipsum@Vestibulumante.com	0
euismod@turpis.org	1
non.justo.Proin@ametconsectetuer.edu	1

REGEXP_INSTR Function

Searches a string for a regular expression pattern and returns an integer that indicates the beginning position of the matched substring. If no match is found, then the function returns 0. `REGEXP_INSTR` is similar to the [POSITION Function \(p. 634\)](#), but lets you search a string for a regular expression pattern. For more information about regular expressions, see [POSIX Operators \(p. 283\)](#).

Syntax

```
REGEXP_INSTR ( source_string, pattern [, position ] )
```

Arguments

source_string

A string expression, such as a column name, to be searched.

pattern

A string literal that represents a SQL standard regular expression pattern.

position

A positive integer that indicates the position within *source_string* to begin searching. The position is based on the number of characters, not bytes, so that multibyte characters are counted as single characters. The default is 1. If *position* is less than 1, the search begins at the first character of *source_string*. If *position* is greater than the number of characters in *source_string*, the result is 0.

Return Type

Integer

Example

The following example searches for the @ character that begins a domain name and returns the starting position of the first match.

```
select email, regexp_instr(email, '@[^\.]*')
from users
limit 5;
```

email	regexp_instr
Cum@accumsan.com	4
lorem.ipsu@Vestibulumante.com	12
non.justo.Proin@ametconsectetuer.edu	16
non.ante.bibendum@porttitorTellus.org	18
eros@blanditatnisi.org	5

(5 rows)

The following example searches for variants of the word Center and returns the starting position of the first match.

```
select venueName, regexp_instr(venueName, '[cC]ent(er|re)$')
from venue
where regexp_instr(venueName, '[cC]ent(er|re)$') > 0
limit 5;
```

venueName	regexp_instr
The Home Depot Center	16
Izod Center	6
Wachovia Center	10
Air Canada Centre	12
United Center	8

REGEXP_REPLACE Function

Searches a string for a regular expression pattern and replaces every occurrence of the pattern with the specified string. REGEXP_REPLACE is similar to the [REPLACE Function \(p. 642\)](#), but lets you search a string for a regular expression pattern. For more information about regular expressions, see [POSIX Operators \(p. 283\)](#).

REGEXP_REPLACE is similar to the [TRANSLATE Function \(p. 651\)](#) and the [REPLACE Function \(p. 642\)](#), except that TRANSLATE makes multiple single-character substitutions and REPLACE substitutes one entire string with another string, while REGEXP_REPLACE lets you search a string for a regular expression pattern.

Syntax

```
REGEXP_REPLACE ( source_string, pattern [, replace_string [ , position ] ] )
```

Arguments

source_string

A string expression, such as a column name, to be searched.

pattern

A string literal that represents a SQL standard regular expression pattern.

replace_string

A string expression, such as a column name, that will replace each occurrence of *pattern*. The default is an empty string ("").

position

A positive integer that indicates the position within *source_string* to begin searching. The position is based on the number of characters, not bytes, so that multibyte characters are counted as single characters. The default is 1. If *position* is less than 1, the search begins at the first character of *source_string*. If *position* is greater than the number of characters in *source_string*, the result is *source_string*.

Return Type

VARCHAR

If either *pattern* or *replace_string* is NULL, the return is NULL.

Example

The following example deletes the @ and domain name from email addresses.

```
select email, regexp_replace( email, '@.*\.(org|gov|com)$')
from users limit 5;
```

email	regexp_replace
DonecFri@semperpretiumneque.com	DonecFri
mklwait@UniOfTech.org	mklwait
sed@redshiftemails.com	sed
bunyung@integermath.gov	bunyung
tomsupporter@galaticmess.org	tomsupporter

The following example selects URLs from the fictional WEBSITES table and replaces the domain names with this value: internal.company.com/

```
select url, regexp_replace(url, '^.*\.[[:alpha:]]{3}/',
'internal.company.com/') from websites limit 4;
```

url	regexp_replace
example.com/cuisine/locations/home.html	internal.company.com/cuisine/locations/home.html
anycompany.employershere.com/employed/A/index.html	internal.company.com/employed/A/index.html
example.gov/credentials/keys/public	internal.company.com/credentials/keys/public
yourcompany.com/2014/Q1/summary.pdf	internal.company.com/2014/Q1/summary.pdf

REGEXP_SUBSTR Function

Returns the characters extracted from a string by searching for a regular expression pattern. REGEXP_SUBSTR is similar to the [SUBSTRING Function \(p. 648\)](#) function, but lets you search a string for a regular expression pattern. For more information about regular expressions, see [POSIX Operators \(p. 283\)](#).

Syntax

```
REGEXP_SUBSTR ( source_string, pattern [, position ] )
```

Arguments

source_string

A string expression, such as a column name, to be searched.

pattern

A string literal that represents a SQL standard regular expression pattern.

position

A positive integer that indicates the position within *source_string* to begin searching. The position is based on the number of characters, not bytes, so that multi-byte characters are counted as single characters. The default is 1. If *position* is less than 1, the search begins at the first character of *source_string*. If *position* is greater than the number of characters in *source_string*, the result is an empty string ("").

Return Type

VARCHAR

Example

The following example returns the portion of an email address between the @ character and the domain extension.

```
select email, regexp_substr(email,'@[^.]*')
from users limit 5;
```

email	regexp_substr
Suspendisse.tristique@nonnisiAenean.edu	@nonnisiAenean
sed@lacusUtneq.ca	@lacusUtneq
elementum@semperpretiumneque.ca	@semperpretiumneque
Integer.mollis.Integer@tristiquealiquet.org	@tristiquealiquet
Donec.fringilla@sodalesat.org	@sodalesat

REPEAT Function

Repeats a string the specified number of times. If the input parameter is numeric, REPEAT treats it as a string.

Synonym for [REPLICATE Function \(p. 643\)](#).

Syntax

```
REPEAT(string, integer)
```

Arguments

string

The first input parameter is the string to be repeated.

integer

The second parameter is an integer indicating the number of times to repeat the string.

Return Type

The REPEAT function returns a string.

Examples

The following example repeats the value of the CATID column in the CATEGORY table three times:

```
select catid, repeat(catid,3)
from category
order by 1,2;
```

```
catid | repeat
-----+-----
 1 | 111
 2 | 222
 3 | 333
 4 | 444
 5 | 555
 6 | 666
 7 | 777
 8 | 888
 9 | 999
10 | 101010
11 | 111111
(11 rows)
```

REPLACE Function

Replaces all occurrences of a set of characters within an existing string with other specified characters.

REPLACE is similar to the [TRANSLATE Function \(p. 651\)](#) and the [REGEXP_REPLACE Function \(p. 639\)](#), except that TRANSLATE makes multiple single-character substitutions and REGEXP_REPLACE lets you search a string for a regular expression pattern, while REPLACE substitutes one entire string with another string.

Syntax

```
REPLACE(string1, old_chars, new_chars)
```

Arguments

string

CHAR or VARCHAR string to be searched search

old_chars

CHAR or VARCHAR string to replace.

new_chars

New CHAR or VARCHAR string replacing the *old_string*.

Return Type

VARCHAR

If either *old_chars* or *new_chars* is NULL, the return is NULL.

Examples

The following example converts the string `Shows` to `Theatre` in the `CATGROUP` field:

```
select catid, catgroup,  
       replace(catgroup, 'Shows', 'Theatre')  
from category  
order by 1,2,3;
```

```
catid | catgroup | replace  
-----+-----+-----  
1 | Sports   | Sports  
2 | Sports   | Sports  
3 | Sports   | Sports  
4 | Sports   | Sports  
5 | Sports   | Sports  
6 | Shows    | Theatre  
7 | Shows    | Theatre  
8 | Shows    | Theatre  
9 | Concerts | Concerts  
10 | Concerts | Concerts  
11 | Concerts | Concerts  
(11 rows)
```

REPLICATE Function

Synonym for the REPEAT function.

See [REPEAT Function \(p. 641\)](#).

REVERSE Function

The REVERSE function operates on a string and returns the characters in reverse order. For example, `reverse('abcde')` returns `edcba`. This function works on numeric and date data types as well as character data types; however, in most cases it has practical value for character strings.

Syntax

```
REVERSE ( expression )
```

Argument

expression

An expression with a character, date, time stamp, or numeric data type that represents the target of the character reversal. All expressions are implicitly converted to variable-length character strings. Trailing blanks in fixed-width character strings are ignored.

Return Type

REVERSE returns a VARCHAR.

Examples

Select five distinct city names and their corresponding reversed names from the USERS table:

```
select distinct city as cityname, reverse(cityname)
from users order by city limit 5;
```

```
cityname | reverse
-----+-----
Aberdeen | needrebA
Abilene  | enelibA
Ada      | adA
Agat     | tagA
Agawam   | mawagA
(5 rows)
```

Select five sales IDs and their corresponding reversed IDs cast as character strings:

```
select salesid, reverse(salesid)::varchar
from sales order by salesid desc limit 5;
```

```
salesid | reverse
-----+-----
172456  | 654271
172455  | 554271
172454  | 454271
172453  | 354271
172452  | 254271
(5 rows)
```

RTRIM Function

The RTRIM function trims a specified set of characters from the end of a string.

Syntax

```
RTRIM( string, trim_chars )
```

Arguments

string

The string column or expression to be trimmed.

trim_chars

A string column or expression representing the characters to be trimmed from the end of *string*.

Return Type

A string that is the same data type as the *string* argument.

Example

The following example trims the characters 'Park' from the end of VENUENAME where present:

```
select venueid, venuename, rtrim(venuename, 'Park')
```



```
from venue
order by 1, 2, 3
limit 10;
```

venueid	venueName	rtrim
1	Toyota Park	Toyota
2	Columbus Crew Stadium	Columbus Crew Stadium
3	RFK Stadium	RFK Stadium
4	CommunityAmerica Ballpark	CommunityAmerica Ballp
5	Gillette Stadium	Gillette Stadium
6	New York Giants Stadium	New York Giants Stadium
7	BMO Field	BMO Field
8	The Home Depot Center	The Home Depot Cente
9	Dick's Sporting Goods Park	Dick's Sporting Goods
10	Pizza Hut Park	Pizza Hut

(10 rows)

Note that RTRIM removes any of the characters P, a, r, or k when they appear at the end of a VENUENAME.

SPLIT_PART Function

Splits a string on the specified delimiter and returns the part at the specified position.

Syntax

```
SPLIT_PART(string, delimiter, part)
```

Arguments

string

The string to be split. The string can be CHAR or VARCHAR.

delimiter

The delimiter string.

If *delimiter* is a literal, enclose it in single quotes.

part

Position of the portion to return (counting from 1). Must be an integer greater than 0. If *part* is larger than the number of string portions, SPLIT_PART returns an empty string.

Return Type

A CHAR or VARCHAR string, the same as the string parameter.

Examples

The following example splits the time stamp field LISTTIME into year, month, and date components.

```
select listtime, split_part(listtime,'-',1) as year,
split_part(listtime,'-',2) as month,
split_part(split_part(listtime,'-',3),' ',1) as date
from listing limit 5;
```

listtime	year	month	date
2008-03-05 12:25:29	2008	03	05
2008-09-09 08:03:36	2008	09	09
2008-09-26 05:43:12	2008	09	26
2008-10-04 02:00:30	2008	10	04
2008-01-06 08:33:11	2008	01	06

(5 rows)

The following example selects the LISTTIME time stamp field and splits it on the '-' character to get the month (the second part of the LISTTIME string), then counts the number of entries for each month:

```
select split_part(listtime,'-',2) as month, count(*)
from listing
group by split_part(listtime,'-',2)
order by 1, 2;
```

month	count
01	18543
02	16620
03	17594
04	16822
05	17618
06	17158
07	17626
08	17881
09	17378
10	17756
11	12912
12	4589

(12 rows)

STRPOS Function

Returns the position of a substring within a specified string.

Synonym of [CHARINDEX Function \(p. 622\)](#) and [POSITION Function \(p. 634\)](#).

Syntax

```
STRPOS(string, substring )
```

Arguments

string

The first input parameter is the string to be searched.

substring

The second parameter is the substring to search for within the *string*.

Return Type

The STRPOS function returns an integer corresponding to the position of the substring (one-based, not zero-based). The position is based on the number of characters, not bytes, so that multi-byte characters are counted as single characters.

Usage Notes

STRPOS returns 0 if the *substring* is not found within the *string*:

```
select strpos('dogfish', 'fist');
strpos
-----
0
(1 row)
```

Examples

The following example shows the position of the string `fish` within the word `dogfish`:

```
select strpos('dogfish', 'fish');
strpos
-----
4
(1 row)
```

The following example returns the number of sales transactions with a COMMISSION over 999.00 from the SALES table:

```
select distinct strpos(commission, '.'),
count (strpos(commission, '.'))
from sales
where strpos(commission, '.') > 4
group by strpos(commission, '.')
order by 1, 2;

strpos | count
-----+-----
5 | 629
(1 row)
```

STRTOL Function

Converts a string expression of a number of the specified base to the equivalent integer value. The converted value must be within the signed 64-bit range.

Syntax

```
STRTOL(num_string, base)
```

Arguments

num_string

String expression of a number to be converted. If *num_string* is empty (`' '`) or begins with the null character (`'\0'`), the converted value is 0. If *num_string* is a column containing a NULL value, STRTOL returns NULL. The string can begin with any amount of white space, optionally followed by a single plus '+' or minus '-' sign to indicate positive or negative. The default is '+'. If *base* is 16, the string can optionally begin with '0x'.

base

Integer between 2 and 36.

Return Type

BIGINT. If *num_string* is null, returns NULL.

Examples

The following examples convert string and base value pairs to integers:

```
select strtol('0xf',16);

  strtol
-----
      15
(1 row)

select strtol('abcd1234',16);
  strtol
-----
2882343476
(1 row)

select strtol('1234567', 10);
  strtol
-----
 1234567
(1 row)

select strtol('1234567', 8);
  strtol
-----
 342391
(1 row)

select strtol('110101', 2);
  strtol
-----
      53

select strtol('\0', 2);
  strtol
-----
      0
```

SUBSTRING Function

Returns the characters extracted from a string based on the specified character position for a specified number of characters.

The character position and number of characters are based on the number of characters, not bytes, so that multi-byte characters are counted as single characters. You cannot specify a negative length, but you can specify a negative starting position.

Syntax

```
SUBSTRING(string FROM start_position [ FOR number_characters ] )
```

```
SUBSTRING(string, start_position, number_characters )
```

Arguments

string

The string to be searched. Non-character data types are treated like a string.

start_position

The position within the string to begin the extraction, starting at 1. The *start_position* is based on the number of characters, not bytes, so that multi-byte characters are counted as single characters. This number can be negative.

number_characters

The number of characters to extract (the length of the substring). The *number_characters* is based on the number of characters, not bytes, so that multi-byte characters are counted as single characters. This number cannot be negative.

Return Type

VARCHAR

Usage Notes

The following example returns a four-character string beginning with the sixth character.

```
select substring('caterpillar',6,4);
substring
-----
pill
(1 row)
```

If the *start_position* + *number_characters* exceeds the length of the *string*, SUBSTRING returns a substring starting from the *start_position* until the end of the string. For example:

```
select substring('caterpillar',6,8);
substring
-----
pillar
(1 row)
```

If the *start_position* is negative or 0, the SUBSTRING function returns a substring beginning at the first character of string with a length of *start_position* + *number_characters* - 1. For example:

```
select substring('caterpillar',-2,6);
substring
-----
cat
(1 row)
```

If *start_position* + *number_characters* - 1 is less than or equal to zero, SUBSTRING returns an empty string. For example:

```
select substring('caterpillar',-5,4);
substring
```

```
-----  
(1 row)
```

Examples

The following example returns the month from the LISTTIME string in the LISTING table:

```
select listid, listtime,  
substring(listtime, 6, 2) as month  
from listing  
order by 1, 2, 3  
limit 10;
```

listid	listtime	month
1	2008-01-24 06:43:29	01
2	2008-03-05 12:25:29	03
3	2008-11-01 07:35:33	11
4	2008-05-24 01:18:37	05
5	2008-05-17 02:29:11	05
6	2008-08-15 02:08:13	08
7	2008-11-15 09:38:15	11
8	2008-11-09 05:07:30	11
9	2008-09-09 08:03:36	09
10	2008-06-17 09:44:54	06

(10 rows)

The following example is the same as above, but uses the FROM...FOR option:

```
select listid, listtime,  
substring(listtime from 6 for 2) as month  
from listing  
order by 1, 2, 3  
limit 10;
```

listid	listtime	month
1	2008-01-24 06:43:29	01
2	2008-03-05 12:25:29	03
3	2008-11-01 07:35:33	11
4	2008-05-24 01:18:37	05
5	2008-05-17 02:29:11	05
6	2008-08-15 02:08:13	08
7	2008-11-15 09:38:15	11
8	2008-11-09 05:07:30	11
9	2008-09-09 08:03:36	09
10	2008-06-17 09:44:54	06

(10 rows)

You cannot use SUBSTRING to predictably extract the prefix of a string that might contain multi-byte characters because you need to specify the length of a multi-byte string based on the number of bytes, not the number of characters. To extract the beginning segment of a string based on the length in bytes, you can CAST the string as VARCHAR(*byte_length*) to truncate the string, where *byte_length* is the required length. The following example extracts the first 5 bytes from the string 'Fourscore and seven'.

```
select cast('Fourscore and seven' as varchar(5));  
  
varchar  
-----  
Fours
```

TEXTLEN Function

Synonym of LEN function.

See [LEN Function \(p. 630\)](#).

TO_HEX Function

The TO_HEX function converts a number to its equivalent hexadecimal value.

Syntax

```
TO_HEX(string)
```

Arguments

string

The input parameter is a number to convert to its hexadecimal value.

Return Type

The TO_HEX function returns a hexadecimal value.

Examples

The following example shows the conversion of a number to its hexadecimal value:

```
select to_hex(2147676847);  
to_hex  
-----  
8002f2af  
(1 row)
```

TRANSLATE Function

For a given expression, replaces all occurrences of specified characters with specified substitutes. Existing characters are mapped to replacement characters by their positions in the *characters_to_replace* and *characters_to_substitute* arguments. If more characters are specified in the *characters_to_replace* argument than in the *characters_to_substitute* argument, the extra characters from the *characters_to_replace* argument are omitted in the return value.

TRANSLATE is similar to the [REPLACE Function \(p. 642\)](#) and the [REGEXP_REPLACE Function \(p. 639\)](#), except that REPLACE substitutes one entire string with another string and REGEXP_REPLACE lets you search a string for a regular expression pattern, while TRANSLATE makes multiple single-character substitutions.

If any argument is null, the return is NULL.

Syntax

```
TRANSLATE ( expression, characters_to_replace, characters_to_substitute )
```

Arguments

expression

The expression to be translated.

characters_to_replace

A string containing the characters to be replaced.

characters_to_substitute

A string containing the characters to substitute.

Return Type

VARCHAR

Examples

The following example replaces several characters in a string:

```
select translate('mint tea', 'inea', 'osin');

translate
-----
most tin
```

The following example replaces the at sign (@) with a period for all values in a column:

```
select email, translate(email, '@', '.') as obfuscated_email
from users limit 10;
```

email	obfuscated_email
Etiam.laoreet.libero@sodalesMaurisblandit.edu	Etiam.laoreet.libero.sodalesMaurisblandit.edu
amet.faucibus.ut@condimentumegetvolutpat.ca	amet.faucibus.ut.condimentumegetvolutpat.ca
turpis@accumsanlaoreet.org	turpis.accumsanlaoreet.org
ullamcorper.nisl@Cras.edu	ullamcorper.nisl.Cras.edu
arcu.Curabitur@senectusetnetus.com	arcu.Curabitur.senectusetnetus.com
ac@velit.ca	ac.velit.ca
Aliquam.vulputate.ullamcorper@amalesuada.org	Aliquam.vulputate.ullamcorper.amalesuada.org
vel.est@velitegestas.edu	vel.est.velitegestas.edu
dolor.nonummy@ipsumdolorsit.ca	dolor.nonummy.ipsumdolorsit.ca
et@Nunclaoreet.ca	et.Nunclaoreet.ca

The following example replaces spaces with underscores and strips out periods for all values in a column:

```
select city, translate(city, ' .', '_') from users
```



```
where city like 'Sain%' or city like 'St%'  
group by city  
order by city;
```

city	translate
Saint Albans	Saint_Albans
Saint Cloud	Saint_Cloud
Saint Joseph	Saint_Joseph
Saint Louis	Saint_Louis
Saint Paul	Saint_Paul
St. George	St_George
St. Marys	St_Marys
St. Petersburg	St_Petersburg
Stafford	Stafford
Stamford	Stamford
Stanton	Stanton
Starkville	Starkville
Statesboro	Statesboro
Staunton	Staunton
Steubenville	Steubenville
Stevens Point	Stevens_Point
Stillwater	Stillwater
Stockton	Stockton
Sturgis	Sturgis

TRIM Function

The TRIM function trims a string by removing leading and trailing blanks or by removing characters that match an optional specified string.

Syntax

```
TRIM( [ BOTH ] [ 'characters' FROM ] string )
```

Arguments

characters

(Optional) The characters to be trimmed from the string. If this parameter is omitted, blanks are trimmed.

string

The string to be trimmed.

Return Type

The TRIM function returns a VARCHAR or CHAR string. If you use the TRIM function with a SQL command, Amazon Redshift implicitly converts the results to VARCHAR. If you use the TRIM function in the SELECT list for a SQL function, Amazon Redshift does not implicitly convert the results, and you might need to perform an explicit conversion to avoid a data type mismatch error. See the [CAST and CONVERT Functions \(p. 658\)](#) and [CONVERT \(p. 658\)](#) functions for information about explicit conversions.

Example

The following example removes the double quotes that surround the string "dog":

```
select trim(' ' FROM 'dog');

btrim
-----
dog
(1 row)
```

UPPER Function

Converts a string to uppercase. UPPER supports UTF-8 multibyte characters, up to a maximum of four bytes per character.

Syntax

```
UPPER(string)
```

Arguments

string

The input parameter is a CHAR or VARCHAR string.

Return Type

The UPPER function returns a character string that is the same data type as the input string (CHAR or VARCHAR).

Examples

The following example converts the CATNAME field to uppercase:

```
select catname, upper(catname) from category order by 1,2;

catname | upper
-----+-----
Classical | CLASSICAL
Jazz      | JAZZ
MLB       | MLB
MLS       | MLS
Musicals  | MUSICALS
NBA       | NBA
NFL       | NFL
NHL       | NHL
Opera     | OPERA
Plays     | PLAYS
Pop       | POP
(11 rows)
```

JSON Functions

Topics

- [JSON_ARRAY_LENGTH Function \(p. 655\)](#)
- [JSON_EXTRACT_ARRAY_ELEMENT_TEXT Function \(p. 656\)](#)
- [JSON_EXTRACT_PATH_TEXT Function \(p. 657\)](#)

When you need to store a relatively small set of key-value pairs, you might save space by storing the data in JSON format. Because JSON strings can be stored in a single column, using JSON might be more efficient than storing your data in tabular format. For example, suppose you have a sparse table, where you need to have many columns to fully represent all possible attributes, but most of the column values are NULL for any given row or any given column. By using JSON for storage, you might be able to store the data for a row in key:value pairs in a single JSON string and eliminate the sparsely-populated table columns.

In addition, you can easily modify JSON strings to store additional key:value pairs without needing to add columns to a table.

We recommend using JSON sparingly. JSON is not a good choice for storing larger datasets because, by storing disparate data in a single column, JSON does not leverage Amazon Redshift's column store architecture.

JSON uses UTF-8 encoded text strings, so JSON strings can be stored as CHAR or VARCHAR data types. Use VARCHAR if the strings include multi-byte characters.

JSON strings must be properly formatted JSON, according to the following rules:

- The root level JSON can either be a JSON object or a JSON array. A JSON object is an unordered set of comma-separated key:value pairs enclosed by curly braces.

For example, `{"one":1, "two":2}`

- A JSON array is an ordered set of comma-separated values enclosed by square brackets.

For example, `["first", {"one":1}, "second", 3, null]`

- JSON arrays use a zero-based index; the first element in an array is at position 0. In a JSON key:value pair, the key is a double quoted string.
- A JSON value can be any of:
 - JSON object
 - JSON array
 - string (double quoted)
 - number (integer and float)
 - boolean
 - null
- Empty objects and empty arrays are valid JSON values.
- JSON fields are case sensitive.
- White space between JSON structural elements (such as `{ }`, `[]`) is ignored.

The Amazon Redshift JSON functions and the Amazon Redshift COPY command use the same methods to work with JSON-formatted data. For more information about working with JSON, see [COPY from JSON Format \(p. 352\)](#)

JSON_ARRAY_LENGTH Function

JSON_ARRAY_LENGTH returns the number of elements in the outer array of a JSON string.

For more information, see [JSON Functions \(p. 654\)](#).

Syntax

```
json_array_length('json_array')
```

Arguments

json_array

A properly formatted JSON array.

Return Type

An integer representing the number of elements in the outermost array.

Example

The following example returns the number of elements in the array:

```
select json_array_length('[11,12,13,{"f1":21,"f2":[25,26]},14]');
json_array_length
-----
5
```

JSON_EXTRACT_ARRAY_ELEMENT_TEXT Function

This function returns a JSON array element in the outermost array of a JSON string, using a zero-based index. The first element in an array is at position 0. If the index is negative or out of bound, `JSON_EXTRACT_ARRAY_ELEMENT_TEXT` returns empty string.

For more information, see [JSON Functions \(p. 654\)](#).

Syntax

```
json_extract_array_element_text('json string', pos)
```

Arguments

json_string

A properly formatted JSON string.

pos

An integer representing the index of the array element to be returned, using a zero-based array index.

Return Type

A VARCHAR string representing the JSON array element referenced by *pos*.

Example

The following example returns array element at position 2:

```
select json_extract_array_element_text('[111,112,113]', 2);
json_extract_array_element_text
-----
113
```

JSON_EXTRACT_PATH_TEXT Function

JSON_EXTRACT_PATH_TEXT returns the value for the *key:value* pair referenced by a series of path elements in a JSON string. The JSON path can be nested up to five levels deep. Path elements are case-sensitive. If a path element does not exist in the JSON string, JSON_EXTRACT_PATH_TEXT returns an empty string.

For more information, see [JSON Functions \(p. 654\)](#).

Syntax

```
json_extract_path_text('json_string', 'path_elem' [, 'path_elem' [, ...]])
```

Arguments

json_string

A properly formatted JSON string.

path_elem

A path element in a JSON string. One path element is required. Additional path elements can be specified, up to five levels deep.

In a JSON string, Amazon Redshift recognizes `\n` as a newline character and `\t` as a tab character. To load a backslash, escape it with a backslash (`\\`). For more information, see [Escape Characters in JSON \(p. 354\)](#).

Return Type

VARCHAR string representing the JSON value referenced by the path elements.

Example

The following example returns the value for the path `'f4', 'f6'`:

```
select json_extract_path_text('{ "f2": {"f3": 1}, "f4":  
{"f5": 99, "f6": "star"} }', 'f4', 'f6');  
  
json_extract_path_text  
-----  
star
```

Data Type Formatting Functions

Topics

- [CAST and CONVERT Functions \(p. 658\)](#)
- [TO_CHAR \(p. 661\)](#)
- [TO_DATE \(p. 663\)](#)
- [TO_NUMBER \(p. 664\)](#)
- [Datetime Format Strings \(p. 665\)](#)
- [Numeric Format Strings \(p. 666\)](#)

Data type formatting functions provide an easy way to convert values from one data type to another. For each of these functions, the first argument is always the value to be formatted and the second

argument contains the template for the new format. Amazon Redshift supports several data type formatting functions.

CAST and CONVERT Functions

You can do run-time conversions between compatible data types by using the CAST and CONVERT functions.

Certain data types require an explicit conversion to other data types using the CAST or CONVERT function. Other data types can be converted implicitly, as part of another command, without using the CAST or CONVERT function. See [Type Compatibility and Conversion \(p. 266\)](#).

CAST

You can use two equivalent syntax forms to cast expressions from one data type to another:

```
CAST ( expression AS type )  
expression :: type
```

Arguments

expression

An expression that evaluates to one or more values, such as a column name or a literal. Converting null values returns nulls. The expression cannot contain blank or empty strings.

type

One of the supported [Data Types \(p. 247\)](#).

Return Type

CAST returns the data type specified by the *type* argument.

Note

Amazon Redshift returns an error if you try to perform a problematic conversion such as the following DECIMAL conversion that loses precision:

```
select 123.456::decimal(2,1);
```

or an INTEGER conversion that causes an overflow:

```
select 12345678::smallint;
```

CONVERT

You can also use the CONVERT function to convert values from one data type to another:

```
CONVERT ( type, expression )
```

Arguments

type

One of the supported [Data Types \(p. 247\)](#).

expression

An expression that evaluates to one or more values, such as a column name or a literal.
Converting null values returns nulls. The expression cannot contain blank or empty strings.

Return Type

CONVERT returns the data type specified by the *type* argument.

Examples

The following two queries are equivalent. They both cast a decimal value to an integer:

```
select cast(pricepaid as integer)
from sales where salesid=100;
```

```
pricepaid
-----
162
(1 row)
```

```
select pricepaid::integer
from sales where salesid=100;
```

```
pricepaid
-----
162
(1 row)
```

The following query uses the CONVERT function to return the same result:

```
select convert(integer, pricepaid)
from sales where salesid=100;
```

```
pricepaid
-----
162
(1 row)
```

In this example, the values in a time stamp column are cast as dates:

```
select cast(saletime as date), salesid
from sales order by salesid limit 10;
```

```
saletime | salesid
-----+-----
2008-02-18 |      1
2008-06-06 |      2
2008-06-06 |      3
2008-06-09 |      4
2008-08-31 |      5
2008-07-16 |      6
2008-06-26 |      7
2008-07-10 |      8
2008-07-22 |      9
```

```
2008-08-06 |      10  
(10 rows)
```

In this example, the values in a date column are cast as time stamps:

```
select cast(caldate as timestamp), dateid  
from date order by dateid limit 10;
```

```
caldate          | dateid  
-----+-----  
2008-01-01 00:00:00 | 1827  
2008-01-02 00:00:00 | 1828  
2008-01-03 00:00:00 | 1829  
2008-01-04 00:00:00 | 1830  
2008-01-05 00:00:00 | 1831  
2008-01-06 00:00:00 | 1832  
2008-01-07 00:00:00 | 1833  
2008-01-08 00:00:00 | 1834  
2008-01-09 00:00:00 | 1835  
2008-01-10 00:00:00 | 1836  
(10 rows)
```

In this example, an integer is cast as a character string:

```
select cast(2008 as char(4));  
bpchar  
-----  
2008
```

In this example, a DECIMAL(6,3) value is cast as a DECIMAL(4,1) value:

```
select cast(109.652 as decimal(4,1));  
numeric  
-----  
109.7
```

In this example, the PRICEPAID column (a DECIMAL(8,2) column) in the SALES table is converted to a DECIMAL(38,2) column and the values are multiplied by 10000000000000000000.

```
select salesid, pricepaid::decimal(38,2)*10000000000000000000  
as value from sales where salesid<10 order by salesid;
```

```
salesid | value  
-----+-----  
1 | 7280000000000000000000000000.00  
2 | 7600000000000000000000000000.00  
3 | 3500000000000000000000000000.00  
4 | 1750000000000000000000000000.00  
5 | 1540000000000000000000000000.00  
6 | 3940000000000000000000000000.00  
7 | 7880000000000000000000000000.00  
8 | 1970000000000000000000000000.00  
9 | 5910000000000000000000000000.00  
(9 rows)
```

TO_CHAR

TO_CHAR converts a time stamp or numeric expression to a character-string data format.

Syntax

```
TO_CHAR (timestamp_expression | numeric_expression , 'format')
```

Arguments

timestamp_expression

An expression that results in a TIMESTAMP or TIMESTAMPTZ type value or a value that can implicitly be coerced to a time stamp.

numeric_expression

An expression that results in a numeric data type value or a value that can implicitly be coerced to a numeric type. For more information, see [Numeric Types \(p. 249\)](#).

Note

TO_CHAR does not support 128-bit DECIMAL values.

format

The format for the new value. For valid formats, see [Datetime Format Strings \(p. 665\)](#) and [Numeric Format Strings \(p. 666\)](#).

Return Type

VARCHAR

Examples

The following example converts each STARTTIME value in the EVENT table to a string that consists of hours, minutes, and seconds:

```
select to_char(starttime, 'HH12:MI:SS')
from event where eventid between 1 and 5
order by eventid;
```

```
to_char
-----
02:30:00
08:00:00
02:30:00
02:30:00
07:00:00
(5 rows)
```

The following example converts an entire time stamp value into a different format:

```
select starttime, to_char(starttime, 'MON-DD-YYYY HH12:MIPM')
from event where eventid=1;
```

```
starttime          |          to_char
-----+-----
2008-01-25 14:30:00 | JAN-25-2008 02:30PM
(1 row)
```

The following example converts a time stamp literal to a character string:

```
select to_char(timestamp '2009-12-31 23:15:59', 'HH24:MI:SS');
to_char
-----
23:15:59
(1 row)
```

The following example converts an integer to a character string:

```
select to_char(-125.8, '999D99S');
to_char
-----
125.80-
(1 row)
```

The following example subtracts the commission from the price paid in the sales table. The difference is then rounded up and converted to a roman numeral, shown in the to_char column:

```
select salesid, pricepaid, commission, (pricepaid - commission)
as difference, to_char(pricepaid - commission, 'rn') from sales
group by sales.pricepaid, sales.commission, salesid
order by salesid limit 10;
```

salesid	pricepaid	commission	difference	to_char
1	728.00	109.20	618.80	dcxix
2	76.00	11.40	64.60	lxv
3	350.00	52.50	297.50	ccxcviii
4	175.00	26.25	148.75	cxlix
5	154.00	23.10	130.90	cxxxi
6	394.00	59.10	334.90	cccxxxv
7	788.00	118.20	669.80	dclxx
8	197.00	29.55	167.45	clxvii
9	591.00	88.65	502.35	dii
10	65.00	9.75	55.25	lv

(10 rows)

The following example adds the currency symbol to the difference values shown in the to_char column:

```
select salesid, pricepaid, commission, (pricepaid - commission)
as difference, to_char(pricepaid - commission, 'l99999D99') from sales
group by sales.pricepaid, sales.commission, salesid
order by salesid limit 10;
```

salesid	pricepaid	commission	difference	to_char
1	728.00	109.20	618.80	\$ 618.80
2	76.00	11.40	64.60	\$ 64.60
3	350.00	52.50	297.50	\$ 297.50
4	175.00	26.25	148.75	\$ 148.75
5	154.00	23.10	130.90	\$ 130.90
6	394.00	59.10	334.90	\$ 334.90
7	788.00	118.20	669.80	\$ 669.80
8	197.00	29.55	167.45	\$ 167.45
9	591.00	88.65	502.35	\$ 502.35

```
10 |      65.00 |      9.75 |      55.25 | $      55.25  
(10 rows)
```

The following example lists the century in which each sale was made.

```
select salesid, saletime, to_char(saletime, 'cc') from sales  
order by salesid limit 10;
```

```
salesid |      saletime      | to_char  
-----+-----+-----  
      1 | 2008-02-18 02:36:48 | 21  
      2 | 2008-06-06 05:00:16 | 21  
      3 | 2008-06-06 08:26:17 | 21  
      4 | 2008-06-09 08:38:52 | 21  
      5 | 2008-08-31 09:17:02 | 21  
      6 | 2008-07-16 11:59:24 | 21  
      7 | 2008-06-26 12:56:06 | 21  
      8 | 2008-07-10 02:12:36 | 21  
      9 | 2008-07-22 02:23:17 | 21  
     10 | 2008-08-06 02:51:55 | 21  
(10 rows)
```

The following example converts each STARTTIME value in the EVENT table to a string that consists of hours, minutes, seconds, and time zone.

```
select to_char(starttime, 'HH12:MI:SS TZ')  
from event where eventid between 1 and 5  
order by eventid;
```

```
to_char  
-----  
02:30:00 UTC  
08:00:00 UTC  
02:30:00 UTC  
02:30:00 UTC  
07:00:00 UTC  
(5 rows)  
  
(10 rows)
```

TO_DATE

TO_DATE converts a date represented in a character string to a DATE data type.

The second argument is a format string that indicates how the character string should be parsed to create the date value.

Syntax

```
TO_DATE (string, format)
```

Arguments

string

String to be converted.

format

A string literal that defines the format of the string to be converted, in terms of its date parts. For a list of valid formats, see [Datetime Format Strings \(p. 665\)](#).

Return Type

TO_DATE returns a DATE, depending on the *format* value.

Example

The following command converts the date 02 Oct 2001 into the default date format:

```
select to_date ('02 Oct 2001', 'DD Mon YYYY');

to_date
-----
2001-10-02
(1 row)
```

TO_NUMBER

TO_NUMBER converts a string to a numeric (decimal) value.

Syntax

```
to_number(string, format)
```

Arguments

string

String to be converted. The format must be a literal value.

format

The second argument is a format string that indicates how the character string should be parsed to create the numeric value. For example, the format '99D999' specifies that the string to be converted consists of five digits with the decimal point in the third position. For example, `to_number('12.345', '99D999')` returns 12.345 as a numeric value. For a list of valid formats, see [Numeric Format Strings \(p. 666\)](#).

Return Type

TO_NUMBER returns a DECIMAL number.

Examples

The following example converts the string 12,454.8- to a number:

```
select to_number('12,454.8-', '99G999D9S');

to_number
-----
-12454.8
(1 row)
```

Datetime Format Strings

You can find a reference for datetime format strings following.

The following format strings apply to functions such as TO_CHAR. These strings can contain datetime separators (such as '-', '/', or ':') and the following "dateparts" and "timeparts".

Datepart or Timepart	Meaning
BC or B.C., AD or A.D., b.c. or bc, ad or a.d.	Upper and lowercase era indicators
CC	Two-digit century number
YYYY, YYY, YY, Y	4-digit, 3-digit, 2-digit, 1-digit year number
Y,YYYY	4-digit year number with comma
IYYY, IYY, IY, I	4-digit, 3-digit, 2-digit, 1-digit International Organization for Standardization (ISO) year number
Q	Quarter number (1 to 4)
MONTH, Month, month	Month name (uppercase, mixed-case, lowercase, blank-padded to 9 characters)
MON, Mon, mon	Abbreviated month name (uppercase, mixed-case, lowercase, blank-padded to 9 characters)
MM	Month number (01-12)
RM, rm	Month number in Roman numerals (I–XII, with I being January, uppercase or lowercase)
W	Week of month (1–5; the first week starts on the first day of the month.)
WW	Week number of year (1–53; the first week starts on the first day of the year.)
IW	ISO week number of year (the first Thursday of the new year is in week 1.)
DAY, Day, day	Day name (uppercase, mixed-case, lowercase, blank-padded to 9 characters)
DY, Dy, dy	Abbreviated day name (uppercase, mixed-case, lowercase, blank-padded to 9 characters)
DDD	Day of year (001–366)
DD	Day of month as a number (01–31)
D	Day of week (1–7; Sunday is 1) Note The D datepart behaves differently from the day of week (DOW) datepart used for the datetime functions DATE_PART and EXTRACT. DOW is based on integers 0–6, where Sunday is 0. For more information,

Datepart or Timepart	Meaning
	see Dateparts for Date or Time Stamp Functions (p. 590) .
J	Julian day (days since January 1, 4712 BC)
HH24	Hour (24-hour clock, 00–23)
HH or HH12	Hour (12-hour clock, 01–12)
MI	Minutes (00–59)
SS	Seconds (00–59)
MS	Milliseconds (.000)
US	Microseconds (.000000)
AM or PM, A.M. or P.M., a.m. or p.m., am or pm	Upper and lowercase meridian indicators (for 12-hour clock)
TZ, tz	Upper and lowercase time zone abbreviation; valid for TIMESTAMPTZ only
OF	Offset from UTC; valid for TIMESTAMPTZ only

The following example shows formatting for seconds, milliseconds, and microseconds.

```
select sysdate,
to_char(sysdate, 'HH24:MI:SS') as seconds,
to_char(sysdate, 'HH24:MI:SS.MS') as milliseconds,
to_char(sysdate, 'HH24:MI:SS.US') as microseconds;

timestamp          | seconds | milliseconds | microseconds
-----+-----+-----+-----
2015-04-10 18:45:09 | 18:45:09 | 18:45:09.325 | 18:45:09:325143
```

Numeric Format Strings

This topic provides a reference for numeric format strings.

The following format strings apply to functions such as TO_NUMBER and TO_CHAR:

Format	Description
9	Numeric value with the specified number of digits.
0	Numeric value with leading zeros.
. (period), D	Decimal point.
, (comma)	Thousands separator.
CC	Century code. For example, the 21st century started on 2001-01-01 (supported for TO_CHAR only).
FM	Fill mode. Suppress padding blanks and zeroes.

Format	Description
PR	Negative value in angle brackets.
S	Sign anchored to a number.
L	Currency symbol in the specified position.
G	Group separator.
MI	Minus sign in the specified position for numbers that are less than 0.
PL	Plus sign in the specified position for numbers that are greater than 0.
SG	Plus or minus sign in the specified position.
RN	Roman numeral between 1 and 3999 (supported for TO_CHAR only).
TH or th	Ordinal number suffix. Does not convert fractional numbers or values that are less than zero.

System Administration Functions

Topics

- [CURRENT_SETTING](#) (p. 667)
- [PG_CANCEL_BACKEND](#) (p. 668)
- [PG_TERMINATE_BACKEND](#) (p. 669)
- [SET_CONFIG](#) (p. 670)

Amazon Redshift supports several system administration functions.

CURRENT_SETTING

`CURRENT_SETTING` returns the current value of the specified configuration parameter.

This function is equivalent to the [SHOW](#) (p. 469) command.

Syntax

```
current_setting('parameter')
```

Argument

parameter

Parameter value to display. For a list of configuration parameters, see [Configuration Reference](#) (p. 809)

Return Type

Returns a CHAR or VARCHAR string.

Example

The following query returns the current setting for the `query_group` parameter:

```
select current_setting('query_group');

current_setting
-----
unset
(1 row)
```

PG_CANCEL_BACKEND

Cancel a query. `PG_CANCEL_BACKEND` is functionally equivalent to the [CANCEL \(p. 313\)](#) command. You can cancel queries currently being run by your user. Superusers can cancel any query.

Syntax

```
pg_cancel_backend( pid )
```

Arguments

pid

The process ID (PID) of the query to be canceled. You cannot cancel a query by specifying a query ID; you must specify the query's process ID. Requires an integer value.

Return Type

None

Usage Notes

If queries in multiple sessions hold locks on the same table, you can use the [PG_TERMINATE_BACKEND \(p. 669\)](#) function to terminate one of the sessions, which forces any currently running transactions in the terminated session to release all locks and roll back the transaction. Query the [STV_LOCKS \(p. 760\)](#) system table to view currently held locks. If you cannot cancel a query because it is in transaction block (BEGIN ... END), you can terminate the session in which the query is running by using the `PG_TERMINATE_BACKEND` function.

Examples

To cancel a currently running query, first retrieve the process ID for the query that you want to cancel. To determine the process IDs for all currently running queries, execute the following command:

```
select pid, trim(starttime) as start,
duration, trim(user_name) as user,
substring (query,1,40) as querytxt
from stv_recents
where status = 'Running';

 pid |          starttime          | duration | user  | querytxt
-----+-----+-----+-----+-----
+-----+-----+-----+-----+-----
 802 | 2013-10-14 09:19:03.55 |      132 | dwuser | select venue name from
venue
```



```
834 | 2013-10-14 08:33:49.47 | 1250414 | dwuser | select * from listing;  
964 | 2013-10-14 08:30:43.29 | 326179 | dwuser | select sellerid from  
sales
```

The following statement cancels the query with process ID 802:

```
select pg_cancel_backend(802);
```

PG_TERMINATE_BACKEND

Terminates a session. You can terminate a session owned by your user. A superuser can terminate any session.

Syntax

```
pg_terminate_backend( pid )
```

Arguments

pid

The process ID of the session to be terminated. Requires an integer value.

Return Type

None

Usage Notes

If you are close to reaching the limit for concurrent connections, use `PG_TERMINATE_BACKEND` to terminate idle sessions and free up the connections. For more information, see [Limits in Amazon Redshift](#).

If queries in multiple sessions hold locks on the same table, you can use `PG_TERMINATE_BACKEND` to terminate one of the sessions, which forces any currently running transactions in the terminated session to release all locks and roll back the transaction. Query the `STV_LOCKS` system table to view currently held locks.

If a query is not in a transaction block (`BEGIN ... END`), you can cancel the query by using the [CANCEL \(p. 313\)](#) command or the [PG_CANCEL_BACKEND \(p. 668\)](#) function.

Examples

The following statement queries the `STV_LOCKS` table to view all locks in effect for current transactions:

```
select table_id, last_update, lock_owner, lock_owner_pid, lock_status  
from stv_locks;
```

table_id	last_update	lock_owner	lock_owner_pid	lock_status
100295	2014-01-06 23:50:56.290917	95402	7723	Holding write lock

```
100304 | 2014-01-06 23:50:57.408457 |          95402 |          7723 |
Holding write lock
100304 | 2014-01-06 23:50:57.409986 |          95402 |          7723 |
Holding insert lock
(3 rows)
```

The following statement terminates the session holding the locks:

```
select pg_terminate_backend(7723);
```

SET_CONFIG

Sets a configuration parameter to a new setting.

This function is equivalent to the SET command in SQL.

Syntax

```
set_config('parameter', 'new_value' , is_local)
```

Arguments

parameter

Parameter to set.

new_value

New value of the parameter.

is_local

If true, parameter value applies only to the current transaction. Valid values are `true` or `1` and `false` or `0`.

Return Type

Returns a CHAR or VARCHAR string.

Examples

The following query sets the value of the `query_group` parameter to `test` for the current transaction only:

```
select set_config('query_group', 'test', true);

set_config
-----
test
(1 row)
```

System Information Functions

Topics

- [CURRENT_DATABASE](#) (p. 671)
- [CURRENT_SCHEMA](#) (p. 671)
- [CURRENT_SCHEMAS](#) (p. 672)

- [CURRENT_USER](#) (p. 673)
- [CURRENT_USER_ID](#) (p. 673)
- [HAS_DATABASE_PRIVILEGE](#) (p. 674)
- [HAS_SCHEMA_PRIVILEGE](#) (p. 674)
- [HAS_TABLE_PRIVILEGE](#) (p. 675)
- [PG_BACKEND_PID\(\)](#) (p. 676)
- [PG_LAST_COPY_COUNT\(\)](#) (p. 677)
- [PG_LAST_COPY_ID\(\)](#) (p. 678)
- [PG_LAST_QUERY_ID\(\)](#) (p. 679)
- [PG_LAST_UNLOAD_COUNT\(\)](#) (p. 679)
- [SESSION_USER](#) (p. 680)
- [SLICE_NUM](#) Function (p. 680)
- [USER](#) (p. 681)
- [VERSION\(\)](#) (p. 681)

Amazon Redshift supports numerous system information functions.

CURRENT_DATABASE

Returns the name of the database where you are currently connected.

Syntax

```
current_database()
```

Return Type

Returns a CHAR or VARCHAR string.

Example

The following query returns the name of the current database:

```
select current_database();

current_database
-----
tickit
(1 row)
```

CURRENT_SCHEMA

Returns the name of the schema at the front of the search path. This schema will be used for any tables or other named objects that are created without specifying a target schema.

Syntax

Note

This is a leader-node function. This function returns an error if it references a user-created table, an STL or STV system table, or an SVV or SVL system view.

```
current_schema()
```

Return Type

CURRENT_SCHEMA returns a CHAR or VARCHAR string.

Examples

The following query returns the current schema:

```
select current_schema();

current_schema
-----
public
(1 row)
```

CURRENT_SCHEMAS

Returns an array of the names of any schemas in the current search path. The current search path is defined in the `search_path` parameter.

Syntax

Note

This is a leader-node function. This function returns an error if it references a user-created table, an STL or STV system table, or an SVV or SVL system view.

```
current_schemas(include_implicit)
```

Argument

include_implicit

If true, specifies that the search path should include any implicitly included system schemas. Valid values are `true` and `false`. Typically, if `true`, this parameter returns the `pg_catalog` schema in addition to the current schema.

Return Type

Returns a CHAR or VARCHAR string.

Examples

The following example returns the names of the schemas in the current search path, not including implicitly included system schemas:

```
select current_schemas(false);

current_schemas
-----
{public}
(1 row)
```

The following example returns the names of the schemas in the current search path, including implicitly included system schemas:

```
select current_schemas(true);

current_schemas
-----
{pg_catalog,public}
(1 row)
```

CURRENT_USER

Returns the user name of the current "effective" user of the database, as applicable to checking permissions. Usually, this user name will be the same as the session user; however, this can occasionally be changed by superusers.

Note

Do not use trailing parentheses when calling CURRENT_USER.

Syntax

```
current_user
```

Return Type

CURRENT_USER returns a CHAR or VARCHAR string.

Example

The following query returns the name of the current database user:

```
select current_user;

current_user
-----
dwuser
(1 row)
```

CURRENT_USER_ID

Returns the unique identifier for the Amazon Redshift user logged in to the current session.

Syntax

```
CURRENT_USER_ID
```

Return Type

The CURRENT_USER_ID function returns an integer.

Examples

The following example returns the user name and current user ID for this session:

```
select user, current_user_id;

current_user | current_user_id
-----+-----
dwuser      |                1
(1 row)
```

HAS_DATABASE_PRIVILEGE

Returns `true` if the user has the specified privilege for the specified database. For more information about privileges, see [GRANT \(p. 420\)](#).

Syntax

Note

This is a leader-node function. This function returns an error if it references a user-created table, an STL or STV system table, or an SVV or SVL system view.

```
has_database_privilege( [ user, ] database, privilege)
```

Arguments

user

Name of the user to check for database privileges. Default is to check the current user.

database

Database associated with the privilege.

privilege

Privilege to check. Valid values are:

- CREATE
- TEMPORARY
- TEMP

Return Type

Returns a CHAR or VARCHAR string.

Example

The following query confirms that the GUEST user has the TEMP privilege on the TICKIT database:

```
select has_database_privilege('guest', 'ticket', 'temp');

has_database_privilege
-----
true
(1 row)
```

HAS_SCHEMA_PRIVILEGE

Returns `true` if the user has the specified privilege for the specified schema. For more information about privileges, see [GRANT \(p. 420\)](#).

Syntax

Note

This is a leader-node function. This function returns an error if it references a user-created table, an STL or STV system table, or an SVV or SVL system view.

```
has_schema_privilege( [ user, ] schema, privilege)
```

Arguments

user

Name of the user to check for schema privileges. Default is to check the current user.

schema

Schema associated with the privilege.

privilege

Privilege to check. Valid values are:

- CREATE
- USAGE

Return Type

Returns a CHAR or VARCHAR string.

Example

The following query confirms that the GUEST user has the CREATE privilege on the PUBLIC schema:

```
select has_schema_privilege('guest', 'public', 'create');  
  
has_schema_privilege  
-----  
true  
(1 row)
```

HAS_TABLE_PRIVILEGE

Returns `true` if the user has the specified privilege for the specified table.

Syntax

Note

This is a leader-node function. This function returns an error if it references a user-created table, an STL or STV system table, or an SVV or SVL system view. For more information about privileges, see [GRANT \(p. 420\)](#).

```
has_table_privilege( [ user, ] table, privilege)
```

Arguments

user

Name of the user to check for table privileges. The default is to check the current user.

table

Table associated with the privilege.

privilege

Privilege to check. Valid values are:

- SELECT
- INSERT
- UPDATE
- DELETE
- REFERENCES

Return Type

Returns a CHAR or VARCHAR string.

Examples

The following query finds that the GUEST user does not have SELECT privilege on the LISTING table:

```
select has_table_privilege('guest', 'listing', 'select');

has_table_privilege
-----
false
(1 row)
```

PG_BACKEND_PID()

Returns the process ID (PID) of the server process handling the current session.

Note

The PID is not globally unique. It can be reused over time.

Syntax

```
pg_backend_pid()
```

Return Type

Returns an integer.

Example

You can correlate PG_BACKEND_PID() with log tables to retrieve information for the current session. For example, the following query returns the query ID and a portion of the query text for queries executed in the current session.

```
select query, substring(text,1,40)
from stl_querytext
where pid = PG_BACKEND_PID()
order by query desc;
```

query	substring
14831	select query, substring(text,1,40) from
14827	select query, substring(path,0,80) as pa

```
14826 | copy category from 's3://dw-tickit/manif
14825 | Count rows in target table
14824 | unload ('select * from category') to 's3
(5 rows)
```

You can correlate PG_BACKEND_PID() with the pid column in the following log tables (exceptions are noted in parentheses):

- [STL_CONNECTION_LOG](#) (p. 695)
- [STL_DDLTEXT](#) (p. 696)
- [STL_ERROR](#) (p. 701)
- [STL_QUERY](#) (p. 724)
- [STL_QUERYTEXT](#) (p. 726)
- [STL_SESSIONS](#) (p. 736) (process)
- [STL_TR_CONFLICT](#) (p. 739)
- [STL_UTILITYTEXT](#) (p. 744)
- [STL_WARNING](#) (p. 748)
- [STV_ACTIVE_CURSORS](#) (p. 753)
- [STV_INFLIGHT](#) (p. 758)
- [STV_LOCKS](#) (p. 760) (lock_owner_pid)
- [STV_RECENTS](#) (p. 762) (process_id)

PG_LAST_COPY_COUNT()

Returns the number of rows that were loaded by the last COPY command executed in the current session. PG_LAST_COPY_COUNT is updated with the last COPY ID, which is the query ID of the last COPY that began the load process, even if the load failed. The query ID and COPY ID are updated when the COPY command begins the load process.

If the COPY fails because of a syntax error or because of insufficient privileges, the COPY ID is not updated and PG_LAST_COPY_COUNT returns the count for the previous COPY. If no COPY commands were executed in the current session, or if the last COPY failed during loading, PG_LAST_COPY_COUNT returns 0. For more information, see [PG_LAST_COPY_ID\(\)](#) (p. 678).

Syntax

```
pg_last_copy_count()
```

Return Type

Returns BIGINT.

Example

The following query returns the number of rows loaded by the latest COPY command in the current session.

```
select pg_last_copy_count();

pg_last_copy_count
-----
                192497
```

```
(1 row)
```

PG_LAST_COPY_ID()

Returns the query ID of the most recently executed COPY command in the current session. If no COPY commands have been executed in the current session, PG_LAST_COPY_ID returns -1.

The value for PG_LAST_COPY_ID is updated when the COPY command begins the load process. If the COPY fails because of invalid load data, the COPY ID is updated, so you can use PG_LAST_COPY_ID when you query STL_LOAD_ERRORS table. If the COPY transaction is rolled back, the COPY ID is not updated.

The COPY ID is not updated if the COPY command fails because of an error that occurs before the load process begins, such as a syntax error, access error, invalid credentials, or insufficient privileges. The COPY ID is not updated if the COPY fails during the analyze compression step, which begins after a successful connection, but before the data load. COPY performs compression analysis when the COMPUPDATE parameter is set to ON or when the target table is empty and all the table columns either have RAW encoding or no encoding.

Syntax

```
pg_last_copy_id()
```

Return Type

Returns an integer.

Example

The following query returns the query ID of the latest COPY command in the current session.

```
select pg_last_copy_id();

pg_last_copy_id
-----
              5437
(1 row)
```

The following query joins STL_LOAD_ERRORS to STL_LOADERROR_DETAIL to view the details errors that occurred during the most recent load in the current session:

```
select d.query, substring(d.filename,14,20),
d.line_number as line,
substring(d.value,1,16) as value,
substring(le.err_reason,1,48) as err_reason
from stl_loadererror_detail d, stl_load_errors le
where d.query = le.query
and d.query = pg_last_copy_id();
```

query	substring	line	value	err_reason
558	allusers_pipe.txt	251	251	String contains invalid or unsupported UTF8 code
558	allusers_pipe.txt	251	ZRU29FGR	String contains invalid or unsupported UTF8 code
558	allusers_pipe.txt	251	Kaitlin	String contains invalid or

```
558| allusers_pipe.txt | 251 | Walter | unsupported UTF8 code  
String contains invalid or  
unsupported UTF8 code
```

PG_LAST_QUERY_ID()

Returns the query ID of the most recently executed query in the current session. If no queries have been executed in the current session, PG_LAST_QUERY_ID returns -1. PG_LAST_QUERY_ID does not return the query ID for queries that execute exclusively on the leader node. For more information, see [Leader Node–Only Functions](#) (p. 492).

Syntax

```
pg_last_query_id()
```

Return Type

Returns an integer.

Example

The following query returns the ID of the latest query executed in the current session.

```
select pg_last_query_id();  
  
pg_last_query_id  
-----  
                5437  
(1 row)
```

The following query returns the query ID and text of the most recently executed query in the current session.

```
select query, trim(querytxt) as sqlquery  
from stl_query  
where query = pg_last_query_id();  
  
query | sqlquery  
-----+-----  
 5437 | select name, loadtime from stl_file_scan where loadtime > 1000000;  
(1 rows)
```

PG_LAST_UNLOAD_COUNT()

Returns the number of rows that were unloaded by the last UNLOAD command executed in the current session. PG_LAST_UNLOAD_COUNT is updated with the query ID of the last UNLOAD, even if the operation failed. The query ID is updated when the UNLOAD is executed. If the UNLOAD fails because of a syntax error or because of insufficient privileges, PG_LAST_UNLOAD_COUNT returns the count for the previous UNLOAD. If no UNLOAD commands were executed in the current session, or if the last UNLOAD failed during the unload operation, PG_LAST_UNLOAD_COUNT returns 0.

Syntax

```
pg_last_unload_count()
```

Return Type

Returns BIGINT.

Example

The following query returns the number of rows unloaded by the latest UNLOAD command in the current session.

```
select pg_last_unload_count();

pg_last_unload_count
-----
                192497
(1 row)
```

SESSION_USER

Returns the name of the user associated with the current session. This is the user who initiated the current database connection.

Note

Do not use trailing parentheses when calling SESSION_USER.

Syntax

```
session_user
```

Return Type

Returns a CHAR or VARCHAR string.

Example

The following example returns the current session user:

```
select session_user;

session_user
-----
dwuser
(1 row)
```

SLICE_NUM Function

Returns an integer corresponding to the slice number in the cluster where the data for a row is located. SLICE_NUM takes no parameters.

Syntax

```
SLICE_NUM( )
```

Return Type

The SLICE_NUM function returns an integer.

Examples

The following example shows which slices contain data for the first ten EVENT rows in the EVENTS table:

```
select distinct eventid, slice_num() from event order by eventid limit 10;
```

eventid	slice_num
1	1
2	2
3	3
4	0
5	1
6	2
7	3
8	0
9	1
10	2

(10 rows)

The following example returns a code (10000) to show that a query without a FROM statement executes on the leader node:

```
select slice_num();
slice_num
-----
10000
(1 row)
```

USER

Synonym for CURRENT_USER. See [CURRENT_USER](#) (p. 673).

VERSION()

The VERSION() function returns details about the currently installed release, with specific Amazon Redshift version information at the end.

Note

This is a leader-node function. This function returns an error if it references a user-created table, an STL or STV system table, or an SVV or SVL system view.

Syntax

```
VERSION()
```

Return Type

Returns a CHAR or VARCHAR string.

Reserved Words

The following is a list of Amazon Redshift reserved words. You can use the reserved words with delimited identifiers (double quotes).

For more information, see [Names and Identifiers \(p. 246\)](#).

```
AES128
AES256
ALL
ALLOWOVERWRITE
ANALYSE
ANALYZE
AND
ANY
ARRAY
AS
ASC
AUTHORIZATION
BACKUP
BETWEEN
BINARY
BLANKSASNULL
BOTH
BYTEDICT
BZIP2
CASE
CAST
CHECK
COLLATE
COLUMN
CONSTRAINT
CREATE
CREDENTIALS
CROSS
CURRENT_DATE
CURRENT_TIME
CURRENT_TIMESTAMP
CURRENT_USER
CURRENT_USER_ID
DEFAULT
DEFERRABLE
DEFLATE
DEFRAG
DELTA
DELTA32K
DESC
DISABLE
DISTINCT
DO
ELSE
EMPTYASNULL
ENABLE
ENCODE
ENCRYPT
ENCRYPTION
END
EXCEPT
EXPLICIT
FALSE
FOR
FOREIGN
FREEZE
FROM
```

FULL
GLOBALDICT256
GLOBALDICT64K
GRANT
GROUP
GZIP
HAVING
IDENTITY
IGNORE
ILIKE
IN
INITIALLY
INNER
INTERSECT
INTO
IS
ISNULL
JOIN
LEADING
LEFT
LIKE
LIMIT
LOCALTIME
LOCALTIMESTAMP
LUN
LUNS
LZO
LZOP
MINUS
MOSTLY13
MOSTLY32
MOSTLY8
NATURAL
NEW
NOT
NOTNULL
NULL
NULLS
OFF
OFFLINE
OFFSET
OID
OLD
ON
ONLY
OPEN
OR
ORDER
OUTER
OVERLAPS
PARALLEL
PARTITION
PERCENT
PERMISSIONS
PLACING
PRIMARY
RAW
READRATIO
RECOVER

REFERENCES
RESPECT
REJECTLOG
RESORT
RESTORE
RIGHT
SELECT
SESSION_USER
SIMILAR
SNAPSHOT
SOME
SYSDATE
SYSTEM
TABLE
TAG
TDES
TEXT255
TEXT32K
THEN
TIMESTAMP
TO
TOP
TRAILING
TRUE
TRUNCATECOLUMNS
UNION
UNIQUE
USER
USING
VERBOSE
WALLET
WHEN
WHERE
WITH
WITHOUT

System Tables Reference

Topics

- [System Tables and Views](#) (p. 685)
- [Types of System Tables and Views](#) (p. 686)
- [Visibility of Data in System Tables and Views](#) (p. 686)
- [STL Tables for Logging](#) (p. 687)
- [STV Tables for Snapshot Data](#) (p. 752)
- [System Views](#) (p. 776)
- [System Catalog Tables](#) (p. 799)

System Tables and Views

Amazon Redshift has many system tables and views that contain information about how the system is functioning. You can query these system tables and views the same way that you would query any other database tables. This section shows some sample system table queries and explains:

- How different types of system tables and views are generated
- What types of information you can obtain from these tables
- How to join Amazon Redshift system tables to catalog tables
- How to manage the growth of system table log files

Some system tables can only be used by AWS staff for diagnostic purposes. The following sections discuss the system tables that can be queried for useful information by system administrators or other database users.

Note

System tables are not included in automated or manual cluster backups (snapshots). STL log tables only retain approximately two to five days of log history, depending on log usage and available disk space. If you want to retain the log data, you will need to periodically copy it to other tables or unload it to Amazon S3.

Types of System Tables and Views

There are two types of system tables: STL and STV tables.

STL tables are generated from logs that have been persisted to disk to provide a history of the system. STV tables are virtual tables that contain snapshots of the current system data. They are based on transient in-memory data and are not persisted to disk-based logs or regular tables. System views that contain any reference to a transient STV table are called SVV views. Views containing only references to STL tables are called SVL views.

System tables and views do not use the same consistency model as regular tables. It is important to be aware of this issue when querying them, especially for STV tables and SVV views. For example, given a regular table `t1` with a column `c1`, you would expect that the following query to return no rows:

```
select * from t1
where c1 > (select max(c1) from t1)
```

However, the following query against a system table might well return rows:

```
select * from stv_exec_state
where currenttime > (select max(currenttime) from stv_exec_state)
```

The reason this query might return rows is that `currenttime` is transient and the two references in the query might not return the same value when evaluated.

On the other hand, the following query might well return no rows:

```
select * from stv_exec_state
where currenttime = (select max(currenttime) from stv_exec_state)
```

Visibility of Data in System Tables and Views

There are two classes of visibility for data in system tables and views: user visible and visible to superusers.

Only users with superuser privileges can see the data in those tables that are in the superuser visible category. Regular users can see data in the user visible tables. In most cases, rows generated by another user are invisible to a regular user. All rows in `STV_RECENTS` and `SVV_TRANSACTIONS` are visible to all users. A superuser can see all rows in all tables.

Filtering System-Generated Queries

The query-related system tables and views, such as `SVL_QUERY_SUMMARY`, `SVL_QLOG`, and others, usually contain a large number of automatically generated statements that Amazon Redshift uses to monitor the status of the database. These system-generated queries are visible to a superuser, but are seldom useful. To filter them out when selecting from a system table or system view that uses the `userid` column, add the condition `userid > 1` to the `WHERE` clause. For example:

```
select * from svl_query_summary where userid > 1
```

STL Tables for Logging

STL system tables are generated from Amazon Redshift log files to provide a history of the system.

These files reside on every node in the data warehouse cluster. The STL tables take the information from the logs and format them into usable tables for system administrators.

To manage disk space, the STL log tables only retain approximately two to five days of log history, depending on log usage and available disk space. If you want to retain the log data, you will need to periodically copy it to other tables or unload it to Amazon S3.

Topics

- [STL_AGGR](#) (p. 688)
- [STL_ALERT_EVENT_LOG](#) (p. 690)
- [STL_ANALYZE](#) (p. 691)
- [STL_BCAST](#) (p. 693)
- [STL_COMMIT_STATS](#) (p. 694)
- [STL_CONNECTION_LOG](#) (p. 695)
- [STL_DDLTEXT](#) (p. 696)
- [STL_DELETE](#) (p. 698)
- [STL_DIST](#) (p. 700)
- [STL_ERROR](#) (p. 701)
- [STL_EXPLAIN](#) (p. 702)
- [STL_FILE_SCAN](#) (p. 704)
- [STL_HASH](#) (p. 705)
- [STL_HASHJOIN](#) (p. 706)
- [STL_INSERT](#) (p. 708)
- [STL_LIMIT](#) (p. 709)
- [STL_LOAD_COMMITS](#) (p. 711)
- [STL_LOAD_ERRORS](#) (p. 713)
- [STL_LOADERROR_DETAIL](#) (p. 715)
- [STL_MERGE](#) (p. 716)
- [STL_MERGEJOIN](#) (p. 717)
- [STL_NESTLOOP](#) (p. 718)
- [STL_PARSE](#) (p. 719)
- [STL_PLAN_INFO](#) (p. 720)
- [STL_PROJECT](#) (p. 722)
- [STL_QUERY](#) (p. 724)
- [STL_QUERYTEXT](#) (p. 726)
- [STL_REPLACEMENTS](#) (p. 727)
- [STL_RESTARTED_SESSIONS](#) (p. 728)
- [STL_RETURN](#) (p. 729)
- [STL_S3CLIENT](#) (p. 730)
- [STL_S3CLIENT_ERROR](#) (p. 731)
- [STL_SAVE](#) (p. 732)

- [STL_SCAN](#) (p. 734)
- [STL_SESSIONS](#) (p. 736)
- [STL_SORT](#) (p. 737)
- [STL_SSHCLIENT_ERROR](#) (p. 738)
- [STL_STREAM_SEGS](#) (p. 738)
- [STL_TR_CONFLICT](#) (p. 739)
- [STL_UNDONE](#) (p. 740)
- [STL_UNIQUE](#) (p. 741)
- [STL_UNLOAD_LOG](#) (p. 742)
- [STL_USERLOG](#) (p. 743)
- [STL_UTILITYTEXT](#) (p. 744)
- [STL_VACUUM](#) (p. 746)
- [STL_WARNING](#) (p. 748)
- [STL_WINDOW](#) (p. 749)
- [STL_WLM_ERROR](#) (p. 750)
- [STL_WLM_QUERY](#) (p. 750)

STL_AGGR

Analyzes aggregate execution steps for queries. These steps occur during execution of aggregate functions and GROUP BY clauses.

This table is visible to all users.

Table Columns

Column Name	Data Type	Description
userid	integer	ID of the user who generated the entry.
query	integer	Query ID. The query column can be used to join other system tables and views.
slice	integer	Number that identifies the slice where the query was running.
segment	integer	Number that identifies the query segment.
step	integer	Query step that executed.
starttime	timestamp	Time in UTC that the query started executing, with 6 digits of precision for fractional seconds. For example: 2009-06-12 11:29:19.131358 .
endtime	timestamp	Time in UTC that the query finished executing, with 6 digits of precision for fractional seconds. For example: 2009-06-12 11:29:19.131358 .
tasknum	integer	Number of the query task process that was assigned to execute the step.
rows	bigint	Total number of rows that were processed.

Column Name	Data Type	Description
bytes	bigint	Size, in bytes, of all the output rows for the step.
slots	integer	Number of hash buckets.
occupied	integer	Number of slots that contain records.
maxlength	integer	Size of the largest slot.
tbl	integer	Table ID.
is_diskbased	character(1)	If true (t), the query was executed as a disk-based operation. If false (f), the query was executed in memory.
workmem	bigint	Number of bytes of working memory assigned to the step.
type	character(6)	The type of step. Valid values are: <ul style="list-style-type: none"> HASHED. Indicates that the step used grouped, unsorted aggregation. PLAIN. Indicates that the step used ungrouped, scalar aggregation. SORTED. Indicates that the step used grouped, sorted aggregation.

Sample Queries

Returns information about aggregate execution steps for SLICE 1 and TBL 239.

```
select query, segment, bytes, slots, occupied, maxlength, is_diskbased,
workmem, type
from stl_aggr where slice=1 and tbl=239
order by rows
limit 10;
```

query	segment	bytes	slots	occupied	maxlength	is_diskbased	workmem	type
562	1	0	4194304	0	0	f		
383385600	HASHED							
616	1	0	4194304	0	0	f		
383385600	HASHED							
546	1	0	4194304	0	0	f		
383385600	HASHED							
547	0	8	0	0	0	f		
0	PLAIN							
685	1	32	4194304	1	0	f		
383385600	HASHED							
652	0	8	0	0	0	f		
0	PLAIN							
680	0	8	0	0	0	f		
0	PLAIN							
658	0	8	0	0	0	f		
0	PLAIN							

```

686 |      0 |      8 |      0 |      0 |      0 | f |
    0 | PLAIN
695 |      1 |     32 | 4194304 |      1 |      0 | f |
383385600 | HASHED
(10 rows)

```

STL_ALERT_EVENT_LOG

Records an alert when the query optimizer identifies conditions that might indicate performance issues. Use the STL_ALERT_EVENT_LOG table to identify opportunities to improve query performance.

A query consists of multiple segments, and each segment consists of one or more steps. For more information, see [Query Processing \(p. 199\)](#).

STL_ALERT_EVENT_LOG is visible to all users.

Table Columns

Column Name	Data Type	Description
userid	integer	ID of the user who generated the entry.
query	integer	Query ID. The query column can be used to join other system tables and views.
slice	integer	Number that identifies the slice where the query was running.
segment	integer	Number that identifies the query segment.
step	integer	Query step that executed.
pid	integer	Process ID associated with the statement and slice. The same query might have multiple PIDs if it executes on multiple slices.
xid	bigint	Transaction ID associated with the statement.
event	character(1024)	Description of the alert event.
solution	character(1024)	Recommended solution.
event_time	timestamp	Time in UTC that the query started executing, with 6 digits of precision for fractional seconds. For example: 2009-06-12 11:29:19.131358.

Usage Notes

You can use the STL_ALERT_EVENT_LOG to identify potential issues in your queries, then follow the practices in [Tuning Query Performance \(p. 199\)](#) to optimize your database design and rewrite your queries. STL_ALERT_EVENT_LOG records the following alerts:

- **Missing Statistics**

Statistics are missing. Run ANALYZE following data loads or significant updates and use STATUPDATE with COPY operations. For more information, see [Best Practices for Designing Queries \(p. 28\)](#).

- **Nested Loop**

A nested loop is usually a Cartesian product. Evaluate your query to ensure that all participating tables are joined efficiently.

- **Very Selective Filter**

The ratio of rows returned to rows scanned is less than 0.05. Rows scanned is the value of `rows_pre_user_filter` and rows returned is the value of rows in the [STL_SCAN \(p. 734\)](#) system table. Indicates that the query is scanning an unusually large number of rows to determine the result set. This can be caused by missing or incorrect sort keys. For more information, see [Choosing Sort Keys \(p. 122\)](#).

- **Excessive Ghost Rows**

A scan skipped a relatively large number of rows that are marked as deleted but not vacuumed, or rows that have been inserted but not committed. For more information, see [Vacuuming Tables \(p. 172\)](#).

- **Large Distribution**

More than 1,000,000 rows were redistributed for hash join or aggregation. For more information, see [Choosing a Data Distribution Style \(p. 110\)](#).

- **Large Broadcast**

More than 1,000,000 rows were broadcast for hash join. For more information, see [Choosing a Data Distribution Style \(p. 110\)](#).

- **Serial Execution**

A `DS_DIST_ALL_INNER` redistribution style was indicated in the query plan, which forces serial execution because the entire inner table was redistributed to a single node. For more information, see [Choosing a Data Distribution Style \(p. 110\)](#).

Sample Queries

The following query shows alert events for four queries.

```
SELECT query, substring(event,0,25) as event,
substring(solution,0,25) as solution,
trim(event_time) as event_time from stl_alert_event_log order by query;
```

query	event	solution
6567	Missing query planner statist	Run the ANALYZE command
7450	Scanned a large number of del	Run the VACUUM command to rec
8406	Nested Loop Join in the query	Review the join predicates to
29512	Very selective query filter:r	Review the choice of sort key

(4 rows)

STL_ANALYZE

Records details for [ANALYZE \(p. 309\)](#) operations.

This table is visible to superusers.

Table Columns

Column Name	Data Type	Description
userid	integer	ID of the user who generated the entry.
xid	long	Transaction ID.
database	char(30)	Database name.
table_id	integer	Table ID.
status	char(15)	Result of the analyze command. Possible values are Full or Skipped.
rows	double	Total number of rows in the table.
modified_rows	double	Total number of rows that were modified since the last ANALYZE operation.
threshold_percent	integer	Value of the analyze_threshold_percent parameter.
is_auto	char(1)	Value that indicates whether the analysis was executed automatically (t) or by the user (f).
starttime	timestamp	Time in UTC that the ANALYZE operation started executing.
endtime	timestamp	Time in UTC that the ANALYZE operation finished executing.

Sample Queries

The following example joins STV_TBL_PERM to show the table name and execution details.

```
select distinct a.xid, trim(t.name) as name, a.status, a.rows,
a.modified_rows, a.starttime, a.endtime
from stl_analyze a
join stv_tbl_perm t on t.id=a.table_id
where name = 'users'
order by starttime;
```

```
xid      | name  | status          | rows  | modified_rows | starttime
| endtime
-----+-----+-----+-----+-----+-----
+-----+-----+-----+-----+-----+-----
 1582 | users | Full           | 49990 | 49990 | 2016-09-22
22:02:23 | 2016-09-22 22:02:28
244287 | users | Full           | 24992 | 74988 | 2016-10-04
22:50:58 | 2016-10-04 22:51:01
244712 | users | Full           | 49984 | 24992 | 2016-10-04
22:56:07 | 2016-10-04 22:56:07
245071 | users | Skipped        | 49984 | 0 | 2016-10-04
22:58:17 | 2016-10-04 22:58:17
245439 | users | Skipped        | 49984 | 1982 | 2016-10-04
23:00:13 | 2016-10-04 23:00:13
(5 rows)
```

STL_BCAST

Logs information about network activity during execution of query steps that broadcast data. Network traffic is captured by numbers of rows, bytes, and packets that are sent over the network during a given step on a given slice. The duration of the step is the difference between the logged start and end times.

To identify broadcast steps in a query, look for bcast labels in the SVL_QUERY_SUMMARY view or run the EXPLAIN command and then look for step attributes that include bcast.

This table is visible to all users.

Table Columns

Column Name	Data Type	Description
userid	integer	ID of the user who generated the entry.
query	integer	Query ID. The query column can be used to join other system tables and views.
slice	integer	Number that identifies the slice where the query was running.
segment	integer	Number that identifies the query segment.
step	integer	Query step that executed.
starttime	timestamp	Time in UTC that the query started executing, with 6 digits of precision for fractional seconds. For example: 2009-06-12 11:29:19.131358.
endtime	timestamp	Time in UTC that the query finished executing, with 6 digits of precision for fractional seconds. For example: 2009-06-12 11:29:19.131358.
tasknum	integer	Number of the query task process that was assigned to execute the step.
rows	bigint	Total number of rows that were processed.
bytes	bigint	Size, in bytes, of all the output rows for the step.
packets	integer	Total number of packets sent over the network.

Sample Queries

The following example returns broadcast information for the queries where there are one or more packets, and the difference between the start and end of the query was one second or more.

```
select query, slice, step, rows, bytes, packets, datediff(seconds, starttime,
endtime)
from stl_bcast
where packets>0 and datediff(seconds, starttime, endtime)>0;
```

query	slice	step	rows	bytes	packets	date_diff
453	2	5	1	264	1	1

798	2	5	1	264	1	1
1408	2	5	1	264	1	1
2993	0	5	1	264	1	1
5045	3	5	1	264	1	1
8073	3	5	1	264	1	1
8163	3	5	1	264	1	1
9212	1	5	1	264	1	1
9873	1	5	1	264	1	1

(9 rows)

STL_COMMIT_STATS

Provides metrics related to commit performance, including the timing of the various stages of commit and the number of blocks committed. Query STL_COMMIT_STATS to determine what portion of a transaction was spent on commit and how much queuing is occurring.

This table is visible to superusers.

Table Columns

Column Name	Data Type	Description
xid	bigint	Transaction id being committed.
node	integer	Node number. -1 is the leader node.
startqueue	timestamp	Start of queueing for commit.
startwork	timestamp	Start of commit.
endflush	timestamp	End of dirty block flush phase.
endstage	timestamp	End of metadata staging phase.
endlocal	timestamp	End of local commit phase.
startglobal	timestamp	Start of global phase.
endtime	timestamp	End of the commit.
queuelen	bigint	Number of transactions that were ahead of this transaction in the commit queue.
permblocks	bigint	Number of existing permanent blocks at the time of this commit.
newblocks	bigint	Number of new permanent blocks at the time of this commit.
dirtyblocks	bigint	Number of blocks that had to be written as part of this commit.
headers	bigint	Number of block headers that had to be written as part of this commit.
numxids	integer	The number of active DML transactions.
oldestxid	bigint	The XID of the oldest active DML transaction.
extwritelatency	bigint	This information is for internal use only.
metadatatwritent	bigint	This information is for internal use only.

Sample Query

```
select node, datediff(ms,startqueue,startwork) as queue_time,
datediff(ms, startwork, endtime) as commit_time, queuelen
from stl_commit_stats
where xid = 2574
order by node;
```

node	queue_time	commit_time	queuelen
-1	0	617	0
0	444950725641	616	0
1	444950725636	616	0

STL_CONNECTION_LOG

Logs authentication attempts and connections and disconnections.

This table is visible to superusers.

Table Columns

Column Name	Data Type	Description
event	character(50)	Connection or authentication event.
recordtime	timestamp	Time the event occurred.
remotehost	character(32)	Name or IP address of remote host.
remoteport	character(32)	Port number for remote host.
pid	integer	Process ID associated with the statement.
dbname	character(50)	Database name.
username	character(50)	User name.
authmethod	character(32)	Authentication method.
duration	integer	Duration of connection in microseconds.
sslversion	character(50)	Secure Sockets Layer (SSL) version.
sslcipher	character(128)	SSL cipher.
mtu	integer	Maximum transmission unit (MTU).
sslcompression	character(64)	SSL compression type.
sslexpansion	character(64)	SSL expansion type.

Sample Queries

To view the details for open connections, execute the following query.

```
select recordtime, username, dbname, remotehost, remoteport
```

```

from stl_connection_log
where event = 'initiating session'
and pid not in
(select pid from stl_connection_log
where event = 'disconnecting session')
order by 1 desc;

```

recordtime	username	dbname	remotehost	remoteport
2014-11-06 20:30:06	rdsdb	dev	[local]	
2014-11-06 20:29:37	test001	test	10.49.42.138	11111
2014-11-05 20:30:29	rdsdb	dev	10.49.42.138	33333
2014-11-05 20:28:35	rdsdb	dev	[local]	

(4 rows)

The following example reflects a failed authentication attempt and a successful connection and disconnection.

```

select event, recordtime, remotehost, username
from stl_connection_log order by recordtime;

```

event	recordtime	remotehost	username
authentication failure	2012-10-25 14:41:56.96391	10.49.42.138	john
authenticated	2012-10-25 14:42:10.87613	10.49.42.138	john
initiating session	2012-10-25 14:42:10.87638	10.49.42.138	john
disconnecting session	2012-10-25 14:42:19.95992	10.49.42.138	john

(4 rows)

STL_DDLTEXT

Captures the following DDL statements that were run on the system.

These DDL statements include the following queries and objects:

- CREATE SCHEMA, TABLE, VIEW
- DROP SCHEMA, TABLE, VIEW
- ALTER SCHEMA, TABLE

See also [STL_QUERYTEXT](#) (p. 726), [STL_UTILITYTEXT](#) (p. 744), and [SVL_STATEMENTTEXT](#) (p. 790). These tables provide a timeline of the SQL commands that are executed on the system; this history is useful for troubleshooting purposes and for creating an audit trail of all system activities.

Use the STARTTIME and ENDTIME columns to find out which statements were logged during a given time period. Long blocks of SQL text are broken into lines 200 characters long; the SEQUENCE column identifies fragments of text that belong to a single statement.

This table is visible to all users.

Table Columns

Column Name	Data Type	Description
userid	integer	ID of the user who generated the entry.
xid	bigint	Transaction ID associated with the statement.
pid	integer	Process ID associated with the statement.
label	character(30)	Either the name of the file used to run the query or a label defined with a SET QUERY_GROUP command. If the query is not file-based or the QUERY_GROUP parameter is not set, this field is blank.
starttime	timestamp	Time in UTC that the query started executing, with 6 digits of precision for fractional seconds. For example: 2009-06-12 11:29:19.131358.
endtime	timestamp	Time in UTC that the query finished executing, with 6 digits of precision for fractional seconds. For example: 2009-06-12 11:29:19.131358.
sequence	integer	When a single statement contains more than 200 characters, additional rows are logged for that statement. Sequence 0 is the first row, 1 is the second, and so on.
text	character(200)	SQL text, in 200-character increments.

Sample Queries

The following query shows the DDL for four CREATE TABLE statements. The DDL text column is truncated for readability.

```
select xid, starttime, sequence, substring(text,1,40) as text
from stl_ddltext order by xid desc, sequence;
```

xid	starttime	sequence	text
1806	2013-10-23 00:11:14.709851	0	CREATE TABLE supplier (s_suppkey int4 N
1806	2013-10-23 00:11:14.709851	1	s_comment varchar(101) NOT NULL)
1805	2013-10-23 00:11:14.496153	0	CREATE TABLE region (r_regionkey int4 N
1804	2013-10-23 00:11:14.285986	0	CREATE TABLE partsupp (ps_partkey int8
1803	2013-10-23 00:11:14.056901	0	CREATE TABLE part (p_partkey int8 NOT N
1803	2013-10-23 00:11:14.056901	1	ner char(10) NOT NULL , p_retailprice nu

(6 rows)

STL_DELETE

Analyzes delete execution steps for queries.

This table is visible to all users.

Table Columns

Column Name	Data Type	Description
userid	integer	ID of the user who generated the entry.
query	integer	Query ID. The query column can be used to join other system tables and views.
slice	integer	Number that identifies the slice where the query was running.
segment	integer	Number that identifies the query segment.
step	integer	Query step that executed.
starttime	timestamp	Time in UTC that the query started executing, with 6 digits of precision for fractional seconds. For example: 2009-06-12 11:29:19.131358.
endtime	timestamp	Time in UTC that the query finished executing, with 6 digits of precision for fractional seconds. For example: 2009-06-12 11:29:19.131358.
tasknum	integer	Number of the query task process that was assigned to execute the step.
rows	bigint	Total number of rows that were processed.
tbl	integer	Table ID.

Sample Queries

In order to create a row in STL_DELETE, the following example inserts a row into the EVENT table and then deletes it.

First, insert a row into the EVENT table and verify that it was inserted.

```
insert into event(eventid,venueid,catid,dateid,eventname)
values ((select max(eventid)+1 from event),95,9,1857,'Lollapalooza');
```

```
select * from event
where eventname='Lollapalooza'
order by eventid;
```

eventid	venueid	catid	dateid	eventname	starttime
4274	102	9	1965	Lollapalooza	2008-05-01 19:00:00
4684	114	9	2105	Lollapalooza	2008-10-06 14:00:00
5673	128	9	1973	Lollapalooza	2008-05-01 15:00:00

```

5740 |      51 |      9 | 1933 | Lollapalooza | 2008-04-17 15:00:00
5856 |     119 |      9 | 1831 | Lollapalooza | 2008-01-05 14:00:00
6040 |     126 |      9 | 2145 | Lollapalooza | 2008-11-15 15:00:00
7972 |      92 |      9 | 2026 | Lollapalooza | 2008-07-19 19:30:00
8046 |      65 |      9 | 1840 | Lollapalooza | 2008-01-14 15:00:00
8518 |      48 |      9 | 1904 | Lollapalooza | 2008-03-19 15:00:00
8799 |      95 |      9 | 1857 | Lollapalooza |
(10 rows)

```

Now, delete the row that you added to the EVENT table and verify that it was deleted.

```

delete from event
where eventname='Lollapalooza' and eventid=(select max(eventid) from event);

```

```

select * from event
where eventname='Lollapalooza'
order by eventid;

```

eventid	venueid	catid	dateid	eventname	starttime
4274	102	9	1965	Lollapalooza	2008-05-01 19:00:00
4684	114	9	2105	Lollapalooza	2008-10-06 14:00:00
5673	128	9	1973	Lollapalooza	2008-05-01 15:00:00
5740	51	9	1933	Lollapalooza	2008-04-17 15:00:00
5856	119	9	1831	Lollapalooza	2008-01-05 14:00:00
6040	126	9	2145	Lollapalooza	2008-11-15 15:00:00
7972	92	9	2026	Lollapalooza	2008-07-19 19:30:00
8046	65	9	1840	Lollapalooza	2008-01-14 15:00:00
8518	48	9	1904	Lollapalooza	2008-03-19 15:00:00

(9 rows)

Then query stl_delete to see the execution steps for the deletion. In this example, the query returned over 300 rows, so the output below is shortened for display purposes.

```

select query, slice, segment, step, tasknum, rows, tbl from stl_delete order
by query;

```

query	slice	segment	step	tasknum	rows	tbl
7	0	0	1	0	0	100000
7	1	0	1	0	0	100000
8	0	0	1	2	0	100001
8	1	0	1	2	0	100001
9	0	0	1	4	0	100002
9	1	0	1	4	0	100002
10	0	0	1	6	0	100003
10	1	0	1	6	0	100003
11	0	0	1	8	0	100253
11	1	0	1	8	0	100253
12	0	0	1	0	0	100255
12	1	0	1	0	0	100255
13	0	0	1	2	0	100257
13	1	0	1	2	0	100257
14	0	0	1	4	0	100259

```
14 | 1 | 0 | 1 | 4 | 0 | 100259
...
```

STL_DIST

Logs information about network activity during execution of query steps that distribute data. Network traffic is captured by numbers of rows, bytes, and packets that are sent over the network during a given step on a given slice. The duration of the step is the difference between the logged start and end times.

To identify distribution steps in a query, look for dist labels in the QUERY_SUMMARY view or run the EXPLAIN command and then look for step attributes that include dist.

This table is visible to all users.

Table Columns

Column Name	Data Type	Description
userid	integer	ID of the user who generated the entry.
query	integer	Query ID. The query column can be used to join other system tables and views.
slice	integer	Number that identifies the slice where the query was running.
segment	integer	Number that identifies the query segment.
step	integer	Query step that executed.
starttime	timestamp	Time in UTC that the query started executing, with 6 digits of precision for fractional seconds. For example: 2009-06-12 11:29:19.131358.
endtime	timestamp	Time in UTC that the query finished executing, with 6 digits of precision for fractional seconds. For example: 2009-06-12 11:29:19.131358.
tasknum	integer	Number of the query task process that was assigned to execute the step.
rows	bigint	Total number of rows that were processed.
bytes	bigint	Size, in bytes, of all the output rows for the step.
packets	integer	Total number of packets sent over the network.

Sample Queries

The following example returns distribution information for queries with one or more packets and duration greater than zero.

```
select query, slice, step, rows, bytes, packets,
datediff(seconds, starttime, endtime) as duration
from stl_dist
where packets>0 and datediff(seconds, starttime, endtime)>0
order by query
limit 10;
```

query	slice	step	rows	bytes	packets	duration
567	1	4	49990	6249564	707	1
630	0	5	8798	408404	46	2
645	1	4	8798	408404	46	1
651	1	5	192497	9226320	1039	6
669	1	4	192497	9226320	1039	4
675	1	5	3766	194656	22	1
696	0	4	3766	194656	22	1
705	0	4	930	44400	5	1
111525	0	3	68	17408	2	1

(9 rows)

STL_ERROR

Records internal processing errors generated by the Amazon Redshift database engine. STL_ERROR does not record SQL errors or messages. The information in STL_ERROR is useful for troubleshooting certain errors. An AWS support engineer might ask you to provide this information as part of the troubleshooting process.

This table is visible to all users.

Table Columns

Column Name	Data Type	Description
userid	integer	ID of the user who generated the entry.
process	character(12)	Process that threw the exception.
recordtime	timestamp	Time that the error occurred.
pid	integer	Process ID. The STL_QUERY (p. 724) table contains process IDs and unique query IDs for executed queries.
errcode	integer	Error code corresponding to the error category.
file	character(90)	Name of the source file where the error occurred.
linenum	integer	Line number in the source file where the error occurred.
context	character(100)	Cause of the error.
error	character(512)	Error message.

Sample Queries

The following example retrieves the error information from STL_ERROR.

```
select process, errcode, linenum as line,
trim(error) as err
from stl_error;
```

process	errcode	line	err
---------	---------	------	-----

```

-----+-----+-----
+-----+-----+-----
padbmaster |      8001 | 194 | Path prefix: s3://awssampled/
venue.txt*
padbmaster |      8001 | 529 | Listing bucket=awssampled prefix=tests/
category-csv-quotes
padbmaster |         2 | 190 | database "template0" is not currently
accepting connections
padbmaster |        32 | 1956 | pq_flush: could not send data to client:
Broken pipe
(4 rows)

```

STL_EXPLAIN

Displays the EXPLAIN plan for a query that has been submitted for execution.

This table is visible to all users.

Table Columns

Column Name	Data Type	Description
userid	integer	ID of the user who generated the entry.
query	integer	Query ID. The query column can be used to join other system tables and views.
nodeid	integer	Plan node identifier, where a node maps to one or more steps in the execution of the query.
parentid	integer	Plan node identifier for a parent node. A parent node has some number of child nodes. For example, a merge join is the parent of the scans on the joined tables.
plannode	character(400)	The node text from the EXPLAIN output. Plan nodes that refer to execution on compute nodes are prefixed with xn in the EXPLAIN output.
info	character(400)	Qualifier and filter information for the plan node. For example, join conditions and WHERE clause restrictions are included in this column.

Sample Queries

Consider the following EXPLAIN output for an aggregate join query:

```

explain select avg(datediff(day, listtime, saletime)) as avgwait
from sales, listing where sales.listid = listing.listid;
          QUERY PLAN

-----+-----+-----
XN Aggregate  (cost=6350.30..6350.31 rows=1 width=16)
->  XN Hash Join DS_DIST_NONE  (cost=47.08..6340.89 rows=3766 width=16)
    Hash Cond: ("outer".listid = "inner".listid)
    -> XN Seq Scan on listing  (cost=0.00..1924.97 rows=192497 width=12)
    -> XN Hash  (cost=37.66..37.66 rows=3766 width=12)

```

```
-> XN Seq Scan on sales (cost=0.00..37.66 rows=3766 width=12)
(6 rows)
```

If you run this query and its query ID is 10, you can use the STL_EXPLAIN table to see the same kind of information that the EXPLAIN command returns:

```
select query,nodeid,parentid,substring(plannode from 1 for 30),
substring(info from 1 for 20) from stl_explain
where query=10 order by 1,2;
```

query	nodeid	parentid	substring	substring
10	1	0	XN Aggregate (cost=6717.61..6	
10	2	1	-> XN Merge Join DS_DIST_NO	Merge Cond:("outer"
10	3	2	-> XN Seq Scan on lis	
10	4	2	-> XN Seq Scan on sal	

(4 rows)

Consider the following query:

```
select event.eventid, sum(pricepaid)
from event, sales
where event.eventid=sales.eventid
group by event.eventid order by 2 desc;
```

eventid	sum
289	51846.00
7895	51049.00
1602	50301.00
851	49956.00
7315	49823.00
...	

If this query's ID is 15, the following system table query returns the plan nodes that were executed. In this case, the order of the nodes is reversed to show the actual order of execution:

```
select query,nodeid,parentid,substring(plannode from 1 for 56)
from stl_explain where query=15 order by 1, 2 desc;
```

query	nodeid	parentid	substring
15	8	7	-> XN Seq Scan on eve
15	7	5	-> XN Hash(cost=87.98..87.9
15	6	5	-> XN Seq Scan on sales(cos
15	5	4	-> XN Hash Join DS_DIST_OUTER(cos
15	4	3	-> XN HashAggregate(cost=862286577.07..
15	3	2	-> XN Sort(cost=1000862287175.47..10008622871
15	2	1	-> XN Network(cost=1000862287175.47..1000862287197.
15	1	0	XN Merge(cost=1000862287175.47..1000862287197.46

rows=87
(8 rows)

The following query retrieves the query IDs for any query plans that contain a window function:

```
select query, trim(plannode) from stl_explain
```

```
where plannode like '%Window%';
```

```
query| btrim
-----+-----
26  | -> XN Window(cost=1000985348268.57..1000985351256.98 rows=170
    | width=33)
27  | -> XN Window(cost=1000985348268.57..1000985351256.98 rows=170
    | width=33)
(2 rows)
```

STL_FILE_SCAN

Returns the files that Amazon Redshift read while loading data via the COPY command.

Querying this table can help troubleshoot data load errors. STL_FILE_SCAN can be particularly helpful with pinpointing issues in parallel data loads because parallel data loads typically load many files with a single COPY command.

This table is visible to all users.

Table Columns

Column Name	Data Type	Description
userid	integer	ID of the user who generated the entry.
query	integer	Query ID. The query column can be used to join other system tables and views.
slice	integer	Number that identifies the slice where the query was running.
name	character(90)	Full path and name of the file that was loaded.
lines	bigint	Number of lines read from the file.
bytes	bigint	Number of bytes read from the file.
loadtime	bigint	Amount of time spent loading the file (in microseconds).
curtime	bigint	Timestamp representing the time that Amazon Redshift started processing the file.

Sample Queries

The following query retrieves the names and load times of any files that took over 1000000 microseconds for Amazon Redshift to read:

```
select trim(name)as name, loadtime from stl_file_scan
where loadtime > 1000000;
```

This query returns the following example output:

```
name | loadtime
-----+-----
```

```

listings_pipe.txt | 9458354
allusers_pipe.txt | 2963761
allevents_pipe.txt | 1409135
tickit/listings_pipe.txt | 7071087
tickit/allevents_pipe.txt | 1237364
tickit/allusers_pipe.txt | 2535138
listings_pipe.txt | 6706370
allusers_pipe.txt | 3579461
allevents_pipe.txt | 1313195
tickit/allusers_pipe.txt | 3236060
tickit/listings_pipe.txt | 4980108
(11 rows)

```

STL_HASH

Analyzes hash execution steps for queries.

This table is visible to all users.

Table Columns

Column Name	Data Type	Description
userid	integer	ID of the user who generated the entry.
query	integer	Query ID. The query column can be used to join other system tables and views.
slice	integer	Number that identifies the slice where the query was running.
segment	integer	Number that identifies the query segment.
step	integer	Query step that executed.
starttime	timestamp	Time in UTC that the query started executing, with 6 digits of precision for fractional seconds. For example: 2009-06-12 11:29:19.131358.
endtime	timestamp	Time in UTC that the query finished executing, with 6 digits of precision for fractional seconds. For example: 2009-06-12 11:29:19.131358.
tasknum	integer	Number of the query task process that was assigned to execute the step.
rows	bigint	Total number of rows that were processed.
bytes	bigint	Size, in bytes, of all the output rows for the step.
slots	integer	Total number of hash buckets.
occupied	integer	Total number of slots that contain records.
maxlength	integer	Size of the largest slot.
tbl	integer	Table ID.
is_diskbased	character(1)	If true (t), the query was executed as a disk-based operation. If false (f), the query was executed in memory.

Column Name	Data Type	Description
workmem	bigint	Total number of bytes of working memory assigned to the step.
num_parts	integer	Total number of partitions that a hash table was divided into during a hash step. A hash table is partitioned when it is estimated that the entire hash table might not fit into memory.
est_rows	bigint	Estimated number of rows to be hashed.
num_blocks_permitted	integer	This information is for internal use only.
row_dist_variance	integer	This information is for internal use only.

Sample Queries

The following example returns information about the number of partitions that were used in a hash for query 720, and indicates that none of the steps ran on disk.

```
select slice, rows, bytes, occupied, workmem, num_parts, est_rows,
       num_blocks_permitted
from stl_hash
where query=720 and segment=5
order by slice;
```

```
 slice | rows | bytes | occupied | workmem | num_parts | est_rows |
num_blocks_permitted
-----+-----+-----+-----+-----+-----+-----+
+-----+-----+-----+-----+-----+-----+-----+
      0 | 145 | 585800 |          1 | 88866816 |          16 |          1 |
          52
      1 |    0 |    0 |          0 |          0 |          16 |          1 |
          52
(2 rows)
```

STL_HASHJOIN

Analyzes hash join execution steps for queries.

This table is visible to all users.

Table Columns

Column Name	Data Type	Description
userid	integer	ID of the user who generated the entry.
query	integer	Query ID. The query column can be used to join other system tables and views.
slice	integer	Number that identifies the slice where the query was running.
segment	integer	Number that identifies the query segment.

Column Name	Data Type	Description
step	integer	Query step that executed.
starttime	timestamp	Time in UTC that the query started executing, with 6 digits of precision for fractional seconds. For example: 2009-06-12 11:29:19.131358.
endtime	timestamp	Time in UTC that the query finished executing, with 6 digits of precision for fractional seconds. For example: 2009-06-12 11:29:19.131358.
tasknum	integer	Number of the query task process that was assigned to execute the step.
rows	bigint	Total number of rows that were processed.
tbl	integer	Table ID.
num_parts	integer	Total number of partitions that a hash table was divided into during a hash step. A hash table is partitioned when it is estimated that the entire hash table might not fit into memory.
join_type	integer	The type of join for the step: <ul style="list-style-type: none"> • 0. The query used an inner join. • 1. The query used a left outer join. • 2. The query used a full outer join. • 3. The query used a right outer join. • 4. The query used a UNION operator. • 5. The query used an IN condition. • 6. This information is for internal use only. • 7. This information is for internal use only. • 8. This information is for internal use only. • 9. This information is for internal use only. • 10. This information is for internal use only. • 11. This information is for internal use only. • 12. This information is for internal use only.
hash_looped	character(1)	This information is for internal use only.
switched_parts	character(1)	Indicates whether the build (or outer) and probe (or inner) sides have switched.

Sample Queries

The following example returns the number of partitions used in a hash join for query 720.

```
select query, slice, tbl, num_parts
from stl_hashjoin
where query=720 limit 10;
```

```
query | slice | tbl | num_parts
```

```

-----+-----+-----+-----
 720 |    0 | 243 |          1
 720 |    1 | 243 |          1
(2 rows)

```

STL_INSERT

Analyzes insert execution steps for queries.

This table is visible to all users.

Table Columns

Column Name	Data Type	Description
userid	integer	ID of the user who generated the entry.
query	integer	Query ID. The query column can be used to join other system tables and views.
slice	integer	Number that identifies the slice where the query was running.
segment	integer	Number that identifies the query segment.
step	integer	Query step that executed.
starttime	timestamp	Time in UTC that the query started executing, with 6 digits of precision for fractional seconds. For example: 2009-06-12 11:29:19.131358.
endtime	timestamp	Time in UTC that the query finished executing, with 6 digits of precision for fractional seconds. For example: 2009-06-12 11:29:19.131358.
tasknum	integer	Number of the query task process that was assigned to execute the step.
rows	bigint	Total number of rows that were processed.
tbl	integer	Table ID.

Sample Queries

The following example returns insert execution steps for the most recent query.

```

select slice, segment, step, tasknum, rows, tbl
from stl_insert
where query=pg_last_query_id();

```

```

 slice | segment | step | tasknum | rows  | tbl
-----+-----+-----+-----+-----+-----
      0 |        2 |    2 |       15 | 24958 | 100548
      1 |        2 |    2 |       15 | 25032 | 100548
(2 rows)

```

STL_LIMIT

Analyzes the execution steps that occur when a LIMIT clause is used in a SELECT query.

This table is visible to all users.

Table Columns

Column Name	Data Type	Description
userid	integer	ID of the user who generated the entry.
query	integer	Query ID. The query column can be used to join other system tables and views.
slice	integer	Number that identifies the slice where the query was running.
segment	integer	Number that identifies the query segment.
step	integer	Query step that executed.
starttime	timestamp	Time in UTC that the query started executing, with 6 digits of precision for fractional seconds. For example: 2009-06-12 11:29:19.131358.
endtime	timestamp	Time in UTC that the query finished executing, with 6 digits of precision for fractional seconds. For example: 2009-06-12 11:29:19.131358.
tasknum	integer	Number of the query task process that was assigned to execute the step.
rows	bigint	Total number of rows that were processed.

Sample Queries

In order to generate a row in STL_LIMIT, this example first runs the following query against the VENUE table using the LIMIT clause.

```
select * from venue
order by 1
limit 10;
```

```
venueid |          venuename          |   venuecity   | venuestate |
venueseats
-----+-----+-----+-----+
+-----+
   1 | Toyota Park                | Bridgeview    | IL         |
   0
   2 | Columbus Crew Stadium      | Columbus      | OH         |
   0
   3 | RFK Stadium                | Washington    | DC         |
   0
   4 | CommunityAmerica Ballpark  | Kansas City   | KS         |
   0
```

```

        5 | Gillette Stadium          | Foxborough    | MA      |
68756
        6 | New York Giants Stadium    | East Rutherford | NJ      |
80242
        7 | BMO Field                  | Toronto       | ON      |
0
        8 | The Home Depot Center      | Carson        | CA      |
0
        9 | Dick's Sporting Goods Park | Commerce City  | CO      |
0
       10 | Pizza Hut Park             | Frisco        | TX      |
0
(10 rows)

```

Next, run the following query to find the query ID of the last query you ran against the VENUE table.

```

select max(query)
from stl_query;

```

```

max
-----
127128
(1 row)

```

Optionally, you can run the following query to verify that the query ID corresponds to the LIMIT query you previously ran.

```

select query, trim(querytxt)
from stl_query
where query=127128;

```

```

query | btrim
-----+-----
127128 | select * from venue order by 1 limit 10;
(1 row)

```

Finally, run the following query to return information about the LIMIT query from the STL_LIMIT table.

```

select slice, segment, step, starttime, endtime, tasknum
from stl_limit
where query=127128
order by starttime, endtime;

```

```

 slice | segment | step |          starttime          |          endtime
      | tasknum
-----+-----+-----+-----+-----+-----
+-----+-----+-----+-----+-----+-----
      1 |         1 |     3 | 2013-09-06 22:56:43.608114 | 2013-09-06
22:56:43.609383 |
      0 |         1 |     3 | 2013-09-06 22:56:43.608708 | 2013-09-06
22:56:43.609521 |
    10000 |         2 |     2 | 2013-09-06 22:56:43.612506 | 2013-09-06
22:56:43.612668 |

```

(3 rows)

STL_LOAD_COMMITS

Returns information to track or troubleshoot a data load.

This table records the progress of each data file as it is loaded into a database table.

This table is visible to all users.

Table Columns

Column Name	Data Type	Description
userid	integer	ID of the user who generated the entry.
query	integer	Query ID. The query column can be used to join other system tables and views.
slice	integer	Slice loaded for this entry.
name	character(256)	System-defined value.
filename	character(256)	Name of file being tracked.
byte_offset	integer	This information is for internal use only.
lines_scanned	integer	Number of lines scanned from the load file. This number may not match the number of rows that are actually loaded. For example, the load may scan but tolerate a number of bad records, based on the MAXERROR option in the COPY command.
errors	integer	This information is for internal use only.
curtime	timestamp	Time that this entry was last updated.
status	integer	This information is for internal use only.

Sample Queries

The following example returns details for the last COPY operation.

```
select query, trim(filename) as file, curtime as updated
from stl_load_commits
where query = pg_last_copy_id();
```

```
query | file | updated
-----+-----+-----
28554 | s3://dw-tickit/category_pipe.txt | 2013-11-01 17:14:52.648486
(1 row)
```

The following query contains entries for a fresh load of the tables in the TICKIT database:

```
select query, trim(filename), curtime
```

```
from stl_load_commits
where filename like '%tickit%' order by query;
```

query	btrim	curtime
22475	tickit/allusers_pipe.txt	2013-02-08 20:58:23.274186
22478	tickit/venue_pipe.txt	2013-02-08 20:58:25.070604
22480	tickit/category_pipe.txt	2013-02-08 20:58:27.333472
22482	tickit/date2008_pipe.txt	2013-02-08 20:58:28.608305
22485	tickit/allevents_pipe.txt	2013-02-08 20:58:29.99489
22487	tickit/listings_pipe.txt	2013-02-08 20:58:37.632939
22593	tickit/allusers_pipe.txt	2013-02-08 21:04:08.400491
22596	tickit/venue_pipe.txt	2013-02-08 21:04:10.056055
22598	tickit/category_pipe.txt	2013-02-08 21:04:11.465049
22600	tickit/date2008_pipe.txt	2013-02-08 21:04:12.461502
22603	tickit/allevents_pipe.txt	2013-02-08 21:04:14.785124
22605	tickit/listings_pipe.txt	2013-02-08 21:04:20.170594

(12 rows)

The fact that a record is written to the log file for this system table does not mean that the load committed successfully as part of its containing transaction. To verify load commits, query the STL_UTILITYTEXT table and look for the COMMIT record that corresponds with a COPY transaction. For example, this query joins STL_LOAD_COMMITS and STL_QUERY based on a subquery against STL_UTILITYTEXT:

```
select l.query,rtrim(l.filename),q.xid
from stl_load_commits l, stl_query q
where l.query=q.query
and exists
(select xid from stl_utilitytext where xid=q.xid and rtrim("text")='COMMIT');
```

query	rtrim	xid
22600	tickit/date2008_pipe.txt	68311
22480	tickit/category_pipe.txt	68066
7508	allusers_pipe.txt	23365
7552	category_pipe.txt	23415
7576	allevents_pipe.txt	23429
7516	venue_pipe.txt	23390
7604	listings_pipe.txt	23445
22596	tickit/venue_pipe.txt	68309
22605	tickit/listings_pipe.txt	68316
22593	tickit/allusers_pipe.txt	68305
22485	tickit/allevents_pipe.txt	68071
7561	allevents_pipe.txt	23429
7541	category_pipe.txt	23415
7558	date2008_pipe.txt	23428
22478	tickit/venue_pipe.txt	68065
526	date2008_pipe.txt	2572
7466	allusers_pipe.txt	23365
22482	tickit/date2008_pipe.txt	68067
22598	tickit/category_pipe.txt	68310
22603	tickit/allevents_pipe.txt	68315
22475	tickit/allusers_pipe.txt	68061
547	date2008_pipe.txt	2572
22487	tickit/listings_pipe.txt	68072

```
7531 | venue_pipe.txt | 23390
7583 | listings_pipe.txt | 23445
(25 rows)
```

STL_LOAD_ERRORS

Displays the records of all Amazon Redshift load errors.

STL_LOAD_ERRORS contains a history of all Amazon Redshift load errors. See [Load Error Reference \(p. 160\)](#) for a comprehensive list of possible load errors and explanations.

Query [STL_LOADERERROR_DETAIL \(p. 715\)](#) for additional details, such as the exact data row and column where a parse error occurred, after you query STL_LOAD_ERRORS to find out general information about the error.

This table is visible to all users.

Table Columns

Column Name	Data Type	Description
userid	integer	ID of the user who generated the entry.
slice	integer	Slice where the error occurred.
tbl	integer	Table ID.
starttime	timestamp	Start time in UTC for the load.
session	integer	Session ID for the session performing the load.
query	integer	Query ID. The query column can be used to join other system tables and views.
filename	character(256)	Complete path to the input file for the load.
line_number	bigint	Line number in the load file with the error. For COPY from JSON, the line number of the last line of the JSON object with the error.
colname	character(127)	Field with the error.
type	character(10)	Data Type of the field.
col_length	character(10)	Column length, if applicable. This field is populated when the data type has a limit length. For example, for a column with a data type of "character(3)", this column will contain the value "3".
position	integer	Position of the error in the field.
raw_line	character(1024)	Raw load data that contains the error.
raw_field_value	character(1024)	The pre-parsing value for the field "colname" that lead to the parsing error.
err_code	integer	Error code.
err_reason	character(100)	Explanation for the error.

Sample Queries

The following query joins STL_LOAD_ERRORS to STL_LOADERROR_DETAIL to view the details errors that occurred during the most recent load.

```
select d.query, substring(d.filename,14,20),
d.line_number as line,
substring(d.value,1,16) as value,
substring(le.err_reason,1,48) as err_reason
from stl_loadererror_detail d, stl_load_errors le
where d.query = le.query
and d.query = pg_last_copy_id();
```

query	substring	line	value	err_reason
558	allusers_pipe.txt	251	251	String contains invalid or unsupported UTF8 code
558	allusers_pipe.txt	251	ZRU29FGR	String contains invalid or unsupported UTF8 code
558	allusers_pipe.txt	251	Kaitlin	String contains invalid or unsupported UTF8 code
558	allusers_pipe.txt	251	Walter	String contains invalid or unsupported UTF8 code

The following example uses STL_LOAD_ERRORS with STV_TBL_PERM to create a new view, and then uses that view to determine what errors occurred while loading data into the EVENT table:

```
create view loadview as
(select distinct tbl, trim(name) as table_name, query, starttime,
trim(filename) as input, line_number, colname, err_code,
trim(err_reason) as reason
from stl_load_errors sl, stv_tbl_perm sp
where sl.tbl = sp.id);
```

Next, the following query actually returns the last error that occurred while loading the EVENT table:

```
select table_name, query, line_number, colname, starttime,
trim(reason) as error
from loadview
where table_name = 'event'
order by line_number limit 1;
```

The query returns the last load error that occurred for the EVENT table. If no load errors occurred, the query returns zero rows. In this example, the query returns a single error:

```
table_name | query | line_number | colname | error | starttime
-----+-----+-----+-----+-----+-----
+-----+-----+-----+-----+-----+-----
+-----+-----+-----+-----+-----+-----
event | 309 | 0 | 5 | Error in Timestamp value or format [%Y-%m-%d %H:%M:%S] | 2014-04-22 15:12:44
(1 row)
```

STL_LOADERROR_DETAIL

Displays a log of data parse errors that occurred while using a COPY command to load tables. To conserve disk space, a maximum of 20 errors per node slice are logged for each load operation.

A parse error occurs when Amazon Redshift cannot parse a field in a data row while loading it into a table. For example, if a table column is expecting an integer data type and the data file contains a string of letters in that field, it causes a parse error.

Query STL_LOADERROR_DETAIL for additional details, such as the exact data row and column where a parse error occurred, after you query [STL_LOAD_ERRORS](#) (p. 713) to find out general information about the error.

The STL_LOADERROR_DETAIL table contains all data columns including and prior to the column where the parse error occurred. Use the VALUE field to see the data value that was actually parsed in this column, including the columns that parsed correctly up to the error.

This table is visible to all users.

Table Columns

Column Name	Data Type	Description
userid	integer	ID of the user who generated the entry.
slice	integer	Slice where the error occurred.
session	integer	Session ID for the session performing the load.
query	integer	Query ID. The query column can be used to join other system tables and views.
filename	character(256)	Complete path to the input file for the load.
line_number	bigint	Line number in the load file with the error.
field	integer	Field with the error.
colname	character(1024)	Column Name.
value	character(1024)	Parsed data value of the field. (May be truncated.)
is_null	integer	Whether or not the parsed value is null.
type	character(10)	Data Type of the field.
col_length	character(10)	Column length, if applicable. This field is populated when the data type has a limit length. For example, for a column with a data type of "character(3)", this column will contain the value "3".

Sample Query

The following query joins STL_LOAD_ERRORS to STL_LOADERROR_DETAIL to view the details of a parse error that occurred while loading the EVENT table, which has a table ID of 100133:

```
select d.query, d.line_number, d.value,
```

```
le.raw_line, le.err_reason
from stl_loadererror_detail d, stl_load_errors le
where
d.query = le.query
and tbl = 100133;
```

The following sample output shows the columns that loaded successfully, including the column with the error. In this example, two columns successfully loaded before the parse error occurred in the third column, where a character string was incorrectly parsed for a field expecting an integer. Because the field expected an integer, it parsed the string "aaa", which is uninitialized data, as a null and generated a parse error. The output shows the raw value, parsed value, and error reason:

query	line_number	value	raw_line	err_reason
4	3	1201	1201	Invalid digit
4	3	126	126	Invalid digit
4	3		aaa	Invalid digit

(3 rows)

When a query joins STL_LOAD_ERRORS and STL_LOADERERROR_DETAIL, it displays an error reason for each column in the data row, which simply means that an error occurred in that row. The last row in the results is the actual column where the parse error occurred.

STL_MERGE

Analyzes merge execution steps for queries. These steps occur when the results of parallel operations (such as sorts and joins) are merged for subsequent processing.

This table is visible to all users.

Table Columns

Column Name	Data Type	Description
userid	integer	ID of the user who generated the entry.
query	integer	Query ID. The query column can be used to join other system tables and views.
slice	integer	Number that identifies the slice where the query was running.
segment	integer	Number that identifies the query segment.
step	integer	Query step that executed.
starttime	timestamp	Time in UTC that the query started executing, with 6 digits of precision for fractional seconds. For example: 2009-06-12 11:29:19.131358.
endtime	timestamp	Time in UTC that the query finished executing, with 6 digits of precision for fractional seconds. For example: 2009-06-12 11:29:19.131358.
tasknum	integer	Number of the query task process that was assigned to execute the step.
rows	bigint	Total number of rows that were processed.

Sample Queries

The following example returns 10 merge execution results.

```
select query, step, starttime, endtime, tasknum, rows
from stl_merge
limit 10;
```

query	step	starttime	endtime	tasknum	rows
9	0	2013-08-12 20:08:14	2013-08-12 20:08:14	0	0
12	0	2013-08-12 20:09:10	2013-08-12 20:09:10	0	0
15	0	2013-08-12 20:10:24	2013-08-12 20:10:24	0	0
20	0	2013-08-12 20:11:27	2013-08-12 20:11:27	0	0
26	0	2013-08-12 20:12:28	2013-08-12 20:12:28	0	0
32	0	2013-08-12 20:14:33	2013-08-12 20:14:33	0	0
38	0	2013-08-12 20:16:43	2013-08-12 20:16:43	0	0
44	0	2013-08-12 20:17:05	2013-08-12 20:17:05	0	0
50	0	2013-08-12 20:18:48	2013-08-12 20:18:48	0	0
56	0	2013-08-12 20:20:48	2013-08-12 20:20:48	0	0

(10 rows)

STL_MERGEJOIN

Analyzes merge join execution steps for queries.

This table is visible to all users.

Table Columns

Column Name	Data Type	Description
userid	integer	ID of the user who generated the entry.
query	integer	Query ID. The query column can be used to join other system tables and views.
slice	integer	Number that identifies the slice where the query was running.
segment	integer	Number that identifies the query segment.
step	integer	Query step that executed.
starttime	timestamp	Time in UTC that the query started executing, with 6 digits of precision for fractional seconds. For example: 2009-06-12 11:29:19.131358 .
endtime	timestamp	Time in UTC that the query finished executing, with 6 digits of precision for fractional seconds. For example: 2009-06-12 11:29:19.131358 .
tasknum	integer	Number of the query task process that was assigned to execute the step.
rows	bigint	Total number of rows that were processed.

Column Name	Data Type	Description
tbl	integer	Table ID. This is the ID for the inner table that was used in the merge join.

Sample Queries

The following example returns merge join results for the most recent query.

```
select sum(s.qtysold), e.eventname
from event e, listing l, sales s
where e.eventid=l.eventid
and l.listid= s.listid
group by e.eventname;

select * from stl_mergejoin where query=pg_last_query_id();
```

userid	query	slice	segment	step	starttime	endtime	tasknum	rows	tbl
100	27399	3	4	4	2013-10-02 16:30:41	2013-10-02 16:30:41	19	43428	240
100	27399	0	4	4	2013-10-02 16:30:41	2013-10-02 16:30:41	19	43159	240
100	27399	2	4	4	2013-10-02 16:30:41	2013-10-02 16:30:41	19	42778	240
100	27399	1	4	4	2013-10-02 16:30:41	2013-10-02 16:30:41	19	43091	240

STL_NESTLOOP

Analyzes nested-loop join execution steps for queries.

This table is visible to all users.

Table Columns

Column Name	Data Type	Description
userid	integer	ID of the user who generated the entry.
query	integer	Query ID. The query column can be used to join other system tables and views.
slice	integer	Number that identifies the slice where the query was running.
segment	integer	Number that identifies the query segment.
step	integer	Query step that executed.

Column Name	Data Type	Description
starttime	timestamp	Time in UTC that the query started executing, with 6 digits of precision for fractional seconds. For example: 2009-06-12 11:29:19.131358.
endtime	timestamp	Time in UTC that the query finished executing, with 6 digits of precision for fractional seconds. For example: 2009-06-12 11:29:19.131358.
tasknum	integer	Number of the query task process that was assigned to execute the step.
rows	bigint	Total number of rows that were processed.
tbl	integer	Table ID.

Sample Queries

Because the following query neglects to join the CATEGORY table, it produces a partial Cartesian product, which is not recommended. It is shown here to illustrate a nested loop.

```
select count(event.eventname), event.eventname, category.catname,
       date.caldate
from event, category, date
where event.dateid = date.dateid
group by event.eventname, category.catname, date.caldate;
```

The following query shows the results from the previous query in the STL_NESTLOOP table.

```
select query, slice, segment as seg, step,
       datediff(msec, starttime, endtime) as duration, tasknum, rows, tbl
from stl_nestloop
where query = pg_last_query_id();
```

query	slice	seg	step	duration	tasknum	rows	tbl
6028	0	4	5	41	22	24277	240
6028	1	4	5	26	23	24189	240
6028	3	4	5	25	23	24376	240
6028	2	4	5	54	22	23936	240

STL_PARSE

Analyzes query steps that parse strings into binary values for loading.

This table is visible to all users.

Table Columns

Column Name	Data Type	Description
userid	integer	ID of the user who generated the entry.

Column Name	Data Type	Description
query	integer	Query ID. The query column can be used to join other system tables and views.
slice	integer	Number that identifies the slice where the query was running.
segment	integer	Number that identifies the query segment.
step	integer	Query step that executed.
starttime	timestamp	Time in UTC that the query started executing, with 6 digits of precision for fractional seconds. For example: 2009-06-12 11:29:19.131358.
endtime	timestamp	Time in UTC that the query finished executing, with 6 digits of precision for fractional seconds. For example: 2009-06-12 11:29:19.131358.
tasknum	integer	Number of the query task process that was assigned to execute the step.
rows	bigint	Total number of rows that were processed.

Sample Queries

The following example returns all query step results for slice 1 and segment 0 where strings were parsed into binary values.

```
select query, step, starttime, endtime, tasknum, rows
from stl_parse
where slice=1 and segment=0;
```

query	step	starttime	endtime	tasknum	rows
669	1	2013-08-12 22:35:13	2013-08-12 22:35:17	32	192497
696	1	2013-08-12 22:35:49	2013-08-12 22:35:49	32	0
525	1	2013-08-12 22:32:03	2013-08-12 22:32:03	13	49990
585	1	2013-08-12 22:33:18	2013-08-12 22:33:19	13	202
621	1	2013-08-12 22:34:03	2013-08-12 22:34:03	27	365
651	1	2013-08-12 22:34:47	2013-08-12 22:34:53	35	192497
590	1	2013-08-12 22:33:28	2013-08-12 22:33:28	19	0
599	1	2013-08-12 22:33:39	2013-08-12 22:33:39	31	11
675	1	2013-08-12 22:35:26	2013-08-12 22:35:27	38	3766
567	1	2013-08-12 22:32:47	2013-08-12 22:32:48	23	49990
630	1	2013-08-12 22:34:17	2013-08-12 22:34:17	36	0
572	1	2013-08-12 22:33:04	2013-08-12 22:33:04	29	0
645	1	2013-08-12 22:34:37	2013-08-12 22:34:38	29	8798
604	1	2013-08-12 22:33:47	2013-08-12 22:33:47	37	0

(14 rows)

STL_PLAN_INFO

Use the STL_PLAN_INFO table to look at the EXPLAIN output for a query in terms of a set of rows. This is an alternative way to look at query plans.

This table is visible to all users.

Table Columns

Column Name	Data Type	Description
userid	integer	ID of the user who generated the entry.
query	integer	Query ID. The query column can be used to join other system tables and views.
nodeid	integer	Plan node identifier, where a node maps to one or more steps in the execution of the query.
segment	integer	Number that identifies the query segment.
step	integer	Number that identifies the query step.
locus	integer	Location where the step executes. 0 if on a compute node and 1 if on the leader node.
plannode	integer	Enumerated value of the plan node. See the following table for enums for plannode. (The PLANNODE column in STL_EXPLAIN (p. 702) contains the plan node text.)
startupcost	double precision	The estimated relative cost of returning the first row for this step.
totalcost	double precision	The estimated relative cost of executing the step.
rows	bigint	The estimated number of rows that will be produced by the step.
bytes	bigint	The estimated number of bytes that will be produced by the step.

Sample Queries

The following examples compare the query plans for a simple SELECT query returned by using the EXPLAIN command and by querying the STL_PLAN_INFO table.

```

explain select * from category;
QUERY PLAN
-----
XN Seq Scan on category (cost=0.00..0.11 rows=11 width=49)
(1 row)

select * from category;
catid | catgroup | catname | catdesc
-----+-----+-----+-----
1 | Sports | MLB | Major League Baseball
3 | Sports | NFL | National Football League
5 | Sports | MLS | Major League Soccer
...

select * from stl_plan_info where query=256;

query | nodeid | segment | step | locus | plannode | startupcost | totalcost
| rows | bytes
-----+-----+-----+-----+-----+-----+-----+-----
+-----+-----+-----+-----+-----+-----+-----+-----

```

```
256 | 1 | 0 | 1 | 0 | 104 | 0 | 0.11 | 11 | 539
256 | 1 | 0 | 0 | 0 | 104 | 0 | 0.11 | 11 | 539
(2 rows)
```

In this example, PLANNODE 104 refers to the sequential scan of the CATEGORY table.

```
select distinct eventname from event order by 1;

eventname
-----
.38 Special
3 Doors Down
70s Soul Jam
A Bronx Tale
...

explain select distinct eventname from event order by 1;

QUERY PLAN
-----
XN Merge (cost=1000000000136.38..1000000000137.82 rows=576 width=17)
Merge Key: eventname
-> XN Network (cost=1000000000136.38..1000000000137.82 rows=576
width=17)
Send to leader
-> XN Sort (cost=1000000000136.38..1000000000137.82 rows=576
width=17)
Sort Key: eventname
-> XN Unique (cost=0.00..109.98 rows=576 width=17)
-> XN Seq Scan on event (cost=0.00..87.98 rows=8798
width=17)
(8 rows)

select * from stl_plan_info where query=240 order by nodeid desc;

query | nodeid | segment | step | locus | plannode | startupcost |
totalcost | rows | bytes
-----+-----+-----+-----+-----+-----+-----
240 | 5 | 0 | 0 | 0 | 104 | 0 | 87.98 | 8798 | 149566

240 | 5 | 0 | 1 | 0 | 104 | 0 | 87.98 | 8798 | 149566
240 | 4 | 0 | 2 | 0 | 117 | 0 | 109.975 | 576 | 9792
240 | 4 | 0 | 3 | 0 | 117 | 0 | 109.975 | 576 | 9792
240 | 4 | 1 | 0 | 0 | 117 | 0 | 109.975 | 576 | 9792
240 | 4 | 1 | 1 | 0 | 117 | 0 | 109.975 | 576 | 9792
240 | 3 | 1 | 2 | 0 | 114 | 1000000000136.38 | 1000000000137.82 | 576 | 9792
240 | 3 | 2 | 0 | 0 | 114 | 1000000000136.38 | 1000000000137.82 | 576 | 9792
240 | 2 | 2 | 1 | 0 | 123 | 1000000000136.38 | 1000000000137.82 | 576 | 9792
240 | 1 | 3 | 0 | 0 | 122 | 1000000000136.38 | 1000000000137.82 | 576 | 9792
(10 rows)
```

STL_PROJECT

Contains rows for query steps that are used to evaluate expressions.

This table is visible to all users.

Table Columns

Column Name	Data Type	Description
userid	integer	ID of the user who generated the entry.
query	integer	Query ID. The query column can be used to join other system tables and views.
slice	integer	Number that identifies the slice where the query was running.
segment	integer	Number that identifies the query segment.
step	integer	Query step that executed.
starttime	timestamp	Time in UTC that the query started executing, with 6 digits of precision for fractional seconds. For example: 2009-06-12 11:29:19.131358.
endtime	timestamp	Time in UTC that the query finished executing, with 6 digits of precision for fractional seconds. For example: 2009-06-12 11:29:19.131358.
tasknum	integer	Number of the query task process that was assigned to execute the step.
rows	bigint	Total number of rows that were processed.

Sample Queries

The following example returns all rows for query steps that were used to evaluate expressions for slice 0 and segment 1.

```
select query, step, starttime, endtime, tasknum, rows
from stl_project
where slice=0 and segment=1;
```

query	step	starttime	endtime	tasknum	rows
86399	2	2013-08-29 22:01:21	2013-08-29 22:01:21	25	-1
86399	3	2013-08-29 22:01:21	2013-08-29 22:01:21	25	-1
719	1	2013-08-12 22:38:33	2013-08-12 22:38:33	7	-1
86383	1	2013-08-29 21:58:35	2013-08-29 21:58:35	7	-1
714	1	2013-08-12 22:38:17	2013-08-12 22:38:17	2	-1
86375	1	2013-08-29 21:57:59	2013-08-29 21:57:59	2	-1
86397	2	2013-08-29 22:01:20	2013-08-29 22:01:20	19	-1
627	1	2013-08-12 22:34:13	2013-08-12 22:34:13	34	-1
86326	2	2013-08-29 21:45:28	2013-08-29 21:45:28	34	-1
86326	3	2013-08-29 21:45:28	2013-08-29 21:45:28	34	-1
86325	2	2013-08-29 21:45:27	2013-08-29 21:45:27	28	-1
86371	1	2013-08-29 21:57:42	2013-08-29 21:57:42	4	-1
111100	2	2013-09-03 19:04:45	2013-09-03 19:04:45	12	-1
704	2	2013-08-12 22:36:34	2013-08-12 22:36:34	37	-1
649	2	2013-08-12 22:34:47	2013-08-12 22:34:47	38	-1
649	3	2013-08-12 22:34:47	2013-08-12 22:34:47	38	-1
632	2	2013-08-12 22:34:22	2013-08-12 22:34:22	13	-1

705	2	2013-08-12 22:36:48	2013-08-12 22:36:49	13	-1
705	3	2013-08-12 22:36:48	2013-08-12 22:36:49	13	-1
3	1	2013-08-12 20:07:40	2013-08-12 20:07:40	3	-1
86373	1	2013-08-29 21:57:58	2013-08-29 21:57:58	3	-1
107976	1	2013-09-03 04:05:12	2013-09-03 04:05:12	3	-1
86381	1	2013-08-29 21:58:35	2013-08-29 21:58:35	8	-1
86396	1	2013-08-29 22:01:20	2013-08-29 22:01:20	15	-1
711	1	2013-08-12 22:37:10	2013-08-12 22:37:10	20	-1
86324	1	2013-08-29 21:45:27	2013-08-29 21:45:27	24	-1
(26 rows)					

STL_QUERY

Returns execution information about a database query.

Note

The STL_QUERY and STL_QUERYTEXT tables only contain information about queries, not other utility and DDL commands. For a listing and information on all statements executed by Amazon Redshift, you can also query the STL_DDLTEXT and STL_UTILITYTEXT tables.

For a complete listing of all statements executed by Amazon Redshift, you can query the SVL_STATEMENTTEXT view.

To manage disk space, the STL log tables only retain approximately two to five days of log history, depending on log usage and available disk space. If you want to retain the log data, you will need to periodically copy it to other tables or unload it to Amazon S3.

This table is visible to all users.

Table Columns

Column Name	Data Type	Description
userid	integer	ID of the user who generated the entry.
query	integer	Query ID. The query column can be used to join other system tables and views.
label	character(15)	Either the name of the file used to run the query or a label defined with a SET QUERY_GROUP command. If the query is not file-based or the QUERY_GROUP parameter is not set, this field value is default.
xid	bigint	Transaction ID.
pid	integer	Process ID. Normally, all of the queries in a session are run in the same process, so this value usually remains constant if you run a series of queries in the same session. Following certain internal events, Amazon Redshift might restart an active session and assign a new PID. For more information, see STL_RESTARTED_SESSIONS (p. 728).
database	character(32)	The name of the database the user was connected to when the query was issued.
querytxt	character(4000)	Actual query text for the query.

Column Name	Data Type	Description
starttime	timestamp	Time in UTC that the query started executing, with 6 digits of precision for fractional seconds. For example: 2009-06-12 11:29:19.131358.
endtime	timestamp	Time in UTC that the query finished executing, with 6 digits of precision for fractional seconds. For example: 2009-06-12 11:29:19.131358.
aborted	integer	If a query was aborted by the system or canceled by the user, this column contains 1. If the query ran to completion (including returning results to the client), this column contains 0. If a client disconnects before receiving the results, the query will be marked as canceled (1), even if it completed successfully in the backend.
insert_pristine	integer	Whether write queries are/were able to run while the current query is/was running. 1 = no write queries allowed. 0 = write queries allowed. This column is intended for use in debugging.

Sample Queries

The following query lists the five most recent queries.

```
select query, trim(querytxt) as sqlquery
from stl_query
order by query desc limit 5;
```

```
query |                               sqlquery
-----+-----
129 | select query, trim(querytxt) from stl_query order by query;
128 | select node from stv_disk_read_speeds;
127 | select system_status from stv_gui_status
126 | select * from systable_topology order by slice
125 | load global dict registry
(5 rows)
```

The following query returns the time elapsed in descending order for queries that ran on February 15, 2013.

```
select query, datediff(seconds, starttime, endtime),
trim(querytxt) as sqlquery
from stl_query
where starttime >= '2013-02-15 00:00' and endtime < '2013-02-15 23:59'
order by date_diff desc;
```

```
query | date_diff | sqlquery
-----+-----
55 | 119 | padb_fetch_sample: select count(*) from category
121 | 9 | select * from svl_query_summary;
181 | 6 | select * from svl_query_summary where query in(179,178);
172 | 5 | select * from svl_query_summary where query=148;
...
```

(189 rows)

STL_QUERYTEXT

Captures the query text for SQL commands.

Query the STL_QUERYTEXT table to capture the SQL that was logged for the following statements:

- SELECT, SELECT INTO
- INSERT, UPDATE, DELETE
- COPY
- VACUUM, ANALYZE
- CREATE TABLE AS (CTAS)

To query activity for these statements over a given time period, join the STL_QUERYTEXT and STL_QUERY tables.

Note

The STL_QUERY and STL_QUERYTEXT tables only contain information about queries, not other utility and DDL commands. For a listing and information on all statements executed by Amazon Redshift, you can also query the STL_DDLTEXT and STL_UTILITYTEXT tables.

For a complete listing of all statements executed by Amazon Redshift, you can query the SVL_STATEMENTTEXT view.

See also [STL_DDLTEXT](#) (p. 696), [STL_UTILITYTEXT](#) (p. 744), and [SVL_STATEMENTTEXT](#) (p. 790).

This table is visible to all users.

Table Columns

Column Name	Data Type	Description
userid	integer	ID of the user who generated the entry.
query	integer	Query ID. The query column can be used to join other system tables and views.
xid	bigint	Transaction ID.
pid	integer	Process ID. Normally, all of the queries in a session are run in the same process, so this value usually remains constant if you run a series of queries in the same session. Following certain internal events, Amazon Redshift might restart an active session and assign a new PID. For more information, see STL_RESTARTED_SESSIONS (p. 728). You can use this column to join to the STL_ERROR (p. 701) table.
sequence	integer	When a single statement contains more than 200 characters, additional rows are logged for that statement. Sequence 0 is the first row, 1 is the second, and so on.
text	character(200)	SQL text, in 200-character increments.

Sample Queries

You can use the `PG_BACKEND_PID()` function to retrieve information for the current session. For example, the following query returns the query ID and a portion of the query text for queries executed in the current session.

```
select query, substring(text,1,60)
from stl_querytext
where pid = pg_backend_pid()
order by query desc;
```

query	substring
28262	select query, substring(text,1,80) from stl_querytext where
28252	select query, substring(path,0,80) as path from stl_unload_l
28248	copy category from 's3://dw-tickit/manifest/category/1030_ma
28247	Count rows in target table
28245	unload ('select * from category') to 's3://dw-tickit/manifes
28240	select query, substring(text,1,40) from stl_querytext where

(6 rows)

STL_REPLACEMENTS

Displays a log that records when invalid UTF-8 characters were replaced by the [COPY \(p. 317\)](#) command with the `ACCEPTINVCHARS` option. A log entry is added to `STL_REPLACEMENTS` for each of the first 100 rows on each node slice that required at least one replacement.

This table is visible to all users.

Table Columns

Column Name	Data Type	Description
userid	integer	ID of the user who generated the entry.
query	integer	Query ID. The query column can be used to join other system tables and views.
slice	integer	Node slice number where the replacement occurred.
tbl	integer	Table ID.
starttime	timestamp	Start time in UTC for the COPY command.
session	integer	Session ID for the session performing the COPY command.
filename	character(256)	Complete path to the input file for the COPY command.
line_number	bigint	Line number in the input data file that contained an invalid UTF-8 character.
colname	character(127)	First field that contained an invalid UTF-8 character.
raw_line	character(1024)	Raw load data that contained an invalid UTF-8 character.

Sample Queries

The following example returns replacements for the most recent COPY operation.

```
select query, session, filename, line_number, colname
from stl_replacements
where query = pg_last_copy_id();
```

query	session	filename	line_number	colname
96	6314	s3://mybucket/allusers_pipe.txt	251	city
96	6314	s3://mybucket/allusers_pipe.txt	317	city
96	6314	s3://mybucket/allusers_pipe.txt	569	city
96	6314	s3://mybucket/allusers_pipe.txt	623	city
96	6314	s3://mybucket/allusers_pipe.txt	694	city
...				

STL_RESTARTED_SESSIONS

To maintain continuous availability following certain internal events, Amazon Redshift might restart an active session with a new process ID (PID). When Amazon Redshift restarts a session, STL_RESTARTED_SESSIONS records the new PID and the old PID.

For more information, see the examples following in this section.

This table is visible to all users.

Table Columns

Column Name	Data Type	Description
currenttime	timestamp	Time of the event.
dbname	character(50)	Name of the database associated with the session.
newpid	integer	Process ID for the restarted session.
oldpid	integer	Process ID for the original session.
username	character(50)	Name of the user associated with the session.
remotehost	character(32)	Name or IP address of the remote host.
remoteport	character(32)	Port number of the remote host.
parkedtime	timestamp	This information is for internal use only.
session_vars	character(2000)	This information is for internal use only.

Sample Queries

The following example joins STL_RESTARTED_SESSIONS with STL_SESSIONS to show user names for sessions that have been restarted.

```
select process, stl_restarted_sessions.newpid, user_name
from stl_sessions
```

```
inner join stl_restarted_sessions on stl_sessions.process =
  stl_restarted_sessions.oldpid
order by process;

...
```

STL_RETURN

Contains details for *return* steps in queries. A return step returns the results of queries executed on the compute nodes to the leader node. The leader node then merges the data and returns the results to the requesting client. For queries executed on the leader node, a return step returns results to the client.

A query consists of multiple segments, and each segment consists of one or more steps. For more information, see [Query Processing \(p. 199\)](#).

STL_RETURN is visible to all users.

Table Columns

Column Name	Data Type	Description
userid	integer	ID of the user who generated the entry.
query	integer	Query ID. The query column can be used to join other system tables and views.
slice	integer	Number that identifies the slice where the query was running.
segment	integer	Number that identifies the query segment.
step	integer	Query step that executed.
starttime	timestamp	Time in UTC that the query started executing, with 6 digits of precision for fractional seconds. For example: 2009-06-12 11:29:19.131358.
endtime	timestamp	Time in UTC that the query finished executing, with 6 digits of precision for fractional seconds. For example: 2009-06-12 11:29:19.131358.
tasknum	integer	Number of the query task process that was assigned to execute the step.
rows	bigint	Total number of rows that were processed.
bytes	bigint	Size, in bytes, of all the output rows for the step.
packets	integer	Total number of packets sent over the network.

Sample Queries

The following query shows which steps in the most recent query were executed on each slice. (Slice 10000 is on the leader node.)

```
SELECT query, slice, segment, step, endtime, rows, packets
from stl_return where query = pg_last_query_id();
```

```

query | slice | segment | step |          endtime          | rows |
packets
-----+-----+-----+-----+-----+-----+-----
0    4 |     2 |     3 |  2 | 2013-12-27 01:43:21.469043 |    3 |
0    4 |     3 |     3 |  2 | 2013-12-27 01:43:21.473321 |    0 |
0    4 |     0 |     3 |  2 | 2013-12-27 01:43:21.469118 |    2 |
0    4 |     1 |     3 |  2 | 2013-12-27 01:43:21.474196 |    0 |
0    4 |     4 |     3 |  2 | 2013-12-27 01:43:21.47704  |    2 |
0    4 |     5 |     3 |  2 | 2013-12-27 01:43:21.478593 |    0 |
0    4 | 10000 |     4 |  1 | 2013-12-27 01:43:21.480755 |    0 |
(7 rows)

```

STL_S3CLIENT

Records transfer time and other performance metrics.

Use the STL_S3CLIENT table to find the time spent transferring data from Amazon S3 as part of a COPY command.

This table is visible to all users.

Table Columns

Column Name	Data Type	Description
userid	integer	ID of the user who generated the entry.
query	integer	Query ID. The query column can be used to join other system tables and views.
slice	integer	Number that identifies the slice where the query was running.
recordtime	timestamp	Time the record is logged.
pid	integer	Process ID. All of the queries in a session are run in the same process, so this value remains constant if you run a series of queries in the same session.
http_method	character(64)	HTTP method name corresponding to the Amazon S3 request.
bucket	character(64)	S3 bucket name.
key	character(256)	Key corresponding to the Amazon S3 object.
transfer_size	bigint	Number of bytes transferred.
data_size	bigint	Number of bytes of data. This value is the same as transfer_size for uncompressed data. If compression was used, this is the size of the uncompressed data.
start_time	bigint	Time when the transfer began (in microseconds).

Column Name	Data Type	Description
end_time	bigint	Time when the transfer ended (in microseconds).
transfer_time	bigint	Time taken by the transfer (in microseconds).
compression_time	bigint	Portion of the transfer time that was spent uncompressing data (in microseconds).
connect_time	bigint	Time from the start until the connect to the remote server was completed (in microseconds).
app_connect_time	bigint	Time from the start until the SSL connect/handshake with the remote host was completed (in microseconds).
retries	bigint	Number of times the transfer was retried.
request_id	char(32)	Request ID from Amazon S3 HTTP response header
extended_request_id	char(128)	Extended request ID from Amazon S3 HTTP header response (x-amz-id-2).
ip_address	char(64)	IP address of the server (ip V4 or V6).

Sample Query

The following query returns the time taken to load files using a COPY command.

```
select slice, key, transfer_time
from stl_s3client
where query = pg_last_copy_id();
```

Result

slice	key	transfer_time
0	listing10M0003_part_00	16626716
1	listing10M0001_part_00	12894494
2	listing10M0002_part_00	14320978
3	listing10M0000_part_00	11293439
3371	prefix=listing10M;marker=	99395

STL_S3CLIENT_ERROR

Records errors encountered by a slice while loading a file from Amazon S3.

Use the STL_S3CLIENT_ERROR to find details for errors encountered while transferring data from Amazon S3 as part of a COPY command.

This table is visible to all users.

Table Columns

Column Name	Data Type	Description
userid	integer	ID of the user who generated the entry.

Column Name	Data Type	Description
query	integer	Query ID. The query column can be used to join other system tables and views.
sliceid	integer	Number that identifies the slice where the query was running.
recordtime	timestamp	Time the record is logged.
pid	integer	Process ID. All of the queries in a session are run in the same process, so this value remains constant if you run a series of queries in the same session.
http_method	character(64)	HTTP method name corresponding to the Amazon S3 request.
bucket	character(64)	Amazon S3 bucket name.
key	character(256)	Key corresponding to the Amazon S3 object.
error	character(1024)	Error message.

Sample Query

The following query returns the errors from COPY commands executed during the current session.

```
select query, sliceid, substring(key from 1 for 20) as file,
substring(error from 1 for 35) as error
from stl_s3client_error
where pid = pg_backend_pid()
order by query desc;
```

Result

query	sliceid	file	error
362228	12	part.tbl.25.159.gz	transfer closed with 1947655 bytes
362228	24	part.tbl.15.577.gz	transfer closed with 1881910 bytes
362228	7	part.tbl.22.600.gz	transfer closed with 700143 bytes r
362228	22	part.tbl.3.34.gz	transfer closed with 2334528 bytes
362228	11	part.tbl.30.274.gz	transfer closed with 699031 bytes r
362228	30	part.tbl.5.509.gz	Unknown SSL protocol error in conne
361999	10	part.tbl.23.305.gz	transfer closed with 698959 bytes r
361999	19	part.tbl.26.582.gz	transfer closed with 1881458 bytes
361999	4	part.tbl.15.629.gz	transfer closed with 2275907 bytes
361999	20	part.tbl.6.456.gz	transfer closed with 692162 bytes r

(10 rows)

STL_SAVE

Contains details for save steps in queries. A save step saves the input stream to a transient table. A transient table is a temporary table that stores intermediate results during query execution.

A query consists of multiple segments, and each segment consists of one or more steps. For more information, see [Query Processing \(p. 199\)](#).

STL_SAVE is visible to all users.

Table Columns

Column Name	Data Type	Description
userid	integer	ID of the user who generated the entry.
query	integer	Query ID. The query column can be used to join other system tables and views.
slice	integer	Number that identifies the slice where the query was running.
segment	integer	Number that identifies the query segment.
step	integer	Query step that executed.
starttime	timestamp	Time in UTC that the query started executing, with 6 digits of precision for fractional seconds. For example: 2009-06-12 11:29:19.131358.
endtime	timestamp	Time in UTC that the query finished executing, with 6 digits of precision for fractional seconds. For example: 2009-06-12 11:29:19.131358.
tasknum	integer	Number of the query task process that was assigned to execute the step.
rows	bigint	Total number of rows that were processed.
bytes	bigint	Size, in bytes, of all the output rows for the step.
tbl	integer	ID of the materialized transient table.
is_diskbased	character(1)	Whether this step of the query was executed as a disk-based operation: true (t) or false (f).
workmem	bigint	Number of bytes of working memory assigned to the step.

Sample Queries

The following query shows which save steps in the most recent query were executed on each slice.

```
select query, slice, segment, step, tasknum, rows, tbl
from stl_save where query = pg_last_query_id();
```

query	slice	segment	step	tasknum	rows	tbl
52236	3	0	2	21	0	239
52236	2	0	2	20	0	239
52236	2	2	2	20	0	239
52236	3	2	2	21	0	239
52236	1	0	2	21	0	239
52236	0	0	2	20	0	239
52236	0	2	2	20	0	239
52236	1	2	2	21	0	239

(8 rows)

STL_SCAN

Analyzes table scan steps for queries. The step number for rows in this table is always 0 because a scan is the first step in a segment.

This table is visible to all users.

Table Columns

Column Name	Data Type	Description
userid	integer	ID of the user who generated the entry.
query	integer	Query ID. The query column can be used to join other system tables and views.
slice	integer	Number that identifies the slice where the query was running.
segment	integer	Number that identifies the query segment.
step	integer	Query step that executed.
starttime	timestamp	Time in UTC that the query started executing, with 6 digits of precision for fractional seconds. For example: 2009-06-12 11:29:19.131358.
endtime	timestamp	Time in UTC that the query finished executing, with 6 digits of precision for fractional seconds. For example: 2009-06-12 11:29:19.131358.
tasknum	integer	Number of the query task process that was assigned to execute the step.
rows	bigint	Total number of rows that were processed.
bytes	bigint	Size, in bytes, of all the output rows for the step.
fetches	bigint	This information is for internal use only.
type	integer	ID of the scan type. For a list of valid values, see the following table.
tbl	integer	Table ID.
is_rrscan	character(1)	If true (t), indicates that range-restricted scan was used on the step.
is_delayed_scan	character(1)	This information is for internal use only.
rows_pre_filter	bigint	For scans of permanent tables, the total number of rows emitted before filtering rows marked for deletion (ghost rows) and before applying user-defined query filters.
rows_pre_user_filter	bigint	For scans of permanent tables, the number of rows processed after filtering rows marked for deletion (ghost rows) but before applying user-defined query filters.
perm_table_name	character(136)	For scans of permanent tables, the name of the table scanned.

Scan Types

Type ID	Description
1	Data from the network.
2	Permanent user tables in compressed shared memory.
3	Transient row-wise tables.
21	Load files from Amazon S3.
22	Load tables from Amazon DynamoDB.
23	Load data from a remote SSH connection.
24	Load data from remote cluster (sorted region). This is used for resizing.
25	Load data from remote cluster(unsorted region). This is used for resizing.

Usage Notes

Ideally `rows` should be relatively close to `rows_pre_filter`. A large difference between `rows` and `rows_pre_filter` is an indication that the execution engine is scanning rows that are later discarded, which is inefficient. The difference between `rows_pre_filter` and `rows_pre_user_filter` is the number of ghost rows in the scan. Run a `VACUUM` to remove rows marked for deletion. The difference between `rows` and `rows_pre_user_filter` is the number of rows filtered by the query. If a lot of rows are discarded by the user filter, review your choice of sort column or, if this is due to a large unsorted region, run a vacuum.

Sample Queries

The following example shows that `rows_pre_filter` is larger than `rows_pre_user_filter` because the table has deleted rows that have not been vacuumed (ghost rows).

```
SELECT slice, segment, step, rows, rows_pre_filter, rows_pre_user_filter
from stl_scan where query = pg_last_query_id();
```

```

query | slice | segment | step | rows | rows_pre_filter |
rows_pre_user_filter
-----+-----+-----+-----+-----+-----+-----
+-----+-----+-----+-----+-----+-----+-----
42915 | 0 | 0 | 0 | 43159 | 86318 |
43159
42915 | 0 | 1 | 0 | 1 | 0 |
0
42915 | 1 | 0 | 0 | 43091 | 86182 |
43091
42915 | 1 | 1 | 0 | 1 | 0 |
0
42915 | 2 | 0 | 0 | 42778 | 85556 |
42778
42915 | 2 | 1 | 0 | 1 | 0 |
0
42915 | 3 | 0 | 0 | 43428 | 86856 |
43428
42915 | 3 | 1 | 0 | 1 | 0 |
0
```

```
42915 | 10000 | 2 | 0 | 4 | 0 |
0
(9 rows)
```

STL_SESSIONS

Returns information about user session history.

STL_SESSIONS differs from STV_SESSIONS in that STL_SESSIONS contains session history, where STV_SESSIONS contains the current active sessions.

This table is visible to all users.

Table Columns

Column Name	Data Type	Description
userid	integer	ID of the user who generated the entry.
starttime	timestamp	Time in UTC that the session started.
endtime	timestamp	Time in UTC that the session ended.
process	integer	Process ID for the session.
user_name	character(50)	User name associated with the session.
db_name	character(50)	Name of the database associated with the session.

Sample Queries

To view session history for the TICKIT database, type the following query:

```
select starttime, process, user_name
from stl_sessions
where db_name='tickit' order by starttime;
```

This query returns the following sample output:

starttime	process	user_name
2008-09-15 09:54:06.746705	32358	dwuser
2008-09-15 09:56:34.30275	32744	dwuser
2008-09-15 11:20:34.694837	14906	dwuser
2008-09-15 11:22:16.749818	15148	dwuser
2008-09-15 14:32:44.66112	14031	dwuser
2008-09-15 14:56:30.22161	18380	dwuser
2008-09-15 15:28:32.509354	24344	dwuser
2008-09-15 16:01:00.557326	30153	dwuser
2008-09-15 17:28:21.419858	12805	dwuser
2008-09-15 20:58:37.601937	14951	dwuser
2008-09-16 11:12:30.960564	27437	dwuser
2008-09-16 14:11:37.639092	23790	dwuser

```
2008-09-16 15:13:46.02195 | 1355 | dwuser
2008-09-16 15:22:36.515106 | 2878 | dwuser
2008-09-16 15:44:39.194579 | 6470 | dwuser
2008-09-16 16:50:27.02138 | 17254 | dwuser
2008-09-17 12:05:02.157208 | 8439 | dwuser
(17 rows)
```

STL_SORT

Displays sort execution steps for queries, such as steps that use ORDER BY processing.

This table is visible to all users.

Table Columns

Column Name	Data Type	Description
userid	integer	ID of the user who generated the entry.
query	integer	Query ID. The query column can be used to join other system tables and views.
slice	integer	Number that identifies the slice where the query was running.
segment	integer	Number that identifies the query segment.
step	integer	Query step that executed.
starttime	timestamp	Time in UTC that the query started executing, with 6 digits of precision for fractional seconds. For example: 2009-06-12 11:29:19.131358 .
endtime	timestamp	Time in UTC that the query finished executing, with 6 digits of precision for fractional seconds. For example: 2009-06-12 11:29:19.131358 .
tasknum	integer	Number of the query task process that was assigned to execute the step.
rows	bigint	Total number of rows that were processed.
bytes	bigint	Size, in bytes, of all the output rows for the step.
tbl	integer	Table ID.
is_diskbased	character(1)	If true (t), the query was executed as a disk-based operation. If false (f), the query was executed in memory.
workmem	bigint	Total number of bytes in working memory that were assigned to the step.

Sample Queries

The following example returns sort results for slice 0 and segment 1.

```
select query, bytes, tbl, is_diskbased, workmem
from stl_sort
```

```
where slice=0 and segment=1;
```

query	bytes	tbl	is_diskbased	workmem
567	3126968	241	f	383385600
604	5292	242	f	383385600
675	104776	251	f	383385600
525	3126968	251	f	383385600
585	5068	241	f	383385600
630	204808	266	f	383385600
704	0	242	f	0
669	4606416	241	f	383385600
696	104776	241	f	383385600
651	4606416	254	f	383385600
632	0	256	f	0
599	396	241	f	383385600
86397	0	242	f	0
621	5292	241	f	383385600
86325	0	242	f	0
572	5068	242	f	383385600
645	204808	241	f	383385600
590	396	242	f	383385600

(18 rows)

STL_SSHCLIENT_ERROR

Records all errors seen by the SSH client.

This table is visible to all users.

Table Columns

Column Name	Data Type	Description
userid	integer	ID of the user who generated the entry.
query	integer	Query ID. The query column can be used to join other system tables and views.
slice	integer	Number that identifies the slice where the query was running.
recordtime	timestamp	Time that the error was logged.
pid	integer	Process that logged the error.
ssh_username	character(1024)	The SSH user name.
endpoint	character(1024)	The SSH endpoint.
command	character(4096)	The complete SSH command.
error	character(1024)	The error message.

STL_STREAM_SEGS

Lists the relationship between streams and concurrent segments.

This table is visible to all users.

Table Columns

Column Name	Data Type	Description
userid	integer	ID of the user who generated the entry.
query	integer	Query ID. The query column can be used to join other system tables and views.
stream	integer	The set of concurrent segments of a query.
segment	integer	Number that identifies the query segment.

Sample Queries

To view the relationship between streams and concurrent segments for the most recent query, type the following query:

```
select *
from stl_stream_segs
where query = pg_last_query_id();
```

query	stream	segment
10	1	2
10	0	0
10	2	4
10	1	3
10	0	1

(5 rows)

STL_TR_CONFLICT

Displays information to identify and resolve lock conflicts with database tables.

A lock conflict can occur when two or more users are loading, inserting, deleting, or updating data rows in the same table at the same time. Every time a lock conflict occurs, Amazon Redshift writes a data row to the STL_TR_CONFLICT system table.

This table is visible to superusers.

Table Columns

Column Name	Data Type	Description
xact_id	bigint	Transaction ID for the rolled back transaction.
process_id	bigint	Process associated with the lock.
xact_start_ts	timestamp	Timestamp for the transaction start.
abort_time	timestamp	Time that the transaction was aborted.
table_id	bigint	Table ID for the table where the conflict occurred.

Sample Query

For examples of lock conflicts, see [Managing Concurrent Write Operations \(p. 181\)](#). To return information about conflicts that involved a particular table, run a query that specifies the table ID:

```
select * from stl_tr_conflict where table_id=100234
order by xact_start_ts;
```

xact_id	process_id	xact_start_ts	abort_time	table_id
1876	8551	2010-03-30 09:19:15.852326	2010-03-30 09:20:17.582499	100234
1928	15034	2010-03-30 13:20:00.636045	2010-03-30 13:20:47.766817	100234
1991	23753	2010-04-01 13:05:01.220059	2010-04-01 13:06:06.94098	100234
2002	23679	2010-04-01 13:17:05.173473	2010-04-01 13:18:27.898655	100234

(4 rows)

You can get the table ID from the DETAIL section of the error message for serializability violations (error 1023).

STL_UNDONE

Displays information about transactions that have been undone.

This table is visible to all users.

Table Columns

Column Name	Data Type	Description
userid	integer	ID of the user who generated the entry.
xact_id	bigint	ID for the undo transaction.
xact_id_undone	bigint	ID for the transaction that was undone.
undo_start_ts	timestamp	Start time for the undo transaction.
undo_end_ts	timestamp	End time for the undo transaction.
table_id	bigint	ID for the table that was affected by the undo transaction.

Sample Query

To view a concise log of all undone transactions, type the following command:

```
select xact_id, xact_id_undone, table_id from stl_undone;
```

This command returns the following sample output:

xact_id	xact_id_undone	table_id
1344	1344	100192

```
1326 |          1326 |    100192
1551 |          1551 |    100192
(3 rows)
```

STL_UNIQUE

Analyzes execution steps that occur when a DISTINCT function is used in the SELECT list or when duplicates are removed in a UNION or INTERSECT query.

This table is visible to all users.

Table Columns

Column Name	Data Type	Description
userid	integer	ID of the user who generated the entry.
query	integer	Query ID. The query column can be used to join other system tables and views.
slice	integer	Number that identifies the slice where the query was running.
segment	integer	Number that identifies the query segment.
step	integer	Query step that executed.
starttime	timestamp	Time in UTC that the query started executing, with 6 digits of precision for fractional seconds. For example: 2009-06-12 11:29:19.131358.
endtime	timestamp	Time in UTC that the query finished executing, with 6 digits of precision for fractional seconds. For example: 2009-06-12 11:29:19.131358.
tasknum	integer	Number of the query task process that was assigned to execute the step.
rows	bigint	Total number of rows that were processed.
is_diskbased	character(1)	If true (t), the query was executed as a disk-based operation. If false (f), the query was executed in memory.
slots	integer	Total number of hash buckets.
workmem	bigint	Total number of bytes in working memory that were assigned to the step.
max_buffers_used	bigint	Maximum number of buffers used in the hash table before going to disk.
type	character(6)	The type of step. Valid values are: <ul style="list-style-type: none"> HASHED. Indicates that the step used grouped, unsorted aggregation. PLAIN. Indicates that the step used ungrouped, scalar aggregation. SORTED. Indicates that the step used grouped, sorted aggregation.

Sample Queries

Suppose you execute the following query:

```
select distinct eventname
from event order by 1;
```

Assuming the ID for the previous query is 6313, the following example shows the number of rows produced by the unique step for each slice in segments 0 and 1.

```
select query, slice, segment, step, datediff(msec, starttime, endtime) as
msec, tasknum, rows
from stl_unique where query = 6313
order by query desc, slice, segment, step;
```

query	slice	segment	step	msec	tasknum	rows
6313	0	0	2	0	22	550
6313	0	1	1	256	20	145
6313	1	0	2	1	23	540
6313	1	1	1	42	21	127
6313	2	0	2	1	22	540
6313	2	1	1	255	20	158
6313	3	0	2	1	23	542
6313	3	1	1	38	21	146

(8 rows)

STL_UNLOAD_LOG

Records the details for an unload operation.

STL_UNLOAD_LOG records one row for each file created by an UNLOAD statement. For example, if an UNLOAD creates 12 files, STL_UNLOAD_LOG will contain 12 corresponding rows.

This table is visible to all users.

Table Columns

Column Name	Data Type	Description
userid	integer	ID of the user who generated the entry.
query	integer	ID for the transaction.
slice	integer	Number that identifies the slice where the query was running.
pid	integer	Process ID associated with the query statement.
path	character(1280)	The complete Amazon S3 object path for the file.
start_time	timestamp	Start time for the transaction.
end_time	timestamp	End time for the transaction.
line_count	bigint	Number of lines (rows) unloaded to the file.

Column Name	Data Type	Description
transfer_size	bigint	Number of bytes transferred.

Sample Query

To get a list of the files that were written to Amazon S3 by an UNLOAD command, you can call an Amazon S3 list operation after the UNLOAD completes; however, depending on how quickly you issue the call, the list might be incomplete because an Amazon S3 list operation is eventually consistent. To get a complete, authoritative list immediately, query STL_UNLOAD_LOG.

The following query returns the pathname for files that were created by an UNLOAD with query ID 2320:

```
select query, substring(path,0,40) as path
from stl_unload_log
where query=2320
order by path;
```

This command returns the following sample output:

```
query | path
-----+-----
 2320 | s3://my-bucket/venue0000_part_00
 2320 | s3://my-bucket/venue0001_part_00
 2320 | s3://my-bucket/venue0002_part_00
 2320 | s3://my-bucket/venue0003_part_00
(4 rows)
```

STL_USERLOG

Records details for the following changes to a database user:

- Create user
- Drop user
- Alter user (rename)
- Alter user (alter properties)

This table is visible to superusers.

Table Columns

Column Name	Data Type	Description
userid	integer	ID of the user affected by the change.
username	character(50)	User name of the user affected by the change.
oldusername	character(50)	For a rename action, the original user name. For any other action, this field is empty.
action	character(10)	Action that occurred. Valid values:

Column Name	Data Type	Description
		<ul style="list-style-type: none"> Alter Create Drop Rename
usecreatedb	integer	If true (1), indicates that the user has create database privileges.
usesuper	integer	If true (1), indicates that the user is a superuser.
usecatupd	integer	If true (1), indicates that the user can update system catalogs.
valuntil	timestamp	Password expiration date.
pid	integer	Process ID.
xid	bigint	Transaction ID.
recordtime	timestamp	Time in UTC that the query started.

Sample Queries

The following example performs four user actions, then queries the STL_USERLOG table.

```
create user userlog1 password 'Userlog1';
alter user userlog1 createdb createuser;
alter user userlog1 rename to userlog2;
drop user userlog2;

select userid, username, oldusername, action, usecreatedb, usesuper from
  stl_userlog order by recordtime desc;
```

userid	username	oldusername	action	usecreatedb	usesuper
108	userlog2		drop	1	1
108	userlog2	userlog1	rename	1	1
108	userlog1		alter	1	1
108	userlog1		create	0	0
(4 rows)					

STL_UTILITYTEXT

Captures the text of non-SELECT SQL commands run on the database.

Query the STL_UTILITYTEXT table to capture the following subset of SQL statements that were run on the system:

- ABORT, BEGIN, COMMIT, END, ROLLBACK
- CANCEL

- COMMENT
- CREATE, ALTER, DROP DATABASE
- CREATE, ALTER, DROP USER
- EXPLAIN
- GRANT, REVOKE
- LOCK
- RESET
- SET
- SHOW
- TRUNCATE

See also [STL_DDLTEXT](#) (p. 696), [STL_QUERYTEXT](#) (p. 726), and [SVL_STATEMENTTEXT](#) (p. 790).

Use the STARTTIME and ENDTIME columns to find out which statements were logged during a given time period. Long blocks of SQL text are broken into lines 200 characters long; the SEQUENCE column identifies fragments of text that belong to a single statement.

This table is visible to all users.

Table Columns

Column Name	Data Type	Description
userid	integer	ID of the user who generated the entry.
xid	bigint	Transaction ID.
pid	integer	Process ID associated with the query statement.
label	character(30)	Either the name of the file used to run the query or a label defined with a SET QUERY_GROUP command. If the query is not file-based or the QUERY_GROUP parameter is not set, this field is blank.
starttime	timestamp	Time in UTC that the query started executing, with 6 digits of precision for fractional seconds. For example: 2009-06-12 11:29:19.131358.
endtime	timestamp	Time in UTC that the query finished executing, with 6 digits of precision for fractional seconds. For example: 2009-06-12 11:29:19.131358.
sequence	integer	When a single statement contains more than 200 characters, additional rows are logged for that statement. Sequence 0 is the first row, 1 is the second, and so on.
text	character(200)	SQL text, in 200-character increments.

Sample Queries

The following query returns the text for "utility" commands that were run on January 26th, 2012. In this case, some SET commands and a SHOW ALL command were run:

```
select starttime, sequence, rtrim(text)
from stl_utilitytext
where starttime like '2012-01-26%'
order by starttime, sequence;
```

starttime	sequence	rtrim
2012-01-26 13:05:52.529235	0	show all;
2012-01-26 13:20:31.660255	0	SET query_group to ''
2012-01-26 13:20:54.956131	0	SET query_group to 'soldunsold.sql'
...		

STL_VACUUM

Displays row and block statistics for tables that have been vacuumed.

The table shows information specific to when each vacuum operation started and finished, and demonstrates the benefits of running the operation. For information about the requirements for running this command, see the [VACUUM \(p. 488\)](#) command description.

This table is visible to superusers.

Table Columns

Column Name	Data Type	Description
userid	integer	The ID of the user who generated the entry.
xid	bigint	The transaction ID for the VACUUM statement. You can join this table to the STL_QUERY table to see the individual SQL statements that are run for a given VACUUM transaction. If you vacuum the whole database, each table is vacuumed in a separate transaction.
table_id	integer	The Table ID.
status	character(30)	<p>The status of the VACUUM operation for each table. Possible values are the following:</p> <ul style="list-style-type: none"> • Started • Started Delete Only • Started Delete Only (Sorted >= nn%) <p>Only the delete phase was started for a VACUUM FULL. The sort phase was skipped because the table was already sorted at or above the sort threshold.</p> <ul style="list-style-type: none"> • Started Sort Only • Finished <p>Time the operation completed for the table. To find out how long a vacuum operation took on a specific table, subtract the Started time from the Finished time for a particular transaction ID and table ID.</p> <ul style="list-style-type: none"> • Skipped <p>The table was skipped because the table was fully sorted and no rows were marked for deletion.</p>

Column Name	Data Type	Description
		<ul style="list-style-type: none"> • Skipped (delete only) The table was skipped because DELETE ONLY was specified and no rows were marked for deletion. • Skipped (sort only) The table was skipped because SORT ONLY was specified and the table was already sorted fully sorted. • Skipped (sort only, sorted>=xx%) The table was skipped because SORT ONLY was specified and the table was already sorted at or above the sort threshold. <p>For more information about the VACUUM sort threshold setting, see VACUUM (p. 488).</p>
rows	bigint	The actual number of rows in the table plus any deleted rows that are still stored on disk (waiting to be vacuumed). This column shows the count before the vacuum started for rows with a started status, and the count after the vacuum for rows with a Finished status.
sortedrows	integer	The number of rows in the table that are sorted. This column shows the count before the vacuum started for rows with started in the Status column, and the count after the vacuum for rows with Finished in the Status column.
blocks	integer	The total number of data blocks used to store the table data before the vacuum operation (rows with a started status) and after the vacuum operation (Finished column). Each data block uses 1 MB.
max_merge_partitions	integer	This column is used for performance analysis and represents the maximum number of partitions that vacuum can process for the table per merge phase iteration. (Vacuum sorts the unsorted region into one or more sorted partitions. Depending on the number of columns in the table and the current Amazon Redshift configuration, the merge phase can process a maximum number of partitions in a single merge iteration. The merge phase will still work if the number of sorted partitions exceeds the maximum number of merge partitions, but more merge iterations will be required.)
eventtime	timestamp	When the vacuum operation started or finished.

Sample Queries

The following query reports vacuum statistics for table 108313. The table was vacuumed following a series of inserts and deletes.

```
select xid, table_id, status, rows, sortedrows, blocks, eventtime
from stl_vacuum where table_id=108313 order by eventtime;
```

```

xid | table_id | status | rows | sortedrows | blocks | eventtime
-----+-----+-----+-----+-----+-----+-----
14294 | 108313 | Started | 1950266199 | 400043488 | 280887 | 2016-05-19 17:36:01
14294 | 108313 | Finished | 600099388 | 600099388 | 88978 | 2016-05-19 18:26:13
15126 | 108313 | Skipped(sorted>=95%) | 600099388 | 600099388 | 88978 | 2016-05-19 18:26:38

```

At the start of the VACUUM, the table contained 1,950,266,199 rows stored in 280,887 1 MB blocks. In the delete phase (transaction 14294) completed, vacuum reclaimed space for the deleted rows. The ROWS column shows a value of 400,043,488, and the BLOCKS column has dropped from 280,887 to 88,978. The vacuum reclaimed 191,909 blocks (191.9 GB) of disk space.

In the sort phase (transaction 15126), the vacuum was able to skip the table because the rows were inserted in sort key order.

The following example shows the statistics for a SORT ONLY vacuum on the SALES table (table 110116 in this example) after a large INSERT operation:

```

vacuum sort only sales;

select xid, table_id, status, rows, sortedrows, blocks, eventtime
from stl_vacuum order by xid, table_id, eventtime;

xid | table_id | status | rows | sortedrows | blocks | eventtime
-----+-----+-----+-----+-----+-----+-----
...
2925 | 110116 | Started Sort Only | 1379648 | 172456 | 132 | 2011-02-24
16:25:21...
2925 | 110116 | Finished | 1379648 | 1379648 | 132 | 2011-02-24
16:26:28...

```

STL_WARNING

Displays a log of any unexpected occurrences for Amazon Redshift that were not severe enough to cause an error.

This table is visible to all users.

Table Columns

Column Name	Data Type	Description
userid	integer	ID of the user who generated the entry.
process	character(12)	Process that triggered the warning.
pid	integer	Process ID.
recordtime	timestamp	Time that the warning occurred.
file	character(20)	Name of the source file where the warning occurred.

Column Name	Data Type	Description
linenum	integer	Line number in the source file where the warning occurred.
bug_desc	character(512)	Warning message.

Sample Query

This table is used mainly for troubleshooting by Amazon Redshift support. If you are working with support on an issue, you might be asked to query this table to provide support with information to help resolve the problem.

STL_WINDOW

Analyzes query steps that execute window functions.

This table is visible to all users.

Table Columns

Column Name	Data Type	Description
userid	integer	ID of the user who generated the entry.
query	integer	Query ID. The query column can be used to join other system tables and views.
slice	integer	Number that identifies the slice where the query was running.
segment	integer	Number that identifies the query segment.
step	integer	Query step that executed.
starttime	timestamp	Time in UTC that the query started executing, with 6 digits of precision for fractional seconds. For example: 2009-06-12 11:29:19.131358.
endtime	timestamp	Time in UTC that the query finished executing, with 6 digits of precision for fractional seconds. For example: 2009-06-12 11:29:19.131358.
tasknum	integer	Number of the query task process that was assigned to execute the step.
rows	bigint	Total number of rows that were processed.
is_diskbased	character(1)	If true (t), the query was executed as a disk-based operation. If false (f), the query was executed in memory.
workmem	bigint	Total number of bytes in working memory that were assigned to the step.

Sample Queries

The following example returns window function results for slice 0 and segment 3.

```
select query, tasknum, rows, is_diskbased, workmem
from stl_window
where slice=0 and segment=3;
```

query	tasknum	rows	is_diskbased	workmem
86326	36	1857	f	95256616
705	15	1857	f	95256616
86399	27	1857	f	95256616
649	10	0	f	95256616

(4 rows)

STL_WLM_ERROR

Records all WLM-related errors as they occur.

This table is visible to all users.

Table Columns

Column Name	Data Type	Description
userid	integer	ID of the user who generated the entry.
recordtime	timestamp	Time that the error occurred.
pid	integer	ID for the process that generated the error.
error_string	character(256)	Error description.

STL_WLM_QUERY

Contains a record of each attempted execution of a query in a service class handled by WLM.

This table is visible to all users.

Table Columns

Column Name	Data Type	Description
userid	integer	ID of the user who generated the entry.
xid	integer	Transaction ID of the query or subquery.
task	integer	ID used to track a query through the workload manager. Can be associated with multiple query IDs. If a query is restarted, the query is assigned a new query ID but not a new task ID.
query	integer	Query ID. If a query is restarted, the query is assigned a new query ID but not a new task ID.
service_class	integer	ID for the service class. Service classes are defined in the WLM configuration file.

Column Name	Data Type	Description
slot_count	integer	Number of WLM query slots.
service_class_start_time	timestamp	Time that the query was assigned to the service class.
queue_start_time	timestamp	Time that the query entered the queue for the service class.
queue_end_time	timestamp	Time when the query left the queue for the service class.
total_queue_time	bigint	Total number of microseconds that the query spent in the queue.
exec_start_time	timestamp	Time that the query began executing in the service class.
exec_end_time	timestamp	Time that the query completed execution in the service class.
total_exec_time	bigint	Number of microseconds that the query spent executing.
service_class_end_time	timestamp	Time that the query left the service class.
final_state	character(16)	Reserved for system use.

Sample Queries

View Average Query Time in Queues and Executing

Service classes 1 - 4 are used internally by Amazon Redshift, and service class 5 is reserved for the dedicated superuser queue. The following queries display the current configuration for service classes greater than 4, which include the superuser and WLM query queues.

The following query returns the average time (in microseconds) that each query spent in query queues and executing for each service class.

```
select service_class as svc_class, count(*),
avg(datediff(microseconds, queue_start_time, queue_end_time)) as
  avg_queue_time,
avg(datediff(microseconds, exec_start_time, exec_end_time )) as avg_exec_time
from stl_wlm_query
where service_class > 4
group by service_class
order by service_class;
```

This query returns the following sample output:

svc_class	count	avg_queue_time	avg_exec_time
5	20103	0	80415
5	3421	34015	234015
6	42	0	944266
7	196	6439	1364399

(4 rows)

View Maximum Query Time in Queues and Executing

The following query returns the maximum amount of time (in microseconds) that a query spent in any query queue and executing for each service class.

```
select service_class as svc_class, count(*),
max(datediff(microseconds, queue_start_time, queue_end_time)) as
  max_queue_time,
max(datediff(microseconds, exec_start_time, exec_end_time )) as max_exec_time
from stl_wlm_query
where svc_class > 5
group by service_class
order by service_class;
```

svc_class	count	max_queue_time	max_exec_time
6	42	0	3775896
7	197	37947	16379473

(4 rows)

STV Tables for Snapshot Data

STV tables are actually virtual system tables that contain snapshots of the current system data.

Topics

- [STV_ACTIVE_CURSORS](#) (p. 753)
- [STV_BLOCKLIST](#) (p. 753)
- [STV_CURSOR_CONFIGURATION](#) (p. 756)
- [STV_EXEC_STATE](#) (p. 756)
- [STV_INFLIGHT](#) (p. 758)
- [STV_LOAD_STATE](#) (p. 759)
- [STV_LOCKS](#) (p. 760)
- [STV_PARTITIONS](#) (p. 761)
- [STV_RECENTS](#) (p. 762)
- [STV_SESSIONS](#) (p. 764)
- [STV_SLICES](#) (p. 764)
- [STV_STARTUP_RECOVERY_STATE](#) (p. 765)
- [STV_TBL_PERM](#) (p. 766)
- [STV_TBL_TRANS](#) (p. 768)
- [STV_WLM_CLASSIFICATION_CONFIG](#) (p. 769)
- [STV_WLM_QUERY_QUEUE_STATE](#) (p. 770)
- [STV_WLM_QUERY_STATE](#) (p. 771)
- [STV_WLM_QUERY_TASK_STATE](#) (p. 772)
- [STV_WLM_SERVICE_CLASS_CONFIG](#) (p. 773)
- [STV_WLM_SERVICE_CLASS_STATE](#) (p. 775)

STV_ACTIVE_CURSORS

STV_ACTIVE_CURSORS displays details for currently open cursors. For more information, see [DECLARE](#) (p. 401).

STV_ACTIVE_CURSORS is visible to all users. A user can only view cursors opened by that user. A superuser can view all cursors.

Table Columns

Column Name	Data Type	Description
userid	integer	ID of user who generated entry.
name	character(256)	Cursor name.
xid	bigint	Transaction context.
pid	integer	Leader process running the query.
starttime	timestamp	Time when the cursor was declared.
row_count	bigint	Number of rows in the cursor result set.
byte_count	bigint	Number of bytes in the cursor result set.
fetches_rows	bigint	Number of rows currently fetched from the cursor result set.

STV_BLOCKLIST

STV_BLOCKLIST contains the number of 1 MB disk blocks that are used by each slice, table, or column in a database.

Use aggregate queries with STV_BLOCKLIST, as the following examples show, to determine the number of 1 MB disk blocks allocated per database, table, slice, or column. You can also use [STV_PARTITIONS](#) (p. 761) to view summary information about disk utilization.

STV_BLOCKLIST is visible to superusers.

Table Columns

Column Name	Data Type	Description
slice	integer	Node slice.
col	integer	Zero-based index for the column. Every table you create has three hidden columns appended to it: INSERT_XID, DELETE_XID, and ROW_ID (OID). A table with 3 user-defined columns contains 6 actual columns, and the user-defined columns are internally numbered as 0, 1, and 2. The INSERT_XID, DELETE_XID, and ROW_ID columns are numbered 3, 4, and 5, respectively, in this example.
tbl	integer	Table ID for the database table.
blocknum	integer	ID for the data block.

Column Name	Data Type	Description
num_values	integer	Number of values contained on the block.
extended_limits	integer	For internal use.
minvalue	bigint	Minimum data value of the block. Stores first eight characters as 64-bit integer for non-numeric data. Used for disk scanning.
maxvalue	bigint	Maximum data value of the block. Stores first eight characters as 64-bit integer for non-numeric data. Used for disk scanning.
sb_pos	integer	Internal Amazon Redshift identifier for super block position on the disk.
pinned	integer	Whether or not the block is pinned into memory as part of pre-load. 0 = false; 1 = true. Default is false.
on_disk	integer	Whether or not the block is automatically stored on disk. 0 = false; 1 = true. Default is false.
modified	integer	Whether or not the block has been modified. 0 = false; 1 = true. Default is false.
hdr_modified	integer	Whether or not the block header has been modified. 0 = false; 1 = true. Default is false.
unsorted	integer	Whether or not a block is unsorted. 0 = false; 1 = true. Default is true.
tombstone	integer	For internal use.
preferred_disk	integer	Disk number that the block should be on, unless the disk has failed. Once the disk has been fixed, the block will move back to this disk.
temporary	integer	Whether or not the block contains temporary data, such as from a temporary table or intermediate query results. 0 = false; 1 = true. Default is false.
newblock	integer	Indicates whether or not a block is new (true) or was never committed to disk (false). 0 = false; 1 = true.
num_readers	integer	Number of references on each block.
flags	integer	Internal Amazon Redshift flags for the block header.

Sample Queries

STV_BLOCKLIST contains one row per allocated disk block, so a query that selects all the rows potentially returns a very large number of rows. We recommend using only aggregate queries with STV_BLOCKLIST.

The [SVV_DISKUSAGE \(p. 778\)](#) view provides similar information in a more user-friendly format; however, the following example demonstrates one use of the STV_BLOCKLIST table.

To determine the number of 1 MB blocks used by each column in the VENUE table, type the following query:

```
select col, count(*)
from stv_blocklist, stv_tbl_perm
where stv_blocklist.tbl = stv_tbl_perm.id
```

```
and stv_blocklist.slice = stv_tbl_perm.slice
and stv_tbl_perm.name = 'venue'
group by col
order by col;
```

This query returns the number of 1 MB blocks allocated to each column in the VENUE table, shown by the following sample data:

col	count
0	4
1	4
2	4
3	4
4	4
5	4
7	4
8	4

(8 rows)

The following query shows whether or not table data is actually distributed over all slices:

```
select trim(name) as table, stv_blocklist.slice, stv_tbl_perm.rows
from stv_blocklist, stv_tbl_perm
where stv_blocklist.tbl=stv_tbl_perm.id
and stv_tbl_perm.slice=stv_blocklist.slice
and stv_blocklist.id > 10000 and name not like '%#m%'
and name not like 'systable%'
group by name, stv_blocklist.slice, stv_tbl_perm.rows
order by 3 desc;
```

This query produces the following sample output, showing the even data distribution for the table with the most rows:

table	slice	rows
listing	13	10527
listing	14	10526
listing	8	10526
listing	9	10526
listing	7	10525
listing	4	10525
listing	17	10525
listing	11	10525
listing	5	10525
listing	18	10525
listing	12	10525
listing	3	10525
listing	10	10525
listing	2	10524
listing	15	10524
listing	16	10524
listing	6	10524
listing	19	10524
listing	1	10523

```
listing |      0 | 10521
...
(180 rows)
```

The following query determines whether any tombstoned blocks were committed to disk:

```
select slice, col, tbl, blocknum, newblock
from stv_blocklist
where tombstone > 0;
```

```
slice | col |  tbl | blocknum | newblock
-----+-----+-----+-----+-----
4     |  0 | 101285 |      0 |      1
4     |  2 | 101285 |      0 |      1
4     |  4 | 101285 |      1 |      1
5     |  2 | 101285 |      0 |      1
5     |  0 | 101285 |      0 |      1
5     |  1 | 101285 |      0 |      1
5     |  4 | 101285 |      1 |      1
...
(24 rows)
```

STV_CURSOR_CONFIGURATION

STV_CURSOR_CONFIGURATION displays cursor configuration constraints. For more information, see [Cursor Constraints \(p. 402\)](#).

STV_CURSOR_CONFIGURATION is visible to superusers.

Table Columns

Column Name	Data Type	Description
current_cursor	integer	Number of cursors currently open.
max_diskspace	integer	Amount of disk space available for cursors, in megabytes. This constraint is based on the maximum cursor result set size for the cluster.
current_diskspace	integer	Amount of disk space currently used by cursors, in megabytes.

STV_EXEC_STATE

Use the STV_EXEC_STATE table to find out information about queries and query steps that are actively running on Amazon Redshift.

This information is usually used only to troubleshoot engineering issues. The views SVV_QUERY_STATE and SVL_QUERY_SUMMARY extract their information from STV_EXEC_STATE.

STV_EXEC_STATE is visible to all users.

Table Columns

Column Name	Data Type	Description
userid	integer	ID of user who generated entry.
query	integer	Query ID. Can be used to join various other system tables and views.
slice	integer	Node slice where the step executed.
segment	integer	Segment of the query that executed. A query segment is a series of steps.
step	integer	Step of the query segment that executed. A step is the smallest unit of query execution.
starttime	timestamp	Time that the step executed.
currenttime	timestamp	Current time.
tasknum	integer	Query task process that is assigned to the execute the step.
rows	bigint	Number of rows processed.
bytes	bigint	Number of bytes processed.
label	char(256)	Step label, which consists of a query step name and, when applicable, table ID and table name (for example, <code>scan tbl=100448 name =user</code>). Three-digit table IDs usually refer to scans of transient tables. When you see <code>tbl=0</code> , it usually refers to a scan of a constant value.
is_diskbased	char(1)	Whether this step of the query was executed as a disk-based operation: true (t) or false (f). Only certain steps, such as hash, sort, and aggregate steps, can go to disk. Many types of steps are always executed in memory.
workmem	bigint	Number of bytes of working memory assigned to the step.
num_parts	integer	Number of partitions a hash table is divided into during a hash step. The hash table is partitioned when it is estimated that the entire hash table might not fit into memory. A positive number in this column does not imply that the hash step executed as a disk-based operation. Check the value in the IS_DISKBASED column to see if the hash step was disk-based.
is_rrscan	char(1)	If true (t), indicates that range-restricted scan was used on the step. Default is false (f).
is_delayed_scan	char(1)	If true (t), indicates that delayed scan was used on the step. Default is false (f).

Sample Queries

Rather than querying STV_EXEC_STATE directly, Amazon Redshift recommends querying SVL_QUERY_SUMMARY or SVV_QUERY_STATE to obtain the information in

STV_EXEC_STATE in a more user-friendly format. See the [SVL_QUERY_SUMMARY](#) (p. 788) or [SVV_QUERY_STATE](#) (p. 786) table documentation for more details.

STV_INFLIGHT

Use the STV_INFLIGHT table to determine what queries are currently running on the database. STV_INFLIGHT does not show leader-node only queries. For more information, see [Leader Node—Only Functions](#) (p. 492).

STV_INFLIGHT is visible to all users.

Table Columns

Column Name	Data Type	Description
userid	integer	ID of user who generated entry.
slice	integer	Slice where the query is running.
query	integer	Query ID. Can be used to join various other system tables and views.
label	character(30)	Either the name of the file used to run the query or a label defined with a SET QUERY_GROUP command. If the query is not file-based or the QUERY_GROUP parameter is not set, this field is blank.
xid	bigint	Transaction ID.
pid	integer	Process ID. All of the queries in a session are run in the same process, so this value remains constant if you run a series of queries in the same session. You can use this column to join to the STL_ERROR (p. 701) table.
starttime	timestamp	Time that the query started.
text	character(100)	Query text, truncated to 100 characters if the statement exceeds that limit.
suspended	integer	Whether the query is suspended or not. 0 = false; 1 = true.
insert_pristine	integer	Whether write queries are/were able to run while the current query is/was running. 1 = no write queries allowed. 0 = write queries allowed. This column is intended for use in debugging.

Sample Queries

To view all active queries currently running on the database, type the following query:

```
select * from stv_inflight;
```

The sample output below shows two queries currently running, including the STV_INFLIGHT query itself and a query that was run from a script called `avgwait.sql`:

```
select slice, query, trim(label) querylabel, pid,
```

```
starttime, substring(text,1,20) querytext
from stv_inflight;
```

```
slice|query|querylabel | pid |          starttime          |          querytext
-----+-----+-----+-----+-----+-----
1011 | 21 |          | 646 | 2012-01-26 13:23:15.645503 | select slice, query,
1011 | 20 | avgwait.sql | 499 | 2012-01-26 13:23:14.159912 | select avg(datediff(
(2 rows)
```

STV_LOAD_STATE

Use the STV_LOAD_STATE table to find information about current state of ongoing COPY statements.

The COPY command updates this table after every million records are loaded.

STV_LOAD_STATE is visible to all users.

Table Columns

Column Name	Data Type	Description
userid	integer	ID of user who generated entry.
session	integer	Session PID of process doing the load.
query	integer	Query ID. Can be used to join various other system tables and views.
slice	integer	Node slice number.
pid	integer	Process ID. All of the queries in a session are run in the same process, so this value remains constant if you run a series of queries in the same session.
recordtime	timestamp	Time the record is logged.
bytes_to_load	bigint	Total number of bytes to be loaded by this slice. This is 0 if the data being loaded is compressed
bytes_loaded	bigint	Number of bytes loaded by this slice. If the data being loaded is compressed, this is the number of bytes loaded after the data is uncompressed.
bytes_to_load_compressed	bigint	Total number of bytes of compressed data to be loaded by this slice. This is 0 if the data being loaded is not compressed.
bytes_loaded_compressed	bigint	Number of bytes of compressed data loaded by this slice. This is 0 if the data being loaded is not compressed.
lines	integer	Number of lines loaded by this slice.
num_files	integer	Number of files to be loaded by this slice.
num_files_complete	integer	Number of files loaded by this slice.
current_file	character(256)	Name of the file being loaded by this slice.
pct_complete	integer	Percentage of data load completed by this slice.

Sample Query

To view the progress of each slice for a COPY command, type the following query. This example uses the PG_LAST_COPY_ID() function to retrieve information for the last COPY command.

```
select slice , bytes_loaded, bytes_to_load , pct_complete from stv_load_state
where query = pg_last_copy_id();
```

slice	bytes_loaded	bytes_to_load	pct_complete
2	0	0	0
3	12840898	39104640	32

(2 rows)

STV_LOCKS

Use the STV_LOCKS table to view any current updates on tables in the database.

Amazon Redshift locks tables to prevent two users from updating the same table at the same time. While the STV_LOCKS table shows all current table updates, query the [STL_TR_CONFLICT](#) (p. 739) table to see a log of lock conflicts. Use the [SVV_TRANSACTIONS](#) (p. 793) view to identify open transactions and lock contention issues.

STV_LOCKS is visible to superusers.

Table Columns

Column Name	Data Type	Description
table_id	bigint	Table ID for the table acquiring the lock.
last_commit	timestamp	Timestamp for the last commit in the table.
last_update	timestamp	Timestamp for the last update for the table.
lock_owner	bigint	Transaction ID associated with the lock.
lock_owner_pid	bigint	Process ID associated with the lock.
lock_owner_start_ts	timestamp	Timestamp for the transaction start time.
lock_owner_end_ts	timestamp	Timestamp for the transaction end time.
lock_status	character (22)	Status of the process either waiting for or holding a lock.

Sample Query

To view all locks taking place in current transactions, type the following command:

```
select table_id, last_update, lock_owner, lock_owner_pid from stv_locks;
```

This query returns the following sample output, which displays three locks currently in effect:

table_id	last_update	lock_owner	lock_owner_pid

```

-----+-----+-----+-----
100004 | 2008-12-23 10:08:48.882319 |          1043 |          5656
100003 | 2008-12-23 10:08:48.779543 |          1043 |          5656
100140 | 2008-12-23 10:08:48.021576 |          1043 |          5656
(3 rows)

```

STV_PARTITIONS

Use the STV_PARTITIONS table to find out the disk speed performance and disk utilization for Amazon Redshift.

STV_PARTITIONS contains one row per node per logical disk partition, or slice.

STV_PARTITIONS is visible to superusers.

Table Rows

Row Name	Data Type	Description
owner	integer	Disk node that owns the partition.
host	integer	Node that is physically attached to the partition.
diskno	integer	Disk containing the partition.
part_begin	bigint	Offset of the partition. Raw devices are logically partitioned to open space for mirror blocks.
part_end	bigint	End of the partition.
used	integer	Number of 1 MB disk blocks currently in use on the partition.
tossed	integer	Number of blocks that are ready to be deleted but are not yet removed because it is not safe to free their disk addresses. If the addresses were freed immediately, a pending transaction could write to the same location on disk. Therefore, these tossed blocks are released as of the next commit. Disk blocks might be marked as tossed, for example, when a table column is dropped, during INSERT operations, or during disk-based query operations.
capacity	integer	Total capacity of the partition in 1 MB disk blocks.
reads	bigint	Number of reads that have occurred since the last cluster restart.
writes	bigint	Number of writes that have occurred since the last cluster restart.
seek_forward	integer	Number of times that a request is not for the subsequent address given the previous request address.
seek_back	integer	Number of times that a request is not for the previous address given the subsequent address.
is_san	integer	Whether the partition belongs to a SAN. Valid values are 0 (false) or 1 (true).
failed	integer	Whether the device has been marked as failed. Valid values are 0 (false) or 1 (true).

Row Name	Data Type	Description
mbps	integer	Disk speed in megabytes per second.
mount	character(256)	Directory path to the device.

Sample Query

The following query returns the disk space used and capacity, in 1 MB disk blocks, and calculates disk utilization as a percentage of raw disk space. The raw disk space includes space that is reserved by Amazon Redshift for internal use, so it is larger than the nominal disk capacity, which is the amount of disk space available to the user. The **Percentage of Disk Space Used** metric on the **Performance** tab of the Amazon Redshift Management Console reports the percentage of nominal disk capacity used by your cluster. We recommend that you monitor the **Percentage of Disk Space Used** metric to maintain your usage within your cluster's nominal disk capacity.

Important

We strongly recommend that you do not exceed your cluster's nominal disk capacity. While it might be technically possible under certain circumstances, exceeding your nominal disk capacity decreases your cluster's fault tolerance and increases your risk of losing data.

This example was run on a two-node cluster with six logical disk partitions per node. Space is being used very evenly across the disks, with approximately 25% of each disk in use.

```
select owner, host, diskno, used, capacity,
(used-tossed)/capacity::numeric *100 as pctused
from stv_partitions order by owner;
```

owner	host	diskno	used	capacity	pctused
0	0	0	236480	949954	24.9
0	0	1	236420	949954	24.9
0	0	2	236440	949954	24.9
0	1	2	235150	949954	24.8
0	1	1	237100	949954	25.0
0	1	0	237090	949954	25.0
1	1	0	236310	949954	24.9
1	1	1	236300	949954	24.9
1	1	2	236320	949954	24.9
1	0	2	237910	949954	25.0
1	0	1	235640	949954	24.8
1	0	0	235380	949954	24.8

(12 rows)

STV_RECENTS

Use the STV_RECENTS table to find out information about the currently active and recently run queries against a database.

All rows in STV_RECENTS, including rows generated by another user, are visible to all users.

Table Columns

Column Name	Data Type	Description
userid	integer	ID of user who generated entry.
status	character(20)	Query status. Valid values are Running , Done .
starttime	timestamp	Time that the query started.
duration	integer	Number of microseconds since the session started.
user_name	character(50)	User name who ran the process.
db_name	character(50)	Name of the database.
query	character(600)	Query text, up to 600 characters. Any additional characters are truncated.
pid	integer	Process ID for the session associated with the query, which is always -1 for queries that have completed.

Sample Queries

To determine what queries are currently running against the database, type the following query:

```
select user_name, db_name, pid, query
from stv_recents
where status = 'Running';
```

The sample output below shows a single query running on the TICKIT database:

```
user_name | db_name | pid | query
-----+-----+-----+-----
dwuser   | tickit  | 19996 | select venueName, venueSeats from
venue where venueSeats > 50000 order by venueSeats desc;
```

The following example returns a list of queries (if any) that are running or waiting in queue to be executed:

```
select * from stv_recents where status <> 'Done';

status | starttime | duration | user_name | db_name | query | pid
-----+-----+-----+-----+-----+-----+-----
Running | 2010-04-21 16:11... | 281566454 | dwuser | tickit | select ... |
23347
```

This query does not return results unless you are running a number of concurrent queries and some of those queries are in queue.

The following example extends the previous example. In this case, queries that are truly "in flight" (running, not waiting) are excluded from the result:

```
select * from stv_recents where status <> 'Done'
```

```
and pid not in (select pid from stv_inflight);  
...
```

STV_SESSIONS

Use the STV_SESSIONS table to view information about the active user sessions for Amazon Redshift.

To view session history, use the [STL_SESSIONS \(p. 736\)](#) table instead of STV_SESSIONS.

All rows in STV_SESSIONS, including rows generated by another user, are visible to all users.

Table Columns

Column Name	Data Type	Description
starttime	timestamp	Time that the session started.
process	integer	Process ID for the session.
user_name	character(50)	User associated with the session.
db_name	character(50)	Name of the database associated with the session.

Sample Queries

To perform a quick check to see if any other users are currently logged into Amazon Redshift, type the following query:

```
select count(*)  
from stv_sessions;
```

If the result is greater than one, then at least one other user is currently logged into the database.

To view all active sessions for Amazon Redshift, type the following query:

```
select *  
from stv_sessions;
```

The sample query output below shows three active sessions currently running on Amazon Redshift:

```
-----+-----+-----+-----  
starttime | process | user_name | db_name  
-----+-----+-----+-----  
2008-08-06 08:54:20.50 | 19829 | dwuser | dev  
2008-08-06 08:56:34.50 | 20279 | dwuser | dev  
2008-08-06 08:55:00.50 | 19996 | dwuser | ticket  
(3 rows)
```

STV_SLICES

Use the STV_SLICES table to view the current mapping of a slice to a node.

The information in STV_SLICES is used mainly for investigation purposes.

STV_SLICES is visible to all users.

Table Columns

Column Name	Data Type	Description
node	integer	Cluster node where the slice is located.
slice	integer	Node slice.

Sample Query

To view which cluster nodes are managing which slices, type the following query:

```
select * from stv_slices;
```

This query returns the following sample output:

node	slice
0	2
0	3
0	1
0	0

(4 rows)

STV_STARTUP_RECOVERY_STATE

Records the state of tables that are temporarily locked during cluster restart operations. Amazon Redshift places a temporary lock on tables while they are being processed to resolve stale transactions following a cluster restart.

STV_STARTUP_RECOVERY_STATE is visible to superusers.

Table Columns

Column Name	Data Type	Description
db_id	integer	Database ID.
table_id	integer	Table ID.
table_name	character(137)	Table name.

Sample Queries

To monitor which tables are temporarily locked, execute the following query after a cluster restart.

```
select * from STV_STARTUP_RECOVERY_STATE;
```

```

db_id | tbl_id | table_name
-----+-----+-----
100044 | 100058 | lineorder
100044 | 100068 | part
100044 | 100072 | customer
100044 | 100192 | supplier
(4 rows)

```

STV_TBL_PERM

The STV_TBL_PERM table contains information about the permanent tables in Amazon Redshift, including temporary tables created by a user for the current session. STV_TBL_PERM contains information for all tables in all databases.

This table differs from [STV_TBL_TRANS \(p. 768\)](#), which contains information about transient database tables that the system creates during query processing.

STV_TBL_PERM is visible to superusers.

Table Columns

Column Name	Data Type	Description
slice	integer	Node slice allocated to the table.
id	integer	Table ID.
name	character(72)	Table name.
rows	bigint	Number of data rows in the slice.
sorted_rows	bigint	Number of rows in the slice that are already sorted on disk. If this number does not match the ROWS number, vacuum the table to resort the rows.
temp	integer	Whether or not the table is a temporary table. 0 = false; 1 = true.
db_id	integer	ID of the database where the table was created.
insert_pristine	integer	For internal use.
delete_pristine	integer	For internal use.
backup	integer	Value that indicates whether the table is included in cluster snapshots. 0 = no; 1 = yes. For more information, see the BACKUP (p. 382) parameter for the CREATE TABLE command.

Sample Queries

The following query returns a list of distinct table IDs and names:

```

select distinct id, name
from stv_tbl_perm order by name;

id | name

```

```
-----+-----  
100571 | category  
100575 | date  
100580 | event  
100596 | listing  
100003 | padb_config_harvest  
100612 | sales  
...  
-----+-----
```

Other system tables use table IDs, so knowing which table ID corresponds to a certain table can be very useful. In this example, `SELECT DISTINCT` is used to remove the duplicates (tables are distributed across multiple slices).

To determine the number of blocks used by each column in the `VENUE` table, type the following query:

```
select col, count(*)  
from stv_blocklist, stv_tbl_perm  
where stv_blocklist.tbl = stv_tbl_perm.id  
and stv_blocklist.slice = stv_tbl_perm.slice  
and stv_tbl_perm.name = 'venue'  
group by col  
order by col;
```

```
col | count  
-----+-----  
0 | 8  
1 | 8  
2 | 8  
3 | 8  
4 | 8  
5 | 8  
6 | 8  
7 | 8  
(8 rows)
```

Usage Notes

The `ROWS` column includes counts of deleted rows that have not been vacuumed (or have been vacuumed but with the `SORT ONLY` option). Therefore, the `SUM` of the `ROWS` column in the `STV_TBL_PERM` table might not match the `COUNT(*)` result when you query a given table directly. For example, if 2 rows are deleted from `VENUE`, the `COUNT(*)` result is 200 but the `SUM(ROWS)` result is still 202:

```
delete from venue  
where venueid in (1,2);  
  
select count(*) from venue;  
count  
-----  
200  
(1 row)  
  
select trim(name) tablename, sum(rows)  
from stv_tbl_perm where name='venue' group by name;  
  
tablename | sum  
-----+-----
```

```
venue      | 202
(1 row)
```

To synchronize the data in STV_TBL_PERM, run a full vacuum the VENUE table.

```
vacuum venue;

select trim(name) tablename, sum(rows)
from stv_tbl_perm
where name='venue'
group by name;

tablename | sum
-----+-----
venue      | 200
(1 row)
```

STV_TBL_TRANS

Use the STV_TBL_TRANS table to find out information about the transient database tables that are currently in memory.

Transient tables are typically temporary row sets that are used as intermediate results while a query runs. STV_TBL_TRANS differs from [STV_TBL_PERM](#) (p. 766) in that STV_TBL_PERM contains information about permanent database tables.

STV_TBL_TRANS is visible to superusers.

Table Columns

Column Name	Data Type	Description
slice	integer	Node slice allocated to the table.
id	integer	Table ID.
rows	bigint	Number of data rows in the table.
size	bigint	Number of bytes allocated to the table.
query_id	bigint	Query ID.
ref_cnt	integer	Number of references.
from_suspended	integer	Whether or not this table was created during a query that is now suspended.
prep_swap	integer	Whether or not this transient table is prepared to swap to disk if needed. (The swap will only occur in situations where memory is low.)

Sample Queries

To view transient table information for a query with a query ID of 90, type the following command:

```
select slice, id, rows, size, query_id, ref_cnt
```

```
from stv_tbl_trans
where query_id = 90;
```

This query returns the transient table information for query 90, as shown in the following sample output:

slice	id	rows	size	query_ id	ref_ cnt	from_ suspended	prep_ swap
1013	95	0	0	90	4	0	0
7	96	0	0	90	4	0	0
10	96	0	0	90	4	0	0
17	96	0	0	90	4	0	0
14	96	0	0	90	4	0	0
3	96	0	0	90	4	0	0
1013	99	0	0	90	4	0	0
9	96	0	0	90	4	0	0
5	96	0	0	90	4	0	0
19	96	0	0	90	4	0	0
2	96	0	0	90	4	0	0
1013	98	0	0	90	4	0	0
13	96	0	0	90	4	0	0
1	96	0	0	90	4	0	0
1013	96	0	0	90	4	0	0
6	96	0	0	90	4	0	0
11	96	0	0	90	4	0	0
15	96	0	0	90	4	0	0
18	96	0	0	90	4	0	0

In this example, you can see that the query data involves tables 95, 96, and 98. Because zero bytes are allocated to this table, this query can run in memory.

STV_WLM_CLASSIFICATION_CONFIG

Contains the current classification rules for WLM.

STV_WLM_CLASSIFICATION_CONFIG is visible to superusers.

Table Columns

Column Name	Data Type	Description
id	integer	Service class ID.
condition	character(128)	Query conditions.
action_seq	integer	Reserved for system use.
action	character(64)	Reserved for system use.
action_service_class	integer	The service class where the action takes place.

Sample Query

```
select * from STV_WLM_CLASSIFICATION_CONFIG;
```

```

id | condition | action_seq | action |
-----+-----+-----+-----
1 | (system user) and (query group: health) | 0 | assign |
  | 1 |
2 | (system user) and (query group: metrics) | 0 | assign |
  | 2 |
3 | (system user) and (query group: cmstats) | 0 | assign |
  | 3 |
4 | (system user) | 0 | assign |
  | 4 |
5 | (super user) and (query group: superuser) | 0 | assign |
  | 5 |
6 | (query group: querygroup1) | 0 | assign |
  | 6 |
7 | (user group: usergroup1) | 0 | assign |
  | 6 |
8 | (user group: usergroup2) | 0 | assign |
  | 7 |
9 | (query group: querygroup3) | 0 | assign |
  | 8 |
10 | (query group: querygroup4) | 0 | assign |
  | 9 |
11 | (user group: usergroup4) | 0 | assign |
  | 9 |
12 | (query group: querygroup*) | 0 | assign |
  | 10 |
13 | (user group: usergroup*) | 0 | assign |
  | 10 |
14 | (querytype: any) | 0 | assign |
  | 11 |
(4 rows)

```

STV_WLM_QUERY_QUEUE_STATE

Records the current state of the query queues for the service classes.

STV_WLM_QUERY_QUEUE_STATE is visible to all users.

Table Columns

Column Name	Data Type	Description
service_class	integer	ID for the service class. Service classes are defined in the WLM configuration.
position	integer	Position of the query in the queue. The query with the smallest <code>position</code> value runs next.
task	integer	ID used to track a query through the workload manager. Can be associated with multiple query IDs. If a query is restarted, the query is assigned a new query ID but not a new task ID.
query	integer	Query ID. If a query is restarted, the query is assigned a new query ID but not a new task ID.

Column Name	Data Type	Description
slot_count	integer	Number of WLM query slots.
start_time	timestamp	Time that the query entered the queue.
queue_time	bigint	Number of microseconds that the query has been in the queue.

Sample Query

The following query shows the queries in the queue for service classes greater than 4.

```
select * from stv_wlm_query_queue_state
where service_class > 4
order by service_class;
```

This query returns the following sample output.

```

service_class | position | task | query | slot_count |          start_time
| queue_time
-----+-----+-----+-----+-----+
+-----+-----+-----+-----+-----+
          5 |         0 | 455 | 476 |         5 | 2010-10-06
13:18:24.065838 | 20937257
          6 |         1 | 456 | 478 |         5 | 2010-10-06
13:18:26.652906 | 18350191
(2 rows)
```

STV_WLM_QUERY_STATE

Records the current state of queries being tracked by WLM.

STV_WLM_QUERY_STATE is visible to all users.

Table Columns

Column Name	Data Type	Description
xid	integer	Transaction ID of the query or subquery.
task	integer	ID used to track a query through the workload manager. Can be associated with multiple query IDs. If a query is restarted, the query is assigned a new query ID but not a new task ID.
query	integer	Query ID. If a query is restarted, the query is assigned a new query ID but not a new task ID.
service_class	integer	ID for the service class. Service classes are defined in the WLM configuration.
slot_count	integer	Number of WLM query slots.

Column Name	Data Type	Description
wlm_start_time	timestamp	Time that the query entered the system table queue or short query queue.
state	character(16)	Current state of the query or subquery. Possible values are: <ul style="list-style-type: none"> • Classified • Completed • Dequeued • Evicted • Evicting • Initialized • Invalid • Queued • QueuedWaiting • Rejected • Returning • Running • TaskAssigned
queue_time	bigint	Number of microseconds that the query has spent in the queue.
exec_time	bigint	Number of microseconds that the query has been executing.

Sample Query

Service classes 1 - 4 are used internally by Amazon Redshift, and service class 5 is reserved for the dedicated superuser queue. The following query displays all currently executing queries in service classes greater than 4, which are the superuser queue and the WLM query queues.

```
select xid, query, trim(state), queue_time, exec_time
from stv_wlm_query_state
and service_class > 4;
```

This query returns the following sample output:

```
xid | query | btrim | queue_time | exec_time
-----+-----+-----+-----+-----
2477 | 498 | Running | 0 | 155981
(1 row)
```

STV_WLM_QUERY_TASK_STATE

Contains the current state of service class query tasks.

STV_WLM_QUERY_TASK_STATE is visible to all users.

Table Columns

Column Name	Data Type	Description
service_class	integer	ID for the service class. Service classes are defined in the WLM configuration.
task	integer	ID used to track a query through the workload manager. Can be associated with multiple query IDs. If a query is restarted, the query is assigned a new query ID but not a new task ID.
query	integer	Query ID. If a query is restarted, the query is assigned a new query ID but not a new task ID.
slot_count	integer	Number of WLM query slots.
start_time	timestamp	Time that the query began executing.
exec_time	bigint	Number of microseconds that the query has been executing.

Sample Query

Service classes 1 - 4 are used internally by Amazon Redshift, and service class 5 is reserved for the dedicated superuser queue. The following query displays the current state of queries in service classes greater than 4, which are the superuser queue and the WLM query queues.

```
select * from stv_wlm_query_task_state
where service_class > 4;
```

This query returns the following sample output:

```
service_class | task | query |          start_time          | exec_time
-----+-----+-----+-----+-----
          5   |  466 |   491 | 2010-10-06 13:29:23.063787 | 357618748
(1 row)
```

STV_WLM_SERVICE_CLASS_CONFIG

Records the service class configurations for WLM.

STV_WLM_SERVICE_CLASS_CONFIG is visible to superusers.

Table Columns

Column Name	Data Type	Description
service_class	integer	ID for the service class. Service classes 1-4 are reserved for system use. Service class 5 is reserved for the superuser queue. Service classes 6 and greater are defined in the WLM configuration
queueing_strategy	character(32)	Reserved for system use.

Column Name	Data Type	Description
num_query_tasks	integer	Current actual concurrency level of the service class. If num_query_tasks and target_num_query_tasks are different, a dynamic WLM transition is in process.
target_num_query_tasks	integer	Concurrency level set by the most recent WLM configuration change.
evictable	character(8)	Reserved for system use.
eviction_threshold	bigint	Reserved for system use.
query_working_mem	integer	Current actual amount of working memory, in MB per slot, assigned to the service class. If query_working_mem and target_query_working_mem are different, a dynamic WLM transition is in process.
target_query_working_mem	integer	The amount of working memory, in MB per slot, set by the most recent WLM configuration change.
min_step_mem	integer	Reserved for system use.
name	character(64)	Description of the service class.
max_execution_time	bigint	Number of milliseconds that the query can execute before being terminated.
user_group_wild_card	Boolean	If TRUE, the WLM queue treats an asterisk (*) as a wildcard character in user group strings in the WLM configuration.
query_group_wild_card	Boolean	If TRUE, the WLM queue treats an asterisk (*) as a wildcard character in query group strings in the WLM configuration.

Sample Query

Service classes 1 - 4 are used internally by Amazon Redshift, and service class 5 is reserved for the dedicated superuser queue. The first user-defined service class is service class 6, which is named Service class #1. The following query displays the current configuration for service classes greater than 4, which are the WLM query queues.

```
select rtrim(name) as name,
num_query_tasks as slots,
query_working_mem as mem,
max_execution_time as max_time,
user_group_wild_card as user_wildcard,
query_group_wild_card as query_wildcard
from stv_wlm_service_class_config
where service_class > 4;
```

```
name | slots | mem | max_time | user_wildcard | query_wildcard
-----+-----+-----+-----+-----+-----
Service class for super user | 1 | 535 | 0 | false | false
Service class #1 | 5 | 125 | 0 | false | false
```

Service class #2	5	125	0	false	false
Service class #3	5	125	0	false	false
Service class #4	5	627	0	false	false
Service class #5	5	125	0	true	true
Service class #6	5	125	0	false	false

(6 rows)

The following query shows the status of a dynamic WLM transition. While the transition is in process, `num_query_tasks` and `target_query_working_mem` are updated until they equal the target values. For more information, see [WLM Dynamic and Static Configuration Properties \(p. 230\)](#).

```
select rtrim(name) as name,
num_query_tasks as slots,
target_num_query_tasks as target_slots,
query_working_mem as memory,
target_query_working_mem as target_memory,
from stv_wlm_service_class_config
where num_query_tasks < > target_num_query_tasks
or query_working_mem < > target_query_working_mem
and service_class > 5;
```

name	slots	target_slots	memory	target_mem
Service class #3	5	15	125	375
Service class #5	10	5	250	125

(2 rows)

STV_WLM_SERVICE_CLASS_STATE

Contains the current state of the service classes.

STV_WLM_SERVICE_CLASS_STATE is visible to superusers.

Table Columns

Column Name	Data Type	Description
<code>service_class</code>	integer	ID for the service class. Service classes are defined in the WLM configuration.
<code>num_queued_queries</code>	integer	Number of queries currently in the queue.
<code>num_executing_queries</code>	integer	Number of queries currently executing.
<code>num_served_queries</code>	integer	Number of queries that have ever been in the service class.
<code>num_executed_queries</code>	integer	Number of queries to have executed since Amazon Redshift was initialized.
<code>num_restarted_queries</code>	integer	Number of queries that have restarted since Amazon Redshift was initialized.

Sample Query

Service classes 1 - 4 are used internally by Amazon Redshift, and service class 5 is reserved for the dedicated superuser queue. The following query displays the state for service classes greater than 5, which are the WLM query queues.

```
select service_class, num_executing_queries,
num_executed_queries
from stv_wlm_service_class_state
where service_class > 5
order by service_class;
```

service_class	num_executing_queries	num_executed_queries
6	1	222
7	0	135
8	1	39

(3 rows)

System Views

System views contain a subset of data found in several of the STL and STV system tables.

These views provide quicker and easier access to commonly queried data found in those tables.

Note

The SVL_QUERY_SUMMARY view only contains information about queries executed by Amazon Redshift, not other utility and DDL commands. For a complete listing and information on all statements executed by Amazon Redshift, including DDL and utility commands, you can query the SVL_STATEMENTTEXT view

Topics

- [SVL_COMPILE](#) (p. 777)
- [SVV_DISKUSAGE](#) (p. 778)
- [SVV_INTERLEAVED_COLUMNS](#) (p. 780)
- [SVL_QERROR](#) (p. 781)
- [SVL_QLOG](#) (p. 781)
- [SVV_QUERY_INFLIGHT](#) (p. 782)
- [SVL_QUERY_QUEUE_INFO](#) (p. 783)
- [SVL_QUERY_REPORT](#) (p. 784)
- [SVV_QUERY_STATE](#) (p. 786)
- [SVL_QUERY_SUMMARY](#) (p. 788)
- [SVL_STATEMENTTEXT](#) (p. 790)
- [SVV_TABLE_INFO](#) (p. 791)
- [SVV_TRANSACTIONS](#) (p. 793)
- [SVL_UDF_LOG](#) (p. 795)
- [SVV_VACUUM_PROGRESS](#) (p. 796)
- [SVV_VACUUM_SUMMARY](#) (p. 797)
- [SVL_VACUUM_PERCENTAGE](#) (p. 798)

SVL_COMPILE

Records compile time and location for each query segment of queries.

SVL_COMPILE is visible to all users.

Table Rows

Row Name	Data Type	Description
userid	integer	ID of the user who generated the entry.
xid	bigint	Transaction ID associated with the statement.
pid	integer	Process ID associated with the statement.
query	integer	Query ID. Can be used to join various other system tables and views.
segment	integer	The query segment to be compiled.
locus	integer	Location where the segment executes. 1 if on a compute node and 2 if on the leader node.
starttime	timestamp	Time in UTC that the compile started.
endtime	timestamp	Time in UTC that the compile ended.
compile	integer	0 if the compile was reused, 1 if the segment was compiled.

Sample Queries

In this example, queries 35878 and 35879 executed the same SQL statement. The compile column for query 35878 shows 1 for four query segments, which indicates that the segments were compiled. Query 35879 shows 0 in the compile column for every segment, indicating that the segments did not need to be compiled again.

```
select userid, xid, pid, query, segment, locus,
datediff(ms, starttime, endtime) as duration, compile
from svl_compile
where query = 35878 or query = 35879
order by query, segment;

gutenkauf-# order by query, segment;
userid |  xid  |  pid  |  query  |  segment  |  locus  |  duration  |  compile
-----+-----+-----+-----+-----+-----+-----+-----
   100 | 112780 | 23028 | 35878 |         0 |         1 |           0 |         0
   100 | 112780 | 23028 | 35878 |         1 |         1 |           0 |         0
   100 | 112780 | 23028 | 35878 |         2 |         1 |           0 |         0
   100 | 112780 | 23028 | 35878 |         3 |         1 |           0 |         0
   100 | 112780 | 23028 | 35878 |         4 |         1 |           0 |         0
   100 | 112780 | 23028 | 35878 |         5 |         1 |           0 |         0
   100 | 112780 | 23028 | 35878 |         6 |         1 |        1380 |         1
   100 | 112780 | 23028 | 35878 |         7 |         1 |        1085 |         1
   100 | 112780 | 23028 | 35878 |         8 |         1 |        1197 |         1
   100 | 112780 | 23028 | 35878 |         9 |         2 |         905 |         1
   100 | 112782 | 23028 | 35879 |         0 |         1 |           0 |         0
   100 | 112782 | 23028 | 35879 |         1 |         1 |           0 |         0
```

100	112782	23028	35879	2	1	0	0
100	112782	23028	35879	3	1	0	0
100	112782	23028	35879	4	1	0	0
100	112782	23028	35879	5	1	0	0
100	112782	23028	35879	6	1	0	0
100	112782	23028	35879	7	1	0	0
100	112782	23028	35879	8	1	0	0
100	112782	23028	35879	9	2	0	0

(20 rows)

SVV_DISKUSAGE

Amazon Redshift creates the SVV_DISKUSAGE system view by joining the STV_TBL_PERM and STV_BLOCKLIST tables. The SVV_DISKUSAGE view contains information about data allocation for the tables in a database.

Use aggregate queries with SVV_DISKUSAGE, as the following examples show, to determine the number of disk blocks allocated per database, table, slice, or column. Each data block uses 1 MB. You can also use [STV_PARTITIONS \(p. 761\)](#) to view summary information about disk utilization.

SVV_DISKUSAGE is visible to superusers.

Table Rows

Row Name	Data Type	Description
db_id	integer	Database ID.
name	character(72)	Table name.
slice	integer	Data slice allocated to the table.
col	integer	Zero-based index for the column. Every table you create has three hidden columns appended to it: INSERT_XID, DELETE_XID, and ROW_ID (OID). A table with 3 user-defined columns contains 6 actual columns, and the user-defined columns are internally numbered as 0, 1, and 2. The INSERT_XID, DELETE_XID, and ROW_ID columns are numbered 3, 4, and 5, respectively, in this example.
tbl	integer	Table ID.
blocknum	integer	ID for the data block.
num_values	integer	Number of values contained on the block.
minvalue	bigint	Minimum value contained on the block.
maxvalue	bigint	Maximum value contained on the block.
sb_pos	integer	Internal identifier for the position of the super block on disk.
pinned	integer	Whether or not the block is pinned into memory as part of pre-load. 0 = false; 1 = true. Default is false.
on_disk	integer	Whether or not the block is automatically stored on disk. 0 = false; 1 = true. Default is false.
modified	integer	Whether or not the block has been modified. 0 = false; 1 = true. Default is false.

Row Name	Data Type	Description
hdr_modified	integer	Whether or not the block header has been modified. 0 = false; 1 = true. Default is false.
unsorted	integer	Whether or not a block is unsorted. 0 = false; 1 = true. Default is true.
tombstone	integer	For internal use.
preferred_diskno	integer	Disk number that the block should be on, unless the disk has failed. Once the disk has been fixed, the block will move back to this disk.
temporary	integer	Whether or not the block contains temporary data, such as from a temporary table or intermediate query results. 0 = false; 1 = true. Default is false.
newblock	integer	Indicates whether or not a block is new (true) or was never committed to disk (false). 0 = false; 1 = true.

Sample Queries

SVV_DISKUSAGE contains one row per allocated disk block, so a query that selects all the rows potentially returns a very large number of rows. We recommend using only aggregate queries with SVV_DISKUSAGE.

Return the highest number of blocks ever allocated to column 6 in the USERS table (the EMAIL column):

```
select db_id, trim(name) as tablename, max(blocknum)
from svv_diskusage
where name='users' and col=6
group by db_id, name;
```

```
db_id | tablename | max
-----+-----+-----
175857 | users      | 2
(1 row)
```

The following query returns similar results for all of the columns in a large 10-column table called SALESNEW. (The last three rows, for columns 10 through 12, are for the hidden metadata columns.)

```
select db_id, trim(name) as tablename, col, tbl, max(blocknum)
from svv_diskusage
where name='salesnew'
group by db_id, name, col, tbl
order by db_id, name, col, tbl;
```

```
db_id | tablename | col | tbl | max
-----+-----+-----+-----+-----
175857 | salesnew  | 0   | 187605 | 154
175857 | salesnew  | 1   | 187605 | 154
175857 | salesnew  | 2   | 187605 | 154
175857 | salesnew  | 3   | 187605 | 154
175857 | salesnew  | 4   | 187605 | 154
175857 | salesnew  | 5   | 187605 | 79
175857 | salesnew  | 6   | 187605 | 79
```

```

175857 | salesnew | 7 | 187605 | 302
175857 | salesnew | 8 | 187605 | 302
175857 | salesnew | 9 | 187605 | 302
175857 | salesnew | 10 | 187605 | 3
175857 | salesnew | 11 | 187605 | 2
175857 | salesnew | 12 | 187605 | 296
(13 rows)

```

SVV_INTERLEAVED_COLUMNS

Use the SVV_INTERLEAVED_COLUMNS view to help determine whether a table that uses interleaved sort keys should be reindexed using [VACUUM REINDEX](#) (p. 489). For more information about how to determine how often to run VACUUM and when to run a VACUUM REINDEX, see [Managing Vacuum Times](#) (p. 174).

SVV_INTERLEAVED_COLUMNS is visible to superusers.

Table Columns

Column Name	Data Type	Description
tbl	integer	Table ID.
col	integer	Zero-based index for the column.
interleaved_skew	numeric(19,2)	Ratio that indicates of the amount of skew present in the interleaved sort key columns for a table. A value of 1.00 indicates no skew, and larger values indicate more skew. Tables with a large skew should be reindexed with the VACUUM REINDEX command.
last_reindex	timestamp	Time when the last VACUUM REINDEX was run for the specified table. This value is NULL if a table has never been reindexed using VACUUM REINDEX.

Sample Queries

To identify tables that might need to be reindexed, execute the following query.

```

select tbl as tbl_id, stv_tbl_perm.name as table_name,
col, interleaved_skew, last_reindex
from svv_interleaved_columns, stv_tbl_perm
where svv_interleaved_columns.tbl = stv_tbl_perm.id
and interleaved_skew is not null;

```

```

tbl_id | table_name | col | interleaved_skew | last_reindex
-----+-----+-----+-----+-----

```



```

100068 | lineorder | 0 | 3.65 | 2015-04-22 22:05:45
100068 | lineorder | 1 | 2.65 | 2015-04-22 22:05:45
100072 | customer  | 0 | 1.65 | 2015-04-22 22:05:45
100072 | lineorder | 1 | 1.00 | 2015-04-22 22:05:45
(4 rows)

```

SVL_QERROR

The SVL_QERROR view is deprecated.

SVL_QLOG

The SVL_QLOG view contains a log of all queries run against the database.

Amazon Redshift creates the SVL_QLOG view as a readable subset of information from the [STL_QUERY](#) (p. 724) table. Use this table to find the query ID for a recently run query or to see how long it took a query to complete.

SVL_QLOG is visible to all users.

Table Columns

Column Name	Data Type	Description
userid	integer	ID of user who generated entry.
query	integer	Query ID. Can be used to join various other system tables and views.
xid	bigint	Transaction ID.
pid	integer	Process ID associated with the query.
starttime	timestamp	Exact time when the statement started executing, with 6 digits of precision for fractional seconds. For example: 2009-06-12 11:29:19.131358
endtime	timestamp	Exact time when the statement finished executing, with 6 digits of precision for fractional seconds. For example: 2009-06-12 11:29:19.193640
elapsed	bigint	Length of time that it took the query to execute (in microseconds).
aborted	integer	If a query was aborted by the system or cancelled by the user, this column contains 1 . If the query ran to completion, this column contains 0 . Queries that are aborted for workload management purposes (and subsequently restarted) also have a value of 1 in this column.
label	character(30)	Either the name of the file used to run the query or a label defined with a SET QUERY_GROUP command. If the query is not file-based or the QUERY_GROUP parameter is not set, this field value is <i>default</i> .
substring	character(60)	Truncated query text.

Sample Queries

The following example returns the query ID, execution time, and truncated query text for the five most recent database queries executed by the user with `userid = 100`.

```
select query, pid, elapsed, substring from svl_qlog
where userid = 100
order by starttime desc
limit 5;
```

query	pid	elapsed	substring
187752	18921	18465685	select query, elapsed, substring from svl_...
204168	5117	59603	insert into testtable values (100);
187561	17046	1003052	select * from pg_table_def where tablename...
187549	17046	1108584	select * from STV_WLM_SERVICE_CLASS_CONFIG
187468	17046	5670661	select * from pg_table_def where schemaname...

(5 rows)

The following example returns the SQL script name (LABEL column) and elapsed time for a query that was cancelled (**aborted=1**):

```
select query, elapsed, label
from svl_qlog where aborted=1;
```

query	elapsed	label
16	6935292	alltickittablesjoin.sql

(1 row)

SVV_QUERY_INFLIGHT

Use the SVV_QUERY_INFLIGHT view to determine what queries are currently running on the database. This view joins [STV_INFLIGHT \(p. 758\)](#) to [STL_QUERYTEXT \(p. 726\)](#). SVV_QUERY_INFLIGHT does not show leader-node only queries. For more information, see [Leader Node-Only Functions \(p. 492\)](#).

SVV_QUERY_INFLIGHT is visible to all users.

Table Columns

Column Name	Data Type	Description
userid	integer	ID of user who generated entry.
slice	integer	Slice where the query is running.
query	integer	Query ID. Can be used to join various other system tables and views.
pid	integer	Process ID. All of the queries in a session are run in the same process, so this value remains constant if you run a series of queries in the same session. You can use this column to join to the STL_ERROR (p. 701) table.
starttime	timestamp	Time that the query started.

Column Name	Data Type	Description
suspended	integer	Whether the query is suspended: 0 = false; 1 = true.
text	character(200)	Query text, in 200-character increments.
sequence	integer	Sequence number for segments of query statements.

Sample Queries

The sample output below shows two queries currently running, the SVV_QUERY_INFLIGHT query itself and query 428, which is split into three rows in the table. (The starttime and statement columns are truncated in this sample output.)

```
select slice, query, pid, starttime, suspended, trim(text) as statement,
       sequence
from svv_query_inflight
order by query, sequence;
```

slice	query	pid	starttime	suspended	statement	sequence
1012	428	1658	2012-04-10 13:53:...	0	select ...	0
1012	428	1658	2012-04-10 13:53:...	0	enueid ...	1
1012	428	1658	2012-04-10 13:53:...	0	atname,...	2
1012	429	1608	2012-04-10 13:53:...	0	select ...	0

(4 rows)

SVL_QUERY_QUEUE_INFO

Summarizes details for queries that spent time in a workload management (WLM) query queue or a commit queue.

The SVL_QUERY_QUEUE_INFO view filters queries executed by the system and shows only queries executed by a user.

The SVL_QUERY_QUEUE_INFO view summarizes information from the [STL_QUERY](#) (p. 724), [STL_WLM_QUERY](#) (p. 750), and [STL_COMMIT_STATS](#) (p. 694) system tables.

This view is visible to superusers.

Table Columns

Column Name	Data Type	Description
database	text	The name of the database the user was connected to when the query was issued.
query	integer	Query ID.
xid	bigint	Transaction ID.
userid	integer	ID of the user that generated the query.
querytxt	text	First 100 characters of the query text.

Column Name	Data Type	Description
queue_start_time	timestamp	Time in UTC when the query entered the WLM queue.
exec_start_time	timestamp	Time in UTC when query execution started.
service_class	integer	ID for the service class. Service classes are defined in the WLM configuration file.
slots	integer	Number of WLM query slots.
queue_elapsed	bigint	Time that the query spent waiting in a WLM queue (in seconds).
exec_elapsed	bigint	Time spent executing the query (in seconds).
wlm_total_elapsed	bigint	Time that the query spent in a WLM queue (queue_elapsed), plus time spent executing the query (exec_elapsed).
commit_queue_elapsed	bigint	Time that the query spent waiting in the commit queue (in seconds).
commit_exec_time	bigint	Time that the query spent in the commit operation (in seconds).

Sample Queries

The following example shows the time that queries spent in WLM queues.

```
select query, service_class, queue_elapsed, exec_elapsed, wlm_total_elapsed
from svl_query_queue_info
where wlm_total_elapsed > 0;
```

query	service_class	queue_elapsed	exec_elapsed	wlm_total_elapsed
2742669	6	2	916	918
2742668	6	4	197	201

(2 rows)

SVL_QUERY_REPORT

Amazon Redshift creates the SVL_QUERY_REPORT view from a UNION of a number of Amazon Redshift STL system tables to provide information about executed query steps.

This view breaks down the information about executed queries by slice and by step, which can help with troubleshooting node and slice issues in the Amazon Redshift cluster.

SVL_QUERY_REPORT is visible to all users.

Table Rows

Row Name	Data Type	Description
userid	integer	ID of user who generated entry.

Row Name	Data Type	Description
query	integer	Query ID. Can be used to join various other system tables and views.
slice	integer	Data slice where the step executed.
segment	integer	Segment number. A query consists of multiple segments, and each segment consists of one or more steps. Query segments can run in parallel. Each segment runs in a single process.
step	integer	Query step that executed.
start_time	timestamp	Exact time when the segment started executing, with 6 digits of precision for fractional seconds. For example: 2012-12-12 11:29:19.131358
end_time	timestamp	Exact time when the segment finished executing, with 6 digits of precision for fractional seconds. For example: 2012-12-12 11:29:19.131467
elapsed_time	bigint	Time (in microseconds) that it took the segment to execute.
rows	bigint	Number of rows produced by the step (per slice). This number represents the number of rows for the slice that result from the execution of the step, not the number of rows received or processed by the step. In other words, this is the number of rows that survive the step and are passed on to the next step.
bytes	bigint	Number of bytes produced by the step (per slice).
label	char(256)	Step label, which consists of a query step name and, when applicable, table ID and table name (for example, scan tbl=100448 name =user). Three-digit table IDs usually refer to scans of transient tables. When you see tbl=0, it usually refers to a scan of a constant value.
is_diskbased	character(1)	Whether this step of the query was executed as a disk-based operation: true (t) or false (f). Only certain steps, such as hash, sort, and aggregate steps, can go to disk. Many types of steps are always executed in memory.
workmem	bigint	Amount of working memory (in bytes) assigned to the query step. This value is the query_working_mem threshold allocated for use during execution, not the amount of memory that was actually used
is_rrscan	character(1)	If true (t), indicates that range-restricted scan was used on the step. Default is false (f).
is_delayed_scan	character(1)	If true (t), indicates that delayed scan was used on the step. Default is false (f).
rows_pre_filtered	bigint	For scans of permanent tables, the total number of rows emitted before filtering rows marked for deletion (ghost rows) and before applying user-defined query filters.

Sample Queries

The following query demonstrates the data skew of the returned rows for the query with query ID 279. Use this query to determine if database data is evenly distributed over the slices in the data warehouse cluster:

```
select query, segment, step, max(rows), min(rows),
case when sum(rows) > 0
then ((cast(max(rows) -min(rows) as float)*count(rows))/sum(rows))
else 0 end
from svl_query_report
where query = 279
group by query, segment, step
order by segment, step;
```

This query should return data similar to the following sample output:

query	segment	step	max	min	case
279	0	0	19721687	19721687	0
279	0	1	19721687	19721687	0
279	1	0	986085	986084	1.01411202804304e-06
279	1	1	986085	986084	1.01411202804304e-06
279	1	4	986085	986084	1.01411202804304e-06
279	2	0	1775517	788460	1.00098637606408
279	2	2	1775517	788460	1.00098637606408
279	3	0	1775517	788460	1.00098637606408
279	3	2	1775517	788460	1.00098637606408
279	3	3	1775517	788460	1.00098637606408
279	4	0	1775517	788460	1.00098637606408
279	4	1	1775517	788460	1.00098637606408
279	4	2	1	1	0
279	5	0	1	1	0
279	5	1	1	1	0
279	6	0	20	20	0
279	6	1	1	1	0
279	7	0	1	1	0
279	7	1	0	0	0

(19 rows)

SVV_QUERY_STATE

Use SVV_QUERY_STATE to view information about the execution of currently running queries.

The SVV_QUERY_STATE view contains a data subset of the STV_EXEC_STATE table.

SVV_QUERY_STATE is visible to all users.

Table Columns

Column Name	Data Type	Description
userid	integer	ID of user who generated entry.
query	integer	Query ID. Can be used to join various other system tables and views.
seg	integer	Number of the query segment that is executing. A query consists of multiple segments, and each segment consists of one or more steps. Query segments can run in parallel. Each segment runs in a single process.

Column Name	Data Type	Description
step	integer	Number of the query step that is executing. A step is the smallest unit of query execution. Each step represents a discrete unit of work, such as scanning a table, returning results, or sorting data.
maxtime	interval	Maximum amount of time (in microseconds) for this step to execute.
avgtime	interval	Average time (in microseconds) for this step to execute.
rows	bigint	Number of rows produced by the step that is executing.
bytes	bigint	Number of bytes produced by the step that is executing.
cpu	bigint	For internal use.
memory	bigint	For internal use.
rate_row	double precision	Rows-per-second rate since the query started, computed by summing the rows and dividing by the number of seconds from when the query started to the current time.
rate_byte	double precision	Bytes-per-second rate since the query started, computed by summing the bytes and dividing by the number of seconds from when the query started to the current time.
label	character(25)	Query label: a name for the step, such as <code>scan</code> or <code>sort</code> .
is_diskbased	character(1)	Whether this step of the query is executing as a disk-based operation: true (t) or false (f). Only certain steps, such as hash, sort, and aggregate steps, can go to disk. Many types of steps are always executed in memory.
workmem	bigint	Amount of working memory (in bytes) assigned to the query step.
num_parts	integer	Number of partitions a hash table is divided into during a hash step. The hash table is partitioned when it is estimated that the entire hash table might not fit into memory. A positive number in this column does not imply that the hash step executed as a disk-based operation. Check the value in the IS_DISKBASED column to see if the hash step was disk-based.
is_rrscan	character(1)	If true (t), indicates that range-restricted scan was used on the step. Default is false (f).
is_delayed_scan	character(1)	If true (t), indicates that delayed scan was used on the step. Default is false (f).

Sample Queries

Determining the Processing Time of a Query by Step

The following query shows how long each step of the query with query ID 279 took to execute and how many data rows Amazon Redshift processed:

```
select query, seg, step, maxtime, avgtime, rows, label
from svv_query_state
where query = 279
```

```
order by query, seg, step;
```

This query retrieves the processing information about query 279, as shown in the following sample output:

query	seg	step	maxtime	avgtime	rows	label
279	3	0	1658054	1645711	1405360	scan
279	3	1	1658072	1645809	0	project
279	3	2	1658074	1645812	1405434	insert
279	3	3	1658080	1645816	1405437	distribute
279	4	0	1677443	1666189	1268431	scan
279	4	1	1677446	1666192	1268434	insert
279	4	2	1677451	1666195	0	aggr

(7 rows)

Determining If Any Active Queries Are Currently Running on Disk

The following query shows if any active queries are currently running on disk:

```
select query, label, is_diskbased from svv_query_state
where is_diskbased = 't';
```

This sample output shows any active queries currently running on disk:

query	label	is_diskbased
1025	hash tbl=142	t

(1 row)

SVL_QUERY_SUMMARY

Use the SVL_QUERY_SUMMARY view to find general information about the execution of a query.

The SVL_QUERY_SUMMARY view contains a subset of data from the SVL_QUERY_REPORT view. Note that the information in SVL_QUERY_SUMMARY is aggregated from all nodes.

Note

The SVL_QUERY_SUMMARY view only contains information about queries executed by Amazon Redshift, not other utility and DDL commands. For a complete listing and information on all statements executed by Amazon Redshift, including DDL and utility commands, you can query the SVL_STATEMENTTEXT view.

SVL_QUERY_SUMMARY is visible to all users.

Table Columns

Column Name	Data Type	Description
userid	integer	ID of user who generated entry.
query	integer	Query ID. Can be used to join various other system tables and views.
stm	integer	Stream: A set of concurrent segments in a query. A query has one or more streams.

Column Name	Data Type	Description
seg	integer	Segment number. A query consists of multiple segments, and each segment consists of one or more steps. Query segments can run in parallel. Each segment runs in a single process.
step	integer	Query step that executed.
maxtime	bigint	Maximum amount of time for the step to execute (in microseconds).
avgtime	bigint	Average time for the step to execute (in microseconds).
rows	bigint	Number of data rows involved in the query step.
bytes	bigint	Number of data bytes involved in the query step.
rate_row	double precision	Query execution rate per row.
rate_byte	double precision	Query execution rate per byte.
label	text	Step label, which consists of a query step name and, when applicable, table ID and table name (for example, scan tbl=100448 name =user). Three-digit table IDs usually refer to scans of transient tables. When you see <code>tbl=0</code> , it usually refers to a scan of a constant value.
is_diskbased	character(1)	Whether this step of the query was executed as a disk-based operation on any node in the cluster: true (t) or false (f). Only certain steps, such as hash, sort, and aggregate steps, can go to disk. Many types of steps are always executed in memory.
workmem	bigint	Amount of working memory (in bytes) assigned to the query step.
is_rrscan	character(1)	If true (t), indicates that range-restricted scan was used on the step. Default is false (f).
is_delayed_scan	character(1)	If true (t), indicates that delayed scan was used on the step. Default is false (f).
rows_pre_filter	bigint	For scans of permanent tables, the total number of rows emitted before filtering rows marked for deletion (ghost rows).

Sample Queries

Viewing Processing Information for a Query Step

The following query shows basic processing information for each step of query 87:

```
select query, stm, seg, step, rows, bytes
from svl_query_summary
where query = 87
order by query, seg, step;
```

This query retrieves the processing information about query 87, as shown in the following sample output:

query	stm	seg	step	rows	bytes
87	0	0	0	90	1890
87	0	0	2	90	360
87	0	1	0	90	360
87	0	1	2	90	1440
87	1	2	0	210494	4209880
87	1	2	3	89500	0
87	1	2	6	4	96
87	2	3	0	4	96
87	2	3	1	4	96
87	2	4	0	4	96
87	2	4	1	1	24
87	3	5	0	1	24
87	3	5	4	0	0

(13 rows)

Determining Whether Query Steps Spilled to Disk

The following query shows whether or not any of the steps for the query with query ID 1025 (see the [SVL_QLOG \(p. 781\)](#) view to learn how to obtain the query ID for a query) spilled to disk or if the query ran entirely in-memory:

```
select query, step, rows, workmem, label, is_diskbased
from svl_query_summary
where query = 1025
order by workmem desc;
```

This query returns the following sample output:

query	step	rows	workmem	label	is_diskbased
1025	0	16000000	141557760	scan tbl=9	f
1025	2	16000000	135266304	hash tbl=142	t
1025	0	16000000	128974848	scan tbl=116536	f
1025	2	16000000	122683392	dist	f

(4 rows)

By scanning the values for IS_DISKBASED, you can see which query steps went to disk. For query 1025, the hash step ran on disk. Steps might run on disk include hash, aggr, and sort steps. To view only disk-based query steps, add `and is_diskbased = 't'` clause to the SQL statement in the above example.

SVL_STATEMENTTEXT

Use the SVL_STATEMENTTEXT view to get a complete record of all of the SQL commands that have been run on the system.

The SVL_STATEMENTTEXT view contains the union of all of the rows in the [STL_DDLTEXT \(p. 696\)](#), [STL_QUERYTEXT \(p. 726\)](#), and [STL_UTILITYTEXT \(p. 744\)](#) tables. This view also includes a join to the STL_QUERY table.

SVL_STATEMENTTEXT is visible to all users.

Table Columns

Column Name	Data Type	Description
userid	integer	ID of user who generated entry.
xid	bigint	Transaction ID associated with the statement.
pid	integer	Process ID for the statement.
label	character(30)	Either the name of the file used to run the query or a label defined with a SET QUERY_GROUP command. If the query is not file-based or the QUERY_GROUP parameter is not set, this field is blank.
starttime	timestamp	Exact time when the statement started executing, with 6 digits of precision for fractional seconds. For example: 2009-06-12 11:29:19.131358
endtime	timestamp	Exact time when the statement finished executing, with 6 digits of precision for fractional seconds. For example: 2009-06-12 11:29:19.193640
sequence	integer	When a single statement contains more than 200 characters, additional rows are logged for that statement. Sequence 0 is the first row, 1 is the second, and so on.
type	varchar(10)	Type of SQL statement: QUERY , DDL , or UTILITY .
text	character(200)	SQL text, in 200-character increments.

Sample Query

The following query returns DDL statements that were run on June 16th, 2009:

```
select starttime, type, rtrim(text) from svl_statementtext
where starttime like '2009-06-16%' and type='DDL' order by starttime asc;
```

starttime	type	rtrim
2009-06-16 10:36:50.625097	DDL	create table ddltest(c1 int);
2009-06-16 15:02:16.006341	DDL	drop view allticketjoin;
2009-06-16 15:02:23.65285	DDL	drop table sales;
2009-06-16 15:02:24.548928	DDL	drop table listing;
2009-06-16 15:02:25.536655	DDL	drop table event;
...		

SVV_TABLE_INFO

Shows summary information for tables in the database. The view filters system tables and shows only user-defined tables.

You can use the SVV_TABLE_INFO view to diagnose and address table design issues that can influence query performance, including issues with compression encoding, distribution keys, sort style, data distribution skew, table size, and statistics.

The SVV_TABLE_INFO view summarizes information from the [STV_BLOCKLIST](#) (p. 753), [STV_PARTITIONS](#) (p. 761), [STV_TBL_PERM](#) (p. 766), and [STV_SLICES](#) (p. 764) system tables and from the [PG_DATABASE](#), [PG_ATTRIBUTE](#), [PG_CLASS](#), [PG_NAMESPACE](#), and [PG_TYPE](#) catalog tables.

SVV_TABLE_INFO returns information only about tables that are visible to the user.

Table Columns

Column Name	Data Type	Description
database	text	Database name.
schema	text	Schema name.
table_id	oid	Table ID.
table	text	Table name.
encoded	text	Value that indicates whether any column has compression encoding defined.
diststyle	text	Distribution style or distribution key column, if key distribution is defined.
sortkey1	text	First column in the sort key, if a sort key is defined.
max_varchar	integer	Size of the largest column that uses a VARCHAR data type.
sortkey1_enc	character(32)	Compression encoding of the first column in the sort key, if a sort key is defined.
sortkey_num	integer	Number of columns defined as sort keys.
size	bigint	Size of the table, in 1 MB data blocks.
pct_used	numeric(10,4)	Percent of available space that is used by the table.
empty	bigint	For internal use. This column is deprecated and will be removed in a future release.
unsorted	numeric(5,2)	Percent of unsorted rows in the table.
stats_off	numeric(5,2)	Number that indicates how stale the table's statistics are; 0 is current, 100 is out of date.
tbl_rows	numeric(38,0)	Total number of rows in the table.

Column Name	Data Type	Description
skew_sortkey1	numeric(19,2)	Ratio of the size of the largest non-sort key column to the size of the first column of the sort key, if a sort key is defined. Use this value to evaluate the effectiveness of the sort key.
skew_rows	numeric(19,2)	Ratio of the number of rows in the slice with the most rows to the number of rows in the slice with the fewest rows.

Sample Queries

The following example shows encoding, distribution style, sorting, and data skew for all user-defined tables in the database. Note that "table" must be enclosed in double quotes because it is a reserved word.

```
select "table", encoded, diststyle, sortkey1, skew_sortkey1, skew_rows
from svv_table_info
order by 1;
```

```
table          | encoded | diststyle          | sortkey1          | skew_sortkey1 |
skew_rows
-----+-----+-----+-----+-----
+-----+
category      | N       | EVEN               |                   |                |
date          | N       | ALL                | dateid            | 1.00           |
event         | Y       | KEY(eventid)       | dateid            | 1.00           |
  1.02
listing       | Y       | KEY(listid)        | dateid            | 1.00           |
  1.01
sales         | Y       | KEY(listid)        | dateid            | 1.00           |
  1.02
users         | Y       | KEY(userid)        | userid            | 1.00           |
  1.01
venue         | N       | ALL                | venueid           | 1.00           |

(7 rows)
```

SVV_TRANSACTIONS

Records information about transactions that currently hold locks on tables in the database. Use the SVV_TRANSACTIONS view to identify open transactions and lock contention issues. For more information about locks, see [Managing Concurrent Write Operations \(p. 181\)](#) and [LOCK \(p. 428\)](#).

All rows in SVV_TRANSACTIONS, including rows generated by another user, are visible to all users.

```

root | ticket | 438490 | 22277 | 2016-03-02 18:42:48.084037 |
AccessShareLock | relation | 52310 | t
root | ticket | 438490 | 22277 | 2016-03-02 18:42:48.084037 | ExclusiveLock
| transactionid | | t
root | dev | 438505 | 22378 | 2016-03-02 18:43:27.611292 |
AccessExclusiveLock | relation | 100068 | f
root | dev | 438505 | 22378 | 2016-03-02 18:43:27.611292 |
RowExclusiveLock | relation | 16688 | t
root | dev | 438505 | 22378 | 2016-03-02 18:43:27.611292 |
AccessShareLock | relation | 100064 | t
root | dev | 438505 | 22378 | 2016-03-02 18:43:27.611292 |
AccessExclusiveLock | relation | 100166 | t
root | dev | 438505 | 22378 | 2016-03-02 18:43:27.611292 |
AccessExclusiveLock | relation | 100171 | t
root | dev | 438505 | 22378 | 2016-03-02 18:43:27.611292 |
AccessExclusiveLock | relation | 100190 | t
root | dev | 438505 | 22378 | 2016-03-02 18:43:27.611292 | ExclusiveLock
| transactionid | | t
(12 rows)

(12 rows)

```

SVL_UDF_LOG

Records system-defined error and warning messages generating during user-defined function (UDF) execution.

This view is visible to all users.

Table Columns

Column Name	Data Type	Description
query	bigint	The query ID. You can use this ID to join various other system tables and views.
message	char(4096)	The message generated by the function.
created	timestamp	The time that the log was created.
traceback	char(4096)	If available, this value provides a stack traceback for the UDF. For more information, go to traceback in the Python Standard Library.

Sample Queries

The following example shows how UDFs handle system-defined errors. The first block shows the definition for a UDF function that returns the inverse of an argument. When you run the function and provide a 0 argument, as the second block shows, the function returns an error. The third statement reads the error message that is logged in SVL_UDF_LOG

```
-- Create a function to find the inverse of a number

CREATE OR REPLACE FUNCTION f_udf_inv(a int)
  RETURNS float IMMUTABLE
AS $$
  return 1/a
$$ LANGUAGE plpythonu;

-- Run the function with a 0 argument to create an error
Select f_udf_inv(0) from sales;

-- Query SVL_UDF_LOG to view the message

Select query, created, message::varchar
from svl_udf_log;

 query |          created          | message
-----+-----
2211 | 2015-08-22 00:11:12.04819 | ZeroDivisionError: long division or
modulo by zero\nNone
```

The following example adds logging and a warning message to the UDF so that a divide by zero operation results in a warning message instead of stopping with an error message.

SVV_VACUUM_PROGRESS

This view returns an estimate of how much time it will take to complete a vacuum operation that is currently in progress.

SVV_VACUUM_PROGRESS is visible to superusers.

Table Columns

Row Name	Data Type	Description
table_name	text	Name of the table currently being vacuumed, or the table that was last vacuumed if no operation is in progress.
status	text	Description of the current activity being done as part of the vacuum operation (initialize , sort , or merge , for example).
time_remaining_estimate	text	Estimated time left for the current vacuum operation to complete, in minutes and seconds: 5m 10s , for example. An estimated time is not returned until the vacuum completes its first sort operation. If no vacuum is in progress, the last vacuum that was executed is displayed with Completed in the STATUS column and an empty TIME_REMAINING_ESTIMATE column. The estimate typically becomes more accurate as the vacuum progresses.

Sample Queries

The following queries, run a few minutes apart, show that a large table named SALESNEW is being vacuumed.

```
select * from svv_vacuum_progress;

table_name      |          status          | time_remaining_estimate
-----+-----+-----
salesnew       | Vacuum: initialize salesnew |
(1 row)
...
select * from svv_vacuum_progress;

table_name      |          status          | time_remaining_estimate
-----+-----+-----
salesnew       | Vacuum salesnew sort    | 33m 21s
(1 row)
```

The following query shows that no vacuum operation is currently in progress. The last table to be vacuumed was the SALES table.

```
select * from svv_vacuum_progress;

table_name      | status | time_remaining_estimate
-----+-----+-----
sales          | Complete |
(1 row)
```

SVV_VACUUM_SUMMARY

The SVV_VACUUM_SUMMARY view joins the STL_VACUUM, STL_QUERY, and STV_TBL_PERM tables to summarize information about vacuum operations logged by the system. The view returns one row per table per vacuum transaction. The view records the elapsed time of the operation, the number of sort partitions created, the number of merge increments required, and deltas in row and block counts before and after the operation was performed.

SVV_VACUUM_SUMMARY is visible to superusers.

Table Columns

Row Name	Data Type	Description
table_name	text	Name of the vacuumed table.
xid	bigint	Transaction ID of the VACUUM operation.
sort_partitions	bigint	Number of sorted partitions created during the sort phase of the vacuum operation.
merge_increments	bigint	Number of merge increments required to complete the merge phase of the vacuum operation.
elapsed_time	bigint	Elapsed run time of the vacuum operation (in microseconds).
row_delta	bigint	Difference in the total number of table rows before and after the vacuum.
sortedrow_delta	bigint	Difference in the number of sorted table rows before and after the vacuum.

Row Name	Data Type	Description
block_delta	integer	Difference in block count for the table before and after the vacuum.
max_merge_partitions	integer	This column is used for performance analysis and represents the maximum number of partitions that vacuum can process for the table per merge phase iteration. (Vacuum sorts the unsorted region into one or more sorted partitions. Depending on the number of columns in the table and the current Amazon Redshift configuration, the merge phase can process a maximum number of partitions in a single merge iteration. The merge phase will still work if the number of sorted partitions exceeds the maximum number of merge partitions, but more merge iterations will be required.)

Sample Query

The following query returns statistics for vacuum operations on three different tables. The SALES table was vacuumed twice.

```
select table_name, xid, sort_partitions as parts, merge_increments as merges,
elapsed_time, row_delta, sortedrow_delta as sorted_delta, block_delta
from svv_vacuum_summary
order by xid;
```

table_ name	xid	parts	merges	elapsed_ time	row_ delta	sorted_ delta	block_ delta
users	2985	1	1	61919653	0	49990	20
category	3982	1	1	24136484	0	11	0
sales	3992	2	1	71736163	0	1207192	32
sales	4000	1	1	15363010	-851648	-851648	-140

(4 rows)

SVL_VACUUM_PERCENTAGE

The SVL_VACUUM_PERCENTAGE view reports the percentage of data blocks allocated to a table after performing a vacuum. This percentage number shows how much disk space was reclaimed. See the [VACUUM \(p. 488\)](#) command for more information about the vacuum utility.

SVL_VACUUM_PERCENTAGE is visible to superusers.

Table Rows

Row Name	Data Type	Description
xid	bigint	Transaction ID for the vacuum statement.
table_id	integer	Table ID for the vacuumed table.
percentage	bigint	Percentage of data blocks after a vacuum (relative to the number of blocks in the table before the vacuum was run).

Sample Query

The following query displays the percentage for a specific operation on table 100238:

```
select * from svl_vacuum_percentage
where table_id=100238 and xid=2200;

xid | table_id | percentage
-----+-----+-----
1337 | 100238 |          60
(1 row)
```

After this vacuum operation, the table contained 60 percent of the original blocks.

System Catalog Tables

Topics

- [PG_DEFAULT_ACL](#) (p. 799)
- [PG_LIBRARY](#) (p. 801)
- [PG_STATISTIC_INDICATOR](#) (p. 801)
- [PG_TABLE_DEF](#) (p. 802)
- [Querying the Catalog Tables](#) (p. 804)

The system catalogs store schema metadata, such as information about tables and columns. System catalog tables have a PG prefix.

The standard PostgreSQL catalog tables are accessible to Amazon Redshift users. For more information about PostgreSQL system catalogs, see [PostgreSQL System Tables](#)

PG_DEFAULT_ACL

Stores information about default access privileges. For more information on default access privileges, see [ALTER DEFAULT PRIVILEGES](#) (p. 294).

PG_DEFAULT_ACL is visible to all users.

Table Columns

Column Name	Data Type	Description
defacluser	integer	ID of the user to which the listed privileges are applied.
defaclnamespace	oid	The object ID of the schema where default privileges are applied. The default value is 0 if no schema is specified.
defaclobjtype	character	The type of object to which default privileges are applied. Valid values are as follows: <ul style="list-style-type: none"> • r—relation (table or view) • f—function
defaclacl	aclitem[]	A string that defines the default privileges for the specified user or user group and object type.

Column Name	Data Type	Description
		<p>If the privileges are granted to a user, the string is in the following form:</p> <pre>{ username=privilegestring/grantor }</pre> <p><i>username</i></p> <p>The name of the user to which privileges are granted. If <i>username</i> is omitted, the privileges are granted to PUBLIC.</p> <p>If the privileges are granted to a user group, the string is in the following form:</p> <pre>{ "group groupname=privilegestring/grantor" }</pre> <p><i>privilegestring</i></p> <p>A string that specifies which privileges are granted.</p> <p>Valid values are:</p> <ul style="list-style-type: none"> • r—SELECT (read) • a—INSERT (append) • w—UPDATE (write) • d—DELETE • x—Grants the privilege to create a foreign key constraint (REFERENCES). • X—EXECUTE • *—Indicates that the user receiving the preceding privilege can in turn grant the same privilege to others (WITH GRANT OPTION). <p><i>grantor</i></p> <p>The name of the user that granted the privileges.</p> <p>The following example indicates that the user <code>admin</code> granted all privileges, including WITH GRANT OPTION, to the user <code>dbuser</code>.</p> <pre>dbuser=r*a*w*d*x*X*/admin</pre>

Example

The following query returns all default privileges defined for the database.

```
select pg_get_userbyid(d.defacluser) as user,
n.nspname as schema,
case d.defaclobjtype when 'r' then 'tables' when 'f' then 'functions' end
as object_type,
array_to_string(d.defaclacl, ' + ') as default_privileges
from pg_catalog.pg_default_acl d
```

```
left join pg_catalog.pg_namespace n on n.oid = d.defaclnamespace;

 user | schema | object_type | default_privileges
-----+-----+-----
+-----+-----+-----
 admin | ticket | tables      | user1=r/admin + "group group1=a/admin" +
 user2=w/admin
```

The result in the preceding example shows that for all new tables created by user `admin` in the `ticket` schema, `admin` grants `SELECT` privileges to `user1`, `INSERT` privileges to `group1`, and `UPDATE` privileges to `user2`.

PG_LIBRARY

Stores information about user-defined libraries.

PG_LIBRARY is visible to all users.

Table Columns

Column Name	Data Type	Description
<code>name</code>	<code>name</code>	Library name.
<code>language_oid</code>	<code>oid</code>	Reserved for system use.
<code>file_store_id</code>	<code>integer</code>	Reserved for system use.
<code>owner</code>	<code>integer</code>	User ID of the library owner.

Example

The following example returns information for user-installed libraries.

```
select * from pg_library;

 name          | language_oid | file_store_id | owner
-----+-----+-----+-----
 f_urlparse   |          108254 |             2000 |    100
```

PG_STATISTIC_INDICATOR

Stores information about the number of rows inserted or deleted since the last `ANALYZE`. The `PG_STATISTIC_INDICATOR` table is updated frequently following DML operations, so statistics are approximate.

PG_STATISTIC_INDICATOR is visible to superusers.

Table Columns

Column Name	Data Type	Description
<code>stairelid</code>	<code>oid</code>	Table ID

Column Name	Data Type	Description
stairows	float	Total number of rows in the table.
staiins	float	Number of rows inserted since the last ANALYZE.
staidels	float	Number of rows deleted or updated since the last ANALYZE.

Example

The following example returns information for table changes since the last ANALYZE.

```
select * from pg_statistic_indicator;
```

stairelid	stairows	staiins	staidels
108271	11	0	0
108275	365	0	0
108278	8798	0	0
108280	91865	0	100632
108267	89981	49990	9999
108269	808	606	374
108282	152220	76110	248566

PG_TABLE_DEF

Stores information about table columns.

PG_TABLE_DEF only returns information about tables that are visible to the user. If PG_TABLE_DEF does not return the expected results, verify that the [search_path](#) (p. 812) parameter is set correctly to include the relevant schemas.

You can use [SVV_TABLE_INFO](#) (p. 791) to view more comprehensive information about a table, including data distribution skew, key distribution skew, table size, and statistics.

Table Columns

Column Name	Data Type	Description
schemaname	name	Schema name.
tablename	name	Table name.
column	name	Column name.
type	text	Datatype of column.
encoding	character(32)	Encoding of column.
distkey	boolean	True if this column is the distribution key for the table.
sortkey	integer	Order of the column in the sort key. If the table uses a compound sort key, then all columns that are part of the sort key have a positive value that indicates the position of

Column Name	Data Type	Description
		the column in the sort key. If the table uses an interleaved sort key, then all each column that is part of the sort key has a value that is alternately positive or negative, where the absolute value indicates the position of the column in the sort key. If 0, the column is not part of a sort key.
notnull	boolean	True if the column has a NOT NULL constraint.

Example

The following example shows the compound sort key columns for the LINEORDER_COMPOUND table.

```
select "column", type, encoding, distkey, sortkey, "notnull"
from pg_table_def
where tablename = 'lineorder_compound'
and sortkey <> 0;
```

column	type	encoding	distkey	sortkey	notnull
lo_orderkey	integer	delta32k	false	1	true
lo_custkey	integer	none	false	2	true
lo_partkey	integer	none	true	3	true
lo_suppkey	integer	delta32k	false	4	true
lo_orderdate	integer	delta	false	5	true

(5 rows)

The following example shows the interleaved sort key columns for the LINEORDER_INTERLEAVED table.

```
select "column", type, encoding, distkey, sortkey, "notnull"
from pg_table_def
where tablename = 'lineorder_interleaved'
and sortkey <> 0;
```

column	type	encoding	distkey	sortkey	notnull
lo_orderkey	integer	delta32k	false	-1	true
lo_custkey	integer	none	false	2	true
lo_partkey	integer	none	true	-3	true
lo_suppkey	integer	delta32k	false	4	true
lo_orderdate	integer	delta	false	-5	true

(5 rows)

PG_TABLE_DEF will only return information for tables in schemas that are included in the search path. See [search_path](#) (p. 812).

For example, suppose you create a new schema and a new table, then query PG_TABLE_DEF.

```
create schema demo;
create table demo.demotable (one int);
select * from pg_table_def where tablename = 'demotable';
```

```
schemaname|tablename|column| type | encoding | distkey | sortkey | notnull  
-----+-----+-----+-----+-----+-----+-----+-----
```

The query returns no rows for the new table. Examine the setting for `search_path`.

```
show search_path;  
  
 search_path  
-----  
 $user, public  
(1 row)
```

Add the `demo` schema to the search path and execute the query again.

```
set search_path to '$user', 'public', 'demo';  
  
select * from pg_table_def where tablename = 'demotable';  
  
schemaname| tablename |column| type | encoding |distkey|sortkey| notnull  
-----+-----+-----+-----+-----+-----+-----+-----  
demo      | demotable | one   | integer | none     | f     | 0     | f  
(1 row)
```

Querying the Catalog Tables

Topics

- [Examples of Catalog Queries \(p. 805\)](#)

In general, you can join catalog tables and views (relations whose names begin with `pg_`) to Amazon Redshift tables and views.

The catalog tables use a number of data types that Amazon Redshift does not support. The following data types are supported when queries join catalog tables to Amazon Redshift tables:

- `bool`
- `"char"`
- `float4`
- `int2`
- `int4`
- `int8`
- `name`
- `oid`
- `text`
- `varchar`

If you write a join query that explicitly or implicitly references a column that has an unsupported data type, the query returns an error. The SQL functions that are used in some of the catalog tables are also unsupported, except for those used by the `PG_SETTINGS` and `PG_LOCKS` tables.

For example, the `PG_STATS` table cannot be queried in a join with an Amazon Redshift table because of unsupported functions.

The following catalog tables and views provide useful information that can be joined to information in Amazon Redshift tables. Some of these tables allow only partial access because of data type and function restrictions. When you query the partially accessible tables, select or reference their columns carefully.

The following tables are completely accessible and contain no unsupported types or functions:

- [pg_attribute](#)
- [pg_cast](#)
- [pg_depend](#)
- [pg_description](#)
- [pg_locks](#)
- [pg_opclass](#)

The following tables are partially accessible and contain some unsupported types, functions, and truncated text columns. Values in text columns are truncated to `varchar(256)` values.

- [pg_class](#)
- [pg_constraint](#)
- [pg_database](#)
- [pg_group](#)
- [pg_language](#)
- [pg_namespace](#)
- [pg_operator](#)
- [pg_proc](#)
- [pg_settings](#)
- [pg_statistic](#)
- [pg_tables](#)
- [pg_type](#)
- [pg_user](#)
- [pg_views](#)

The catalog tables that are not listed here are either inaccessible or unlikely to be useful to Amazon Redshift administrators. However, you can query any catalog table or view openly if your query does not involve a join to an Amazon Redshift table.

You can use the OID columns in the Postgres catalog tables as joining columns. For example, the join condition `pg_database.oid = stv_tbl_perm.db_id` matches the internal database object ID for each `PG_DATABASE` row with the visible `DB_ID` column in the `STV_TBL_PERM` table. The OID columns are internal primary keys that are not visible when you select from the table. The catalog views do not have OID columns.

Examples of Catalog Queries

The following queries show a few of the ways in which you can query the catalog tables to get useful information about an Amazon Redshift database.

View Table ID, Database, Schema, and Table Name

The following view definition joins the `STV_TBL_PERM` system table with the `PG_CLASS`, `PG_NAMESPACE`, and `PG_DATABASE` system catalog tables to return the table ID, database name, schema name, and table name.

```
create view tables_vw as
select distinct(id) table_id
,trim(datname) db_name
,trim(nspname) schema_name
,trim(relname) table_name
from stv_tbl_perm
join pg_class on pg_class.oid = stv_tbl_perm.id
join pg_namespace on pg_namespace.oid = relnamespace
join pg_database on pg_database.oid = stv_tbl_perm.db_id;
```

The following example returns the information for table ID 117855.

```
select * from tables_vw where table_id = 117855;
```

table_id	db_name	schema_name	table_name
117855	dev	public	customer

List the Number of Columns per Amazon Redshift Table

The following query joins some catalog tables to find out how many columns each Amazon Redshift table contains. Amazon Redshift table names are stored in both PG_TABLES and STV_TBL_PERM; where possible, use PG_TABLES to return Amazon Redshift table names.

This query does not involve any Amazon Redshift tables.

```
select nspname, relname, max(attnum) as num_cols
from pg_attribute a, pg_namespace n, pg_class c
where n.oid = c.relnamespace and a.attrelid = c.oid
and c.relname not like '%pkey'
and n.nspname not like 'pg%'
and n.nspname not like 'information%'
group by 1, 2
order by 1, 2;
```

nspname	relname	num_cols
public	category	4
public	date	8
public	event	6
public	listing	8
public	sales	10
public	users	18
public	venue	5

(7 rows)

List the Schemas and Tables in a Database

The following query joins STV_TBL_PERM to some PG tables to return a list of tables in the TICKIT database and their schema names (NSPNAME column). The query also returns the total number of rows in each table. (This query is helpful when multiple schemas in your system have the same table names.)

```
select datname, nspname, relname, sum(rows) as rows
```

```

from pg_class, pg_namespace, pg_database, stv_tbl_perm
where pg_namespace.oid = relnamespace
and pg_class.oid = stv_tbl_perm.id
and pg_database.oid = stv_tbl_perm.db_id
and datname = 'tickit'
group by datname, nspname, relname
order by datname, nspname, relname;

```

datname	nspname	relname	rows
tickit	public	category	11
tickit	public	date	365
tickit	public	event	8798
tickit	public	listing	192497
tickit	public	sales	172456
tickit	public	users	49990
tickit	public	venue	202

(7 rows)

List Table IDs, Data Types, Column Names, and Table Names

The following query lists some information about each user table and its columns: the table ID, the table name, its column names, and the data type of each column:

```

select distinct attrelid, rtrim(name), attname, typname
from pg_attribute a, pg_type t, stv_tbl_perm p
where t.oid=a.atttypid and a.attrelid=p.id
and a.attrelid between 100100 and 110000
and typname not in('oid','xid','tid','cid')
order by a.attrelid asc, typname, attname;

```

attrelid	rtrim	attname	typname
100133	users	likebroadway	bool
100133	users	likeclassical	bool
100133	users	likeconcerts	bool
...			
100137	venue	venuestate	bpchar
100137	venue	venueid	int2
100137	venue	venueseats	int4
100137	venue	venuecity	varchar
...			

Count the Number of Data Blocks for Each Column in a Table

The following query joins the STV_BLOCKLIST table to PG_CLASS to return storage information for the columns in the SALES table.

```

select col, count(*)
from stv_blocklist s, pg_class p
where s.tbl=p.oid and relname='sales'
group by col
order by col;

```

col	count
0	4

1		4
2		4
3		4
4		4
5		4
6		4
7		4
8		4
9		8
10		4
12		4
13		8

(13 rows)

Configuration Reference

Topics

- [Modifying the Server Configuration \(p. 809\)](#)
- [analyze_threshold_percent \(p. 810\)](#)
- [datestyle \(p. 810\)](#)
- [extra_float_digits \(p. 811\)](#)
- [max_cursor_result_set_size \(p. 811\)](#)
- [query_group \(p. 811\)](#)
- [search_path \(p. 812\)](#)
- [statement_timeout \(p. 813\)](#)
- [timezone \(p. 814\)](#)
- [wlm_query_slot_count \(p. 816\)](#)

Modifying the Server Configuration

You can make changes to the server configuration in the following ways:

- By using a [SET \(p. 465\)](#) command to override a setting for the duration of the current session only.

For example:

```
set extra_float_digits to 2;
```

- By modifying the parameter group settings for the cluster. The parameter group settings include additional parameters that you can configure. For more information, see [Amazon Redshift Parameter Groups](#) in the *Amazon Redshift Cluster Management Guide*.
- By using the [ALTER USER \(p. 306\)](#) command to set a configuration parameter to a new value for all sessions run by the specified user.

```
ALTER USER username SET parameter { TO | = } { value | DEFAULT }
```

Use the SHOW command to view the current parameter settings. Use SHOW ALL to view all the settings that you can configure by using the [SET \(p. 465\)](#) command.

```
show all;
```

name	setting
analyze_threshold_percent	10
datestyle	ISO, MDY
extra_float_digits	2
query_group	default
search_path	\$user, public
statement_timeout	0
timezone	UTC
wlm_query_slot_count	1

analyze_threshold_percent

Values (Default in Bold)

10, 0 to 100

Description

Sets the threshold for percentage of rows changed for analyzing a table. To reduce processing time and improve overall system performance, Amazon Redshift skips analyze for any table that has a lower percentage of changed rows than specified by `analyze_threshold_percent`. For example, if a table contains 1,000,000 rows and 90,000 rows have changes since the last ANALYZE, then by default the table is skipped because fewer than 10 percent of the rows have changed.

Example

```
set analyze_threshold_percent to 15;
```

datestyle

Values (Default in Bold)

Format specification (**ISO**, Postgres, SQL, or German), and year/month/day ordering (DMY, **MDY**, YMD).

ISO, MDY

Description

Sets the display format for date and time values as well as the rules for interpreting ambiguous date input values. The string contains two parameters that can be changed separately or together.

Example

```
show datestyle;  
DateStyle  
-----
```

```
ISO, MDY  
(1 row)  
  
set datestyle to 'SQL,DMY';
```

extra_float_digits

Values (Default in Bold)

0, -15 to 2

Description

Sets the number of digits displayed for floating-point values, including float4 and float8. The value is added to the standard number of digits (FLT_DIG or DBL_DIG as appropriate). The value can be set as high as 2, to include partially significant digits; this is especially useful for outputting float data that needs to be restored exactly. Or it can be set negative to suppress unwanted digits.

max_cursor_result_set_size

Values (Default in Bold)

0 (defaults to maximum) - 14400000 MB

Description

The *max_cursor_result_set_size* parameter is deprecated. For more information about cursor result set size, see [Cursor Constraints](#) (p. 402).

query_group

Values (Default in Bold)

No default; the value can be any character string.

Description

This parameter applies a user-defined label to a group of queries that are run during the same session. This label is captured in the query logs and can be used to constrain results from the STL_QUERY and STV_INFLIGHT tables and the SVL_QLOG view. For example, you can apply a separate label to every query that you run to uniquely identify queries without having to look up their IDs.

This parameter does not exist in the server configuration file and must be set at runtime with a SET command. Although you can use a long character string as a label, the label is truncated to 30 characters in the LABEL column of the STL_QUERY table and the SVL_QLOG view (and to 15 characters in STV_INFLIGHT).

In the following example, query_group is set to **Monday**, then several queries are executed with that label:

```
set query_group to 'Monday';
SET
select * from category limit 1;
...
...
select query, pid, substring, elapsed, label
from svl_qlog where label = 'Monday'
order by query;
```

query	pid	substring	elapsed	label
789	6084	select * from category limit 1;	65468	Monday
790	6084	select query, trim(label) from ...	1260327	Monday
791	6084	select * from svl_qlog where ..	2293547	Monday
792	6084	select count(*) from bigsales;	108235617	Monday
...				

search_path

Values (Default in Bold)

'\$user', **public**, *schema_names*

A comma-separated list of existing schema names. If **'\$user'** is present, then the schema having the same name as `SESSION_USER` is substituted, otherwise it is ignored. If **public** is present and no schema with the name `public` exists, it is ignored.

Description

This parameter specifies the order in which schemas are searched when an object (such as a table or a function) is referenced by a simple name with no schema component.

- When objects are created without a specific target schema, they are placed in the first schema listed in the search path. If the search path is empty, the system returns an error.
- When objects with identical names exist in different schemas, the one found first in the search path is used.
- An object that is not in any of the schemas in the search path can only be referenced by specifying its containing schema with a qualified (dotted) name.
- The system catalog schema, `pg_catalog`, is always searched. If it is mentioned in the path, it is searched in the specified order. If not, it is searched before any of the path items.
- The current session's temporary-table schema, `pg_temp_nnn`, is always searched if it exists. It can be explicitly listed in the path by using the alias `pg_temp`. If it is not listed in the path, it is searched first (even before `pg_catalog`). However, the temporary schema is only searched for relation names (tables, views). It is not searched for function names.

Example

The following example creates the schema `ENTERPRISE` and sets the `search_path` to the new schema.

```
create schema enterprise;
```



```
set search_path to enterprise;
show search_path;

 search_path
-----
enterprise
(1 row)
```

The following example adds the schema ENTERPRISE to the default search_path.

```
set search_path to '$user', public, enterprise;
show search_path;

 search_path
-----
"$user", public, enterprise
(1 row)
```

The following example adds the table FRONTIER to the schema ENTERPRISE:

```
create table enterprise.frontier (c1 int);
```

When the table PUBLIC.FRONTIER is created in the same database, and the user does not specify the schema name in a query, PUBLIC.FRONTIER takes precedence over ENTERPRISE.FRONTIER.:

```
create table public.frontier(c1 int);
insert into enterprise.frontier values(1);
select * from frontier;

frontier
----
(0 rows)

select * from enterprise.frontier;

c1
----
1
(1 row)
```

statement_timeout

Values (Default in Bold)

UTC, time zone

Description

Aborts any statement that takes over the specified number of milliseconds.

If WLM timeout (`max_execution_time`) is also specified as part of a WLM configuration, the lower of `statement_timeout` and `max_execution_time` is used. For more information, see [WLM Timeout \(p. 225\)](#).

Example

Because the following query takes longer than 1 millisecond, it times out and is cancelled.

```
set statement_timeout to 1;

select * from listing where listid>5000;
ERROR: Query (150) cancelled on user's request
```

timezone

Values (Default in Bold)

UTC, time zone

Syntax

```
SET timezone { TO | = } [ time_zone | DEFAULT ]

SET time zone [ time_zone | DEFAULT ]
```

Description

Sets the time zone for the current session. The time zone can be the offset from Coordinated Universal Time (UTC) or a time zone name.

Note

You can't set the `timezone` configuration parameter by using a cluster parameter group. The time zone can be set only for the current session by using a `SET` command or for all sessions run by a specific database user by using the [ALTER USER \(p. 306\)](#) command.

When you set the time zone using the `SET timezone` (one word) command with either `TO` or `=`, you can specify *time_zone* as a time zone name, a POSIX-style format offset, or an ISO-8601 format offset, as shown following.

```
SET timezone { TO | = } time_zone
```

When you set the time zone using the `SET time zone` command *without* `TO` or `=`, you can specify *time_zone* using an `INTERVAL` as well as a time zone name, a POSIX-style format offset, or an ISO-8601 format offset, as shown following.

```
SET time zone time_zone
```

Time Zone Formats

Amazon Redshift supports the following time zone formats:

- Time zone name
- INTERVAL
- POSIX-style time zone specification

- ISO-8601 offset

Because time zone abbreviations, such as PST or PDT, are defined as a fixed offset from UTC and don't include daylight savings time rules, the SET command doesn't support time zone abbreviations.

For more details on time zone formats, see the following.

Time Zone Name – The full time zone name, such as America/New_York. Full time zone names can include daylight savings rules.

The following are examples of time zone names:

- Etc/Greenwich
- America/New_York
- CST6CDT
- GB

Note

Many time zone names, such as EST, MST, NZ, and UCT, are also abbreviations.

To view a list of valid time zone names, run the following command.

```
select pg_timezone_names();
```

INTERVAL – An offset from UTC. For example, PST is –8:00 or –8 hours.

The following are examples of INTERVAL time zone offsets:

- –8:00
- –8 hours
- 30 minutes

POSIX-Style Format – A time zone specification in the form *STDoffset* or *STDoffsetDST*, where *STD* is a time zone abbreviation, *offset* is the numeric offset in hours west from UTC, and *DST* is an optional daylight-savings zone abbreviation. Daylight savings time is assumed to be one hour ahead of the given offset.

POSIX-style time zone formats use positive offsets west of Greenwich, in contrast to the ISO-8601 convention, which uses positive offsets east of Greenwich.

The following are examples of POSIX-style time zones:

- PST8
- PST8PDT
- EST5
- EST5EDT

Note

Amazon Redshift doesn't validate POSIX-style time zone specifications, so it is possible to set the time zone to an invalid value. For example, the following command doesn't return an error, even though it sets the time zone to an invalid value.

```
set timezone to 'xxx36';
```

ISO-8601 Offset – The offset from UTC in the form \pm [hh] : [mm].

The following are examples of ISO-8601 offsets:

- -8:00
- +7:30

Examples

The following example sets the time zone for the current session to New York.

```
set timezone = 'America/New_York';
```

The following example sets the time zone for the current session to UTC–8 (PST).

```
set timezone to '-8:00';
```

The following example uses INTERVAL to set the time zone to PST.

```
set timezone interval '-8 hours'
```

The following example resets the time zone for the current session to the system default time zone (UTC).

```
set timezone to default;
```

wlm_query_slot_count

Values (Default in Bold)

1, 1 to 50 (cannot exceed number of available slots (concurrency level) for the service class)

Description

Sets the number of query slots a query will use.

Workload management (WLM) reserves slots in a service class according to the concurrency level set for the queue (for example, if concurrency level is set to 5, then the service class has 5 slots). WLM allocates the available memory for a service class equally to each slot. For more information, see [Implementing Workload Management \(p. 222\)](#).

Note

If the value of `wlm_query_slot_count` is larger than the number of available slots (concurrency level) for the service class, the query will fail. If you encounter an error, decrease `wlm_query_slot_count` to an allowable value.

For operations where performance is heavily affected by the amount of memory allocated, such as Vacuum, increasing the value of `wlm_query_slot_count` can improve performance. In particular, for slow Vacuum commands, inspect the corresponding record in the `SVV_VACUUM_SUMMARY` view. If you see high values (close to or higher than 100) for `sort_partitions` and `merge_increments` in the

SVV_VACUUM_SUMMARY view, consider increasing the value for `wlm_query_slot_count` the next time you run Vacuum against that table.

Increasing the value of `wlm_query_slot_count` limits the number of concurrent queries that can be run. For example, suppose the service class has a concurrency level of 5 and `wlm_query_slot_count` is set to 3. While a query is running within the session with `wlm_query_slot_count` set to 3, a maximum of 2 more concurrent queries can be executed within the same service class. Subsequent queries wait in the queue until currently executing queries complete and slots are freed.

Examples

Use the SET command to set the value of `wlm_query_slot_count` for the duration of the current session.

```
set wlm_query_slot_count to 3;
```

Sample Database

Topics

- [CATEGORY Table \(p. 819\)](#)
- [DATE Table \(p. 820\)](#)
- [EVENT Table \(p. 820\)](#)
- [VENUE Table \(p. 820\)](#)
- [USERS Table \(p. 821\)](#)
- [LISTING Table \(p. 821\)](#)
- [SALES Table \(p. 822\)](#)

Most of the examples in the Amazon Redshift documentation use a sample database called TICKIT. This small database consists of seven tables: two fact tables and five dimensions. You can load the TICKIT dataset by following the steps in [Step 6: Load Sample Data from Amazon S3](#) in the Amazon Redshift Getting Started.

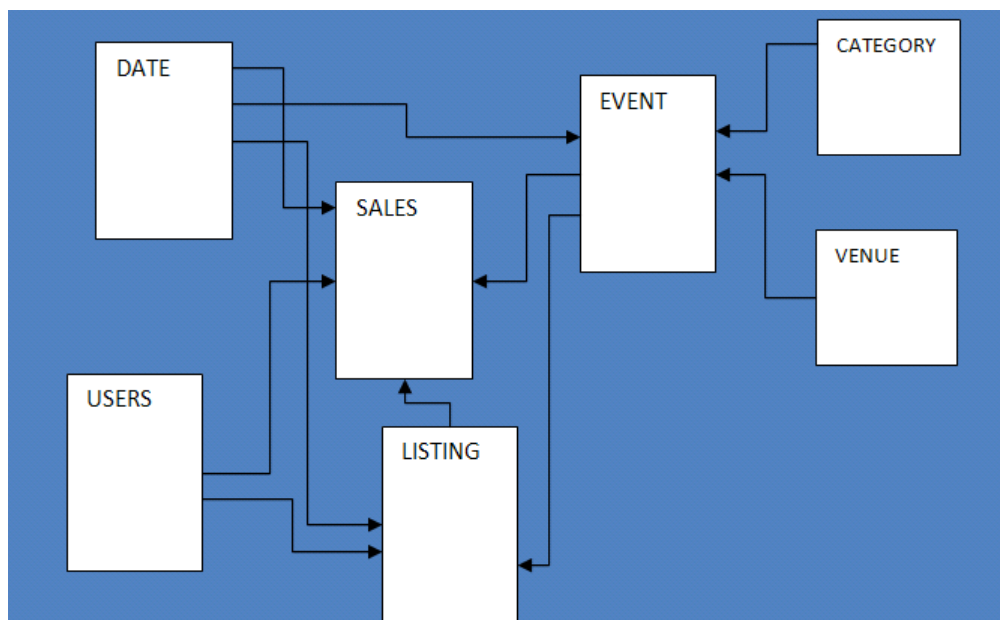

This sample database application helps analysts track sales activity for the fictional TICKIT web site, where users buy and sell tickets online for sporting events, shows, and concerts. In particular, analysts can identify ticket movement over time, success rates for sellers, and the best-selling events, venues, and seasons. Analysts can use this information to provide incentives to buyers and sellers who frequent the site, to attract new users, and to drive advertising and promotions.

For example, the following query finds the top five sellers in San Diego, based on the number of tickets sold in 2008:

```
select sellerid, username, (firstname || ' ' || lastname) as name,
city, sum(qtysold)
from sales, date, users
where sales.sellerid = users.userid
and sales.dateid = date.dateid
and year = 2008
and city = 'San Diego'
group by sellerid, username, name, city
order by 5 desc
limit 5;
```

```
sellerid | username | name | city | sum
-----+-----+-----+-----+-----
49977 | JJK84WTE | Julie Hanson | San Diego | 22
19750 | AAS23BDR | Charity Zimmerman | San Diego | 21
29069 | SVL81MEQ | Axel Grant | San Diego | 17
43632 | VAG08HKW | Griffin Dodson | San Diego | 16
36712 | RXT40MKU | Hiram Turner | San Diego | 14
(5 rows)
```

The database used for the examples in this guide contains a small data set; the two fact tables each contain less than 200,000 rows, and the dimensions range from 11 rows in the CATEGORY table up to about 50,000 rows in the USERS table.

In particular, the database examples in this guide demonstrate the key features of Amazon Redshift table design:

- Data distribution
- Data sort
- Columnar compression

CATEGORY Table

Column Name	Data Type	Description
CATID	SMALLINT	Primary key, a unique ID value for each row. Each row represents a specific type of event for which tickets are bought and sold.
CATGROUP	VARCHAR(10)	Descriptive name for a group of events, such as shows and sports .
CATNAME	VARCHAR(10)	Short descriptive name for a type of event within a group, such as Opera and Musicals .
CATDESC	VARCHAR(30)	Longer descriptive name for the type of event, such as Musical theatre .

DATE Table

Column Name	Data Type	Description
DATEID	SMALLINT	Primary key, a unique ID value for each row. Each row represents a day in the calendar year.
CALDATE	DATE	Calendar date, such as 2008-06-24.
DAY	CHAR(3)	Day of week (short form), such as SA.
WEEK	SMALLINT	Week number, such as 26.
MONTH	CHAR(5)	Month name (short form), such as JUN.
QTR	CHAR(5)	Quarter number (1 through 4).
YEAR	SMALLINT	Four-digit year (2008).
HOLIDAY	BOOLEAN	Flag that denotes whether the day is a public holiday (U.S.).

EVENT Table

Column Name	Data Type	Description
EVENTID	INTEGER	Primary key, a unique ID value for each row. Each row represents a separate event that takes place at a specific venue at a specific time.
VENUEID	SMALLINT	Foreign-key reference to the VENUE table.
CATID	SMALLINT	Foreign-key reference to the CATEGORY table.
DATEID	SMALLINT	Foreign-key reference to the DATE table.
EVENTNAME	VARCHAR(200)	Name of the event, such as Hamlet or La Traviata.
STARTTIME	TIMESTAMP	Full date and start time for the event, such as 2008-10-10 19:30:00.

VENUE Table

Column Name	Data Type	Description
VENUEID	SMALLINT	Primary key, a unique ID value for each row. Each row represents a specific venue where events take place.
VENUENAME	VARCHAR(100)	Exact name of the venue, such as Cleveland Browns Stadium.
VENUECITY	VARCHAR(30)	City name, such as Cleveland.
VENUESTATE	CHAR(2)	Two-letter state or province abbreviation (United States and Canada), such as OH.

Column Name	Data Type	Description
VENUESEATS	INTEGER	Maximum number of seats available at the venue, if known, such as 73200. For demonstration purposes, this column contains some null values and zeroes.

USERS Table

Column Name	Data Type	Description
USERID	INTEGER	Primary key, a unique ID value for each row. Each row represents a registered user (a buyer or seller or both) who has listed or bought tickets for at least one event.
USERNAME	CHAR(8)	An 8-character alphanumeric username, such as PGL08LJI .
FIRSTNAME	VARCHAR(30)	The user's first name, such as victor .
LASTNAME	VARCHAR(30)	The user's last name, such as Hernandez .
CITY	VARCHAR(30)	The user's home city, such as Naperville .
STATE	CHAR(2)	The user's home state, such as GA .
EMAIL	VARCHAR(100)	The user's email address; this column contains random Latin values, such as turpis@accumsanlaoreet.org .
PHONE	CHAR(14)	The user's 14-character phone number, such as (818) 765-4255 .
LIKESPORTS, ...	BOOLEAN	A series of 10 different columns that identify the user's likes and dislikes with true and false values.

LISTING Table

Column Name	Data Type	Description
LISTID	INTEGER	Primary key, a unique ID value for each row. Each row represents a listing of a batch of tickets for a specific event.
SELLERID	INTEGER	Foreign-key reference to the USERS table, identifying the user who is selling the tickets.
EVENTID	INTEGER	Foreign-key reference to the EVENT table.
DATEID	SMALLINT	Foreign-key reference to the DATE table.
NUMTICKETS	SMALLINT	The number of tickets available for sale, such as 2 or 20.
PRICEPERTICKET	DECIMAL(8,2)	The fixed price of an individual ticket, such as 27.00 or 206.00.
TOTALPRICE	DECIMAL(8,2)	The total price for this listing (NUMTICKETS*PRICEPERTICKET).

Column Name	Data Type	Description
LISTTIME	TIMESTAMP	The full date and time when the listing was posted, such as 2008-03-18 07:19:35.

SALES Table

Column Name	Data Type	Description
SALESID	INTEGER	Primary key, a unique ID value for each row. Each row represents a sale of one or more tickets for a specific event, as offered in a specific listing.
LISTID	INTEGER	Foreign-key reference to the LISTING table.
SELLERID	INTEGER	Foreign-key reference to the USERS table (the user who sold the tickets).
BUYERID	INTEGER	Foreign-key reference to the USERS table (the user who bought the tickets).
EVENTID	INTEGER	Foreign-key reference to the EVENT table.
DATEID	SMALLINT	Foreign-key reference to the DATE table.
QTYSOLD	SMALLINT	The number of tickets that were sold, from 1 to 8. (A maximum of 8 tickets can be sold in a single transaction.)
PRICEPAID	DECIMAL(8,2)	The total price paid for the tickets, such as 75.00 or 488.00. The individual price of a ticket is PRICEPAID/QTYSOLD.
COMMISSION	DECIMAL(8,2)	The 15% commission that the business collects from the sale, such as 11.25 or 73.20. The seller receives 85% of the PRICEPAID value.
SALETIME	TIMESTAMP	The full date and time when the sale was completed, such as 2008-05-24 06:21:47.

Appendix: Time Zone Names and Abbreviations

Topics

- [Time Zone Names \(p. 823\)](#)
- [Time Zone Abbreviations \(p. 833\)](#)

The following lists contain most of the valid time zone names and time zone abbreviations that can be specified with the [CONVERT_TIMEZONE Function \(p. 566\)](#).

Time Zone Names

The following list contains most of the valid time zone names that can be specified with the [CONVERT_TIMEZONE Function \(p. 566\)](#). For a current, complete of list time zone names, execute the following command.

```
select pg_timezone_names();
```

Even though some of the time zone names in this list are capitalized initialisms or acronyms (for example; GB, PRC, ROK), the `CONVERT_TIMEZONE` function treats them as time zone names, not time zone abbreviations.

```
Africa/Abidjan  
Africa/Accra  
Africa/Addis_Ababa  
Africa/Algiers  
Africa/Asmara  
Africa/Asmera  
Africa/Bamako  
Africa/Bangui  
Africa/Banjul  
Africa/Bissau  
Africa/Blantyre  
Africa/Brazzaville  
Africa/Bujumbura  
Africa/Cairo  
Africa/Casablanca  
Africa/Ceuta
```

Africa/Conakry
Africa/Dakar
Africa/Dar_es_Salaam
Africa/Djibouti
Africa/Douala
Africa/El_Aaiun
Africa/Freetown
Africa/Gaborone
Africa/Harare
Africa/Johannesburg
Africa/Juba
Africa/Kampala
Africa/Khartoum
Africa/Kigali
Africa/Kinshasa
Africa/Lagos
Africa/Libreville
Africa/Lome
Africa/Luanda
Africa/Lubumbashi
Africa/Lusaka
Africa/Malabo
Africa/Maputo
Africa/Maseru
Africa/Mbabane
Africa/Mogadishu
Africa/Monrovia
Africa/Nairobi
Africa/Ndjamena
Africa/Niamey
Africa/Nouakchott
Africa/Ouagadougou
Africa/Porto-Novo
Africa/Sao_Tome
Africa/Timbuktu
Africa/Tripoli
Africa/Tunis
Africa/Windhoek
America/Adak
America/Anchorage
America/Anguilla
America/Antigua
America/Araguaina
America/Argentina/Buenos_Aires
America/Argentina/Catamarca
America/Argentina/ComodRivadavia
America/Argentina/Cordoba
America/Argentina/Jujuy
America/Argentina/La_Rioja
America/Argentina/Mendoza
America/Argentina/Rio_Gallegos
America/Argentina/Salta
America/Argentina/San_Juan
America/Argentina/San_Luis
America/Argentina/Tucuman
America/Argentina/Ushuaia
America/Aruba
America/Asuncion
America/Atikokan

America/Atka
America/Bahia
America/Bahia_Banderas
America/Barbados
America/Belem
America/Belize
America/Blanc-Sablon
America/Boa_Vista
America/Bogota
America/Boise
America/Buenos_Aires
America/Cambridge_Bay
America/Campo_Grande
America/Cancun
America/Caracas
America/Catamarca
America/Cayenne
America/Cayman
America/Chicago
America/Chihuahua
America/Coral_Harbour
America/Cordoba
America/Costa_Rica
America/Creston
America/Cuiaba
America/Curacao
America/Danmarkshavn
America/Dawson
America/Dawson_Creek
America/Denver
America/Detroit
America/Dominica
America/Edmonton
America/Eirunepe
America/El_Salvador
America/Ensenada
America/Fort_Wayne
America/Fortaleza
America/Glace_Bay
America/Godthab
America/Goose_Bay
America/Grand_Turk
America/Grenada
America/Guadeloupe
America/Guatemala
America/Guayaquil
America/Guyana
America/Halifax
America/Havana
America/Hermosillo
America/Indiana/Indianapolis
America/Indiana/Knox
America/Indiana/Marengo
America/Indiana/Petersburg
America/Indiana/Tell_City
America/Indiana/Vevay
America/Indiana/Vincennes
America/Indiana/Winamac
America/Indianapolis

America/Inuvik
America/Iqaluit
America/Jamaica
America/Jujuy
America/Juneau
America/Kentucky/Louisville
America/Kentucky/Monticello
America/Knox_IN
America/Kralendijk
America/La_Paz
America/Lima
America/Los_Angeles
America/Louisville
America/Lower_Princes
America/Maceio
America/Managua
America/Manaus
America/Marigot
America/Martinique
America/Matamoros
America/Mazatlan
America/Mendoza
America/Menominee
America/Merida
America/Metlakatla
America/Mexico_City
America/Miquelon
America/Moncton
America/Monterrey
America/Montevideo
America/Montreal
America/Montserrat
America/Nassau
America/New_York
America/Nipigon
America/Nome
America/Noronha
America/North_Dakota/Beulah
America/North_Dakota/Center
America/North_Dakota/New_Salem
America/Ojinaga
America/Panama
America/Pangnirtung
America/Paramaribo
America/Phoenix
America/Port_of_Spain
America/Port-au-Prince
America/Porto_Acre
America/Porto_Velho
America/Puerto_Rico
America/Rainy_River
America/Rankin_Inlet
America/Recife
America/Regina
America/Resolute
America/Rio_Branco
America/Rosario
America/Santa_Isabel
America/Santarem

America/Santiago
America/Santo_Domingo
America/Sao_Paulo
America/Scoresbysund
America/Shiprock
America/Sitka
America/St_Barthelemy
America/St_Johns
America/St_Kitts
America/St_Lucia
America/St_Thomas
America/St_Vincent
America/Swift_Current
America/Tegucigalpa
America/Thule
America/Thunder_Bay
America/Tijuana
America/Toronto
America/Tortola
America/Vancouver
America/Virgin
America/Whitehorse
America/Winnipeg
America/Yakutat
America/Yellowknife
Antarctica/Casey
Antarctica/Davis
Antarctica/DumontDUrville
Antarctica/Macquarie
Antarctica/Mawson
Antarctica/McMurdo
Antarctica/Palmer
Antarctica/Rothera
Antarctica/South_Pole
Antarctica/Syowa
Antarctica/Vostok
Arctic/Longyearbyen
Asia/Aden
Asia/Almaty
Asia/Amman
Asia/Anadyr
Asia/Aqtai
Asia/Aqtobe
Asia/Ashgabat
Asia/Ashkhabad
Asia/Baghdad
Asia/Bahrain
Asia/Baku
Asia/Bangkok
Asia/Beirut
Asia/Bishkek
Asia/Brunei
Asia/Calcutta
Asia/Choibalsan
Asia/Chongqing
Asia/Chungking
Asia/Colombo
Asia/Dacca
Asia/Damascus

Asia/Dhaka
Asia/Dili
Asia/Dubai
Asia/Dushanbe
Asia/Gaza
Asia/Harbin
Asia/Hebron
Asia/Ho_Chi_Minh
Asia/Hong_Kong
Asia/Hovd
Asia/Irkutsk
Asia/Istanbul
Asia/Jakarta
Asia/Jayapura
Asia/Jerusalem
Asia/Kabul
Asia/Kamchatka
Asia/Karachi
Asia/Kashgar
Asia/Kathmandu
Asia/Katmandu
Asia/Khandyga
Asia/Kolkata
Asia/Krasnoyarsk
Asia/Kuala_Lumpur
Asia/Kuching
Asia/Kuwait
Asia/Macao
Asia/Macau
Asia/Magadan
Asia/Makassar
Asia/Manila
Asia/Muscat
Asia/Nicosia
Asia/Novokuznetsk
Asia/Novosibirsk
Asia/Omsk
Asia/Oral
Asia/Phnom_Penh
Asia/Pontianak
Asia/Pyongyang
Asia/Qatar
Asia/Qyzylorda
Asia/Rangoon
Asia/Riyadh
Asia/Riyadh87
Asia/Riyadh88
Asia/Riyadh89
Asia/Saigon
Asia/Sakhalin
Asia/Samarkand
Asia/Seoul
Asia/Shanghai
Asia/Singapore
Asia/Taipei
Asia/Tashkent
Asia/Tbilisi
Asia/Tehran
Asia/Tel_Aviv

Asia/Thimbu
Asia/Thimphu
Asia/Tokyo
Asia/Ujung_Pandang
Asia/Ulaanbaatar
Asia/Ulan_Bator
Asia/Urumqi
Asia/Ust-Nera
Asia/Vientiane
Asia/Vladivostok
Asia/Yakutsk
Asia/Yekaterinburg
Asia/Yerevan
Atlantic/Azores
Atlantic/Bermuda
Atlantic/Canary
Atlantic/Cape_Verde
Atlantic/Faeroe
Atlantic/Faroe
Atlantic/Jan_Mayen
Atlantic/Madeira
Atlantic/Reykjavik
Atlantic/South_Georgia
Atlantic/St_Helena
Atlantic/Stanley
Australia/ACT
Australia/Adelaide
Australia/Brisbane
Australia/Broken_Hill
Australia/Canberra
Australia/Currie
Australia/Darwin
Australia/Eucla
Australia/Hobart
Australia/LHI
Australia/Lindeman
Australia/Lord_Howe
Australia/Melbourne
Australia/North
Australia/NSW
Australia/Perth
Australia/Queensland
Australia/South
Australia/Sydney
Australia/Tasmania
Australia/Victoria
Australia/West
Australia/Yancowinna
Brazil/Acre
Brazil/DeNoronha
Brazil/East
Brazil/West
Canada/Atlantic
Canada/Central
Canada/Eastern
Canada/East-Saskatchewan
Canada/Mountain
Canada/Newfoundland
Canada/Pacific

Canada/Saskatchewan
Canada/Yukon
CET
Chile/Continental
Chile/EasterIsland
CST6CDT
Cuba
EET
Egypt
Eire
EST
EST5EDT
Etc/GMT
Etc/GMT+0
Etc/GMT+1
Etc/GMT+10
Etc/GMT+11
Etc/GMT+12
Etc/GMT+2
Etc/GMT+3
Etc/GMT+4
Etc/GMT+5
Etc/GMT+6
Etc/GMT+7
Etc/GMT+8
Etc/GMT+9
Etc/GMT0
Etc/GMT-0
Etc/GMT-1
Etc/GMT-10
Etc/GMT-11
Etc/GMT-12
Etc/GMT-13
Etc/GMT-14
Etc/GMT-2
Etc/GMT-3
Etc/GMT-4
Etc/GMT-5
Etc/GMT-6
Etc/GMT-7
Etc/GMT-8
Etc/GMT-9
Etc/Greenwich
Etc/UCT
Etc/Universal
Etc/UTC
Etc/Zulu
Europe/Amsterdam
Europe/Andorra
Europe/Athens
Europe/Belfast
Europe/Belgrade
Europe/Berlin
Europe/Bratislava
Europe/Brussels
Europe/Bucharest
Europe/Budapest
Europe/Busingen
Europe/Chisinau

Europe/Copenhagen
Europe/Dublin
Europe/Gibraltar
Europe/Guernsey
Europe/Helsinki
Europe/Isle_of_Man
Europe/Istanbul
Europe/Jersey
Europe/Kaliningrad
Europe/Kiev
Europe/Lisbon
Europe/Ljubljana
Europe/London
Europe/Luxembourg
Europe/Madrid
Europe/Malta
Europe/Mariehamn
Europe/Minsk
Europe/Monaco
Europe/Moscow
Europe/Nicosia
Europe/Oslo
Europe/Paris
Europe/Podgorica
Europe/Prague
Europe/Riga
Europe/Rome
Europe/Samara
Europe/San_Marino
Europe/Sarajevo
Europe/Simferopol
Europe/Skopje
Europe/Sofia
Europe/Stockholm
Europe/Tallinn
Europe/Tirane
Europe/Tiraspol
Europe/Uzhgorod
Europe/Vaduz
Europe/Vatican
Europe/Vienna
Europe/Vilnius
Europe/Volgograd
Europe/Warsaw
Europe/Zagreb
Europe/Zaporozhye
Europe/Zurich
GB
GB-Eire
GMT
GMT+0
GMT0
GMT-0
Greenwich
Hongkong
HST
Iceland
Indian/Antananarivo
Indian/Chagos

Indian/Christmas
Indian/Cocos
Indian/Comoro
Indian/Kerguelen
Indian/Mahe
Indian/Maldives
Indian/Mauritius
Indian/Mayotte
Indian/Reunion
Iran
Israel
Jamaica
Japan
Kwajalein
Libya
MET
Mexico/BajaNorte
Mexico/BajaSur
Mexico/General
Mideast/Riyadh87
Mideast/Riyadh88
Mideast/Riyadh89
MST
MST7MDT
Navajo
NZ
NZ-CHAT
Pacific/Apia
Pacific/Auckland
Pacific/Chatham
Pacific/Chuuk
Pacific/Easter
Pacific/Efate
Pacific/Enderbury
Pacific/Fakaofu
Pacific/Fiji
Pacific/Funafuti
Pacific/Galapagos
Pacific/Gambier
Pacific/Guadalcanal
Pacific/Guam
Pacific/Honolulu
Pacific/Johnston
Pacific/Kiritimati
Pacific/Kosrae
Pacific/Kwajalein
Pacific/Majuro
Pacific/Marquesas
Pacific/Midway
Pacific/Nauru
Pacific/Niue
Pacific/Norfolk
Pacific/Noumea
Pacific/Pago_Pago
Pacific/Palau
Pacific/Pitcairn
Pacific/Pohnpei
Pacific/Ponape
Pacific/Port_Moresby

```
Pacific/Rarotonga  
Pacific/Saipan  
Pacific/Samoa  
Pacific/Tahiti  
Pacific/Tarawa  
Pacific/Tongatapu  
Pacific/Truk  
Pacific/Wake  
Pacific/Wallis  
Pacific/Yap  
Poland  
Portugal  
PRC  
PST8PDT  
ROK  
Singapore  
Turkey  
UCT  
Universal  
US/Alaska  
US/Aleutian  
US/Arizona  
US/Central  
US/Eastern  
US/East-Indiana  
US/Hawaii  
US/Indiana-Starke  
US/Michigan  
US/Mountain  
US/Pacific  
US/Pacific-New  
US/Samoa  
UTC  
WET  
W-SU  
Zulu
```

Time Zone Abbreviations

The following list contains all of the valid time zone abbreviations that can be specified with the [CONVERT_TIMEZONE Function \(p. 566\)](#).

For a current, complete list of time zone abbreviations, execute the following command.

```
select pg_timezone_abbrevs();
```

```
ACSST  
ACST  
ACT  
ADT  
AESST  
AEST  
AFT  
AKDT  
AKST  
ALMST
```

ALMT
AMST
AMT
ANAST
ANAT
ARST
ART
AST
AWSST
AWST
AZOST
AZOT
AZST
AZT
BDST
BDT
BNT
BORT
BOT
BRA
BRST
BRT
BST
BTT
CADT
CAST
CCT
CDT
CEST
CET
CETDST
CHADT
CHAST
CHUT
CKT
CLST
CLT
COT
CST
CXT
DAVT
DDUT
EASST
EAST
EAT
EDT
EEST
EET
EETDST
EGST
EGT
EST
FET
FJST
FJT
FKST
FKT
FNST
FNT

GALT
GAMT
GEST
GET
GFT
GILT
GMT
GYT
HKT
HST
ICT
IDT
IOT
IRKST
IRKT
IRT
IST
JAYT
JST
KDT
KGST
KGT
KOST
KRAST
KRAT
KST
LHDT
LHST
LIGT
LINT
LKT
MAGST
MAGT
MART
MAWT
MDT
MEST
MET
METDST
MEZ
MHT
MMT
MPT
MSD
MSK
MST
MUST
MUT
MVT
MYT
NDT
NFT
NOVST
NOVT
NPT
NST
NUT
NZDT
NZST

NZT
OMSST
OMST
PDT
PET
PETST
PETT
PGT
PHOT
PHT
PKST
PKT
PMDT
PMST
PONT
PST
PWT
PYST
PYT
RET
SADT
SAST
SCT
SGT
TAHT
TFT
TJT
TKT
TMT
TOT
TRUT
TVT
UCT
ULAST
ULAT
UT
UTC
UYST
UYT
UZST
UZT
VET
VLAST
VLAT
VOLT
VUT
WADT
WAKT
WAST
WAT
WDT
WET
WETDST
WFT
WGST
WGT
YAKST
YAKT
YAPT

YEKST
YEKT
Z
ZULU

Document History

The following table describes the important changes since the last release of the *Amazon Redshift Database Developer Guide*.

API version: 2012-12-01

Latest documentation update: November 10, 2016

For a list of the changes to the *Amazon Redshift Cluster Management Guide*, see [Amazon Redshift Cluster Management Guide Document History](#).

For more information about new features, including a list of fixes and the associated cluster version numbers for each release, go to the [Amazon Redshift forum](#).

Change	Description	Date Changed
ANALYZE COMPRESSION estimated reduction	The ANALYZE COMPRESSION command now reports an estimate for percentage reduction in disk space for each column. For more information, see ANALYZE COMPRESSION (p. 310) .	Nov 10, 2016
Connection limits	You can now set a limit on the number of database connections a user is permitted to have open concurrently. You can also limit the number of concurrent connections for a database. For more information, see CREATE USER (p. 397) and CREATE DATABASE (p. 371) .	Nov 10, 2016
COPY sort order enhancement	COPY now automatically adds new rows to the table's sorted region when you load your data in sort key order. For specific requirements to enable this enhancement, see Loading Your Data in Sort Key Order (p. 178)	Nov 10, 2016
CTAS with compression	CREATE TABLE AS (CTAS) now automatically assigns compression encodings to new tables based on the column's data type. For more information, see Inheritance of Column and Table Attributes (p. 392) .	Oct 28, 2016
Time stamp with time zone data type	Amazon Redshift now supports a time stamp with time zone (TIMESTAMPTZ (p. 260)) data type. Also, several new functions have been added to support the new data type. For more information, see Date and Time Functions (p. 561) .	Sept 29, 2016

Change	Description	Date Changed
Analyze threshold	To reduce processing time and improve overall system performance for ANALYZE (p. 309) operations, Amazon Redshift skips analyzing a table if the percentage of rows that have changed since the last ANALYZE command run is lower than the analyze threshold specified by the analyze_threshold_percent (p. 810) parameter. By default, <code>analyze_threshold_percent</code> is 10.	August 9, 2016
New system table STL_RESTARTED_SESSIONS	When Amazon Redshift restarts a session, STL_RESTARTED_SESSIONS (p. 728) records the new process ID (PID) and the old PID.	August 9, 2016
Updated the Date and Time Functions documentation	Added a summary of functions with links to the Date and Time Functions (p. 561) , and updated the function references for consistency.	June 24, 2016
New columns in system table STL_CONNECTION_LOG	The STL_CONNECTION_LOG (p. 695) system table has two new columns to track SSL connections. If you routinely load audit logs to an Amazon Redshift table, you will need to add the following new columns to the target table: <code>sslcompression</code> and <code>sslexpansion</code> .	May 5, 2016
MD5-hash password	You can specify the password for a CREATE USER (p. 397) or ALTER USER (p. 306) command by supplying the MD5-hash string of the password and user name.	April 21, 2016
New column in system view STV_TBL_PERM	The <code>backup</code> column in the STV_TBL_PERM (p. 766) system view indicates whether the table is included in cluster snapshots. For more information, see BACKUP (p. 382) .	April 21, 2016
No-backup tables	For tables, such as staging tables, that won't contain critical data, you can specify <code>BACKUP NO</code> in your CREATE TABLE (p. 378) or CREATE TABLE AS (p. 389) statement to prevent Amazon Redshift from including the table in automated or manual snapshots. Using no-backup tables saves processing time when creating snapshots and restoring from snapshots and reduces storage space on Amazon S3.	April 7, 2016
VACUUM delete threshold	By default, the VACUUM (p. 488) command now reclaims space such that at least 95 percent of the remaining rows are not marked for deletion. As a result, VACUUM usually needs much less time for the delete phase compared to reclaiming 100 percent of deleted rows. You can change the default threshold for a single table by including the <code>TO threshold PERCENT</code> parameter when you run the VACUUM command.	April 7, 2016
SVV_TRANSACTION system table	The SVV_TRANSACTIONS (p. 793) system view records information about transactions that currently hold locks on tables in the database.	April 7, 2016

Change	Description	Date Changed
Using IAM roles to access other AWS resources	To move data between your cluster and another AWS resource, such as Amazon S3, Amazon DynamoDB, Amazon EMR, or Amazon EC2, your cluster must have permission to access the resource and perform the necessary actions. As a more secure alternative to providing an access key pair with COPY, UNLOAD, or CREATE LIBRARY commands, you can now specify an IAM role that your cluster uses for authentication and authorization. For more information, see Role-Based Access Control (p. 348) .	March 29, 2016
VACUUM sort threshold	The VACUUM command now skips the sort phase for any table where more than 95 percent of the table's rows are already sorted. You can change the default sort threshold for a single table by including the TO <i>threshold</i> PERCENT parameter when you run the VACUUM (p. 488) command.	March 17, 2016
New columns in STL_CONNECTION_LOG	The STL_CONNECTION_LOG (p. 695) system table has three new columns. If you routinely load audit logs to an Amazon Redshift table, you will need to add the following new columns to the target table: sslversion, sslcipher, and mtu.	March 17, 2016
UNLOAD with bzip2 compression	You now have the option to UNLOAD (p. 471) using bzip2 compression.	February 8, 2016
ALTER TABLE APPEND	ALTER TABLE APPEND (p. 303) appends rows to a target table by moving data from an existing source table. ALTER TABLE APPEND is usually much faster than a similar CREATE TABLE AS (p. 389) or INSERT (p. 424) INTO operation because data is moved, not duplicated.	February 8, 2016
WLM Query Queue Hopping	If workload management (WLM) cancels a read-only query, such as a SELECT statement, due to a WLM timeout, WLM attempts to route the query to the next matching queue. For more information, see WLM Query Queue Hopping (p. 225)	January 7, 2016
ALTER DEFAULT PRIVILEGES	You can use the ALTER DEFAULT PRIVILEGES (p. 294) command to define the default set of access privileges to be applied to objects that are created in the future by the specified user.	December 10, 2015
bzip2 file compression	The COPY (p. 317) command supports loading data from files that were compressed using bzip2.	December 10, 2015
NULLS FIRST and NULLS LAST	You can specify whether an ORDER BY clause should rank NULLS first or last in the result set. For more information, see ORDER BY Clause (p. 459) and Window Function Syntax Summary (p. 510) .	November 19, 2015

Change	Description	Date Changed
REGION keyword for CREATE LIBRARY	If the Amazon S3 bucket that contains the UDF library files does not reside in the same region as your Amazon Redshift cluster, you can use the REGION option to specify the region in which the data is located. For more information, see CREATE LIBRARY (p. 375) .	November 19, 2015
User-defined scalar functions (UDFs)	You can now create custom user-defined scalar functions to implement non-SQL processing functionality provided either by Amazon Redshift-supported modules in the Python 2.7 Standard Library or your own custom UDFs based on the Python programming language. For more information, see Creating User-Defined Functions (p. 192) .	September 11, 2015
Dynamic properties in WLM configuration	The WLM configuration parameter now supports applying some properties dynamically. Other properties remain static changes and require that associated clusters be rebooted so that the configuration changes can be applied. For more information, see WLM Dynamic and Static Configuration Properties (p. 230) and Implementing Workload Management (p. 222) .	August 3, 2015
LISTAGG function	The LISTAGG Function (p. 496) and LISTAGG Window Function (p. 519) return a string created by concatenating a set of column values.	July 30, 2015
Deprecated parameter	The <i>max_cursor_result_set_size</i> configuration parameter is deprecated. The size of cursor result sets are constrained based on the cluster's node type. For more information, see Cursor Constraints (p. 402) .	July 24, 2015
Revised COPY command documentation	The COPY (p. 317) command reference has been extensively revised to make the material friendlier and more accessible.	July 15, 2015
COPY from Avro format	The COPY (p. 317) command supports loading data in Avro format from data files on Amazon S3, Amazon EMR, and from remote hosts using SSH. For more information, see AVRO (p. 334) and Copy from Avro Examples (p. 367) .	July 8, 2015
STV_STARTUP_RECOVERY_STATE	COPY STV_STARTUP_RECOVERY_STATE (p. 765) system table records the state of tables that are temporarily locked during cluster restart operations. Amazon Redshift places a temporary lock on tables while they are being processed to resolve stale transactions following a cluster restart.	May 25, 2015
ORDER BY optional for ranking functions	The ORDER BY clause is now optional for certain window ranking functions. For more information, see CUME_DIST Window Function (p. 514) , DENSE_RANK Window Function (p. 515) , RANK Window Function (p. 527) , NTILE Window Function (p. 523) , PERCENT_RANK Window Function (p. 524) , and ROW_NUMBER Window Function (p. 529) .	May 25, 2015

Change	Description	Date Changed
Interleaved Sort Keys	Interleaved sort keys give equal weight to each column in the sort key. Using interleaved sort keys instead of the default compound keys significantly improves performance for queries that use restrictive predicates on secondary sort columns, especially for large tables. Interleaved sorting also improves overall performance when multiple queries filter on different columns in the same table. For more information, see Choosing Sort Keys (p. 122) and CREATE TABLE (p. 378).	May 11, 2015
Revised Tuning Query Performance topic	Tuning Query Performance (p. 199) has been expanded to include new queries for analyzing query performance and more examples. Also, the topic has been revised to be clearer and more complete. Best Practices for Designing Queries (p. 28) has more information about how to write queries to improve performance.	March 23, 2015
SVL_QUERY_QUEUE_INFO	The SVL_QUERY_QUEUE_INFO (p. 783) view summarizes details for queries that spent time in a WLM query queue or commit queue.	February 19, 2015
SVV_TABLE_INFO	You can use the SVV_TABLE_INFO (p. 791) view to diagnose and address table design issues that can influence query performance, including issues with compression encoding, distribution keys, sort style, data distribution skew, table size, and statistics.	February 19, 2015
UNLOAD uses server-side file encryption	The UNLOAD (p. 471) command now automatically uses Amazon S3 server-side encryption (SSE) to encrypt all unload data files. Server-side encryption adds another layer of data security with little or no change in performance.	October 31, 2014
CUME_DIST window function	The CUME_DIST Window Function (p. 514) calculates the cumulative distribution of a value within a window or partition.	October 31, 2014
MONTHS_BETWEEN function	The MONTHS_BETWEEN Function (p. 580) determines the number of months between two dates.	October 31, 2014
NEXT_DAY function	The NEXT_DAY Function (p. 582) returns the date of the first instance of a specified day that is later than the given date.	October 31, 2014
PERCENT_RANK window function	The PERCENT_RANK Window Function (p. 524) calculates the percent rank of a given row.	October 31, 2014
RATIO_TO_REPORT window function	The RATIO_TO_REPORT Window Function (p. 528) calculates the ratio of a value to the sum of the values in a window or partition.	October 31, 2014
TRANSLATE function	The TRANSLATE Function (p. 651) replaces all occurrences of specified characters within a given expression with specified substitutes.	October 31, 2014
NVL2 function	The NVL2 Expression (p. 558) returns one of two values based on whether a specified expression evaluates to NULL or NOT NULL.	October 16, 2014

Change	Description	Date Changed
MEDIAN window function	The MEDIAN Window Function (p. 520) calculates the median value for the range of values in a window or partition.	October 16, 2014
ON ALL TABLES IN SCHEMA <i>schema_name</i> clause for GRANT and REVOKE commands	The GRANT (p. 420) and REVOKE (p. 431) commands have been updated with an ON ALL TABLES IN SCHEMA <i>schema_name</i> clause. This clause allows you to use a single command to change privileges for all tables in a schema.	October 16, 2014
IF EXISTS clause for DROP SCHEMA, DROP TABLE, DROP USER, and DROP VIEW commands	The DROP SCHEMA (p. 407) , DROP TABLE (p. 408) , DROP USER (p. 411) , and DROP VIEW (p. 412) commands have been updated with an IF EXISTS clause. This clause causes the command to make no changes and return a message rather than terminating with an error if the specified object doesn't exist.	October 16, 2014
IF NOT EXISTS clause for CREATE SCHEMA and CREATE TABLE commands	The CREATE SCHEMA (p. 377) and CREATE TABLE (p. 378) commands have been updated with an IF NOT EXISTS clause. This clause causes the command to make no changes and return a message rather than terminating with an error if the specified object already exists.	October 16, 2014
COPY support for UTF-16 encoding	The COPY command now supports loading from data files that use UTF-16 encoding as well as UTF-8 encoding. For more information, see ENCODING (p. 342) .	September 29, 2014
New Workload Management Tutorial	Tutorial: Configuring Workload Management (WLM) Queues to Improve Query Processing (p. 77) walks you through the process of configuring Workload Management (WLM) queues to improve query processing and resource allocation.	September 25, 2014
AES 128-bit Encryption	The COPY command now supports AES 128-bit encryption as well as AES 256-bit encryption when loading from data files encrypted using Amazon S3 client-side encryption. For more information, see Loading Encrypted Data Files from Amazon S3 (p. 141) .	September 29, 2014
PG_LAST_UNLOAD_COUNT function	The PG_LAST_UNLOAD_COUNT function returns the number of rows that were processed in the most recent UNLOAD operation. For more information, see PG_LAST_UNLOAD_COUNT() (p. 679) .	September 15, 2014
New Troubleshooting Queries section	Troubleshooting Queries (p. 233) provides a quick reference for identifying and addressing some of the most common and most serious issues you are likely to encounter with Amazon Redshift queries.	July 7, 2014
New Loading Data tutorial	Tutorial: Loading Data from Amazon S3 (p. 56) walks you through the process of loading data into your Amazon Redshift database tables from data files in an Amazon S3 bucket, from beginning to end.	July 1, 2014

Change	Description	Date Changed
PERCENTILE_CONT window function	PERCENTILE_CONT Window Function (p. 525) is an inverse distribution function that assumes a continuous distribution model. It takes a percentile value and a sort specification, and returns an interpolated value that would fall into the given percentile value with respect to the sort specification.	June 30, 2014
PERCENTILE_DISC window function	PERCENTILE_DISC Window Function (p. 526) is an inverse distribution function that assumes a discrete distribution model. It takes a percentile value and a sort specification and returns an element from the set.	June 30, 2014
GREATEST and LEAST functions	The GREATEST and LEAST (p. 556) functions return the largest or smallest value from a list of expressions.	June 30, 2014
Cross-region COPY	The COPY (p. 317) command supports loading data from an Amazon S3 bucket or Amazon DynamoDB table that is located in a different region than the Amazon Redshift cluster. For more information, see REGION (p. 324) in the COPY command reference.	June 30, 2014
Best Practices expanded	Amazon Redshift Best Practices (p. 21) has been expanded, reorganized, and moved to the top of the navigation hierarchy to make it more discoverable.	May 28, 2014
UNLOAD to a single file	The UNLOAD (p. 471) command can optionally unload table data serially to a single file on Amazon S3 by adding the PARALLEL OFF option. If the size of the data is greater than the maximum file size of 6.2 GB, UNLOAD creates additional files.	May 6, 2014
REGEXP functions	The REGEXP_COUNT (p. 637) , REGEXP_INSTR (p. 638) , and REGEXP_REPLACE (p. 639) functions manipulate strings based on regular expression pattern matching.	May 6, 2014
New Tutorial	The new Tutorial: Tuning Table Design (p. 30) walks you through the steps to optimize the design of your tables, including testing load and query performance before and after tuning.	May 2, 2014
COPY from Amazon EMR	The COPY (p. 317) command supports loading data directly from Amazon EMR clusters. For more information, see Loading Data from Amazon EMR (p. 141) .	April 18, 2014
WLM concurrency limit increase	You can now configure workload management (WLM) to run up to 50 queries concurrently in user-defined query queues. This increase gives users more flexibility for managing system performance by modifying WLM configurations. For more information, see Defining Query Queues (p. 223)	April 18, 2014

Change	Description	Date Changed
New configuration parameter to manage cursor size	<p>The <code>max_cursor_result_set_size</code> configuration parameter defines the maximum size of data, in megabytes, that can be returned per cursor result set of a larger query. This parameter value also affects the number of concurrent cursors for the cluster, enabling you to configure a value that increases or decreases the number of cursors for your cluster.</p> <p>For more information, see DECLARE (p. 401) in this guide and Configure Maximum Size of a Cursor Result Set in the <i>Amazon Redshift Cluster Management Guide</i>.</p>	Mar 28, 2014
COPY from JSON format	The COPY (p. 317) command supports loading data in JSON format from data files on Amazon S3 and from remote hosts using SSH. For more information, see COPY from JSON Format (p. 352) usage notes.	Mar 25, 2014
New system table STL_PLAN_INFO	The STL_PLAN_INFO (p. 720) table supplements the EXPLAIN command as another way to look at query plans.	Mar 25, 2014
New function REGEXP_SUBSTR	The REGEXP_SUBSTR Function (p. 641) returns the characters extracted from a string by searching for a regular expression pattern.	Mar 25, 2014
New columns for STL_COMMIT_STATS	The STL_COMMIT_STATS (p. 694) table has two new columns: <code>numxids</code> and <code>oldestxid</code> .	Mar 6, 2014
COPY from SSH support for gzip and lzop	The COPY (p. 317) command supports gzip and lzop compression when loading data through an SSH connection.	Feb 13, 2014
New functions	The ROW_NUMBER Window Function (p. 529) returns the number of the current row. The STRTOL Function (p. 647) converts a string expression of a number of the specified base to the equivalent integer value. PG_CANCEL_BACKEND (p. 668) and PG_TERMINATE_BACKEND (p. 669) enable users to cancel queries and session connections. The LAST_DAY (p. 580) function has been added for Oracle compatibility.	Feb 13, 2014
New system table	The STL_COMMIT_STATS (p. 694) system table provides metrics related to commit performance, including the timing of the various stages of commit and the number of blocks committed.	Feb 13, 2014
FETCH with single-node clusters	When using a cursor on a single-node cluster, the maximum number of rows that can be fetched using the FETCH (p. 419) command is 1000. <code>FETCH FORWARD ALL</code> is not supported for single-node clusters.	Feb 13, 2014

Change	Description	Date Changed
DS_DIST_ALL_INNER redistribution strategy	DS_DIST_ALL_INNER in the Explain plan output indicates that the entire inner table was redistributed to a single slice because the outer table uses DISTSTYLE ALL. For more information, see Join Type Examples (p. 205) and Evaluating the Query Plan (p. 114) .	Jan 13, 2014
New system tables for queries	Amazon Redshift has added new system tables that customers can use to evaluate query execution for tuning and troubleshooting. For more information, see SVL_COMPILE (p. 777) , STL_SCAN (p. 734) , STL_RETURN (p. 729) , STL_SAVE (p. 732) STL_ALERT_EVENT_LOG (p. 690) .	Jan 13, 2014
Single-node cursors	Cursors are now supported for single-node clusters. A single-node cluster can have two cursors open at a time, with a maximum result set of 32 GB. On a single-node cluster, we recommend setting the ODBC Cache Size parameter to 1,000. For more information, see DECLARE (p. 401) .	Dec 13, 2013
ALL distribution style	ALL distribution can dramatically shorter execution times for certain types of queries. When a table uses ALL distribution style, a copy of the table is distributed to every node. Because the table is effectively collocated with every other table, no redistribution is needed during query execution. ALL distribution is not appropriate for all tables because it increases storage requirements and load time. For more information, see Choosing a Data Distribution Style (p. 110) .	Nov 11, 2013
COPY from remote hosts	In addition to loading tables from data files on Amazon S3 and from Amazon DynamoDB tables, the COPY command can load text data from Amazon EMR clusters, Amazon EC2 instances, and other remote hosts by using SSH connections. Amazon Redshift uses multiple simultaneous SSH connections to read and load data in parallel. For more information, see Loading Data from Remote Hosts (p. 145) .	Nov 11, 2013
WLM Memory Percent Used	You can balance workload by designating a specific percentage of memory for each queue in your workload management (WLM) configuration. For more information, see Defining Query Queues (p. 223) .	Nov 11, 2013
APPROXIMATE COUNT(DISTINCT)	Queries that use APPROXIMATE COUNT(DISTINCT) execute much faster, with a relative error of about 2%. The APPROXIMATE COUNT(DISTINCT) function uses a HyperLogLog algorithm. For more information, see the COUNT Function (p. 495) .	Nov 11, 2013

Change	Description	Date Changed
New SQL functions to retrieve recent query details	Four new SQL functions retrieve details about recent queries and COPY commands. The new functions make it easier to query the system log tables, and in many cases provide necessary details without needing to access the system tables. For more information, see PG_BACKEND_PID() (p. 676), PG_LAST_COPY_ID() (p. 678), PG_LAST_COPY_COUNT() (p. 677), PG_LAST_QUERY_ID() (p. 679).	Nov 1, 2013
MANIFEST option for UNLOAD	The MANIFEST option for the UNLOAD command complements the MANIFEST option for the COPY command. Using the MANIFEST option with UNLOAD automatically creates a manifest file that explicitly lists the data files that were created on Amazon S3 by the unload operation. You can then use the same manifest file with a COPY command to load the data. For more information, see Unloading Data to Amazon S3 (p. 185) and UNLOAD Examples (p. 476).	Nov 1, 2013
MANIFEST option for COPY	You can use the MANIFEST option with the COPY (p. 317) command to explicitly list the data files that will be loaded from Amazon S3.	Oct 18, 2013
System tables for troubleshooting queries	Added documentation for system tables that are used to troubleshoot queries. The STL Tables for Logging (p. 687) section now contains documentation for the following system tables: STL_AGGR, STL_BCAST, STL_DIST, STL_DELETE, STL_HASH, STL_HASHJOIN, STL_INSERT, STL_LIMIT, STL_MERGE, STL_MERGEJOIN, STL_NESTLOOP, STL_PARSE, STL_PROJECT, STL_SCAN, STL_SORT, STL_UNIQUE, STL_WINDOW.	Oct 3, 2013
CONVERT_TIMEZONE function	The CONVERT_TIMEZONE Function (p. 566) converts a timestamp from one time zone to another, with the option to automatically adjust for daylight savings time.	Oct 3, 2013
SPLIT_PART function	The SPLIT_PART Function (p. 645) splits a string on the specified delimiter and returns the part at the specified position.	Oct 3, 2013
STL_USERLOG system table	STL_USERLOG (p. 743) records details for changes that occur when a database user is created, altered, or deleted.	Oct 3, 2013
LZO column encoding and LZOP file compression.	LZO (p. 104) column compression encoding combines a very high compression ratio with good performance. COPY from Amazon S3 supports loading from files compressed using LZOP (p. 341) compression.	Sept 19, 2013
JSON, Regular Expressions, and Cursors	Added support for parsing JSON strings, pattern matching using regular expressions, and using cursors to retrieve large data sets over an ODBC connection. For more information, see JSON Functions (p. 654), Pattern-Matching Conditions (p. 278), and DECLARE (p. 401).	Sept 10, 2013

Change	Description	Date Changed
ACCEPTINVCHAR option for COPY	You can successfully load data that contains invalid UTF-8 characters by specifying the ACCEPTINVCHAR option with the COPY (p. 317) command.	Aug 29, 2013
CSV option for COPY	The COPY (p. 317) command now supports loading from CSV formatted input files.	Aug 9, 2013
CRC32	The CRC32 Function (p. 626) performs cyclic redundancy checks.	Aug 9, 2013
WLM wildcards	Workload management (WLM) supports wildcards for adding user groups and query groups to queues. For more information, see Wildcards (p. 225) .	Aug 1, 2013
WLM timeout	To limit the amount of time that queries in a given WLM queue are permitted to use, you can set the WLM timeout value for each queue. For more information, see WLM Timeout (p. 225) .	Aug 1, 2013
New COPY options 'auto' and 'epochsecs'	The COPY (p. 317) command performs automatic recognition of date and time formats. New time formats, 'epochsecs' and 'epochmillisecs' enable COPY to load data in epoch format.	July 25, 2013
CONVERT_TIMEZONE function	The CONVERT_TIMEZONE Function (p. 566) converts a timestamp from one timezone to another.	July 25, 2013
FUNC_SHA1 function	The FUNC_SHA1 Function (p. 627) converts a string using the SHA1 algorithm.	July 15, 2013
max_execution_time	To limit the amount of time queries are permitted to use, you can set the max_execution_time parameter as part of the WLM configuration. For more information, see Modifying the WLM Configuration (p. 226) .	July 22, 2013
Four-byte UTF-8 characters	The VARCHAR data type now supports four-byte UTF-8 characters. Five-byte or longer UTF-8 characters are not supported. For more information, see Storage and Ranges (p. 256) .	July 18, 2013
SVL_QERROR	The SVL_QERROR system view has been deprecated.	July 12, 2013
Revised Document History	The Document History page now shows the date the documentation was updated.	July 12, 2013
STL_UNLOAD_LOG	STL_UNLOAD_LOG (p. 742) records the details for an unload operation.	July 5, 2013
JDBC fetch size parameter	To avoid client-side out of memory errors when retrieving large data sets using JDBC, you can enable your client to fetch data in batches by setting the JDBC fetch size parameter. For more information, see Setting the JDBC Fetch Size Parameter (p. 237) .	June 27, 2013
UNLOAD encrypted files	UNLOAD (p. 471) now supports unloading table data to encrypted files on Amazon S3.	May 22, 2013

Change	Description	Date Changed
Temporary credentials	COPY (p. 317) and UNLOAD (p. 471) now support the use of temporary credentials.	April 11, 2013
Added clarifications	Clarified and expanded discussions of Designing Tables and Loading Data.	February 14, 2013
Added Best Practices	Added Best Practices for Designing Tables (p. 21) and Best Practices for Loading Data (p. 24) .	February 14, 2013
Clarified password constraints	Clarified password constraints for CREATE USER and ALTER USER, various minor revisions.	February 14, 2013
New Guide	This is the first release of the <i>Amazon Redshift Developer Guide</i> .	February 14, 2013