

HOUSING ACT OF 1954

HEARING

BEFORE THE

COMMITTEE ON BANKING AND CURRENCY

HOUSE OF REPRESENTATIVES

EIGHTY-THIRD CONGRESS

SECOND SESSION

ON

H. R. 7839

A BILL TO AID IN THE PROVISION AND IMPROVEMENT
OF HOUSING, THE ELIMINATION AND PREVENTION OF
SLUMS, AND THE CONSERVATION AND DEVELOPMENT OF
URBAN COMMUNITIES

MARCH 2, 3, 4, 5, 8, 9, 10, 12, 15, 16, 17, AND 18, 1954

Printed for the use of the Committee on Banking and Currency



COMMITTEE ON BANKING AND CURRENCY

JESSE P. WOLCOTT, Michigan, *Chairman*

RALPH A. GAMBLE, New York
HENRY O. TALLE, Iowa
CLARENCE E. KILBURN, New York
GORDON L. McDONOUGH, California
WILLIAM B. WIDNALL, New Jersey
JACKSON B. BETTS, Montana
WESLEY A. D'EWART, Montana
MYRON V. GEORGE, Kansas
WALTER M. MUMMA, Pennsylvania
WILLIAM E. McVEY, Illinois
D. BAILEY MERRILL, Indiana
CHARLES G. OAKMAN, Michigan
EDGAR W. HIESTAND, California
DOUGLAS R. STRINGFELLOW, Utah
WILLIAM K. VAN PELT, Wisconsin

BRENT SPENCE, Kentucky
PAUL BROWN, Georgia
WRIGHT PATMAN, Texas
ALBERT RAINS, Alabama
ABRAHAM J. MULTER, New York
CHARLES B. DEANE, North Carolina
GEORGE D. O'BRIEN, Michigan
HUGH J. ADDONIZIO, New Jersey
ISIDORE DOLLINGER, New York
RICHARD BOLLING, Missouri
WILLIAM A. BARRETT, Pennsylvania
WAYNE L. HAYS, Ohio
BARRATT O'HARA, Illinois
EUGENE J. MCCARTHY, Minnesota

WILLIAM J. HALLAHAN, *Clerk*

ORMAN S. FINK, *Professional Staff*

JOHN E. BARRIERE, *Professional Staff*

CONTENTS

	Page
H. R. 7839, a bill to aid in the provision and improvement of housing, the elimination and prevention of slums, and the conservation and development of urban communities.....	1
Statement of—	
Baughman, Stanley, president, Federal National Mortgage Association.....	73
Bean, Lee C., chairman, legislative committee, Wherry Housing Association.....	806
Benjamin, Alvin, attorney, David Shaw & Co., Brooklyn, N. Y.....	309
Bialac, Jerry, vice president, Rental Development Corporation of America, Beverly Hills, Calif.....	884
Burns, Fritz B., Los Angeles, Calif., chairman, Build America Better Council, National Association of Real Estate Boards.....	715, 734
Campbell, Wallace J., director, Washington office, Cooperative League of the United States of America.....	663
Clarke, William A., president, Mortgage Bankers Association of America.....	405
Colborn, Fern M., secretary, social education and action, National Federation of Settlements and Neighborhood Centers.....	814
Cole, Hon. Albert M., Housing and Home Finance Administrator....	32,
	73, 145
Colton, Herbert, National Association of Home Builders.....	596
Daniel, Wilbur C., chairman, National Economic Commission, American Legion.....	678
Dickerman, John, National Association of Home Builders.....	596
Ditchy, Clair W., president, the American Institute of Architects, accompanied by Louis Justement.....	710
Downer, A. M., assistant legislative officer, Veterans of Foreign Wars of the United States.....	688
Du Laurence, Henry, chairman, legislative committee, National Apartment Owners Association, Inc.....	771
Edelman, John W., Washington representative, Textile Workers Union of America (CIO).....	285, 296
Ehlers, Joseph H., field representative, American Society of Civil Engineers.....	815
Fernós-Isern, Hon. A., Resident Commissioner of Puerto Rico.....	849
Ferry, John M., special assistant for installations to the Secretary of the Air Force.....	253
Fischer, Ben, housing director, Congress of Industrial Organizations.....	285
Fitzpatrick, B. T., Deputy Administrator and General Counsel, Housing and Home Finance Agency.....	73, 145
Follin, James W., Director, Division of Slum Clearance and Urban Redevelopment, Housing and Home Finance Agency.....	73, 126
Foster, Charles E., assistant national director of legislation, Disabled American Veterans.....	701
Foster, H. B., manager, Brick and Tile Service, Inc., Greensboro, N. C.....	875
Goldman, Arthur S., building economist.....	797
Hazeltine, John C., Commissioner of Community Facilities, Housing and Home Finance Agency.....	145
Held, Harry, vice president, Bowery Savings Bank, New York City, representing the National Association of Mutual Savings Banks....	456
Hollander, Edward B., representing Americans for Democratic Action.....	298
Hollyday, Guy T. O., Commissioner, Federal Housing Administration.....	42
Houser, Mrs. Jency Price, national organizer, Residence at Ease Association.....	809
Hughes, R. G., president, National Association of Home Builders, accompanied by John Dickerman and Herbert Colton.....	593, 596

Statement of—Continued	Page
Javits, Hon. Jacob K., a Representative in Congress from the State of New York.....	831
Jewett, John, vice president, Prudential Insurance Co.....	465
Johnson, Earl M., treasurer, American Hotel Association.....	507
Jones, Hon. Robert, a Representative in Congress from the State of Alabama.....	836
Kahn, Efrein A., Jamaica, N. Y.....	877
Kaul, Ralph, consultant, Trailer Coach Association.....	783
Kennedy, Miles, legislative director, American Legion.....	677
King, T. B., Acting Assistant Deputy Administrator (Loan Guaranty) Department of Veterans' Benefits, Veterans' Administration.....	215
Lantaff, Hon. William C., a Representative in Congress from the State of Florida.....	846
Levitt, William, president, Levitt & Sons, builders.....	631
Mason, Norman P., representing the Chamber of Commerce of the United States.....	339
Massey, Maurice R., Jr., president, Peoples Bond & Mortgage Co., Philadelphia, Pa.....	405, 446
McAllister, Walter W., Chairman, Home Loan Bank Board.....	145
McCord, Col. Hal, Air Force.....	253
McCormick, Pat, general counsel, Trailer Coach Association.....	783
McLeaish, Hon. R. B., Administrator, Farmers Home Administration, Department of Agriculture.....	855
Mitchell, John W.....	253
Mobile Homes Manufacturers Association, Chicago, Ill.....	824
Moore, John H., executive director, United Community Defense Service, Inc.....	886
Murphy, M. K. M., past president, United States Savings and Loan League.....	516
Murray, William E., representing Florida Sun Deck Homes Co., Leisure City, Fla.....	871
National Council of Jewish Women, New York, N. Y.....	821
Neal, Sam, general counsel, Mortgage Bankers Association of America.....	405
Northup, H. R., executive vice president, National Retail Lumber Dealers Association.....	543
O'Grady, Rt. Rev. Msgr. John, secretary, National Conference of Catholic Charities.....	642
O'Malley, James J., president, First Federal Savings & Loan Association, Wilkes-Barre, Pa., representing the National Savings and Loan League.....	450
Painter, A. Lee, president, Mobilehome Dealers National Association.....	822
Patton, James G., president, National Farmers Union.....	812
Paul, Lt. Gen. Willard S. (retired), assistant to the Director for Non-military Defense, Office of Defense Mobilization.....	869
Rafsky, William L., housing coordinator, city of Philadelphia, Pa.....	878
Raider, David L., attorney, New York City.....	305
Reilly, John A., representing the American Bankers Association.....	379
Robbins, Ira S., president, National Housing Conference.....	554
Robbins, Paul H., executive director, National Society of Professional Engineers.....	818
Rouse, James W., Baltimore, Md., on behalf of Mortgage Bankers Association of America.....	422
Searles, John, chairman, Redevelopment Section, District of Columbia Redevelopment Land Agency.....	317
Shanks, Carrol M., president, Prudential Insurance Company of America, representing Life Insurance Association of America.....	465
Shaw, E. R., representing the Trailer Coach Association, Los Angeles, Calif.....	783
Shishkin, Boris, secretary of the housing committee, American Federation of Labor.....	267
Slusser, Charles E., Public Housing Commissioner.....	145
Smith, Henry C., Deputy Administrator, Farmers' Home Administration.....	855
Staal, B. J., treasurer, Holland Furnace Co., Holland, Mich.....	805
Summer, Alexander, Newark, N. J., past president, National Association of Real Estate Boards, and member, the President's Advisory Committee on Housing.....	715

Statement of—Continued	Page
Trump, Fred, president, Redevelopment Builders of New York.....	819
Vieser, M. A., vice president, Mutual Benefit Life Insurance Co., Newark, N. J.	465
Waltemade, Henry G., chairman, realtors' Washington committee, National Association of Real Estate Boards.....	715
Watts, Hon. John C., a Representative in Congress from the State of Kentucky.....	847
Weitzer, Bernard, national legislative director, Jewish War Veterans of the United States of America.....	703
Wellman, Charles A., executive vice president, Glendale Federal Savings & Loan Association.....	652
Whiteman, Lewis, executive director, Associated Builders of Greater New York.....	304, 315
Winston, Oliver C., president, National Association of Housing and Redevelopment Officials.....	317
Additional data submitted to the committee:	
A Preliminary Estimate of Housing Needs, 1955-70—By Dr. William Wheaton, University of Pennsylvania, for National Housing Con- ference.....	556
Average Federal subsidy for public housing, submitted by AFL.....	283
Characteristics of residents of public housing for low-income families.....	154
Comparative Costs of a Standard House, article from Insured Mort- gage Portfolio, 1953, by Curt C. Mack, FHA Assistant Commis- sioner.....	327
Composition of Wherry housing completed or under construction at February 28, 1954.....	265
Cost of interest charges under proposed section 221 program, sub- mitted by AFL.....	275
Default status of FHA-insured mortgages as of December 31, 1953, (table).....	62
"Easy Money" Comes Back—Dollars Abundant, but Borrowing Slow, article from U. S. News & World Report, of February 26, 1954.....	684
Effect of increased interest rates on average Wherry housing mortgage of \$8,100.....	261
Elapsed time in processing loan applications, statement from Veterans' Administration.....	113, 232
Farm housing program data, from inception of program through December 31, 1953 (table).....	60
Higley, H. V., Administrator, Veterans' Administration, letter of December 22, 1953, to Hon. Albert M. Cole.....	219
Housing for America, statement of James G. Thimmes, member, the President's Advisory Committee on Housing.....	291
Housing units (nonfarm), under \$7,000.....	105
Hughes, Rowland, Deputy Director, Bureau of the Budget, letter of February 26, 1954, to Hon. Albert M. Cole.....	34
Incomes of families already residents of public housing, calendar year 1952.....	153
Life Insurance Association of America, letter of March 18, 1954, to Hon. Jesse P. Wolcott (data requested by Mr. Merrill).....	493
Mortgage Bankers Association of America:	
Comparative digest of Association policy and the President's Advisory Committee Report.....	426
Recommendations made by the President's Advisory Committee to which the proposed housing legislation does not address itself.....	432
National Association of Home Builders:	
Suggested amendments.....	610
Support to the economy represented by residential construction.....	613
Prospective FNMA operations (charts):	
How FNMA operates now.....	616
Proposed FNMA changeover—Government supervised- Government financed in 10 years to Government super- vised-privately financed.....	617
Five years later.....	617
Ten years later.....	618

Additional data submitted to the committee—Continued	
National Association of Home Builders—Continued	
Prospective FNMA operations (charts)—Continued	Page
Results and benefits of Government supervision, private capital	618
Consumer expenditures for housing, food, and autos	618
Cost of money for housing, and for autos, and other consumer durables	619
Size of owner-occupied housing by years built	620
Percent of bedroom needs met	621
Housing needs to 1960	621
Dependence on FNMA by States	622
Use of FHA by States	623
National Housing Conference, letter of March 19, 1954, signed Edward F. Barry, in answer to questions asked by members of the committee during the hearing	591
National policy on housing and mortgage lending—a statement of life-insurance company views	467
Open-end mortgage provisions and forms	453
Outline of steps taken to construct public housing	186
President's Advisory Committee on Government Housing Policies and Programs	33
Proposed and current schedules for maximum mortgage amounts for 1- to 4-family home mortgages insured under FHA section 203 (table)	40
Prospective level of residential construction and availability of mortgage money, 1954-58	82
Savings and Loan savings accounts grouped according to size	527
Selected statistics on housing in 168 standard metropolitan areas, 1950 (table)	92
States and Territories having legislation authorizing slum clearance and urban redevelopment projects	137
Status of low-rent program initiated under the Housing Act of 1949, as of December 31, 1953	143
Suspension of builders, statement from Veterans' Administration	238
The open-end mortgage, excerpt from the September 1953 issue of Legal Bulletin, published by the United States Savings and Loan League	345
Trailer Coach Association:	
Proposed amendments to include mobile dwellings in the National Housing Act	786
Summary outline proposal to include trailer coach mobile homes and parks in National Housing Act	787
Basic facts on trailer coach mobile home industry and market	787
Questions and answers concerning proposed legislation for mobile dwellings	791
Treasury Department, statement of, to Hon. Wright Patman	227
United States Savings and Loan League—Amendments recommended	522
\$7,000 homes built in 1953, by geographic areas	163

HOUSING ACT OF 1954

TUESDAY, MARCH 2, 1954

HOUSE OF REPRESENTATIVES,
COMMITTEE ON BANKING AND CURRENCY,
Washington, D. C.

The committee met at 10 a. m., Hon. Jesse P. Wolcott (chairman) presiding.

Present: Chairman Wolcott (presiding), Messrs. Talle, Kilburn, McDonough, Widnall, Betts, George, Mumma, McVey, Oakman, Hiestand, Stringfellow, Van Pelt, Spence, Brown, Patman, Multer, Deane, O'Brien, Addonizio, Dollinger, Bolling, Barrett, and O'Hara.

The CHAIRMAN. The committee will come to order.

We have met this morning to begin hearings on H. R. 7839, a bill to aid in the provision and improvement of housing, the elimination and prevention of slums, and the conservation and development of urban communities.

(The bill is as follows:)

[H. R. 7839, 83d Cong., 2d sess.]

A BILL To aid in the provision and improvement of housing, the elimination and prevention of slums, and the conservation and development of urban communities

Be it enacted by the Senate and House of Representatives of the United States of America in Congress assembled, That this Act may be cited as the "Housing Act of 1954".

TITLE I—FEDERAL HOUSING ADMINISTRATION

AMENDMENTS OF TITLE I OF NATIONAL HOUSING ACT

SEC. 101. Section 2 (b) of the National Housing Act, as amended, is hereby amended—

(1) by striking out clause numbered (1) and inserting the following: "(1) if the amount of such loan, advance of credit, or purchase exceeds \$3,000";

(2) by striking out of clause numbered (2) the words "three years" and inserting "five years"; and

(3) by striking out of the first proviso "\$10,000 and having a maturity not in excess of seven years" and inserting "\$10,000 or \$1,500 per family unit, whichever is the greater, and having a maturity not in excess of ten years".

SEC. 102. Section 2 (f) of said Act, as amended, is hereby amended by adding the following at the end thereof: "The account heretofore established in connection with insurance operations under this section and identified in the accounting records of the Federal Housing Administration as the Title I Claims Account shall be terminated as of June 30, 1954, at which time all of the remaining assets of such account, together with deposits therein for the account of obligors, shall be transferred to and merged with the account established pursuant to this subsection. Moneys in the account established pursuant to this subsection not needed for the current operations of the Federal Housing Administration may be invested in bonds or other obligations of, or in bonds or other obligations guaranteed as to principal and interest by, the United States."

SEC. 103. Section 8 of said Act, as amended, is hereby amended by striking the period at the end of subsection (a) and inserting a colon and the following: "And

provided further, That no mortgage shall be insured under this section after the effective date of the Housing Act of 1954, except pursuant to a commitment to insure issued on or before such date."

AMENDMENTS OF TITLE II OF NATIONAL HOUSING ACT

Sec. 104. Section 203 (b) (2) of said Act, as amended, is hereby amended to read as follows:

"(2) Involve a principal obligation (including such initial service charges, appraisal, inspection, and other fees as the Commissioner shall approve) in an amount not to exceed \$20,000 in the case of property upon which there is located a dwelling designed principally for a one- or two-family residence; or \$27,500 in the case of a three-family residence; or \$35,000 in the case of a four-family residence; and not to exceed an amount equal to the sum of (i) 95 per centum of \$8,000 of the appraised value (as of the date the mortgage is accepted for insurance), and (ii) 75 per centum of such value in excess of \$8,000: *Provided*, That the mortgagor shall have paid on account of the property at least 5 per centum (or such larger amount as the Commissioner may determine) of the Commissioner's estimate of the cost of acquisition in cash or its equivalent: *And provided further*, That such mortgage shall not involve a principal obligation exceeding the maximum amount prescribed by the provisions of this section 203 in effect prior to the effective date of the Housing Act of 1954, unless the President, pursuant to section 201 of the Housing Act of 1954 has authorized a greater maximum amount, in which event such principal obligation shall not exceed such greater maximum amount."

Sec. 105. Section 203 (b) (3) of said Act, as amended, is hereby amended to read as follows:

"(3) Have a maturity satisfactory to the Commissioner, but not to exceed, in any event, thirty years from the date of the insurance of the mortgage: *Provided*, That the maturity of any such mortgage shall not exceed the maximum maturity prescribed therefor by the provisions of this section 203 in effect prior to the effective date of the Housing Act of 1954, unless the President, pursuant to section 201 of the Housing Act of 1954, has authorized a greater maturity, in which event the maturity of such mortgage shall not exceed such greater maturity."

Sec. 106. Section 203 (b) (5) of said Act, as amended, is hereby amended to read as follows:

"(5) Bear interest (exclusive of premium charges for insurance, and service charges if any) at not to exceed 5 per centum per annum on the amount of the principal obligation outstanding at any time, or not to exceed such per centum per annum not in excess of 6 per centum as the Commissioner finds necessary to meet the mortgage market."

Sec. 107. Section 203 (c) of said Act, as amended, is amended by striking out of the second sentence the word "*Provided*" and inserting: "*Provided*, That debentures presented in payment of premium charges shall represent obligations of the particular insurance fund to which such premium charges are to be credited: *Provided further*."

Sec. 108. Section 203 (d) of said Act, as amended, is hereby amended by striking the period at the end thereof and inserting a colon and the following: "*And provided further*, That no mortgage shall be insured pursuant to this subsection after the effective date of the Housing Act of 1954, except pursuant to a commitment to insure issued on or before such date."

Sec. 109. Subsections (f) and (g) of section 203 of said Act, as amended, are hereby repealed.

Sec. 110. Section 203 of said Act, as amended, is hereby further amended by adding the following new subsection at the end thereof:

"(h) Notwithstanding any other provision of this section, the Commissioner is authorized to insure any mortgage which does not involve a principal obligation in excess of \$7,000 or in excess of 100 per centum of the appraised value of a property upon which there is located a dwelling designed principally for a single-family residence, where the mortgagor is the owner and occupant and establishes (to the satisfaction of the Commissioner) that his home which he occupied as an owner or as a tenant was destroyed or damaged to such an extent that reconstruction is required as a result of a flood, fire, hurricane, earthquake, storm, or other catastrophe which the President, pursuant to section 2 (a) of the Act entitled 'An Act to authorize Federal assistance to States and local governments in major disasters and for other purposes' (Public Law 875, Eighty-first Congress, approved September 30, 1950), as amended, has determined to be a major disaster."

SEC. 111. Section 204 (a) of said Act, as amended, is hereby amended—

(1) by striking out of the third sentence the words "any mortgage insurance premiums paid after either of such dates" and inserting "any mortgage insurance premiums paid after either of such dates, any tax imposed by the United States upon any deed or other instrument by which said property was acquired by the mortgagee and transferred or conveyed to the Commissioner";

(2) by striking out of the second-proviso the words "or under section 213 of this Act," and inserting the following: "or under section 213 of this Act, or with respect to any mortgage accepted for insurance under section 203 on or after the date of enactment of the Housing Act of 1954,"; and

(3) by striking the period at the end thereof and inserting a colon and the following: "and provided further, That notwithstanding any requirement contained in this Act that debentures may be issued only upon acquisition of title and possession by the mortgagee and its subsequent conveyance and transfer to the Commissioner, and for the purpose of avoiding unnecessary conveyance expense in connection with payment of insurance benefits under the provisions of this Act, the Commissioner is authorized, subject to such rules and regulations as he may prescribe, to permit the mortgagee to tender to the Commissioner a satisfactory conveyance of title and transfer of possession direct from the mortgagor or other appropriate grantor and to pay the insurance benefits to the mortgagee which it would otherwise be entitled to if such conveyance had been made to the mortgagee and from the mortgagee to the Commissioner."

SEC. 112. Section 204 (d) of said Act, as amended, is hereby amended by striking out of the second sentence thereof the words "three years after the 1st day of July following the maturity date of the mortgage on the property in exchange for which the debentures were issued, except that debentures issued with respect to mortgages insured under section 213 shall mature twenty years after the date of such debentures" and inserting "ten years after the date thereof".

SEC. 113. Section 204 of said Act, as amended, is hereby amended by adding at the end thereof the following new subsection:

"(i) In the event that any mortgagee under a mortgage insured under section 203 forecloses on the mortgaged property but does not convey such property to the Commissioner in accordance with this section, and the Commissioner is given written notice thereof, or in the event that the mortgagor pays the obligation under the mortgage in full prior to the maturity thereof, and the mortgagee pays any adjusted premium charge required under the provisions of section 203 (c), and the Commissioner is given written notice by the mortgagee of the payment of such obligation, the obligation to pay any subsequent premium charge for insurance shall cease, and all rights of the mortgagee and the mortgagor under this section shall terminate as of the date of such notice."

SEC. 114. Section 205 of said Act, as amended, is hereby amended to read as follows:

"SEC. 205. (a). The Commissioner shall establish as of July 1, 1954, in the Mutual Mortgage Insurance Fund a General Surplus Account and a Participating Reserve Account. All of the assets of the General Reinsurance Account shall be transferred to the General Surplus Account whereupon the General Reinsurance Account shall be abolished. There shall be transferred from the various group accounts to the Participating Reserve Accounts as of July 1, 1954, an amount equal to the aggregate amount which would have been distributed under the provisions of section 205 in effect on June 30, 1954, if all outstanding mortgages in such group accounts had been paid in full on said date. All of the remaining balances of said group accounts shall as of said date be transferred to the General Surplus Account whereupon all of said group accounts shall be abolished.

"(b) The aggregate net income thereafter received or any net loss thereafter sustained by the Mutual Mortgage Insurance Fund in any semiannual period shall be credited or charged to the General Surplus Account and/or the Participating Reserve Account in such manner and amounts as the Commissioner may determine to be in accord with sound actuarial and accounting practice.

"(c) Upon termination of the insurance obligation of the Mutual Mortgage Insurance Fund by payment of any mortgage insured thereunder, the Commissioner is authorized to distribute to the mortgagor a share of the Participating Reserve Account in such manner and amount as the Commissioner shall determine to be equitable and in accordance with sound actuarial and accounting practice: *Provided*, That, in no event, shall any such distributable share exceed

the aggregate scheduled annual premiums of the mortgagor to the year of termination of the insurance.

"(d) No mortgagor or mortgagee of any mortgage insured under section 203 shall have any vested right in a credit balance in any such account or be subject to any liability arising out of the mutuality of the Fund and the determination of the Commissioner as to the amount to be paid by him to any mortgagor shall be final and conclusive."

Sec. 115. Section 207 (c) of said Act, as amended, is hereby amended—

(1) by inserting after the first proviso in paragraph numbered (2) the following: "*Provided further*, That nothing contained in this section shall preclude the insurance of mortgages covering existing construction located in slum or blighted areas, as defined in paragraph numbered (5) of subsection (a) of this section, and the Commissioner may require such repair or rehabilitation work to be completed as is, in his discretion, necessary to remove conditions detrimental to safety, health, or morals.;"

(2) by striking out the word "Alaska" in paragraph numbered (2) and inserting "Alaska, or in Guam,;" and

(3) by striking out paragraph numbered (3) and inserting the following: "(3) not to exceed, for such part of such property or project as may be attributable to dwelling use, \$2,000 per room (or \$7,200 per family unit if the number of rooms in such property or project does not equal or exceed four per family unit): *Provided*, That as to projects to consist of elevator type structures, the Commissioner may, in his discretion, increase the dollar amount limitation of \$2,000 per room to not to exceed \$2,400 per room and the dollar amount limitation of \$7,200 per family unit to not to exceed \$7,500 per family unit, as the case may be, to compensate for the higher costs incident to the construction of elevator type structures of sound standards of construction and design: *And provided further*, That such mortgage shall not involve a principal obligation exceeding the maximum amount prescribed by the provisions of this section 207 in effect prior to the effective date of the Housing Act of 1954, unless the President, pursuant to section 201 of the Housing Act of 1954 has authorized a greater maximum amount, in which event such principal obligation shall not exceed such greater maximum amount."

Sec. 116. Section 207 (d) of said Act, as amended, is hereby amended by inserting the words "of the Housing Insurance Fund" between the words "debentures" and "issued" in the first sentence of such section.

Sec. 117. Section 207 (h) of said Act, as amended, is hereby amended by striking out the period at the end of the first sentence and adding the following: "and a reasonable amount for necessary expenses incurred by the mortgagee in connection with the foreclosure proceedings, or the acquisition of the mortgaged property otherwise, and the conveyance thereof to the Commissioner."

Sec. 118. Section 212 (a) of said Act, as amended, is hereby amended, by inserting at the end thereof the following new sentence: "The provisions of this section shall also apply to the insurance of any mortgage under section 220 which covers property on which there is located a dwelling or dwellings designed principally for residential use for twelve or more families."

Sec. 119. Section 214 (b) of said Act, as amended, is hereby amended by striking clauses (1) and (2) and inserting:

"(1) not to exceed \$5,000,000, or not to exceed \$25,000,000 if the mortgage is executed by a mortgagor regulated or supervised under Federal or State laws or by political subdivisions of State or agencies thereof, as to rents, charges, and methods of operation; and

"(2) not to exceed, for such part of such property or project as may be attributable to dwelling use, \$2,250 per room (or \$8,100 per family if the number of rooms in such property or project does not equal or exceed four per family unit), and not to exceed 90 per centum of the estimated value of the property or project when the proposed improvements are completed: *Provided*, That if at least 65 per centum of the membership of the corporation or number of beneficiaries of the trust consists of veterans, the mortgage may involve a principal obligation not to exceed \$2,375 per room (or \$8,550 per family unit if the number of rooms in such property or project does not equal or exceed four per family unit), and not to exceed 95 per centum of the estimated value of the property or project when the proposed physical improvements are completed: *Provided further*, That as to projects which consist of elevator type structures, and to compensate for the higher costs incident to the construction of elevator type structures of sound

standards of construction and design, the Commissioner may, in his discretion, increase the aforesaid dollar amount limitations per room or per family unit (as may be applicable to the particular case) within the following limits: (i) \$2,250 per room to not to exceed \$2,700; (ii) \$2,375 per room to not to exceed \$2,850; (iii) \$8,100 per family unit to not to exceed \$8,400; and (iv) \$8,550 per family unit to not to exceed \$8,900: *Provided further*, That such mortgage shall not involve a principal obligation exceeding the maximum amount per room or per family unit prescribed by the provisions of this section 213 in effect prior to the effective date of the Housing Act of 1954, unless the President, pursuant to section 201 of the Housing Act of 1954 has authorized a greater maximum amount, in which event such principal obligation shall not exceed such greater maximum amount: *And provided further*, That for the purposes of this section the word 'veteran' shall mean a person who has served in the active military or naval service of the United States at any time on or after September 16, 1940, and prior to July 26, 1947, or on or after June 27, 1950, and prior to such date thereafter as shall be determined by the President."

SEC. 120. Section 213 (f) of said Act, as amended, is hereby amended by striking the last sentence thereof.

SEC. 121. Section 217 of said Act, as amended, is hereby amended to read as follows:

"SEC. 217. Notwithstanding limitations contained in any other section of this Act on the aggregate amount of principal obligations of mortgages or loans which may be insured (or insured and outstanding at any one time), the aggregate amount of principal obligations of all mortgages which may be insured and outstanding at any one time under insurance contracts or commitments to insure pursuant to any section or title of this Act (except section 2) shall not exceed the sum of (a) the outstanding principal balances, as of July 1, 1954, of all insured mortgages (as estimated by the Commissioner based on scheduled amortization payments without taking into account prepayments or delinquencies), (b) the principal amount of all outstanding commitments to insure on that date, and (c) \$1,500,000,000, except that with the approval of the President such aggregate amount may be increased by not to exceed \$500,000,000.

"It is the intent and purpose of this section to consolidate and merge all existing mortgage insurance authorizations or existing limitations with respect to any section or title of this Act (except section 2) into one general insurance authorization to take the place of all existing authorizations or limitations."

SEC. 122. Section 219 of said Act, as amended, is hereby amended by striking out the words "or the Defense Housing Insurance Fund," and inserting "the Defense Housing Insurance Fund, or the Section 220 Housing Insurance Fund,".

SEC. 123. Title II of said Act, as amended, is hereby amended by adding at the end thereof the following new sections:

"REHABILITATION AND NEIGHBORHOOD CONSERVATION HOUSING INSURANCE

"SEC. 220. (a) The purpose of this section is to supplement the insurance of mortgages under sections 203 and 207 of this title by providing a system of mortgage insurance to provide financial assistance in the rehabilitation of existing dwelling accommodations and the construction of new dwelling accommodations as an aid in the elimination of blight and slum conditions and in the prevention of the deterioration of property located in an urban renewal area (as defined in title I of the Housing Act of 1949, as amended) in a community respecting which the Housing and Home Finance Administrator has made the certification to the Commissioner provided for by subsection 101 (c) of the Housing Act of 1949, as amended.

"(b) The Commissioner is authorized, upon application by the mortgagee, to insure, as hereinafter provided, any mortgage (including advances during construction on mortgages covering property of the character described in paragraph (3) (B) of subsection (d) of this section) which is eligible for insurance as hereinafter provided, and, upon such terms and conditions as he may prescribe, to make commitments for the insurance of such mortgages prior to the date of their execution or disbursement thereon: *Provided*, That the property covered by the mortgage is in an urban renewal area referred to in subsection (a) of this section.

"(c) As used in this section, the terms 'mortgage', 'first mortgage', 'mortgagee', 'mortgagor', 'maturity date', and 'State' shall have the same meaning as in section 201 of this Act.

"(d) To be eligible for insurance under this section a mortgage shall meet the following conditions:

"(1) The mortgaged property shall be located in a delineated area (within an urban renewal area as defined in title I of the Housing Act of 1949, as amended) with respect to which delineated area a specific plan of rehabilitation and conservation has been established to carry out the purposes set forth in subsection (a) of this section: *Provided*, That, in the opinion of the Commissioner (i) there exists necessary authority and financial capacity to assure the completion of such plan and (ii) such plan will be effective to assure compliance with such standards and conditions as the Commissioner may prescribe to establish the acceptability of such property for mortgage insurance.

"(2) The mortgaged property shall be held by—

"(A) a mortgagor approved by the Commissioner, and the Commissioner may in his discretion require such mortgagor to be regulated or restricted as to rents or sales, charges, capital structure, rate of return and methods of operation, and for such purpose the Commissioner may make such contracts with and acquire for not to exceed \$100 stock or interest in any such mortgagor as the Commissioner may deem necessary to render effective such restriction or regulations. Such stock or interest shall be paid for out of the Section 220 Housing Insurance Fund and shall be redeemed by the mortgagor at par upon the termination of all obligations of the Commissioner under the insurance; or

"(B) by Federal or State instrumentalities, municipal corporate instrumentalities of one or more States, or limited dividend or redevelopment or housing corporations restricted by Federal or State laws or regulations of State banking or insurance departments as to rents, charges, capital structure, rate of return, or methods of operation.

"(3) The mortgage shall involve a principal obligation (including such initial service charges, appraisal, inspection and other fees as the Commissioner shall approve) in an amount—

"(A) not to exceed \$20,000 in the case of property upon which there is located a dwelling designed principally for a one- or two-family residence; or \$27,500 in the case of a three-family residence; or \$35,000 in the case of a four-family residence; or in the case of a dwelling designed principally for residential use for more than four families (but not exceeding such additional number of family units as the Commissioner may prescribe) \$35,000 plus not to exceed \$7,000 for each additional family unit in excess of four located on such property; and not to exceed an amount equal to the sum of (i) 95 per centum of \$8,000 of the appraised value (as of the date the mortgage is accepted for insurance) and (ii) 75 per centum of such value in excess of \$8,000: *Provided*, That such mortgage shall not involve a principal obligation exceeding the maximum amount prescribed by the provisions of section 203 in effect prior to the effective date of the Housing Act of 1954, unless the President, pursuant to section 201 of the Housing Act of 1954 has authorized a greater maximum amount, in which event such principal obligation shall not exceed such greater maximum amount; or

"(B) (i) not to exceed \$5,000,000, or, if executed by a mortgagor coming within the provisions of paragraph (2) (B) of this subsection (d), not to exceed \$50,000,000; and

"(ii) not to exceed 90 per centum of the estimated value of the property or project when the proposed improvements are completed (the value of the property or project may include the land, the proposed physical improvements, utilities within the boundaries of the property or project, architect's fees, taxes, and interest during construction, and other miscellaneous charges incident to construction and approved by the Commissioner); and

"(iii) not to exceed, for such part of such property or project as may be attributable to dwelling use, \$2,250 per room (or \$7,200 per family unit if the number of rooms in such property or project does not equal or exceed four per family unit): *Provided*, That as to projects to consist of elevator-type structures, the Commissioner may, in his discretion, increase the dollar amount limitation of \$2,250 per room to not to exceed \$2,700 per room and the dollar amount limitation of \$7,200 per family unit to not to exceed \$7,500 per family unit, as the case may be, to compensate for the higher costs incident to the construction of elevator-type structures of sound standards of construction and design: *Provided further*, That a mortgage coming within the provisions of this paragraph (3) (B) shall not involve a principal obligation exceeding the maximum amount prescribed by the provisions of

section 207 in effect prior to the effective date of the Housing Act of 1954, unless the President, pursuant to section 201 of the Housing Act of 1954 has authorized a greater maximum amount, in which event such principal obligation shall not exceed such greater maximum amount: *And provided further*, That nothing contained in part (B) shall preclude the insurance of mortgages covering existing multifamily dwellings to be rehabilitated or reconstructed for the purposes set forth in subsection (a) of this section.

"(4) The mortgage shall provide for complete amortization by periodic payments within such terms as the Commissioner may prescribe, but as to mortgages coming within the provisions of paragraph (3) (A) of this subsection (d) not to exceed the maximum maturity prescribed by the provisions of section 203 in effect prior to the effective date of the Housing Act of 1954, unless the President, pursuant to section 201 of the Housing Act of 1954, has authorized a greater maturity, in which event the maturity of such mortgage shall not exceed such greater maturity: *Provided*, That such maturity shall not exceed, in any event, thirty years from the date of insurance of the mortgage. The mortgage shall bear interest (exclusive of premium charges for insurance and service charge, if any) at not to exceed 5 per centum per annum on the amount of the principal obligation outstanding at any time, or not to exceed such per centum per annum not in excess of 6 per centum as the Commissioner finds necessary to meet the mortgage market; contain such terms and provisions with respect to the application of the mortgagor's periodic payment to amortization of the principal of the mortgage, insurance, repairs, alterations, payment of taxes, default reserves, delinquency charges, foreclosure proceedings, anticipation of maturity, additional and secondary liens, and other matters as the Commissioner may in his discretion prescribe.

"(e) The Commissioner may at any time, under such terms and conditions as he may prescribe, consent to the release of the mortgagor from his liability under the mortgage or the credit instrument secured thereby, or consent to the release of parts of the mortgaged property from the lien of the mortgage.

"(f) The mortgagee shall be entitled to receive the benefits of the insurance as hereinafter provided—

"(1) as to mortgages meeting the requirements of paragraph (3) (A) of subsection (d) of this section, as provided in section 204 (a) of this Act with respect to mortgages insured under section 203; and the provisions of subsections (b), (c), (d), (e), (f), (g), and (h) of section 204 of this Act shall be applicable to such mortgages insured under this section, except that all references therein to the Mutual Mortgage Insurance Fund or the Fund shall be construed to refer to the Section 220 Housing Insurance Fund and all references therein to section 203 shall be construed to refer to this section; or

"(2) as to mortgages meeting the requirements of paragraph (3) (B) of subsection (d) of this section, as provided in section 207 (g) of this Act with respect to mortgages insured under said section 207, and the provisions of subsections (h), (i), (j), (k), and (l) of section 207 of this Act shall be applicable to such mortgages insured under this section, and all references therein to the Housing Insurance Fund or the Housing Fund shall be construed to refer to the Section 220 Housing Insurance Fund.

"(g) There is hereby created a Section 220 Housing Insurance Fund which shall be used by the Commissioner as a revolving fund for carrying out the provisions of this section, and the Commissioner is hereby authorized to transfer to such Fund the sum of \$1,000,000 from the War Housing Insurance Fund established pursuant to the provisions of section 602 of this Act. General expenses of operation of the Federal Housing Administration under this section may be charged to the Section 220 Housing Insurance Fund.

"Moneys in the Section 220 Housing Insurance Fund not needed for the current operations of the Federal Housing Administration under this section shall be deposited with the Treasurer of the United States to the credit of such Fund, or invested in bonds or other obligations of, or in bonds or other obligations guaranteed as to principal and interest by, the United States. The Commissioner may, with the approval of the Secretary of the Treasury, purchase in the open market debentures issued under the provisions of this section. Such purchases shall be made at a price which will provide an investment yield of not less than the yield obtainable from other investments authorized by this section. Debentures so purchased shall be canceled and not reissued.

"Premium charges, adjusted premium charges, and appraisal and other fees received on account of the insurance of any mortgage accepted for insurance under this section, the receipts derived from the property covered by such mort-

gage and claims assigned to the Commissioner in connection therewith shall be credited to the Section 220 Housing Insurance Fund. The principal of, and interest paid and to be paid on debentures issued under this section, cash adjustments, and expenses incurred in the handling, management, renovation, and disposal of properties acquired under this section shall be charged to such Fund.

"Sec. 221. (a) This section is designed to supplement systems of mortgage insurance under other provisions of the National Housing Act in order to assist in relocating families to be displaced as the result of governmental action in a community respecting which the Housing and Home Finance Administrator has made the certification to the Commissioner provided for by subsection 101, (c) of the Housing Act of 1949, as amended. Mortgage insurance under this section shall be available only in those localities or communities which shall have requested such mortgage insurance to be provided: *Provided*, That the Commissioner shall prescribe such procedures as in his judgment are necessary to secure to the families to be so displaced, referred to above, a preference or priority of opportunity to purchase or rent such dwelling units: *And provided further*, That the total number of dwelling units in properties covered by mortgages insured under this section in any such community shall not exceed the total number of such dwelling units which the Commissioner determines to be needed for the relocation of families to be so displaced and who would be eligible to obtain the benefits of the insurance authorized by this section.

"(b) The Commissioner is authorized, upon application by the mortgagee, to insure under this section as hereinafter provided any mortgage which is eligible for insurance as provided herein and, upon such terms and conditions as the Commissioner may prescribe, to make commitments for the insurance of such mortgages prior to the date of their execution or disbursement thereon.

"(c) As used in this section, the terms 'mortgage', 'first mortgage', 'mortgagee', 'mortgagor', 'maturity date' and 'State' shall have the same meaning as in section 201 of this Act.

"(d) To be eligible for insurance under this section, a mortgage shall—

"(1) have been made to and be held by a mortgagee approved by the Commissioner as responsible and able to service the mortgage properly;

"(2) involve a principal obligation (including such initial service charges, appraisal, inspection, and other fees as the Commissioner shall approve) in an amount not to exceed \$7,000, and not to exceed 100 per centum of the appraised value (as of the date the mortgage is accepted for insurance) of a property, upon which there is located a dwelling designed principally for a single-family residence: *Provided*, That the mortgagor shall be the owner and occupant of the property at the time of the insurance and shall have paid on account of the property at least \$200 (which amount may include amounts to cover settlement costs and initial payments for taxes, hazard insurance, mortgage insurance premium, and other prepaid expenses): *Provided further*, That nothing contained herein shall preclude the Commissioner from issuing a commitment to insure and insuring a mortgage pursuant thereto where the mortgagor is not the owner and occupant and the property is to be built for sale and the insured mortgage financing is required to facilitate the construction of the dwelling and provide financing pending the subsequent sale thereof to a qualified owner-occupant, and in such instances the mortgage shall not exceed 85 per centum of the appraised value; or

"(3) if executed by a mortgagor which is a nonprofit corporation or association or other acceptable nonprofit organization, regulated or supervised under Federal or State laws or by political subdivisions of State or agencies thereof, as to rents, charges, and method of operation, in such form and in such manner as, in the opinion of the Commissioner, will effectuate the purposes of this section, the mortgage may involve a principal obligation not in excess of \$5,000,000; and not in excess of \$7,000 per family unit for such part of such property or project as may be attributable to dwelling use, and not in excess of 100 per centum of the Commissioner's estimate of the value of the property or project when repaired and rehabilitated for use as rental accommodations for ten or more families eligible for occupancy as provided in this section; and

"(4) provide for complete amortization by periodic payments within such terms as the Commissioner may prescribe, but not to exceed forty years from the date of insurance of the mortgage; bear interest (exclusive of premium charges for insurance and service charge, if any) at not to exceed 5 per centum per annum on the amount of the principal obligation outstanding at

any time, or not to exceed such per centum per annum not in excess of 6 per centum as the Commissioner finds necessary to meet the mortgage market; and contain such terms and provisions with respect to the application of the mortgagor's periodic payment to amortization of the principal of the mortgage, insurance, repairs, alterations, payment of taxes, default reserves, delinquency charges, foreclosure proceedings, anticipation of maturity, additional and secondary liens, and other matters as the Commissioner may in his discretion prescribe.

"(e) The Commissioner may at any time, under such terms and conditions as he may prescribe, consent to the release of the mortgagor from his liability under the mortgage or the credit instrument secured thereby, or consent to the release of parts of the mortgaged property from the lien of the mortgage.

"(f) The property or project shall comply with such standards and conditions as the Commissioner may prescribe to establish the acceptability of such property for mortgage insurance.

"(g) The mortgagee shall be entitled to receive the benefits of the insurance as hereinafter provided—

"(1) as to mortgages meeting the requirements of paragraph (2) of subsection (d) of this section, as provided in section 204 (a) of this Act with respect to mortgages insured under section 203; and the provisions of subsections (b), (c), (d), (e), (f), (g), and (h) of section 204 of this Act shall be applicable to such mortgages insured under this section except that all references therein to the Mutual Mortgage Insurance Fund or the Fund shall be construed to refer to the Section 221 Housing Insurance Fund and all references therein to section 203 shall be construed to refer to this section; or

"(2) as to mortgages meeting the requirements of paragraph (3) of subsection (d) of this section, as provided in section 207 (g) of this Act with respect to mortgages insured under said section 207, and the provisions of subsections (h), (i), (j), (k), and (l) of section 207 of this Act shall be applicable to such mortgages insured under this section, and all references therein to the Housing Insurance Fund or the Housing Fund shall be construed to refer to the Section 221 Housing Insurance Fund; or

"(3) in the event any mortgage insured under this section is not in default at the expiration of twenty years from the date the mortgage was endorsed for insurance, the mortgagee shall, within a period thereafter to be determined by the Commissioner, have the option to assign, transfer, and deliver to the Commissioner the original credit instrument and the mortgage securing the same and receive the benefits of the insurance as hereinafter provided in this paragraph, upon compliance with such requirements and conditions as to the validity of the mortgage as a first lien and such other matters as may be prescribed by the Commissioner at the time the loan is endorsed for insurance. Upon such assignment, transfer, and delivery the obligation of the mortgagee to pay the premium charges for insurance shall cease, and the Commissioner shall, subject to the cash adjustment provided herein, issue to the mortgagee debentures having a total face value equal to the amount of the original principal obligation of the mortgage which was unpaid on the date of the assignment, plus accrued interest to such date. Debentures issued pursuant to this paragraph (3) shall be issued in the same manner and subject to the same terms and conditions as debentures issued under paragraph (1) of this subsection, except that the debentures issued pursuant to this paragraph (3) shall be dated as of the date the mortgage is assigned to the Commissioner, and shall bear interest from such date at the going Federal rate determined at the time of issuance. The term "going Federal rate" as used herein means the annual rate of interest which the Secretary of the Treasury shall specify as applicable to the six-month period (consisting of January through June or July through December) which includes the issuance date of such debentures, which applicable rate for each such six-month period shall be determined by the Secretary of the Treasury by estimating the average yield to maturity, on the basis of daily closing market bid quotations or prices during the month of May or the month of November, as the case may be, next preceding such six-month period, on all outstanding marketable obligations of the United States having a maturity date of eight to twelve years from the first day of such month of May or November, and by adjusting such estimated average annual yield to the nearest one-eighth of 1 per centum. The Commissioner shall have the same authority with respect to mortgages assigned to him under this paragraph

as contained in section 207 (k) and section 207 (l) as to mortgages insured by the Commissioner and assigned to him under section 207 of this Act.

"(h) There is hereby created a Section 221 Housing Insurance Fund which shall be used by the Commissioner as a revolving fund for carrying out the provisions of this section, and the Commissioner is hereby authorized to transfer to such Fund the sum of \$1,000,000 from the War Housing Insurance Fund established pursuant to the provisions of section 602 of this Act. General expenses of operation of the Federal Housing Administration under this section may be charged to the Section 221 Housing Insurance Fund.

"Moneys in the Section 221 Housing Insurance Fund not needed for the current operations of the Federal Housing Administration under this section shall be deposited with the Treasurer of the United States to the credit of such fund, or invested in bonds or other obligations of, or in bonds or other obligations guaranteed as to principal and interest by, the United States. The Commissioner may, with the approval of the Secretary of the Treasury, purchase in the open market debentures issued under the provisions of this section. Such purchases shall be made at a price which will provide an investment yield of not less than the yield obtainable from other investments authorized by this section. Debentures so purchased shall be canceled and not reissued.

"Premium charges, adjusted premium charges, and appraisal and other fees received on account of the insurance of any mortgage accepted for insurance under this section, the receipts derived from the property covered by such mortgage and claims assigned to the Commissioner in connection therewith shall be credited to the Section 221 Housing Insurance Fund. The principal of, and interest paid and to be paid on debentures issued under this section, cash adjustments, and expenses incurred in the handling, management, renovation, and disposal of properties acquired under this section shall be charged to such Fund."

SEC. 124. Title II of said Act, as amended, is hereby further amended by adding at the end thereof the following new section to transfer to title II the mortgage insurance program in connection with the sale of certain publicly owned property as contained in section 610 of title VI; the insurance of mortgages to refinance existing loans insured under section 608 of title VI and sections 903 and 908 of title IX; and to authorize the insurance under title II of mortgages assigned to the Commissioner under insurance contracts and mortgages held by the Commissioner in connection with the sale of property acquired under insurance contracts:

"MISCELLANEOUS HOUSING INSURANCE

"SEC. 222. (a) Notwithstanding any of the provisions of this title, and without regard to limitations upon eligibility contained in section 203 or section 207 the Commissioner is authorized, upon application by the mortgagee, to insure or make commitments to insure under section 203 or section 207 of this title any mortgage—

(1) executed in connection with the sale by the Government, or any agency or official thereof, of any housing acquired or constructed under Public Law 849, Seventy-sixth Congress, as amended; Public Law 781, Seventy-sixth Congress, as amended; or Public Law 9, 73, or 353, Seventy-seventh Congress, as amended (including any property acquired, held, or constructed in connection with such housing or to serve the inhabitants thereof); or

(2) executed in connection with the sale by the Public Housing Administration, or by any public housing agency with the approval of the said Administration, of any housing (including any property acquired, held, or constructed in connection with such housing or to serve the inhabitants thereof) owned or financially assisted pursuant to the provisions of Public Law 671, Seventy-sixth Congress; or

(3) executed in connection with the sale by the Government, or any agency or official thereof, of any of the so-called Greenbelt towns, or parts thereof, including projects, or parts thereof, known as Greenhills, Ohio; Greenbelt, Maryland; and Greendale, Wisconsin, developed under the Emergency Relief Appropriation Act of 1935, or of any of the village properties under the jurisdiction of the Tennessee Valley Authority; or

(4) executed in connection with the sale by a State or municipality, or an agency, instrumentality, or political subdivision of either, of a project consisting of any permanent housing (including any property acquired, held, or constructed in connection therewith or to serve the inhabitants thereof), constructed by or on behalf of such State, municipality, agency, instrumentality, or political subdivision, for the occupancy of veterans of World War II, or Korean veterans, their families, and others; or

(5) executed in connection with the first resale, within two years from the date of its acquisition from the Government, of any portion of a project or property of the character described in paragraphs (1), (2), and (3) above; or

(6) given to refinance an existing mortgage insured under section 608 of title VI prior to the effective date of the Housing Act of 1954 or under section 903 or section 908 of title IX: *Provided*, That the principal amount of any such refinancing mortgage shall not exceed the original principal amount or the unexpired term of such existing mortgage and shall bear interest at a rate not in excess of the maximum rate applicable to loans insured under section 203 or section 207, as the case may be, except that in any case involving the refinancing of a loan insured under section 608 or 908 in which the Commissioner determines that the insurance of a mortgage for an additional term will inure to the benefit of the applicable insurance fund, taking into consideration the outstanding insurance liability under the existing insured mortgage, such refinancing mortgage may have a term not more than twelve years in excess of the unexpired term of such existing insured mortgage: *Provided*, That a mortgage of the character described in paragraph (1), (2), (3), (4), or (5) shall have a maturity satisfactory to the Commissioner, but not to exceed the maximum term applicable to loans insured under section 203 or section 207, as the case may be, and shall involve a principal obligation (including such initial service charges, appraisal, inspection, and other fees as the Commissioner shall approve) in an amount not exceeding 90 per centum of the appraisal value of the mortgaged property, as determined by the Commissioner, and bear interest (exclusive of premium charges and service charges, if any) at not to exceed the maximum rate applicable to loans insured under section 203 or section 207, as the case may be.

"(b) The Commissioner shall also have authority to insure under this title any mortgage assigned to him in connection with payment under a contract of mortgage insurance or executed in connection with the sale by him of any property acquired under title I, title II, title VI, title VIII, or title IX without regard to any limitation upon eligibility contained in this title II."

SEC. 125. Title II of said Act, as amended, is hereby amended by adding at the end thereof the following new sections:

"INTEREST RATES AND MORTGAGE TERMS

"SEC. 223. The Commissioner shall make such rules and regulations in connection with his functions under this Act as may be necessary to carry out limitations relating thereto established by the President pursuant to the authority vested in him by section 201 of the Housing Act of 1954.

"OPEN-END MORTGAGES

"SEC. 224. Notwithstanding any other provisions of this Act, in connection with any mortgage insured pursuant to any section of this Act which covers a property upon which there is located a dwelling designed principally for residential use for not more than four families in the aggregate, the Commissioner is authorized, upon such terms and conditions as he may prescribe, to insure under said section the amount of any advance for the improvement or repair of such property made to the mortgagor pursuant to an 'open-end' provision in the mortgage, and to add the amount of such advance to the original principal obligation in determining the value of the mortgage for the purpose of computing the amounts of debentures and certificate of claim to which the mortgagee may be entitled: *Provided*, That the Commissioner may require the payment of such charges, including charges in lieu of insurance premiums, as he may consider appropriate for the insurance of such 'open-end' advances: *And provided further*, That the insurance of 'open-end' advances shall not be taken into account in determining the aggregate amount of principal obligations of mortgages which may be insured under this Act."

ADDITIONAL AMENDMENTS RELATING TO FEDERAL HOUSING ADMINISTRATION

SEC. 126. Title VI of said Act, as amended, is hereby amended by adding the following new section at the end thereof:

"SEC. 612. Notwithstanding any other provision of this title, no mortgage or loan shall be insured under any section of this title after the effective date of the Housing Act of 1954 except pursuant to a commitment to insure issued on or before such date."

SEC. 127. Title VII of said Act, as amended, is hereby repealed. The Housing Investment Insurance Fund established to carry out the purposes of said title shall be terminated as of the effective date of the Housing Act of 1954, at which time all of the remaining assets of such Fund shall be transferred to the National Defense Housing Insurance Fund. The amount remaining of funds appropriated to the Secretary of the Treasury by the Supplemental Appropriation Act, 1949 (Public Law 904, Eightieth Congress), to be made available to the said Housing Investment Insurance Fund shall be carried to the surplus fund of the Treasury.

SEC. 128. Section 803 (a) of said Act, as amended, is amended by striking out "July 1, 1954" and substituting therefor "June 30, 1955".

SEC. 129. Section 104 of the Defense Housing and Community Facilities and Services Act of 1951, as amended, is hereby amended by striking out the material within the parentheses in clause (a) and substituting therefor "except pursuant to a commitment to insure issued on or before such date".

TITLE II—HOME MORTGAGE INTEREST RATES AND TERMS

SEC. 201. On the basis of reviews, which shall be made from time to time at the request of the President by officers of the Federal Government designated by him, of conditions affecting the mortgage investment market (including current market yields on comparable investments such as long-term obligations of the United States and of States and municipalities and long-term corporate bonds), and after taking into consideration conditions in the building industry and the national economy, the President is hereby authorized, without regard to any other provision of law except provisions hereafter enacted expressly in limitation hereof, to establish from time to time—

(1) the maximum rates of interest (exclusive of premium charges for insurance and service charges, if any) for various classifications of residential mortgage loans insured or guaranteed or made under the National Housing Act, as amended, or the Servicemen's Readjustment Act of 1944, as amended: *Provided*, That no such maximum rate of interest shall, at the time established by the President, exceed $2\frac{1}{2}$ per centum plus the annual rate of interest determined by the Secretary of the Treasury, at the request of the President, by estimating the average yield to maturity, on the basis of daily closing market bid quotations or prices during the calendar month next preceding the establishment of such maximum rate of interest, on all outstanding marketable obligations of the United States having a maturity date of fifteen years or more from the first day of such next preceding month, and by adjusting such estimated average annual yield to the nearest one-eighth of 1 per centum;

(2) the maximum financing charges for various classifications of loans as to which financial institutions are insured against losses under title I of the National Housing Act, as amended;

(3) the rate of interest for debentures issued under the National Housing Act, as amended, in connection with defaults upon mortgages insured thereunder: *Provided*, That no such rate shall, at the time established by the President, exceed the annual rate of interest determined by the Secretary of the Treasury in the manner set forth in numbered clause (1) of this section;

(4) the maximum fees and charges permitted to cover the costs of the origination of, including the costs of supervision of non-Government assisted construction loan disbursements in connection with, residential mortgage loans insured or guaranteed under the National Housing Act, as amended, or the Servicemen's Readjustment Act of 1944, as amended, and the maximum special service charges, if any, permitted in connection with those mortgages insured under section 203 of said National Housing Act for which such special service charges may be found to be appropriate by the President on the basis of the low original principal amounts of the mortgages or on the basis of other factors impeding an adequate flow of credit for the type of housing involved and in connection with mortgages insured under sections 220 or 221 of the National Housing Act, as amended; and

(5) the maximum ratios of loan to value and the maximum maturities with respect to residential mortgage loans eligible for assistance under the National Housing Act, as amended, or the Servicemen's Readjustment Act of 1944, as amended, and the maximum dollar amount limitation per room or per family unit with respect to such mortgage loans eligible for assistance under the National Housing Act, as amended: *Provided*, That no such maximum ratio of loan to value and no such maximum dollar amount limitation in the case of mortgages insured under the National Housing Act, as

amended, shall be in excess of the applicable maximum ratio of loan to value or the applicable maximum dollar amount limitation per room or per family unit prescribed by that Act, and no such maximum maturity shall be in excess of the applicable maximum maturity prescribed by the National Housing Act, as amended, or the Servicemen's Readjustment Act of 1944, as amended: *And provided further*, That no action by the President pursuant to this section shall apply with respect to loans made, or loans with respect to which a contract of insurance or guaranty or a firm commitment to insure or guarantee has been entered into, under the National Housing Act, as amended, or the Servicemen's Readjustment Act of 1944, as amended, prior to such action.

SEC. 202. The Servicemen's Readjustment Act of 1944, as amended, is hereby amended by adding the following new section at the end of title III:

"SEC. 515. With respect to mortgage loans for the purchase or construction of residential property (not including farm homes) guaranteed, insured, or made pursuant to this title the Administrator shall make such rules and regulations concerning (1) maximum rates of interest for such residential mortgage loans, (2) maximum ratios of loan to value and maximum maturities with respect to such residential mortgage loans, and (3) maximum fees and charges permitted to cover the costs of the origination of, and of the supervision of construction loan disbursements in connection with, such residential mortgage loans as may be necessary to carry out limitations relating thereto established by the President pursuant to the authority vested in him by section 201 of the Housing Act of 1954."

SEC. 203. Section 504 of the Housing Act of 1950, as amended, is hereby repealed.

TITLE III—FEDERAL NATIONAL MORTGAGE ASSOCIATION

SEC. 301. Title III of the National Housing Act, as amended, is hereby amended to read as follows:

"TITLE III—FEDERAL NATIONAL MORTGAGE ASSOCIATION

"PURPOSES

"SEC. 301. The Congress hereby declares that the purposes of this title are to establish in the Federal Government a secondary market facility for home mortgages, to provide that the operations of such facility shall be financed by private capital to the maximum extent feasible, and to authorize such facility to—

"(a) provide supplementary assistance to the secondary market for home mortgages by providing a degree of liquidity for mortgage investments, thereby improving the distribution of investment capital available for home mortgage financing;

"(b) provide special assistance (when, and to the extent that, the President has determined that it is in the public interest) for the financing of (1) selected types of home mortgages (pending the establishment of their marketability) originated under special housing programs designed to provide housing of acceptable standards at full economic costs for segments of the national population which are unable to obtain adequate housing under established home financing programs, and (2) home mortgages generally as a means of retarding or stopping a decline in mortgage lending and home building activities which threatens materially the stability of a high level national economy; and

"(c) manage and liquidate the existing mortgage portfolio of the Federal National Mortgage Association in an orderly manner, with a minimum of adverse effect upon the home mortgage market and minimum loss to the Federal Government.

"CREATION OF ASSOCIATION

"SEC. 302. (a) There is hereby created a body corporate to be known as the 'Federal National Mortgage Association' (hereinafter referred to as the 'Association'), which shall be a constituent agency of the Housing and Home Finance Agency. The Association shall have succession until dissolved by Act of Congress. It shall maintain its principal office in the District of Columbia and shall be deemed, for purposes of venue in civil actions, to be a resident thereof. Agencies or offices may be established by the Association in such other

place or places as it may deem necessary or appropriate in the conduct of its business.

"(b) For the purposes set forth in section 301 and subject to the limitations and restrictions of this title, the Association is authorized to make commitments to purchase and to purchase, service, or sell, any residential or home mortgages (or participations therein) which are insured under this Act, as amended, or which are insured or guaranteed under the Servicemen's Readjustment Act of 1944, as amended: *Provided*, That (1) no mortgage may be purchased at a price exceeding 100 per centum of the unpaid principal amount thereof at the time of purchase, with adjustments for interest and any comparable items: and (2) the Association may not purchase any mortgage if (i) it is offered by, or covers property held by, a Federal, State, territorial, or municipal instrumentality or (ii) the original principal obligation thereof exceeds or exceeded \$12,500 for each family residence or dwelling unit covered by the mortgage.

"CAPITALIZATION

"SEC. 303. (a) The Association shall have nonvoting capital stock, to which the Secretary of the Treasury initially shall subscribe as provided in subsections (d) and (e) of this section. The stock of the Association shall have a par value of \$100 per share, and shall not be transferable except on the books of the Association. At the option of the Association such stock shall be retireable at par value at any time, except that retirements of stock (other than stock held by the Secretary of the Treasury) shall not be made if, as a consequence thereof, the amount remaining outstanding would be less than \$100,000,000. With respect to such stock held by him, the Secretary of the Treasury shall be entitled to cumulative dividends for each fiscal year until such stock is retired, at rates determined by him at the beginning of each such fiscal year, taking into consideration the current average interest rate on outstanding marketable obligations of the United States as of the last day of the preceding fiscal year. The Secretary of the Treasury shall permit the retirement of the stock held by him in the manner provided in this section. Funds of the capital surplus and the general surplus accounts of the Association shall be available to retire the capital stock held by the Secretary of the Treasury as rapidly as the Association shall deem feasible.

"(b) The Association shall accumulate funds for its capital surplus account from private sources by requiring each mortgage seller to make payments of nonrefundable capital contributions equal to not less than 3 per centum of the unpaid principal amount of mortgages therein involved in purchases or contracts for purchases between such seller and the Association, or such greater percentage as may from time to time be determined by the Association. In addition, the Association may impose charges or fees for its services with the objective that all costs and expenses of its operations should be within its income derived from such operations and that such operations should be fully self-supporting. All earnings from the operations of the Association shall annually be transferred to its general surplus account. At any time, funds of the general surplus account may, in the discretion of the board of directors, be transferred to reserves. All dividends shall be charged against the general surplus account. This subsection (b) shall not apply to the special assistance functions of the Association under section 305 of this title or to the management and liquidating functions of the Association under section 306 of this title.

"(c) Until such time as all the stock held by the Secretary of the Treasury has been retired, the Association shall issue, from time to time, to each mortgage seller its convertible certificates (only in denominations of \$100 or multiples thereof) evidencing any capital contributions made by such seller pursuant to subsection (b) of this section, which certificates shall not be transferable except on the books of the Association. Subject to such terms and conditions as may be prescribed by the board of directors, such certificates shall be convertible into capital stock of the Association having an equal par value, but no such conversion shall be permitted or made until such time as all of the outstanding capital stock of the Association held by the Secretary of the Treasury has been retired and the Secretary of the Treasury does not hold any of the obligations of the Association purchased under section 304 (c) of this title. After all of the stock held by the Secretary of the Treasury has been retired, the Association may effect the direct issuance of stock in lieu of and in the same manner as is provided in this subsection for the issuance of convertible certificates. Such dividends as may be declared by the board of directors in its discretion shall be paid by the Association to its stockholders, but in any one fiscal year

the general surplus account of the Association shall not be reduced through the payment of dividends (other than to the Secretary of the Treasury) which exceed in the aggregate 5 per centum of the par value of the outstanding stock of the Association.

"(d) Within sixty days following the effective date of the Housing Act of 1954, as of the day following a cutoff date to be determined by the Association, the Association is authorized and directed to issue and deliver to the Secretary of the Treasury, and the Secretary of the Treasury is authorized and directed to accept capital stock of the Association having an aggregate par value equal to the sum of (1) the amount of \$21,000,000 (being the amount of the original subscription for capital stock of \$20,000,000 and paid-in surplus of \$1,000,000 of the Association) and (2) an amount equal to the Association's surplus, surplus reserves, and undistributed earnings, computed as of the close of the cutoff date.

"(e) The capital stock of the Association delivered to the Secretary of the Treasury pursuant to subsection (d) of this section shall be in exchange for (1) the note or notes evidencing the aforesaid original \$21,000,000 (upon which the accrued interest shall have been paid through the cutoff date referred to in subsection (d) of this section), and (2) the release to the Association of any and all rights or claims which the United States might otherwise have or claim in and to the Association's capital, surplus, surplus reserves, and undistributed earnings, computed as of the close of the aforesaid cutoff date.

"(f) Notwithstanding any other provision of law, any institution, including a national bank or State member bank of the Federal Reserve System, trust company, or other banking organization, organized under any law of the United States, including the laws relating to the District of Columbia, shall be authorized to make payments to the Association of the nonrefundable capital contributions referred to in subsection (b) of this section, to receive stock or convertible certificates of the Association evidencing such capital contributions, and to hold or dispose of such stock or certificates, subject to the provisions of this title.

"(g) As promptly as practicable after all of the capital stock of the Association held by the Secretary of the Treasury has been retired, the Housing and Home Finance Administrator shall transmit to the President for submission to the Congress recommendations for such legislation as may be necessary or desirable to make appropriate provisions to transfer to the owners of the outstanding capital stock of the Association the assets and liabilities of the Association in connection with, and the control and management of, the secondary market operations of the Association under section 304 of this title in order that such operations may thereafter be carried out by a privately owned and privately financed corporation.

"SECONDARY MARKET OPERATIONS

"SEC. 304. (a) To carry out the purposes set forth in paragraph (a) of section 301, the operations of the Association under this section shall be confined, so far as practicable, to mortgages which are deemed by the Association to be of such quality, type, and class as to meet, generally, the purchase standards imposed by private institutional mortgage investors. In the interest of assuring sound operation, the prices to be paid by the Association for mortgages purchased in its secondary market operations under this section, should be established, from time to time, at or below the market price for the particular class of mortgages involved, as determined by the Association. The volume of the Association's purchases and sales, and the establishment of the purchase prices, sale prices, and charges or fees, in its secondary market operations under this section, should be determined by the Association from time to time, and such determinations should be consistent with the objectives that such purchases and sales should be effected only at such prices and on such terms as will reasonably prevent excessive use of the Association's facilities, and that the operations of the Association under this section should be within its income derived from such operations and that such operations should be fully self-supporting.

"(b) For the purposes of this section, the Association is authorized to issue, upon the approval of the Secretary of the Treasury, and have outstanding at any one time obligations in an aggregate amount sufficient to enable it to carry out its functions under this section, such obligations to have such maturities and to bear such rate or rates of interest as may be determined by the Association with the approval of the Secretary of the Treasury, and to be redeemable at the option of the Association before maturity in such manner as may be

stipulated in such obligations; but the aggregate amount of obligations of the Association under this subsection outstanding at any one time shall not exceed ten times the sum of its capital, capital surplus, general surplus, reserves, and undistributed earnings, and in no event shall any such obligations be issued if, at the time of such proposed issuance, and as a consequence thereof, the resulting aggregate amount of its outstanding obligations under this subsection would exceed the amount of the Association's ownership pursuant to this section, free from any liens or encumbrances, of cash, mortgages, and bonds or other obligations of, or bonds or other obligations guaranteed as to principal and interest by, the United States. The Association shall insert appropriate language in all of its obligations issued under this subsection clearly indicating that such obligations, together with the interest thereon, are not guaranteed by the United States and do not constitute a debt or obligation of the United States or of any agency or instrumentality thereof other than the Association. The Association is authorized to purchase in the open market any of its obligations outstanding under this subsection at any time and at any price.

"(c) The Secretary of the Treasury is authorized in his discretion to purchase any obligations issued pursuant to subsection (b) of this section, as now or hereafter in force, and for such purpose the Secretary of the Treasury is authorized to use as a public debt transaction the proceeds of the sale of any securities hereafter issued under the Second Liberty Bond Act, as now or hereafter in force, and the purposes for which securities may be issued under the Second Liberty Bond Act, as now or hereafter in force, are extended to include such purchases. The Secretary of the Treasury shall not at any time purchase any obligations under this subsection if (1) all of the capital stock of the Association held by the Secretary of the Treasury has been retired, or (2) such purchase would increase the aggregate principal amount of his then outstanding holdings of such obligations under this subsection to an amount greater than \$500,000,000 plus an amount equal to the total of such reductions in the maximum dollar amount prescribed by section 306 (c) as have theretofore been effected pursuant to that section: *Provided*, That such aggregate principal amount under this subsection (c) shall in no event exceed \$1,000,000,000. Each purchase of obligations by the Secretary of the Treasury under this subsection shall be upon such terms and conditions as to yield a return at a rate determined by the Secretary of the Treasury, taking into consideration the current average rate on outstanding marketable obligations of the United States as of the last day of the month preceding the making of such purchase. The Secretary of the Treasury may, at any time, sell, upon such terms and conditions and at such price or prices as he shall determine, any of the obligations acquired by him under this subsection. All redemptions, purchases, and sales by the Secretary of the Treasury of such obligations under this subsection shall be treated as public debt transactions of the United States.

"(d) The Association may not purchase participations or make any advance contracts or commitments to purchase mortgages for its operations under this section, except that the Association may, in the discretion of its board of directors, issue a purchase contract (which shall not be assignable or transferable except with the consent of the Association) in an amount not exceeding the amount of the sale of mortgages purchased from the Association, entitling the holder thereof to sell to the Association mortgages in the amount of the contract, upon such terms and conditions as the Association may prescribe.

"SPECIAL ASSISTANCE FUNCTIONS

"SEC. 305. (a) To carry out the purposes set forth in paragraph (b) of section 301, the President, after taking into account (1) the conditions in the building industry and the national economy and (2) conditions affecting the home mortgage investment market, generally, or affecting various types or classifications of home mortgages, or both, and after determining that such action is in the public interest, may under this section authorize the Association, for such period of time and to such extent as he shall prescribe, to exercise its powers to make commitments to purchase and to purchase such types, classes, or categories of home mortgages (including participations therein) as he shall determine.

"(b) The operations of the Association under this section shall be confined, so far as practicable, to mortgages (including participations) which are deemed by the Association to be of such quality as to meet, substantially and generally, the purchase standards imposed by private institutional mortgage investors but

which, at the time of submission of the mortgages to the Association for purchase, are not necessarily readily acceptable to such investors. Subject to the provisions of this section, the prices to be paid by the Association for mortgages purchased in its operations under this section shall be established from time to time by the Association. The Association shall impose charges or fees for its services under this section with the objective that all costs and expenses of its operations under this section should be within its income derived from such operations and that such operations should be fully self-supporting.

"(c) The total amount of purchases and commitments authorized by the President pursuant to subsection (a) of this section shall not exceed \$200,000,000 outstanding at any one time: *Provided*, That, notwithstanding such limitation, the President pursuant to subsection (a) of this section may also authorize the Association to exercise its powers to enter into commitments to purchase immediate participations and to make related deferred participation agreements as hereinafter in this subsection provided, but only to the extent that the total amount of such immediate participation commitments and purchases pursuant thereto (but not including the amount of any related deferred participation agreements or purchases pursuant thereto) shall not in any event exceed \$100,000,000 outstanding at any one time, and any such deferred participation agreements shall be made by the Association only on the basis of a commitment by it to purchase an immediate participation of a 20 per centum undivided interest in each mortgage and a related deferred participation agreement by the Association to purchase the remaining outstanding interest in such mortgage conditional upon the occurrence of such a default as gives rise to the right to foreclose.

"(d) The Association may issue to the Secretary of the Treasury its obligations in an amount outstanding at any one time sufficient to enable the Association to carry out its functions under this section, such obligations to mature not more than five years from their respective dates of issue, to be redeemable at the option of the Association before maturity in such manner as may be stipulated in such obligations. Each such obligation shall bear interest at a rate determined by the Secretary of the Treasury, taking into consideration the current average rate on outstanding marketable obligations of the United States as of the last day of the month preceding the issuance of the obligation of the Association. The Secretary of the Treasury is authorized to purchase any obligations of the Association to be issued under this section, and for such purpose the Secretary of the Treasury is authorized to use as a public debt transaction the proceeds from the sale of any securities issued under the Second Liberty Bond Act, as now or hereafter in force, and the purposes for which securities may be issued under the Second Liberty Bond Act, as now or hereafter in force, are extended to include any purchases of the Association's obligations hereunder.

"MANAGEMENT AND LIQUIDATING FUNCTIONS

"SEC. 306. (a) To carry out the purposes set forth in paragraph (c) of section 301, the Association is authorized and directed, as of the close of the cutoff date determined by the Association pursuant to section 303 (d) of this title, to establish separate accountability for all of its assets and liabilities (exclusive of capital, surplus, surplus reserves, and undistributed earnings to be evidenced by capital stock as provided in section 303 (d) hereof, but inclusive of all rights and obligations under any outstanding contracts), and to maintain such separate accountability for the management and orderly liquidation of such assets and liabilities as provided in this section.

"(b) For the purposes of this section and to assure that, to the maximum extent, and as rapidly as possible, private financing will be substituted for Treasury borrowings otherwise required to carry mortgages held under the aforesaid separate accountability, the Association is authorized to issue, upon the approval of the Secretary of the Treasury, and have outstanding at any one time obligations in an aggregate amount sufficient to enable it to carry out its functions under this section, such obligations to have such maturities and to bear such rate or rates of interest as may be determined by the Association with the approval of the Secretary of the Treasury, and to be redeemable at the option of the Association before maturity in such manner as may be stipulated in such obligations; but in no event shall any such obligations be issued if, at the time of such proposed issuance, and as a consequence thereof, the resulting aggregate amount of its outstanding obligations under this subsection would exceed the

amount of the Association's ownership under the aforesaid separate accountability, free from any liens or encumbrances, of cash, mortgages, and bonds or other obligations of, or bonds or other obligations guaranteed as to principal and interest by, the United States. The proceeds of any private financing effected under this subsection shall be paid to the Secretary of the Treasury in reduction of the indebtedness of the Association to the Secretary of the Treasury under the aforesaid separate accountability. The Association shall insert appropriate language in all of its obligations issued under this subsection clearly indicating that such obligations, together with the interest thereon, are not guaranteed by the United States and do not constitute a debt or obligation of the United States or of any agency or instrumentality thereof other than the Association. The Association is authorized to purchase in the open market any of its obligations outstanding under this subsection at any time and at any price.

"(c) No mortgage shall be purchased by the Association in its operations under this section except pursuant to and in accordance with the terms of a contract or commitment to purchase the same made prior to the cutoff date provided for in section 303 (d), which contract or commitment became a part of the aforesaid separate accountability, and the total amount of mortgages and commitments held by the Association under this section shall not, in any event, exceed \$3,350,000,000: *Provided*, That such maximum amount shall be progressively reduced by the amount of cash realizations on account of principal of mortgages held under the aforesaid separate accountability and by cancellation of any commitments to purchase mortgages thereunder, as reflected by the books of the Association, with the objective that the entire aforesaid maximum amount shall be eliminated with the orderly liquidation of all mortgages held under the aforesaid separate accountability: *And provided further*, That nothing in this subsection shall preclude the Association from granting such usual and customary increases in the amounts of outstanding commitments (resulting from increased costs or otherwise) as have theretofore been covered by like increases in commitments granted by the agencies of the Federal Government insuring or guaranteeing the mortgages. There shall be excluded from the total amounts set forth in this subsection and subsection (e) of this section the amounts of any mortgages otherwise transferred by law to the Association and held under the aforesaid separate accountability.

"(d) The Association may issue to the Secretary of the Treasury its obligations in an amount outstanding at any one time sufficient to enable the Association to carry out its functions under this section, such obligations to mature not more than five years from their respective dates of issue, to be redeemable at the option of the Association before maturity in such manner as may be stipulated in such obligations. Each such obligation shall bear interest at a rate determined by the Secretary of the Treasury, taking into consideration the current average rate on outstanding marketable obligations of the United States as of the last day of the month preceding the issuance of the obligation of the Association. The Secretary of the Treasury is authorized to purchase any obligations of the Association to be issued under this section, and for such purpose the Secretary of the Treasury is authorized to use as a public debt transaction the proceeds from the sale of any securities issued under the Second Liberty Bond Act, as now or hereafter in force, and the purpose for which securities may be issued under the Second Liberty Bond Act, as now or hereafter in force, are extended to include any purchases of the Association's obligations hereunder.

"(e) Of the \$3,650,000,000 total amount of investments, loans, purchases, and commitments heretofore authorized to be outstanding at any one time under this title III prior to the enactment of the Housing Act of 1954, a total of not to exceed \$300,000,000 shall be applicable as provided in section 305 of this title, and a total of not to exceed \$3,350,000,000 shall be applicable as provided in subsection (c) of this section.

"SEPARATE ACCOUNTABILITY

"SEC. 307. The Association shall establish and at all times maintain separate accountability for (a) its secondary market operations authorized by section 304 hereof, (b) its special assistance functions authorized by section 305 hereof, and (c) its management and liquidating functions authorized by section 306 hereof.

"BOARD OF DIRECTORS

"SEC. 308. (a) The Association shall have a Board of Directors consisting of five persons, one of whom shall be the Housing and Home Finance Administrator as Chairman of the Board, and four of whom shall be appointed by said Administrator from among the officers or employees of the Association, of the immediate office of said Administrator, or (with the consent of the head of such department or agency) of any other department or agency of the Federal Government. The board of directors shall meet at the call of its chairman, who shall require it to meet not less often than once each month. Within the limitations of law, the board shall determine the general policies which shall govern the operations of the Association. The chairman of the board shall select and effect the appointment of qualified persons to fill the offices of president and vice president, and such other offices as may be provided for in the bylaws, with such executive functions, powers, and duties as may be prescribed by the bylaws or by the board of directors, and such persons shall be the executive officers of the Association and shall discharge all such executive functions, powers, and duties. The basic rate of compensation of the position of president of the Association shall be the same as the basic rate of compensation established for the heads of the constituent agencies of the Housing and Home Finance Agency. The members of the board, as such, shall not receive compensation for their services.

"GENERAL POWERS

"SEC. 309. (a) The Association shall have power to adopt, alter, and use a corporate seal, which shall be judicially noticed; by its board of directors, to adopt, amend, and repeal bylaws governing the performance of the powers and duties granted to or imposed upon it by law; to enter into and perform contracts, leases, cooperative agreements, or other transactions, on such terms as it may deem appropriate, with any agency or instrumentality of the United States, or with any State, territory, or possession, or with any political subdivision thereof, or with any person, firm, association, or corporation; to execute, in accordance with its bylaws, all instruments necessary or appropriate in the exercise of any of its powers; in its corporate name, to sue and to be sued, and to complain and to defend, in any court of competent jurisdiction, State or Federal, but no attachment, injunction, or other similar process, mesne or final, shall be issued against the property of the Association or against the Association with respect to its property; to conduct its business in any State of the United States, including the District of Columbia and all territories and possessions of the United States; to lease, purchase, or acquire any property, real, personal, or mixed, or any interest therein, to hold, rent, maintain, modernize, renovate, improve, use, and operate such property, and to sell, for cash or credit, lease, or otherwise dispose of the same, at such time and in such manner as and to the extent that the Association may deem necessary or appropriate; to prescribe, repeal, and amend or modify, rules, regulations, or requirements governing the manner in which its general business may be conducted; to accept gifts or donations of services, or of property, real, personal, or mixed, tangible, or intangible, in aid of any of the purposes of the Association; and to do all things as are necessary or incidental to the proper management of its affairs and the proper conduct of its business.

"(b) Except as may be otherwise provided in this title, in the Government Corporation Control Act, or in other laws specifically applicable to Government corporations, the Association shall determine the necessity for and the character and amount of its obligations and expenditures and the manner in which they shall be incurred, allowed, paid, and accounted for, and such determinations shall be final and conclusive upon all officers of the Government.

"(c) The Association, including its franchise, capital, reserves, surplus, mortgages, and income shall be exempt from all taxation now or hereafter imposed by the United States, by any territory, dependency, or possession thereof, or by any State, county, municipality, or local taxing authority, except that (1) any real property of the Association shall be subject to State, territorial, county, municipal, or local taxation to the same extent according to its value as other real property is taxed, and (2) the Association shall, with respect to its secondary market operations under section 304 after the cutoff date referred to in section 303 (d) of this title, pay annually to the Secretary of the Treasury, for covering into miscellaneous receipts, an amount equivalent to the amount of Federal income taxes for which it would be subject if it were not exempt from such taxes with respect to such secondary market operations.

"(d) The Chairman of the Board shall have power to select and appoint or employ such officers, attorneys, employees, and agents, to vest them with such powers and duties, and to fix and to cause the Association to pay such compensation to them for their services, as he may determine, subject to the civil service and classification laws. Bonds may be required for the faithful performance of their duties, and the Association may pay the premiums therefor. With the consent of any Government corporation or Federal Reserve bank, or of any board, commission, independent establishment, or executive department of the Government, the Association may avail itself on a reimbursable basis of the use of information, services, facilities, officers, and employees thereof, including any field service thereof, in carrying out the provisions of this title.

"(e) No individual, association, partnership, or corporation, except the body corporate created by section 302 of this title, shall hereafter use the words 'Federal National Mortgage Association' or any combination of such words, as the name or a part thereof under which he or it shall do business. Every individual, partnership, association, or corporation violating this prohibition shall be guilty of a misdemeanor and shall be punished by a fine of not exceeding \$100 or imprisonment not exceeding thirty days, or both, for each day during which such violation is committed or repeated.

"(f) In order that the Association may be supplied with such forms of obligations or certificates as it may need for issuance under this title, the Secretary of the Treasury is authorized, upon request of the Association, to prepare such forms as shall be suitable and approved by the Association, to be held in the Treasury subject to delivery, upon order of the Association. The engraved plates, dies, bed pieces, and other material executed in connection therewith shall remain in the custody of the Secretary of the Treasury. The Association shall reimburse the Secretary of the Treasury for any expenses incurred in the preparation, custody, and delivery of such forms.

"(g) The Federal Reserve banks are authorized and directed to act as depositaries, custodians, and fiscal agents for the Association in the general performance of its powers, and the Association shall reimburse such Federal Reserve banks for such services in such manner as may be agreed upon.

"INVESTMENT OF FUNDS

"SEC. 310. Moneys of the Association not invested in mortgages or in operating facilities shall be kept in cash on hand or on deposit, or invested in bonds or other obligations of, or in bonds or other obligations guaranteed as to principal and interest by, the United States.

"OBLIGATIONS OF ASSOCIATION LEGAL INVESTMENTS

"SEC. 311. All obligations issued by the Association shall be lawful investments, and may be accepted as security for all fiduciary, trust, and public funds, the investment or deposit of which shall be under the authority and control of the United States or any officer or officers thereof.

"SHORT TITLE

"SEC. 312. This title III may be referred to as the 'Federal National Mortgage Association Charter Act.'"

SEC. 302. The Federal National Mortgage Association, established pursuant to the provisions of title III of the National Housing Act as in effect prior to July 1, 1948, and named in section 101 of the Government Corporation Control Act, as amended, shall be the body corporate referred to in section 302 of title III of the National Housing Act, as amended by the Housing Act of 1954.

SEC. 303. The penultimate sentence of paragraph Seventh of section 5136 of the Revised Statutes, as amended, is hereby amended by striking "or obligations of national mortgage associations" and inserting "or obligations of the Federal National Mortgage Association".

SEC. 304. (a) Subsection (b) of section 11 of the Federal Home Loan Bank Act, as amended, is hereby amended by inserting after "in obligations of the United States," a comma and the following: "in obligations of the Federal National Mortgage Association.". The last sentence of section 16 of said Act is amended by inserting after "in direct obligations of the United States" a comma and the following: "in obligations of the Federal National Mortgage Association,".

(b) The first paragraph of subsection (c) of section 5 of the Home Owners' Loan Act of 1933, as amended, is hereby amended by inserting in the second proviso before the colon and after "Federal Home Loan Bank" the following: "or in the obligations of the Federal National Mortgage Association".

SEC. 305. Subsection (b) of section 2 of the Alaska Housing Act, as amended, is hereby repealed.

SEC. 306. Public Law 243, Eighty-second Congress, approved October 30, 1951, as amended, is hereby repealed.

TITLE IV—SLUM CLEARANCE AND URBAN RENEWAL

SEC. 401. The heading of title I of the Housing Act of 1949, as amended, is hereby amended to read "TITLE I—SLUM CLEARANCE AND URBAN RENEWAL".

SEC. 402. Title I of said Act, as amended, is hereby amended by inserting the following new section immediately after the heading of title I:

"URBAN RENEWAL FUND

"SEC. 100. The authorizations, funds, and appropriations available pursuant to sections 103 and 104 hereof shall constitute a fund, to be known as the 'Urban Renewal Fund', and shall be available for advances, loans, and capital grants to local public agencies for urban renewal projects in accordance with the provisions of this title, and all contracts, obligations, assets, and liabilities existing under or pursuant to said sections prior to the enactment of the Housing Act of 1954 are hereby transferred to said Fund."

SEC. 403. Section 101 of said Act, as amended, is hereby amended to read as follows:

"SEC. 101. (a) In entering into any contract for advances for surveys, plans, and other preliminary work for projects under this title, the Administrator shall give consideration to the extent to which appropriate local public bodies have undertaken positive programs (through the adoption, modernization, administration, and enforcement of housing, zoning, building and other local laws, codes, and regulations relating to land use and adequate standards of health, sanitation, and safety for buildings, including the use and occupancy of dwellings) for (1) preventing the spread or recurrence in the community of slums and blighted areas, and (2) encouraging housing cost reductions through the use of appropriate new materials, techniques, and methods in land and residential planning, design, and construction, the increase of efficiency in residential construction, and the elimination of restrictive practices which unnecessarily increase housing costs.

"(b) In the administration of this title, the Administrator shall encourage the operations of such local public agencies as are established on a State, or regional (within a State), or unified metropolitan basis or as are established on such other basis as permits such agencies to contribute effectively toward the solution of community development or redevelopment problems on a State, or regional (within a State), or unified metropolitan basis.

"(c) No contract shall be entered into for any loan or capital grant under this title, or for annual contributions or capital grants pursuant to the United States Housing Act of 1937, as amended, and no mortgage shall be insured, and no commitment to insure a mortgage shall be issued, under sections 220 or 221 of the National Housing Act, as amended, unless (1) there is presented to the Administrator by the locality a workable program (which shall include an official plan of action, as it exists from time to time, for effectively dealing with the problem of urban slums and blight within the community and for the establishment and preservation of a well-planned community with well-organized residential neighborhoods of decent homes and suitable living environment for adequate family life) for utilizing appropriate private and public resources to eliminate, and prevent the development or spread of, slums and urban blight, to encourage needed urban rehabilitation, to provide for the redevelopment of blighted, deteriorated, or slum areas, or to undertake such of the aforesaid activities or other feasible community activities as may be suitably employed to achieve the objectives of such a program, and (2) on the basis of his review of such program, the Administrator determines that such program is satisfactory and certifies to the constituent agencies affected that the Federal assistance may be made available in such community.

"(d) The Administrator is authorized to establish facilities (1) for furnishing to communities, at their request, an urban renewal service to assist them in the

preparation of a workable program as referred to in the preceding subsection and to provide them with technical and professional assistance for planning and developing local urban renewal programs, and (2) for the assembly, analysis, and reporting of information pertaining to such programs."

Sec. 404. Section 102 of said Act, as amended, is hereby amended--

(1) by amending the first sentence in subsection (a) to read as follows: "To assist local communities in the elimination of slums and blighted or deteriorated or deteriorating areas, in preventing the spread of slums, blight, or deterioration, and in providing maximum opportunity for the redevelopment, rehabilitation, and conservation of such areas by private enterprise, the Administrator may make temporary and definitive loans to local public agencies in accordance with the provisions of this title for the undertaking of urban renewal projects.":

(2) by inserting in the second sentence of subsection (a) before the word "expenditures" the word "estimated" and by inserting after the word "bonds" the words "or other obligations":

(3) by striking out "new uses of land in the project area" at the end of the first sentence of subsection (b) and inserting "new uses of such land in the project area":

(4) by striking out the words "bear interest at such rate" in the second sentence of subsection (b) and inserting "bear interest at such rate"; and

(5) By amending subsection (d) to read as follows:

"(d) The Administrator may make advances of funds to local public agencies for surveys and plans for urban renewal projects which may be assisted under this title, including but not limited to, (i) plans for carrying out a program of voluntary repair and rehabilitation of buildings and improvements, (ii) plans for the enforcement of State and local laws, codes, and regulations relating to the use of land and the use and occupancy of buildings and improvements, and to the compulsory repair, rehabilitation, demolition, or removal of buildings and improvements, and (iii) appraisals, title searches, and other preliminary work necessary to prepare for the acquisition of land in connection with the undertaking of such projects. The contract for any such advance of funds shall be made upon the condition that such advance of funds shall be repaid, with interest at not less than the applicable going Federal rate, out of any moneys which become available to the local public agency for the undertaking of the project involved."

Sec. 405. Subsection (a) of section 103 of said Act, as amended, is hereby amended to read as follows:

"(a) The Administrator may make capital grants to local public agencies in accordance with the provisions of this title for urban renewal projects: *Provided*, That the Administrator shall not make any contract for capital grant with respect to a project which consists of open land. The aggregate of such capital grants with respect to all the projects of a local public agency on which contracts for capital grants have been made under this title shall not exceed two-thirds of the aggregate of the net project costs of such projects, and the capital grant with respect to any individual project shall not exceed the difference between the net project cost and the local grants-in-aid actually made with respect to the project."

Sec. 406. Section 104 of said Act, as amended, is hereby amended by striking "section 110 (f) of land" and inserting "section 110 (f) of the property".

Sec. 407. Section 105 of said Act, as amended, is hereby amended--

(1) by striking "Contracts for financial aid" and inserting "Contracts for loans or capital grants";

(2) by amending subsections (a) and (b) to read as follows:

"(a) The urban renewal plan (including any redevelopment plan constituting a part thereof) for the urban renewal area be approved by the governing body of the locality in which the project is situated, and that such approval include findings by the governing body that (i) the financial aid to be provided in the contract is necessary to enable the project to be undertaken in accordance with the urban renewal plan; (ii) the urban renewal plan will afford maximum opportunity, consistent with the sound needs of the locality as a whole, for the rehabilitation or redevelopment of the urban renewal area by private enterprise; and (iii) the urban renewal plan conforms to a general plan for the development of the locality as a whole;

"(b) When real property acquired or held by the local public agency in connection with the project is sold or leased, the purchasers or lessees and their assignees shall be obligated (i) to devote such property to the uses specified in the urban renewal plan for the project area; (ii) to begin within a reasonable time any improvements on such property required by the urban renewal plan; and (iii) to comply with such other conditions as the Administrator finds, prior to the execution of the contract for loan or capital grant pursuant to this title, are necessary to carry out the purposes of this title: *Provided*, That clauses (ii) and (iii) of this subsection shall not apply to mortgagees and others who acquire an interest in such property as the result of the enforcement of any lien or claim thereon;"

(3) by striking the word "project" wherever it appears in subsection (c) and inserting the term "urban renewal"; and

(4) by striking out the proviso at the end of subsection (c), and substituting a period for the colon preceding said proviso.

SEC. 408. Section 106 of said Act, as amended, is hereby amended by inserting the following proviso before the period at the end of subsection (b): "*Provided*, That necessary expenses of inspections and audits, and of providing representatives at the site, of projects being planned or undertaken by local public agencies pursuant to this title shall be compensated by such agencies by the payment of fixed fees which in the aggregate will cover the costs of rendering such services, and such expenses shall be considered nonadministrative; and for the purpose of providing such inspections and audits and of providing representatives at the sites, the Administrator may utilize any agency and such agency may accept reimbursement or payment for such services from such local public agencies or the Administrator, and credit such amounts to the appropriations or funds against which such charges have been made".

SEC. 409. Section 107 of said Act, as amended, is hereby amended by striking out the words "redevelopment plan" and inserting "urban renewal plan".

SEC. 410. Section 109 of said Act, as amended, is hereby amended to read as follows:

"SEC. 109. In order to protect labor standards—

"(a) any contract for loan or capital grant pursuant to this title shall contain a provision requiring that not less than the wages prevailing in the locality, as predetermined by the Secretary of Labor pursuant to the Davis-Bacon Act (49 Stat. 1011), shall be paid to all laborers and mechanics, except such laborers or mechanics who are employees of municipalities or other local public bodies, employed in the development of the project involved for work financed in whole or in part with funds made available pursuant to this title; and the Administrator shall require certification as to compliance with the provisions of this paragraph prior to making any payment under such contract; and

"(b) the provisions of title 18, United States Code, section 874, and of title 40, United States Code, section 276c, shall apply to work financed in whole or in part with funds made available for the development of a project pursuant to this title."

SEC. 411. Section 110 of said Act, as amended, is hereby amended to read as follows:

"SEC. 110. The following terms shall have the meanings, respectively, ascribed to them below, and, unless the context clearly indicates otherwise, shall include the plural as well as the singular number:

"(a) 'Urban renewal area' means an urban area that (1) the governing body of the locality determines to be blighted, deteriorated, or deteriorating and designates as appropriate for an urban renewal project, and (2) the Administrator approves as appropriate for a project under this title.

"(b) 'Urban renewal plan' means a plan, as it exists from time to time, for an urban renewal project, which plan (1) shall conform to the general plan of the locality as a whole and to the workable program referred to in section 101 hereof: (2) shall be sufficiently complete to indicate such land acquisition, demolition and removal of structures, redevelopment, improvements, and rehabilitation as may be proposed to be carried out in the urban renewal area, zoning and planning changes, if any, land uses, maximum densities, building requirements, and the plan's relationship to definite local objectives respecting appropriate land uses, improved traffic, public transportation, public utilities, recreational and community facilities, and other public improvements; and (3) shall include, for any part of the urban renewal area proposed to be acquired and redeveloped in accordance with clause (1) of the second sentence of sub-

section (c) of this section, a redevelopment plan approved by the governing body of the locality.

"(c) 'Urban renewal project' or 'project' may include undertakings and activities of a local public agency in an urban renewal area for the elimination and for the prevention of the development or spread of slums and blight, in accordance with an urban renewal plan to achieve sound community objectives for the establishment and preservation of well-planned residential neighborhoods of decent homes and suitable living environment for adequate family life, and may involve slum clearance and redevelopment in an urban renewal area, or rehabilitation or conservation in an urban renewal area, or any combination or part thereof, in accordance with such urban renewal plan. For the purposes of this subsection, 'slum clearance and redevelopment' may include (1) acquisition of (i) a slum area or a deteriorated or deteriorating area, or (ii) land which is predominantly open and which because of obsolete platting, diversity of ownership, deterioration of structures or of site improvements, or otherwise, substantially impairs or arrests the sound growth of the community, or (iii) open land necessary for sound community growth which is to be developed for predominantly residential uses (except that the determination required by clause (1) of paragraph (a) of this section that the area is blighted, deteriorated, or deteriorating shall not be applicable in the case of an open land project); (2) demolition and removal of buildings and improvements; (3) installation, construction, or reconstruction of streets, utilities, parks, playgrounds, and other improvements necessary for carrying out in the area the urban renewal objectives of this title in accordance with the urban renewal plan; and (4) making the land available for development or redevelopment by private enterprise or public agencies (including sale, initial leasing, or retention by the local public agency itself) at its fair value for uses in accordance with the urban renewal plan. For the purposes of this subsection, 'rehabilitation' or 'conservation' may include the restoration and renewal of a blighted, deteriorated, or deteriorating area by (1) carrying out plans for a program of voluntary repair and rehabilitation of buildings or other improvements in accordance with the urban renewal plan; (2) acquisition of real property and demolition or removal of buildings and improvements thereon where necessary to eliminate unhealthful, insanitary or unsafe conditions, lessen density, eliminate obsolete or other uses detrimental to the public welfare, or to otherwise remove or prevent the spread of blight or deterioration, or to provide land for needed public facilities; (3) installation, construction, or reconstruction, of such improvements as are described in clause (3) of the preceding sentence; and (4) the disposition of any property acquired in such urban renewal area (including sale, initial leasing, or retention by the local public agency itself) at its fair value for uses in accordance with the urban renewal plan.

"For the purposes of this title, the term 'project' shall not include the construction or improvement of any building, and the term 'redevelopment' and derivatives thereof shall mean development as well as redevelopment. For any of the purposes of section 109 hereof, the term 'project' shall not include any donations or provisions made as local grant-in-aid and eligible as such pursuant to clauses (2) and (3) of section 110 (d) hereof.

"(d) 'Local grants-in-aid' shall mean assistance by a State, municipality, or other public body, or (in the case of cash grants or donations of land or other real property) any other entity, in connection with any project on which a contract for capital grant has been made under this title, in the form of (1) cash grants; (2) donations, at cash value, of land or other real property (exclusive of land in streets, alleys, and other public right-of-way which may be vacated in connection with the project) in the urban renewal area, and demolition, removal, or other work or improvements in the urban renewal area, at the cost thereof, of the types described in clause (2) and clause (3) of either the second or third sentence of section 110 (c); and (3) the provision in the urban renewal area, at their cost, of public buildings or other public facilities (other than publicly-owned housing) which are necessary for carrying out in the area the urban renewal objectives of this title in accordance with the urban renewal plan: *Provided*, That in any case where, in the determination of the Administrator, any park, playground, public buildings, or other public facility is of direct benefit both to the urban renewal area and to other areas, and the approximate degree of the benefit to such other areas is estimated by the Administrator at 20 per centum or more of the total benefits, the Administrator shall provide that, for the purpose of computing the amount of the local grants-in-aid for the project, there shall be included only such portion

of the cost of such park, playground, public building, or other public facility as the Administrator determines to be appropriate: *And provided further*, That for the purpose of computing the amount of local grants-in-aid under this section 110 (d), the estimated cost (as determined by the Administrator) of parks, playgrounds, public buildings, or other public facilities may be deemed to be the actual cost thereof if (i) the construction or provision thereof is not completed at the time of final disposition of land in the project to be acquired and disposed of under the urban renewal plan, and (ii) the Administrator has received assurances satisfactory to him that such park, playground, public building, or other public facility will be constructed or completed when needed and within a time prescribed by him. With respect to any demolition or removal work, improvement, or facility for which a State, municipality, or other public body has received or has contracted to receive any grant or subsidy from the United States, or any agency or instrumentality thereof, the portion of the cost thereof defrayed or estimated by the Administrator to be defrayed with such subsidy or grant shall not be eligible for inclusion as a local grant-in-aid.

“(e) ‘Gross project cost’ shall comprise (1) the amount of the expenditures by the local public agency with respect to any and all undertakings necessary to carry out the project (including the payment of carrying charges, but not beyond the point where the project is completed), and (2) the amount of such local grants-in-aid as are furnished in forms other than cash.

“(f) ‘Net project cost’ shall mean the difference between the gross project cost and the aggregate of (1) the total sales prices of all land or other property sold, and (2) the total capital values (i) imputed, on a basis approved by the Administrator, to all land or other property leased, and (ii) used as a basis for determining the amounts to be transferred to the project from other funds of the local public agency to compensate for any land or other property retained by it for use in accordance with the urban renewal plan.

“(g) ‘Going Federal rate’ means (with respect to any contract for a loan or advance entered into after the first annual rate has been specified as provided in this sentence) the annual rate of interest which the Secretary of the Treasury shall specify as applicable to the six-month period (beginning with the six-month period ending December 31, 1953) during which the contract for loan or advance is made, which applicable rate for each six-month period shall be determined by the Secretary of the Treasury by estimating the average yield to maturity, on the basis of daily closing market bid quotations or prices during the month of May or the month of November, as the case may be, next preceding such six-month period, on all outstanding marketable obligations of the United States having a maturity date of fifteen or more years from the first day of such month of May or November, and by adjusting such estimated average annual yield to the nearest one-eighth of 1 per centum. Any contract for loan made may be revised or superseded by a later contract, so that the going Federal rate, on the basis of which the interest rate on the loan is fixed, shall mean the going Federal rate, as herein defined, on the date that such contract is revised or superseded by such later contract.

“(h) ‘Local public agency’ means any State, county, municipality, or other governmental entity or public body, or two or more such entities or bodies, authorized to undertake the project for which assistance is sought. ‘State’ includes the several States, the District of Columbia, and the territories and possessions of the United States.

“(i) ‘Land’ means any real property, including improved or unimproved land, structures, improvements, easements, incorporeal hereditaments, estates, and other rights in land, legal or equitable.

“(j) ‘Administrator’ means the Housing and Home Finance Administrator.”

SEC. 412. Notwithstanding the amendments in this title to title I of the Housing Act of 1949, as amended, the Administrator, with respect to any project covered by any Federal aid contract executed, or prior approval granted, by him under said title I before the effective date of this Act, may extend financial assistance for the completion of such project in accordance with the provisions of said title I in force immediately prior to the effective date of this Act.

SEC. 413. The provisos with respect to the appropriation for capital grants for slum clearance and urban redevelopment contained in title I of the First Independent Offices Appropriation Act, 1954 (Public Law 178, Eighty-third Congress) are hereby repealed.

SEC. 414. The Housing and Home Finance Administrator is authorized to make grants, subject to such terms and conditions as he shall prescribe, to public

bodies, including cities and other political subdivisions, to assist them in developing, testing, and reporting methods and techniques, and carrying out demonstrations and other activities for the prevention and the elimination of slums and urban blight. No such grant shall exceed two-thirds of the cost, as determined or estimated by said Administrator, of such activities or undertakings. In administering this section, said Administrator shall give preference to those undertakings which in his judgment can reasonably be expected to (1) contribute most significantly to the improvement of methods and techniques for the elimination and prevention of slums and blight, and (2) best serve to guide renewal programs in other communities. Said Administrator may make advance or progress payments on account of any grant contracted to be made pursuant to this section, notwithstanding the provisions of section 3648 of the Revised Statutes, as amended. The aggregate amount of grants made under this section shall not exceed \$5,000,000 and shall be payable from the capital grant funds provided under and authorized by section 103 (b) of the Housing Act of 1949, as amended.

TITLE V—LOW-RENT PUBLIC HOUSING

Sec. 501. The United States Housing Act of 1937, as amended, is hereby amended—

(1) by striking the words following the first colon up to and including the words "such families" in subsection 10 (g) and inserting the following: "First, to families which are to be displaced by any low-rent housing project or by any public slum-clearance, redevelopment or urban renewal project, or through action of a public body or court, either through the enforcement of housing standards or through the demolition, closing, or improvement of dwelling units, or which were so displaced within three years prior to making application to such public housing agency for admission to any low-rent housing: *Provided*, That as among such projects or actions the public housing agency may from time to time extend a prior preference or preferences: *And provided further*, That, as among families within any such preference group"; and

(2) by striking the words "or was to be displaced by another low-rent housing project or by a public slum-clearance or redevelopment project" in clause (ii) of subsection 15 (8) (b) and inserting the following: "or was to be displaced by any low-rent housing project or by any public slum-clearance, redevelopment or urban renewal project, or through action of a public body or court, either through the enforcement of housing standards or through the demolition, closing, or improvement of a dwelling unit or units".

SEC. 502. Subsection 10 (h) of said Act, as amended, is hereby amended to read as follows:

"(h) Every contract made pursuant to this Act for annual contributions for any low-rent housing project initiated after March 1, 1949, shall provide that no annual contributions by the Authority shall be made available for such project unless such project is exempt from all real and personal property taxes levied or imposed by the State, city, county, or other political subdivisions, but such contract shall require the public housing agency to make payments in lieu of taxes equal to 10 per centum of the annual shelter rents charged in such project or such lesser amount as (i) is prescribed by State law, or (ii) is agreed to by the local governing body in its agreement for local cooperation with the public housing agency required under subsection 15 (7) (b) (i) of this Act, or (iii) is due to failure of a local public body or bodies other than the public housing agency to perform any obligation under such agreement: *Provided*, That if at the time such agreement for local cooperation is entered into it appears that such 10 per centum payments in lieu of taxes will not result in a contribution to the project through tax exemption by the State, city, county, or other political subdivisions in which the project is situated of at least 20 per centum of the annual contributions to be paid by the Authority, the amounts of such payments in lieu of taxes shall be limited by the agreement to amounts, if any, which would not reduce the local contribution below such 20 per centum: *Provided further*, That, with respect to any such project which is not exempt from all real and personal property taxes levied or imposed by the State, city, county, or other political subdivisions, such contract shall provide, in lieu of the requirement for tax exemption and payments in lieu of taxes, that no annual contributions by the Authority shall be made available for such project unless and until the State, city, county, or other political subdivisions in which such project

is situated shall contribute, in the form of cash or tax remission an amount equal to the greater of (i) the amount by which the taxes paid with respect to the project exceeds 10 per centum of the annual shelter rents charged in such project or (ii) 20 per centum of the annual contributions paid by the Authority (but not in excess of the taxes levied): *And provided further*, That, prior to execution of the contract for annual contributions the public housing agency shall, in the case of a tax-exempt project, notify the governing body of the locality of its estimate of the annual amount of such payments in lieu of taxes and of the amount of taxes which would be levied if the property were privately owned, or in the case where the project is taxed, its estimate of the annual amount of the local cash contribution, and shall thereafter include the actual amounts in its annual reports. Contracts for annual contributions entered into prior to the effective date of the Housing Act of 1954 may be amended in accordance with the first sentence of this subsection."

SEC. 503. Section 10 of said Act, as amended, is hereby amended by adding the following new subsection:

"(i) Every contract made pursuant to this Act for annual contributions for any low-rent housing project for which no such contract has been entered into prior to the enactment of the Housing Act of 1954 shall provide that—

"(1) after payment in full of all obligations of the public housing agency in connection with the project for which any annual contributions are pledged, and until the total amount of annual contributions paid by the Authority in respect to such project has been repaid pursuant to the provisions of this subsection (a) all receipts in connection with the project in excess of expenditures necessary for management, operation, maintenance, or financing, and for reasonable reserves therefor, shall be paid annually to the Authority and to local public bodies which have contributed to the project in the form of tax exemption or otherwise, in proportion to the aggregate contribution which the Authority and such local public bodies have made to the project, and (b) no debt in respect to the project, except for necessary expenditures for the project, shall be incurred by the public housing agency;

"(2) if, at any time, the project or any part thereof is sold, such sale shall be to the highest responsible bidder after advertising, or at fair market value, and the proceeds of such sale together with any reserves, after application to any outstanding debt of the public housing agency in respect to such project, shall be paid to the Authority and local public bodies are provided in clause 1 (a) of this subsection: *Provided*, That the amounts to be paid to the Authority and the local public bodies shall not exceed their respective total contribution to the project".

SEC. 504. Paragraph (6) of section 16 of said Act, as amended, is hereby repealed.

SEC. 505. Paragraph (2) of section 16 of said Act, as amended, is hereby amended to read as follows:

"(2) Any contract for loans, annual contributions, capital grants, sale, or lease pursuant to this Act shall contain a provision requiring that not less than the wages prevailing in the locality, as determined or adopted (subsequent to a determination under applicable State or local law) by the Authority, shall be paid to all maintenance laborers and mechanics employed in the administration of the low-rent housing or slum-clearance project involved; and shall also contain a provision that not less than the wages prevailing in the locality, as predetermined by the Secretary of Labor pursuant to the Davis-Bacon Act (49 Stat. 1011), shall be paid to all laborers and mechanics employed in the development of the project involved; and the Authority shall require certification as to compliance with the provisions of this paragraph prior to making any payment under such contract."

TITLE VI—HOME LOAN BANK BOARD

SEC. 601. The National Housing Act, as amended, is hereby amended—

(1) by amending section 402 (c) (4) to read as follows:

(4) To sue and be sued, complain and defend, in any court of competent jurisdiction in the United States or its territories or possessions, and may be served by serving a copy of process on any of its agents or any agent of the Home Loan Bank Board and mailing a copy of such process by registered mail to the Corporation at Washington, District of Columbia."; and

(2) by adding the following new subsection to section 405:

"(c) No action against the Corporation to enforce a claim for payment of insurance upon an insured account of an insured institution in default shall be brought after the expiration of three years from the date of default unless, within such three-year period, the conservator, receiver, or other legal custodian of the insured institution shall have recognized such insured account as a valid claim against the insured institution and the claim for payment of insurance shall have been presented to the Corporation and its validity denied, in which event the action may be brought within two years from the date of such denial."

SEC. 602. The Federal Home Loan Bank Act, as amended, is hereby amended by striking "\$20,000" in section 10 (b) (2) and inserting "\$35,000."

SEC. 603. The Home Owners' Loan Act of 1933, as amended, is hereby amended—

(1) by striking "\$20,000" wherever it appears in the first paragraph of subsection (c) of section 5 and inserting "\$35,000"; and

(2) by amending subsection (d) of section 5 to read as follows:

"(d) (1) The Board shall have power to enforce this section and rules and regulations made hereunder. In the enforcement of any provision of this section or rules and regulations made hereunder, or any other law or regulation, and in the administration of conservatorships and receiverships as provided in subsection (d) (2) hereof, the Board is authorized to act in its own name and through its own attorneys. The Board shall have power to sue and be sued, complain and defend in any court of competent jurisdiction in the United States or its territories or possessions. It shall by formal resolution state any alleged violation of law or regulation and give written notice to the association concerned of the facts alleged to be such violation, except that the appointment of a Supervisory Representative in Charge, a conservator or a receiver shall be exclusively as provided in subsection (d) (2) hereof. Such association shall have thirty days within which to correct the alleged violation of law or regulation and to perform any legal duty. If the association concerned does not comply with the law or regulation within such period, then the Board shall give such association twenty days written notice of the charges against it and of a time and place at which the Board will conduct a hearing as to such alleged violation of duty. Such hearing shall be in the Federal judicial district of the association unless it consents to another place and shall be conducted by a hearing examiner as is provided by the Administrative Procedure Act. The Board or any member thereof or its designated representative shall have power to administer oaths and affirmations and shall have power to issue subpoenas and subpoenas duces tecum, and shall issue such at the request of any interested party, and the Board or any interested party may apply to the United States district court of the district where such hearing is designated for the enforcement of such subpoena or subpoena duces tecum and such courts shall have power to order and require compliance therewith. A record shall be made of such hearing and any interested party shall be entitled to a copy of such record to be furnished by the Board at its reasonable cost. After such hearing and an adjudication by the Board, appeals shall lie as is provided by the Administrative Procedure Act, and the review by the court shall be upon the weight of the evidence. Upon the giving of notice of alleged violation of law or regulation as herein provided, either the Board or the association affected may, within thirty days after the service of said notice, apply to the United States district court for the district where the association is located for a declaratory judgment and an injunction or other relief with respect to such controversy, and said court shall have jurisdiction to adjudicate the same as in other cases and to enforce its orders. The Board may apply to the United States district court of the district where the association affected has its home office for the enforcement of any order of the Board and such court shall have power to enforce any such order which has become final. The Board shall be subject to suit by any Federal savings and loan association with respect to any matter under this section or regulations made thereunder, or any other law or regulation, in the United States district court for the district where the home office of such association is located, and may be served by serving a copy of process on any of its agents and mailing a copy of such process by registered mail, to the Home Loan Bank Board, Washington, District of Columbia.

"(2) The grounds for the appointment of a conservator or receiver for a Federal savings and loan association shall be one or more of the following: (i) insolvency in that the assets of such association are less than its obligations to its creditors and others, including its members; (ii) violation of law or of a regulation; (iii) the concealment of its books, records, or assets or the refusal to submit its books, papers records, or affairs for inspection to any examiner or lawful agent appointed by the Home Loan Bank Board; and (iv) unsafe or unsound operation. The Board shall have exclusive jurisdiction to appoint a Supervisory Representative in Chicago, conservator, or receiver. If, in the opinion of the Board, a ground for the appointment of a conservator or receiver as herein provided exists and the Board determines that an emergency exists requiring immediate action, the Board is authorized to appoint ex parte and without notice a Supervisory Representative in Charge to take charge of said association and its affairs who shall have and exercise all the powers herein provided for conservators and receivers. Unless sooner removed by the Board, such Supervisory Representative in Charge shall hold office until a conservator or receiver, appointed by the Board after notice as herein provided, takes charge of the association and its affairs, or for six months, or until thirty days after the termination of the administrative hearing and final proceedings herein provided, or until sixty days after the final termination of any litigation affecting such temporary appointment, whichever is longest. The Board shall have the power to appoint a conservator or receiver but no such appointment of a conservator or receiver shall be made except pursuant to a formal resolution of the Board stating the grounds therefor and except notice thereof is given to said association stating the grounds therefor and until an opportunity for an administrative hearing thereon is afforded to said association. Such hearing shall be held in accordance with the provisions of the Administrative Procedure Act and shall be subject to review as therein provided and the review by the court shall be upon the weight of the evidence. A conservator shall have all the powers of the members, the directors, and officers of the Federal association and shall be authorized to operate it in its own name or conserve its assets in the manner and to the extent authorized by the Board. The Board shall appoint only the Federal Savings and Loan Insurance Corporation as receiver for any Federal savings and loan association, which shall have power as receiver to buy at its own sale subject to approval by the Board. With the consent of the association expressed by a resolution of the board of directors or of its members, the Board is authorized to appoint a conservator or receiver for a Federal association without notice and without hearing. The Board shall have power to make rules and regulations for the reorganization, merger, and liquidation of Federal associations and for such associations in conservatorship and receivership and for the conduct of conservatorships and receiverships. Whenever a Supervisory Representative in Charge, conservator, or receiver, appointed by the Board pursuant to the provisions of this section, demands possession of the property, business and assets of any association, the refusal of any officer, agent, employee, or director of such association to comply with the demand shall be punishable by a fine of not more than \$1,000 or by imprisonment for not more than one year or both by such fine and imprisonment."

TITLE VII—URBAN PLANNING AND RESERVE OF PLANNED PUBLIC WORKS

URBAN PLANNING

SEC. 701. To facilitate urban planning for smaller communities lacking adequate planning resources, the Administrator is authorized to make planning grants to State planning agencies for the provision of planning assistance (including surveys, land use studies, urban renewal plans, technical services and other planning work, but excluding plans for specific public works) to cities and other municipalities having a population of less than 25,000 according to the latest decennial census. The Administrator is further authorized to make planning grants for similar planning work in metropolitan and regional areas to official State, metropolitan, or regional planning agencies empowered under State or local laws to perform such planning. Any grant made under this section shall not exceed 50 per centum of the estimated cost of the work

for which the grant is made and shall be subject to terms and conditions prescribed by the Administrator to carry out this section. The Administrator is authorized, notwithstanding the provisions of section 3648 of the Revised Statutes, as amended, to make advance or progress payments on account of any planning grant made under this section. There is hereby authorized to be appropriated not exceeding \$5,000,000 to carry out the purposes of this section, and any amounts so appropriated shall remain available until expended.

RESERVE OF PLANNED PUBLIC WORKS

SEC. 702. (a) In order (1) to encourage municipalities and other public agencies to maintain a continuing and adequate reserve of planned public works the construction of which can rapidly be commenced whenever the economic situation may make such action desirable, and (2) to attain maximum economy and efficiency in the planning and construction of local, State, and Federal public works, the Administrator is hereby authorized, during the period of three years commencing on July 1, 1954, to make advances to public agencies from funds available under this section (notwithstanding the provisions of section 3648 of the Revised Statutes, as amended) to aid in financing the cost of engineering and architectural surveys, designs, plans, working drawings, specifications, or other action preliminary to and in preparation for the construction of public works: *Provided*, That the making of advances hereunder shall not in any way commit the Congress to appropriate funds to assist in financing the construction of any public works so planned.

(b) No advance shall be made hereunder with respect to any individual project unless it conforms to an overall State, local, or regional plan approved by a competent State, local, or regional authority, and unless the public agency formally contracts with the Federal Government to complete the plan preparation promptly and to repay such advance when due.

(c) Advances under this section to any public agency shall be repaid without interest by such agency when the construction of the public works is undertaken or started: *Provided*, That in the event repayment is not made promptly such unpaid sum shall bear interest at the rate of four per centum per annum from the date of the Government's demand for repayment to the date of payment thereof by the public agency. All sums so repaid shall be covered into the Treasury as miscellaneous receipts.

(d) The Administrator is authorized to prescribe rules and regulations to carry out the purposes of this section.

(e) There is hereby authorized to be appropriated not exceeding \$10,000,000 to carry out the purposes of this section, and any amounts so appropriated shall remain available until expended. Not more than 5 per centum of the funds so appropriated shall be expended in any one State.

DEFINITIONS

SEC. 703. As used in this title, (1) the term "State" shall include any State, territory, or possession of the United States, including the District of Columbia; (2) the term "Administrator" shall mean the Housing and Home Finance Administrator; (3) the term "public works" shall include any public works other than housing; and (4) the term "public agency" or "public agencies" shall mean any State, as herein defined, or any public agency or political subdivision therein.

TITLE VIII—MISCELLANEOUS PROVISIONS

SEC. 801. Section 607 of the Act entitled "An Act to expedite the provision of housing in connection with national defense, and for other purposes", approved October 14, 1940, as amended, is hereby amended by adding the following new subsection at the end thereof:

"(g) The Administrator may dispose of any permanent war housing without regard to the preferences in subsections (b) and (2) of this section when he determines that (1) such housing, because of design or lack of amenities, is unsuitable for family dwelling use, or (2) it is being used at the time of disposition for other than dwelling purposes, or (3) it was offered, with preferences substantially similar to those provided in the Housing Act of 1950 (64 Stat. 48), to veterans and occupants prior to enactment of said Act, or (4) it is to be sold with a requirement that it be removed from its present location."

SEC. 802. (a) The Housing and Home Finance Administrator shall, as soon as practicable during each calendar year, make a report to the President for

submission to the Congress on all operations under the jurisdiction of the Housing and Home Finance Agency during the previous calendar year.

(b) Section 311 of "An Act to expedite the provision of housing in connection with national defense, and for other purposes", approved October 14, 1940, as amended; section 6 of "An Act to provide for the advance planning of non-Federal public works", approved October 13, 1949, as amended; and sections 5 and 402 (f) of the National Housing Act, as amended, are hereby repealed.

(c) The National Housing Act, as amended, is hereby amended—

(1) by striking the heading "ANNUAL REPORT" immediately after section 4 and inserting "TAXATION"; and

(2) by striking from subsection (e) of section 406 the word "Congress" and inserting "Housing and Home Finance Administrator".

(d) The first sentence of section 7 (b) of the United States Housing Act of 1937, as amended, is hereby amended to read as follows: "The annual report of the Housing and Home Finance Administrator to the President for submission to the Congress on the operations of the Housing and Home Finance Agency shall include a report on the operations and expenses of the Authority, including loans, contributions, and grants made or contracted for, low-rent housing and slum-clearance projects undertaken, and the assets and liabilities of the Authority."

(e) Section 106 (a) of the Housing Act of 1949, as amended, is hereby amended by striking ";" and" at the end of paragraph (3) thereof, inserting a period in lieu thereof, and striking paragraph (4).

(f) The Federal Home Loan Bank Act, as amended, is hereby amended by striking the second sentence of section 20.

SEC. 803. The Housing and Home Finance Agency, including its constituent agencies, and any other departments or agencies of the Federal Government having powers, functions, or duties with respect to housing under this or any other law shall exercise such powers, functions, or duties in such manner as, consistent with the requirements thereof, will facilitate progress in the reduction of the vulnerability of congested urban areas to enemy attack.

ACT CONTROLLING

SEC. 804. Insofar as the provisions of any other law are inconsistent with the provisions of this Act, the provisions of this Act shall be controlling.

SEPARABILITY

SEC. 805. Except as may be otherwise expressly provided in this Act, all powers and authorities conferred by this Act shall be cumulative and additional to and not in derogation of any powers and authorities otherwise existing. Notwithstanding any other evidences of the intention of Congress, it is hereby declared to be the controlling intent of Congress that if any provisions of this Act, or the application thereof to any persons or circumstances, shall be adjudged by any court of competent jurisdiction to be invalid, such judgment shall not affect, impair, or invalidate the remainder of this Act or its applications to other persons and circumstances.

The CHAIRMAN. We are very glad to have back with us this morning Mr. Albert Cole, who was an outstanding member of this committee at one time and is now the Administrator of the Housing and Home Finance Agency.

We are very pleased to welcome you back before us, Mr. Cole.

MR. COLE. Thank you, Mr. Chairman.

The CHAIRMAN. With Mr. Cole is Mr. Hollyday, Commissioner of the Federal Housing Administration, and Mr. Fitzpatrick, general counsel for the Housing and Home Finance Agency.

Mr. Cole has a statement and, without objections, Mr. Cole may proceed without interruption with his statement, after which, of course, he will be very glad to submit himself to whatever questioning there may be by the members of the committee.

MR. COLE. Mr. Chairman, may I make a suggestion. I think the bill is so constituted that we may, at the end of certain segments,

pause for questioning. For instance, as we finish with FHA titles we will so indicate, and ask Mr. Hollyday to make his statement then and we will submit ourselves to questioning on FHA.

Following that the proposals with respect to the secondary mortgage facilities, and then we will submit to questioning upon that. If that is satisfactory.

The CHAIRMAN. The committee will proceed as suggested.

Mr. COLE. Thank you, Mr. Chairman.

The CHAIRMAN. You may proceed, Mr. Cole.

STATEMENT OF HON. ALBERT M. COLE, HOUSING AND HOME FINANCE ADMINISTRATOR

Mr. COLE. Mr. Chairman and members of the committee, I appreciate very much the opportunity to appear before your committee. It is my purpose to extend to you such assistance as I can in your consideration of H. R. 7839, a bill to aid in the provision and improvement of housing, the elimination and prevention of slums, and the conservation and development of urban communities.

H. R. 7839 is a very extensive housing bill. It covers eight titles in its 107 pages. A rather detailed section-by-section summary of its provisions has been made available to your committee, so I shall try in my statement to cover generally the major features of the bill.

I should like to emphasize the fact that this legislation, which embodies a number of measures designed to promote the efforts of our people to acquire good homes and to assist our communities to develop wholesome neighborhoods in which American families can live and prosper, ranks high among the proposals included in the program which President Eisenhower has recommended to the Congress. On January 25 of this year, the President transmitted to the Congress a special message containing his recommendations for housing legislation. In that message the President pointed out that the development of conditions under which every American family can obtain good housing is a major objective of national policy, stating:

It is important for two reasons. First, good housing in good neighborhoods is necessary for good citizenship and good health among our people. Second, a high level of housing construction and vigorous community development are essential to the economic and social well-being of our country. It is, therefore, properly a concern of this Government to insure that opportunities are provided every American family to acquire a good home.

To help find the best ways of meeting this major objective of national policy, the President last fall appointed an Advisory Committee on Government Housing Policies and Programs. Its membership consisted of leading citizens experienced in the problems of housing, mortgage finance, and community development. For the information of your committee we have supplied a list of the names of its members.

This Advisory Committee, as you gentlemen know, made an exhaustive study of the existing Federal housing legislation and programs. Also it analyzed numerous proposals looking toward the development of a housing program better adapted to current requirements. I can testify from personal experience that the members of the Advisory Committee worked long and hard on the task assigned to them, for I served as chairman of the committee, and I stayed with

them day after day, night after night, and week after week in their efforts to develop a well-rounded program to better the living conditions of American families. I think the members of this Advisory Committee did an excellent job and performed an important public service.

The conclusions and recommendations of the Advisory Committee were set forth in the report which it submitted to the President on December 14, 1953. I have sent copies of that report to each member of your committee. Most of the conclusions of the Advisory Committee, as well as the results of our own studies and experience in administering the existing housing legislation, were reflected in the recommendations contained in the President's special housing message, and are included in the pending bill.

I desire to advise your committee that I have been authorized by the Bureau of the Budget to state that the enactment of the bill would be in accord with the program of the President. Since the clearance letter contains specific comments with respect to two or three provisions of the bill I am submitting a copy of that letter for the information of your committee.

The CHAIRMAN. Without objection the list of members of the President's Advisory Committee may be inserted in the record at this point.

(The document referred to is as follows:)

MEMBERS OF THE PRESIDENT'S ADVISORY COMMITTEE ON GOVERNMENT HOUSING POLICIES AND PROGRAMS

George L. Bliss, president, Century Federal Savings and Loan Association, New York, N. Y.

Ernest J. Bohn, director, Cleveland Metropolitan Housing Authority, Cleveland, Ohio.

Ehney A. Camp, Jr., vice president and treasurer, Liberty National Life Insurance Co., Birmingham, Ala.

Miles L. Colean, economist and author, Washington, D. C.

A. R. Gardner, president, Federal Home Loan Bank of Chicago, Chicago, Ill.

Richard J. Gray, president, Building and Construction Trades Department, American Federation of Labor, Washington, D. C.

Richard G. Hughes, first vice president, National Association of Home Builders, Pampa, Tex.

Rodney Lockwood, past president, National Association of Home Builders, Detroit, Mich.

William A. Marcus, senior vice president, American Trust Co., San Francisco, Calif.

Norman P. Mason, treasurer, William P. Proctor Co., North Chelmsford, Mass.

Robert M. Morgan, vice president and treasurer, the Boston Five Cents Savings Bank, Boston, Mass.

Thomas W. Moses, attorney, Pittsburgh, Pa.

Aksel Nielsen, president, Title Guaranty Co., Denver, Colo.

Robert Patrick, financial vice president, Bankers Life Insurance Co., Des Moines, Iowa.

James W. Rouse, the Moss-Rouse Co., Baltimore, Md.

Bruce C. Savage, Bruce Savage Co., Indianapolis, Ind.

John J. Scully, vice president, the Chase National Bank of the City of New York, New York, N. Y.

Alexander Summer, Alexander Summer Co., Teaneck, N. J.

James G. Thimmes, chairman, CIO Housing Committee, Pittsburgh, Pa.

Ralph T. Walker, past president, American Institute of Architects, New York, N. Y.

Paul R. Williams, architect, Los Angeles, Calif.

Ben H. Wooten, president, First National Bank, Dallas, Tex.

EXECUTIVE OFFICE OF THE PRESIDENT,
BUREAU OF THE BUDGET,
Washington 25, D. C., February 26, 1954.

Hon. ALBERT M. COLE,
Administrator, Housing and Home Finance Agency,
Washington 25, D. C.

(Attention: Mr. B. T. Fitzpatrick.)

MY DEAR MR. COLE: This will acknowledge your letters of January 15 and February 9, 1954, transmitting drafts of a bill which you desire to present to the Congress, entitled "The Housing Act of 1954."

The major provisions of this legislation were reviewed and agreed upon prior to January 25 when the President sent forward his message to the Congress. The revised draft, as your letter of February 9 indicates, incorporates changes made in the course of these and later drafting sessions in addition to certain changes recommended by the chairmen of the Banking and Currency Committees.

Title I includes a new section (sec. 129) authorizing the Federal Housing Commissioner to insure advances made pursuant to "open end" provisions in mortgages. Authority of this type is clearly needed, but this Bureau questions the necessity for the last proviso exempting such advances in determining the aggregate amount of mortgages which may be insured under the National Housing Act.

Title III would drastically revise the present Federal National Mortgage Association, with the objective of shifting as rapidly as feasible to private ownership and control most future assistance to the secondary market for home mortgages. This would be accomplished by requiring each mortgage seller to make payments of nonrefundable capital contributions of not less than 3 percent of the amount of mortgages involved in any purchases or contracts for purchases. The certificates issued evidencing these capital contributions would be convertible into capital stock of the Association when all of the outstanding stock and obligations of the Corporation held by the Treasury have been retired. During this interim period, however, no return would be paid on these certificates. In the interest of encouraging more extensive use of the secondary market and more rapid retirement of the Government stock, this Bureau suggests that provision be made for payment of interest on these certificates at the same rate as provided under section 303 (a) for capital stock held by the Secretary of the Treasury.

During the initial period when the Federal Government would still own and control the secondary market operations of the Association, it would be required under section 309 (c) to make payments to the Treasury in amounts equivalent to Federal corporation income taxes with respect to the secondary market operations. The Treasury Department suggests that the desired objective could be achieved more effectively and with benefit of better public understanding if the Association were subjected directly to income taxation on a parity with private enterprise. Presumably, under this approach if returns were paid on the convertible capital certificates as recommended above, they should be treated as nontaxable expenses of doing business.

Title IV would broaden the existing Federal authority to make loans and grants to local public agencies for slum clearance and urban redevelopment by authorizing similar assistance for other types of urban renewal. The Administrator under section 414 also would be authorized to make grants to local public agencies "to assist them in developing, testing, and reporting methods and techniques, and carrying out demonstrations and other activities for the prevention and the elimination of slums and urban blight." The necessity for this additional authority is not apparent, since the activities under the broadened urban renewal program in the normal course of operations, if properly administered, should provide ample opportunity for developing new methods and techniques without requiring separate Federal grants for this specific purpose.

Title VI includes in section 603 (2) detailed legal provisions spelling out the authority and procedures for the Home Loan Bank Board in enforcing its rules and regulations and in appointing conservators or receivers for Federal savings and loan associations. The provision of legislative standards for the appointment of conservators is highly desirable, but the need to prescribe detailed administrative procedures is not apparent.

While this Bureau questions the necessity of desirability of the specific provisions mentioned above, the bill otherwise adequately carries out the recommendations made by the President in his message of January 25 to the Congress. Accordingly, you are advised that there is no objection to the presentation of

the draft legislation to the Congress for its consideration, and that its enactment would be in accord with the program of the President.

Sincerely yours,

ROWLAND HUGHES,
Deputy Director.

Mr. COLE. I should like to comment briefly on 3 or 4 of the principal features of the bill relating to the operations of the FHA. Federal Housing Commissioner Guy Hollyday is here with me and has a more detailed statement covering the provisions of the bill relating to the FHA. If it is agreeable to your committee it might be helpful if Commissioner Hollyday were permitted to present his statement to you at the conclusion of the portion of my statement on the FHA provisions of the bill. We could then proceed with questions on this phase of the bill before I proceed with the remainder of my testimony on the secondary mortgage credit facility and the other titles of the bill.

IMPROVEMENT AND CONSERVATION OF EXISTING HOUSING

In my judgment, one of the most important features of this bill is represented by various provisions which are designed to assist in the improvement and conservation of our supply of existing housing. Because of the housing shortages which developed during the depression and war years much of the Federal housing legislation—particularly in recent years—has been directed primarily toward increasing the volume of new housing construction. This bill likewise contains a number of important provisions designed further to assist in achieving and maintaining a high annual volume of new housing construction. At the same time it recognizes that we need to direct more specific attention to the fact that in our existing homes we have a tremendous asset. It also recognizes that by assisting families in their efforts to keep their homes in good repair and to bring them up to modern standards of comfort and convenience we can make an important contribution to the raising of national housing standards.

Several provisions of the bill are directed toward this important objective. With respect to the home repair loan program under title I of the National Housing Act, the bill increases the maximum loan from \$2,500 to \$3,000 and the maximum maturity from 3 to 5 years. The latter provision would reduce the monthly charges required to carry such loans by about 35 percent. For example, the monthly charge required to carry a \$1,000 loan having a 5-year maturity would be about \$21, as compared with about \$32 in the case of a 3-year maturity.

Certain changes would also be made with respect to title I loans to finance the improvement or conversion of existing structures used or to be used as dwellings for two or more families. The present maximum of \$10,000 for this type of loan would be changed to \$1,500 per family unit, or \$10,000, whichever is the greater, and the maximum maturity would be increased from 7 to 10 years.

It is recognized, of course, that the FHA title I home modernization and repair loan program has inherent limitations. Because they are usually unsecured "character" loans and the insurance of loans meeting the specified standards must be more or less automatic, the title I modernization and repair loans must be small and of short term.

The result, of course, is that the title I home modernization and repair loan program, while most useful and helpful in financing relatively less costly home repairs and improvements, is of limited assistance to families of modest income who need to finance major home improvements or modernization work. Assistance for such work therefore must be on a relatively long-term mortgage loan basis which permits lower monthly carrying charges.

Several other provisions of the bill are designed to help in better maintenance and fuller utilization of existing housing. The bill would eliminate the existing statutory disadvantages in the maximum loan to value ratios which now apply to FHA insured loans on existing housing as compared with newly constructed housing.

In his statement Commissioner Hollyday will furnish two examples which clearly illustrate the desirability of this provision of the bill. The bill would also eliminate the present statutory disadvantage in the maximum maturity which now applies to FHA insured loans on existing housing regardless of its physical condition or durability. The FHA, of course, would not permit a maturity in connection with an existing house which was longer than warranted by the physical condition and the expected economic life of the particular house involved. I believe that these provisions of the bill would be of material assistance to families who desire to purchase good existing homes well suited to their particular needs, and also to families who wish to enlarge or modernize existing homes.

The new FHA section 220 and section 221 programs proposed in the bill would also assist in the improvement and conservation of our existing housing supply. These sections would authorize mortgage insurance to assist in financing the rehabilitation of existing dwellings as well as the construction of new dwellings in connection with slum clearance and urban renewal undertakings as contemplated by title IV of the bill. Both of these new FHA insurance programs are directly related to the broader effort to rehabilitate and restore whole neighborhoods, and I will discuss them further in the later portion of my testimony dealing with title IV.

As an aid to the elimination and prevention of the spread of slums and blight in urban renewal areas, new mortgage insurance provisions are included in the proposed legislation by adding section 220 to the National Housing Act. It is expected that the provisions of section 220 will provide a stimulus to local community action and encourage the support of builders, lenders, and others in the rehabilitation of blighted areas and the conservation of residential values.

The proposed section 221 FHA program should be particularly helpful in facilitating urban renewal programs in many communities by providing housing for many of the families displaced from their homes as a result of urban renewal activities. The enforcement of local housing codes to reduce overoccupancy, the rehabilitation of housing, the clearance of slum areas, and other renewal activities generate needs for housing for relocation purposes. The relocation needs of the low-income families, particularly the minority group, are particularly acute and require special provisions.

The section 221 program would make mortgage insurance available on very favorable terms so that displaced low-income families could buy these homes or acquire them on lease-and-purchase options. The

maximum mortgage amount would be \$7,000 and not in excess of 100 percent of value for a single-family dwelling where the mortgagor is the owner-occupant. A minimum cash outlay of \$200 would be required. Builders would be permitted to obtain 85 percent loans to facilitate construction and financing pending subsequent sale to qualified owner-occupant purchasers under purchase contract or lease-option agreements. The maximum term is fixed at 40 years.

Mortgage insurance would also be provided under this section for the repair or rehabilitation of dwellings for use by ten or more families as rental accommodations for qualified displaced families where the mortgagor is a nonprofit corporation, association, or organization, public or private, which is regulated under Federal or State laws as to rents, charges, and methods of operation. The maximum mortgage would be \$7,000 per family unit and not in excess of 100 percent of value, with a maximum term of 40 years.

There is one other matter about the section 221 program to which I want to call particular attention. It should be recognized frankly as an experimental program. Recognizing it as such, I am strongly of the opinion that it is very necessary and a very worthwhile program. The development of a better supply of adequate housing for families of low income is one of our most important and pressing problems. The urban renewal program contemplated by this bill necessarily will displace many families of low income from the unsatisfactory dwellings in which they are now living. I do not propose to turn my back on this important problem. That is why I feel so strongly that this section 221 program ought to be tried.

It is an effort to develop a practical means for making it possible to meet more of this particular need through private enterprise. But, to me, private enterprise means not only that the housing is built by private builders and owned and operated by individual families or private business organizations. It means also that it is financed by private long-term mortgage credit supplied by private lenders who obtain the necessary funds from private sources—not from the Federal Government. Section 221 offers every inducement to make this possible. It provides a means under which lenders can invest funds in such loans without risk of loss. It provides a means under which the income hazards of long investment at a fixed rate of return are minimized by permitting any such loan in good standing to be assigned to the FHA at any time after 20 years in exchange for 10-year fully guaranteed debentures. Such debentures would bear interest at a rate equivalent to the yield on Government marketable obligations of comparable maturity at the time such debentures are issued. We are prepared to go even further to make it possible for private enterprise to meet more of this need. We are prepared to have FNMA agree in advance to buy any such loans from the lender upon default, thus permitting the private lender to obtain settlement in cash rather than in debentures. We are even prepared, if necessary, to have FNMA purchase a modest part of any such loan at the time of origination.

I believe we ought to try the approach provided by section 221, because it is my belief and my hope that, in time, it could result in a substantial and vital source for the provision of adequate housing for families of lower income and could progressively reduce the pres-

sure for public housing. In this connection I want to make it perfectly clear that we recognize, however, that until such alternate means of providing adequate housing for low-income families can be established on a practical and effective basis, federally assisted low-rent public housing provides the only present means that most cities have for rehousing the lowest-income families and, as the President indicated in his special housing message, it is an integral and very necessary part of the administration's overall housing program.

Finally, as a further aid in financing needed home additions or improvements, the bill would authorize FHA insurance of advances to a mortgagor made pursuant to provisions in an open end FHA insured home mortgage. Open-end mortgages are mortgages which provide that the outstanding balance can be increased in order to advance additional loan funds to a mortgagor for improvement, alteration, or repair of the home covered by the mortgage without the necessity of executing a new mortgage. This would eliminate the expenses of title search and recordings. Also, it would permit the homeowner to borrow for the improvements at the low rate of interest prescribed in the mortgage and generally for a longer term than otherwise available. The authority to insure open end mortgages would apply only to insured mortgages covering dwellings for four families or less.

I regard this authorization as an important forward step. However, I want to add a word of caution. The mere enactment of such a provision will not automatically make it operate effectively. A great deal of work and study, both within and without the Government, must be done to assure that this provision does operate effectively and that housing consumers have an opportunity to obtain its full advantages. So far as the Housing and Home Finance Agency is concerned, I want to say that all of us will do everything possible to see that what is required of us to accomplish this will be done. I realize also that there are some real problems to be overcome, particularly, I expect, in connection with the lien laws of the various States. If the Congress enacts this provision of the bill it is my intention to request an appropriation sufficient to permit us to undertake a thorough examination of such problems and the development of model State legislation designed to eliminate such obstacles to the effective operation of the open end mortgage provisions as are identified in the course of such examination.

INSURANCE AUTHORIZATION

The bill would consolidate into a single authorization all existing mortgage insurance authorizations with respect to all FHA programs, except the home modernization and improvement program under section 2 of title I. This would greatly simplify operations under the present several separate insurance authorizations, and establish at all times the amount of the current mortgage insurance authority for all programs. The bill provides that the total authorization shall not exceed the estimated amount of insurance in force and commitments outstanding as of July 1, 1954, plus \$1½ billion, except that with the approval of the President such total authorization could be increased by amounts up to a total of not to exceed \$500 million.

There are some very important aspects bearing upon the necessity for an adequate insurance authorization which I want to emphasize. To be an effective aid in housing and home financing, the FHA requires a considerable degree of flexibility in its operations. It should not be in the position of having to close down insurance operations because of the exhaustion of its insurance authorization. There is always a high degree of uncertainty over the volume of applications which will be submitted by home builders and mortgagees. For this reason it is impossible to forecast with precise accuracy the dollar amount of insurance authorization which will be required in a given period of time, because the volume can vary substantially and rapidly with changing conditions.

I understand there have been eight or ten occasions during recent years when the exhaustion of an insurance authorization has required that insuring operations under one or more of the active programs either be suspended or placed under direct daily control of the Washington office. This is a very expensive process—both from the standpoint of the FHA and from the standpoint of the builders and the lenders who rely upon the FHA. The FHA is intended to be a stabilizing influence on homebuilding, but when its operations are cut off entirely by reason of insufficient insurance authorization it seriously disrupts the home-building and home-financing industry.

No one recognizes and appreciates more fully than I do the right, and the desirability, of the Congress to control the insurance liability to be underwritten by the FHA. I earnestly recommend to your committee that the FHA be granted sufficient authorization to carry out its operations without interruption until the Congress has adequate opportunity and time to again review the situation and to provide for such additional insurance authorization as it deems desirable until the next succeeding period of congressional review and action.

According to Commissioner Hollyday's best estimate, the \$2 billion provided for in this bill would be sufficient, with a reasonable margin of safety, to permit FHA to continue its operations without interruption until June 30 next year. I strongly urge your committee to provide sufficient insurance authorization to accomplish that purpose.

MORTGAGE LOAN AMOUNTS

There is a very real need for some adjustment and simplification of the various provisions of the National Housing Act governing the determination of the maximum amounts of mortgage loans which may be insured by the FHA. This is particularly true with respect to the FHA section 203 program relating to the insurance of mortgages on 1- to 4-family homes. Also since FHA or VA insured or guaranteed home mortgage loans represent a large segment of the home mortgage market and, therefore, exert a strong influence on the level of construction activity, it is vitally important to permit the terms of such Government-guaranteed or insured home mortgage credit to be fully responsive to changing economic conditions. The bill seeks to meet both of these important problems.

For example, in connection with the section 203 program on 1- to 4-family homes, the bill would provide that the maximum amount of a mortgage which may be insured by FHA could not exceed the sum of 95 percent of the first \$8,000 of value and 75 percent of the

value in excess of \$8,000, and in no event to exceed \$20,000 for a 1- or 2-family residence, \$27,500 for a 3-family residence, or \$35,000 in the case of a 4-family residence. These statutory maximum dollar amounts would compare with the present ceilings of \$16,000 for a 1- or 2-family home; \$20,500 for a 3-family home, and \$25,000 for a 4-family home. We have prepared for the use of your committee a table showing the existing and proposed maximum loan amounts permitted in the case of 1- to 4-family homes.

The CHAIRMAN. Without objection, the table will be inserted in the record.

(The document is as follows:)

PROPOSED AND CURRENT SCHEDULES FOR MAXIMUM MORTGAGE AMOUNTS FOR 1- TO 4-FAMILY HOME MORTGAGES INSURED UNDER FHA SEC. 203

A. 1- and 2-family home mortgages

Federal Housing Administration appraised value (per structure)	Proposed		Current					
	1-and 2-family, new and existing ¹ (all mortgagors except operative builders)		1-family new, sec. 203 (b) (2) (D) ² (owner-occupant mortgagors)		1-family new, sec. 203 (b) (2), (C) ³ (owner-occupant mortgagors)		1-and 2-family, new and existing, sec. 203 (b) (2) (A) ⁴ (all mortgagors except operative builders)	
	Maximum insured mortgage ⁵	Loan-value ratio (percent)	Maximum insured mortgage	Loan-value ratio (percent)	Maximum insured mortgage	Loan-value ratio (percent)	Maximum insured mortgage	Loan-value ratio (percent)
\$4,000.....	\$3,800	95.0	\$3,800	95	\$3,800	95.0	\$3,200	80.0
\$5,000.....	4,750	95.0	4,750	95	4,750	95.0	4,000	80.0
\$6,000.....	5,700	95.0	5,700	95	5,700	95.0	4,800	80.0
\$7,000.....	6,650	95.0	6,650	95	6,650	95.0	5,600	80.0
\$8,000.....	7,600	95.0	7,600	95	7,350	91.9	6,400	80.0
\$9,000.....	8,350	92.8	8,550	95	8,050	89.4	7,200	80.0
\$10,000.....	9,100	91.0	9,500	95	8,750	87.5	8,000	80.0
\$11,000.....	9,850	89.5			9,450	85.9	8,800	80.0
\$12,000.....	10,600	88.3					9,600	80.0
\$13,000.....	11,350	87.3					10,400	80.0
\$14,000.....	12,100	86.4					11,200	80.0
\$15,000.....	12,850	85.7					12,000	80.0
\$16,000.....	13,600	85.0					12,800	80.0
\$17,000.....	14,350	84.4					13,600	80.0
\$18,000.....	15,100	83.9					14,400	80.0
\$19,000.....	15,850	83.4					15,200	80.0
\$20,000.....	16,600	83.0					16,000	80.0
\$21,000.....	17,350	82.6					16,000	76.2
\$22,000.....	18,100	82.3					16,000	72.7
\$23,000.....	18,850	82.0					16,000	69.6
\$24,000.....	19,600	81.7					16,000	66.7
\$24,600.....	20,000	81.3					16,000	65.0

¹ Proposed terms for 1- and 2-family new and existing: Not to exceed 95 percent of \$8,000 value and 75 percent of value in excess of \$8,000, and not to exceed a mortgage of \$20,000.

² Current terms for 1-family new under sec. 203 (b) (2) (D): Not to exceed 95 percent of value and not to exceed a mortgage of \$6,650, plus \$950 per room for 3d and 4th bedrooms.

³ Current terms for 1-family new under sec. 203 (b) (2) (C): Not to exceed 95 percent of \$7,000 value and 70 percent of value in excess of \$7,000, and not to exceed a mortgage of \$9,450.

⁴ Current terms for 1- and 2-family new and existing under sec. 203 (b) (2) (A): Not to exceed 80 percent of value, and not to exceed a mortgage of \$16,000 per structure.

⁵ Per structure.

⁶ Minimum of 3 bedrooms per family unit.

⁷ Minimum of 4 bedrooms per family unit, or minimum of 3 bedrooms per family unit in geographic area where Commissioner finds cost levels so require.

⁸ Minimum of 4 bedrooms per family unit in geographic area where Commissioner finds cost levels so require.

B. 3- and 4-family mortgages (new and existing homes)

Federal Housing Administration appraised value (per structure)	3-family				4-family			
	Proposed ¹		Current ²		Proposed ¹		Current ²	
	Maximum insured mortgage	Loan value ratio (percent)	Maximum insured mortgage	Loan value ratio (percent)	Maximum insured mortgage	Loan value ratio (percent)	Maximum insured mortgage	Loan value ratio (percent)
\$10,000 ³	\$9,100	91.0	\$8,000	80.0	\$9,100	91.0	\$8,000	80.0
\$11,000	9,850	89.5	8,800	80.0	9,850	89.5	8,800	80.0
\$12,000	10,600	88.3	9,600	80.0	10,600	88.3	9,600	80.0
\$13,000	11,350	87.3	10,400	80.0	11,350	87.3	10,400	80.0
\$14,000	12,100	86.4	11,200	80.0	12,100	86.4	11,200	80.0
\$15,000	12,850	85.7	12,000	80.0	12,850	85.7	12,000	80.0
\$16,000	13,600	85.0	12,800	80.0	13,600	85.0	12,800	80.0
\$17,000	14,350	84.4	13,600	80.0	14,350	84.4	13,600	80.0
\$18,000	15,100	83.9	14,400	80.0	15,100	83.9	14,400	80.0
\$19,000	15,850	83.4	15,200	80.0	15,850	83.4	15,200	80.0
\$20,000	16,600	83.0	16,000	80.0	16,600	83.0	16,000	80.0
\$21,000	17,350	82.6	16,800	80.0	17,350	82.6	16,800	80.0
\$22,000	18,100	82.3	17,600	80.0	18,100	82.3	17,600	80.0
\$23,000	18,850	82.0	18,400	80.0	18,850	82.0	18,400	80.0
\$24,000	19,600	81.7	19,200	80.0	19,600	81.7	19,200	80.0
\$25,000	20,350	81.4	20,000	80.0	20,350	81.4	20,000	80.0
\$25,625	20,800	81.2	20,500	80.0	20,800	81.2	20,500	80.0
\$26,000	21,100	81.2	20,500	78.8	21,100	81.2	20,800	80.0
\$27,000	21,850	80.9	20,500	75.9	21,850	80.9	21,600	80.0
\$28,000	22,600	80.7	20,500	73.2	22,600	80.7	22,400	80.0
\$29,000	23,350	80.5	20,500	70.7	23,350	80.5	23,200	80.0
\$30,000	24,100	80.3	20,500	68.3	24,100	80.3	24,000	80.0
\$31,000	24,850	80.2	20,500	66.1	24,850	80.2	24,800	80.0
\$31,250					25,000	80.0	25,000	80.0
\$32,000	25,600	80.0	20,500	64.1	25,600	80.0	25,000	78.1
\$33,000	26,350	79.8	20,500	62.1	26,350	79.8	25,000	75.8
\$34,000	27,100	79.7	20,500	60.3	27,100	79.7	25,000	73.5
\$34,000	27,500	79.5	20,500	59.2				
\$35,000					27,850	79.6	25,000	71.4
\$36,000					28,600	79.4	25,000	69.4
\$37,000					29,350	79.3	25,000	67.6
\$38,000					30,100	79.2	25,000	65.8
\$39,000					30,850	79.1	25,000	64.1
\$40,000					31,600	79.0	25,000	62.5
\$41,000					32,350	78.9	25,000	61.0
\$42,000					33,100	78.8	25,000	59.5
\$43,000					33,850	78.7	25,000	58.1
\$44,000					34,600	78.6	25,000	56.8
\$44,550					35,000	78.6	25,000	55.6

¹ Proposed sec. 203 (b) (2): Not to exceed 95 percent of \$8,000 of appraised value and 75 percent of such value in excess of \$8,000, and not to exceed a mortgage amount of \$27,500 for a 3-family structure, or \$35,000 on a 4-family structure.

² Current sec. 203 (b) (2) (A): Not to exceed 80 percent of appraised value, and not to exceed a mortgage of \$20,500 for a 3-family structure, or \$25,000 for a 4-family structure.

³ Mortgages on 3- and 4-family structures of less than \$10,000 value are eligible for insurance on the basis of the above formulas but have been omitted from these schedules in order to conserve space.

Mr. COLE. I want to emphasize that these, as well as the similar adjustments in the maximum amounts for other FHA programs, would represent the statutory maxima which would not automatically go into effect upon the enactment of the bill. The authority to establish the actual terms under which the FHA would operate would be vested in the President. It is contemplated that, if the Congress enacts these proposals, the President would, when he approves the legislation, put into effect a new scale of maximum mortgage loan amounts employing the new simplified formula, but establishing the amounts below the various maxima permitted by the bill.

INTEREST RATES

The bill would also place in the President authority to establish the maximum rates of interest on home mortgage loans insured or guaranteed by the Federal Housing Administration or Veterans' Administration. The bill provides that such maximum interest rates would be established by the President from time to time on the basis of reviews to be made at his request by appropriate officials of the Federal Government. Such reviews would be required to cover conditions affecting the mortgage investment market, and to take into consideration conditions in the building industry and the national economy generally. The maximum interest rate could in no event be established at a rate exceeding the average market yield on marketable Government bonds having a remaining maturity of 15 years or longer, plus $2\frac{1}{2}$ percent.

I want to call particular attention to the fact that this latter provision is not a formula which requires the interest rate to be set at two and a half points above the average yield. It is a "ceiling limitation" permitting, within that limitation, the essential flexibility required for appropriate adjustment of the interest rate to changing economic conditions.

This provision for administering interest rates is in substantial conformity with the recommendations of the President's Advisory Committee. I should like also to emphasize that the committee was of the opinion that no change was needed at this time in present maximum interest rates. I agree with this position and would not recommend any change in interest rates under present market conditions.

If agreeable with the committee, I should like to suggest that Mr. Hollyday now present his statement. Mr. Hollyday brings to the position of FHA Commissioner an enviable record of successful mortgage banking experience. He has also done an outstanding job of pioneering in the field of rehabilitation and neighborhood conservation—a field in which the pending bill would give important new responsibilities to the FHA.

The CHAIRMAN. Mr. Hollyday, you may proceed with your statement as suggested.

STATEMENT OF GUY T. O. HOLLYDAY, COMMISSIONER, FEDERAL HOUSING ADMINISTRATION

Mr. HOLLYDAY. Mr. Chairman and members of the committee, it is a privilege to appear today to discuss with you the portions of H. R. 7839 which pertain to FHA operations. The bill proposes two new FHA mortgage insurance programs. It also makes a number of modifications in existing programs, consolidates existing insurance programs in several instances and terminates some programs which either are inactive or are no longer justified. It also includes several technical amendments to refine, clarify or simplify existing programs.

All of the provisions are designed to enable FHA to serve the Nation more effectively in raising housing standards and conditions or to enable FHA to perform its functions more efficiently.

NEW MORTGAGE INSURANCE PROGRAMS

The new mortgage insurance programs are provided for in section 123 of H. R. 7839 which adds section 220 and section 221 to the National Housing Act. Each of these programs has a specific and important role to play in neighborhood rehabilitation and urban renewal.

The new section 220 program is designed to provide private financing under insured mortgages for housing in the specific areas undergoing rehabilitation.

Before section 220 can become operative as to any community, the community must have developed a comprehensive and practical plan to attack its problem of urban blight and slums, the Administrator of the Housing and Home Finance Agency must have examined this plan and have certified it to be a workable plan. Pursuant to this plan, certain areas will be designated and approved by the Administrator of the Housing and Home Finance Agency as "urban renewal areas." Within such areas mortgage insurance for rehabilitation and construction of individual homes or projects may be made available by FHA under section 220.

Before issuing any commitments to insure mortgages under section 220, the Federal Housing Commissioner must be satisfied that there is a specific program of rehabilitation and conservation for the delineated area which will be effective in restoring the quality of that area to a condition which would justify mortgage insurance, and that there exists the necessary authority and financial capacity in the community to carry out the established program.

In short, FHA must be satisfied that action will be taken which will restore satisfactory living conditions, property values and economic strength to the area which will endure throughout the life of the insured mortgage. FHA consideration will relate to public facilities, public services and public areas such as streets, schools, parks, and playgrounds within the delineated areas, as well as to land uses and conditions of privately owned property.

It should be borne in mind that many of the areas in which FHA would be authorized to insure mortgages under section 220 would be areas which would be rejected by FHA in the absence of the local community's action under its urban renewal plan. It is the action of the community under its urban renewal plan which would warrant FHA's acceptance of mortgages in these blighted areas. It might be well, therefore, to enumerate briefly some of the basic elements in such a community plan:

1. Continuing official general planning activity to supply the base upon which renewal programs are predicated.
2. Suitable facilities for studying the condition of city areas and planning renewal programs.
3. Adequate legislative authority to support regulatory measures.
4. Sufficiency of local codes and ordinances and adequacy of their enforcement.
5. Authoritative administrative machinery for carrying out entire program.
6. Financial ability to support city's expenditures for administrative functions and for public improvements.
7. Feasible means of relocating persons displaced by all renewal programs.

8. Citizen participation and public education, both city-wide and on specific programs.

9. Followup program to sustain upgrading of renewed areas.

Maximum mortgage insurance terms will generally be consistent with section 203 for small properties and with section 207 for projects of 12 or more units with two exceptions. In order to provide a full range of coverage for the various types and sizes of properties likely to be found in such areas, home mortgage terms will be available for structures with from 1 to 11 dwelling units, instead of the section 203 limitation to 1- to 4-family units. Multifamily project mortgages will be limited to 90 percent of value.

It is anticipated that FHA processing of section 220 applications will generally parallel the processing of section 203 and section 207 applications, with essentially similar eligibility standards.

It is our opinion that the section 220 program can be an important aid to local communities which are interested in eliminating urban blight and restoring deteriorated neighborhoods while placing primary dependence upon private ownership and private financing. It should be emphasized, however, that the effectiveness of the program depends fundamentally on local initiative and participation.

It is our further opinion that mortgage insurance for such undertakings can be as successful with proper underwriting as it is in the types of activity to which other title II programs apply.

Section 221 is designed to provide privately financed housing under insured mortgages for families displaced by governmental action from urban renewal areas. These will be low income families—generally families who have been living in substandard housing in substandard neighborhoods. They are being forced to move. These families must find decent homes. Unless they are adequately housed, the problem of overcrowding and blight is not solved; it is just moved from one part of the city to the other.

Some of these displaced families will be able to find decent homes in the existing housing inventory of the community. Many of them will not. Having come from substandard housing, they might be forced again into substandard housing unless public housing were made available—or unless some way can be found to bring privately financed housing within their means. That is what section 221 is for.

Section 221 is designed to bring privately financed housing within the reach of at least some portion of these families by applying the insured mortgage system on the most liberal terms deemed feasible and on a frankly new and untried basis.

I might add in this connection that, while section 221 is a new approach to the problem of rehousing families displaced from blighted areas, FHA has had some very limited experience with 100 percent insured mortgages in disaster areas. That experience, although limited, has been good.

I believe section 221 is an intelligent approach to a very serious problem. Let me briefly summarize its specific terms.

Section 221 is available only in communities which have been certified by the Administrator of the Housing and Home Finance Agency as having workable programs for the elimination and prevention of urban blight. It is available only for housing to be built or rehabilitated for families being displaced from their homes by govern-

mental action in such communities. It is intended for use in those situations where there is an insufficient supply of suitable housing available from other sources to take care of such displaced families.

The maximum mortgage under section 221 would be \$7,000 per unit. This limit is designed to insure provision of housing within the financial means of a substantial portion of the modest-income families being displaced from urban renewal areas. The maximum term would be 40 years and the mortgage insured by FHA could be as high as 100 percent of value. The properties covered by the insured mortgages under section 221 could be single family homes for sale to eligible displaced families or may be projects of 10 or more units to be rehabilitated by nonprofit organizations for rent to such families.

Mortgage financing is also available for single family homes built for sale in amounts not to exceed 85 percent of value, to assist in the construction and provide financing pending subsequent sale to a qualified owner-occupant.

To encourage private funds for section 221 projects, one of the terms of the insurance contract would provide that if the mortgage is in good standing, the mortgagee would have the option at the end of 20 years to assign the mortgage to FHA and receive in exchange debentures for the unpaid principal balance of the mortgage.

As in the case of section 220, FHA processing of applications and standards of eligibility under section 221 will generally parallel the respective procedures of section 203 and 207.

MODIFICATIONS OF PRESENT FHA PROGRAMS

Changes in the terms of mortgage insurance under various outstanding FHA programs are provided for in a number of individual sections of title I of H. R. 7839. Section 101 modifies the property improvement loan insurance program of title I by increasing the general maximum insurable loan from \$2,500 to \$3,000 and increasing the maximum permissible loan term from 3 to 5 years.

The same section also raises the present \$10,000 maximum insurable loan for multifamily structures to \$10,000 or \$1,500 per unit, whichever is higher, with an accompanying increase in maximum term from 7 to 10 years.

All of these changes are intended to make the Title I program more effective in financing modernization and improvement of existing residential structures. The expanded insurance program for multifamily projects is expected to be operated in a conservative fashion principally as a substitute for insured mortgage financing under other programs in those instances where existing indebtedness precludes use of the regular mortgage insurance programs.

Section 104 authorizes a simplified system of maximum mortgage amounts for section 203, raising the limits for 1- to 2-family structures to \$20,000 from the present limit of \$16,000 which was first established in 1934 and raising the maxima for 3- and 4-family structures to \$27,500 and \$35,000, respectively, from present limits of \$20,500 and \$25,000.

For both new and existing structures with 1- to 4-dwelling units, this section proposes as a single formula that maximum mortgage amounts be limited to 95 percent of the first \$8,000 of value plus 75 percent of value in excess of \$8,000. This single formula would re-

place a very complex series of maximum mortgage standards applicable under the present law to a variety of types of structures, sizes of units, and construction status of structures. The single formula would also remove the present disadvantage of mortgage terms for existing construction. As between properties of equal value, there appears to be no sound reason for differing mortgage limits. Perhaps I can best illustrate this point by one or two examples.

Take a case where 2 houses—1 a newly constructed house and 1 an older house—are both appraised at \$8,000. The newly constructed house may be a 2-bedroom house; the older house may be a 3-bedroom house. Under the existing law, the FHA may insure a loan of \$7,350 on the newly constructed house, so that a family could purchase it with a downpayment of \$650. However, on the older house, even though the appraised value is the same, the FHA could not insure a loan of more than \$6,400. The family purchasing the older house would have to make a downpayment of \$1,600—\$950 more than would be required to purchase a new house with the same value. In such a case, it could well be that the older house with 3 bedrooms would better meet the needs of a particular family than the newly constructed 2-bedroom house, but solely because of the much larger downpayment required, the family might choose to purchase the new 2-bedroom house.

Again, take the case of an existing house valued at \$6,000 which with the addition of a bedroom and the modernization of the kitchen would be worth \$8,000. Since FHA presently could not insure a loan of more than \$6,400, a family purchasing the house and making the additions and improvements would have a cash outlay of \$1,600 as compared to \$650 for the purchase of a new house of the same value.

The proposed maximum mortgage limits are also intended to provide a more consistent schedule of mortgage amounts. For example, a new home with a value of \$11,000 is now eligible for a mortgage of \$9,450, or 85.9 percent. Another new house of \$11,800 would be eligible only for that same maximum mortgage amount, or 80 percent of value, and a house of \$12,000 value is eligible for a mortgage of only \$9,600, or \$150 more mortgage than is available to the first unit worth \$1,000 less. More favorable mortgage terms for existing home mortgages would also be effective in helping to sustain the marketability of new homes and the volume of new construction.

Section 105 proposes a single maximum mortgage term of 30 years for application to all section 203 mortgages, replacing present varying limits ranging from 20 to 30 years.

Section 106 simplifies the maximum interest rate provisions of section 203 and permits the Commissioner to allow in connection with section 203 mortgages, a continuing monthly service charge such as has been applicable under section 8.

Each of the changes proposed in sections 104, 105, and 106 can become effective only upon action of the President in keeping with the terms of these sections and of section 201 of this bill.

Section 112 proposes that the terms of debentures issued under section 203 and section 213 be established at 10 years instead of the present terms of 20 years for section 213 and 3 years after maturity of related mortgage for section 203. This would make the debenture terms con-

sistent for all FHA programs and would improve the availability of funds for insured mortgage financing.

Section 114 modifies the mutual mortgage insurance system in order to increase the strength of the fund as a protection against the contingent possibility of payment of debentures by the Treasury. Fundamentally, the changes proposed would combine the independent resources of the 192 individual active group accounts in the present system into a single reserve system consisting of a general surplus account and a participating reserve account from which dividends would be paid.

Under the present system, only the resources of the general reinsurance account stand between a deficit in liquidation of insurance for a single year's mortgages in a particular group account and a call upon the Treasury for redemption of debentures issued. The present proposal would make all of the resources of the entire system available for redemption of maturing debentures before a call to the treasury would be necessary.

It should be noted that the risk of loss to FHA is most substantial at all times with respect to the mortgages most recently insured. The declining risk of loss with passing years reflects both the reduction in indebtedness through amortization of the insured mortgages and the accumulation of resources in the insurance system from premiums and interest on investments. The simultaneous accumulation of resources and decline in required reserves against losses in group accounts under the present system causes the individual group accounts to move rapidly from heavy deficits in reserves to a condition of credit balances in excess of required reserves during a short period in the life of the mortgages between about the fourth and eighth years. Under the present system, these credit balances in older group accounts can in no way be used to support the system's losses with respect to more recent group accounts.

Further aspects of the proposed revision are that management of the system can be accomplished at somewhat lower administrative cost if the group account system is abolished and that dividend distributions can be held to a minimum during the period of accumulation of adequate reserves.

It is perhaps unnecessary to mention that the concept of required reserves for such an insurance system as mortgage insurance must always be based on an assumption that a real estate depression could start in the immediate future. In that event, heavy losses would always be expected with respect to recently insured mortgages. The reserve concept does not involve a forecast of a depression at any particular time, but rather is designed to have the system able to endure a depression whenever it may occur. To the extent that a real estate depression is delayed or mitigated, the insurance reserves will prove to be more than adequate and the excess will properly be available for return to the appropriate mortgagors in the form of participating dividends.

Section 115 of H. R. 7839 modifies the section 207 program of FHA in several respects; first, by extending the program to cover mortgages for rehabilitation of existing structures in blighted areas; second, by making section 207 mortgage insurance available in Guam on the same basis as applies in Alaska; and third, by revising the maximum mort-

gage amount provisions to remove the present \$10,000 ceiling and to allow mortgage amounts as high as \$2,400 per room, or \$7,500 per unit in projects with less than four rooms per unit, in projects of elevator structures if FHA determines that construction cost levels require such mortgage amounts.

The elevator structure increases are proposed in the light of the higher costs generally inherent in the fireproof or fire-resistant qualities of construction required for these structures and the higher land costs typical of central city locations where these structures are provided, including slum clearance sites. It may be noted that these last changes do not alter the basic limitation of these mortgages to 80 percent of FHA's appraised value.

Section 119 proposes to amend the maximum mortgage limits of the section 213 program, that is, cooperative housing, in several regards: first, mortgages up to \$25,000,000 would be insurable for mortgagors publicly regulated or supervised as to rents, charges, and methods of operation; secondly, increases are provided in maximum mortgage amounts on a per room and per unit basis (to \$2,250 per room, or \$8,100 per unit for projects averaging less than four rooms per unit, with proportional further increases for veterans' cooperatives); third, additional increases in maximum mortgage amounts are provided with respect to elevator structures (to \$2,700 per room, or \$8,400 per unit in projects with less than four rooms per unit, with related further increases for veterans' cooperatives), such further increases to be dependent upon the necessities of higher cost levels; fourth, mortgage limits are based upon appraised values of properties instead of replacement cost, as formerly; and fifth, veterans' preferential mortgage limits are made available only to projects having 65 percent of the membership composed of veterans.

The increases in mortgage amounts bring the section 213 maxima into balance with section 207 maxima after allowance for the differences between the maximum permitted loan to value ratios. As in the case of section 207, higher mortgage ceilings are proposed for elevator structures. Basing mortgage limits on appraised values instead of replacement costs would increase the protection of the insurance fund and would encourage elimination of any elements of cost which do not contribute to value.

The change in the formula for determining additional mortgage amounts for veterans' benefits is proposed as a means of simplifying the present complicated formula for determining maximum mortgage amounts for these projects.

Section 121 of the bill amends section 217 of the National Housing Act to consolidate all FHA mortgage insurance authorizations into a single limitation. With the increasing number of separate insurance programs and separate insurance authorizations, it becomes increasingly difficult to forecast with reasonable accuracy the authorization requirements of the individual programs. Consolidation of these authorizations is therefore proposed as a means of reducing administrative workload and minimizing the necessary total amount of insurance authorization. It may be noted that the proposed language provides only sufficient authorization for operation of all FHA programs through mid-year in 1955.

Section 125 of HR 7839 authorizes the Commissioner to insure additions to outstanding insured mortgages for purposes of additions or other property improvement, pursuant to so-called "open-end" provisions in the mortgages. In administering this authority, FHA will perform whatever appraisal, credit analysis, and property inspections may be necessary to assure the adequacy of the security to sustain the increased insurance liability. Charges for use of the open-end provision will be computed to cover both processing cost and insurance risk, and it is contemplated that the most effective form of charge may be a single charge at time of insurance.

It is to be noted that the use of open-end provisions in insured mortgages would in no way alter the responsibility of the mortgagee, in the event of foreclosure, to make available to FHA a satisfactory title in exchange for debentures. FHA will tackle the development of the open-end mortgage with determination. We recognize, however, that there will be many problems and that time and patience will be required to make it a really effective tool in the housing program.

Section 128 extends the section 803 military housing program to June 30, 1955.

A further modification of the operation of the FHA insurance programs is provided in section 201 of H. R. 7839 where authority is given to the President to establish interest rates and financing charges for various FHA programs. That section permits maximum interest rates for FHA-insured mortgages to be established within a limit of 2½ percent above the estimated average yield on outstanding government bonds with maturities of 15 years or more.

This is a maximum limitation which would have been adequate for all FHA operations in the past. A chart has been distributed to the members of the Committee showing the relation of this limitation to the actual maxima in effect under section 203 over a period of 10 years. The same chart also indicates that a similar maximum based on a 2-percent spread above the yield on long-term Government bonds would not have been adequate for much of the period from 1945 to 1950 to have allowed the actual limits to have been in effect.

Transfers and consolidations of insurance programs:

In order to simplify and improve the effectiveness of FHA operations, several consolidations of insurance programs are proposed by H. R. 7839. In none of these cases is it intended to alter the character of the insurance programs consolidated. In the specific case of section 8, which is proposed to be absorbed by section 203, it is expected that the program will be improved by virtue of increased availability of mortgage money as a consequence of the consolidation.

Section 8 is to be absorbed substantially intact into section 203. It is our intent and conviction that the program will be even more effective if it is an integral part of our title II operations.

The CHAIRMAN. I don't think the schedule of rates to which you referred has been inserted in the record. Without objection it will be inserted in the record.

(The information is as follows:)

AVERAGE YIELD ON U. S. TREASURY TAXABLE BONDS WITH 15 OR MORE YEARS REMAINING MATURITY ROUNDED TO NEAREST 1/8 PERCENT,^{1/}
 PLUS 2 PERCENTAGE POINTS AND SAME AVERAGE BOND YIELD PLUS 2 1/2 PERCENTAGE POINTS, AND MAXIMUM INTEREST RATES
 ON FHA-INSURED SECTION 203 LOANS, MONTHLY 1944 - JANUARY 1954

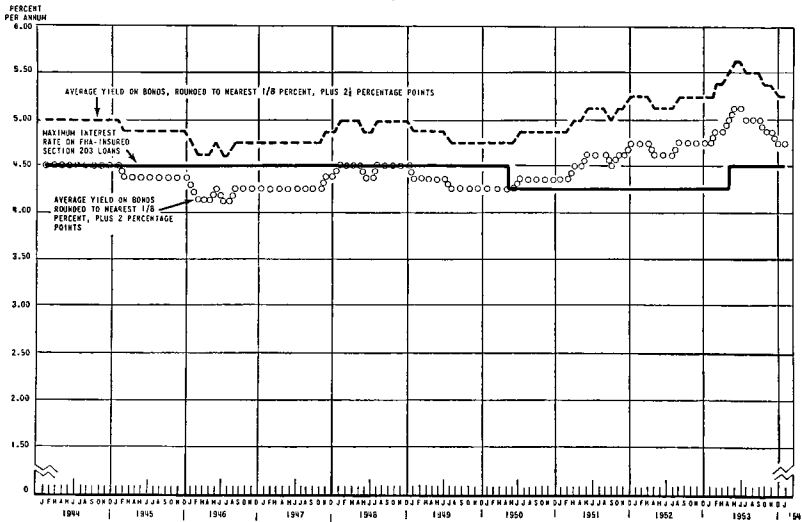

^{1/} Average from January 1944 through March 1952 based on the mean of the daily closing bid and asked prices of all Treasury bonds neither due nor callable for 15 years; April 1952 through January 1953, bonds neither due nor callable for 12 years (average probably differs from .01 to .04 percent from average yield for bonds with 15 or more years remaining maturity); February 1953 through January 1954, average yield based on bonds with 15 or more years of remaining maturity. Beginning with April 1953, yields based on closing bid quotations. Yields computed to first call if bonds selling above par; to maturity if bonds selling below par. Latest figures shown are for January 1954.

Source: Annual Reports of Secretary of the Treasury and Treasury Bulletins for January 1944 through January 1953; unpublished averages computed by U.S. Treasury Department for February 1953 through January 1954.

Mr. HOLLYDAY. Thank you, sir.

Legislatively, the only actions required are the termination of section 8 as provided in section 103 of the bill and the provision for monthly service charges in section 106 of the bill. Other adaptations of section 203 procedures with respect to property standards and case processing which are necessary in adapting section 203 to the section 8 program can be and will be accomplished by administrative action. It will be of interest to the committee that the recent improvement in the availability of mortgage money has already led to significant increases in section 8 applications and it is expected that consolidation of the program with section 203 would further expand activity.

Section 110 of the bill provides for transfer of the disaster home loan operations of the section 8 program to section 203 without change.

Section 124 transfers to title II, into a new section 222 of the National Housing Act, authority for insurance under section 203 or section 207 for all classes of mortgage insurance transactions presently authorized under section 610 (publicly owned housing sold with private financing), insurance of refinancing mortgages under section 608, section 903, and section 908, and insurance of mortgages assigned to the Commissioner or acquired by him in sale of acquired properties. The authority to insure mortgages assigned to the Commissioner constitutes a new authority which is desirable in the economical liquidation of these mortgages without necessity for FHA foreclosure and sale of the property, when in the best interest of the Government.

In order to increase the efficiency of FHA operations and terminate programs which are no longer justified, H. R. 7839 provides in section 108 the termination of special provisions for farm housing mortgage insurance under section 203 (d); section 126 proposes termination of special provisions for insuring prefabricated housing loans under section 609 and construction loans for groups of single-family houses for sale pursuant to section 611; section 127 proposes termination of title VII programs for insurance of the yield on equity investments in rental housing.

The title VII program has had no insurance activity in the 6 years the program has been available. It appears that any situation suitable for yield insurance can be equally well or better handled with a mortgage insurance transaction.

The programs provided by sections 609 and 611 have both had very little use in nearly 6 years and are therefore recommended for termination.

The farm housing program of section 203 (d) has been virtually inoperative for many years. In more than 2 years since January 1952, only four mortgages have been insured.

TECHNICAL AMENDMENTS AND REFINEMENTS OF EXISTING PROGRAMS

The remaining provisions of title I of H. R. 7839 consist of technical amendments and improvements of various existing programs.

Section 102 provides for closing the accounting records pertaining to title I property improvement loan insurance prior to June 30, 1939, and authorizes the investment of surplus funds of the revolving title I insurance fund in Government obligations, as is now permitted for surplus funds of all other insurance funds.

Section 107 and section 116 limit the use of debentures for payment of premiums to the insurance funds which issued the debentures. This provision extends to the MMI fund and the housing insurance fund the same provisions which apply to all other programs but which have not in the past been applicable to these two funds because of an oversight at the time the second of these two funds was created in 1938 supplementing the single fund established under title II in 1934.

Section 109 removes a requirement for a special certification in connection with each refinancing loan transaction stating that the holder of the existing mortgage has refused a refinancing loan on equivalent terms.

Section 111 permits inclusion in debentures of (1) amounts paid by mortgagee for internal revenue stamps on conveyances required to obtain benefits of insurance; and (2) an amount to cover foreclosure expenses up to two-thirds of such costs on \$75 whichever is greater for all mortgages covering 1- to 4-family dwellings, which allowances are now permitted only as to special programs; and (3) permits conveyance of title direct to FHA by mortgagor or by trustee or by sheriff, rather than to the mortgagee and then to FHA, and thereby avoids duplication of conveyance costs. This would accomplish only a mechanical change and would not change basic procedure or in any manner increase the liability of FHA under the insurance contract.

Section 113 transfers from section 205 to section 204 a paragraph which is no longer appropriate to section 205 in view of the revision of that section provided by section 114 of this bill.

Section 117 is a clarifying amendment to section 207 to remove any question as to the inclusion of necessary foreclosure costs, costs of acquisition, and costs of conveyance to the Commissioner in the certificate of claim, consistent with the other rental housing programs.

Section 118 extends to multifamily projects insured under section 220 the labor standard provisions of section 212 which are now applicable to the other multifamily programs under the National Housing Act.

Section 120 removes from the National Housing Act the mandatory requirement that an Assistant Commissioner for Cooperative Housing be appointed. This action is recommended to be consistent with the action of the Congress in terminating this provision with the following proviso in the Independent Offices Appropriation Act for fiscal year 1954:

Provided further, That the position of Assistant Commissioner, established pursuant to section 213 (f) of the National Housing Act, as amended, is no longer authorized.

Section 122 extends the provisions of section 219 of the National Housing Act to the section 220 Housing Insurance Fund so that assets of various other insurance funds excepting the MMI fund can be made available if required by the operation of this program.

Section 129 terminates new insuring activity under the title IX defense housing program.

Section 802 of H. R. 7839 repeals the requirement for an annual report from the FHA Commissioner to the Congress and provides instead for the HHFA Administrator to make such a report.

Mr. Chairman, I thank you for the opportunity to discuss this proposed legislation. I regret that this report is a little longer than I had hoped it would be, but it seemed impossible to shorten it.

The CHAIRMAN. Thank you.

Mr. COLE. Mr. Chairman, that completes our comments with respect to the FHA provisions of the bill. We are ready to answer questions on those provisions at this time, Mr. Chairman.

The CHAIRMAN. Are there any questions with respect to the statements which have already been made with respect to FHA?

Mr. SPENCE. I would like to know how the open-end mortgage operates.

Mr. HOLLYDAY. Well, sir, you ask a very difficult question because it will have to operate differently in each one of the States.

There has been a request, for some time, from persons who felt that the use of title I, which has been a 3-year loan for repair of properties, places a rather heavy burden on people who wish to borrow, and that if, as is the case in certain States, an advance could be made by the existing mortgagee to the borrower, and have that amount included in the existing mortgage, in many cases it would simplify the procedures and save funds.

By virtue of the varying laws in different States, as indicated in both Mr. Cole's report and mine, it is going to take quite a bit of study for the FHA to adjust itself to the requirements of the different States.

Mr. SPENCE. That is in the legislative authority of the States, is it?

Mr. HOLLYDAY. Yes, sir, it is, and by cooperating, and making it as simple as possible, there would be and should be many cases where a borrower could help repair his own home without going to a shorter and more expensive term of financing.

Mr. SPENCE. How many States have authorized the open-end mortgage?

Mr. COLE. Mr. Chairman, it is my understanding that we do not have up-to-date information about that at the present time. There are some States, though, that do permit open-end mortgages. We are quite interested in this proposal, and are very hopeful that can be made a workable program to assist people to rehabilitate and modernize their houses.

Mr. SPENCE. It looks to me as though it would be a very good device, if they don't trap the subsequent mortgagee or lien holder.

Mr. COLE. Yes, as Commissioner Hollyday indicated, there are many problems involved in setting up the program, but we are quite interested in the program.

Mr. HIESTAND. Mr. Chairman.

The CHAIRMAN. Mr. Hiestand.

Mr. HIESTAND. Mr. Hollyday, you cite the discontinuance of the new insuring activity under title IX, defense housing program. Is that an inactive operation at present?

Mr. HOLLYDAY. I think in that particular title, which originates with programing by the Housing and Home Finance Agency, there have been such few requests for programs that it was deemed desirable to have the program terminate because, for all practical purposes, we can handle the problem under our regular title II programs.

Mr. HIESTAND. Does that apply to the present discussion that we have had recently, with respect to the Antelope Valley, in California? That was under title IX, was it not, or proposed to be?

Mr. HOLLYDAY. Yes, sir, I think we were referring, in the California case, to a title IX operation.

Mr. HIESTAND. If this passed, then that would terminate any chance of the extension of that little operation?

Mr. HOLLYDAY. No, sir, because that had been initiated before the Bill would be in effect. And any operation initiated such as that would be taken care of.

Mr. HIESTAND. Thank you very much.

Mr. GEORGE. Mr. Chairman.

The CHAIRMAN. Mr. George.

Mr. GEORGE. The bill provides that one of the functions of the Housing Administration is to support the new title I of this FHA for 100 percent on 40-year loans. Assuming for the sake of argument that these loans would not be acceptable in the ordinary mortgage market, is it sound proposal to provide that the new associations to support this program, that is not acceptable to the ordinary lender? In other words, will you not with this provision go beyond the needs for a new secondary market?

The CHAIRMAN. Mr. George, may I suggest that we haven't taken that up yet.

Mr. GEORGE. Section 221 was mentioned.

Mr. COLE. Section 221 was mentioned, the part of my testimony just presented; but we do prefer that this type of question come up under discussion of FNMA, since it does have to do with the support of section 221 mortgages.

The CHAIRMAN. Is that agreeable, Mr. George?

Mr. GEORGE. That is agreeable.

The CHAIRMAN. Are there any further questions on these provisions?

Mr. MUMMA. Mr. Chairman.

The CHAIRMAN. Mr. Mumma.

Mr. MUMMA. The Administrator spoke of the necessity of doing away with title searches. Certainly if a man had liens put against him from the time of the original mortgage, he certainly couldn't put a secondary mortgage on, or an extension without giving him consideration.

Mr. HOLLYDAY. I think you put your finger, sir, on one item in the Administrator's report that does need clarification. In many cases—in fact, I think in almost most cases—for the protection of the mortgagee, who is going to give back, in case of default, a good title to us, a search will have to be instituted.

Mr. BETTS. From now on, the provisions would be taken care of in the original mortgage?

Mr. HOLLYDAY. Well, it will vary with the different States. If it is taken care of, then, of course, there may be cases where a search would not have to be made, but in most cases, even where special provision is made in the mortgage, in order to make sure that, contrary to the provision in the mortgage, liens have not been put against the property, a search will be required. Otherwise there would be no protection.

Mr. COLE. May we add one more thing to that: It also would depend upon the various and individual State laws, Mr. Betts. Some State laws would take care of that situation. Others would not. But it does depend upon the State laws.

Mr. STRINGFELLOW. Mr. Chairman.

The CHAIRMAN. Mr. Stringfellow.

Mr. STRINGFELLOW. I have just one question regarding section 221, Mr. Hollyday. In my community the Public Housing Authority is programing the disposition some of the Lanham projects created during the war. Certainly they are substandard in every respect, and families living in these units are low-income families.

Now, will section 221 apply in such communities where they are going to close many of these projects, and where people will have to go out and find adequate housing?

Mr. HOLLYDAY. There is no relationship between present existing Lanham Act housing and the approval of a community in which FHA can operate with section 220 and section 221, provided the city will do the things that will be necessary to correct the blight conditions in the community. The mere existence of a Lanham Act house or housing operation has no direct relationship at all to the creation of an area in which section 221 can operate. Sections 220 and 221 can operate only in a city where the city has set up a program which the Administrator deems desirable and satisfactory, and I think the term in the law is "workable."

Where there is such a program in effect in a city, then FHA can come in and take an individual area, and say that in that particular area, if the city will do thus and so, and spell out an amplification of the nine points that I have just read, then we can operate in that area. There is no relationship, per se, between public housing, and a new area, which is going to be delineated and created by the new law.

Mr. STRINGFELLOW. I noted your limitation in the third paragraph on page 5 of your statement, and I appreciate your clarification.

Mr. DEANE. Mr. Chairman.

The CHAIRMAN. Mr. Deane.

Mr. DEANE. I am sure that I speak for all of the members of our committee and especially for the minority in expressing our gratitude at having Mr. Cole, our former colleague, with us and in amplifying off the record his statement of a moment ago to the effect that he could understand the need for a staff sitting behind with him, with the length of these bills and exhibits; we feel that we need your staff sitting behind us, almost.

I wanted to direct my first question to page 2 of your statement, Mr. Hollyday, and I address this to you and Mr. Cole.

Have you made any spot checks of the areas of the country where you feel that these urban renewal programs would work, and where these areas would cooperate?

Mr. HOLLYDAY. It is very gratifying to be able to report, Mr. Deane, that throughout the entire country there is great and ever-increasing interest on the part of the cities to do something about their dwindling real estate values and the increasing inability to get sufficient taxation therefrom to operate city hall. Cities such as—

Mr. DEANE. I understand from that statement that the areas involved are so blighted, and the tax arrears, and the overall appearance are such that it is more or less a financial liability to city hall?

Mr. HOLLYDAY. In the average older metropolitan community, in the areas that we have under consideration, 45 cents out of each dollar goes into the blighted areas of the community, and about 6 cents comes out of these areas, and a realization of that rather striking and very vital statistic is being appreciated all over the country.

There are such cities as Chicago, Detroit, New Orleans—just to mention a few—where the importance of making that correction is almost paramount in the minds of the mayors of those three great communities.

Mr. DEANE. Have you surveyed those areas? Have you had conferences with those people in those particular areas on the approach to the problem as outlined in your statement?

Mr. HOLLYDAY. Yes, sir; the FHA has designated Detroit and New Orleans as pilot cities for special study, and we have delegated men to work with the citizens' committees and the mayors, in a study of ways and means of correcting those conditions, and for the first time in the history of FHA we will be given a tool—if section 220 becomes law—with which to hold out to these different cities real assistance in the form of private capital if the city will do thus and so, and we will be able to hold out, with a very considerable degree of assurance, the determination that if they will do what we would like to have them do, that the blight conditions can and will be corrected.

Mr. DEANE. What power do you give to the city officials in your bill that would give them the right to move in and condemn, and take over these blighted areas to do something about it?

Mr. HOLLYDAY. All we can do is hold out the reward. It will be up to the cities that do not have to have a sufficient enabling act to go to their legislature and get an enabling act to permit them to do that which FHA would require before private capital would be justified in coming into the particular community.

Mr. DEANE. You say on page 4: "It should be emphasized, however, that the effectiveness of the program depends fundamentally on local initiative and participation."

Mr. HOLLYDAY. Yes, sir.

Mr. DEANE. In other words, there is nothing in the bill giving the right of condemnation?

Mr. HOLLYDAY. As I said, we have no right at all.

Mr. DEANE. That is what I mean.

Mr. HOLLYDAY. Insofar as section 220 is concerned, that is, to take any such steps.

Mr. DEANE. You mentioned these larger cities.

Mr. COLE. Mr. Deane, may I interrupt you? Mr. Hollyday's answer was correct, that in section 220 there is nothing to give the right of condemnation. I think you asked, however, was there a right in the bill.

Mr. DEANE. That is right.

Mr. COLE. We do not want to mislead you. The urban renewal redevelopment and slum clearance program as contemplated by this bill does contemplate that cities exercise the police power and the condemnation power. This bill, of course, does not and cannot, confer any such powers upon cities. Their powers are derived from the State legislatures.

Mr. DEANE. Well, now, you mentioned these large cities, Mr. Hollyday, I am interested in smaller communities of 10,000 people because they have blighted areas, too. How are you going to approach the problem there?

Mr. HOLLYDAY. Fortunately, it is a little easier. It is the same germ that causes the same disease.

I was in Midland, Tex., a few months ago, and it never occurred to me that they would have a first class slum right within the city limits. But they have, and the correction of such a condition is the same, although simpler than on a larger scale.

The conditions arise by virtue of neglect, primarily on the part of city hall, and abetted by the indifference of the citizens to the conditions, and the fact that heretofore no group of business people has taken the time and trouble to go into the slums and make a specific recommendation.

The least that this section could possibly do would be to point the way to a situation and tell how it can be corrected.

Mr. DEANE. In other words, unless the property owners, the city officials, really come to grips with the problem there is not very much chance of eliminating these slums?

Mr. COLE. May I interrupt a moment, Mr. Hollyday?

We are now talking about section 220, and section 221, in the FHA procedures. Mr. Deane, I think you will be very much interested in the sections which will follow, in the urban renewal slum clearance and redevelopment, which will in our judgment contemplate some of the things to which you are directing your attention. In other words, we do expect cities to accomplish more than merely voluntary action; we do expect them to exercise their police powers to enforce local codes and regulations relating to housing.

The approach, as Mr. Hollyday has indicated, is primarily the voluntary approach, giving to the localities the responsibility and stimulating within the localities and the communities a desire to do the job.

In addition thereto, however, you will find in the bill, if Congress approves it, authority which contemplates that the cities will go into an urban renewal area and exercise their legal, authority, under their State law, to enforce certain actions. Mr. Hollyday is talking about—

Mr. DEANE. And those other sections would have the force and effect of entering into this revised section, of this section 220?

Mr. COLE. Yes, sir; in other words, section 220, under FHA, can cooperate with and be part of the renewal area, which is set up under the authority of the renewal program, and which is contained in the later authorizations.

Mr. DEANE. Are both sections so cohesive as to allow working together?

Mr. COLE. We think there is no question but that it not only would permit it, but would require it.

The provisions in the law would require coordinated action. It requires that a workable plan be presented to the Administrator for his determination, so that all the tools provided for in this legislation may be and will be used in a given city to accomplish this objective.

Mr. DEANE. Over on page 9 of your statement, Mr. Hollyday—I haven't really read it carefully enough to get a full appreciation, but what you propose to do there, in section 105, on the single maximum mortgage term of 30 years, is to increase that limit now from 20 to 30 years?

Mr. HOLLYDAY. There are quite a few variations now in the different sections and the different titles, varying from 20 to 25 and 30. We are recommending that all section 203 loans have a maximum term of 30 years.

Mr. DEANE. I don't know whether I am referring to the right section or not, but I have received correspondence from some responsible builders in my State of North Carolina, and I want to read a paragraph from a letter in which this is stated:

It is difficult to understand, Mr. Deane, why a potential home owner, young enough to warrant a 30-year mortgage, must pay a penalty in the form of excessive down payment if he desires to incorporate enough quality to make the home worthy of a long-term mortgage. For example, if he wants a \$10,000 home, why must he have two and a fourth times as much cash as if he were willing to settle for an \$8,000 home, which at today's prices has little chance to last, let alone remain desirable, for 30 years.

Mr. HOLLYDAY. Actually, I think we have a good answer for him, Mr. Deane, on page 7, under section 104, which deals with the improved series of mortgage limitations.

Mr. DEANE. In other words, he sends along here some pictures. Here is a house 5 years old, with a \$600 repair bill.

Mr. Cole will remember some tours that we made out through his section of the country, and into Texas, and a few other places, and I wonder if, in the opinion of Mr. Cole, remembering Corpus Christi, Tex., he thinks that those particular mortgages would be wise on a 30-year basis?

Mr. COLE. Mr. Deane, I wouldn't want to superimpose my judgment on the underwriter's better judgment, but may I say to you that the schedule which FHA has set up here, and the program which they have proposed, will in my opinion meet this objection, and this suggestion which your constituent mentions.

Specifically, as to houses which you described in Corpus Christi, there are some houses which, in my judgment, should not be insured for 30 years, and the FHA in their underwriting standards take that into consideration.

Frankly, I think they have done a good job in that regard.

Mr. DEANE. Do you have complete discretionary authority to decide whether or not the mortgage will go over that period?

Mr. HOLLYDAY. We do. The answer, usually, though, is determined, Mr. Deane, by the life insurance representative, or the bank, or the savings and loan association, which would be making the loan, as to how long they would be willing to make the loan for. That would be the maximum permitted.

Mr. DEANE. Moving now to one title—

Mr. COLE. Mr. Deane, may I make my statement a little more clear. A 30-year loan, under the FHA procedures, would not be granted if the life of the house was 20 years, for insurance. This simply illustrates what I said a moment ago about the Texas homes.

Mr. DEANE. Well, pursuing that thought a step further, on houses already financed under FHA, will this permit him to go in and re-finance for a longer maturity debt?

Mr. HOLLYDAY. If at any time the mortgagee and the mortgagor desired to do so, if they got together, that could be done. It would have to be a refinancing transaction, with a reexamination of the whole situation.

Mr. DEANE. Have you determined what the charges would be to the homeowner, for the refinancing, and what, if anything, he could lose in refinancing if he were really a deserving case, and in order to save the house?

Mr. HOLLYDAY. The refinancing costs, Mr. Deane, are essentially those that the local community and the customs determine.

Mr. DEANE. In other words, your office does not set up the type of fees that are chargeable?

Mr. HOLLYDAY. The charges FHA would impose would be incidental compared to the local charges for refinancing a property.

Mr. DEANE. Mr. Chairman, I want to direct a question now to Mr. Cole on why title V for the farm home program is not being recommended for continuance.

Mr. COLE. I suppose the first answer is a practical one, which is that it has not been utilized. As Mr. Hollyday said, I think only four applications for mortgages have been received under the program in 2 years.

Mr. DEANE. I think you and I are thinking about different programs, Mr. Cole.

Mr. COLE. Well, you are probably talking about title V of the 1949 Housing Act?

Mr. DEANE. That is right.

Mr. COLE. I understand that the Department of Agriculture's Farmers Home Administration is carrying out the functions of assisting farmers to obtain loans on their homes.

We also understand that the program is being carried out in a satisfactory manner.

Mr. DEANE. Well, are you recommending the passage of these bills which have been introduced?

Mr. COLE. We have not had them before us for clearance yet, Mr. Deane, but will have them this session for our opinion on clearance.

Mr. DEANE. Would it be practical to offer an amendment to your present legislation to extend this program?

Mr. COLE. I assume the Congressman could offer an amendment.

Mr. DEANE. Would you have any objection?

Mr. COLE. To you offering any amendment?

Mr. DEANE. No; to the program being offered.

Mr. COLE. Well, Mr. Deane, as I said in the first place, we have not cleared these bills, and, as I say to you, I am generally favorable to assisting farmers to obtain loans on their houses. And that is about as far as I can go today on it. That particular program is administered by the Department of Agriculture.

Mr. DEANE. Mr. Chairman, at this point in the record I would like to have inserted a statement that was furnished me by Mr. McLeaish, Administrator of the Farmers Home Administration, which indicates the farm housing program data from the inception of the program to December 31, 1952.

The CHAIRMAN. Without objection.

(The document referred to is as follows:)

U. S. Department of Agriculture, Farmers' Home Administration—Farm housing program data, from inception of program through Dec. 31, 1953

60

State	Number loans made		Amount loaned		Average amount loaned		Number of borrowers in arrears on Jan. 31, 1953	Applications on hand Dec. 31, 1953			
	Veteran and non-veteran	Veteran only	Veteran and nonveteran	Veteran only	Veteran and non-veteran	Veteran only		Veteran and nonveteran		Veteran only	
								Number	Estimated amount	Number	Estimated amount
(1)	(2)	(3)	(4)	(5)	(6)	(7)	(8)	(9)	(10)	(11)	
United States total	18,401	7,675	\$93,992,181	\$39,819,108	\$5,108	\$5,188	761	5,097	\$25,916,845	2,042	\$10,701,349
Alabama.....	1,022	502	5,509,475	2,802,306	5,391	5,582	8	560	3,018,960	228	1,272,696
Arizona.....	100	33	722,462	251,015	7,225	7,607	5	13	93,925	2	15,214
Arkansas.....	971	438	3,209,342	1,419,134	3,305	3,240	14	426	1,407,930	156	505,440
California.....	449	198	2,734,762	1,173,054	6,091	5,925	20	100	609,100	40	237,000
Colorado.....	212	101	1,232,162	602,578	5,812	5,966	14	45	261,540	21	125,286
Connecticut.....	34	15	142,082	64,417	4,179	4,294	1	4	16,716	2	8,588
Delaware.....	5	1	26,290	5,100	5,258	5,100	0	0	0	0	0
Florida.....	357	203	2,100,878	1,106,646	5,885	5,895	7	104	612,040	58	341,910
Georgia.....	1,164	546	5,716,975	2,752,180	4,911	5,041	27	482	2,367,102	166	836,806
Idaho.....	338	121	2,095,506	750,456	6,200	6,202	37	71	440,200	24	148,848
Illinois.....	336	122	1,328,605	433,169	3,954	3,551	1	60	237,240	23	81,673
Indiana.....	302	113	1,539,997	613,875	5,099	5,433	1	77	392,623	45	244,485
Iowa.....	355	85	1,667,289	488,405	4,697	5,141	1	60	281,820	15	77,115
Kansas.....	267	103	1,419,791	531,248	5,318	5,158	27	57	303,126	20	103,160
Kentucky.....	424	192	2,227,883	1,055,420	5,254	5,497	8	56	294,224	31	170,407
Louisiana.....	640	265	3,322,580	1,403,117	5,192	5,285	13	238	1,235,696	100	529,500
Maine.....	263	109	1,049,715	399,057	3,991	3,661	7	37	147,667	16	58,576
Maryland.....	137	51	736,046	287,165	5,373	5,631	1	42	225,666	15	84,465
Massachusetts.....	20	6	97,043	31,300	4,852	5,217	1	3	15,651	3	15,651
Michigan.....	414	171	2,002,630	866,094	4,837	5,065	11	69	333,753	29	146,885
Minnesota.....	304	96	1,262,580	361,770	4,153	3,768	11	65	269,945	19	71,592
Mississippi.....	1,145	564	4,860,853	2,406,339	4,245	4,297	30	383	1,625,835	155	661,385
Missouri.....	883	381	3,218,484	1,398,627	3,645	3,671	22	189	688,905	72	264,312
Montana.....	139	77	1,140,615	462,725	6,035	6,099	24	42	253,470	19	114,171
Nebraska.....	362	142	1,653,595	705,858	4,568	4,971	28	21	95,928	14	69,594
Nevada.....	25	9	180,807	62,750	7,232	6,972	3	3	21,696	0	0
New Hampshire.....	16	10	57,420	42,045	3,828	4,204	0	10	38,280	6	25,224
New Jersey.....	145	43	240,953	240,943	5,110	5,603	2	17	86,870	5	28,016
New Mexico.....	238	100	1,357,541	570,475	5,704	5,705	20	39	222,456	23	131,215
New York.....	165	53	908,547	320,290	5,506	6,043	13	34	187,204	14	84,602
North Carolina.....	739	309	4,229,947	1,780,397	5,724	5,762	7	152	870,048	101	581,962
North Dakota.....	196	67	1,239,038	426,387	6,322	6,364	22	162	1,024,164	41	260,924
Ohio.....	190	88	873,480	369,458	4,597	4,198	7	43	197,671	17	71,366

HOUSING ACT OF 1954

Oklahoma.....	960	367	4,847,383	1,833,676	5,049	4,966	77	216	1,090,584	74	369,704
Oregon.....	204	76	1,332,914	453,866	6,534	5,972	9	47	307,098	14	83,608
Pennsylvania.....	358	182	1,495,857	782,419	4,238	4,299	12	61	258,518	25	107,475
Rhode Island.....	2	1	5,570	3,140	2,785	3,140	0	1	3,140	1	3,140
South Carolina.....	613	319	3,597,104	2,064,680	5,868	6,472	8	206	1,208,805	86	556,592
South Dakota.....	216	66	1,139,024	367,273	5,273	5,565	28	64	337,472	27	150,255
Tennessee.....	586	269	3,040,455	1,394,213	5,197	5,383	12	117	608,049	62	333,746
Texas.....	1,158	415	6,673,353	2,425,767	5,763	5,845	121	215	1,239,045	81	473,445
Utah.....	264	80	1,654,674	537,207	6,268	6,715	14	51	319,668	26	174,590
Vermont.....	18	4	71,375	15,365	3,965	3,841	1	7	27,755	1	3,841
Virginia.....	328	167	2,122,887	1,124,077	6,512	6,731	22	92	599,104	45	302,895
Washington.....	207	98	1,412,972	681,734	6,826	6,956	8	56	382,256	33	229,548
West Virginia.....	246	114	1,575,047	790,436	6,403	6,934	3	114	729,942	53	367,502
Wisconsin.....	289	87	1,328,991	418,855	4,599	4,814	8	51	234,549	9	43,326
Wyoming.....	141	54	817,672	332,790	5,799	6,163	16	17	98,583	9	55,467
Alaska.....	1	1	1,000	1,000	1,000	1,000	0	0	0	0	0
Hawaii.....	101	22	825,950	145,135	8,178	6,597	3	13	106,314	3	19,791
Puerto Rico.....	296	35	1,369,450	170,585	4,627	4,489	17	98	453,446	13	58,357
Virgin Islands.....	15	1	75,130	3,000	5,009	3,000	6	7	35,068	0	0

Dr. DEANE. Mr. Cole, one other question on this subject: Under date of February 16 I asked Mr. McLeaish to give me some idea of this program. I can appreciate the fact that you cannot keep all of these facts at your fingertips, and since this is a program, as I understand, administered altogether by the Farmers Home Administration, that you might not have all of the facts before you.

He writes to me under date of February 16:

As of the end of January the reports received from our State office indicate that there are on hand 5,020 applications for farm housing loans, and of this amount 1,971 are from veterans. The applications on hand, multiplied by \$5,800, the estimated average size home, for 1954 fiscal year, would amount to \$29,116,000. Loans could likely not be made in each of these instances even if funds were available, since the eligibility of each applicant has not been approved, and not all of the farm units have been appraised. The farm housing funds remaining unobligated for 1953-54 fiscal year are \$3,219,226. Loans are in process which will use these funds by April 1.

This table, and this statement from Mr. McLeaish, indicate the tremendous impact of this program, and indicate to me that it is a highly desirable piece of legislation, and I would like very much to see this program carried along, and I would like to further point out that, on the basis of the loans that are in arrears, that they are less than 5 percent.

I wonder if you could tell us about it? Will you show at some time during your statement the number of loans that are behind under the various programs, and the particular problems that may be involved on any particular section?

Mr. COLE. Of FHA?

Mr. DEANE. Yes, sir.

Mr. COLE. Yes, sir; we can supply that information for the record.

Mr. DEANE. Mr. Chairman, I wonder if we could be provided with that information, loans on 608, and all loans made under the insured program, to show their status, so far as the number that are in arrears, let us say those at least 90 days in arrears?

Mr. HOLLYDAY. We have that data kept up to date, Mr. Deane, and will be very glad to insert the information you desire in the record.

I might say that the amount is less than 1 percent under all titles.

Mr. DEANE. Thank you very much.

(The data requested above is as follows:)

DEFAULT STATUS OF FHA-INSURED MORTGAGES AS OF DEC. 31, 1953

Home mortgage programs

	Insured mortgages in force	Mortgages in default	
		Number	Percent
Sec. 8.....	16, 298	90	0.55
Sec. 203.....	1, 540, 975	6, 737	.44
Sec. 213.....	6, 226	40	.64
Sec. 603.....	323, 630	2, 299	.71
Secs. 603-610.....	2, 979	10	.34
Sec. 811.....	72		
Sec. 903.....	85, 305	1, 602	4.54
Total.....	1, 925, 485	10, 778	.56

Project mortgage programs

	Dwelling units under mortgages in force	Dwelling units under mortgages in default	
		Number	Percent
Sec. 207.....	24, 530	214	0.87
Sec. 213.....	19, 543		
Sec. 608.....	430, 555	4, 191	.97
Secs. 608-610.....	2, 945		
Sec. 611.....	421		
Sec. 803.....	71, 766		
Sec. 908.....	7, 097	749	10.55
Total.....	556, 857	5, 154	.93

Mr. COLE. Mr. Chairman, may Mr. Hollyday make another comment on section 203, for the record?

The CHAIRMAN. Mr. Hollyday.

Mr. HOLLYDAY. A great deal of interest has been created by the program known as title I, section 8. Assistance was given to this program last spring, but the assistance came a little bit too late by virtue of the tight money market that existed at the time.

We now find that there is, as I am glad to report, an ever-increasing interest in the financing of those lower-cost homes. Actually, I think, in 2½ months since December 1, 1953, we have done more business and have had more applications than we had in the entire year before.

Some concern has been expressed as to whether or not the absorption of title I, section 8, into title II might be harmful to the program. The purpose of the absorption is to assist title I, section 8, financing. By putting it into title II, that should make the mortgages more acceptable, and the program is one on which we feel there will be very real activity during the coming year.

Mr. BROWN. Mr. Chairman.

The CHAIRMAN. Mr. Brown.

Mr. BROWN. Mr. Cole, I want to congratulate you on the fine cooperation existing between your office and the Members of Congress. I am sure the members of your old committee have full confidence in your ability and your integrity.

Mr. COLE. Thank you very much, Mr. Brown.

Mr. PATMAN. I want to associate myself with the statement just made by Mr. Brown. I agree with him 100 percent.

Mr. COLE. Thank you, Mr. Patman.

Mr. BARRETT. Mr. Chairman.

The CHAIRMAN. Mr. Barrett.

Mr. BARRETT. What effect is this going to have, Mr. Cole, this bill, on the redevelopment authority contained in the Housing Act of 1949?

Mr. COLE. May I reserve that question until we get to the redevelopment?

Mr. BARRETT. I think your bill provides for aid provisions for the elimination and prevention of slums. I understand the act of 1949 provides for redevelopment, in which there were \$500 million provided for that purpose.

Mr. COLE. Yes, sir.

Mr. BARRETT. Wouldn't this be somewhat overlapping? How would that be handled in your bill?

Mr. COLE. Mr. Barrett, we cover that in our statement, but may I say to you generally, before we arrive at that point in the statement, that it is my judgment it will not be overlapping, but will be complementary to the present urban redevelopment program.

Mr. BARRETT. What portion of the \$500 million has been used as of this date? Are you able to tell us that?

Mr. COLE. We can supply it for you. We will supply that information for you.

The CHAIRMAN. Mr. Multer.

Mr. MULTER. I think I have already expressed to our former colleague, Mr. Cole, how happy I am to see the wonderful job he is doing and to welcome him back. I am also glad to see by good friend, Commissioner Hollyday, here.

Mr. Cole, I am wondering whether or not the policy of our Government is going to be to make this FHA program a permanent part of our statutes? If I recall correctly, we started this program as an emergency program to stimulate and help the building industry get on its feet, and also to supply the very real need for housing which has not yet been completely supplied.

I am wondering whether or not the program which is now being submitted isn't going to put this Government insurance program on a permanent basis and keep it permanently in Government instead of trying to have private enterprise take it back where it belongs?

Mr. COLE. Mr. Multer, FHA is permanent legislation. The agency is a permanent agency which, in my judgment, has done a very fine, remarkable job.

Mr. MULTER. I agree heartily.

Mr. COLE. Let me follow through: I think Commissioner Hollyday and I are both in agreement on this one thing. If it becomes possible in the future, in an economic situation and in a political situation, that FHA or these other Government tools could be eliminated, we would say "Yes."

I personally see no way, in any even distant future, that we are going to be able to eliminate FHA, or that Congress or the people want an elimination of the programs which are provided under FHA. I just don't see it.

Mr. MULTER. I don't want the program eliminated. I want private enterprise to take over the doing of it. You and I, when you were up here, were in agreement on that, I think.

Mr. COLE. Certainly.

Mr. MULTER. Private enterprise should do the job wherever possible. Why can't the insurance companies and the lending fraternity get together and take over this insurance program on their own?

Mr. COLE. That is very true and Mr. Hollyday and I would both agree with you that that objective is a fine objective. It could not be better. I would like to have him comment on it.

Mr. HOLLYDAY. I don't believe, in a new industry—and I think that is what FHA insurance is; I do not believe that the assumption of the risk by private capital, without the Government holding the hand of private capital, will be possible until this departure has been really tested.

It is possible that you may be able to get the Bureau of Standards to investigate the record of what we have done, with their electronic brain, and be able to say that when the reserves of FHA are thus and so in proportion to the risk that has been assumed, it will then be salable to the insurance companies, Mr. Multer, and I think FHA ought also be run on the basis that the time will come when, with the experience that we have in the business, the accumulation of reserves to protect the Government, that the time will come, as in the Federal Deposit Insurance Corporation, when you would have a situation where the people who are experienced in the business would say "Well, there are sufficient funds there to protect the Government."

Mr. MULTER. That is precisely what I have in mind. We established the program, backed with Government money and Government insurance. It is a very profitable program. Your loss experience ratio is less than that of credit insurance. We demonstrated already that it is time to start building up to where the private industry can get us out of it.

Mr. HOLLYDAY. Well, we are doing it. Our \$319,000,000 reserve is desirable, and the fact that within the next 10 days I will be able to give to the Treasury a sum which will repay all Treasury advances up to date as to both principal and interest, is desirable, but I don't think I could sell you, we will say, as a representative of the Metropolitan Life Insurance people, and others, on buying out the insurance operation when during the almost entire 20 years of operation we have had a very remarkable, let us say, unusual rise in the real estate market so that we actually have not met the test. Until we have met the test then I do not think a conservative investor would want to put the funds of someone he was representing into an agency of this kind.

Mr. MULTER. That is getting close to this so-called gloom philosophy. We should not wait to go through a depression to show that this is a good program. If this country continues to need a million and a half new housing units a year, and we will need that for at least the next 10 years, and there is no possibility at least in the immediate future of building that many a year—I think your own program only contemplates a million a year—and we know that we cannot catch up in the next 10 years if we build as much as a million and a half, why should we contemplate that anything can go wrong in this industry?

Mr. HOLLYDAY. I just don't believe it is possible to sell a new, untried industry, and that is what FHA is, to you as a hard-headed businessman. I think you are not going to buy it. I don't think you have yet had enough of a test where you are dealing with the risk involved in mortgage insurance, when you look at the losses that have occurred in the real estate cycle.

Mr. MULTER. I was hopeful that you and Commissioner Cole would tell me that you were going to try to sell that to the insurance and lending fraternity, but you have given me the same answer they give me.

Mr. McVey. Mr. Chairman, I should like to second what my colleague from New York has said. I think our aim should be to transfer this situation to the lending agencies as rapidly as we can.

We do have in Chicago a project that is being constructed by the New York Life Insurance Co. It is a pretty large-sized project, for

clearing slums in Chicago. I think we should create a desire to do that sort of thing on the part of insurance companies.

Mr. COLE. We certainly agree with you, Mr. McVey.

Mr. MULTER. May I pursue another topic for a moment or two.

I notice that you are trying to give us a substitute for the public housing program.

The CHAIRMAN. Mr. Multer, before you came in, I believe, we decided that to proceed in an orderly fashion we would take up one subject at a time.

Mr. MULTER. I will try to adhere to that, Mr. Chairman.

The CHAIRMAN. Of course, that question might be contained in this subject, but I have in mind this: To proceed as we have with these different subjects, in order to avoid confusion. Then when we are all through taking them up one at a time, we can go back and tie the whole thing together.

Mr. MULTER. I think that is a good method of procedure, Mr. Chairman. I was going to direct myself to section 221.

Would you rather I do that when we talk about public housing?

The CHAIRMAN. No, we have discussed section 221, I believe.

Mr. COLE. Oh, yes.

I would like, Mr. Multer, if in discussing section 221 you are going into the philosophy of it and the support of it by the Government, through the secondary credit facility, I would like to make my statement on that, first.

Mr. MULTER. I do not intend to get into that phase of it at this time. What I was going to do was this—and, again, if you think we should wait until you have made your statement on that subject I will withdraw the question—I was going to address myself for a moment to the provisions of section 221 for housing, the \$7,000 family units.

Mr. COLE. That is a proper question at this time.

Mr. MULTER. Do you think we should pursue that now?

Mr. COLE. Yes, sir.

Mr. MULTER. I think you project a possible monthly charge of \$62.92 as the cost of interest and amortization and insurance.

Mr. COLE. All costs.

Mr. MULTER. Including utilities.

Mr. COLE. Including utilities—everything that the householder would pay.

Mr. MULTER. That would give a person a \$7,000 house at a cost of \$62.92 per month?

Mr. COLE. Yes, sir.

Mr. MULTER. What income group do you contemplate will be able to purchase that house?

Mr. COLE. That would be approximately the \$3,000 to \$4,000 income group.

Mr. MULTER. Then that would not touch the lowest income group?

Mr. COLE. Oh, no.

Mr. MULTER. I am mistaken in thinking that section 221 is urged to take the place of public housing.

Mr. COLE. It is not suggested as a substitute for those measures intended to take care of the lowest income people. May I add this one thing, Mr. Multer—

The CHAIRMAN. Mr. Multer, the lowest income people cannot qualify for public housing now.

Mr. MULTER. Unfortunately that is right. There is a limitation, which is just under \$2,000 annual earnings per family to qualify for public housing, and if it was intended to take care of that group I was going to suggest this would not do that.

Mr. COLE. That is correct. May I add one more thing, Mr. Multer: If my memory serves me correctly, 16 percent of the present occupants of public housing pay more than \$50 per month.

Now, they are the higher income occupants of public housing. It is not our suggestion that section 221 can substitute, again, for the lowest income people, or can be a substitute.

Mr. MULTER. Then it might be more nearly accurate, assuming you could build this \$7,000 house, that this might take care of some of the middle income group?

Mr. COLE. Yes, sir.

Mr. MULTER. The lowest part of the middle income group.

Mr. COLE. Also that is what it means in my statement, when I say relieve the pressure on public housing.

Mr. MULTER. Would this be the proper time to comment upon your program for financing of old homes, under FHA?

Mr. COLE. Yes.

Mr. MULTER. Tell me, has your agency gathered any statistics on how many old homes cannot at present be refinanced, and therefore need FHA refinancing or financing?

Mr. HOLLYDAY. Mr. Multer, to answer specifically, I have to say no, but I think I could give you a reasonably good answer by saying that about 30 percent of all the FHA business is on older homes. So that we have a day-to-day experience, and we have no fear at all of our ability to rate, and, therefore, to insure, older properties that have been built, just as well as we commit on the plans and specifications of properties to be built.

Mr. MULTER. You say that presently 30 percent of your financing is on older houses?

Mr. HOLLYDAY. About one-third of our 1- to 4-family business, our big title II operation is on houses that have already been built.

Mr. MULTER. Are we talking about the same thing? Are we talking about older houses which started out with FHA financing and are being refinanced?

Mr. HOLLYDAY. No, the great bulk of those houses, in the existing home classification, are properties which were never valued or insured heretofore by FHA.

Mr. MULTER. Well, if 30 percent of your loans have been on older homes, then you do not need authority in this bill to do that. You already have the authority.

Mr. HOLLYDAY. We have the authority, but the penalty on the man who has a moderate downpayment is great. We have been in effect forcing him to buy a new home with, let us say, maybe 800 square feet, where the man actually needs 1,200 square feet, which he could obtain in an older house. We would like to have the downpayment in relation to the value and the risk irrespective of whether the house is old or new.

Mr. COLE. Mr. Multer, may I illustrate on the existing home insurance, downpayment. Under the present law, and under the proposed law, I will give 2 or 3 illustrations.

A \$12,000 existing house, now would have a \$2,400 downpayment. Under the new law, it would have a \$1,400 downpayment. Under the existing law, an \$8,000 house would have a \$1,600 downpayment. Under the proposed law, it would be \$400.

There is an entire scale, but that gives you a little illustration of the distinction. In other words, that brings it in line exactly with the new construction.

Mr. MULTER. Of course, you have in mind that it requires a different type of appraisal on an older house than a new house, where you are going to watch it go up from the foundations?

Mr. HOLLYDAY. That is very definitely true, but the volume we do is so great, that frankly I have no fears about our ability to handle the business that would come in.

Mr. MULTER. To go on to another phase of the subject, in increasing the amount of loans that you will be able to make, don't you think that we are going to be getting into the luxury-class house, rather than the type of house that we need so badly?

Mr. HOLLYDAY. That would have to presuppose that FHA went in the luxury business in 1934, when we had a mortgage ceiling of \$16,000, which hasn't been changed in 19 years.

Mr. MULTER. Well, maybe we were wrong in the initial setup of the plan. Let's try to appraise things as of today. What type of house do we want to encourage being built?

Mr. HOLLYDAY. Well, if I am going to make a sale of this agency to the people that you had in mind, then, as a matter of good business, we ought not be limited, in an insurance agency, to certain specified classes of risk. Actually, to do the job, we ought not to be kept down by some welfare point of view, but as an insurance company or agency, we ought to play the insurance business in housing up to a point where we would have some of the better risks involved, as well as some of the poorer risks. We ought to insure some of the more robust individuals as well as some of the less robust individuals.

Mr. MULTER. You gentlemen are in complete agreement, I think, with every member of this committee. We dislike very much trying to break up our economy into classes and talk about the high class, the middle class, and the low class. But we have got a problem here to try to accomplish a goal that is to give decent housing to the maximum number of our citizens, and what I am afraid of is, when you raise your mortgage maximum—not because we don't want to help the man in the luxury class—but what you are going to do is drive the builder into that class, because after all he is interested in profit. We don't blame him for that. That is why he is in business. But if you let him go into the higher priced house, there is more money in it for him, and there is a bigger profit for him, and instead of getting a maximum amount of building, you are going to get a maximum of high cost building, because that is going to be the profitable business for him. That is precisely why private enterprise will not touch public housing, because there is not a good return in it. I don't blame them for not wanting it.

Mr. COLE. Mr. Multer, may I suggest that the market will control this to a very large extent. The market, the great bulk of the market,

is in the lower cost housing, and the builder will find the need to construct housing in the lower cost group.

Now, it is a matter of judgment as to where this ceiling should be placed, and you might disagree with us that it should be raised.

We feel, and Mr. Hollyday certainly feels, that with the market control, the great pressure for housing coming from the families of relatively modest income, from people who desire housing in the middle and lower price brackets, that this market demand will control it.

I do not agree with you, if I may say so, that a \$20,000 house, in the present market, would be termed a "luxury" house. It is a good house, but compared to the \$16,000 house, if we assume the \$16,000 house was right at that time—and that is the only assumption we can make—if we so assume that that was right then, it does provide a good substantial, decent house.

Mr. MULTER. I am suggesting you ought to forget about what the standard was, forget about the \$16,000, and say what is the right amount to fix today. You are talking about a \$20,000 house. But your program calls for as much as a \$25,000 house.

Mr. COLE. On the more than 1- to 4-family units.

Mr. MULTER. I am sure you will agree with me—

Mr. COLE. On values, I am sorry. I made an error there.

Mr. MULTER. I am sure you will agree with me, that as you liberalize credit on your building program and allow the more expensive house to be built, the new one, that is going to automatically push up the price on the old house, and we are not accomplishing what we want, which is maximum decent housing.

Mr. COLE. I think, Mr. Multer, Mr. Hollyday is better qualified to answer this than I, but may I add one thing and then let him answer.

Mr. MULTER. Surely.

Mr. COLE. I think experience discloses that by reason of the fact that the greater number of houses built in the lower valuation class indicates that this scale is proper—that is just my recollection to it. Mr. Hollyday is much more qualified to answer that.

Mr. HOLLYDAY. Mr. Multer, it might be interesting to you to quote a statistic out of our report which indicates that in the year 1952, only 1 percent of the business done by FHA was for mortgages above \$12,000.

Mr. MULTER. Well, I know that you have seen, as all of us have going through the country, houses which as shortly as 5 years ago were being built for \$7,000 and today are selling for \$12,000. And they are not one whit better.

Mr. COLE. That is the reason for the suggested increase.

Mr. MULTER. Well, aren't you going too high, though?

Mr. COLE. We think not. However, as I said, it is purely a matter of judgment.

Mr. MULTER. Again it is one of those things where once it gets up there, you will never roll it back.

Thank you, Mr. Chairman.

Mr. WIDNALL. Mr. Hollyday, in what urban sections of the country do you find you can build a \$7,000 home with three bedrooms?

Mr. HOLLYDAY. Were you talking about section 221?

Mr. WIDNALL. Your new proposal.

Mr. HOLLYDAY. Yes, section 221. Of course, you have put your finger on a difficult situation, but if you get above \$7,000, then you get into a price bracket that frankly we are afraid is designed for people of higher income than those that are largely going to be affected. As soon as you go out of the metropolitan area, you do get into an area where \$7,000 will take care of people. To our surprise, about 10 percent of the title I section 8 insurance took place in Michigan at a time when the ceiling for that program was only \$4,750. Now, that didn't have the same standard as the title II house has, but it did provide homes and accommodations. That was raised last year through congressional authority from a mortgage ceiling of \$4,750, to \$5,700, and in the present bill is due to go up to \$6,000.

When you get out into the less high land cost, \$7,000 will take care of a great many people.

Mr. WIDNALL. Then you will have dislocations as far as employment is concerned. When you move out to such areas, homeowners usually have to have a car to get to the job they held before. They have either got to get a new job, or they are running into too much transportation cost.

Mr. HOLLYDAY. The thought in section 221, of course, is that the program is going to provide accommodations through modernization of some of the older properties, that would make them livable. There is no doubt about it, you have put your finger on a problem, but we believe that we went as high as we should in the ceiling of \$7,000.

Mr. COLE. May I stress the modernization of existing houses as a real benefit for the urban areas? We think it has great potentiality. Mr. Hollyday has commented upon the problem with respect to the high land cost areas, and we understand that. You cannot build a \$7,000 house on extremely high cost land. We know that.

But we do think, Mr. Widnall, that section 221 authority for loans on existing housing will be of great benefit to provide decent and good housing in the urban areas.

Mr. WIDNALL. I agree with that 100 percent, but I do feel that you might have a little larger authority, as far as multifamily dwellings are concerned, to take care of the urban areas.

Mr. COLE. We think we would point out that the liberalization, the advanced authorities, of 207 and 213, will also be helpful in this connection.

Mr. WIDNALL. I would like to make this one comment. Mr. Multer spoke about a change over to the insurance companies and the lending agencies and their taking over this program themselves. Wouldn't you have to change the evaluation of examination that takes place now? Many times, the lending agencies can't assume certain risks, or have certain assets in their portfolios, because Federal or State examiners determine there is not sufficient security. But where you have a Government guaranty, they will pass it.

Mr. HOLLYDAY. I think you point out one of the things that I had in mind in talking to Mr. Multer, namely, that private funds will come in as long as the Government is there to hold the hand of the investor whose money he is putting to work, but I don't think he is going to come in with those funds until there has been a table of experience built up, and sufficient resources built up, to have private funds take over.

We try, under risk rating, not to insure any loans which will get us out of the insurance business and into the real estate business, but time and experience will tell how good our valuations and our assumptions are.

We can and do make possible loans that investors would not make without the Government guaranty. Certainly, we believe the larger loans that we propose to insure, with the system that we now use, are not going to involve the Government in the real estate business, and yet I think they would not be invested in without the insurance which the FHA gives to the investor.

Mr. WIDNALL. That is all, Mr. Chairman. Thank you.

The CHAIRMAN. Are there any further questions on this phase of the bill?

I understand that Mr. Cole, Mr. Hollyday, Mr. Fitzpatrick and the rest of the staff will be with us again tomorrow morning for the continuation of this study.

Mr. COLE. May I ask this question, Mr. Chairman. We are through with the FHA presentation. I am now ready to begin with the secondary mortgage facilities. Is that your understanding?

The CHAIRMAN. That is our understanding, of course subject to the fact that when we get through with each of these subjects separately, we may take up the whole thing again.

Mr. COLE. Very well.

The CHAIRMAN. The committee will stand in recess until tomorrow morning at 10 o'clock.

(Whereupon, at 12:25 p. m., the committee adjourned until 10 a. m., Wednesday, March 3, 1954.)

HOUSING ACT OF 1954

WEDNESDAY, MARCH 3, 1954

HOUSE OF REPRESENTATIVES,
COMMITTEE ON BANKING AND CURRENCY,
Washington, D. C.

The committee met at 10 a. m., Hon. Jesse P. Wolcott (chairman) presiding.

Present: Chairman Wolcott (presiding), Messrs. Talle, Kilburn, McDonough, Betts, D'Ewart, George, Mumma, McVey, Merrill, Oakman, Hiestand, Stringfellow, Spence, Brown, Rains, Multer, Deane, O'Brien, Dollinger, Bolling, Hays and O'Hara.

The CHAIRMAN. The committee will come to order.

We will resume the hearings on H. R. 7839.

We have Mr. Cole and his staff back with us this morning.

Mr. Cole, you may proceed.

Mr. RAINS. May I interrupt, Mr. Chairman, to ask how far along we have gotten? I was not able to be here yesterday.

The CHAIRMAN. I believe we are on page 12, of Mr. Cole's statement.

Mr. RAINS. Are you going to complete the statement before interrogation, Mr. Chairman?

The CHAIRMAN. Yesterday we decided to take the statement up by subjects, with questioning after each subject.

Mr. RAINS. Thank you, Mr. Chairman.

STATEMENT OF HON. ALBERT W. COLE, HOUSING AND HOME FINANCE ADMINISTRATOR, ACCOMPANIED BY STANLEY BAUGHMAN, PRESIDENT OF FNMA; AND B. T. FITZPATRICK, DEPUTY ADMINISTRATOR AND GENERAL COUNSEL; AND JAMES W. FOLLIN, DIRECTOR, DIVISION OF SLUM CLEARANCE AND URBAN REDEVELOPMENT, HOUSING AND HOME FINANCE AGENCY

Mr. COLE. Mr. Chairman, I am delighted to return this morning on the occasion of a matter of personal interest of the chairman. I want to congratulate the chairman upon arriving at a ripe young age today, and to congratulate the country upon the fact that we have you as chairman of this great committee.

Mr. RAINS. Happy birthday, Mr. Chairman.

The CHAIRMAN. Thank you, gentlemen.

Mr. COLE. I will continue with my statement, Mr. Chairman.

I believe there is a strong consensus as to the necessity for a secondary mortgage credit facility. Yet, despite the agreement as to need, I doubt that there is any other area where there would be greater difficulty in developing a proposal which would be completely satis-

factory to all the various groups which have a substantial interest and concern in this matter. In my judgment, however, the provisions of the bill dealing with the secondary mortgage credit facility represent a constructive approach to this difficult problem and would provide a sound and sensible basis for meeting it.

PRINCIPAL FUNCTIONS

The bill would recharter FNMA the existing Federal secondary credit facility for Government guaranteed or insured home mortgages. It would provide for the capitalization and operation of FNMA under its new charter, and would assign to it three distinct principal functions:

First, secondary market functions;

Second, special assistance operations providing for direct Government assistance for certain types of mortgages or for certain periods of time; and

Third, management and liquidating functions with respect to the present mortgage portfolio now held by FNMA.

To carry out these three functions, FNMA would be authorized, subject to the limitations prescribed by the bill, to purchase, service, or sell home mortgages insured by the Federal Housing Commissioner or guaranteed or insured by the Administrator of Veterans' Affairs. No mortgage could be purchased at a price exceeding 100 percent of the unpaid principal amount of the mortgage, and no mortgage could be purchased if the original principal amount thereof exceeded \$12,500 for each family dwelling unit.

SECONDARY MARKET FUNCTIONS

The bill provides that the secondary market operations of FNMA shall be confined, so far as practicable, to mortgages which are deemed to be of such quality, type, and class as to meet, generally, the purchase standards imposed by private institutional mortgage investors. FNMA's activities must meet two principal objectives. First, to avoid excessive use of its facilities. Second, that its secondary market operations should be wholly self-supporting. In brief, these functions would constitute a true secondary market, with FNMA purchasing only those mortgages which are generally marketable, and otherwise carrying on a business-type operation.

FNMA would be prohibited from purchasing any participations or making advance commitments in connection with its secondary market functions, except that, in the discretion of the board of directors, it could make advance commitments for purchase of an amount of mortgages equal to an amount of mortgages sold to the lender to whom the advance contract would be issued.

The bill provides that FNMA would have nonvoting capital stock. The initial issuance of stock would be subscribed for by the Secretary of the Treasury in an amount equal to the sum of the present capital stock of the existing Federal National Mortgage Association, and its paid-in surplus, surplus reserves, and undistributed earnings as of the close of a cutoff date to be within 60 days following the effective date of the bill. It is estimated this will amount to approximately \$70 million. The Secretary of the Treasury would be entitled to receive

cumulative dividends on the capital stock held by him for each fiscal year until it is retired, at rates determined by him at the beginning of each fiscal year, based on the current average interest rate on outstanding marketable Government obligations.

The bill also provides for capital funds from private sources. This private capital would be obtained in connection with the secondary market operations, but not in connection with its special assistance operations, or its management and liquidation functions. In its secondary market operations the FNMA would require each mortgage seller to make payments of nonrefundable capital contributions of not less than 3 percent of the amount of mortgages involved in any purchases or contracts for purchases. Convertible certificates would be issued to each mortgage seller evidencing the capital contributions made by the seller. After all of the outstanding capital stock held by the Secretary of the Treasury is retired, these certificates would be convertible into capital stock of equal par value. These convertible certificates would not bear interest, nor would any dividends be payable to the holders thereof.

After all the stock held by the Secretary of the Treasury is retired, FNMA would be authorized to issue stock directly to mortgage sellers. The board of directors would be given power to declare dividends at a rate not to exceed in any year 5 percent of the par value of the outstanding stock. Such dividends would not be cumulative.

FNMA would also be authorized to impose charges or fees for its services. Earnings would be transferred annually to a general surplus account. Provision would also be made for the establishment of reserves. The capital stock held by the Secretary of the Treasury would be retirable from funds of the capital surplus and the general surplus accounts. Except as to stock held by the Secretary of the Treasury, capital stock would not be retirable if, as a consequence, the amount remaining outstanding would be less than \$100 million.

To carry out its secondary market operations, FNMA would be authorized to issue, with the approval of the Secretary of the Treasury, obligations for sale to the investing public. The aggregate amount outstanding at any one time could not exceed ten times the sum of its capital, capital surplus, general surplus, reserves, and undistributed earnings. At the time of issuance, the total of obligations could not exceed the amount of the cash, mortgages, and Government bonds held by FNMA in connection with its secondary market operations. Such obligations would not be guaranteed as to principal or interest by the United States.

The Secretary of the Treasury would be authorized, in his discretion, to purchase the secondary market obligations of the Association, but his holdings could not at any time exceed \$500 million plus an amount equal to a total of the reductions in the amount of the existing FNMA portfolio which FNMA would be liquidating or, in any event, \$1 billion. This authority of the Secretary of the Treasury would terminate when all of the capital stock held by the Secretary of the Treasury had been retired. This provides for Treasury backup, if necessary. It is believed, however, that FNMA could raise funds required for its secondary market operations by the sale of its obligations to private investors without resort to Treasury borrowings.

As soon as possible after all the capital stock of the Association held by the Secretary of the Treasury has been retired, the Housing Administrator would be required to transmit to the President for submission to Congress recommendations for legislation to transfer the assets and liabilities of the Association in connection with, and the control and management of its secondary market operations, to the private owners of the outstanding capital stock.

In connection with the proposed secondary market functions of the Association, there are two matters which I think merit particular consideration.

First, as I have already indicated, the convertible certificates which are issued by the Association to mortgage sellers on account of the capital contributions made by them do not bear interest, and no dividends would be payable to the holders thereof. It seems to me that consideration should be given to providing discretionary power to the board of directors to permit some return on the moneys paid in by mortgage sellers as capital contributions during the period they hold these convertible certificates, and prior to the time when they are exchanged for capital stock which is entitled to such dividends as the board of directors may declare. I suggest that the board of directors be given discretion to permit a return not exceeding the rate of return on the capital stock held by the Secretary of the Treasury.

Second, the requirement that each mortgage seller must make non-refundable capital contributions of not less than 3 percent of the principal amount of mortgages sold to FNMA may be so high as to impede the successful carrying out of the contemplated secondary market functions. It would be my hope that the testimony presented to your committee during the course of the hearings would provide the basis for an appropriate determination as to the figure to be established for the nonrefundable contribution to be required of mortgage sellers.

SPECIAL ASSISTANCE OPERATIONS

The bill provides that the President, after taking into account conditions in the building industry and the national economy and conditions affecting the home-mortgage investment market, may authorize FNMA to make commitments to purchase, and to purchase such types, classes, or categories of home mortgages as he may determine. The funds required to carry out these special assistance operations would be obtained entirely from Treasury borrowings.

TWO TYPES OF SPECIAL ASSISTANCE ARE AUTHORIZED

First, FNMA could purchase and make commitments to purchase such home mortgages and participations therein, but the total thereof could not exceed \$200 million outstanding at any one time.

Second, FNMA could be authorized to enter into commitments to purchase immediate cash participations in mortgages and to make related deferred participation agreements. The deferred participation agreements could be made only on the basis of its purchasing an immediate cash participation of a fixed 20 percent undivided interest in a mortgage and a related deferred participation agreement to purchase the remaining outstanding interest in such mortgage condi-

tional upon the occurrence of a default. The total amount of such immediate cash participations—not including the amount of any related deferred participation agreements or purchases pursuant thereto—could not exceed \$100 million at any one time. The \$100 million relates to immediate purchase of a fixed 20 percent undivided interest in each mortgage, with purchase of the remaining interest in the event of default being excluded from such dollar limitation. Thus, the \$100 million authorization would permit such special assistance to cover a total of not exceeding \$500 million in mortgages.

I have not been able to fully satisfy myself as to the desirability of the provisions of the bill which would require the purchase of a fixed 20 percent undivided interest in each mortgage in connection with a participation agreement to purchase the remaining outstanding interest. For example, if this authority were to be used to provide assistance for mortgages insured under the new FHA section 221 program—and it is intended to be available for that purpose—I can see no reason why a lender who would be willing to make such a loan on the basis of a deferred participation agreement by FNMA to buy the loan if it went into default, would be particularly interested in disposing of 20 percent of such loan at the time of origination, and thus proportionately reduce the return which it could earn on such a relatively small loan.

Under the circumstances, it seems to me that your committee may well wish to give consideration to the desirability of changing this particular provision to make it more flexible and perhaps better suited to meeting conditions as they arise. One way of doing this would be to provide that FNMA may make deferred participation agreements to purchase mortgage loans, conditional upon the occurrence of a default, without any cash participation at the time the loan is made, and to authorize the Association to make immediate cash participations of not exceeding a 20 percent undivided interest in any mortgage to accommodate lenders who might wish to have the Association as an immediate partial participant in the loan.

In such case the appropriate dollar limitations would be \$500 million for both participation and commitments.

The provisions of the bill relating to the management and liquidating functions of FNMA would provide a sound basis for the orderly liquidation of the present mortgage portfolio, without disruption of the home mortgage market and with minimum loss to the Treasury. At the same time, it could very substantially reduce the burden required of the Treasury to carry the present portfolio by permitting the substitution, as rapidly as practicable, of private financing for outstanding Treasury borrowings.

To assure maximum private financing to carry the mortgages held in the present portfolio, FNMA would be authorized, with the approval of the Secretary of the Treasury, to issue obligations for sale to the investing public. Such obligations would not be guaranteed as to principal or interest by the United States. The total of such obligations could not exceed the amount of the cash, mortgages, and Government bonds held by FNMA in connection with these management and liquidating functions. The proceeds of any private financing would be paid to the Secretary of the Treasury in reduction of the present outstanding indebtedness of FNMA to the Secretary.

FNMA would also be authorized to issue its obligations to the Secretary of the Treasury in sufficient amount to carry out its functions in this connection. However, the maximum amount of obligations which could be issued to Treasury could never increase beyond the limit of \$3,350,000,000 to accommodate the present portfolio and outstanding commitments for which authority already exists. Provision is also made for the progressive reduction of this maximum amount by the amount of cash realizations from the liquidation of the portfolio, with the objective that the entire amount shall be eliminated as promptly as practicable.

I think most of the members of the committee know and appreciate the very excellent job which Mr. Stanley Baughman has done since he has been president of FNMA. Mr. Baughman is here with me and, together, we will try to answer any questions you may have.

The CHAIRMAN. I believe that concludes the presentation of the problems of FNMA?

Mr. COLE. That is correct, Mr. Chairman.

The CHAIRMAN. According to our previous understanding, we will take up this question at this time.

Are there questions of Mr. Cole by members of the committee with respect to the presentation on FNMA?

Mr. RAINS. I have some, Mr. Chairman.

The CHAIRMAN. Mr. Rains.

Mr. RAINS. First of all, Mr. Cole, maybe I do not understand it, but is your mind actually clear on how this is going to work, or is this just a bunch of language all jumbled up together? I note you seem to be for it and then against it in one or two places.

Mr. COLE. No; I am not against it any place, Mr. Rains. There are one or two questions which are not quite resolved—minor questions, may I say, or relatively minor.

My mind is very clear about the purpose for which FNMA is set up in this bill.

Mr. RAINS. What will be the interest that the Treasury will receive on its stock in FNMA?

Mr. COLE. The going rate of interest.

Mr. RAINS. It would be the going rate?

Mr. COLE. Yes, sir. A rate calculated to return to the Treasury the funds supplied by it to purchase the capital stock.

Mr. RAINS. And what interest would the private investors then receive on their contributions?

Mr. COLE. They will receive a dividend. I assume you mean the certificates—when it becomes stock?

Mr. RAINS. That is right.

Mr. COLE. Yes, sir; they will receive dividends on capital stock, not to exceed 5 percent, Mr. Rains.

Mr. RAINS. I am wondering whom you intend to have pay the 3-percent contribution, the lender, the purchaser, or the home builder?

Mr. COLE. It is the seller of the mortgage to FNMA.

Mr. RAINS. The seller?

Mr. COLE. Yes, sir; the seller of the mortgage would be an institution which is now supervised—life insurance companies—

Mr. RAINS. A fiduciary institution of some kind?

Mr. COLE. Yes, sir; or a private corporation which meets FNMA's regulations.

Mr. RAINS. Well, now, when those institutions which are tied up by rules and regulations as to how much they will be able to lend their money for, not knowing how much they are going to be able to get out of their contribution, how are they going to be able to make an investment in FNMA if they cannot tell at the beginning what their return is going to be?

Mr. COLE. They will not be able to tell what their returns will be in the beginning, Mr. Rains. This is set up following a procedure which has been not only recognized but has been operated very satisfactorily in the Government under other programs, where the participants have taken advantage of the benefits offered, and it has worked very satisfactorily. Apparently the lenders find that the advantages are sufficient to take whatever risk there may be involved in the uncertainty with respect to the amount of return.

Mr. RAINS. Well, actually, Mr. Cole, in the long run, the purchaser will be paying the 3-percent contribution? In the final analysis that means the man buying the house, doesn't it?

Mr. COLE. Not necessarily, Mr. Rains. The procedures of FHA and VA., and their appraisals, should be sufficient to protect the purchaser.

Mr. RAINS. It appears to me from reading the—and I admit I am not able to understand all of it—that the purchaser of the house, or the home, what he is actually doing is buying stock for a lending institution in this organization and that when he pays it off that they get the benefit from the stock and he gets nothing, and they have put nothing in it.

Mr. COLE. No, I cannot agree with you, Mr. Rains. The purpose of a secondary mortgage credit facility is to assist the even flow of money from savings areas to expanding producing areas, where money is scarce.

Now, we must recognize that there are areas in this country where people do pay more for their money than in other areas.

Mr. RAINS. Mine is one of them, but I do not want to accentuate that difference.

Mr. COLE. Nor do I, and may I say that this is a positive approach to the accomplishment of the objective in which you are interested, and that is to provide for people in the areas where money may be scarce, to provide for those people who want to build homes and to own homes, to provide them with a greater facility, a greater opportunity to borrow money, which will aid them in securing the homes they want.

Mr. RAINS. Well, I understand that is the aim of it, but what I am trying to determine is whether or not it is going to do that.

Mr. COLE. That is right.

Mr. RAINS. Now, let me ask you another question: When the Treasury stock which you mentioned—was that in amount of \$70 million?

Mr. COLE. Approximately.

Mr. RAINS. When that is retired, under this bill, and according to your statement, will not private lending institutions acquire the ownership of this multimillion dollar corporation?

Mr. COLE. The people who have participated in the building of the secondary mortgage facility; that is correct.

Mr. RAINS. I cannot find anywhere where they are going to have any money in it.

Mr. COLE. They will have it in through their participation through their purchase of the certificates, and then later, the conversion of those certificates into capital stock. They will purchase their stock, in other words, by contributions made at the time they use the facility. In other words, it is a 3-percent participation.

Mr. RAINS. But actually what that is doing is taking the credit of the Federal Government in the amount of \$70 million, if that is what it is, building up this corporation, and then when that stock is retired, with the credit of the Government having been used, the people who are going to get the benefit of it are the people who have invested in FNMA., the lenders and not the purchasers?

Mr. COLE. No, I cannot agree with that. I can agree with you partially. But the lenders will certainly have some advantage, Mr. Rains, and it would be incorrect for me to say that they would not.

But I do not agree with you that the only people that will have the advantage are the lenders. The other people that will have an advantage, if this secondary credit facility works—and I think it has every possibility of working—the other people who will have an advantage will be the home buyers, the persons who now find it difficult and have found it difficult to secure mortgage money by reason of scarcity of the money in their particular areas. They will have an advantage.

Now, this is not a new proposal.

Mr. RAINS. It is new in turning the whole organization over to the lender instead of to the purchaser and the builder, isn't it? That part of it is new?

Mr. COLE. Let me say this: It is new so far as FNMA is concerned.

Mr. RAINS. Yes, sir.

Mr. COLE. It is not new as a program of the Federal Government to assist people in obtaining a facility which later is controlled, owned, and operated by the so-called private industry.

The Federal Home Loan Bank is one example; the Home Owners Loan is another. The Federal Deposit Insurance Corporation and the Federal Farm Credit.

Mr. RAINS. Well, of course, the Federal Deposit Insurance Corporation, as you said, was not intended to be controlled by the banks. The control is in the Federal Government. But when the Federal Government gets out and the stock is returned in this instance, are you going to turn over to a private institution the servicing and management of public purpose loans made by the Treasury?

Mr. COLE. Mr. Rains, I want to add one more thing: When it becomes apparent that it can be converted to private ownership, at that time, according to my statement, and according to the legislation, the administrator would be required to present to Congress his recommendations for legislation, to be either approved or disapproved, to transfer the secondary market functions to the private owners of the stock.

In other words, it is not an automatic disposal of it. Congress has the final judgment, and the final decision, as it should have, as to the method, or, frankly, whether it should be done, or how it should be done.

Mr. RAINS. Well, there is no difference between us, I am sure, on the need of a secondary mortgage market. I know that in areas like the

South and West, away from the big financial centers of the country, that if we are going to have housing we will have to have it. So the only place I differ with you is here: It is difficult for me to see how men who are in the business of lending money are going to move into this kind of a situation, such as is suggested in this bill, when today they have a higher return from their money outside, in all the loans they can make. How is that going to work?

Mr. COLE. Let me first comment on the first part of your question, and that is that part of this to be converted to private ownership is only that which is the true secondary mortgage lending facility. Neither the liquidating functions of FNMA, nor the supporting functions of FNMA, will be converted.

Secondly, there has been a great deal of discussion, a great deal of study, and a great deal of investigation, of the possibility of successful operation of this type of a facility. The President's Advisory Committee studied it very exhaustively. Our agency has conducted a great deal of investigation along this line. We are convinced that it has an excellent opportunity of success. I don't mean to imply that investors will immediately pour out millions of dollars to invest in the organization, but as it grows, and as they find that it does channel money to the areas where the money is required, and as it begins to expand more and more of them will use it, as has been done in other agencies and other facilities which I described to you a little while ago.

Quite truthfully it is a different approach, and a new approach, so far as FNMA is concerned, but we think it is well worth trying to accomplish this objective—to accomplish the objective of providing an even flow of money without complete and absolute Government formation and control of funds. We believe that the people themselves who buy, who build, who lend, who are a part of the free market system, can, if given some original support, develop an agency which is not completely a Government agency, and not completely a Government-controlled operation, and not operated completely with Government funds. It is a matter of judgment as to whether or not it can work.

Mr. RAINS. Well, now, you restrict this to only marketable mortgages, which means, of course, that they have got to be completely sound mortgages, and if they are remote from financial centers what do you think about that?

Mr. COLE. I think they are just as sound if they are remote from financial centers—

Mr. RAINS. No, I say that in order for them to be purchased at all they must be sound, since you say they can only buy marketable mortgages.

Mr. COLE. That is correct.

Mr. RAINS. You say, too, that it must be at or below the market; that is correct, isn't it?

Mr. COLE. The purchase?

Mr. RAINS. The purchase.

Mr. COLE. Yes, sir.

Mr. RAINS. This is what I do not understand: You add, too, that it must be at the market price, yet under FNMA you are going to add to each transaction 3 percent of the transaction, which added to the price makes it now higher than the one for one that FNMA is now putting out, doesn't it?

Mr. COLE. It is about comparable, Mr. Rains.

Mr. RAINS. About comparable?

Mr. COLE. Yes, sir.

Mr. RAINS. You mentioned a moment ago some studies that your organization had made. I wonder, are you familiar with one prepared by the FHA called "Prospective Level of Residential Construction and Availabilities of Mortgage Money, 1954-58"?

Mr. COLE. I am generally familiar with it.

Mr. RAINS. I do not want to burden the record, Mr. Chairman, but there are one or two of those issues which have to do with the number of farm families in need of housing assistance. I would like to have put in the record that matter. I think it is good background material.

What do you think, Mr. Cole?

Mr. COLE. I think it is good background material.

Mr. RAINS. It does not bear out my point especially, but it does show the need. I think it would be helpful.

The CHAIRMAN. The study may be helpful.

Without objection, it may be put in the record.

Mr. BOLLING. Which ones?

Mr. RAINS. "Prospective Level of Residential Construction," and the one which has to do with the number of nonfarm families in need of housing assistance.

(The data referred to above are as follows:)

OCTOBER 9, 1953.

To: Subcommittee on FHA and VA Programs and Operations, President's Advisory Committee on Housing Policy

From: Allan F. Thornton, subcommittee staff adviser

Subject: Prospective Level of Residential Construction and Availability of Mortgage Money, 1954-58

As requested by the subcommittee, the attached memorandum has been prepared to appraise the prospective level of residential construction and the availability of mortgage money for financing this volume of construction.

The estimates and analysis have been made without including any assumptions as to the amount of new construction which will be generated by urban redevelopment or neighborhood rehabilitation programs. These programs have been omitted because their character and scope appear to be generally dependent on programs yet to be determined. It may be noted, however, that after 1954 it appears that availability of mortgage money, assuming adequate protection, should not prove a substantial obstacle to either type of program.

It should be emphasized that the attached estimates should not be looked upon as forecasts, although every effort has been made to be realistic and reasonable in the making of projections. However, substantial variations are possible in many of the assumptions which have been necessary, especially with respect to economic conditions and the terms of governmental programs.

The staff adviser has had the valuable assistance of consultation and working materials from individual economists in the Bureau of the Budget, the HHFA Office of the Administrator, the Veterans' Administration, the Federal Reserve Board, and the Bureau of Labor Statistics, as well as in my own staff in the Federal Housing Administration. Technical materials have also been made available by the Council of Economic Advisers. It should be noted, of course, that none of these agencies can assume any responsibility for the content of the attached memorandum.

The shortness of time for preparation of the memorandum must be mentioned as partial explanation for any inadequacies of the report for the uses of the subcommittee.

ALLAN F. THORNTON,
Subcommittee Staff Adviser.

Attachment.

PROSPECTIVE LEVEL OF RESIDENTIAL CONSTRUCTION AND AVAILABILITY OF MORTGAGE MONEY, 1954-58

The projections contained in this memorandum are in no sense a forecast of future trends in business and home building activity. Rather they represent an attempt to show the level of home building which might be attained provided we remain at peace and have a continued high level of business activity. The projections do not include any estimates of new construction because of either present urban redevelopment programs or proposed rehabilitation operations. In addition to these basic assumptions the major economic assumptions inherent in this broad description of economic conditions are enumerated in the attached memorandum No. 1.

If the basic and economic assumptions adopted hold during the next 5 years it is likely that neither construction capacity nor the availability of mortgage funds would be a major deterrent to the production of housing. The adequacy of building capacity is discussed in appended memorandum No. 2, and limitations to the adequacy of mortgage money are considered subsequently in this memorandum.

It should be noted that the projected level of home building is further conditioned by implications of continued progress in the adjustment of housing production to the shifting requirements of the market as reflected in particular demand characteristics. Some of these characteristics are discussed below under "Qualifying Factors." They highlight specific housing problems, the solution of which requires continuing and increasing attention. To the extent that these problems are resolved in substantially greater degree than recent trends indicate the level of home building may be expected to exceed the present projection.

Estimated volume of new residential construction, 1954-58

In December 1952 the Bureau of the Census released its latest available estimates of prospective net household formation (series P-20, No. 42). Net increases in households are estimated by the Bureau in high, medium, and low series for the time intervals from April 1952 to July 1955 and from July 1955 to July 1960.

For the "high" series, based on economic assumptions generally consistent with the assumptions of this memorandum, average annual increases of households are estimated at 915,000 for the period before July 1955 and 800,000 for the next 5 years, to July 1960. Corresponding average annual increases in the "medium" series are 697,000 and 624,000. A Census Bureau release dated October 4, 1953 (series P-20, No. 48), estimates actual household increases at 950,000 for the 12 months ending in April 1953—a figure which is close enough to support the use of the 915,000 annual increase for the remaining period until mid-1955.

Averaging 18 months of 915,000 annual increase and 42 months of 800,000 annual increase results in an estimated average annual increase of 834,500 for the entire period 1954-58, inclusive. This series of estimates from the Bureau of the Census provides for a modest further reduction in the number of married couples living as "extra families". (The above estimates of increase are presented as national totals but may also be used as estimates of non-farm increase on the assumption that farm households will not change in number.) This average annual increase of 834,500 households constitutes the major part of the requirement for additional dwelling units which it is estimated will be provided for occupancy during that time.

In addition to this number, it is estimated that a minimum of 60,000 dwelling units annually will be required as replacements of units destroyed by catastrophe, other hazards, and other demolitions (except for redevelopment and rehabilitation programs). This estimate is the most recent made by the Bureau of Labor Statistics. However, it is conceivable that the number of demolitions might be substantially larger in a high level economy in which incomes and housing standards continue to rise, making for a more rapid downward filtering of older houses.

Still further additions to the housing supply can be made which could lead to vacating other habitable units up to an increase in total vacancy of such units of perhaps 500,000 to 750,000 by the end of 1958. It appears that such an increase in effective vacancies, properly distributed geographically, would not materially affect the marketability of either new or existing housing (the national supply of habitable, nonseasonable, vacant units available for rent or sale might then be about 3 percent, as compared with 1.6 percent reported by

the 1950 census) and would materially encourage the improvement of housing conditions through the filtering process.

The combination of these numbers indicates from 994,500 to 1,044,500 units as the range of average annual residential production during the 1954-58 period.

This estimate is believed appropriate for an estimate of new construction, since it is our opinion that net losses of units from conversions (i. e., conversions to nonresidential use or to fewer residential units in excess of conversions creating additional units—an excess of perhaps 10,000 to 25,000 annually) will be compensated for by transfers of units from farm to nonfarm occupancy (estimated by BLS at 30,000 annually from 1940 to 1950, often as an accompaniment to construction of new units for farm occupancy, releasing existing units for transfer to nonfarm use).

It should be noted explicitly that these estimates are exclusive of any construction to compensate for either slum clearance operations or organized neighborhood rehabilitation programs which destroy units in addition to the 60,000-unit demolition estimate for other causes presented above.

It may be further noted that if economic conditions are somewhat less favorable, although still prosperous, net household formation and housing construction may average as much as 200,000 annually less than the above estimates. If, on the other hand, favorable economic conditions prevail, including the ready availability of mortgage funds for liberal financing and an output of new housing concentrated to a greater degree than heretofore in the lower and middle price ranges to serve the broad market of families having incomes of \$2,000 to \$5,000, the volume of new housing might range upward as much as 200,000 units higher than the estimates given above. The attainment of such a high volume of effective demand might require 100 percent, 25- to 30-year loans for veterans and almost as liberal financing for lower income nonveterans.

The apparent range of reasonable residential construction start estimates for the next 5 years is thus from about 800,000 to 1,250,000 annually, with a greater likelihood that the actual average volume will stay within the range of 900,000 to 1,100,000 annually under the economic conditions described in memorandum attachment No. 1.

Qualifying factors concerning estimated level of construction housing quality.—If the level of construction estimated is to be attained, exclusive of net additions by urban redevelopment and rehabilitation, the quality of the housing produced must be effectively related to the characteristics of the market requirements. Without intending that the following discussion attempt a detailed distribution of housing requirements, it does appear that specific mention is desirable of some demand characteristics of the market which have not as yet been fully recognized.

The high birthrate of recent years (averaging nearly 3.7 million annually from 1946 to 1952) has increased the sizes of younger families beyond the typical family of prewar years. This fact suggests a need for greater proportions of 3- and 4-bedroom units in total new construction than has been characteristic of postwar construction, especially among moderate priced units.

The attached table 1, showing family incomes for total nonfarm families in 1951, indicates the relative importance of the families with income from \$2,000 to \$5,000, which included 52 percent of the total in 1951. While the filtering process can be expected to assist in improving housing standards for lower income families, nevertheless the maintenance of a high level of new construction inevitably will be dependent on pricing policies which put a minimum of reliance on the filtering process. That is to say, much of the new housing must be sold or rented to families with incomes throughout the \$2,000 to \$5,000 range or a glut of the market may develop because of the problems involved in marketing a substantial number of existing homes vacated by higher income families moving into new housing. The provision of a significant amount of new housing for families in the lower levels of the income range indicated above presents a real challenge and requires positive action for achievement.

The continuing and heavy migration of nonwhite population into metropolitan areas of the Nation has posed special problems in the housing field. It seems essential that special attention and effort be directed to these problems both in the interest of improving the housing standards for this population and of assuring a maximum market for the additional housing produced. It appears that opportunities might be examined both for marketing new housing directly to minority families and also for a more expeditious marketing of units released in the existing housing inventory through operation of the filtering process.

The continued aging of the population, combined with the increasing coverage of social security and pension programs, will continue to increase the number of households comprised of retired couples and individuals. It seems important that the sound economic opportunities for marketing new housing to such households, many of whom are self-supporting, should be explored and developed if a high level of new construction is to be sustained. Attached table 2 shows the numeric increase in population over 55 from 1930 to 1950 and projected expectations from 1950 to 1960.

Availability of equity funds for home purchase should not prove a serious problem during the coming 5-year period if mortgage money is readily available and if new housing produced is made attractive in both price and quality to families already living in better than substandard conditions. The most recent reports of the Federal Reserve Board Survey of Consumer Finances, from which the attached tables 3 and 4 are drawn, indicate widespread holdings of liquid assets by spending units in all income ranges and also substantial equities in such properties as homes which could be converted to downpayments on new houses.

The importance of liberal terms for mortgage financing is emphasized, however, by the fact that many households have only limited amounts of liquid assets—some 45 percent of all spending units, as reported by the Federal Reserve Board, having less than \$200 in liquid assets. For others who have more ample liquid assets, liberal financing terms may also be essential if families are to be induced to leave housing they now occupy (which may well be acceptable on the basis of minimum standards) in order to improve their housing conditions by moving to new and more modern accommodations.

Market considerations.—The production of about 1 million new units per year for the 1954-58 period could have serious effects on the condition of the housing market. Even though household formation exceeds an average of 800,000 annually, a proper allocation of new units geographically and by price or rental will be essential to assure a continuing healthy condition in the housing market.

At least one major aspect of the housing market which will require careful attention is that for existing homes. While some reduction in prices of older somewhat depreciated homes may be desirable for a rapid filtering-down process, avoidance of undue softening of existing home prices may be aided by availability of adequate financing, by modernization of units, by maintenance and rehabilitation of neighborhoods, by aggressive marketing, and by measures for removal of obsolete or dilapidated units through closing or demolition.

While some increase in vacancies is not only tolerable but probably desirable in some localities, a careful observation and analysis of vacancy trends might be most salutary in guiding market developments during the 5-year period. The creation of local facilities for measuring and recording the trend of vacancies would be most helpful in this respect as well as special measures which could be taken by the Bureau of the Census for recording national trends.

Liberal financing.—The availability of adequate mortgage financing is a prerequisite to the accomplishment of the expected volume of construction. It is difficult to appraise the extent to which further liberalization of financing (beyond "adequate" funds on present FHA terms and modest GI downpayment terms) would stimulate additional construction.

With respect to loans for veterans, it is not unreasonable to assume that general availability of 100-percent mortgages might raise the expected level of GI home loans closed from a 35,000 monthly average indicated by cumulative past experience to about 52,000 monthly—approximating the average of the peak year 1950. If about three-fourths of the aggregate increase is provided for by new construction, a maximum of perhaps 500,000 to 600,000 additional new units might be started on the basis of VA approvals before July 25, 1957 (75 percent of 731,000, which is 17,000 per month increase for 43 months from January 1954 to July 1, 1957). This number would constitute an average of 100,000 to 120,000 extra units annually above the previous estimated volume of construction.

It is still more difficult to appraise the influence which would be exerted by liberalization of mortgage financing for nonveterans. Liberal credit for new construction only could be expected to provide a temporary stimulant to new construction, followed successively and in due course by an accumulation of vacant existing homes, a weakening of existing home prices, a weakening of new home prices, and a curtailment of the volume of new construction.

Although mortgage credit on existing older homes might be expected to be somewhat less liberal than for new homes, liberalized credit for both new and

existing homes might well effect a sustained stimulation of new construction with an acceleration of the filtering process, an increase in homeownership, and eventual demolition of a larger number of abandoned properties.

Caution must be advised in the administration of liberalized credit in two major regards: First, liberalization of terms may result only in friction, public disillusion, and dislocation of market operations if the total money available for mortgages is not plentiful at the time of liberalization; second, special care should be exercised to avoid inflation of prices by virtue of liberalized credit. The dangers of the second type are likely to be less in the economic climate, housing situation, and condition of the building industry during the next 5 years than was the case in the years immediately following World War II.

Residential mortgage financing requirements, 1954-58

Under the broad assumptions outlined earlier, with production of new housing continuing large in the 1954-58 period, although possibly somewhat smaller than in recent years, and with the transfer of existing properties falling not far below recent record highs, gross mortgage-lending requirements will also remain large. Repayments on the very large and still growing outstanding mortgage debt, however, including regular amortization, partial prepayments, and payments in full owing to the sale of property and other reasons, are likely to increase further. As a result, the net flow of funds into mortgages required in the 5 years of high level activity ahead are likely to be smaller than in the preceding 5 years.

Financing the output and sale of new houses.—The amount of funds required to finance a given volume of housing depends on a number of related factors—terms of financing, proportion of federally aided and conventional mortgages, price distribution of houses sold. As a result of variations in these and other factors, the same number of housing units may require different amounts of mortgage funds, and conversely a given amount of funds may be associated with different numbers of housing units. For example, the estimated 950,000 new homes sold in 1952-53 required \$5.8 billion of mortgage funds in the former year and \$6.1 billion in the latter. Conversely, the amount of funds required in 1950 was only slightly larger than the amount required in 1952, although the number of new houses sold in the earlier year was considerably larger. In these years the average size of mortgage loan varied considerably, the proportion of FHA and VA financing was substantially different, and the price composition of houses sold was changing.

In suggesting, therefore, what volume of mortgage financing might be associated with an average annual output of 1 million private housing units in the next 5 years, basic assumptions with respect to these factors must be made within the framework of the more general assumptions discussed earlier. It has been assumed that the price structure will not change much with builders continuing their recent proportions of output in the low and middle price groups, and that prices in general will remain at least at current levels; that interest rates will stabilize at about the present level and that FHA-insured and VA-guaranteed loans will be generally acceptable in the market; that partly as a result of the foregoing, the proportion of federally underwritten loans will rise from recent reduced levels; that overall financing terms may become more favorable to the borrower and that as one consequence the average size of mortgage loan will rise. Considering all of these factors, the weighted average amount of mortgage loan made on new 1- to 4-family houses over the next 5 years may be around \$500 larger than the 1953 average, or about \$7,800.

If an average of 1 million private housing units is started and completed in the 1954-58 period, on the order of 925,000 may be in 1- to 4-family dwellings. According to experience in recent years, about one-eighth of these units will be purchased for cash or otherwise financed without a mortgage, leaving 815,000 units requiring mortgage financing.

On the basis of the above calculations and assumptions, therefore, the gross flow of funds into mortgages required to finance new 1- to 4-family housing in the next 5 years will average about \$6.3 billion a year, or total \$31.5 billion over the entire period.

Financing the sale of existing houses.—Factors favorable to an active market for new houses do not necessarily insure a strong market for existing houses. Some of the conditions necessary for a favorable existing house market have already been discussed, and on the assumption that these will be present, a continued relatively high level of demand for existing housing, consistent with the high level of demand for new housing, is assumed in the 5 years ahead. Sales of

existing houses have been unusually large in the recent past, however, owing to a combination of many stimulative factors and may fall somewhat in the immediate years ahead. Compared to a volume of close to 2 million units in 1952-53, sales may fall to an average of around 1.7 million units in the 1954-58 period, about as large as the 1950-51 volume, and considerably larger than the 1948-49 average volume.

About one-fifth of all purchases of existing houses are on the basis of mortgage or nonmortgage financing, according to current information, so that 1.4 million units will require mortgage financing. This would amount to about \$9.2 billion of gross mortgage lending, assuming an increase in the average size of mortgage to about \$6,600. (Assumptions are roughly similar to those outlined above for new house purchases.)

In addition to mortgage lending associated with purchases, there will be funds loaned on existing houses for other purposes—refinancing, repair and modernization, children's college expenses, etc. On the basis of recent experience, this may total around \$4 billion.

Net mortgage financing requirements.—The total gross funds required, therefore, to finance new and existing 1- to 4-family houses may average around \$19.5 billion a year in the 1954-58 period, or total \$97.5 billion. Repayments to mortgageholders on previously contracted mortgage debt, however, may be expected to rise further during these years. The rate of repayment may not be as high as it is currently, since sales of existing houses which give rise to a large part of total repayments, are expected to decline somewhat. Nevertheless, regular amortization and partial prepayment on the large and increasing mortgage debt together with a still large volume of retirement through property sale, would give rise to an increasing volume of debt retirement—possibly averaging about \$15 billion a year for the next 5 years. If this volume of debt repayment is realized, and reinvested in mortgages, then net flow of funds required for mortgages on small homes will average \$4.5 billion, compared with an average of about \$6.6 billion in the past 3 years and the peak of \$7.6 billion in 1950.

Considerably less data are available to indicate future net mortgage financing requirements for multifamily units. The volume of new construction is not expected to be large, perhaps averaging about 75,000 units in the 1954-58 period. Together with transfers of existing multifamily units, this may require an average net volume of mortgage funds of \$1 billion per year.

Total residential financing requirements, therefore, would amount to an annual average of \$5.5 billion net as shown in table 5, or a total of \$27.5 billion for the 5 years ahead, of which \$22.5 billion will be for 1- to 4-family units. Based on an outstanding mortgage debt of \$65 billion at the end of 1953, the outstanding volume on 1- and 4-family properties at the end of 1958 will amount to about \$87.5 billion.

Availability of mortgage funds

The increasing volume of debt repayment in the next few years which would decrease the net mortgage funds requirements to finance a given volume of house purchases would also be characteristic of other segments of the economy. Thus, capital consumption allowance, which consist largely of corporate depreciation allowances on plant and equipment, would total an estimated \$34 billion by about the middle of the 1954-58 period, as compared with an estimated \$29 billion in 1953. The latter dollar amounts include an allowance for housing depreciation which is more or less accounted for in monetary funds by the mortgage amortization payments. Depreciation allowances on plant and equipment are realized by corporations through deductions from taxable income although these deductions might or might not be realized in cash accumulations by business firms, depending on their pricing policies. Under the assumed high-level employment economy, with the further assumption of stable price levels, it is logical that the corporations would realize cash accumulations equal to the depreciation allowances. These depreciation allowances will be very high in the next few years due to the rapid amortization certificates for tax purposes issued during the last 3 years to stimulate plant expansion for defense production.

In addition to the high depreciation allowances, it is assumed that by the middle of the 1954-58 period the Government will have arrived at a surplus budgetary position, allowing for some retirement of the Federal debt. This will also increase funds available for private investment.

It is also expected that a high level of personal savings slightly in excess of the current level will continue to provide a substantial flow of funds for long-term investments.

For these reasons, despite the high level of gross private investment projected for the high-level economy during an average 1954-58 year (\$66 billion as compared with an estimate of \$56 billion during 1953) it is expected that ample funds will be available to finance housing and other investment activity. Industrial corporate expansion will probably be financed to a much greater extent from retained profits and the increased depreciation allowances than during 1953.

The development of an ample supply of investment funds, which has been described, is not expected to assume significant proportions in 1954 but a gradual improvement in the supply of such long-term funds should take place, and the average-year relationships which have been described may be in effect by about the latter part of 1955. Under these average-year relationships, since the repayments on mortgages will be substantially higher than at present and since it is contemplated that the volume of housing to be financed will not be greater than in the current year, the net mortgage fund requirements would be only about \$5.5 billion as compared with about \$7.8 billion in 1953.

On the other hand, the institutions making mortgage loans, particularly the life-insurance companies, will have less opportunity to place their funds in alternative investments, and it is expected that the volume of new funds seeking investment in mortgages in the average 1954-58 year will total about \$9 billion. Even if it is assumed that the institutional investors would purchase about \$0.5 billion of mortgages from the FNMA portfolio, it would still leave about \$8.5 billion of funds seeking investment in mortgages. Under these conditions, it is logical to conclude that the present FHA and VA 4½ percent maximum would be an effective rate and that the mortgage financing terms offered by lenders probably would be somewhat more liberal than at present.

If some softening in the economy were to develop, causing lower total investment demand and some decline in mortgage fund requirements, the supply of mortgage funds would be even more adequate at current interest rates, although lenders might tend to tighten up on the downpayment requirements and shorten maturity terms.

On the other hand if, due to unforeseen increased defense production expenditures, the Government should not reach a budgetary surplus position the supply of funds for mortgages in relation to the demand would be tighter than has been projected, the degree of tightness depending on the extent of Government deficit financing which might become necessary.

MEMORANDUM ATTACHMENT No. 1

The following are the major assumptions as to the economic environment during the 5-year period for which the housing construction estimates in this memorandum have been prepared:

1. No substantial change in international relations, that is, no "hot" war, but continued "cold" war without substantial gains on either side.
2. Maintenance of high level of economic activity in the Nation, not far below the recent past.
3. Federal expenditures close to current levels with a possible moderate budget surplus (including sustained foreign-aid programs and military expenditures close to recent rates, with military strength maintained at current levels).
4. Unemployment slightly above recent past, but not higher than would be consistent with a high level of economic activity.
5. Plant and equipment investment at high levels.
6. Federal taxation at about present levels.
7. Price structure stable, with wage increases generally in conformity with productivity increases.

It is further assumed that the scheduled ending of home-loan guaranty privileges as of July 25, 1957, does not require for this memorandum any special recognition since the continued availability of similar benefits for Korean veterans will be of increasing importance at about the same time. Presumably, some construction of new units after July 25, 1957, will be financed by VA-guaranteed loans for World War II veterans who made their financing arrangements before the expiration of the program. Simultaneous expansion of home purchasing by Korean veterans will further minimize any decline in home starts because of the termination of the World War II guaranty program.

MEMORANDUM ATTACHMENT No. 2

CAPACITY OF THE CONSTRUCTION INDUSTRY

Under the conditions assumed in this analysis it is anticipated that the construction industry will have no serious difficulty in providing the volume of housing, together with other types of construction, which will be needed over the next 5 years. The construction industry is highly flexible in nature, especially as regards residential building. Individual builders expand and contract their scale of operations quite readily and may enter or leave the industry with ease, as the demand for their product changes.

Although there are an increasing number of large firms in the residential building industry, there still remain many thousands of small operators who contribute very significantly to the total volume of housing construction. A survey made by the Bureau of Labor Statistics in 1949 indicated that there were 120,000 firms in the residential building industry at that time. In addition, however, over one-fourth of the privately built nonfarm dwellings were constructed by nonprofessionals, that is, persons who built houses for their own families, frequently doing part of the construction themselves.

The flexibility of the industry is aided by the fact that relatively little capital is needed for the initiation of small-scale residential construction. Many skilled construction tradesmen have become independent contractors or speculative builders during the past few years.

Past experience indicates that there should be no serious labor shortage problems under the general conditions assumed. Employment in construction has varied widely, reflecting both seasonal and cyclical influences. Even during periods of continuous relatively full employment the number of workers in construction has fluctuated rather wildly. This comes about in part because of the greater mobility of construction workers than is found among many other groups, and also from the fact that the high hourly rates offered for construction work during prosperous seasons attracts skilled craftsmen who may be employed in other industries or self-employed during slack periods. Total labor requirements for the construction industry at its present rate of operations are estimated at around 3 million workers. This includes not only employment in contract construction but also the workers involved in force-account construction for Government agencies and private firms. A measure of the flexibility of employment in construction may be found by examining the record of the war and postwar period. Contract employment averaged 1,790,000 per month in 1941 and jumped to 2,200,000 in 1942. In 1944 it had dropped back to about 1,100,000.

Under the conditions assumed, it cannot be taken for granted that the supply of construction labor will be fully adequate at all times and in all places. The economic situation expected to prevail will result in virtually full employment. This means that the construction industry will be competing with other industries for the available labor supply and in some areas temporary labor shortages will cause trouble. Such local pressures are necessary, however, to bring about the labor mobility which is essential in the construction industry as it functions in this country.

TABLE 1.—*Distribution of nonfarm families in United States by total money income 1951*

Income	Number of families	Percent distribution	Income	Number of families	Percent distribution
Under \$500.....	1,146,000	3.3	\$4,500 to \$4,999.....	2,439,000	7.0
\$500 to \$999.....	1,220,000	3.5	\$5,000 to \$5,999.....	4,156,000	12.0
\$1,000 to \$1,499.....	1,452,000	4.2	\$6,000 to \$6,999.....	2,599,000	7.5
\$1,500 to \$1,999.....	1,811,000	5.2	\$7,000 to \$9,999.....	2,827,000	8.1
\$2,000 to \$2,499.....	2,428,000	6.9	\$10,000 and over.....	1,349,000	3.9
\$2,500 to \$2,999.....	2,694,000	7.8			
\$3,000 to \$3,499.....	3,626,000	10.4	Total.....	34,762,000	100.0
\$3,500 to \$3,999.....	3,598,000	10.4	Median income, \$3,919.		
\$4,000 to \$4,499.....	3,417,000	9.8			

Source: Census Series P-60 No. 12.

TABLE 2.—Total population of United States 55 years old and over

	Total		Increase
1930.....	15,030,703	1930-40.....	4,560,816
1940.....	19,591,519	1940-50.....	5,972,613
1950.....	25,564,132	1950-60.....	5,817,868
1960 (estimate)	¹ 31,382,000		

¹ Estimate of Census release P-25, No. 78, based on assumption there will be a continuation of the decrease in mortality observed during the 1940's. The rates of decrease in mortality during the 1940-50 decade were so considerable that the assumption used may result in some overstatement of the number of survivors at the upper extreme.

TABLE 3.—Proportion of liquid assets held by spending units and family units at various income levels, early 1953

1952 money income before taxes	Spending units		Family units	
	Percentage distribution	Proportion of liquid assets held	Percentage distribution	Proportion of liquid assets held
Under \$1,000.....	11	6	10	5
\$1,000 to \$1,999.....	14	7	12	6
\$2,000 to \$2,999.....	16	9	14	7
\$3,000 to \$3,999.....	18	13	16	10
\$4,000 to \$4,999.....	15	9	15	9
\$5,000 to \$7,499.....	17	21	21	23
\$7,500 and over.....	9	35	12	40
All units.....	100	100	100	100

Source: 1953 Survey of Consumer Finances, Part IV, supplementary table 9.

TABLE 4.—Ownership of assets within income groups, early 1953

Assets	All spending units	1952 money income before taxes (percentage of group owning asset)			
		Under \$3,000	\$3,000 to \$4,999	\$5,000 to \$7,499	\$7,500 and over
Liquid assets.....	71	52	76	93	98
Automobile.....	61	36	70	84	92
Owner-occupied nonfarm home.....	43	32	43	57	65
Business interests ¹	7	3	6	8	22
Corporate stock.....	7	4	5	10	28
Money loaned out.....	12	12	11	14	17

¹ Includes unincorporated business and owner-operated privately held corporations.

Source: 1953 Survey of Consumer Finances, pt. IV, table 5.

TABLE 5.—Mortgage lending on nonfarm residential properties

[In billions of dollars]

	1952	1953 ¹	1954-58 average
Total residential properties: Net increase in mortgage debt.....	7.1	7.8	5.5
Multifamily properties: Net increase in mortgage debt.....	.8	1.0	1.0
1- to 4-family properties:			
Net increase in mortgage debt.....	6.3	6.8	4.5
Gross mortgage lending.....	18.0	20.0	19.5
Apparent retirements.....	11.7	13.2	10.0
Outstandings (end of period).....	58.2	65.0	87.5
Average amount of mortgage for house purchase:			
New houses ¹	\$6,900	\$7,300	\$7,800
Existing houses ¹	5,500	6,900	6,600

¹ Partly estimated.

TABLE 6.—*Estimates of net savings inflows and net additions to residential mortgage holdings of lenders in 1953 and annual average of net savings inflow and of new funds¹ seeking mortgage investment in a high level employment economy, 1954-58, inclusive*

[In billions of dollars]

Type of lender and type of long-term funds	Estimated net savings inflow		Estimated increase in mortgage holdings, 1953	Estimated new funds seeking mortgage investment in average year, 1954-58
	1953	Average year, 1954-58		
Savings and loan associations, net inflow of savings.....	3.8	4.1	3.3	3.7
Life insurance companies, growth of assets.....	5.0	5.4	1.6	2.1
Mutual savings banks, net increase in deposits.....	1.8	2.0	1.4	1.6
Commercial banks, net increase in time deposits.....	2.8	3.0	.8	1.0
Institutional subtotal.....	² 13.4	² 14.5	7.1	8.4
Individuals and others.....			.3	.6
Private subtotal.....			7.4	9.0
Government—FNMA funds and VA direct loans.....			² .4	³ —.5
Total.....			7.8	8.5

¹ Exclusive of repayments to portfolios

² Additional personal liquid savings flowing into nonmortgage lending channels are estimated as follows:

Private-pension funds.....	1953	1954-58 average
United States savings bonds.....	\$1.2 billion	\$1.5 billion
	.2 billion	.5 billion

³ Estimate of amounts of actual increase or decrease in holdings rather than of funds seeking investment.

Mr. BOLLING. Perhaps at this point it would be appropriate to ask that the census of 1953 statistics on housing and income of the United States nonfarm and standard metropolitan area families go in the record as well.

The CHAIRMAN. A summary of it?

Mr. BOLLING. What would Mr. Cole think about that?

Mr. COLE. From our point of view I think it is all right, if it is not too long. That is a matter for the committee to decide. I think the information is well worth having.

Mr. BOLLING. I am not in position to say exactly how voluminous it is.

Mr. RAINS. How about the summary of it?

Mr. BOLLING. I think the staff can make that determination. I want the salient facts in the record.

The CHAIRMAN. You do not want it broken down into localities, do you?

Mr. BOLLING. No; overall.

The CHAIRMAN. We will leave it this way: If it can be determined that it can be put in in summary form, without objection, it will be inserted in the record.

(The material referred to is as follows:)

Selected statistics on housing in 168 standard metropolitan areas: 1950

Subject	Total
OCCUPANCY, TENURE, AND RACE	
Occupied dwelling units.....	24,514,440
Owner occupied.....	12,508,912
Percent of all occupied.....	51.0
White.....	11,893,649
Negro.....	592,755
Other races.....	22,508
Renter occupied.....	12,005,528
White.....	10,576,283
Negro.....	1,378,634
Other races.....	50,611
Nonresident dwelling units.....	60,395
Vacant dwelling units.....	1,051,546
Nonseasonal not dilapidated, for rent or sale.....	414,207
Percent of all dwelling units.....	1.6
For rent.....	276,015
For sale only.....	138,192
Nonseasonal not dilapidated, not for rent or sale.....	277,782
Nonseasonal dilapidated.....	91,603
Seasonal.....	267,954
POPULATION	
Population in dwelling units, 1950.....	80,799,991
Population per occupied dwelling unit.....	3.3
Total population, 1940.....	69,282,301
Population per occupied dwelling unit.....	3.8
TYPE OF STRUCTURE	
All dwelling units.....	25,626,381
1 dwelling unit, detached.....	12,550,820
1 dwelling unit, attached.....	995,302
1 and 2 dwelling unit, semidetached.....	1,118,814
2 dwelling unit, other.....	3,657,794
3 and 4 dwelling unit.....	2,591,713
5 to 9 dwelling unit.....	1,767,918
10 to 19 dwelling unit.....	969,587
20 to 49 dwelling unit.....	1,147,193
50 dwelling unit or more.....	666,159
Trailers.....	160,581
Vacant nonseasonal not dilapidated dwelling units, for rent or sale.....	414,207
1 dwelling unit, detached.....	177,986
1 dwelling unit, attached.....	11,600
1 and 2 dwelling unit, semidetached.....	18,689
2 dwelling unit, other.....	47,995
3 and 4 dwelling unit.....	51,555
5 dwelling unit or more.....	106,382
All dwelling units.....	25,626,381
WATER SUPPLY	
Hot and cold piped running water inside structure.....	21,591,736
Only cold piped running water inside structure.....	2,527,716
Piped running water outside structure.....	321,480
No piped running water.....	859,402
Not reported.....	326,017
TOILET FACILITIES	
Flush toilet inside structure, exclusive use.....	21,716,139
Flush toilet inside structure, shared.....	1,290,921
Other toilet facilities (including privy).....	2,083,559
No toilet.....	181,757
Not reported.....	354,005
BATHING FACILITIES	
Installed bathtub or shower, exclusive use.....	20,821,515
Installed bathtub or shower, shared.....	1,212,480
No bathtub or shower.....	2,934,213
Not reported.....	658,173

Source: Housing Census of 1950.

Mr. RAINS. Recognizing, Mr. Cole, that the secondary market is one of the most essential factors in achieving the goal which you have set for housing for the country for this year—and when I say “you,” I mean the Administration—will you inform the committee as to what your goal is for housing starts this years?

Mr. COLE. We do not have a goal, Mr. Rains, as such. I believe, and I think, based upon sound statistics and judgments which have been presented to us, that we can establish a production of a million houses this year.

Mr. RAINS. A million houses?

Mr. COLE. Yes, sir.

Mr. RAINS. Let me ask you another question: Do you regard a million houses as a satisfactory effort in meeting the needs of the housing problem as shown by these studies made by your organization?

Mr. COLE. I would say that if we build a million houses we are satisfactorily producing and consuming, in our present economy, a commodity which is essential.

If you would ask me if I thought that a million houses would meet all the needs of all the people, the answer is “No.” But I want to say to you that in a sound economy, in a level of high activity and of productivity, I would think that a million houses would be a reasonable expectation.

Mr. McDONOUGH. Will the gentleman yield?

Mr. RAINS. Just for one question.

Mr. McDONOUGH. Well, the million houses that you referred to are all new houses, are they not?

Mr. COLE. Oh, yes, sir.

Mr. RAINS. That is what I am asking about, new starts.

Mr. COLE. That is correct.

Mr. RAINS. What percentage of the national income in the past year was the housing construction business? Do you know?

Mr. COLE. We can get it very quickly.

3.4 percent of gross national product, I am informed.

The CHAIRMAN. I thought it was one-fourth.

Mr. COLE. Well, we will provide it for the record.

Mr. RAINS. The entire housing construction industry would be more than 3.4.

Mr. COLE. This is gross national product.

The CHAIRMAN. I refer to the report of the Joint Committee on the Economic Report, which shows that the new construction has accounted for about one-fourth of the national income.

Mr. RAINS. That is the figure I was reaching for.

Recognizing it is essential to maintain income up to a high level, isn't there some other reason why we should keep up the figure of housing starts, rather than the one most basic, perhaps, of giving people homes.

Mr. COLE. Mr. Rains; yes, sir. There is a social reason.

By social reason, I mean there is a need by people who do not have decent houses now, to acquire houses, and certainly, within what can be done, properly, it is my objective to do everything possible to assist

in increasing the availability of housing for people who are now living in slums and blighted areas and under conditions which are deplorable.

Mr. RAINS. Of course, it has a sound economic reason, also, because if you keep the housing construction at a high level—I am speaking of the whole construction industry—it helps solve the economic problem, which some people don't like to talk about, but back in the grass-roots we know about it. Wouldn't it help in that way?

Mr. COLE. I may have misunderstood you. Of course, I think the economic problem is very, very important in this field.

Mr. RAINS. Do you believe that FNMA—I have a lot of respect for your judgment, having served on the committee with you—yet I think you are delving into a very tricky business with this FNMA; do you believe that the mortgage money necessary will be purchased to achieve even a million new starts next year?

Mr. COLE. Yes, sir.

Mr. RAINS. And I say at reasonable rates of interest.

Mr. COLE. Yes. Now may I say, Mr. Rains, that the authority to help accomplish that objective is contained in the entire FNMA proposal, not entirely in the purely secondary mortgage facilities.

Mr. RAINS. What has been the result of the operation that we knew as one-for-one? How did it turn out?

Mr. COLE. That increased the availability of money in areas where money was tight, where mortgage money was difficult to obtain. The one-for-one program did assist people who wanted to buy homes, who wanted to find homes in those areas, it assisted them materially, in my judgment, in securing homes.

Mr. RAINS. Now, FNMA is out of funds at the present time, is that right?

Mr. COLE. No.

Mr. RAINS. How much does it have?

Mr. COLE. Well, Mr. Baughman corrects me. I said "no" and he said just about. That is about it.

Mr. RAINS. What is the current net income of FNMA, do you know?

Mr. BAUGHMAN. The current income of FNMA?

Mr. RAINS. Yes.

Mr. BAUGHMAN. This year we expect to earn approximately \$27 million.

Mr. RAINS. \$27 million.

Mr. BAUGHMAN. Yes.

Mr. RAINS. Under this operation we are speaking about, that \$27 million, of course, could be estimated as profit to the lenders who participate, could it, or not?

Mr. BAUGHMAN. If we had the same size portfolio, that would be true. Except in this bill you will notice that the corporation as proposed is not exempt from income taxes.

Mr. RAINS. Yes, I understand.

Mr. BAUGHMAN. Federal income tax, that is.

Mr. RAINS. You are talking about the dividends or the returns to those contributing to the funds?

Mr. BAUGHMAN. The earnings of the new corporation is subject to Federal income tax.

MR. RAINS. One other thing: You said you expect to get a spread of—you call them contributions, I call them investments in the fund—whatever they are, across the country, and I deem you visualize getting small lending institutions and so forth to do it, but as I read your bill and statement, it appears to me that since only 3 percent is the amount, that you are not going to get those contributions except from the extra large financial institutions. What is your idea on that?

MR. COLE. Mr. Rains, that is the one area in which I have not found a firm conclusion upon my part. May I say to you that I have been advised that the 3 percent will meet some resistance, and that it should be lowered. I have also been advised that it should be 4 percent, because there should be greater contributions on the part of those contributions or investments on the part of those who deal with the facilities, and it is, after all, a privilege that is worth money.

I try to resolve it in this way—and maybe we came to a compromise on it: We tried to resolve it in this way: We want a facility which will work, which will actually do the job of helping to provide an even flow of mortgage money, and we would like to hear, as well as this committee, additional testimony upon this, to help us come to a conclusion. We are not dodging the issue. I am merely saying to you very frankly that we have compromised between those who say it will not work at 4 percent and that 2 percent is required, and we say here it is at 3 percent, as a trial figure to throw out.

I would be satisfied, personally, to start off and try it at 3 percent, unless this committee finds that it doesn't work. If it doesn't work we can always come back and say that our experiment is not right and we will try it over again.

It is one of those things that is a matter of judgment, and some of that judgment may be influenced, to some extent, by personal interest in the matter, of course, and so we are just doing the best we can and saying this seems to be a compromise within the range of judgments which have been expressed.

MR. RAINS. Mr. Cole, I think I can tell you where you are basically wrong. I don't believe you can operate an agency of this type, in charge of lenders, and I don't believe that any secondary market can ever work unless you have Government control and regulation of it.

MR. COLE. Well, I certainly would agree with you to this extent: that where the Government has an interest in it, and as long as the Government has an interest in it, then the Congress, the executive branch, must have some control over it.

MR. RAINS. For instance, you took FDIC. I don't think FDIC would work if it were in the hands of the banks entirely. Not at all.

MR. COLE. As long as the Government has some interest then the Government must take some responsibility.

MR. RAINS. Don't you visualize when this requirement is arrived at, that will be turned away from the Treasury completely, and away from the Government?

MR. COLE. I may not go as far as you. I take one step further. I refuse to recognize the fact that all of the lending, all of the building, all of the business of assisting people to secure money, through this type of a facility or some other type of facility, I refuse to believe that the only way that that can be done is through Government, and

therefore, I say, let's try to do something which will make a facility available to the people who want to buy, who want to build, to accomplish this objective themselves.

Now, that is just a matter of philosophy.

Mr. RAINS. It is rather a calculated risk we are taking when we need lending so badly, so desperately for housing, isn't it?

Mr. COLE. No, for this reason: It would have been in my judgment had we merely offered to this committee a secondary market facility which would have been the first organization, or the first segment of this. But we do say that in the present circumstances of the economy, and otherwise, that there must be a Government-supported segment of this facility, and therefore have, frankly, said so.

Mr. RAINS. Mr. Chairman, I have taken too much time. I want to ask one other question, not on this particular section. Talking about housing, I didn't find anything here about rural housing. I would like to have the Administrator tell me what he thinks about it, and whether or not an amendment should be introduced.

Mr. COLE. Mr. Deane raised the question yesterday, Mr. Rains. It was not left out of this bill by reason of any adverse decision on our part. I understand that there are bills introduced, both in the Senate and House, with respect to title V of the 1949 act.

It is, in my judgment, a matter of concern for the Secretary of Agriculture, and the operations of that program have been conducted in that Department.

By reason of the lag in time of clearances, it hasn't come to our agency for final clearance, and I don't mean to indicate any adverse action on it at all.

Mr. RAINS. May I ask the chairman if, when that time arrives, for consideration of that subject, whether we will be able to be heard and whether it will be considered along with this bill?

The CHAIRMAN. I am not prepared to say right now. There is a question of the time element, but I think we can find the time.

Mr. RAINS. I don't think it would take a lot of time.

Thank you, Mr. Chairman, and Mr. Cole.

Mr. STRINGFELLOW. Mr. Chairman.

The CHAIRMAN. Mr. Stringfellow.

Mr. STRINGFELLOW. First, Mr. Cole, I would like to compliment you and your agency for taking this very worth while and constructive approach for recommending some sort of a secondary mortgage credit facility to excite the even flow of money, even though your proposal doesn't embody all of the desirable features that I would like to see, I believe it is a step in the right direction.

Now, to clarify one point in my mind, why is it that you placed a limitation on the mortgages in the amount of \$12,500, when the facility will deal specifically with FHA and VA mortgages, when yesterday Mr. Hollyday testified to the fact that they are raising their limitation to \$20,000 on a one-family unit?

Mr. COLE. The present limitation on FNMA is \$10,000, Mr. Stringfellow, and this is an expanded authority, up to \$12,500.

The \$10,000 limitation was placed, as I recall it, in FNMA because it was felt that the FNMA support should be for the lower valued houses, and that it should not be a facility which would lend its support to, shall we say, luxury-type homes, which we were discussing yesterday.

Mr. STRINGFELLOW. But isn't it a fact that you are not acquiring mortgages for your own portfolio, but to be able to acquire money?

Mr. COLE. We certainly hope so. That is the function of it, to turn them over.

Mr. STRINGFELLOW. Well, it seems to me that it would be more desirable to have the two limitations more consistent.

Mr. COLE. Well, Mr. Stringfellow, one of the members was questioning me yesterday on the expansion of authority from \$16,000 to \$20,000 on FHA, and on the other side of this issue, he thought it should be lower.

Now it is a question of judgment. We felt that we were doing some considerable moving in expanding it up to \$12,500.

Mr. STRINGFELLOW. I recognize that fact.

Mr. COLE. We really believe that. I naturally would leave that to the judgment of the committee. If they disagree with me in that regard, they can change it.

Mr. STRINGFELLOW. I appreciate your comments, Mr. Cole.

Now, I believe I should direct these next questions to Mr. Baughman, who is president of FNMA. Mr. Baughman, in reference to Mr. Cole's statement, on page 15, "convertible certificates would be issued to each mortgage seller evidencing the capital contributions made by the seller." Would there be any objection to issuing stock to those who market paper, to FNMA, rather than issuing the convertible certificates called for by the bill?

Mr. BAUGHMAN. It could be done, except I think the position that has been taken so far is that as long as the Treasury has its money invested in capital stock, that it should remain the sole stockholder until the stock of the Treasury has been retired.

Mr. STRINGFELLOW. We will say we did issue stock to those who marketed paper with FNMA, would there be any objection to paying dividends on such stock?

Mr. BAUGHMAN. Providing the earnings were such that they could be paid, it would be possible to do so.

Mr. STRINGFELLOW. Now my final question: Would there be any objection, in view of the fact that the capital of FNMA would progressively become private capital, to have a minority of the directors of FNMA elected by the private stockholders?

Mr. COLE. Our position has been that as long as the Government is in, the directors should be entirely Government personnel. The question of representation on, or control of, the board of directors by the private stockholders should be decided after the Government capital is retired.

Mr. STRINGFELLOW. Thank you, Mr. Chairman.

Mr. BOLLING. Mr. Chairman.

The CHAIRMAN. Mr. Bolling.

Mr. BOLLING. Mr. Cole, I believe you said in reply to a question by Mr. Rains that you anticipated a million units of new construction within the coming year.

Mr. COLE. Yes, I put it in this way, Mr. Bolling: I don't think a million units, this year, can be constructed, unless the market, those who are building, those who are lending, see to it that the building is maintained at a high level. The Government tools should be used effectively, too. In other words, it could slip behind.

Mr. BOLLING. How much behind?

Mr. COLE. I don't know.

Mr. BOLLING. It could slip very substantially behind, to the tune of a hundred or two hundred thousand units?

Mr. COLE. No, I wouldn't think so. Mr. Bolling, the reason I always hesitate to say "goals" for 1,000,000, or 1,100,000, or 900,000, is because it isn't a goal, but rather a maintaining of a high level of activity and productivity.

Mr. BOLLING. From what you have just said, it would appear, however, that you do not anticipate this going over the million.

Mr. COLE. It could.

Mr. BOLLING. Do you think it more likely that it will go over or under?

Mr. COLE. Well, you have me there. I think it is more possible that it would go slightly over than under, Mr. Bolling, in the present market situation.

Mr. BOLLING. I would assume that in the studies made by the Commission on Housing—and it's obvious from titles of the things Mr. Rains has had inserted, that some sort of survey has been made of need.

Did you come to any conclusion as to what the annual rate of construction is that is needed, by a certain date, to achieve a reasonable level of adequacy?

Mr. COLE. Mr. Bolling, the problem of need has been discussed in this committee and in the President's Advisory Committee, and by us, in the agency, and by others interested in housing, for many years.

The question of need becomes, again, one of judgement, I do not think there has been, yet, a satisfactory investigation of the precise dimension of the need for housing by the people of America.

I think it requires a tremendous operation to accomplish that objective.

Now, to go one step further: There are some statistics which are available, and which we can insert in the record, and which would give you an indication of how we arrive at our opinions concerning our prophecy concerning the new starts.

Mr. BOLLING. In other words, what you are saying is, in effect, that the need is the million units which you anticipate will be built this year?

Mr. COLE. The need is more than a million, Mr. Bolling, without any question. If you say to me "Will a million houses, constructed next year, provide decent housing for all the people of America?", the answer obviously is "No."

Mr. BOLLING. Does that mean that if we constructed a million a year for an indefinite period that the answer might be "Yes"?

Mr. COLE. I don't know. I really don't know. It depends in part on predictions of the future rates of population growth, net new family formation, and so forth.

Mr. BOLLING. In other words, the million units is not necessarily related to the need?

Mr. COLE. If you are talking of a social need, the million is not necessarily related to the social need.

Mr. BOLLING. Then, turning to another area, turning to the actual and theoretical capacity of the home building industry to build, have you made any estimates of what their capacity on an annual basis is?

Mr. COLE. Their capacity in my judgment is far above a million.

Mr. BOLLING. Would you make a guess? Is it a million and a half, two and a half million?

Mr. COLE. I don't believe I would guess at it. I am not qualified. But I have a very definite idea that this home building industry is a tremendously vigorous, active, aggressive industry, and it is growing and expanding.

I don't know how many houses they could build in the year, truthfully.

Mr. BOLLING. But it is well over a million?

Mr. COLE. Oh, without any question.

Mr. OAKMAN. Would the gentleman yield?

Mr. BOLLING. Yes.

Mr. OAKMAN. Commissioner, isn't the stated program of the building industry to build 1,400,000 homes a year for the next 10 years? Wasn't that more or less the program adopted at their national convention in Chicago earlier this year?

Mr. COLE. The answer is "Yes," I am informed.

Mr. DOLLINGER. Will the gentleman yield?

Mr. BOLLING. Certainly.

Mr. DOLLINGER. The million you speak of, Mr. Cole, was what kind of housing? What kind of housing would that be?

Mr. COLE. All kinds.

Mr. DOLLINGER. What percentage of that would be \$7,000 housing?

Mr. COLE. I would hope it would be a very high percentage, Mr. Dollinger.

Mr. HAYS. There is such a thing as \$7,000 housing?

Mr. COLE. Yes. I can make a guess on that, Mr. Dollinger.

Mr. DOLLINGER. All right.

Mr. BOLLING. I take it, then, that your goal of a million—and I suppose goal is the right word—

Mr. COLE. Well, I won't use the word "goal."

Mr. BOLLING. What word do you use?

Mr. COLE. I don't use a word. I say that the industry can produce, and the people can consume, a million houses next year.

Mr. BOLLING. So you have indicated, if I understand your statement—

Mr. COLE. May I add one more thing?

Mr. BOLLING. Certainly.

Mr. COLE. And that the economy will absorb them.

Mr. BOLLING. Limiting ourselves to the first criterion, namely that the market will absorb and the industry will produce, roughly a million units, if I understand you correctly you have indicated that you thought that the social need, which may be very substantially different from what the market can absorb at certain prices, was substantially more than a million units, that the capacity of the industry was also substantially more than a million?

Mr. COLE. Right.

Mr. BOLLING. So this must be governed, then, really by the third factor—what the economy can absorb?

Mr. COLE. Certainly it is a governing factor.

Mr. BOLLING. It is apparently, from our conversation, the governing factor.

Mr. COLE. No, I don't agree. It is a governing factor.

Mr. BOLLING. On what basis do you disagree?

Mr. COLE. Well, when you say a governing factor, it is within the possibility that this Congress could appropriate and approve legislation, which would build all the houses for all the people that need them, Mr. Bolling.

Mr. BOLLING. That is one extreme.

Mr. COLE. That is an extreme.

Mr. BOLLING. Now, this is the point in which I am very much interested: Where would you place the administration's program? Somewhere between complete inactivity and the extreme you have just mentioned? Would you say that it was half-way between?

Mr. COLE. No, I wouldn't say any percentage. I say that this Government, this administration—we can put it on this administration, if you care to do so—this Government, has the responsibility to do everything within its power to assist the people of this country to obtain decent housing, and that must take into consideration, Mr. Bolling, the social need, and the economic need.

I don't think the two can be split. I think they much be considered together.

Mr. BOLLING. You then feel, from the point of view of the social needs and from the point of view of the needs of the economy, that this—whatever it is—I am not sure what word to use now—that this million-unit estimate is approximately the right one?

Mr. COLE. No, I haven't said that and do not say that. I think that if the social needs and the economic needs can be so adjusted that we can build more than a million houses a year, I will be for it and do everything I can to bring it about. I really mean that.

Mr. BOLLING. I don't understand that because you have come up here with a proposed program.

Mr. COLE. Yes, and this proposed program, in my judgment, is the best program that I can envision, which will permit an expanding activity, which will not tie us to a million-unit figure as a goal, but will give the impetus, socially, economically, and politically, to expand just as far as possible to meet the need.

Mr. BOLLING. Mr. Cole, are you familiar with the last paragraph of the section dealing with housing of the committee report of the Joint Committee on the Economic Report? It is on page 11 and reads:

All housing programs, especially public housing, and slum clearance programs, should recognize that there are times when economic conditions may call for accelerated active efforts and flexibility in the area of public housing and slum clearance, and making them important sustaining forces in the year ahead.

Mr. COLE. Yes.

Mr. BOLLING. You are, I take it, familiar with that?

Mr. COLE. Yes.

Mr. BOLLING. We have been discussing an estimate, or a guesstimate, or a hoped-for goal, not goal, but a hoped-for something, for the present year in the field of housing construction.

Without getting into the broad question of what the state of economy is today, am I correct in believing that housing constructed in the last year was approximately 1,100,000 units?

Mr. COLE. Yes.

Mr. BOLLING. Now, what would your comment be when you relate those two facts together, the estimate for the year 1954 being a hundred

thousand less, apparently, than the construction level in the year 1953.

How would you comment on that in relation to that last paragraph of the committee report of the Joint Committee on the Economic Report, in connection with the present economic situation?

In other words, is this housing program going to have a sustaining effect on the economy?

Mr. COLE. No question about it, it will have a sustaining effect.

Mr. BOLLING. In the sense that if you didn't have a million units, it would be considerably worse. Is it going to be better, in any sense, than 1,100,000 units, in its effect on the economy?

Mr. COLE. If I understand your question, the answer is "No."

Mr. BOLLING. In other words, this is a program which goes down almost 10 percent from the actual construction.

Mr. COLE. No, the program does not go down, Mr. Bolling. Again you are talking to me about goals. My goal is not a million houses. The administration's goal is not a million houses. The Agency's goal is not a million houses. We say that we would be delighted if it would be, if 2,000,000 houses can be produced in a year, provided it meets the tests of social and economic needs.

Now, that is not set by Government, in my judgment. You see, I don't believe that Government sets the entire economic atmosphere of the country. We can assist. Government can assist in maintaining a stability, and I am certainly one who believes that we have not even approached the expansion and productivity that this country is capable of.

Mr. BOLLING. What is the administration's program in one of those fields in which the Government could have a great deal to do with determining the level of housing construction was, as you pointed out earlier, what is the administration's program in the public housing field? What is the level of units recommended by the administration?

Mr. COLE. Thirty-five thousand a year for the next 4 years.

Mr. BOLLING. Well now, if we take seriously the last paragraph of the Committee's report, the Joint Committee on the Economic Report, if we found that housing other than public housing were not being started at anything like an adequate rate to play its part in a stabilized economy—and I use that word not because I agree with the concept of a stabilized economy—I happen to believe in an expanding economy—but if it were found that in this particular almost entirely controllable area of housing activity, if it were found that in other types of housing we were not close to achieving the hoped-for million units, and if it could be estimated that we would not achieve that, what would be your attitude with regard to this paragraph, which implies—

Mr. COLE. With respect to public housing?

Mr. BOLLING. Yes.

Mr. COLE. Mr. Bolling, I don't consider public housing primarily an economic problem, except as it has an impact upon the economy.

I consider that public housing is primarily a social problem, and therefore it should so be approached. It would be my personal judgment that if we find the need for expanding, pump-priming, then it would seem to me to be more appropriate that we use such tools as

are available to provide housing for the people, generally through the instruments available.

Now, the public housing side of it is a need which is a social need, and the number of public housing units to be built, in my opinion, should be based upon that social need, and not upon an economic need.

Mr. BOLLING. In other words, you are saying that you present a program which will assist the private sector of the economy, the private economy, to produce a million units, more or less, in this year, and you feel that this is a program adequate to produce a million units, and yet you have just said that if we found this program inadequate to produce a million units, you would then move in the direction which I believe you said earlier the Government had very little influence over.

Mr. COLE. No. No, you must have misunderstood me. I think the Government has tremendous influence over it.

Mr. BOLLING. Well, what would you do to soup-up that part of the program which is supposed to assist private industry in building more houses at prices people can afford, and at prices at which they will buy?

Mr. COLE. There are provisions in the present bill, there are authorities contained in the present proposed legislation, which would accomplish that objective.

Some of them have to do with FNMA. Some of them have to do with FHA's expanded authority with respect to loan to value ratios, and downpayments. Some have to do with the general economic conditions of the country—tools which the Government has to prime the pump, through the Federal Reserve System.

Mr. BOLLING. Credit means?

Mr. COLE. Yes.

Mr. BOLLING. Making credit easier?

Mr. COLE. Yes.

Mr. BOLLING. Well, I am reminded at that point, of course, of what Marriner Eccles said a long time ago and which has been repeatedly quoted, and that is that in a deflationary period, credit and monetary policy has somewhat the same effect as of pushing on the end of a string and I don't share your optimism as to its effectiveness. But I do understand that regardless of what happens under this program in the coming year, that you would not be in favor of an increase in public housing because you feel it should be decided on the basis of social necessity and obviously your decision for 35,000 units is on that basis.

Mr. COLE. Mr. Bolling, I wish I could make any question having to do with this agency as simple as that. They are not. They are more complex. There are other factors that enter into it, and may I add one that I doubt if Congress would permit any more than the 35,000 units.

Mr. BOLLING. I take it you are hopeful Congress will go along with 35,000 units?

Mr. COLE. Absolutely.

Mr. BOLLING. I am delighted to hear that, because I think a great deal depends on the vigorous attitude of the administration with regard to this particular item, because the Congress has already

indicated in recent years that even 35,000 units might seem to it excessive.

Mr. COLE. Mr. Bolling, you have sat on this committee with me, and know some of the things I have said about public housing in the past.

Let me say this: The Federal Government is now proposing, in this bill, programs which will dispossess people from their homes in these slum areas, both through urban redevelopment, slum clearance and rehabilitation.

The Federal Government then has the responsibility, in my judgment, to take care of those people who will need, and who cannot find, decent homes. We have a certain responsibility in that area, and until we can find such a plan which will assist those people, I am not willing to say that we wipe it all out, I never have been.

Mr. BOLLING. Well, I am not in any way raising any question as to your sincerity on this proposal.

Mr. COLE. I know that.

Mr. BOLLING. We might have had some disagreements before, but we have always been able to have them on an honorable basis. The thing that has disturbed me a good deal is the fact that almost immediately after the President's program was submitted to the Congress in his housing message, there were items in the newspapers which would make it very convenient for people who wanted to be in a position of going along with the President, and yet at the same time were opposed to public housing, to say "Well, the President is really not very much for this."

Mr. COLE. The President is very much for it, I will say that.

Mr. BOLLING. He is enthusiastically for it and is very anxious to see the 35,000 units included in the next 4 years.

Mr. COLE. That is right.

Mr. BOLLING. There can be no question about this regardless of the quotations which we have seen in the papers and attributed to him by others.

Mr. COLE. That is correct.

Mr. KILBURN. Mr. Bolling, I didn't suppose Congress had anything more to do with this 35,000 units.

Mr. MULTER. We have a great deal to do with it.

Mr. BOLLING. Yes, there is an appropriation.

Mr. KILBURN. I mean this committee.

Mr. BOLLING. I would say it was the responsibility of this committee to deal with this matter.

Mr. KILBURN. We don't need any more legislation, do we?

Mr. BOLLING. No, except to repeal the appropriations rider which was imposed upon us: that is also true in the case of housing research. This raises a very fundamental question of whether or not the rules of the House are to be followed and that there not be legislation on appropriation bills, or are we to give up our jurisdiction as the legislative committee on this subject?

Mr. McDONOUGH. Will you yield?

Mr. BOLLING. Certainly.

Mr. McDONOUGH. Do you believe that public housing should be built or advocated by the Federal Government in areas where the

Mr. COLE. I would like to insert a comment on that matter from areas have not requested it and there is no evident need for it?

Mr. BOLLING. I would prefer not to try to make a specific answer to that at this time. I am familiar with the situation in Los Angeles, and I don't think there is any particular point in getting into the very complicated merits of that particular argument. Obviously—

Mr. McDONOUGH. I just asked the question.

Mr. BOLLING. Obviously the Federal Government cannot build public housing in areas where the community takes no action.

Mr. McDONOUGH. I beg your pardon. There have been cases in the United States where they have imposed it on them.

Mr. BOLLING. Not at this moment.

Mr. McDONOUGH. I agree not at this moment.

Then let me ask another question: You believe, in connection with public housing, that the public housing units should be built in the areas—that is within the 35,000 units per year—in areas where a demand is made by the municipalities, the States, or counties, for such housing? A demand for public housing units?

Mr. BOLLING. Mr. McDONOUGH, I have to point out that I think 35,000 units is totally inadequate.

Mr. McDONOUGH. That is beside the question.

Mr. BOLLING. No, it is not. It is very much to the point. I think the point of the question is to indicate that there is so much demand for the 35,000 units in certain areas that it obviously should not be considered for other areas.

Mr. McDONOUGH. I didn't mean that. If we were to build, let us say, a hundred thousand units, and the demands were for 90,000 units, do you think those 90,000 units should be built only in those areas where the States, cities, and counties have requested they be built?

Mr. BOLLING. I must not be able to understand the law, but I understood that this was in effect a cooperative program which required, in many cases, enabling legislation by a State legislature and then action by a local group. I don't understand what you mean.

Mr. McDONOUGH. Well, in other words, I understand from what you say that you don't believe that the Federal Government should go into an area and build public housing where there is no cooperation on the part of the local interests, by ordinance, by law, or by—

Mr. BOLLING. It depends a great deal on what you mean by interests.

Mr. McDONOUGH. Well, there have been areas where they have used their influence to convince the local people that public housing should be built in their area, and the people don't agree with it.

Do you think that should be done in any part of the United States?

Mr. BOLLING. I think it depends on the specific facts and conditions in that particular area. I see no reason for me to make a general answer which is designed to be applied to a specific situation.

Mr. DEANE. Will you yield?

The CHAIRMAN. I wonder if we haven't gone somewhat afield from the question of FNMA. I notice that there is a chapter in this proposed legislation on public housing, and perhaps we could delay this discussion until we get to that—I hope.

Mr. BOLLING. I will defer to your wishes, Mr. Chairman.

The CHAIRMAN. I can assure you that you will have an opportunity to revert to this question, Mr. Bolling.

Mr. DOLLINGER. I had asked Mr. Cole a question before, and I think the record ought to show the answer, Mr. Chairman.

Mr. COLE. I am sorry, we will provide it.

Mr. DOLLINGER. Would you also, at that time, Mr. Cole, indicate in what areas would \$7,000 houses be built, and the minimum price at which you can build housing in areas such as New York City, Chicago—the larger cities.

Mr. COLE. Yes, sir.

(The data referred to above are as follows:)

It is impossible to predict with any degree of precision what percentage of the expected 1954 new nonfarm housing production will be \$7,000 houses. Based on experience since 1950 and assuming generally stable prices, an estimate of 10 percent seems reasonable. On the assumption of a million nonfarm housing starts in 1954, this would produce approximately 100,000 units priced at \$7,000 or less.

It is also not possible to predict the communities in which builders will be successful in producing a significant number of houses under \$7,000. It is pertinent to note, however, that in 1950 the FHA insured the mortgage financing on new dwelling units on which FHA appraisals placed values below \$7,000 in practically every major metropolitan community. The year 1950 is the only recent year for which these data are available on a locality basis. Although prices have risen since then, data on the percentage of under \$7,000 houses constructed during 1950 in the larger metropolitan areas will suggest the volume of low-cost housing which might be built in these areas in 1954. The following table lists 20 metropolitan areas ranging from the east coast to the west coast in the northern half of the country, showing for each the number of new dwelling units on which FHA-insured mortgages during 1950 under section 203 and the proportion of these units which had valuations below \$7,000.

Metropolitan area	Number of units	Percent under \$7,000	Metropolitan area	Number of units	Percent under \$7,000
Boston, Mass.....	378	0.8	Indianapolis, Ind.....	1,640	37.6
Buffalo, N. Y.....	695	5.2	Milwaukee, Wis.....	1,167	.3
Chicago, Ill.....	4,376	4.8	Minneapolis, St. Paul.....	1,365	.8
Cincinnati, Ohio.....	499	11.7	New York, N. Y.....	23,391	8
Cleveland, Ohio.....	2,166	2.8	Omaha, Nebr.....	758	21.0
Columbus, Ohio.....	1,666	12.6	Philadelphia, Pa.....	7,480	7.2
Denver, Colo.....	2,343	2.4	Pittsburgh, Pa.....	2,801	6.6
Des Moines, Iowa.....	558	2.5	Portland, Oreg.....	2,124	29.1
Detroit, Mich.....	7,331	5.8	Rochester, N. Y.....	446	.9
Grand Rapids, Mich.....	1,041	8.0	Seattle, Wash.....	1,099	3.1

Although the property standards are somewhat less exacting under the section 8 program, it may be pertinent to observe that there has been insured mortgage financing under this section 8 program in all insuring office jurisdictions in the continental United States, with the exception of Wilmington, Del.; Bangor, Maine; Milwaukee, Wis.; New Orleans, La.; and Sacramento, Calif. Among the more active localities have been the suburban areas of New York City and Detroit, where insuring office totals of 1,359 and 2,973 dwelling units, respectively, had been insured by December 31, 1953, under the section 8 program.

Even in localities where a substantial volume of new construction in prices of \$7,000 or less might be difficult, the section 221 program could be expected to operate effectively in the production of decent housing through rehabilitation of existing structures which could be financed with a \$7,000 mortgage.

The \$7,000 ceiling for section 221 mortgages may be expected to encourage builders to make special efforts to provide housing which is within the financial capacity of a majority of the families which would be displaced by urban renewal operations. For families which can afford higher priced homes, liberal terms would be available under section 203 for mortgage amounts in excess of \$7,000. For these families of somewhat higher incomes, the downpayment requirements and somewhat larger monthly payments involved under section 203 should not be a serious deterrent to rehousing operations.

The CHAIRMAN. Are these further questions on this matter of FNMA?

Mr. BOLLING. I have one question on FNMA when it gets back around to me, Mr. Chairman.

The CHAIRMAN. Mr. Bolling, you have the floor on this question.

Mr. BOLLING. I gathered from your statement, and from what you said in answer to some questions, Mr. Cole, that you felt it was extremely important to get the Government out of absolute control of the secondary money market in the housing field?

Mr. COLE. No, I can't answer that "yes" or "no." I feel it is extremely important that the Federal Government get out of a truly secondary market facility. By that I mean, that which can be operated to assist in the even flow of funds, through the regular market operations.

Mr. BOLLING. Now, I am interested in finding out, and tying down, this: Apparently your most important mission is to assist as you can, within certain limitations, in achieving housing construction?

Mr. COLE. That is right.

Mr. BOLLING. I am curious as to whether the view that it is important to get the Government out of this particular limited field, this aspect of FNMA's operations, is in your mind more important than getting housing?

Mr. COLE. No, it isn't, Mr. Bolling, or I would not have recommended the second part of FNMA.

Let me say one more thing, so I won't be misunderstood: If we talk philosophy, I am very much interested in the people of this country having the opportunity to do the job of buying, building, lending, that to me is America. I don't want to do anything to stop, to curtail that advance of the people doing the job, so I want to put the program on the basis of helping the people to help themselves. But I still say that there is a responsibility on the part of the Government, yet, to help the people accomplish this objective.

Mr. BOLLING. The point I am getting at is this: I wanted to be sure that there was no rigidity in your attitude with regard to this particular recommendation.

Mr. COLE. No.

Mr. BOLLING. I take it that it is considered to be experimental and that if it fails, there would be no hesitation to return to another system that has a chance to work.

Mr. COLE. Certainly, if it fails, I hope I will have the courage enough to say that it has failed. I will, however, be looking for other areas in which we can assist the people to help themselves, to look for another facility to accomplish the objective.

Mr. BOLLING. I think nobody could disagree with that, but one of the things that slightly disturbs me is that if this present proposal were not a success, and it failed to achieve its purposes, its sound purposes, then you might come up with an indefinite series of experiments, all of which could fail, which would have a very serious effect, or which could have a very serious effect on the building of houses in certain relatively specific localities.

Mr. COLE. Mr. Bolling, you know, I have a feeling that a failure to help the people help themselves is far less damaging to our country than a failure—than the Government establishing a program which fails.

In other words, I would rather take a chance in failing on a program which would help the people help themselves, than helping on a program for the Government, to control and operate it.

Mr. BOLLING. I hope you wouldn't be willing to do that over 14 or 15 experiments.

Mr. COLE. I would be willing to do it for a hundred experiments.

Mr. BOLLING. In this same field?

Mr. COLE. I would do it in a thousand experiments, Mr. Bolling.

Mr. BOLLING. With the potential disastrous effects on construction of housing over a period of years?

Mr. COLE. If you add that last statement, of course not, I would not propose a program which I thought had a potential disastrous effect on housing, no. Of course, I couldn't do that.

Mr. BOLLING. That is all, Mr. Chairman.

The CHAIRMAN. Mr. McDonough.

Mr. McDONOUGH. Is it your hope for this new plan of Fannie May, Mr. Cole, that the secondary mortgages will eventually, if your plan works, be handled by private capital, rather than Government subsidy?

Mr. COLE. Yes.

Mr. McDONOUGH. And in the course of arriving at that, under the plan which you suggest, that the present outstanding secondary mortgage market will be taken care of—those that are now so-called "sour" mortgages will be taken care of?

Mr. COLE. I can't agree with you about the "sour" mortgages, Mr. McDonough.

Mr. McDONOUGH. Then let me explain that point. Do I understand you to say that Fannie May should purchase only those marketable mortgages that the banks and other financial institutions will not purchase?

Mr. COLE. No; not on the basis of soundness, but on the basis of not being willing to go into the area, let us say, as one reason. You see, a bank located at a remote—

Mr. McDONOUGH. Well, that would be refusing to purchase.

Mr. COLE. But not on the basis of a "sour" mortgage, Mr. McDonough. An institution in one area of the country does not want to loan in another area of the country, for very practical reasons—servicing, distance from the office, and all of those things. And so, they naturally hold their money back or invest in other areas.

I wouldn't say these are "sour" mortgages which FNMA has been buying.

Mr. McDONOUGH. In other words, they are mortgages in which the normal financial institutions do not want to invest, although they are sound mortgages, in your opinion?

Mr. COLE. The best evidence of that is the record of practically no loss which FNMA or the FHA have had on these mortgages.

I should point out, Mr. McDonough, along that line, a very interesting thing has occurred in FHA. I wasn't around Washington at the time when it was set up, but there was a great deal of resistance to FHA mortgage insurance on the basis that these mortgages were unsound, and also on the basis of the long-term amortization and low downpayment.

FHA has proven that long-term mortgages are sound.

Now, I understand why banks resist—and I think it is proper, I want them to be careful with the few dollars I put in their bank, I think it is proper for them to be conservative—but FHA has provided as Mr. Hollyday said yesterday, a test, with the Government back-stopping that test, to give the bankers an experience, where then they can, with more confidence, participate with your money and mine. That is why I say that not necessarily are these mortgages unsound.

Mr. McDONOUGH. Do you have any idea how long it would take, if the present plan works, to eventually provide the means for private enterprise, private industry to take up this secondary mortgage market?

Mr. COLE. I would like to have Mr. Baughman answer that.

Mr. BAUGHMAN. The best estimate we have made so far, providing we are able to get sufficient volume of mortgage purchases and sales, would be approximately 6½ years.

Mr. McDONOUGH. Six and a half years?

Mr. BAUGHMAN. Yes.

Mr. McDONOUGH. What will the total capitalization of that institution be according to your plan, at that time.

Mr. BAUGHMAN. The private capital is only involved in what we call the secondary market. We start out with a \$70 million capital provided by the Treasury, and then our capital contributions in that connection are only applied on the secondary market functions. It has no relationship whatever to the present portfolio of FNMA, or the special operations program, which is in this bill, too.

In other words, it is limited to the secondary mortgage-market functions, which we will start from scratch and build up over that 6½ years.

Mr. McDONOUGH. Mr. Cole, in reference to the question of the number of units that may be built this year, do you believe that the FNMA program as outlined in this will stimulate the construction of additional units that were not possible to build under last year's program?

Mr. COLE. I think it has the authority to do so. I think that the stimulation would be based upon the judgment of the board of directors, after taking into consideration all of the advice that they will receive from the Treasury, the Federal Reserve, the Council of Economic Advisers—whatever advice they could receive.

Mr. McDONOUGH. The program is designed for the purpose of making that possible, the building of additional homes?

Mr. COLE. Yes.

Mr. McDONOUGH. Now, the so-called 1 million units that we have been talking about, as I mentioned a moment ago, are, in your opinion, all new units?

Mr. COLE. Yes.

Mr. McDONOUGH. How many additional livable units will we produce under this present bill, by rehabilitating existing homes, slum clearance, and so forth, in your opinion?

Mr. COLE. Again, Mr. McDonough, that would be a pure guess.

I have found tremendous interest in the rehabilitation and conservation program in communities throughout the country. I visited 12 representative cities last summer, talking about housing and housing

programs, and the people there, in those communities, plus other people who have talked to me at those meetings which I have attended, and who have written to me, have caused me to be very enthusiastic about the acceptance of this plan.

I think the people are ready to do the job to rehabilitate deteriorated homes now, and I think it can be expanded into a tremendous program.

Mr. McDONOUGH. And we are providing for the financing of that kind of rehabilitation.

Mr. COLE. We are providing the insurance assistance.

Mr. McDONOUGH. That we didn't have before?

Mr. COLE. That is right.

Mr. McDONOUGH. That is all, Mr. Chairman.

Mr. DEANE. Mr. Chairman.

The CHAIRMAN. Mr. Deane.

Mr. DEANE. Mr. Cole, H. R. 7839, which includes the provision for the new association, that perhaps this bill, Mr. Chairman, isn't too frightening when we note that some 26 pages are devoted to the new association.

I would like you to refer to the bill, Mr. Cole, page 46, line 12, where it says: "Agencies or offices may be established by the Association in such other place or places as it may deem necessary or appropriate in the conduct of its business."

I wonder if you would mind elaborating on that, so far as all areas of the country are concerned.

Mr. COLE. There are now five area offices. Last year there were six. One was eliminated.

Mr. DEANE. The reason I am asking is this: Take the small business organization. These affairs are restricted. Where they did have an aggressive RFC office in my State, the Richmond office now serves about five States, and the little fellow finds it difficult to get into Richmond, or to get service from Richmond. Perhaps it is mainly due to the fact that they don't have enough funds to operate, but what I am concerned about here is to what extent you are going to be able to break this down to the individual States.

Mr. COLE. I think you have a very real question, and a very real problem. May I say to you, though, that an interesting thing about the Fannie May operation is that, in our judgment, five offices are operating about as effectively as the six.

That doesn't mean that you can completely eliminate offices and finally wind up with none and operate more effectively. Remember, Mr. Deane, that this is a financial transaction between people who know, generally, about financial transactions. It can be handled very satisfactorily by mail. It isn't the business of a small-business man, of whom there are millions in this country, attempting to find an area office. Rather it involves a much more restricted clientele than the small business operation.

If we would find—I will make this promise to you—if we would find that it is necessary for us to expand the area offices in order to do a real job, I will be the first one to ask for it. I do want to say, however, that when FNMA was transferred to the Housing Agency it had 31 field offices. Since its transfer, we cut those 31 offices down to 5 or 6, and we are rendering effective public service.

Mr. DEANE. I realize that there must be somewhat of a restricted organization, but at the same time I think that you are trying to broaden the services.

Mr. COLE. That is right.

Mr. DEANE. And from my observation of legislation, organizations and offices and special groups move in and they capture these special agencies or services in a way that sometimes the average person isn't apprised of, or doesn't know how to proceed to get the service that he needs.

Mr. COLE. I think the problem is more acute, let us say, for FHA, than it is with FNMA, because it does deal with thousands of individual builders. We are aware of your problem, Mr. Deane.

Mr. DEANE. I followed the questioning by Mr. Rains, and I want to say that I am not opposing the new plan, because, like you, I am interested in housing. Did I understand you to say that on this particular association—of course, you were the chairman of the overall President's Advisory Committee, but were you chairman of the subcommittee—

Mr. COLE. I was not chairman of the subcommittee, but of the committee of the whole.

Mr. DEANE. On page 12 of the report of the Advisory Committee, if you will refer to that page, please, first paragraph, in the middle of the page, it goes on to say that—

a substantial minority of the committee has disagreed with certain aspects of the National Mortgage Marketing Corporation as recommended by the majority.

I wonder, Mr. Chairman, just so that we may have all of the viewpoint, if that paragraph, comprising about 30 lines, might be included, and then if Mr. Cole wishes to make a comment on that, I would be glad to have him do so at this point.

The CHAIRMAN. Without objection, it may be included.

(The statement is as follows:)

A substantial minority of the committee has agreed with certain aspects of the National Mortgage Marketing Corporation as recommended by the majority. Those who differ with the proposal believe that the Treasury should have authority to guarantee limited amounts of the debentures of the Corporation, as necessary, to enable the Corporation to support the proposed new programs for insurance of mortgages in urban renewal areas and for the insurance of long-term, small downpayment loans to low-income families. They believe, also, that the Corporation should not be capitalized with funds subscribed by the Federal home-loan banks, but rather by the temporary utilization of funds to be transferred from the Federal National Mortgage Association and thereafter retired from the proceeds of stock subscription purchased by participating institutions. In addition, the Corporation should be authorized to make loans on the security of insured and guaranteed mortgages. Although the majority report did not prohibit the granting of advance commitments by the Corporation, the minority desired to have this authority made explicit. The minority also believed that the minimum stock investment of financial institutions selling mortgages to the Corporation should be 2 percent of the unpaid balance of mortgages held by the Corporation rather than the 4-percent figure contemplated by the majority. The minority, moreover, did not believe that the new National Mortgage Marketing Corporation should be administered by the same board which would also be in charge of supervising the Federal home-loan bank system.

Mr. COLE. As I indicated at the opening of my statement on FNMA, there are diverse opinions with respect to this facility, and they are very vigorous, and as indicated in the report of the President's Ad-

visory Committee, this was not a unanimous decision. As a matter of fact, there was a substantial minority opposing the majority recommendation.

Now, in proposing the legislation which we have suggested here today, we have not eliminated all of the ideas or all of the suggestions of the majority of the advisory committee. Primarily, we have felt that in the present economic picture, we cannot eliminate entirely Government support of certain programs in housing, and therefore, it seems to me that is the major difference between our proposal here and the proposal of the majority—the major difference—there are others, of course.

Mr. DEANE. I notice this line, in the minority thinking: Speaking about those who differed: "They believe also that the Corporation should not be capitalized from funds derived from Federal home-loan banks, but rather by temporary utilization of funds to be transferred from the Federal National Mortgage Association and thereafter retired from the proceeds of stock subscriptions purchased by participating institutions."

Mr. COLE. We followed that procedure.

Mr. DEANE. You are following that procedure?

Mr. COLE. Yes.

Mr. DEANE. Your so-called revolving fund is \$70 million, is that right?

Mr. COLE. Yes, that is the initial capital stock subscription.

Mr. DEANE. Yes. Do you think that is going to be sufficient to meet the needs?

Mr. COLE. No, I don't, Mr. Deane. Fannie May is authorized to issue debentures, and I am quite confident that the public will invest in these debentures.

Mr. DEANE. To start with, where do you think that the main source of your association capitalization is going to come from, to start with?

Mr. COLE. To start with, the original \$70 million subscribed by the Treasury; secondly the sale of debentures; and thirdly either the subscription or contribution, whatever you want to call it, on the part of those using the facility.

Mr. DEANE. What I mean, what areas of the country have you had assurance from, that they are ready to move in and buy?

Mr. COLE. Well, we have some information that there are investors who would be interested in these debentures.

I am reminded that the mortgage sellers would come largely from the South and Southwest and West.

Mr. DEANE. In other words, that is where your principal money would come from?

Mr. COLE. That would be the sellers, not where the money would come from.

Mr. DEANE. From what areas?

Mr. COLE. The South, Southwest, and West. The Middle West would be on that to some extent, too, I think.

Mr. DEANE. Mr. Chairman, with your permission, I wonder if we might include in the record, from the President's budget message, a statement on page 67, involving the Federal National Mortgage Association, in which it says "The legislation which I shall propose will provide," and so forth. It is a short paragraph.

The CHAIRMAN. Without objection, that may be done.

(The information referred to is as follows:)

The legislation which I shall propose would provide authority to establish, from time to time, maximum interest rates and other terms on insured and guaranteed mortgages with the objective of encouraging an adequate, but not excessive, supply of private mortgage funds for all parts of the country. This proposal would make unnecessary in the future large Government purchases of mortgages such as were required in the past, whenever interest rates made such mortgages unattractive to private lenders. I shall also recommend the initiation of a new program, financed in large part from private funds, to furnish many of the secondary market facilities now provided by the Federal National Mortgage Association.

Mr. DEANE. Going on, Mr. Cole, he says:

This proposal would make unnecessary, in the future, large Government purchases of mortgages such as were required in the past whenever interest rates made such mortgage unattractive to private lenders.

Is the purpose of this legislation mainly to attract, because of the interest factor, private lenders?

Is it due to the fact that the market is slowed because of the interest factor that you are not able to get the support required for secondary mortgages?

Mr. COLE. The interest rate is always a very definite factor in it, Mr. Deane. The proposal is an effort to assist the people in those areas where they cannot readily get the money, to assist them to acquire mortgage funds. I don't know whether that answers your question or not.

Mr. DEANE. I realize that the real problem in getting banks and others to come in and support the FHA program in general is that. I don't know whether this is applicable at this particular point, but I wonder if you are in a position to give in general the present reaction to FHA-insured mortgages by average small-town banks?

Mr. COLE. Mr. Deane, the average small-town bank has some difficulty with the FHA-insured mortgage.

Mr. DEANE. Why is that true?

Mr. COLE. Well, part of it is due to the fact of the complications involved. The few mortgages offered to the bank for processing are so few that he cannot set up a department within his bank to take care of it. They are practical problems, rather than any real resistance to the FHA program.

My judgment is that FHA insurance can be stimulated for the use of the small banker. FHA is very aware of that, and the Advisory Committee was aware of it, and steps are being taken to assist the small institutions—by small, I mean small areas, small towns, small capitalizations—the small institutions to utilize the FHA insurance.

I think a great deal should be done, and I am hopeful that a great deal can be done toward that end.

Mr. DEANE. I wonder if you are not losing an area of support in the local community where, under the present regulations, at least in some areas I know about, where an attorney "X" or "Y" or "Z" is encouraging an FHA loan, who completes the abstract yet the borrower must go to attorney A, who closes the loan and receives another fee. I have had several attorneys write me that they feel that program is not in the best interests of FHA.

What is your reaction to it?

Mr. COLE. I am not familiar with that, Mr. Deane. I can't comment. I would say on the basis of what you say, on the basis of your statement, that it certainly requires attention. May I comment—

Mr. DEANE. I know of a case where a lawyer wrote me, and he processed, up to practically the closing, and then FHA told him "Well, you go to this other attorney and he will give you a final clearance."

Mr. COLE. I would like to insert a comment on that matter from FHA, in the record. May I do that?

Mr. DEANE. I would be glad to have it.

Mr. COLE. I think it is important enough for us to comment on it.

Mr. DEANE. I would be very grateful for your reply.

(Comment of FHA, referred to above, is as follows:)

FHA does not participate in the closing of loans on 1- to 4-family houses nor does it recommend attorneys for such purpose.

The CHAIRMAN. Isn't the question perhaps one of local attorneys representing a client—in this case, as I understand it, a bank—passing upon the type?

Mr. DEANE. That is right. In other words, they said they would not accept a certain attorney and they would have to go through a separate attorney in the community in order to get the final closing, and, of course, that involved an additional fee.

The CHAIRMAN. That is a case where the title was insured?

Mr. DEANE. The key attorney designated to clear FHA mortgages, the attorney that wrote me processed the search of the title, and when he got ready to close, they said the other attorney would have to close.

Mr. DEANE. That is all.

Mr. TALLE. Mr. Chairman.

The CHAIRMAN. Mr. Talle.

Mr. TALLE. Mr. Chairman, I have a question I would like to ask. I should have asked the question yesterday of Mr. Hollyday, but there was no opportunity for it.

Perhaps you will ask Mr. Hollyday if he will inquire into and indicate for the record approximately how much time elapses between the filing of an application for an FHA loan, and the consummation of the loan to the point where the borrower has it available for us.

Mr. COLE. We will do that, Dr. Talle.

Mr. TALLE. Thank you. I might add, as an explanation of why I asked the question, that I have had experience with applications of veterans who have attempted to get loans under the Veterans' Administration. I am terribly disappointed in the very slow operation of VA in the processing of loans. I am not charging that against FHA. I should like this information in order to show the contrast between the two agencies.

I know from experience that VA is very, very slow.

(Data requested by Mr. Talle, follow:)

FHA records indicate that during the current fiscal year 67 percent of applications for home mortgage insurance have been processed to either commitment or rejection within 14 days of the date of application. Although data are not available for establishing averages on this subject, it appears that the median application is probably processed in about 10 to 12 days and the average processing time for all cases is probably from 13 to 16 days.

It is to be noted that the time when money is available to the borrower may be dependent on many things after the FHA has issued its commitment to insure the mortgage. From FHA's point of view, the case is suitable for closing as soon as a commitment has been issued, subject to compliance with any specific conditions noted on the commitment. However, actual closing of the loan and endorsement for insurance may be delayed by several months for a construction period with respect to new houses or for periods of a month or longer with respect to existing houses depending on necessary title search, repair activities, or vacating of the property by the seller. FHA processing time does not, of course, include these operations.

Mr. COLE. In commenting on that, Dr. Talle, I want to add one thing which we are aware of, and that is the need for some budget flexibility on the part of FHA. There are a lot of problems which we have. I also think that section 203 here may have something to do with alleviating that situation. But we will ask Mr. Hollyday to prepare a statement on that.

Mr. TALLE. I appreciate that. Thank you.

Mr. COLE. Mr. Chairman, Mr. George had asked a question yesterday, which you suggested he ask today. He informed me that he had to leave. I have here his question and he wants an answer for the record. May I answer it at this time?

The CHAIRMAN. You may do so.

Mr. COLE. Mr. George of Kansas asked if section 221 loans are not acceptable to private lending institutions, do we believe it is sound for or proper for Fannie May to buy them. Mr. Chairman, I am scheduled to make a speech in New York City this afternoon at 2 o'clock and just happened to have had in the speech a comment which I think might be an answer to Mr. George's question, if I may quote it. It is very short.

This program has been criticized, I know, on the grounds that such high-ratio, long-term loans in a relatively high-risk market are economically unsound. I think we must frankly admit, that from the point of view of accepted economic standards in the field of private financing, that is true. But this program has not been put forward, nor did the members of the committee so consider it, as one which could meet the test of all the requirements that are normally expected in private lending.

It is frankly admitted a high risk program intended to meet a special and emergency need. It would be my hope that with the trial and experience it would be established on a reasonably sound basis. But the committee felt, as do I, that it was proper and necessary, at this stage at least, for the Government to assume a larger part of the risk in order that private lenders could participate with the Government in enabling this group to obtain good housing.

Certainly it seems to me that such an approach is far better, where it can be successfully applied, than the use of direct subsidy—better for the family which assumes a responsibility in return for a real opportunity to become independent, and better for the Government from the point of view of its ultimate cost.

That is the end of the quote and that would be my answer to the question.

Mr. O'HARA. Mr. Chairman, may I ask a question? Is Mr. Cole to return on some other day?

The CHAIRMAN. If the committee can obtain permission to sit this afternoon during the general debate in the House, we will reconvene at 2 o'clock. We will reconvene, when we recess for the morning, at 2 o'clock.

Mr. MUMMA. Mr. Chairman, I have some questions which refer to FNMA, about slum clearance and public housing.

The CHAIRMAN. That is the next subject.

Mr. MULTER. Mr. Chairman, may I address myself to FNMA?

The CHAIRMAN. Mr. Multer.

Mr. MULTER. Mr. Cole, I believe I understood you correctly to state that you are heartily in accord with the FNMA setup being changed over to a corporation that will eventually be owned by private enterprise and taken out of Government.

Mr. COLE. In part which I say is a true secondary mortgage facility. Not the part which would have Government support.

Mr. MULTER. So that eventually the money for that secondary market program would come from private enterprise and not the Government?

Mr. COLE. Yes.

Mr. MULTER. I am very happy to have you go that far, Mr. Cole. Now, I would like to know why we can't do the same thing for FHA.

Mr. COLE. Well, we discussed that yesterday, Mr. Multer. I would look at a program which could assist FHA to become a private insurance operation, certainly because it meets with my basic philosophy of the belief that our country is strong by reason of the fact that the people are strong and not by reason of the fact that the Government tells them how to do things.

FHA was set up and is still operating, again, to assist, first, the even flow of the money, but another important thing, as I mentioned a moment ago, as a test, to assist lenders to test what they can do in loaning my money and yours.

I don't envision that it is impossible to eliminate FHA, but on a practical basis, I see no possibility in the immediate foreseeable future that it be eliminated.

Mr. MULTER. I see our good friend Bernie Weitzer sitting out there. For years he has been coming to us with a plan whereby, just as you are working it out of FNMA, you could have FHA do the same thing. Let the Government continue until you have enough private funds. You remember the old days when they were selling certificates against mortgages. That was good business. It went sour. Those people lost their money because of the bad administration of a very good plan. The certificate holders all were burned in those days because the issues would take a hundred thousand dollar building, appraise it at \$300,000 put a \$200,000 mortgage on it and sell the certificates to the public. We don't have that situation in FHA. But why can't we use that method with proper safeguards? Instead of having the Government go out and borrow the money to run this program, why can't we set up a corporation just as you are intending to do for FNMA, and let the general public buy those certificates, issued by the FHA corporation, and let that money be used for this lending program?

Mr. COLE. There is this distinction, Mr. Multer, and a very real problem which Mr. Hollyday pointed out to you yesterday. Until we have had a test of the insurance features of FHA, you will have great resistance on the part of investors to putting their money in an investment of that sort.

Now, again, you are speaking my language. I like to hear what you are saying, and I don't mean to brush it off. I mean that you will receive my cooperation, and I am sure the agency's cooperation, in looking at a plan which might be so devised.

Mr. MULTER. You see, I don't know whether the day will ever come, because that test would only come in a depression, and I hope we never get that. This would be no different from any banks or private enterprise, getting capital invested in it. Here you have the best guaranties in the world.

Mr. COLE. I just want to point out to you, Mr. Multer, that the business of securing private investors is a difficult, complex and sometimes it seems an almost impossible one.

I just want to say that it is a difficult and complex problem. We are willing to look at it and wiling to work on it.

Mr. MULTER. That is encouraging, Mr. Cole. May I just refer to section 221, 40-year loans for a brief moment. Do you think that the private lenders will make these 40-year insured loans under section 221?

Mr. COLE. I think it is very doubtful at the present time. That is the reason we have suggested this support on the part of FNMA. I don't think, Mr. Multer, that it is impossible in the future. I don't think that, after the test has been run, and experience gained, that it is impossible for the private lenders to invest. I want to emphasize that I agree with conservatism on the part of those investors who have my money, that they can't go into an experimental field, and frankly, shouldn't until we have had a test of it.

Mr. MULTER. I am inclined to agree with you, that we are going to get no private money into these 40-year loans. Not that they are going to be bad, but I just don't think we will.

Mr. COLE. Well, they are cautious, and I think it is right that they be cautious.

Mr. MULTER. Thank you, sir.

The CHAIRMAN. It is very apparent that we can't finish this subject this morning, and there has been a rollcall calling us to the floor.

I assume that there will be no objection by anyone to a request that we meet during the general debate on the appropriation bill this afternoon. We will stand in recess until 2:30.

(Whereupon, at 12:10 p. m., the committee recessed until 2:30 p. m., the same day.)

AFTERNOON SESSION

(The committee reconvened at 2:30 p. m., Hon. Jesse Wolcott (chairman) presiding.)

Present: Hon. Jesse Wolcott (chairman) presiding, Messrs. Talle, Kilburn, McDonough, Widnall, Betts, Mumma, McVey, Merrill, Oakman, Heistand, Stringfellow, Van Pelt, Spence, Brown, Deane, O'Brien, Bolling, Hays, and O'Hara.

The CHAIRMAN. The committee will come to order.

We will proceed with consideration of H. R. 7839, on the general subject of FNMA.

Mr. Spence would like to ask some questions, Mr. Cole.

Mr. SPENCE. Mr. Cole, I may say that I am glad to see our colleague come back as the Administrator of the Housing and Home Finance Agency. While we may disagree with some of the statements and some of his theories sometimes, I know that everybody here has absolute confidence in him. We are very glad to have you come to present your case to us, Mr. Cole.

Mr. COLE. Thank you very much, Mr. Spence.

Mr. SPENCE. I want to know this: What powers do you expect to exert under section 702, which authorizes you to advance money for planning for public works, when the definition of public works is any public works other than housing.

Now, I will tell you why I am interested in this: There has been an effort to have a great deal of work done to control the pollution of our rivers, and the public health is advancing right rapidly in the solution of that problem, and the States have made compacts having a view to cleaning up the rivers. I think that these public works, if they deal with water supply, or disposal of sewage, that we ought to be assured that they are still under the control of the Public Health. And I want to know how you feel about that.

Mr. COLE. I am aware of your great interest, Mr. Spence, in this public works program, and of your deep concern with water pollution and the problems you have mentioned connected with it.

We will comment upon the public works part of the legislation a little later, but may I say to you now that the proposed legislation provides that it shall conform with the overall State, local, or regional plan, approved by the State or local regional authority, and we feel that each State and local government or local authority should make their plans within their laws.

May I indicate to you, however, that we believe that an advanced planning program will assist these States in developing sound, workable public works. Therefore, we think it will be most helpful.

Mr. SPENCE. Would you object to any amendment, if we might consider it necessary, to say that it would conform with the laws of the United States with reference to public health?

Mr. COLE. Mr. Spence, it would seem to me that there would be no objection to that. Offhand, I don't see any objection to that.

Mr. SPENCE. I don't know whether that would be necessary or not, but I do think that whoever the Administrator is ought to conform to the rules and regulations of Public Health, which have been pretty effective, and which might be overruled by States or local subdivisions. It is an important thing to the people who are living in the Ohio Valley, and such places where pollution has made such inroads on the water supply to the extent of practically destroying the potable water. That is all, Mr. Chairman.

The CHAIRMAN. We have no permission to sit while roll calls are in progress, so the committee will stand in recess for one-half hour to answer the present roll call.

(Recess taken.)

The CHAIRMAN. The committee will come to order.

Mr. MUMMA.

Mr. MUMMA. Mr. Cole, in this matter of slum clearance which you are coming to, it would be possible for the public housing authorities to work out a plan for authorization to us that ground under certain situations?

Mr. COLE. Yes, that is correct.

Mr. MUMMA. That is all I have at this time, Mr. Chairman.

Mr. COLE. Shall I proceed, Mr. Chairman? I am now ready to proceed with the slum clearance provisions of the bill.

The CHAIRMAN. Mr. Hays, do you have any questions on FNMA, before we proceed?

Mr. HAYS. I have 1 or 2, Mr. Chairman.

I was interested in what you said this morning, Mr. Cole, when you said that 3 percent wouldn't be passed on to the purchaser of the house. What makes you think it will not be?

Mr. COLE. Well, the FHA and VA appraisals should be sufficient to protect the purchaser of the house. By that I mean, that those appraisals always will give the homeowner the benefit of the judgment of FHA and VA as to the value of the house, and therefore cannot be, or should not be, passed on.

Now, if you ask me, do I think there may be some circumstances in which it would be passed on, I would say there could be some isolated circumstances, but as a broad policy, as a broad operation of a tremendously large program, I do not think that will occur.

Mr. HAYS. I ask this in a very friendly way: Have you had much experience with appraisal work?

Mr. COLE. No, very little, Mr. Hays, and I know in a very friendly way what you are saying, namely that appraisals can vary, and I am well aware of the fact that sometimes appraisals vary, having to do with the need to accomplish a specific objective. I realize that.

Mr. HAYS. I wasn't thinking so much of that as I was of the fact that it is just pretty hard to make an appraisal down within 3 percent, or 5 percent, or sometimes as much as 10 percent.

Mr. COLE. That is right, it is difficult.

Mr. HAYS. I spent a year in the field one time with one of the best appraisal companies in the country. It is done very scientifically and I would hesitate to say that they could appraise anything within 5 percent at any time, even with all the cost factors, the cube-foot factors, the cost of materials in the vicinity, and every other factor they use. I don't think there is any really practical way to keep the 3 percent from being passed on. I think that is exactly what will happen, and there will be 3 percent more added to the cost of the house.

Mr. COLE. Mr. Hays, the only answer that I can think of that is pertinent here is that the buyer of a house pays for the use of the money, and quite truthfully, in some areas of the country, he pays more than he pays in other areas. I recognize that fact.

It is our job to do what we can to prevent the establishment of procedures which will permit a pass-through of costs which he should not properly pay, and I certainly recognize the problem you are speaking of.

I do say that the integrity of the FHA and VA appraisal system, in my judgment, is good.

Mr. HAYS. I am not questioning their integrity. I am just questioning the possibility of doing it. While we are on that subject I will say to you this, and it may be helpful: In my limited experience in the field, many people in my area will pay 1 percent more rather than fool with FHA, because of the kind of poor service we get from them.

We have a loan pending at a bank that I know about that has been pending for some 60 days and the FHA haven't acted on it one way or the other. You can't keep people waiting around that long.

Mr. COLE. We will be glad to have FHA check that specific case if you like.

The same question was asked by Mr. Talle, and we will request FHA to make a comment upon that.

Mr. HAYS. I am sure they will have some comment. It probably won't amount to much, but they will have it.

Now, I would like to ask 1 or 2 more questions about this interest matter.

On page 40 of the bill, line 21, section 201 (1), would give the President the authority to set the maximum insurance rates on VA and FHA mortgages. Is that correct? Is that a fair statement?

Mr. COLE. It authorizes the President in his discretion and on the basis of reviews of the pertinent facts made for him by Federal officials designated by him, establish interest rates within certain ceilings, yes.

Mr. HAYS. Previously, and heretofore, the Congress had always set that maximum by law.

Mr. COLE. By statutory authority, that is correct.

Mr. HAYS. Under this new procedure, the maximum—

Mr. COLE. May I add to that: They did, however, within that ceiling, give flexibility.

Mr. HAYS. Under this new procedure the maximum could be 2.5 percent plus the yield on long-term governments, is that correct?

Mr. COLE. Yes, that is it. That is the maximum ceiling.

Mr. HAYS. In the past, what would you say the spread on long-term governments had been, about 1½ percent or somewhere around that?

Mr. COLE. I think the spread, the net spread, was about 1.75 percent.

Mr. HAYS. Well, VA says one and a half, but I expect you are more nearly right.

Now, this section 201 (1) would make possible a spread of 2.5?

Mr. COLE. That is right.

Mr. HAYS. Now, the Treasury, under similar provisions in the housing amendments of 1954, established a rate of 2⅞ percent; is that right?

Mr. COLE. That is right.

Mr. HAYS. On this basis, then, you could put mortgages up to 5½ percent?

Mr. COLE. That is correct, that would be the maximum.

Mr. HAYS. And they could go to 6½ on FHA, with the 1 percent premium for insurance, or one and a half.

Mr. COLE. That would be right if you consider the charge for an insurance premium to be the same as interest charges. I don't believe that would be appropriate, and, in any event, the FHA premium charge is one-half of 1 percent; not 1 percent.

Mr. HAYS. So, in other words, this thing could run conventional mortgages up to about 7 percent, if you were just going in for straight mortgages outside of FHA. There would be a little premium there, would there not?

Mr. COLE. Well, I would hesitate on that, Mr. Hays.

Mr. HAYS. I don't know of any bank in Ohio that is loaning money at the same price of an FHA loan. They are all premium loans, if you borrow straight from the bank. And mostly they are a premium of 1 percent. I have only given the benefit of a half of 1 percent.

Mr. COLE. I think it is generally conceded that a conventional loan might run higher than FHA or VA.

Mr. HAYS. Well, that is sort of a "heads I win, tails you lose" proposition for the purchaser, isn't it?

Mr. COLE. I don't understand you.

Mr. HAYS. The interest rate can very easily go up some more, and frankly—

Mr. COLE. It can come down.

Mr. HAYS. Well, it can but—

Mr. COLE. Interest rates have been coming down.

Mr. HAYS. Yes, because of the fact that I think they got them a little too high, and started to dry up the source of money, and business suffered as a result of it. That is what I am interested in.

Mr. COLE. Well, once again, I am not an economist, but as I understand the procedures involved in this sort of action, Mr. Hays, the Federal Reserve Board believes in the setting of rates to permit a sufficient supply of money to meet an expanding economy. That is a broad statement, but the result of that is, in my judgment, that there will be times when the executive branch, through the Treasury and the Federal Reserve, will, through their powers, increase or lower, as they see the economic picture with which we are faced.

Mr. HAYS. That is the theory, of course, but I think there is, of course, a great deal of room for difference of opinion as to how it works in practice.

Mr. COLE. That is right.

Mr. HAYS. My opinion is that in practice it is partially responsible for the situation, even though some people say there is no situation, in which we find ourselves today.

Mr. COLE. There is always a situation, Mr. Hays, where the economy, where the production and consumption and the supply of money is changing. It is a flexible situation. It will increase, and it will decrease, and the effort on the part of the Federal Reserve Board is to keep that at a level which will permit the expansion to meet the needs of the consumers.

Now, that means, then, that there will be times when they find that it should be expanded and times when they will find that it should be contracted. Those people who believe that they have made an error, by reason of the fact that they make a change, it is perfectly proper for them to say so, but if they enter into such a procedure, that means a change in position, and not a static position. It is a matter of judgment, really.

Mr. HAYS. Well, the thing that made me pursue this line of questioning about this interest rate, for one thing, was a report that I got from the East Liverpool (Ohio) Chamber of Commerce, and I don't think anyone could consider them biased against the present administration, at all, and they, to my mind, showed a very definite relationship between bank loans and the general prosperity of the area, and they showed bank loans to be down 9.5 percent over a year ago. Payrolls were down 28½ percent. Car sales were down 30 percent. Used car sales, down 31 percent. And sales tax receipts, which they prepay in Ohio, and which is a very good barometer, were down 22 percent, and interest rates were up. It looked to me like the whole thing—

Mr. COLE. No, I beg your pardon. Interest rates are down.

Mr. HAYS. Well, they are up over a year ago in that area.

Mr. COLE. That may be.

Mr. HAYS. I am not relating that specifically to your program, but I am just saying the interest rates seem to be related to the whole prosperity of the general area.

Mr. COLE. There isn't any question about that. I would certainly agree with that.

Mr. HAYS. I am saying that there in a very friendly spirit.

Mr. COLE. I appreciate that.

Mr. HAYS. I am just trying to find out if your thoughts along that line run along the general line of mine.

Mr. COLE. I appreciate that.

Mr. HAYS. That is all, Mr. Chairman.

The CHAIRMAN. Are there further questions on this subject of FNMA?

We will proceed to the subsection of slum clearance.

Mr. COLE. The broadened authorization provided in title IV of the bill is designed to assist in our cities to increase both the scope and effectiveness of their efforts to eliminate slums and blight, and to develop and preserve well-organized residential neighborhoods of good homes in a suitable living environment for adequate family life. The major change of emphasis and approach which would be provided by the bill would, in my judgment, permit a much more realistic and effective means of accomplishing that basic objective.

This bill recognizes that slums and blighted areas are the symptoms, not the causes, of this particular urban disease. It recognizes the plain fact that we cannot cure the disease by eliminating only the symptoms and doing nothing about the causes. It recognizes that the pressure from these causes pushes American cities along the pipeline of deterioration faster than slums can be demolished and cleared at one end and new dwellings added at the other. It recognizes that we must continue to demolish and clear our slums, and to add good new housing to the supply, but that, if we are to be realistic about the job of eliminating urban slums and blight, it is necessary to go after the causes as well as the symptoms of the trouble.

It seems to me that most people would agree that any effective program to accomplish this desirable objective should provide for these three things:

First, prevention of the spread of blight into good areas of a community through adequate enforcement of housing standards and occupancy controls, and other appropriate local codes and regulations.

Second, rehabilitation of areas of a community which still can be saved, converting them into sound, healthy neighborhoods by replanning, removing congestion, providing parks and playgrounds, reorganizing streets and traffic, and by facilitating physical rehabilitation of structures which, while deteriorated, are basically sound.

Third, demolition and clearance of slum and blighted areas which, otherwise, cannot be restored, and the redevelopment of such areas.

The present slum clearance and community redevelopment legislation permits assistance for an effective attack upon only the third of these three essential tasks. The broadened authorization provided by the bill is designed to permit assistance for an effective attack upon all three.

Briefly, the bill proposes an enlargement of the scope of a project eligible for Federal assistance in two respects. First, the types of projects are enlarged so that they may include not only the slum pockets necessitating clearance, but also other neighborhood or other areas which may be deteriorated but are suitable for the application of rehabilitation and conservation measures. Secondly, the scope of the project is increased by broadening the activities which may be financed through Federal aid to include those which are necessary for an effective rehabilitation and conservation program, as well as for a program of clearance and redevelopment.

The broadened authorization does not require that a project must hereafter include both clearance and redevelopment and conservation and rehabilitation. It simply means that projects may involve either clearance and redevelopment, or conservation and rehabilitation, or a combination of both, according to the locality's determination as to what is required to meet its particular needs. However, before any locality can obtain Federal assistance for any type of urban renewal project, it must have a workable program for dealing with the whole problem of urban slums and blight, including the rehabilitation of dwellings worth saving. I will discuss this workable program requirement more fully in the latter portion of my statement.

The enlargement of the project area to cover an urban renewal area—which may be an entire neighborhood or a very large deteriorated area—results in an extension of the site improvements and facilities required for the larger area. Streets, utilities, parks, playgrounds, and other site improvements and public facilities when undertaken by the local public agency in order to accomplish the urban renewal objectives may be eligible under the Federal finance contract.

The cost of additional facilities and activities which are required to make possible sound clearance and redevelopment, or neighborhood restoration and renewal, and which are provided by the local community in an urban renewal area will, of course, be included as gross project costs. Thus, for example, the gross project cost would include, in addition to costs in connection with planning and carrying out slum clearance and redevelopment as now authorized in the law, public expenditures in connection with:

1. Carrying out plans for a program of voluntary repair and rehabilitation of buildings or other improvements in accordance with the urban renewal plan;

2. Acquisition of real property and demolition or removal of buildings and improvements, and disposition of property in the broader urban renewal area where necessary to eliminate unhealthful, insanitary, or unsafe conditions, lessen density, eliminate obsolete or detrimental use, or to otherwise remove or prevent the spread of blight or deterioration; and

3. Installation, construction or reconstruction of streets, utilities, parks, playgrounds, and other improvements in the urban renewal area which are necessary for carrying out the urban renewal plan.

Under the present law, where a public facility primarily serves the redevelopment project area, the Administrator is authorized to permit its entire cost to then be counted as a local grant-in-aid even though it serves other areas to some extent. Also, under the present law,

where it directly serves both the project area and other areas, the Administrator may provide, in computing the local grant-in-aid, for an appropriate apportionment of cost. There is at present no statutory guide, other than general guides such as the use of the word "primarily," for determining when the cost will be apportioned. The administrative rule which has been in effect in this respect required apportionment and inclusion as a local grant-in-aid of only the apportioned cost of any such public facility in cases where the degree of the benefits to areas outside the project are amounted to one-third or more of the total benefits. The bill would remove this from the area of administrative regulation by making such apportionment mandatory in all cases where the degree of the benefit to areas outside the urban renewal area is estimated at 20 percent or more of the total benefits derived from the facility.

In many cases, rehabilitation of dwellings alone will not reestablish a deteriorated area as a sound neighborhood. Older, deteriorated neighborhoods frequently are characterized by the poor condition of their streets and alleys, the lack of adequate sewers, poor lighting, the almost complete lack of playgrounds, parks, or other open spaces, and by old and inadequate school buildings. Parks, playgrounds and other recreation areas are essential to the reestablishment and maintenance of healthy neighborhoods. Also, streets, alleys, sidewalks, street lights, and other improvements must be restored and rehabilitated to meet modern needs in order to achieve sound and lasting rehabilitation and conservation objectives.

I have the feeling that it is inequitable for a city to call upon an owner to spend several thousand dollars rehabilitating his home if the city cannot assure that necessary action will also be taken to rehabilitate the streets and other public facilities in the neighborhood and to provide such other public improvements and facilities as are necessary to establish and maintain a desirable neighborhood. The protection of the investment of a private owner in the rehabilitation of his home may, in large measure, be dependent upon appropriate public improvements to rehabilitate the area. Without this public investment, the city surely cannot induce the owner to spend more than what is required to meet bare, minimum standards which may fall far short of the level of rehabilitation which may be desirable.

The provision in the urban renewal area of public buildings or other public facilities, other than publicly owned housing, necessary for carrying out urban renewal objectives may be included at their cost as noncash local grants-in-aid. It should be noted that no improvement or facility constructed outside the urban renewal project area can be eligible as a local grant-in-aid under the bill.

However, buildings and facilities in the project area may be eligible as local grants-in-aid. This is essential to facilitate the rejuvenation of urban areas. One illustration will suffice. Antiquated and wholly inadequate school buildings contribute immeasurably to the rundown neighborhood conditions and would impede efforts to rehabilitate the neighborhoods in which they are located. The removal of the old structure and the construction of a new school building as part of the rehabilitation program of a neighborhood will enhance the livability of the entire neighborhood and give a positive lift to the renewal efforts.

As I have indicated, the problem of eliminating urban slums and blight, while national in scope, is essentially a problem for our cities. The basic responsibility for its solution must therefore rest with the local community. However, Federal assistance is justified for those communities which are willing to face up to the problem of neighborhood decay and to undertake programs directed to its prevention. For those communities which are not willing to do so, Federal assistance is not justified. Urban renewal, in its broad and true sense, therefore really consists of two basic parts: One is the community program of action, on which the whole approach is predicated. The other is the Federal responsibility for assisting, through any of the several principal aids available, the communities to carry out this plan. The one is dependent on the other.

Accordingly, the bill provides that before any of the principal types of Federal help that are proposed—whether it be loans or grants for slum clearance and urban renewal, loans and contributions for low-rent public housing, or mortgage insurance under section 220 or 221—could be extended to any locality, the community itself must present a workable program for dealing with both the causes and the consequences of slum formation and urban decay.

Once the community has presented a workable plan, the Federal Government will make available its various resources in the new integrated approach to urban renewal. The slum clearance and urban renewal program will be available to help clear away the old slums and for the rehabilitation and conservation of neighborhoods; the low-rent public housing program will be operative to help house displaced low-income families; and the FHA section 220 and 221 programs will provide assistance for rebuilding cleared areas and an opportunity for housing displaced families through home purchases and lease-purchase arrangements. Thus the demolition of slums would be only the beginning of an integrated urban renewal process, in which the low-rent public housing and the special, as well as regular, FHA programs would all have mutually supplementary roles, rather than activities under each program being in uncoordinated isolation.

Such a workable program is, in effect, an official plan of action, with such revisions as are made from time to time, for effectively dealing with the problem of slums and blight within the community, and for the establishment and preservation of a well-planned community with well-organized residential neighborhoods of decent homes and suitable living environment for adequate family life. Such a program should provide for utilizing appropriate private and public resources to eliminate and to prevent the development or spread of slums and urban blight, to encourage needed rehabilitation, and to provide for the redevelopment of blighted, deteriorated, or slum areas. It should mean that cities should undertake such of these or other feasible community activities as may be suitably employed to achieve the basic objective of urban renewal.

This workable program requirement does not mean that a community must first exhaust all its efforts and resources in meeting these problems before it finally came to the Federal Government to be rescued. Nor does it mean that a community must undertake a protracted period of detailed and clairvoyant planning and forecasting of the city's future for the next several generations before it can make

an appropriate case for Federal assistance. It does mean that a community must find out where it really stands and where it intends to go, and determine what present resources it can mobilize to get started in the right direction.

This workable program requirement is intended to stimulate and encourage the community to undertake to develop better and more up-to-date codes and regulations and vigorous, effective enforcement of those codes in an effort to see that its housing is brought within at least minimum decent standards. It is intended to stimulate and encourage the community to undertake positive measures to bring about the conservation and rehabilitation of neighborhoods and areas that are economically sound and worth saving in order to prevent the creation of new slums, and to see that practical steps are taken to assure adequate rehousing and fair treatment for families who may be displaced by subsequent clearance or rehabilitation operations.

There should be no straitjacket applied by reason of the workable program requirement. From those cities more advanced in bettering their conditions we should expect more. From those cities just beginning this long road to removing slums and blight and to preventing it through realistic codes and aggressive enforcement, we should be understanding of the time and effort it takes to develop and put into effect a full-scale local attack. We should take full account of varying local situations, and the different circumstances confronting the large and the smaller city. What we are seeking, I think, is a bona fide and practical expression of the community's own projected program to deal with its own problems, presented in good faith and with the firm resolve to carry that program through to accomplishment. The workable program requirement would be meaningless on any other basis, and any community that defaults on its own program, through laxity or indifference, should forfeit its right to continued Federal assistance.

SAVINGS PROVISION

If the proposed legislation be enacted, some time must elapse before local communities will be prepared to undertake urban renewal projects. They will have to perform considerable preparatory work and readjust their activities to the needs of the new program. In addition, many local communities are presently carrying out slum clearance and urban redevelopment projects under the existing slum clearance and community redevelopment legislation. It is both equitable and desirable that they be permitted, if they desire, to complete such projects under the provisions of the Federal law in force when they commenced such projects. In view of these considerations, a provision has been included authorizing the Administrator, with respect to any project covered by any Federal aid contract executed before the effective date of the proposed amendments, to extend financial assistance for the completion of such project in accordance with the provisions of applicable law in force immediately prior to the effective date of the proposed amendments.

URBAN PLANNING

Urban renewal requires sound community planning as a basis for its successful consummation. The importance of a general plan to guide

the physical development of urban areas in renewal undertakings must not be underestimated. The proposed legislation appropriately recognizes the essentiality of planning. The bill includes an authorization for grants to assist planning for the smaller communities and coordinated planning for communities in metropolitan and regional areas. Grants up to 50 percent of the estimated costs could be made to State agencies for the provision of planning assistance to cities and other municipalities having a population of less than 25,000. Grants could also be made to metropolitan or regional planning agencies. A total of \$5 million would be authorized for such grants.

This program will materially implement the urban renewal program by assisting in the preparation of adequate urban renewal plans, workable programs, and general city plans.

GRANTS FOR TESTING

The bill also contains a provision to authorize special grants to localities to assist them in developing, testing, and reporting on improved techniques for preventing and eliminating slums and urban blight. Grants would be limited to two-thirds of the cost of the undertakings. Aggregate grants under this section would be limited to \$5 million, to be obtained from the authorization for other grants authorized by title I of the Housing Act of 1949. Such an authorization was recommended by the Subcommittee on Urban Redevelopment of the President's Advisory Committee on Government Housing Policies and Programs.

In the present form the bill would repeal the existing provisions of law relating to present determination of salaries to be paid to architects and draftsmen employed on urban renewal projects. I would recommend that your committee eliminate this repeal provision.

Now, Mr. Chairman, as you gentlemen know, Mr. James W. Follin is my director of the present slum clearance and community development program. He is here with me, and we will do our best to answer any questions you have on the provisions of the bill relating to urban renewal.

May I also add, Mr. Chairman, in addition, that we are working now with the District Commissioners on legislation which will permit the qualification of the District under the broadened authorization contained in this legislation. We hope to be in a position to recommend provisions along that line for inclusion in this bill.

Mr. Chairman, I ask that Mr. Follin make a statement at this time.

The CHAIRMAN. You may proceed with your statement, Mr. Follin.

STATEMENT OF HON. JAMES W. FOLLIN, DIRECTOR, DIVISION OF SLUM CLEARANCE AND URBAN DEVELOPMENT, HOUSING AND HOME FINANCE AGENCY

Mr. FOLLIN. Mr. Chairman and members of the committee, I am grateful for this opportunity to appear before you today to discuss briefly certain aspects of H. R. 7839 pertaining to the urban renewal program as provided in title IV and section 701 of the bill.

And in doing so I hope to answer the questions raised before the committee during the session of yesterday.

As you know, the Division of Slum Clearance and Urban Redevelopment has been administering the slum clearance and urban redevelopment program since July 15, 1949, the date of the enactment of the basic legislation therefor, title I of the Housing Act of 1949. The bill which you are now considering provides for substantial amendments to title I of the Housing Act of 1949 for the purpose of expanding the scope of the Federal aid authorized thereunder in conformity with the President's program.

Since its beginning in July, 1949, the title I program has been gaining momentum. The lack of adequate State enabling legislation has been substantially remedied and at the present time approximately two-thirds of the States have enacted legislation authorizing local public agencies to undertake slum clearance and urban redevelopment projects. The constitutionality of such enabling legislation has been upheld by most of the supreme courts to which the constitutional issues have been presented for adjudication. The enactment of such State legislation has been accompanied with an increase in the scope of the title I program. As of December 31, 1953, 211 localities in 30 States, and in Alaska, Hawaii, Puerto Rico, and the District of Columbia, had made reservations of capital grant funds for slum clearance and urban redevelopment programs. Of these 211 localities, 166 have actually initiated slum clearance and urban redevelopment projects with title I assistance. As of December 31, 1953, in these 166 communities, 60 projects had reached the land acquisition and development stages, 94 reached the final planning stages, and 105 were in the preliminary planning stages.

It is interesting to note that most of these 166 localities are in the higher population brackets and that comparatively few of them are in the lower population brackets. All but one of the 18 cities above 500,000 have initiated slum clearance and urban redevelopment projects with title I assistance. Of the 3,865 incorporated places in the continental United States with populations between 2,500 and 500,000, fewer than 150 have initiated title I projects. It is, therefore, clear that the slum clearance and urban redevelopment type of program for which title I assistance is available is not the type that a small city can readily engage in. The clearance of any sizable portion of a small community would constitute a rather audacious undertaking. That accounts for the fact that very few of the smaller communities have initiated programs of the type for which Federal aid is presently available. The rehabilitation of deteriorating areas and spot clearance, as authorized in the bill, are better suited to the needs of the smaller communities, and it is my expectation that with the enactment of the bill a higher percentage of the smaller communities will avail themselves of the benefits provided under the bill.

The urban renewal service which is authorized under the provisions on page 73, beginning at line 23 of the bill, will involve the furnishing to communities, at their request, services to assist them in the preparation of the workable program and technical and professional assistance for planning and developing local urban renewal programs. The establishment of this urban renewal service will be particularly valuable to the smaller communities with limited staffs and resources. The services will be rendered only upon the request of the cities to

assist them in their slum and blight elimination and prevention programs.

It is expected that the broadened program of Federal assistance authorized under the bill may be initiated and carried out during the coming fiscal year without any increased authorization of loan or capital grant funds. Under the provisions of title I, loan funds of not to exceed \$1 billion outstanding at any one time and capital grant funds in a total amount not exceeding \$500 million are authorized.

As of December 31, 1953, approximately \$74 million of loan funds were committed. It is estimated that by June 30, 1955, approximately \$284 million of loan funds will have been committed. Hence, it is believed that the loan authorization in the existing legislation will be adequate for the present even under the broader urban renewal program. Moreover, it is likely that only a small portion of the loan commitments will actually result in loan payments. Under the provisions of the existing law, local public agencies may pledge their rights under Federal loan contracts as security for short-term private loans. Through such procedure most of the loan funds for the projects will be provided through private financing and the amount of Federal loan funds actually disbursed will be materially reduced.

With respect to capital grant funds, as of December 31, 1953, \$105 million of capital grant funds were allocated for specific projects. It is estimated that as of June 30, 1955, a total of more than \$235 million of capital grant funds will have been definitely committed for slum clearance and urban renewal projects initiated under the 1949 act. Hence, out of the total \$500 million authorization for capital grants, approximately half will have been definitely committed by the end of the fiscal year 1955.

It is difficult to estimate with any degree of accuracy what the volume of activity under the new program may be. During the first year following the enactment of the new legislation it is safe to assume that much preparatory work will have to be done by the local communities in studying their local situations, developing workable programs, organizing their staffs and machinery, and otherwise in getting ready to undertake the broad-scale programs of the type contemplated under the provisions of the bill. The demands upon us for funds will be largely confined in the first year to advances for planning.

During fiscal year 1955 our major task will still be the administration of the program that is already under way under the existing provisions of law. Under section 412 of the bill it is provided that with respect to any project covered by a Federal aid contract executed, or prior approval granted, under title I of the Housing Act of 1949, before the date of enactment of the bill, financial assistance may be granted for the completion of such project in accordance with the provisions of title I in force immediately prior to the enactment of the bill. Section 412, therefore, will permit completing slum clearance and urban redevelopment projects, initiated before the bill is passed, in conformity with the provisions of the existing law and without regard to the provisions of the pending bill. Thus pending projects will not have to be modified to conform to the new law and local public agencies need not be concerned about having new requirements under the bill imposed on projects which are under way.

It is believed that for the interim period, pending the enactment of supplementary State enabling legislation, the existing State legislation may be adequate to permit local public agencies to carry out urban renewal projects even though in many cases such projects may have to be limited in scope to conform to existing authorization. In general, the State enabling legislation which is presently in force authorizes local public agencies to undertake and carry out slum clearance and urban redevelopment projects but contains no express authorization for the additional type of activities included within the purview of an urban renewal project. Thus the necessary authority to carry out an urban renewal project involving rehabilitation and conservation, in addition to slum clearance and redevelopment, may not be presently vested in a redevelopment agency or housing authority under State law. However, city governments are generally vested with police powers and authorized to enact and enforce ordinances, codes, and other regulatory measures relating to housing and similar matters covered by the urban renewal legislation and, hence, the redevelopment agency, or housing authority, and the city together may have adequate powers under existing law to carry out urban renewal projects of the type for which Federal aid under the bill may be provided.

It should be noted that the definition of "local public agency," on page 87, beginning at line 3, is being amended to provide that two or more governmental entities or public bodies authorized to undertake the project for which assistance is sought may be considered as a local public agency for Federal aid purposes. This amendment is intended to authorize contracts for Federal assistance with, for example, both a redevelopment agency and a city for an urban renewal project. Thus the slum clearance and redevelopment powers of the redevelopment agency may be combined with the police powers and other powers of the city government to consummate an urban renewal project of the type authorized under the bill. Needless to say, amendments of existing State laws so as to bring them in line with the requirements and provisions of the bill will facilitate the program and it is hoped that States will eventually enact the necessary amendatory legislation. However, until such time as such additional State legislation is enacted, means can be worked out to carry out urban renewal projects through special arrangements and new procedures, including tripartite agreements, or separate agreements, involving three parties, namely, the Federal Government, the city and the redevelopment agency or housing authority.

Committees necessarily will have to confine themselves only to such urban renewal activities authorized under State and local laws. Generally, such activities may include slum clearance and urban redevelopment activities, now authorized in about two-thirds of the States, the provisions of streets, utilities, and other necessary public improvements, planning activities, police power activities involving the enforcement of codes and regulatory measures, including the enforcement of certain rehabilitation measures and the abatement of nuisances, the promotion of voluntary rehabilitation, and probably certain other activities for which express or implied authority may exist.

Where cities have been vested with rather complete home rule powers, such as cities in Ohio, the need for supplementary State

legislation for urban renewal projects may not be as important. In general, however, it is my judgment that urban renewal projects, at least on a limited basis, can be undertaken and carried out in most States without additional legislation, but the enactment of additional State legislation is necessary and desirable to facilitate carrying out urban renewal programs of the broad type contemplated under the provisions of the bill.

I believe that the enactment of the bill at this time will coincide with a general national recognition of the need for an effective urban renewal program in our cities to end the extravagance and menace of urban decay. The climate of opinion appears to be more favorably disposed toward urban renewal than at any other time in our history. The enactment of legislation for an urban renewal program is in tune with a growing interest and determination among the people throughout the land to take remedial action both with respect to the causes of slums and blight and the effects thereof. This growing interest has in large measure been aroused and fostered by industry groups, civic organizations, and many others. Realtors, home builders, public officials, civic associations, and other groups now are in the forefront waging the battle to save our cities by urging broad-scale, integrated campaigns for slum and blight elimination and prevention. With the help of these various groups and with such a ground swell of interest and enthusiasm, our local communities are in a stronger position now than they ever have been to carry out successful urban renewal programs with the aid of the Federal Government as provided in the bill.

The CHAIRMAN. Are there questions of Mr. Cole and Mr. Follin on this subject?

Mr. O'HARA. Mr. Chairman.

The CHAIRMAN. Mr. O'Hara.

Mr. O'HARA. I have a few questions, Mr. Cole, that I would like to address to you.

In the 81st Congress you and I did not always agree in the matter of housing legislation, but always I respected your sincerity.

When you were appointed to your present position, I told my friends in Chicago that I was sure they could repose complete confidence in Al Cole attempting to do a good job, according to the best of his lights.

Mr. COLE. Thank you.

Mr. O'HARA. And I think you are attempting to do that.

Mr. COLE. Thank you.

Mr. O'HARA. That does not mean that I shall always agree with you, but I think you are sincerely trying to do a job.

Mr. COLE. Thank you, Mr. O'Hara.

Mr. O'HARA. I was interested in the statement of your associate that at the present time the climate is more favorable to housing development and progress than it ever has been, and I think that is true. I want to assure you as representing the Administration that I am going as far as I can in good conscience in the support of your housing legislation. I shall attend the hearings of our committee with an open mind.

Mr. COLE. Thank you.

Mr. O'HARA. I am doing it because I know we are in a storm. The storm is gathering, and if real estate sinks it means we are in a real

depression. We will be in an even worse situation than we were in in the early thirties. I see in the proper housing legislation our greatest hope of abating the development of the storm.

Now, what I am interested in, first of all, was covered by Mr. Dollinger's question. I was a little impatient this morning because coming from Chicago I was naturally most interested in a phase that was not mentioned until the time of the question that the gentleman from New York, Mr. Dollinger, propounded. I do not know that the gentleman's question was answered.

What are you doing, or what can be done, to promote the construction of houses within the financial means of most people in the middle-income class in the large cities, either to own or to rent? I mean, are we approaching anywhere close to putting houses on the market selling for seven or eight thousand dollars?

Mr. COLE. Mr. O'Hara. I think that within the confines of this bill, and the authorizations provided herein, is a tremendous step in that direction. I do not think it is a perfect program. I do not think we have solved the problem by this legislation. I do not think we have a proposal here which I can come back to you on a year from now and say "We have solved this problem." That is not my approach to it at all.

I say to you, however, that within the authorizations contained in this legislation we have made a long, forward, vigorous step in approaching the solution of the problem. It is so complex, so difficult, that we cannot possibly say to you "This is it."

I do say, though, that with the authority for loans under the 203 provision of FHA, the expansion of authority to make loans on existing houses to the same extent as on new construction, the authority to back-stop the low cost, low-priced homes for low-income people, under sections 220 and 221, the provision is in connection with FNMA, other provisions here which will channel and assist the channelizing of funds into these areas and for the benefit of the people, I really am very enthusiastic, Mr. O'Hara, that we have made a long step, a great, progressive step, toward accomplishing this objective.

Mr. O'HARA. Well, I like your attitude, Mr. Cole. You are frankly saying you are experimenting.

Mr. COLE. Some of the things are, frankly.

Mr. O'HARA. As we all are.

Now, along that line, Mr. Cole, I thought one of the strongest features of our Housing Act of the 81st Congress was that providing for the research department. That is that from that laboratory of study, we might look forward, perhaps, to new plans of construction, new plans of financing, that would bring the American home within the reasonable financial means of all of our people.

Now, as I understand it, not through your desires, certainly not through the desires of this committee, but through the Appropriations Committee, that has been killed.

Mr. COLE. That is right, we are liquidating it.

Mr. O'HARA. Now, are you using your influence with the President, and with the Administration, to have the efficiency of the Research Department restored?

Mr. COLE. Mr. O'Hara—

Mr. O'HARA. Don't answer if I am embarrassing you, because I do not wish to do that.

Mr. COLE. That isn't it at all.

Mr. O'HARA. I think there is a proper sphere for a program of research in the Government, particularly housing. I want to say to you that I recommended the continuation of the research program last year, when I appeared before the House Appropriations Committee, and the other committees; in the wisdom of Congress it was eliminated, and we are liquidating, and it will be completely liquidated, so far as that program is concerned, this year.

I cannot say to you that we have not proposed in this bill new authorization, because the authorization is there. I do not think there is more than this committee can do.

Now, I do not believe that Congress intends for us to close our eyes, and not attempt to do what we can toward a proper program toward the investigation and research in housing. Therefore, it seems that we can do certain things to accomplish those objectives.

There is a great deal of controversy about research in the Housing and Home Finance Agency. I am not now ready to recommend that anything further be done about it unless I see that there is some possibility of a desire on the part of Congress and the people involved in it to get behind it. I am just sort of left in that position.

Mr. O'HARA. But you are frank in telling us that you are reaching out for the answer, that you, yourself, are studying the problem, and I suppose you would welcome any help that could be given you in your study?

Mr. COLE. Yes, sir.

Let me say this: As I view the great objection on the part of those who have objected to research in the Housing and Home Finance Agency, it is divided into two phases. Statistical research, perhaps, most people agree that it is right and proper for the agency to conduct. Some people, however, had considerable doubt about the Housing and Home Finance Agency, as such, conducting experimental research into laboratory programs. They felt that it could be done more efficiently and better through the Bureau of Standards and through other means.

This has not been resolved, and our Advisory Committee did nothing about it, and unless we would find some strength behind such a drive, or such a program, we are just sitting, for the present, except to continue our study and examination to determine what might be done.

Mr. O'HARA. Well, you are somewhat in a quandary, then, are you not? Because no provision is made for research, and yet you are required to pursue research?

Mr. COLE. Having been in Congress, I realize what happens sometimes with the authorizations which we have approved here in this committee, and then find, to our utter amazement, that the people who hold the purse strings do not agree.

You are right, we are in a quandary. We have authorization for a research director, and no research.

Mr. O'HARA. You will recall, Mr. Cole, that in the first session, when the Appropriations Committee had in its gracious generosity taken our jurisdiction away from us—and, I might say, of course, with

the aid of the Rules Committee—you were quoted by your former Republican colleagues on the floor as being against public housing. We, on our side, believe you meant exactly what you said, and the President meant exactly what he said, and we voted our faith in you and in the President, and we were a little surprised and disappointed that some of our Republican colleagues didn't put the same faith in you and in the President that we did, and we are glad that you did prove up, and that the President did, too.

Mr. OAKMAN. Would Mr. O'Hara yield?

Mr. O'HARA. I will be delighted.

Mr. OAKMAN. One of the things on public housing is that there are two schools of thought. You cannot speak of public housing as just public housing, period. Public housing, I believe, is more often than not associated with the large cities, large communities. The public housing theory was sold to the Congress back about 1937 on the basis that it would do two things: It would clear out the slums in the big cities, which were in a financial straight-jacket and could not afford to do it themselves, and that it would also provide decent housing—what at that time was referred to as low-cost housing—which we found later was not—and that by and large this philosophy has been acceptable to the large cities.

But, then, there came a new school of thought, and that was to abandon the slums and leave them there because we were in wars, or we were in high-cost periods, or we were in this or that or the other thing, and it was not the proper time to attack the slums. That is what the public housing people came out and told us, and they argued against us doing anything about our slums. But they did come up with a big program to ring the city, taking every large vacant, virgin piece of property and building public housing on the virgin land that would have otherwise been built up in a few years with private homes.

And what did they do to the big cities? They froze their tax base at a very low figure, at a fraction of what the tax base would have been had that same property been developed with private homes, paying full taxes.

I think this is one of your big conflicts, Mr. O'Hara, in the matter of public housing. A lot of people say "I am opposed to public housing." But they are not opposed to slum clearance and redevelopment, which was the original thesis under which it was sold to this Congress, or previous Congresses.

Mr. O'HARA. I think the gentleman is correct. There is a difference of opinion as to the methods of procedures, but we are agreed that we must clear our slums.

Mr. OAKMAN. I go along with that.

Mr. O'HARA. We are agreed on that. And it is upon that that I would like to pursue my inquiry with Mr. Cole.

As I understand from your statement, Mr. Cole, it will probably be some time before your new system of slum clearance can become operative. Do you anticipate it may require some additional enabling legislation?

Mr. COLE. Some of the newer functions; yes, sir.

Mr. O'HARA. But in order that there shall be no delay, and I think you emphasized that, programs that are now under way in the cities like Chicago, will not be interfered with.

Mr. COLE. That is right.

Mr. HAYS. What about cities that are just in the process of getting started, and then were halted because of lack of funds? Is there any prospect that those can be renewed?

Mr. COLE. Are you talking about public housing, Mr. Hays?

Mr. HAYS. Slum clearance; yes, sir.

Mr. OAKMAN. Public housing.

Mr. HAYS. Urban redevelopment and slum clearance.

Mr. COLE. Well, they are two different programs.

Mr. HAYS. Well, there are some cities that have a combined program for clearing slums and building public housing.

Mr. COLE. They do not combine the two programs.

May I say this: Public housing can eliminate slums and place the public housing unit upon the ground from which the slum was eliminated.

Mr. HAYS. That is what I am thinking about.

Mr. COLE. Yes, sir.

Now, returning to your question, it will depend upon the action of this Congress with respect to the number of units which we have requested, and those cities which are ready to go ahead with their plans, depending upon their condition, will have their projects approved or not approved. And that is about as far as I can go.

Mr. HAYS. This one I am thinking about has been approved, and then it was halted because of lack of funds. Of course, I think it might be a good idea to give some of it to some cities that have not had any at all, rather than concentrate it all in cities which have had a great deal of public housing done.

Mr. COLE. I think you have a real problem, a real question. You see, the limitation was placed upon the number of houses that could be started, and then in the pipeline were thousands of others pressing against it.

Some of those, in my judgment, are binding contracts, which must be complied with. There are others who have preliminary plans in various stages of completion.

Mr. Slusser, the new Public Housing Commissioner, is aware of the need to examine the area, the cities, under the new program, outside of those where we are bound legally. He is aware of that.

Mr. HAYS. Thank you.

Mr. O'HARA. Mr. Cole, what is your own attitude with regard to public housing?

Mr. COLE. My own attitude toward public housing is expressed in the statement. I think, Mr. O'Hara, that when the Federal Government proposes a plan to eliminate slums, either by slum clearance programs or by rehabilitation, or the enforcement of occupancy codes—the overcrowding code, for instance, where we go into an area and through the use of the tools of the Federal Government we set up such a program, it is my judgment that the Federal Government has a responsibility to help those people in those areas who are not able to help themselves.

I think it is a social problem that we must face, frankly. You can either face it or walk away from it. I do not think we can walk away from it. There are people in those slums who cannot find a place to live by reason of their low-income, and I mean low income. Those

people, then, are removed from their homes by action implemented by the Federal Government. Therefore, it is my judgment that in those areas we have a responsibility to help them obtain homes.

I do not see, in the present laws, sufficient assistance for those people. I do not recognize that the only way in which you can rehouse people cleared by slums is through public housing, and I have felt in the past that many people who supported public housing said that that was the only way that you could rehouse people in the slum areas. I do not agree with that. I think many people living in the slum areas—my judgment is half the people living in the slum areas can find decent housing if they can pay for it, in low-priced housing. But there are a great number of those people who cannot do so.

Therefore, I am recommending that while we are testing this program, while we are attempting to do it through other means, I am not willing to say that we just walk away from the problem and forget it.

Mr. O'HARA. In the 81st Congress you disagreed with the late Senator Taft in the matter of public housing. In your present high position you have had a year's close experience in this field. After this intimate contact with the problem would you say that your conclusions are closer to those of Senator Taft than they were before you had this year's experience in the field?

Mr. COLE. I do not know whether you are enjoying the probing of my mind and conscience or not—

Mr. O'HARA. No, I do not mean to do that.

Mr. COLE. —but I think it is a proper question. I really think it is a proper question.

But I want to say, Mr. O'Hara, I have not changed my opinion regarding the objections which I have had to public housing. Some of those objections are these: I am not in favor of socialized housing, I mean I am not in favor of the Government building and subsidizing housing for people who can afford to own their houses and to rent their houses, or people who have an opportunity to acquire housing. I am not in favor of that.

I felt originally that practically everybody who was in favor of public housing wanted that type of program as it was presented to me on this committee. I know now there are many sincere people who believe in public housing who object to socialized public housing or socialized housing as much as I do. That is one difference in what I have learned since I have been sitting in this chair as Administrator as against sitting in that chair as a Member of Congress.

But let me follow through. I am still just as opposed to a program of public housing which would house a great segment of our population in publicly owned subsidized homes, irrespective of the fact that they have been forced out of slum areas, irrespective of their need, irrespective of the social impact and the social need. That was practically my greatest objection.

I have had other objections, and still have other objections, to a program which would cause a great segment of our people, irrespective of need, to be housed in Government-owned houses, whether it is city-owned or federally owned houses.

Mr. O'HARA. Sometimes I think, Mr. Cole, that it is all a matter of vocabulary.

Mr. COLE. I do not agree.

Mr. O'HARA. There was so much in what you said that was a beautiful picture, and I thought you were doing it not only eloquently but with sincerity. However, it was largely a use of pretty words to draw a pretty picture of a dream that you hoped would come true. Sometimes we speak of socialized housing, socialized medicine. We are merely reaching out to get a disagreeable term, to arouse a prejudice against something which, if given a beautiful label, would be approved.

Don't you think we do too much of that?

Mr. COLE. Well, I will agree that we sometimes use terms when we should use ideas, and that is the reason I try to refrain from talking about socialized housing. All I am saying is this: The thing that I have objected to is the movement which I have felt was strong on the part of many people, which would accomplish the objective of housing a great segment of our people, irrespective of need, in publicly owned houses. I will put it that way. That is what I object to.

Mr. O'HARA. And none of us want that.

Mr. COLE. No.

Mr. O'HARA. We want to take care of the people. We have got to furnish decent housing to all of our people. Some of them cannot afford to pay for it. We appreciate that. We do not want public housing to exceed the legitimate demand for it. That is where we are in agreement.

I do not want to take up too much time. Briefly, how will your program of slum clearance operate in Chicago under your plan?

Mr. COLE. We feel that Chicago is doing a very good job, and is quite ready for this program.

I do not mean to say to you that I think it has been solved in Chicago any more than it has been solved in any of the other great cities, but I have the impression, and I am sure Mr. Follin has a better idea than I, I have the impression that Chicago is making very fine progress, vigorous progress, towards fitting their ideas into this program. Mr. Follin, I would like you to comment on that.

Mr. FOLLIN. Mr. O'Hara, Illinois is one of the very few States in the Union which has passed legislation expressly for the purpose of encouraging conservation and rehabilitation, and that program is being applied in Chicago to the point where I think they could get a very early start under this broadened program.

Mr. O'HARA. That is, you feel that in Illinois there is at the present time sufficient enabling legislation?

Mr. FOLLIN. Yes, sir.

Mr. O'HARA. That being so, how would you immediately apply this to the city of Chicago, if this bill becomes the law? What will be done in Chicago?

Mr. FOLLIN. The city, of course, would apply it itself, you understand.

Mr. O'HARA. Yes, sir; I appreciate that. But how?

Mr. FOLLIN. They are working out their own local means of doing it. They are setting up a conservation commission, under that law. Just how that is going to be tied in to the other agency is now being determined, and they will simply outline areas and draw plans for rehabilitation of the properties, and for the upgrading of the neighborhoods, and those plans, if they care to put them through us, and

ask us for our assistance, would receive our financial assistance, in the planning and in the carrying out of the program, which would involve, as Mr. Cole has so well expressed today, considerable public improvements, which are done for the purpose of stabilizing the neighborhoods and keeping permanent the rehabilitation to the properties.

In other words, making it a sound neighborhood and a sound investment and well worth the money which would go into the rehabilitation.

Mr. O'HARA. I presume that both you and Mr. Cole, unquestionably, read the newspaper articles in the Chicago Daily News on the slum problem in Chicago?

Mr. FOLLIN. Yes, sir; we did, sir.

Mr. O'HARA. An illuminating series of articles, I thought.

Mr. FOLLIN. Very illuminating.

Mr. O'HARA. Will the legislation which you are proposing be helpful in the city of Chicago in meeting the problems raised in the series of editorial articles in the Chicago Daily News?

Mr. FOLLIN. I should certainly think so.

Mr. COLE. We are quite firm in our belief that it will do that very thing. It will assist very materially.

Mr. O'HARA. Thank you very much.

Mr. BROWN. Mr. Chairman.

The CHAIRMAN. Mr. Brown.

Mr. BROWN. Mr. Follin, on page 6 of your statement, at the bottom of the page, in the last paragraph, you state:

Communities necessarily will have to confine themselves only to such urban renewed activities authorized under State and local laws. Generally, such activities may include slum-clearance and urban-redevelopment activities, now authorized in about two-thirds of the States—

would it be too much trouble to name those States or supply the record with same?

Mr. FOLLIN. We could supply those for the record; yes, sir. Unfortunately, Georgia is not among those States, we regret to say, and the enactment that was made by the Georgia Legislature was declared unconstitutional in a test suit, and so the projects which had been initiated in Georgia had to be suspended until the constitutional deficiency was corrected.

Mr. FITZPATRICK. I should point out that Georgia is on the way back in. The legislature at its recent session enacted a bill which will put before the electorate, in November, the constitutional amendment that would bring your urban redevelopment within the authority of the constitution.

Mr. BROWN. I am glad to hear that.

(Data requested by Mr. Brown is as follows:)

The following 32 States and 4 Territories, and the District of Columbia have legislation specifically authorizing slum clearance and urban redevelopment projects:

Alabama
Arkansas
California
Colorado
Connecticut
Delaware

(Georgia-----	Georgia's redevelopment legislation is ineffective as result of State supreme court decision, but legislature since passed constitutional amendment for submission to popular vote in order to permit effective redevelopment legislation.)
Illinois	
Indiana	
Kansas-----	Applies to Kansas City only.
Kentucky	
Louisiana	
Maine-----	Applies to the city of Portland only.
Maryland-----	Applies to the city of Baltimore only.
Massachusetts	
Michigan	
Minnesota	
Missouri	
Nebraska-----	Applies to the city of Omaha only.
New Hampshire	
New Jersey	
New York	
North Carolina	
Ohio	
Oregon	
Pennsylvania	
Rhode Island	
South Carolina	
South Dakota	
Tennessee	
(Texas-----	Although Texas has no State enabling legislation, San Antonio has provisions in its home-rule charter authorizing redevelopment activities.)
Virginia	
Wisconsin	
West Virginia	
Alaska	
Hawaii	
Puerto Rico	
Virgin Islands	
District of Columbia	

Mr. OAKMAN. Mr. Chairman.

The CHAIRMAN. Mr. Oakman.

Mr. OAKMAN. I am very much interested in this. As I understand, going back to Mr. O'Hara's interest in big-city development, that we will have a continuation, in fact an acceleration, of the slum clearance and urban redevelopment, which is under Mr. Follin's agency, I understand.

Mr. COLE. Yes.

Mr. OAKMAN. In our home town of Detroit, as you know, we have made great strides. We were one of the first in, and we have cleared a hundred and some acres, right in the worst slum areas of the city. Those buildings have all been razed, the property has been cleared, and rezoned and re-restricted, and sold.

I think that cost around \$7 million in round figures. We got over a million dollars back from the sale. So there was a \$6 million subsidy, of which the city put in \$2 million in cash and the Federal Government 4. But then they are all through for all time. That redeveloped area then pays full taxes and increases the local tax base of the city because it will pay far more in taxes than before the project was undertaken. If you watch these blighted areas and slum areas,

you will note that they go right down like that, so that the city is collecting very little in taxes.

Then, point 2, is your public housing. There are 2 types of that, as we have mentioned, where you go in and redevelop, where you have cleared slums or where you go out on virgin land in the periphery of communities. Where you do it as a slum-clearance project, you can carry on, next door to each other, your urban redevelopment program on the one hand, and your slum clearance and public housing on the other. They are not necessarily inimical to each other.

Then, you have this new device, your urban renewal service, which I think is probably one of the finest things that has come out of a Federal housing bill at any time, and the most needed, because of the forty-odd million urban homes, where these exist, a very substantial percentage of which are in a state of deterioration.

Then, of course, you have got the fourth thing, which is your FHA assistance for new construction.

Now, going back to these millions of existing homes, which have been permitted to deteriorate. I think, as you have said, Mr. Cole, there is a lot of philosophy connected with this thing, a lot of thinking, a lot of ideas.

We had a friend come to our apartment the other night. He proudly told us of an 86-year-old home he acquired here in Washington. He had pictures of it. It was delightful. For this section of the country that is a comparatively new home. Up through New England last summer we saw thousands of homes centuries old, beautifully refurbished, and modernized. The people were very proud of them.

West of the Appalachians, I think you have had a different line of thinking. Well, when a house gets to be 30 or 40 years old, they started looking around for a new one, like they would a new model automobile.

Mr. COLE. I live in the Middle West. I have remodeled a 40-year-old house and I think it is a very nice home.

Mr. OAKMAN. In the city?

Mr. COLE. No; a little town.

Mr. OAKMAN. In the towns; yes. But your neighborhoods in your big, growing cities change rapidly, so that people just go from one neighborhood to another. It is not uncommon that in a lifetime a family will live in 3 or 4 different neighborhoods, and the property left behind goes down and down.

I think that these people that are being moved out, through condemnation and eminent domain, for expressways or slum clearance or other purposes, will find, a great many of them, good modern housing, as a result of this urban renewal service.

Mr. COLE. I think so, too.

Mr. OAKMAN. I don't think that at today's prices every American family can afford a new home, any more than they can all afford 1954 model automobiles, but many of those older homes can be made pleasant, sanitary, and safe for all practical purposes, just as nice as lots of brandnew homes in the periphery from where many people spend half their lives going to and from work.

Have you any figures or estimates on how many units we might anticipate being rehabilitated or modernized under this program, throughout the whole country?

Mr. COLE. We don't have figures, Mr. Oakman.

Mr. OAKMAN. Have you a goal or estimate?

Mr. COLE. About all we can say is it is a tremendous field.

Mr. OAKMAN. It might be more than new starts on new homes eventually, could it not?

Mr. COLE. Yes; I would say, if you cover the whole periphery of rehabilitation and remodeling.

Mr. OAKMAN. Take Boston: There is very little virgin land left. Detroit even has very little virgin land left. So inside the corporate limits they are not going to have very many more starts in new housing. So what they have to do now, to enhance the tax base, in such cities, is to depend heavily upon the rehabilitation program.

Mr. COLE. I think it is a saving of not only the real estate values and tax base, but also a great social advance. I think all across the whole line of urban living, it is a tremendous approach to it.

Mr. OAKMAN. Thank you, Mr. Chairman.

Mr. BOLLING. Mr. Chairman.

The CHAIRMAN. Mr. Bolling.

Mr. BOLLING. Mr. Cole, as I understood the two statements that were made, the number of public housing units that have been requested by the administration are an integral part of the total effort at urban renewal and slum clearance.

Mr. COLE. The total effort of housing, yes, including urban renewal and slum clearance. Your statement is more correct than mine.

Mr. BOLLING. And the 35,000 units are an essential element to that program?

Mr. COLE. That is my judgment.

Mr. BOLLING. Do you know offhand how many public housing units there are in the country?

Mr. COLE. With those that are now constructed, and those that are in the process of actual construction, about 400,000.

Mr. BOLLING. Presumably each of those houses a family?

Mr. COLE. Yes, except those that are vacant. But that is approximately correct.

Mr. BOLLING. You mentioned earlier, in reply to a question, that one of the reasons you opposed public housing in the past had been that you opposed the philosophy that would house a large number of people in public housing units?

Mr. COLE. Yes.

Mr. BOLLING. Would you care to give a figure of what a large number of families is in that respect?

Mr. COLE. I think that is a proper question. Let me first, though, preface it by this: An interesting thing, if you will examine my statements, when I was in Congress, is that practically every speech I made I said "It isn't a question of whether we shall do it, but how we shall do it."

And that has been my approach. I felt then, as I feel now, that there is a movement on the part of some people, who would like to see great segments of our population housed in government-owned housing, and as I saw many of the people promoting and suggesting public housing, I became more and more convinced that that was the goal.

Now, what do I mean by a great segment of our population? I mean a segment of our population which goes beyond the objective,

that objective being to take care of those people in need of publicly subsidized houses.

Let's talk about socialism a little bit. I think the Federal Government has the responsibility and obligation to assist people who are in need, when it is a Federal problem. I do not feel that it is a Federal problem for the Federal Government to build houses for people who can pay for them. When the Federal Government does that, then it becomes a socialistic approach to the problem.

Mr. BOLLING. Mr. Cole, you have very successfully avoided pinning yourself down to a figure, but my point in asking the question was the obvious one.

Mr. COLE. Well, let's say 50 percent, certainly, let's make it a very black and white case, if you would house 50 percent of the people, I think certainly you would have done that, you would have—

Mr. BOLLING. Well, since you have raised this question of a large number of people, I wondered if you had considered the relationship between 400,000 families to 47 million families.

Mr. COLE. Of course, I did, and I don't think 400,000 public housing units today does what I am saying, nor do I think that 400,000 plus 140,000 would, if properly used. But Mr. Bolling, one house built for a person who doesn't need it is improper. One house.

Mr. BOLLING. True enough. Then I presume, on the basis of that, in relation to these extensive studies that you have, you then could give me some sort of estimate of the number of people that need this kind of housing.

Mr. COLE. No, I wouldn't be able to do that.

Mr. BOLLING. That was not taken into consideration?

Mr. COLE. Frankly, Mr. Bolling, the final determination of 35,000 houses, in my opinion, at least, was a pretty practical one. It was a practical one upon two bases:

One is that I saw the program of slum clearance and urban redevelopment and rehabilitation proceed within the next few years, which could absorb 35,000 houses.

Secondly, the Public Housing Administration, I am informed, by Mr. Slusser, can operate to assist in the construction of that number of houses. I doubt if they could do more within the next year.

Thirdly, I have felt that, as I said before, Congress would not permit more than 35,000.

Mr. BOLLING. This then was an eminently pragmatic decision, on 35,000 units, and really didn't take into consideration since you didn't have the figures, how many people might need this kind of assistance.

Mr. COLE. As I said this morning, there has never been a study of the needs of the people broad enough, deep enough, for me or for you to determine what the needs of those people are.

Mr. BOLLING. Of course, there are statistics that exist which would indicate that a very substantial percentage of the population of the United States lives on less than \$2,000 a year.

Mr. COLE. That is very true. However, I do not admit that all of those people require public housing.

Mr. BOLLING. I didn't suggest that.

Mr. COLE. No.

Mr. BOLLING. But I would think that that would give rise to a desire to make this decision, perhaps, not only pragmatically and

practically, but also on a much firmer basis and an understanding of need, and I gather both from what opportunity I have had to study the report of the Commission, and from what you have said today, that more consideration was given to the practical aspects, one might even say the—well, the practical aspects as they affect Congress, rather than the question of need.

Mr. COLE. Mr. Bolling, if I may pursue that—and I think it is a very important question—I could say to the people of America we will build 150,000 public housing units this year. I think that would be wrong. I think it would be wrong for me to hold out to people a dream that cannot be realized, where I don't see the possibility of realizing it.

We feel that we had better get down to this problem and talk about it in practical realities rather than talking about some great expanded program which no one can achieve. It wasn't achieved in the past, and it won't be achieved under that type of approach today.

I feel that we had better look at these things carefully, sincerely, meeting the problem as we can meet it, and not just open up tremendous vistas which can never be achieved.

Mr. BOLLING. Well, I would have to disagree with most of that statement, because I think that merely because it is impossible politically to do today what needs to be done does not mean that we should not set our goals high enough to meet the need.

Mr. COLE. I must say this: I have felt that some people in the past have, for political reasons, talked about a number of public housing units, irrespective of the need, irrespective of whether or not they could achieve the objective, irrespective of whether or not the people of this country would or should build them, and they did it solely for political reasons.

Mr. BOLLING. You certainly are not having reference to the 810,000 units included in the 1949 act, are you?

Mr. COLE. I am just merely giving that as my statement.

Mr. BOLLING. Because you would be covering a broad territory and making an indictment of a number of very responsible people on the other side of the Hill, some of whom are no longer with us.

Mr. COLE. I am merely making that statement, and if the shoe fits anyone, they can wear it.

Mr. BOLLING. Unfortunately, some of the people that were most energetic in the support of this type of program, including Senator Taft, are no longer in a position to answer that kind of statement.

Mr. COLE. My statement is not directed at the late and greatly respected Senator Taft nor at you. It is directed only at those people who take a political position on this: public housing has been a political issue, a political football. We have for the first time, in my judgment, raised this problem of housing above politics, Mr. Bolling. Just look at the attitude of Congress today about public housing. I think it is a better attitude today than it has been in years, and I think it is by reason of the approach which we are making, a sound, careful, and if you want to say, even conservative approach to it.

Mr. BOLLING. I would go as far as to say that, even though I consider 35,000 units a year totally inadequate, if the Congress were to accept 35,000 units this year, it would indicate that there was some-

element of truth in what you imply. It seems quite clear that there is still some question as to what Congress is going to do.

Mr. COLE. With that I will agree.

Mr. BOLLING. Now still pursuing the question of public housing units, there was a great deal of discussion when the Appropriations Committee came to the floor last year, with regard to public housing. There was a great deal said, and frankly, if everything that was said was precisely accurate, it was certainly very confusing—there was a great deal said about the status of certain public housing units—a great many of them—whether they were under firm contract, between the local authorities and the Federal Government.

Now, I would like to know, what is the specific status, and stage, of all the public housing that is under way in any fashion, in any community in the United States today, and for the record, I would like that in detail. At the moment I would like the general figures.

(The data requested by Mr. Bolling, follow:)

Status of low-rent program initiated under the Housing Act of 1949 as of Dec. 31, 1953

<i>Status</i>	<i>Number of units</i>
Completed	118,686
Under construction	59,313
Under annual contributions contract, not under construction	¹ 49,230
Under preliminary loan contract, not under annual contributions contract	² 124,112
Total preliminary loan contracts entered into	351,341
Total program reservations issued	355,585
Total applications received	540,859

¹ 35,810 units will remain under annual contributions contract on June 30, 1954, for which construction has not been authorized.

² Preliminary loan contracts for these units are in process of liquidation.

Mr. COLE. May I ask Mr. Slusser, Public Housing Commissioner, to comment on that, and then if you care to have me say anything, I will. Mr. Slusser, will you comment?

Mr. SLUSSER. Coming up here I lost your question.

Mr. McDONOUGH. Mr. Chairman, a point of order. Mr. Cole hasn't read his paragraph on public housing and we are discussing public housing. We have, up to now, adhered to the rule of discussing this bill by sections.

Mr. BOLLING. Mr. Chairman, I would like to speak to the point briefly, if there is any question on it.

The CHAIRMAN. The chair has been a little tolerant of the discussion because it saw an affiliation between the provisions of public housing, as they were expected to be enhanced by slum clearance and urban redevelopment. But I think I would like to clear up one thing. We haven't taken up public housing yet, and it is 5 minutes to 5. If you would bear with me for a moment, Mr. Bolling, I should like to find out whether Mr. Cole, Mr. Slusser, Mr. McAllister, and all those who have to do with the part of the program which we have not taken up, primarily public housing and Home Loan Bank Board, can come back tomorrow morning.

Mr. COLE. Mr. Chairman, may I say that the legislation affecting the Home Loan Bank Board will elicit some questions and the public

works program a few, and that is about it. We are about through when we finish up slum clearance and public housing.

The CHAIRMAN. Yes, but I think I would at least like to state to the committee that we would like to have an opportunity to tie this all in together after we have taken it up by subjects.

Mr. BOLLING. To that I would add this, Mr. Chairman. The series of questions on which I am embarked now will, I think, have us sitting rather late.

The CHAIRMAN. You might find yourself sitting here by yourself. I think these are questions in which we would all be interested.

May we find out first whether Mr. Cole, and his staff, can return tomorrow? I assume you will want Mr. McAllister with you.

Mr. COLE. He is here, Mr. Chairman. Mr. Slusser is here, too.

The CHAIRMAN. These gentlemen can be here tomorrow, along with whatever others you will want with you?

Mr. COLE. Mr. McAllister says yes, and the rest of us can.

Mr. HAYS. I have a parliamentary question when you are through, Mr. Chairman.

The CHAIRMAN. I guess you had better put it now because I was about to say that if it is agreeable to the committee we would stand in recess.

Mr. HAYS. I wanted to know whether we can come back to the urban redevelopment question if we go on into public housing. I have some questions on that.

The CHAIRMAN. Yes. I had indicated that it was my own desire, and I thought it was the proper way to proceed; that we would take the matters up subject by subject, in the questioning with Mr. Cole, and his staff, and after that was over, we would take up the whole subject and tie it all in together.

Without objection, we will stand in recess until tomorrow morning at 10 o'clock.

(Whereupon, at 5 p.m., the committee adjourned until 10 a.m., Thursday, March 4, 1954.)

HOUSING ACT OF 1954

THURSDAY, MARCH 4, 1954

HOUSE OF REPRESENTATIVES,
COMMITTEE ON BANKING AND CURRENCY,
Washington, D. C.

The committee met at 10 a. m., Hon. Jesse P. Wolcott (chairman) presiding.

Present: Chairman Wolcott (presiding), Messrs. Talle, Kilburn, McDonough, Widnall, Betts, Mumma, McVey, Merrill, Oakman, Hiestand, Van Pelt, Spence, Brown, Patman, Multer, Deane, Adonizio, Dollinger, Bolling, O'Hara, and McCarthy.

The CHAIRMAN. The committee will come to order.

We will proceed with the consideration of H. R. 7839.

Mr. Cole and Mr. Slusser, together with other members of the staff, are back with us this morning.

I believe, Mr. Cole, we had concluded the questioning on slum clearance. You may proceed now with low-rent public housing.

Mr. BOLLING. Mr. Chairman, before he starts I would like to be sure that I can return to this section when he completes the next one.

The CHAIRMAN. I might state again that it is the intention that, when we finish these subjects, as they have been taken up, that we shall go back to the whole bill, and open up the whole bill for questioning, in order to tie all sections in together, and at that time there will be opportunity for members to discuss any part of the bill.

Mr. BOLLING. In addition, Mr. Chairman, I would like to point out that perhaps there is going to be some confusion in the record because when we adjourned last night I had just begun a series of questions on public housing. We will have lost the continuity.

The CHAIRMAN. That is what we are going to start with this morning, Mr. Bolling.

Mr. BOLLING. Thank you, Mr. Chairman.

The CHAIRMAN. You may proceed, Mr. Cole.

STATEMENT OF HON. ALBERT W. COLE, HOUSING AND HOME FINANCE ADMINISTRATOR, ACCOMPANIED BY B. T. FITZPATRICK, DEPUTY ADMINISTRATOR AND GENERAL COUNSEL; CHARLES E. SLUSSER, PUBLIC HOUSING COMMISSIONER; WALTER W. McALLISTER, CHAIRMAN, HOME LOAN BANK BOARD; AND JOHN C. HAZELTINE, COMMISSIONER OF COMMUNITY FACILITIES, HOUSING AND HOME FINANCE AGENCY

Mr. COLE. I will now go to the section on low-rent public housing, Mr. Chairman.

In order to permit public housing to serve better its overall objects, the President's Advisory Committee recommended certain

changes in the basic legislation, and the bill includes the provisions necessary to carry out those recommendations.

The program of slum clearance and urban renewal contemplated by the bill will, of necessity, result in the displacement of many thousands of families through the demolition of slum areas, the rehabilitation of blighted areas, and the enforcement of building, health, sanitary, or other codes prohibiting or reducing the occupancy of particular dwellings. In addition, thousands of families are being displaced each year in our cities by public improvement programs such as new thoroughfares and street widenings, and the construction of public buildings and improvements. Many of the families displaced from their homes by these public undertakings are in the lowest income groups. An adequate supply of housing must be available for all the families displaced by these various programs. The Advisory Committee pointed out that about half of the families displaced by the present slum clearance and redevelopment program have incomes so low as to fall within the limits set for admission in public housing. The difficulties of relocation are particularly acute for low-income families in minority racial groups.

In order that public housing may better facilitate urban renewal programs through the provision of housing for displaced families of low income, preference in admission should be granted to all such families. At present, first preference in admission is limited to families displaced only by low-rent housing projects or by public slum clearance and redevelopment projects. The bill would extend the preference to families who are to be displaced through other public actions, thus permitting public housing to facilitate all types of public undertakings involved in the total process of urban renewal. Also, in order to permit proper coordination of relocation activities, the bill would permit local housing authorities to grant special preference as to any of the projects or actions entitled to the general preferences. Veterans would continue to have a first preference within all preference groups.

The bill also contains provisions to assure that the payments in lieu of taxes which local governments expect from their low-rent projects will be made on a contractual rather than on a voluntary basis. These payments in lieu of taxes will, with certain exceptions, be equal to 10 percent of the shelter rents charged in the various low-rent projects.

A further change recommended by the Advisory Committee is designed to make public housing projects self-liquidating to the maximum possible extent. The bill provides that, as soon as the capital cost of a project has been repaid, future net revenues of the project would be used to repay to the Federal Government and to local governments the contributions made by them to the project during its earlier life.

The Advisory Committee also made a number of further recommendations for the improvement of the low-rent housing program and for the elimination of certain weaknesses. These recommendations relate to such matters as the rehabilitation, where feasible, of existing sound structures for low-rent use; the development of public housing projects at lower densities with less crowding of project sites; the provision of smaller projects with greater use of scattered sites; and greater conformity to local dwelling patterns and construction practices. These recommendations have real merit, and are heartily con-

curred in by Mr. Slusser, the new Public Housing Commissioner, who is here with me. Mr. Slusser has already demonstrated a keen ability to manage the affairs of his agency in a businesslike manner. He has inspired well-merited confidence that he will take the necessary administrative steps to improve the operations of the PHA along the lines recommended by the committee. He advises me that no legislative changes are needed in this connection.

That completes the statement on the low-rent public housing, Mr. Chairman.

The CHAIRMAN. Mr. Mumma.

Mr. MUMMA. Did you change the name of this program advisedly? It used to be called low-cost public housing, didn't it?

Mr. COLE. No, not legislatively, Mr. Mumma.

Mr. MUMMA. Well, that was a side remark, you might say.

Here is the problem that I see, and whether I am right or wrong I would like to have your opinion: What should the length of occupancy of a public housing project be? In other words, would you say that when a family gets into a public housing project they should be allowed to live there without any prodding to get them to help themselves by becoming homeowners?

Mr. COLE. Mr. Mumma, I have said publicly, recently, in a speech, that public housing must be a conduit through which the low-income families pass. It should be a pipeline to assist those people with low incomes, the poorer families, to obtain better housing.

Certainly it would be a failure of this program if it is so developed that families have no opportunity to better themselves, to move out of public housing and take their place in the community outside of public housing.

It is my concept, at least, that public housing must be this type of an operation, and if it is not it is a failure.

Now, recognizing, of course, that mass living in these great urban centers is a little different than living in smaller communities, and that people in certain areas find it more difficult to advance and better themselves, we direct this program—not necessarily the public-housing program, but the entire program which we are presenting to Congress—we direct this program to that objective, to the definite objective of helping people help themselves, to give to the people with lower incomes the assistance which they may require to help themselves to acquire better homes.

It is a very complex and difficult thing to accomplish, but certainly that is my objective, and the objective of this administration.

Mr. MUMMA. Well, that is my conception of it, too. You know, at Harrisburg, Pa., we have about 1,700 units, and we have a very, very good housing authority. They have done very well. But they are continually confronted with these people that go to every subterfuge, a good many of them, to conceal their real income, so as to remain there, and they did put on a drive to study this thing, and I think the program which you have announced is very good, especially when you are getting away from the conception that public housing must be crowded on as small a site as it can be. Your tendency now is to spread out, and, I might say that a group that I have tried to help to better these programs have now as a minority group begun their own project, and they have gotten downpayments

from people who can afford it, and I think they are doing very well. And I certainly hope that you will find it within your power to try to help these people. They have started a wonderful program, and I certainly am all for it.

I think that at Harrisburg we have a nucleus there of people in unfortunate circumstances who should be given the preference, but at the same time I do not know whether a lease should be made saying they can only live there 3 years, subject to review, or something like that, but they ought to have an incentive to better themselves.

Mr. COLE. I would like Mr. Slusser to comment on that.

Mr. SLUSSER. With reference to the review, there is a yearly review made by our audit section of the occupancy.

Mr. MUMMA. It is a review, but they do not go in there figuring that in 3 years, or in some other definite period of time, they may be obliged to move. They certainly don't have much reason not to try to own a house if this program goes through with a very limited down-payment and a desirable period of time payments.

Mr. SLUSSER. I strongly urge it.

Mr. MUMMA. I think it is a good thing.

Mr. SLUSSER. If at the time of review people have rehabilitated themselves economically and socially, that they should have an opportunity to go on, and not go back to live in a slum for a difference of \$100 a year more income.

Mr. MUMMA. The average American, whether it is right or wrong, does not like to see a big Lincoln car sitting out before a housing project when he is trying to maintain a house and a smaller automobile. It may be wrong, but they just do not like it up in my territory.

Mr. MERRILL. Mr. Chairman.

The CHAIRMAN. Mr. Merrill.

Mr. MERRILL. Why do you think this provision for the repayment of the money advanced by the Government will be successful? In other words, what percentage of your original investment do you think you can recover eventually through this provision for self-liquidation?

Mr. COLE. Mr. Merrill, I would be less than frank with you if I did not say that the problems involved in this repayment are not all resolved, but it was suggested by the Advisory Committee to meet an objection about the subsidies. The Federal Government having assisted in the construction of these buildings through a subsidy, it should, they stated, when the buildings have been paid for, be repaid, as well as the local government, to the extent that project income thereafter will permit such repayment.

It is an effort to once more bring back to the local authorities, the local city or municipality, the realization of local responsibility.

Now, we have no specific, nor even estimates, of what can be done in that regard. The Advisory Committee thought, and I believe, that it is a step to bring it more into the atmosphere of local responsibility.

Mr. MERRILL. Then this does not hold out any hope on the part of your department that public housing could be self-liquidating?

Mr. COLE. I think there is some hope. When you say real hope, I do not know.

Mr. MERRILL. On this 10-percent contribution, I know different localities have different tax rates, but how closely does this 10 percent

contribution come to what an actual tax levy would be in the different cities? Do you have any guide on that?

Mr. SLUSSER. The local contribution would be about half as much again.

Mr. MERRILL. So this 10 percent wouldn't, then, approach the tax a comparable private dwelling would be paying to the local community?

Mr. SLUSSER. That is right.

Mr. OAKMAN. Mr. Chairman.

The CHAIRMAN. Mr. Oakman.

Mr. OAKMAN. What would the taxes average, roughly, per unit?

Mr. SLUSSER. About \$10 a month per unit, full taxes.

Mr. OAKMAN. Full taxes would average about \$120 a year?

Mr. SLUSSER. About \$10 a month per unit.

Mr. OAKMAN. Yes, sir. And the 10 percent payment in lieu of taxes would roughly be what?

Mr. SLUSSER. \$2.56.

Mr. OAKMAN. Per month?

Mr. SLUSSER. That is right.

Mr. OAKMAN. So that it is about one-quarter of what full taxes to the local community would be?

Mr. SLUSSER. That is right, sir.

Mr. OAKMAN. Families eligible under the act—for instance, in my home town of Detroit we are contemplating building a hundred miles of expressways—over a period of years, naturally—which necessitates the moving of tens of thousands of families, over this period of time. They would be eligible for this; would they not?

Mr. SLUSSER. Under the new bill; yes, sir.

Mr. OAKMAN. Under the revised bill?

Mr. SLUSSER. That is right.

Mr. OAKMAN. And the thinking—this is a little far afield, but just as a matter of information, are you now trying to stress slum clearance in these big cities, for your low-rent housing projects, as opposed to the thinking of a very few short years ago, of going out in the periphery of these communities and building on virgin land?

Mr. SLUSSER. Yes, sir.

Mr. OAKMAN. You are trying to give all the emphasis you can to slum clearance and redevelopment?

Mr. SLUSSER. That is right, just as you are doing in Detroit. I went up there and consulted with your mayor and went over the program. They are trying to do it in Philadelphia and Chicago and other cities as well.

Mr. OAKMAN. In my district we have two or more public housing projects. The Herman Gardens project consists of around 2,400 families, 10,000 people in one public housing project. If there was ever a vote taken I think the people would be 10 to 1 against it. There is public resentment against these huge public housing projects put in the midst of single-residential neighborhoods. While there isn't anywhere near that same public resentment to the slum clearance and redevelopment programs.

Mr. SLUSSER. I think that would be true in part. However, I have found in my visits to various authorities that in some places

they are very well accepted in the residential sections. I can name one or two cities where they have fit in very well.

Mr. OAKMAN. Not that large, though.

Mr. SLUSSER. Not that large, and it depends a good deal on the architectural design and the layout of the land. I think that becomes very important, the site selection and the placement upon the site.

Mr. COLE. That is why, Mr. Oakman, we have stressed in our statement the design, the livability, as an effort to get away from the big institutionalized projects that have been prevalent in the past.

We realize—Mr. Slusser realizes—that in the great, huge cities it is sometimes impossible to build other than large-type projects, but we certainly have a strong desire to eliminate the large institutionalized project.

Mr. OAKMAN. You do find there is much less resentment in the average community, though, where you go in with the slum clearance and redevelopment program than where you go out into virgin land, do you not?

Mr. SLUSSER. I would think that is probably right.

Mr. OAKMAN. Because people are anxious to get rid of slums.

Mr. SLUSSER. That is right.

Mr. OAKMAN. They feel that there is a place in the community, to the extent that public subsidized housing is needed, and they think that is the best place because the average municipality cannot afford to go into its slums and do the job by itself, because the municipalities are largely limited to the ad valorem tax base, the States and Federal Government having usurped all forms of taxes known to the mind of man, and that is all that is left to them.

Mr. SLUSSER. I will agree with you.

Mr. OAKMAN. Thank you.

The CHAIRMAN. Mr. Deane.

Mr. DEANE. Mr. Cole, examining the the report on the Housing Act of 1949, with reference to rural and farm areas, dealing with the public housing program, could you tell us how many units have been built since the inception of the act?

Mr. COLE. Since the inception of the 1949 act or the original act of 1937?

Mr. DEANE. We will say since 1949.

Mr. COLE. Since 1949?

Mr. DEANE. Yes, sir.

Mr. COLE. Mr. Slusser would have that figure.

Mr. SLUSSER. You are speaking of rural, nonfarm?

Mr. DEANE. Altogether, the whole total.

Mr. COLE. You mean all public housing?

Mr. DEANE. All public housing units, total units built.

Mr. SLUSSER. That would be 126,988 units under the Housing Act of 1949.

Mr. DEANE. How many of those are in the rural nonfarm areas?

Mr. SLUSSER. Approximately 7,000.

Mr. DEANE. Seven thousand?

Mr. SLUSSER. Yes, sir.

Mr. DEANE. Has there been any thinking or have there been any changes in the philosophy or thinking of the agency with reference to the views expressed in the report here, that the housing needs of

low-income families who live in rural nonfarm areas are as serious as those of low-income families in urban areas? "Two provisions have, therefore, been written into the bill with specific reference to this problem."

Are you following any particular policy with reference to the rural nonfarm areas?

Mr. COLE. Mr. Deane, we are in agreement with the statement made in the report which you have quoted, to the effect that people in the rural nonfarm areas are in need of housing just as those people in the great urban areas need housing. I am, however, of the opinion that the great problem of public housing is centered in the large urban areas. That follows along with our thinking that public housing, primarily, at this stage of the development, is a matter of housing people with low incomes who have been displaced through slum clearance and rehabilitation projects.

That does not mean that the program has ignored the fact that there are people with low incomes in the nonfarm areas.

Mr. DEANE. How many units were approved by Congress last year?

Mr. COLE. Twenty thousand.

Mr. DEANE. How many of those units were allocated to rural nonfarm areas?

Mr. COLE. We will furnish that for the record, Mr. Deane. We do not have it now.

Mr. DEANE. I feel that we are not showing to these areas the consideration we should in view of your statement, Mr. Cole.

Mr. COLE. Let me get it out on the table very frankly, Mr. Deane.

I have some question as to the advisability, where we have a limited supply of public housing, of authorizing and building, in a community, let us say, a 4-unit public housing authority, or a 6-unit public housing authority, or project. Not that I disagree that those people need housing.

Mr. DEANE. When you speak of that number, how many tenants are you thinking about?

Mr. COLE. A 4-unit would mean 4 families. Six units would mean 6 families.

Mr. DEANE. Well, of course, I would agree with you on that basis, but I am thinking of a unit where 50 or 60 families could be accommodated.

Mr. COLE. All right, we are talking then about a division. I am glad you defined it. I would not disagree with your position, and Mr. Slusser might comment upon that.

Mr. DEANE. In other words, the figure which you furnish would be thinking in terms of units that would accommodate, let us say, a minimum of 50 families?

Mr. COLE. Then we are not too far apart on our thinking, Mr. Deane.

Mr. DEANE. How many units, of the 120,000, were given to existing projects?

Mr. COLE. Given to local authorities which have had in the past projects in operation?

Mr. DEANE. That is right.

Mr. COLE. That I am sure we would have to furnish. We will have to furnish that for the record, Mr. Deane.

(The information is as follows:)

Out of the 35,000 units put under construction in fiscal 1953, as authorized by the Congress for that year, there were 3,566 rural nonfarm units in 105 localities.

On June 30, 1953, there remained only 501 rural nonfarm units which were under annual contributions contract but on which construction had not commenced. The Independent Offices Appropriation Act for 1954 limited construction to 20,000 units, all of which had to come out of existing contracts.

Selection of the 20,000 units for construction in 1954 out of the 56,000 units under annual contributions contracts at the beginning of the year was based primarily upon how long the units had been under contract and how much investment had already been made in land purchase and plans. Other considerations were whether the units could be ready for the relocation needs of families displaced by slum-clearance operations; whether they were required to achieve racial equity in a locality and whether there had been any previous construction in the locality. Because of these considerations there are 49 rural nonfarm units in 2 localities scheduled to start construction in fiscal 1954.

Of the 20,000 units allocated for construction in fiscal 1954, 580 units are in 9 localities which have had no low-rent units so far constructed under the Housing Act of 1949.

MR. DEANE. As I study the public-housing program the existing authorities know the procedures and know how to take advantage of the program. I am just wondering whether the agency will take it upon itself to really try to channel some of these units into these areas, that would service at least a minimum of 50 units?

MR. SLUSSER. There were a number under the 20,000 that went into first projects in a community. That number would have to be furnished to you. But I can explain this to you, in allocating 20,000 units we took, first, the amount of money involved by loan, in the community, the heaviest investment was one consideration. Another consideration was where there had been no housing projects formerly built in that community. And the slum-clearance sites, of course, that were prepared and ready to go ahead, constituted another consideration.

MR. DEANE. The proposed bill suggests a plan looking toward the sale of these low-rent public-housing projects. Have you reached the point in your thinking that in the event of sales—or do you have the authority, under the act, to sell the projects? Perhaps I should ask that first.

MR. COLE. Mr. Deane, let me say that we have not made any recommendation about the sale of public-housing units in this proposed legislation.

MR. DEANE. Do you have the authority under the act now?

MR. COLE. I wanted to answer that. It is doubtful, as I thought, that we do have authority to sell them, except where it could be proven without any question that they were not needed in the community.

MR. DEANE. In view of that fact, if you found those facts to be true, what preference, if any, would you give to existing tenants or groups of tenants within the projects?

MR. COLE. That is a matter that would seem to me to require considerable discussion and thought, Mr. Deane. I have no present attitude about it. I do not know whether Mr. Slusser has any comment about it or not.

MR. SLUSSER. No, I believe it would require legislation, Mr. Congressman.

MR. DEANE. Now, I have some very interesting tables here. I wonder, Mr. Chairman, if it would be permissible to insert them in the record. It is a page and a half of the President's Advisory Committee,

page 303, exhibit 14, "Characteristics of Residents of Public Housing for Low-Income Families." If I may have that included I would be very grateful.

The CHAIRMAN. Without objection, that may be inserted in the record.

Does that indicate the average family income that is necessary as a minimum to be eligible for occupancy?

Mr. DEANE. I was coming to that, Mr. Chairman. This exhibit 14 refers to service status, minors, heads of families, assistance, and broken families.

The other page I would like to include would be the page with reference to the income.

The CHAIRMAN. Without objection, they may be inserted in the record.

(The information referred to is as follows:)

EXHIBIT 11—INCOMES OF FAMILIES ALREADY RESIDENTS OF PUBLIC HOUSING, CALENDAR YEAR 1952¹

Incomes of residents are verified at least once a year after admission to determine whether the family is eligible for continued occupancy. In addition to the exemptions from net income for determining eligibility at admission, the law authorizes the exemption of all or part of any income of a minor in lieu of the \$100 exemption for that minor. This provision was included by the Congress so that families would not be made ineligible for continued occupancy because of temporarily increased incomes due to the employment of minors. While the family remains eligible the increased income is taken into account in determining the rent.

Annual income	Number of persons in family				
	1 ¹	2	3 or 4	5 or more	All families
<i>Income for eligibility</i>	<i>Percent</i>	<i>Percent</i>	<i>Percent</i>	<i>Percent</i>	<i>Percent</i>
Total.....	100.0	100.0	100.0	100.0	100.0
Under \$1,000.....	67.2	28.3	11.0	6.9	15.5
\$1,000-\$1,499.....	17.3	29.6	20.2	13.2	20.0
\$1,500-\$1,999.....	8.6	19.5	19.3	18.2	18.7
\$2,000-\$2,499.....	4.0	12.6	18.3	20.2	17.1
\$2,500-\$2,999.....	2.1	6.2	15.5	18.3	13.8
\$3,000-\$3,499.....	.6	2.2	8.8	12.5	8.2
\$3,500 and over.....	.2	1.6	6.9	10.7	6.7
Median.....	\$796	\$1,348	\$1,988	\$2,291	\$1,885
<i>Net income</i>					
Total.....	100.0	100.0	100.0	100.0	100.0
Under \$1,000.....	65.9	24.1	5.6	2.0	10.6
\$1,000-\$1,499.....	18.1	30.7	17.8	6.8	17.4
\$1,500-\$1,999.....	8.8	20.6	20.5	15.9	18.7
\$2,000-\$2,499.....	4.2	13.4	19.3	20.0	17.7
\$2,500-\$2,999.....	1.9	6.7	16.8	20.6	15.2
\$3,000-\$3,499.....	.8	2.6	10.4	16.4	10.1
\$3,500 and over.....	.3	1.9	9.6	18.3	10.3
Median.....	\$815	\$1,408	\$2,154	\$2,626	\$2,087

¹ While single persons are not admitted, a surviving individual of a family may continue in occupancy if otherwise eligible. About 3 percent of the units were occupied by such individuals.

² Net income: Same as at admission.

The figures in this table cover all families whose incomes were verified for continued occupancy, including those families found ineligible to remain. The next table gives the incomes of eligible and ineligible families. (See exhibit 12.)

¹ Source: Statistics Branch, Public Housing Administration.

EXHIBIT 14.—CHARACTERISTICS OF RESIDENTS OF PUBLIC HOUSING FOR LOW-INCOME FAMILIES

Characteristics	Families admitted during 1952	Families reexamined Jan.-June 1952
	<i>Percent</i>	<i>Percent</i>
Race:		
White.....	68.1	59.3
Negro and other.....	31.9	40.7
Service status:		
Veterans and servicemen.....	48.2	33.6
No service connection.....	51.8	66.4
Minors:		
None.....	15.8	20.4
One or two.....	49.6	44.6
Three or four.....	26.2	26.0
Five or more.....	8.4	9.0
Average number of minors.....	2.09	2.07
Age of head of family:		
Under 25 years.....	22.0	7.9
25-44.....	60.0	60.8
45-64.....	12.3	21.7
65 and over.....	5.7	9.6
Assistance:		
Receiving assistance ¹	25.6	29.0
Not receiving assistance.....	74.4	71.0
Broken families: ² As percent of all families.....	26.2	³ 22.4

¹ Receiving public or private relief or recipients under Social Security or other public pension or payment plans.

² Families with minors and only one adult.

³ For 1951; data for 1952 not yet available.

Source: Statistics Branch, Public Housing Administration.

Some of the highlights of the above table and comparisons are as follows:

1. Negro families (and a small number of "other" races) represent about 32 percent of all families being admitted to and 41 percent of all families in low-rent public housing, although they are only about 8 percent of all nonfarm families in the United States. This reflects their lower economic status and greater inability to secure standard private housing within their means.

2. Of the families of veterans and servicemen admitted, 10 percent were families of disabled or deceased veterans or servicemen.

3. The more than 2 minors per family in public housing compares with 1.13 minors (under 18 years) per nonfarm family in the United States according to the 1950 census.

4. Nearly 10 percent of families already in and 6 percent of the families admitted in 1952 had a family head 65 years old or over. Almost 12 percent of all nonfarm families in the United States, according to the 1950 census, were headed by a person 65 years old or over.

5. Twenty-nine percent of the families who were living in low-rent public housing and whose eligibility was reexamined in the first 6 months of 1952, and 26 percent of those admitted during 1952, received some form of assistance.

6. Twenty-six percent of families admitted and 22 percent of families already in the low-rent public housing in 1952 were broken families, that is, families with children but only one adult present.

Mr. DEANE. Mr. Cole, from your observation since you have been head of the agency, have you had an opportunity to study the Commissioners and the people administering these programs?

Mr. COLE. I have met with a great many of them, Mr. Deane, both in the localities and as they came to Washington. Mr. Slusser has seen many more of them than I, and has become much more familiar with them than I have. But I would say that I have met quite a few of them.

Mr. DEANE. What is your opinion of these men?

Mr. COLE. I assume you mean as to character, reputation, and ability?

Mr. DEANE. That is right.

Mr. COLE. It is good. Excellent. I have no criticism of them.

Mr. DEANE. I only know those in a number of projects in North Carolina, and I have found them to be men of outstanding ability and vitally interested in housing for the lower income group. Would you share that view?

Mr. COLE. Yes, sir; I would share that view. As I commented in response to a question from Mr. Bolling last night, I think one of the things that I have found in my experience as administrator has been that among the people who are working with and are a part of this program, both employees and the so-called public members—I mean those who are nonpaid members of the authority, the great majority of them, practically all of them, have a strong sense of civic duty and responsibility, and that, to me, is a very fine thing.

The statement which I made yesterday, about some people who would carry on a program irrespective of what can be done or should be done, has been dissipated somewhat, in my mind.

Mr. DEANE. I am glad to have you be a little more moderate in your response. I wouldn't say it was heated, yesterday, but from my observations I have seen a minimum amount of political activity in the PHA projects in my areas. At least I have never been the recipient of it.

Mr. COLE. Mr. Deane, most of my fears about public housing having been due to those things which I saw as possibilities. I want to make that very plain—possibilities, if they were not carefully eliminated in their applications, and I still say that. The possibilities, the tool which you place in the hand of the centralized Federal Government leads to those possibilities. Personally, I would just as soon not discuss any more of that. We want to determine what we can accomplish for the benefit of our people.

Mr. DEANE. I think this is true, that these people who have been close to the public housing program, are sold on the program, and in view of the action of the Congress in gradually whittling away the program they have been, perhaps, taking aggressive steps that they otherwise would not. I guess that would be characteristic of farm groups, labor groups, manufacturers, and all the rest. Would that be true?

Mr. COLE. Very true. I want to say one more thing. I have found that there is not an unanimity of opinion among those people who are strongly in favor of public housing. By that I mean, I find that they have differences of opinion about matters of policy, procedure, and law, and there is quite a wide variance of opinion among those people, and a sincere one. And many of them agree with me.

Mr. DEANE. I do not know whether you would have any comment, but during the last 2 years the House has not assumed any responsibility toward approving any units, leaving it to the Senate to write the legislation.

I am just wondering, have you appeared before the Appropriations Committee urging the House to include sufficient funds for the 35,000 units?

Mr. COLE. Some years ago, when I was a House Member, I appeared before the Appropriations Committee and gave them a statement, and then went out and gave it to the press. I did not realize that I was under restrictions. I thought I was a House Member to do as I

pleased. But I find that testimony before the House Appropriations Committee is a privileged communication until the printed hearings are available.

May I say this to you, however: The 35,000 units per year for 4 years, is a program of the President, it is a program of this administration, and it is my program, and I have done everything possible within my power, and will do everything possible within my power, to help Congress to establish that program.

MR. DEANE. That is very fair, and I thank you. Thank you, Mr. Chairman.

MR. BOLLING. Mr. Chairman.

The CHAIRMAN. Mr. Bolling.

MR. BOLLING. Yesterday, when we adjourned, Mr. Cole, I was beginning to get into the question of the effect of the action of the Congress on public housing during the last year, and I would like to begin in a slightly different fashion today.

As I understand it, the PHA operates now under legislation which is essentially a modification of the Housing Act of 1949 by appropriations riders, and I would like that described for the record, the action that we took last year.

MR. COLE. The appropriations rider?

MR. BOLLING. Well, the effect of it.

MR. COLE. The effect of it?

MR. BOLLING. Yes, sir. What can be done in the field of public housing as of now, say?

MR. COLE. Well, the appropriations so-called rider limited the construction of public housing units, in the fiscal year, to 20,000. It stopped the so-called pipeline for the preparation, planning, architectural studies, plans, the acquisition of land, the securing of contracts, and so forth, it stopped all of that preparation because no additional units could be constructed beyond the 20,000.

Therefore, the business of preparation, to keep the inflow of units, one year to the next, was terminated.

MR. BOLLING. Now, if that specific item of legislation in the appropriations bill were repealed, then what would be the effect, on just that item?

MR. COLE. It would make considerable difference.

MR. BOLLING. Where would we be, then, in terms of number of units authorized, and so on?

MR. COLE. The units authorized, then, would be that number authorized by the substantive legislation, 135,000 a year. 135,000 a year would be authorized.

MR. BOLLING. Well, now, if, let us say, to make the thing clear—I pose this theoretical possibility—if the Appropriations Committee repealed the 1954 fiscal year rider, then would we not in fact return to the 1953 fiscal year rider?

MR. COLE. If they merely repealed it?

MR. BOLLING. Yes, sir.

MR. COLE. We think not.

MR. BOLLING. You think not. What was the limitation imposed on an annual basis in the 1953 fiscal year independent offices appropriations bill?

MR. COLE. Thirty-five thousand units per year.

Mr. BOLLING. Now, I would like to return to the line of questioning that I left last night, and I would like to find out, for the record, what was the effect of the action, in terms of numbers. You have already described that it limited to 20,000 the units for this fiscal year, and cut the pipeline off.

What was the effect, and how many units are now under firm contract, which I gather could not be implemented without additional action from the Congress; how many units or projects, which were working under preliminary loans, had to be liquidated and, finally, how many reservations—which I understand is a very loose process—existed at the time the pipeline was cut off?

Mr. COLE. Mr. Slusser will answer that.

Mr. SLUSSER. There are authorized now 35,810 units. We know of a certainty that there will be some attrition there, possibly bringing that down to between 32,000 and 33,000 units that would be available.

Under the preliminary loan contract, but not under annual contribution contracts, 124,112. These are now in process of being liquidated.

Mr. BOLLING. What I am trying to establish, in effect, is the amount of, and the stage, of concrete community interest in the program, and there is one further step that I would like to get to, if we can. I realize that they are not in any sense binding, but they indicate the interest of the community in proceeding in an orderly fashion toward public housing building—reservations, I believe, is what they are called. Do you have a figure on that?

Mr. SLUSSER. I do not have a figure as to number of units. That would not be possible, because the applications were never processed. In July 1952, all preliminary loan applications were stopped.

Mr. BOLLING. Do you know as of that time how many preliminary loan applications there were?

Mr. SLUSSER. There were about 1,100 cities that had filed applications.

Mr. BOLLING. That had filed preliminary loan applications?

Mr. SLUSSER. Yes, sir.

Mr. BOLLING. If I understand that correctly—and please interrupt me to correct me if I am in error—

Mr. COLE. Mr. Bolling, may I interrupt a moment so the record will not be incorrect, and will be corrected before we get too far? I was in error, in answer to your question about the removal of the present limitation. If the present appropriations rider is removed, you are correct in your assumption that it would return to the 35,000 limitation of the prior year. We have checked it and found that I was in error in my statement.

Mr. BOLLING. So that in effect there are two riders to be considered, one of which, by a coincidence, the 1953 rider, would provide for the level of construction recommended in the President's program.

Mr. COLE. Yes, sir.

Mr. BOLLING. Now if I have understood these figures correctly, you have 35,800 units under firm contract, and you have 124,000 units which were under preliminary loan and were or are in process of liquidation.

Mr. SLUSSER. That is right.

Mr. BOLLING. Then you have additionally 11,000 communities which have indicated—

Mr. SLUSSER. Eleven hundred?

Mr. BOLLING. Excuse me, 1,100 communities which have indicated a sufficient interest to request a reservation?

Mr. SLUSSER. That is not in addition, but total, including the 124,000 units.

Mr. BOLLING. But in any event, going back to the figures, and with the assumption that there will be certainly an increase in the figure of firm contracts plus preliminary loans, when we contemplate the reservations, there will certainly be additional units involved in that 1,100 figure, although it is inclusive of the others; isn't that true?

Mr. SLUSSER. Yes, sir.

Mr. BOLLING. We find, then, that you have a total, if my mathematics are correct, of approximately 160,000 units, where communities have either gone so far that they are under firm or binding contract, as I understand it, or that have gone so far as to be under a preliminary loan which is now in liquidation. Now, I presume that all of this was taken into account when the program was devised, which provided for a total of 140,000 units.

Mr. SLUSSER. Yes, sir.

Mr. BOLLING. So you are prepared to present a program which actually provides for less than the communities have indicated a very substantial interest in.

Mr. KILBURN. Are you talking about public housing?

Mr. BOLLING. Yes, sir.

Am I correct in that understanding?

Mr. COLE. Yes, sir; you are correct in the understanding that the program represented here is less than that represented by the evidences which you mentioned.

Mr. BOLLING. So that we cannot say, in effect, that the communities are inadequately interested in this program?

Mr. COLE. I do not know. I do not know that I understand your question.

Mr. BOLLING. Well, just on the figures, it seems evident that the communities are more interested in the program than the administration is willing to recommend that the program be.

Mr. COLE. Of course I would not agree with that, Mr. Bolling. You understand the preliminary problems of communities involved.

Mr. BOLLING. Somewhat.

Mr. COLE. You must remember that Mr. Slusser, in his statement about the firm contracts, stated that even with those that are in existence now there is some attrition. Out of 36,000 they believe there may be an attrition of three to four thousand.

Mr. BOLLING. If I may interrupt, there, that is hardly startling in view of the way Congress has acted on this program.

Mr. COLE. Well, "yes" and "no." You are partially right about it. It may be partially Congress' fault, it may be partially my fault, or partially someone else's fault. All I am saying is that the mere evidence on the part of the community that they are interested in a program does not mean that they are going to complete it, nor does it mean that they should. They may change their mind, and they do change their mind, some of them.

Mr. BOLLING. You do not think that these figures indicate anything?

Mr. COLE. I think they do indicate something. I do not say that they indicate a firm, positive, absolute, unequivocal commitment that this number of units, first, will be desired by the community, and, secondly, that they are needed.

Mr. BOLLING. The indications would be to me, at least, that there were as of the time of the last appropriations rider's passing, a strong possibility that there was a desire on the part of enough communities to build a great many more units in a year than Congress was willing to appropriate money for.

Now, I would like to turn to another subject which has to do still with this business of slum clearance and urban renewal.

I am not sure that I understand entirely the significance of these \$7,000 single-family 40-year mortgage units. I gather from what you said, and from other things that I have read in your statement, that it is in effect hoped that this would ultimately be a substitute for public housing?

Mr. COLE. No, I have not said that. I have said this: First, it is an experiment. Secondly, that we refuse to recognize that the only means of housing people with low incomes is public housing.

This, I think, is the first time that a program has been presented to achieve that objective. By that I mean, the recognition of other means of housing low-income people than through public housing. We are quite enthusiastic about the possibilities to be developed through section 221, in addition to section 220. We think that a test, a trial, will show that a successful operation of such a program will relieve the pressure for the need to assist people with low incomes to obtain decent housing.

Now, Mr. Bolling, you and I both know that there are people in this country—and God forbid there probably will be for many, many years, maybe always—people in this country who could never pay an economic rent or ever buy a house. We know that, and we must face that problem.

After facing it, then we decide what to do with it. This is merely another step to test, to see what can be done.

Mr. BOLLING. If I understand this correctly, it is designed to see, on an experimental basis, if we cannot house a number of people who are displaced by slum clearance in houses provided by the private enterprise without subsidy?

Mr. COLE. Well, when you add the latter, I do not know what you mean by subsidy. You know I am a little cautious about what a subsidy really is.

Yes, sir; I would say the answer is "Yes." If you press me a little bit about subsidy, then I might say—

Mr. BOLLING. Well, that is what I intend to do.

Mr. COLE. All right, let us be frank about it. If you mean Government support is subsidy, I won't argue with you.

Mr. BOLLING. Let us define that. Do you mean the insurance feature?

Mr. COLE. Yes, sir.

Mr. BOLLING. No, that isn't the point—

Mr. COLE. The FNMA feature, the FNMA support.

Mr. BOLLING. Well, actually, the point that I had in mind was perhaps even more simple than that, and it is contained on page 29

of your statement, where you describe what this program is, this 221 program, and the key sentence is that "It provides a means under which the income hazards of long investment at fixed rate of return are minimized by permitting any such loan in good standing to be assigned to FHA at any time after 20 years, exchanged for 10-year fully guaranteed debentures."

Mr. COLE. Yes, sir.

Mr. BOLLING. Now, check me if I am wrong in this: The effect of this is that if a substantial amount of this housing is built, and if there should be, let us say, a significant shift in interest rates over a 20-year period, then the person or the institution which held that paper—maybe it held it at an interest rate of 5 or 6 percent, and conceivably I think in that period interest rates went up substantially—it would be able to turn in this particular paper, drawing a certain percent, for a debenture which drew a very substantially larger percent.

Mr. BROWN. Mr. Bolling, will you yield to me?

Mr. BOLLING. Certainly.

Mr. BROWN. These \$7,000 houses over a period of 40 years, how much per month will these people have to pay?

Mr. COLE. In a \$7,000 house our estimate is around \$62 per month, which would include interest, amortization, utilities, fuel—all of the other necessary living costs to live in the house as though you were living in a completely provided for apartment, you understand.

Mr. BROWN. Thank you.

Mr. BOLLING. Am I incorrect in my understanding?

Mr. COLE. I want to check with counsel if you will allow me.

Mr. BOLLING. Certainly.

Mr. COLE. I think basically you are correct, but remembering this point, that an investor may shift his investment for a number of reasons. He may want to rearrange his portfolio. There may be a number of reasons why he would do so.

Now, may I add one more thing: The point we are making is that this does provide a test of this type of an investment. Therefore, we think it is proper to do so.

Mr. BOLLING. Well, I have no objection to that point of view. The only thing that I am interested in doing at this point is revealing the implications, and it seems to me pretty clear that there is very evident an implication here that there may very well be, in this program, a quite significant subsidy, but it is a subsidy which is very ingeniously handled and which comes about later in the game, in addition to what other subsidies there may be in the Government program as a whole, and it is a subsidy to the investor. It may be perfectly proper, but I think it should be recognized as such, at least that the potential exists.

Mr. COLE. If you define a subsidy as any program which the Government undertakes to support, and which may require, in the final analysis, some money to be paid by the Government for that support, then this could in my judgment be a subsidy.

I do not agree, however, that it is a subsidy solely for the investor. It is a subsidy for the people who obtain the homes.

Mr. BOLLING. It would be a subsidy that went to many different people.

Mr. COLE. Right.

Mr. BOLLING. Including the people who had quite a bit of this particular type of mortgage. Now, presumably, although this is an experimental program—admittedly and recognizedly—there has been some estimate made, both as to number and quality of houses that might be expected under this particular program, and I would like to have some information, quite specifically, as to what kind of a house you get for \$7,000 and whether or not competent judges feel that this is the kind of house that will be in good shape in 40 years.

Mr. COLE. I don't know what you mean by specifically. I can give it to you generally, but not specifically.

I know some builders who are building \$7,000 houses, and I know some prefabricated manufacturers who are manufacturing \$7,000 houses, I know some houses that are now, having been built some years, in substantial condition, I know that a \$7,000 house can be built, in practically every area of this country, and I rather think in every area of this country.

Once more, it is an experiment. I don't think it is an experiment with respect to the fact that a \$7,000 house can be built, nor do I personally feel that it is an experiment that a \$7,000 house will last 40 years, Mr. Cole.

Mr. BOLLING. You feel convinced of that?

Mr. COLE. Yes.

Mr. BOLLING. Have you got evidence of that?

Mr. COLE. Yes, we have some evidence of that. It is a matter of statement on the part of builders who feel that that can be done.

Mr. BOLLING. This is a matter of statement than can be done and not an illustration that it has been done?

Mr. COLE. Oh, when you press me for that, many \$7,000 homes have been built in the past longer than 40 years ago, that are good, decent, sound houses.

Mr. BOLLING. We know what we are talking about, Mr. Cole, we are talking about a \$7,000 house at 1954 prices.

Mr. COLE. I know, we are talking about that—

Mr. BOLLING. If you translate a \$7,000 house at 1954 prices to a \$7,000 house on an equivalent basis, with the change in value of the dollar, then we have something to talk about.

Mr. COLE. Then we are talking about a guess which anybody might have.

Mr. BOLLING. That is what I want to find out.

Mr. COLE. But let me say this: There have been many advances made in the construction of housing over the last few years, many advances, which provide for a low-cost construction with the type of construction that was never dreamed of a few years ago, which, by the mere examination of the house, looking at it, some uninformed people might think it is a shell, a flimsily built house, whereas that is not true.

Many of the finely constructed houses today are built with materials which we never dreamed were available in years past, and bring the

cost down. Mass production will also come into play to accomplish this objective.

Now, I am not saying to you that I know positively that the \$7,000 house is an answer to this problem. I won't say that. None of us know that. We merely say we are going to make a test of it, and we are advancing with our ideas on it and we are going to go about it in such a way that we think will be slow enough to really test it, and not to test it.

Mr. BOLLING. If I understand you correctly, this is a very important experiment and I would presume that you would have fairly careful studies, not only on the subject that we have just been discussing, but also on the subject of what the repair ratio would be, if that is the right way to put it, to keep a \$7,000 house in good shape so that it would be worth something in 20, 30, and 40 years.

Mr. COLE. If repair work is done properly—

Mr. BOLLING. What does it cost? It is a question of cost. That enters into the total cost of dwellings, certainly.

Mr. OAKMAN. Would the gentlemen yield?

Mr. BOLLING. Yes.

Mr. OAKMAN. We took a day off and drove up to Levittown, Pa., is it, Mr. Cole, where they are building thousands—a brand new community—of houses, with a depot, and everything, a beautiful modern community, with large lots.

Mr. BOLLING. I think we are going to have the privilege of having Mr. Levitt testify, if I understand correctly.

Mr. OAKMAN. I think that would be excellent.

Mr. BOLLING. I do, too.

Mr. OAKMAN. They are very attractive homes, with natural fireplaces, electric ranges, and so forth. I forget the exact price of those homes, but it seems to me they are in the \$7,900 class. Mr. Cole, there isn't anything sacrosanct about the figure of \$7,000, is there?

Mr. COLE. No.

Mr. OAKMAN. That could be changed to \$7,500 or \$7,300 or \$7,700. But I say, I saw thousands of those homes, in a matter of a few hours. It is located around 35 or 40 miles out of Philadelphia.

Mr. BOLLING. I understand that is a unique development.

Mr. COLE. It is a unique development but there are many builders in this country that are doing a tremendous job in that field, Mr. Bolling. You would be amazed at what they are doing in that field.

Mr. BOLLING. I understand there are a number of people that want me to yield. Mr. Multer.

Mr. MULTER. It may be that some of these fellows can build a house for \$7,000, but I am sure that none of those builders are willing to do it, in my district or Mr. Deane's district or Mr. Bolling's. We would like to know where they are. They are not in our districts.

Mr. COLE. When you are talking about your district Mr. Multer, you are talking about a different situation.

Mr. MULTER. I will take the entire metropolitan area of New York; Long Island, Nassau County, N. J.

Mr. COLE. Levittown is built in your area, and may I say, in response to that, and in response to a question on this side of the aisle

yesterday, that in the great urban centers, Mr. Multer, in Manhattan, in densely populated areas, with expensive land, a \$7,000 new single-unit cannot be built. I know that. But the one provision which would be helpful is the fact that these loans can be made on existing houses for remodeling or rehabilitation. That is one step.

Mr. O'HARA. Mr. Chairman, will the gentleman yield for one observation?

Mr. BOLLING. Certainly.

Mr. O'HARA. If Mr. Cole can find a purchasable new \$7,000 or \$8,000, or even a \$9,000 house in Chicago, he will be a greater discoverer than Christopher Columbus.

Mr. COLE. My answer to you, Mr. O'Hara is exactly the same as it was to Mr. Multer as to these great areas. We are not contending that you can, on high-priced land, build a \$7,000 house, but I am saying to you that within your area, the metropolitan area, that either the seven, eight or nine thousand dollar house can be built, as we advance in our modernization and mass production methods, but more important to you, in your district, would be the authority to remodel and rehabilitate the existing homes under this provision, plus your other sections, 207 and 213.

Mr. O'HARA. I am in agreement with the gentleman to the extent that at the present time the remodeling and rehabilitation authority offers a more practical approach than promises of \$7,000 homes, which in Chicago, just do not exist.

Mr. BOLLING. Now I would like to know, more specifically—I am sure you have made a thorough study of this matter and discussed it with many builders—how many bedrooms are going to be in this \$7,000 house?

Mr. COLE. You can have a 2- or 3-bedroom.

Mr. BOLLING. You think you could have a 2- or 3-bedroom house for \$7,000?

Mr. COLE. Yes.

Mr. BOLLING. One more question: How many \$7,000 houses were built in 1953?

Mr. COLE. We could furnish that.

Mr. BOLLING. I would like to see it broken down, of course, by geographical area, by urban versus rural, and so on.

Mr. COLE. We will do the best we can about that.

(The information is as follows:)

SEVEN-THOUSAND-DOLLAR HOMES BUILT IN 1953, BY GEOGRAPHIC AREAS

Data with which to measure precisely the price distribution of all new homes built in 1953 are not available. There are data on the value and price distributions of new homes started under FHA or VA financing, respectively, but homes started under the FHA and VA programs accounted for about 38 percent of the total sales housing units started in 1953. Price information is not available for conventionally financed units. Therefore, an estimated distribution was derived with the use of current FHA and VA data and census data on new homes acquired in 1949-50 with FHA-insured loans, VA-guaranteed loans or conventional loans.

Table 1 shows the estimated distribution of new units in 1- to 4-family structures started during 1953, priced at less than \$7,000 or \$7,000 and over. This and other distributions shown here are taken from more detailed price distributions

which were derived. The price distribution of homes started under FHA or VA inspection is based on the value and price distributions of homes on which loans were insured by FHA and guaranteed by VA, respectively, during 1953. There is a time lag between the start of a home and the completion of a home, so that the price distribution for homes started is not exactly the same as that for homes completed and on which loans are insured or guaranteed. However, it is believed that within the period of a year, characterized by relative stability of construction costs, this lag would not cause a significant difference in the price distribution of new homes started, as compared with the price distribution of homes on which loans were insured or guaranteed by FHA and VA.

The price distribution of new units in 1- and 2- family structures started under conventional financing in 1953 was derived on the basis of data from the 1950 census of housing. The 1950 census of housing contained information on new owner-occupied residential properties acquired in 1949 and the first half of 1950 by type of loan—FHA-insured, VA-guaranteed or conventional. Due to the limitations of the available data, it was necessary to assume that the same relative changes within price classes had taken place since 1949-50 in the price distribution for conventionally financed new homes as for new homes with FHA-insured and VA-guaranteed loans. On this basic assumption, an estimated 1953 price distribution for conventionally financed new sales housing units was derived, and it then was combined with comparable 1953 distributions for new homes with FHA-insured and VA-guaranteed mortgages, to obtain a price distribution for all new sales housing units started in 1953. The resultant distribution for all 1953 new sales housing units started (table 1) shows that almost 10 percent of the units were priced at under \$7,000. In absolute numbers, the under \$7,000 units amounted to about 96,000 and it is estimated that about 84,000 were conventionally financed.

In the 1949-50 price distribution shown in table 2, the number of conventionally financed properties of under \$7,000 accounted for 37.5 percent of all conventionally financed new homes; whereas the houses of under \$7,000 financed with FHA-insured and VA-guaranteed loans accounted for only about 16 percent of the new houses with such financing.

From data on purchase price by income of 1949-50 home buyers appearing in the census of housing, it can be inferred reasonably that poorer quality, low-priced homes generally were bought by lower-income groups with conventional loans than with FHA-insured or VA-guaranteed loans.¹

The latest information available to indicate the areas in which homes priced at under \$7,000 might be produced is as of 1950. Although the proportion of under \$7,000 homes constructed in any area undoubtedly has decreased since 1950, the 1950 data will indicate in which areas the estimated 10 percent of new homes priced at \$7,000 in 1953 may have been produced. Table 3, based on the 1950 census of housing, provides a general indication by showing the price distribution of new homes acquired in 1949 and the first half of 1950 inside and outside standard metropolitan areas. Inside standard metropolitan areas less than 17 percent of the new homes were priced at under \$7,000, and outside standard metropolitan areas 43 percent of new homes purchased in 1949-50 were priced at less than \$7,000. Obviously, a greater concentration of such low-price houses is to be found outside standard metropolitan areas than inside. (The census of housing does not provide separate purchase-price data for new urban and new rural nonfarm houses acquired in 1949-50.)

However, other data for 1950, shown in table 4, indicate that many standard metropolitan areas, particularly those in the South Atlantic States and in the Southwest, and smaller metropolitan areas in all parts of the country had a fairly significant proportion of 1-family homes financed with FHA-insured mortgages which had an FHA appraised value of under \$7,000. The proportions of under \$7,000 homes built in 1950 under the FHA programs were very low, primarily, in the largest standard metropolitan areas where incomes and housing standards generally are higher than in the rest of the country.

¹ Reference: Highlights of Outstanding Mortgage Debt Analysis, Housing Research, No. 6, October 1953, p. 47.

TABLE 1.—*Estimated summary price distribution of new sales housing units started in 1953*

Price or value class	FHA and VA starts		Conventionally financed starts ¹		All new sales housing units started	
	Number	Percent distribution	Number	Percent distribution	Number	Percent distribution
Total.....	373,000	100.0	602,000	100.0	975,000	100.0
Under \$7,000.....	11,563	3.1	84,280	14.0	95,843	9.9
\$7,000 and over.....	361,437	96.9	517,720	86.0	879,157	90.1

¹ Based on assumption of same relative changes within price classes for conventionally financed new homes from 1949-50 to 1953 as for new homes purchased with FHA-insured and VA-guaranteed loans.

Source: Federal Housing Administration Veterans' Administration, and 1950 census of housing, vol. IV, Residential Financing, pt. 1, United States, ch. 2, tables 12a, 12b, and 12c, pp. 145-147.

TABLE 2.—*Summary price distribution of new owner-occupied residential properties for which price was reported acquired in 1949—first half of 1950 with FHA-insured, VA-guaranteed and conventional mortgage loans*

Price class	Number of new residential properties purchased with—				New residential properties purchased with conventional loans	
	FHA-insured loans	VA-guaranteed loans	FHA-insured and VA-guaranteed loans		Number	Percent
			Number	Percent		
Total.....	266,470	158,175	424,645	100.0	310,559	100.0
Under \$7,000.....	42,068	26,272	68,340	16.1	116,498	37.5
\$7,000 and over.....	224,402	131,903	356,305	83.9	194,061	62.5

Source: 1950 census of housing, vol. IV, Residential Financing, pt. 1, United States, ch. 2, tables 12a, 12b, and 12c, pp. 145-147.

TABLE 3.—*Summary purchase price distribution of new owner-occupied mortgaged properties acquired in 1949—first half of 1950 inside and outside standard metropolitan areas in the United States*

Price class	Inside standard metropolitan areas		Outside standard metropolitan areas	
	Number	Percent	Number	Percent
Total.....	518,967	100.0	216,507	100.0
Under \$7,000.....	91,687	17.6	93,151	43.0
\$7,000 and over.....	427,280	82.4	123,356	57.0

Source: 1950 census of housing, vol. IV, Residential Financing, pt. 1, United States, ch. 2, tables 12d and 12e, pp. 147-148, exclusive of small percentage of properties for which price not reported.

TABLE 4.—Number of new homes with FHA-insured loans and percent of 1-family new homes of under \$7,000 FHA value with FHA-insured sec. 203 mortgages in 1950 in standard metropolitan areas in which FHA insured at least 200 mortgages in 1950

Standard metropolitan area	Number of FHA-insured new construction mortgages on 1- to 4-family homes ¹	Percent of 1-family sec. 203 new homes with FHA value of under \$7,000 ²
New England and Middle Atlantic:		
Albany-Schenectady-Troy, N. Y.	782	4.2
Atlantic City, N. J.	285	6.2
Binghamton, N. Y.	118	1.7
Boston, Mass.	379	.8
Bridgeport, Conn.	54
Buffalo, N. Y.	696	5.2
Erie, Pa.	130	50.0
Harrisburg, Pa.	355	.8
Hartford, Conn.	596
New Haven, Conn.	181	1.7
New York-Northeastern New Jersey	25,155	.8
Newark-Northeastern New Jersey	5,379	.3
New York-Long Island	19,776	.9
Philadelphia, Pa.	8,472	7.2
Pittsburgh, Pa.	2,803	6.6
Portland, Maine	108	4.6
Providence, R. I.	192	2.2
Rochester, N. Y.	447	.9
Springfield-Holyoke, Mass.	159
Stamford-Norwalk, Conn.	135
Syracuse, N. Y.	170	23.7
Trenton, N. J.	63
Worcester, Mass.	70
South Atlantic:		
Atlanta, Ga.	1,296	16.9
Baltimore, Md.	1,181	11.1
Charleston, S. C.	233	35.7
Charleston, W. Va.	354	33.1
Charlotte, N. C.	858	28.4
Jacksonville, Fla.	1,479	23.3
Durham, N. C.	166	24.8
Greensboro-High Point, N. C.	712	57.2
Greenville, S. C.	162	35.4
Huntington, W. Va.-Ashland, Ky.	152	22.7
Macon, Ga.	90	27.0
Miami, Fla.	2,795	18.8
Norfolk-Portsmouth, Va.	942	65.6
Orlando, Fla.	511	13.6
Raleigh, N. C.	351	69.4
Richmond, Va.	1,133	60.0
Roanoke, Va.	154	48.7
San Juan-Rio Piedras, P. R.	1,096	2.1
Savannah, Ga.	341	18.2
Tampa-St. Petersburg, Fla.	2,153	30.0
Washington, D. C.	1,998	.1
Wilmington, Del.	514	.2
Winston-Salem, N. C.	418	87.8
East North Central Division:		
Akron, Ohio	709	25.2
Canton, Ohio	74	54.0
Chicago, Ill.	4,444	4.8
Cincinnati, Ohio	584	11.7
Cleveland, Ohio	2,194	2.8
Columbus, Ohio	1,667	12.6
Dayton, Ohio	601	22.0
Detroit, Mich.	7,380	5.8
Evansville, Ind.	642	59.3
Flint, Mich.	726	5.0
Fort Wayne, Ind.	566	45.2
Grand Rapids, Mich.	1,045	8.0
Hamilton-Middletown, Ohio	278	9.1
Indianapolis, Ind.	1,644	37.6
Kalamazoo, Mich.	369	46.7
Madison, Wis.	237	.8
Lansing, Mich.	432	24.6
Lorain-Elyria, Ohio	164	31.3
Milwaukee, Wis.	1,178	.3
Muncie, Ind.	170	74.7
Peoria, Ill.	229	57.6
Rockford, Ill.	54	12.9
South Bend, Ind.	873	34.5
Springfield, Ill.	236	63.1
Springfield, Ohio	305	35.8

See footnotes at end of table.

TABLE 4.—Number of new homes with FHA-insured loans and percent of 1-family new homes of under \$7,000 FHA value with FHA-insured sec. 203 mortgages in 1950 in standard metropolitan areas in which FHA insured at least 200 mortgages in 1950—Continued

Standard metropolitan area	Number of FHA-insured new construction mortgages on 1- to 4-family homes ¹	Percent of 1-family sec. 203 new homes with FHA value of under \$7,000 ²
East North Central Division—Continued		
Toledo, Ohio.....	612	5.4
Youngstown, Ohio.....	676	23.5
West North Central:		
Davenport, Iowa.....	224	19.9
Des Moines, Iowa.....	558	2.5
Kansas City, Mo.....	2,141	5.4
Lincoln, Nebr.....	299	3.1
Minneapolis-St. Paul, Minn.....	1,404	.8
Omaha, Nebr.....	769	21.0
St. Louis, Mo.....	2,980	7.8
Sioux City, Iowa.....	29	
Sioux Falls, S. Dak.....	293	1.4
Topeka, Kans.....	313	4.8
Waterloo, Iowa.....	102	
Wichita, Kans.....	1,628	23.6
East South Central and West South Central:		
Amarillo, Tex.....	381	54.0
Austin, Tex.....	169	14.9
Baton Rouge, La.....	286	47.0
Beaumont-Port Arthur, Tex.....	557	15.4
Birmingham, Ala.....	938	25.9
Chattanooga, Tenn.....	298	22.5
Cornus Christi, Tex.....	650	12.7
Dallas, Tex.....	4,294	49.2
El Paso, Tex.....	1,037	51.0
Fort Worth, Tex.....	1,259	66.7
Galveston, Tex.....	257	18.7
Houston, Tex.....	4,610	16.0
Jackson, Miss.....	986	47.0
Knoxville, Tenn.....	387	49.6
Lexington, Ky.....	190	50.5
Little Rock-North Little Rock, Ark.....	794	36.7
Louisville, Ky.....	1,357	66.2
Lubbock, Tex.....	342	15.9
Memphis, Tenn.....	3,155	52.4
Mobile, Ala.....	166	26.0
Montgomery, Ala.....	258	20.6
Nashville, Tenn.....	796	31.8
New Orleans, La.....	2,070	7.6
Oklahoma City, Okla.....	2,365	17.0
San Antonio, Tex.....	936	33.1
Shreveport, La.....	1,250	20.1
Tulsa, Okla.....	2,801	27.7
Waco, Tex.....	101	83.9
Wichita Falls, Tex.....	246	33.3
Mountain and Pacific:		
Albuquerque, N. Mex.....	2,408	20.2
Denver, Colo.....	2,343	2.4
Fresno, Calif.....	1,015	7.3
Honolulu, T. H.....	594	
Los Angeles, Calif.....	10,538	16.2
Ogden, Utah.....	213	1.4
Phoenix, Ariz.....	2,466	44.6
Portland, Oreg.....	2,220	29.1
Pueblo, Colo.....	244	.8
Sacramento, Calif.....	2,824	10.2
Salt Lake City, Utah.....	1,441	2.2
San Bernardino, Calif.....	891	52.6
San Diego, Calif.....	1,580	16.9
San Francisco-Oakland, Calif.....	11,224	2.3
San Jose, Calif.....	2,744	0.5
Seattle, Wash.....	1,116	3.1
Spokane, Wash.....	975	27.0
Stockton, Calif.....	672	1.2
Tacoma, Wash.....	792	37.8

¹ Includes new 1- to 4-family units with mortgages insured under title I, secs. 2 and 8, and under sec. 203.

² The numbers on which these percentages are based are for sec. 203 1-family homes only and are exclusive of new home mortgage loans insured under title I, secs. 2 and 8, which totaled about 1,550, and under sec. 603 about 3,100 throughout the country in 1950.

Source: FHA Homes in Standard Metropolitan Areas, 1950, Federal Housing Administration, Washington, D. C., 1952.

Mr. BOLLING. As I understand this program, Mr. Cole, this particular experiment is supposed to be quite an important element in the whole slum clearance and urban renewal program, and frankly, I have the gravest doubts that in the metropolitan areas of the cities—and I believe you have stated already that there are a number of metropolitan areas in which it probably wouldn't be effective, it seems to me that the problem of slums is a metropolitan problem, largely—not exclusive—and that it is highly unlikely that in certainly the great metropolitan areas, and many of the smaller and medium-sized metropolitan areas, it is highly unlikely that adequate housing at this price can be built.

Now, the gentleman from Michigan mentioned Levittown. I gather that that is a rather different situation than the situation perhaps in a city like Detroit, or a city like Chicago, or a city like my own, Kansas City, and I am wondering if there is any supporting evidence—and that is the reason I asked the last question—to indicate that such houses will be built in those areas.

Mr. COLE. Mr. Bolling, I don't know any other answer that I can give you other than that which I already have.

It would be a grave mistake on my part, and not an honest statement, if I did not explain to you my questions and my doubts about the building of such a house in a high-cost area, and we are not suggesting that.

But we are suggesting that this has a tremendous potentiality in helping people find homes.

Mr. BOLLING. Where are slums in cities?

Mr. COLE. You will find slums in all parts of cities. The great Bedrock slums, as you know, are in the core of the cities, the downtown areas.

Mr. BOLLING. Are those low-cost areas?

Mr. COLE. Mostly high-cost areas.

Mr. BOLLING. Thank you, Mr. Cole.

Mr. HIESTAND. Mr. Chairman.

The CHAIRMAN. Mr. Hiestand.

Mr. HIESTAND. Mr. Cole, I am very happy to hear your expression of basic principles on this matter of low-cost, low-rent public housing, and your philosophy, and I am happy also to have you express your confidence in the people in that activity, your confidence in their integrity and their principles.

I am concerned, as you are, about possibilities for the future if it should extend unlimitedly, but I am also concerned about the actualities, how they are working right now, with reference to the future.

I would like to be assured, if I may—and I am sure the committee—on these new projects that are from time to time promoted or started. Just what is the basis for selection of those communities? How do you select those communities?

Mr. COLE. Mr. Slusser.

Mr. SLUSSER. You are speaking now of a totally new program, new starts?

Mr. HIESTAND. New projects, a new authority to be established.

Mr. SLUSSER. It would be selected on the basis of their ability to get ready for the program. There are so many that can be allocated

each year. The question of site selection, and all of that planning, engineering—

Mr. HIESTAND. Well, the establishment of a new authority, shall we say, in a community—you will do that selecting?

Mr. SLUSSER. Yes.

Mr. COLE. May I interrupt and call attention to one other provision in the proposed law, and that is the requirement that the administrator must be satisfied there is a workable program in that community to attack the problem of blight, deterioration, and slums. By that I mean, we feel that in all of these fields, the community should have recognized the responsibility of the community to do the job which they themselves can do, and that it is wrong for the community themselves or the Federal Government to participate in a program which attacks a pocket of a slum area, and then forgets the rest of the community, the blighted, the slums, the advancing of the slums, and so forth.

In other words, to recognize the causes to rehabilitate and conserve the community. That is an important part of it, in our proposal.

Mr. HIESTAND. Is there the requirement that that initiative must come from the community as to need, as to desirability?

Mr. COLE. Very definitely, it must come from the community.

Mr. HIESTAND. And is it correct to say that no new authority, new project, will be established, under this administration, except at the request of the community?

Mr. COLE. That is right.

Mr. HIESTAND. May we go on and say, then, that none will be established that the community does not want?

Mr. COLE. That is correct.

Mr. HIESTAND. I have this in mind because we know of one instance, and there are a number, of where an authority is established and is a power unto itself, responsible unto nobody, apparently, and the community voted, by over 100,000 votes, in spite of a very strong pro-housing, well-financed campaign, financed by the authority itself, in spite of that, voted by over 100,000 votes against it, and yet this Frankenstein which our previous Congresses have established, insisted "you shall have housing whether you want it or not."

Mr. COLE. I would like to have Mr. Slusser comment on that, and I think he will expound our mutual ideas about it, because he is in direct charge of this program, and as you know is a former mayor of Akron and has had a lot of experience in these fields.

Mr. HIESTAND. Glad to have it.

Mr. SLUSSER. Mr. Congressman, first of all, the community itself must initiate the authority.

Mr. HIESTAND. That is an established requisite?

Mr. SLUSSER. That is right. They must also get the approval of the city officials to enter into any contract for a start.

Now, I am certain that I would never recommend to Mr. Cole the beginning of a project in any community where there is an adverse attitude toward the program, or where there has been a referendum. And we would go into it very carefully, even if there was not a referendum, but where there was an uprising of civic indignation over a program or project location, we would go into that very carefully before making a decision.

Mr. McDONOUGH. Will the gentleman yield?

Mr. HIESTAND. Yes.

Mr. McDONOUGH. Mr. Slusser, in that connection what are you doing about previous commitments, that previous administrations have made to areas, where they have agreed to deliver, over a period of years, a certain amount of money for public housing?

Mr. SLUSSER. Well, we have a contract with the community. There isn't anything I can do about it but complete the contract.

Mr. McDONOUGH. There is nothing you can do about it unless the community asks for a cancellation of the contract?

Mr. SLUSSER. I beg your pardon?

Mr. McDONOUGH. If the community says they don't want the commitment that they previously asked for carried out, then you are privileged to cancel that?

Mr. SLUSSER. Oh, yes, quite willing to liquidate the contract.

Mr. McDONOUGH. But if the community doesn't take official action but there is a feeling in the community that they should not continue with the project, do you do anything to stimulate action in the community? Are you in position to cancel a contract at this end?

Mr. SLUSSER. No, sir, my instructions to my staff is that they are the mechanics of this particular job of public housing. They have no authority to promote or in any way go into a field other than in an advisory capacity, if they are asked to come.

Mr. McDONOUGH. You are familiar with the situation in Los Angeles, are you?

Mr. SLUSSER. I came in just as it was being completed, yes, sir.

Mr. McDONOUGH. There was an original commitment and understanding, with the previous administration of the city of Los Angeles, and with the previous administration of this Government, to set aside enough money to provide for 10,000 public housing units in Los Angeles, and subsequent to that action there was considerable controversy in the community.

Mr. Fitzpatrick is familiar with that situation, I believe.

It was finally resolved that instead of continuing the construction of 10,000 units, that those units that were now built, and one that was not completed, which would make a total of about 4,300 public housing units in the city of Los Angeles, would be the limit to which we would go, and that we would cancel out the balance of the 10,000 units.

Now, under your administration, I would like to know for certain, is that your understanding? Do you have any program for the construction of additional public housing units in the city of Los Angeles from here on?

Mr. SLUSSER. Only that that was agreed upon in the settlement of the housing problem at Los Angeles, and I believe it is not 6,700, but 4,300 of the 10,000.

Mr. BOLLING. Will the gentleman yield?

Mr. McDONOUGH. Mr. Hiestand has the floor.

Mr. BOLLING. Excuse me.

Mr. HIESTAND. Yes.

Mr. BOLLING. I wanted to ask Mr. McDonough a question. It seems to me that I remember that there was a referendum on that matter.

Mr. McDONOUGH. Both State and city; yes.

Mr. BOLLING. Also I seem to remember that the court took some action on that referendum.

Mr. McDONOUGH. The State supreme court took the position there was a legitimate contract between the city of Los Angeles and the Federal Government and that contract should be fulfilled. That is right.

Mr. BOLLING. Thank you.

Mr. HIESTEAD. That is all, Mr. Chairman.

The CHAIRMAN. Mr. Kilburn.

Mr. KILBURN. Is there any provision in this bill for public housing?

Mr. COLE. In this bill?

Mr. KILBURN. Yes.

Mr. COLE. If you mean for additional authorizations, or changes in authorizations, no.

Mr. KILBURN. Isn't it true that if we furnish public housing for the millions of families that can't afford their own homes, that it would cost the Federal Government between one hundred and forty and one hundred and fifty billion dollars?

Mr. COLE. Congressman, I don't know.

Mr. KILBURN. Well those figures were worked out.

Mr. COLE. I don't know. The amount would be tremendous.

Mr. KILBURN. Well, it is between one hundred forty and one hundred fifty billion dollars.

Mr. COLE. It would run to many, many billions of dollars, and, of course, part of your assumption was on the basis of families who can't afford housing. I can't answer your question yes or no.

Mr. KILBURN. So to pick out a few people at the expense of many and give them a house at the expense of the Federal Government is what public housing is doing, is that right?

Mr. COLE. Well certainly, first they don't give all of the people similarly situated a public housing unit, you understand.

In other words, in an area, there are more people located who might meet the criteria for entrance than are entitled to enter, or permitted to enter, by reason of the fact that there isn't sufficient housing, that is true.

Mr. KILBURN. Well, if there is any provision in this bill for public housing, I would be inclined to vote against the whole bill. I just want to make sure there isn't.

Mr. COLE. Nothing, Mr. Kilburn, except amendments, having nothing to do with the continuation of the program.

Mr. BOLLING. Will you yield?

Mr. KILBURN. Yes.

Mr. BOLLING. My question is only this: Would you give me the assumed figures on how many people cannot afford their own home in this country, that leads to between one hundred forty and one hundred fifty billion dollar figure?

Mr. KILBURN. It was contained in a speech made before the House.

Mr. DOLLINGER. Mr. Chairman, will the gentleman yield?

Mr. KILBURN. I am through.

The CHAIRMAN. Mr. McDonough.

Mr. McDONOUGH. Mr. Cole, as I understand it, the present authorization for public housing, which the Congress previously passed, was for 810,000 units.

Mr. COLE. That is right.

Mr. McDONOUGH. And the present program is for 35,000 additional units, in various parts of the United States, for the next fiscal year?

Mr. COLE. That is right.

Mr. SLUSSER. That is the present proposal. The President's recommendation.

Mr. McDONOUGH. That still have to be approved by the Congress, of course.

Mr. SLUSSER. Yes.

Mr. McDONOUGH. That is the proposal, and the authority for providing for that comes through the Appropriations Committee?

Mr. SLUSSER. That is right.

Mr. McDONOUGH. Now, in your—

The CHAIRMAN. The authority comes from existing law. The money would or would not be recommended by the Appropriations Committee.

Mr. McDONOUGH. The money would be or would not be recommended by the Appropriations Committee to effectuate the program.

The CHAIRMAN. That is correct.

Mr. McDONOUGH. In your administration of public housing throughout the United States, of course, you are in contact with the municipalities and counties and with certain States that have public housing authorities?

Mr. SLUSSER. That is right.

Mr. McDONOUGH. That is, those three units there are set up public housing units in the cities, counties, and States.

Mr. SLUSSER. That is true.

Mr. McDONOUGH. The Federal law presently provides that the commission set up for public housing in those three units is appointed by the local authorities, but once they are appointed they become a Federal commission, and they have no further responsibility to the source of their appointment, is that correct?

Mr. SLUSSER. I don't believe that is correct. I would prefer to turn that over to Mr. Fitzpatrick.

Mr. COLE. Your statement that they become Federal commissions is not accurate, Mr. McDonough. They are still a local authority, receiving their authority and their right to act, through State and local laws.

Mr. McDONOUGH. I am not sure that you are right about that, Mr. Cole, for the reason that we have had experiences with the Housing Authority in Los Angeles that didn't recognize the local people at all.

Mr. COLE. You are talking about a different thing.

Mr. McDONOUGH. I am talking about a public housing authority in a city, county, or State.

Mr. COLE. Let me make my statement more clear for the record. When I say that it is not a Federal commission, I mean it is not appointed by, nor under any law of the Federal Government except as it is under the public housing authority.

These people are first appointed by the local city or county authority. If they are, shall we say, autonomous of, and not under the direct control of the city government, by reason of the State law; not Federal law.

Mr. McDONOUGH. However, they are appointed by that source?

Mr. COLE. Yes.

Mr. McDONOUGH. Now, their autonomy clothes them with certain privileges, and in some cases they assume them, that are beyond the local authority.

Mr. COLE. That is correct, if you mean this sort of a situation: Is it possible for the mayor and city council to direct the local authority to do a certain thing, they cannot do so, except in some States.

Mr. McDONOUGH. Well, let's take the reverse, that the public housing authority, having been appointed according to the present legislation, the city council cannot direct them to do certain things, but on the other hand, the public housing authority can direct the local government to do certain things to create public housing units in their area—at least that is our experience in Los Angeles, where the public housing authority insisted upon the city council vacating certain streets, acquiring certain land, and proceeding to build in defiance of the city government.

Mr. COLE. I am not personally familiar with the action which you have described, Mr. McDonough. We are of the opinion that if the local council follows what the local authority demands, it is a decision by the local council. They could refuse it.

Mr. McDONOUGH. Don't you think that that section of the law ought to be clarified so that there would be some control of a public housing authority within a State, city, or county in the United States, that would not give them autonomy over the authority that appointed them? It doesn't seem to be consistent with any other commission that I know of in the Government of the United States, where the source of appointment has no further control over the committee that it appoints.

Mr. COLE. You put your finger on a very important point in my personal judgment. Your problem, however, revolves around the business of local responsibility and what the local people want to do.

We want to do everything we can to see that this is decentralized from Washington, and the responsibility placed locally.

Let me check one minute with my counsel.

Mr. MULTER. While he is doing that, Mr. McDonough, may I ask you, isn't your problem solved by your own amendment, which was written into the law, which prohibits any of these public housing projects going into any area which has been rejected by the local authority?

Mr. COLE. I wanted to follow through with my comment after checking with counsel.

The local city, in entering into its cooperative agreement with the local public housing authority, may retain such authorities as the local city council desires.

Mr. McDONOUGH. You mean in the contract it can be stipulated that they retain certain authorities?

Mr. COLE. Yes.

Mr. McDONOUGH. I understand. In other words, the Commission, then, operates on the terms of the cooperative contract if there are any specific stipulated terms, and they could limit their authority by those terms?

Mr. COLE. Yes.

Mr. McDONOUGH. In the 35,000 units that are proposed for this year, Mr. Slusser, if you find that a community, or several communi-

ties, in the United States, request the construction of more new public housing units than you have the authority to permit, that is for more than 35,000 units, what are you going to do about it?

Mr. COLE. We are going to have to wait until the next allocation.

Mr. McDONOUGH. You are going to say to those communities you can't have public housing because the Congress hasn't authorized it?

Mr. COLE. That is right, we are in that position now with the 20,000 units.

Mr. McDONOUGH. Mr. Cole, do you think that the slum clearance and rehabilitation of existing homes, which includes rehabilitation of the low-cost as well as the high-cost homes, will supplement, or will reduce the demand for the construction of public housing to any great extent in the United States?

Mr. COLE. I think there is a very real possibility, yes.

Mr. McDONOUGH. In doing that, if we can reduce the number of public housing units by making livable those that are not now livable quarters, in various parts of the United States—you don't have to buy any new land, and you merely insure the loan for the repair.

Mr. COLE. That is correct.

Mr. McDONOUGH. You are thereby cleaning up an area that has become deteriorated. Most of those homes are located in areas that are convenient for transportation, commercial intercourse with the community, and so forth, while most of the public housing units are located in some newly acquired area, and in some places occupy parks and playgrounds, which were set aside for the convenience of the public, and throw into immediate contact a lot of new people, that we find in many instances, may increase the crime wave in the areas.

We had a report from the chief of police of Los Angeles that the crime incident to public housing areas was higher than it was in old, established, so-called slum areas in the city of Los Angeles.

So that you have a situation here where, if we stimulate the rehabilitation of existing homes throughout the country, we are not only cleaning up a lot of bad and blighted areas, but we are preventing the possibility of crime incidence that might be brought about by a lot of people being thrown together in a public housing unit.

That is all for the present, Mr. Chairman.

Mr. OAKMAN. Mr. Chairman, could I just bring this out?

The CHAIRMAN. Mr. Oakman.

Mr. OAKMAN. Mr. Slusser, how many thousand more public housing units were contracted for by the Public Housing Administration than had been authorized by the Congress?

Mr. SLUSSER. What do you mean by that?

Mr. OAKMAN. We were told in the hearings last year, on the floor of the House, that "X" number of public housing units had been contracted for by the agency, which was many thousands more than had been authorized by the Congress.

Are you familiar with those figures?

Mr. SLUSSER. No. I am not, sir. No more have been contracted for than could be.

Mr. OAKMAN. We were told on the floor of the House—it is a matter of record—that they had contracts, and that was the reason that we should extend the authorizations to meet commitments already made on the part of PHA.

Mr. SLUSSER. My understanding, sir, is that they were within the limits granted by Congress, as to the number of units per year to be built, in making the contracts.

Mr. OAKMAN. I wonder if we could get a breakdown of that for the record?

(The data requested above are as follow:)

The Housing Act of 1949 authorized the Public Housing Administration to enter into annual contributions contracts for low-rent public housing at a rate of 135,000 units per year, with a total limit of 810,000 units.

The Independent Offices Appropriation Act, 1953, provided that "The Public Housing Administration shall not, with respect to projects initiated after March 1, 1949, * * * after the date of approval of this act, enter into any agreement, contract, or other arrangement which will bind the Public Housing Administration with respect to loans, annual contributions, or authorizations for commencement of construction, for dwelling units aggregating in excess of 35,000 to be authorized for commencement of construction during any one fiscal year subsequent to the fiscal year 1953, unless a greater number of units is hereafter authorized by the Congress."

On the date of approval of this act, July 5, 1952, the Public Housing Administration had outstanding annual contributions contracts for 62,400 units which had not been authorized for construction. Since 35,000 units were to be put under construction in fiscal 1953, there would have been at the end of that year a backlog of only 27,000 units covered by annual contributions contracts if no additional contracts were entered into. Inasmuch as it takes on an average of from 1½ to 2 years to move from annual contributions contracts to the commencement of construction, this backlog would not have been sufficient to sustain construction at the 35,000-per-year rate contemplated by the Congress in the appropriation act. Accordingly, the PHA, during fiscal 1953, entered into annual contributions contracts for an additional 35,000 units, which were necessary to maintain the contemplated rate of construction. The validity of this action by PHA has been sustained by an opinion of the Comptroller General (B-115087, dated May 18, 1953).

On July 5, 1952, the Public Housing Administration had on hand 151,000 units covered by preliminary loan contracts. These are contracts pursuant to which local housing authorities carry on surveys and planning necessary to the execution of definitive annual contributions contracts. Since this backlog, together with a small number of contracts in process, was large enough to provide annual contributions contracts at a 35,000-a-year rate for some years, no further applications for preliminary loan contracts were entertained by the Public Housing Administration after July 5, 1952.

The Independent Offices Appropriation Act, 1954, limited construction to 20,000 units out of the some 56,000 units under annual contributions contract on June 30, 1953, and prohibited the Public Housing Administration from entering into any additional annual contributions contracts. Thus, on June 30, 1954, there will be approximately 36,000 units remaining under annual contributions contracts which have not been authorized for construction.

Mr. OAKMAN. Then the other point, Mr. Chairman, is this: The gentleman from Missouri is apparently critical of the Congress, and the Public Housing Administration, and others, because we haven't authorized and appropriated for the total number of local requests for public housing units that have been made. Now, that is so, isn't it? We have met what percentage of firm requests? What percentage of requests have we been able to meet? Ten percent, 20 percent, 40 percent, or 60 percent?

Mr. SLUSSER. I would have to go back historically, sir, to the 1949 act, when there was a great amount of work done in the survey.

Mr. OAKMAN. I think that would be interesting for the record too. In the Committee on Public Works, I note that the Congress has authorized approximately \$14 billion worth of public works programs—rivers, harbors, flood control, and the like. Yet we have not appropriated the money for same.

Testimony before the House Public Works Committee shows that we need between \$100 billion and \$150 billion to bring the Nation's highways up to par. Many of the thousands of people that are being killed annually would be saved, and that many of the 1½ million people injured are injured because of an antiquated highway system. We haven't met that demand.

Then we also have, as we know, requests, potential requests, too, for billions more in public works programs, and for schools and hospitals.

I think that we have probably met a much higher percentage of the requests for public housing, in this country, than we have of the requests for the other essentials of life, which are our community facilities.

I don't think that public housing has been the only phase of the Nation's needs that has been neglected.

(The data requested above are as follow:)

After enactment of the Housing Act of 1949 the Public Housing Administration accepted applications from local housing authorities for assistance in the provision of public housing for low-income families. The local authorities were told that no matter how great the local need they might not apply at one time for more units than they believed could feasibly be put under construction within a 2-year period. This was done to assure an equitable distribution of the units available and to provide for an orderly construction program. Under these regulations, applications covering initial 2-year programs were received from more than 1,100 localities for over 500,000 units by July 5, 1952, after which date no further applications were accepted.

It should be noted that all applications of local authorities, even for preliminary loans, must be approved by the local governing body of the locality involved. No public housing can be built anywhere without local initiation and approval of the local government.

Against the total applications for over 500,000 units, the Public Housing Administration entered into preliminary loan contracts for only 351,000 units. The reductions made were to assure a fair distribution among the respective applicants. There were a few instances in which localities had applied for more units than appeared to be needed at the time.

Out of the 351,000 units for which preliminary loan contracts were made, 191,000 will be completed or under construction by June 30, 1954. This is slightly less than 40 percent of the 500,000 units requested by localities for their initial 2-year programs and about 55 percent of the units actually put under annual contributions contract.

Remaining on June 30, 1954, are 36,000 units, located in 65 localities, which are under annual contributions contract and 124,000 units in 515 localities, which are under preliminary loan contract.

It should be stated that if the low-rent public-housing program is resumed all outstanding reservations would be reviewed in the light of any changes which have occurred since they were issued.

Mr. DOLLINGER. Mr. Chairman, may I ask a question?

The CHAIRMAN. Mr. Dollinger.

Mr. DOLLINGER. I would like to know whether any public housing authority was ever established that the community did not want?

Mr. SLUSSER. I can't answer that.

Mr. DOLLINGER. Can you answer, Mr. Cole?

Mr. COLE. Mr. Dollinger, you have raised the question of what the community wants and what they don't want.

Mr. DOLLINGER. I asked that question because of the Los Angeles situation.

Mr. COLE. I understand, but it involves a judgment of what you mean by what the community wants or does not want. I think that there have been some public housing authorities established where

perhaps, if it were submitted to a vote of the community, the community would have voted in the negative.

Now, if you ask me, legally, on the basis of the legally constituted authorities on the part of a community, the answer is no.

In a republic such as we have, the legally constituted authorities are the representatives of the community and when they enter into a contract I think that should be recognized.

Mr. DOLLINGER. Mr. Cole, even the Los Angeles situation, that authority was originally established at the request of the community. The quibbling only took place after its establishment, not before. It was on the question of reducing the number of units, isn't that correct?

Mr. COLE. I don't know. I can't answer that question, Mr. Dollinger. I do think, though, that it is important that we recognize, when we are talking about community acceptance or rejection, that we know what we are talking about, that we don't take a poll of a certain group and say "this group wants it, therefore the community wants it," or "this group does not, and therefore the community does not." We in this administration have legal things and bodies to deal with, and legal contracts to deal with.

We can only deal with the legal side of the situation, and that is the way we intend to do it.

Mr. DOLLINGER. And every authority that was created was created in a legal manner—

Mr. COLE. Well, I assume so.

Mr. DOLLINGER. We all presume that.

Mr. COLE. Yes.

Mr. DOLLINGER. The reason I asked the question was because, I think Mr. Hiestand made the statement that this was a Frankenstein. If it is, I would like to know in what way.

Mr. COLE. Well, let's go one step further in expanding on what Mr. Slusser said.

Mr. Slusser, in the operation of his agency, has said this: In addition to the legal authority, that he would be very reluctant to authorize the establishment of a new authority in a community where there seemed to be tremendous opposition. Why? Because there are so many other communities where there is no opposition, where there would be no difficulty. Therefore, he would be reluctant to enter into a new project, proposed project, in a community where there was a great hassle about it in the community.

Mr. DOLLINGER. Do we have any illustration of that in the past where that situation arose and where the authorities still insisted upon them taking it?

Mr. COLE. I would think we could develop some, if you wanted them.

Mr. DOLLINGER. I would like to know what the facts are. A lot of talk has been going on here, but I would like to know the true facts.

Mr. COLE. I think there are some.

Mr. DOLLINGER. I don't think any of us want to condone errors, but I want to know what the facts are. I don't think it is fair to make statements here that this is a Frankenstein, and charge us with the responsibility for it. I am certain that the previous administration,

and this administration, try to administer the law fairly and honestly and if there is proof to the contrary we should get the facts.

Mr. HIESTAND. Will you yield?

Mr. DOLLINGER. Yes.

Mr. HIESTAND. I think that calls for an explanation and I am sure you would like to have it.

Mr. DOLLINGER. That is right.

Mr. HIESTAND. Actually the Los Angeles housing authority was founded at the request of the legally authorized city authorities at that time, the mayor and the city council.

They started in operations. The community realized that there was not the great housing shortage that was supposed to exist, and that there were lots of vacancies, and that there was very much less need. Some of the units were completed. It was decided that about 6,000 of them were not needed, and we had a pretty hard time getting the housing authority into the position of giving up the privilege of building those.

There were still another 400 which had not been started, which we were unable to include in that. The community had voted, by the way, some 350,000 to 250,000, that they didn't want any more public housing, they didn't want this, but they were stuck with it, frankly, so the community in which this other four hundred and fifty-odd units was slated, did not want that either, but the land had been negotiated for and partially condemned. There were some 22 parcels still in the courts, and the people, almost unanimously, in that area, didn't want it.

In the meantime, those parcels which had been condemned had been vacated. They were, it is true, substandard. However, even as far as 2 years before, the people of those houses had endeavored to bring their houses up to standard, and had been refused by the city building authorities permits to put in these installations because the project was projected at that time, and the influence of the housing authority was great enough to turn down those attempts, by those people, to improve their houses.

Of course, during the time this was in process of condemnation, those houses which had been vacated, 36 to 39 of them, strangely enough, had fires, and they were burned to the ground, all of them, in some 39 separate fires. Well, I don't know who set the fires, but again and again, the community appealed to the Housing Authority, stating "We don't want this." The Housing Authority then said "You shall have it."

We had no way of stopping it. The authority, as I said, was autonomous, we had created a Frankenstein, as it were, who said "You must have this whether you want it or not." That is un-American and it is not in accordance with our basic principles.

But as the autonomous authority had been granted by previous Congresses and previous administrations, I wanted to bring out the fact that that is a very important principle, as Mr. McDonough also brought out. Here we have an authority that is created, and it is responsible to no one. The people themselves vote it out, but have no authority, and it is an important thing, that we should know. Does that explain it, sir?

Mr. DOLLINGER. Only to a certain extent. The only fault I found in it, originally was, and I think my thinking will bear that out, that originally the local community set up the authority.

Mr. HIESTAND. That is a matter of record.

Mr. DOLLINGER. There was no Frankenstein at its inception. What happened subsequently was another story. In any event the authority was created in a legal manner and when established was proper in every respect.

Mr. HIESTAND. But it shows how an authority without responsibility to some individual group, can wield its power without referendum.

Mr. MULTER. But I think the autonomous body that became the Frankenstein was one organized not by the Congress but by the local community, which set up the local housing authority.

Mr. HIESTAND. Under Federal laws, as I understand it.

Mr. MULTER. We said we will cooperate with these agencies. Then the community itself, either the city or State, set up the local housing authority. Local maladministration is not the fault of the Congress.

Mr. HIESTAND. Except we must have made a law which permitted that kind of an incorporation and that kind of a setup.

The CHAIRMAN. Are you through, Mr. Dollinger?

Mr. DOLLINGER. Yes.

The CHAIRMAN. Mr. Betts.

Mr. BETTS. Mr. Cole, because of the nature of our district, I am not much of an authority on public housing. All the information, as I understand it, this morning, and all the questions, have been directed to you on the assumption that there is need for Federal help in this field.

Now, going to another angle, I would like to ask you if, from your experience, and your observations, you find evidence of willingness or ability, on the part of local communities and cities, to go it alone, so to speak, and if so, to what extent. How far are we getting into it where it could be done by the municipalities without Federal help?

Mr. COLE. Mr. Betts, last summer I began a series of conferences which I called "shirt sleeve conferences" to which I invited people from all over the country to advise me about what they thought the Federal Government should do and can do, in the field of housing.

To these conferences I invited builders, lenders, contractors, real estate people, representatives of labor, representatives of public housing, redevelopment authorities, welfare workers, educators, mayors, representatives of State governments, and so forth.

Then I went into 12 representative cities of the country and held public hearings there, asking the same types of people who come and tell me what they thought the housing policies of the Federal Government should be.

After that, the President's Advisory Committee was set up to study this program.

So we had a very careful analysis of the problem, based upon the time and appropriations which we had, and I think it has been an outstanding examination of the entire problem.

Mr. BETTS. You understand, I am not attempting to discourage it. I am just trying to understand.

Mr. COLE. No, I am merely giving you the background so you will understand what I am going to say. One of the questions almost al-

ways asked at these conferences was "Is this a Federal responsibility? Is it not a responsibility of the local governments, the State or city government?"

The question was asked, "Why does the Federal Government assume the responsibility when after all, traditionally, constitutionally, the local government should undertake what is really a social problem, having to do with the local communities?"

On the basis of the studies which I have made, and on the basis of the statements made to me by these people, I have not been able to convince myself that the cities—and I am speaking of cities now—that the cities of this country are now in such a financial situation that they can undertake such aid to public housing as may be necessary, and decided upon as advisable.

The studies which are now being conducted by the State and local government relations commission will develop, I hope, some facts, some statistics, and possibly some means by which the Federal Government will determine that there might be fields within the cities, which the cities themselves may undertake, certain tax programs, certain other activities, and the Federal Government will be removed from them. I am not saying that that will happen with public housing. I am merely saying that upon my investigation I found that instead of cities being able to increase their services, by reason of the tax take-out of the cities for city's services, that many of them are decreasing the services which they now have—fire, police, and other activities. They are decreasing their personnel to such an extent that I think it is a very real problem. It is a very real question, on the basis of the present tax structure, the great take which the Federal Government is eliciting from the cities, whether the cities can do very much more than they are now doing in the social and welfare field, I don't know. Therefore, my answer is, after studying it very carefully and fully, that I cannot recommend that the cities can do much more than they are doing now.

Mr. BETTS. Well, are they doing anything?

Mr. COLE. They are doing something now, and may I add one thing more, that this bill will require the cities to expend actual dollars in attacking this problem, in the field of presenting a workable program of conservation, and rehabilitation, and the enforcement of codes.

I do not look upon this requirement as a mere statement to the cities. I look upon it as a requirement that the cities will actually do something about it, that they will increase the machinery to establish the operation, the enforcement of, their codes, which will eliminate much of the unhealthy and unsanitary conditions, much of the overcrowding, and that will cost the cities definite dollars.

In addition, we must see to it that streets, lights, sewers, water facilities are provided. That will require the cities to spend money. It will require additional responsibility on the part of the cities. They can't do all of these things at once, of course, but we have a very firm resolve that the cities must live up to their responsibilities.

Mr. BETTS. And what evidence are you going to require that they have the money, or the ability, or are willing to make that expense before the Federal Government steps in?

Mr. COLE. We have been studying that problem carefully. We haven't finally come to all of our decisions upon the matter. We are

studying this in the agency. We are securing advice from the people outside of the agency.

Let's begin, first. We have a savings clause here with those cities who are now under contract, so that we will not delay or impede their action because we think any new laws should not affect them.

On the other hand, there is a law which does require certain activities on the part of the cities before they obtain that benefit. But we must start out gradually, truthfully, Mr. Betts. We can't set up a rigid straitjacket regulation or standard with which no city can comply in the next 10, 15, or 20 years. We must approach the problem realistically and realize that certain things can be done.

We think that the cities must inventory what they can do. We think the cities must present what they are doing in connection with codes, and enforcement of them, and what machinery they have to do it.

We think that they must present a plan showing that they are looking at the community as a whole and not just one little segment of it, and that they are looking at it in the future, that they are looking at it to determine what should be done to resolve this problem.

We also think that they can't look in a clairvoyant way to that plan, but that it must be a sound, workable plan.

Those are the things we are going to look for. By inventory, I mean to include their tax structure. Are they really assessing their people, locally, as much as they should, and can. Those things are proper for us to consider. We expect to do it.

Mr. BETTS. I am glad to hear that, and the reason I asked the question was because I felt that that angle should be in the record.

Mr. COLE. It is very important.

Mr. BETTS. As I understand it, there are many cases where cities have had proposals for levies on ballots, which failed of passage, and I just want to make sure that you have considered these questions.

Mr. COLE. I am glad you raised the question. I think it is an important one.

Mr. OAKMAN. In your public housing program there is absolutely no local contribution required or asked for, is there?

Mr. SLUSSER. Oh, yes, sir, the services are granted entirely by the cities.

Mr. OAKMAN. What type of services?

Mr. SLUSSER. All of the garbage collection, street lighting services, and so forth.

Mr. OAKMAN. Yes, but the city does not have to put up a dollar in cash, or a square inch of land, or provide any plans or specifications for the proposed projects. All they do is come in with an application and say to the Public Housing Administrator, "We would like to have X number of units."

Mr. COLE. Mr. Oakman, may I interrupt, so that we have that clear?

Mr. SLUSSER. There is one more point I want to make. There are other contributions, by way of tax exemption.

Mr. OAKMAN. That is correct. That is a continuing thing. But they don't have to put up a cent going in. In other words, a lot of cities have been sold by this type of thinking: "You don't have to put up a cent, we will come in and build you 500 or 2,500 public federally-subsidized housing units and it won't cost you a cent."

Then PHA has said, "We have made a survey of this area of yours, it is a slum-clearance project, and you are not getting very much in taxes now, and we will show you, and oftentimes can, that the redeveloped area, for subsidized housing, will pay more through the 10-percent payment in lieu of taxes than the city has formerly been getting from the slum area."

So the cities are not really losing anything or putting up anything.

If you go out and take a virgin piece of land, and build public housing on that, you will show them where they will be getting more than in the past, but as you pointed out this morning, they will only get about a quarter of what they would if private houses were built on the same ground.

But Mr. Betts' question was, what is the local community doing, and on public housing, actually, from a cash advance standpoint, the answer is nothing. They don't have to show any more than good will. The Mayor and the Council can get up and beat their chests and say to the town folks, "We have gotten the Federal Government to come in here and give us 2,500 housing units, and it won't cost a cent."

Mr. BOLLING. Will the gentleman yield? Is it true that the Federal Government comes in and builds the units at no cost to anybody in the community?

Mr. SLUSSER. As I said before, the contribution is in the form of taxes and services that the city gives.

Mr. BOLLING. The local housing authority doesn't have any cost?

Mr. SLUSSER. The local housing authority bears the cost, by the issuance of bonds, for the property.

Mr. BOLLING. How is the local housing authority authorized? The people in the city are paying the largest share of the cost, aren't they? The local housing authority is a city agency, a community agency?

Mr. SLUSSER. That is right, it is part of the city.

Mr. BOLLING. So that it would not be accurate to say that the community doesn't have to make any contribution?

Mr. OAKMAN. As a matter of fact, it costs the cities plenty over a period of years, believe me, but they are usually gotten into the project on the basis that it is going to cost nothing, because they don't have to put up anything.

In my district we have one project, of around 2,400 units, and we are getting our 10 percent of shelter rent in lieu of taxes.

Now, the city has grown all around this project, and if private homes had been in there we would be getting four times as much in taxes. But it didn't cost the city a cent. And as I say, oftentimes, the local boys beat their chests, and are very proud, and sometimes use that in their election campaign platforms, that they got the Federal Government to come in and build so many units without spending a cent.

In contrast to that is your very excellent program of slum clearance and urban redevelopment where the city has to put one-third on the barrelhead. But then they are through with the subsidy and the Federal Government has paid two-thirds and it is through. They have assisted the community to clear that slum, and have greatly enhanced and strengthened the local community's tax base for all time.

Mr. MERRILL. Pursuing the idea that Mr. Betts brought out, of the local community doing something for itself in the field, on page 28 of your statement, Mr. Cole, you refer to the fact that this 221 program of 40-year mortgage with no downpayment could be extended to non-

profit private corporations, or to public corporations for the rehabilitation of old dwellings.

Mr. COLE. Yes.

Mr. MERRILL. Am I seeing too much in that particular program, when I see a possibility of using that for having the communities do something about housing these people outside of the public housing program?

Mr. COLE. I think you are absolutely right. I think that there is a great possibility in that. I am very enthusiastic about the possibility of doing that.

Mr. MERRILL. I note this about it: It says that these associations can operate only where they are under regulation by the Federal or State Government.

Now, the question that I had in mind is this: I don't think this is a program that is going to catch on in a total area like a State. I think maybe some enlightened community is going to see the possibility of this thing and may want to use it.

Would there be anything wrong in changing the terms of this particular section of the act so that the regulations which you are requiring, which you now say must be State or Federal, could be purely local regulations?

The thing I am thinking about is this: Suppose one city had the imagination to see the great possibilities in this program, and they wanted to move ahead. Well, they couldn't convince the State capitol or wait until the State legislature met. Couldn't this be worked out so that if some community wanted, either through a nonprofit corporation, or through the city itself, do so, that they could provide the necessary regulations so as to proceed with this program without waiting for the State or Federal Government to give them the regulations on rents, and charges, which you are requiring? Do you see the point I am trying to make?

Mr. COLE. Yes, it seems to me to be a legal question. If the State would give them the authority to do it, the answer is yes. But the limitation, as I understand it, was placed in the bill, by reason of the legal question. If they have the authority to do it, that is all right.

Mr. MERRILL. Well, couldn't you do it by contract? Couldn't you provide the same protection for the use of these facilities by a contract between the housing authority here in Washington, and the contracting authority?

Mr. COLE. It is possible that FHA could do it under its regulations.

Mr. MERRILL. Because I think there is great possibility in this thing. Now, when you wrote this provision into the act you limited it to rehabilitation.

Did you come to the conclusion that this provision could not possibly be applied to new construction—by that I mean, take a situation at home where a large group of colored people are being forced out of an area that was once defense housing, and which are shacks. Possibly a nonprofit corporation might want to undertake to do something about that total community, put them into different quarters.

Did you check the possibility of using this same provision, for new construction, as well as rehabilitation of old construction, and decide that it wouldn't work?

Mr. COLE. It is for both old and new.

Mr. MERRILL. This statement says: "This section is for the repair and rehabilitation of dwellings." I don't know.

Mr. COLE. We will check it and see. I think it is for both old and new.

Mr. OAKMAN. Those are the old Lanham projects, though, aren't they?

Mr. COLE. No.

Mr. MERRILL. It seems to me that this section of the act has more imagination expressed in it than any other and I would just like to see it have the largest possible flexibility, because communities one at a time are going to become aware of the possibilities here and I don't like to see them restricted by rules that have to be made at the State capitol, where the State doesn't have the vision.

Mr. COLE. We are in accord with your objectives on it.

The CHAIRMAN. The Chair will recognize Mr. McVey.

There has been a rollcall on the floor and it is very obvious that we can't continue further this morning.

Mr. Cole, is it agreeable to you to come back this afternoon, with reasonable assurance that it will be your last appearance here?

Mr. COLE. I have enjoyed it, Mr. Chairman. Yes.

The CHAIRMAN. We have enjoyed having you with us.

We will stand in recess until 2:30 this afternoon, that is provided I can get permission for the committee to sit.

(Whereupon, at 12 o'clock noon, the committee recessed until 2:30 p. m., the same day.)

AFTERNOON SESSION

(The committee reconvened at 2:30 p. m., pursuant to adjournment, Hon. Jesse Wolcott (chairman) presiding.)

Present: Chairman Wolcott, Messrs. Talle, Kilburn, McDonough, Widnall, Betts, Mumma, McVey, Merrill, Oakman, Hiestand, Van Pelt, Spence, Brown, Patman, Multer, Deane, Addonizio, Dollinger, Bolling, O'Hara and McCarthy.

The CHAIRMAN. I believe when we recessed this morning, Mr. McVey had been recognized.

Mr. McVEY. Thank you, Mr. Chairman.

I had understood you to say yesterday that we would eventually come back to the other titles of this bill.

The CHAIRMAN. That is our intention.

Mr. McVEY. My question concerns this: Since we have passed title I, I have received a letter from a civic organization back in Chicago that raised a question concerning an amendment to that title. I would like to know if Mr. Cole is going to be here when we go back to this title I, because I would like to have his reaction to this question.

The CHAIRMAN. I don't think it would avail us to go back and cover the whole picture unless he was here. I think he is the key to that situation. It is his program.

Mr. McVEY. I shall be glad to postpone the question, then, until we get ready for it, if the Administrator is going to be here.

Mr. COLE. I will be here, Mr. McVey.

Mr. HIESTAND. I would like to put something in the record here in further response to Mr. Dollinger's question of this morning. It was a very good question and I appreciate his asking it, but it is not any

reflection on our administrators. As a matter of fact, on the intent of the people who wrote the law.

But here, gentlemen, is what has happened. A State charters a public housing authority. It specifies that it shall be operated by a board of commissioners appointed by the head of a municipality, presumably a mayor. Those administrators hold term for 4 years, say, and they are completely autonomous. They have tremendous power. They appoint an administrator, they can issue bonds up into the hundreds of millions of dollars, tax-free bonds, and guaranteed by the Federal Government, ultra-desirable bonds, so that they have complete authority over the administration of that housing project. Actually, the way the thing has worked out is that a mayor can, the day before he leaves office, appoint four more commissioners for 4 more years, and nobody can do anything about it.

They can appoint an administrator who has absolute authority, practically, and no one can fire him, no one can restrain him. The public can vote by hundreds of thousands of votes that they don't want it, but he can say "you have to have it." And he has the power to issue the bonds, and so forth.

Now, what has happened in this area where housing was not wanted—actually a lot of people were dispossessed by condemnation. It so happens that practically all of them—I have a string of petitions in my office signed by them, pleading to allow them to improve their housing and to stay there. They are practically all members of a minority group, but a very fine, ideal minority group. They believe in free enterprise, in independence, and they want to continue to own their houses. But they were arbitrarily forced out of the place, and nobody has authority to control this housing authority. It is so autonomous that it has more power, shall we say, than the President of the United States. He has to be elected every 4 years, and they are appointed, and nobody can unappoint him unless the mayor wants to. These men were appointed the day before the former mayor went out of office. They are there and the committee is stuck with them, and they are backing their administrator.

I feel the committee should know those things and it should be a part of the record. It isn't a reflection on the intent of those who framed the original law, nor on the administrators of the law as it is at present, but that is how it can get out of hand, and I wanted to say that.

Mr. DOLLINGER. Would you yield for a question? Was the vote in the whole city of Los Angeles?

Mr. HIESTAND. Yes.

Mr. DOLLINGER. There was only one vote?

Mr. HIESTAND. Yes. And the overwhelming sentiment, not only of the people in the area, but also of the neighboring areas, was indicated by the vote.

Mr. DOLLINGER. Then that is purely a fault of the mayor of Los Angeles.

Mr. HIESTAND. That is right, but under this law there is nothing we can do. I think we should have some limiting authority so that appointed people should be responsible to those who appoint them.

Mr. DOLLINGER. I can see that, but when the Federal Government steps in, we are criticized and the States object and claim State rights. Here we give the thing right back to them in the form of local admin-

istration, and they are criticizing the Government for not stepping in.

Mr. HIESTAND. Except that we created this law which makes a situation like that possible.

Mr. BOLLING. Mr. Chairman, I would like to ask unanimous consent that the Administrator or the Commissioner furnish to the committee a brief but clear outline of the process by which a public housing unit begins to be constructed. In other words, the steps taken.

Mr. COLE. I think we can do that.

Mr. HIESTAND. Including the steps to select the location, how it is chosen. Does that meet your approval, sir?

Mr. BOLLING. Yes.

The CHAIRMAN. Mr. Cole will have some information on that for the record.

(The information is as follows:)

OUTLINE OF STEPS TAKEN TO CONSTRUCT PUBLIC HOUSING

A local housing authority is created under authorization of State law for the principal purpose of constructing and operating low-rent public housing. Commissioners, generally five in number, constitute the governing body of the local authority. They are appointed by the mayor, the city county or other public body and generally serve without pay. In a few States the local authority is part of the city government rather than a separate independent agency. In any event, the form of the local authority, the number of commissioners who compose it, and the relationship to the local government are determined by the terms of the State law under which the authority is established.

The need for public housing for low-income families in each locality is determined by the local housing authority in conjunction with and subject to the approval of the local governing body of the locality. It then makes application to the Federal Government for financial assistance.

When a local housing authority demonstrates to the satisfaction of the Federal Government that there is a need for the housing applied for which is not being met by private enterprise, the Government makes a preliminary loan to cover the cost of surveys and planning of specific housing developments.

The local housing authority then selects sites for the development which, in some cases, must be approved by the local government under the terms of its cooperation agreement with the local authority, and in every case, by the Public Housing Administration. After the sites have been selected and approved, the local authority has them appraised, has preliminary plans prepared by architects and engineers selected by it, makes firm estimates of the cost of the housing and its operation, and, so as to avoid any possibility of competition with standard private housing, determine through study and analysis of the private market, whether the maximum rents for admission to the proposed housing are at least 20 per centum below the lowest rents at which private enterprise (through new construction and available existing structures) is providing a substantial supply of decent, safe and sanitary housing toward meeting the need of an adequate volume thereof. This determination is also required by the United States Housing Act and must be approved by the PHA; it is intended to prevent any possibility of competition by low-rent public housing with standard private housing available in the locality.

Under the law, the local housing authority must obtain a cooperation agreement from the local government. This agreement provides for payments in lieu of taxes of up to 10 percent of the shelter rents of the housing (tax exemption has been provided under State law and reviewed by the courts) and how the payment is to be distributed among taxing jurisdictions. It also provides, as required by the United States Housing Act of 1937, as amended, for the elimination of substandard housing by the local government and for municipal services to be furnished to the residents of the housing and for any necessary street closings and off-site improvements in the same manner and to the same degree as furnished to other citizens. When a city, for example, makes a separate charge for supplying water or for collecting garbage or trash, the local housing authority makes the same payments that a private owner would make. Similarly, any off-site improvements not ordinarily furnished the private owners are paid for separately by the local housing authority.

After preliminary plans are completed and a cooperation agreement is entered into, a local housing authority furnishes a development program which contains all of the features of the specific proposal. On the basis of these submissions, the Federal Government, if it approves of the feasibility of the proposal and if it conforms to the requirements of law and regulations, enters into a contract with the local housing authority for financial assistance in the development and operation of the housing.

The contract between the local housing authority and the Federal Government provides that (1) the Federal Government will, if necessary, lend funds for development of the housing up to 90 percent of the cost and (2) will make annual contributions for a period not exceeding 40 years in an amount just sufficient to cover the difference between expenses of operation, including debt service, and the rental that low-income families can afford to pay up to a specified maximum. The maximum Federal annual contribution equals level debt service on the development cost of the housing for a period not exceeding 40 years.

After the contract for assistance has been entered into with the Federal Government the local housing authority proceeds to acquire the site, prepare final plans and specifications and take competitive bids from private contractors for construction.

Financing during the course of development is obtained through short-term notes. The short-term borrowing may be from private sources or from the Federal Government. Of the short-term borrowing outstanding on September 30, 1953, on all public housing for low-income families, over 77 percent was obtained from private sources.

As soon as feasible, the local housing authorities finance the housing through the sale of long-term bonds and retire the short-term notes with the proceeds. These are revenue bonds which, like other bonds of States and municipalities, are exempt from Federal taxes. The bonds are secured by the pledge of the Federal Government to pay, if necessary, annual contributions sufficient to cover debt service.

Mr. COLE. Mr. Chairman, it was requested that we put in the record statistics which are with respect to the \$7,000-home, or that class of home. We will do that. We will put the statistics in the record, but for the moment, I have some pictures which the committee might care to see while we are discussing other matters. This is a bulletin by the Federal Housing Administration, and contains some pictures that I thought the committee would like to see.

The CHAIRMAN. They may be passed around to the members of the committee.

Mr. MULTER. Mr. Chairman.

The CHAIRMAN. Mr. Multer.

Mr. MULTER. Thank you, Mr. Chairman.

I have followed with interest and with approval the public statements of Mr. Slosser, your public housing administrator, which I think shows very clearly that he and you intend, so far as it is within your power, to carry out that public housing program in accordance with the intent of Congress.

I was very happy to note that the President, in his housing message, indicated a need for continuing public housing, even if on a lesser basis than some of us think it should be.

I have found nothing in the bill which would permit the continuance of the program. I have reference to starting and continuing new projects. Am I right in that respect, Mr. Cole, that there is nothing in this bill to effectuate that part of the program, as to new starts?

Mr. COLE. Yes, you are right, for this reason: This committee has already authorized more than the number that we have requested.

Mr. MULTER. I know, but you are now going back to the original law as amended, as it came out of this committee on various occasions,

requiring—I think the last number of starts as written into the law at the suggestion of this committee was 75,000 per year.

The CHAIRMAN. 135,000.

Mr. MULTER. 135,000 per year, that is right.

The CHAIRMAN. Until the figure of 810,000 had been reached.

Mr. MULTER. That is right. But the Congress overrode that, did it not, when it provided that there shall be no more starts of public housing? I am referring to the Appropriations Committee.

Mr. COLE. Well, the Appropriations Committee did that.

Mr. MULTER. And the Appropriations Committee bill was finally enacted into law.

Mr. COLE. That is right.

Mr. MULTER. So as the law now stands and as enacted by the Congress, there can be no new starts in public housing.

Mr. COLE. There cannot be unless that is changed by legislative act of Congress.

Mr. MULTER. Now, certainly we can't expect the Appropriations Committee to do it, and I wouldn't be one bit surprised that if a member of the Appropriations Committee tried to offer that kind of a provision on the appropriations bill a point of order then would be sustained because it is legislation on an appropriations bill.

Mr. COLE. Mr. Multer, you will face that problem irrespective of what this committee does. You know more about it than I do.

Mr. MULTER. I am trying to tackle it from the practical parliamentary approach. If we are going to give the President the authority he asked for for new public housing starts, in the next fiscal year, doesn't this committee have to assume the burden of putting it into this law that we are bringing out?

Mr. COLE. No.

Mr. MULTER. How will we get it done?

Mr. COLE. By the rider being repealed in the appropriations measure.

Mr. MULTER. By a repealer?

Mr. COLE. Yes, in the appropriations measure. Mr. Multer, it could be done here. You and I know this committee could change the substantive law. That would not, however, affect whatever is done about the appropriations measure.

Mr. MULTER. It would not, but why shouldn't we do what we are charged with by law? This committee has jurisdiction over that legislative subject. Don't you think this committee should bring in the repealer?

Mr. COLE. Well, Mr. Multer, having been a former member of this committee, and having been very zealous of the prerogatives of the substantive committee, you know what my answer would be.

But sitting here as administrator, I don't believe it is my job to tell this committee or the Congress how to handle it.

Mr. MULTER. Well, may I ask you as the Administrator to prepare and submit to this committee an appropriate provision which we can offer as an amendment to this bill before we report it out, which will give you and the President the authority which the President has asked for, for the new starts for public housing in this fiscal year?

Mr. COLE. I can do that.

The CHAIRMAN. I might suggest, Mr. Multer, if I may, that we look with displeasure at bureaucrats submitting amendments to bills which we have before us. We have a staff which is very competent to deal with those subjects. I would like to keep away from the practice as much as possible of bureaus giving us language for legislation. They should tell us what they have done and we will determine what they shall do about it. If we decide to give it to them we are competent to draft the legislation.

Mr. MULTER. I humbly apologize to our staff. I didn't say they weren't competent to do this job. I don't care where the bill comes from. The administration sent up a program here. I have always contended that Members of Congress neither here nor on the floor, should argue about where the bill came from, or who wrote it. The question is whether the bill is good or bad. I don't care who writes it.

The CHAIRMAN. It is a matter of principle involved, and has to do with maintaining the integrity of the committee.

Mr. MULTER. Very good.

Mr. BOLLING. May I ask Mr. Multer to yield?

Mr. MULTER. I yield.

Mr. BOLLING. I am delighted and I would like to congratulate the staff on the extensive efforts which they must have put in on H. R. 7839.

Mr. COLE. May I add that the staff did a tremendous job on H. R. 7839.

The CHAIRMAN. I am sure the staff is competent.

Mr. DOLLINGER. May I ask, Mr. Chairman, can we have a rider attached to the bill, then?

Mr. MULTER. I will pursue that one step further.

The CHAIRMAN. I have merely said the staff is competent to draft an amendment for any member of the committee who wants to offer one.

Mr. DOLLINGER. I was trying to determine whether we would get such a rider passed by this committee, that is all.

The CHAIRMAN. I can't speak for the committee in that respect. It will probably be considered.

Mr. MULTER. Mr. Chairman, what I want done, is to have a proposed amendment, whether this committee adopts it or not, I would like to have such a proposed amendment prepared and submitted to Mr. Cole so that Mr. Cole can tell us whether he thinks that will accomplish the purpose set forth by the President in his message on housing, for 35,000 new starts on public housing in the next year.

I don't want any arguments later if we can avoid them, that the amendment is not in conformity with the President's message.

Mr. McDONOUGH. Will the gentleman yield?

Mr. MULTER. Yes.

Mr. McDONOUGH. I am sure the gentleman is efficient enough to realize we shouldn't pass redundant legislation here. That there is already a declared intention to build 35,000 public housing units this year.

Mr. MULTER. Where is that?

Mr. McDONOUGH. In the President's message.

Mr. MULTER. We haven't enacted that into law yet. This bill is intended to do that.

Mr. McDONOUGH. The authority for 35,000 additional public housing units is already part of the existing legislation of this Congress. That any repetition of that is redundant in my opinion. It isn't necessary.

Mr. MULTER. Where is the legislation?

Mr. McDONOUGH. The Congress previously passed legislation providing for 810,000 units, and the rate of 135,000 per year.

The CHAIRMAN. Couldn't we discuss the procedures better in executive session?

Mr. McDONOUGH. I think so.

Mr. MULTER. That is all right, Mr. Chairman, but I want, on this public record, a statement of how we are going to accomplish the President's intent and purpose as expressed in his message on housing.

Mr. McDONOUGH. I think that will be debated in the House. There will be plenty said about that in the House.

Mr. MULTER. Certainly there will. My purpose is obvious. I am going to put everybody on the spot, so far as the merits of this are concerned. I am going to try to avoid any parliamentary points of order on this so that we can discuss its merits. I want this submitted to the Congress and to this committee in such a way that we are going to argue it on the merits, and either enact it or defeat it on its merits. That is what I am looking for.

The CHAIRMAN. I think Mr. Cole is in a position to answer whether it is in keeping with the President's program, such an amendment, or not, or whether it can be done in any other way. Is that your question?

Mr. MULTER. I think he has already told us. If he hasn't, I will be glad to hear it. Mr. Cole.

Mr. COLE. Sir? What is the question, Mr. Multer?

Mr. MULTER. Is there any doubt in your mind that the President has asked, in his housing message, that the Congress authorize the start and construction of at least 35,000 new units of public housing during the next fiscal year?

Mr. COLE. None whatsoever. That is absolutely correct.

Mr. BOLLING. Will you yield?

Mr. MULTER. Yes, sir.

Mr. BOLLING. Would it be in accord with the President's program if such a provision were included in the bill now before the Committee?

Mr. COLE. My understanding is that the present program is as I have said. Certainly he would not object if this Committee decides to put it in the legislation.

I also understand that the President agrees that it may be handled by the Appropriations Committee. That would be my answer.

Mr. MULTER. And there should be no misunderstanding but that the law as now on the statute books of our country prohibits any new starts for public housing?

Mr. COLE. That is correct.

Mr. MULTER. And unless we repeal that law, and authorize the new starts, we can't get the new starts.

Mr. COLE. That is right.

Mr. McDONOUGH. Mr. Chairman, I don't think that is correct. I think that is as applies to the fiscal year.

Mr. COLE. Well, when I said that is correct, I meant unless Congress repeals the present law.

Mr. McDONOUGH. You mean that the action that Congress took last year denies any additional new public housing starts from here on?

Mr. COLE. Beyond this fiscal year.

Mr. McDONOUGH. Beyond this fiscal year, that is what I mean.

Mr. MULTER. Do you want the language of the statute, Mr. McDonough?

Mr. McDONOUGH. At the end of the fiscal year it repeals the action of the Congress.

Mr. MULTER. It does not. This legislation says in so many words that after the date of the approval of this act, we may not enter into any new agreements, contracts or other arrangements, preliminary or otherwise, which ultimately bind the public housing administration during fiscal 1954, or for any future years, with respect to public housing.

Mr. McDONOUGH. Is that the end of the statement?

Mr. MULTER. Do you want me to read the whole thing?

Mr. McDONOUGH. Yes.

Mr. MULTER (reading):

Provided further, That notwithstanding the provisions of the U. S. Housing Act of 1937 as amended, the Public Housing Administration shall not, with respect to projects initiated after March 1, 1949, (1) authorize during fiscal year 1954 the commencement of construction of in excess of 20,000 dwelling units, or —

Mr. McDONOUGH. There.

Mr. MULTER. Let me finish. You wanted the whole thing. You wouldn't take the excerpt, now listen to the whole thing.

Mr. McDONOUGH. Go ahead.

Mr. MULTER (continuing):

or, (2) after date of the approval of this act, enter into any new agreements, contracts or other arrangements, preliminary or otherwise, which will ultimately bind the Public Housing Administration during the fiscal year 1954, or for any future years, with respect to loans, or annual contributions, for any additional dwelling units or projects, unless hereafter authorized by the Congress to do so.

Mr. McDONOUGH. It says 25,000.

Mr. MULTER. Not any at all. Twenty thousand was for last year, and after last year, none whatsoever, unless this Congress otherwise authorizes.

That is the situation of your existing law, and if you repeal just that, you will go back to the 1952 amendment, which again ties your hands and you can't go any further. So unless this Congress authorizes those 35,000 new starts, you can't get them, either this year, next year, or any other year.

Mr. McDONOUGH. Mr. Chairman, I have the President's message on housing before me, and I can't find any place where the President specified 35,000 new public housing units.

Mr. MULTER. Did he ask for public housing units?

Mr. McDONOUGH. I don't find where. I have the message in front of me. Will somebody enlighten me as to where it is?

The CHAIRMAN. Aren't these matters we can take up in executive session?

Mr. McDONOUGH. I beg your pardon, I find here "recommendation that the Congress authorize 140,000 public housing units in groups of 35,000 units." That is right.

Mr. MULTER. Unless we enact the legislation the message will be ignored and we can't get them. I don't care how you finally vote on the thing, but I want to be sure that every Member of this Congress is going to get an opportunity to vote on the merits of that part of the message. We can only do it if there is an appropriate part of this bill covering the subject.

Now, to go back, Mr. Cole, leaving this for the time being, and to go back to the question of \$7,000 houses, I have been, during the last year, in these communities throughout the country in addition to metropolitan New York: Dayton, Ohio; Gary, Ind.; Hartford, Conn.; San Francisco, Los Angeles, and San Diego, Calif.; Pittsburgh, Pa.; and from Orlando south to Palm Beach in Florida.

I have been unable to find in any of those areas any houses or any builders who will build houses at anything like \$7,000 a year. I have seen some in California that have been referred to by everybody as tinderboxes, that are selling at about \$7,000, but I am sure that you couldn't get an FHA loan on them. They wouldn't qualify.

Mr. COLE. Mr. Multer, without casting any aspersions on those people who will look at a house and say it is a tinderbox, I think there is a great deal of misinformation about the construction of houses in this class or price range. And as these pictures show you, in addition to the statistics which we will present for the benefit of the committee, I want to point out to you that home loans by the Federal savings and loan associations, for construction of homes and purchases, average \$7,800 and \$7,900.

Mr. MULTER. That is almost a \$1,000 difference.

Mr. COLE. Yes, Mr. Multer, and I have carefully said—although the committee has been talking about \$7,000 houses—I have carefully said that I don't want to be tied down to an exact figure of \$7,000. It might be \$8,000, it might be \$6,000, depending upon your area.

I merely said, once more, that this is an experiment, this is an effort, this is a trial. We say that it has some possibilities. We don't say that it is an answer to all of these problems. It is one trial, one experiment, one method which we would like to try, and believe in. That is as far as we go.

Mr. MULTER. Well, I for one am willing to let you try the experiment, but I think you are just going to lose that much time and nothing will come of it.

Mr. COLE. We won't lose any time where we house people.

Mr. MULTER. You are not going to find builders who will build for that price. You will find purchasers who will want them at that price, yes.

Mr. COLE. We will not lose time if houses are built for the people in the seven to eight thousand dollar class.

Mr. HAYS. Will you yield?

Mr. MULTER. Yes.

Mr. HAYS. Mr. Cole, do you think that under present prices and present conditions, that there can be much of a house built for seven or eight thousand dollars?

Mr. COLE. Yes, I do, very definitely, very definitely.

Mr. HAYS. Well out in my section prices are considerably below what they are in this area, and I have had occasion to look at some houses lately with a view of making a loan on them, and they were fantastic little cheese boxes. They tell me that they cost fourteen and fifteen thousand dollars, and should be so appraised.

Mr. COLE. Mr. Hays, I just can repeat that in the best careful judgment, and best investigation that I can make, it can be done, and we are willing to stake that judgment on this recommendation. Once more, and continually, I must repeat: We don't expect that this will be a palatial luxury home. It can't be. It cannot be built in some specific spots where land costs are high. It must be built in low-cost land areas. There isn't any question about that.

All I am saying to the committee is that here is an effort, this is one more step. Congress is not going to permit direct subsidy, direct building of homes in this class. I am merely saying, let's do something to try to get houses for people with low incomes. That is all I say. Let's try it. Let's make an effort to do it. Are we just going to sit and say "We are not going to do anything about it?" Not me. I am going to say "I want to do something about this problem," and I face it practically and realistically, by saying that as I see the problem, the present housing program—and again, I underscore the fact that this is not a substitute for public housing in the lower income brackets—but as I see the public housing program, Mr. Hays, I don't see that Congress is ever going to establish a great program of 150,000 or 125,000 units a year of public housing.

I want to do something to help people in the lower income brackets get adequate homes.

Mr. HAYS. Mr. Cole, I think you misinterpreted my intent. I am sympathetic to the housing program and I am not an advocate of a tremendous public housing program. I think you should know that from being on the committee.

Mr. COLE. Yes, I know that.

Mr. HAYS. I do believe that there is a certain amount of public housing necessary, at least three times as much as this bill calls for, but I have never been one who thought the Federal Government should go into an unlimited program. I am trying to be realistic. I built a little addition to my barn this fall, with labor much cheaper than you can hire it here. I bought no land. The land was already there. It isn't finished on the inside. There is no plumbing in it except three drinking cups, and the thing cost me \$4,000 for a 20 by 30 building.

Now, I just know a little bit from personal experience about building costs and I just don't think that you can get a house for \$7,000 that anybody wants to live in long enough to get it paid for.

Mr. COLE. I think to carry this discussion further would be pointless, because I am not a builder.

Mr. HAYS. Well, I am not either.

Mr. COLE. And I am not an expert in it. But there will be people following who are supposed to know more about it than I, and I hope you will question them closely upon this point.

Mr. HAYS. I hope they can do it. I think it would be grand if they can. But I was just trying to get some information on how it can be done. Thank you, Mr. Multer.

Mr. MULTER. Thank you, Mr. Chairman.

Mr. McDONOUGH. Mr. Chairman.

The CHAIRMAN. Mr. McDonough.

Mr. McDONOUGH. Without attempting to be out of order, Mr. Chairman, I just wanted to continue the reading of the amendment, Mr. Multer read to the committee in last year's housing bill concerning public housing units, and from where you stopped I am beginning to read, Mr. Multer, which reads:

And during the fiscal year 1954, the housing and Home Finance Administrator shall make a complete analysis and study of the low-rent public housing program, and on or before February 1, 1954, shall transmit to the Appropriations Committee of the House and the Senate his recommendations with respect to such low-rent public housing program—

which is in relationship to the proposal the President made, and indicates that it is the desire of the administration to see that so many public housing units shall be built during the fiscal year. What the report of the Administrator to the House and Senate will be, I don't know, but that is part of the amendment, and consequently the desire of the Congress.

You say there isn't any legislation available. It is there. The authority is there. Any added authority that this committee might add to this bill is just a repetition to what is already on the books.

Mr. MULTER. How anything that you read in this law, requiring a report to be made to the Appropriations Committee, can affect the number of houses to be built is beyond me.

Mr. McDONOUGH. It is certainly up to the judgment of the Housing Administrator.

Mr. MULTER. You have just read that all he is supposed to do is study and report. You can't get housing out of a study or report. You get it pursuant to authorizing legislation, not from a study or report. There is nothing in this that says if we report we need a hundred thousand units, that we will build a hundred thousand units. The study and report is merely informative to the Appropriations Committee. But why should the Appropriations Committee get that kind of information rather than this committee?

Mr. McDONOUGH. Well, when Congress adopted the amendment they asked that the report be made.

Mr. MULTER. The President has said regardless of the report we need 35,000 new units a year.

Mr. McDONOUGH. That is an indication of what the Administrator will recommend.

Mr. MULTER. That is what the President recommends as a minimum. It is a strange thing that the minority party must argue for the program of the President who was the candidate of the majority party.

Mr. McDONOUGH. Mr. Chairman, I have a question.

The CHAIRMAN. Mr. McDonough.

Mr. McDONOUGH. Mr. Cole, before I came in I understand Mr. Hiestand reviewed the possibility of an amendment to the bill which would limit the authority of the public housing authorities throughout the country so that they would be responsible to some extent to the appointive power. Do you think such legislation should be added to this bill, or do you think that the power of the public housing authority is a little too broad, and that there should be something in the bill to reduce it so that we wouldn't override or attempt to override the local authority?

Mr. COLE. Mr. McDonough, I am sure that some of the unfortunate occurrences which happened in the past would be eliminated perhaps if that were done. May I point out to you, however, that my own personal basic philosophy about matters of this sort would oppose that type of an approach. I don't believe the Federal Government should intrude on matters which are appropriately within the area of State control by State and local legislation.

I believe in this program being a local program, within all of the areas possible. It should be locally conceived, locally planned, locally programed, locally carried out.

Now, saying it in as nice a way as I can, if a community has badly planned, badly contracted for, carried out the program erroneously, we have certain responsibilities because we have a support—the Federal Government, I mean, we are assisting by subsidy. So we have a certain support.

But if you will take time to examine all of the reasons for local responsibility of the authorities in this bill, I would hesitate very much before I would recommend that the Congress, in its legislation, say that certain things must be done locally, and control taken away from the local people.

Mr. McDONOUGH. I wouldn't say that any control should be taken away from them. I mean to say that they should have complete control, and that they should also have some jurisdiction over the autonomy that the public housing authorities now have.

Mr. COLE. I have been very disturbed about that problem, Mr. McDonough, not only as administrator but as Congressman. I have been very disturbed about the fact that an autonomous agency is set up in a community without any responsibility flowing to the elected officials, but I think it is their job to see that that does not happen. That is clearly a matter for the States to decide themselves.

In my judgment there are so many overriding reasons why the Federal Government should not interpose its judgment, either on the State Legislature or on the city in connection with this public housing authority, that I can't recommend it, even though I am quite disturbed about it.

Mr. McDONOUGH. Let me give you an instance. If there had not been a voluntary compromise arrived at between the Federal Government and the Los Angeles public housing authority, the public housing authority could have proceeded, in defiance of the vote of the people of Los Angeles and of the State of California, to seek the funds from a bond issue, an attractive bond issue, that was bought very readily by the financial institutions, to build 10,000 public housing units in Los Angeles.

Mr. FITZPATRICK. It is not a matter of cooperative agreement, Mr. McDonough. It is a matter of the provisions in the State laws. Most of the State laws, as I recall them offhand, do provide for the appointment of commissioners on staggered terms, and also provide that they may be removed by the appointing power for malfeasance in office or failure to perform their statutory duties.

I do not know of any offhand which provide that they serve at the pleasure of the appointing power; there may be some. In any event, the State legislatures can so provide if, in their discretion, they deem it wise.

Mr. MERRILL. I think that under Indiana law the mayor has the power to remove every person he appoints in the city administration, which would mean in Indiana that we have decided we want to keep our finger on those things.

Mr. FITZPATRICK. I can check Indiana law for you, but it is a matter of the choice of the State legislature.

Mr. MERRILL. What we want to do is in our own wisdom, or foolishness, make our decision.

Mr. FITZPATRICK: That is right.

The CHAIRMAN. May I request some information from Mr. Fitzpatrick. Is there anything, other than in the definitions of the Public Housing Act, which has to do with the setting up of these authorities? Does a local housing authority come under the definition of a public housing agency under the law?

Mr. FITZPATRICK. Yes, sir, it does.

The CHAIRMAN. All right, let us settle this now and see if we cannot get somewhere on this question.

Section 9 of the United States Housing Act of 1937 states:

The definition of a public housing agency—

a public housing agency—

means any State, any county, any municipality, or other governmental entity or public body, exclusive of the authority—

that is the Federal authority—

which is authorized to engage in the development or administration of low rent housing and slum clearance.

Now, I assume from that that the local housing authority must have been set up by the State legislature, under such terms and conditions and limitations as stated in the enabling act setting up the authority, over which the Federal public housing authority has no jurisdiction any more than it would have jurisdiction over a municipality or State.

Mr. FITZPATRICK: That is entirely correct, Mr. Chairman.

The CHAIRMAN. I think that perhaps we might place some limitation upon the authority which they have to meet the Los Angeles situation or any other situation, but under existing law, according to the law as I read it, I must agree with Mr. Cole that they have not any jurisdiction, administratively, over the local housing authority which has been set up under State law, any more than they would have over a municipality or a State which in itself is a distinct entity. The State can create a distinct political entity, which they call a housing authority, to deal with the Federal public housing authority in those respects; unless the act sets up other standards, then Mr. Cole is correct, that we have no jurisdiction over it.

There may be a looseness in the law in that respect, but, of course, if there is a looseness in the law then we must take into consideration that any tightening up of the law must apply as well to the States, themselves, or the municipalities.

Mr. FITZPATRICK. In Mr. Wolcott's own State, the legislature did choose to deal with it in a different way. They chose there to vest the basic powers in the city. Under the Michigan law, the power to issue the bonds, for example, may be exercised only by the city.

In Michigan the Housing Commissions function solely as an agent of the city, and the basic control, basic powers, are invested in the city.

There are 2 or 3 other States that have followed the same pattern as Michigan.

The CHAIRMAN. Let us be clear on this Los Angeles situation, now that we are on it. As I understand it, and I may be wrong, a new mayor was elected; a day or so before he was to take office the outgoing mayor appointed a public housing authority thereby, under the enabling act, tying the hands of the new mayor so that the new mayor could do nothing whatsoever about it.

Now, I ask Mr. McDonough and Mr. Hiestand this question: Is the public housing authority set up in Los Angeles a self-perpetuating unit, over which the State legislature has no jurisdiction?

Mr. McDONOUGH. They have so declared.

The CHAIRMAN. Who has so declared?

Mr. McDONOUGH. The Public Housing Authority.

The CHAIRMAN. Or is it a contract between the State and the Public Housing Authority which cannot be terminated by State law?

I have always sympathized with your problem out there, but I think it is purely and simply a State question and not a Federal question.

Mr. McDONOUGH. The situation stems to the original contract made by the original Public Housing Authority of the previous mayor of the city of Los Angeles.

The CHAIRMAN. I am sure the question came to the Public Housing Authority here in Washington early. But the State legislature could have acted and made it possible for the new administration of Los Angeles to set up a new housing authority, which could have rescinded by resolution or otherwise the action of the housing authority which was given this autonomy the day before it took office.

I am sure the situation in Los Angeles would have been different, because the new public housing authority would have abided by the wishes of the new authority.

Mr. McDONOUGH. The previous housing authority, under the previous mayor of Los Angeles, the judicial review of this authority in relation to the original contract was reviewed by the State Supreme Court, that it was a contract entered into in good faith and would have to be abided by.

The CHAIRMAN. It could have been rescinded, of course, only by the same agency that entered into the contract in the first place, so a new public housing agency, set up under a new concept of public housing under State law, could have rescinded the action taken by the then existing public housing authority.

I have never understood why the people of Los Angeles did not seek relief through the State legislature. I do not think we have any jurisdiction over the matter down there.

Mr. COLE. Mr. McDonough, isn't part of the answer to your question the fact that the Los Angeles situation has been settled, completely?

Mr. McDONOUGH. No, I would not say that. The question that I am concerned about is that, from the autonomous action of the public housing authority in Los Angeles, that it appears to me that under

the existing legislation similar autonomous authorities could be created in other parts of the United States, and, in our case, if there was a fault on the part of the State legislature the fault became evident after we had been obligated to build 10,000 units against the will of the people and to assume an obligation of \$100 million, or something of that sort.

The CHAIRMAN. Mr. McDonough, under the laws of every State that I know of, where a political subdivision of that State, the administrators of a political subdivision of that State, are not following the clear intent exhibited by the people, then they are all subject to removal by the Governor who is the chief executive of every State. I do not know of a State law which does not save to the Governor himself the authority to go in to any situation so long as it is a subdivision of the State.

Mr. McDONOUGH. Down to the city level?

The CHAIRMAN. Below the city level, and remove anyone who has been set up, who is not responsive to the people.

Now, if the State of California has not reserved that right to the Governor, in law or by constitution, then it is not the fault of the Federal Government, it is the fault of the State of California.

Mr. BOLLING. Mr. Chairman.

The CHAIRMAN. Mr. Bolling.

Mr. BOLLING. If we are through with this phase of the problem I would like to ask a couple of questions about the Los Angeles situation.

The CHAIRMAN. Could not we get back on the bill? Because I might say that if we are going ahead with these hearings we have got to close out on these subjects. Mr. Cole has a part of his original statement yet to cover, very important questions, and we can take up the interpretations of this law, it seems to me, in executive session, as well as here in open session, and not take up his time. Because we are going to be in a terrible situation if we do not dispose of these witnesses whom we have before us here this afternoon. We have got to start rolling tomorrow or this whole thing is going to be thrown into imbalance.

Mr. GAMBLE. Aren't we always that way with regard to housing over the years?

The CHAIRMAN. We would like to avoid it this year if possible.

Mr. BOLLING. Mr. Chairman, there is another facet of the matter which ought to be in the record, which will be very brief. Has there been any cost to the Federal Government through its reduction by voluntary agreement from 10,000 to 4,300 units?

Mr. COLE. Yes, sir.

Mr. BOLLING. What has that cost been?

Mr. COLE. It has been estimated at about \$2 million. The final determination has not been arrived at.

Mr. BOLLING. Just out-of-pocket cost, \$2 million, with nothing in return for it, for anybody?

Mr. COLE. Well, I do not know whether there is nothing in return for it. I suppose it is settlement of a most controversial and difficult problem, and that may enter into some of the cost, Mr. Bolling, and it was. It was a thing which caused more grief to the program of public housing, both pro and con, than anything else. It expanded far beyond the confines of the area.

Mr. McDONOUGH. With reference to the cost, it has not been finally determined?

Mr. COLE. That is right.

Mr. McDONOUGH. Because there is a residue of return in the disposal of certain land acquisitions, and certain materials that were not used.

Mr. COLE. I said it was an estimate.

Mr. McDONOUGH. So there is not any final determination as yet.

I would say that the revenue from the State of California will balance that off, Mr. Bolling, without any question. We have a per capita income tax return to the Federal Government a little higher than most States of the Union.

Mr. BOLLING. Now, we are going very far afield.

Mr. McDONOUGH. That is right.

Mr. MULTER. Of course, New York will keep quiet for the moment.

Mr. McDONOUGH. Mr. Chairman, I will terminate this discussion, if it is agreeable.

Now, Mr. COLE, with relation to the discussion we have been having on \$7 or \$8 thousand houses, I think it is a little difficult, and I can understand your position, to say that it can be done, and I think it is a fine thing that we should attempt to do it. I think we should do everything possible to create low-cost housing for those who cannot afford to pay for a so-called high-cost or middle-cost house.

But, insofar as that type of house being called a tinderbox whenever they apply that term they forget that there are certain regulations that the builders have to meet—fire hazards, sanitary conditions, and so forth, in the construction of the house. You cannot build a house that is not a good house if you live up to the building ordinances in the city of Los Angeles, because the building department won't allow you to build it.

You cannot build a poor house in the county of Los Angeles because the county building authorities won't allow you to do it. And so if there are places in the United States where a \$7,000 house is a tinderbox and fire hazard it is up to the local authorities to see that their ordinances are brought up to standard, and I think it is one of the finest things we can do, to stimulate low-cost housing, as this bill provides.

That is all for the present, Mr. Chairman.

The CHAIRMAN. If there is no further discussion—

Mr. MULTER. Mr. Chairman, just one very brief matter.

The CHAIRMAN. Mr. Multer.

Mr. MULTER. Mr. Cole, on page 261 of the report to the President, by the President's Advisory Committee on Government Housing Policies and Programs, we find recommendation No. 3 which deals with public housing.

Was there any division within the committee as to that recommendation, or was that a unanimous recommendation?

Mr. COLE. It is not unanimous but my recollection is that only one voted against the final recommendation, which is not that, Mr. Multer.

Mr. MULTER. Which is the final recommendation?

Mr. COLE. The final recommendation you will find—there may have been two. but not over two—you will find the final recommendation

on page 13, but it does cover, in essence, recommendation No. 3 of the subcommittee. It begins on page 15, rather.

Mr. MULTER. Page 15?

Mr. COLE. Yes, sir.

Mr. MULTER. Item No. 2?

Mr. COLE. That is correct. You see, it is substantially the same.

Mr. MULTER. Yes, sir.

Mr. COLE. There is some little difference in wording.

Mr. MULTER. Mr. Chairman, if there is no objection, may we have included in our record at this point the paragraph, item No. 2, from page 15 of the President's Advisory Committee Report on Government Housing Policies and Programs, and also that on page 261, which is recommendation No. 3?

The CHAIRMAN. Without objection, that may be done.

(The material referred to is as follows:)

2. To meet the continuing housing needs of low-income families, and pending demonstrated progress of other programs recommended by the committee designed to stimulate through Federal Housing Administration mortgage insurance the private production of housing for low-income families and the rehabilitation of obsolete structures in decaying neighborhoods, the committee recommends a continuation of the public-housing program as contained in the Housing Act of 1949, with certain amendments summarized below. The committee believes that determinations as to the size of the program and the method of financing it are responsibilities of the administration and the Congress. The committee is unanimous in its belief in the objective of a more effective operation of the private housing market so as to steadily lessen the need for direct subsidies. (Appendix 3, recommendation 3; attachment to appendix 3.)

Recommendation No. 3:

We recommend continuation of the public housing program for low-income families as contained in the Housing Act of 1949 with such legislative and administrative changes as we shall propose below as an essential part of the overall housing program of the Federal Government. It is understood that the number of units to be contracted for during any particular period is a matter for administration recommendation and congressional action.

After an exploration of such alternatives as were proposed to our subcommittee and our own review of the existing program, we are convinced that the program of public housing for low-income families as contained in the Housing Act of 1949 should be continued. The Congress authorized under the provisions of that act a program of 810,000 dwelling units for low-income families to be made available at the rate of 135,000 dwelling units per year for 6 years. In 1950, after the outbreak of hostilities in Korea, the President reduced the rate to 75,000 units per year. In 1951, through the Independent Offices Appropriation Act and without amending the Housing Act of 1949, the Congress reduced the program to 50,000 units for that year; in 1952 to 35,000; and in 1953 to 20,000 units out of existing authorizations. Thus, by June 30, 1954, just about 200,000 units of the 810,000-unit authorization in the basic law, or around one-fourth, will have been completed or under construction.

We believe that one of the important reasons for continuing the public housing program for low-income families is to provide relocation housing for families displaced through urban redevelopment, rehabilitation, and law-enforcement programs. Official data presented by the Housing and Home Finance Agency to the Subcommittee on Urban Redevelopment, Rehabilitation, and Conservation show that just about one-half of the families displaced by redevelopment operations under title I in the continental United States are eligible for public housing under existing income limits for admission. The problem of relocation is particularly difficult for minority groups. While about 45 percent of displaced white families are eligible for public housing, over 55 percent of displaced minority group families are within the public housing income limits.

Mr. MULTER. That is all.

The CHAIRMAN. You may proceed with your statement, Mr. Cole.

Mr. COLE. The Home Loan Bank Board has been conferring with managers and representatives of Federal savings and loan associations for a number of years on various legislative proposals governing the enforcement of the Board's supervisory authority and its powers with respect to the appointment of conservators and receivers for these associations. Under broad statutory powers the provisions for the appointment of conservators and receivers have always been incorporated in the regulations for the Federal Savings and Loan System. Because such regulations can be changed from time to time by the Board representatives of the institutions supervised by the Board have felt it desirable that the provisions should be clearly set out in the statutes as they are in the National Banking Act, the Federal Reserve Act, the Federal Deposit Insurance Act, and in the statutes in most of the States.

The bill would give the Board the authority needed to protect the welfare of Federal associations and their members, and at the same time provide more orderly procedures for the exercise of the supervisory powers of the Board. It is my understanding that these provisions of the bill are satisfactory to the representatives of the savings and loan industry as well as to the Board.

Presently the Board has rather broad powers with respect to the appointment of conservators and receivers. However, even under these broad powers the Board presently has no means, except through the appointment of a conservator or receiver, to enforce the laws and regulations under which Federal savings and loan associations operate. The bill would therefore provide a method for the enforcement of law and regulations without the necessity of the appointment of a conservator or receiver, and would also establish standards and procedures for the appointment of conservators and receivers.

It provides that, in the event of a violation of law or regulation the Board will give the Federal association concerned notice of such violation, and 30 days in which to correct the same. At any time during the 30 days either the Board or the association is given the right to apply to the United States District Court for a declaratory judgment, an injunction, or other relief. If after 30 days the violation has not been corrected, the Board will give the association 20 days' notice of the time and place of a hearing which will be held in the judicial district where the association is located unless the association consents to another place. After hearing and adjudication by the Board, the right of appeal is given as is provided by the Administrative Procedure Act, and court review is upon the weight of the evidence. The Board is specifically given the access to the courts for the enforcement of its adjudication and orders.

The bill also provides standards and procedures for the appointment by the Board of a conservator or receiver, and gives the Board exclusive jurisdiction to make such an appointment. The grounds for such appointment are: (i) insolvency; (ii) violation of law or regulations; (iii) concealment of books, records or assets; and (iv) unsafe and unsound operation.

The bill provides that a conservator or receiver shall not be appointed until after notice and an opportunity for an administrative

hearing held in accordance with the provisions of the Administrative Procedure Act, that such appointment shall be subject to court review as provided in the Administrative Procedure Act, and that such review shall be upon the weight of the evidence. However, the bill further provides that, if the Board determines that an emergency exists requiring immediate action the Board may, without notice and hearing, appoint a supervisory representative in charge who shall have all the powers of a conservator or receiver. Such a supervisory representative may hold office for not more than 6 months, or until a conservator or receiver is appointed and takes charge, or until 30 days after the final proceedings of a hearing, or until 60 days after final termination of any litigation affecting such temporary appointment, whichever is longest.

In my judgment, these provisions of the bill retain in the Board the authority and power needed for the proper discharge of its responsibilities and, at the same time, give adequate protection to the institutions supervised. I believe this represents a fine example of the results of industry and Government working together to develop a constructive solution to a particularly vexing problem. I think Mr. McAllister, the Chairman of the Home Loan Bank Board, who is here with me, and who will be glad to answer any questions you gentlemen may have, is to be congratulated for his work in connection with this matter.

The CHAIRMAN. Are there questions of Mr. Cole in connection with this section of his statement?

Mr. McDONOUGH. I have not any particular questions, Mr. Chairman, but I think that this section of this bill, and the review just made of it by Mr. Cole of what it contains is very satisfactory.

It has met a situation that has required a great deal of conference and cooperation within the industry. I introduced the first text of this proposal, which has since been revised several times, and now it is brought down to the point where both the industry, the Bank Board, and the administrator agree, and I would like to see it adopted as it is now contained here.

Mr. MULTER. Mr. Chairman.

The CHAIRMAN. Mr. Multer.

Mr. MULTER. Mr. Chairman, this proposed change in the law was initiated primarily because it was charged that at least in one instance they went in and took over a perfectly solvent association and wound it up. Isn't that what brought this up, and there was no way of reviewing that action of the Board?

Mr. McALLISTER. Are you talking about the San Diego Federal?

Mr. MULTER. It was one in California. I thought it was in Long Beach.

Mr. McALLISTER. Well, the Board took over the San Diego Federal, and the institution, from subsequent examination, was not insolvent, and later was returned to the management. And the subject is still in dispute, as far as some suits in the courts are concerned.

Mr. MULTER. How long a period elapsed between the time it was taken over and then turned back?

Mr. McALLISTER. Perhaps 2 years. I am not too well posted, Mr. Congressman, with reference to that.

Mr. MULTER. It was that kind of situation that this is primarily intended to cover?

Mr. McALLISTER. Yes, sir. In other words, as the law stands right now we have the authority to go in and appoint a conservator, and that seems to be a foolish thing to do if the institution is insolvent, and is merely guilty of violating the law or some of the rules of the Board, and this will give us a practical means of discussing and arbitrating and settling such disputes.

It gives the association and its management a protection that it does not have today, from what might be termed capricious acts on the part of the Board. On the other hand, it does retain full authority in the Board to step in and take over an institution if it is necessary to do so, immediately.

Mr. MULTER. Of course you appreciate that it is just as bad to put in a temporary receiver or conservator of an insolvent institution as it is to put in the permanent one, if the temporary one is going to remain for a great length of time. Isn't that right?

Mr. McALLISTER. That is correct, but we have tempered it a little by giving him a different name and also by stating that he can only stay there for a maximum period of 6 months, or until the court has determined what the situation is.

Mr. MULTER. Will you point out to me, please, if it is the provision in this proposal which permits court review of the appointment of the temporary receiver or conservator, or whatever name you give him?

Mr. McALLISTER. Counsel says that that is included, sir.

Mr. MULTER. Would you mind directing my attention to it so that I may read the language?

Mr. WADE HARRISON. The provision states that he can remain there for 6 months or 60 days after the court proceeding affecting such appointment.

Mr. MULTER. But where is the provision giving them the right to come in and contest the appointment of a supervisory representative, temporary representative?

Mr. HARRISON. That provision infers that it could be—

Mr. MULTER. That is the conclusion I came to. It is by implication or inference. You do not give him the right under the law to go to court and contest it?

Mr. HARRISON. Except that under the Administrative Procedure Act it would be an action of an administrative agency and, as such, under that act you would have the right of appeal.

Mr. MULTER. How long ordinarily would it take to review that kind of action in the courts?

Mr. HARRISON. Well, it would be a suit in court and that would depend on many factors. As you know, a suit can be delayed a long time, or you might get a prompt decision. It is just another lawsuit.

Mr. McDONOUGH. But he cannot remain there longer than 6 months.

Mr. MULTER. Let us see if that is so. Six months or until 60 days after final determination of any litigation affecting such temporary appointment, whichever is longest.

Mr. McDONOUGH. That is right.

Mr. MULTER. So if the litigation runs for a year, it is a year and 60 days, and not 6 months. Is that right?

Mr. HARRISON. That is right.

Mr. MULTER. I think that is too dangerous a situation to let rest that way. I think we ought to try to get some language so as to permit of some kind of an early determination as to whether that temporary supervisor should be there. Otherwise you are likely to run into the same situation as we did in California. I hope we never will. I hope the board will do the good job that we would like to have it do at all times.

But suppose somebody doesn't.

Mr. McALLISTER. Certainly our effort has been to provide a reasonable measure of protection to the institution, and I can only say that this proposal has been discussed and changed and amended and worked on for about 2 years by representatives of the industry, and finally this comes up as a consensus.

Mr. MULTER. Do you mind directing my attention to the provision for review? I think I have it here. It is on page 97 of the bill, is it not (reading):

And review by the court shall be upon the weight of the evidence.

Does that mean that if the court finds that there is any evidence in the record to sustain the finding of the board the court is without power to act?

Mr. HARRISON. No, sir; that takes it out of that rule, and that was the reason for putting it in there. As you know, under the regular Administrative Procedure Act if they found any evidence, or substantial evidence, to support the administrative agency they would support the administrative agency. This "weight of the evidence" was put in to take it out of that group, where the court would really weigh the evidence.

Mr. MULTER. I am very happy to have that interpretation. I was very much afraid that we might get the contrary interpretation. But having put in that language which I have just read don't we have to go a little further and say the review by the court shall be upon the law and upon the weight of the evidence? Otherwise somebody is likely to read this and say, well, the only thing they can review is the weight of the evidence?

Mr. HARRISON. No, sir; under the Administrative Procedure Act they would review the law. They would have a right to question the law at any time.

Mr. MULTER. I am inclined to agree you are right, because it is in the conjunctive here. I think you are right about that.

Mr. HARRISON. Yes, sir.

Mr. MULTER. I do think that the other provision I referred to a moment ago needs some further attention, the possibility of keeping a temporary supervisor in for a year or two requires some further attention, I think. I hope you will consider it and come up with some additional language and let us have it.

I know you are going to do your best not to have a repetition of the California situation. Since it has happened once, it may happen again. Let us try to avoid it as best we can.

Mr. McDONOUGH. Of course this whole section is designed to prevent a situation like that developing. The supervisor in charge, so-called, in this bill, is the exclusive jurisdiction of the board only where immediate possession is necessary and where there is evidence that

immediate possession is necessary. That does not apply to the conservator or receiver. The supervisor in charge is appointed only when an extreme emergency exists.

Mr. MULTER. The difficulty is we have no definition of an emergency. If the board determines there is an emergency they go in with a supervisory representative as a temporary expedient; I can easily understand how you cannot put into language a description of "emergency."

Mr. McALLISTER. On page 98 (reading) :

The grounds for appointment of a conservator or receiver for a federal savings and loan association shall be one or more of the following: (i) insolvency in that the assets of such association are less than its obligations to its creditors and others, including its members; (ii) violation of law or of a regulation; (iii) the concealment of its books, records, or assets or the refusal to submit its books, papers, records, or affairs for inspection to any examiner or lawful agent appointed by the Home Loan Bank Board; and (iv) unsafe or unsound operation.

In other words, we have tried to spell out for our own guidance and for the protection of the business, under what conditions we can step in immediately and put in a conservator.

Mr. MULTER. You have tried to do a good job, and I know you have been conscientious about it. But you cannot blame me for being somewhat cautious about it. For instance, you say one of the grounds for the appointment of a receiver shall be violation of law or of a regulation. Now, it could be the most minor regulation that they send out their mail under a frank, that they have no right to use. That is violation of a regulation and it is a violation of a law. Certainly you are not going to appoint a receiver for that reason. I am trying to think of the most picayune thing you can pick on.

Mr. McALLISTER. Well, if you have a means of suggesting a practical improvement we certainly are more than willing to consider it.

Mr. MULTER. I will see if I cannot come up with something.

Mr. McALLISTER. Mr. Chairman, there are four other minor corrections in the law included in this section 6.

Under the first, section 601 of the Housing Act, paragraph 4, that permits the Federal Savings & Loan Insurance Corp. to be sued, and is a protection in the event of insolvency of an institution taken over by the corporation to permit people who have accounts in the association to get service against the corporation on a reasonable and practical basis. Currently, it would probably be necessary for them to come to Washington in order to serve the corporation. So we feel that that is in the public interest.

The next amendment is on page 95 of the bill. There is no statute of limitations applying to claims against the corporation. In the event of the insolvency of an institution we have to carry up on our books indefinitely claims of any of the shareholders of that institution. There is generally a statute of limitation applying to matters of that kind, and we have suggested here a statute of limitation covering a period of 3 years.

I might say that we want to be generous and liberal in that period of time, and think that we have been so.

Mr. McDONOUGH. And you further limit it to action brought within 2 years from the date of such denial.

Mr. McALLISTER. Yes, sir; and the FDIC, I might state, has a limitation of 18 months, as compared to our 3 years.

Then section 602, amending the Home Loan Bank Act, increases the loans that the banks may take as collateral from their members, from the current limit of \$20,000 per residence, to a maximum of \$35,000.

Then the amendment to section 603 grants to Federal savings and loan associations permission to make loans on residences, and increases that limit from \$20,000 to \$35,000. Currently they may make loans above \$20,000, but all such loans must be included in a specific 15-percent-of-assets limitation.

This would raise the limitation to \$35,000.

Those are the only other amendments.

The CHAIRMAN. Are there further questions?

Mr. McDONOUGH. Mr. Multer, in relation to your concern, this will give the Federal savings and loan associations a great deal more liberality than they have had under the existing law, and I think that, although the original law was restrictive in the beginning, it perhaps had to be because the Federal savings and loan associations of that time were somewhat of an experiment. Now, we have millions of depositors, we have billions of dollars on deposit, it is probably the most commonly used middle class and low-income class group of deposit, next to postal savings, and the arbitrary, autocratic authority that the Board had in the beginning should, in my opinion, be modified because it has to do with the assets of so many people throughout the United States.

Mr. MULTER. I am in complete agreement with it, and I think this is an improvement over what the law was up to now.

Mr. McDONOUGH. That is all, Mr. Chairman.

The CHAIRMAN. Are there further questions with respect to this section?

Mr. Cole, you may proceed with the remainder of your statement.

Mr. COLE. The bill would also carry out the President's recommendations contained in his budget message and in his economic report with respect to Federal assistance to States and communities for the advance planning of State and local public works.

The advance planning of such public works has long been recognized as a valuable tool in establishing and maintaining a high level of operation in the construction industry which is an important factor in the maintenance of a healthy national economy. A substantial volume of planned State and local public works could be very useful in helping to stabilize the construction industry and, in turn, economic activity in general. It is, in my judgment, a sensible and economical form of insurance which will enable the States and their local public bodies to proceed promptly to expand the volume of the construction of worthwhile public works in the event that economic conditions should, at any time, make such action desirable.

These provisions of the bill are somewhat similar to the former advance planning laws, but, dollarwise, are on a more modest scale, since the funds authorized would be limited to \$10 million. In order to achieve the maximum benefit from such funds we expect to confine, to the greatest extent possible, the use of the Federal advances to the preparation of preliminary plans for specific public works

in lieu of fully completed plans. Obsolescence of plans will be materially reduced by emphasis on preliminary planning and completion of detailed planning at the time of construction. This should be an important factor in recovery of advances. Also by this procedure it is estimated that preliminary plans for 2,200 public-works projects, with an average estimated construction cost of \$300,000 each, can be provided with the \$10 million. It is estimated roughly that construction costs of the 2,200 projects should amount to approximately \$660 million. The average Federal advance per project would be some \$4,500 or about 28 percent of the average cost of obtaining fully completed plans under the second advance planning program undertaken by the Federal Government in 1949.

There are two particular features of these provisions of the bill which I wish to emphasize. The first is that the Federal funds are in no sense outright gifts, as is true in the case of grant-in-aid legislation. These advances become fully repayable when the sponsors of the projects commence the construction of the public works contemplated by such planning. Accordingly, the program which would be authorized by this bill is in the general nature of a self-liquidating program, with overall benefits of an additional value which naturally accrue to the communities in particular, and the Nation as a whole, from the provision of sound and useful public works. The second is that full control over the selection of each proposed public-works project is at the State and local levels, since no advance can be made for any project unless the project conforms to an overall State, local, or regional plan approved by a competent State, local, or regional authority.

The operations of our agency having to do with two earlier advance planning programs authorized by the Congress are carried out under the supervision of Mr. John Hazeltine, my new Commissioner of Community Facilities. He is here with me today and I would like you to meet him and get acquainted with him.

Mr. BOLLING. Mr. Chairman.

The CHAIRMAN. Mr. Bolling.

Mr. BOLLING. Mr. Cole, are you familiar with the section of the Joint Committee on the Economic Report, the committee report, which is at the bottom of page 14, reading as follows:

As an aid to getting the most possible out of public works as a device with which to turn recession, the committee recommends the proposals which would facilitate the immediate planning and coordination through administrator, directly responsible to the President, of all Federal public works and community development, in cooperation with Federal, State, and local governments.

I read that so that you will know my purpose in asking you questions.

The channel of command in effect, from the Commissioner, is through you, and through you to the President; is that correct?

Mr. COLE. Yes, sir.

Mr. BOLLING. What kind of projects are contemplated in the 2,200 that are mentioned?

Mr. COLE. I will have Mr. Hazeltine comment on that.

Mr. HAZELTINE. Various projects, running all the way from rather large sized projects, such as a reservoir for water systems for large towns or cities, or through to sewage systems, water systems, hospitals, and even schools. The whole realm of public works.

Mr. BOLLING. The whole realm of public works, not including roads and dams?

Mr. HAZELTIN. Dams and that sort of thing, and I believe roads would be included in that, if necessary.

Mr. BOLLING. This is conceived of, I take it, not so much in the terms of the Joint Committee report, but more in terms of—is it conceived of with very heavy consideration being given to its antirecession feature?

Mr. COLE. May I comment on that, Mr. Bolling?

The proposal as presented here in light of the present authorities, the present organization activities which are now set up in the Federal Government. It is presented, however, as a result of the study made by the Council of Economic Advisers, and at their recommendation, as I understand it. The planning activities in the past have been conducted in this fashion—in the recent past—as you know, the second advanced planning program has been allocated to this agency. Largely, I think, the reason for it is that the personnel, the technicians, are located within the agency, and they are people who have done it in the past, and who had experience with this type of program.

Mr. BOLLING. If I understand this correctly, this will provide for planning and a limited amount of coordination between the Federal Government and States and local governments.

What provision is made in this section for overall coordination between the States, the localities, and all of the many agencies of the Federal Government which are in the public-works field? I cannot say offhand how many of the agencies of the Federal Government are, but it seems to me that they would be the Bureau of Public Roads, Office of Education, the Surgeon General, United States Public Health Service, Chief of Engineers, Forest Service, General Services Administration, Interior Department, Labor Department, the Post Office Department, the Secretary of Defense, Office of Defense Mobilization, Atomic Energy Commission. All of those Federal agencies are to one degree or another in the public-works field.

Is there a coordination provided for by this section, or any other legislation with which you are familiar, proposed or enacted, that will provide for an overall coordination and planning of public works, State, local, and Federal?

Mr. HAZELTINE. It was considered that administratively, all of the Federal activities that would have anything to do with an advance for planning any which applicant might request, all of those people would be contacted to see whether or not it conformed with their ideas prior to making advance for this plan.

Mr. BOLLING. Would it be fair to say that this is in effect a program of planning and coordination in a limited field of public works, largely leading out of that coordination and planning, a coordination of Federal public works with all others?

Mr. COLE. Yes, sir; that is right.

Mr. BOLLING. This is a limited program, not destined to coordinate the whole public-works field?

Mr. COLE. In other words, not to coordinate the Federal public works, the works which the Federal Government will do.

Mr. BOLLING. It seems to me fairly obvious that this represents a very serious problem, just from the reading of the number of agen-

cies of the Federal Government that are involved in public works of one kind or another. I have felt strongly for some time that we needed an overall coordinating agency. I understand that certain functions of that sort are performed in the Bureau of the Budget, but it seems to me that this may be a step, in a sense, towards not a further disintegration, actually, because you are going to have planning of certain limited types of projects, but it will, in a sense, really increase the confusion as well as solving some of it. Do you see my point?

Mr. COLE. I see your point. Certainly I think a coordinated effort on planning is necessary.

Mr. BOLLING. Mr. Chairman, I think that at this point I will have to have a commercial.

I have introduced a bill with Senator Douglas, which I would actually very much like to get a comment on from your agency, although it probably goes beyond your jurisdiction, and it goes to the question of the total overall coordination, H. R. 7766. My own view is that while this will certainly be of help in the localities, that we have failed in Congress to ever meet the very complicated and difficult problem of the overall coordination of all public works in which the Federal Government might have any part to play.

Thank you, Mr. Chairman.

Mr. MERRILL. Mr. Chairman.

The CHAIRMAN. Mr. Merrill.

Mr. MERRILL. As I understand it, this is merely a planning program for State or local public-works projects?

Mr. COLE. That is right.

The CHAIRMAN. Are there further questions?

Mr. O'HARA. Mr. Chairman.

The CHAIRMAN. Mr. O'Hara.

Mr. O'HARA. Is it intended that this shall cover Puerto Rico?

Mr. COLE. Yes, sir; it does cover the Territories, Mr. O'Hara.

Mr. O'HARA. I am wondering whether Puerto Rico is covered by this language. "Shall include any State, Territory or possession of the United States." Would that cover Puerto Rico?

Mr. COLE. Counsel advises me that it does cover Puerto Rico. We will check it further.

Mr. O'HARA. A commonwealth is a possession?

Mr. FITZPATRICK. Puerto Rico is considered and has been for years, under the language of the bill, to be covered.

Mr. GAMBLE. Under the language of what, sir?

Mr. FITZPATRICK. Under the language "Territories and possessions" Puerto Rico is covered. It has been consistently interpreted that way by the State Department.

Mr. GAMBLE. Would it include a commonwealth?

Mr. FITZPATRICK. I do not know whether it includes a commonwealth stated as such, but I do know it includes Puerto Rico, which has acquired a commonwealth status.

Mr. GAMBLE. They consider themselves a little bit different than a Territory or other possession. It is defined in their own constitution, as I understand it, from the Governor.

The CHAIRMAN. Will you yield to Mr. Gamble, Mr. O'Hara?

Mr. O'HARA. Surely.

Mr. GAMBLE. Excuse me, Mr. O'Hara.

I do not know the exact language, but they define themselves a little bit differently in their constitution, which, incidentally, was written by the Governor who was here the other day. It is just a technical question.

Mr. O'HARA. I wonder if there has been any judicial determination on the question? Has any court ever passed upon it?

Mr. FITZPATRICK. I could not tell you offhand, Mr. O'Hara.

Mr. GAMBLE. Mr. O'Hara, their constitution is only about 2 years or a year and a half old. So I would not imagine that there has been any judicial determination of anything like that.

Mr. O'HARA. I am wondering, Mr. Gamble, if we shouldn't include the word "commonwealth" in the language of this definition.

Mr. GAMBLE. I yield to counsel on that.

Mr. FITZPATRICK. Well, if you feel there is any uncertainty about it you can always add Puerto Rico by name, Mr. O'Hara, but, quite frankly, we felt the language was satisfactory to cover it.

Moreover, I will say that similar language is also used in the title I, slum-clearance title, and it has been interpreted over the past year as including Puerto Rico and we have entered into loan contracts with municipalities in Puerto Rico under that language.

Mr. O'HARA. I suppose the State Department should know whether calling Puerto Rico a possession arouses any sensitiveness on the part of the Puerto Ricans. It has been my understanding that the status of commonwealth was something else.

Mr. FITZPATRICK. I am not competent to answer that question.

Mr. O'HARA. I do not know.

Mr. GAMBLE. Will you yield?

Mr. O'HARA. I yield.

Mr. McDONOUGH. Do you have any doubt about that, Mr. O'Hara, that they do not like the fact that they are considered a possession?

Mr. O'HARA. I do not know. What I am saying is not motivated by the recent happening. It so happened that a year or so ago, I was privileged to spend several hours in conversation with the very able Resident Commissioner of Puerto Rico, and I got the distinct impression that he regarded the commonwealth status as carrying a greater degree of equality and independence than would attach to the status of possession.

Mr. GAMBLE. You mean he considered it that way?

Mr. O'HARA. I rather thought so. I may be wrong in it.

Mr. GAMBLE. I think that is correct. A subcommittee of Banking and Currency were in Puerto Rico a year ago in December, and we had a talk with the Governor at that time. He kept referring to the commonwealth status as being on a different level from a Territory or any other possession; of course you have FHA loans in Puerto Rico, and you have an agent down there.

Mr. FITZPATRICK. That is right.

Mr. GAMBLE. That would probably be a precedent for something else that would follow; would it not?

Mr. FITZPATRICK. That is correct, Mr. Gamble.

Mr. McDONOUGH. Mr. O'Hara, is it your point that they should not participate in this legislation?

Mr. O'HARA. Oh, no. To the contrary, I want to make it certain that they can participate. As I understand their status, and I may be wrong, if this legislation is enacted then it is optional with them. They can accept it or reject it. Is that about it, Mr. Gamble, as you understand it?

Mr. GAMBLE. I think so.

Mr. O'HARA. That is if they elect to take the advantage of the law they must also assume the obligations. Within a certain limitation they can take or reject a law that we enact. What I am concerned in now is whether the term "possession" is exactly the proper term.

Mr. GAMBLE. I think you could check on that by making an example of their basic law down there, their constitution, or whatever they call it.

Mr. COLE. As Mr. Fitzpatrick suggested, if the committee has any doubts about it certainly we would have no hesitation or no objection to making it clear and explicit.

Mr. O'HARA. That is "any State, Territory, Commonwealth, or possession.

The CHAIRMAN. Just a minute, we are getting pretty deep into something here. We better make sure we are going in the right direction. I don't think there should be any question but that, regardless of the form of government which they have down there, they have not Statehood and they have not territorial government, so it would be obvious that it is a possession, as a State or Territory is a possession of the United States, and I think the terms of the amendment would apply to that. I think before we go to any new language we better get a ruling from the State Department on it because it not only affects this law but thousands of other laws in operation.

Mr. COLE. I would yield to the chairman's better judgment in that regard.

The CHAIRMAN. As you know, sometimes when you try to define these things too specifically you exclude a great many other things which you don't intend to exclude. I think the term "possession" would apply to Puerto Rico, Guam, Wake Island, and all the other possessions.

If there are no further questions on this particular subject, according to the original plan, the whole statement and the whole bill are open for such questions as Mr. Cole and his staff may be able to answer.

Are there any questions with respect to any phase of the program?

Mr. DEANE. Mr. Chairman.

The CHAIRMAN. Mr. Deane.

Mr. DEANE. Mr. Cole, you are familiar with the interest of Mr. Rains in some type of warranty provision?

Mr. COLE. Yes, sir.

Mr. DEANE. He has been unavoidably detained. He wanted me to ask you if you would kindly comment on that subject. I am interested likewise, in view of, you will recall, a little investigation of a year or so ago.

Mr. COLE. I know of Congressman Rains' deep interest in the problem of the builders' warranty, and I know of yours. I myself took quite an interest in it when I was a member of the Rains subcommittee. I studied the matter a great deal, and the President's Advisory Committee went into the problem very carefully.

While they were not unanimous in their decision, they came to the conclusion that the ramifications involved in a statutory builders' warranty were so difficult that the objective to be attained could be accomplished through the regulations of FHA, and that the difficulties involved in it were almost overriding in that regard.

Now, I am well aware of the need for FHA, and, for that matter for VA—I am speaking of FHA because I am primarily interested in FHA—the need of FHA to carefully, vigorously, and with every facility at its command, to see that its regulations are carried out, and then when they find that inspections are such that a builder has permitted shoddy construction they do have the authority, and have exercised it, Mr. Deane, to blacklist the builder, to forbid him from receiving insurance—by putting certain restrictions against it—and I am advised by FHA that it is working quite satisfactorily. Not that I believe that it is working perfectly, but at least following the President's Advisory Committee's recommendations, we have therefore not submitted an amendment for a builders' warranty.

MR. DEANE. I do not know what Mr. Rains' intentions are so far as the warranty is concerned. I know that he is very much interested in it, and I am very grateful for your interest to the extent of seeing that the houses that are constructed are given proper inspection.

MR. COLE. Mr. Hollyday is quite aware of that, and has been very insistent that that procedure be followed carefully.

MR. DEANE. On that point, do you think that you have sufficient appropriations and staff to promulgate this legislation that you are proposing in the way that it should be?

MR. COLE. You are speaking now of the entire legislation which we have?

MR. DEANE. That is right.

MR. COLE. Mr. Deane, there will be a reorganization plan presented to the Congress by the President that has not been firmed yet—firm decisions have not been made, I understand he has not come to definite conclusions on it—but I don't envision any advance in the appropriations which we requested under the present budget, appreciably, or any at all, frankly, at the present time.

I would think that, generally speaking, we do have those authorities and almost sufficient budget, at any rate. Necessarily it must be rearranged, it must be reorganized to do the coordinated, integrated job which we envision in this legislation.

MR. DEANE. Mr. Chairman, I want to thank Mr. Cole for his patience and for the forthright way in which he has answered questions directed to him.

MR. COLE. Thank you very much, Mr. Deane.

MR. McVEY. Mr. Chairman.

THE CHAIRMAN. Mr. McVey.

MR. McVEY. I have received a request from a civic organization in Chicago for an opinion regarding an amendment which I am not sponsoring myself but which is very important in the minds of the members of this civic organization and I should like to have a reaction to it. It involves the use of land along the railroad trackage in the city of Chicago. There seems to be considerable acreage there which is not being used at the present time. But in order to get that land, it is felt by this group that the 1954 Housing Act provides the best vehicle

for such improvements, but it would involve an amendment in the Housing Act of 1949, section 110, title I (c), which states as follows:

The project may include acquisition of land which is predominantly open and which because of obsolete platting, diversity of ownership, deterioration of structure or site improvements or otherwise substantially impairs or arrests the sound growth of the community which is to be developed for predominantly residential uses.

That is the section. They propose to add the very simple phrase here which may have considerable implication. They want to add "or open land to be developed for commercial and industrial use."

That is the amendment suggested. Now, that may have implications. I would like to have the Administrator's reaction on it, if he is willing to give it to us. It is proposed that this land will be acquired by the Federal Government and resold for commercial or development purposes.

Mr. COLE. Mr. McVey, in this proposal we have dropped the predominantly residential requirement.

May we study the amendment and discuss it with you? It is possible that it might be covered; quite possible that it is already covered.

Mr. McVEY. Thank you. I will be very glad to do that.

Thank you, Mr. Chairman.

The CHAIRMAN. Mr. O'Hara.

Mr. O'HARA. I am happy that Mr. McVey brought up the matter and presented it so ably. I had received a similar letter. I think the organization addressed it to both of us. I would appreciate it if you would give me a copy of your opinion on that, too, in order that I may be better informed when we go into executive session.

Mr. COLE. All right, Mr. O'Hara.

The CHAIRMAN. Are there further questions of Mr. Cole and his staff?

If not, Mr. Cole, we are very grateful to you for having been so patient with the committee, and for the very valuable contribution you have made to this study.

I assume that the committee can be assured that you will be available from time to time during our further hearings and discussions on this bill for such advice as we may desire.

Mr. COLE. Yes, sir.

The CHAIRMAN. If there is no objection, your part of the proceedings will now be terminated and we will take up tomorrow the question of veterans' housing. We will have with us representatives from the Veterans' Administration and from the armed services. If we have time, following that, we will take up some of the veterans' organizations.

So the committee will stand in recess until tomorrow morning at 10 o'clock.

(Whereupon, at 4:42 p. m., the committee adjourned to meet at 10 a. m., Friday, March 5, 1954.)

HOUSING ACT OF 1954

FRIDAY, MARCH 5, 1954

HOUSE OF REPRESENTATIVES,
COMMITTEE ON BANKING AND CURRENCY,
Washington, D. C.

The committee met at 10 a. m., Hon. Jesse P. Wolcott (chairman) presiding.

Present: Chairman Wolcott (presiding), Messrs. Gamble, Talle, Kilburn, McDonough, Widnall, Betts, D'Ewart, Merrill, Oakman, Hiestand, Van Pelt, Spence, Brown, Patman, Deane, Dollinger, Bolling, Barrett, Hays, and O'Hara.

The CHAIRMAN. The committee will come to order.

We will resume hearings on H. R. 7839.

We have with us this morning, Mr. King, Acting Assistant Deputy Administrator (Loan Guaranty), Department of Veterans' Benefits, Veterans' Administration.

Mr. King, we are very happy to have you with us this morning. You may proceed with your statement.

STATEMENT OF T. B. KING, ACTING ASSISTANT DEPUTY ADMINISTRATOR (LOAN GUARANTY), DEPARTMENT OF VETERANS' BENEFITS, VETERANS' ADMINISTRATION, ACCOMPANIED BY JOHN M. DERVAN, LEGAL CONSULTANT IN THE LOCAL GUARANTY OFFICE OF THE VETERANS' ADMINISTRATION

Mr. KING. Mr. Chairman, I have with me Mr. John M. Dervan, legal consultant in the Loan Guaranty Office of the Veterans' Administration.

The CHAIRMAN. We are very glad to have you both here, Mr. King.

Mr. KING. I appreciate the privilege of appearing before this committee.

Before turning to my detailed comments which will be directed toward H. R. 7839, 83d Congress, a bill to aid in the provision and improvement of housing, the elimination and prevention of slums, and the conservation and development of urban communities, I wish to state that my remarks have been informally coordinated by the Deputy Administrator for Veterans' Benefits with the Administrator of Veterans' Affairs and have his general approval. Of course, time has not permitted discussing any of this material with the Bureau of the Budget to determine its relation to the program of the President.

Our comment is confined to those provisions of the subject bill which have some direct or substantial although indirect effect on the loan guaranty and insurance programs. We have not considered it neces-

sary to comment on those provisions of the bill which have little or no bearing on the GI loan program.

Sections 104 to 125 of the bill would amend title II of the National Housing Act. Some of these proposed amendments are of interest to the Veterans' Administration in that they have an indirect effect on the GI loan program. Sections 104 and 105 provide for an increase of the maximum insurable mortgage and an increase in the maximum permissible term of the mortgages insurable under section 203 of the National Housing Act. The maximum insurable mortgage would be increased from \$16,000 to \$20,000 in the case of 1- and 2-family residences, to \$27,500 for a 3-family residence, and to \$35,000 for a 4-family structure. The permissible 30-year maturity which heretofore was applicable only in the case of low-cost housing—mortgage amounts up to \$6,650—would be applicable to any mortgage eligible for FHA insurance. Other liberalization would be effected under section 104 of the proposed bill by increasing substantially the maximum loan to value ratios heretofore authorized. The increases in loan to value ratios are set forth in the printed table on page 4 of the House committee's summary of the provisions of The Housing Act of 1954. The higher ratios thus proposed affect both existing and proposed housing, the increase over present limits being greater in the case of existing housing. Formerly the maximum loan on an existing unit was 80 percent of the FHA valuation, but under the bill the maximum loan could be as much as 95 percent of the valuation in the lower price range.

The proposed increases in loan to value ratios and the corollary reduction in the cash downpayments, together with the increase in the permissible term of the loan which will make lower monthly carrying charges possible, will make considerably more liberal financing terms possible for prospective home purchasers under the FHA program. This, of course, would tend to dilute or impair the preference which has been available to veterans obtaining GI financing, since the amendments would place nonveterans in virtually an equal position in respect to housing credit terms. The extent to which such dilution would take place depends, of course, upon whatever action may be taken by the President in exercising his authority under section 201 of the proposed bill. Under the bill the President must authorize the more liberal terms contemplated by the bill before they become applicable to the FHA program.

On the other hand, it is noted that the only action which the President would be enabled to take in respect to VA guaranteed home loans would be to make GI loan terms more restrictive. If the FHA program is liberalized as contemplated in the bill all eligible veterans, including recent veterans of the Korean conflict, will be deprived to a considerable degree of the preferred position they heretofore enjoyed in respect to housing credit. Inasmuch as it is not known to what extent the President would liberalize the FHA program the exact effect of the proposed legislation upon the preferred position of veterans in the housing market cannot be forecast.

Section 125 of the proposed bill would add two new sections, 223 and 224, to the National Housing Act. Section 223 would authorize insurance by FHA of advances to a mortgagor made pursuant to the provisions of a so-called open-end FHA insured home mortgage. The type of open-end mortgages this contemplates would provide that

loans or advances in addition to the original loan secured by the mortgage may be made to a mortgagor for improvement, alteration, or repair of the home covered by the mortgage without the necessity of executing a new mortgage. This authority would be granted FHA in connection with mortgages secured by property containing four family units or less.

FHA insurance formerly was not available to cover such advances made under the terms of an open-end mortgage. Such liberalization of the FHA insurance would have the effect of authorizing the insurance of advances which, generally speaking, are to protect or improve the security for the mortgage.

It may be noted that under VA supplemental loan procedure, open-end mortgage provisions may be utilized for such purposes but additional guaranty coverage of the advances made under open-end mortgages is available only to the extent that the veteran has unused guaranty entitlement available. The Congress, whether or not it gives favorable consideration to this provision of the bill, may wish to consider liberalizing the provisions of the Servicemen's Readjustment Act relative to such supplemental lending for purposes of repair or improvement of veterans' homes. As the law now provides, the Veterans' Administration cannot extend guaranty coverage comparable to the proposed FHA program without a change in the existing statute since the \$7,500 entitlement currently available to veterans under section 501 (b) of the act is restricted to loans for the purchase or construction of residential property to be occupied by the veteran as his home. Consequently, additional entitlement for supplemental loans for the alteration or improvement of the veteran's home is available only if he used less than \$4,000 of his entitlement in connection with the purchase or construction of his home. In recent years most veteran home purchasers have used at least \$4,000 of their entitlement in connection with the original purchase of the home, and, accordingly, have no entitlement available for alteration or improvement advances. Naturally, lender interest in making such advances would be stimulated if some additional guaranty protection for such advances were obtainable.

Furthermore, the housing needs of a large segment of the 3 million families who have obtained homes with the assistance of GI financing have changed materially, due to increasing family size, and in many cases there has been an improvement in the economic status of these homeowners. It is to be borne in mind also that in many instances a substantial reduction in the mortgage debt has taken place since the home was purchased. Those veterans are now in a position to undertake the responsibility entailed in financing improvements and alterations to their homes.

It should be borne in mind further that these homes in many instances are some 8 or 9 years older than when the VA guaranteed the initial loan.

If a lender is willing to make a GI supplemental loan, the veteran obtains the advance on a low-cost, long-term repayment basis, and the primary loan is not jeopardized by the high carrying cost of short-term improvement loans, which would be otherwise the sole thing available to the veteran for that purpose.

Such a result could be obtained in many cases by removing the existing limitation on the use of the currently authorized \$7,500 maximum by a simple amendment to section 501 (b) of the Servicemen's Readjustment Act of 1944, as amended, permitting the \$7,500 maximum to apply to loans for alterations, improvements, and repairs, as well as the purchase and construction of residential property and by removing the April 20, 1950, date limitation.

Section 201 of the bill authorizes the President, on the basis of reviews of conditions affecting the mortgage investment market, and after taking into consideration conditions in the building industry and the national economy, to establish from time to time—

(1) The maximum rates of interest (exclusive of premium charges for insurance and service charges, if any) for various classifications of residential mortgage loans insured or guaranteed or made under the National Housing Act, as amended, or the Servicemen's Readjustment Act of 1944, as amended: *Provided*, That no such maximum rate of interest shall, at the time established by the President, exceed $2\frac{1}{2}$ per centum plus the annual rate of interest determined by the Secretary of the Treasury, at the request of the President, by estimating the average yield to maturity, on the basis of daily closing market bid quotations or prices during the calendar month next preceding the establishment of such maximum rate of interest, on all outstanding marketable obligations of the United States having a maturity date of 15 years or more from the first day of such next preceding month, and by adjusting such estimated average annual yield to the nearest one-eighth of 1 per centum.

As you know, under present law the Administrator of Veterans' Affairs is authorized, with the approval of the Secretary of the Treasury, to establish such rate of interest, not in excess of $4\frac{1}{2}$ percent as he may find the loan market demands. The National Housing Act provides somewhat similar authority for adjustment of maximum interest rates by FHA, up to a maximum of 5 percent for most home mortgages, although section 203 provides authorization for rates up to 6 percent if the Commissioner finds that in certain areas or under special circumstances the mortgage market demands it. Since there is adequate authority in the Federal Housing Commissioner to authorize an upward adjustment of the interest rate on FHA loans, as described, the effect of proposed new section 201 is to make an upward adjustment of the interest rate for GI loans possible if deemed necessary because of changing market conditions, and to vest the authority for adjusting both FHA and VA interest rates in the President.

In this connection, it should be emphasized that, under the provisions of H. R. 7839, the figure arrived at by the formula approach is a maximum—a ceiling above which the President may not go. There does not appear to be any compulsion implied in the bill for maintaining the effective FHA and VA rates at or close to the ceilings. It is worthy of note that the $2\frac{1}{2}$ percent spread contemplated by the proposed provisions exceeds that which experience has demonstrated is necessary.

In view of the considerable administrative experience to the effect that maxima tend to become the minima as well it would appear worthy of consideration that the proposed authority be vested in the President without prescribing any limit or formula. It is also desired to point out that in view of the considerable range of geographic disparity which has been demonstrated in the market in respect to the flow of mortgage money into the various areas of the country it is apparent that incident to the fixing of rates under the proposed new

authority there will be for consideration the matter of whether differing rates should be established. It would be clarifying if the committee were to indicate expressly whether or not it contemplates that the establishment of such varying rates would be within the authority prescribed in the bill.

There is also a technical question with respect to whether the average yield on all marketable Government bonds with a maturity of 15 years or more is the best base for comparison with FHA and VA interest rates. While the majority of GI loans are written for terms of 20 or 25 years, under the statutory maximum of 30 years, the best available estimates indicate that such mortgages will probably have an average life of not over 10 or 12 years. Accordingly, it may be well to consider the exclusion of extremely long-term issues such as the 3¼ percent issue maturing in 1983 from any average used for comparison with mortgage interest rates. From a technical viewpoint, it is believed that the average yields on Government bonds with from 8 to 15 years remaining before the first due or call date would be more nearly comparable with the expected life of FHA and VA mortgages.

Under section 201(4) of the bill the President may establish maximum fees and charges which may be imposed or collected in connection with the origination of residential mortgage loans which are to be guaranteed or insured under the Servicemen's Readjustment Act, or the National Housing Act. Such authority extends not only to the charges made in connection with the guaranteed or insured loan to the purchaser of the unit, but also includes fees and charges that may be imposed in connection with non-Government assisted construction financing obtained by the project builder or, for that matter, an individual lot owner desiring interim financing to construct a home on his lot, who contemplates permanent financing in the form of a guaranteed or insured loan.

It is not known whether this authority in the President will be exercised immediately following enactment of the bill, or only if abuses develop in connection with the fees and charges imposed or collected incident to the extension of construction or so-called permanent financing.

In conjunction with the foregoing provision it is noted that section 203 of the bill would repeal section 504 of the Housing Act of 1950, as amended. The Veterans' Administration concurs in the proposal to repeal section 504 and heretofore recommended such repeal to the Administrator of the Housing and Home Finance Agency for the reasons set forth in the attached copy of a letter dated December 22, 1953.

The CHAIRMAN. Without objection, the letter may be inserted in the record.

(The letter referred to is as follows:)

DECEMBER 22, 1953.

HON. ALBERT COLE,
*Administrator, Housing and Home Finance Agency,
Washington 25, D. C.*

DEAR MR. COLE: This is in response to your request of December 14, 1953, that I advise you regarding the experience of the Veterans' Administration with section 504 of the Housing Act of 1950, and that I state my views as to whether it has proved to be workable and effective.

It is considered advisable at the outset to advert to the situation which existed when the Congress originally enacted section 504 of the Housing Act of 1950. The following is quoted from Conference Report No. 1893, dated April 5, 1950, which accompanied S. 2246:

"Section 504 of the Senate bill contained a provision directed against the practice of lenders requiring excessive charges in consideration for making FHA- or VA-guaranteed loans. In lieu of the provision of H. R. 6070 that no otherwise eligible mortgages could be purchased by the Federal National Mortgage Association unless the mortgagee certifies that no bonus, fees, or other charges in excess of those expressly authorized by the association has been or would be charged or received by such mortgagee to or from the builder or the mortgagor in connection with such mortgage, the Senate language specifically authorizes and directs both the Federal Housing Commissioner and the Administrator of Veterans' Affairs to prescribe the maximum fees which could be charged in connection with financing of construction or sale of housing built or sold with the assistance of any FHA-insured or VA-guaranteed loan, and to require certification from the mortgagee that no excess charges have been imposed by such mortgagee. These regulations would apply not only to charges in connection with the particular mortgage loans insured or guaranteed by the Government, but to charges in connection with other loans made for the construction or sale of housing involved. The conference substitute contains the Senate language."

In the report from the Senate Committee on Banking and Currency on the amendment of S. 2246 (Rept. 1286, dated February 24, 1950) it was stated:

"With respect to these GI-guaranteed loans, a committee amendment previously reported would have required the mortgagee, as a condition to the sale to the FNMA, to certify that no bonus, fee, or charge, other than those approved by the FNMA, has been or will be received in connection with the placement of the loan. The amendment was directed against a practice in some areas of payments by builders to lenders in order to get them to make 4-percent GI loans for resale to FNMA. This practice tends to increase the price of housing sold to veterans and to defeat the purpose of the 4-percent interest rate limitation for GI loans. Your committee has now deleted this amendment, which would have applied only in the case of FNMA purchases of VA-guaranteed loans, and in lieu thereof is recommending a provision to be included in title VI of the amendment (sec. 604), which would specifically authorize and direct both the Federal Housing Commissioner and the Administrator of Veterans' Affairs to prescribe maximum fees which could be charged in connection with the financing of construction or sale of housing built or sold with the assistance of any FHA-insured mortgage or VA-guaranteed loan, and to require certifications from the mortgagee that no excess charges have been imposed by it. Regulations so issued could apply to all charges made in connection with financing of housing built or sold with such assistance, even though some portion of the financing was not assisted by the Government. Thus the maximum benefits from such a provision would be extended to all purchasers of homes for which loans are guaranteed or insured by the Government, whether or not the loans are sold to FNMA."

It should be borne in mind that initially what the Congress proposed was a control on fees chargeable by the mortgagee only with respect to those mortgages being tendered to Fannie May. At that time the Federal National Mortgage Association was issuing advance commitments and many such commitments were held by lenders. Furthermore, the mortgagee could sell all of his GI loan originations to FNMA and those lenders who had the Fannie May commitments were, in some areas, charging builders very substantial sums in order to obtain the financing which eventually resulted in a mortgage owned by the Government. The lender was (in effect) exacting a fee from the builder or sponsor for obtaining GI financing that actually represented the use of Government funds. It is considered that this was the practice Congress was mainly concerned about and was desirous of curbing, although there was, in addition, concern that the cost to the purchaser of the house would include this charge to the builder. As you know, Congress has changed the FNMA advance commitment authority. Such change together with other developments concerning the purchase of mortgages by Fannie May have operated as effective curbs on the practice (the charging of fees for what really was the use of Government funds) which the Congress was seeking to control when section 504 was originally enacted on April 20, 1950.

Prior to June 30, 1953, section 504 of the Housing Act of 1950 directed the Administrator of Veterans' Affairs (and the Commissioner of the Federal Housing Administration) to control the charges and fees lenders could impose on the builder or seller of residential construction being sold with the aid of Government guaranteed or insured financing. The statute required controls on the charges and fees that lenders could impose against builders not only in connection with the guaranteed or insured financing to the persons purchasing the completed units but also in connection with conventional construction financing obtained by the builder to construct the units. The Federal Housing Administration and this agency took coordinated action to issue appropriate regulations and approved schedules of permissible fees and charges. The respective agencies construed the statute as prohibiting the payment or absorption by builders of the discounts incurred by originating lenders when disposing of loans guaranteed or insured by such agencies to investors, and the schedules prohibited lenders from passing such discounts on the builders. As you know, VA guaranteed 4-percent loans were selling in the secondary market at substantial discounts. FHA insured 4½-percent loans had a somewhat more favorable market. In this economic market lenders and builders sought ways and means of legally circumventing the prohibitions in the VA regulations and schedules against the payment or absorption by builders of the discounts being incurred by lenders when disposing of 4-percent loans in the secondary market and a situation developed which was not satisfactory from an administrative standpoint, or from the standpoint of lenders and builders.

On June 30, 1953, Congress endeavored to cure the situation by an amendment to section 504 which has the effect of authorizing builders to pay or absorb the discounts and other charges lenders originating Government guaranteed or insured loans incur when disposing of these loans to secondary investors. It is true that under this amendment lenders originating GI loans for retention may not make any charges to builders in connection therewith since the statute contemplates the absorption or payment of discounts by builders only in the event the loans originated are sold. The industry has overcome this obstacle by having the loans originated by builders or by their subsidiaries or affiliates who thereafter sell the loans to the "permanent" lenders at a discount. You will recognize that this arrangement is necessary in order to cope with the competitive advantage which the statute currently affords to secondary investors who acquire loans by purchase rather than through direct origination. Such local institutions as savings banks, savings and loan associations and others that ordinarily would originate loans on local properties for retention are naturally adverse to doing so at a par cost when their position yieldwise will be improved by acquiring loans through purchase.

Section 504 as it currently provides precludes effective control over the amount of the charges against builders since the statute clearly contemplates that builders may pay whatever discounts and charges secondary investors actually charge the lenders originating loans guaranteed or insured by the Federal Housing Administration or the Veterans' Administration. There obviously is little point in controlling the charges a lender makes in connection with conventional construction financing extended to the builder so long as the builder can originate the "takeout" loans and thereafter sell them to the construction lender at whatever discount is agreed upon. The enactment of legislation prohibiting builders from originating GI loans directly or through the medium of a subsidiary or affiliate would not be a remedy because it would only serve to continue in effect and to accentuate the competitive advantage which investors acquiring loans by purchase currently have under section 504 over investors acquiring loans by origination. These factors and the fact that the practice which mainly induced the original enactment of section 504 no longer obtains leads this agency to recommend that section 504 be repealed. The effect of such a repeal would be that both this Agency and the Federal Housing Administration would confine its control to the regulation of the charges lenders may make against the borrowers obtaining guaranteed or insured loans while control of charges against builders both in respect to guaranteed and insured financing to persons purchasing homes and to conventional construction financing obtained by the builders would be determined by competitive forces. The Veterans' Administration is of the opinion that this is desirable and that Government controls should exist only if practicable and clearly necessary. The repeal of section 504 would also allow local investors such as savings banks and savings and loan associations to compete on equal terms with secondary investors without the necessity

for resorting to the indirect origination of loans by builders or their subsidiaries or affiliates.

We are not unmindful that some contend that builders do not absorb discounts or other charges made by lenders but merely pass such charges to the home purchaser by increasing the sales price of the homes. It is the opinion of the Veterans' Administration that this contention is not generally valid in that it overlooks the appraisal controls which this agency can exercise through refusal to recognize increases in reasonable value. Regional offices of this agency have been exhorted to exercise extreme care to avoid yielding to any upward pressures from builders to permit the reflection of discounts through higher reasonable values. While we do not deny the possibility or even the probability that in some instances the builder is able to obtain higher valuations sufficient to recompense him for all—or at least part—of whatever discount he may be required to pay for his financing, we are of the opinion that such instances are a minority and that in the great majority of cases it is unlikely that a builder is able to recoup his discount costs through higher reasonable values. In any case, there is no reason to believe that the builder would be more successful in having his discount absorptions reflected in the reasonable value if section 504 were to be repealed, since our instructions requiring the vigilant examination of appraisal requests to avoid the reflection of discounts will remain unchanged. This would be consonant with the intent manifested by the Congress when the provisions of section 504 were liberalized to authorize builders to absorb discounts since the Congress contemplated that the control against builders passing discounts on to veterans would, in fact, be the appraisal control. In that connection the conference report (Report No. 692, dated June 30, 1953) which accompanied S. 2103, states as follows:

"In adopting the language of the House amendment, the committee of conference wishes to make clear that the Veterans' Administration may take reasonable measures to assure that any discounts or warehousing or similar fees which may be absorbed by the builder are not to be passed back to the veteran purchaser. Any such cost cannot be passed back to the veteran if the certificate of reasonable value, issued by the Veterans' Administration in connection with the sale of the property, is in fact a realistic value. In connection with the sale of a property guaranteed or insured by the Veterans' Administration the VA issues a so-called certificate of reasonable value, commonly referred to as a CRV, which sets a maximum limit at which the property may be sold and the veteran still obtain an insured or guaranteed loan upon it. This is the control mechanism to guard against abuses in either financing cost or construction practices. Obviously if the CRV is a realistic figure such abuses cannot exist."

Historically, there has always been a geographic variance in the adequacy of the supply of mortgage money. As a consequence certain mortgages would command a premium in some areas of the country while in other areas the same mortgage would be sold at a discount. Within reasonable limits this is an entirely proper situation. On the other hand, there is always the possibility of the practice exceeding normal bounds and unquestionably it would be highly desirable to endeavor to keep it within reasonable limits. That the effectuation of such control through restrictive legislation is not practicable is indicated by the experience of this agency in its endeavor to administer effectively the provisions of section 504 as they existed prior to June 30, 1953. Since the prime motivating factor which originally prompted the passage of section 504 no longer obtains and since the recent amendment to the statute does not afford any really effective control over charges against builders this agency is of the opinion that the preferable course action is to recommend to the Congress that the statute be repealed. We think the clarifying effect of such repeal would have a healthful and desirable effect of encouraging many responsible investors to resume or augment their participation in GI loans as it would eliminate the concern over the possibility that inadvertently or otherwise the fees attendant loan origination may have been in derogation of the law as it now exists.

Sincerely yours,

H. V. HIGLEY, *Administrator.*

Mr. KING. With the repeal of section 504 of the Housing Act of 1950, as amended, the VA would, in the absence of the establishment of fees and charges maxima by the President only regulate the fees and charges that lenders may impose directly against the veterans obtaining GI guaranteed or insured loans. It would not attempt

to regulate the fees and charges that lenders may impose against builders, sellers, or other parties interested in the transaction. As a consequence, lenders, builders, sellers, and other parties in interest—except the veteran borrower—would be at liberty to bargain freely in connection with the charges to be paid incident to the extension of both construction and permanent financing. In this situation competitive factors or considerations would operate to determine the fees and charges payable. The Veterans' Administration is of the opinion that this is desirable both from the standpoint of the lending and building industries and from an administrative standpoint as well.

Section 201 (5) of the proposed bill authorizes the President to establish maximum ratios of loan to value and maximum maturities for home loans guaranteed or insured under the Servicemen's Readjustment Act. Currently, VA may guarantee or insure 100 percent 30-year home loans. Under section 201 (5) of the bill the VA may continue to guarantee or insure 100 percent 30-year loans until such time as the President exercises the authority in the proposed section 201 (5) and establishes lesser maxima. We consider the proposed section 201 (5) to be in the nature of a standby authority insofar as GI loan program is concerned. Such authority presumably would be exercised by the President only in the event an inflationary situation develops, but it is not clear whether the Congress contemplates that such power shall be exercised merely to coordinate the terms of the FHA and VA loans.

In this connection, it is desired to bring to the committee's attention that the proposed section 201 does not include specific statutory authority which would enable the President, when establishing shorter maturities and reduced loan-to-value ratios for GI and FHA loans, should such action become necessary, to establish a preference for veterans seeking to purchase under GI financing. The committee may wish to consider the desirability of including language in the proposed section 201 (5) which would enable the President to maintain veterans' present preferred position in the acquisition of new or existing housing.

Section 202 of the bill adds a new section 515 to the Servicemen's Readjustment Act which will enable the Administrator of Veterans' Affairs to make such rules and regulations as may be necessary to carry out the limitations established by the President pursuant to section 201 of the bill. This amendment to the Servicemen's Readjustment Act is of a technical nature to accompany the provisions of section 201 of the bill.

Title III of the bill concerns the Federal National Mortgage Association. In this connection it is desired to state that the Veterans' Administration favors the concept of a privately financed secondary market facility. Historically the Congress has made specific provision from time to time for the support of the GI loan program by the Federal National Mortgage Association. The preferential treatment thus afforded to veterans loans has ranged from unrestricted support down to a maximum eligibility of 50 percent of total originations.

Currently the FNMA is not given any over-the-counter support for GI loans.

In the reconstitution of the Federal National Mortgage Association provided under title III of the bill there is no indication as to whether

it is the will of the Congress that preferred treatment continue to be afforded to GI loans. As the bill stands it would appear to negate any legislative intent that preferred support be given to GI loans under the reconstituted secondary market facility. It may be mentioned in this connection that GI loans are not enumerated among the special assistance programs authorized by section 301 (b) of the bill. The committee may therefore desire to consider the desirability of broadening the provisions of section 301 (b) to authorize special assistance for GI loans.

Mr. Higley will be glad to supply for the information of this committee, Mr. Chairman, any supplemental data which it may require pertinent to this testimony, or to the GI loan program.

Thank you very much, Mr. Chairman.

The CHAIRMAN. Thank you, Mr. King.

Are there questions?

Mr. PATMAN. Mr. Chairman.

The CHAIRMAN. Mr. Patman.

Mr. PATMAN. You mentioned the 3¼ percent bonds, that they probably should be excluded from consideration in determining the maximum interest rate. That is due to the fact, I assume, that you consider them out of line with the interest rates on long-term securities generally?

Mr. KING. It is not so much the disparity in the yield factor on those bonds, Congressman, that is adjusted very readily by the market. But they are 30-year bonds.

Mr. PATMAN. I know, but that is a different situation. They will adjust themselves, those particular bonds will. But they will not adjust the veterans' loans based upon those bonds?

Mr. KING. Basically, what we attempted to say here, Congressman, is that you perhaps do not have the more desirable pattern facing the President if you prescribed for him a 2½-percent margin to work under.

Mr. PATMAN. Over and above?

Mr. KING. Yes, sir. And if you also indicate that the Secretary of the Treasury should look at specific types of issue.

We point out that the 30-year 3¼ issue, and the 15-year issues, as well, should not necessarily be the guiding line. We point out that—

Mr. PATMAN. I think your words of caution are well taken there. I agree with you.

Now, Section 201, subparagraph (1), would give the President authority to set maximum interest rates on VA and FHA mortgages. That is the point you brought out.

Mr. KING. Yes, sir.

Mr. PATMAN. Heretofore Congress has always done that, has it not?

Mr. KING. There was prescribed by the Congress several years back authority which permitted the Administrator of Veterans' Affairs, with the concurrence of the Secretary of the Treasury—

Mr. PATMAN. But it was for a definite amount, was it not?

Mr. KING. Well, it featured a margin.

Mr. PATMAN. That is right.

Mr. KING. It featured a margin, but the margin was more restrictive than the one proposed here.

Mr. PATMAN. This permits a 2½ percent increase in addition to the long-term rate?

Mr. KING. Yes, sir; it contemplates that the market may need as high as a 2½ percent spread.

Mr. PATMAN. Isn't it a fact that in the past 1½ percent was the the normal spread?

Mr. KING. That is a point on which the Veterans' Administration insisted, until everybody got a little bit tired of hearing us insist on it, Congressman.

Mr. PATMAN. I beg your pardon?

Mr. KING. We maintained that point at considerable length, over the years.

Mr. PATMAN. One-and-a-half percent?

Mr. KING. Yes sir. We were adverting primarily to the situation, the market situation, which was in vogue, or which was experienced, prior to the March 1951, accord between the Treasury and the Federal Reserve Board.

Mr. PATMAN. So this is about a 75-percent increase?

Mr. KING. No, sir; the point is that that 1½ percent has not been reflected by experience since March 1951.

Mr. PATMAN. Do you mean it should be more?

Mr. KING. I say the market has demanded more.

Mr. PATMAN. It should be more?

Mr. KING. I say that under conditions which have been facing the lending industry, and due to the supply-and-demand factors which have obtained since March 1951, one would be hard put to insist that that 1½ percent pattern always would be adequate and should be maintained.

Mr. PATMAN. The point I was attempting to make, though, was that regardless of the merits or demerits, an increase from 1½ to 2½ percent is about a 75-percent increase, is it not?

Mr. KING. Yes, sir.

Mr. PATMAN. Roughly?

Mr. KING. Yes, sir.

Mr. PATMAN. Now, in the case of public housing bonds, that is a similar situation, I assume. The Treasury established a rate of 2⅞ percent as the average yield on long-term Governments.

Mr. KING. That is right.

Mr. PATMAN. That rate we are discussing is 2½ percent above the long-term yield, isn't it?

Mr. KING. Yes, sir.

Mr. PATMAN. On this basis, the Veterans' Administration mortgages could go to about 5½ percent, and FHA mortgages could go to 6½ percent. FHA can charge between one-half and one percent premium for instance. Conventional mortgages under that condition would be about 7 percent, wouldn't they?

Mr. KING. I think they probably wouldn't be making as many conventional mortgages, Congressman.

Mr. PATMAN. If they did they would be at 7 percent, would they not?

Mr. KING. Yes; usury laws in many States would hold it down to that.

Mr. PATMAN. This looks like a sort of a heads I win and tails you lose deal, since when the interest rates on Government bonds are rising, this provision can be used to force up interest rates on mortgages. But if the yield on Governments drops, mortgage rates would not

necessarily reflect that drop, because section 201 (1) does not govern the action of the FHA Commissioner. Under the authority we are giving him in title I of this bill, he could keep the rate on FHA mortgages at 6 percent, plus 1 percent for insurance, no matter how far the yield on Governments dropped. With such a rate on FHA mortgages, of course, no VA loans would be made. Do you agree with that?

Mr. KING. Yes, sir.

I would point out, Congressman, however, that as we sit here today I believe these 15-year Governments yield $2\frac{1}{2}$.

Mr. PATMAN. At this particular time.

Mr. KING. Yes, sir.

Mr. PATMAN. Just the last few days, you might say, recently.

Mr. KING. Well, it has been close to that for some time. Now, if you took this margin of $2\frac{1}{2}$ you would only be up to 5 percent.

Now, we know full well that as we sit here today that FHA and VA loans at $4\frac{1}{2}$ percent interest are not generally selling at or above par, although the trend is favorable.

Mr. PATMAN. Well, there are two things about this that disturb me. One is that the banks are insisting on more and more Government-guaranteed paper, and are insisting more and more on doing a riskless business, and thereby getting out of the normal functions of real commercial banking. That is one that bothers me very much.

The other is a diversion of income of the normal average family, more and more from the purchase of the comforts and necessities of life, and maybe a luxury now and then, the diversion of that small income to interest and service charges. In other words, the more we take out of that man's income and make him pay in the way of interest and service charges, and for discounts on mortgages, the less and less he will be able to buy, and the more and more money will be taken from the bloodstream of business and commerce.

Those two points worry me considerably about this bill. But I will not ask your comments on that because I do not want to take up too much time.

I would like to ask, Mr. Chairman, without taking up any more time—the gentlemen's testimony is very interesting, it is thought provoking, it is comprehensive, and it is very fine for consideration. There is one point, however, which I believe should be covered here that will require additional information. I should like to ask, Mr. Chairman, that the Secretary of the Treasury be requested to file a statement at this point in the record setting forth the facts in regard to those $3\frac{1}{4}$ -percent bonds, the date they were issued, the amount issued, and the classes of investors or purchasers, with the amounts purchased opposite each category.

In other words, insurance companies, savings accounts, banks, independent individual investors, and so forth. I particularly want to know how much was allocated to the private commercial banks. I ask consent, Mr. Chairman, that that statement be filed in the record by someone in the Treasury who has the knowledge of the facts.

The CHAIRMAN. Are you addressing an inquiry to the Treasury as to whether that is available?

Mr. PATMAN. I am sure it is available. It was published at the time.

The CHAIRMAN. I think we should find out about it. I just do not offhand see the relevancy of the question as to who bought 3¼ bonds.

Mr. PATMAN. Oh, yes, sir. You see, you had to apply for them.

The CHAIRMAN. I do not see where that could be of interest to this study.

Mr. PATMAN. It is of interest for this reason. The commercial banks are making a terrible mistake and will eventually put themselves out of business doing it, because they are getting out of the commercial banking field. I do not want anything to continue here that will encourage the commercial banks, which really manufacture the money to buy these bonds. I do not want to encourage them further in deals of this particular kind.

The CHAIRMAN. Although I see it is an ancillary problem, Mr. Patman, I think it is so remotely connected with this that I do not think we would be justified in asking the Treasury, with respect to these studies, for that information.

Mr. PATMAN. I ask consent to place in the record a statement which I shall get from the Secretary of the Treasury, because I know he will give it to me.

The CHAIRMAN. Without objection, that may be inserted.
(The information referred to is as follows:)

On April 13, 1953, the Treasury offered for cash subscription 3¼-percent fully marketable long-term Treasury bonds dated May 1, 1953, maturing June 15, 1983, callable on and after June 15, 1978.

The following excerpts are taken from the Treasury statement regarding the operation as printed in the May 1953 Treasury Bulletin.

"It was stated further that the bond was designed to attract people's savings as they accumulate, especially in such institutions as life-insurance companies, savings banks, pension funds, etc. * * * Subscriptions from commercial banks were limited to a percentage of their time deposits * * *.

* * * * *

"Cash subscriptions to the 3¼-percent Treasury bonds of 1978-83 amounted to \$5¼ billion, and total allotments were \$1,188 million. Subscriptions in amounts up to and including \$5,000 were allotted in full. All other subscriptions were allotted 20 percent, subject to adjustment to the next higher \$500, but not less than \$5,000 on any one subscription. The allotment total included \$117.8 million to Government investment accounts.

"Allotments by investor classes were as follows :

<i>Investor class</i>	<i>Allotments (in millions)</i>
Individuals, partnerships, and personal trust accounts-----	\$254. 6
Savings banks-----	102. 2
Insurance companies-----	97. 4
Building and loan and savings and loan associations-----	37. 8
Other nonbanking corporations, pension trusts, etc-----	214. 4
Commercial banks-----	128. 6
Dealers, brokers, and investment houses-----	158. 2
State and local governments-----	74. 6
Federal agencies-----	2. 0
 Total-----	 1, 069. 8
Government investment accounts-----	117. 8
Grand total-----	1, 187. 6"

Mr. KILBURN. Mr. Chairman.

The CHAIRMAN. Mr. Kilburn.

Mr. KILBURN. I do not know of the pertinency of this thing, but some of the statements made by Mr. Patman, I don't believe, are correct. Do you want them refuted here, in this testimony, or not?

Mr. PATMAN. I think they should be if they are not correct.

The CHAIRMAN. In what respect?

Mr. KILBURN. He keeps saying commercial banks are getting more and more Government-guaranteed bonds. I don't know of a commercial bank in the country whose Government-bond portfolio hasn't gone down, and whose regular commercial loans have not gone up. He says the opposite. I don't think what he says is correct.

Mr. PATMAN. Well, temporarily, you might be correct. Over the long pull they are going more and more into Government-bond brokerage.

Mr. KILBURN. That has happened for years.

Over the last few years the Government portfolios have been going down.

Mr. PATMAN. But they are getting more and more CCC and RFC paper, and all that sort of paper, at a higher rate of interest.

Mr. KING. Mr. Chairman, if I may—

Mr. PATMAN. Just a minute.

Temporarily, on long-term bonds. I suspect you are correct.

Mr. KING. It was my intention, Mr. Chairman, to draw the conclusion that even though the 2½-percent factor proposed in the bill seemed pretty high, it would pretty much take that margin for some localities under the present situation, although as you know the trend is shifting from scarcity of money, as against high demands, into a more level flow of supply of money in relation to demand.

So, although we have raised the question as to whether or not the 2½ margin should be in here, it was not that we considered it clearly unreasonable for given situations, but we just question as to whether a more adequate or better handling over the long pull could not be achieved without having a specific limit which everybody would be staring at.

The CHAIRMAN. Dr. Talle.

Mr. TALLE. Thank you, Mr. Chairman.

Mr. King, approximately how much time elapses between the time when a veteran makes an application for a loan and the time when he has the money available for use?

Mr. KING. It would be hard to draw a pattern on that, Mr. Congressman. It would vary from VA office to VA office; it would vary from time to time, depending upon whether the particular office, with its fixed manpower factor, were handling, reducing, or increasing volume.

If you would like any specific information on that I would be happy to try to supply it. Some offices succeed in staying fairly current in the face of the immediate workload, some offices fall behind in the face of the immediate workload.

Mr. TALLE. I would appreciate that very much, Mr. King. Could you do this, briefly, for the record: Could you set up the steps, 1, 2, 3, 4, and so on. There are certain things that must be done to get a VA loan. Could you set out those steps, and make the best guess that you can as to how long it would take for each step and arrive at a total for all the steps?

Mr. KING. I would be very happy to do that, but it probably would be so long you would not want to put in the record, Congressman.

Mr. TALLE. Well, will you make it brief? For instance, step 1, filing the application. That is enough for that step.

Mr. KING. Yes, sir.

Mr. TALLE. It could be very brief.

Mr. KING. Some of our offices are backlogged more with respect to one phase of the operation than another. I have backlog estimates with me on application volume, but then we have ancillary phases of the program in which a given office whose examining section may be right up to date, may be delayed on account of appraisals or there may be delays on account of project appraisals.

Mr. TALLE. You mention one point which is a sore one with me, this matter of appraisals.

How does a person go about getting appraisals promptly? It seems there are obstacles and delays. Some years ago I tried to help a veteran friend in Santa Monica, Calif., whom I know very well. I talked to everybody I thought could be helpful in the VA here in Washington, D. C., and elsewhere, but the loan could not be pried loose, and, finally, the veteran, because the house he wanted to buy would be sold to somebody else if he did not take it after a long delay, gave up the VA loan and went to the bank and got it.

Mr. KING. In some instances delays in the GI loan program are due to the inefficiency of the local VA office. That inefficiency may be directly attributable to lack of sufficient personnel to handle the upcoming workload, or it may be attributed to something else more basic.

We are chargeable, however, with the elapsed time, even though the particular failure may not be that of the VA office at all. Commonly, in complaints I see, people state they sent their application in on X date. Very often the reason for the delay is that the submission was faulty, and all VA could do would be to send it back, and that is true with respect to either submissions of requests for individual appraisal, submissions of requests for the appraisal of a proposed building project, or requests for approval of a proposed application for a loan.

It is pretty hard, Congressman, to trace, from any figures we could give you, what the true significance of those things may be. I can supply you with an estimate showing the application backlog in every VA office currently. You find that that average was surprisingly low, and you would find also that that average is disaffected by the fact that many submissions have to be sent back so that they can be correctly filed out before they can be considered by the VA office.

Mr. TALLE. I have another specific case in mind, and I talked to you about that over the telephone last summer. But I am not charging any delay to you because it is my impression that your part in that deal was done promptly and properly.

Mr. KING. Thank you.

Mr. TALLE. But somehow, it was stalled in Chicago. Because of the delay the veteran lost the advantage of the wonderful weather last fall, during which people could build. There seem to be all sorts of peculiar delays. I tried to see rhyme or reason in them and couldn't find either one, and the thing dragged on so long that this veteran had to build during the winter, when he might just as well have had his house built during that excellent weather last fall.

It is not good for the Veterans' Administration to have such cases in its record of business dealings.

I do not believe these are unusual cases. They may be unusual in this sense, that these veterans met up with some inefficient people locally, but there was nothing unusual about their applications for loans.

Mr. KING. Let me, partially by way of defense and partially by way of shedding light on this, Congressman, mention one thing.

VA offices, as you know, are staffed with a complement of personnel dependent, under Department of the Budget practices, upon an annual workload factor. Now, I recall a specific complaint that came in to my office a year or so ago, and when I tried to find out why the office was backlogged I found out that in the course of some 40 days they had gotten submissions on 6,000 units. That was probably half, or a third, of what they would get during the entire year. Where you cannot summon more hands to the job immediately, as I see it, it is inevitable, under the system, that there should be some backlog. We try desperately to avoid it, we have adopted various types of expedients to try to offset backlogs, and we are not complacent about backlogs, but the budget system, to my mind, is not geared to the contemplation of these very abrupt shifts in workload over various parts of the year.

I do not know any other answer. I know that time after time, in which a builder or lender has complained bitterly and justly, because he was losing money, he has said, in the same breath, that he cannot blame the local VA office because he knows they are just working as hard as they can.

So all we find ourselves able to do, Congressman, is to just keep sparking and keep plugging, and try to get along as expeditiously as we can. We are always grateful for help from the people making these submissions to VA, if they will give us papers that are in proper form so that it does not take three times as long to process them.

Mr. TALLE. I think the program is moving along better now than it did some time back.

Now, may I ask you in passing, what was that veteran's benefit that expired as to law on the 31st of last August?

Mr. KING. That was a provision that had been in the law, which enabled the Veterans' Administration to credit to the loan transaction, or to the loan itself, a payment equal to 4 percent of the guaranteed portion of the loan. In the case of any loan the maximum such payment would be \$160.

Mr. TALLE. Yes, sir; I understand that is correct.

Mr. KING. By law we ceased to make that payment as to applications incoming after September 1, 1953.

Mr. TALLE. There was a noticeable drag during August. It was quite apparent that there was a drag which practically resulted in the expiration of the law a month at least before the first of September, because if the papers weren't cleared by a certain time, I was told, the \$160 would not be forthcoming.

Mr. KING. Yes, sir; the VA offices worked over the whole Labor Day weekend in order to clear pending applications. We were faced with one of these abrupt shifts in workload at that time, and went

suddenly from around 26,000 applications in 1 month up to 34,000 the next month, and we are probably geared to handle about 20,000.

Mr. TALLE. Of course my next question obviously is, What was the filing date of each pending application?

Mr. KING. What date?

Mr. TALLE. Yes, sir; what was the date of each pending application? How long had they been pending?

Mr. KING. Every application, Congressman, had to be in the office before the deadline in order to receive the benefit of the gratuity, and the difficulty was—and, of course, there are a lot of last-minute interchanges, in the way of questions, and so on, and so forth, which would promote substantially workload routine over that period.

But the workload factor that these folks worked over the weekend on, for example, consisted of applications that got in before the bars went down.

Mr. TALLE. Some veterans have told me that they received such discouragement in August that they thought it useless to attempt it, and they decided, at least some of them, that I talked with, that they would not bother, it involved so much trouble to get \$160.

Mr. KING. That may be very well be, Congressman. It may be that offices advised them honestly that they should not make the attempt.

For example, veterans come into the VA regional office who do not even know what kind of a house they want, much less having selected a house, and as to that type of inquiry they probably would be told not to make the try, that they probably would be sorry if they were to move hastily, to get probably \$160 or less.

Mr. TALLE. I certainly appreciate you comments.

Now, is my request clear? I do not want a long statement. All I want are the various steps, step 1 being filing the application, and then very briefly each step that follows, getting down to an appraisal, and so on, and, finally, the issuance of the loan, to try to measure what would be a reasonable time for applying for and consummating a loan.

Mr. KING. Yes, sir. Incidentally, we are currently nearing completion of a system under which we will serve appraisal requests as to existing housing, on a telephone basis. If you put down on paper the elapsed time between the initial step and the final step, and if it is all done by mail, and you remove every incident of that course that can be removed, and you can find no quarrel with any of the parties in the course as to the time interval they require, you still are up to about 19 days.

So we are planning to put in a procedure whereby all of it can be done by telephone unless there is a special problem incident to the particular unit, and we also cannot extend it where we have got a lot of long-distance telephoning to do ourselves.

So we are going to let each regional office work this thing out on as broad a pattern as it can handle, and we think where that is put into effect that people will be able to get appraisal of existing houses in as little as 4 days. That is a goal, of course, and probably will not be an end result.

Mr. TALLE. Thank you very much, Mr. King.

Thank you, Mr. Chairman.

(The material referred to above is as follows:)

STATEMENT OF THE VETERANS' ADMINISTRATION REGARDING ELAPSED TIME IN
PROCESSING LOAN APPLICATIONS

In accordance with Congressman Talle's request, the purpose of this statement is to indicate the processing steps which are necessary between the time a veteran makes application to a lender for a loan and the time at which the veteran is notified that the proposed loan will be made, and to supply such information as is available on the approximate elapsed time involved for the various steps, insofar as VA processing is concerned.

The table which follows outlines the typical processing steps for VA-guaranteed loans which are submitted on a prior approval basis (which represent 65 percent of the volume of applications filed) and where the VA appraisal is not made until after the veteran applies to the lender for a loan—the most time-consuming type of procedure normally encountered. The data on average elapsed time for those steps where VA processing is involved are taken from a special survey conducted by VA in April and May of 1953. A further discussion of the variations for other typical processing procedures follows the table.

Typical processing steps for VA-guaranteed home loans on existing property, including VA appraisal of individual unit and processing of loan application submitted for VA prior approval

<i>Processing step</i>	<i>Average elapsed time for VA processing, per sample survey, April-May 1953—days¹</i>
1. Veteran applies to lender for loan after he has entered into a contract for purchase.	
2. Lender obtains veteran's discharge papers or certificate of eligibility, checks income and credit rating of veteran, and (if not previously done by seller or veteran) requests VA to appraise property.	
Total -----	18.0
3. VA appraisal function: ²	
(a) VA receives appraisal request, notifies fee appraiser of appraisal assignment-----	1.4
(b) VA's fee appraiser makes appraisal of property, checks for compliance with minimum property requirements, and sends report to VA-----	11.2
(c) VA reviews fee appraiser's report, checks data on comparable property sales, determines reasonable value, and issues certificate of reasonable value (CRV)-----	5.4
4. Lender receives CRV, completes VA loan application and mails to VA with supporting documents.	
5. VA loan processing (prior approval loans). ² VA receives loan application, checks eligibility of veteran, reasonable value of property, veteran's ability to repay, etc., prepares certificate of commitment and mails to lender-----	12.4
6. Lender advises veteran that loan will be closed on specified date, provided title to property is found to be satisfactory. ³	

¹ Elapsed time in calendar days, including weekends and holidays.

² Steps 3 and 5 may be concurrent.

³ After the loan has been fully disbursed, the lender submits a report to VA, and VA issues the evidence of guaranty.

VA estimates that most offices should be able to process appraisals currently on existing properties (step 3 in the table) within 2 weeks of the time the request for appraisal is received, and hopes to cut the time further by the introduction of streamlined procedures which are to be issued shortly.

The time for VA loan processing (step 5) should be reduced since VA has decentralized entitlement control in January 1954, and it is believed that most offices are currently in a position to issue guaranty commitments within 1 week or less of the time the application is received. However, any substantial increase in the volume of loan activity may, in view of existing personnel limitations, cause the development of some delays in processing in the offices concerned.

In considering the data in the table, it should be emphasized that both the processing steps and the typical elapsed time will vary depending on the circum-

stances. If the veteran applies for a loan from a supervised lender (e. g., a bank, savings and loan association, or insurance company), which intends to process the loan on an automatic basis—i. e., close the loan and report to the Veterans' Administration after it is disbursed—it is only necessary for the lender to determine that the proposed loan meets certain requirements, e. g., that the applicant is an eligible veteran, that the veteran's income and credit reputation are such that he has an indicated ability to repay the obligation, and that the proposed purchase price of the property does not exceed the reasonable value thereof as determined by the Veterans' Administration, the certificate of reasonable value having been obtained by the lender prior to his commitment to make the loan. In all "automatic loan" cases, steps 4 and 5 in the table would be eliminated, and if the VA appraisal had been made in advance (at the request of the builder or seller) step 3 would also be unnecessary.

With respect to loans originated by nonsupervised lenders, and those loans made by supervised lenders where VA's prior approval is requested, it is necessary to submit a formal application to VA for prior approval of the proposed loan. In such cases, the VA appraisal may also have been completed before the veteran makes application to the lender, in which case the only time lapse occasioned by VA processing is that between the receipt of the veteran's loan application by VA and VA's approval thereof (step 5).

In those cases where the VA appraisal has not been completed in advance, the lender or seller would immediately request a Veterans' Administration appraisal of the property. The typical elapsed time required for such processing is dependent on the circumstances. For example, the appraisal of a single completed home can be completed much more expeditiously than the appraisal, based on plans and specifications, of a proposed housing project involving many units. Of course, in most large subdivisions the builder will obtain an appraisal from VA before he starts building operations, and usually before the prospective veteran purchaser is in the picture.

With respect to the determination of the veteran's eligibility, such determinations will not normally delay the processing of the loan application since the Veterans' Administration regional office can determine whether or not the veteran is eligible for GI loan benefits very quickly in practically all cases. In "prior approval" processing, the eligibility determination is a part of the regular processing procedure. In "automatic loan" cases, the lender may require the veteran to obtain a certificate of eligibility, but since most offices are in a position to give 48-hour service on practically all such requests, the eligibility determination would normally be completed concurrently with the lender's actions in checking the veteran's credit and preparing the necessary loan instruments. Accordingly VA's eligibility determinations should ordinarily occasion no delay for either automatic or prior approval loans.

Mr. DEANE. Mr. Chairman.

The CHAIRMAN. Mr. Deane.

Mr. DEANE. Mr. King, I appreciate your presence today. I have been very sympathetic with our VA program. Perhaps this is a policy question which you are not prepared to answer, but I am receiving letters with reference to the reorganization of the VA housing program.

I wonder if you are prepared to say whether or not a plan of reorganization of the VA housing program is being considered?

Mr. KING. Are you speaking of field office reorganization or central office reorganization?

Mr. DEANE. Central office reorganization.

Mr. KING. The central office reorganizational pattern is simply the adoption of a staff and line concept, instead of the combined type of concept we heretofore have worked under.

Mr. DEANE. I don't understand what you mean.

Mr. KING. Well, up till a very recent date, my own office has been directly chargeable with responsibility for the delays such as Congressman Talle was talking about, although those delays were opera-

tional in character and didn't have to do with the planning or policy formulation part of the business.

Under the new concept which has been impressed upon all programs of the Veterans' Administration, those having to do with policy direction, policy formulation, the writing of directives, and various types of activity of that kind, which are broadly labeled staff functions, will be independent of operational functions, which concerns the regular daily routine attendant the work of the field offices. They will be handled under another person called the operations officer.

Mr. DEANE. I don't know whether your statement will answer these questions, but during the testimony by Mr. Cole there was mention of a reorganization plan coming to the Congress, and I am just wondering if that contemplates the Veterans' Administration.

Mr. KING. Congressman Deane, I have no direct information on the subject, but I do not think Mr. Cole's plan contemplates the Veterans' Administration. I think Mr. Cole's plan primarily is a reorganization of the housing agencies now under the guidance and jurisdiction of the Housing and Home Finance Agency.

Mr. DEANE. So I can answer these letters that so far as the immediate present is concerned, that applications and other loans involving veterans could be cleared through the various State offices of the Veterans' Administration?

Mr. KING. For the sake of clarity, Congressman, let me emphasize that I have no personal knowledge of the scope or gamut of Mr. Cole's plans, but as far as the Veterans' Administration is concerned, those who have been doing business with VA will find they need little change in how they do business with VA, or whom they do business with in VA.

Mr. DEANE. What I was concerned about was whether or not any proposed reorganization plan would contemplate a change in the present operations of the VA home loan program.

Mr. KING. Congressman, adverting to what I said, it does make the change in the separation of the staff and line functions, but basically—and this certainly 80 or 90 percent true—the aspects of the reorganization which are the essential aspects, are internal in their nature, and will have very little effect in the way of change or discombobulation upon the people with whom the VA loan-guarantee program does business—builders, lenders, and so forth.

Mr. DEANE. My questions were not intended to mean that I am not in favor of improving the VA loan program. I wanted to know how to intelligently answer these inquiries so far as whether or not there is contemplated a reorganization plan that would bring the VA program into the Housing and Home Finance Agency, or the FHA.

Mr. KING. I know of no such plan that is now under study by VA.

Mr. DEANE. That answers my question. I know quite well the problems that you faced back when housing was going up very rapidly. Perhaps you didn't have the inspections which you needed.

I wonder how many complaints you are receiving now on housing construction, on the basis of monthly reports?

Mr. KING. I have seen those figures and it is my recollection, Congressman, that currently we are receiving some up to 500 complaints each month, which we deem worthy of investigation.

Now, I don't have any breakdown as to the end result of those 500 cases. The statistics that I read were statistics which were submitted to me primarily from a workload basis.

Now, as to those 500 cases, we will find that some involved complaints that should not have been made. In other cases, the complaints are relatively trivial, and contact with the builder readily results in their being corrected. In other cases—and I am sure that these are relatively a small number—there are basic factors.

Mr. DEANE. How many contractors have you ceased doing business with within the last 6 months, on the basis of defective housing?

Mr. KING. I don't know that by number, Congressman, and I am not too sure I can get it, because regional offices can suspend those builders, and sometimes the suspension is—

Mr. DEANE. Lifted?

Mr. KING (continued). One that hurries people up a little bit so it is of very short duration.

Mr. DEANE. What I am interested in is whether or not VA is acting courageously, and coming to grips with the problem of defective construction, where the responsibility rests with the contractor.

Mr. KING. Mr. Deane, Mr. Dervan tells me that since the beginning of the program we have suspended approximately 150 builders, for long or short spells. And for various reasons.

Mr. DEANE. I have a letter from Administrator Higley concerning a number of loans that have been made. I notice here a total of 322,160 home loans, totaling \$3.064 billion, but I notice that there have been 1,455 farm loans, totaling \$6.2 million, for 1953.

Now, the bill before us does not include in it any continuation of the title for rural nonfarm housing, and it is significant to me that for the calendar year 1953, this letter from the Administrator that you have made only 1,455 farm loans. I wonder if we can expect to keep the veterans on the farms if we are not going to have to do something in the way of housing in order to keep them there?

Mr. KING. Congressman, I am not quick enough to have gotten the particular figures you used, but apparently you were using monthly figures.

Mr. DEANE. Activities in connection with the operation of the loan guarantee and direct loan program, during the calendar year 1953. I quote from Mr. Higley's letter:

Under the loan-guaranty program it reveals that there were 322,170 loans, 1,455 farm loans, 1953.

Mr. KING. Yes, sir; that is a yearly figure. Cumulatively, we have had 65,533 farm loans through December of last year.

Mr. DEANE. And how many other loans?

Mr. KING. An overall total of 3,472,000 loans.

Mr. DEANE. Holding our attention to 1953, don't you think there is a wide spread between the two groups.

Mr. KING. Yes, sir, our farm-loan program has languished.

Mr. DEANE. Why has it languished? Because of the inability to get financing?

Mr. KING. Partially, Congressman, and partially because we never raised the guaranty entitlement for farm loans when we did the home-loan entitlement. It has always remained at \$4,000, whereas in 1950 we raised, or the Congress raised, the home-loan benefit to \$7,500.

Mr. DEANE. You do not have discretionary power, so far as that ration is concerned?

Mr. KING. No, sir, it must come as a statutory power. However, there is a bill before another committee of the House which proposes to increase that farm-loan entitlement.

Mr. DEANE. Does that meet with the Agency's approval, to have that ratio changed?

Mr. KING. I think the tenor of the comments of the agency on the bill, Congressman, were favorable.

Mr. DEANE. One other part which gives me a little concern about the VA program is the fact that while the FHA, in view of the statutory provisions of the Housing Act, provides for insurance premiums, and the accumulating of a reserve, that isn't true, is it, with VA-insured and direct loans?

Mr. KING. In the VA-guaranteed or insurance loan activities, we have no premium charge against the veteran, and we have no reserve of any kind.

In the direct loan program we have some ability to accumulate some reserve because of the spread between that way we charge the veterans on the loans and that which we pay the Secretary of the Treasury.

Mr. DEANE. Would it add very much cost to the program to set up an insurance charge in order to give certain protection to the Treasury?

Mr. KING. Well, it would add a cost factor to the veteran home buyer, percisely equivalent to the charge made for that reserve, and such reserve would accumulate so slowly, in fact, that it would be hardly efficacious.

If you were to make a charge which was commensurate with possible risk factors, it would have to be a heavy charge indeed.

Mr. DEANE. You have read the bill. I would like you to refer to title II on page 41.

Mr. KING. Yes, sir.

Mr. DEANE. Do you understand that paragraph No. 3? That gives to the President the right, as spelled out in the bill, to set the rate of interest, and that applies to all types of VA loans, does it?

Mr. KING. Yes, VA home loans, certainly, but paragraph three has to do with the—subsection 3, beginning on line 19 of the draft before me has to do not with the primary rate of interest charged to borrowers under the National Housing Act, but to the rate of interest paid on debentures issued to lenders following foreclosure.

Mr. DEANE. Well, amending my query, then, title II would give to the President authority to set the interest rates as outlined in that title?

Mr. KING. Yes, sir, that is right. As I brought out in my statement, he would have that authority equally over the programs handled under the National Housing Act and under the GI home-loan program, and handled under the Servicemen's Readjustment Act.

Mr. DEANE. In this same title III and referring to your statement on page 11, you say that the:

Veterans Administration favors the concept of a privately financed secondary market facility.

Do I understand by your statement that you favor the concept of, as being with the belief that you will have sufficient secondary mortgage facilities for GI loans, if FNMA is eliminated?

Mr. KING. Our choice of terms, there, Congressman, was not artful. We have long publicly commented upon the desirability of having the flow of mortgage money, by way of offsetting acute breaks in supply and demand trends, lessened or softened by some sort of private secondary markets.

So, it was only in adversion to those past statements, that we had in mind when we used this phrase "the concept of."

Concerning the mortgagor phase of your question, I have not given study to, nor do I consider myself eminently qualified to, draw conclusions as to how this proposed Federal National Mortgage Association in its reconstituted garb will work in given market situations.

Mr. DEANE. Does this bill before us retain, as previously has been true in all respects, veterans' preference?

Mr. KING. I missed the key word. Did you say "retain"?

Mr. DEANE. That is right.

Mr. KING. No, sir, as I pointed out in my testimony, we drew attention to the fact that the bill will weaken, comparatively and competitively, the housing advantage which veterans have heretofore inherited under the Servicemen's Readjustment Act of 1944.

Mr. DEANE. It is probably true that we are moving into a new era of housing, but I did feel that we should understand clearly, so far as the bill before us is concerned, whether or not the basic concept of veterans' preference is being maintained or if it is being modified, or to a certain extent eliminated.

Mr. KING. Yes, sir, that was our purpose when we phrased our statement the way we did, and drew that fact to the attention of this committee.

Mr. DEANE. Mr. Chairman, will you have a final windup on this witness as we previously did? I have a few more, but I feel I should stop now.

The CHAIRMAN. We will have to wind up pretty soon.

Mr. DEANE. Well, I will pass for the time being.

The CHAIRMAN. Are there other questions of Mr. King?

Mr. WIDNALL. Mr. Chairman.

The CHAIRMAN. Mr. Widnall.

Mr. WIDNALL. Do you have any breakdown as to complaints, as to the numbers where the borrower says the escrow payments have been made to the builder, despite the fact that deficiencies have not been checked?

Mr. KING. No, I do not, Congressman. I would think that that type of case was a rare case.

I know of maybe 2 or 3 instances in which a situation of that kind has come to my attention. I do not say that there are not many more, or several more. I could only get that information and I will be happy to do it if you so desire, by round-robinning the 67 regional offices and asking them to draw on either their records or their memory.

Mr. WIDNALL. Don't you have a record of complaints filed here in Washington?

Mr. KING. We have a record only of the number of complaints, Congressman, or those complaints which are brought to the attention of the Washington office for some particular reason.

Mr. WIDNALL. The reason I bring the matter up is this: In the recent housing investigation that we conducted, there were many

complaints out in the field that borrowers have seen their escrow payments paid over to the builder and had been left high and dry when he had failed to make good on a number of complaints. And I have recently had a number of other letters alleging the same state of facts. I would like to know what your totals are.

Mr. KING. I would be glad to give you any facets of that which you may wish to have, Congressman, but let me point out for the record that escrow funds, under the VA system, are commonly provided for specific purposes.

For example, the installation of sidewalks, gutters, curbs, and so on, when weather permits.

Now, if that work is done satisfactorily, we have to release the escrow. Now it may be that an individual veteran found, at about the same time, that he had a wet cellar, for example. We could not hold up the payment of those moneys out of escrow because that complaint had reached our attention. We are under contract, so to speak, so that if the work for which the escrow was reserved is accomplished satisfactorily, the man who does the work is entitled to a release of the funds.

Mr. WIDNALL. That has been understood in the past, but we ran into a number of deficiencies along that line, where the members of the committee felt that the practices should in the future be corrected.

So often the homeowner found himself completely high and dry with no recourse except a legal suit against the contractor, and presumably there had been inspection on the part of the VA or FHA.

Mr. KING. Yes, sir.

Mr. WIDNALL. Now, in all fairness to your Department, I have got to recognize that you guarantee hundreds of thousands of homes, and there was a relatively small percentage of cases involving complaints, but at the same time, in certain areas, there were large groups of complaining homeowners, who felt the inspections had failed. How do we get at the failure of inspection?

Mr. KING. Well, Congressman, if you will remember—and I am sure you will because it was largely through your efforts—the Congress included in the 1952 bill a provision for the suspension of builders by VA. I think that that was recommended by Congressman Rains' committee, which sat under a resolution you originated. I think in truth, then, that that has been fairly effective. I don't say that there are not any situations which are not regrettable or which do not require more cure than we can effect, but basically, that change in the law, plus some very positive action on the part of local builders' groups to bring their people in line, has measurably stepped up the quality of housing and lessened the occurrence of major types of deficiencies, over the last year and a half.

Mr. WIDNALL. May we have for the record the number of suspensions in force at the present time?

Mr. KING. We will be happy to give them to you.

(The material referred to is as follows:)

STATEMENT OF THE VETERANS' ADMINISTRATION REGARDING SUSPENSION OF BUILDERS

As the committee is aware, the Servicemen's Readjustment Act was amended by Public Law 550, 82d Congress, approved July 16, 1952, to authorize the

Veterans' Administration to suspend builders from further participation in the program under certain circumstances, by adding a new subsection (c) to section 504 of the act. Section 504 (c) reads as follows:

"The Administrator shall have the right to refuse to appraise any dwelling or housing project owned, sponsored, or to be constructed by any person identified with housing previously sold to veterans under this title as to which substantial deficiencies have been discovered, or as to which there has been a failure or indicated inability to discharge contractual liabilities to veterans, or as to which it is ascertained that the type of contract of sale or the methods or practices pursued in relation to the marketing of such properties were unfair or unduly prejudicial to veteran purchasers."

Under this authority a total of 465 builders had been suspended—174 such suspensions have been lifted after correction of deficiencies, leaving 291 builder suspensions still in force as of March 9, 1954. In addition to the above, many builders were notified of proposed suspensions but avoided such action by timely correction of the deficiencies involved without the necessity of actual suspension.

It should be emphasized that the suspensions imposed by VA have affected only a very small segment of the building industry. The suspensions currently in force represent less than 2 percent of the approximately 15,000 builders on VA mailing lists.

Mr. WIDNALL. Thank you, Mr. Chairman.

Mr. BOLLING. Mr. Chairman.

The CHAIRMAN. Mr. Bolling.

Mr. BOLLING. I would like to return to two sections of your statement, one of them one which Mr. Deane drew particular attention to, that is the section on page 3, which begins at the top of the page and runs through the paragraph, and the other is the section, the next to last full sentence on page 11 of your statement: "There is no indication as to whether it is the will of the Congress that preferred treatment continue to be afforded to GI loans."

Now, if I understood your statement, and your answer to Mr. Deane, it would appear to me that, in effect, veterans' preference in the housing field is completely overrun by this bill. Would that be correct?

Mr. KING. Well, that would have to be qualified, Congressman. We used the words "dilute" or "impair" and that is dependent in turn and in part, not upon what the bill does, but on what might be done under the bill.

Mr. BOLLING. In effect we are creating the situation, if the bill is passed without amendment, in its present form, we are creating the situation where, by administrative action, it would be possible to virtually eliminate the differential that classically has existed under the laws passed by Congress, between the nonveteran and the veteran, in the housing field.

Mr. KING. Yes, sir; that is a possibility.

Mr. BOLLING. Now, I do not wish to put words in your mouth, but it seems to me very clear, from this, that we have a situation here, where perhaps through the back door, the classical policy of Congress, that the veteran will have certain preference in housing, is going to be eliminated unless very substantial amendments are made to this bill, and the freedom provided to the administrators very carefully hemmed in by legislative action.

Now, I would like—the chairman expressed himself the other day to the effect that the staff was in a position to prepare any amendments. I would like very much, either from the staff or from the agency, to have those amendments necessary to safeguard the clas-

sical position of the veteran in this particular field, and I would leave it entirely to the discretion of the chairman as to whether those were furnished to me by the staff or directly by the agency.

The CHAIRMAN. There is contact between you and the staff, and if I haven't made it clear, any member of the committee may visit with the staff at any time.

Mr. BOLLING. I am aware of that, Mr. Chairman, but my point in phrasing this request in this particular fashion—

The CHAIRMAN. I might add that we have a drafting service which always sits with us during the executive sessions, and they are set up primarily to draft just such things as you are speaking of.

Mr. BOLLING. Yes, Mr. Chairman, but my point is this: It is perfectly obvious, that although I may study this matter very carefully, that I am not as completely familiar with the provisions of the housing legislation as it affects veterans as is the man who is charged with the administration of those provisions, and I would like his advice not only on the technical drafting, but also as to the substantive provisions.

I am afraid that I might possibly miss some of the hooks in the bill, unless I had the most competent advice.

Mr. MERRILL. Will you yield?

Mr. BOLLING. I yield.

Mr. MERRILL. Do you propose that we deny to the general American public certain of the benefits of this legislation so that we can keep the veteran ahead of the parade.

Mr. BOLLING. If you can read that into my statement, sir, you are an extremely clever person. That is not at all what I said.

Mr. MERRILL. I asked you.

Mr. BOLLING. Of course not. I intend by amendment, if possible, to see to it that we retain the classic standard view that Congress has taken repeatedly with regard to veterans' preference in the housing field.

Mr. MERRILL. Well, I guess we had better look at the amendment and then discuss it.

The CHAIRMAN. I am sure, Mr. Bolling, that if you would contact the drafting service, which is made available to all Members of Congress, that they can get something up to meet your desires.

Mr. BOLLING. I take it that I can also contact the Veterans' Administration on a personal basis.

Mr. MERRILL. May I pursue this questioning a little further then with Mr. Bolling? Let's take this section that provides for no down-payment, and a \$200 fee, in the case of certain displaced people when they get housing.

What would you propose to do for a veteran in that case? Eliminate the fee completely? The question I have in my mind is this: It looks to me as if what we are trying to do here is to take the total American public and give them the best possible deal we can give them in acquiring new homes, consistent with soundness.

Now, personally, I don't see why we have to worship at the shrine of veterans' preference if we are giving everybody something better. I would just like to know what your thinking is.

Mr. BOLLING. Mr. Merrill, that question deserves an answer. In the first place, it should have been clear, in the last few days, that I am not entirely satisfied with the provisions of the bill, either in their

capacity to produce housing for low- and middle-income people or in their capacity to produce the total number of units to fill the need of both the economy and the people. Therefore, I do not start from a base of being completely delighted with the provisions of the bill.

At the same time, I do feel that, as we are at this stage of the hearings, it is perfectly proper and even wise, to explore the implications of the bill as they affect other groups, specifically, in this case, the veterans' group, in their relationship with the people generally, as to their preference, their extra opportunities to get housing.

If I knew the answer, Mr. Merrill, I wouldn't be asking for all the advice from the staff, the drafting service and the Veterans' Administration, but I think it is obviously a question that needs much more thorough exploration than evidently it has had to date.

Mr. Hiestand. Mr. Chairman.

The Chairman. Mr. Hiestand.

Mr. Hiestand. Mr. King, as I understand it, pursuing further Mr. Deane's line of inquiry, as I understand it, the loan insurance part of the VA program has been a sound one. I mean it has paid its way, over the years, has it?

Mr. King. Under the experience witnessed to date, Congressman, the program has cost the Government very little money indeed, and it has amazed everybody, but there has been quite a decent level of economic conditions over that period.

Our total loan volume of about \$23 billion now carries about, very roughly speaking, a total contingent liability of only between \$8 and \$9 billion on the part of the Government.

Now to date, the home-loan program has resulted in payment of the guaranty by the Government in only approximately one-half of 1 percent of all home-loan cases, and we have recaptured nearly two-thirds of the guaranty payments we have had to make.

Mr. Hiestand. In other words, it has been operating on a sound basis. It has paid for itself and is satisfactory. You are in sympathy with broadening, or shall we say, liberalizing parts of this present bill, are you, for the veterans?

Mr. King. I pointed out, Congressman—I am being very careful in my phrasing—

Mr. Hiestand. Yes.

Mr. King. I pointed out, for the attention of the committee, that there were several things it might want to take into consideration.

Mr. Hiestand. But in general you favor the liberalizing?

Mr. King. Personally, I favor, at this time—although I didn't several years back—the liberalizing of the farm entitlement for veterans. I favor liberalizing the provisions of the law which will assist in the making of supplemental loans, although I wouldn't have so testified 5 years ago.

So I do think that it is an appropriate time, now, to let a couple of the straps off the bag, with relation to these specifics.

Mr. Hiestand. Surely. In what way has the veterans' preference helped the veteran over the nonveteran in the program so far? I mean, has the nonveteran been denied something the veteran has had in the way of insurance?

Mr. King. I have to almost go back to the egg to explain that.

Mr. HIESTAND. I don't want to go into too much detail, but he has had an advantage, has he not, the veteran?

Mr. KING. The veteran, when he stepped up on Sunday afternoon to buy a specific house, was more welcome to the builder trying to garner a market, from place to place, because he didn't need any downpayment, or would need only a small downpayment. The veteran had a better chance, with less money in his pocket, of getting any homes that were for sale in a given locality.

Mr. HIESTAND. It has worked out, then, to the advantage of the veteran?

Mr. KING. Yes, sir.

Mr. HIESTAND. Now, if we further liberalize the measure so that the veteran gets even a little better break than he had before, have you any objection to allowing the nonveteran to have the same break?

Mr. KING. I am not acquainted with what is proposed in the way of giving the veteran something more than he had in the past.

Mr. HIESTAND. I mean as proposed in the bill.

Mr. KING. Well, the bill doesn't propose to give the veteran anything in addition, Congressman. In other words—

Mr. HIESTAND. I thought you said it did. Well, excuse me, go ahead.

Mr. KING. The bill will bring up to a parity with the veteran the status of anyone who desires to buy or construct a home.

Mr. HIESTAND. Is it your judgment that that will work out to the disadvantage of the veteran?

Mr. KING. Well, you ask whether that will work to the disadvantage of the veteran in terms of superficialities, immediate things, and so on? If the provisions of the bill are exercised, it will work to the disadvantage of the veteran with respect to his losing his advanced or preferred credit position.

Now, whether it will work to his ultimate disadvantage is something that—

Mr. HIESTAND. As long as there are unlimited credit facilities, he wouldn't be in a disadvantageous position, would he?

Mr. KING. Yes, sir. Let me put it this way: If a builder is building a hundred units, nowadays he pretty near has to come into VA and get a certificate of reasonable value in order that he can have as broad a market as he needs, and as a matter of fact in many instances he can't get his construction money unless he has that certificate of reasonable value, which will assure him of the broadest possible market.

But he has to sell under the appraised value issued by the Veterans' Administration.

Now, if both nonveteran and veteran can get another financing vehicle, that is just as good as the one the veteran had in the past, the builder won't have to come into VA. The builder can sell at any price he wants—which may or may not be a bad thing—and the veteran will have to take a form of financing that costs him a little more. For example, he will have to take the FHA form of financing, which involves, under current rates, by dint of the requirement of a half percent service charge, that he pay 5 percent rather than the 4½ percent that he will get under the VA loan.

The VA loan, from the veteran's standpoint, is considerably more preferable, and because of this small equity which the veteran needed to have under the situation which has heretofore existed, the builder

pretty much had to make that loan available to him. Now, this will revise the practical impacts of that situation.

Mr. MERRILL. Will you yield for a question?

Mr. HESTAND. I yield.

Mr. MERRILL. Wouldn't your theory work if we were still in the situation where there was demand for every house that was being built? Back a few years ago there was a demand for more houses than could be built, and, therefore, the builder could choose whatever area he wanted to go into. Then, of course, financing was cut a little short and he had to go into VA because that was where the money was.

Now, in the present market, where the home building industry is able to produce for the complete demand, will not a builder be required, if the veteran insists upon VA financing, since a builder can no longer say "Well, my total production could be consumed under FHA financing," won't the builder have to satisfy the veteran's demand for a VA type loan, or else let his houses go empty?

In other words, the market has now reached the point, in home building, where it is a buyer's market and not a seller's market, and the home builder cannot say "Here it is, boys, take it the way I packaged it up or I will sell it to somebody else." Under present conditions isn't the seller going to have to package the way the buyer wants it so that the veteran is going to say "I insist upon the veteran's package rather than the FHA package?"

Mr. KING. To a certain extent that analysis is correct, Congressman, but of great practical weight is the fact that this bill will create a new market for the builder. It will bring a lot of new people into the market who have not got the money to buy a house under current ratio of loan to value maxima, so the builder will be somewhat in the position of saying to the veteran: "Well, here it is, you take it and it won't hurt you much to take it, because I have got a 95-percent loan at the door here, and the cost to you will be minuscule as opposed to G.I. financing."

The way I phrased it informally is, if you build a better mousetrap the world will flock to your door. If you are building a better mousetrap, which makes it possible for a builder to find a market without going through the detail that he is required to go through by the Veterans' Administration—

Mr. MERRILL. But then you do not think that this program as it will be administered by the President under the flexible terms that will be had, you do not think that he is going to let this program operate and become so loose, or so liberal in terms, that he is going to let the housing market get as tight for purchasers as it was in the past, do you?

Mr. KING. Congressman, I don't presume that the President, in exercising the powers conferred upon him by this bill, is going to lose the preferential treatment of the veterans.

Mr. MERRILL. Yes, sir.

Mr. KING. My job here this morning is to point out that the bill contains no sentiment on the part of the Congress, or no expression on the part of the Congress, that it is desirable, from the standpoint of legislative policy, to observe preference to veterans in whatever may be done under the bill.

Mr. MERRILL. There is no point in taking the dog-in-the-manger attitude and saying "Just so as I can retain my preference as a veteran I want to handicap everybody else." The spirit of the bill up to this point has been that if it can make a good deal for everybody and not harm the veteran, that is fine. Isn't that the spirit of the bill up to the present time?

Mr. KING. I am not sure, Congressman. I had no part in the preparation of the bill.

Mr. MERRILL. Well, would you agree with this, that the building industry has a capacity far in excess of a million homes a year in new starts at this time?

Mr. KING. Most certainly; yes, sir.

Mr. MERRILL. So that if this bill is administered so that—and I am not trying to say that will be the amount—but if this bill is administered by the President, through his ability to adjust the terms, so that the housing industry continues to produce approximately a million new starts a year, he will do that by controlling the demand from the people, through letting more or fewer people into the market, by means of adjusting the terms, won't he?

Mr. KING. Presumably so; yes, sir.

Mr. MERRILL. Then if this bill is administered so that about a million starts, new starts, are made each year, then we are going to have a climate which is a buyer's market and not a seller's market, because the capacity of the industry is far in excess of that; isn't that right?

Mr. KING. Well, I don't see the significance of your statement as to capacity of the industry in that regard. I may be just a little bit stupid on that point. But I do think it is going to be a buyer's market because the potential of the industry, and the likelihood that they will produce great volume is such that they will be looking for purchasers.

Mr. MERRILL. You have said the same thing I said only that you said it better, so that we both understand you.

Mr. KING. And obviously the purpose is to bring those purchasers up to the line.

Mr. MERRILL. So long as there is a buyer's market, then, while the disadvantage to the veteran that you described would be a possibility, if we have used this law in creating a seller's market, the disadvantage to a veteran might occur, but as long as this remains a buyer's market so that the buyer can say "I will take this under the veteran's package but not under the FHA package," then the thing you are talking about, so far as disadvantage to veterans is concerned, will not occur, will it?

Mr. KING. It will, Congressman, for this reason, that the margin of difference is narrowed so by the bill that the veteran will be inclined to take one rather than another.

Mr. MERRILL. Then, we would be—

Mr. KING. But he will be the loser thereby.

Mr. MERRILL. Then, if we would do anything but accept this bill we would be fighting for an advantage for the veteran that the veteran does not give a hoot about; that isn't important enough to the veteran to worry about; is that it?

Mr. KING. I don't think that is a fair deduction from what I said, Congressman.

Mr. MERRILL. I am not trying to be antagonistic to you. I am just trying to see, to explore this thing fully.

As you have said, the difference is going to be so little that the veteran actually, even though it is a buyer's market, is not going to insist that you give him the veteran's package instead of the FHA package, because you say the difference is not going to be enough that he will bother. Is that what you said? If it isn't, correct me.

Mr. KING. The veteran, very often, will not be well acquainted with details sufficiently to know whether or not he can afford, or he will lose substantially, by taking what is proffered to him rather than what he could get if he insisted upon it.

The fact is, as I have heard many builders state, that a great many people are buying houses today by merely asking what the monthly payment is, and I have seen houses advertised throughout the country in which the price is not a part of the ad, but only the monthly payment is part of the ad.

I cannot, myself, in discussing a given purchase price, or a given range, assemble in my own mind what the various factors are. It requires sitting down with tables and working out various suppositions.

I would have no great difficulty if I were a real-estate salesman in inducing a veteran to take one rather than the other on the theory it really didn't make much difference, but the advantages of a GI loan to the veteran are definite enough so that it would be desirable if you are going to contemplate the continuance of the veteran's preference in housing, to see that it continued to be available to him insofar as you can determine that.

Now, I was about to say, it is 9 or 10 years since the end of the war. It may be that the Congress contemplated that the benefit to veterans should expire in 1957. Nobody thought of Korea at that time, I guess. Maybe the situation is such that there should be an adjustment of these things. I don't know, and that is policy beyond my concern, and perhaps beyond the concern of the Veterans' Administration. I don't know. But we were required this morning, because of the character of our agency, to bring to the attention of you gentlemen what the practical factors would be with respect to the acquisition of housing by veterans under the provisions of this bill as proposed.

Mr. MERRILL. As I understand it, then, the only way in which we could keep the advantage that the veteran now enjoys would be to keep freezing a great block of the nonveterans out of the market and curtail the housing industry so that we keep forcing the builders into the veterans' market as the only place where they can go to find a market for their housing. That is true, isn't it?

Mr. KING. Looking at one facet of the thing, they are true statements, Congressman, but there are other facets that could be looked at.

Mr. MERRILL. But the reason that you gave for the veteran having this advantage now, which you say this bill would destroy, is this: That now the builder has to go into the veterans' market because he cannot produce for the nonveterans' market; isn't that right, and, therefore, he is forced into the veterans' market, under present conditions?

Mr. KING. The builder, the average project builder today—

Mr. MERRILL. Is forced into the veterans' market?

Mr. KING. Finds that he is selling a large percentage of his output to veterans, because other people haven't got the cash margin that is necessary, either for conventional loans or FHA loans.

Mr. MERRILL. So in order to keep this present advantage for the veteran, the one that he will lose because of this bill, the only way to keep it would be to keep freezing the nonveterans out of the market the way we are doing right now, wouldn't it?

Mr. KING. Well, you see, Congressman, when you use that phrasing, you are kind of making a philosophical assault on me, because I think that we have unfrozen the market too much already. We were at 40 percent downpayments just a few years back, then we went to 20 percent, and then we went to 10 percent, and then we went to 5, and then we go to no down payments, and, obviously, you are weakening the structure, as you proceed in that direction.

The same thing has been true with reference to the credit terms that the average buyer is required to have. Obviously, as you weaken the credit factor you are weakening the whole structure, and if you let several marginal credit factors into a given project you place at stake the property values and rights of all the rest of the people in that project.

Mr. MERRILL. Then you would say this: That if we go this far with the nonveteran you certainly would not advise, that having gone this far with the nonveteran from this credit structure, that in order to preserve the veteran preference that we go even further with the veteran, would you?

Mr. KING. No, sir; I do not advocate that. There is no step beyond the infinite.

Mr. MERRILL. That is what I mean.

Mr. HIESTAND. Mr. King, I am very sure there is nobody in the Congress but wants to give the veteran every possible break. That is the state of mind of the Congress; I know that.

Mr. KING. Yes, sir.

Mr. HIESTAND. You are aware, however, that this is an administration-recommended bill.

Mr. KING. Yes, sir.

Mr. HIESTAND. Do we dare take the assumption from your testimony that the VA opposes it in its present form?

Mr. KING. Congressman, I think the only correct statement on that would be to say that the VA is drawing attention of this committee to the fact that the bill is silent as to whether or not it will continue to be the policy of the Congress to accord the veteran a preference in the housing picture which will enable him to make effective use of his guaranty entitlement.

Mr. HIESTAND. Thank you very much.

The CHAIRMAN. Are there further questions of Mr. King?

Mr. MULTER. Mr. Chairman.

The CHAIRMAN. Mr. Multer.

Mr. MULTER. Mr. King, how much money does the Veterans Administration have on hand presently for direct loans? Unused authority, that is.

Mr. KING. The Veterans' Administration currently is operating its commitments under the \$25 million which it got on January 1. Now, I don't know just how many dollars are committed today, but I could

give that figure. However, basically, we will use the \$25 million by April 1, when we get our next allotment. We get another allotment April 1.

Mr. MULTER. I understand the Veterans' Affairs Committee has reported a bill authorizing an additional \$100 million for the direct-loan program. Was it the belief of your agency that that would carry it through the next year?

Mr. KING. As you probably know, there are a number of bills before the Committee on Veterans' Affairs covering the direct-loan program. In its comments upon those various bills, which had quite a variant approach, the VA more or less indicated that that which had the more merit was the one that would extend the direct-loan program for 1 year, and continue the current \$25-million-per-quarter factors.

It is very difficult to say what amount is needed to satisfy demand. I think we pointed out that, in one of our comments on one of those bills, that of late, we were staying fairly current with respect to backlog of applications. There is a backlog of applications, but when we go to these applicants and tell them "Now, the money is available," there is a substantial falloff. They have made other plans. Or they didn't have plans.

Mr. MULTER. How long does it take, ordinarily, between the date of application and the date of notification, to have the money available?

Mr. KING. Well, there is no application under the routine we use, Congressman, until the money is available. We advise the veteran that money is available and send him an application at the same time.

Mr. MULTER. I don't follow you, then. How can you have a backlog of applications?

Mr. KING. Well, we have a backlog of inquiries.

Mr. MULTER. I see. Well, can you give us any idea as to what time would elapse between the date of inquiry and the date of application?

Mr. KING. I would think several months elapse. When a given veteran writes or comes into VA and says he would like a direct loan for this or that purpose, very often it is several months before we can reach him.

Mr. MULTER. Is that because of the backlog of work or because of the unavailability of the funds?

Mr. KING. That is because of the fact that we do not have funds available for a location to him at that particular time.

Mr. MULTER. I see.

Mr. KING. He has to wait and be a beneficiary of the next allotment.

Mr. MULTER. What is the cause for the delay, in many instances, of sometimes as much as 6 months, in making payment after an application has been processed, commitment issued, building erected, passed, and everything else, and the documents are all completed? Or am I inferring a fact that is not so?

I have been told that in some instances there is as much as 6 months' delay in getting the money after the application is approved, the building is completed, has passed inspection, and documents have been approved and signed.

Mr. KING. I would be extremely surprised if you could cite to me a case in which after all those events have taken place it has taken VA 6 months to produce the money.

Mr. MULTER. What is the average length of time it takes them to produce the money?

Mr. KING. I would think that—you are talking about a construction loan, Congressman?

Mr. MULTER. No, I am not. I am talking about the final payment on the loan after everything is in order, the house is sold, the veteran has moved in, and the mortgagee is still waiting for his money from VA.

Mr. KING. I am sorry, because the sequence you narrated, beginning with the application, and then through toward completion, indicated a construction loan.

Where a veteran puts in his application to get direct-loan money, and he is buying a completed house, I would think that that money would be forthcoming fairly quickly.

We asked our staff appraisers to look at as high a percentage of these direct loans as we can. It may be that it took the staff appraiser some time to get there. It could be due to any number of factors, but I think you will find that, case by case, when the final facts are in, the housing is completed, and so forth, that VA pays the money out very promptly. It pays it out through a settlement, in which it uses its own closing attorney, and, of course, there has to be some wait to getting title evidence, and so forth.

Mr. MULTER. Well, the one I may have in mind may be an isolated case, so I won't take your time with it now, but I will send you the information and let you give me a complete report on it.

Mr. KING. I will be glad to do so.

Mr. MULTER. I am glad to know that it is not the rule, but is rather the exception.

Now, if we may turn to another subject for a moment, can you give us the total amount, in dollars, and in numbers of, inquiries you have on hand as of the last date, the nearest date for which you have the information on hand?

Well, you didn't take applications not having money available, I presume. Do you have such a compilation?

Mr. KING. As of January 31, 1954, there were about 32,000 veterans with loan requests on file, for which funds had not been reserved in the VA regional offices, and which lay or lie in areas designated as eligible for direct loans.

However, that figure, that 32,000 figure, is a very unreliable figure because of the influence I mentioned a few minutes ago, when I said that when we will offer many of those 32,000 veterans the money, and tell them to file their applications because the money is available, it will be found that they don't have fixed plans, or that they have made other plans.

Mr. MULTER. And the other plans invariably are that they have gone out and gotten money at a higher interest rate somewhere else?

Mr. KING. That may have been the result in the individual case, but there is a great variety of reasons.

Mr. MULTER. You have no statistics breaking down the reasons why, after inquiry, and between the inquiry and notice of availability of money they have gone elsewhere for the money?

Mr. KING. The only way in which I could tell you would be to make a special survey of those cases by visiting those veterans, which would involve a prohibitive cost.

I would think that in many cases they just didn't get the house they had in mind, and forgot about the whole thing.

Mr. MULTER. Do you have any aggregate figure of dollars as to the amount of those 32,000 inquiries, how much money they would need in the aggregate?

Mr. KING. Our direct loan maximum is \$10,000. I think our direct loan average is somewhere around \$7,000. So I think you will find that the average amount of money those folks would contemplate having would lay somewhere between those two margins.

Mr. MULTER. Well, if we took the minimum of \$7,000, which you say is average?

Mr. KING. Yes, sir.

Mr. MULTER. Do they drop off more than 50 percent between inquiry and notice of availability of money?

Mr. KING. I wouldn't be surprised if the dropoff were somewhere between 30 and 50 percent.

Mr. MULTER. Does VA inspect these houses in addition to FHA, before final approval?

Mr. KING. Are you talking about direct loans still, or are you talking about something else?

Mr. MULTER. Well, does the procedure differ?

Mr. KING. Yes, sir; the direct loan program largely is a rural program, in which an existing house is involved, and VA makes the appraisal and there is no question of inspections.

Now, when you come into the metropolitan areas, in large project building areas, then you have a situation where either FHA or VA may be inspecting during the course of construction.

Mr. MULTER. But does VA make a final inspection even though FHA may have been handling the inspection up to final completion?

Mr. KING. The general practice, Congressman, is that if FHA is inspecting a unit under construction, VA does not make any inspection. It accepts the FHA final inspection form 2051. In given places and instances, VA has either required all its own inspections or has required a final check inspection.

Those instances are in the minority. Wherever a lender will certify to us that the in-place construction is identical with that which was in the plans and specifications submitted to VA, or in the veterans' contract, then we will not require that final inspection.

But where we can't get evidence to that effect elsewhere, we don't have any choice except to make final inspection.

Mr. MULTER. The President's Advisory Committee on Government Housing Policies and Programs has recommended, as you probably know, that both FHA and VA should establish a procedure for the exchange of information concerning builders with whom respective agencies have had unsatisfactory results. Has anything been done along that line?

Mr. KING. We do have provision, by statute, for suspending lenders or for suspending builders.

Mr. MULTER. Now, the Commission has recommended that the various agencies, FHA and VA, exchange information. Apparently they haven't been doing it. They have the right to suspend, but if FHA finds a bad builder or you find a bad builder, and you don't tell the other agency about it, they have got to find out about it themselves.

Mr. KING. I am sorry, I misheard that part of the inquiry. We do exchange information on those things and we have been doing so ever since the Rains subcommittee of this committee brought in its report.

Mr. MULTER. The same President's committee also suggested that FHA and VA require sworn statements of substantial compliance with specifications before payments are made. Have you done anything to implement that suggestion?

Mr. KING. Sworn statements from whom?

Mr. MULTER. From the builder, of substantial compliance with the specifications.

Mr. KING. No, sir, we don't require a sworn statement from a builder in any instance where the agency has inspected.

Mr. MULTER. Don't you think you should?

Mr. KING. There might be some merit in that. However, I believe the practical problem there is to get a builder to certify as to things which he contends with some truth lie in the realm of judgment.

For example, various proposals were made for a builder to certify that they were in compliance with the minimum property requirements, and I go along with the builder in saying that he ought to be careful about signing that type of certification because there are many points involved there in which judgments could differ. You and I could differ, in every house, as to whether there had been compliance or not, and we would both be perfectly sincere.

Mr. MULTER. I think what the Commission had in mind and what I have in mind is a situation of a veteran or anyone else buying a new building, which was sold to the buyer, from plans and specifications, and then the building turns out to be other than in accordance with plans and specifications, and the complaint is made to your agency or the FHA, and then referred to the United States attorney's office, and there is nothing he can do about it. But if you took an affidavit from that builder you could do something about it.

I am not referring to questions of judgment, that is one thing. But if there were questions of actual fraud, that would be another. Then the United States attorney could do something.

I think that is what they had in mind in recommending these affidavits of substantial compliance. They don't say exact compliance. Nobody can do that. Substantial compliance. I think your agency can cover that situation by regulation and I think both you and FHA should do it.

Mr. KING. I promise you that we will take it under advisement, Congressman.

Mr. MULTER. Thank you, Mr. Chairman.

The CHAIRMAN. Mr. King, you exhibited some fear that in the administration of the act there might be some dilution of the veterans' preference. Now, as I understand it, there is nothing in the proposed bill which will prevent the President from maintaining that preference.

Mr. KING. No, sir, Mr. Chairman. As the bill reads, it is perfectly possible for the President to maintain the preference.

The CHAIRMAN. Well, any fear along that line, then, must be predicated upon the President destroying the relative preference which veterans now have?

Mr. KING. Yes, sir; but our comment, in addressing to the attention of this committee that aspect—

The CHAIRMAN. You would like to prevent that by creating more rigid standards, I take it?

Mr. KING. Was with the hope that the committee might decide, if they considered that at this date it was still desirable to retain the housing preference for veterans, that the committee would so indicate in the bill. It would strengthen the President's hand in keeping some preference margins.

The same problem came up, as you may recall, Mr. Chairman, in reference to the credit controls, in 1950. The point was raised as to whether or not veterans should have preference in the imposition of credit controls, and it had a long history in and out of Congress, and we thought that that point could be cleared up once and for all through the medium of this bill.

The CHAIRMAN. You think it should be made a little clearer in respect to legislative intent, perhaps?

Mr. KING. Yes, sir, precisely.

The CHAIRMAN. It could be done, of course, in the report as well as in the legislation.

Mr. KING. Yes, sir.

Mr. MERRILL. Mr. Chairman.

The CHAIRMAN. Mr. Merrill.

Mr. MERRILL. I want to get this completely clear in my mind. As I understand it, the only way that we would preserve this preference for the veterans, under this present situation, and do it soundly, would be to deny to the nonveteran something that this bill in its present form gives him. Is that right?

Mr. KING. You are assuming, of course, that the President has activated his power. The bill in its major aspect doesn't give this authority, give these things, but poses an authority through which these things can be given.

Mr. MERRILL. Yes; but in order to maintain the preference, the effect of it would have to be to deny to the nonveteran something which the bill in its present form now gives the nonveteran.

Mr. KING. Something which the bill in its present form now contemplates might be given to the nonveteran.

Mr. MERRILL. Yes.

Mr. KING. That is true. But it isn't denying the nonveteran anything, because, basically, the liberal housing credit aids supplied for veterans were a gift to veterans, in fact.

Mr. MERRILL. But the bill in its present form provides for certain possibilities of credit. Now, to protect the veteran, to give him his preference, it would have to deny to the nonveteran some of the possibilities of credit which the bill now gives him; is that right?

Mr. KING. To preserve a preferential position for veterans would require the continuance of a margin as between veteran and nonveteran.

Mr. MERRILL. And to deny to the nonveteran something which potentially was given to the nonveteran in this bill.

Mr. KING. Well, sir, if you give me and one of these gentlemen each a gift, and you don't give Mr. Fink a gift, do you deny him the gift?

Mr. MERRILL. Well, let's say this: The bill in its present form treats them all alike, let's say. Now the bill in its present form does. To make the difference, you are going to have to have to withdraw, or contract the benefits in this bill so far as the nonveteran is concerned, aren't you?

The CHAIRMAN. This is our situation. I wonder if Mr. King could answer that question on the record. We have got to go to the floor. The second bell has rung, and we are taking up the Commodity Credit bill, a bill reported by this committee, and I had hoped that we might dispose of this question with Mr. King this morning and I hope we can. Can't your colloquy be in the form of a revision of your remarks, Mr. Merrill? Because we have got to go to the floor and have to be there in the next 3 or 4 minutes. And we want to be there to move that the House resolve itself into a Committee of the Whole to consider the Commodity Credit legislation. So we have got to adjourn.

Mr. MERRILL. I think we can let the record stand as it is, Mr. Chairman.

The CHAIRMAN. Very well. Thank you very much, Mr. King.

Mr. KING. Thank you, Mr. Chairman.

The CHAIRMAN. The committee will stand in recess until Monday morning at 10 o'clock.

(Whereupon, at 12:05 p. m., the committee adjourned until 10 a. m., Monday, March 8, 1954.)

HOUSING ACT OF 1954

MONDAY, MARCH 8, 1954

HOUSE OF REPRESENTATIVES,
COMMITTEE ON BANKING AND CURRENCY,
Washington, D. C.

The committee met at 10 a. m., Hon. Jesse P. Wolcott (chairman) presiding.

Present: Chairman Wolcott, Messrs. Kilburn, McDonough, Mumma, McVey, Merrill, Hiestand, Stringfellow, Van Pelt, Spence, Brown, Deane, O'Brien, Bolling, Hays, and O'Hara.

The CHAIRMAN. The committee will come to order.

We will proceed to consideration of H. R. 7839.

We have with us as our first witness this morning Mr. Ferry, of the Department of Defense, accompanied by Colonel McCord, representing the Air Force. We are happy to have you proceed, gentlemen.

I think we should apologize to these gentlemen for having them wait around here last week. We just couldn't do otherwise.

Mr. FERRY. You were caught up in a very interesting discussion. I was very interested in hearing the discussion.

STATEMENT OF JOHN M. FERRY, SPECIAL ASSISTANT FOR INSTALLATIONS TO THE SECRETARY OF THE AIR FORCE, ACCOMPANIED BY COL. HAL McCORD AND JOHN W. MITCHELL

Mr. FERRY. My name is John M. Ferry and I am the special assistant for installations to the Secretary of the Air Force. I have a prepared statement which I will be glad to read and then answer any questions which the committee may have.

I have brought up to the witness table with me Col. Hal McCord, who is in charge of the housing program for the Air Force, and may be able to add any details with which I may not be familiar.

On behalf of the Department of Defense, I wish to express my appreciation for this opportunity to appear before your committee and to present the Department's views on the extension of the Wherry Act.

The military departments have a very special interest in this legislation because it is one of the principal means by which the military services retain experienced and qualified personnel. One of the quickest ways to lose our personnel is to effectively deny them the opportunity to maintain their families at their accustomed standard of living. Our surveys to determine factors that bear upon the decision "to stay in" or "to get out" of the service shows that adequate housing is one of the principal considerations weighed by both the enlisted

men and officer personnel. The lack of proper housing in the past, as you know, has caused the services to lose many fine well-trained individuals who might otherwise have made a career of service for our country. One of the greatest single items of expense that the services are forced to contend with is that expense incurred in training specialists to operate the highly technical equipment of modern warfare. Training, of course, is always with us, but the cost of retraining to replace those who leave the service because of living conditions is very large indeed. The extension of title VIII of the National Housing Act which appears in section 128 of this bill, H. R. 7839, would continue for the military departments the existing authority through which permanent family housing can be provided and in this manner assist in retaining our experienced and qualified personnel.

The Wherry Act has been utilized to the fullest extent practicable at our permanent installations. It must be noted that the military utilization of installations has greatly changed within the past few years and particularly is this true of air installations. During the last war airbases in this country were utilized principally for training and movement to combat areas. With the advent of long-range defensive weapons and striking forces, our installations have now become war operational areas either for offensive or defensive operations. When this fact is recognized it becomes apparent that base life as it existed previously must be changed to meet the new military conditions. For this reason the military departments must now of necessity bring their personnel closer and closer to the actual operating sites. It is imperative that we tune our thinking to this new concept and its relationship to the location of our people with respect to their job. Air Force personnel who may be unable to perform their military assignment within a very short time are not only a loss to the service but effectively reduce our ability to fight off invasion or to launch an effective counter-attack. For example, a fighter interceptor pilot or his crew chief obviously cannot live a great distance away from his base across a congested area of city traffic and be ready to do the job as effectively as if that pilot or crew chief were living on or adjacent to the base. Housing military families on the reservation, therefore, has been found to be the only practical method of assuring a constant availability of the maximum number of operational personnel in time of emergency.

The Wherry Act has contributed more to the stability and welfare of Air Force personnel and personnel of the other departments than any other similar measure pertaining to the provision of housing that has been adopted by the Congress. Rents in many locations are still beyond the financial capability of service personnel and impose quite a hardship on the serviceman who is transferred into an area of high costs. We are doing our best to provide the serviceman with housing where he will not be subject to rentals beyond his ability and substandard housing conditions. There are still areas where high rentals and high living costs cause some service personnel to live under other than desirable conditions. The Wherry Act has assisted immeasurably at the permanent stations to correct these conditions but there is still much room for improvement and there are still areas where rents are simply too high for our people to afford. Many sacrifices are made by service personnel to maintain their individual dignity and the dignity of the uniform.

The necessity for continuation of the Wherry Act can also be demonstrated by citing a few statistics. At the present time the Departments have 22,000 units which represent the present expectation of construction under the provisions of the act. These units will be spread throughout the United States to increase the number of units at existing projects and to provide new locations. The Departments requirements for family housing for the 3 services total in the neighborhood of 600,000 units. The available housing amounts to about 200,000 units leaving a deficiency of approximately 400,000 units. Of the amount available about 87,000 units have been completed or certified under the Wherry program. It may be noted that there is a vast difference between the requirement, the total available, and the remaining deficit. While we know that many organizations and individuals believe that the Wherry Act has been used more extensively than the figures demonstrate, it must be realized that even with all of the assistance of the Wherry program the military must still rely for the most part upon adjacent communities for family housing.

It is equally significant to note the number of temporary units which are currently in existence. Of the houses available approximately 15,000 are of such temporary construction and have reached such an age that they are approaching a point where it is no longer economically feasible to continue maintenance. Maintenance on temporary units and on the older public quarters gradually reaches a point where the return is less than the investment warrants. These units are not only, therefore, unattractive from the standpoint of living conditions, but are economically unsound.

The Wherry program is actively developed in consonance with the military public works program. As you know, housing projects must be so timed that occupancy will be assured upon completion. It is very important, therefore, that we so plan and construct the Wherry units that they will be ready when the base or installation is completed. In no case thus far have we built the housing before an installation has been actually occupied. I believe, therefore, that the services are carrying out your wishes in properly providing the housing under the Wherry program and recommend that the extension of the act be granted. It would be unwise, I think, not to continue this program at this time and it would certainly be unfair to require men who sacrifice so much by entering the service of their country to live apart from their families or force them to live under substandard conditions.

The CHAIRMAN. Thank you, Mr. Ferry.

Are there questions of Mr. Ferry by members of the committee?

Mr. MERRILL. Mr. Chairman.

The CHAIRMAN. Mr. Merrill.

Mr. MERRILL. As I understand it, the bill as it is now written satisfies your requirements as stated here?

Mr. FERRY. Yes, sir; Mr. Merrill. We are very, very pleased with it.

Mr. DEANE. Mr. Chairman.

The CHAIRMAN. Mr. Deane:

Mr. DEANE. I was impressed that Mr. Ferry, on the first page of your statement, about the necessary housing for the military in order to maintain the proper military personnel. I had a noncommissioned officer visit me yesterday afternoon, and what he and his wife discussed was housing. He had been moved from a camp in Virginia to a camp

in Maryland, and I asked him how long was he going to stay in the service, and whether he was going to make it his career. He had been in 7 or 8 years. And very suddenly he spoke out and said, well, he didn't know how much longer because the housing was so unsuitable. That is the first time his wife had heard him express that. She said "That is news to me. I didn't know you were thinking along those lines."

So I feel very strongly, as you do, that if we are to maintain the proper military personnel housing is a key factor.

Do you care to amplify on what you say here on page 1 of your statement?

Mr. FERRY. I would be glad to, Mr. Deane.

In personal conversations that I have had as I have gone around from one installation to the other—these are largely Air Force installations that I am speaking of—I have talked to a great many of the enlisted personnel, and I have found that of all the factors which influence their dislike or their disagreement with conditions under which they are living, the inadequacy of housing, in many instances, is the most pertinent factor that I have discovered. I think it outweighs the question of pay, I think it outweighs the question of fringe benefits about which we hear so much nowadays.

If a man is living with his family, and his wife is unhappy, I think we all know pretty well she can make him an unhappy man, he is not going to stay in the service.

Mr. DEANE. I direct my questioning now to the Wherry Act. As I understand it, housing under the Wherry Act is for permanent installations.

Mr. FERRY. That is correct, sir. That is legally the only place where we can build Wherry housing.

Mr. DEANE. Of course you need housing in areas where they are not permanent installations?

Mr. FERRY. Yes, sir.

Mr. DEANE. I wonder if you are in a position to advise, so far as the needs with reference to the other services, as well as the Air Force?

Mr. FERRY. I would prefer, if I might, not to speak beyond the needs of the air services. But I have with me Mr. Mitchell who can speak about that.

Mr. DEANE. I think that is important, Mr. Chairman.

Mr. FERRY. I will ask Mr. Mitchell to answer that.

Mr. Mitchell, would you tell the committee something of the needs of the Army and Navy for housing?

Mr. MITCHELL. Yes, Congressman Deane and members of the committee, the figures quoted in the statement which has just been read by Mr. Ferry do cover the entire Defense Establishment. The deficiency as shown is 200,000 units—that is for the three military departments.

The other means for providing housing, of course, if that is what you refer to, Congressman Deane, are titles IX and III. We have obtained some benefits from these sources at both permanent or temporary installations.

Mr. DEANE. So far as I understand, as far as the Wherry housing is concerned, would you break that down as far as each of the services is concerned?

Mr. MITCHELL. As to what has been obtained?

Mr. DEANE. That is right, for each of the services.

Mr. MITCHELL. There are a total of 227 projects at the present time in the program. That represents those which have been certified by the Secretary of the Military Department and are either in the developmental stages, in the process of construction, or have been completed.

Of those 227 projects, 146 are completed entirely. The 227 projects account for approximately 87,000 units, of which 63,000 are completed; 18,000 at Army installations, 14,500 at Navy, and 30,800 at Air Force bases.

Mr. DEANE. Eighty-seven thousand, 63,000 complete?

Mr. MITCHELL. That is right. In addition, there are 42 projects with 14,000 units under construction, some of which may have been completed, but our reports do not reflect it until the entire project is complete. Another 39 projects with 10,000 units in various stages of processing.

Mr. DEANE. How many projects are on the boards, being projected?

Mr. MITCHELL. There are 22,000 units tentatively planned for next year's program. The total number of projects in the planning and development stage is 55.

Mr. DEANE. When would those projected projects be in construction?

Mr. MITCHELL. Thirty of those fifty-five have been certificated and are actually in the developmental stages.

Mr. DEANE. How long does it take to certificate a project and get it ready for construction? What period of time?

Mr. MITCHELL. Well, it varies considerably. I might let Colonel McCord speak on that.

Colonel McCORD. Mr. Deane, it has been our experience over about 17 projects in the last 18 months to 2 years that it requires 15 months from the time that a project is decided as being required and the planning directive is issued, until the commitment by FHA is issued. Within 60 or 90 days after the commitment is issued construction has begun.

Mr. DEANE. This bill proposes to extend the Wherry Act for how long?

Mr. FERRY. Another year, sir, after the end of June.

Mr. HAYS. Will you yield?

Mr. DEANE. I yield.

Mr. HAYS. You will hardly have enough time to get FHA on the balance in that time.

Colonel McCORD. That is true, Mr. Hays. We have to start programming our units in April in order to insure issuance of the commitment under the extension which we are seeking.

Mr. HAYS. I hate to put you on the spot, but do you think FHA needs to take that long?

Colonel McCORD. It isn't all FHA. They have been extremely cooperative. But in order to insure the economic stability of the project it is necessary to make a very careful determination of the requirements in an area, to develop the plans and specifications under competent engineer supervision, for the sponsor to be selected under a bid procedure, and for that sponsor to secure his financing.

Those are requisite to the procedure before FHA will finally issue a commitment for the insurance.

Mr. HAYS. How long do they take after you are ready?

Colonel McCORD. FHA will issue a commitment after we have made the application, in anywhere from 30 to 60 days. It has averaged in some places in the neighborhood of 45 to 60 days.

Mr. HAYS. Do they ask your architects to make changes very often?

Colonel McCORD. Frequently, that is true, particularly if we have an inexperienced architect, with a title VIII program, he will incorporate features which will extend the cost beyond the mortgage limitation that is imposed by the legislation.

Mr. HAYS. Thank you. Mr. Deane.

Mr. DEANE. You stated, Mr. Ferry, that you were satisfied with this particular bill. As I understand it, title III has been dropped.

Mr. FERRY. It has not proved too useful for us.

Mr. DEANE. I sympathize with you on that score, and I feel the same way. But also title IX has been dropped, has it not?

Mr. FERRY. Yes, sir. We haven't found that worked out too well. The Wherry housing seems to have been the actual practical approach to getting this housing, sir.

Mr. DEANE. As I understand, then, you are, to a limited extent, or to a full extent, depending upon Wherry housing for your main housing projects; is that right?

Mr. FERRY. That is true, sir, at the permanent basis.

Now, of course, let me clarify this for the members here. We still depend upon the local economy to take up some of the slack. In other words, we do not program for, nor do we build for, the full military requirements at a base. If there is a community within reasonable distance that can take part of it.

Mr. DEANE. Colonel McCord, would you describe the type of people, as far as military personnel, who are now using Wherry housing, as to whether they are enlisted men or junior officers, and the rents that are being charged, and other factors which you think would be of interest to the committee?

Mr. FERRY. I will ask Colonel McCord to give you figures on rents because I am not too familiar with those, but, actually, you know all military personnel are not entitled to housing. Only the three upper grades, which in the Air Force are master sergeant, staff sergeant, and technical sergeant.

The use of this Wherry housing is confined to those three grades, which in the other services are comparable—Navy and Army—and to officers ranging in rank right on up to full colonels.

Can you give us a breakdown of the rentals as between enlisted personnel and officer personnel, Colonel?

Colonel McCORD. Mr. Deane, I have not a breakdown specifically between the officer and airman rental charges. I do have the statistics on the average for the projects that we now have in being.

Mr. DEANE. And can you give us the size of the rooms, and so forth?

Colonel McCORD. I have the average square feet per dwelling unit. We have computed the average square feet per dwelling unit as being the livable space—net areas—that is exclusive of storage areas, walls, partitions, and so forth. Of our present projects our average is 964 square feet per unit. The average mortgage, per dwelling unit,

is \$8,093. The average shelter rent, exclusive of utilities, is approximately \$70. Our average utility cost—that is per month, of course. Our average utility cost, per month, has been in the neighborhood of \$12 per unit per month. It gives us, then, a gross rent of approximately \$82 per unit per month, and the average quarters allowance paid Air Force personnel is \$86 per month.

Mr. DEANE. How does that compare to the other two services?

Colonel McCORD. I do not have the figures for the other two services, but I think it is probably comparable.

Mr. FERRY. It is substantially the same, Mr. Deane. We have the figures here in case you would like to have them specifically.

Mr. DEANE. If they are comparable, we will pass along.

Mr. HAYS. Will you yield?

Mr. DEANE. I yield.

Mr. HAYS. You said 964 square feet?

Colonel McCORD. Yes, sir.

Mr. HAYS. Translate that into rooms so that I will have some idea what you are talking about? Is it a 2-bedroom unit, or a 1-bedroom, or what?

Colonel McCORD. No, those are 2- and 3-bedroom type units. We have tried to maintain a 2-bedroom unit on approximately 900 feet—880—and a 3-bedroom unit will run about 1,100 feet.

Mr. HAYS. Thank you.

Mr. DEANE. Now, this housing, is it on the base or contiguous, or where is it located?

Mr. FERRY. These are usually, sir, upon the actual military reservations.

Mr. DEANE. Is it true that in some places the local taxing authorities have either considered or have been advised by the military with reference to taxing these housing units?

Mr. FERRY. There have been attempts where attempts have been made or pressures have been exerted to get some of this on the taxrolls.

Mr. DEANE. What was the military viewpoint on that?

Mr. FERRY. The military viewpoint is substantially that if taxes were to be levied on these projects, on military installations, it would raise rents substantially to the point where it would work an additional hardship upon our people, and we are resisting the notion.

Mr. DEANE. Going back to Colonel McCord, we have in this record evidence which has been given on the cost of construction with reference to these long-range amortizations. I understand you to say that this 2- or 3-bedroom house, which I understand is brick, costs approximately \$8,000.

Colonel McCORD. Mr. Deane, the materials of construction varies with the cost area. In many low-cost areas we have projects with masonry-type construction. In other areas it is frame-type construction.

Mr. DEANE. Well, this \$8,000 unit, which you mentioned, what kind of construction is that?

Colonel McCORD. It varies, sir. It meets the FHA minimum requirements. In many of our low-cost areas we have masonry units.

Mr. DEANE. Does that include the land?

Colonel McCORD. No, sir; that does not include the land.

Mr. DEANE. Going back again, Mr. Ferry, to your statement that, so far as the legislation is concerned, the bill meets with your approval, I wonder if you have had an opportunity to really study completely the possibility of what this housing will cost if the interest factor changed materially?

Colonel McCORD. Yes, sir.

Mr. DEANE. I have asked a member of the staff to prepare this statement for me in the last few minutes since I came to the committee room, and I wonder if you would check me to see whether this is correct.

As far as FHA is concerned, maximum interest rate on Wherry housing remains unchanged at 4½ percent. It was 4 until last year, when it was increased, was it not, to how much?

Colonel McCORD. At the discretion of the Commissioner, but the maximum was not to exceed 4½ percent, sir.

Mr. DEANE. What is the approximate rate now?

Colonel McCORD. Four and a quarter percent.

Mr. DEANE. Four and a quarter?

Colonel McCORD. Yes, sir.

Mr. DEANE. Under the authority of this bill, section 201, the President could raise interest rates to 2½ percent, plus an average yield on long-term—say 15-year—Government securities, and under a similar authority contained in last year's Housing Act, the Treasury has set for this 6 months, a 2⅞ percent. Now, what I am trying to arrive at—the interest rates could be 2½ percent, plus the 3, or approximately 5½ percent.

Have you studied the bill to the point of analyzing the interest factor, so far as the rental cost for these Wherry units is concerned?

Colonel McCORD. Yes, sir; for every quarter percent increase in the interest rate the rents would be adjusted upward, if the interest rates were increased, \$2 per unit per month.

Mr. DEANE. Approximately what are the FHA charges with regards to the premium, approximately?

Colonel McCORD. I think it is a half of 1 percent, Mr. Deane.

Mr. DEANE. A half of 1 percent?

I have here from a half to 1½ percent.

Colonel McCORD. Right. Right now I think our figures on most of our development projects are based on a half of 1 percent.

Mr. DEANE. Well, the significant factor that I gain from the interest factor here is, of the large increase in the rental cost—Did you say that would be for every quarter of percent change in the interest rate \$2 per unit per month?

Colonel McCORD. Yes, sir; that is correct.

Mr. MERRILL. Mr. Deane, will you yield?

Mr. DEANE. I yield.

Mr. MERRILL. I don't quite see how that works. You say the average mortgage is \$8,000.

Colonel McCORD. It cannot exceed \$8,100.

Mr. MERRILL. Well, if you take \$8,000, and take a quarter of 1 percent of that, does that come out to \$20?

Colonel McCORD. I have not any mathematics available for the committee at the moment. I can furnish that information and the computations which have just been filed for this particular \$2 per unit per month increase in rents.

Mr. MERRILL. It looks to me as if a quarter of 1 percent of \$8,000 is \$20. That is the maximum amount of the mortgage at any time. Now, that mortgage will be decreasing over the years.

Now, \$2 a month is \$24 a year. It looks to me as though \$2 a month increase in rent is \$4 more than the maximum possible increase in the interest, at the maximum time of the mortgage. Am I wrong in that?

Colonel McCORD. If the chairman will permit, I will bring that computation to the committee this afternoon and we will furnish it to you, Mr. Merrill.

The CHAIRMAN. Very well. It may be put in the record.
(The material referred to follows:)

Effect of increased interest rates on average Wherry housing mortgage of \$8,100

Percent rate	Rate per \$1,000 amortization and interest	Per \$8,100 mortgage	Cumulative increase	Vacancy (rent increase)		Installment
				3 percent	7 percent	
						<i>Months</i>
4		\$37.13	(¹)			391
4 $\frac{1}{4}$	4.791667	38.81	\$1.68	\$1.92	\$2.01	381
4 $\frac{1}{2}$	5.0	40.50	3.37	3.86	4.03	371
4 $\frac{3}{4}$	5.20833	42.19	5.06	5.80	6.05	362
5	5.41667	43.88	6.75	7.73	8.06	353
5 $\frac{1}{4}$	5.625	45.56	8.43	9.65	10.07	345
5 $\frac{1}{2}$	5.8333	47.25	10.12	11.59	12.09	337
5 $\frac{3}{4}$	6.041667	48.94	11.81	13.52	14.11	330
6	6.25	50.63	13.60	15.46	16.13	323
6 $\frac{1}{4}$	6.45833	52.31	15.18	17.39	18.14	317
6 $\frac{1}{2}$	6.66666	54.00	16.87	19.32	20.15	310

¹ PUPM base.

Mr. DEANE. That is all, Mr. Chairman.

The CHAIRMAN. Are there further questions?

Mr. SPENCE. Colonel McCORD, are you asking that the existing law be continued without change?

Colonel McCORD. Yes, sir.

Mr. SPENCE. You have no suggestions for any amendments?

Colonel McCORD. No, sir; we are asking that it be continued as is, Mr. Spence.

Mr. MUMMA. Mr. Chairman.

The CHAIRMAN. Mr. Mumma.

Mr. MUMMA. Colonel, is the architectural service under the control of the sponsor of the project? Who furnishes the architectural service?

Colonel McCORD. The using department.

Mr. MUMMA. In other words, your department?

Colonel McCORD. That is correct.

Mr. MUMMA. Do they have more or less standard plans which are adapted for the site, or does everybody do his own work?

Colonel McCORD. We try to vary the type of units so that they don't become too stereotyped. There are certain service of plans, Mr. Mumma, which we must follow, from our experience in developing a project, within the limitations of the \$8,100 mortgage.

Mr. MUMMA. When the Army did the big building during World War II, or previous to it, they had standard plans for every type building, and they just employed an engineer to put the utilities in.

Colonel McCORD. That is correct, sir.

Mr. FERRY. We still do that, Mr. Mumma.

Mr. MUMMA. Well, it just struck me as funny. There is one little Wherry project that I was interested in. As I remember it, the architect, or the fellow who drew the plans, was from Newark, N. J. Now, it seems to me that there could be economy two ways, if they had more or less of a standard plan, and came in as you did in a big project and got an engineer, locally, who fit the whole thing in, which way to face the buildings, and everything. Every question the Wherry man had to solve he had to go to some fellow in Newark. As I remember, it was a Jersey location.

It seems to me that you could have more or less standard plans and save the Government a lot of money.

Mr. FERRY. We are making an attempt now, Mr. Mumma, in our latest procedure, to use local architects if they are qualified and have housing experience.

Mr. MUMMA. For a Wherry housing job?

Mr. FERRY. Yes, sir.

Mr. MUMMA. I think you will find most of them practicing in Pennsylvania are. You have to have a license to practice to start with.

Mr. FERRY. Well, people who have not had experience in keeping it within the cost limits on this FHA housing are sometimes at a bit of a disadvantage.

Mr. MUMMA. Well, we have those fellows, too. It seems to me that was pretty far afield, unless the sponsor had something to do with it.

Mr. FERRY. We are trying to use local architects.

Colonel McCORD. One point, Mr. Mumma, which I think would probably clarify it: The cost of the plans and specifications is not a cost that is borne by the Government. It is paid for out of the planning funds, and as soon as a successful sponsor is selected that sponsor reimburses the fund from which the planning funds were drawn for the plans and specifications, so that the sponsor himself paid for the plans and specifications upon being awarded the contract.

Mr. MUMMA. How does he pay for it, out of his own pocket, or out of the gross?

Colonel McCORD. No; it is paid for out of the mortgage proceeds, which makes it a construction cost, put into the project, and is probably returned to him, then, over the period of years, in the form of his operational expenses and costs. He may get that back if the project is a successful project.

Mr. MUMMA. What I was wondering about was just this: If every fellow has to design his own building that takes about 10 times longer to do it than if a plan is furnished to him, which he should follow, using the local material which best fits into the project.

Colonel McCORD. We have attempted to design the plans, or have the architect design the plans to secure the greatest living-space possible within the area, for which the project is proposed.

Mr. MUMMA. I still think if you are developing a project you don't have to go to another community to get an architect.

Thank you.

Mr. HAYS. Mr. Chairman.

The CHAIRMAN. Mr. Hays.

Mr. HAYS. Mr. Ferry, you said you are satisfied with this bill. I would just like to ask you this: If the interest rates go up to the maximum allowable under this bill, don't you think there is a possibility that Congress will then be called upon to adjust upward the quarters allowances?

Mr. FERRY. Sir, that is one of the most difficult things that we could ask the Congress to do, would be to make any change in the living allowances. It has been some time since there has been any change in the military living allowances, and I think it is just one of the hazards that has to be faced with the present economic conditions.

If the economic conditions of the country dictate higher interest rates, I think we just have to suffer.

Mr. HAYS. I am not convinced that the economic conditions are dictating it. I think I can find supporting evidence and statements that it has been planned that way, and I am convinced also that it is one of the things which has slowed down the construction of housing. I just wondered if your thinking followed along that line.

Mr. FERRY. Well, I think I have to answer, sir, perhaps being impelled into this by the experience we have had in the past, that this Wherry housing has been so successful, it has been such a tremendous assist to the military, that I think we would rather live with the devil we know than the devil we don't know.

Mr. HAYS. Well, I think you are missing the point there. I am agreeing with you, about the Wherry housing. You say it has been so successful. I say then why tamper with it, why not just let it ride along as it is without tampering with the interest rates or giving someone leeway to adjust them upwards to maybe one and a half percent?

Mr. FERRY. Well, I have to make assumptions without knowing the facts. The only reason interest rates would be adjusted upwards would be because of economic pressures, competition for money. I could not imagine the adjustment being permitted if the interest rates were stable or falling, in the commercial field.

Mr. HAYS. Of course I think the commercial field sort of offset the artificial stimulation of interest rates, because lately they have been going down, much, I might say, to the dissatisfaction of certain people who said high interest rates were necessary. I don't think we need any artificial stimulus to interest rates. I think supply and demand will take care of it.

Mr. FERRY. I agree with you there, Congressman.

Mr. HAYS. One other question: Do you apply this Wherry Act housing to installations in foreign countries?

Mr. FERRY. No, sir.

Mr. HAYS. How do you build your installations in Germany? What funds do you use there?

Mr. FERRY. The German installations are rather a special case because they were built—

Mr. HAYS. I would think so, from what I have seen of them.

Mr. FERRY. They have fine housing, and they were built by deutsche-marks. The Germans actually paid for them themselves.

And they were building with an eye ultimately to using these themselves some day to come, and they built pretty fine houses. In fact, the nicest I have seen.

Mr. HAYS. I agree they are very fine. I was just wanting to get into the record exactly what funds were used to build them because, frankly, there have been a lot of articles and stories written in various newspapers and magazines, and the constituents of many Members of Congress have been led to believe that there has been a lot of money wasted, especially for higher rank officers, and I want to get your statement in. I had been told the same thing that you are saying, that they were built with counterpart funds.

Mr. FERRY. That is correct.

Mr. HAYS. Now, do you plan any housing at your Spanish bases, in North Africa?

Mr. FERRY. No, sir; we do not. We expect to keep our troop personnel at a fairly low level, and our present view is that the local economy will be able to house the families of those who are over there.

Of course, we will have barracks on the bases for the personnel and bachelor officer quarters for the single personnel, but we expect to house the families in the local economy.

Mr. HAYS. You might be interested to know that I have had several complaints from people who have come back from installations overseas, which said "If we have to live in the type of place that we can find in the continental United States I am going to get out of the service." I was just thinking that it seems to me that you ought to be encouraged to build here within the continental United States and its Territories for that reason, as well as the fact that there will be some sort of a stimulus to the economy here.

Mr. FERRY. We have no plans for any family housing developments in Spain. We do not plan them.

Mr. DEANE. Mr. Hays, will you yield?

Mr. HAYS. I yield.

Mr. DEANE. Do you have any military people in Cuba, in the Canal Zone, or in that area, where housing is needed?

Mr. FERRY. In Cuba, sir, I doubt very much that we have any military personnel other than the Embassy people, who may be assigned for Embassy duty.

Mr. DEANE. What about the Canal Zone?

Mr. FERRY. I am sorry, there is Guantanamo, of course, the naval base there.

In the Canal Zone, we have a great deal of Government housing, utilized for military purposes.

Mr. DEANE. The reason I am asking that is this: Is it still true that certain treaty provisions prevent you from using Wherry Act housing?

Mr. FERRY. We may only use Wherry Act housing, sir, on permanent military installations within the United States, its territories, and possessions; Puerto Rico, Hawaii, and so forth.

Mr. DEANE. Where are you going to get the housing for these installations?

Mr. FERRY. Well, the Canal Zone—I better not answer that question. It is so long since I have been in the zone, sir. I am going to turn the question to Mr. Mitchell. I think it is Government-owned housing.

Mr. MITCHELL. Most of it has been out of the appropriated funds.

Mr. DEANE. I beg your pardon?

Mr. MITCHELL. Most of it has been out of appropriated funds in the Canal Zone.

Mr. DEANE. The reason I am bringing this up, a committee headed by our colleague, Mr. Rains, found that that was true, that housing was not what it should be in the Canal Zone, principally because of the lack of Wherry housing, and because of the fact that the cost limited the operation. Is that true?

Mr. MITCHELL. There has not been any Wherry housing considered for the Canal Zone. To my knowledge, there is nothing under consideration because the area is not eligible for such housing.

Mr. HAYS. What about Guantanamo? That is the same situation.

Mr. MITCHELL. That is regarded as a foreign country, and the Wherry Act does not apply to a base like that.

Mr. HAYS. Of course, we have a 99-year lease on that.

Mr. MITCHELL. Yes, but the law does not permit it.

Mr. HAYS. How do they build their housing?

Mr. FERRY. Government funds, appropriated funds.

Mr. HAYS. I was down there last year and the housing that is there is very nice, but they tell me there is not nearly enough of it, especially for top enlisted men and junior officers. You have to be high up on the list before you can get in that housing down there. Is that true?

Mr. FERRY. That is true, sir.

Mr. HAYS. One other question: Would it be possible to provide the committee with a breakdown of the percentage number of units in your housing that are available for enlisted men and the percentage for lower-grade commissioned officers?

Mr. FERRY. That is available, sir, and we will be happy to furnish it for the record.

Mr. HAYS. Thank you.

(The information referred to is as follows:)

Composition of Wherry housing completed or under construction at Feb. 28, 1954

Type	Number of bed-rooms	Number of units	Percent	Type	Number of bed-rooms	Number of units	Percent
Airmen.....	1	1,477	4	Officer.....	1	636	2
Do.....	2	13,048	37	Do.....	2	8,483	24
Do.....	3	6,079	18	Do.....	3	5,080	15
				Do.....	4	260	
Total.....		20,604	59	Total.....		14,459	41

The CHAIRMAN. Are there further questions?

Mr. MERRILL. One more question.

The CHAIRMAN. Mr. Merrill.

Mr. MERRILL. I noted that the average cost of this housing, as compared to the average allowance for housing in the serviceman's pay, shows that at the present time allowance to military personnel for housing exceeds the average cost of housing in these projects.

Mr. FERRY. That is right.

Mr. MERRILL. By how much?

Mr. FERRY. Four dollars a month, roughly.

Mr. MERRILL. That is the average. Does that hold true as you break it down into the various grades. When you get down, say, to a technical sergeant, is it still true that his housing allowance is adequate for the amount of rent he has to pay under these projects?

Mr. FERRY. It would depend, sir, on the size of housing unit that he occupied. For example, if a technical sergeant were living in a 3-room house, he would obviously have to pay a higher rental than if he had a 2-bedroom house. And yet his quarters allowance is fixed, and we can do nothing about it.

Mr. MERRILL. That is right. I just wondered how that did break down by grades. Would you have information on that?

Mr. FERRY. Do we have information on that, Mr. Mitchell?

Mr. MITCHELL. We do not have it grade by grade. The average allowance for the top three grade men runs around \$80—\$77 to \$96, and averages out at \$80.

For officers, it averages out at \$105. That is the allowance.

The rental does not exceed that amount in any case. I might just point out that roughly two-thirds of the allowances go to the enlisted men. That is the Wherry housing.

Mr. MERRILL. Thank you.

Mr. BOLLING. Mr. Chairman, I have a question.

The CHAIRMAN. Mr. Bolling.

Mr. BOLLING. Could you furnish me, now or for the record, a breakdown as to the number of 1-, 2-, 3-, and 4-bedroom units?

Mr. FERRY. Yes, we will be glad to do so.

Mr. O'HARA. Mr. Chairman.

The CHAIRMAN. Mr. O'Hara.

Mr. O'HARA. Mr. Ferry, I have just one or two questions: I want to get Guam into the picture. What about the housing in Guam?

Mr. FERRY. There are some very comfortable Navy quarters, I know, which have been built on Guam, but those have been built out of appropriated funds. We have no Wherry Act housing on Guam.

I just find, sir, that we have a project afoot, both Air Force and Navy, for some additional housing at Guam, and we are looking at the possibilities of getting some Wherry Act housing. We have none so far.

Mr. O'HARA. That unfortunately is the case. I am afraid it is one reason why we are not doing as well as we might in creating the proper climate among the people in that far-flung outpost of American democracy. The fact is that there has been an entire lack of provision for suitable quarters for employees of the Government of Guam required to move from the new Naval Hospital area housing, and this despite the fact that there has been almost a year's notice. The Organic Act specifies that the Federal Government shall furnish suitable housing, yet the burden has been left entirely on the Government of Guam and even FHA personnel in Guam occupy the housing provided by the Guam Government instead of that resulting from FHA activities. I have been interested in what has been brought out about housing in the Canal Zone, Guantanamo, and at the bases in North Africa, but I am just as much interested, and I think you gentlemen should be, in the housing in Guam, which although it is far away is an American possession and is entitled to as much consideration as any other area of our great Union. You can assure me, Mr. Ferry, that you are giving attention to Guam?

Mr. FERRY. Yes, sir.

Mr. O'HARA. Appreciating that at the present time the housing in Guam is not at all comparable to that in other areas coming under the jurisdiction of the housing legislation enacted by this Congress?

Mr. FERRY. Sir—

Mr. O'HARA. Is that the situation on Guam now?

Mr. FERRY. I am not familiar with that, sir. I regret I cannot answer that question of my own knowledge.

Mr. O'HARA. You will look into it?

Mr. FERRY. I don't know.

Mr. O'HARA. That is, the armed services will look into the matter of housing on Guam?

Mr. FERRY. We will, sir.

The CHAIRMAN. Thank you very much, Mr. Ferry, and gentlemen.

Mr. FERRY. Thank you, Mr. Chairman.

The CHAIRMAN. Our next witness is Mr. Boris Shishkin, secretary of the housing committee of the American Federation of Labor.

We are glad to have you back with us, Mr. Shishkin.

STATEMENT OF BORIS SHISHKIN, SECRETARY OF THE HOUSING COMMITTEE OF THE AMERICAN FEDERATION OF LABOR

Mr. SHISHKIN. Mr. Chairman, members of the committee, I am Boris Shishkin, secretary of the housing committee of the American Federation of Labor.

I appreciate very much the opportunity to appear before the committee this morning in order to present our views on the pending housing legislation.

I would like to say at the outset that we regard the housing legislation before this session of Congress as of paramount importance to the economy of the United States. We feel that there are three major aspects of the legislation that need to be given particular consideration. First, relation of housing construction in this country at this time to our economy as a whole, and its health and vitality, since housing is one of the major economic forces, constructive forces, that have very wide ramifications in the growth of the economy.

Secondly, the relation of anything that we do with regard to housing, to the long-term future. Housing is not an industry, as many others are, in which the activity in one year may be of only a passing significance. It has very wide ramifications on the face of the land and the shape of our communities for many years to come, so that as far as building for a better America in the future, our actions here will have to meet that test, of whether or not they are sound in terms of their future effect.

And, third, of course, and most important of all, as far as the current legislation is concerned, is the relationship of housing to the present need. It is that immediate and crucial test to which any of the legislative proposals must be subjected.

I would like to say in connection with what I have said just now, that we are here to present our views on this legislation in the light of the record of many years of the activity of the American Federation of Labor in this field. We have been active in it for many years, active not only as representatives of workers as producers,

but also as representatives of wage earners as consumers—that is representatives of people who live in housing. I want to emphasize that anything that we present here is meant to be submitted in the most constructive and helpful spirit to this committee, which is confronted with a very complex and difficult problem.

The adequacy of proposals for housing legislation must be measured against housing needs. There is no basis for appraising such proposals unless we have the answers to certain basic questions. How many houses do we need? What groups in the population have the most urgent need for housing? To what extent can we rely on the existing supply to meet housing needs? How many new houses must be constructed? How soon must we have them?

Perhaps the first and foremost reason why we need a high level of residential building activity in this country is that our population is rapidly increasing. The actual growth of population has outstripped all past estimates of the Census Bureau and other population experts. Now we can look for an even more rapid increase in population in the years ahead.

By 1960 our present population of about 161 million will—actually, we have already reached that level of 161 million now—will increase to approximately 175 million. Thereafter, the population will increase even more rapidly as the huge crop of World War II babies reach the age when they marry and begin to have children. It is altogether possible that by 1970 we may have a population of more than 200 million.

In addition to the housing needed to keep up with this population growth, we must also replace the large existing supply of substandard housing. In 1950 there were at least 8 million substandard nonfarm units in the United States, and by now this number has increased considerably. The fact is that the current level of housing construction has not even kept up with the rate of population increase. As the result, none of this new construction has been left over to replace the rundown dwellings in which millions of American families are forced to live.

In the past few years, housing construction has been at a high level. But relative to the growth of population it has lagged behind. The fact is that even on an absolute basis housing activity has barely topped that of the 1920's. Thus for the years 1923-27 construction averaged 872,000 new housing starts each year. That is nonfarm. During the past 3 years new housing construction averaged 1.1 million.

For 1954 the forecast and the goal of the proposed program is only 1 million. This means that our sights are set on housing construction volume only 14.6 percent above 1923-27. Yet since 1923 our population has grown by nearly 50 million, an increase of 45 percent, and total national production has almost quadrupled.

It is indeed difficult to accept the target of 1 million nonfarm units for 1954 which barely exceeds the volume of such construction maintained some 30 years ago. It is even more difficult to square this with the housing picture that confronts us in the years that lie just ahead. It is a picture of a steadily increasing population and a large accumulation of substandard and rapidly deteriorating houses. This picture reflects the need for annual housing construction of at least 2 million units a year until 1960. After 1960, with the even greater increase

in population, it calls for even greater expansion of housing construction activity.

The need is for 2 million units. Yet in our judgement the legislation your committee is now considering will produce at the most, 1 million units. This would be our estimate of the production potential that could be expected under this legislation even if the administration had not already acknowledged that only 1 million units could be produced under it.

One of the encouraging signs of the times is that the extent of unmet needs for housing in the United States (particularly among low- and middle-income families, has at last been acknowledged, even by those who in the past have refused to concede them. Even the homebuilders' association is coming close to our estimate of the housing need.

Here are some recent estimates of annual average housing construction needed in the period 1955-60:

American Federation of Labor, 2 million.

National Housing Conference, 2 million.

National Association of Homebuilders, 2 million, including rehabilitation.

Twentieth Century Fund, 1,800,000.

Fortune Magazine, 1,400,000.

We are greatly encouraged by the evidence of increasing agreement with us regarding the immediate and urgent need for a substantial expansion in housing construction activity throughout the Nation. We believe it is important to recognize that this need must be met mainly through new housing construction rather than by patching up of that portion of our housing stock which is old, rundown, and subject to further rapid obsolescence.

I want to make sure that our position is not misconstrued. We believe that where it is feasible and economical to rehabilitate existing dwellings, where such rehabilitation will produce livable homes, and where it can be accomplished without subjecting the present occupants to distress, rehabilitation is both appropriate and justified. But such rehabilitation must, above all, produce homes that are adequate for family life in decent neighborhoods. These essential conditions of rehabilitation should not be underestimated. If these conditions are to be met it would be folly to assume that there exist in this country any large number of dwellings now occupied which can be patched up for many future years of livability. We estimate that, at the very most, not more than 200,000 units a year can be properly and effectively rehabilitated—and even this estimate is likely to be quite high. Let me emphasize that this number of units suitable for rehabilitation is over and above the need for 2 million new units which should be constructed each year.

The limitations of the rehabilitation approach were emphasized in a report made to the President's Advisory Committee on Government Housing Policies and Programs by two consultants to the committee, Jack M. Siegel and C. William Brooks. Messrs. Siegel and Brooks examined very closely actual experience with rehabilitation projects in a number of cities, including Philadelphia, a city which has had the most experience with areawide rehabilitation. They presented their findings and recommendations to the committee in a 143-page

report. In the section of this report dealing with rehabilitation they offer this conclusion: "Minimum rehabilitation in blighted areas may tend to perpetuate rather than eliminate slums."

The wise advice of these expert consultants seems to have been lost on the President's Advisory Committee on Housing, which in its report placed an undue emphasis on the potential value of the rehabilitation approach to the housing problem. It is unfortunate that this unrealistic emphasis on continued use of existing housing is also to be found in the bill which your committee is now considering.

The bill, H. R. 7839, contains three important provisions which, if enacted, would encourage the overuse of existing housing. The bill would convert the slum clearance and urban redevelopment program authorized in the Housing Act of 1949 into the so-called urban renewal program. Instead of the comprehensive city rebuilding which the 1949 legislation promised, cities would be encouraged to make do with the old instead of building anew. Communities would be called on to patch up and mask their rundown slum areas instead of clearing them out and building for future needs.

It must be recognized that the rehabilitation and conservation programs called for by the proposed legislation would entail serious problems of relocation of slum families. Our real need is not for "renewal" but for redevelopment of our cities to make them good places to live in in the years ahead. Redevelopment must provide for growth. It must be equal to the economic, industrial, and social demands of modern American life.

We must begin by acknowledging the hard, but unchallengeable fact, that genuine and lasting urban redevelopment requires a substantial amount of slum clearance and rebuilding in rundown areas. Ineffective and uneconomical rehabilitation of housing which has long since outlived its usefulness will not do the job in areas which should be thoroughly rebuilt and replanned for decent family life.

Whatever legislation is enacted to deal with this problem Congress should make it unmistakably clear that financial assistance must not be withheld from communities undertaking thoroughgoing slum clearance and urban redevelopment programs. Congress should also direct the Administrator to authorize financial assistance for rehabilitation and conservation only when from the long-term viewpoint such activities in the community are feasible, economical, and will produce livable homes in sound neighborhoods.

Both in the special provisions for FHA insurance of existing dwellings in designated urban renewal areas (proposed new sec. 220 of the National Housing Act) and in the provision for equalization of mortgage terms for existing and newly constructed units under all FHA programs, the proposed bill would further encourage overuse of existing housing. The liberalized financial terms for existing housing would not only encourage the continued use of dwellings which should be retired from the housing stock, but would also inflate the prices of such dwellings. New residential construction would be put at a disadvantage while the sale and rental of existing houses would become more profitable. In the meantime, buyers and tenants of existing houses would have to pay higher charges. The net result would be fewer houses and increased costs for families needing housing while

real estate brokers and mortgage lending institutions would reap windfall profits in financial transactions involving old houses.

And I might say that such windfall profits would be of passing character, since they would not last very long because of the effect of this policy on the housing market as a whole.

We strongly feel that the reliance the bill would place on continued utilization of housing which has passed its period of useful life is misguided. We believe also that the provisions of the bill for financial assistance for construction of new housing are at best inadequate and in some respects seriously harmful.

Perhaps the most widely publicized of these provisions is the proposed section 221 of the National Housing Act which would authorize a special program of FHA mortgage insurance for construction of so-called low-cost private housing. Under the proposed bill the FHA could insure 100 percent loans for the maximum amortization period of 40 years for houses costing no more than \$7,000 a unit. Priority for occupancy of these houses would be given to families displaced by slum clearance and other Government projects.

This proposed program is open to very serious criticism on a number of counts. In the first place, it is extremely unlikely that private builders will construct any considerable number of houses in the urban centers where families are displaced by slum-clearance projects to sell for \$7,000 or less. Housing costs in these areas simply do not permit construction of even the most inadequate type of houses at such an extremely low cost. Thus even if long-term mortgage financing could be obtained for houses built under this program, the realities of prevailing housing costs in such areas indicate that the program could never get off the ground.

Even if financing could be obtained and houses could be built at the maximum costs specified in the bill the houses would still not be suitable for low-income families who constitute the majority of slum residents. The FHA estimates that houses under the proposed section 221 program selling for \$7,000 would involve a monthly housing cost of \$62.90. This is twice as much as low-income families in most cities can afford to pay.

Yet this program has been described by some as a substitute for low-rent public housing. The bill before you, except for some minor provisions, ignores public housing. Although the President has requested a token 140,000-unit program to be built over a period of 4 years, even this token and clearly inadequate request is not included in the bill. Yet it has been proven again and again that the low-rent public housing program, which has made good homes available to hundreds of thousands of low-income families, is the only effective means for permitting families in the low-income brackets to obtain decent homes.

I appreciate the fact that under the previous authority the Appropriations Committee may consider a provision of funds for such housing. But it seemed to us that it would be desirable to spell out the related programs and here spell it out in terms of the real housing need.

The American Federation of Labor is thoroughly convinced that construction of low-rent public housing should be considerably ex-

panded at this time and should certainly figure largely in any housing legislation that is enacted.

The bill before you also fails to make provision for the needs of middle-income families, even though it has become abundantly clear that private speculative builders are either unable or unwilling to construct homes that most families of moderate means can afford. Without going into detail, let me cite one fact to illustrate the failure of private speculative builders under current programs to meet housing needs. In 1952 the latest year for which figures are available, only families with incomes of more than \$5,000 could afford to meet monthly housing expenses for the average FHA house or apartment. Yet in 1951, the latest year for which we have census data, only 31 percent of all nonfarm families had incomes of \$5,000 or more.

The proposed bill would do nothing to right this imbalance between incomes and housing costs. Instead of developing a fundamental approach to the middle-income housing problem this bill would simply reduce the downpayment requirement and extend the maximum amortization period for some types of Government-insured housing, and at the same time would authorize an increase in the maximum interest rate to a possible effective rate of 6 to 6½ percent.

The lower downpayment requirements for houses in the luxury-price brackets will simply encourage builders to construct such houses and discourage them from building more moderate priced dwellings. As far as the moderately priced housing is concerned, the lowering of monthly charges resulting from the extension of the amortization period, but actual increase in total costs over the life of the mortgage, will be considerably offset by the increase in the interest rate. Under the bill the President is given authority to establish maximum interest rates on FHA and VA loans up to 2½ percent above average market yields of Federal long-term obligations. Since all the pressure will be on the President to increase interest rates rather than to lower them, there is every reason to believe that the apparent flexibility in mortgage terms which the bill seeks to introduce would in fact result in a continued high level of mortgage interest rates under the FHA and VA programs.

The net result of the changes in these terms which the bill would bring would be increased concentration on construction of higher-priced houses and higher costs for prospective middle-income home purchasers. This is obviously not the way to assure an adequate supply of housing for middle-income families at costs within their budgets.

Just a word on the proposed changes in the Federal National Mortgage Association directed primarily toward the support authorized for special housing programs. The bill authorizes a total of \$700 million for this purpose without specifying any priority of use. Since this could assist the construction of only about 70,000 dwelling units it is clearly not the proper way of providing necessary financing for housing for cooperative groups or for minorities and others who are especially disadvantaged in obtaining private financing in the existing market. While we endorse the proposal for an authorization of special assistance for such housing, we think that the types of housing which would be assisted should be spelled out in the bill. Moreover, such authorization should clearly assure more adequate source

of financing for types of housing for which there is a special need including a priority for cooperative housing and housing for minority groups.

Let me comment briefly on two other points raised by this legislation.

(1) Cooperative housing: Section 213 of National Housing Act. The bill changes the basis for determining the maximum mortgage insurance amount from "replacement cost" to "value." Since FHA nearly always determines "value" at less than "replacement cost," this would place cooperative housing at a serious disadvantage. We also object to the explicit removal of an authorization for an assistant commissioner in the FHA for cooperative housing. We feel that such removal will further weaken the already understaffed FHA cooperative housing section.

(2) Protection of labor standards: The bill would remove the requirements that the Public Housing Administration determine minimum salaries to be paid to architects and other technical employees employed in the development of low-rent housing projects. This would be a backward step and we urge that this proposed change be removed from the bill.

In other words, we ask that the language at present in effect be put back into the legislation and this deletion removed.

Certainly the Federal Government should not make funds available for projects which involve substandard wages for any employees.

RECOMMENDATIONS AND CONCLUSION

In order to strengthen the legislation your committee is considering so that it will fully measure up to the housing needs of the Nation, the American Federation of Labor makes the following positive recommendations:

1. To make good housing at low cost available to low-income families, we ask the Congress to authorize construction of 600,000 low-rent public housing units within the next 3 years.

2. We urge a broadened urban redevelopment program providing necessary financial assistance to cities for slum clearance and rebuilding and replanning of metropolitan areas. Reliance on lesser methods such as rehabilitation and neighborhood conservation should be used only to the extent that such methods are economical and workable.

3. We ask for expanded Government assistance for middle-income housing. In particular we urge that interest rates for housing for middle-income families be reduced and if, and only if this is accomplished, maximum amortization periods lengthened. These aids should be made available for all housing meeting livability requirements at costs middle-income families can afford, but priority for such assistance should go to genuine cooperative and nonprofit housing since their costs are necessarily lower than those of speculative builders.

4. We request that home buyers under federally assisted programs be protected by two specific measures.

(a). Every builder of FHA-insured housing, or receiving other financial assistance under the program, should be required to sign a

builder's warranty against structural defects that may develop within the first 2 years after completion.

(b) Purchasers of homes under the FHA and VA programs should be given protection through a lapsed payments plan. This would establish a revolving fund out of which monthly payments could be maintained in the event a home buyer is forced to miss monthly payments by unemployment, illness, death in the family, or other emergency. The mortgager would be expected to make slightly higher monthly payments to make up for the lapsed time and reimburse the revolving fund.

5. We ask that housing built under the FHA and VA programs, as well as all other programs involving Federal financial assistance, be made subject to the requirement for the payment to all employees of wage rates prevailing in the locality, as determined by the Secretary of Labor.

In conclusion, I should like to emphasize to the members of this committee that the Nation's housing problems will not be solved until good housing is brought within the financial reach of all families at costs they can afford. Only when the housing placed on the market runs the gamut of all incomes will the country begin to obtain an adequate supply of housing.

The speed with which we meet these requirements is important not only because it will determine how soon we can achieve the goal of a good home for every family, but also because a high level of housing construction is urgently needed now so that housing could play its full part in maintaining prosperity and full employment.

We urge that your committee broaden the proposals in the present bill to include the recommendations we have made. Inclusion of these recommendations in the legislation enacted will help raise the level of housing construction, will help provide good homes for every American family, and will help sustain economic prosperity.

The CHAIRMAN. Thank you, Mr. Shishkin.

Are there questions of Mr. Shishkin?

We are very grateful to you, Mr. Shishkin, for this contribution. If you have any further ideas, and, as it should be generally understood, witnesses may revise and extend their remarks, and, without objection, it will be so ordered with respect to all witnesses, so you may do so, Mr. Shishkin, if you wish.

Mr. HAYS. I have a question, Mr. Chairman.

The CHAIRMAN. Mr. Hays.

Mr. HAYS. Mr. Shishkin, do you have any figures at hand to show how much interest would be paid on a home under this new section proposing a 40-year amortization in comparison to the cost of the home? Have you worked out anything on that?

Mr. SHISHKIN. Do you mean the total amount of interest charges that would be payable by a mortgagor?

Mr. HAYS. Yes. In other words, if this bill went through the way it is written here, we are going to lengthen the amortization period and probably increase the interest rate.

Mr. SHISHKIN. That is right.

Mr. HAYS. To give you an example, on, say, a \$10,000 home, or if there is such a thing, an \$8,000 home, I would like to know, in addition to the original cost of the home how much the interest is going to be? I haven't been able to get anyone who has worked out the figures.

Mr. SHISHKIN. Well, do you mean, Congressman, the increase in the interest rates, assuming the maximum permitted by this bill?

Mr. HAYS. I think it would be interesting to know that, assuming that they would be set at the maximum. It does not necessarily follow that they will, but I would like to know how much it would cost if they were.

Mr. SHISHKIN. I don't have the figures with me now but we would be glad to submit to you the approximations that it is possible to establish under the maximum interest rates.

Mr. HAYS. I thought perhaps you didn't, but I thought you might be interested in including those with your remarks. I think they would be very illuminating.

Mr. SHISHKIN. We will be glad to submit a supplementary statement on that.

Mr. HAYS. That is all.

(The information is as follows:)

COST OF INTEREST CHARGES UNDER PROPOSED SECTION 221 PROGRAM

The maximum effective interest rate permissible under the proposed section 221 of the National Housing Act is approximately 6 percent.

H. R. 7839 gives the President authority to set maximum interest rates on FHA and VA loans up to $2\frac{1}{2}$ percent above the rate of long-term Government obligations. This rate is currently about $2\frac{7}{8}$ percent. This would mean a net interest rate of $5\frac{1}{8}$ percent or, since the maximum interest rate for FHA and VA loans is usually set at $\frac{1}{4}$ percent intervals, 5 percent. In addition, there is the $\frac{1}{2}$ percent FHA premium (under the law, FHA may establish the premium at a maximum of 1 percent, but in the past it has been held at $\frac{1}{2}$ percent, and we are assuming that this rate would be continued in the future).

Under the proposed section 221, the mortgagee is permitted to charge a $\frac{1}{2}$ percent service charge in addition to the maximum interest rate. Thus, the maximum gross interest rate would be $2\frac{7}{8}$ percent plus $2\frac{1}{2}$ percent plus $\frac{1}{2}$ percent (FHA premium) plus $\frac{1}{2}$ percent (service charges) or 6 $\frac{1}{2}$ percent, which, rounded, is 6 percent.

Mr. SHISHKIN. In that connection, Mr. Chairman, I would like to point out that one of the things that gives us most serious concern is this so-called flexible approach to the interest rates. Actually, it amounts to the allowance of higher interest rates than prevailed before. We feel that under the present impact of the economic trends this is unwarranted and dangerous. Although we in no way regard the situation in our economy as a cause for grave alarm, at the same time we feel that at this time, in relation to the trends in activity in the housing field, and comparing those trends over the past few years, it would be indeed a grave mistake to permit the continued tightening of credit terms and to establish the future projection of the housing program on high-credit terms instead of lower ones.

The CHAIRMAN. Are there further questions?

Mr. DEANE. Mr. Chairman, I have one question. Assuming, Mr. Shishkin, that these houses, for \$7,000, with 40-year amortization, could be built, have you actuarially determined the amount of interest that would be paid, assuming some interest factor which you may have selected, what the interest rate might be?

Mr. SHISHKIN. We will prepare this statement on the effect, under the maximum rates allowable, on monthly charges, both as to interest and principal, if you would like to have it. I don't have the figures with me.

Mr. DEANE. I would like to have that.

There is one other question, Mr. Chairman, at the present time, FHA or VA, how long do they allow a mortgage to stay in a lapsed condition before they foreclose?

Mr. SHISHKIN. The practice has been changed somewhat. The old classic practice was, in the earlier period, anywhere between 3 and 5 months. As far as the current practice is concerned, I don't know, but I know that the action is up to the mortgage lender. Just how far the FHA allows the mortgage lender to let the home buyer go, without meeting the obligation, I cannot tell you at the present time, offhand.

Mr. DEANE. I am directing my question with reference to B in your recommendations. I don't quite understand what you mean there.

Mr. SHISHKIN. May I explain the proposal? It is a very simple proposal. We are simply proposing that a revolving fund be established, out of which any lapse of payments due to an emergency could be met. This means an emergency on the part of the home buyer, so that the eviction and loss of equity, as a result, would not take place in an emergency of this kind. Upon resumption of regular employment on the termination of the emergency, it should be possible for the mortgagor to resume his payments. If his payments are resumed they will be a few cents higher on the monthly basis in order to reimburse the fund. So the revolving fund would be replenished. We made some years ago a fairly careful study of the application of this, and the incidence of such emergencies that might present a problem of this kind. Of course, it would vary under different conditions. I mean if the length of unemployment were longer, of course, the incidence of such lapses would be greater and their term would be longer.

But in other emergencies, such as sickness, and things of that sort, the terms would be relatively low.

Mr. DEANE. Where would you get the funds from? From direct appropriations?

Mr. SHISHKIN. Well, in all probability it would be best to have it established by direct appropriation or from the available reserves, and administered by the National Housing Agency.

Mr. DEANE. That is all, Mr. Chairman.

Mr. O'HARA. Mr. Chairman.

The CHAIRMAN. Mr. O'Hara.

Mr. O'HARA. I take it from your testimony, Mr. Shishkin, that you do not see much hope in the proposed legislation?

Mr. SHISHKIN. Well, I would say this: There are many provisions here simply realigning and revising the existing procedures. Some of them are certainly the result of thorough study, and are well intended.

But if you take this 107-page bill as a whole, in terms of the realities of the present housing situation, we doubt very much that the stimulations intended are either directed properly or are sufficient to bring us anywhere near the volume of housing construction of 2 million units which our estimate, made last August, shows is necessary in order to meet the housing requirements this year, and in the coming years.

Mr. O'HARA. I agree with you in most of your recommendations, and I have been disheartened at the progress we have been making in housing.

However, we have now this realistic situation to face: The present administration will not do all that you and I believe that for the welfare of the country it should do. We have not the votes to put through the kind of housing legislation that we think would give greater promise to putting a decent roof over the heads of all American families.

Now, under the existing circumstances what can we do? What suggestion can we make to the administration which it may accept to the end that this housing bill, from our viewpoint, will be a better bill than otherwise it would be?

What would be your suggestion along that line?

Mr. SHISHKIN. Congressman, first let me say that I think that the kind of recommendations which have been made by the Housing Administrator, of course, are only indications and guides, and they were very largely in the light of the study of this advisory committee that has submitted them.

The responsibility of accomplishing the kind of a job that you are looking for is the responsibility of the Congress, and I think it is the responsibility of this committee to explore such proposals that would give us an increased volume and stimulate the market.

Let me divide my answer into two parts: First, it seems to me that recommendations we have stated here broadly could be very easily translated into specific legislative formulation—low-rent housing, aids to middle-income housing, and, thirdly, establishment of priorities for such housing as might be brought closer to the financial reach of the families and, of course, the other related recommendations for stimulating the market.

The second part, I think, relates to the fact that, as I have stated at the outset, our prospects in the United States of America are for very rapid growth. No matter what anyone says, if our economic forces are in balance there is no need, on the part of mortgage lenders, real-estate men, or anyone else, to worry about a rapidly developing, prosperous economy in which everyone can share. But the important thing is the balance. If we are dedicated solely to build primarily, for the well-to-do, to raise terms, and to create favorable conditions for those who are already largely in the position where they have the ability to pay, if we don't provide the safeguards against any possible decline for which we need to be prepared, if we don't provide a balanced program in which all of the population can share—and those who do not share in the housing market today are permitted to share—then we will have a measure which is a million-unit-a-year measure instead of a 2-million-unit-a-year measure, or to put it simply, a half measure, such as that which is before us today for the housing for the country.

That is only a point of departure. I think it can be developed into legislation and in very simple terms. We have had ample experience. This committee has studied these problems in great detail, and I think it can be accomplished by this Congress in this session.

Mr. O'HARA. You are speaking for the American Federation of Labor, are you not?

Mr. SHISHKIN. That is right.

Mr. O'HARA. Therefore you represent a great segment of our population. American labor, of course, is interested in the continuance of

good times. We don't want a dépression. We are agreed on that, are we not? You are saying that a recession could be stopped, and a depression avoided, if we go ahead boldly with programs based on faith in the people, and in the future. That envisions a housing program that would bring housing within the reach of all our people. I agree with you. The progress we are making in housing for our middle and low-income groups makes me low in spirit coming from Chicago.

Mr. MERRILL. I don't blame you.

Mr. O'HARA. I always appreciate the smiles of my colleagues as indicative of their good hearts and will. I wish to assure them that I am very low in heart coming from Chicago, when I contemplate a housing program that provides no housing within the financial reach of many people in the city from which I come.

Do you know of any place in Chicago where a house can be built and sold for less than ten or eleven or twelve thousand dollars?

Mr. SHISHKIN. Well, Congressman, it seems to me we had testimony here this morning that in the case of Wherry housing under especially favorable conditions, including tax exemption, a two-bedroom house, the Army testifies, the rental is set at \$80 a month, plus \$2 additional a month for maintenance. Here is an \$82-a-month level for a house of that sort. I mean here you have that, with all the aids provided in legislation for a house which is pretty small, 964 square feet, and that isn't confined to Chicago, where the costs, of course, are higher.

Mr. O'HARA. And yet here, before an experienced committee in the Congress of the United States, advocates of this bill talk about \$7,000 homes in cities like Chicago. As far as Chicago is concerned it is housing that is nonexistent.

Mr. HAYS. Or anywhere else.

Mr. O'HARA. Or anywhere else is right. The \$7,000 house exists only in the dreams of the administration.

Mr. McDONOUGH. Will the gentleman yield to me?

Mr. O'HARA. Certainly.

Mr. McDONOUGH. I appreciate the problem the gentleman is reciting very much, and I would like to see every provision made for the provision of low-cost housing for those people who cannot afford to buy a ten or twelve or fifteen thousand dollar home.

I would like to have the gentleman inform the committee what we should do in the bill to provide \$7,000 houses for these people who cannot buy the higher costs not now provided in the bill.

Mr. O'HARA. I understand that the gentleman from Missouri, Mr. Bolling, has a bill which contains the provisions—and we had a similar bill in the 81st Congress—which would reduce the cost of housing at least one-third, and all the provisions of that very good bill some of us introduced in the 81st Congress I understand are in the bill which the gentleman from Missouri has introduced in this Congress.

Mr. McDONOUGH. To reduce the cost by one-third? In what respect would it reduce the cost of housing?

Mr. O'HARA. I am going to ask this witness, and I think he can answer. You suggested in your testimony, Mr. Shishkin, that in this bill they are attempting further to destroy cooperative housing. Is there not in cooperative housing the promise of at least a one-third reduction in the cost of construction?

Mr. SHISHKIN. Well, we have regarded—and in our many appearances before this committee in the past have indicated that we have long regarded cooperative housing as the best approach, which provides great economies, and tremendous possibilities, especially for the middle-income field. The provisions which would encourage such housing, which are now in the law, should be liberalized instead of being shrunk, as the proposed legislation does.

Mr. McDONOUGH. This proposed legislation does, you say?

Mr. SHISHKIN. Yes, sir; it eliminates the administrative framework for maintaining a major cooperative housing program and also narrows down the preferences for cooperative housing in terms of favorable terms, and it does not give priority to cooperative housing under FHA, and other provisions which we believe should apply.

Mr. McDONOUGH. Well, how much priority should they have that they do not now have?

Mr. SHISHKIN. Well, there is no priority in the legislation. The FNMA provision does not include any priority to any type of housing, and we feel it should.

Mr. McDONOUGH. You mean cooperative housing secondary mortgages are not given a preference?

Mr. SHISHKIN. That is right

Mr. McDONOUGH. Over other types of mortgages?

Mr. SHISHKIN. That is right

Mr. McDONOUGH. For the FNMA institution to purchase?

Mr. SHISHKIN. That is right

Mr. McDONOUGH. You think they should have?

Mr. SHISHKIN. Yes, sir.

Mr. McDONOUGH. How much more should they have over others?

Mr. SHISHKIN. Well, it can be given more favorable terms that can be applied through administrative discretion.

Mr. McDONOUGH. Well, wait a minute, if we are going to write legislation, are you going to give the discretion to the Administrator, or are you going to say in the law that the cooperative housing should have a preference of a certain percentage or number of units or dollars? If we are going to write legislation let us get your idea. You are complaining, and I would like to know what you want to say.

Mr. SHISHKIN. No, those three methods are not the only ones, Congressman. I am quite sincere in my feeling.

Mr. McDONOUGH. I am, too, and I want to see these people provided with homes, and I want to know if there is a solution to the problem.

Mr. SHISHKIN. We feel it should be applied realistically. You have to have an institution that is capable of soundly administering a cooperative housing project, and in a particular community it may be available or it may not. If such an institution is available, if there is demand for it, if the people who are ready to go into that kind of project and have it developed are available, then that kind of an available institution should command a priority over other types of housing in that community.

Mr. McDONOUGH. You are talking about cooperative housing?

Mr. SHISHKIN. That is right.

Mr. McDONOUGH. Do you think that a more liberal program, and a priority for cooperative housing, would solve the question of the low-income group of people who are not now properly housed?

Mr. SHISHKIN. I think that, as I sort of feel the atmosphere in this room is still charged with the complexity of housing legislation, as has been demonstrated, that no one step will solve the problem. But this is one of the essential elements of real importance, we feel, but it does not do all of it.

Mr. McDONOUGH. All right, you say it does not solve the problem, but it will help.

Mr. SHISHKIN. Indeed.

Mr. McDONOUGH. What else would we have to do to provide homes for these low-income group people, in addition to that?

Mr. SHISHKIN. Well, cooperative housing, of course, is mainly related—

Mr. McDONOUGH. We have admitted that that would help; what else?

Mr. SHISHKIN. That helps middle-income people. As far as low-income people are concerned, we have felt that there is need for providing a degree of subsidy, that the best formula we have had is the public housing program, administered by the local housing authorities, with the full exercise of local responsibility, but with a degree of public aid in order to bring that housing within the reach of low-income families.

Mr. McDONOUGH. To what extent, so that we can get some idea of what that should mean, in specific terms? We have to write legislation here, you know.

Mr. SHISHKIN. Well, we feel that the formula that has been developed and authorized by the Housing Act of 1949 is a pretty sound one. We don't want it rigid enough to say that in 1954 it should not be subjected to some modifications. But fundamentally that is it.

Mr. McDONOUGH. Well, that is existing legislation.

Mr. SHISHKIN. Yes, but that legislation has been on the books without being translated into reality. The first session of this Congress authorized only 20,000 units, and expressed the hope that the program would be terminated altogether.

Mr. McDONOUGH. You are talking about public housing now?

Mr. SHISHKIN. Yes, sir.

Mr. McDONOUGH. Do you mean that the number of units are not sufficient to take care of the demand?

Mr. SHISHKIN. Well, the President's recommendation is for 140,000 units over a period of 4 years.

Mr. McDONOUGH. I understand, but how about the demand against the number allocated? What is the deficiency at the present time?

Mr. SHISHKIN. The need, as we have pointed out, would call for the construction of 200,000 units a year.

Mr. McDONOUGH. How many?

Mr. SHISHKIN. Two hundred thousand per year.

Mr. McDONOUGH. Well, the first year that we had 140,000, there wasn't demand sufficient to build that number of units.

Mr. HAYS. Will the gentleman yield?

Mr. McDONOUGH. Yes.

Mr. HAYS. There is quite a backlog of cities that are ready to go, with public housing, which cannot get the approval because of the limitation. I think that almost answers your question as to whether there is a demand. I would say that there is a demand.

Wouldn't you agree with me?

Mr. McDONOUGH. We have arrived at two things in this discussion so far, that there should be a more liberal financing for cooperative housing, in your opinion.

Mr. SHISHKIN. That is right.

Mr. McDONOUGH. Would that take care of all of the low-cost housing?

Mr. SHISHKIN. Well, our approach has been consistently, Congressman, that housing aids provided under the national legislation are aids actually which provide stimulation to those engaged in construction activities. Housing is basically a local responsibility, and standards need to be provided in order to have that responsibility properly and fully exercised and they need to be established under national legislation, but that the primary initiative must come locally.

The approach which would contemplate and accept higher credit terms, extension, with higher credit terms, of amortization period, all of those, we don't think are appropriate. We think we need to have ways and means to keep the interest rates down in order to stimulate the demand for private housing, which is fundamentally the core of our residential construction activity that benefits everybody. The supplementation of these by special terms for low-income and middle-income families in order to bring the lower rate money into the market and in order to provide for the needs of those who cannot afford to have decent homes, are the only kinds of supplementation that we seek in order to round out the housing supply picture and bring it to all segments of the community.

Mr. McDONOUGH. Thank you.

Mr. MUMMA. Will the gentleman yield?

Mr. O'HARA. I yield.

Mr. MUMMA. I notice you used the statement that there could be tremendous savings in the cost of housing. In what percentage of a certain activity do you think the greatest saving could be made? Certainly not in the administrative end.

Mr. SHISHKIN. No. Let me point out that in terms of unit costs today there is evidence which shows that a great deal of progress, remarkable progress, has been made, particularly during the past 10 years or so, in home construction technology.

Mr. MUMMA. Where would you say that occurs?

Mr. SHISHKIN. All over the country.

Mr. MUMMA. In what particular phase of it? The foundation, or the walls?

Mr. SHISHKIN. Greater standardization, greater use of prefabricated parts of the housing structure, and so forth.

Mr. MUMMA. Would you cite Lustron as an example of that?

Mr. SHISHKIN. Well, Lustron is an example of a prefabricated house, but I meant prefabricated parts, window sashes, door knobs, and things of that sort.

Mr. MUMMA. Well, they put everything on one truck and load it right to the site, and the house is right there. It certainly couldn't be much more prefabricated or predesigned.

Mr. SHISHKIN. Unfortunately we didn't have an opportunity to witness the economies.

Mr. MUMMA. Why? Because the cost was high?

Mr. SHISHKIN. Yes. But there has been enough experience to show that technological advances have reduced the cost of the unit.

Mr. McDONOUGH. Not in the Lustron experience, however.

Mr. SHISHKIN. I wouldn't comment on the Lustron experience because the volume of units produced didn't give us a basis to actually appraise its cost. They never went into mass production.

Mr. MUMMA. How was the Gunnison project?

Mr. SHISHKIN. Well, in the field of prefabrication, you have had Gunnison, you have had a very wide variety of experiences dating back to the older Sears & Roebuck in the twenties.

Mr. MUMMA. Do you think that Gunnison homes ought to be pretty good?

Mr. SHISHKIN. I am not in a position to endorse a product before the committee.

Mr. MUMMA. Well, in my home community Gunnison have just built a tremendous factory, and they are advertising, through the Union Supply Co., which is a subsidiary of United States Steel, their prefabricated houses for 9 and 11 thousand dollars. I just can't see, having a little knowledge of that business, where you are going to make any tremendous savings unless it is in the field of materials and labor.

Mr. SHISHKIN. Well, there has been quite a saving made. Of course, our experience with prefabricated housing in this country so far has been extremely limited. It hasn't taken root. Site assembly prefabrication has been much more used.

Mr. MUMMA. Do you agree with me that there can be tremendous savings?

Mr. SHISHKIN. There could be substantial savings.

Mr. MUMMA. Well, you are changing your word. There might be substantial savings, but I don't see how we are going to get a tremendous saving under the present level of material costs and labor costs.

Mr. SHISHKIN. One of the major elements of unit costs, that is the cost of the monthly charges, is geared to the variation in the cost of financial charges.

Mr. MUMMA. Well, do you believe that money should be worthy of its hire?

Mr. SHISHKIN. Indeed.

Mr. MUMMA. Capital should be entitled to be paid, also. You took the position and used the words where a man is sick for a month or so, that it would be just a matter of a couple of cents added to his monthly payments to make that up. Do you realize that if it is \$62 a month, and you would figure that he would have to pay \$2 a month more, it would be over 30 months before he got back to where he was? It isn't a matter of a couple of cents, is it? It is a matter of a couple of dollars, and if he is sick 2 or 3 months it would be pretty nearly an impossibility.

Mr. SHISHKIN. Well, it depends—

Mr. MUMMA. I am not picking on your words, but it is not so simple.

Mr. SHISHKIN. Well, I said a few cents, Congressman. Of course, if the emergency occurred early in the life of the mortgage, and that was prorated throughout the entire remainder of the mortgage, of course, the additional charge to cover the difference would be very small. If it occurred later—

Mr. MUMMA. It would be a few dollars, rather than a couple of cents, wouldn't it?

Mr. O'HARA. Mr. Shishkin. If the gentleman will permit—

Mr. MUMMA. I have just one more question, if I may ask that.

What was the average extent of subsidy per housing unit, would you say, in public housing?

Mr. SHISHKIN. Do you mean the—

Mr. MUMMA. The contribution or subsidy.

Mr. SHISHKIN. The monthly contribution?

Mr. MUMMA. Yes, in each public housing unit.

Mr. SHISHKIN. On the average now?

Mr. MUMMA. On the average over the country. It is quite high; isn't it?

Mr. SHISHKIN. Well, it is between 8 and 9 dollars a unit.

Mr. MUMMA. That couldn't be \$29, could it?

Mr. SHISHKIN. No. That is the total rent, so it couldn't possibly be.

Mr. MUMMA. Well, it could be. They started building at \$7,000, and the last ones that I know of cost \$12,000.

I think it is substantially higher than that, as I read in the testimony 2 years ago in this committee.

Mr. SHISHKIN. The experience, judging by the reports submitted by the Public Housing Administration, is that the actual subsidy provided on a monthly basis is lower than originally anticipated.

Mr. MUMMA. I haven't looked it up lately. I thought it was \$29.

Mr. SHISHKIN. I will be glad to submit the actual figures, Congressman.

(The information follows:)

AVERAGE FEDERAL SUBSIDY FOR PUBLIC HOUSING

I was asked to state the average monthly subsidy required in public housing units.

According to a report prepared by the Public Housing Administration for the Subcommittee on Housing for Low-Income Families of the President's Advisory Committee on Government Housing Policies and Programs, the annual contribution of the Federal Government under the original public housing program authorized by the Housing Act of 1937 is \$5.70 per unit per month.¹

There have been larger payments under the newer program authorized by the Housing Act of 1949, but this is to be expected in view of the substantially higher capital costs, the reduction in the maximum amortization period of the local housing authority bonds from 60 to 40 years, and the increase in the interest rate. It should be noted that the experience under the 1949 program to date has been too limited to warrant a definite conclusion regarding the amount of Federal subsidy that will be necessary in future years. The figures based on this limited experience indicate that the average Federal contribution has been \$26.90 per unit per month.

It is worthwhile noting that annual contributions over the 13-year period since the first public housing projects were built have been only \$116.2 million or 44.2 percent of the maximum pledged for payment if necessary.

The average monthly interest payments on a 40-year, 6 percent \$7,000 mortgage loan would be \$23.99. The total interest payments over the 40-year amortization period would be \$11,515.

Mr. O'HARA. Mr. Shishkin, you have made a great contribution to our deliberations here. We are going along with the dream that there could be, in cities like Chicago, a \$7,000 house. Now, that \$7,000 home doesn't exist.

The other part of it is this: When they come to you and to me and say "How are we going to get a \$7,000 house in Chicago, how are you going to build it," we haven't any answer for them.

¹ Report of the Advisory Committee, pp. 309-315.

I think you have built the climate under which we should be discussing this housing bill. We are all working for the right answers. The right answers can come only from research. You will recall in the 81st Congress, when we passed, after great difficulties, the housing bill, we were all very happy, including Senator Taft, who probably was the most happy of us all, because the Housing Act of 1949 had in it the provision for research. In a program to bring housing within the reach of all our people there are many fields for inquiry, including those of financing, and types of material and structures. There are many factors bearing upon the excessive cost of construction, and we thought that through the research department—provided in the Housing Act of 1949—we would be able to find the answers. This administration has killed the research work.

You have made a great contribution here, in the frank and forthright manner in which you have answered my questions and those of my colleagues. Where it was the fact you have said: "I don't know the answer any more than you do but we are seeking, and will continue to seek, out the right answers by an intellectual approach." I want to thank you again for the great contribution you have made to our deliberations.

Mr. SHISHKIN. Thank you, Congressman.

The CHAIRMAN. Are there further questions?

Mr. SPENCE. Mr. Shishkin, what character of house could be built for \$7,000, in the average American city, to meet the minimum standards of FHA, let us say?

Mr. SHISHKIN. Mr. Spence, it seems to me that we have to recognize first that the existing FHA standards have permitted a great diminution in the size and livability of the housing units permitted. The houses have grown smaller, they are not adequate in many cases, even when meeting FHA standards.

For \$7,000 there are very few communities, and certainly no large cities, in which an adequate and livable house, even meeting FHA standards, can be built today, and it seems to me a mistake to seek as a goal the construction of a \$7,000 house, or a house of any given set figure—and I am now speaking as an economist. You have to recognize the conditions of the market, the costs of construction, and set the standards accordingly, and provide a unit in which you do have an adequate shelter given to a family, an American family, at a proper standard, at costs that are not inflated or speculative.

If you are accomplishing that, and still don't bring that unit within the financial reach of the family at the low-income level, then you have to face up squarely to the necessity of providing, either through tax exemption, direct subsidy, or some other formula, some kind of an aid in order to bring that unit within the reach of a low-income family.

But you have to recognize the realities of the market, and instead of bending the market to an artificial cost, recognize that cost, eliminate abuses, both speculative and in terms of extraneous charges, and keep the market clean.

Mr. SPENCE. A house that is not well built, and not well taken care of, would not be a very good security for a 40-year mortgage, would it?

Mr. SHISHKIN. Most of the single-family units today are going to be meeting the test of being a good security 35 years from now rather creakily.

Mr. SPENCE. The life of a house depends upon its original construction.

Mr. SHISHKIN. That is right.

Mr. SPENCE. Upon the method in which it is taken care of?

Mr. SHISHKIN. Maintenance is very important, too.

Mr. SPENCE. If a house wasn't well constructed and wasn't well taken care of the subject of the mortgage would probably disappear before the mortgage expired.

Mr. SHISHKIN. That is right.

The CHAIRMAN. Are there further questions of Mr. Shishkin?

If not, thank you very much, Mr. Shishkin, for your valuable contribution.

Mr. SHISHKIN. Thank you, Mr. Chairman, I appreciate the opportunity to be heard.

The CHAIRMAN. Mr. Fischer, the director of the CIO housing committee, and Mr. John Edelman, will be our next witnesses.

We are glad to have you both back with us again, gentlemen.

You may proceed.

STATEMENT OF BEN FISCHER, CIO HOUSING DIRECTOR, ON BEHALF OF THE CONGRESS OF INDUSTRIAL ORGANIZATIONS, ACCOMPANIED BY JOHN W. EDELMAN, WASHINGTON REPRESENTATIVE, TEXTILE WORKERS UNION OF AMERICA (CIO)

Mr. FISCHER. I appreciate the opportunity to be here.

My name is Ben Fischer, director of the CIO housing committee, and Mr. James Thimmes, the chairman of our committee, regrets his inability to be here.

We would have liked very much to review the entire proposed legislation but it is fairly lengthy and elaborate, so we are trying to concentrate on certain matters of very particular interest to us.

The CHAIRMAN. Would it be sufficient for your purpose that Mr. Thimmes' letter to the President's Advisory Committee be incorporated in the record following your testimony?

Mr. FISCHER. Yes, sir.

The CHAIRMAN. It may be inserted at the end of your testimony.

Mr. FISCHER. Thank you.

The administration's proposed housing legislation, H. R. 7839, deeply disturbs CIO. We appreciate this opportunity to express the cause for our concern and to discuss some suggestions for improving the legislation.

We do not appear here claiming any special expertness in the field of finance, the techniques of constructions, or the intricacies of real-estate law and practice. We do, however, have a very clear understanding of the fact that the cost and quality of housing is one of the most vital ingredients determining the standard of living of our membership. Furthermore, we know that the prosperity of the housing industry is one of the most vital factors in maintaining the economic welfare of the entire Nation. The whole problem of full employment is tied in directly with the success or failure of the housing industry to meet the needs of the millions of Americans who still lack adequate shelter. It is in light of these basic factors that we feel impelled to

view critically the major features of H. R. 7839 without engaging in detailed comments about each title and subtitle of the draft bill.

We wish to emphasize our view that America needs a larger housing program than the industry and the Government have been able to develop in this entire postwar period. To stimulate economic prosperity we need more and better homes both for the many millions who now live in substandard dwellings and for those who aspire to own or rent more suitable homes for their families. Indeed, the great expansion of home construction is one of the major methods by which we can reinvigorate our slackened economy. There is no field in which the hopes are so great, the needs so urgent, and extensive, and the potential results so fruitful as in private home building. There is increasing recognition and agreement that America can absorb and actually needs an addition of about 2 million housing units a year for some years to come. We do not propose to split statistical hairs over whether this broad estimate is a little too large or a little too small. It seems sufficient to us to merely recognize that the present building rate falls woefully short of any reasonable fulfillment of need and further is inadequate to serve as a powerful antirecessionary force.

Despite the elaborate, and we believe, generally excellent, report of President Eisenhower's Committee on Housing, the administration has actually not offered either the Congress or the country really new, hopeful, or substantial solutions for the pressing problems to which the committee addressed itself. No new private housing would be built as a result of any new section in this legislation. No bona fide substitute proposal is herewith offered to provide public housing for low-income families for which no new shelter is possible under any other plan or method yet devised or suggested. In this lengthy legislation before us the only significant new item which is offered as a device for aiding new home construction is the 40-year term 100 percent loan program. An analysis of this device reveals that even this is without practical meaning. In its present form this new section of the law, if enacted, would not provide for adequate standard new housing because it is restricted to a price of no more than \$7,000, a figure so low as to negate the proposal.

In addition, this highly publicized, allegedly liberalized program, is apparently to be restricted only to relocation housing which makes it still more unworkable and still less significant in terms of stimulating or aiding the home building industry generally.

Inadequate as this widely-heralded new 40-year term 100 percent loan program turns out to be, because of its limitation to nonexistent \$7,000 houses and its restricted application to the few relocation areas, there is emerging a final crippling feature. Unlike other types of FHA loans, it is proposed that the misnamed beneficiaries of this specially liberal program be assessed an additional half percent interest charge dressed up as a service charge. At present rates, actual charges to the consumer would turn out to be $5\frac{1}{2}$ percent, thus forcing the lowest income group to pay the highest rates under the Federal housing program.

Other phases of this legislation can be described in somewhat comparable terms. They sound good but there isn't much there.

We call special attention to the proposals dealing with interest rates and related matters. The President is to be given power to fix

interest rates on FHA and VA loans up to 2½ points above the prevailing yield on Government issues. The spokesman for the President, Mr. Cole, says there is no intention to increase interest rates; is it the purpose, however, to impose extra charges which in effect are the same thing?

But in any case, Congress has already established ceilings and the entire history of this new proposal gives rise to justified fears that it may facilitate boosting interest rates and other charges to the detriment of both the consumer and the building industry including the basic materials manufacturing industry which supplies the ingredients out of which houses are made.

We wish to state for the record that any increase in interest rates or service charges, even if slightly disguised, can only do serious harm to the people who need housing and the industry which must build them. At a time when we should be stimulating production and eliminating excessive costs, any move to increase costs would discourage production and restrict the potential demand for new housing.

Throughout this bill we find specified broad discretionary powers delegated to the President. Our objection to this is not based on any theory of Government but is a practical objection to a situation which, by engendering uncertainty, would discourage the growth of enterprise and boldness in the industry. If a builder or lender is uncertain as to what interest rates will be permitted and what the allowable amortization periods will be a year or two from now, he is discouraged from making broad plans. Sound project development requires time; land must be assembled, often rezoned, developed. Materials must be contracted for, a labor force organized. A careful market analysis must be made. Early sales are helpful in reducing costs and risks. Community facilities may be required. All this requires time and confident planning involving the integration of many factors including actions by local government and many local business institutions.

A comprehensive presentation of our attitude toward many of the individual items dealt with in the administration bill was made by CIO in January in the form of a letter to President Eisenhower from Mr. James G. Thimmes, who is the CIO's housing chairman, and who also served as a member of the President's Advisory Committee. A copy of this letter is presented here for your information and for the record.

What is basically needed is a housing program related realistically to the requirements of the people and the Nation. Presently, the housing industry operates successfully in the higher-priced market. We assume this can continue without any substantial revision of existing legislation. The essential fact we feel Congress must understand is that the housing industry does not operate effectively in the lower-priced market. While it is true that many middle-income and some low-income families have purchased new homes or do rent new housing today, in most cases they must spend an unreasonably large part of their current income to do so. The great mass of middle- and low-income families, however, cannot be buyers in the housing market under prevailing prices and payment terms.

We believe that any substantial expansion of the home building rate requires a program geared to the needs and ability-to-pay of this

great mass of urban families. The 1951 census reveals that 58 percent of the urban families of the Nation earned between \$2,500 and \$6,000 a year, before taxes, and 45½ percent earned between \$2,500 and \$5,000. This section of the population constitutes the great bulk of the potential housing market. A program which does not provide housing that is marketable to the families in this income range cannot encourage an expansion of housing supply.

A realistic appraisal of the percentage of family income which should go into housing expense—including cost of utilities and home maintenance—is 20 percent. This 20 percent allowance was thoroughly weighed in a special study made for the President's Advisory Committee on Housing and is reproduced on pages 282 to 290 of the committee's report.

The 20 percent figure applied to the \$2,500 to \$6,000 a year income group—which contains the bulk of the potential new housing market—would allow a \$12 to \$90 outlay for housing a month. Taking into account some of the tax factors, this is the amount these families can reasonably be expected to pay for all housing costs. In weighing the significance of these figures, it should be borne in mind that total housing expense is roughly twice as much as the cost of mortgage payments applicable to interest and the retirement of principal.

The income of the bulk of potential consumers we know; what these people can spend each month we know; the final ingredient, then, is the cost of the house. We firmly believe that the housing industry, as presently constituted, cannot provide housing for less than \$12,000 per unit—or perhaps as low as \$10,000, under unusually favorable conditions—if the housing is to be adequate and well-constructed, on fully developed sites and with proper facilities for wholesome family living. There is no evidence that standard and fully-completed housing can be furnished for less in the major urban areas of the Nation.

I would like to add here that I am afraid some of the concepts you gentlemen have heard from representatives of the administration, and perhaps from others, as to what a standard house is, are based on a very solicitous attitude toward the people of our great Nation.

My idea of what a standard house is is one that I would like to live in, and not one that some poor neighbor of mine might be relegated to. And I think the growing trend to rationalize this problem by suggesting that the bulk of the American people can live in totally inadequate neighborhoods, with inadequate facilities, with inadequate space, is one which should not be encouraged.

Mr. McDONOUGH. Will you yield at that point?

In other words, you don't object to any one living, who is satisfied to do so, in a so-called inadequate house, which you consider inadequate?

Mr. FISCHER. I don't object to it, but I object to a program which does not make it possible for him to have a choice.

Mr. McDONOUGH. Well, if he had a choice, and was still satisfied to live in the kind of a house that you did not think was adequate, you would say that he was satisfied?

Mr. FISCHER. Certainly. But I think that the Government, in its operations, should lend its weight toward providing a kind of housing that people who could attain that kind of housing would want.

Mr. McDONOUGH. Don't you think that this bill provides that?

Mr. FISCHER. No, I do not.

Mr. McDONOUGH. What do you think out to be done to the bill to make it more adequate?

Mr. FISCHER. If I don't cover that—I wish you would come to it later.

The CHAIRMAN. I wonder if Mr. Fischer could be permitted to proceed with his statement to its conclusion.

Mr. McDONOUGH. Very well, Mr. Chairman.

Mr. FISCHER. A sound housing program must be realistically based upon the existing costs of housing, not on a vague hope of more favorable price development in the future. The consumer cannot purchase a hope or a promise; he can only purchase a house that can be produced now in a place near enough to the location of his employment.

The monthly cost of a 40-year 100-percent mortgage is furnished by FHA to the advisory committee—page 94 of the report. If we assume a 4½ percent loan and the normal FHA insurance charge, but no special extras such as service charges, we find that a \$10,000 house would involve a housing cost of \$82 a month. Since the \$10,000 price is surely a rockbottom figure, we see that a 40-year amortization allowance could substantially stimulate home buying by families with incomes between \$4,900 and \$6,000 a year. We believe this to be important and strongly recommend that loans be made available on this basis. Apparently this is not now contemplated under the proposed legislation.

However, even such a provision would leave the bulk of the problem still unresolved. The need is clear—the monthly cost must be brought down substantially below the \$82 figure, not by cheapening the house, neglecting the site development, or choosing undesirable neighborhoods or leaving the house half completed.

There are many ways to reduce monthly housing costs including efficient land assembly and development, efficient building methods, etc. But the major area in which the Federal Government can operate most effectively to reduce overall housing costs is financing.

Interest rates can be reduced, primarily by the skillful use of Government credits and guaranties. There is no sound reason why the Government which now guarantees billions of dollars in outstanding mortgages cannot borrow money directly, lend it to the consumer and use the income from the consumer to pay off the obligations incurred. This would enable sharp cuts in interest charges.

Yet even this, while helpful in enabling more people to enter the new housing market, is not sufficient to do the entire job. It is, therefore, desirable to develop methods of making loans which are not retired during the first years of their existence. A system of one private loan, and one Government loan, with the former treated conventionally and the latter held intact with payment of interest only is a common practice in some countries and can be worked out here on a practical basis.

In fact, there are any number of methods to bring monthly payments down to the ability of the average family to pay—if the Congress wants to achieve this objective. We are suggesting that the key question is the objective itself. Once a firm decision is made that new housing must be made attainable to the bulk of the families in the \$2,500 to \$6,000 income brackets at a monthly cost approximating 20 percent of their earnings, the methods can and will be found.

We again emphasize the special role of Government in such a program. We favor Government-aided research which seeks out every possible method of producing better housing at lower prices. But we know that this is a long-range objective. The area in which Government must primarily operate now is in investment. This is the role it can most usefully and immediately perform in behalf of both consumers and producers.

It would be highly desirable if private investment funds were available, without any Government guaranties. But if we are serious about securing an expanding housing program we cannot be romantic about long ago. Let us face the facts of present-day life. The billions of dollars of annual investment in new housing that are needed cannot be obtained without the involvement of our Federal Government.

This fact should cause no great concern. Government involvement in stimulating private housing in no sense represents a raid on the Treasury. On the contrary, the funds are borrowed from private sources; the interest charges are paid by the housing consumers; the credit risks are backed by sound real-estate properties, and the overall program, if properly constructed, helps produce a level of economic activity and prosperity which contributes to the tax revenue flowing into the United States Treasury.

Halfway measures will not work. We urge the Congress to be both courageous and realistic and to write a program which is sufficiently comprehensive to be effective.

Even the best conceived program to bring home ownership to the bulk of the American people will not solve the entire housing problem, however, since there will remain hundreds of thousands of families at the lower end of the income ladder who cannot be served by private housing no matter how the burden is eased. For this group there is no solution except a form of direct Federal subsidy. This is the basic conclusion Senator Taft reached after years of study. The President has declared that the Taft public housing program should be continued. The advisory committee has so declared. No feasible alternatives have been suggested.

We are disturbed, therefore, that this housing bill does not include the legislative provisions necessary to return to the Taft program of 135,000 public housing units a year with a permissible rate of 200,000. Our country can afford and indeed must adequately house all of the families of the Nation. Public housing is a sound method of providing decent shelter for those who cannot afford to do so themselves. The Taft program places a maximum reliance on private enterprise and local responsibility and involves Government support only to the degree necessary and essential to the safety and welfare of the Nation as a whole.

In conclusion we repeat our urgent and emphatic recommendation to this committee, that in view of the imperative needs of the economy for stimulation at this time that nothing less than the full housing program so long identified with the name of the late Senator Robert A. Taft be authorized by Congress and promptly put into effect by the housing agencies of our Government.

As a postscript, let us make clear for the record that we have not attempted in this testimony to deal with several vital matters which should be included as parts of a comprehensive housing program. For instance, there are the special aids required for the handling

of minority problems, the stimulation and support of the cooperative housing program, provisions for builders' warranties to give the consumer a measure of protection against faulty construction and methods to encourage moderate rental housing.

We know that many organizations with which we cooperate are appearing before you and will deal specifically with most of these particular problems on the basis of specialized knowledge and experience. We hereby identify ourselves with the widespread interest in these special problems and in a general way support their recommendations.

We appreciate the opportunity to express our viewpoint here. We have avoided a detailed item-by-item discussion of the proposed legislation because we know others will cover the field extensively. Furthermore, we feel that the central problem of getting down to "brass tacks" in constructing a genuine new housing program for America is so important that the particular emphasis we have given in this presentation is fully warranted.

(The statement by Mr. James G. Thimmes is as follows:)

HOUSING FOR AMERICA

Statement by

James G. Thimmes

Member, The President's Advisory Committee on Housing

The material in this pamphlet is the text of a letter addressed by James G. Thimmes, a member of President Eisenhower's Advisory Committee on Housing, to the President. In the letter, which was sent on January 8, 1954, Mr. Thimmes expressed his individual views, on behalf of the CIO, on a number of issues reviewed in the Report of the President's Advisory Committee. Mr. Thimmes, in addition to being chairman of the CIO housing committee, is a vice president of both the United Steelworkers of America and the Congress of Industrial Organizations.

It is the belief of the CIO housing committee that these views on our national housing situation will be of interest to people in every phase of housing activity. The CIO believes that these issues take on special significance in 1954 because housing constitutes a major field in which adoption of proper policies and programs can serve to combat the menacing growth of unemployment and recession.

MR. THIMMES' LETTER TO PRESIDENT EISENHOWER

I wish to express my appreciation for the opportunity you have given to me to participate in the Advisory Committee on Government Housing Policies and Programs. It was for me a welcome and valuable experience. The presentation of the ideas and proposals of organized labor have contributed, we feel sure, to a more complete consideration of the Nation's housing problems.

The report issued to you is significant. While I join in the report, I do not agree with some of the recommendations and regret some significant and serious omissions. However, the fact that there has been a wide area of agreement can be useful to you and the Congress in developing a fully comprehensive program to meet the housing needs of the people and the Nation's requirement of a high level of house-building activity.

We of CIO are disturbed at persistent indications that Government officials and industry spokesmen are setting their sights for the coming year for too low. A goal of a million new housing units during the coming year will not contribute the new homes needed to attack the problem of adequately housing the people of America; nor will it enable the housing industry to provide enough jobs for its own employees and related industries to fully use housing as an antidepression weapon.

We recognize that the mere statement of a goal, such as the 2 million annual rate advocated by the CIO convention, will not of itself bring about the desired level of housing production. But the statement of the goal will enable the Government to plan its own program in such manner as to encourage the types of homes, the price levels, and the financing means to enable its achievement.

We urge therefore that the goal of 2 million units be adopted and that each item in the housing program be evaluated accordingly. My comments on the committee report are made with this objective.

PUBLIC HOUSING

We welcome the committee's endorsement of the public housing program. We hope that the partisan bitterness that has surrounded this subject in the past will now be ended and that an objective determination can now be made regarding the rate of public housing required by the Nation.

Thorough examination of all factors reveals that the original goal of the 1949 act of 135,000 units a year is modest. A larger program could be justified to catch up with the lag of the past several years. However, there can be little doubt that the 135,000 unit program can be sustained. It will make a real dent in meeting the pressing needs of low-income families. It will be a valuable aid to the total building industry and the overall need of a high level of housing production. It will produce wealth which will constitute a firm asset to the Nation; in fact, the Federal subsidy required may be repaid eventually out of rental income if the committee's recommended legislative changes are accepted.

Because slum clearance and redevelopment of the great urban centers are urgently required, full resumption of the public-housing program is especially necessary. We are confident that the redevelopment and slum clearance goals agreed to by all of us will not be achieved unless adequate provision is made for housing low-income families. A small public housing program will not sustain a widespread redevelopment program. Community support will not be readily available unless slum dwellers can be adequately rehoused at prices within their means.

In fact, a small program of 20,000 or 35,000 public housing units does not justify the overhead required to develop further public housing. We of CIO consider a continuation of this token-size program as being tantamount to no public housing program at all.

LOW INCOME PRIVATE HOUSING

The public-housing program was never proposed as the total answer to the problem of slum clearance or of fulfilling low-income family housing needs. The major responsibility for providing housing for low-income families has always been, and appropriately, reserved for the traditional methods of private enterprise activity. The committee recognizes, however, that private enterprise cannot meet the problem without substantial Government aids.

We believe that the Government's program should be based on encouraging large-scale new construction of homes for low-income groups. We believe that 135,000 public housing units is only a start in this direction and other methods must be provided. We endorse the idea of using long-term mortgages, low down-payments and advance commitments to builders to encourage the workings of private industry provided that the Federal Housing Administration takes special care to assure high standards of construction and does not become a party, wittingly or unwittingly, to high pressure sales methods which push people into housing costs beyond their means. Only disaster could follow if new slums were built or if economic strangulation were imposed on low-income families.

We recognize that there may be some reluctance to face up to the reality of what a low-income family really is and how important this group is to the achievement of a high rate of home construction. For the purpose of planning an overall housing program, families with incomes up to \$5,000 are clearly low income. They are not eligible for public housing but they do need adequate housing and they do constitute the great mass of consumers with unfulfilled housing requirements. It is in the \$3,000 to \$5,000-per-year group that the major reservoir of desirable and available consumer demand must be recognized.

Therefore, I strongly urge that the liberalized long-term mortgage recommendations be extended far enough to include this entire group. To do this, the price of the housing covered by such a program must go as high as \$10,000, especially in the higher cost areas.

FINANCING AN EXPANDED PROGRAM

To assure the success of this program it is essential that investment funds be channeled into this highly productive activity. If ready financing is not available for housing for the \$3,000 to \$5,000-income family and for homes priced at \$10,000 and under, with long-term mortgages and nominal downpayments, a high level of home production cannot and will not be achieved.

We therefore urge that FNMA not be terminated or liquidated. In fact, we urge that it be given greatly expanded authority to enter into this field. Recognizing the dangers, we urge that some special supervisory authority be established to assure proper use of an expanded FNMA program. Such assurance should be directed toward developing housing in areas where needed, in neighborhoods where community facilities and occupancy patterns permit proper neighborhood life and democratic selection of home owners and tenants. It should also include high construction standards and granting of loans on a proper credit basis. If this is done, this program should be acceptable to the private investor of mortgage funds or at least should become readily acceptable when its soundness is demonstrated. In this way, the Government will not become the direct subsidy source; the private investment market will eventually hold the mortgages but the possible initial reluctance of private investors will not delay the prompt implementation of the program.

BUILDERS' WARRANTY

Assurance of high construction standards will be aided if FHA requires builders using FHA facilities to issue a builder's warranty to the purchasers of new homes. We regret that the committee failed to endorse this proposal. Discussions with builders and FHA representatives failed to reveal any real reason for not making such a simple requirement. Its practical value is demonstrated in that many builders now issue such warranties; only the irresponsible builder would conceivably oppose such a proposal.

INTEREST RATES

To sustain a high level of building, prices must be suitable to the purchaser. The rate of interest and other related charges constitute important items in the consumer's monthly housing costs. The proposal to abandon present statutory interest-rate ceilings and tie the limits to the current yield on Government bonds could pierce the present interest-rate ceilings. We urge that you do not accept this recommendation. An increase in interest rates would be a major disaster for the expansion of home building.

Coupled with this recommendation is a proposal to set up an interagency committee to set FHA and VA interest rates and premium and service charges. On its face this appears reasonable. However, in the context of the suggested removal of the statutory ceiling and the widespread advocacy of numerous types of premium and service charges, we must conclude that the proposed interagency committee would unfortunately serve as a device for facilitating increased charges to the consumer. We believe that such a course would discourage home ownership, work against high levels of production and burden the consumer unjustifiably. We urge rejection of this recommendation.

RENTAL AT MODERATE PRICES

The committee's report does not deal adequately with a very troublesome problem, the construction of rental units which are within the means of families of low and moderate incomes. This field has been woefully neglected by the industry for many years. Many slum-clearance and redevelopment plans are doomed unless this problem is solved. For a variety of reasons, many families desire and need rental properties rather than their own homes. In some urban areas, the nature of the community and patterns of living makes the need for rental housing at moderate rents especially acute.

To facilitate slum clearance and redevelopment, to assure that rental housing needs be met, and to enable this type of program to contribute to the total high level of housing production, we propose that legislation be developed and supported to provide longer term mortgage financing of specified rental housing. We suggest as high as 75-year mortgage terms, a not unreasonable figure when it is noted that 40-year mortgages on old housing are being recommended in the committee report.

We further suggest that a mortgage interest rate slightly in excess of the Government bond yield be provided, that an appropriate Government corporation sell debentures to finance the program, and that we thus will have the maximum reliance on private enterprise consistent with the need to provide an answer to an otherwise unanswered problem.

COOPERATIVE HOUSING

A portion of the need for housing moderate income, and perhaps even low-income families, can be met by the activities of cooperative housing groups, provided that adequate finances are made available. The cooperative housing program has been proved sound as an investment. Nevertheless, in many areas investors are reluctant to enter the field.

We regret that the advisory committee has not developed a solution to making investment funds available. We believe the proposal of the cooperative organizations for a central mortgage facility initiated by the Federal Government and to be privately owned eventually, provides an answer to this troublesome problem. Pending this development, however, we believe that FNMA authority in this field should be continued with greater authorization. In no other way, as we now see it, will the consumers who desire to solve their housing problem by means of cooperatives be enabled to do so.

REHABILITATION

We support the program for rehabilitation of existing dwellings and neighborhoods. However, we believe it will be a great error to overemphasize this program. It can accomplish great good but if it is held up as a major answer to slums or as an alternative to new construction, it will impede the total housing program.

We urge that this program of rehabilitation be kept in its proper perspective to assure its aid to the total objectives of a sound housing program.

MINORITIES

We of the CIO believe that the kind of housing program we have described here will make easier the solution of special problems of minority group families. However, I am confident that you and your associates are keenly aware of the need to work diligently in this field so that the Government's deep involvement in the housing field will be used to cure and not neglect or aggravate the undemocratic housing practices which are all too common in our communities.

To solve the minority housing problem, special attention must be given to making sites available for new construction of units available to minorities; the tendency to squeeze minorities into overcrowded, restricted areas must be successfully resisted; and the relocation of minority families in slum areas which are demolished must be provided in such manner as to provide better housing and more democratic neighborhood patterns.

Recognition must also be given to the increasing tendency of minority families to improve their economic status so as to enable the acquisition of substantially improved housing facilities. The failure to provide such families with the full opportunity to obtain favorable mortgage financing and access to homes and rental units consistent with their economic capacity constitutes a sad reflection on the ability of our free economy to operate fairly and democratically. Every step must be taken to correct this glaring inequity.

We note that in your state of the Union message of January 7, you advised the Congress you intended to submit on January 25, a special message on housing problems. We sincerely trust, Mr. President, that you will give serious consideration to the recommendations made in this letter; recommendations designed to achieve the goal you so eloquently stated to the Congress when you said: "And no good American family should honestly have to be ashamed of its home."

In closing, I wish to pay special tribute to the chairman of the committee, Albert M. Cole, for the fair and constructive manner in which he presided over the work of the committee and hope that his great responsibilities as the chief housing officer of our Government will be carried on with equal fairness and with vigor and determination.

The CHAIRMAN. Thank you, Mr. Fischer.
Are there questions of Mr. Fischer?

Mr. DEANE. Mr. Chairman, I have one.

The CHAIRMAN. Mr. Deane.

Mr. DEANE. On the present availability of credit, under the present housing program, what is your experience?

Mr. FISCHER. Well, I can't begin to speak as an expert, sitting on the President's Advisory Committee all the bankers constantly insisted that the market was getting looser and all the builders were saying it was rough. That seems to be the prevailing situation.

I think that, generally speaking, the mortgage situation is better for A-1 risks. If you are willing to put down a 30 or 40 percent downpayment, and get an FHA guaranty, and you have a very good piece of property, and your personal credit is good, I think money is available. It always has been and I assume always will be.

But for the kind of enterprising housing which is necessary to a big housing program, it appears that the situation is quite rough. I don't think there is any question of doubt that in any 40-year program, 95- or 100-percent loans, which is addressed at reaching lower strata in our economic ladder than what is generally met now, you are going to find extreme resistance from the lending institutions. I don't think anybody has given any indication that the private lending institutions would be interested in any greatly expanded low-cost housing program.

Mr. DEANE. What is the approximate present downpayment for, say, a \$10,000 home?

Mr. FISCHER. For a \$10,000 home it will run about 10 percent, I suppose. These things change very rapidly and for different kinds of housing and different localities.

Mr. DEANE. I checked recently with the building and loan association in my own hometown and they are requiring 30-percent downpayment.

Mr. FISCHER. If you are talking about the practice; yes. I thought—

Mr. DEANE. That is what I am interested in.

Mr. FISCHER. I thought you were addressing yourself to what FHA requires. I think the practice is quite extreme, you are right.

I do not think there is any substantial reason for hoping that in the next year or two, at any rate, there will be any significant sums of private money made directly available for large-scale housing development.

Mr. DEANE. I make this observation, Mr. Fischer. What concerns me involves the thought, we have one group against another group, here is one viewpoint and here is another viewpoint. Why is it that we cannot come together on unifying ideas for what is right and not who is right?

Mr. FISCHER. Well, I thought that the Advisory Committee had come together to a substantial extent on an idea, and that was that we would try to encourage the construction, financing, and sale of reasonably low-price homes with very favorable terms. What happened to that idea of the Advisory Committee makes an interesting story, and a long one. It got watered down just a bit. By the time it got to the Administrator it was watered down further. By the time it got into this legislation it has become a fragment of the original proposal and quite meaningless. The original proposal along these

lines in the Advisory Committee involved a program cut to \$10,000 housing, with 40-year loans, and with FNMA support, based on the assumption that there would not be private money readily available for this kind of program.

And you can see what has happened since then. The thing has been restricted and cut down and skeletonized until at this point it seems to me it has very little meaning left.

Mr. DEANE. Thank you, Mr. Chairman.

The CHAIRMAN. Are there further questions of Mr. Fischer or Mr. Edelman?

If not, we are very grateful for your testimony, gentlemen.

Mr. EDELMAN. Mr. Chairman, my name is John W. Edelman. May I file this supplementary statement on the question of public housing with Mr. Fischer's as a sort of postscript or appendix to the principal presentation made on behalf of the CIO by Mr. Fischer?

The CHAIRMAN. Without objection, that may be inserted in the record as part of the CIO's presentation.

(The material referred to is as follows:)

SUPPLEMENTARY TESTIMONY PROTESTING OMISSION IN H. R. 7834 OF LEGISLATIVE IMPLEMENTATION OF A PUBLIC HOUSING PROGRAM OF AT LEAST 200,000 UNITS PER YEAR, PRESENTED ON BEHALF OF THE CONGRESS OF INDUSTRIAL ORGANIZATIONS BY JOHN W. EDELMAN, WASHINGTON REPRESENTATIVE, TEXTILE WORKERS UNION OF AMERICA (CIO)

The Congress of Industrial Organizations is strongly of the opinion that the lack of clear and positive implementation in so-called housing bill now before the committee for at least 200,000 units of low-rent public housing in the forthcoming fiscal year, is a fatal and inexcusable defect. The CIO insists that overwhelming and irrefutable testimony has been presented to congressional committees in the past sessions, demonstrating beyond question the pressing and tragic need for a slum-clearance and public-housing program amounting to at least 10 percent of a total housing program of 2 million units a year for 10 years.

The administration's weak and tentative recommendations for an appropriation of 35,000 units of public housing for the current fiscal year is tantamount to a rejection of the very carefully considered recommendation of the report made in December 1953 by the President's Advisory Committee on Government Housing Policies and Programs. The members of this Committee are well aware of the fact that the majority of the persons who served on the President's Advisory Committee on Housing are businessmen and others whose political leanings are definitely those of the present administration.

In its careful and hard-boiled analysis both of the problem of slum eradication and of the housing needs of low-income families (the distinction between the two is almost insignificant), the President's Advisory Committee accepted the 1950 census data on housing supply and housing conditions as solid and dependable. Based on our first-hand contact with the housing situation in hundreds of urban and nonurban areas in all sections of this country, it is our considered view that the 1950 census understates rather than overstates the actual and prevailing extent of degrading and dangerous slum conditions and the needs for additional housing supply for families of low and middle income.

Nor do we know of any serious attack on the census data on housing by any responsible person or institution. These figures on housing can, of course, be ignored; they cannot in our judgment be substantially impeached. We ask the Members of Congress this question: What reasons or excuses can be offered by a responsible legislative body for disregarding the evidence of the census and the recommendations of the Advisory Committee based on that body of statistical data on housing needs?

The National Housing Conference, with whose views on this subject the CIO associates itself, will offer a competent reanalysis of the facts and figures on housing needs and supply and on the extent of slums and substandard housing. We, therefore, merely sketch in our understanding of the basic problem.

There are in the United States some 15 million substandard dwelling units in both urban and farm areas. Between 10 and 11 million of those unsafe and unsanitary units are in urban communities.

Even if the assumption is made that only 10 million of these 15 million unfit units should be replaced, the country is faced with a housing problem of much greater proportions than Congress has ever faced up to. It is our view that these 10 million units must be torn down entirely and that perhaps 4 to 5 million can be fixed up in one way or another to be made habitable for a few more years.

Over and above the number of dilapidated, unsanitary or otherwise unfit dwellings in the 15 million overall total, an additional 40,000 housing units are destroyed each year through fire or some other hazard such as windstorms or tornadoes. Demolition of existing dwellings by new highway construction or other types of public works adds up to a surprisingly large number each year. This is in addition to the 40,000 units. About 300,000 units of war housing, most of which are still occupied, must be torn down in the next few years or they will fall down through neglect. Not all the dwellings in these categories should be replaced by public housing, but it is obvious that most of this total now houses very low income families or is actually unfit.

There is the further problem of dangerous overcrowding in housing which may not in itself be substandard, but becomes actually unfit when occupied by two or more families. The statistics show that over 2 million families are living in quarters providing less than one room per person. This constitutes a real menace to both health and morals.

Even though the doubling up of families has been reduced somewhat in the past several years, the census shows 1.7 million families still living doubled up. Few if any of these families live on top of each other by preference; they are forced to do so because of lack of income or inability to find separate housing within their means.

We wish to repeat here what we have pointed out on so many previous occasions over the years—that the amount of the very small subsidy required by a public-housing program for the low-income groups, when properly analyzed, adds up to an expenditure of less public money than is now drained out of all our pocketbooks by the continued existence of slums and slum conditions. Some barefaced efforts have been made in local referendum campaigns aimed at scuttling public housing to divert the public's mind from the fact that the dollars and cents outlays of taxpayers' money on police and fire protection and other inescapable social costs arising out of slum conditions is greater than the cost of subsidies to well planned and properly managed low-rent housing units. Yet, year after year, responsible city officials find themselves forced to testify anew to this melancholy fact—slums cost money, slums spread moral infections and cause economic blight to spread into otherwise healthy neighborhoods. Our present expenditures due to slum conditions is greater than the cost of a public-housing program.

The 35,000 units of low-rent public housing as suggested by the administration for this year's program, we insist, is utterly inadequate. Urban blight cannot be checked without a substantial public-housing program equal to at least 10 percent of the total new housing starts for that year. CIO takes the position that a minimum of 2 million new housing units of all types are needed every year for the next 10 years. This gives us the figure of 200,000 low-rent public housing dwellings per annum.

The public-housing program, as authorized by the Housing Act of 1936 and 1949 and administered under constant attack and sabotage from many sides, is by no means the final or ideal solution to the problems of slum eradication and the housing needs of low-income families. This is, however, the best program that has so far been devised and has proven to be a boom of inestimable value to hundreds of thousands of families in many communities, both large and small, in all sections of these United States.

Happily, not a large segment of trade-union membership still remains in the income groups eligible for public housing. Yet in almost every labor market we find a proportion of our people who for one reason or another have a low earning power or are still in low-wage industries, who can only find decent homes in public-housing projects.

Only 2 weeks ago, I spent a Sunday in a southern city visiting families whose breadwinners were members of my own union and who live in slum-clearance projects. We can assure this committee on the basis of this first-hand inspection (as well as many similar visits in other towns and cities) that

the amenities afforded our members in the projects are absolutely minimum, and that far from being pampered in our judgment were less than should be afforded these upright and deserving American citizens, some of whom have literally given lifeblood in the armed service of their country.

The CIO wishes to be on record in declaring the need for further study and possible revision of the public-housing program as well as its extension and revision. We seriously believe that over a period of years in a healthy and expanding economy that income levels can be raised to the point where subsidies to these low-rent projects can be scaled down until finally they become self-supporting and even valuable additions to the real properties of the communities in which they are located.

For the time being, however, and for some years to come there must be subsidies such as are now paid to most public-housing units, if the constantly encroaching and dangerous slum areas are to be contained and reduced.

Finally, we register our bitter protest against the action of the Congress in assigning year after year the decision as to how many housing units should be built to a notoriously hostile subcommittee of the Appropriations Committee which meets behind closed doors and whose members refuse to study the considerable body of economic and social data which is the solid and uncontroversial justification for a housing program of the dimensions the CIO is urging.

The Banking and Currency Committee does at least listen to some recitation of the fundamental and vital data which must be understood and evaluated before sensible decisions as to housing need and policy can be arrived at. The subcommittee, in effect, insulates itself so that the emotional stench and impact of the monstrous and tragic conditions which exist in the slums of America do not disturb what we believe to be an inexplicable obduracy in refusing to face facts and human needs.

The CHAIRMAN. The committee will stand in recess until 2:15, subject to getting permission from the House for the committee to sit while the House is also in session.

(Whereupon, at 12:30 p. m., a recess was taken in the committee until 2:15 p. m. of the same day.)

AFTERNOON SESSION

The committee reconvened at 2:15 p. m., pursuant to recess, Hon. Jesse P. Wolcott (chairman) presiding.

Present: Chairman Wolcott, Messrs. Kilburn, McDonough, Betts, Mumma, McVey, Merrill, Hiestand, Stringfellow, Van Pelt, Spence, Brown, Deane, Dollinger, and O'Hara.

The CHAIRMAN. The committee will come to order.

We will proceed with the hearings on H. R. 7839, and we will first hear from Edward B. Hollander, of the Americans for Democratic Action.

We are glad to have your testimony, Mr. Hollander.

Mr. HOLLANDER. Thank you, sir.

The CHAIRMAN. You may proceed.

STATEMENT OF EDWARD B. HOLLANDER, REPRESENTING AMERICANS FOR DEMOCRATIC ACTION

Mr. HOLLANDER. Mr. Chairman, members of the committee, my name is Edward Hollander. I am national director of Americans for Democratic Action. I appreciate this opportunity to appear before you to present the views of ADA on the housing bill you are considering.

ADA from the time of its founding in 1947, has consistently advocated measures to improve housing conditions of the American people.

It has always seemed to us a cruel and unnecessary contradiction that in this great and rich country, with its enormous resources of manpower and materials, so many of our families—now estimated at 8 million—should be forced to live in homes that are seriously substandard at best, and at worse, unfit for human habitation.

As the report of President Eisenhower's Advisory Committee on Housing said:

* * * our country which has the highest standard of living in the world * * * cannot permit a substantial number of its citizens to live in filth and squalor, in hovels which health laws for the protection of our people would not allow for farm animals.

There is another reason why ADA strongly urges action to wipe out substandard conditions of living. In its outspoken and resolute opposition to communism, here and abroad, ADA has always believed that a high standard of living for all the American people is indispensable in the arsenal of our weapons against communism.

By these means we can prove to our own people by the daily experience of their lives, and to the rest of the world by our example, that democracy is the way not only to freedom but to abundance and security as well. As President Eisenhower said not long ago, in dedicating a public housing development for low-income families:

In it we expect to see living happy families, families who because of their standard of living are our Nation's best weapon against communism. More eloquent defense against that insidious doctrine than the most eloquent tongue of any lawyer, preacher, or teacher. A more sure defense than any battleship or any plane or any gun or any bomb of whatever kind. This is the kind of thing that will preserve this Nation.

We of ADA fervently believe so.

It is encouraging to find in the President's message on housing, and in the report of the Advisory Committee which the message mainly follows, explicit recognition of the Nation's housing needs and the urgency of meeting them. It is particularly encouraging to find a committee composed largely of businessmen, builders, and financiers confirming what some of us have contended for many years: That there is a serious housing problem that demands solutions so that every American family can have a decent place to live.

We believe that the uniform recognition of this problem reflects the rebellion of the American people against slum conditions and their aroused demand for the kind of living that this country can provide. This recognition is a first and necessary step toward the achievement of good housing.

Unfortunately, the progress of our action has not kept pace with the progress in our thinking.

Since the war we have been building a little over 1 million dwellings a year—scarcely enough to provide what most experts agree is needed to house new families and replace losses through destruction. The National Association of Home Builders have estimated that we need to put on the market 2 million new or new-conditioned homes each year for the next 10 years.

The greatest demand is for medium- and low-cost housing, but most of the newly built homes are out of reach of medium- and low-income families.

By June 30 of this year, we will have built only 200,000 public housing units for low-income families, of the 810,000 units authorized by the Housing Act of 1949.

We have made only a token start toward eradicating our disgraceful slums, although there are 8 million families living in substandard conditions.

Little progress has been made against the scandalous conditions in the housing of minority groups. Yet it is estimated that 70 percent of our nonwhite families are living in dwellings that are dilapidated or seriously deficient.

I will not take your time to rehearse the facts of the staggering costs—both human and financial—that arise from slum housing. These are already well known to you and generally admitted. The question is: How are we going to get rid of them? The beginnings we have made since the war are pathetically modest, and I am afraid that I cannot see in the bill before you very much reason to hope that we are going to do a great deal better. In saying this, I do not mean to overlook the constructive features of the bill.

Certainly there is much merit in measures to make mortgage credit more readily available and to maintain fluid primary and secondary markets for mortgages. The emphasis in this bill on urban renewal, on rehabilitation of housing, and on preventive measures to check the spread of slum and blighted areas, will undoubtedly make our communities pleasanter places to live in. But let no one believe that this bill will go very far toward meeting our country's housing needs.

For this is a builders' and financiers' bill, not primarily a housing bill. It will probably result in some increase in the building and rehabilitation of homes. It will strengthen the market for homes, probably at higher prices. But what will it do to provide housing to those who need it, at prices they can afford?

Mr. Chairman, Americans for Democratic Action believe in private enterprise and recognizes its great contribution to our standard of living. It seems to us that this bill, however, takes the "enterprise" out of "private enterprise" by shifting most of the risks from the builders and lenders to the Government. Under this bill, only as much housing will be built as will yield a quick and almost risk-free profit to the builders.

But how would this bill help the consumers of housing? Take, for example, the liberalization of mortgage terms. The higher loan-value ratios and longer periods for repayment are proposed to bring home ownership within the reach of more families.

Experience, however, has proven that sellers most often take advantage of more liberal credit terms to raise the prices of housing, thus diverting the benefit from the buyer to the seller and negating the purpose. What safeguards are there in the bill to prevent this?

With adequate safeguards against unwarranted and unintended price increases, we believe that this bill would make possible the building of houses at somewhat lower prices than heretofore. While we do not think that by this bill housing can be brought within the reach of low-income families, we do think it may stimulate building of more homes which could be brought within the reach of families with somewhat higher incomes.

Mr. Chairman, I should like to discuss briefly three principal points raised in the President's housing message, relating to this bill. They are separate subjects, though they are related to each other.

First, the question of slum clearance; second, the question of housing low-income families; third, the housing of minority groups.

We believe that slum clearance and urban renewal are goals in themselves. The case against the slums has been made; it remains to get rid of them. The Subcommittee on Urban Redevelopment estimated that if we were to spend on slum clearance five times what we are now spending it would take 50 years to clear the present substandard dwellings from our cities. At the present rate it would take 200 years. The subcommittee estimated that \$1.5 billion a year would be required to do the job in 10 years; if at the same time we take steps to prevent the spread of new slums.

Can we honestly say that we cannot afford \$1.5 billion a year to rid ourselves of the costs and the misery of slums, in a country with a national product of nearly \$400 billion a year? Less than one-half of 1 percent. What is impossible about that? It is less than the price of keeping the slums to breed delinquency, crime, and disease.

It is estimated that although slum and blighted areas comprise about 20 percent of metropolitan residential areas, they account for 45 percent of major crimes, 55 percent of juvenile delinquency, 60 percent of tuberculosis, 50 percent of arrests, 35 percent of fires, 45 percent of city service costs and only 6 percent of real-estate-tax revenues. If we want to do away with them, it will take a bold program. The cautious, cumbersome approaches we have adopted will never do it.

But slum clearance and urban renewal, though they are necessary to save our cities and protect our people, do not solve the housing problem. On the contrary, in the short run they aggravate it, by displacing families from substandard homes.

Even rehabilitation of dwellings, though it improves the quality of housing, invariably results in increased rents, often beyond the means of the original occupants. The plain fact is that people live in slums because they cannot find good housing at prices they can pay. There cannot be large-scale slum clearance, nor effective enforcement of housing codes, until there is enough housing of suitable standards for the families who would be displaced.

The problem of housing in the United States is very largely the problem of finding suitable housing for low-income families and minorities. When we consider that about half of our 27 million city families have annual incomes of less than \$4,000, one-fifth of them (about 5½ million) less than \$2,500, you can recognize the size of the low-cost, low-income housing needs.

Incomes under \$2,500 a year mean that families cannot afford more than \$40 a month for housing, and what kind of housing can be had for \$40 or less on the market in our cities today?

Even on the most liberal credit terms, this will buy less than \$5,000 of house; hardly half the cost of the lower priced housing now being built.

I am sure this story is familiar to you by now: The rehousing of the families in the bottom quarter of the income scale waits on the depreciation of existing housing to a price they can afford. This is a slow

process; by the time it happens, much of the housing is hardly worth having. We see nothing in this bill that would lead us to believe that it will bring good housing—new or used—within the means of low-income families.

Indeed, in some important respects this bill represents not an advance but a retreat in our housing program. The Housing and Home Finance Administrator has indicated his hope that 1 million new homes a year may be built under it—30 percent below the number built in the highest postwar year and barely enough to house new families.

The bill fails to take account of the experience under the National Housing Act: At today's construction costs, continued overreliance on the market incentives, even when builders' risks are minimized, will mean continued failure to provide housing in quantities and at prices required to rehouse slum dwellers.

The most direct means of providing low-rent housing, through the public-housing programs for low-income families, has been three-fourths stifled by the lack of appropriations. And the President has recommended only a token program of 35,000 public-housing units for the next fiscal year—one-fourth of the program authorized by the Housing Act of 1949.

The conclusion is inescapable that the bill before you in spite of some constructive features in it, seems not even designed to remedy the serious housing situation recognized on all sides. ADA believes that no bill will do this that does not recognize the limitations of the market incentives—however they may be sharpened by reducing the risks—and that does not undertake to use the resources of the Federal Government boldly and generously to supplement the efforts of communities and builders in bringing good housing within the reach of all our families.

Such a program would include direct use of the Government's credit in liberal financing; more generous grants to cities for urban renewal; public housing for lower income families on a much larger scale and with fewer restrictions than heretofore; cooperative housing for middle-income families; and vigorous search for methods of reducing housing costs and assuring good quality. All this seems to us to be lacking in the present bill.

The difficult situation of minority groups needs special attention. The President in his eight-point message to Congress spoke out frankly and honestly in acknowledging "that many members of minority groups, regardless of their income or their economic status, have had the least opportunity of all of our citizens to acquire good homes." The President went on to say that far too little has been done to meet this minority housing problem, and that his administration would see to it that equal opportunity for adequate housing would be available to minority groups. There is nothing in this administration bill that would help solve the particular problem of minority housing. ADA agrees with the President that something should be done about it.

One of the principal problems in minority housing has been the unwillingness of private lending institutions to make home loans to members of minority groups on the same basis as to other prospective home owners. These private lending institutions have been supported in this practice by the Federal Housing Administration. We suggest

that the Congress, as a part of the pending legislation, create within the Housing and Home Finance Agency authority to assist members of minority groups to secure private financing for the purchase and rehabilitation of homes and, where such private financing is not forthcoming because of the race or religion of the individual applicant, direct Federal loans be made available. Such a program if enacted, would stand or fall upon the will of the administration to carry it out and the responsibility would be clearly in the hands of the H.H.F.A.

As a further housing aid to the members of minority groups, anti-discrimination provisions should be written wherever relevant in the pending legislation. If the Government is to guarantee private capital against risks, or provide funds for slum clearance or urban redevelopment, or public housing, the people have the right to insist that such guaranties be made on the merits of each application, without regard to the minority status of individuals.

In emphasizing the human and community importance of housing, we should not overlook its importance in the national economy. The debilitating effect of slums on the finances of our cities is universally conceded. Beyond this, we must remember the role of the home-building industry in maintaining full employment. At its postwar peak this \$12-billion-a-year industry accounted for one-fourth of total private investment; last year for one-fifth. It provides employment directly for a million or more workers and indirectly for hundreds of thousands more. The home-furnishings industries also largely depend on the rate of new housing. In our efforts to regain full employment, we must not neglect the influence of the housing industries.

Finally, Mr. Chairman, ADA believes we should lift up our eyes to the future, to the America of the 1960's and 1970's. The children who are now growing up in slums will not thank us if we persist in timid approaches which will leave them burdened with these same problems, aggravated by time and inaction. This country has the resources to house its people as they should be housed. We cannot confess ourselves incapable of using them to accomplish this important purpose. The resourcefulness and enterprise which have brought our people the highest standard of living ever known can also bring them good housing.

Thank you, Mr. Chairman.

The CHAIRMAN. Thank you, Mr. Hollander. Are there questions of Mr. Hollander?

Mr. KILBURN. Mr. Chairman.

The CHAIRMAN. Mr. Kilburn.

Mr. KILBURN. On page 5 of your statement, at the bottom, you say:

One of the principal problems in minority housing has been the unwillingness of private lending institutions to make home loans to members of minority groups on the same basis as to other prospective homeowners.

What was the basis for that statement?

Mr. HOLLANDER. I think, sir, it is a widely known fact and a common experience that under the present housing programs, the restrictions on minority housing make it very difficult for members of minority groups to get financing on the same basis as others.

For one thing, the institutions which do the lending have been reluctant to provide financing which enables members of minority

groups to move into areas which have been hitherto denied them, and since there is scarcely room in the restricted areas in many cases for them to build their homes, they are almost dependent on their ability to move into newer areas.

Mr. DOLLINGER. Mr. Kilburn, will you yield?

Mr. KILBURN. Just a second. I wish to develop that. I don't see that it is the lending institution's function to tell the fellow that is developing the housing what to do. They are just loaning the money. I have never heard of any financial institution refusing a loan because the borrower is a member of a minority group.

Mr. HOLLANDER. I think this does happen, sir.

Mr. KILBURN. Well, I have never known of it happening and I would like to know of an instance where it is happening.

Mr. DOLLINGER. Can I give you some?

Mr. KILBURN. Give me one.

Mr. DOLLINGER. Right in the city of New York, there are areas where mortgages on apartment houses, because minorities are housed in them, have difficulty in renewing mortgages and some of the banks will not touch those areas. Right in New York City, right in my own county. That condition exists there as it does in other parts of the country.

Mr. KILBURN. All right. Isn't there a housing development in New York City for colored folks?

Mr. DOLLINGER. That is not what we are discussing. We are not talking about segregated housing now.

Mr. KILBURN. They got a mortgage from a private institution.

Mr. DOLLINGER. Yes, the Metropolitan Life has homes up there. That is a segregated area. We are not talking about that.

Mr. KILBURN. I'm talking about a financial institution, because some minority group comes in, and the man says we don't want to lend to you because you are colored.

Mr. DOLLINGER. They don't want to lend money because they are afraid certain areas are becoming Negro areas and they won't lend money in those areas not only to Negro owners, but white owners who have Negro tenants. I know of such instances.

Mr. HOLLANDER. Sir, when I went to get a mortgage on my own home in the city of Washington, I was not able to get it because there is no restrictive covenant on the land and I refused to put one on it.

The CHAIRMAN. Are there further questions?

If not, thank you very much, Mr. Hollander.

Mr. Lewis Whiteman is executive director of the Associated Builders of Greater New York.

STATEMENT OF LEWIS WHITEMAN, EXECUTIVE DIRECTOR, ASSOCIATED BUILDERS OF GREATER NEW YORK

Mr. WHITEMAN. Mr. Chairman and members of the committee, I am Lewis Whiteman, executive director of Associated Builders of Greater New York, with headquarters in Forest Hills, N. Y.

First of all, I should like to thank the committee for giving us this opportunity to appear here and to express our views on this important legislation.

Our organization is in its 44th year. It is a voluntary, nonprofit association of builders and management firms who operate almost exclusively in the multiple-dwelling field, throughout the metropolitan New York area, in New Jersey, Connecticut, and in other Eastern States.

The Housing Act is a matter of particular interest to our members since they produce, by far, the largest volume of apartment house construction in the Greater New York area, much of it heavily committed under FHA programs, 207, and 213. It is estimated that the total dollar volume of multifamily residential construction being carried on by our members would run from \$200 million to \$300 million and although I am the executive head of the association, I am not on the firing line of FHA activity and so I feel that it would be presumptuous of me to discuss some of the technical aspects of this bill.

However, I have with me today Mr. Alvin Benjamin, who is a principal in the mortgage firm of David Shaw & Co., of Brooklyn, N. Y., and also Mr. David Raider, counsel. Both these gentlemen have been handling FHA applications for our members and they are familiar with the mechanics of FHA as well as the provisions and criteria of the present and proposed legislation. Both gentlemen are authorized to speak for our association, and with your permission, Mr. Chairman, I would like to have them quickly summarize a few of the objections that our association would like to record to the proposed bill, and thereafter, to submit to any specific inquiries which the committee may have in mind.

The CHAIRMAN. Without objection, that may be done.

STATEMENT OF DAVID L. RAIDER, ATTORNEY, NEW YORK CITY

Mr. RAIDER. Mr. Chairman and members of the committee, my name is David L. Raider. I am an attorney practicing in the city of New York. I have handled many FHA projects, both 213 and 608, for the past 6 or 7 years, since the recent inception of the program.

The present condition of the 213 program in the city of New York is that it is definitely on the downgrade.

The reason for this is that there is sales resistance to the sale of stock in cooperative apartments. The main reason for that is due to the fact that the downpayments required for the purchase of stock, at present, are too high for the person who needs the moderate units that are being constructed under section 213 of the National Housing Act.

The present law, in my opinion, will remedy the situation by increasing the per room mortgage amount limitation quite substantially.

Mr. DEANE. I didn't get that point.

Mr. RAIDER. I say that the proposed law, as it is before your committee, would remedy the situation that I referred to by increasing the per room mortgage amount limitation from what was \$8,550 for veterans, per unit increasing it as high as \$2,850 per room at the present time.

That increase would result in increasing the mortgage financing and decreasing the amount of downpayment required. I would say that

at the present time the average downpayment on some type of construction would run about \$1,000 to \$1,200, and in others in other localities, such as Westchester, might run as high as from \$1,700 to \$2,500.

With the increase of the per room mortgage amount limitation, it will substantially cut those downpayments and improve the program. I, therefore, heartily recommend the proposed legislation in respect to the per room mortgage amount limitation, as increased by the proposed bill.

There is one item of the bill, however, that I believe may counteract the advantage set up by the increase of per room mortgage amount limitation, and that is a change in ratio from mortgage amount to value, as compared to mortgage amount to replacement cost.

The existing legislation uses replacement cost as a basis for a determination of mortgage amount, by taking 95 percent of that replacement cost. For some reason or other—I don't know what it is—the new bill substitutes the word "value" instead of replacement cost.

Now, administratively, FHA has had three methods of adopting that ratio.

They have had the summation method, which is the replacement cost; they have had the capitalization method, which is the value method that the new bill proposes; and they have had the method based upon comparison.

As far as I know, in the 213 program, they have never used a method based upon comparison.

The reason for that is that it is very difficult to get a comparable unit. Units differ in some respect or other.

They have used the summation method. The summation method, or the method of ratio between mortgage loan and replacement cost, is a definite method. It is not a matter of opinion. It is based upon the market cost of construction. The figures are there. The figures in respect to a breakdown of all the items that go into construction are more or less fixed.

However, if you shift over to the capitalization method, which is value as set forth in the proposed legislation, you put yourself in the position where the local offices of the Federal Housing Administration, whether it is in the hands of the district director, or whether it is in the hands of the underwriter, will determine what the amount of the mortgage is, and the fact that you have a per room mortgage amount limitation may be of no effect at all because it may be decreased substantially by placing a low value on the particular project.

The capitalization method, which has been used in 207 construction, is based upon a return of income on a profit-making operation.

Two hundred and thirteen is a nonprofit organization. The carrying charges are figures based upon past experience for the past year, and projected into the following year to determine what the carrying charges will be for each individual cooperator-occupant of the project.

I do not know how a district director or an underwriter will be in a position to capitalize on a nonprofit organization. He probably will have to set up some theoretical figure of reasonable rental and go along on those lines. That I think will be highly unsatisfactory.

I say that based on past experience, where the question of value comes up, on the value of land in a leasehold 213 project. There, of

course, there is no alternative for summation because of the fact that land has to be determined by expert opinion testimony.

Most of the conflict between the various builders and the FHA administrative office have taken place in respect to value, because of the fact that they have disagreed with low values placed on particular land. Now, if we take value in respect to fixing the entire mortgage amount, we are going to hit a situation where we multiply the troubles that we had before, because after all, the land end of it was a small portion of the entire project. And I think it would be unwise to leave a question of valuation in the hands of the various local offices, whether it can be tied down more definitely by setting forth the summation theory of determining the criteria for mortgage amount limitations.

So that I say, that even though this proposed act has increased substantially the per room mortgage amount limitation, that may be completely nullified by a particular local office or a particular district director or underwriter in that particular office.

It is my suggestion, therefore, that if possible, the change that is anticipated in the new legislation, by going from capitalization to summation, be eliminated and that the act in that respect remain exactly as it was, namely by setting up as one of the criteria, a ratio of mortgage loan to summation, or replacement cost, rather than to value or capitalization.

That is the only point that I am going to take up, although I also think there is a further provision of the bill requiring the affirmative act of the President before the increase in the mortgage limitation can take effect. The building program, for this year, is just about ready to start with the spring weather coming on. I don't know how long this bill will take to come out of committee, and then be finally enacted, but we will then meet a situation, under the provisions of the proposed bill, that the President must give his affirmative approval of the new increase. Otherwise, the old act remains in effect.

It is my suggestion for the purpose of speeding up the activity of building sadly needed in the city of New York, that reference in the proposed bill to the affirmative action of the President be eliminated.

Mr. Benjamin will talk about other phases of 207 and minority housing.

Mr. DOLLINGER. May I ask a question, Mr. Chairman?

The CHAIRMAN. Mr. Dollinger.

Mr. DOLLINGER. You made reference in your statement to the effect that if we reduced the downpayment there would be more purchasing of property.

Mr. RAIDER. I believe so.

Mr. DOLLINGER. What would the monthly charges be with the present downpayment schedule and what would they be if we used the new limitations? The monthly carrying charges?

Mr. RAIDER. The only effect it would have on your monthly carrying charges would be that by an increase in mortgage you would have an increase in amortization and interest payments.

Mr. DOLLINGER. What would that amount to?

Mr. RAIDER. Well, I would take $4\frac{1}{4}$ or $4\frac{3}{4}$, roughly 5 percent of an increase of a thousand dollar mortgage, on a unit would be, let's say, \$4 a month, roughly.

Mr. DOLLINGER. About \$50 a year?

Mr. RAIDER. That is right. If it were an increased \$1,500, it would be an increase of \$75 a year. But that would be—in other words, you would have a lower downpayment and you would amortize that obligation over 40 years.

Mr. DOLLINGER. But their carrying charges would be greater and the thing that bothers me is we are trying to help people who don't have sufficient money. They are living on budgets. Won't that make it more difficult for them?

Mr. RAIDER. No, in this respect. A lot of these people are in position to meet the carrying charges but they don't care to set up these large deposits, \$1,500, \$2,000, or \$2,500. They would be glad to amortize it over a 40-year period.

Mr. DOLLINGER. I should imagine they would want to reduce the rent as they go along and not increase it.

Mr. RAIDER. Well, they are just not in position to make the downpayment. Take an individual purchasing a 1-family house. That individual no doubt would prefer to buy a \$15,000 house with no downpayment. He would have no carrying charge in relation to amortization and interest on the mortgage. But since he is not in a position to do that, you have your GI mortgages where they carry as much as \$14,000 and \$14,500 on a \$15,000 unit. That individual is able to purchase a home that he wouldn't be able to purchase otherwise.

Mr. DOLLINGER. I hope you are right. I don't think it is going to increase the amount of housing purchased by these people, because they are going to be concerned with carrying charges.

Mr. RAIDER. No, if you can't sell, you can't create 213.

Mr. DOLLINGER. That is the reason I think you can't sell 213. Because your carrying charges there are too high. That is the reason people are not going into those projects.

Mr. RAIDER. Let me say this: In comparative garden-type apartments, and I have handled many of them under 608, and I have handled garden-type apartments under 213—I will say that a 2-bedroom unit, classified as a 4½-room unit under 608, today, is renting for \$120 a month average, whereas I have garden-type apartments in cooperative projects, with 3 bedrooms, with a complete additional room, renting at \$105 to \$110 a month.

Now, there has been a lot said about increased carrying charges. All you have to do with respect to that is to go to the mayor of New York City and the Governor of the State of New York. We have already got a tax increase from 3.47 to 3.74 in the city of New York. We are going to get another increase.

Mr. DOLLINGER. Let me stop you at this point.

The reason you are having difficulty in selling these co-ops is because people, when they bought the house, were told the figures would be approximately so much, and once they made the purchase found those carrying charges far exceeded what they anticipated and they can't afford the higher payments.

And others are not buying for that very reason.

Mr. RAIDER. My experience on that is that any increase that has come about has been due to an increase in cities like the city of New York in two respects. First, in respect of increasing assessed valuations beyond what the FHA, in their project analysis, have estimated

the assessed valuation to be, and secondly by increasing the rate this year 27 points and going up next year again.

Mr. DOLLINGER. That is only a small feature. I don't want to get myself involved in a controversy between the Governor of New York and New York City as to the shortchanging of New York City by the State of New York.

Mr. RAIDER. I do believe this, that the carrying charges increases are attributable directly to the increases in taxes.

Mr. DOLLINGER. That is only a small feature.

Mr. RAIDER. That has been my experience, but the others have been underestimated. They didn't get the correct figures. Perhaps they couldn't, I don't know. But the things that they have to think about went just beyond taxes.

Mr. DOLLINGER. That hasn't been my experience.

Mr. RAIDER. That hasn't been my experience.

Mr. DOLLINGER. That is all, Mr. Chairman.

The CHAIRMAN. Mr. Benjamin.

**STATEMENT OF ALVIN BENJAMIN, OF THE FIRM OF
DAVID SHAW & CO., BROOKLYN, N. Y.**

Mr. BENJAMIN. My name is Alvin Benjamin; I am with the firm of David Shaw & Co., real estate brokers, in Brooklyn. We are brokers who specialize in the securing of mortgage financing on new construction.

We are concerned currently with providing or developing projects for minority housing groups. We have made, within the last year and a half, efforts at the start of such projects.

A 213, in the New Park area, of 300 apartments, has been successfully completed and financed by a private lending institution in New York City.

There are several other 213's in Metropolitan New York which are in the stage of being processed, on which assurances of financing by lending institutions have been given.

The problem with regard to minority housing is a question of the ability of the prospective purchaser to have the downpayment to purchase his apartment. We have found that once they have purchased their apartment and taken occupancy, their record has been uniformly good—as good as for other groups with regard to repayment of their obligations.

We feel that, with the proposed bill, which will increase the mortgage amounts that are available to them, and therefore decrease their downpayment, that more of this group will be able to take advantage of this type of housing.

And we are not dealing in generalities. We have actually sold these apartments, turned away thousands of interested purchasers who had the necessary credit status to carry the apartments but who did not have the cash downpayment to purchase the apartment.

I think part of that is due to the fact that most of these prospective purchasers were veterans who have been working for only a few years, who have recently had children, and who have growing families, and they have not had the time to develop sufficient cash reserves to make large downpayments on either houses or apartments.

I would say that at least 3,000 units are programed which can be activated if this new bill is passed.

There is also developing a program for providing rental housing for minority groups in New York City. It will be confined to that section of 207 which provides for a mortgage of \$7,200 per family unit, with the average unit containing two bedrooms or more.

It is anticipated that under this section of 207 rentals of about \$96 to \$98 per apartment will be developed.

A rental of \$96 to \$98 per apartment is substantially below the current rental market for comparable six-story apartment dwellings, to the extent of \$30 to \$35 a room.

We feel that lending institutions, in New York, and in the Greater New York area, will provide mortgage money for this type of housing. They have one legitimate reservation, principally the fact that the amount of downpayment that they are receiving on this type of housing is not as substantial as that taken as an average on other types of housing, and they, therefore, feel that the extent of their exposure, their risk, is greater—and their risk probably is greater.

We have a technical suggestion which should provide that in the event there is a default on the part of the purchaser of a minority house, that the bank, instead of furnished debentures on the passing of title of the house to FHA, be paid in cash. I think that would reduce the question of risk and make risk comparable on the two types of housing offerings.

But I feel that even without this alteration, that the majority of lending institutions in New York are prepared to finance this type of housing, and I think the next step is the developing of jobs for submission to them.

The CHAIRMAN. Are there questions of Mr. Benjamin or Mr. Raider?

Mr. DOLLINGER. Mr. Chairman.

The CHAIRMAN. Mr. Dollinger.

Mr. DOLLINGER. You state that banks want more assurances on the risks for minority housing than other type housing?

Mr. BENJAMIN. I didn't say that. I said if you were to take 2 mortgages, 1 with a 5-percent down payment, and 1 with a 15-percent down payment, per se the mortgage with the 15-percent down payment is the more attractive offering.

Mr. DOLLINGER. Well you have made the admission, I think, that the banks are not inclined to go along in making mortgage loans on housing for minority groups, as a rule.

Mr. BENJAMIN. I have made that statement that we have placed loans on every project which we developed to the point of submission to a lending institution.

Mr. DOLLINGER. Yes, but they weren't in restricted areas were they?

Mr. BENJAMIN. They were in areas that were found attractive to the lender, the purchaser, and the builder.

Mr. DOLLINGER. But let's get down to the point basically. I don't want to fence with you.

You stated before that \$98 a month would be the approximate rent for minority housing.

Where would that be? In what areas or localities?

Mr. BENJAMIN. In what localities?

Mr. DOLLINGER. That is right.

Mr. BENJAMIN. Within the metropolitan New York area, including the Borough of the Bronx.

Mr. DOLLINGER. Were there minority groups living in the areas?

Mr. BENJAMIN. The areas in which this housing will be developed will be areas where the renter will want to live, and there will be areas that will be acceptable to the FHA, without relation to whether they are segregated or not.

Mr. DOLLINGER. The FHA will accept any area in which you can build. They wouldn't be concerned with the area itself if there are sufficient transportation facilities, and if it isn't off the beaten path.

Mr. BENJAMIN. Well, the basic question as to site approval of the location still obtains, as to whether it has the facilities, whether the question of obsolescence is not a deterrent factor.

Mr. DOLLINGER. Can you go to any bank in the city of New York and get a loan on a house where Negroes reside; or would only very few banks go along with that?

Mr. BENJAMIN. I think we are confusing the question as to the securing of mortgages on existing deteriorating structures and the question of securing financing on new construction.

The question of securing financing on new construction is the problem we are confronted with here.

Mr. DOLLINGER. That is correct. But what I am trying to find out is whether the banks would go along and give a mortgage to Negro people who wanted to reside in any area they selected.

Mr. BENJAMIN. I think the first question of a builder is, Can he secure financing?

Mr. DOLLINGER. I am not fighting the builders or anyone else. I am trying to get at the facts and if you don't want to answer, why that is all right.

Mr. KILBURN. Didn't I understand you to say that you had no difficulty in getting private financing in New York City for a minority group?

Mr. BENJAMIN. Yes, sir, Mr. Kilburn, that is the answer.

Mr. KILBURN. These people are not going to go in and try to settle the colored question.

Mr. DOLLINGER. I am not trying to dictate to the builders. I do want to know whether minority groups can go anywhere and build housing and get financing.

Mr. KILBURN. He just said the minority groups had in New York no difficulty in New York City.

Mr. DOLLINGER. I know what happens in New York, and other places when a Negro family wants to move in and buy a house. They just don't get an opportunity. We were speaking of minority housing; let it be minority housing. Let's not fence and say we are giving them something when we are not.

Mr. KILBURN. I am not fencing about it. It seems to me you are.

Mr. DOLLINGER. I was asking what they meant by minority housing and I now understand what they mean by that. It means they will build houses in areas selected by the builders and bankers. It means minority groups again will have no choice in selecting the site.

Mr. BENJAMIN. Then I think we have a thousand segregated areas in New York.

Mr. DOLLINGER. Sure.

Mr. BENJAMIN. Every block is a segregated area, then.

Mr. DOLLINGER. That is how they were built originally and we are trying to get away from that sort of thing. This bill is improperly labeled as one that will obtain housing for minority groups, because it does not give the assurance that minority groups will have the right to build housing and get financing in any area of their choice.

Mr. BENJAMIN. I think the end result of all our efforts is to produce good housing at a price these people can afford and in good volume. That is what we should get after.

Mr. DOLLINGER. That is all, Mr. Chairman.

The CHAIRMAN. Are there further questions?

Mr. MUMMA. May I ask a question, Mr. Chairman?

The CHAIRMAN. Mr. Mumma.

Mr. MUMMA. You say your units rent at about \$98. Are there any comparable units around this location? I am familiar with the general situation, but are the metropolitan housing projects different from these, or what would their average rents be as compared to yours?

Mr. BENJAMIN. The program of the city of New York that would come as close to this proposed program as any other type of housing program is the city tax-exempt self-sustaining housing program, where the average rent is about \$21 a room, about \$96 for a four and a half room apartment, with an average area of about 750 square feet to an apartment unit.

Mr. MUMMA. What is the square footage in your units?

Mr. BENJAMIN. About 875 square feet.

Mr. MUMMA. You are higher?

Mr. BENJAMIN. 125 feet more area.

Mr. MUMMA. Is there any comparable public housing now, for which you could give me the average rental?

Mr. BENJAMIN. That is the public housing that I am referring to.

Mr. MUMMA. Then you mean it is as high as that? Are you speaking of the New York City public housing program?

Mr. BENJAMIN. There are two programs for public housing in New York City, three. One is the program under title I, the other is the State-aided, low-rent subsidized public housing program, and the third is the—

Mr. MUMMA. Do you have a program where the State is not in it, but just local housing authority, with Federal contributions?

Mr. BENJAMIN. I am referring to the program by the local city housing authority of the city of New York, where the rentals cover the cost of operation, maintenance, and the repayment of the original loan, which loans incidentally are secured by the full faith and credit of the city of New York, and bear an interest of less than 3 percent, whereas the interest rate will be four and a quarter plus a half of percent premium on this loan.

Taking those two types of housing, and putting them side by side, this housing will cost the same per room as the city housing project.

Mr. MUMMA. Is this the cooperative one you are talking about?

Mr. BENJAMIN. No, there is the 207 rental units.

Mr. MUMMA. They would be practically the same type of construction, going by the code, wouldn't they?

Mr. BENJAMIN. No, the type of construction of the city housing job is fireproof construction, with minimum specifications.

This would be semifireproof construction—

Mr. MUMMA. Yours would be?

Mr. BENJAMIN. Yes, sir.

Mr. MUMMA. What do you mean by that? A new type wood?

Mr. BENJAMIN. Frame and structural steel. The cost of construction of the city housing project is greater than the per unit cost of these units.

Mr. MUMMA. The reason there is so little difference is really in the type of construction, isn't it?

Mr. BENJAMIN. That is part of the reason. Another part of the reason is that on a square foot basis, the area of the proposed housing would be larger than on the public housing projects.

Mr. MUMMA. The difference in area would eliminate part of the cost of construction.

Mr. BENJAMIN. That is correct. Incidentally, the difference in construction does not provide for any greater amenity in these city projects than in the rental project. It provides for less amenity. It is more of a bare wall, stone type of construction.

Mr. MUMMA. How many stories are yours?

Mr. BENJAMIN. They will be either 2-story garden apartments, or 6 stories.

Mr. MUMMA. Can you get away from that frame and steel in 6 stories?

Mr. BENJAMIN. Well the 6 stories semifireproof construction. That is steel with girders.

Two story is frame and brick veneer construction.

The CHAIRMAN. I don't know to whom I should address this question, but do you think the appraisals on 213's should be the same as on 207's?

Mr. RAIDER. That is referring to the statement that I originally made, I believe: 207 is based upon valuation or capitalization; 213 was based upon summation, or replacement cost rather than valuation.

As a matter of fact, we should prefer that the 207 be put in the same category as the 213's as they are today, namely, on the replacement cost basis, to take some part of the discretion that lies with the local offices away from the local offices and make it more a matter of fact than a matter of opinion.

I don't know why the change was proposed in section 213. I can say, however, that if it is retained in 207, that is if valuation is retained in 207, with its basis on capitalization, and if 213 retains its basis of summation, based on replacement cost, that there is a very good argument for it because the 207 is a profitmaking operation, where you might be able to determine, by capitalization, the reasonable value of the asset of construction, whereas in 213, where your carrying charges are fixed and determined by a board of directors of a cooperative corporation, just to meet the charges that are required to carry that property you have a nonprofit organization, and you have no basis for capitalizing the asset and determining value as a result.

The CHAIRMAN. When we set up 213 we thought we were getting all this speculation out of 213. That was one of the things which was held out for it, that the promoters would only have to pay the fees for construction, so there would not be any opportunity for mortgaging out, which has been one of the competitive practices right along.

We find now that, for some reason or another, when we break it down, the per unit cost for a cooperative has been about \$9,000, and on a 207 it is only about \$5,100, and that some of the promoters have been indulging in some mortgaging-out practices with respect to 213.

What would you suggest be done to avoid that?

Mr. RAIDER. You made a statement about 207 being how much?

The CHAIRMAN. \$5,100.

Mr. RAIDER. That statement I cannot agree with.

The CHAIRMAN. Here is the breakdown on it: 601 projects with 60,375 units, mortgages totaling \$308,345,545, for an average of \$5,100.

Mr. RAIDER. Are you referring to 207?

The CHAIRMAN. That is right.

Now, 213's: 147 projects, 25,810 units, mortgages totaling \$243,919,000, for an average of \$9,450.

Mr. BENJAMIN. Sir, I believe that the arithmetic on those figures is grossly inaccurate. There is a difference in the per unit replacement cost between 213's and 207's. The one basic reason for the difference in cost is that 207's average about 3.6 rooms per apartment unit. The 213's average about 4.5 rooms per apartment unit. The theory of the FHA being that the 213 apartment house is intended for continued use, and, therefore, should be made available to families with children, and that the 207's are rental housing units, on which a lower room average is acceptable.

But I think that taking the difference in room count, the comparable difference in area between the two programs, and the difference in specifications, you will find that on an average there is probably no more than \$650 to \$700 a unit difference between the 207's and the 213's.

The CHAIRMAN. Well, the point was, what do you suggest could be done to take the speculation out of the 213's and get back to our original intent?

Mr. BENJAMIN. Well, we have proposed this remedy to the FHA this morning, and that is to have the builder put up the equity for the project at the time of the start of construction, and to deliver to the cooperative corporation, upon the completion of construction, the completed building. That would involve an assumption of risk on the part of the builder to provide for the venture capital that is needed, and it would protect the cooperative corporation by having them get only what they bargained for at the time they wanted to take occupancy.

It would develop the situation where it would be comparable to your small-home sale, where you have a contract for sale entered into with title being passed at the time the building is completed.

I think that would eliminate most of the areas of difference between the cooperative corporation and its ambiguous position in relation to the contractor during the course of construction.

The CHAIRMAN. Are there further question of these gentlemen?

If not, thank you, Mr. Benjamin and Mr. Raider and Mr. Whitman, for your assistance.

As I explained this morning—I don't know whether you were here at the time—if you have any further information which you think might be helpful to the committee, you may have the privilege of revision of your remarks to include such information in the record.

Mr. WHITMAN. Thank you, Mr. Chairman.

(The prepared statement of the previous witness is as follows:)

STATEMENT SUBMITTED BY LEWIS WHITEMAN, EXECUTIVE DIRECTOR, ASSOCIATED BUILDERS OF GREATER NEW YORK, INC.

The Housing Act of 1954, as proposed in identical bills introduced in the 83d Congress, 2d session, (S. 2938, H. R. 7839) contains provisions that are of vital interest to members of this association who are active multifamily builders under FHA programs in the New York metropolitan area and in other States along the eastern seaboard.

Section 119 (referring to 213's): The general provisions of the Housing Act with regard to section 213, as recited in section 119 of the proposed act, are endorsed by the members of this association. It is their experience that a majority of the interested purchasers have been unable to avail themselves of current 213's being offered for sale due to their inability to meet the high down-payments required. Generally, these potential purchasers are families who do not have substantial cash reserves, but who are nevertheless excellent credit risks. The intended purpose of the new Housing Act, in making cooperative apartments available at low down payments, should provide good housing at moderate carrying charges for these people who heretofore have been unable to avail themselves of the benefits of cooperative housing. It is the intention of the builder-members of this association to proceed with large-scale projects upon the enactment of this new legislation.

An analysis of the proposed bill indicates, however, that the provision which would substitute a ratio of mortgage to value for the current ratio of mortgage to replacement cost might present a very serious obstacle to the implementing of the basic provisions of the bill which are intended to provide more liberal mortgage credit to cooperative purchasers and therefore might tend to defeat the fundamental purpose of this legislation.

Assuming for example, that the same formula for determining valuation will be used in 213's as is currently used in determining value under 207's, we start with the basic assumption that the value can be no higher than replacement cost, but it can be substantially lower than replacement cost. The FHA arrives at a determination of value on 207 projects by using either a value by summation, capitalization of net income or profit, or by comparison, whichever is lower. The value by summation is the same as replacement cost. The value by comparison is very rarely, if ever, used because of the inability to secure precisely parallel projects. The use of value by capitalization on a cooperative project, where there is no income or profits, does not appear to be a sound method for arriving at the value of such a project. Therefore, the only reasonable method of arriving at a value of a cooperative project is the use of value by summation. Since the value by summation is the same as replacement cost, the Housing Act should be explicit in stating that the limiting criteria should be a mortgage as a percentage of the replacement cost rather than as a percentage of value.

The Federal Housing Administration, by its processing procedure, adequately covers the question of the economic desirability of the project at the time of the site submission and submission of the architectural plans. The site is considered acceptable only if it can justify the intended project and the plans are reviewed in the light of the development of the site for its highest and best use. We therefore believe that the processing routine safeguards the question of economic desirability and that a further restriction of making the loan as a percentage of value rather than a percentage of replacement cost can cause undue hardship on individual projects and could perhaps defeat the purpose of the proposed legislation in its aim to liberalize mortgage loans covering this type of project.

Section 115 (referring to 207's) : The provisions of the Housing Act in respect to section 207, as recited in section 115 of the proposed legislation, have been liberalized in respect to the per family and per room mortgage amount limitation. Our members feel that such increase in mortgage financing will attract builders in the metropolitan area with the result that rental projects that are needed will be built. However, the ratio of mortgage loan to estimated value has not been increased by the proposed legislation. This produces the possibility that the increase in the per room and per family mortgage amount limitation will not be reflected due to the limitation of ratio of mortgage loan to estimated value remaining unchanged. This conclusion is based upon an analysis of projects that have been processed pursuant to section 207 of the National Housing Act as currently in effect where the criteria of ratio of mortgage loan to estimated value has been either lower than or slightly higher than the present \$2,000 per room and \$7,200 per unit limitation.

That section of 207 which provides for a ratio of mortgage to a value of 90 percent, where the project averages two bedrooms with the maximum mortgage being no more than \$7,200 a unit, should be liberalized to the same extent as the other 207 sections to provide a maximum mortgage loan of \$7,500 per living unit. The metropolitan areas of our country have land development cost and code restrictions which work against development of this type of project; but it is felt that with this suggested increase that these projects can be economically developed. The large group of lower middle income tenants have not been accommodated since the war because of high construction costs. However, it is felt that with the suggested liberalization of the mortgage, under this provision of section 207, that it is possible that large scale projects can be developed to accommodate this group.

Sections 115, 119, 201 : The proposed legislation provides that the maximum amount of mortgage affecting sections 213 and 207 shall not exceed the maximum mortgage amounts as same existed before the effective date of the Housing Act of 1954 unless the President, pursuant to section 201 of the Housing Act of 1954, authorizes a greater maximum amount, in no event to exceed the maximum amount as set forth in the proposed legislation. This requires affirmative action on the part of the President in order to put into effect the new legislation after its enactment by Congress. It is our belief that Congress intends to bestow the benefit of the new legislation for the coming building season. This legislation must be considered by the separate committees and then acted upon by both the Senate and the House of Representatives. It is expected that the enactment of this bill will permit the utilization of this legislation in the 1954 building season. The delay however that might be occasioned by awaiting Presidential action might suspend the effective use of the act until the 1955 building season.

Minority housing : It is a concern of the building industry to provide housing for minority groups. The problems in developing this type of housing are unique. It is anticipated that several of the problems will be resolved by the current legislation, principally with regard to the proposed liberalization of 213 mortgage proceeds. With less of a downpayment required a greater number of the minority groups will be in a position to participate in the benefits of the act. It is also expected that the provision with regard to a 90 percent ratio of mortgage to value on a 207 with a room average of two bedrooms can be favorably developed provided that the mortgage amount can be increased slightly from \$7,200 to \$7,500 as heretofore requested. The projects developed pursuant to this section will produce housing at moderate rentals. The unresolved problem with regard to developing a minority housing program of any substantial scale is the availability of mortgage money. There are savings institutions that have taken minority housing loans and who have been satisfied with these loans in their portfolio. Nevertheless the market for these offerings is limited and therefore the loans are sold either at a substantial discount or there is no market for said loans. It has been suggested that lending institutions might be more receptive to these loans if the guaranty of the Federal Housing Administration were not limited to the form of debentures.

The CHAIRMAN. We next have the National Association of Housing and Redevelopment Officials, Mr. Winston, president, accompanied by Mr. Searles.

You may proceed, Mr. Winston.

STATEMENT OF OLIVER C. WINSTON, PRESIDENT, NATIONAL ASSOCIATION OF HOUSING AND REDEVELOPMENT OFFICIALS, ACCOMPANIED BY JOHN SEARLES, CHAIRMAN, REDEVELOPMENT SECTION, AND EXECUTIVE DIRECTOR, DISTRICT OF COLUMBIA REDEVELOPMENT LAND AGENCY

Mr. WINSTON. Mr. Chairman, members of the committee, my name is Oliver C. Winston. I am appearing as president of the National Association of Housing and Redevelopment Officials and also the executive director of the Housing Authority of Baltimore City. Mr. John Searles, who is chairman of the Redevelopment Section and also executive director of the District of Columbia Redevelopment Land Agency, is appearing with me to answer questions pertaining to the expanded urban renewal program.

I should like to make a general statement on major items in the bill and then submit for the record a more detailed comment on the bill's provisions. The general statement does not follow necessarily the order of the provisions in the bill but our detailed statement has been geared, for the most part, to sequence of the bill's provisions.

The National Association of Housing and Redevelopment Officials is a nonprofit professional association of citizens and local public officials interested in furthering good public administration in the fields of housing and urban redevelopment. This association, although concentrating its efforts in these fields, has always had as its objective the provision of adequate housing for the entire people and a particular concern that private enterprise play as large a role as possible in attaining this objective. The members of our organization, by and large, are those who will be administering the provisions of this bill having to do with public housing and urban renewal. We have a very real interest, therefore, in the legislation, for we are anxious that it provide the best possible tools to enable us to assist in carrying out its objectives.

The introduction of new ideas on Federal participation in community rebuilding and the interest evidenced in assisting cities in tackling their problem of urban decay gives us great satisfaction. We are pleased to know that the administration is recognizing the need for assistance in this field and is carrying out the major recommendations of the President's Advisory Committee. We are of the opinion; however, that in some respects the bill is not broad enough to encompass all the major facets of the housing problem and we are disappointed that it does not recognize all major housing needs.

The President's Advisory Committee on Housing Policies and Programs estimated that 5 million homes must be demolished and 15 million homes rehabilitated. These figures suggest that something like 10 million families may have to move over a period of years because their homes are to be cleared or extensively remodeled. This vast movement of population will require positive and effective relocation measures. Not hopes, but homes, will be necessary before any substantial number of these families can be relocated. The suggestion that enforcement campaigns must be in effect before relocation housing will be authorized completely contradicts the needs of the situation. New housing, public and private, must be available first to accommo-

date relocated families at the rents and prices and in the locations, sizes, and types needed for them.

Pending the establishment of a substantial reservoir of such relocation housing certain aspects of the programs of rehabilitation and enforcement must proceed slowly.

The collapse of rental housing construction in adequate volume in recent years must be ruled as a grave deficiency in current housing production. The solutions proposed in the pending legislation may provide some additional volume of rental housing, but lower rents and larger volume are essential to any comprehensive housing program.

A minimum national program for middle- and lower-income private housing requires effective aid for the development of cooperative, rental, and sales housing, particularly in larger-sized units and at prices or rent levels of \$50 to \$60 per month in northern cities, and \$30 to \$40 per month in southern and western cities. To the extent that these objectives can be accomplished through FHA insurance, the program should be conducted under a special authorization and with a separate insurance fund so that its costs are recognized.

We certainly endorse the expansion of the present slum-clearance and urban-redevelopment programs to assist cities in doing a more comprehensive job of treating slum and blighted areas. We feel that the existing slum-clearance and urban-redevelopment program is essential and should continue, but we feel also that where possible cities should be given assistance to treat larger areas, areas with a core of slum clearance and urban redevelopment surrounded by an area that may be rehabilitated. We want to be sure, however, that in no event will a city be precluded from receiving Federal assistance for a slum-clearance and urban-redevelopment project merely because at the time it applies for such assistance it is not in a position to undertake treatment of a much larger area. The slum-clearance and urban-redevelopment program is just now getting up a full head of steam and any attempt to make this additional assistance a mandatory extension of slum clearance and urban redevelopment as we now know it will have the effect of drastically reducing, rather than increasing, the activity under the proposed urban-renewal program. Many cities today are moving ahead rapidly in their urban-redevelopment programs. If they can meet the requirement of progress toward a workable program, this healthy progress should not be slowed down while State legislation is being passed, local organizations established, and techniques perfected to use the other tools of slum elimination included in urban renewal.

We ask, therefore, that this new legislation encourage and accelerate urban redevelopment as we know it today as well as providing assistance for the use and development of the other slum-clearance tools.

In this connection we should like to raise the point of whether localities will be able to apply for assistance for urban renewal projects since State redevelopment legislation does not use this particular term. We suggest that the language of the bill be changed to make it clear that applications for assistance for slum-clearance and urban-redevelopment projects come within the province of applications for assistance for urban-renewal projects and are not rejected on the ground

that the term "urban redevelopment" rather than "urban renewal" is used.

We also endorse the aids provided in the proposed legislation for encouraging rehabilitation but we should like to caution against an overemphasis on what may be accomplished by rehabilitation. In conservation areas and in recently developed areas, it may be possible to prevent the origins of blight. Strong economic forces that deter investment in older neighborhoods are unlikely to be reversed on a widespread basis by even the most vigorous of campaigns. Care must be taken to avoid modernization programs in areas where modernization may be economically unsound or where it will increase the cost of future clearance. While we support the principles of rehabilitation and enforcement, we believe that there is ample evidence that in many areas these programs may not achieve the successes expected by the sponsors in terms of quality of the work, its durability as a community improvement, or its economic and social soundness.

We heartily endorse section 220 which provides a special FHA mortgage insurance program for urban renewal areas. This program recognizes the special problems which face the FHA in underwriting mortgages on new construction or rehabilitation in slum areas which are being cured. These problems have already become very apparent in redevelopment programs throughout the country. We feel that the programs in these cities can move forward under section 220 with the few minor technical changes which are discussed under the detailed comments submitted as part of this testimony.

At the present time, however, there are a number of redevelopment projects in various stages of progress which will continue to operate under the existing title I terms because of the savings provision of section 412. Since these projects have already had to meet tests quite similar to a workable program, we earnestly recommend that section 220 be made applicable to these projects without requiring the delay which would be necessary to secure the approval of a workable program.

We also endorse section 221 for it appears to provide a means of providing housing and those families displaced because of urban renewal and other governmental activity. Rehousing these families in decent, safe, and sanitary dwellings is a major part of our present urban redevelopment and public housing program, and we welcome a program which provides additional assistance in this field. We should like to point out, however, the incongruity of requiring stricter and more effective building and housing codes in the urban renewal program and at the same time encouraging under section 221 the construction of housing at a cost that precludes it from adhering to building codes in most sections of the country. We think, therefore, that the \$7,000 maximum is unrealistic. We recommend a maximum of \$8,600 and, in high cost areas, a maximum of \$10,000, since it is in our larger cities that the rehousing situation is the most acute.

We feel that while many cities have made great strides in housing codes and housing code enforcement they have not taken adequate steps toward a truly workable program in planning for conservation and rehabilitation that there are few, if any, cities today that have the kind of a program that we feel can be achieved in a period of several years. We feel, therefore, that either the Housing Administrator will

have to set unduly low standards for a workable program or that progress in the slum elimination field will be retarded since Federal aids will be available only to those cities which have achieved an appropriate standard for a workable program. We believe, therefore, that the Administrator's criteria for a workable program should be progress toward a workable program. We believe the language of the bill should be changed to reflect this criterion of progress rather than immediate achievement.

The President's Advisory Committee had before it and published evidence that approximately half of all families in redevelopment areas were in income groups eligible for public housing. Since it is apparent that 10 million families will have to be relocated under an effective program of housing and rehousing, there is clearly indicated a need for housing for 5 million families of low income as a result of future redevelopment and rehabilitation. It would be optimistic to assume that half of these families can be located in existing and rehabilitated units. Thus, there is an enormous need for additional public housing for relocation alone. This takes no account of additional needs for public housing arising from other public improvements and from conditions of health, age, income, overcrowding, and the like.

On the basis of this evidence provided by the President's Advisory Committee, we conclude that it is essential that the Congress authorize the immediate resumption of the public housing program enacted in the Housing Act of 1949. We urge that the existing restrictions adopted as a result of appropriation actions be eliminated entirely. The President may then exercise the authority originally provided by law to vary, the volume of public housing started within the limits of 50,000 to 200,000 units per year as circumstances warrant.

It is essential that in a program as broad and long range as the one proposed in this bill that public housing be permitted to plan ahead to enable it to meet the relocation and other needs resulting from the program. The present year-to-year limitation now embodied in the amendments to the Housing Act of 1949 makes it impossible to plan ahead to meet these needs.

This concludes my oral testimony, and I am submitting herewith our detailed comments on the bill for the committee's consideration.

Thank you, Mr. Chairman.

The CHAIRMAN. Do you desire to have the detailed comments inserted in the record?

Mr. WINSTON. Yes, sir.

The CHAIRMAN. Without objection, that may be done.

(The material referred to is as follows:)

DETAILED COMMENTS

Section 220: We favor section 220 as a special financing vehicle for slum clearance and urban renewal because we feel that urban renewal from our experience with urban redevelopment has special problems. The existing provisions of sections 207 and 203 are not, we feel, as effective as they should be in aiding the financing of new construction in areas that are in the process of being improved. Housing projects in such areas have been penalized by low evaluations by FHA because of the uncertain environment. We, as redevelopment officials, do not feel that a greater risk is involved in the case of projects constructed on the cleared slum cores of our cities, but we do feel that a special section as is proposed in this bill will permit the FHA to differentiate these proj-

ects from those that are being constructed in newer sections of the city. We feel that this new section will lead not only to more interest on the part of private enterprise in rebuilding slum and blighted areas but also will result in projects of a higher physical standard; that is, with larger rooms and more amenities for the same rent.

We feel that the 90 percent mortgage amount for multifamily units is justified because these projects must conform to a publicly approved redevelopment area plan which must in turn conform to a comprehensive plan for the city. These requirements are stricter than for projects financed under section 207. We feel, however, that the 90 percent mortgage ought to be a true 90 percent mortgage and ought not to be scaled down considerably below 90 percent of estimated replacement cost because of the FHA methods of determining "estimated value."

We recommend that section 220 provide for a maximum mortgage term of 40 years for new construction in urban renewal areas.

There appears to be a slight inconsistency in the bill which we believe should be corrected for multiunit projects which have an average of less than four rooms. The maximum mortgage amount under both sections 220 and 207 as proposed are the same; namely, 7,200 for nonelevator construction and \$7,500 per unit for elevator construction. Since section 207 provides for a mortgage amount of 80 percent of estimated value, it contemplates maximum valuations of \$9,000 and \$9,375, respectively. Section 220, however, provides for 90 percent mortgages and thus would permit maximum estimated valuations of \$8,000 and \$8,333 respectively. We do not believe that Congress has any intention to penalize apartments of smaller units built under section 220 rather than section 207. We therefore recommend increasing the maximum mortgage amounts under section 220 for the smaller units to \$8,100 and \$8,400 respectively. This would appear to be consistent with the proposed provisions of sections 213 and 207.

Under the proposed legislation, section 220 will be available only in urban renewal areas and in those cities where the Administrator has made the determination that the city has a workable program. Although we approve these qualifications for the use of section 220, we feel that its use should not be precluded in the financing of urban redevelopment projects now under way. We would hope therefore, that the bill might be amended to include a provision similar to the savings provision, section 412, for redevelopment projects now under way. We would like the bill to include language stating specifically that section 220 would be available for those urban redevelopment projects under contract or prior approval at the time of the passage of the bill. In those circumstances, the workable program requirement would not be applied, and the fact that the project to be financed under section 220 was in an urban redevelopment area would be considered the same as being in an urban renewal area. We also hope that urban redevelopers with commitments under section 207 will have the opportunity of transferring their commitment without penalty to the more liberal terms of section 220.

Since it is contemplated that section 220 will be applicable in urban renewal areas and that urban redevelopment programs will be undertaken in these areas as well as rehabilitation and conservation, we suggest a change in the language to make it clear that section 220 may be used for redevelopment projects. On page 17, line 19, we suggest the language be changed to read: "* * * a specific plan of rehabilitation and conservation or redevelopment has been established to carry out the purposes set forth * * *." The present language seems restrictive and might be interpreted as excluding the use of section 220 for redevelopment projects.

Also on page 17, line 23, we feel that the first part of the proviso is unnecessary. This now reads "That, in the opinion of the Commissioner (i) there exists necessary authority and financial capacity to assure the completion of such plan * * *." Under the urban renewal program as proposed in the amendments to title I, the Administrator will be required to make such a finding in his approval of the urban renewal plan submitted by the locality. We feel that it is inconsistent to provide that the FHA Commissioner in effect make an additional finding as to the authority and financial capacity of the local public agency to complete the urban renewal plan. It will undoubtedly slow up approvals and add an unnecessary administrative procedure. We feel that the responsibility of the FHA Commissioner to see that FHA standards are met are adequately covered by the second part (ii) of the proviso. To make sure that the structures built and rehabilitated under section 220 conform to the urban

renewal plan, we suggest that a third proviso (iii) be added to the effect that the rehabilitation or new construction is in conformity with the urban renewal plan and local standards. The purpose of this proviso is to make sure that section 220 cannot be used to finance the rehabilitation of a structure which is contrary to the plan or standards established by the community.

Under the proposed legislation, FHA will determine rents on all multifamily structures of eight units or more financed under section 220. Since section 220 is to be used for rehabilitating existing dwellings, we feel it is essential that FHA have some say on the rents to be charged for all rehabilitated units. We therefore recommend that section 220 be amended to include a provision covering FHA rental determination on all rehabilitated units, making sure that the 1- to 7-family units are included. It is our opinion that under normal circumstances a mortgage term of 30 years for rehabilitated structures is too long and suggest that section 220 be amended to provide for a maximum term of 20 years for such structures. However, there may be special conditions and circumstances where it would be advisable to permit a term of 30 years for such housing, as for example the need to provide housing for minority groups. We suggest that in such cases that the Commissioner be authorized to grant a longer term not to exceed 30 years.

Section 221: In general we favor section 221 because it appears to provide a means for rehousing families displaced by urban renewal and other governmental activity. We do, however, feel that there are few, if any, areas in the country where new housing can be built at the \$7,000 ceiling. We recommend a higher ceiling, the \$8,600 recommended by the President's advisory committee, with our additional recommendation for a \$10,000 ceiling for high-cost areas. While we are in favor of 40 years for new construction under section 221, it is our judgment that it is too long a term for rehabilitated houses and suggest, therefore, a maximum term of 30 years in the latter cases. We should also like to point out, that if the administration expects that some 200,000 units will be demolished under this new program, additional measures will have to be considered. If section 221 is to be used to provide housing for families displaced because of this demolition, then FNMA should have sufficient authorization to assure the materialization of a program of these proportions. We feel that the present FNMA authorization is adequate in this respect.

We note that section 221 makes no mention of income limits nor does it provide for any reserve for maintenance as recommended by a subcommittee of the President's advisory committee. We are of the opinion that families purchasing homes under section 221 should not have to pay more than an equitable and reasonable percentage of their income for housing. Therefore there should be some criteria established based upon the ability of the families to acquire and pay for such housing. The continued maintenance of such housing is very important and we feel that families purchasing these homes may need some assistance or guidance in helping them maintain their homes properly. We believe that by requiring the establishment of reserves for this purpose, a reasonable degree of maintenance can be assured.

FNMA: The Federal National Mortgage Association has proved to be essential in launching new programs of mortgage insurance, in meeting temporary and local area mortgage shortages, in financing new types of housing and new types of risk, and in veterans' housing programs. A permanent secondary mortgage facility that will meet these needs is essential. The provisions in the bill do not meet these needs. The amount authorized in the bill is limited and appears inadequate to meet these special purpose needs. We hope that the wording on page 45, lines 12 to 16, is sufficiently broad to permit FNMA to purchase all special purpose mortgages. We object to the provision in the bill which prohibits FNMA from purchasing mortgages offered by, or covering property held by, a municipal instrumentality.

Urban renewal: We are heartily in favor of broadening the slum clearance and urban redevelopment concept to the more inclusive idea of urban renewal which includes rehabilitation and conservation as well as clearance and redevelopment. As mentioned earlier, however, the most important point we wish to make in connection with the proposed urban renewal program is that this broadening must not impede the slum clearance and urban redevelopment program as such. It is imperative that cities not be precluded from undertaking urban renewal projects involving only slum clearance and urban redevelopment. For many reasons it may be that at a particular time it is in a city's best interest to undertake such a project, rather than the broader type of project envisaged in this bill. One of these reasons is the question as to whether the

locality has sufficient authority under State enabling legislation to permit it to undertake the broader urban renewal type of project, and in this connection we should like to raise a question on the use of the term "urban renewal" to cover slum clearance and urban redevelopment.

Since a locality under this bill applies for assistance to carry out an urban renewal project rather than an urban redevelopment project, we are not sure whether the local governing body and the local public agency have the authority to pass the necessary resolutions making reference to "urban renewal" rather than to "urban redevelopment." State enabling legislation for urban redevelopment makes no mention of the term "urban renewal" and it may be that the substitution of the new term for the old may in effect preclude localities from participating in the urban renewal program. Therefore, we should like to suggest that the language of the bill be changed to make it clear that a locality may submit an application for a slum clearance and urban redevelopment project and that such an application will be honored by HHFA as an application for an urban renewal project under the terms of the bill.

Although we think it important to continue the redevelopment program as such, we think it is equally important that cities be given assistance to accomplish rehabilitation and conservation. We have long recognized that there are areas in our cities which are deteriorating but not to the extent as to require clearance. Our cities need financial assistance and other encouragements in making a broad-scale attack on these lesser slums. In general the type of Federal assistance provided in the legislation is desirable. We point out, however, that if cities are to do comprehensive urban renewal projects in conjunction with a workable program as outlined in these amendments, nearly all States must pass additional enabling legislation. As most of our legislatures meet every 2 years, an immediate expansion of activity under this title cannot be expected immediately. It is important for Congress to recognize, therefore, that immediate results in any volume will not be forthcoming under the proposed bill. The major activity for some little time to come will have to continue to be the slum clearance and urban redevelopment program with a gradual expansion of operations to include the gamut of activities envisaged under the urban renewal concept.

Under the present slum clearance and urban redevelopment program, we have encountered situations where cities have put up more than their one-third share because of expenditures for certain public facilities. HHFA has ruled that such expenditures are not reimbursable—the Federal grant cannot be paid to cover an excess of local expenditures for such public facilities. Under urban renewal a good part of the cost of a project will be made up of public improvements such as streets, street lights, parks, playgrounds, and the like. Language in the present bill clears up this problem to some extent, but we feel that the bill should make it clear that a true two-thirds-one-third formula is intended and that technicalities should not be allowed to force cities to bear more than one-third of net project cost.

We also feel that the inclusion of inspection costs as part of the cost of the project as provided on page 78 of the bill is an unfair charge against the project. We think that these costs are legitimate Federal expenditures, made to assure the proper expenditure of Federal funds and that they should be part of the administrative costs of HHFA.

We object to the language on page 80, lines 12 and 13, which requires the Housing Administrator to approve an area as appropriate for urban renewal. The program presumably stresses local responsibility and local determinations. There is already a condition in the legislation that requires the local governing body to make the determination that the area is appropriate for an urban renewal project. An additional finding by the Administrator implies that he must substitute his judgment for that of the city council. This appears to be an unwarranted interference with local programs and becomes a matter of subjective determination on the part of the Administrator. The Administrator should establish objective eligibility standards in accordance with the proposed legislation and apply these standards when an application for a project is submitted. The provision that an urban renewal plan should be in conformity with the workable program appears to be anomalous and unclear. We concur in the requirement that the urban renewal plan, which is a plan for physical development, should be in conformity with the workable program, but to insert this as a requirement is to increase unnecessarily the administrative work required by HHFA in order for a locality to undertake an urban renewal project.

On page 84, lines 2 and 5, there is an amendment to the present title I which appears to restrict the eligibility of certain local public improvements such as parks, playgrounds, schools, etc., as part of the locality's one-third contribution toward the cost of the project. The language of the proposed bill would require that these facilities be in the project area. We take the position that if a new public facility is constructed to serve the project area in whole or in part, then to the extent to which it serves the project, it should be considered as an eligible local expenditure for the project. To use happenstance of location as an eligibility criterion seems to us to be completely unwarranted. Frequently these facilities will be built on publicly owned ground just outside or beyond the area. As an example, we point to the proposed Eastwick project in Philadelphia, a large area of 3,000 acres that has not developed satisfactorily because it is improperly drained. Philadelphia plans to clear the slum structures from this site and redevelop it. In so doing, it will be necessary to build a costly pumping station to raise the water drained from the area and empty it into the river. This pumping station must of necessity be located outside the area. Under the proposed legislation, Philadelphia would receive no credit for its rather large expenditures for this facility merely because it will have to be outside the area. We would prefer that the phrases "in the urban renewal area" be deleted and that the principle be followed of allowing credit for those public facilities that serve the project areas. The language of the bill would have the tendency to penalize urban redevelopment projects since they are apt to be much smaller than urban renewal projects encompassing rehabilitation and conservation.

There is some general language in the amendments to title I which differs from the original title I. Title I in the Housing Act of 1949 stressed local determinations and local responsibilities and was based on the principle that if local projects met certain objective criteria toward which the Federal program was aimed, the project would be approved. In the amendments, the phrase "satisfactory to the Administrator" is used in several places. As pointed out before when discussing the approval of urban renewal areas this implies a subjective determination on the part of the Administrator on the eligibility of local projects. We feel that this is a dangerous precedent and may invite the Administrator to substitute his decision and his judgment for that of the locality. It is entirely out of keeping with the philosophy of the program and the administration. These concepts and this language should be stricken from the bill.

While on the subject of the philosophy of the program, we should like to point out the difficulties of a locality in carrying a program under excessive Federal controls. We fully recognize the need for controls over Federal funds, including budgets, audits, and prior approval of certain contractual commitments. We do feel, however, that the bill should reflect a philosophy of local responsibility and initiative with a minimum of Federal direction.

The result of an overly complex administrative control procedure has been that a substantial part of the effort in slum clearance and urban redevelopment to date has been in documenting applications for Federal assistance and otherwise conforming to Federal requirements. Quite apart from the job of taking the necessary concrete action to move forward in our battle against the slums. It has meant that our slum clearance projects have been retarded and as a result much more costly than they should be. We do not mention these difficulties by way of criticism but merely as a danger which should be kept in mind in the drafting of this new and tremendous program of urban renewal. We feel that it can move ahead rapidly and can be effective only if it is truly a program of local encouragement and assistance. If, however, it is a program of Federal control of local action, the result will be that of greatly increased costs and limited achievement. We would suggest that the language of the bill clearly delineate the respective responsibilities.

We feel also that the \$5 million fund to be used for testing programs of rehabilitation and conservation is essential. This is an activity about which little is known. We have little experience to guide those cities that wish to undertake comprehensive rehabilitation and conservation programs. The assistance and experience provided and gathered with this \$5 million should be of considerable value.

And finally, we feel that if Congress is to be realistic about this new program of urban renewal that it ought to recognize that additional authorizations will be needed. The present authorization of \$500 million for grants and \$1 billion for loans was made for the slum clearance and urban redevelopment program. If that program is to continue and is not to be repudiated, then that authorization is still necessary even though the rate at which the authorization has been

used has been much slower than originally anticipated. Additional authorizations should be provided for the urban renewal portion of the program. We propose an additional authorization of \$200 million in grants and \$400 million in loans to take care of the increased demands that are bound to result from an expansion of the present program.

Workable program: The principal condition for Federal aids included in the amendments is the presentation by a community and the approval by the Administrator of a workable program for each city for attacking its problem of slums and blight. As we have said earlier, we are in hearty accord with this principle but we caution again excessive or too strict an interpretation in that we may kill that which we are trying to encourage. In order to make it quite clear that progress toward the achievement of a workable program is that which we are seeking rather than the immediate attainment of a full-blown program, we suggest that the language on page 73, line 5 be changed to read as follows: " * * * there is presented to the Administrator by the locality evidence that it is progressing toward a workable program * * * " In addition we strongly recommend that the term "workable program" specifically include the existence of a positive program to meet the relocation needs of families displaced because of rehabilitation, conservation, redevelopment, and public housing programs. Existing legislation and administrative requirements already require this for the last two programs; it should be required in connection with the first two, as well, as part of the workable program.

Public housing: We have already made our general comments on public housing. The bill, however, includes several amendments and we should like to comment on some of them. We concur in the provision that payments in lieu of taxes are encouraged to be put on a universal 10 percent of shelter-rent basis. We note, however, that changes are proposed so that local housing authorities may pay full taxes and cities may pay an annual cash subsidy. The present wording of the legislation would appear to require generally that the community make a local contribution substantially in excess of 20 percent of the Federal annual contribution. We urge that any change in the bill provide for a local contribution at the 20 percent of the Federal subsidy amount.

On section 503 which provided for the repayment of Federal and local contributions after the public housing projects have paid all their obligations, we question the workability of this provision. We think it is unlikely that at the end of 40 years a public housing project will be able to continue serving tenants of low income and at the same time have an income sufficient to do little more than pay for the operating costs of the project. We feel that the amount of funds available for repaying the local and Federal contributions will be nominal.

We applaud the extension of priority to families displaced because of code enforcement or other governmental action. We should like to point out, however, the need for housing the aged single person and suggest that occupancy regulations under the public housing program be broadened to make it possible to house such people.

Urban planning: We support section 701 providing for Federal grants to encourage metropolitan planning and planning in small communities. With redevelopment and rehabilitation playing large roles in the reconstruction of cities, along with the development of newer areas, it is important that adequate and satisfactory plans be prepared and followed for the most effective contribution to sound economic and physical urban growth. We point out, however, that the present language does not provide for assistance to urban counties of less than 25,000 population, and that planning in such areas is just as important as planning in the small municipality.

Title I—FHA: We concur in the liberalization of FHA title I loans for rehabilitation but we believe that it is essential that more positive measures be developed to prevent past abuses in this field.

Builder warranty: We feel that the bill is deficient in that it does not provide that homes built with Federal financial and credit assistance should carry a full warranty as to construction quality.

Minority housing: We feel that the bill is deficient in that it does not provide any special assistance for housing and minority groups. Special secondary market funds should be available to assist in financing private housing for such groups and other measures should be developed. The problem of minority group housing is particularly grave with respect to relocation needs arising from redevelopment and rehabilitation programs—urban renewal projects—and should receive special attention.

Rural, non-farm housing: We note that the bill does not include any provision for rural non-farm and small community housing. The problems in this field

may be eased by following the recommendations of the President's Advisory Committee with respect to participation loans and special VA procedures.

Mutuality: We object to the change in the FHA mutuality system by eliminating the group accounts. Under the system in the proposed legislation, payments to home owners from this fund would apparently be discontinued.

Research program: We recommend the reestablishment of the now liquidating housing research program.

Defense housing: We feel that title IX, defense housing, should be kept on the books as a standby provision to permit rapid action in case it is needed.

Yield insurance: In a number of our communities, there have been efforts to work out a feasible project to be financed under Title VII—Yield Insurance. We have long felt that this title offered interesting possibilities for securing funds to finance housing developments at lower interest rates than are customary under our current mortgage procedure. A number of prominent investment houses and distinguished bond counsels have spent a great deal of time in trying to work out yield insurance projects. We feel that they have been close enough to success to warrant keeping the title on the books for a few more years and that the FHA should be directed to give its attention towards exploiting its possible workability.

Advance planning: We are in favor of section 702 providing for the advance planning of public works. We feel it is important to build up a shelf of public works as a hedge against adverse economic conditions.

The CHAIRMAN. Are there questions of Mr. Winston?

Mr. McDONOUGH. Mr. Chairman.

The CHAIRMAN. Mr. McDonough.

Mr. McDONOUGH. Mr. Winston, from your observation of this low-cost housing, do you think that the authorization under the bill, which is \$7,000, should be not less than \$8,600?

Mr. WINSTON. Yes, sir.

Mr. McDONOUGH. In determining your figure of \$8,600, are you judging that on a nationwide basis cost of labor and materials, or are you judging from your survey and experience in building in the Chicago area?

Mr. WINSTON. Not in Chicago; I am in Baltimore.

Mr. McDONOUGH. I am sorry.

Mr. WINSTON. But I am judging on the basis of the overall national experience, so far.

Mr. McDONOUGH. I see your home office is in Chicago.

Mr. WINSTON. Yes, sir; that is correct.

Mr. McDONOUGH. Have you read the comparative costs for a standard house in this bulletin issued by the Federal Housing Administration, reviewing the comparative costs of local standard houses in various parts of the country?

Mr. WINSTON. I have not. Perhaps Mr. Searles has.

Mr. McDONOUGH. Let me inform you that in that, the cost of the standard house, which according to the plan outlined, shows 2 bedrooms, a living-dining room, kitchen—it is practically a 5-room house, and in the Los Angeles area the cost is \$6,152. In the Chicago area it is \$8,333.

In the Baltimore area it is \$7,550.

I think the committee and the Congress want to provide a means for building homes for the low-income groups, and we want to try to insure those loans, to provide a standard house, that will stand up for a long period of time, and for a long-term mortgage, and insofar as increasing it above \$7,000, we are then removing from the experimental market the development of new materials that might be built into a \$7,000 house.

Your recommendation to make it \$8,600 does not give the area of experimentation. I think we should challenge the building industry to build a house for \$7,000, that will meet the building standards, that will meet the requirements of sanitation and convenience to the average family, so that we can satisfactorily insure a loan on such a house.

Mr. WINSTON. May I answer in this respect, sir: This particular recommendation of ours is based upon the building of private housing in urban redevelopment areas, most of which will be in your in-town areas, which will have perhaps more strict building codes and fire requirements than the outlying areas where perhaps the six- or seven-thousand-dollar houses can be built.

In your downtown areas you have to build more sturdy construction. A considerable number of them will be apartment buildings.

Mr. McDONOUGH. You always have in that area more demand for low-cost area for more people than in the suburban areas, and you will also have the demand, in those areas, for the removal of inadequate housing facilities for many people in the low-income groups, and the prevention of necessity for building additional public housing units. That is the purpose of this section of this bill, as I understand it.

Mr. WINSTON. Its purpose also is to try to get the cost per month, to the family involved, down as low as possible. The 40-year extension of mortgage would help do that.

Mr. McDONOUGH. That is right.

Mr. WINSTON. It is not to encourage an increase in cost, but to make it possible, where in certain cases it might not be possible to build for the \$7,000 limit. The whole intent would be to get the cost per month to the tenant down, and the lowest capital cost possible will assist that, of course.

Mr. McDONOUGH. Undoubtedly there are areas in the United States where we cannot do it for \$7,000, but I would not want to change the figure in the bill so that we would have to raise that, and then remove the possibility of challenging the industry to meet that requirement, because the more we approach that kind of building, the greater demand there will be on the building industry to provide it, and the greater possibility of relieving those people in low-income groups of the possibility of not obtaining a home.

(The following data was submitted for the record at p. 336.)

[From Insured Mortgage Portfolio, spring 1953]

COMPARATIVE COSTS OF A STANDARD HOUSE

(By Curt C. Mack, FHA Assistant Commissioner, Underwriting)

(The following article gives the results of a study made in 1952 to indicate the relationship of construction cost data in use by various FHA insuring offices. This relationship is shown in a list of replacement cost estimates of an identical one-story frame house, based on cost data in use in each insuring office.)

Early in 1952 the Underwriting Division of the Federal Housing Administration began a series of estimates illustrating the cost of constructing a simple two-bedroom frame house in each of the areas served by the FHA insuring offices. The purpose of the series was to demonstrate the differences in costs of construction in the various insuring office areas, and also to guide the insuring offices in determining appropriate data to be used in estimating the cost of building improvements.

The estimates indicate the cost of constructing this particular house in one city in each area served by an insuring office, except the areas served by the

Puerto Rico, Hawaii, and Alaska offices. The city selected in each area was that from which the insuring office receives the greatest number of applications and in which the type of construction is most representative of construction in the entire area served by the insuring office. An additional factor in selecting the particular city was the availability of cost data continuously over a period of years. The data used in preparing the estimates were those that the insuring office would use if an application for insurance on this house were received in the office.

The selection of a house presented some difficulties because of the considerable variations in specifications and design in different sections of the United States. For this reason it was decided to choose a house which, though perhaps not actually constructed in certain sections of the country, could be built in all sections. The house selected is illustrated in the sketch plan below. The

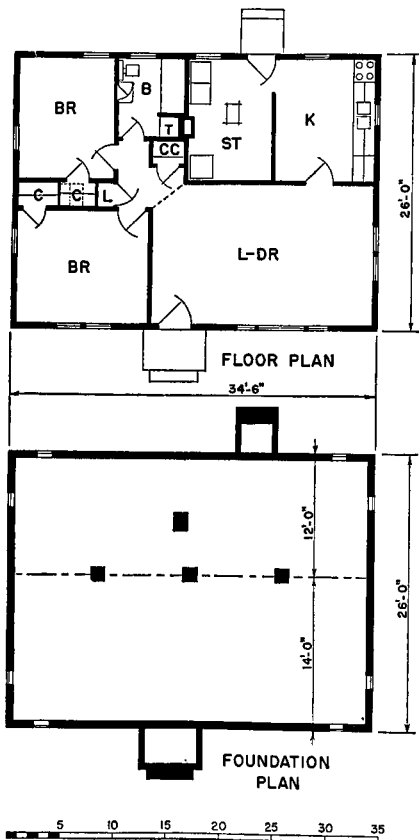

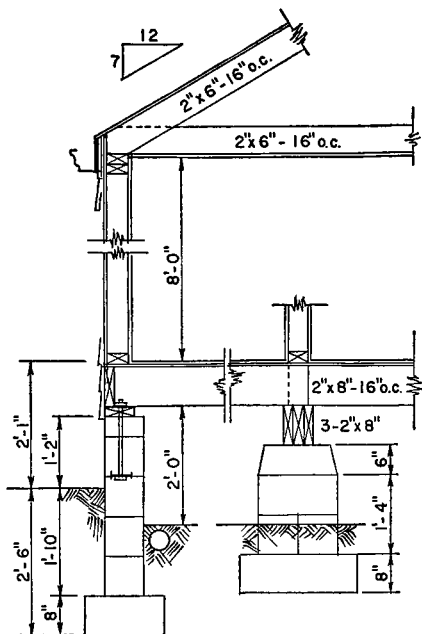

DETAIL
SECTION



materials specified are noted in the list on pages 331-332 of quantities used in preparing the estimates. The construction is generally typical of that found in many sections of the country.

SPECIFICATIONS

The house is basementless, being supported by concrete-block foundation walls and piers. The floor is constructed of 2-by 8-inch joists with a subfloor of 1-by 8-inch boards. Select oak flooring is laid over felt and finished by sanding, shellac or varnish, and wax. The exterior walls are beveled siding over felt and board sheathing. The framing is 2-by 4-foot studs. Gable ends are the same as the exterior walls. The roof consists of 2-by 6-inch rafters with 1-by 8-inch solid sheathing, covered by felt and 210-pound asphalt shingles. Walls and ceilings are $\frac{1}{2}$ -inch gypsum dry wall, painted with 3 coats of enamel on kitchen and bathroom walls and ceilings and 2 coats of casein paint on the rest of the walls and ceilings. All exterior wood and interior millwork and trim have three coats of paint.

Windows are wood, double-hung, weatherstripped and have full-sized galvanized screens. Interior wood doors are 1 $\frac{3}{8}$ -inch, 2-panel; the exterior doors are 1 $\frac{3}{4}$ -inch 6-panel colonial for the front entrance and 1 $\frac{3}{4}$ -inch with glazed top for the rear entrance. The kitchen cabinets are wood, mill-made, with linoleum

counter top and back splash. The kitchen floor is of asphalt tile with plywood underfloor, and the bathroom floor is ceramic tile with ceramic tile wainscot 4 feet high around the entire room. Plumbing fixtures are good quality of standard grade. Electrical wiring is nonmetallic sheathed, with standard-grade outlets, switches, and lighting fixtures. The ceiling is insulated with 2-inch mineral wool.

No heating has been included in the estimated cost because of the wide variations in type and size of heating systems that result from differences in climatic conditions, availability of fuels, and popular demand. The estimates include costs for a brick chimney with an 8- by 12-foot flue, and for front-and-rear entrance platforms and steps. Connections to sewer, water, gas, and electric lines are included only to a point 5 feet beyond the foundation walls, because of variations in the distance that dwellings may be set back from the street. No costs are included for seeding or sodding, planting, sidewalks, driveways, or street improvements.

FLOOR PLAN AND SECTION

The illustrated sketch plan indicates locations for the range and refrigerator in the kitchen and the heater in the utility room, but no costs are included in the estimates for these three items of equipment.

COST ESTIMATES

The estimates of cost include materials, labor, subcontracts, workmen's compensation insurance, public liability insurance, unemployment insurance, social-security tax, sales taxes, incidental job costs, and general overhead and profit. They do not include architectural services, the cost of the lot, land development, carrying charges during construction, financing costs, fire insurance, or hazard insurance.

The estimated costs for building this house in the 70 selected cities are listed below. These are the amounts that the insuring offices would have determined as the estimated costs for this house on January 1, 1953.

Albany, N. Y.....	7, 928	Los Angeles, Calif.....	6, 152
Albuquerque, N. Mex.....	7, 175	Louisville, Ky.....	7, 844
Atlanta, Ga.....	6, 857	Manchester, N. H.....	6, 434
Baltimore, Md.....	7, 550	Memphis, Tenn.....	6, 399
Billings, Mont.....	7, 409	Miami, Fla.....	6, 644
Birmingham, Ala.....	6, 560	Milwaukee, Wis.....	8, 573
Boise, Idaho.....	7, 050	Minneapolis, Minn.....	7, 479
Boston, Mass.....	7, 464	Nassau County, N. Y.....	6, 863
Buffalo, N. Y.....	8, 553	Newark, N. J.....	7, 092
Burlington, Vt.....	6, 746	New Orleans, La.....	7, 356
Camden, N. J.....	7, 476	Oklahoma City, Okla.....	6, 503
Charleston, W. Va.....	7, 484	Omaha, Nebr.....	8, 141
Charlotte, N. C.....	6, 453	Philadelphia, Pa.....	7, 254
Cheyenne, Wyo.....	7, 068	Phoenix, Ariz.....	6, 608
Chicago, Ill.....	8, 333	Pittsburgh, Pa.....	8, 064
Cincinnati, Ohio.....	7, 950	Portland, Maine.....	6, 632
Cleveland, Ohio.....	9, 117	Portland, Oreg.....	7, 461
Columbia, S. C.....	6, 567	Providence, R. I.....	7, 521
Columbus, Ohio.....	7, 950	Reno, Nev.....	8, 162
Dallas, Tex.....	6, 463	Richmond, Va.....	7, 032
Denver, Colo.....	6, 942	Sacramento, Calif.....	7, 614
Des Moines, Iowa.....	8, 102	St. Louis, Mo.....	7, 877
Detroit, Mich.....	7, 471	Salt Lake City, Utah.....	7, 626
District of Columbia.....	7, 383	San Antonio, Tex.....	7, 362
Fargo, N. Dak.....	8, 242	San Diego, Calif.....	8, 136
Fort Worth, Tex.....	6, 821	San Francisco, Calif.....	7, 546
Grand Rapids, Mich.....	7, 122	Seattle, Wash.....	7, 744
Hartford, Conn.....	7, 767	Shreveport, La.....	7, 641
Houston, Tex.....	6, 942	Sioux Falls, S. Dak.....	8, 317
Indianapolis, Ind.....	7, 579	Spokane, Wash.....	7, 239
Jackson, Miss.....	6, 693	Springfield, Ill.....	8, 636
Jacksonville, Fla.....	7, 399	Tampa, Fla.....	7, 402
Kansas City, Mo.....	7, 728	Topeka, Kans.....	7, 670
Little Rock, Ark.....	6, 934	Tulsa, Okla.....	6, 941
Long Beach, Calif.....	6, 127	Wilmington, Del.....	7, 643

In addition to demonstrating differences in costs in the various insuring office areas, the estimates may also indicate to an insuring office the need for restudy of the cost data used for a particular locality in processing applications for insurance. This is particularly true with respect to costs being used by 2 separate insuring offices in preparing estimates for houses which may be situated in 2 contiguous localities served by the respective insuring offices. Responses received from the insuring offices since the issuance of the first study have revealed the continuing interest with which the offices are observing changes in cost levels in their areas as compared with changes in other areas.

Although the comparison of costs is generally reliable and to a great extent indicative of general cost levels in the area of each insuring office, it should be fully understood that the comparative costs listed may not be indicative of cost levels in all localities served by the individual office. Differences in the types of construction prevalent in individual areas or sections of the country may result in significant differences in costs.

MATERIALS AND EQUIPMENT

The following is a detailed list of the quantities of specified materials and equipment required to construct the dwelling and included in the estimates of cost:

- 40 cubic yards of excavation for crawl space.
- 9 cubic yards of trench excavation for foundations.
- 7 cubic yards of backfill around walls.
- 118 lineal feet of 8' x 16" concrete wall footings (1-3-5 mix), forms 2 sides.
- 4 concrete footings 24' x 24' x 8" (1-3-5), forms.
- 355 square feet of concrete block walls, 8" thick.
- 3 concrete block piers, 16' x 16' x 1'10".
- 8 screened cast iron foundation vents, 8' x 16".
- 120 lineal feet of 4" tile footing drain with crushed stone.
- 34 lineal feet of 6' x 8" #2 built-up wood girder.
- 121 lineal feet of 2' x 6" #2 wood sill with anchor bolts 8'0" on center.
- 22 lineal feet of 4" brick chimney with 8' x 12" T. C. flue.
- 1,267 square feet of exterior frame wall made up of—
 - 2' x 4' #2 studs 16' on center.
 - 1' x 8" #2 horizontal sheathing.
 - 15-pound asphalt saturated felt.
 - ½' x 8" beveled "A" siding.
 - 3 coats of lead and oil paint.
- 897 square feet of 2' x 8" #2 floor joists 16' on center with cross bridging.
- 897 square feet of 1' x 8" #2 S. E. subfloor laid diagonally.
- 608 square feet of 25/32" x 2¼" select oak floor, including 15-pound felt and finishing.
- 840 square feet of 2' x 4' #2 partition studs 16' on center.
- 897 square feet of 2' x 6" #2 ceiling joists 16' on center.
- 1,041 square feet of roof consisting of—
 - 2' x 6" #2 roof rafters 16' on center, 7/12 slope.
 - 1' x 8" #2 roof sheathing.
 - 210-pound asphalt shingles with 15-pound felt.
- 69 lineal feet of 26-gage galvanized iron gutter.
- 40 lineal feet of 2¾" x 3¼" 26-gage galvanized iron downspouts.
- 4 cement splash blocks.
- 3,469 square feet of ½" gypsum dry wall, taped.
- 1,063 square feet of 3-coat enamel on walls and ceilings.
- 2,406 square feet of 2-coat casein on walls and ceilings.
- 8 interior doors, 2-panel, 1¾", including frame and trim.
- 329 lineal feet of 2-member pine base.
- 14 wood double-hung windows, weatherstripped and with full-size 1½" wood mill-made screens of galvanized cloth.
- 2 plain exterior entrance door frames with simple trim and weatherstripping.
- 1 exterior door—6-panel colonial, 1¾", weatherstripping.
- 1 exterior door—top half glazed, 1¾", weatherstripping.
- 2 mill-made 1½" wood screen doors, galvanized.
- 2 triangular gable peak wood louvres, screened.
- 2 pair of wood batten shutters, fixed.
- Mill-made wood kitchen cabinets as follows:
 - Base units:
 - 1 door type, 24" wide.
 - 1 drawer type, 30" wide.
 - 1 sink front, 30" wide.

Wall units:

1—18' x 30'.

1—36' x 24'.

1—36' x 30'.

7 lineal feet of linoleum counter top and splash back.

1 linen closet with shelving only, no doors, no drawer.

1 towel closet with shelving only, no doors, no drawer.

3 clothes closets with 1 shelf, clothes rod, and hook rail.

1 metal medicine cabinet.

1 plumbing access door.

1 attic access door.

1 crawl space access door.

191 square feet of light color asphalt tile, grease-proof, on $\frac{5}{8}$ " plywood floor.

28 square feet of ceramic tile floor, white.

85 square feet of ceramic tile wainscot, white.

1 set of 5 china bath accessories.

Plumbing installation as shown on sketch plan and consisting of—

1 recessed bathtub with overhead shower and curtain rod.

1 lavatory.

1 water closet.

1 double-compartment kitchen sink.

1 double-compartment cement laundry tray.

1 automatic gas hot water heater, 30 gallons gas distribution for cooking and hot water.

1 soil and vent stack.

1 waste and vent stack.

20 lineal feet of interior house drain.

2 sill cocks.

33 nonmetallic electric outlets and wiring, including service entrance and distribution panel.

8 lighting fixtures of medium grade.

897 square feet of 2" mineral wool batt ceiling insulation.

38 square feet of 4" concrete entrance slab with 8" concrete block foundations.

8 lineal feet of concrete step for entrances.

Mr. McDONOUGH. That is all, Mr. Chairman.

The CHAIRMAN. Are there further questions?

Mr. O'HARA. Mr. Chairman.

The CHAIRMAN. Mr. O'Hara.

Mr. O'HARA. Mr. Winston, your association is located in the city of Chicago, in what I think is the finest congressional district in America, which, Mr. Chairman, is the Second District of Illinois.

The CHAIRMAN. We assume it to be, Mr. O'Hara.

Mr. O'HARA. Mr. Winston, you are familiar with the situation, I know, as regards housing in the city of Chicago?

Mr. WINSTON. To some extent, sir.

Mr. O'HARA. As a member of this committee, and a member of the Congress, I want to be helpful as much as I can in getting legislation that will give to the people the maximum amount of housing possible. I want to go along with the administration as far as I can in trying to get a good housing bill. I hope that our suggestions for amendments to that end will be helpful. Having in mind the situation in Chicago, what changes would you suggest in the bill that we have before us as regards public housing?

Mr. WINSTON. This bill has few amendments to the 1949 Housing Act. The changes I would suggest would be to eliminate the 1954 and 1953 restrictions, which do not provide more than 20,000 in 1 case, and 25,000 units per year in another case. Those are the major amendments that ought to be made legislatively right now. There are other minor amendments which we have covered here, one of which is the

recommendation of the advisory committee for payment of taxes, and also the providing of housing for aged single persons.

Mr. O'HARA. You believe, do you not, that the President of the United States is sincerely concerned in a reasonable amount of public housing?

Mr. WINSTON. I did not hear you, sir.

Mr. O'HARA. You believe that the President of the United States is sincerely interested in increasing the units of public housing?

Mr. WINSTON. I do, sir.

Mr. O'HARA. And do you think—

Mr. WINSTON. His statement so indicates, his message to Congress.

Mr. O'HARA. Do you think it would be improper for the administration to suggest to Members of the House that matters in regard to public housing should be determined first, by this committee, the Banking and Currency Committee, and then the Congress itself, the Members on the floor, rather than by a limited number of members of the Committee on Appropriations? Now, you know what I am talking about; don't you?

Mr. WINSTON. Yes; I do.

Mr. O'HARA. What suggestion would you have to make along that line?

Mr. WINSTON. We would like to see the present legislation include legislation to take away the restrictions which were placed on the appropriations bills for 1954 and 1953, which do limit the Housing Act of 1949.

Mr. O'HARA. Now, the Housing Act of 1949 was a pretty good act; wasn't it?

Mr. WINSTON. Yes, sir; it worked.

Mr. O'HARA. And you were here at the time of its enactment, were you not?

Mr. WINSTON. I was.

Mr. O'HARA. And you remember, before it came to the House, that there was a great question as to whether it would pass, and the doubt was resolved when the statesman from Ohio, the late Senator Taft, issued his statement. You remember that, don't you?

Mr. WINSTON. I certainly do.

Mr. O'HARA. Calling your attention to the provisions in the Housing Act of 1949 for a research department, that came largely from the mind of Senator Taft; did it not? You would give Senator Taft the credit for being one of the fathers of the great legislative concepts in the Housing Act of 1949?

Mr. WINSTON. We certainly do.

Mr. O'HARA. Now, the President's advisers, at the present time, have submitted a report, have they not, finding that 10 million American families this year will have to find relocation of their homes?

Mr. WINSTON. That is the finding of the President's Advisory Committee.

Mr. O'HARA. The advisers of the President?

Mr. WINSTON. That is right.

Mr. O'HARA. That is, this is the committee that is giving information and counsel to the President of the United States at the present time; is that right?

Mr. WINSTON. That is correct.

Mr. O'HARA. And I understand, and I presume you understand, that the President of the United States has in the Congress at the present time, and in the House, a majority membership of his party. That is right, sir?

Mr. WINSTON. That is right.

Mr. O'HARA. Now, you have found, have you, that of these 10 million American families that will have to find new homes, that at least 5 million are in the middle-income or below the middle-income wage group?

Mr. WINSTON. That is the finding of the Advisory Committee, sir.

Mr. O'HARA. Then you may say as far as this administration is concerned, that is final and official. Is that a fair statement?

Mr. WINSTON. I cannot say what—are you talking about this committee or the Advisory Committee?

Mr. O'HARA. The Advisory Committee.

Mr. WINSTON. Oh, yes; that is the published report.

Mr. O'HARA. That is the Advisory Committee that made a deep and impartial study of the situation; is that right?

Mr. WINSTON. That is right.

Mr. O'HARA. Then as far as this committee is concerned, studying this legislation, we must proceed on the thought that we must come through with legislation that is going to give some homing possibility to 5 million American families that are in the middle-income or below the middle-income wage group?

Mr. WINSTON. Yes, sir.

Mr. O'HARA. Will this legislation which is here proposed meet that problem?

Mr. WINSTON. The legislation as proposed, as far as public housing is concerned, is silent except for a few amendments to the 1949 Housing Act, but there is nothing in this legislation which relieves the restrictions placed upon this bill by the last two annual appropriations bills, or the riders to those bills, which restrict the operations under the 1949 Housing Act. Without the removal of those restrictions the legislation on the books is of no particular good to use, and I think that the public-housing program, although very small in itself, is a sine qua non of the whole comprehensive program recommended here.

Mr. O'HARA. Then the legislation that is proposed, having in mind the 10 million American families that the Advisory Committee has found will require new housing or relocation, may beneficially, to some degree, affect 5 million families; is that right?

Mr. WINSTON. That is correct.

Mr. O'HARA. But the other 5 million families are entirely unattended to; is that correct?

Mr. WINSTON. I don't quite follow that, sir.

Mr. O'HARA. Is there any benefit in the legislation we are now considering, any benefit that will reflect itself upon the 5 million American families, among the 10 million, that are in the low-income bracket?

Mr. WINSTON. You are referring to the 5 million listed by the Advisory Committee as those being in such low-income status as to be eligible for public housing?

Mr. O'HARA. Yes, sir.

Mr. WINSTON. Unless the restriction is taken off the Housing Act of 1949, either through this committee or by legislation, or otherwise,

it is not likely that much housing is going to be provided for that low-income group. It is unlikely that very many of those will find housing through rehabilitation in the immediate future or through the efforts of the new section 221, which we are strongly for, but which we do not think will get down to the real low-income group.

Mr. O'HARA. Then what is going to happen to most of the people in that 5 million family group?

Mr. WINSTON. If slums are cleared, and the renewal program goes on, they will be pushed—the impact of those families will probably cause other slums on the periphery of the ones you have just cleared.

Mr. O'HARA. Then instead of making progress we will be going backward; is that what you fear?

Mr. WINSTON. It has been the experience in those cities which have proceeded with a slum-clearance program without a relocation program simultaneously or previous thereto.

Mr. O'HARA. Did I understand correctly from your testimony that you envision, in the operation of this proposed rehabilitation program, that it will be impossible to relocate the displaced families?

Mr. WINSTON. I think it will be, sir. To give one example, in my own city of Baltimore, right now they have several urban redevelopment projects. One large one of 30 acres. In Baltimore our connection is through a private redevelopment agency. We have a contract whereby the primary authority does all the relocation work for the redevelopment agency. It is our responsibility to relocate all the families. We have relocated over a thousand families in one area. We have just now approved and are going to proceed with a State office building, which will clear over a thousand families from a large slum area. That could not be possible were it not for the fact that we hope to have ready by that time another large public-housing project in that general neighborhood to take care of those families by the time the relocation is upon us. That is the best way I can illustrate, or answer by illustration.

Mr. O'HARA. You are acquainted with the situation in Chicago, I presume?

Mr. WINSTON. To some extent, sir.

Mr. O'HARA. Where we are constructing a great system of super-highways and building subways, and in doing that we were delocating a great number of people and had to find new homes for them.

Mr. WINSTON. That is right.

Mr. O'HARA. And that would have been impossible if it had not been for the public-housing projects in Chicago.

Mr. WINSTON. That is right. The result is to create——

Mr. O'HARA. I don't think enough stress has been put upon that great urban undertaking in Chicago, giving perhaps the finest super-highways system in the world, which would have been impossible had we not had the cooperation of the Public Housing Authority.

Mr. WINSTON. In Baltimore the expressway plan was deferred by the city council until the civic public housing could be completed.

Mr. McDONOUGH. Will you yield?

Mr. O'HARA. I am happy to yield to the distinguished gentleman from California.

Mr. McDONOUGH. Concerning your building of expressways and freeways in Chicago, I do not know how extensive it is, but I can

assure the gentleman that in Los Angeles we are going into a program, have had under way a program, that has required the dislocation of thousands of people. In one instance I think some 40,000 living units were affected, and there are others being affected now, but the Public Housing Authority has not been the solution to it. People have found places in other parts of the community to live without going to the public housing units.

So that, although it may be necessary in Chicago, it isn't the whole solution to the problem—that is public housing is not the whole solution for the provision of living quarters for people dislocated by the construction of expressways.

Mr. O'HARA. I would say, dear colleague, that every city has its own problems, and that I would not be at all competent to discuss the problems of Los Angeles, and I know that my colleague would not hold himself as being in position to know the problems of Chicago as well as I do.

Mr. McDONOUGH. I agree.

May I ask unanimous consent, Mr. Chairman, that immediately following my previous remarks, that there be included in the record an article entitled "Comparative Costs of a Standard House," in the Insured Mortgage Portfolio issued by the Federal Administrator, which is pages 15, 16, 17, and 18, including the design?

The CHAIRMAN. Without objection, it may be inserted.

(The material referred to appears at p. 327.)

Mr. WINSTON. May I add this, Mr. Chairman, on that cost of mortgages, and so forth, I would state once more that we are concerned with making it possible for builders to build downtown and also to build larger-sized units.

Again I have to ask your forgiveness for referring to my own situation in Baltimore, because that is the one that I am most familiar with. It would not be possible to build such structures in the downtown areas of Baltimore at the \$7,000 level, and, if you did, you would have to build what has actually been proposed—and I hope it will never be built there—housing units of which 1 section have no bedrooms, merely efficiency apartments, and 1-bedroom units, and no 2- or 3-bedroom units. That will not take care of the families displaced.

You can build housing at any cost, if you want to go out and ignore your downtown areas, but what we are trying to do, I presume, in this bill is to replace some of the slums we clear with good housing, and replace it with housing for the people who want to live there, and not just for single people who don't need a bedroom, but just an efficiency apartment. There is a little difference there, I believe, sir.

The CHAIRMAN. Are there further questions?

Mr. DEANE. Mr. Chairman.

The CHAIRMAN. Mr. Deane.

Mr. DEANE. I direct this question to both of you gentlemen. Would you consider, say, the area here in Washington, between the Capitol and the Social Security Building, to be an urban renewal area?

Mr. WINSTON. Mr. Searles can answer that, perhaps.

Mr. SEARLES. I think between here and the railroad tracks, sir, would be a part of a renewal area. The renewal concept does go much beyond the slum-clearance area, as we understand the legislation, and

actually the area between the railroad tracks, running on Virginia Avenue; and Maryland Avenue, and the Mall, have been designated over a long period of years as a Federal taking area and has just been released from that category. There has been some rehabilitation in that area, and included with the clearance area, which lies south of it in the southwest, it would be a part of a large renewal area, where different kinds of treatments could take place.

Mr. DEANE. How many families would you say are located in that area?

Mr. SEARLES. Are you referring to the entire southwest area?

Mr. DEANE. Well, principally where you are thinking about. I think we are thinking of the same area.

Mr. SEARLES. Well, the area lying from the railroad tracks out to Fort McNair, and from South Capitol Street over to the waterfront and Fourteenth Street, contains now 22,000 people, or almost 6,000 families.

Mr. DEANE. What is the approximate rental they are paying—average?

Mr. SEARLES. The average rental—there is no block there that averages more than \$50 a month. Some are as low as \$25 a month, on an average, by block. The average for the entire areas runs around \$40 a month.

Mr. DEANE. And how many thousand people?

Mr. SEARLES. Twenty-two thousand people, between 5,500 and 6,000 families.

Mr. DEANE. Assuming that this was declared an urban renewal area, what would be the procedure that would be followed in submitting an application under this bill?

Mr. SEARLES. Well, it so happens, sir, that that area has already been declared an urban redevelopment area, and that under this legislation's saving clause it would be an urban renewal area also, and, therefore, I presume that we would proceed as we are proceeding with it.

Mr. DEANE. Under the bill now pending the Administrator approves as appropriate for a project such an area; is that correct?

Mr. SEARLES. That is right.

Mr. DEANE. Is that according to the present law?

Mr. SEARLES. Under the present law he has also had to approve areas as appropriate for redevelopment under title I, and he has done that with the area you are discussing, sir.

Mr. DEANE. Where would these people find housing, in Washington?

Mr. SEARLES. They must find housing in a number of places. Each family has to be carefully studied for its own income, needs, and so on. We have a staff which has made such a study of each family, and we try to find housing to meet the particular family's problems.

Those that can afford private accommodations are offered those. Always they must be decent, safe, and sanitary, under the law, and within their means, and Washington does have a housing market which is a little looser than that of Chicago, and there are houses available for those families in the upper half, or upper 60 percent of those who live there, as far as income goes.

The lower 40 percent will have a priority in low-rent public housing, and they have been exercising that priority up to now, sir.

MR. DEANE. I learned for the first time, Mr. Winston, that the success of your program in Baltimore has been dependent, to a certain extent, upon the public housing program because you were able to move the people from one area into the other.

MR. WINSTON. That is correct, sir. In Baltimore we have what we like to refer to as our balanced three-prong program. We have the rehabilitation, as you call it, or law enforcement, as it is referred to under the Baltimore plan; we have our redevelopment commission, and the local housing authority, which deals in public housing.

I would like to add one thing to the statement I made a moment ago, for the gentleman who asked about it, that the housing authority has a contract with the commission to relocate all of its families. That does not mean that we depend on public housing alone. We locate those families according to their need. We have to search out private housing. We always try to find private housing for them. I say that just to indicate that I did not want to leave any impression that we depend upon public housing alone, because many of the families are ineligible for public housing, in the first place, and we are still responsible for relocating that family in some housing in the city, whether private or public.

MR. DEANE. Of those in public housing?

MR. WINSTON. I would say the percentage going into public housing depends upon the vacancies. We have a small turnover of the vacancies and we are trying to complete a program of housing in Baltimore right now. We have three programs under construction. The State office building is likely to be held up if we cannot proceed more rapidly than we are now with the completion of housing for low-income families. This one site happens to be a horrible slum and some thousand families will have to be relocated within the next 2 years.

MR. DEANE. Under the present law a slum area now devoted to commercial or industrial projects, if Federal funds are used, must be converted into residential; isn't that true?

MR. WINSTON. Mr. Searles can answer that.

MR. SEARLES. That is true, sir, that at the present time, if the area is not now residential, its new uses must be predominantly residential in character to receive loans and grants under title I.

MR. DEANE. That isn't true under present legislation; is it?

MR. SEARLES. What I am citing is the present legislation, that would be changed by the proposed legislation.

MR. DEANE. That is what I mean.

MR. SEARLES. So that it could be—

MR. DEANE. In other words, a deteriorated commercial area now existing could be reconverted into a commercial area?

MR. SEARLES. Under the proposed legislation.

MR. DEANE. Yes, sir.

MR. SEARLES. Yes, sir.

MR. DEANE. Using Federal funds to do so?

MR. DEANE. Yes, sir.

MR. DEANE. That is all, Mr. Chairman.

The CHAIRMAN. Are there further questions?

If not, thank you very much, gentlemen for your valuable assistance. The committee will stand in recess until tomorrow morning at 10 o'clock.

(Whereupon, at 4:12 p. m., the committee adjourned.)

HOUSING ACT OF 1954

TUESDAY, MARCH 9, 1954

HOUSE OF REPRESENTATIVES,
COMMITTEE ON BANKING AND CURRENCY,
Washington, D. C.

The committee met at 10 a. m., the Honorable Jesse P. Wolcott (chairman) presiding.

Present: Chairman Wolcott, Messrs. Talle, Kilburn, McDonough, Betts, Mumma, Merrill, Oakman, Hiestand, Stringfellow, Van Pelt, Spence, Brown, Patman, Multer, Deane, O'Brien, Addonizio, Dollinger, Bolling, and O'Hara.

The CHAIRMAN. The committee will come to order.

We will proceed with consideration of H. R. 7839.

We have with us this morning Mr. Norman P. Mason of the United States Chamber of Commerce.

Mr. Mason, we are very glad to have you here. You may proceed with your statement. If it is agreeable, Mr. Mason will proceed with his statement without interruption until he is through, and then will submit himself to such questioning as the members may wish to conduct.

Mr. MASON. Thank you, Mr. Chairman.

STATEMENT OF NORMAN P. MASON, CHAMBER OF COMMERCE OF THE UNITED STATES

My name is Norman P. Mason. My home is in Chelmsford, Mass., where I am engaged in the building material business. I am chairman of the construction and civic development department committee of the United States Chamber of Commerce, and I am testifying on behalf of the chamber in respect to H. R. 7839.

The Chamber of Commerce of the United States is in hearty accord with the aims of this legislation. We believe it is good legislation because it expresses renewed faith in and increases reliance on a free competitive economy to bring about a constant improvement in the living standards of our people. It makes the system of privately financed mortgage insurance which has been successfully developed in the Federal Housing Administration over the past 20 years an even more useful feature of that market. It places the Federal Government in a position where it can strengthen these private forces, it increases American ability to add a large volume of new houses. It is a real step toward conserving our present housing and preventing the spread of blight. All this the national chamber endorses.

We commend the simplification of the FHA statute by the elimination of provisions that either have no proven usefulness or have out-

lived their usefulness. We applaud those provisions eliminating differences in terms on the debentures offered in payment of the insurance and in allowances of foreclosure costs applicable to the several sections and subsections of the act.

Over the years FHA has been so laden with special purpose functions and special mortgage patterns designed to meet some assumed need or some current emergency that today it is difficult to count the number of possible ways of making an FHA mortgage. The effort to return to one general pattern for insuring loans on single-family houses and one for multi-family and cooperative structures should result in savings both to FHA and its users.

Two features of the bill will make homeownership easier for the great majority of people. One would replace the existing variety of systems of loans to value relations for FHA-insured mortgages with a single system of loan to value ratios of not to exceed 95 percent of \$8,000 value and 75 percent of the value in excess of that amount. The other feature would increase the maximum mortgage which may be insured by FHA from the present \$16,000 for a 1- or 2-family residence to \$20,000 with corresponding increases for 3- and 4-family houses.

The raising of the top dollar limits for insured mortgages makes a partial adjustment to restore FHA to the broad coverage of the market that it had in its beginning. It does this by providing an even schedule of loan ratios and avoiding a sharp increase in the downpayment requirement at a mortgage amount of about \$12,000 as is now the case. The legislation removes an artificial barrier that has caused builders to build to meet an arbitrary formula rather than to seek out and serve the actual demand that may exist at the time. We believe it is best to have the wishes of our citizens, rather than a Federal official, determine the direction of production.

Another very important provision of the legislation, which the chamber endorses, is that for a flexible interest rate to be regulated by the President from time to time so that FHA and VA mortgages will draw adequate funds to the building market. While we felt that the suggestion of the President's advisory committee that a board of five meeting at frequent intervals would have been a more workable way to have handled this adjustment, we believe that this proposal can be operated so that there is no arbitrary restriction on the normal flow of funds to this field. Certainly the ordinary American citizen is better served by a realistic interest rate which brings an adequate amount of lendable funds into the market rather than by a low fixed interest rate but no funds to borrow.

The proposal to provide the same mortgage insurance terms for new and existing construction is in keeping with the original idea of FHA as an accessory to the whole home mortgage market. It was not for several years after the creation of FHA that provisions specially favoring new construction were introduced. Whatever justification there may have been for doing this at the time no longer exists. Under present-day conditions we must recognize the desirability of favoring terms for financing existing homes not only as a means for encouraging maintenance of such property in good condition, but also as a means of stimulating new building. More and more the sale of a new home will depend upon the ability of the new home buyer to

make a satisfactory sale of his old home. The proposed amendment would be very helpful in this direction.

We commend the recognition given in the bill to the importance of maintaining and improving the value of existing dwellings. Particularly noteworthy are the increase in loan limits and maturities for the insurance of modernization and repair loans and the provisions which would enable an FHA mortgagor to get the benefits of the so-called open-end feature. He could obtain a loan for the improvement or alteration of his home by adding the amount of the loan to his existing mortgage without the necessity and costs of executing a new mortgage. In addition, there is a provision which would make FHA insurance under certain safeguards available for both old and new residences located in rundown or blighted areas.

These provisions should be of immeasurable benefit in conserving the largest single element in our national wealth—our housing. They should help to improve housing conditions generally, and they should be of especial help in increasing the supply of substantial, comfortable, modern housing for families with low incomes.

The chamber has worked for many years to encourage the elimination of slums and the restoration of blighted urban areas to economic and social usefulness. While we had reservations about the urban rehabilitation plans established in the housing acts of 1949, believing it to be too limited and too costly, the pending legislation promises to remove these defects. This legislation places a definite responsibility on the locality to put its own house in order with ordinances and enforcement of these ordinances to assure the proper maintenance of housing and to prevent its overcrowding, before that community can go to the Federal Government for assistance. It lets the Federal Government help in such a way as to encourage the conservation of sound structure. It helps to retard the decline of existing neighborhoods and to eliminate the causes of blight before it becomes necessary to do a wholesale clearance operation. Because of these desirable features, the provisions of title IV of the bill are strongly supported by the chamber and we urge their enactment.

We also endorse the idea of setting up a secondary mortgage market and doing away with the present Federal National Mortgage Association. This new facility is really needed to help the rank and file of American citizens living in the fast-growing areas such as in the West and Southwest, and those living in hundreds of average American small towns and cities which have no source of mortgage capital. To them such a secondary mortgage market spells the difference between their ability to have or not to have the house they desire and need. We in the chamber with our many grassroots contacts are especially aware of this need of our average American citizens. In the past many of the aids which have been extended by the Federal Government have been to help the mass builder to serve the needs in our large urban communities. Now, we need this new facility to help those in our smaller cities and towns.

We hope that with this in mind you will review carefully the recommended legislation on the secondary market and make it even more workable for these average people. I refer to the fixed non-refundable charge of 3 percent which must be borne by all regular borrowers. We believe that the proposal of the President's Commit-

tee which makes this refundable when the mortgage has been sold by the marketing organization is more equitable.

And I would like to add that we also believe that the \$12,500 limit on this type of loan is detrimental to the welfare of the average American citizen.

We are disturbed at the idea of asking a sound business organization, such as this secondary market facility ought to be, to furnish funds for an experiment in mortgage lending which appears to us to be unsound. I refer to the 40-year, no downpayment, FHA-insured loan proposal in the legislation. We do not believe that it is good practice to ask an institution to run itself on sound lines so that it may finance its need through borrowing from the public and then ask this same institution to take Government funds and make them available for questionable risks. The idea of the sound secondary mortgage market which is the essence of the proposed legislation could work to the advantage of millions of our citizens and we endorse this.

What I have described comprises, we believe, a practicable housing program, one with attainable objectives: It is one that does not promise more than it can deliver but promises, nevertheless, a rapid and comprehensive upgrading and enlargement of the whole housing supply.

It appears to us that the extension of authority to the President to vary the loan to value ratios and maturities on FHA and VA loans is a provision which could be eliminated from the legislation without loss. It seems to us that this proposal would provide for a form of direct and selective credit control on the FHA, VA sector of the mortgage market which would keep that market in a state of constant uncertainty and would permit its manipulation to serve a wide range of political and social purposes that might be quite unrelated to the actual need for housing on the part of our average American citizens. We believe that the maximum limits on these loans should be directly controlled only by statute and that dependence can be placed on general monetary actions to regulate the flow of funds. Credit and price controls are not popular with our American citizens and we do not think they should be used except in wartime.

So far as the 40-year FA-insured loans are concerned we want to remind you that the liberalized provisions of the regular FHA-insured loans which we have endorsed should have an opportunity to be tried out before any such radical departure as this is called for. We feel sure that with the other changes proposed in section 203 loans that this special type of loan will not be needed. This special type of loan calls for a great deal of Federal programing, supervision, and general Federal meddling which is unnecessary and undesirable.

We wish to make a plea for greater dependence on a free market economy which, as we understand it, is the primary aim of this administration and its legislative program. We believe that this dependence on the free market economy is justified by performance. In the short time since the end of World War II and despite the difficulties created by the Korean war the industry built over 8 million new housing units and added several million more by converting existing dwellings. Besides this it has very markedly improved the condition of existing housing through the expenditure of billions of dollars on repair and modernization. All this constitutes a giant step

toward the goal of providing every American family with a decent home.

There is still a big job to be done but it is not a staggering one. For assuming the continuance of the same rate of progress we have had, the goal which heretofore has never been reached in any country of the world is within our grasp. The provisions of the pending legislation that the national chamber is endorsing should greatly help to speed up and make sure the accomplishment of this goal. The question before you gentlemen is which methods will prove quickest and most effective, and which ones will contribute most to the stability of our American economy. The continued addition of a million or more privately built and financed new houses a year combined with a vigorous program of upgrading the quality of the existing housing and removing housing that no longer can be economically maintained in good condition is the best method of doing this job. Any other method can have no more than a token effect at best.

Mr. Chairman, I would be very glad to answer questions, if I can.

The CHAIRMAN. Are there questions?

Mr. PATMAN. Mr. Chairman.

The CHAIRMAN. Mr. Patman.

Mr. PATMAN. This flexible interest rate, you referred, I presume, to the section that fixes $2\frac{1}{2}$ percent as a margin between the Government long-term yield and the mortgage rate?

Mr. MASON. That is correct, Mr. Patman.

Mr. PATMAN. Hasn't $1\frac{1}{2}$ percent been customary in the past? Hasn't it been almost a traditional policy that $1\frac{1}{2}$ percent is sufficient, Mr. Mason?

Mr. MASON. Well, the figures prove, and our investigations prove, that $1\frac{1}{2}$ was not adequate.

Mr. PATMAN. Well, that is what we have had in the past, isn't it?

Mr. MASON. I cannot answer that part of the question. I can just say that $1\frac{1}{2}$ percent would not have been adequate.

Mr. PATMAN. Well, $1\frac{1}{2}$ percent has been used in the past, and this is $2\frac{1}{2}$. That is an increase of 1 percent, isn't it?

Mr. MASON. In the past—

Mr. PATMAN. Obviously it is an increase of 1 percent.

Mr. MASON. Mr. Patman, in the past we have had a fixed interest rate, rather than a flexible one. We are asking for a flexible one now.

Mr. PATMAN. Well, you are asking for $2\frac{1}{2}$ percent above the long-term bond yield.

Mr. MASON. I am sorry, we are not asking for $2\frac{1}{2}$ percent. We are putting a limit of $2\frac{1}{2}$ percent on because we believe that when the Government insures a mortgage that it cannot have an entirely free rate, that it has to have a stopping place somewhere.

Mr. PATMAN. You do not expect it to be less than $2\frac{1}{2}$, do you?

Mr. MASON. Under present market conditions, I certainly would expect it to be less than $2\frac{1}{2}$ percent.

Mr. PATMAN. Well, $2\frac{1}{2}$ percent seems to me to be rather high, especially in view of the fact that $1\frac{1}{2}$ percent has been customary in the past.

I figured up the other day, on a \$9,600 home mortgage, with a borrower who pays one-half of one percent additional on a 25-year mort-

gage, he would be out about \$814 over the entire period of time. He could have used that money for an extra bedroom. Is that in accord with your figures?

Mr. MASON. I don't have those figures in front of me, of course.

Mr. PATMAN. I thought maybe you had a table that would show it.

Mr. MASON. No.

Mr. PATMAN. If that is correct, and I believe it is approximately correct, a 1 percent increase would be \$1,626 more than a borrower would have to pay on a \$9,600 mortgage over a period of 25 years. That is really a substantial sum. The way I view it, when you take that \$1,628 away from him in interest, you are preventing it from going into the bloodstream of the Nation's commerce and to be used to purchase goods and commodities and necessities of life, and thus expand our economy and maintain full employment.

Mr. MASON. Well, it is our belief and our observation, Mr. Patman, that the necessity is to have funds available so that people can borrow to build houses, and that the fixing of an interest rate at any figure which means that you do not get money is an illusory thing, that you really don't work to the benefit of the borrower when you do that.

What happens is then you have subterfuges and other steps taken in order to get those funds.

Mr. PATMAN. What is your concern, Mr. Mason?

Mr. MASON. My company?

Mr. PATMAN. Yes, sir.

Mr. MASON. I work for the William P. Proctor Co. of North Chelmsford, Mass. They are in the retail lumber business.

Mr. PATMAN. And I guess you do a lot of this title I lending? I mean, you service a lot of those title I loans, \$2,500 modernization loans?

Mr. MASON. Yes, sir.

Mr. PATMAN. That is rather popular, isn't it?

Mr. MASON. It is an excellent thing to make possible for your people the making of repairs to keep their property up to date.

Mr. PATMAN. It occurs to me that that interest rate is rather high, 9.7 percent, for what is tantamount to a riskless loan. The banks carry that paper principally, do they not, Mr. Mason?

Mr. MASON. Yes, sir; I think they do.

Mr. PATMAN. Don't you think that is a pretty high interest rate, 9.7 percent?

Mr. MASON. Again, if it were too high other forces would come in to relieve this situation. We are advocating also, as you observed here, the use of the open-end mortgage, which would make lower priced money available.

Mr. PATMAN. I am going to ask you about that next. But this 9.7 percent seems to me pretty high, especially when the banks create the money on their books. You know the banks are the biggest manufacturers in this country. They manufacture paper money. They create their own money, and when they can create money on the basis of several dollars to one it occurs to me that 9.7 percent on a riskless loan is a rather high interest rate.

Mr. MASON. Just offhand I couldn't quote you the exact figures, but certainly the automobile loans, there is a great deal more money involved than in these title loans.

Mr. PATMAN. And these shotgun loan offices have even higher rates. On the open-end mortgages, Mr. Mason, how many States will permit the open-end mortgage provision to be effective?

Mr. MASON. Well, certainly, your State does not. Most of the others do.

Mr. PATMAN. Do you have a list of the States that permit them?

Mr. MASON. No, sir.

Mr. PATMAN. Well, it occurs to me that that is a rather important question. Are you on the Advisory Committee?

Mr. MASON. Yes, sir; I was on the President's Advisory Committee.

Mr. PATMAN. Did the Advisory Committee make a report indicating how effective this would be, the States where it would apply and the States where it would not apply?

Mr. MASON. Yes, sir.

Mr. PATMAN. Where is that information?

Mr. MASON. I do not have it here with me, certainly.

Mr. PATMAN. Mr. Chairman, do you know where it could be found? Does Mr. Hallahan, the clerk, have it?

Mr. HALLAHAN. I think I can get a compilation of it.

Mr. PATMAN. I would like it in the record at this point.

The CHAIRMAN. It may be obtained and, without objection, may be inserted at this point.

(The following excerpt from the September 1953 Legal Bulletin published by the United States Savings and Loan League contains a résumé by Horace Russell and William Crather of the open-end mortgage and the court decisions or statutory provisions applicable to their operation in each of the States in the United States.)

THE OPEN-END MORTGAGE

An open-end mortgage is a contract between the lender and the borrower providing that future borrowings after the original loan may be secured by the original mortgage. It means that once a homeowner has qualified for a mortgage on his property, he is enabled thereafter within varying limitations in the different jurisdictions to increase the amount of his mortgage to cover the cost of modernization or needed improvements or for other purposes.

The open-end form offers advantages material to both parties. To the borrower, it allows modernization on a long-term credit basis, easy payments with no money down, and an economy in or elimination of refinancing costs. To the lender, it offers a large source of additional investments and an opportunity to give additional service to the public; it tends to prevent an overextension of credit on the part of the borrower, with consequent arrears and foreclosures. The economy and ease of additional financing often provide a strong incentive for the borrower to keep his loan with the original lender instead of going elsewhere, thus enabling the lender to retain seasoned loans with an enhanced value to the original security.

LIEN STATUS OF ADDITIONAL ADVANCES

There are three major kinds of future advances: (1) where the lender is, by the terms of the mortgage, *obligated* to make certain advances; (2) where the lender has the right to make certain advances to protect the security, independently of the will of the mortgagor; and (3) where future advances may or may not be made, depending on the future agreement of the parties. We will not deal extensively with the first, inasmuch as the law appears to be uniform throughout the country: where the lender is contractually obligated to make certain advances, the advances if properly made take precedence over any lien

or incumbrance arising after the date of recording of the mortgage,²⁴ and usually even where the prior mortgagee has actual notice of the intervening incumbrance. An example is the construction loan, where in many instances the lender is obligated to disburse funds as the building progresses. In holding that an obligatory advance is a part of the original debt and that the lien relates back to the date the "entire debt" was created, the courts reason that it would be manifestly unsound to hold that even actual notice of a subsequent lien would deprive the mortgagee of his lien for advances which he is compelled to make.²⁵

Neither will we consider extensively the second type of advance, where, by the terms of the mortgage, the mortgagee reserves the right to make further advances or expenditures which are necessary to protect the security or the priority of the mortgage, whether or not the borrower shall request or desire the same. The situation could arise, for example, in a construction loan where the mortgagor has abandoned the work, the mortgagee having the right to protect his interests by making additional expenditures to complete the structure and to have a lien therefor which is superior to intervening incumbrances. Payment of delinquent taxes and assessments and the making of essential repairs often fall within such cases.²⁶ Although the matter has been little litigated, it is clear that in such cases there is a contractual interest which is as entitled to protection as an option to purchase. When such an interest is put on record there is little reason to believe that a subsequent incumbrancer could impair it, irrespective of the mortgagee's notice thereof.²⁷

²⁴ "Where a mortgagee is obligated, by contract with the mortgagor, to advance funds to be secured by the mortgage, such mortgage will be a valid lien from the time of its recording, as against all subsequent incumbrances, even though the mortgage money is paid to the mortgagor after such subsequent incumbrances have attached to the mortgaged land. This holds true even though the mortgagee is actually aware of the existence of the subsequent incumbrances at the time he pays out the mortgage money. *Land Title & Trust Co. v. Schoemaker*, 257 Pa. 213, 101 A 335. Because of the mortgagee's obligation to pay out the money, the mortgage debt is regarded as being in existence from the very beginning." *Kratovil, Real Estate Law*, Sec. 332.

²⁵ "A mortgage, duly recorded, given for definite future advances which the mortgagee is obligated to make, is entitled to priority for the full amount of such advances over a subsequent mortgage, recorded after the former one, though prior to the making of such future advances." *Connecticut General Life Insurance Co.*, 101 NE (2d) 408 (Ohio 1950), quoting *Kuhn v. Southern Ohio Loan and Trust Co.*, 101 Ohio St. 34, 126 NE 820. In *Schaeppi v. Glade*, 195 Ill. 62, the court said, ". . . where the mortgagee is bound to make the advances, the lien relates back to the date of the mortgage recordation, and is superior to any subsequent lien or conveyance." Other cases upholding the priority of "obligatory" future advances, even where the mortgagor has actual notice: *Peaslee v. Evans*, 82 N.H. 313, 133 A 448; *Brinkmeyer v. Browneller, et al.*, 55 Ind. 487; *Guaranteed Title & Trust Co. v. Thompson*, 93 Fla. 983; *Chartz v. Cardelli*, 52 Nev. 1, 279 P 761; *Omaha Coal, Coke & Lumber Co. v. Suess*, 74 NW 620, 54 Neb. 379; *Gerrity v. Warham Bank*, 202 Mass. 214; *Boise Payette Lumber Co. v. Winward*, 47 Idaho 485, 276 P 971; *Antrim Lumber Co. v. Claremore Federal Savings and Loan Association*, (Okla. 1951), 230 P (2d) 274 (LEGAL BULLETIN, May, 1953); *Cedar v. Roche Fruit Co.*, 16 Wash. (2d) 652, 134 P (2d) 437 (1943); *Elmendorf-Anthony Co. v. Dunn*, 10 Wash. (2d) 29, 116 P (2d) 253, 138 ALR 558; *Hance Hardware Co. v. Denbigh Hall, Inc.*, 17 Del. Ch. 234, 152 A 130; *Land Title & Trust Co. v. Schoemaker*, 257 Pa. 213, 101 A 335; *Anglo-American Savings and Loan Association v. Campbell*, 13 App. D.C. 581; and other cases listed below in table of approximate state positions.

²⁶ In many instances provision for such advances has been made by statute. See, for example, Sec. 14 (3), Colorado B&L Act. "An association may pay taxes, special assessments, insurance premiums, repairs and other similar charges for the protection of its real estate loans. All such payments may . . . be added to the unpaid balance of the loan and shall be equally secured by the first lien on the property."

See also Sec. 45-54, S.C. Code, where the law uses the words "[Such advances] shall be secured by the mortgage and have the same rank and priority as the principal debt secured thereby . . ."

²⁷ One of the most excellently reasoned cases on this subject is *Cedar v. Roche Fruit Co.*, 16 Wash. (2d) 663, 134 P (2d) 437 (1943): Whether advances made under a mortgage are obligatory or optional usually depends upon whether or not the mortgagee is contractually bound to make them; however, advances are considered obligatory when the mortgagee is obliged to make them for his own security. "We believe the advances made . . . can be said to have been obligatory in the sense that they were necessary to protect the previous loans and advances made." Court held that even actual notice of intervening liens would not jeopardize the priority of later advances. See *Lidster v. Poole*, 122 Ill. App. 227.

See also 1, Jones on Chattel Mortgages, Sec. 97: "Advances made by a mortgagee after he has actual notice that others have acquired rights in the property will be postponed to the rights acquired by such other persons, unless the mortgagee be under a binding contract to make the advances, or it be essential to his own security to complete the advances contemplated by the mortgage." (Italics ours.)

The decisions on their facts covered herein contain little at variance with this view,²⁸ although on occasion the courts have mistakenly applied to this type of advance the rules governing *optional* advances rather than the more appropriate rules governing *obligatory* advances.²⁹

It is with the third or optional future advance that we are primarily concerned, where the mortgage contains a provision that the mortgage shall stand as security for such sums as the mortgagor shall thereafter desire to borrow and the mortgagee shall be willing to lend.

OPTIONAL FUTURE ADVANCES

Under common law, it is clear that if first mortgages are properly drafted to secure original advances and if they properly describe optional future advances up to a limit stated in the mortgage, such advances may be made safely by the lender and remain secured as a first lien until the mortgage is cancelled. It is sufficient that the mortgage clearly show a contract between the parties that the mortgage is to stand as security for both an original debt and such additional indebtedness as may arise from future dealings between the parties. Provided such mortgages are properly recorded, they are notice to the world of contractual obligations and agreements according to the stated terms, and if a subsequent purchaser or incumbrancer fails to take notice, he is not entitled to protection. This would be the almost universal law today, were it not that several states have dealt with the matter by statute with varying degrees of effectiveness.³⁰

In an effort to form a general rule applicable in all state jurisdictions, it may be said that a mortgage which by its own terms is given to secure optional future advances is valid everywhere as between the parties and, duly recorded, will prevail against subsequent purchasers and incumbrancers if the mortgagee be without notice, actual or constructive, of such subsequent conveyance or incumbrance; and that in jurisdictions where the point is undecided, record notice of such subsequent conveyance or incumbrance might, and actual notice thereof probably would, give to the subsequent purchaser or the junior lienor a prior, claim as to advances made after such notice.³¹

PROBLEM OF SPECIFICITY

Most courts hold that a mortgage to stand validly as security for optional future advances, a full expression of the parties' intention must be set out in the mortgage, clear enough so that it will serve as notice to anyone exercising common prudence and ordinary diligence, not only of the parties' intent that the mortgage shall secure future optional advances, but also of the upper limit or aggregate amount of the advances contemplated.³² Cases have varied from one

²⁸ See *Bellamy & Sons v. Cathcard*, 72 Iowa 207, 33 NW 636, where such right to advance was upheld, because even though bondsmen had not obligated themselves to advance money to complete a bridge, they had the right to do so upon threatened default by the contractor for their own protection. Also *Rowan v. Sharp's Rifle Mfg. Co.*, 28 Conn. 282; *Hyman v. Hauff*, 139 N. Y. 48, 33 NE 735; *Hamilton v. Rhodes*, 72 Ark. 625, 83 SW. 351; *Tolson v. Pyramid Life Insurance Co.*, 254 SW (2d) 53 (Ark. 1953).

²⁹ *Elmendorf-Anthony Co. v. Dunn*, 10 Wash. (2d) 29, 116 P (2d) 253, 138 ALR 558.

³⁰ "A mortgage for future advances was recognized as valid by the common law. It is believed they are held valid throughout the United States except where forbidden by the local law." *Jones v. New York Guaranty Co.*, 101 U. S. 622. In *Leeds v. Cameron*, 3 Sumn. 492, Mr. Justice Story declared, "Nothing can be more clear, both upon principle and authority, than that at the common law a mortgage, bona fide made, may be for future advances . . . by the mortgagee, as well as for present debts and liabilities." See also *Lawrence v. Tucker*, 23 How. 14, 16 L. Ed. 474.

³¹ Jones states the general rule somewhat more strongly—with the warning, however, that it is "subject to qualification": "The rule that a recorded mortgage expressed to cover future advances has priority in all cases over subsequent conveyances and encumbrances, has full support in recent discussions, and must now be regarded as a settled rule of law. Notwithstanding all the distinctions and refinements which have been introduced into the law on this subject by the many conflicting adjudications upon it, there is strong reason and authority for the rule that a mortgage to secure future advances, which on its face gives information enough as to the extent and purpose of the contract, so that anyone interested may by ordinary diligence ascertain the extent of the encumbrance, whether the extent of the contemplated advances be limited or not, and whether the mortgagee be bound to make the advances or not, will prevail over the supervening claims of purchasers or creditors, as to all advances made within the terms of such mortgage, whether made before or after the claims of such purchasers or creditors arose or before or after the mortgagee had notice of them . . ." *Jones on Mortgages*, Sec. 457.

³² *Jones on Mortgages*, Vol. 1, Sec. 450 (8th ed.): "Future liabilities intended to be secured should be described with reasonable certainty. If the nature and amount of the

extreme, to the effect that the mortgage need scarcely make such reference at all,³³ to the other extreme, where it is held that the actual date and amount of each subsequent advance must be carefully spelled out in the mortgage (as in Maryland).³⁴ As a matter of sound business policy, however, in addition to legal prudence, it is recommended that in all cases—even in the jurisdictions where it has been clearly held that a maximum limit need not be set out in the mortgage—that such a limit be specified.³⁵ Not only is the matter of moral fairness involved, but the avoidance of possible later charges of inequity or lack of adequate notice on the part of an intervening lienor. Even though in many cases it might easily be proved in court that such a limit need not be specified, much needless litigation could be avoided in advance if not only is the clear intent spelled out but a maximum limit specified to the contemplated advances.

It might be pointed out here that "dragnet" clauses (i. e., where the mortgage purports to secure any and all future indebtedness of unspecified nature accruing from the grantors) are not strictly within the scope of this article. Most courts manifest a repugnance to this type of all-inclusive clause, and, in the words of the Iowa court, "construe this type of clause carefully and strictly."³⁶

PROBLEM OF NOTICE

Although the general rule is well established that the mortgage will constitute a prior lien for all optional advances made in accordance with its terms before notice of an intervening incumbrance, there has been some diversity of opinion as to what kind of notice will jeopardize the priority. The great majority of states hold that only actual notice or knowledge will adversely affect the lien of the later advances; a minority holds that, in addition to actual notice, notice arising by operation of the recording statutes is sufficient.

Apparently the basis of disagreement between the majority rule and the dissenting courts is a differing theory as to when rights become vested under a mortgage securing optional future advances. The majority opinion rests on the equitable maxim, "What has agreed to be done shall, for the advancement of justice, be regarded as done." Since the advances have been provided for, the courts will consider them as made, thus causing the lien for the whole sum to be advanced to attach as of the time of the mortgage agreement,³⁷ and not as a lien for each separate advance existing only from the time of the advancement.³⁸ Although there is common agreement that the right to enforce the collection of the advances can arise only after the making of each advance,³⁹ it is the majority opinion that since the lien to the whole has already attached, the recording of subsequent incumbrances does not affect the first mortgage. It is almost universally accepted that "actual notice or knowledge" of an intervening lien on the part of the mortgagor will prejudice the priority of later optional advances. The term "actual notice," of course, includes not only express notice but implied notice as well, the latter being notice inferred from the fact that the person charged with notice had available to him a means of dis-

incumbrance is so described that it may be ascertained by the exercise of ordinary discretion and diligence, that is all that is required."

Sec. 457: "... even though no specific sum be named in the mortgage as to what future advances it was intended to secure, if the instrument on its face gives information as to the extent and purpose of the contract between the parties, that it is to stand as security for future advances, it will be sufficient to put a subsequent incumbrancer on notice of probable future dealings between the parties affecting the mortgaged property, and the duty of investigating the extent of liability that may attach to the property by reason of the mortgage devolves upon such incumbrancer."

³³ *Corn Belt Trust & Savings Bank v. May*, 197 Iowa 54, 196 NW 735.

³⁴ *In re Shapiro*, 34 F. Supp. 737, affirming 118 F (2d) 348.

³⁵ See Annotation, 81 ALR 631.

³⁶ *B. E. First v. Byrne*, 28 NW (2d) 509; see Annotation of this case where the subject of "dragnet" clauses is fully discussed and the cases set out therein, 172 ALR 1079 (1948).

³⁷ "That the liens of the trust deed and the mortgage date from the time they were filed for record or the [later] parties had actual notice thereof, notwithstanding that the money was advanced after the work was commenced, is too obvious to call for discussion." *Mutual Reserve Association v. Zeran*, 152 Wash. 342, 277 P 984.

³⁸ The minority view was set out by the Michigan court in *Ladue v. Detroit, etc.*, 13 Mich. 380, 87 An. Dec. 759: "The instrument can only take effect as a mortgage or encumbrance from the time when some debt or liability shall be created, or some binding contract is made, which is to be secured by it. Until this takes place, neither the land, nor the parties, nor third persons, are bound by it. It constitutes, of itself, no binding contract. Either party may disregard or repudiate it at his pleasure."

³⁹ I Wiltzie on Mortgage Foreclosure, p. 178, Sec. 95 (5th ed.): "When a mortgage in terms secures future advances, the sum named as the consideration is of no importance, because as between the parties it will be security for the money actually advanced upon it, and for nothing more."

covery which he should have used.⁴⁰ "Constructive" notice is that type of notice imputed to a person not having actual notice, and is solely a creature of statute—for example, that type of notice provided for by many recording statutes. In none of the cases that we have reviewed has there been an instance where the decision turned on "constructive" notice other than "record" notice, and indeed many courts have specifically stated that "record" notice shall not constitute even "constructive" notice.⁴¹ Therefore, for the purposes of this discussion and the tabulation of states and cases, we will use the terms "actual notice" and "record notice," since those terms represent the only real distinction made in any of the court decisions, although in a few instances certain courts have left the door open to some type of constructive notice other than record notice.

In order for the optional advances to prevail, the intervening lienor, of course, must have been legally charged with notice of the existence of the mortgage securing future advances, and usually of its terms. The recording of the mortgage will accomplish such necessary notice as to the existence of the mortgage. Whether or not the terms have been sufficiently stated therein has been discussed above. The recording statutes have in most states been held to operate as notice *forward* to subsequent purchasers or creditors and not *backward* to prior parties, whose rights are already fixed by the previous record of their own mortgages.⁴² Chief Justice Redfield considered this matter, together with the problem of actual notice on the part of the prior mortgagee, in an article in 2 American Law Reg. (N.S.) 18:

"The most important remaining inquiry is in regard to the extent and kind of notice of the subsequent mortgage, which it is requisite the first mortgagee should have, in order to postpone his further advances to such intervening security. As a general rule, it has been considered that the registry of the second mortgage will only be notice of its contents to *future* purchasers and incumbrancers, and not to *prior* incumbrancers, thus operating forward and not backward . . . The general view of the American courts, and the universal declaration of the English courts, as far as we know, is that nothing short of notice in fact will have this effect . . . This may now be regarded as settled law, notwithstanding an occasional case seems to require something more."

Pomeroy states the rule thus:

"When a mortgage to secure future advances reasonably states the purposes for which it is given, its record is a constructive notice to subsequent purchasers and encumbrancers; they are thereby put upon an inquiry to ascertain what advances or liabilities have been made or incurred. *The record of a subsequent mortgage or conveyance, or the docketing of a subsequent judgment, is not a constructive notice of its existence to such prior mortgagee.* The prior mortgage, therefore, duly recorded, has a preference over subsequent recorded mortgages or conveyances, or subsequent docketed judgments, not only for advances previously made but also for advances made after their recording or docketing without notice thereof. As the record of the second encumbrance does not operate as a constructive notice, it requires an actual notice to cut off the lien of the prior mortgage; and the subsequent encumbrancer may, by giving actual notice, at any time prevent further advances from being made to his own prejudice." [Italics ours.]⁴³

However, the wording of the recording statutes in a few instances has been held in effect to import notice both forward and backward. See the consideration *infra* of Ohio.

⁴⁰ See LEGAL BULLETIN, March, 1953, p. 35, noting *First Federal Savings and Loan Association of Miami v. Fisher*, 60 So. (2d) 496 (Fla., 1952).

⁴¹ "In regard to what constitutes actual notice, it seems that any information of the existence of the subsequent incumbrance is sufficient to charge a prior mortgagee with the legal effect of making future advances with knowledge. Notice of the fact of the existence of the subsequent incumbrance, called to the attention of the prior mortgagee by the subsequent incumbrancer, in such a manner that the prior mortgagee, as a prudent and reasonable man of business, is bound to remember that such subsequent incumbrance on the premises has been given, and to regulate his conduct accordingly, seems to be all that can be required in such cases in order that the parties giving and receiving the notice may thereafter have the rights and duties which arise from notice." Sec. 212, 19 Ruling Case Law 429.

⁴² *Ackerman v. Hunsicker*, 85 N. Y. 43; *Union National Bank v. Moline*, 7 N. D. 201, 73 NW 527; *Schmidt v. Zahndt*, 148 Ind. 447, 47 NE 335, and other cases cited *infra* in the tabulation of state positions.

⁴³ *Rochester Lumber Co. v. Dygert*, 240 N. Y. S. 580, and other cases cited *infra* in the tabulation of state positions.

⁴⁴ Pomeroy, *Equity Jurisprudence*, Sec. 1199 (3rd ed.).

TABULATION OF STATE POSITIONS

We shall now set out what appears to be the legal status of optional future advances as they stand today in the 49 jurisdictions, both under the mortgage laws and by court decision. In states where the common law or a variation or reaffirmance of the common law doctrine is in force, additional advances have priority over an intervening lien in the absence of actual notice, and the lender can ordinarily make an advance in safety without a title search. In states where the advance does not have first priority in all cases, however, the lender, even in the absence of actual notice, must make sure that no lien has been placed of record against the property since the original mortgage date before he makes an advance.

In some of the states placed in the "Probable" column below, there is little or no authority on the subject of optional future advances, and in such states it is our opinion that properly drafted and recorded contracts will preserve the superior lien of the advances in the absence of actual notice. In some of the states, the decisions on the subject have been based upon poorly or incompletely drafted contracts, and in many instances there were disputes as to notice. Cases properly presented, based on properly drafted contracts, in many such states would, in our opinion, result in upholding the superior lien of the future advances. We have placed in the "Minority" column only those states which have refused to recognize the superiority of the lien for optional advances under a properly drafted contract properly recorded and where there is no dispute as to absence of actual notice of an intervening lien or claim.

Although we set out the approximate position of each of the state jurisdictions, together with a brief discussion of the laws and leading cases, it is recommended that in those states where the law is not comprehensive or definitely formulated, mortgagees desiring to deal properly with this question should have a careful and authoritative study made of their own state law, and a mortgage form clearly and properly drafted to secure described additional advances up to a stated limit.⁴⁴

The majority or "California" rule

The majority rule that an optional advance is superior to an intervening claim if the mortgagee has no actual notice or knowledge of the intervening lien was well enunciated by the court in the California case of *Oaks v. Weingartner*,⁴⁵ decided in 1951:

"Although the lien of a mortgage does not operate to secure optional advances made under the mortgage *after the mortgagee has acquired actual notice* of an encumbrance, subsequent in point of time to his mortgage so as to defeat or impair the rights of the subsequent encumbrancer, the mortgage does have priority over all liens subsequent to its execution and recording *to the extent of advances made without actual notice.*"

It will be noted that the important distinction of the rule is the word "actual."⁴⁶ In California and 31 other States, either the statutes provide or the courts have held that the only way for the priority of optional future advances to succumb to intervening liens is for the intervening lienor to prove that the mortgagee had actual notice or knowledge of the intervening lien at the time the advance was made. As mentioned earlier, in this group of states record alone does not constitute actual notice and is not sufficient to subordinate the priority of later advances. The following states follow the majority rule:

Alabama	Maine	North Dakota
California	Maryland	Oregon
Colorado	Minnesota	Rhode Island
Connecticut	Mississippi	South Carolina
Florida	Missouri	Texas
Georgia	Montana	Vermont
Indiana	Nebraska	Virginia
Iowa	Nevada	Washington
Kentucky	New Jersey	West Virginia
Louisiana	New Hampshire	Wisconsin
Massachusetts	New York	

⁴⁴ Forms which may serve as a basis for individual drafting are set out in Part IV of this article.

⁴⁵ 234 P (2d) 194, discussed in LEGAL BULLETIN, July, 1952, p. 53.

⁴⁶ See excellent justification of the Actual Notice rule in Sec. 16.74, Vol. IV, *American Law of Property*, p. 132.

The actual notice rule was first laid down by Chief Justice Marshall in *Shirras v. Craig*, 7 Cranch 51.

Probably follow the majority or "California" rule

Although the decisions are few, inconclusive or incomplete in these states and many times based on poorly drafted contracts, it is our opinion that given a properly drawn open-end mortgage contract, the courts would uphold the priority of optional future advances in the absence of actual notice of intervening incumbrances. However, even though existing court decisions favor the superiority of the optional advance, many prudent lenders in this group of states will require a title search in the absence of a decision both clearly defined and directly in point, although an affidavit is usually relied upon where the advances are for relatively small amounts.

In several of these States where there is little or no litigation on the subject, our first suggestion is a test case to determine the present law. If it is held that optional future advances under a properly drafted open-end mortgage are superior to intervening liens, this should settle the matter. If it is held to the contrary, then we suggest legislation on the subject (for which see suggestion on page 110). The States in this group are:

Arizona	Kansas	Tennessee
Arkansas	New Mexico	Utah
Delaware	North Carolina	Wyoming
District of Columbia	Oklahoma	
Idaho	South Dakota	

The minority or "Michigan" rule

A small but important group of states hold to the minority view that the lien of an optional advance is inferior to subsequent incumbrances, even though it is made without actual notice of the intervening interest. For priority purposes, the optional advance is treated as if it were a new mortgage taken as of the time of the advance, the lien attaching as of the time of the advance and not relating back to the date of the parent instrument as in the majority group of states. Here the matter of record notice comes into full play: since each new advance is treated as a new mortgage, the advancer must make certain that there have been no "prior" liens placed against the property since the original mortgage date. A second mortgage, properly recorded after the recording of the first mortgage, would thereby be "prior" to an advance made thereafter under the first mortgage. A title search before the making of each advance is unavoidable in these states, although again, if the amount is nominal, an affidavit is often taken as a calculated risk.

In this minority group, the courts when dealing with optional advances apparently close their eyes to the fact of notice to subsequent incumbrancers of the expressed terms of a recorded instrument. In Illinois, for example, although it has been repeatedly held that later incumbrancers are chargeable with notice of what was apparent of record with regard to prior trust deeds and mortgages,⁴⁷ such protection is denied to even the most clearly expressed open-end clause. Equitably (and according to the majority rule), it would appear that a subsequent incumbrancer examining a prior mortgage should be charged with notice of the clear and unambiguous terms of a clause providing for optional future advances, and be thereby put on inquiry as to the extent if any of the advances already made. Yet the courts allow the second mortgagee in the fact of such notice to blithely record the second mortgage and thereby take precedence over later advances made by the first mortgagee according to the expressed terms of his prior mortgage, the terms of which were recorded as notice to the world.⁴⁸

This results in apparently inconsistent holdings, because, except for the unfortunate theory that each optional advance rates as a new mortgage, the minority courts ordinarily decide notice questions in accordance with the majority. Again in Illinois, it was held that "the record of a subsequent deed or mort-

⁴⁷ *Schaepfi v. Glade*, 95 Ill. App. 500, affirmed by 62 NE 874, 195 Ill. 62.

⁴⁸ The New York Court in *Ackerman v. Hunsicker*, 85 N. Y. 43, pp. 49-52, criticized the minority view as follows: "The doctrine that a party who takes a mortgage to secure further optional advances, upon recording his mortgage is protected against intervening liens, for advances made upon the faith and within the limits of the security until he has notice of such intervening lien, and that the recording of the subsequent lien is not constructive notice to him, has, we think, been generally accepted. . . . It seems to us that the doctrine we have affirmed in this case is most consistent with equity, and establishes a rule which is reasonable and easy of application. The opposite rule imposes the burden of notice and vigilance upon the wrong person. The party taking the subsequent security may protect himself by notice and as said by Mr. Jarman in his notes to Bytherwood's Conveyancing, 'No person ought to accept a security subject to a mortgage authorizing future advances, without treating it as an actual advancement to that extent.'" (Italics ours.)

gage is not notice to the prior mortgagee; nor is [he] required to search the records from time to time for subsequent incumbrances; and [a] subsequent purchaser, mortgagee, or lienor, wishing to protect himself, *must bring home to the first mortgage actual notice* of his equities."⁴⁹

It seems little to ask that a subsequent incumbrancer, wishing to prevent further advances from being made to his own prejudice, be required to give the prior mortgagee actual notice of the later incumbrance. It is to be hoped that the underlying theory of optional future advances will be reexamined by these courts: Illinois, Michigan, Ohio, and Pennsylvania.

THE LAW, STATE BY STATE

We set out the following capsule résumé of what we believe to be the law in the 49 jurisdictions. In every State, an open-end mortgage is good between the parties. A warranty deed, if given to secure a debt or obligation, is ordinarily treated as a mortgage in all States, and it is an open-end mortgage. In all cases, we advise that open-end mortgages be clearly drafted so as to indicate what is secured by the mortgage, including the maximum amount to be secured thereby. (See Forms, Part IV.) Even where the statute or court decisions appear to permit the advancement of moneys after actual notice of an intervening lien or claim, we advise against additional optional advances after actual notice, in all cases.

Alabama—Majority rule

By decision. The ruling case is *Farmers' Union Warehouse Co. v. Barnett Bros.*, 223 Ala. 435, 137 So. 176: "There is no disagreement that, when the mortgage provides for such additional advances, the mortgagee, though not obligated to do so, may make them on the security of the mortgage in priority over the rights of a second mortgagee with notice, provided, at the time of making the additional advance, the first mortgagee had no notice of the rights of the second mortgagee." The court went on to state that "the record of the later mortgage is not notice to the prior mortgagee." That notice to the prior mortgagee must be something more than record notice is supported in *Bank of Oakman v. Thompson et al.*, 224 Ala. 89: "While the record of a second mortgage is not notice to a first mortgagee, and may not affect its priority by a renewal, it is notice to the extent that a new debt is created which the first mortgage *made no reference.*"

In the latter case, as well as in the Farmers' Union case, the point is made that specific provision for future advances must be contained in the mortgage, although the exact amount need not be set out. Again in *Boger v. Jones Cotton Co.*, 238 Ala. 180, 189 So. 737, the court said, "There is no question now of the validity of a mortgage to secure future advances, though uncertain in amount."

Arizona—Probably majority rule

The case on the subject is *Griffith v. State Mutual Bank and Trust Association*, 51 P (2d) 246, 46 Ariz. 359, where the court said: "It is the unquestioned rule that a mortgage may be given to secure not only money loaned at the time of the mortgage, but also *any* amount which is to be advanced in the future, and that such a provision is good as against all subsequent encumbrancers and purchasers having notice of the mortgage, for all advances made before they have acquired their rights, while many cases hold it is good for later advances also." A top limit apparently need not be set out in the mortgage, but the clear intent of the parties to secure future advances should be set out, as in the noted case.

The decision left the actual *v.* record notice question open, inasmuch as it was determined that the advance had been made in point of time before the second lien had attached. (See Section 71-426, Arizona Code, to the effect that the record shall be constructive notice to all persons.)

Arkansas—Probably majority rule

By decision. The validity of mortgages covering optional future advances has been upheld repeatedly. *Jarratt v. McDaniel*, 32 Ark. 598; *Brewster v. Clamfit*, 33 Ark. 72; *Patterson v. Ogles*, 238 SW 598, 152 Ark. 395; *American Bank and Trust Co. v. First National Bank*, 43 SW (2d) 248, 184 Ark. 689. Although the early case of *Tompkins v. Little Rock & Ft. S. Ry.*, 15 F 6, upheld the minority rule to the effect that "each [optional] advance is as upon a new mortgage," the later case of *Superior Lumber Co. v. National Bank of Commerce*, 176 Ark. 300,

⁴⁹ *Boone v. Clark*, 21 NE 850, 129 Ill. 466, 5 LRA 276. Also *Iglehart v. Crance*, 42 Ill. 261; *Heaton v. Prather*, 84 Ill. 330; *Waughop v. Bartlett*, 46 NE 197, 165 Ill. 124.

2 SW (2d) 1093 (1928), laid down the rule: "Mortgages to secure future advances are valid; but, where it is entirely optional with the mortgagee whether to make future advances or not, advances made after notice of a subsequent incumbrance, such as a lien for materials furnished, are inferior to the materialman's lien. In other words, the general rule is that, if the amount for which the mortgage shall stand is wholly optional with the mortgagee, he cannot, after notice that a subsequent lien has attached, deplete the value of the equity to the disparagement of its lienors by advances which, if refused, would not have been in force." From the language in the Superior Lumber case, together with the holding in *Pillow v. Sentelle*, 49 Ark. 430, where it was held that such advances "should stand on the same footing as the original debt," and the case of *Birnie v. Main*, 29 Ark. 251, to the effect that the recording of a second mortgage will not give constructive notice to the prior mortgagee, it would lead us to believe the Arkansas courts favor the majority rule.

The intent to secure future advances must "clearly appear from the instrument and will not be presumed," *Patterson v. Ogles*, *supra*, and it is essential that the agreement in the mortgage be "unequivocal," although the maximum amount of such advances need not be stated. *Moore v. Terry*, 66 Ark. 393, 50 SW 998; *Jones v. Dowel*, 176 Ark. 986, 4 SW (2d) 949; *Brewster v. Clamftt*, 33 Ark. 72. Optional advances made after maturity are not valid charges against the land: *Dempsey v. Portis Mercantile Co.*, 119 SW (2d) 915, 196 Ark. 751 (1951). Also not valid security for debts owing by mortgagor's transferee unless specifically provided: *Walter v. Whitmore*, 165 Ark. 276, 262 SW 678.

California—Majority rule

By decision. The rule as set out in *Oaks v. Weingartner*, *supra*, was repeated in the 1953 case of *Imhoff v. Title Insurance and Trust Co.*, 247 P (2d) 851, where the court also specifically held that the lien of a trust deed does not operate to secure optional advances which are made under the trust deed, after the beneficiary has acquired actual notice of an incumbrance subsequent in point of time to the trust deed, and does not defeat or impair the rights of the subsequent incumbrancer.

No limit to amount of future advances. This rule, repeated in the *Oaks* case, was originally set out in the leading case of *Tapia v. Demartini*, 19 P 641, 11 Am. St. 288, where the court said, "If the mortgage discloses upon its face that it is to stand as security for future advancements, the amount of the advances to be made need not be set out. It is sufficiently definite to put subsequent incumbrancers on inquiry, and they must ascertain the extent of the lien or suffer the consequences." (Italics ours.)

Colorado—Majority rule

By decision. The majority rule was adopted by the court in the ruling case of *Du Bois v. First National Bank*, 43 Col. 400, 96 P 169: "No question is made concerning the validity of the mortgage to cover future advances. * * * The position of the [mortgagee] is that, until [the intervening lienor] gave to it actual notice of the acquisition of her interest in the property, it might continue to make advances to the mortgagor even after maturity of the mortgage notes, since the mortgage did not restrict the time within which the advances were to be made, which would be protected by the mortgage as to the entire property * * * it would seem from the authorities that such advances are within the lien of the mortgage." The case was cited as authority in *Ferguson v. Mueller*, 115 Col. 139, 169 P (2d) 610 (1946). In *Clay v. Atencio*, 74 Col. 17, 218 P 906, the court said that the recording statute provided that a conveyance "may be recorded" and "from and after the filing thereof for record * * * and not before * * * shall take effect as to subsequent bona fide purchasers." Apparently, filing is constructive notice only as to subsequent purchasers and incumbrancers, but no further; see *Colorado Digest*, Key 154, Mortgages.

The intent to secure future advances must be set out: "The lien of a deed of trust cannot be extended to secure a subsequent debt or obligation in the absence of a written agreement to that effect." *Jones v. Sturgis*, 118 Col. 579, 199 P (2d) 646 (1948). As to description of the debt, the latest pronouncement was in *Smith v. Haertel*, 126 Col. —, 244 P (2d) 377 (1952): "In order to constitute a valid mortgage * * * it is necessary that * * * this indebtedness be recited in the mortgage; and the nature and amount of the indebtedness secured by the mortgage must be so expressed that subsequent purchasers and attaching creditors need not look beyond the mortgage itself to ascertain both the existence

and amount of the debt." It is recommended therefore that a maximum limit be specified in the mortgage.

Note on the Savings and Loan Statute—Section 14 (3) of Chapter 25 provides that "Any association may invest any portion of its funds in loans to its members, secured by first lien trust deeds or mortgages upon improved real estate, provided that additional loans or advances on the same property shall be deemed to be first liens for the purposes of this chapter, unless intervening lien or liens have been recorded, and upon [shares, etc.]." [Italics ours.] The italicized portion of the statute appears to be interpretative in character rather than limiting. The statute grants savings and loan associations the power to make certain loans if they are secured by a first lien. The italicized language merely sets out that in the absence of recorded intervening liens, additional loans or advances shall be deemed to be such first liens. In our opinion this does not preclude an advance where, under the law of the state, a first lien can be obtained in the absence of actual notice even though record of an intervening lien does exist.

Connecticut—Majority rule

By statute and decision. Section 5894(h), as amended in 1951, provides that savings and loan associations may make future advances which "shall be a part of the mortgage debt * * * provided such advancements shall not exceed the difference between the indebtedness at the time of the advancement and the original mortgage debt, and provided further the original mortgage deed * * * shall contain specific provisions permitting such advancements, and provided the terms of repayment * * * shall not extend the time of repayment beyond the maturity of the original mortgage debt."

The statute sets a limit to future advances and requires the specific agreement covering such optional advances to be set out in the mortgage. In *Rowan v. Sharp's Rifle Mfg. Co.*, 29 Conn. 282, and *Boswell v. Goodwin*, 31 Conn. 74, the courts upheld the theory of priority of optional future advances, and laid down the actual notice rule concerning intervening liens. In the first case, the court said, "We think the law would not infer notice from the record, and that [the first mortgagee] was not obliged to take notice of the record. * * *" As to recording operating forward, the court said, "The rule of law certainly is that a purchaser is not bound to take notice of a deed which is subsequent to his own, unless he seeks to obtain some new and further interest than his deed already gives him."

In *Lampson Lumber Co. v. Chiarelli*, 100 Conn. 301, it was held that the intent to provide for and the amount of the future advances should be set out in the mortgage, thereby giving reasonable notice of its contents to subsequent incumbrancers. In view of this case and the decisions in *Balch v. Chaffee*, 73 Conn. 318, and *Matz v. Arick*, 76 Conn. 388, 56 A 630, together with the inferences from Sections 5894 (h) and 7194 (covering construction loans) of the statute, all such mortgages should contain a specific agreement providing for the optional future advances and a maximum limit should also be set out for such advances.

Delaware—Probably majority rule

Although obligatory future advances have been upheld (see *Hance Hardware Co. v. Denbigh Hall, Inc.*, 17 Del. Ch. 234, 152 A 130), even after notice thereof and recording of subsequent liens, the question of optional future advances apparently has not been litigated. In the Hance case, however, the court said, *obiter dictum*: "The mortgage was therefore not one under which the mortgagee retained an option to make future advances. When a construction mortgage is of that type, there are authorities which hold that the priority of the mortgage as to future advances over liens entered subsequent to its recording is affected by the presence or absence of actual notice to the mortgagee of the existence of the subsequent liens. [Court quotes Pomeroy and other authorities.] The instant case does not, however, call for a consideration of the question * * * for this is not a case of optional advances." The court appears to have an open mind on the question, and, if anything, leans toward the majority rule to an appreciable degree.

District of Columbia—Probably majority rule

No decision directly in point. In *Richards v. Waldron*, 20 D. C. 585, optional future advances were held valid and superior to later liens, but since the advances had been made prior in point of time to the recording of the later liens, the decision isn't definitive as to notice. In *Anglo-American Savings and Loan*

Assn. v. Campbell, 13 App. D. C. 581, 43 LRA 622, construction advances were upheld as having the priority of obligatory advances in face of both actual and record notice of intervening liens—even though it was not obligatory on the part of the mortgagee to see that the money was paid over to the proper material and labor contractors. It was held that the association was not charged with constructive notice of the liens recorded subsequent to the recordation of its own mortgage or deed of trust. See also *First National Bank v. Morsell*, 91 U. S. 357, 23 L. Ed. 436.

Florida—Majority rule

By decision. The governing case is *Bullard v. Fender et al.*, 192 So. 167, 140 Fla. 448, where in effect the court adopted the actual notice rule: Where a mortgage to secure optional future advances states the purpose for which it is given, its record is thereby notice to subsequent purchasers and incumbrancers to put them on inquiry to ascertain what advances have actually been made. "The record of a subsequent mortgage or conveyance is not a constructive notice of its existence to such prior mortgagee. The prior mortgage, therefore duly recorded, has a preference over subsequent recorded mortgages or conveyances, or subsequent docketed judgments, not only for advances previously made, but also for advances made after their recording without notice thereof."⁵⁰ The decision appears to establish the law in Florida as to optional future advances and is not in any real conflict with the 1932 holding in *Guaranty Title Co. v. Thompson*, 93 Fla. 983, where the court enunciated the rule governing obligatory future advances. See also *Bright v. Buckman*, 39 F 243, where it was held that recording in Florida was notice only to subsequent purchasers and creditors. The plain implication in *Flynn-Harris-Bullard Co. et al. v. Johnson*, 107 So. 358, 90 Fla. 654, however, is that priority of later advances will succumb to intervening liens where "the mortgagee had actual notice before making other optional loans." (Italics ours.)

There is also a clear implication that a maximum limit to such advances must be specified in the mortgage. See *McEwen et ux. v. Growers Loan and Guaranty Co.*, 104 Fla. 176, where the court said: "The rule * * * is that a mortgage securing future advances need not contain a definite statement of the amount if described with reasonable certainty and within limitations so that they may be ascertained by the exercise of due diligence on proper inquiry." [Italics ours.]

Georgia—Majority rule

By decision. Although one case, *Hurst v. Flynn-Harris-Bullard*, 166 Ga. 480, 143 SE 503, goes so far as to say that optional future advances are entitled to priority even where such advances were made with actual knowledge of the intervening lien, the more prudent policy would be to withhold further advancements after receipt of actual notice of an intervening claim.

A maximum limit to future advances should be stated in the mortgage to preclude claim of lack of notice or inequity on the part of an intervening incumbrancer. This was the holding in *Benton-Shingler Co. v. Mills*, 13 Ga. App. 632, 79 SE 755, although the earlier case of *Allen v. Lathrop*, 46 Ga. 133, had held that even though the future advances must be mentioned in the mortgage, the precise amount need not be set out, since "the means of finding it * * * are plain."

Idaho—Probably majority rule

Section 45-108, Idaho Code, specifically gives first lien status and priority over intervening liens to necessary or obligatory advances. Such advances must be made under the express terms of a mortgage where the mortgagee is "legally bound to make the advance * * * or where the advances were necessarily and actually applied to the maintenance and/or preservation" of the mortgaged property. The statute provides that to be valid as to third parties, the mortgage must state "the maximum amount of the obligations to be so secured." Statute does not cover the field of optional advances.

The leading case on optional advances is *Weiser Loan and Trust Co. v. Comerford*, 41 Idaho 172, 238 P 515. The priority of optional future advances was upheld over intervening incumbrances: "Where the parties so intend, a mortgage conditioned for the payment of future advances, in an amount specified * * * is a continuing security for a floating balance of indebtedness up to the specified

⁵⁰ The court here was quoting as the law excerpts from Pomeroy's *Equity Jurisprudence*, Sec. 1199 (2d ed.). The court also quoted with approval the statement from Jones on Mortgages set out in footnote 31 herein.

amount, even though the total advances may have exceeded that amount and been in part repaid." In the case of *Boise Payette Lumber Co. v. Winward*, 47 Idaho 485, 276 P 971, the court held that the rule as to optional advances was that if they are made after the intervening "lien accrued, and notice thereof, the mortgage is postponed." In the 1952 case of *Goss v. Iverson*, 72 Idaho 240, it was held that a mortgagee with actual knowledge of intervening lien could not continue to make advances without sacrificing their priority. Although Section 55-811 provides that recording is constructive notice "of the contents thereof to subsequent purchasers and mortgagees," the point has never been specifically decided as to what effect record notice of an intervening lien has on the prior mortgagee. The three cases mentioned, however, give a clear implication that only actual notice will defeat the priority of the lien.

The wording of the statute as to obligatory advances, together with the *Weiser* case and the case of *Goss v. Iverson*, where the advances were almost wholly lacking in identification, advise the policy of fully describing the intent to secure future advances, and of setting a maximum limit to the advances in the mortgage.

Illinois—Minority rule

By statute and decision. The cases agree that a mortgage may validly secure future advances, whether optional or obligatory. *Frye v. Bank of Illinois*, 11 I.L. 367; *Good v. Woodruff*, 208 Ill. App. 147; *Schimberg v. Waite*, 93 Ill. App. 130. As to intervening liens, however, the lien of the advance will not always be paramount.

In 1931, an act (Sec. 30-37a, Ill. Rev. Stat. 1951) was passed providing that advances (including both optional and obligatory) made within 18 months of the date of recording were to relate back to that date. Apparently the priority of all advances, irrespective of notice, is assured provided they are made within 18 months. (In practice, it would be prudent, however, to operate under the actual notice rule as to optional advances during these 18 months.) Thus, for this period, Illinois may be considered to be within the "Majority or 'California' Rule."

Optional future advances made after the 18-months period are good as between the parties, but as to third parties the general rule remains as it was prior to 1931. In *Schaepfi v. Glade*, 195 Ill. 62, the court held the rule to be "well-settled that where the mortgagee has the option to make the advances or not, each advance is as on a new mortgage, and will therefore be subordinated to intervening liens." See also *Tompkins v. Little Rock & F. S. Ry. Co.*, 15 F. 6. Section 227, Reeves on Illinois Mortgages, states the rule: "Where a first mortgage [is] given to secure [optional] future advances . . . and a second mortgage [is] made on the same premises to secure an existing debt . . . the latter mortgage [is] entitled to priority over the former to the extent of any advances made by the first mortgagee after the attaching of the second . . ." (Apparently regardless of notice.) Reaffirmed in the much-quoted case of *Frentel v. Schmitz*, 299 Ill. 323, and formally incorporated into the statute in 1931, the rule makes a title search unavoidable.

Although in *Davidson v. Iwondowski*, 93 NE (2d) 139, 341 Ill. App. 152 (1952), *Good v. Woodruff*, *supra*, and *Collins v. Carlile*, 13 Ill. 254, it was held that mortgages to secure future advances "need not express that object in the mortgage itself, though it would be better if it did," the better policy would be to state clearly the intention and to set a maximum limit to the amount of the advances. See in this respect *Ogden v. Ogden*, 54 NE 750, 180 Ill. 543.

Indiana—Majority rule

By decision. The first clear statement of the law in Indiana was in *Brinkmeyer v. Browneller et al.*, 55 Ind. 487, where—after firmly upholding the validity and priority of obligatory advances—the court said: "Where there is no obligation on the mortgagee, and such advances * * * are merely optional with him, and he has actual notice of a subsequent encumbrance or conveyance of the mortgaged premises before making advances * * * his lien is not good as against the subsequent purchaser or encumbrancer." The rule was rephrased to a positive approach, and restated in the leading case of *Schmidt et al. v. Zahrdt*, 148 Ind. 447, 47 NE 335: "* * * if the future advances are optional, the prior mortgage, which is duly recorded, has preference over subsequent recorded mortgages or conveyances, not only for advances previously made, but also for advances made after their recording without actual notice thereof; that recording the second incumbrance does not operate as constructive notice, but actual notice is required." See also *Personal Finance Co. v. Flecknoe*, 216 Ind. 330, 24 NE (2d) 694 (chattel mortgage).

Although the point as to whether a maximum limit to such advances must be stated in the mortgage has not been specifically passed upon, both the leading Indiana cases cited involved mortgages wherein an upper limit was stated, and it is recommended that such a limit be specified. Other cases pointing to this conclusion: *Boven v. Ratcliff*, 140 Ind. 393, 39 NE 860, and *Aetna Life Ins. Co. v. Finch*, 84 Ind. 301.

Iowa—Majority rule

By decision. The law appears well settled in Iowa as set out in the two leading cases of *Corn Belt Trust and Savings Bank v. May*, 197 Iowa 54, 196 NW 735, and *Everist v. Carter*, 202 Iowa 498, 210 NW 559. In the first case, the court said: "A mortgage for a sum certain, given in good faith as security for future advances, is valid, as against general creditors of the mortgagor, for advances not exceeding the sum specified in the mortgage, and also as against third persons acquiring an interest in the mortgaged premises by mortgage or otherwise, at least up to the time their interest attaches and notice thereof is given to the mortgagee." In the latter case, the court said, "Mere constructive notice of the second mortgage, such as is, in a proper case, imparted by the record, will not defeat the priority of the lien of a first mortgage for advancements made pursuant to it, and after the execution and recording of the second mortgage. The authorities announcing this doctrine, almost without exception, hold that actual notice is required, and that the burden is upon the second mortgagee to establish actual notice. This is the rule laid down in the *Corn Belt Trust and Savings Bank* case, where we said: 'The prior mortgagee is not required to search the record before each advancement.' The holding in that case is controlling here."

In neither of the cases quoted did the mortgage state an upper limit to such advances (nor indeed that they were specifically intended to secure additional advances). In view of later cases, however, where the Iowa court has manifested a repugnance to any "dragnet" clause (i. e., where the mortgage purports to secure "any and all future indebtedness"), and in view of its announced policy to construe such clauses "carefully and strictly," it is highly recommended that the intent of the parties concerning the future advances be carefully spelled out, and that a maximum limit to such advances be plainly stated in the mortgage. See the latest expression of the court in *B. E. First v. Byrne*, 28 NW (2d) 509, 172 ALR 1072, and the cases cited therein; also *Monticello State Bank v. Schata*, 222 Iowa 335, where a dragnet clause was upheld.

Kansas—Probably majority rule

By decision. The leading case of *Union State Bank v. Chapman*, 124 Kan. 315, 259 P 681, upheld the validity of optional future advances to the extent they were actually made under a mortgage which set out a consideration of \$1.00 plus any advances. The decision was firmly upheld in *State Bank v. Tinker*, 131 Kan. 525, 292 P 748, which also was concerned with a mortgage reciting \$1.00 consideration plus further advances. The court said such a mortgage would be "upheld and judicially enforced." A similar decision was reached in 1939 in *Kansas City Life Insurance Co. v. Banaka*, 150 Kan. 334, 92 P 63. In none of these cases was the notice question an issue in the decision. It is believed that record notice would be insufficient to jeopardize the priority of optional future advances, in view of the holding in *Zear v. Boston Safe-Deposit and Trust Co.*, 43 P 977, 2 Kan. App. 505, where it was held that the recording of a mortgage is notice of the contents thereof to subsequent parties.

Kentucky—Majority rule

By statute and decision. Section 382.520 of the Revised Statutes of 1948 provides that if the mortgage describes the loan and future advances, and provided that additional advances shall "not exceed \$2,000 in addition to the original amount loaned," the mortgage shall secure the additional debt.

Reading the language of the statute together with several prior court decisions, *Louisville Banking Co. v. Leonard*, 90 Ky. 106, 13 SW 521, *Straeffer v. Rodman*, 146 Ky. 1, and *Taulbee v. First National Bank*, 279 Ky. 153, 130 SW (2d) 48, it is clear that the mortgage must contain a specified maximum amount, and that such amount cannot be for more than the amount of the original debt plus \$2,000.

The early case of *Nelson's Heirs v. Boyce et al.*, 30 Ky. 401, contains what is and has been the law in Kentucky regarding the mortgagee's notice of an intervening incumbrance: "We admit that a prior mortgagee, after notice of the execution of a subsequent mortgage, cannot place additional encumbrances

upon the estate by new advances to the mortgagor * * * and thereby prejudice the subsequent mortgagee * * *. There is no evidence that [the mortgagor] ever had notice of the [subsequent] mortgage, unless the recording of the subsequent mortgage be notice * * *. There is no act of the general assembly * * * that gives a lien in behalf of a subsequent mortgagee for the amount of his debt, to the exclusion of an advance made at a later period than the execution of the subsequent mortgage, by prior mortgagee, merely because the subsequent mortgage has been recorded in due time. In other words, [nothing] requires a prior mortgagee * * * to take notice of transactions which the mortgagor and third persons may place upon the records of the county * * *. The subsequent mortgage, *unless there had been proof of actual notice* [to the original lender], cannot operate against the decree." (Italics ours.) See also *Kentucky Lumber & Mill Work Co. v. Kentucky Title Savings Bank & Trust Co.*, 184 Ky. 244, 211 SW 765, 5 ALR 391. In the 1950 case of *Collier v. Dillon*, 313 Ky. 244, 230 SW (2d) 617, it was reiterated, however, that *actual knowledge* would subordinate the priority of later advances.

Louisiana—Majority rule

By statute. Section 6:767, Revised Statutes, establishes a "statutory open-end" mortgage for certain purposes: "* * * any savings and loan association may advance to the borrower money for the payment of taxes, insurance, premiums, special assessments on, repairs to, and maintenance of, the property on which the original loan was made. These advances * * * shall be secured by the same vendor's privileges and mortgage securing the original note * * *". The implication of the law is that advances for these purposes need not be specifically provided for in the mortgage, although it is felt that a prudent policy would call for incorporation of the plan in the mortgage. Apparently such advances may be made for any amount, since in 1942 the law was amended to drop the provision that such advances together with the unpaid balance be limited to the original amount of the loan. Again prudence would dictate that a maximum limit to such advances be set out in the mortgage.

Section 9:4801, as amended in 1952, provides that where a mortgage is made by a savings and loan for the purpose of securing future advances and is properly recorded, "the amount of the advances made thereafter shall be secured by said mortgage in precedence to and with priority over" certain listed subsequent liens with the exception of a laborer's lien. The new amendment doesn't specifically subordinate intervening liens or incumbrances other than mechanics', materialmen's and related liens and, when the additional advances are for a purpose other than those listed in Section 6:767, it would be advisable to make a search of the record before making supplemental advances. Although the "actual notice" rule would apply to mortgages qualifying under Section 6:767, "record notice" of intervening incumbrances would apparently be sufficient to subordinate the priority of other additional advances. See *American Brewing Co. v. Artignes*, 147 La. 155, 84 So. 571. In all mortgages providing for future advances, it is recommended that the full intent be spelled out in the mortgage document and that a maximum limit to such advances be specified. Cases are few on the open-end mortgage in Louisiana, although it is clear that they are legally recognized outside the above statutory provisions: "Mortgages may be given to secure debts having no legal existence at the date of the mortgage * * * It may be described as security for existing debts, and yet used to protect those which, in contemplation of the parties, were to be created at a future time." *Hortman-Salmen Co., Inc. v. White*, 168 La. 1057, 123 So. 711 (1929).

Massachusetts—Majority rule

By statute and decision. Section 28A, Chapter 183, Massachusetts Laws, added in 1946, creates a "statutory open-end" mortgage that apparently need not by its own terms provide for future advances: "Any sum or sums which shall be loaned by the mortgagee to the mortgagor at any time after the recording of any mortgage of real estate, to be expended for paying for repairs or placements to, or for taxes or other municipal liens, charges or assessments on, the mortgaged premises, shall be equally secured with and have the same priority as the original indebtedness, to the extent that the aggregate amount outstanding at any one time when added to the balance due on the original indebtedness shall not exceed the amount originally secured by the mortgage." From the language of the law, it might be inferred that even actual notice of an intervening claim would not endanger the priority of a later advance which qualifies under the statute.

Apparently the law doesn't preclude an open-end mortgage providing for optional future advances for other purposes than the above, or for an amount in excess of that stipulated, but such sums would be vulnerable in the event the mortgagee had actual knowledge of an intervening lien or incumbrance; see *Gray v. McClellan*, 214 Mass. 92, 100 NE 1093, and *Barnard v. Moore*, 90 Mass. 273. In such cases the mortgage should fully describe the intent and should contain a maximum limit to the contemplated advances.

Maine—Majority rule

By decision. *Bunker v. Barron*, 93 Me. 87. "Though the mortgage * * * calls only for optional and not obligatory future advances, still the intervening mortgage * * * is only constructive notice * * *, and such notice is not enough as it must be direct and personal," said the court.

No limit to future advances—although prudence would dictate that a maximum limit be specified in the mortgage.

Maryland—Majority rule

By statute (1945). Section 2, Article 66, provides that additional advances for the purpose of repair, alteration or improvement may be made up to the original amount of the mortgage or \$500, whichever is lesser. The actual amount or amounts of the future advances and the time or times when they are to be made must be specifically stated in the mortgage. In *re Shapiro*, 34 F. Supp. 737, affirmed *Schumacher & Seiler v. Sandler*, 118 F. (2d) 348 (1940), where the court held that the statute meant exactly what it said and that any mortgage not complying with the statute as to specificity would create no lien on the property whatever. Provided the stated requirements are met, the statute provides that all such future advances "shall be secured by such mortgage equally and to the same extent as the amount originally advanced * * * superior to all rights of subsequent creditors, purchasers, mortgagees, and other lienors and encumbrances * * *" Apparently even actual notice will not subordinate the priority of later advances. See *Wilson v. Russell*, 13 Md. 532. There is doubt as to the full applicability of Section 2 to Baltimore and Prince Georges' Counties—witness Section 3 and the case of *Welsh v. Kuntz*, 75 A. (2d) 345.

Michigan—Minority rule

By decision. What is still apparently the ruling case is *Ladue v. Detroit & M. R. Co.*, 13 Mich. 380, 87 Am. Dec. 759, where it was held that a mortgage securing optional future advances, duly recorded, is notice to subsequent incumbrancers, but only to the extent of the liabilities which have been actually incurred prior to the recording of the later incumbrance. Court also repeated the theory behind the decision to be that, as to optional advances, the mortgage is at any time a lien only to the extent of liabilities then incurred. See also *Riess v. Old Kent Bank*, 253 Mich. 557; *Ginsberg v. Capitol City Wrecking Co.*, 300 Mich. 712.

The intent to secure future advances must be set out in the mortgage, although apparently a maximum limit need not be stated. *Citizens Savings Bank v. Kook*, 117 Mich. 225, 75 NW 458; *Piconning State Bank v. Henry*, 258 Mich. 44, 241 NW 913.

Minnesota—Majority rule

By decision. The latest pronouncement of the Supreme Court was given in 1951, *Axel Newman Heating and Plumbing Co. v. Sauers*, 234 Minn. 140, 47 NW (2d) 769: "Where [pursuant to a mortgage to secure future advances] the advances are optional, the subsequent encumbrance will take priority over all advances made after the mortgagee receives actual notice of the subsequent encumbrance." See also *obiter dictum* in *Landers-Morrison-Christenson Co. v. Ambassador H. Co.*, 171 Minn. 445, 214 NW 503, 53 ALR 573.

Apparently there is no limit to the amount of future advances, although discretion and implications found in the case of *Finlayson v. Crooks*, 49 NW 398, would recommend that an upper limit be set out in the mortgage.

Mississippi—Majority rule

By decision. Although the earlier case of *Witczinski v. Everman*, 51 Miss. 841, had held that even actual notice of an intervening lien or incumbrance would not defeat the priority of a later optional advance where the mortgage so provided, the recent decision of the Mississippi Supreme Court in 1950, *North v. J. W. McClintock, Inc.*, 44 So. (2d) 412, 208 Miss. 289, modifies this position and formally adopts the actual notice rule as to optional futures advances. "We

adopt the stated rule as being equitable and just." This appears to be the settled law in Mississippi.

The Witczinski case appears still to govern insofar as no limit to such future advances need to be set out in the mortgage: "If it contains enough to show a contract that it is to stand as security to the mortgagee for such indebtedness as may arise from future dealings between the parties, it is sufficient * * *." This was later followed in *Candler v. Cromwell*, 101 Miss. 161, 57 So. 554, where the court said, "It is not necessary for a mortgage for future advances to specify any particular or definite sum which it is to secure."

Missouri—Majority rule

By statute and court decision. Section 369.365 (3), Revised Statutes of Missouri, provides that associations may make future advances "for any purpose, to the extent authorized by the instrument evidencing a recorded first lien on home property." Although unlimited future advances are permitted (*Rice Bros. v. Davis*, 99 Mo. App. 636, 74 SW 431), the law has clear implication that a maximum limit to such advances must be set out in the mortgage. "Actual notice or knowledge" rule apparently prevails.

Section 369.365 (2) creates a "statutory open-end" mortgage for certain purposes and to the extent of \$1,000. Law provides that an association holding a first lien on home property may "make an additional loan or loans, not exceeding in the aggregate \$1,000 and which hereby shall be and stand secured by such first lien for the improvement, equipment or furnishing of such home property * * *." This section apparently puts the world on notice that any home mortgage held by a savings and loan association, including a "closed-end" mortgage by its own terms, is statutorily endowed with the open-end feature for certain purposes up to \$1,000. Although apparently giving such advances, first lien status irrespective of notice, a construction of this section with other sections of the statute would recommend that the lender operate under the "actual notice" rule.

Section 369.365 (1) provides that where advances are necessary to protect the security of any loan or the priority of lien thereon, such may be made without limit and shall "stand secured by such first lien irrespective of intervening liens * * *." In this case, even actual notice would apparently not endanger priority.

Montana—Majority rule

By Statute. Section 52-201, Revised Codes of Montana: "[Any interest in real property capable of being transferred] may be mortgaged to secure existing debts, to secure debts created simultaneously with the execution of the mortgage, and to secure advances then in contemplation but to be made in the future. The total amount of all future advances contemplated and to be subject to the mortgage protection *must be stated in the mortgage*, provided the mortgagee may reserve the right, at the mortgagee's option, to refuse to make all or any part thereof. The lien for said stated amount of said future advances *shall have priority to the same extent as if the amount thereof had been actually advanced * * * at the time of the execution of the mortgage*. The mortgagee shall, upon demand of the mortgagor or a creditor, furnish a statement of all such advances and amounts paid on the principal sum secured, provided such statement shall not impair or affect the lien created for all advances. Upon receipt of such statement, or at any other time following the execution and delivery of the mortgage, the mortgagor may deliver written notice, duly acknowledged, to the mortgagee plainly stating that the mortgagor does not desire to request or apply for any * * * further advances * * *, clearly identifying the mortgage by reference to its [date, parties, original debt, limit to future advances]. Upon the recording of such written notice by the mortgagor in the county and counties where the mortgage is recorded, the lien of the mortgage shall continue to have priority, but only for the aggregate amount of the indebtedness then existing, including any advances theretofore made, interest due and other charges as evidenced by the original loan-contract, and indebtedness thereafter accumulating on such basis, exclusive of any other future advances originally contemplated. Any lien entitled to actual priority over the lien of mortgage by force of any express provision of the laws of this state shall continue to have priority to the extent prescribed by law." (Italics ours.) The priority of other liens referred to in the last sentence apparently refers to Sections 45-504 and 45-506, which prefer mechanics' or materialmen's liens even to prior mortgages, but only as to the building and not the land. See the case of *Interstate Lumber Co. v. Rider*, 93 Mont. 489, 19 P (2d) 644.

The theory of the Montana law is slightly different from most: Instead of providing for a possible *future agreement to make* the advances, the mortgage provides that the advances *shall* be made, subject to the option of either to stop the advance. Although actual notice of an intervening incumbrance would apparently not jeopardize the priority of the lien of later advances, prudence would advise proceeding upon the actual notice rule.

Nebraska—Majority rule

By decision. The Nebraska law was established by the ruling case of *Omaha Coal, Coke and Lime Co. v. Suess*, 74 NW 620, 54 Neb. 379: "A mortgage to secure future advances is valid between the parties and as to third persons; that if the mortgage *on its face states that it is for that purpose*, or if it appears to be a mortgage for a sum certain and the actual debt does not exceed that sum, a junior lienor takes subject thereto for all moneys then advanced or which may be advanced after the junior lien attaches and before the senior mortgagee has notice thereof. The recording of a junior lien, or the rendition of a judgment against the mortgagor does not charge the mortgagee with notice of such junior lien." See also Section 76-238, Revised Statutes, Recording. However, it has been held that one examining a record is thereby charged with actual notice of matters therein. *Mulligan v. Snavely*, 223 NW 8, 117 Neb. 765.

A maximum limit to optional advances should be specified in the mortgage, witness the case of *Wagner v. Breed*, 29 Neb. 720, where the court, in holding an agreement for unlimited advances good as between the contracting parties, remarked that as to third parties the mortgage lien would take precedence for advances only to "the limit fixed by the terms of the instrument upon which the advances [are] to be made."

Nevada—Majority rule

By decision. The law is found in *Chartz v. Cardelli*, 52 Nev. 1, 279 P 761: "Mortgages are but contracts, and it is the law that a mortgage made in good faith, for the purpose of securing future debts, is valid * * *." Where later advances were obligatory, the court held that even "actual notice or knowledge" of intervening liens did not jeopardize the priority. As to optional future advances, the court said "* * * advances made after notice of a subsequent incumbrance are not superior to that of such subsequent incumbrance * * * prior mortgage is not allowed knowingly to prejudice the rights of the subsequent incumbrancer, or defeat or impair his lien, by adding voluntarily to his own incumbrance." From a construction of the language above and the case of *Sharon v. Minnock*, 6 Nev. 378, it would appear that record notice alone would not be sufficient to endanger the priority of a later advance. "The record * * * only imparts notice of the contents thereof to subsequent purchasers and mortgagees * * *." It is advised that a full description of intent and a maximum limit to the advances be set out in the mortgage; see the Charon decision: "The record is not notice of anything not contained" in the instrument.

New Hampshire—Majority rule

By statute. Section 3A, Chapter 261, Revised Laws, provides that optional future advances to the mortgagor "for making repairs, additions or improvements to the mortgaged premises, shall be equally secured with and have the same priority as the original indebtedness, to the extent that the aggregate amount outstanding at any one time when added to the balance due on the original indebtedness shall not exceed the amount originally secured by the mortgage." The clear intent of the parties should be spelled out in the mortgage, the purpose of the advances should be confined to those mentioned, and the maximum limit specified to be that allowed by Section 3A of the statute. Although the statute would probably protect priority of advances made even with actual notice of intervening liens, the better practice would be to act as if the actual notice rule were in force.

Caution should be exercised and a search of the records made in making optional advances called for by a mortgage for other than the purposes and amounts specified in Section 3A. Although Section 4 provides that mortgages for future advances may be made (if provision therefor is specifically made together with any limitations on advances; see also *Mica Products Co. v. Heath*, 81 N. H. 470, 128 A 805), the law provides that the advances shall be secured by the mortgage only as, when, and to the extent the advances are actually made. Thus, in accordance with the "Minority" rule discussed earlier herein, intervening recorded liens would appear to take precedence over later advances made

under any provisions other than those of Section 3A. See *Leeds v. Cameron*, 3 Sumn. 488.

New Jersey—Majority rule

By statute and court decision. Section 78 (2) of the savings and loan act sets up a "statutory open-end" provision. Where the association already holds a mortgage, "additional loans" may be made for repairs, alterations, or improvements to the property, or to pay the cost of certain life insurance. Amount of additional loans cannot exceed the lesser of \$1,000, or the amount the principal has been reduced if a direct reduction loan, or the withdrawal value of pledged installment account if a sinking fund loan. Law provides that each such additional loan is to be evidenced by an obligation stating the terms, and that the amount will be added to the amount due under the mortgage, and that it shall be secured thereby. "All persons who acquire any rights in, or liens upon, the mortgaged real estate subsequent to the recording of any association's mortgage shall hold such rights and liens subject to the * * * additional loans. For the purpose of such additional loans, no search or examination of the title * * * shall be required."

The above "statutory open-end" provision is expressly "in addition to and not to the exclusion of, the power to make any other lawful loan or any other lawful additional loan, or to make advances for any purpose expressly or impliedly reserved or provided for in any bond, mortgage or other obligation held by or hereafter acquired by any such association." From this provision, it is clear that an association can make any open-end mortgage that it has corporate power to make. A review of decisions indicates that the mortgage, by its terms, need not state a maximum limit to such advances (*First National Bank v. Byard*, 20 N. J. Eq. 255), although it is recommended that such a maximum limit be set out to preclude charges of lack of notice or inequity by the intervening incumbrancer. *Bell v. Fleming*, 12 N. J. Eq. 13.

The "actual notice" rule was well stated and firmly upheld in *Ward v. Cooke*, 17 N. J. Eq. 93: "A mortgage given to secure future advances, duly registered, is good, not only as against the mortgagor, but is entitled to priority over subsequent encumbrances, for all advances made prior to notice of the subsequent encumbrance * * * and the notice must be an *actual*, not a constructive notice." The court went on to say that the priority of the advances was "not effected by the registry of the [intervening] mortgage." See also *Central Trust Co. v. Continental Iron*, 51 N. J. Eq. 605. Again in *Micela v. Falduti*, 101 N. J. Eq. 103, 137 A 92, the court held that "where the making of future advances is * * * optional, the mortgage is a prior lien to all subsequent encumbrances until there is actual notice to the mortgagee as distinguished from constructive notice."

New Mexico—Probably majority rule

Coon v. Bosque Bonita Land Co., 8 N. M. 123, 42 P 77, 50 ALR 576, held good a mortgage providing for future advances. "The deed of trust was a public record [when the subsequent interest was created], and the clause for future advances in it was sufficient to put the [subsequent holder] on inquiry, and it is now estopped from setting up want of notice * * *". The clause providing for future advances was held good, even though no maximum limit was stated in the mortgage. The same result was reached in *Smith v. Montoya*, 3 N. M. 39. The question as to how record notice by the first mortgagee of an intervening lien would affect priority of later advances is apparently still an open one in New Mexico.

New York—Majority rule

By decision. The common law rule prevails in New York, see *in re Harris*, 282 N. Y. S. 571. "Actual," not record, notice of an intervening interest is required to subordinate the lien, the latter is superior, *Rochester Lumber Co. v. Dygert*, 136 Misc. 292, 240 N. Y. S. 580. Same as above, but when the advance is made with actual notice or knowledge of intervening lien, the latter is superior. *Catskill National Bank v. Sawc*, 24 N. Y. S. (2d) 82.

Although no limit to the amount of future advances need be stated in the mortgage (*Robinson v. Williams*, 22 N. Y. 380), (1) it is safer to state a limit to such future advances to preclude intervening lienor's possible claim of inequity or lack of notice (*Beckman v. Frost*, 18 Johns 544), and (2) it is more convenient on account of state mortgage tax, which may be paid in advance on the total amount of advances if maximum is stated in mortgage, rather than piece-meal as advances are made.

North Carolina—Probably majority rule

Although cases in point are few, in *Moore v. Ragland*, 74 N. C. 343, the court held: "It is clear that a man may lawfully mortgage his property to secure future and contingent debts * * * [and that the mortgagee's rights are not affected by a prior unregistered mortgage]." The same result was reached in *Todd v. Outlaw*, 79 N. C. 216, except that a defectively recorded mortgage was concerned. In the latter case the court said: "* * * to the extent of the payments made by the [mortgagees under the validly recorded mortgage] before notice of the defendant's equity, the legal title acquired by them will protect and secure them. If, after the execution of the mortgage to the plaintiffs and before they had made any part of, or all the advancements stipulated, they had been fixed with notice of defendant's equity, any advancements subsequently made by them would have been made at their peril * * * but as plaintiffs were unaffected with notice before they paid out their money, the legal title must prevail as a security for repayment."

The question as to the effect of record notice where both mortgages have been properly recorded has not been directly litigated, although it is believed the actual notice rule would probably be upheld. See *Insurance Company v. Knix*, 220 N. C. 725, where it was held that the registration of a mortgage is "constructive notice of all matters which would be discovered by reasonable inquiry * * * (1) has the mortgage debt been kept in date by payments?"

The intent should be spelled out and a maximum limit to the advances should be included in the mortgage. See *Belton v. Bank*, 186 N. C. 614, where the court said that "an agreement to secure one or more obligations must be confined to those intended to be secured by the parties to the contract, for nothing not within the contemplation of the parties will be included in any such agreement." See also *Weathersbee v. Farrar*, 97 N. C. 106, 1 SE 616, where even advances that appeared necessary to save the security were disallowed because not provided for in the loan contract.

North Dakota—Majority rule

By statute. Section 7-0414, North Dakota Revised Code, as amended in 1953, permits savings and loan associations to make additional advances for maintenance, repairs, modernization, and improvement up to the original amount of the mortgage or \$2,500, whichever is lesser, provided the first mortgage reserved the right to make such advances, and provided the funds are used for the purposes above. Law also deems such advances to be merged in and secured by the first mortgage and provides that the association shall thereby have a first lien.

Although the phraseology of the law would apparently preserve the first lien status of additional advances made even with actual notice of an intervening lien, it would perhaps be advisable, in view of decisions rendered prior to the passage of the law, to assume that the "actual notice" rule remains in force. See *Merchants' Bank v. Tufts*, 14 N. D. 238, 103 NW 760; also *Union National Bank v. Milburn & Stoddard Co.*, 7 N. D. 201, 73 NW 527, where the court said, "* * * the recording of the subsequent lien will not constitute constructive notice. * * * Our decision is that the mortgage is, so far as this point is concerned, a superior lien as to the whole amount due thereon, unless the plaintiff had actual notice of the existence of the defendant's lien."

Ohio—Minority rule

By decision. The prevailing rule is stated in Section 3891, Hausser on Ohio Practice, Vol. 3 (1952 ed.): "Future advances may be covered by mortgage valid against subsequent lienholders. However, the mortgagee must be obligated to make the future advances in a definite amount."⁶¹ To the contrary, if the mortgagee is not obligated to make definite future advances, a subsequent mortgage will probably have priority as to any advances made after such subsequent mortgage is placed on record." See *Kuhn v. Southern Ohio Loan, etc.*, 101 Ohio St. 34, 126 NE 820; *West v. Klotz*, 37 Ohio St. 420; and *Spader v. Lawler*, 17 Ohio 371, 49 Am. Dec. 461, all of which held that a mortgage securing optional advances would be postponed to a second mortgage recorded before the future advances were made. In the Spader case the court said: ["The decision is based] on the statute which declares that all mortgages shall be recorded * * * and shall take effect from the time when the same are recorded. [The inter-

⁶¹ An obligatory construction mortgage, to maintain its priority over mechanics' liens, must be drawn in strict conformity with G. C. 8321-1. See *Connecticut General Life Insurance Co. v. Birzer Building Co.*, 101 NE (2d) 408 (Ohio 1950).

vening] mortgage took effect in 1836, and its effect was to hold and bind the precise interest which [the mortgagor] then had in the premises. * * * There is no reason why the record should not be notice to [the prior mortgagee making the advances], as well as to every other man."

The latest expression of the court was in *Second National Bank of Warren v. Boyle*, 155 Ohio St. 48, 99 NE (2d) 474 (1952): "Obviously where there is no obligation to make future advances a mortgage, purporting to secure such advances, cannot secure such advances until the advances have been made. Until then, so far as such advances are concerned, there is nothing for the mortgage to secure; and the provisions * * * merely represent an expression of the intention * * * that the mortgage shall operate as a security for the obligations of the mortgagor with respect to such advances, if and when such obligations arise. At most, those provisions represent an offer by the mortgagor to provide the security of the mortgage for such advances if and when they are made." See also 27 Ohio Jurisprudence 174.

Apparently the mortgage need not expressly state the intention to secure optional advances (*Utter v. Hudnell*, 6 Ohio Dec. Rep. 621), although such must be contemplated at the time of the mortgage (*Re Grotenkemper*, Goebel 224).

Note.—Although savings and loan associations have been given power under Section 9657 (Fourth part), Ohio Statutes, to make five-year loans up to \$1,500 to borrowing members for "property alteration, repair, or improvement," it should be noted that neither the statute, nor the improvement loan in itself, has the effect of "open-ending" the existing mortgage, and such loans should not be confused with additional advances which are made by the mortgagee in accordance with the expressed terms of an open-end mortgage. This statutory provision does not in any way affect the Ohio court decisions listed above as to the priority or time of attachment of the lien of an advance made under an open-end provision of a mortgage.

Oklahoma—Probably majority rule

The first finding of the law was in *Davis v. Carlisle*, 142 F. 108 (Indian Territory, 1905), where the court said: "When, under a mortgage [containing an express and unambiguous provision] for future advances, but leaving it optional with the mortgagee whether he shall make them, they are made *after he has been advised* that a subsequent mortgage has been given upon the property, his lien for such advances will be postponed to that of the junior encumbrance." The latest finding directly in point was also by federal court in *Continental Supply Co. v. Marshall et al.*, 52 F. Supp. 717 (1945), reversed, 152 F. (2d) 300, *certiorari* denied, 66 S. Ct. 962, 327 U. S. 803: "[On the subject of real estate mortgages under the Oklahoma Law] the court held, in accordance with the unquestionable weight of authority, that advances made by the Bank to Marshall under its mortgages, after *actual notice* of Continental's intervening mortgage, which it was not required to make either under the mortgage contract or to protect its security, were junior in lien to Continental's second mortgage." Although the implication is plain that actual notice is needed, the direct question of the effect of record notice has apparently not been in issue. (Although the two recent cases of *Antrim Lumber Co. v. Claremore Federal Savings and Loan Assn.*, 204 Okla. 387, 230 P (2d) 274, Legal Bulletin, May 1953, and *Local Federal Savings and Loan Assn. v. Davidson & Case Lumber Co.*, 255 P (2d) 248 (1953), firmly upheld the priority of *obligatory* future advances over intervening liens, the cases contribute little to the determination of *optional* future advance status, since the latter was not directly in issue.)

Although a mortgage covering a stated amount and "any further sums" was upheld in *Paschal v. Bohannon*, 59 Okla. 139, 158 P 365, later holdings in *First National Bank of Ardmore v. Gillam*, 134 Okla. 237, and *Farmers National Bank of Cherokee v. DeFever* (both chattel mortgage cases) were to the effect that the parties' intention shall be more definitely spelled out. See also the 1953 case of *Gilpatrick v. Hatter*, 258 P (2d) 1200. It is recommended that the intention to secure the future advances and a maximum amount be clearly stated in the mortgage.

See also the 1946 case of *Garey v. Rufus Lillard Co.*, 165 P (2d) 344, 196 Okla. 421, where, although the first mortgage provided for optional future advances, the mortgagee took second and third mortgages at the time of the advances, and he was estopped to assert their priority as future advances under the first mortgage as against intervening lienors.

Oregon—Majority rule

By decision. The rule is stated in the leading case of *U. S. National Bank of Portland v. Embody*, 25 P (2d) 149, 144 Ore. 488: "If the mortgagee is not obligated to make the advances, the mortgage lien attaches only to such advances as are made before notice of the junior lien * * * actual notice is sufficient." See also *Bradtl v. Sharkey*, 113 P 653, to the effect a recorded instrument is not constructive notice to a prior grantee.

The intent to secure future advances should be spelled out and a maximum limit set out in the mortgage. See *Rutherford v. Edward L. Eyre & Co.*, 148 P (2d) 530, 152 ALR 1172 (involving a chattel mortgage), which held optional advances superior up to the amount specified; also the implications of the early case of *Hendrix v. Gove*, 8 Ore. 407.

Pennsylvania—Minority rule

It has been consistently held that mortgages to secure future advances, whether optional or obligatory, are valid as between the parties. "There is no doubt but that mortgages may be made to cover future advances and that they are valid and binding," *Moats v. Thompson*, 283 Pa. 313, 129 A. 105; see also *Land Title and Trust Co. v. Shoemaker*, 257 Pa. 213, and *re Pusey, Maynes, Breish Co.*, 122 F. (2d) 606, affirming 37 F. Supp. 316. Such mortgages are also good as against subsequent lienors, as to optional advances made before the subsequent lien attaches. *Batten v. Jurist et al.*, 306 Pa. 64, 158 A 557, 81 ALR 625.

As to optional advances made after attachment of subsequent liens, however, Pennsylvania apparently still adheres to the minority rule (although there is evidence that the courts might be considering a shift to the majority rule). In the *Moats* case, the court recognized the rule that "while they are protected by the mortgage, such voluntary advances relate in lien to the actual date of the advancement instead of the date of the mortgage, and are subject to all intervening-encumbrances." See also *Wardman v. Iseman*, 99 Pa. Super. 551. In the prior case of *Bank of Montgomery County's Appeal*, 36 Pa. 170, 3 Grant 300, the same rule was upheld: "As to future advances, therefore, and as against other mortgages and judgments, this mortgage only took rank from the date of such advances, and not from its own date * * * [The prior mortgagee] is bound to take notice of junior and intervening recorded encumbrances, in the same manner as if he were about to accept of a new and independent liability from the party, having no reference whatever to any prior encumbrance."

It would appear that a maximum limit need not be stated: "A mortgage to secure future advances, unlimited as to time and amount is valid as to advances made * * *" (*Batten* case, *supra*), although the earlier case of *Garber v. Henry*, 6 Watts 57, held that the record must contain information of the extent of the lien.

It is to be hoped that the Pennsylvania courts will reconsider their position in regard to the time of attachment of the lien and as to notice. There is evidence of a possible shift toward the majority rule in the *Batten* case, *supra*, where the court said, *obiter dictum*, "A mortgagee cannot make voluntary future advances after knowledge of an intervening claim and then have priority as to such advances. 'Actual notice to the mortgagee will cut off his priority as to all optional advances thereafter made.'" (*Italics ours.*) It should be noted that neither the *Batten* case nor the *Moats* case, *supra*, expressly repudiates the majority rule, since neither case was directly in point—the question of *intervening liens* being discussed *obiter dictum*.

A very encouraging decision was rendered by the Pennsylvania Supreme Court in June of 1953, *Housing Mortgage Corp. v. Allied Construction Co.*, 97 A (2d) 802, wherein the court set out the actual notice rule. The case, however, involved a situation where the mortgagee making the optional advances had actual notice of the subordinate lien at the time of the advances, and we hesitate to take the position that the decision "overruled" the earlier cases. Although only partially stated by the court, the actual notice rule, however, was clearly implied to be the law: "The law is definitely established that an advance made pursuant to a mortgage to secure future advances which the mortgagee was not obligated to make, is subordinate in lien to an encumbrance intervening between the giving of the mortgage and the making of the advance, if the advance was made with actual notice or knowledge of the intervening encumbrance; the lien of an advance under such circumstances dates only from the time it was made and not from the time of the creation of the mortgage. In other words, after notice of the existence of a junior lien, the senior mortgagee will not be protected in making further advances under his mortgage unless he is under a

binding obligation to make such advances." (Italics ours.) Unfortunately, the court did not go on to complete the actual notice rule—they failed to add: "Optional advances under the mortgage contract will take precedence over intervening liens where the mortgagee did not have actual notice of them."

The recording laws and cases involving other mortgages would appear to support a definite shift to the majority rule. The Act of June 28, 1951, 68 Pa. Stat. 601-603, provides, "Liens against real property shall have priority over each other on the following basis: * * * (2) Other mortgages [than purchase money mortgages] and defeasible deeds in the nature of mortgages from the time they are left for record." In *Beckman v. Altoona Trust Co.*, 2 A (2d) 826, 332 Pa. 545, the court said, "*The purpose of the recording statutes * * * is to notify future incumbrancers.*" In *Evans v. Jones*, 1 Yeates 172, it was held that the record of a mortgage is notice of contents to subsequent mortgagees. In *Taylor v. Maris*, 5 Rawle 51, it was held that the record of a mortgage is not constructive notice to a prior incumbrancer.

Rhode Island—Majority rule

By statute. Section 20, Chapter 442, as added in 1952, provides that if properly titled and if a maximum amount of the total of loans to be secured is set out, a mortgage "shall be security from the time of its recording * * * for all additional loans made from time to time by such mortgagee to such mortgagor * * * provided, however, that such stated maximum amount shall not be an amount which exceeds by more than \$3,000 the total of the principal amount of loans which at the time or before such recording such mortgagee made or agreed to make to such mortgagor. And provided further that such portion of the total amount of the principal of all loans outstanding at any one time * * * as is in excess of said stated maximum amount shall not to the extent of such excess be secured by such mortgage while such total amount so outstanding is in excess of such stated maximum amount." Subject to the above, law provides that such advances shall have "full priority" over all liens and incumbrances not recorded prior to the mortgage.

EXCEPTION: Record notice of a writ of attachment or execution, or notice of *lis pendens* is, however, sufficient to subrogate dignity of later advances.

The rather complicated language apparently means that optional advances up to \$3,000 over the amount of the loan plus advances which the mortgagee obligated itself to make will be given first lien status provided that the overall total is set out in the mortgage.

From the language of the law—so far not interpreted by a court—it could be inferred that even actual notice of intervening liens and incumbrances would not jeopardize the first lien status of the later advances, excepting of course notice of attachment, execution or *lis pendens*, in which cases even record notice, by the terms of the law, would suffice to subordinate the lien of a later advance. It will be seen that for safety, a title search before each advance would be advisable.

South Carolina—Majority rule

By statute. Section 45-55, Code of South Carolina, provides: "Any mortgage * * * securing existing indebtedness or future advances to be made, regardless of whether such advances are to be made at the option of the lender, shall be valid from the day and hour when recorded so as, to affect the rights of subsequent creditors, whether lien creditors or simple contract creditors, or purchasers for valuable consideration without notice to the same extent as if such advances were made as of the date of the execution of such mortgage or other instrument for the total amount of advances made thereunder, together with all other indebtedness and sums secured thereby, the advances not to exceed, however, the *Maximum amount stated therein.*" In our opinion this is one of the best statutes on the subject. It will be seen that intent to secure the advances and a maximum limit should be stated in the mortgage. Such liens were also firmly upheld prior to the statute; see *Seaman & Mure v. Fleming*, 28 S. C. Eq. 283: "The object of the mortgage was in part to secure future voluntary advances, and such a purpose has been pronounced good as between the parties, and good as to creditors * * *" See also *Ex parte American Fertilizing Co.*, 122 S. C. 171, 115 SE 236; *Behrman v. Brown*, 122 S. C. 39, 113 SE 273.

Although the statute apparently safeguards the prior lien of the future advances regardless of the notice question, in view of decisions antedating the statute it would be better to proceed as if the actual notice rule were in effect; witness the case of *National Bank of Chester v. Gunhouse & Co.*, 17 S. C. 489,

where it was held that a mortgage to secure future advances is postponed to a mortgage of later date, as to all indebtedness contracted under the security of the first mortgage after notice had by the first mortgagee of the second mortgage. See also *Ex parte American Fertilizing Co.*, *supra*.

South Dakota—Probably majority rule

No cases in point.

Tennessee—Probably majority rule

The first direct and apparently ruling adjudication on the question was *McGavock et ux. v. Deery*, 41 Tenn. 265, where the court held that a mortgage "by express stipulation might as well be given to secure future advances and continuing debts as those which already exist and are certain and due." Although the mortgage recited \$1.00 consideration plus advances, it was held that the subsequent lienors, having had notice of the prior mortgage, had the opportunity "to ascertain the full amount of the charge resting upon the property * * * [and that] if they neglected to do so it was their own folly and they are as much bound and in the same way affected as if they had." See also *Garrett v. Adams et al.*, 39 SW 730, 145 Tenn. 19 (although in this case a lien for mortgagee's later attorney's fees was held subordinate to intervening lien). That the intent to secure future advances must be expressed on the face of the mortgage is also attested to by *Turbeville v. Gibson*, 52 Tenn. 568, where "secret" agreement to make the advances was held void. In this case, court commented that the McGavock case had been "held most correctly." Also in *Thurman v. Jenkins*, 61 Tenn. 426, court said, "Where future advances are to be secured, this should appear on the face of the * * * mortgage." In the case of *Hunt v. Curry*, 153 Tenn. 11 (not an open-end case), the court said, "Literal exactness in describing the indebtedness secured by a mortgage or trust deed is not required. It is enough if the description is correct as far as it goes and full enough to call attention to sources of accurate and complete information, and the language employed is not calculated to deceive or mislead as to the nature or amount of the debt." Court quoted the open-end case of *Aetna Life Insurance Co. v. Finch* (see *supra* Indiana) as authority. It will be seen that the intent must be expressed on the face of the instrument and that the better policy would be to set an upper maximum limit to the advances.

Apparently the question of notice has not been litigated. Section 7666, Tennessee Code, provides that trust deeds take effect and shall be notice from the time of registration. "Registration is constructive notice" to later purchasers of "rights shown in a properly registered instrument." *Parker v. Hall*, 39 Tenn. 641. Section 7667 gives priority according to the recording date. See also *Chatten v. Knoxville Trust Co.* (Tenn. 1926), 289 SW 536, 50 ALR 537.

Texas—Majority rule

The law is well settled that property capable of being mortgaged may be made the subject of a valid open-end mortgage and that optional future advances provided for therein have full priority over subsequent liens and incumbrances whether such advances are made before or after attachment of the junior lien. (See 29 Texas Juris., Secs. 38, 60.) Numerous cases support the doctrine; see the leading case of *Freiberg v. Magale*, 70 Texas 116, 7 SW 684, wherein the court endorsed the Witzinski case (see *supra*, Mississippi) even to the extent that actual notice of an intervening lien would not jeopardize the priority of an advance. In the later case of *Cisco Banking Co. v. Keystone Pipe & Supply Co.*, 277 SW 1060, the court quoted from 19 RCL 429, Sec. 210: "The record of [an open-end mortgage] is notice to all subsequent incumbrancers * * * all the adjudications agree that in the absence of notice of an inferior lien, the holder of the security for future advances may continue to treat the property as free from subsequent incumbrances and therefore can safely make further loans to the debtor. His prior equity under the mortgage is superior to the subsequent equity of one who holds a later lien as to all advances made in ignorance of such subsequent incumbrance whether made before or after it attached to the property." (The authority was speaking of actual notice.) Other cases: *Foxworth-Galbraith Co. v. Southwestern Cont. Corp.*, 165 SW (2d) 221, error refused; *Poole v. Cage*, 214 SW 500, error refused; *Groos & Co. v. Chittim*, 100 SW 1006; *Brunson v. Dawson State Bank*, 175 SW 438 (chattel mortgage); *Willis v. Sanger*, 15 CA 655, 40 SW 229. In *First National Bank v. Zarafonitis*, 15 SW (2d) 155, the court said: "The rule is well settled in this state that a recorded mortgage expressed to cover future advances has priority in all cases over subsequent

conveyances and incumbrances. And the mortgagee is entitled to rely upon it and to make such advances without regard to what other incumbrances may afterward be put upon it." [Italics ours.] The holding appears to be irrespective of notice.

Cases have held that a limit to such advances need not be stated in the mortgage; see Willis, Groos cases, *supra*, and also the Freiberg case: "[A mortgage which on its face] gives information as to the extent and purpose * * * so that any one interested may by ordinary diligence ascertain the amount of the incumbrance, whether the extent of the advances be limited or not * * * will prevail over supervening claims * * * as to all advances made within the terms * * * " (Italics ours.)

A validly established homestead, however, is incapable of being mortgaged in Texas except for certain purposes: see Article 16, Section 50, Constitution: "* * * no mortgage, trust deed, or other lien on the homestead shall ever be valid, except for purchase money therefor, or improvements made thereon, as hereinbefore provided * * * " The words "never be valid" have been interpreted to mean "void," *Hall v. Jennings*, 104 SW 489, and *Ingc v. Cain*, 65 Texas 75. In *King v. Plainview National Farm Loan Assn.*, 100 SW (2d) 434, reversed on other grounds, 132 Texas 481, 122 SW (2d) 1060, the court held that any attempt to create a lien or mortgage on a homestead to secure a debt, regardless of the method or form used, except for the things provided by the constitution, is a nullity. The homestead right cannot be waived, *Bayless v. Guthrie*, 235 SW 843. For definition of homestead, see Section 51, Article 16, Constitution.

A mortgage, therefore, would be valid and superior to the claim of homestead only for the purchase price (*Denni v. Elliott*, 60 Texas 337; *Floyd v. Hammond*, 268 SW 146), for taxes (*Firardeau v. Perkins*, 59 CA 552, 126 SW 633, writ of error refused), or for work or materials for improvements (*International Building and Loan Assn. v. Barker*, 16 CA 676, 39 SW 317). It would appear that an open-end form could be used for such purposes, but that in every instance where money is disbursed the association must purchase the vendor's lien, tax lien or mechanics' liens as the case may be, and advance no amount in excess of that actually used for proper purposes. *Dallas Building and Loan Assn. v. Henry*, 98 SW (2d) 1030; *Building and Loan Assn. of Dakota v. Logan*, 33 SW 1088. In *Blair v. Guaranty Savings, Loan and Inv. Co.*, 54 CA 443, 118 SW 608, where a husband and wife executed a mortgage to secure a loan for the purpose of taking up or extending vendor's lien notes and a mechanic's lien, with the understanding that these were to be assigned to the mortgagee, and that the notes and lien were so assigned together with the superior title of the vendor, it was held that the mortgagee became subrogated to all the rights arising from these liens and was vested with superior title.

Utah—Probably majority rule

By decision. About the only case involving optional future advances is *Stockyards National Bank v. Bragg*, 67 Utah 60, 245 P. 966, where the validity of optional advances was upheld. The case is inconclusive, however, as the facts were based on advances of a character more or less "necessary" to preserve the security of the mortgage.

Vermont—Majority rule

By statute. Placed in the banking statute, but apparently applying to all mortgage lenders, Section 8756 of Vermont Statutes gives first lien status to mortgages written to secure a present debt and any future advances to the extent of the "full amount of debt directly created between the parties, due to the mortgagee at any given time * * * " Statute provides that "a subsequent mortgage on the same premises shall be inferior to the first mortgage unless the second mortgagee in writing notifies the first mortgagee of the incidence of his mortgage, in which case indebtedness created by the mortgagor to the first mortgagee subsequent to such notice shall be inferior to the lien of the second mortgage." The statute appears to define "actual notice" as "notice in writing" and makes even more definite the holdings in *Patch & Co. v. First National Bank*, 90 Vt. 4, 96 A 423, where the court said that "something more than a mere knowledge in the mortgagee of such subsequent interest" is necessary, and in *McDaniels v. Colwin*, 16 Vt. 300, 42 Am. Dec. 512, where the court said, "The persons interested in limiting the further advances must give notice; but the first mortgagee is not bound to search the records from day to day to learn whether his mortgagor has made any further incumbrances, or whether any attachments have been made, or to ascertain that of which notice must be given him by the persons interested."

A fair construction of the statute, together with the decisions in *Lamoille County Savings Bank v. Belden*, 90 Vt. 535, and *Keyes v. Bump*, 59 Vt. 391, 9 A 598, would indicate that there is no top limit on the amount of such future advances. Prudence, however, would recommend that a top limit be stated in the mortgage.

Virginia—Majority rule

By decision. The leading case is *Alexandria Savings Institution v. Thomas*, 29 Gratt 483, where the court said: "Where it is optional with the mortgagee whether he will make the future advances * * *, he will be affected by any subsequent lien or encumbrance which is brought to his knowledge before the advance is made * * *. But if without notice of the second encumbrance, he acts under his mortgage, he will be protected and take precedence accordingly." The court didn't specifically decide the import of record notice: "Whether the recording of the second mortgage or encumbrance is of itself notice to the first mortgagee, or whether he can be affected only by express notice * * * there is much diversity of opinion." It has been held, however, that the recording statutes are for the purpose of giving "constructive" notice to subsequent parties, and Michie, in Section 42, Mortgages, Virginia and West Virginia is as follows: "The that the law both in Virginia and West Virginia is as follows: "The holder of a duly recorded deed of trust to secure future advances is affected only by actual notice of a lien subsequently acquired on the property, and for all advances made by him under his deed of trust and within its terms before receiving actual notice of a subsequent lien, his deed of trust is a valid and prior security."

There is little question that Michie's statement of the law in Virginia is correct, although it must be said that no case can be found in Virginia in which the question of notice by recordation to a mortgagee in a mortgage to secure optional future advances has been directly raised. See also on this subject note in 6 Virginia Law Review 280.

The Alexandria case also held it to be well settled that a mortgage "to protect future loans is perfectly valid, although it does not state the amount intended to be secured." It is recommended, however, that the intent to secure optional future advances be fully set out, as well as a maximum limit to the advances, in view of the court's later language: "As a general rule, it would be better for the [mortgage] in all cases, accurately to define the nature and extent of the obligations for which it is given."

Washington—Majority rule

By decision. The leading case is *Elmendorf-Anthony Co. v. Dunn*, 10 Wash. (2d) 29, 116 P (2d) 253, 138 ALR 558. Although the court applied "optional" advance rules to future advances made by the mortgagee to preserve the security, the decision, together with that in *Cedar v. Roche Fruit Co.*, 16 Wash. (2d) 663, 134 P (2d) 437, serves to state the rule as to optional future advances in Washington: "The following conclusion * * * may be regarded as furnishing the prevailing rule: When [such a] mortgage reasonably states the purpose for which it is given, its record is a constructive notice to subsequent purchasers and encumbrancers; they are thereby put upon an inquiry to ascertain what advances or liabilities have been made or incurred. *The record of a subsequent mortgage or conveyance, or the docketing of a subsequent judgment, is not a constructive notice of its existence to such prior mortgagee.* The prior mortgage, therefore, duly recorded, has a preference over subsequent recorded mortgages or conveyances, or subsequent docketed judgments, not only for advances previously made, but also for advances made after their recording or docketing, without notice thereof." [Italics ours.] See also The Seattle case (Wash. 1909) 170 F. 284, where the court said, "By the decided weight of authority * * * and we so hold, such future advances, although optional, are within the lien of the mortgage, and prior to that of a second incumbrance, if they were made without actual notice of the second incumbrance, and the recording of a second mortgage does not import notice to the first mortgagee." [Italics ours.]

In an *obiter dictum*, the court used even stronger language in the Elmendorf-Anthony case: "We would be inclined to view the rights of the first mortgagee relative to advances made pursuant to an optional clause in a construction contract, *even after notice of a junior encumbrance, as superior to such junior encumbrance.*" (Italics ours.) The court, however, held that actual notice on the part of the prior mortgagee did impair the priority of later "optional" advances, quoting "almost universal weight of authority" as holding that actual notice defeated the priority.

The leading case serves to point out that the mortgagee should specifically provide for future advances (see also *Inland Trading Co. v. Edgecombe*, 57 Wash. 257, 106 P 768), and although there is authority to the effect that a limit need not be stated in the mortgage (*Carey v. Herrick*, 146 Wash. 2S3, 263 P. 190), it is recommended that a maximum limit to the advances be set out in the mortgage. See *Tesdahl v. Collins*, 97 P (2d) 649, 2 Wash. (2d) 76: "The debt must be capable of identification, and the amount thereof must be ascertainable."

West Virginia—Majority rule

By decision. In the governing case of *Hall v. Williamson Grocery Co.*, 69 W. Va. 761, 72 SE 780, the actual notice rule was clearly enunciated as the law in West Virginia.

No limit need be set on advances—it is sufficient that the mortgage disclose that it is to stand as security for such indebtedness as may arise.

Wisconsin—Majority rule

By decision. The rule was set out in *Wisconsin Planing Mill Co. v. Schuda*, 72 Wis. 277, where the court said, "A mortgage * * * to secure future advances * * * becomes a lien upon the mortgaged premises from the time of the execution and recording of such mortgage, and, if it is recorded before the commencement of the building, it will take precedence of liens for [labor and materials used]." The court didn't distinguish between obligatory or optional advances, and expressly rejected the doctrine that the lien of the advances accrued only as of the time the advances were made, and then only for the actual sum advanced. In *Provident Loan and Building Assn. v. Carter*, 107 Wis. 383, 83 NW 655, it was held that since the recording act was applicable only to subsequent purchasers and incumbrancers, the record of a second mortgage was not notice to a prior mortgagee who, after the recording of the second mortgage, but without actual notice thereof, made a second loan to the mortgagor upon the security. In *Duster v. McCamus*, 14 Wis. 307, it was held that the record of a subsequent mortgage is not notice to a prior mortgagee of the equities of the subsequent mortgage; but to bind him "he must have actual notice, or sufficient information to put him on inquiry."

Section 215.22(7), Wisconsin Statutes, provides that mortgages securing mortgage loans made by building and loan associations "shall have priority over all liens, except tax and assessment liens, upon the mortgaged premises and the buildings and improvements thereon, which shall be filed subsequent to the recording of such mortgage." Such Section 215.22(1) indirectly authorizes advances and additional loans on the same security, the statute buttresses the holding in the above cases as to savings and loan optional advance loans.

It is recommended that the mortgage clearly recite the intent to secure advances on its face (see *Estate of Dunlap*, 184 Wis. 345) and also that a maximum limit to such advances be set out.

Wyoming—Probably majority rule

There are no cases directly in point. In *Walter v. Kressman*, 169 P 3, 25 Wyo. 292, where conflicting mortgages were in issue, the court allowed the amounts actually advanced, stating: "Believing that the law sustains this position under all the circumstances of this complicated case, this court has determined * * * the question of rank of mortgages, not upon the question of the earlier advances, or the prior date of execution, recording [etc.], but upon broad grounds of equity."

Section 66-206, Wyoming Laws, provides: "Every such mortgage, when otherwise duly executed, shall be deemed and held a good and sufficient mortgage in fee to secure the payment of the moneys therein specified * * *." Section 66-116 provides "Each and every * * * mortgage * * * shall be notice to and take precedence of any subsequent purchaser * * * from the time of [its] delivery * * * for record." In *First National Bank v. Citizens State Bank*, 11 Wyo. 32 (involving the priority of an extended mortgage over an intervening lien), the court said: "The thing secured is the debt, and so long as the debt can be traced, whatever form it may assume, the security remains good as security for the debt."

OTHER PROBLEMS

Sometimes the matter of estoppel enters into the question of the priority of the optional future advance. For example, in a recent Oklahoma case⁶² it was held that where a mortgage recited that it secured optional future advances, but,

⁶² *Garey v. Rufus Lillard Co.*, 165 P (2d) 344, 196 Okla. 421 (1946).

after other liens had attached to the mortgaged property, the mortgagee lent additional sums to the mortgagor and took second and third mortgages on the property, the mortgagee could not exclude the intervening liens on the theory that the subsequent loans constituted future advances under the first mortgage, but that they would be deemed to have been additional loans made upon the security of the second and third mortgages, which would be treated as junior incumbrances. A similar holding was made in Ohio.⁵³ It thus seems that an attempt to bolster an open-end provision with extra arrangements might have exactly the opposite effect. The lender making an open-end mortgage must in-creasingly depend upon it exclusive of other mortgage arrangements.

An Arkansas case has held that if an open-end mortgage provides for future advances to the mortgagor, the mortgage will not cover advances made to a grantee of the mortgagor.⁵⁴ This pitfall can be obviated by use of proper terminology in the mortgage document.

The Veterans' Administration has recognized the value and advantages to be gained from the open-end mortgage and has made provision for such advances. In each case the lender must secure a "prior approval" from the VA for the amount of each supplemental advance, and a new application and appraisal will ordinarily be required. The procedure and available guaranty entitlement for such open-end advances are set out in Regulation 36.4355, along with provisions for separate additional loans for property improvements.⁵⁵ The FHA regulations apparently do not contemplate open-end advances, although it is to be hoped that eventually these mortgages too can receive the open-end benefits.

LEGISLATION

Although it would probably be better to depend on the common law, we know of no objection to clarifying the situation by statute if it is desired. The greatest care should be given to the drafting of such a statute, however (witness the various and sometimes strange results of some of the state statutes set out above), and in some cases several statutes may be needed for complete clarity. In some states where the legislature has full sovereign power unrestricted by constitutional provision, one law will probably suffice. In others, perhaps it will be necessary to amend the recording laws, mortgage laws, and the statutes relating to the various financial institutions. Homestead laws may have to be examined.

If clarifying legislation is desired, we recommend the following text, which is based generally on the present South Carolina and Montana statutes. Although the language covers all types of mortgagees, perhaps it will be desired to amend only the savings and loan law, or other particular laws:

"Any interest in real property capable of being transferred may be mortgaged to secure existing debts or obligations, to secure debts or obligations created simultaneously with the execution of the mortgage, to secure future advances necessary to protect the security, and to secure future advances to be made at the option of the parties up to a total amount stated in the mortgage, and all such debts, obligations, and future advances shall, from the time the mortgage is filed for record as provided by law, be secured by such mortgage equally with, and have the same priority over the rights of all persons who subsequent to the recording of such mortgage acquire any rights in or liens upon the mortgaged real estate, as the debts and obligations secured thereby at the time of the filing of the mortgage for record; except that (1) the mortgagor or his successor in title is hereby authorized to file for record, and the same shall be recorded, a notice limiting the amount of optional future advances secured by such mortgage to not less than the amount actually advanced at the time of such filing, provided a copy of such filing is also filed with the mortgagee, and (2) if any optional future advance shall be made by the mortgagee to the mortgagor or his successor in title after written notice of any mortgage, lien or claim against such real property which is junior to such mortgage, then the amount of such advance shall be junior to such mortgage, lien or claim of which such written notice was given."

⁵³ Where a later chattel mortgage was taken in support of an advance made by a mortgagee who held an open-end mortgage, it was held that to be covered by the open-end mortgage, the mortgagee "must rely on the mortgage" in making the later loan. *Second National Bank of Warren v. Boyle et al.*, 99 NE (2d) 474 (Ohio 1951). See *contra*, *Northampton National Bank v. Holland*, 126 Pa. Super, 597, 190 A 483.

⁵⁴ *Walker v. Whitmore*, 165 Ark. 276, 262 SW 678. See *contra*, *In re Great Lakes*, 8 F. (2d) 96 (Pa.).

⁵⁵ See also VA Solicitor's Opinion No. 156-49, April 26, 1949, and TB 4A-55; also Regs. 36.4511 and 36.4503, as amended July 7, 1953.

Mr. PATMAN. The open-end provision has some appeal, I will admit, and it would save the high interest rate there.

Mr. MASON. Yes; it would.

Mr. PATMAN. Because the borrower who has some equity could use that instead of resorting to this title I provision to pay the 9.7 percent, couldn't he?

Mr. MASON. Yes; he could.

Mr. PATMAN. Now, on the secondary mortgage market, how will that affect ordinary Joe Doaks down, say, in Texarkana, Tex.? He wants to get financing for a home. How will he do it under this provision of the bill if it becomes law?

Mr. MASON. Well, the reason, as we see it, why Joe Doaks in Texarkana, or probably some smaller town than Texarkana—

Mr. PATMAN. Well, that is not a very large town.

Mr. MASON. But Texarkana does have mortgage facilities, probably, but there are hundreds and hundreds of towns where there are not mortgage facilities. There is a national bank there which cannot tie up its capital in long-term mortgage loans. This bank could take this loan and dispose of it to the secondary market, and thereby pull funds for this borrower into the area.

Mr. PATMAN. I know, but I wish you would tell me this: We will take the X National Bank, for instance, that wants to help Joe Doaks.

Mr. MASON. That is right.

Mr. PATMAN. And he wants a \$9,600 mortgage. He wants to handle that. He wants to get that much on his home. How will X National Bank help him? How will it proceed?

Mr. MASON. It will make the loan to Mr. Doaks, and then will have a place to dispose of that loan so that it can stay within the provisions of the banking act and not have its funds tied up.

Mr. PATMAN. When you say that it has a place to dispose of it, where is that place?

Mr. MASON. The secondary mortgage market, the Federal National Mortgage Association.

Mr. PATMAN. Would it be set up here in Washington?

Mr. MASON. That is my understanding of the bill; yes, sir.

Mr. PATMAN. Who will operate this secondary mortgage market?

Mr. MASON. It would be operated by a new Federal Mortgage Marketing Association, as I understand the bill.

Mr. PATMAN. Who will be the head man? Who will run it? Who will operate it?

Mr. MASON. Well, it is operated by the president of the bank doing the actual operation of it, and, of course, it is under the Housing and Home Financing Agency's wing.

Mr. PATMAN. Will the officials be public officials or will they be private officials?

Mr. MASON. Oh, yes.

Mr. PATMAN. They will be public officials?

Mr. MASON. Yes, sir. And appointed by the President.

Mr. PATMAN. Will the obligations be guaranteed by the Government, directly or indirectly?

Mr. MASON. I wouldn't think so.

Mr. PATMAN. Well, who is going to pay them?

Mr. MASON. No; they are not.

Mr. PATMAN. After they get the money somebody has to guarantee these things. At least they have got to have something behind them.

Mr. MASON. They start with Government money.

Mr. PATMAN. How much money will be put up?

Mr. MASON. \$70 million dollars.

Mr. PATMAN. \$70 million dollars?

Mr. MASON. Yes, sir.

Mr. PATMAN. And that is as a starter, and then, of course, the mortgages will be added as assets, and they accumulate, I assume.

Mr. MASON. The plan, as I understand it, is that these mortgages would be sold after they are acquired and not held.

Mr. PATMAN. Not like the RFC used to do; keep them?

Mr. MASON. The idea is to find an area—these are areas in this country, you know, where there are excess funds.

Mr. PATMAN. Yes, sir. All right. Suppose, though, that they accumulate a lot of these mortgages and cannot sell them as rapidly as they would like to, and there is a loss of more than \$70 million. Who stands that loss?

Mr. MASON. Well, that is a pretty farfetched conclusion, which could originate all right. It is a Federal corporation.

Mr. PATMAN. A Federal corporation?

Mr. MASON. Yes, sir.

Mr. PATMAN. And, of course, the Government would be behind it, I guess, just as it is behind, really, all the other housing agencies.

Mr. MASON. That is right. Certainly to start with it would be.

Mr. PATMAN. The full faith and credit of the Nation is behind it, then? That is correct, isn't it?

Mr. MASON. Well, certainly the reputation of the Nation would be behind it to start with.

Mr. PATMAN. And the Congress could not afford not to appropriate the money to take care of any losses. So it is a Government institution. It would be in effect, for all practical purposes, Government-guaranteed paper?

Mr. MASON. It is as proposed in the legislation; yes, sir.

Mr. PATMAN. It is Government-guaranteed paper?

Mr. MASON. No. I don't know that the Government guarantees the paper. That is not in there. But it is a Federal corporation, with Federal funds. The President's Advisory Committee did not make that recommendation, however. But that is the legislation.

Mr. PATMAN. Beg pardon?

Mr. MASON. The President's Advisory Committee did not recommend Federal funds, but that is the recommendation in this bill, and we are supporting this recommendation.

Mr. PATMAN. If one like this X National Bank at Texarkana gets this Joe Doaks' \$9,600 mortgage financed through this secondary mortgage association in Washington, doesn't the bill say something about putting up 3 percent?

Mr. MASON. Yes; it does.

Mr. PATMAN. Where does that 3 percent go?

Mr. MASON. The 3 percent goes into stock of the corporation to retire the Government funds.

Mr. PATMAN. Who will ultimately pay that? Will Joe Doaks pay it, or will the national bank pay it or the Government? What happens to it?

Mr. MASON. Well, the chamber is opposed to that provision.

Mr. PATMAN. I know; but notwithstanding that, you see, it is in the bill.

Mr. MASON. It is in the bill; that is right.

Mr. PATMAN. And you are advocating the bill.

Mr. MASON. We are advocating the bill but we are recommending that you look at that section and leave it out, sir.

Mr. PATMAN. Leave out the 3 percent?

Mr. MASON. No, leave it out as a nonrefundable charge.

Mr. PATMAN. In other words, the bank could make him pay the 3 percent and not refund it?

Mr. MASON. We say he should be able to get that money back when the mortgage is sold by the corporation to the bank or insurance company, or whoever is going to hold it.

Mr. PATMAN. And Joe Doakes will be out that money for good under this bill; is that right?

Mr. MASON. Well, it would appear that the bank would be the one who would pay the 3 percent.

Mr. PATMAN. Well, you know they are not going to pay it. You don't know of a banker in this country that would do that, do you?

Mr. MASON. That is why we do not favor this proposal, because we believe it will work to his disadvantage also, and also this means won't be used. It is too costly.

Mr. PATMAN. I would just like to clear up that one thing and then I will be through. That is, what happens to this 3 percent?

Under this bill, which, of course, you are not in favor of—this particular part—you think that 3 percent should go back to Joe Doakes when that mortgage is sold. But it is all right for Joe Doakes to put up the 3 percent but it ought to come back to him when the mortgage is sold. But under the bill what happens to it?

Mr. MASON. Could I say there that under the provision Mr. Doakes should not have to pay that 3 percent at all. That 3 percent should be paid by the bank.

Mr. PATMAN. Well, Joe Doakes is the borrower. He is John Q. Public. He is the fall guy.

Mr. MASON. The point is that the bank pays that for the privilege of doing this business.

Mr. PATMAN. The banks pays it?

Mr. MASON. Yes, sir. And it should only have to invest those funds for a period, and then get them back. And then it is all right.

Mr. PATMAN. They certainly would not be out any 3 percent just for that privilege, not for good. But I want to know, and it is still not clear to me; if it is to the other members I will stop.

But I don't know what is going to happen to this 3 percent under this bill. Let us talk about your provision. You do not agree with that. Under this bill what happens to the 3 percent?

Mr. MASON. Under the bill this becomes the capital of the Federal National Mortgage Association.

Mr. PATMAN. Permanent capital?

Mr. MASON. Yes.

Mr. PATMAN. Joe Doakes is out that money?

Mr. MASON. The bank in Texarkana is out that money.

Mr. PATMAN. Well, you know the bank in Texarkana is not going to be out that money. Or any other bank in any other town in the United States. You know that. That is idle talk.

Well, that 3 percent that Joe Doakes is going to be out, is part of the permanent capital, and instead of him paying interest on \$9,600 he will be paying interest on \$9,600 and also 3 percent that he does not get, won't he?

Mr. MASON. You are presuming something which I cannot agree to.

Mr. PATMAN. Well, you don't have any idea that any bank—

Mr. MASON. I fear it, but I cannot agree to it.

Mr. PATMAN. You do not claim, do you, Mr. Mason, that any bank in the United States, any one bank in the United States, will pay that 3 percent?

Mr. MASON. And have their funds tied up permanently? No, sir; I do not believe they would.

Mr. PATMAN. Or temporarily, either?

Mr. MASON. I think they would temporarily. I am sure they would.

Mr. PATMAN. Well, yes; if it is returned when the mortgage is sold.

Mr. MASON. In 6 or 8 or 4 months.

Mr. PATMAN. But as it is now, this new FNMA, this New Look, it will be capitalized at \$70 million by Uncle Sam, and then all the Joe Doakes of the Nation will put in 3 percent every time a mortgage is put up and that builds up the capital of FNMA.

Mr. MASON. It is the Texarkana banks that will put up the 3 percent. Where they get it I don't know.

Mr. PATMAN. Well, you are just spinning your wheels on that. We are not getting anywhere. I know the Texarkana bank is not going to pay it, and as smart a man as I know you are I know you don't believe it.

Mr. MASON. I don't think the provision should be in there; no, sir. I agree with you in that respect.

Mr. PATMAN. So I don't see too much in that. It looks to me like it is going to be pretty expensive for that poor Joe Doakes, you know. He has to pay interest on that \$9,600 and 3 percent of that he won't even get. Three percent of it is contribution to the Great White Father, here in Washington.

Mr. MASON. Now, Mr. Patman—

Mr. PATMAN. For permanent capital.

Mr. MASON. If the recommendation of the Chamber of Commerce of the United States is taken, that won't come out of Joe Doakes, and everybody will be happy.

Mr. PATMAN. That is all, Mr. Chairman.

The CHAIRMAN. Are there further questions?

Mr. O'BRIEN. Mr. Chairman.

The CHAIRMAN. Mr. O'Brien.

Mr. O'BRIEN. What is the rate of interest going to be under this program for these long-term mortgages, these 30- to 40-year mortgages on \$7,000 homes? What will the rate of interest be?

Mr. MASON. Are you talking about the section 221 program?

Mr. O'BRIEN. Give me the whole thing. What would the range of interest rates be under all of the program?

Mr. MASON. They would follow the market on money. That is, the President would change this rate so that we would not get into

the position we were in last year, when we had a time when house-building slowed down because builders could not get mortgage funds.

Mr. O'BRIEN. Do you contemplate now what the range would be? The range of interest rates, that is?

Mr. MASON. Right now the rate is adequate. What it may be in the future will depend upon the demand for money, as I see it.

Mr. O'BRIEN. Will there be any maximum?

Mr. MASON. We have suggested that a range of 2½ percent, as provided in the bill, is a safeguard against the President raising that rate unreasonably.

Mr. O'BRIEN. I mean the rate of interest the mortgagor pays.

Mr. MASON. That is right, the rate of interest the mortgagor pays, sir, is set by the President, under the new legislation.

At the present time it is set by the Congress.

Mr. O'BRIEN. Well, if we pass that authority to the President, would that give him authority to supersede maximums under State laws?

Mr. MASON. No, it would not, I don't believe.

Mr. O'BRIEN. Well—

Mr. MASON. Also the usury laws certainly would apply.

Mr. O'BRIEN. That is certain?

Mr. MASON. Yes.

Mr. O'BRIEN. Well, could you give, in figures, what the range of interest rates approximately would be under this bill, if passed, for the different features or sections? The interest rates paid by the mortgagor, that is?

The CHAIRMAN. At the present time it would be 1⅞ plus 2½, wouldn't it?

Mr. MASON. I cannot give you the figure.

Mr. O'BRIEN. Is this the first time in this sort of legislation that the rates have been made discretionary?

Mr. MASON. Yes, sir.

Mr. O'BRIEN. It is the first time?

Mr. MASON. They have been fixed by the Congress, so far as I know, in the past.

Mr. O'BRIEN. Do you envision any particular range of interest rates resulting from this discretionary power, in figures?

Mr. MASON. Well, it would be all the way from 4 percent to 5 or 5¼ percent.

Mr. O'BRIEN. Could it be 6 or 7 percent?

Mr. MASON. No, that is the kind of stop that is on there. Of course, the President, in our estimation, isn't going to be too liberal, anyway.

Mr. O'BRIEN. Then what charge to the mortgagor is there in addition to those interest rates? Is there any service charge for the mortgage?

Mr. MASON. For Federal Housing Administration mortgages there is; yes, sir.

Mr. O'BRIEN. What is that?

Mr. MASON. It is a half of 1 percent.

Mr. O'BRIEN. A half of 1 percent?

Mr. MASON. Yes, sir; that is the insurance premium.

Mr. O'BRIEN. And that is added to whatever interest rate the President fixes for a particular program?

Mr. MASON. That is correct.

The CHAIRMAN. Are there further questions of Mr. Mason?

If not, thank you very much, Mr. Mason, for your presentation.

Mr. PATMAN. Just a minute, I want to ask one other question, Mr. Chairman.

The CHAIRMAN. Mr. Patman.

Mr. PATMAN. You stated that this would follow the market. You know who makes the market, don't you? Doesn't the Federal Reserve Open Market Committee make the market?

Mr. MASON. Well, it helps to, sir, but I believe they told us that they did not make the market, that they only feel the market and make their loans accordingly.

Mr. PATMAN. Feel it? You mean there is no understanding or anything, you just kind of accept the market as they accept the pattern? Is that what you are saying, Mr. Mason?

Mr. MASON. I say that they claim to us that they do not set the market, but that they plan their borrowings so that it goes along with the market.

Mr. PATMAN. Well, you know last year, in the first half of the year, when they were not buying any bonds, and didn't buy any at all, that made money hard?

Mr. MASON. That is correct.

Mr. PATMAN. And interest rates high. You realize that, don't you?

Mr. MASON. That is correct; yes.

Mr. PATMAN. And in the last half they loosened up and made it easy.

Well, in the first half they made it hard and in the last half they made it easy, didn't they?

Mr. MASON. That is right.

Mr. PATMAN. So the Federal Reserve made the market, didn't they?

Mr. MASON. Well, they influenced the market, sir.

Mr. PATMAN. The Open Market Committee—well, they made it?

Mr. MASON. Well, that is a matter of opinion.

Mr. PATMAN. Yes. The Open Market Committee did that. So when you say the rate will follow the market, you mean it will follow the market that is made. Now, I understand that they are going to reduce the rediscount rate again. They reduced it the other day for the first time in 10 years. The only thing about that, the banks don't borrow from the Federal Reserve, so that is purely psychological, isn't it?

In other words, it is the Federal Reserve fixing a pattern, notifying the banks "We are going to have easier money." Is that the way you look at it?

Mr. MASON. Well, I know the effect on the housing market, sir, and I know that we can have, under a flexible interest rate, as this bill envisions, lower interest rates as well as higher ones.

Mr. PATMAN. And don't the banks follow this pattern, fixed by the Federal Reserve Open Market Committee, and if they raise rediscount rates that means harder money, and if they lower them that means easier money, doesn't it?

Mr. MASON. The amount of mortgage funds that are available in the essence sets the rate.

Mr. PATMAN. I am talking about the Federal Reserve fixing the rate and the way I think there is a kind of an unconventional under-

standing between the Federal Reserve and the banks. Although the banks don't borrow from the Federal Reserve, when the Board lowers the rate; they ease up.

Mr. MASON. Unfortunately, Mr. Patman, I am not Secretary of the Treasury, and I am not really competent to discuss that matter fully.

Mr. PATMAN. I am asking a fellow from way back in the grass-roots. I will bet you make a lot of these loans. How many of them did you make last year?

Mr. MASON. Well, I don't make loans, sir.

Mr. PATMAN. Well, I mean, though, you service them, through the banks, title I loans?

Mr. MASON. In New England, sir, we are not very dependent on FHA money. We have savings banks.

Mr. PATMAN. You have money outside of that?

Mr. MASON. Yes, sir.

Mr. PATMAN. I see.

Mr. MULTER. Mr. Chairman?

The CHAIRMAN. Mr. Multer.

Mr. MULTER. Mr. Mason, I notice that you indicate that extension or continuance of FNMA, and setting up of this secondary mortgage market, will be of help to the rank and file of American citizens in fast-growing areas such as the West and Southwest.

As I understood the operation of FNMA, that did not help those people at all. All that did was to take the mortgages off the hands of the lenders in the big communities, where all the capital was, and give them more capital with which to operate.

Mr. MASON. You are correct as to the past operations of the Federal National Mortgage Association, which is why we are in favor of doing away with the old Federal National Mortgage Association, liquidating it, as this bill provides, and setting up a new one, to really serve the people of America.

Mr. MULTER. Well, tell me, I am very much interested: How is the new one going to serve these areas that are not now getting any capital? I want them to get the capital. Show me how it is going to happen.

Mr. MASON. So do I, and so do hundreds of other small-town people who are interested in chambers of commerce around the country. That is what they tell us. The man in Missoula, Mont., area, which is growing and which does not have capital, their banking organization, if they have one, has limited capital, and yet they have a lot of people who want to borrow money. If we had a proper secondary mortgage market opening as we hope it would, this secondary market would buy from that bank the mortgage that it makes to the individual in that area and sell it to somebody in New York, or to some insurance company, some pension trust, some large reservoir of capital, which this man, being a small man, cannot spend his time to approach and won't spend his time to approach.

Mr. MULTER. If I understand you, we are in agreement that some organization should be set up to help that situation. I have studied the bill very carefully and have followed Mr. Cole and his staff in their testimony. I would like to have you point out what there is in this new bill that is going to accomplish that purpose that you and I think ought to be accomplished.

Mr. MASON. Well, this new secondary mortgage market facility should work that way, provided this 3-percent charge is not made, which will discourage the small banker from taking over.

Mr. MULTER. Well, now, wait, the 3-percent charge is a one-time 3-percent charge on the face amount; is that right?

Mr. MASON. That is right.

Mr. MULTER. With the elimination of that charge—

Mr. MASON. We don't eliminate it, we simply say that he will be able to get his money back when that loan is sold. We believe that this bank should not take advantage of this secondary market, if he has other facilities. We are not setting up something to transfer the whole loaning business. We just say there should be a penalty for his using it, but it should not be a penalty where he has that money tied up forever.

Mr. MULTER. Do you think that the refund of that 3-percent charge is going to bring that money, the capital, into those smaller communities?

Mr. MASON. I believe that this secondary mortgage market, working in this way, without this 3-percent charge, would bring the money to these small communities.

Mr. MULTER. I don't see how it is going to be done.

Mr. MASON. Well, I spent a great deal of time investigating this, and talking with people, and it is our opinion that it would do that, sir. I spent about three times exploring this particular feature and means of getting help to the small towns of America.

Mr. MULTER. I hope you are right. I don't see it being accomplished that way, though.

Thank you, sir.

The CHAIRMAN. Are there further questions of Mr. Mason?

If not, thank you, Mr. Mason.

Mr. MASON. Thank you, sir.

The CHAIRMAN. We have next Mr. John A. Reilly, president of the Second National Bank of Washington, D. C.

We are glad to have you, Mr. Reilly. You may proceed.

Mr. REILLY. Thank you, Mr. Chairman, and members of the committee.

STATEMENT OF JOHN A. REILLY, ON BEHALF OF THE AMERICAN BANKERS ASSOCIATION

Mr. REILLY. My name is John A. Reilly. I am president of the Second National Bank of Washington, D. C. I am also a member of the committee on Federal legislation of the American Bankers Association and chairman of its subcommittee on mortgage financing and urban housing. It is in this capacity that I appear here today to express the views of the American Bankers Association on the proposed Housing Act of 1954, H. R. 7839.

In general, we are in sympathy with the objectives set forth in the bill. It sets high goals for community betterment and improvement of home conditions in areas of need. It gives recognition to the value of the country's vast investment in existing homes and the need to preserve them. Consideration is given to the need for maintaining an adequate supply of new homes; to assisting all persons regardless

of race, color, or creed to have equal opportunities for adequate housing, and to assisting low-income families in their housing problems. It recognizes the principle of flexible interest rates and fees and charges to assist in providing an adequate flow of mortgage credit. It provides a more efficient mortgage insurance program through simplification and elimination of unnecessary provisions in the National Housing Act.

Although recognizing the importance of the slum clearance and urban renewal program set forth in title IV of the bill and the changes in existing statutes proposed in subsequent titles in connection with the overall national housing policy, we are directing our testimony to the first three titles of the bill, all of which relate to mortgage credit.

We approve generally the changes in the National Housing Act in title I of the bill which are designed to streamline and simplify the mortgage insurance program, such as (1) the transfer of the section 8, title I, small home loans to and its integration with section 203 loans; (2) the equalization of terms of insured mortgages on existing homes with those on new homes; (3) increasing the maximum limits on amounts of FHA mortgages, among others. Our views on these changes will be discussed in more detail later on in this statement.

However, there are other provisions of the bill to which we are opposed. Some of the methods proposed for achieving the objectives mentioned above do not conform with our interpretation of the basic national housing policy as expressed in the President's housing message and in the report of the President's Advisory Committee on Government Housing Policies and Programs. For example, instead of encouraging private enterprise to assume greater responsibility in meeting housing and home-financing needs without Government support or assistance, certain provisions of the bill involve the Government more deeply than ever in the housing and home-financing field. A housing emergency does not now exist. The great volume of mortgage credit which has been extended for home construction and the large number of new homes that have been built in recent years, all indicate that now is a time for Government participation in this field to be reduced rather than enlarged.

Savings funds are traditionally a primary source of mortgage investment capital. In the years following World War II savings have increased rapidly and financial institutions have invested these funds heavily in the mortgage market. In 1945 commercial banks had total savings and time deposits of \$30,155,000,000 and their real-estate loans totaled \$4,772,000,000. By 1953 total savings and time deposits in the commercial banks had grown to \$43,430,000,000 and their real-estate mortgages to a total of \$17 billion. In 1945 mutual savings banks had total savings deposits of \$15,385,000,000 and total real-estate loans of \$4,279,000,000. By 1953 total savings deposits in the mutual savings banks had grown to \$24,387,000,000 and their real-estate loans to a total of \$12,799,000,000. Thus, the investment in real-estate mortgages by both commercial banks and mutual savings banks during these years more than kept pace with the growth in their savings deposits. The same is true of savings and loan associations and life insurance companies.

In view of the growing participation in the mortgage business by private lenders and the filling of the emergency demands for housing,

the time has now come when it is appropriate for the Government to curtail its activities in the housing and home-financing field. If the theory is correct that Government assistance is sometimes needed to support the economy during a time of stringency, it certainly follows that the Government should withdraw its support when the need has been filled.

By the terms of the bill, and as implied in the President's message, it is the intention of the Government to maintain and even raise the present level of home building and to assure the means of financing it. Caution should be exercised in this regard for it can result in developing a program of home building beyond that necessary to satisfy a real need for homes or of the available credit means from private enterprise sources to safely finance such programs. It is true that home construction requires the services of labor, absorbs materials and supplies, and helps to create new markets for home furnishings, appliances, and conveniences. But it is not sound business to stimulate these processes beyond the ability of our economy to support.

The first proposal in title I of the bill relates to extending the amount and maturities of FHA title I loans for home modernization, repairs, and improvements. We see no objection to increasing the dollar amount of the home modernization credit limitation from \$2,500 to \$3,000 in class 1 (a) loans, but are opposed to increasing the maturity beyond the present 3 years and 32 days.

Expenditures for materials and supplies going into home repairs and improvements should generally be financed over a short period of time in the same manner that the purchase of other consumer durable goods are financed, for otherwise the whole credit base of the country is weakened. During recent years the banks have been making every effort to hold the line on maximum terms of consumer credit. If an expansion of terms of FHA title I loans is permitted it will inevitably bring pressure to bear for term expansion on other types of consumer credit loans, which we believe would not be sound for the consumer, the lender, or for the economy.

If the repairs, alterations, or improvements to the property are in the nature of long-term capital improvements, as distinguished from loans for ordinary wear and tear, longer-term loans, in larger amounts may be justified, but they should be secured by mortgage.

With regard to class 1 (b) loans, it is our opinion that the present \$10,000 loan limit and maximum term of 7 years, 32 days should continue unchanged for properties of 2- to 4-family units.

With regard to the rehabilitation of larger properties designed for more than 4-family units, we see no objection to raising the maximum amount to \$10,000 per structure, or \$1,500 per unit, whichever is greater, and for a maximum term of 10 years provided security in the form of a real-estate lien is required and that prior credit approval is obtained from the FHA.

FHA SECTION 8, TITLE I LOANS, SECTION 103

We are in favor of transferring the program for insurance of loans to finance small-home construction from title I to title II of the National Housing Act. Title I is designed primarily for the insurance of unsecured consumer credit loans. It is entirely proper that

the small-home construction program of section 8, title I, should be transferred to and integrated into section 203 of title II, thus consolidating it into the general FHA mortgage insurance program.

INCREASED LIMITS FOR FHA LOANS, SECTION 104

We support in general the restriction of credit to sound economic principles. Changing values in recent years, however, have occurred, and we therefore recognize the desirability of increasing maximum limits on amounts for FHA loans on 1- to 4-family dwellings as provided by the bill.

EQUAL FHA INSURANCE ON NEW AND EXISTING HOMES, SECTION 104

Within reasonable limits there should be some equalization of FHA credit on new and existing homes. However, we endorse the thinking expressed by HHFA Administrator Cole:

The FHA should not permit a maturity in connection with an existing house which is higher than warranted by the physical condition and expected economic life of the particular house involved.

To assure this objective we recommend that in no event should the loan on existing construction exceed 25 years.

THIRTY-YEAR MATURITIES ON FHA LOANS, SECTION 105

A primary reason for lengthening maturities on mortgages is to reduce the monthly payment. From the builders' or dealers' viewpoint this is very important, for it helps to sell houses. A 30-year \$10,000 mortgage at 4½ percent requires monthly payments of \$50.75 to meet payments for interest and principal. The same loan for 25 years requires \$55.60 a month, and for 20 years it requires \$63.30 a month. A prospective buyer of real estate is naturally more easily attracted to the \$50.70 payment, and it influences his decision as to the size of his investment and whether he would buy that house in lieu of another in which more conservative financing terms are required.

Actually, however, the longer maturity is not necessarily the best loan for the borrower. If a loan of \$10,000 was repaid over a 20-year period instead of a 30-year period, the borrower would save 10 years of interest charges.

To foster sound credit and strength in our national economy, a 25-year mortgage for larger loans is enough. The property owner must have some equity in his property to make the credit economically sound. In this period of high production of homes and very high prices for real estate, it is not desirable to provide longer-term loans and even more liberal terms.

TERMINATION OF FHA LOANS ON FARMS, SECTION 108

It is proposed to eliminate FHA insurance on farm housing loans now provided by section 203 (d) of the National Housing Act. Commissioner Hollyday has stated that the reason for terminating this provision is because it has been practically inoperative in the past. In view of the stated reason, we see no objection to terminating this provision. We believe, however, that farmers should have equal opportunity with all others for proper home financing.

TECHNICAL CHANGES

We concur in the provisions of the Housing Act of 1954 relating to eliminating the need of a mortgagor to certify on refinancing a mortgage, the adjustment of fees in foreclosure, the 10-year maturity provision for FHA debentures, and the annual insurance authorization for FHA, as provided by sections 107, 111, 112, and 121, respectively.

FHA LOANS ON RENTAL PROPERTY IN SLUM AREAS, SECTION 115

We favor extending authority of FHA to insure loans under section 207 of the National Housing Act on existing rental multifamily structures in community slum or blighted areas where part of the proceeds are used to repair or rehabilitate the property, as provided by this bill.

COOPERATIVE HOUSING, SECTION 119

We see no objection to increasing the top limits of FHA-insured loans on cooperative housing projects, as proposed by this section of the housing bill; providing that these limits should not exceed those provided under the rental housing program, except insofar as they provide preference for veterans.

NEW FHA SECTIONS 220 AND 221, SECTION 123

While approving in principle the need and desirability of urban renewal programs, the use of FHA insurance for this purpose needs very careful consideration and should be segregated to an individual insurance fund to support the entire risk. Insurance funds underwriting the risk on residential properties under other sections of the National Housing Act should not be commingled with slum-clearance and welfare housing programs. These types of loans have unusual risk, and their terms and conditions should reflect it.

We are opposed to the provisions contained in the proposed new FHA section 221 for insured loans to low-income families for 40-year loans with little or no downpayment.

The only possible attraction for a mortgage investor to this type of loan is the insurance protective feature, which is not sound justification.

Mortgages should be made to stand or fall on their own merits with insurance only as a secondary factor. Forty-year loans, even with the opportunity to convert into debentures at the end of 20 years, would of necessity depend heavily on the insurance factor for their marketability and are unsound in principle.

OPEN-END MORTGAGE, SECTION 125

We are opposed in principle to the addition of open-end mortgage contracts for FHA loans. There may be situations where the funds are used for capital improvement purposes which would be helpful to a borrower, but the way is opened for use for consumer credit purposes.

It is our belief that equities in real property should not be used as a means of extending the debt further, which delays true ownership of

a home. An open-end mortgage arrangement, unless very carefully controlled, can serve as a means for keeping the homeowner constantly in debt.

TERMINATION OF CERTAIN FHA INSURANCE AUTHORITIES, SECTIONS 126-129

Simplifying the National Housing Act by terminating FHA title VI loans to finance fabricated housing, title VII yield insurance provisions, title VIII loans on military housing, and title IX defense housing loans has our approval.

PRESIDENTIAL CONTROL OF INTEREST RATES AND MORTGAGE TERMS, TITLE II

Under the Housing Act of 1954 the President is given exceedingly wide latitude in the control of housing credit, which in turn can influence the volume of home construction if he determines it to be necessary. He can fix interest rates on FHA-insured and VA-guaranteed loans, determine adjustments in fees and charges, and direct the extension of Government credit through the new mortgage-marketing corporation.

To the extent that this authority provides a means for flexibility of interest rates on insured and guaranteed loans within specified limits and provides for an adjustment of fees and charges in connection with originating and servicing of loans in small communities and remote areas, we approve and believe that many of the ills of the past would be corrected.

FEDERAL NATIONAL MORTGAGE ASSOCIATION, TITLE III

If interest rates were to be permitted to adjust to the supply-and-demand factors of a free market, there would be no need, in our opinion, for any form of Government-supported secondary market facility, as private financial institutions would meet all reasonable demands for home financing through an adequate flow of investment funds into mortgages.

The discretionary authority given the President to adjust interest rates and fees and charges, if exercised in a manner that recognizes area differentials, would stimulate the flow of funds to those areas where demand may exceed supply and thus make the continuance of the Federal National Mortgage Association unnecessary except for the purpose of liquidating its present mortgage portfolio in an orderly manner.

We believe that, at the present rates on FHA and VA mortgages, private investors will supply all funds needed to maintain a sound volume of home construction and that a Government-supported secondary market will tend to overstimulate building, leading to an overproduction of residential properties.

INDEPENDENT STATUS FOR FHA

We have long felt that a mutual mortgage-insurance system such as the Federal Housing Administration should be an independent agency and not grouped with other agencies organized for different purposes or subject to policy control by a superior agency. It should be free

to establish policies consistent with sound insurance practices. We urge Congress to give consideration to restoring the FHA to a completely independent status.

That completes my statement, Mr. Chairman.

The CHAIRMAN. Are there questions of Mr. Reilly?

Mr. PATMAN. Mr. Chairman.

The CHAIRMAN. Mr. Patman.

Mr. PATMAN. Mr. Reilly, you heard me ask the preceding witness about the 2½-percent spread, did you not?

Mr. REILLY. I did, sir.

Mr. PATMAN. Do you agree that the spread heretofore has been 1½ percent?

Mr. REILLY. I do not. I have never heard of it.

Mr. PATMAN. You have never heard of it?

Mr. REILLY. No, sir.

Mr. PATMAN. We had testimony here the other day from a gentleman who represented the Veterans' Administration, and he said that 1½ percent was the customary spread; that is, the margin differential between the long-term Government yield and the mortgage rate. What has been the rate, then, Mr. Reilly?

Mr. REILLY. The rates have ranged anywhere from 4 to 5 percent. Very often the rate on Government bonds, long-term rate, has been 2½ percent.

Mr. PATMAN. Two and a half percent?

Mr. REILLY. Yes, sir. Three and a quarter recently.

Mr. PATMAN. You don't agree that one and a half has been the traditional margin?

Mr. REILLY. I do not, and I do not believe that one and a half is appropriate margin now.

Mr. PATMAN. You do not think it is sufficient?

Mr. REILLY. No, sir; I do not.

Mr. PATMAN. I notice on page 3 of your statement that real-estate loans totaled \$12 billion. How much of that was in FHA or other guaranteed paper, Mr. Reilly?

Mr. REILLY. I do not know that I can answer that, Mr. Patman. We do not have it here. We would be glad to supply it.

Mr. PATMAN. Well, was a major part of it or a minor part of it?

Mr. REILLY. I would think a major part of it, sir.

Mr. PATMAN. The banks don't generally take paper that isn't guaranteed one way or another by the Government, do they, Mr. Reilly?

Mr. REILLY. Oh, yes, I think a great many banks have taken conventional loans and have preferred them.

Mr. PATMAN. For what length of time?

Mr. REILLY. Under the Banking Act we cannot make them over 10 years and we have to get 40 percent back in before that 10 years.

Mr. PATMAN. And that is in the savings department?

Mr. REILLY. Yes.

Mr. PATMAN. In this you represent the American Bankers Association, don't you, sir?

Mr. REILLY. That is right.

Mr. PATMAN. Do you know a man by the name of Wendell T. Burns?

Mr. REILLY. Yes, sir; I know him very well.

Mr. PATMAN. Last year, June 22, 1953, he was before this committee, and I brought out the point—he was suggesting that the banks were not faring too well, or something along that line, and I brought out that the Government is out about a hundred million dollars a year clearing checks for the privately owned commercial banks, and I said “Now, is that complete subsidy? Are you in favor of that?” That is in the hearings on the housing amendments for 1953. [Reading:]

Mr. BURNS. Offsetting that, the Federal Reserve has these reserves deposited with the Federal Reserve banks.

Mr. PATMAN. But they can't use them.

Mr. BURNS. They invest them in Government bonds.

Mr. PATMAN. You are mistaken about that. You are getting off now. That is not accurate. You can't invest reserves of the Federal Reserve banks in Government bonds. They have no reason to invest reserves.

Mr. BURNS. Well, we are getting quite away from mortgages, but the Federal —

Mr. PATMAN. I know, but we are on subsidies. You mentioned the subsidy matter in your statement as being against all subsidies.

Mr. BURNS. All right. The Federal Reserve Board, however, does invest its surplus funds in United States Governments.

Mr. PATMAN. Oh, no; the Federal Reserve banks?

Mr. BURNS. Sure.

Mr. PATMAN. Why, of of course not. They can't invest these reserves. They have got to be kept right there intact, and they have no power to invest them. None. You are wrong about that, my friend. The Federal Reserve banks trade printed money—Federal Reserve notes—for the Government bonds they buy. In other words, the money is created by the Federal Reserve banks for that purpose. It is done under their power to create money.

You represent the great American Bankers Association, but they had better get you straight because you are wrong about that.

Now, then, I asked Mr. Burns to file a statement and correct that, but he never has done it, and I want to ask you, as representing the American Bankers Association, to file a statement about this. In other words, is it the policy of the American Bankers Association to tell the people, in educational campaigns, or otherwise, that the Federal Reserve banks are using the reserves of the commercial banks in buying United States Government bonds? Because I believe that that is incorrect, and I think it ought to be clarified. And I want to ask you, representing the American Bankers Association, to clarify that point in your testimony.

In other words, admit that Mr. Burns was wrong, or claim that he was right, and state why you believe he was right. Will you do that, Mr. Reilly?

Mr. REILLY. Mr. Patman, my testimony this morning was limited to the provisions of the housing bill. I am not prepared to discuss that, and I cannot speak for ABA on it.

Mr. PATMAN. That is the reason I asked you to file a statement.

Mr. REILLY. I will be glad to pass that on to the ABA authorities.

Mr. PATMAN. Will you do that, get a statement from the ABA on it and file it?

Mr. REILLY. I will pass your request on to them, sir.

(The data referred to was not received in time for printing in this volume.)

The CHAIRMAN. It is understood that you are to pass the request on to the American Bankers. So if the statement does not come in—

Mr. REILLY. It will be their decision, not mine.

The CHAIRMAN. The American Bankers Association and you, as far as I am concerned, may decide that that question is not germane to

this study, and at some other time we might have it before us. But I hope to confine these hearings to matters which are germane to the subject of housing.

Mr. REILLY. That is what we tried to do in our testimony, Mr. Chairman.

Mr. PATMAN. But the American Bankers Association cannot afford to have a statement out that is wholly false and untrue. If a statement has been made by their representative which is wholly unfounded and untrue, the American Bankers Association should be the first to want to come in and correct it because I don't think the association wants to mislead the people or this committee.

The CHAIRMAN. I assume if they want to make a statement they can do so, but I doubt if this is the time and place to make it, when we are discussing the housing bill. When we take up, if we ever do, the question of creation of money, or something along that line, it might be germane to that subject, but I cannot see how that subject is germane to housing.

Mr. PATMAN. Well, I want to call on the American Bankers Association for that statement and put it in as part of this gentleman's statement.

The CHAIRMAN. If they see fit to do so, that is up to them.

Mr. PATMAN. I hope the gentleman doesn't persuade them not to.

Mr. BETTS. Mr. Chairman.

The CHAIRMAN. Mr. Betts.

Mr. BETTS. At the bottom of page 6 of your statement, Mr. Reilly, you comment about the fact that farmers should have equal opportunity for home financing. What are your views on that?

Mr. REILLY. As I understand it, sir, the farmers have a number of agencies from which they can get credit, and they used the FHA facility to a very negligible degree, and for that reason it was recommended that it be eliminated. But the ABA wanted to be on record as saying that the farmers should have the same protection as anyone else, and we were only going along with that because Mr. Hollyday had stated in his testimony that it was not being used. I think he said six loans were all that were had under the section. That is our position.

Mr. TALLE. Mr. Chairman.

The CHAIRMAN. Dr. Talle.

Mr. TALLE. Will you yield, Mr. Betts?

Mr. BETTS. Yes, sir.

Mr. TALLE. I just want to make the observation at this point, that the initials FHA are confusing, because on the one hand they may represent the Federal Housing Agency, and on the other hand, the Farmers Home Administration. In each case the initials are FHA, and a person has to make clear which he is referring to.

Mr. REILLY. I was referring to the Federal Housing Administration, Dr. Talle.

Mr. TALLE. I realize that.

Thank you, Mr. Betts.

Mr. BETTS. I am interested in your comments on the open-end mortgage. Would you approve of it if there were some limitation put on the amount?

Mr. REILLY. I think that the open-end mortgage is going to be a very difficult vehicle to service. I don't agree with the statements that were made by others that it eliminates title expenses.

If you have an open-end mortgage, I think a lender would be bound to have that title brought down to date before he would make a subsequent disbursement on a loan already on the books. He would be foolish if he didn't, because there could be intervening judgments, or a lot of things that could have happened that would require a title report to make it sound. It is perfectly true he might not have to sign additional mortgage papers, and so forth, but he would have to get his title, which is the real expense.

Also the various States have laws in hopeless conflict on the subject. Some agree that they are, and some agree that they are not good for a community.

I think in view of that situation that anyone that needs a substantial improvement to his home, which should be the only time that an open-end mortgage is used, that he should go to the expense of having his mortgage reset, and have a new title—it isn't going to cost him very much more, anyhow—and you have got a nice clean mortgage and it will eliminate the abuse that can come from having an open-end mortgage every time somebody wants to borrow a little money.

It should only be used if the money is to be back into the house, but it is a difficult thing to police, and that is why we are opposed to it.

Mr. PATMAN. I can see your point.

The CHAIRMAN. I think there would be in the record a list of the States which authorize open-end mortgages.

Under the District of Columbia law, are they authorized?

Mr. REILLY. They are not, Mr. Chairman.

Mr. PATMAN. Mr. Chairman, I want to ask one other question about this 2½-percent margin.

The CHAIRMAN. Mr. Patman.

Mr. PATMAN. Mr. T. B. King—I believe you stated you hadn't heard about this—he is Chief of the Loan Guaranty Division, Veterans' Administration, testified before this committee on March 5, 1954, and stated, and I quote:

It is worthy of note that the 2½-percent spread contemplated by the proposed provisions exceeds that which experience has demonstrated is necessary.

Then I asked him this question:

Mr. PATMAN. Isn't it a fact that in the past 1½ percent was the normal spread?

Mr. KING. That is a point on which the Veterans' Administration insisted, until everybody got a little bit tired of hearing us insist on it, Congressman.

Mr. PATMAN. I beg your pardon?

Mr. KING. We maintained that point at considerable length, over the years.

Mr. PATMAN. One and a half percent?

Mr. KING. Yes, sir. We were advertising primarily to the situation, the market situation, which was in vogue, or which was experienced, prior to the March 1951 accord between the Treasury and the Federal Reserve Board.

Mr. PATMAN. So this is about a 75-percent increase?

Mr. KING. No, sir; the point is that 1½ percent has not been reflected by experience since March 1951.

In other words, before March 1951, when the so-called accord was made, the traditional rate, according to Mr. King, was 1½ percent. That is the point I was trying to make a while ago, Mr. Reilly.

Mr. REILLY. Mr. Patman, I think that 1½ percent was probably what was in his mind when the mortgage rate was 4 percent and the long-term Government rate was 2½ percent, and you had an abundant supply of money, then, of course, traditionally the spread was 1½ percent. But when money got tight a year ago, those same mortgages that were selling at par and sometimes above par sold as low as 91 and 92 in some sections, so that your traditional 1½ did not work. If you had a flexible interest rate at that time within reasonable bounds you would have protected it.

Mr. PATMAN. That is after this so-called accord. Some of the Government bonds went down to 89.

Mr. REILLY. That is correct.

Mr. PATMAN. Mr. Reilly, don't you agree that the Federal Reserve open-market committee determines the money market?

Mr. REILLY. I think it has a very pronounced influence on it. I would not say it determines it.

Mr. PATMAN. Well, last year, in the first half of the year, it was hard, and in the last half it was easy.

Mr. REILLY. I will admit that your evidence is good on that. I don't think they control it completely. There are other factors in the economy, too.

Mr. PATMAN. Well, when they have the power to go in the market and buy unlimited amounts of bonds that is bound to affect the market; isn't it? That is bound to affect the market?

Mr. REILLY. It always has.

Mr. PATMAN. Pardon me?

Mr. REILLY. It always has.

Mr. PATMAN. It always has; yes.

Mr. REILLY. Probably always will.

Mr. PATMAN. What disturbs me about that, Mr. Reilly, the Federal Reserve having so much power, the banks have too much power with the Federal Reserve.

I want the banks to remain prosperous and profitable. Do you consider a bank a public utility?

Mr. REILLY. Well, it is a question of what you mean by public utility.

Mr. PATMAN. There is, serving the public as a public institution.

Mr. REILLY. As I have always understood in a public utility you get a guaranteed rate of return on your investment; in that connection a bank is not a public utility.

Mr. PATMAN. That is right, to that extent it is not.

Mr. REILLY. As far as being interested in the public, as we all know, the depositors generally have 10 times as much money in the bank as the investors do, so we have a very strong responsibility to fulfill to our depositors.

Mr. PATMAN. But operating principally on the Government's credit—

Mr. REILLY. I don't agree with that at all. I think we operate on money that we lend to private people for industrial, commercial, and housing purposes. We are not subsidized by the Government.

Mr. PATMAN. The thing that disturbs me about the Federal Reserve Open Market Committee—I got their report the other day, March 5 report—and there is something in that report that I have been afraid of all the time. Namely, that the Open Market Committee, which is

the most powerful Committee in the United States, I suppose, as far as monetary matters are concerned, more powerful than Congress, because Congress has delegated the power in the Constitution to those 12 men—now, there is 1 vacancy on that Board, so there are just 6 members of the Board now, and 5 members who represent the private banks, because they were selected by the private banks, and the last report of the Board of Governors shows that on one important question, those 5 private representatives of the banks voted one way and there were only 4 members of the Board who voted the other way and the public members lost entirely. I don't believe that is right, for the financial affairs of the country to be under the control of the Board, if it can be dominated by the private banks.

That is the reason I say that Congress, in looking into housing, should look into that, too, and make sure that too much control is not lodged in the private banks in performing a public obligation.

I will not get off on that, Mr. Chairman.

The CHAIRMAN. Are there further questions?

Mr. MULTER. Mr. Chairman.

The CHAIRMAN. Mr. Multer.

Mr. MULTER. I am very pleased, Mr. Reilly, to find somebody finally coming forth representing private industry who is in agreement with what I have been saying on this committee for about 3 years. It is time that the Government got out of this insurance business.

They are trying to do it with this FNMA title. Eventually if that FNMA title is enacted and is administered in accordance with the intent of the law I think it will finally become a privately owned institution.

Why can't the same thing be done with FHA?

Mr. REILLY. Do you mean to make FHA a private agency?

Mr. MULTER. Yes. If the lenders of the country won't lend on mortgages unless they are guaranteed, why don't they set up their own guaranty agency?

Mr. REILLY. Mr. Multer, we did not consider that question, but I will be glad to give you my own views on it.

The FHA has been in business now for approximately 20 years. I don't think that FHA has had a fair test, as to what the liability is going to be on defaulted mortgages. As one of my associates said here a short while ago, you had to be a genius to make a mistake in the last 15 to 20 years.

We have had a very excellent situation, full employment at all times, shortage of houses, people who wanted occupancy, and they have gone in there and have kept their payments up because they had the money to.

Now, whether that is going to continue on indefinitely or not I don't know. I don't think the reserves have built up to a point where it could operate as an independent agency, because, say, whatever you think about it, when somebody in a small town out in the country makes a mortgage and wants to sell it to one of the permanent lenders in the big industrial centers, the guarantee of the Government of the United States behind that mortgage has a great deal to do with it, and whether you would destroy the market or not, I don't know.

As worthy as the thought may be, for the Government to get further out of business, I certainly would not subscribe to the FHA Federal

insurance being removed at this time because I think it would demoralize the market.

Mr. MULTER. Well, then, you don't mean what you say here, about getting the Government out of this business.

Mr. REILLY. Yes, sir; I say that, and don't get them further into business, and liquidate FNMA, but your question—

Mr. MULTER. I don't follow that. The bill before us is to take FNMA out of Government and make it a private enterprise. And it also says continue FHA and the Government-guarantee program. You don't want the Government to get further into business but you want FHA continued and the FNMA program discontinued.

Mr. REILLY. We think the FHA program is basically sound, with the 80-percent loans, 90- and 95-percent loans on the smaller amounts, insured by the Government, the monthly payments, the reserve for taxes—

Mr. MULTER. Isn't that the nub of it? You take the guarantees out of this, and the banks, particularly the commercial banks, won't buy these FHA mortgages. The reason why you have got an increase in commercial and time deposits, in savings and time deposits from \$30 billion to \$43 billion, with increase of your mortgage or real-estate loans from \$4 billion to \$17 billion, is because they are guaranteed by the Government, and you look upon those guaranteed mortgages just as you do upon a long-term Government bond.

Mr. REILLY. That is perfectly true, but if you restrict the banks to conventional mortgages, and you have to make 60-percent loans, you are going to deprive a great many millions of people in the United States of housing that they apparently need, sir.

Mr. MULTER. Yes, we heard that same cry, though, about amortized mortgages. The banks wouldn't make amortized mortgages. The only way was the traditional way, long-term mortgage, 3 years, 5 years, pay it off at the end of that time or renew for the full amount.

HOLC came along and proved the way to do is to amortize. FHA has proved the same thing.

Now, don't you think it is time that the real estate and banking and lending fraternities stood on their own feet on this program?

Mr. REILLY. I certainly think it is a worthy objective, but whether you can expect the banks to lend 90 or 95 percent without a Government guarantee is something that I would very seriously doubt. We will lend 60. We are glad to lend them, on an amortized basis.

Mr. MULTER. I hope the test that some people think is the only test to prove whether this program can stand on its own feet will never come. Because apparently unless you get a full-scale depression you will never get the test to see whether these mortgages will stand up.

Mr. REILLY. I don't think you need a depression to test it out. I think you have got to have a greater supply of the houses than are needed for occupancy, and then the market will seek its own level. I don't think you need a depression to do it.

Mr. MULTER. Well, now, you also comment here, along that same line, that we are no longer in an emergency so far as housing is concerned.

I think unfortunately when an emergency goes on long enough we accommodate ourselves to it and overlook it being an emergency and think it is normal.

The fact is we don't have enough housing in this country today. Isn't that so?

Mr. REILLY. We don't think there is an emergency in housing. We think it can be met through normal sources.

Mr. MULTER. Well, do you think it is possible for us to build more than 1½ million family units a year in this country?

Mr. REILLY. I suppose it is possible. I don't know that is desirable.

Mr. MULTER. Is it likely?

Mr. REILLY. No, it is not likely.

Mr. MULTER. Do you agree with the statement that it will take at least 10 years of building, at a million and a half family units a year, to catch up with the demand?

Mr. REILLY. I don't think it would take that long, sir. I am frank to say that I have no alternative suggestion to make, but I think that the housing problem is one that is going to be with us from here out as long as we want to raise the standard of living of people, and to get the ultimate objective it might take that long, but I am talking about normal supply and demand. I don't think we have an existing shortage, except in certain possible areas, but, generally, there has been a catching up of that, and I believe the market is going to seek its own level. It certainly is true in this area.

Mr. DEANE. Will you yield?

Mr. MULTER. Yes.

Mr. DEANE. One of the witnesses testifying yesterday, Mr. Reilly, quoted from a survey conducted by Fortune magazine, which indicates that estimates by Fortune magazine are that the annual average housing construction needed, in the period 1955 to 1960, was 1,400,000. Did you see that survey, or would you agree with it?

Mr. REILLY. I didn't see it, sir, and I am not prepared to say whether it is accurate or not.

I have understood, generally, in talking to bankers throughout the country, that the housing situation is not as acute as it has been, and we are getting back to a more normal market. That certainly is true, I think, in the metropolitan area of Washington, with which I am personally familiar.

Mr. DEANE. Thank you, Mr. Multer.

Mr. MULTER. I understand that you agree with the standby authority given to the President as to controlling the interest rates, flexible interest rates?

Mr. REILLY. Yes, sir.

Mr. MULTER. And the like as set forth in your statement?

Mr. REILLY. Yes.

Mr. MULTER. Tell me, how is that any different from the standby controls we tried to give the President last year? Never mind standby price controls, but referring only to standby credit controls. How is this any different?

Mr. REILLY. Well, it measures the flexibility of the rate by 2½ percent, and I think that that is one of the greatest safeguards in it, that the President can determine what that rate should be and not have discounted paper on the market.

Mr. MULTER. Do you think anything has happened since the beginning of last year, 1953, to change our thinking on whether or not the President should have standby credit controls?

Mr. REILLY. I surely do, sir.

I disagreed with it last year. I agree now that he should have it because there is an abundance of money.

Mr. MULTER. Well, is it only when there is an abundance of money that you need them?

Mr. REILLY. No; but I think I have revised my opinion about it. I think he should have it.

Mr. MULTER. In other words, somebody should have the authority to act when money gets tight and when money gets loose?

Mr. REILLY. That is correct.

Mr. DEANE. Will you yield?

Mr. MULTER. I yield.

Mr. DEANE. One other point: You said that the banks are prepared to move in and do this financing, generally speaking. Is that true?

Mr. REILLY. I think it is true, Mr. Deane. I think that you will see, from some figures that I saw the other day, that the time deposits in the various banks, and in the mutual savings banks, in the reserves and insurance, have built up \$12 billion in the last 12 months.

Mr. DEANE. Where are those banks?

Mr. REILLY. Largely in the eastern section of the United States, the larger sections.

What we have got to do in the banking business—

Mr. DEANE. I want to follow the point for a moment. You said in the eastern sections, and in the larger sections?

Mr. REILLY. Yes.

Mr. DEANE. Well, now, the Congress and this committee have to think in terms of the entire country, and I doubt seriously that your statement will measure up so far as the smaller community banks are concerned. Isn't that true?

Mr. REILLY. That is what I was trying to explore for you. I think that what we have got to do is to find some vehicle to bring together the permanent lender and the originator of the mortgage and the homeowner.

I think it is the small areas that have been deprived of what they should have, sir, and I think that that is a challenge to the banking profession, and I hope that if the Government gets out of this business that we will be able to meet that challenge. There is plenty of money available to do it, in my opinion.

Mr. DEANE. Thank you, Mr. Multer.

Mr. MULTER. Mr. Reilly, you say on the last page of your statement:

FHA should be free to establish policies consistent with sound insurance practices.

Are you referring there to sound insurance practices such as are followed by the private insurance companies in insuring credit?

Mr. REILLY. No; I don't think the FHA's insurance funds should be diluted with welfare programs. I think it should be an independent insuring agency. These premiums are paid by those people, and I don't think those funds should be diverted for welfare purposes.

Mr. MULTER. Is the FHA program a welfare or subsidy program?

Mr. REILLY. No, sir; I don't so regard it. I think it is a sound insurance program.

Mr. MULTER. Is that because it guarantees the bankers and lending institutions against loss?

Mr. REILLY. No; I think it is a sound insuring program.

Mr. MULTER. Yet you won't compare it with credit-risk insurance?

Mr. REILLY. With credit-risk insurance?

Mr. MULTER. Yes; that is carried on by the private insurance companies.

Mr. REILLY. I don't think that I understand your question.

Mr. MULTER. Well, are you familiar with the credit insurance issued by private insurance companies throughout the country?

Mr. REILLY. Oh, yes; I am familiar with credit insurance.

Mr. MULTER. Why shouldn't we insure those programs?

Mr. REILLY. I don't think you should.

Mr. MULTER. Why not?

Mr. REILLY. I think that the housing program was something that the people had to have—

Mr. MULTER. What good is housing if we don't have an economy in which they can earn the money to pay off their mortgages?

Mr. REILLY. I think if the FHA is let alone, that it will stand on its own feet and will be able to pay them off.

Mr. MULTER. As long as the Government is guaranteeing them?

Mr. REILLY. Well, the payoff will come out of the reserves built up out of the insurance premiums paid by the borrowers. I think it is a sound program. But I don't think it has received a sufficient test yet, to say turn it over lock, stock, and barrel to private enterprise and to expect the market to maintain its hold on it.

Mr. MULTER. It would be a sound program provided the Government is not called upon to make any payment, and that any payments that are required to be made under the guaranties come out of the reserves; is that right?

Mr. REILLY. I would say that would be ideal; yes, sir.

Mr. MULTER. And those reserves necessarily would be built up out of the profits of the program?

Mr. REILLY. That is correct.

Mr. MULTER. Isn't that private enterprise?

Mr. REILLY. That is what we think.

Mr. MULTER. Why shouldn't it be private enterprise?

Mr. REILLY. You have got to have the marketability of the loans guaranteed by the Government or you won't be able to sell the loans because a 95-percent loan is not bankable without a guaranty on it. That is the reason for it.

Mr. MULTER. That is the reason the Government got into the program in the first place?

Mr. REILLY. That is correct. You would not have had any housing if it didn't.

Mr. MULTER. The insurance companies and other lenders wouldn't lend moneys for that?

Mr. REILLY. We don't feel we should lend depositors money at 95 percent and take 25 years to get it back.

Mr. MULTER. That is what this program is. If the premiums don't build up enough reserves the taxpayers' money is going to guarantee you against loss.

Mr. REILLY. I think that is true.

Mr. MULTER. That is not a welfare program, then?

Mr. REILLY. It hasn't operated as welfare. My difference, there would be the clearing up of these slums and doing this work, where the people need actual protection by the Government. In this program the borrower puts his money down, puts his downpayment down, and makes his monthly payments, his credit is analyzed, it is supposed to be a sound basis—

Mr. MULTER. Will you admit that we should have slum clearance, and that we must clean out the blights in the various communities?

Mr. REILLY. I certainly do; and I don't think we need to go any further than right here in Washington, but I don't think that we should expose this reserve fund to that kind of work. I think it is a problem of the Government.

Mr. MULTER. Then what you are saying is that both programs are needed and they are necessary, the one should be carried on by an agency which will use the taxpayers' money as an outright subsidy, that is the slum-clearance and rehabilitation program, and the other should be kept separate as a strictly business enterprise with the Government in the business.

Mr. REILLY. That is right.

Mr. MULTER. Just one thing more, sir: I noticed that in the beginning of your statement you said that these alteration and repair and improvement loans, in larger amounts, may be justified, but they should be secured by mortgage. And then, in the latter part of your statement, you say that you do not approve of the open-end mortgage.

Mr. REILLY. That is right.

Mr. MULTER. Now, if these repairs are to be secured by mortgage, and we are not to have the open-end mortgage, then we have got to get back to the old second or third mortgage market.

Mr. REILLY. No; I think you could pay off your existing mortgage and get a larger mortgage, probably, by the same lender, or by a different one, and wrap it up in one package. The reason we object to the extension of title I to the 5-year period is because we think that it encourages people to be extravagant.

Mr. MULTER. We are now not talking about term. We are talking about the security. At least that is what I intended to direct your attention to. I am not going to get into an argument with you as to whether it should be 3 or 5 years on these loans. We are now talking about the security, and I am directing your attention to the fact that you think that those repair and alteration and improvements loans should be secured by mortgage, in the larger amounts.

Mr. REILLY. We would be glad to amend that statement by first mortgage. That is what we mean.

Mr. MULTER. What is the difference between refinancing the existing mortgage, with a new mortgage, and adding on to that the cost of the repair, and adding the cost of the repair to an open-end first mortgage. It is still a first mortgage.

Mr. REILLY. Yes, but the people will use the money for things other than the house, which they should not do, and they are going to have to get their titles, anyhow, and the laws of the various States are in hopeless conflict on the subject, it stimulates speculation, and a good many people who maybe do not have the same high degree of ethics as others would use that open-end mortgage to abuse the homeowner.

Mr. MULTER. What I see in your objection, sir, is that you would

rather do it your way, of refinancing the mortgage, and adding on the cost of repair to the new mortgage, because that means a financing of a \$10,000 mortgage, and paying for a \$10,000 mortgage, instead of taking a first mortgage of \$7,000 and letting it stay, and adding \$3,000 at the end of it.

Mr. REILLY. We feel it is better for the borrower.

Mr. MULTER. Instead of paying a finance charge on \$3,000, he is going to pay it on \$10,000. That may be good business for the lender but I don't think it is good for the owner.

I think on an open-end mortgage you would be paying a higher premium than you would on a repair loan. Because the people who make those loans would see they got their charges. They wouldn't come through the banks.

Mr. MULTER. I don't think that has been the experience.

Mr. REILLY. In some locations it may have worked, but we think the open-end mortgage leads to things that are not good for the borrower. We think that you should not make the loan unless you get a title, brought down to date, and it costs you almost as much, if not as much, and you would be foolish to make it if you did not do it because of possible intervening judgments and liens against that property, so we don't see that it serves any useful purpose, and that is why we are against it. Not to get additional commissions.

Mr. MULTER. Tell me, what do you think the reaction will be of the banks and insurance companies that are lending money on real-estate mortgages to the program for \$7,000 houses with 40-year terms?

Mr. REILLY. What do we think the reaction will be?

Mr. MULTER. Yes.

Mr. REILLY. We are absolutely opposed to that.

Mr. MULTER. Do you think that any of the bankers or insurance companies will support that kind of a program?

Mr. REILLY. I do not, sir.

Mr. MULTER. You think not?

Mr. REILLY. I think not. Forty years is too long, and no downpayment is no good.

Mr. MULTER. And the fact that the program calls for issuance or the taking up of any balance unpaid at the end of 20 years, and the issuance of bonds against it, you don't think that would affect the situation?

Mr. REILLY. I don't think that adds a thing to it, because if you have a mortgage in good shape at the end of 20 years, why would you change a 4½ percent mortgage for a 2½ percent debenture? I don't think it means anything. It is just a bait.

Mr. MULTER. So, first, we have got to find the builder who is willing to build a \$7,000 house, and then a lender who is going to lend, even with a guaranty?

Mr. REILLY. That is right.

Mr. MULTER. You don't think that program will produce any houses?

Mr. REILLY. I don't think it is sound, and I don't think it will work.

Mr. DEANE. Will you yield?

Mr. MULTER. Yes.

Mr. DEANE. Why can't we have a \$7,000 house?

Mr. REILLY. I didn't say that. I said you shouldn't have a \$7,000 house with no downpayment and 40 years to pay it back.

Mr. DEANE. What would you recommend for, say, the people in the Southwest Washington area, where a witness yesterday said the average rental was around \$10 to \$44 a month? What type of housing do you recommend for those people when they are displaced?

Mr. REILLY. I think they have got to be taken care of but I think—

Mr. DEANE. What would your organization recommend?

Mr. REILLY. I don't know, but certainly a person living in a slum area now paying a low rental is no kind of a risk to build a house for and sell it to him for \$7,000, and take his note and give him 40 years to pay it back. There has got to be some Government subsidy in that, as I see it.

It is a social-welfare problem that has to be solved by the Government and not by lending money to them.

Mr. DEANE. You understand I am not trying to put you on the spot.

Mr. REILLY. I understand.

Mr. DEANE. We must do something for those people.

Mr. REILLY. We surely do. I think it is a Government welfare program and should be considered by the Congress as such. And not toss it off into the loan field.

Mr. DEANE. Is that the viewpoint of the American Bankers Association?

Mr. REILLY. It certainly is.

Mr. MULTER. I would like to clear this up. By my questions with reference to the \$7,000 house, and I think by your answers, Mr. Reilly, neither you nor I intend to infer that we cannot build a fairly good house for \$7,000 in certain areas?

Mr. REILLY. That is right.

Mr. MULTER. But as long as there is a demand for a \$10,000 house the builder is going to build the \$10,000 house.

Mr. REILLY. I think it is reasonable to assume that.

Mr. MULTER. That is all.

Mr. PATMAN. I want to ask you about this 3 percent, Mr. Reilly, under this substitute for FNMA.

This 3 percent is to be paid by the borrower, under the bill as written, as I understand it. Is that your understanding?

Mr. REILLY. That is my understanding of it. It certainly would not be paid by the Second National Bank. We would not pay it.

Mr. PATMAN. Well, you heard the discussion here a while ago with Mr. Mason, and you agree that the banks certainly are not going to pay it. They don't expect to pay.

Mr. REILLY. I said my bank would not pay it.

Mr. PATMAN. You don't know of any banker that would?

Mr. REILLY. No.

Mr. PATMAN. So that 3 percent, under this bill, will be paid by the borrower, and it will go into the fund for the public good, and will be forever a part of the capital of the organization. Is that your understanding?

Mr. REILLY. Of course, it seemed to me that that would be the normal phase of it, but the bankers are opposed to that, anyhow.

Mr. PATMAN. I understand that.

In other words, on a \$10,000 mortgage this Joe Doaks I was speaking of, or John Q. Public, would pay \$300—3 percent—into that fund. So he would actually get about \$9,700.

But for a period of time—is it a 25-year mortgage, or what is the length of the mortgage?

Mr. REILLY. Thirty-year mortgage.

Mr. PATMAN. For 30 years he would pay interest on this loan as though it were \$10,000, when he actually didn't receive but \$9,700, and he would be making a contribution of \$300 to the permanent capital of the new FNMA?

Mr. REILLY. Well, we are opposed to that.

Mr. PATMAN. I understand you are, Mr. Reilly.

That is all, Mr. Chairman.

Mr. MERRILL. Mr. Chairman.

The CHAIRMAN. Mr. Merrill.

Mr. MERRILL. Mr. Reilly, do you think that the difference of 2½ percent between the bond rate and the maximum mortgage rate, in this bill, is enough to assure a steady and adequate flow of private capital into this program?

Mr. REILLY. I would think so; yes, sir.

Mr. MERRILL. Is it your understanding that that rate can be adjusted to different regions?

Mr. REILLY. Yes; that is what we are recommending, a flexible rate, so that if the rate in an area will not produce the loans, the rate can be changed.

Mr. MERRILL. How small a region would that be?

Mr. REILLY. It would depend on the locality in the country. Some of these small-town moneylenders, they don't think in 4½ or 5 percent, they think in terms of 6, 7, and 8 percent, and that is the reason for this Government guaranty on this FHA mortgage, with a flexible rate, recognizing that money costs more in those areas, it would work out all right. That is why the bankers feel that flexibility is necessary.

Mr. MERRILL. The flexibility would not necessarily be on geographic areas, but on size of towns?

Mr. REILLY. Size of towns and available money.

Mr. MERRILL. Do you understand that there is anything in the bill that would prevent the President from determining the manner in which he would determine the variation?

Mr. REILLY. I think not. It is a broad discretion that he has, and I think that is what it should be.

Mr. MERRILL. Do you think there in any other method, other than giving this broad discretion to the President, by which we might bring about the necessary flexibility in the interest rate?

Mr. REILLY. I know of none at the present time, sir. I couldn't make any suggestion.

Mr. MERRILL. This is the very best plan——

Mr. REILLY. That has been devised up to now.

Mr. MERRILL. Coming to another point, do you take the position, then, that public housing is the only solution for taking care of these displaced people?

Mr. REILLY. No, I think grants-in-aid can be of assistance, and not outright public housing.

Mr. MERRILL. Then, you mean to make a grant-in-aid instead of a more liberal loan?

Mr. REILLY. That is correct.

Mr. MERRILL. You would prefer to give a man a thousand dollars rather than give him a more liberal loan?

Mr. REILLY. I would not give him the thousand dollars to spend, but would make it available in some way to supplement what he can afford to pay.

Mr. MERRILL. Yes. You think the better plan would be to make a direct grant to one of these displaced persons, toward the purchase of a better home, so that the loan then would be sound rather than—

Mr. REILLY. But I would like to see private enterprise build the houses, and not the Government.

Mr. MERRILL. I see.

Thank you.

Mr. MULTER. Mr. Chairman.

The CHAIRMAN. Mr. Multer.

Mr. MULTER. When you say rather than Government build the housing, you don't mean that the Federal Government is building public housing; do you?

Mr. REILLY. No; I would rather let private enterprise do the job as far as it can rather than let the Government take them over and collect the rents and rent them out as public housing.

Mr. MULTER. Even where the municipalities build public housing it is private enterprise that built them.

Mr. REILLY. But private enterprise does not collect the rent. Rental is under a governmental operation.

Mr. MULTER. Do you mean, then, that the municipality or State, with or without Federal aid, should put up public-housing projects and turn them over to private enterprise?

Mr. REILLY. No, sir; I think private enterprise should do the building.

Mr. MULTER. Well, do you know of any public-housing project in any part of this country which was put up by private enterprise for private enterprise operations?

Mr. REILLY. I don't know of any where private enterprise did it.

Mr. MULTER. And the reason they have not done it is because even where you give them tax exemption they cannot build any housing that will rent low enough to accommodate that lowest income group that goes into the public-housing projects?

Mr. REILLY. That is right. It is economically not sound.

Mr. MULTER. I think the rule is almost uniform throughout the country that no family earning more than \$2,000 a year in income may enter a public-housing project.

Mr. OAKMAN. Mr. Chairman, that is not the case.

Mr. MULTER. Where their income goes up they may not be put out but they should be. The regulations require it.

Do you know of any place where they move in in the first instance where they have greater income?

Mr. OAKMAN. We have them with as high an income as \$300 a month in public-housing units in Detroit.

Mr. MULTER. Well, I am sure there is something wrong with your public-housing project, then.

Mr. OAKMAN. For a single man, or a couple without dependents, you are possibly right, but if they have 3 or 4 or 5 children it goes up very rapidly.

Mr. MULTER. Almost 90 percent of the figures I have seen in the regulations stop just under \$2,000 as the maximum income per family.

If there are any other than that in your area you should know, but I think it is violative of the principles set up in all these public-housing projects.

Mr. OAKMAN. Mr. Chairman, may I put that in the record, the scale for Detroit? I imagine it would be somewhat uniform throughout the country.

Mr. MULTER. You will find it set forth in the President's Advisory Committee's report on housing.

The CHAIRMAN. Scale of income? Can't we agree as to an average?

Mr. PATMAN. I know that a lot of them have much larger incomes after they get in there.

Mr. MULTER. They should be put out. I think you will find the figures in exhibit 9, page 297, of the President's Advisory Committee's report, and if there is no objection we might insert that page in the record at this point, Mr. Chairman.

Mr. DEANE. Mr. Chairman, I understand that was inserted the other day.

Mr. HALLAHAN. It is already in the record.

The CHAIRMAN. Apparently it is already in the record.

Mr. McDONOUGH. Will you yield?

Mr. MULTER. Yes.

Mr. McDONOUGH. Do you believe that in the administration of a public-housing program that none but those who earn up to \$2,000 a year should be admitted—not more than that?

Mr. MULTER. Yes, the lowest income group are the only ones that should be accommodated in public housing.

Mr. McDONOUGH. And that after they are admitted, if their earnings increase to the extent, we will say, of \$50 or \$100 a year, that they should be ordered out of the public housing?

Mr. MULTER. Well, you have got to draw an arbitrary line somewhere.

Mr. McDONOUGH. I am asking your opinion.

Mr. MULTER. Whatever is the limit for eligibility. When they get beyond that eligibility they should be given a reasonable time to find quarters outside of the project. That is what we do with them in New York City.

Mr. McDONOUGH. Don't you think that there is a tendency on the part of the individual not to seek a better job and to stay within the earning limit of the public-housing specifications?

Mr. MULTER. That has not been our experience in New York City.

Mr. McDONOUGH. How many have you moved out after you put them in?

Mr. MULTER. I think our moving rate in public-housing projects in the city of New York is the greatest moving rate we have in the city. They move in and out frequently. And they are moving in and out frequently because they must move out. They get beyond the eligibility limitations and are required to move.

The CHAIRMAN. Will you yield?

Mr. MULTER. I yield.

The CHAIRMAN. You say \$2,000 should be the maximum. I understand that at the present time, a short time ago, some months ago, the average was \$2,600. The rate of income is set by the Public Housing Authority. We had the figures here once that the average income to be eligible for occupancy in a public-housing project was \$2,600.

Mr. MULTER. I don't want to be put in position of appearing to quibble, but we cannot sit here and say whether it should be \$2,600 or \$2,100. But these agencies are in a position to determine what is the lowest income group and take care of them. Whether it is \$2,000, or \$2,100, or \$2,600, isn't important. The important thing is that we establish the principles that the lowest income group can be taken care of only, and that is what should be done.

The CHAIRMAN. Wait a minute; I don't understand that the public housing is intended to take care of the lowest income people. Then you get down into relief. You have a social problem there.

We have to set an annual contribution, on some basis, on public housing.

Mr. MULTER. I thought we had gotten beyond discussing the philosophy of whether or not it was wise to supply housing to the lowest income group or the people who had the lowest income.

The CHAIRMAN. I understand that the lowest income group has never been taken care of in public housing, and that is why some of us have objected to the program. You held out that public housing is, in fact, slum clearance, and you have played upon this idea that public housing is slum clearance throughout the years.

Mr. MULTER. I for one—

The CHAIRMAN. You and I know that public housing is not necessarily slum clearance, and that we do not take care of the lowest income people. We might as well be realistic about it.

Mr. MULTER. Mr. Chairman, there are two different matters to be taken care of. One is clearing the slums, and I haven't heard anybody who is opposed to that.

And quite apart from the clearing of the slums is the other problem of taking care of those who cannot buy or rent housing within which to live. That is the lowest income group, isn't it?

The CHAIRMAN. No, it is not the lowest income group.

Mr. MULTER. What is it?

The CHAIRMAN. You don't take care of the lowest-income group in public housing. So you can't say public housing takes care of the lowest-income group.

Mr. MULTER. Whom do you take care of, then?

The CHAIRMAN. You take care of no one who does not qualify on the average of income of more than \$2,600.

Mr. MULTER. Isn't that the lowest income group?

The CHAIRMAN. No.

Mr. McDONOUGH. Mr. Multer, in your welfare administration in New York City, or any of the other States of the Union, there is the agency for the counties or the States that contract the rental of houses for people who are eligible for aid. We are doing it in Los Angeles County by the hundreds of cases, finding homes for those people who cannot or will not earn enough money to take care of themselves and their families. But the Federal Public Housing Agency of the Federal Government is only, if at all, taking care of those groups that the county and State don't take care of on relief.

Mr. MULTER. The Federal Government, as such, does not house anybody. It makes contributions to the States, and for these public-housing projects, and every public-housing project is run either by the State or the local municipality.

Mr. McDONOUGH. Yes. But under very strict regulations of the Federal law.

Mr. MULTER. That is right.

Mr. McDONOUGH. But it only takes care of those people that the States and counties cannot take care of, and those that are between that maximum and minimum wage.

Mr. MULTER. Who takes care of what the city and State does not take care of?

Mr. McDONOUGH. That is what you say public housing is supposed to do.

Mr. MULTER. I did not say any such thing.

Mr. McDONOUGH. Well, you tell me who it does take care of.

Mr. MULTER. Your public-housing program, as the Congress has set it up, as your Federal statute sets it up, provides for loans and grants to States and the local municipalities, which, in turn, build the public-housing projects. You cannot name a single Federal public-housing project that the Government is running, or that the Government has built, meaning the National Government.

Mr. McDONOUGH. Who do the public-housing authorities take care of?

Mr. MULTER. They are intended to take care of the lowest income group. Those who cannot otherwise get housing because of lack of income.

Mr. McDONOUGH. That is where you are wrong. They are not taken care of in public housing.

Mr. MULTER. Maybe we are talking about different things. What is the lowest income group?

Mr. McDONOUGH. There are many categories.

Mr. MULTER. There are not. For the purposes we are talking about the lowest income group is the lowest third of the earners of the country. You have the middle income group, the highest, and the lowest.

Mr. McDONOUGH. What is the line of demarcation?

Mr. MULTER. Approximately \$2,000.

Mr. McDONOUGH. Everybody below \$2,000 should be taken care of by public housing; is that what you mean?

Mr. MULTER. I did not say that. In some areas they take care of them, and in some it is less. Those who cannot take care of themselves, those who cannot get decent housing ought to be provided for in the public-housing projects, and no one else. And if any in those projects are earning more and have gone into second class, they don't belong there and should be ousted.

Mr. McDONOUGH. So that eliminates the charitable organizations of the States and counties.

Mr. MULTER. It does not.

Mr. McDONOUGH. Say the lowest income groups, below \$2,000. That takes care of all the rest.

Mr. MULTER. How does it take care of all the rest? Take a man who is earning \$10 a month, and his rent is \$40 a month. How does he pay that? The county charitable organization pays the difference.

Mr. McDONOUGH. He has to go to a charitable organization in the State.

Mr. MULTER. What has that to do with the problem we are talking about?

Mr. McDONOUGH. It has everything to do with it.

Mr. MULTER. You are saying a man earning \$10 a month can go into the project. I agree. But he has to pay \$40. So charity has to pay his rent. What has that to do with this problem? We used to send them to the poorhouse. It has now been decided as a matter of good social planning and good government that we should not have people living in poorhouses.

Mr. McDONOUGH. Not in poorhouses, in private homes.

Mr. MULTER. That is what your public housing is trying to do.

Mr. McDONOUGH. Before the public housing ever existed they were contracting for private homes.

Mr. MULTER. That does not change the problem.

Mr. McDONOUGH. It was taking care of them and we did not need public housing on the part of the Federal Government.

Mr. DEANE. Will you yield, Mr. Multer?

Mr. MULTER. I yield.

Mr. DEANE. Getting back, Mr. Reilly, to a question asked a moment ago about the adjusting of the interest factors, region by region, where do you think the interest rate would be the highest?

Mr. REILLY. Well, at the very highest, it is about the 15-year average on Government maturities, and I would say that that would be less than 3 percent, possibly 3 percent and add the $2\frac{1}{2}$ on that, which would be $5\frac{1}{2}$ at the very highest.

Mr. DEANE. In other words, they could go to $5\frac{1}{2}$ or 6 percent, in your opinion?

Mr. REILLY. It depends on the Government rate for 15-year maturities. But the way they have got to manage the bond account, that rate cannot get too high.

Mr. DEANE. As I understand the bill, the President could determine what the interest factor would be?

Mr. REILLY. Two and a half percent above the average 15-year rate for Government money, and that is the limitation, and I think it will take care of itself.

Mr. MULTER. I didn't think Mr. Deane was going to change the subject.

I want to revert to public housing for a moment. You suggested that it might be better to have the Government make a grant of as much as a thousand dollars to the person who—

Mr. REILLY. No, I didn't say a thousand dollars. You asked me if I would rather give him a thousand dollars. I said I wouldn't give it to him but would handle it through an agency. I haven't any idea what it should be, Mr. Multer.

Mr. MULTER. I want to point this out to you and see if you agree with me: If we are taking care of in public housing the income group earning \$2,600 a year or less—I have raised the ante now—could that family afford to purchase a house, even one that is sold for \$7,000?

Mr. REILLY. The American Banking Association has limited its testimony to the loaning features of the bill. We haven't gotten into the welfare features of it.

Mr. MULTER. That is part of the feature, though, is it not? Certainly that person earning \$2,600 a year would have to go in with little or no downpayment.

Mr. REILLY. That is right.

Mr. MULTER. If it is a \$7,000 house they would have to finance to the extent of \$6,500 or \$7,000. On that basis a 40-year loan would run about \$60 a month in carrying charges for interest and amortization, insurance, and utilities.

Mr. REILLY. I don't think you will get the banks to buy those loans.

Mr. MULTER. Let us assume the builder will put up the \$7,000 house and the banker will buy the loan. Can the man earning \$2,600 a year carry that house?

Mr. REILLY. That I don't know.

Mr. MULTER. Well, if the carrying charge, including amortization, interest, and insurance, and utilities, is \$60 a month, can he carry it?

Mr. REILLY. Earning \$2,600?

Mr. MULTER. Yes.

Mr. REILLY. I would think he could. It is 25 percent. I don't think that is out of line as a budget for housing.

Mr. MULTER. That is all.

Mr. OAKMAN. Mr. Chairman, I appreciate Mr. Multer giving us the place where this is to be found. It shows that the incomes of the people in public housing, for an average, those over \$2,000 a year comprise 49½ percent of those people, over \$2,500 a year comprise 23 4/10 percent, and over \$3,000 a year 6½ percent.

That is all, Mr. Chairman.

The CHAIRMAN. Are there further questions of Mr. Reilly?

If not, thank you very much, Mr. Reilly.

Mr. REILLY. Thank you, Mr. Chairman and members of the committee, for the opportunity of presenting our views.

The CHAIRMAN. The committee will stand in recess until tomorrow morning at 10 o'clock.

(Whereupon, at 12:20 p. m., the committee adjourned, to meet at 10 a. m., Wednesday, March 10, 1954.)

HOUSING ACT OF 1954

WEDNESDAY, MARCH 10, 1954

HOUSE OF REPRESENTATIVES,
COMMITTEE ON BANKING AND CURRENCY,
Washington, D. C.

The committee met at 10 a. m., Hon. Jesse P. Wolcott (chairman) presiding.

Present: Chairman Wolcott (presiding), Messrs. Talle, Kilburn, McDonough, Betts, George, McVey, Merrill, Oakman, Stringfellow, Van Pelt, Spence, Brown, Patman, Multer, Deane, O'Brien, Addonizio, Dollinger, Barrett, and O'Hara.

The CHAIRMAN. The committee will come to order.

We will proceed with the consideration of the Housing bill, H. R. 7839.

We have with us this morning the president of the Mortgage Bankers Association, Mr. W. A. Clarke, who is accompanied by Maurice Massey and Sam Neal, general counsel.

Mr. Clarke, we are very glad to have you here with us. You may proceed with your statement without interruption. At the conclusion of your statement the members may want to ask you some questions.

Mr. CLARKE. Thank you, Mr. Chairman.

STATEMENT OF WILLIAM A. CLARKE, PRESIDENT, MORTGAGE BANKERS ASSOCIATION OF AMERICA, ACCOMPANIED BY MAURICE R. MASSEY, JR., PRESIDENT, PEOPLES BOND & MORTGAGE CO., PHILADELPHIA, PA., AND SAM NEAL, GENERAL COUNSEL, MORTGAGE BANKERS ASSOCIATION OF AMERICA

Mr. CLARKE. My name is William A. Clarke. My home is in Media, Pa. I am the principal owner and operating head of a mortgage company bearing my name in Philadelphia. I am appearing today on behalf of the Mortgage Bankers Association of America, of which I have the honor of being the president.

Although the Mortgage Bankers Association has in its membership over 2,000 representation of all types of mortgage lending institutions, the largest part consists of organizations the primary function of which is the development of mortgage business and the organization and servicing of loans for the account of other institutions, mainly banks and life-insurance companies. Mortgage bankers must have close relations with, and intimate knowledge of, every element and aspect of home-building and home-financing activity. There can be no advantage to them that is not an advantage to this great activity as a whole, for only when mortgage money is available at attractive

terms, when builders are able to find a good market for their houses, when buyers are both satisfied with their houses and capable of meeting their mortgage obligations—when, in short, the country is prosperous and the economy expanding, can the mortgage banking industry live and grow. There is no way in which mortgage bankers can prosper unless all with whom they deal are prospering.

The interest of mortgage bankers, consequently, is not a narrow one. Since the legislation before this committee, if enacted, will have a profound influence on the future course and character of the housing market and, through that, on the whole economy of this country, our concern with it is justifiably great, as I believe our view toward it and its implications is genuinely broad.

We have been much impressed by and are in full accord with the statement of basic policy which introduces the recent report of the President's Advisory Committee on Government Housing Policies and Programs. Because of its significance, as well as its bearing on what I shall later say, I ask your indulgence to let me read it in full:

It is the conviction of this committee that the constant improvement of the living conditions of all the people is best accomplished under a strong, free, competitive economy, that every action taken by Government in respect to housing should be for the purpose of facilitating the operation of that economy to provide adequate housing for all the people, to meet demands for new building, to assure the maintenance, restoration, and utilization of the existing stock of housing, and the elimination of conditions that create hazards to public safety and welfare and to the economic health of our communities, and that only those measures that prove to be successful in meeting these objectives should be continued.

Since this statement has been quoted or paraphrased both in messages of the President and speeches and statements of the Housing Administrator, we assume that it offers the underlying principle on which this legislation is based. Our examination of the bill has been made with the view of considering the extent to which this principle has been embodied in its specific provisions.

Title I, for the most part, we believe faithfully follows this underlying principle. It looks upon FHA as did its originators back in 1934, as a means for improving private lending methods, of making possible a wider distribution of the savings of the country for mortgage lending purposes, and, through that, a great expansion of the housing market and the improvement of housing conditions; but not as a means for supplanting private savings with Government credit, or supplanting private decisions, based upon demand as expressed in a free market, with official decisions as to what ought to be built and where and how much.

The original FHA statute was relatively a simple affair, dealing broadly with the whole housing market, high, low, new, and old, without discrimination or special favor. In the intervening years the tendency has been to move away from this position, to substitute special purposes for one broad purpose, Government direction of activity for private decisions, and complexity for simplicity.

The results have not been satisfactory. The law has had to be frequently changed to prevent excesses resulting from misconceptions of the market by Government officials. The creation of special provisions for one type of activity or another has produced pressures of

all kinds to increase or modify these favors. In the end the statute has been so cluttered up with procedural variations and provisions of little or no utility that it has got beyond the comprehension of the experts in the field, let alone the ordinary citizen for whose benefit it was intended.

The pending bill probably goes as far as is presently possible to simplify the statute, to remove discrimination as between one type of house and one type of borrower as against another, to reassert confidence in the private market to make its own decisions, and to make FHA again truly an instrument for facilitating the operation of "a strong, free, competitive economy."

Specifically, we endorse the elimination of sections of the National Housing Act that have no proven utility; the simplification of procedures for handling group accounts in the mutual mortgage insurance fund, the allowances made against the cost of foreclosure, the provisions on debentures issued on foreclosure, the removal of distortions in the schedule of loan-to-value ratios so as to avoid undue concentration on one area of the market; the increase in the top dollar limits so as partially to restore FHA's original board market coverage, the equalization of terms for new and existing construction, the increase in the limits for financing unsecured loans for repair and modernization, the application of the open-end procedure to FHA-insured loans, and the utilization of FHA-insured loans for the renewing of blighted neighborhoods.

We have only a few suggestions to make about these sections of the act. One of these would be to give FHA authority to refund its own debentures, if necessary, at their 10-year maturity, instead of having to resort to Treasury financing as might be necessary if the foreclosed properties should not have been previously liquidated. Another is a proposal to facilitate the operation of section 213 of the National Housing Act dealing with cooperatives. This is being presented for the Mortgage Bankers Association by Mr. Maurice R. Massey, Jr., who has probably had more experience in financing cooperatives under this section than anyone else in our business.

We also wish to urge the adoption of a provision in the Advisory Committee's report, but not included in the bill, which would give FHA greater leeway in using its income to meet the inevitable variability in its operating expenses. We refer you specifically to recommendation No. 27 of that committee as it appears on page 56 of the printed report.

We believe that if the things are done that I have been discussing, all that may be done to make FHA a beneficial aid to the operation of the private market will have been done. To go beyond this would only be to revert to the practice of setting up a special provision to meet each real or assumed emergency, to renew pressure to make the new provision applicable to a greater range of cases, and to turn builders and lenders away from their own responsibility for meeting public demand to dependence on Government support and direction.

For example, the bill proposes enactment of a new insurance program to be called section 220. We support the objectives of this proposed program but we do not support the method it is proposed to use to accomplish these objectives. So far as we can determine the maximum loan limits and other terms proposed for these new 220

loans are almost identical with those which would be imposed if the proposed amendments to section 203 are enacted.

It is our belief, therefore, that the purposes of section 220 could be effected by FHA under the new 203 program if proper underwriting instructions are issued by FHA with reference to the kind of neighborhood improvement operation contemplated for section 220.

If this is so, why then again make the same mistake which has been made so frequently in the past? Why set up an entirely new insurance program when the desired aim is to simplify FHA's operations? Therefore, it is our belief and recommendation that section 220 not be enacted, but that FHA be directed to accomplish the desired results under section 203 as it will be amended.

Further, the proposed section 221 for the National Housing Act, calling for a loan with no downpayment—except for closing costs—and a 40-year maturity, seems to us to represent even further this kind of retrogression. We do not believe this proposed section is necessary, in the light of the generous maximum terms to be provided for the basic FHA operation. We doubt that it will prove attractive to private lenders even with the proposed increased assumption of risk by the Government. We know that it will add to the complexity and cost of administration of FHA. We are confident that pressure soon would be created to extend its provisions to the basic FHA operation. Finally, we question the reality of the advantage to its supposed beneficiaries, assuming that the plan will work at all.

The building industry has all too frequently been criticized for opposing public housing while at the same time requesting more and more Government assistance for our own operations in terms of higher interest rates, lower downpayments, and longer maturities. Even though I do not believe such criticism has been justified in the past, it would certainly be justified now, if the Mortgage Bankers Association of America as an organization of lenders were either to sponsor the proposed section 221 program, or were to fail to point out its inconsistencies as a so-called private enterprise program.

If this section of the bill is passed we, as lenders, will endeavor to utilize its provisions in accordance with the purposes of the legislation, but we believe its enactment would be against our better judgment.

From the borrower's point of view the expansion of the loan-to-value ratio and the extension of the amortization period may be a very deceptive expedient. In the guise of reducing the cost of his housing it actually increases his housing cost in terms of the interest that he must pay over the life of the loan. For example, on a \$5,000 mortgage the difference in principal and interest monthly payments between a 30-year and a 40-year amortized loan—assuming 4½ percent interest—is only \$2.85. \$25.35 as versus \$22.50. But this supposed saving actually results in the difference of paying \$5,800 instead of \$4,126 in interest over the life of the loan. A decrease of 11 percent in the monthly payment between a 30- and 40-year loan thus results in a 41-percent increase in the total interest payment. This is a high long-term price for a small short-term advantage.

We should also like to point out the very small difference in downpayment requirements between the proposed section 220, or at new limits under section 203, and this section 221. Under section 220, or under section 203, the downpayment on a \$7,000 house would be \$350.

Under section 221 the cash payment required would be \$200. The difference seems almost so little as to question the necessity of setting up an entire new insurance structure.

The basic trouble with section 221 is that it is trying to do what is essentially a welfare job with a device that is not suited to the purpose. Rather than run the risk of destroying the place of FHA in a private credit system we believe it would be better if such a necessity exists to make an outright grant of a downpayment, or part of the interest payment, or some similar subsidy, but in any case to recognize such subsidies for what they are, rather than to conceal their true nature by offering them as a normal credit transaction.

In title II of the bill we find a significant departure from both the specific recommendations and the spirit of the advisory committee report. The report urged the creation of a statutory committee charged with the responsibility of seeing to it that all times the interest rates on insured and guaranteed loans would be kept in line with the general structure of interest rates. The committee was to have no other powers, but action on the authority given to it was to be mandatory.

The idea was that by reposing mandatory action in a committee instead of permissive action in a single individual, the control of interest rates would be removed as well as it would be from political and other special pressures. It was the idea, further, that by keeping the interest in line with the market FHA and VA loans would at all times receive a more or less constant share of the total supply of mortgage money, and that the general control of credit through Treasury and Federal Reserve action could be counted on, without other means, to exercise sufficient influence on downpayment and maturity to prevent an inflationary use of credit. It may be noted that in the past it was the failure to exercise such general control that brought about excesses in FHA and VA financing.

The bill substantially differs from the report. First, it places the control in the President, upon whom the full weight of political pressure can be brought, rather than in a group of designated officials. Second, it makes the action permissive rather than mandatory, thus inducing delay when political expediency counsels against action. Third, it substitutes a form of selective-credit control applied solely to one part—and a minority part—of the mortgage market for reliance on the general controls which affect all parts of the market equally.

We believe that this approach is contrary to the basic principle upon which this legislation is based. We believe it substitutes political considerations for market considerations. We believe, moreover, that it creates an undue hazard to the users of the Government-sponsored systems, whose activities could be completely controlled while those using conventional financing would be totally unaffected.

We can see no excuse for this sort of discrimination. We fail to recognize any justification, for example, for applying selective credit controls to institutions making mortgages directly insured by the Federal Government and not applying it to institutions making mortgages indirectly insured by the Federal Government through the insurance of their deposits or share accounts. We do not, of course, advocate the extension of direct controls to these other institutions; we merely point out the inconsistency.

We oppose all forms of direct, selective, and optional controls, as being contrary to the very essence of a strong, free, competitive economy. We consider that the control of the price of money, and the rationing of the supply of money by official action, is just as deleterious to the effective operation of a free economy as official price control or rationing commodities. Such controls as are proposed can only serve to drive activity away from the controlled areas. In the relationship between private business and Government it is vital that the rules be known and that changes be infrequently made. Private enterprise cannot effectively operate in an atmosphere of apprehension or uncertainty caused by frequent and unforeseeable changes in the rules of the game. That atmosphere leads to attempts to double guess the Government and to act on judgments of probable Government action rather than on estimates of the demands of the market.

The Mortgage Bankers Association has long advocated that the rate of interest on FHA and VA loans be left free to find its place in the market, in the confidence that the insurance and guaranty features would be sufficient to give these rates a competitive differential. Actually, in the end, no other method of setting rates will work unless public credit is to be substituted for private credit and public distribution substituted for the private market.

We have accepted the proposal in the advisory committee report as being a step in the right direction and probably the longest one that could be made at the present time. We cannot, however, endorse a plan that places the FHA and VA part of mortgage activity under as strict and comprehensive controls as ever have been found necessary in an acute national emergency in the midst of an otherwise free market. We cannot help but point out that our entire history not so long ago fought vigorously in protesting the extension of authority to impose controls under regulation X, to end the very types of controls now proposed in title II. The plan is neither fair nor practicable. It will not work. It promises only trouble for any administration that seeks to operate it.

At that place I would like to make a comment that I don't believe the people who prepared these bills thought the matter through.

The responsibility for increasing interest rates, or decreasing them, the responsibility for changing terms, is left to the President. I don't believe that either a Republican or a Democratic administration would like to put the onus on the President of having headlines in the newspapers at some time when it became a complete necessity to change rates of interest—and, let us assume it was up—"that the President increased the interest rates on veterans in the United States." Either Republican or Democrat, I don't think would want to take that possible responsibility.

It seems to me that the thinking ought to go back to that plan as recommended by the advisory committee, of having a specific committee charged with the responsibility for setting the rate that would keep these loans at the market.

Mr. PATMAN. Mr. Clarke, you are assuming that they would always be increased.

Mrs. CLARKE. Not necessarily, sir.

Mr. PATMAN. Think about the credit the President would get for decreasing them.

Mr. CLARKE. Exactly. I have seen it both ways, Mr. Patman. But the point is the action should take place fast, both up and down.

I will illustrate for you: Going back before the Federal accord FHA interest rates were $4\frac{1}{2}$ percent. They were selling at a very substantial premium in the market. The interest rate was too high. That delayed and delayed and delayed much too long, with the premium continuously going up. Finally the rate was cut to $4\frac{1}{4}$. By that time the $4\frac{1}{4}$ rate was still too high, and they were still selling at a premium.

In other words, a premium market, in my opinion, is just so bad and evil as a discount market, and if the thing is free, or if there is a specific committee that is charged with changing the market as the market conditions change, it would be done fast.

The problem that comes in this connection is that there are terrific lags, both up and down.

Our opinion is that title III of the bill—dealing with the revival of the Federal National Mortgage Association—also is a significant and unfortunate departure from the recommendation of the President's Advisory Committee. In an unimpeded free market, controlled by freely moving interest rates, supported by increasing savings and active competition all along the line among various types of lenders and various kinds of borrowers, the need for a secondary mortgage market facility is not great.

This conclusion is based on a year-long study recently completed by the Association, the final report of which I am submitting herewith, with the request that it be included in the record—appendix A.

In substance, we believe it would be desirable to provide the users of FHA and VA financing with an institution of last resort that could help to even out irregularities in the regional and seasonal flow of mortgage funds and could offer a source of liquidity in times of unusual stress. We do not, however, believe that such an institution should promise to maintain a flow of funds at all times or under all conditions, that it should support credit programs that are not inherently sound, or that it should provide a means for avoiding interest rate adjustments that the market demands.

The plan offered by the President's Advisory Committee conformed to the specifications I have just set forth. It would be capitalized with non-Government money. It would follow the pattern of the land-bank system in requiring an investment in stock at a ratio recommended at not more than 4 percent to the amount of mortgages sold to the institution, this stock to be redeemable whenever these mortgages might be repaid or sold to another investor. It would obtain additional operating funds by offering debentures in the market at a maximum ratio of 12 times its capital and surplus. It would receive no support from Government and assure no support for otherwise unmarketable activities. It could, however, well serve to tide over temporary distortions in the flow of funds and to expand the market for loans in areas of capital deficiency. With minor suggested modifications the Association endorsed the recommended plan.

The proposal in the legislation, on the one hand, offers a completely impracticable mechanism so far as concerns what might be called a normal secondary market function, and, on the other, provides

the Government with a powerful means for creating public debt to support activities, such as the proposed section 221, which might not be acceptable to the private market, as well as for pouring public credit into the market at such times as the President might believe it desirable.

The part of the plan presumably dealing with normal secondary market needs is limited to purchases of mortgages in the lower part of the market rather than being designed to service the market as a whole. It requires sellers of these mortgages, in addition to other charges and discounts, to make a nonrefundable capital contribution equivalent to 3 percent of the amount of mortgages sold to the institution. This contribution carries a certificate exchangeable for stock in the corporation at such time as the original Government capital might be retired. Because this contribution is in the nature of the purchase of a right it would not be deductible for tax purposes as a business expense. Yet it would receive no dividends so long as Government capital remained in the corporation and would carry no right of redemption even in the extremely remote contingency that the Government stock was retired. These extraordinary provisions practically assure that this part of the plan would have no practical utility.

When, however, the President might desire to use the facility for the purpose of supporting the whole FHA-VA market, or any selected part of it, for example section 221, the 3-percent-contribution provision could be dropped and the facility could be operated exactly as FNMA was in the lush days of 1949 and 1950 when, in its support of the VA housing program, it became one of the principal engines of the price inflation of that period. With the Treasury support given it, this portion of the plan obviously could be made to work and, especially in view of the impracticality of the first part of the plan, pressure for its invocation would be unremitting.

We think it neither necessary nor desirable for the Government to keep such a financial bomb in its closet. The private mortgage market has, after the postwar turmoil, achieved a good measure of stability. The prospect is that the supply of mortgage funds from the people's savings in the years ahead will be ample to meet the needs of a broadening housing market. Aside from the assurance of a market rate of interest for FHA and VA loans, no more is needed than a means to reduce the incidence of the usually temporary fluctuations to which the private market is subject.

The association urges that this section of the bill be given thorough reconsideration. We recommend a return to the principles enunciated and proposals offered in the report of the advisory committee, and while as an alternative we would accept the initial use of Government capital in lieu of the proposal to permit investment of home loan bank funds, we oppose any further major departure from the committee's plan.

Title IV of the bill, dealing with urban renewal, has our complete endorsement. So important do we feel its provisions to be to the maintenance of economically sound cities, healthful and attractive living conditions, and the encouragement of greater private investment in housing property, that we are offering special testimony on this subject by Mr. James W. Rouse, whom we are proud to claim as one of the principal authors of the proposal.

Mr. James W. Rouse is a very valuable member of the association, and on our board, and who was a member of the advisory committee, and who is given credit for 220, was going to be here this morning to testify on this provision. Unfortunately Mr. Rouse's wife is sick and she is being taken to the hospital this morning, and he will not be here. However, we will have his testimony and will submit it for the record, we have been informed.

In respect to title V, dealing with public housing, we consider the proposed amendments to be of minor significance. If the existing statute is to provide the basis for the continuance of this activity they may offer some mild improvement. We regret that the bill does not go to the heart of the question of whether it should be continued at all, but since it does not we do not consider it appropriate to discuss the question here.

We are submitting for your consideration a memorandum which we have prepared on this subject, with a request that it be included in the record.

That is a memorandum as to a method of financing public housing which we think is better than the one now in use.

Although the Mortgage Bankers Association includes but few savings and loan institutions and, consequently, is not ordinarily concerned with their special problems, we nevertheless fully endorse the provisions of title VI of the bill that give these institutions better protection against arbitrary action by Government officials and make possible their broader coverage of the mortgage market. We can only wish that the same attitude of confidence could be manifested in this legislation to those institutions that more generally deal in insured and guaranteed mortgages.

In concluding my testimony, I ask for greater confidence in these institutions—the insurance companies, the banks, and the mortgage companies that over a 20-year period have made the insured mortgage system a vital feature of the private mortgage lending structure of the country. All but a small fraction of the 3.4 million mortgages financed with FHA mortgages since 1934 have been financed by the institutions I have mentioned. Of the total amount of this activity only 193,200, or 6 percent, have ever found their way into FNMA and this mainly during periods or in respect to programs when interest rates were set below marketable levels.

The mortgage-lending institutions of the country have well demonstrated their desire to work with the Government in improving housing conditions. They have a great record with insured, guaranteed, and conventional loans. They will keep up this record provided their freedom to perform is not arbitrarily hampered. In the main this bill enlarges the area of potential performance. I have endeavored to point out the sections of the bill that do this as well as to indicate those sections that appear to us to be in conflict with this objective. We urge your reconsideration of the conflicting sections to the end that, relying on a strong, free, competitive economy we may look forward to even greater progress in the improvement of the housing conditions of our people in years ahead than has been achieved during the troubled period through which we have passed.

That concludes my statement, Mr. Chairman.

The CHAIRMAN. Without objection, the appendixes referred to in Mr. Clarke's statement, and the exhibits also referred to, may be inserted as a part of the record at this point.

(The material referred to is as follows:)

APPENDIX A

PROPOSAL FOR THE CREATION OF A SECONDARY MARKET FOR HOME MORTGAGE LOANS INSURED OR GUARANTEED BY THE FEDERAL GOVERNMENT

I. WHY A SECONDARY MARKET FACILITY IS PROPOSED

A. THE FINANCING REQUIREMENTS OF THE BUILDING INDUSTRY

1. Home building now a mass industry

During the last 20 years, homebuilding has achieved the status of a major industry. The size of its operating units has grown; the proportion of the total supply built by the larger operators has risen; and the practice of building for unknown buyers has become a major factor in the market.

Back of the construction organizations, and in many respects a part of the total industrial operation, are the producers and distributors of building materials and equipment. Like the new building organizations, the manufacturers and suppliers have geared themselves to meet a broad and growing demand.

In other words, homebuilding has become a mass production industry.

2. Dependable source of financing essential

As a result of this development, the financing requirements of the homebuilding industry are similar to those of other mass-producing industries: in order to maintain its operating units and improve its operating practices, it requires a dependable and relatively constant source of funds to finance the construction and sale of new housing.

At the same time, the homebuilding industry is peculiarly dependent upon borrowed funds both to carry its own operations and to finance its buyers. Unlike many industries having large amounts of permanently committed capital, homebuilding has little internal resources, while the mass of its buyers must also depend upon large amounts of credit.

Because of the importance of maintaining fluidity in the used-house market (on which new sales will more and more be dependent), a dependable supply of funds for this market is equally important. Because of the conditions described below, the housebuilding industry has less assurance of the kind of financing it requires than do other mass-production industries.

B. SHORTCOMINGS OF THE HOME MORTGAGE MARKET

1. Variability in the flow of mortgage funds

(a) Savings and loan associations provide the nearest thing to a constant source of home-mortgage money. Their investments are almost wholly in home mortgages and they provide annually about a third or more of the total supply of funds for this purpose. This proportion, as well as the absolute amount of mortgage lending, has been increasing during recent years—testimony to the steadiness of this sector of mortgage lending in comparison with the rest. While this circumstance gives, year in and year out, a fairly dependable base of mortgage activity, it still leaves the bulk of the market subject to other influences. Moreover, since most savings and loan institutions do not have sufficient resources to finance the large housebuilding development, this type of operation is generally dependent on other credit sources.

(b) Other institutional mortgage lenders, comprising mainly life insurance companies, mutual savings banks and commercial banks, are mortgage lenders only incidentally to their role as general investing institutions. They vary the amount of their mortgage lending according to the relative advantage to be gained from other types of investment and, consequently, may make fairly abrupt changes in their lending policies. The result is occasional marked increases or decreases in the amount of mortgage loans currently being made by them, or, actually, temporary withdrawals from the market.

Other types of investors (trusts, pension funds, and individuals) are less important and less dependable as mortgage lenders.

(c) Because of these circumstances, the home-mortgage market may find itself temporarily restricted in the supply of funds, for reasons that may be wholly unrelated to the demand for housing.

2. *Unevenness of regional distribution of mortgage funds*

(a) Surplus and scarcity areas are typical of the home-mortgage market even in times when funds are generally available from the investors discussed above. In the older areas of the country, notably New England, the Middle Atlantic, and part of the Great Lakes regions, the funds available for mortgages often exceed the demand for loans. On the other hand, the South, the Southwest, and the West chronically are importers of mortgage money.

(b) Reasons for the unevenness are many. The main cause is that the savings of the country are created in or drawn into the older, more mature regions, and that the more rapidly growing sections of the country find their local resources insufficient for their needs. Metropolitan areas have greater access to funds than small, nonmetropolitan communities, which lack substantial local institutions and present an especially costly servicing problem. States with onerous foreclosure statutes often have greater difficulty in obtaining mortgage money than States in which foreclosure is simple.

(c) Therefore, even in times when mortgage money is generally available, areas ranging in size from single small communities to whole regions may have insufficient funds to meet local demands. In times when money becomes generally stringent, these areas appear to suffer earlier and more drastically than more favorably situated localities.

3. *Unevenness in economic distribution of mortgage funds*

Because of low loan-to-value ratios and limitations on payment periods imposed by State law or supervision, most institutional lenders have been unable, under conventional loan practices, to serve the mass market with first mortgage financing. Consequently, where the market has to rely on conventional lending, risky and costly second mortgage financing usually becomes an unavoidable adjunct to the mortgage system.

C. PARTICIPATION OF THE FEDERAL GOVERNMENT IN HOME MORTGAGE FINANCING

1. *Characteristics of Government home mortgage activities*

(a) *Scope.*—The Federal Government, under the direction of the Home Loan Bank Board, maintains a reserve credit system (the Federal Home Loan Bank System), mainly for savings and loan associations, and a system of share account insurance (Federal Savings and Loan Insurance Corporation). The Board also charters Federal savings and loan associations.

The Government operates a number of systems of mortgage insurance through the Federal Housing Administration and a special home-loan guaranty and insurance system through the Veterans' Administration. Also through the Veterans' Administration, it provides a system of direct lending for veterans who are unable to obtain private financing within the terms fixed by statute.

Through the Federal National Mortgage Association, it has maintained a reserve credit facility of a very limited and specialized character for institutions making FHA and VA loans.

(b) The purposes of these Government agencies are to give stability to mortgage lending activity, to broaden the geographic distribution of mortgage funds, mainly through private financial channels, and to give emphasis to the channeling of funds to the mass housing market.

The extent to which the agencies have achieved their objectives and the shortcomings they have encountered are briefly described below.

2. *Accomplishments*

(a) *Home Loan Bank Board.*—The strength and stability to savings and loan associations provided by the home loan banks and the FSLIC have in large measure accounted for the growth of savings and loan institutions. Through use of its chartering power, the Home Loan Bank Board has helped to provide loan sources in some heretofore underserved areas.

(b) The Federal Housing Administration and the VA Loan Guaranty Service, by creating a standard form of low risk mortgage investment, have increased the geographical and economic ranges of mortgage lending, particularly by life-insurance companies and mutual savings banks. They also have augmented.

local sources of mortgage funds by encouraging commercial banks to make home-mortgage loans. These agencies have gone far toward creating a national market in which insured and guaranteed mortgages may be traded. Largely through the influence exercised by these programs and the Home Loan Bank System, complete and regular amortization has become standard practice, thus making unlikely such a collapse of the mortgage structure as occurred in the early 1930's.

(c) The Federal National Mortgage Association, especially prior to World War II, has been helpful in increasing the flow of funds into underserved areas and in reducing the impact of temporary disruptions in the home-mortgage market.

3. Shortcomings of the Federal programs

(a) *Limited influence on conventional lending.*—Aside from the influence exerted through the Home Loan Bank System, none of the Federal programs have had any effect in eliminating deficiencies in the conventional loan area of the market. Instead, they have resulted in the creation of parallel systems of mortgage lending and have developed a national market around these systems.

(b) *Limited appeal of Government programs.*—Only to a limited extent have savings and loan associations participated in the insured and guaranteed loans programs, the bulk of their operations remaining in conventional loans. Major participation has been on the part of banks and insurance companies. In other words, the the greatest appeal of the Government programs has been to those institutions which characteristically show the most variability in their mortgage lending policies. As a result, the Government programs have been generally more susceptible to fluctuations in the availability of funds than home mortgage lending as a whole.

(c) *Aggravation of variability in the flow of funds.*—The ordinary tendency of the guaranteed and insured programs to be subject to greater than normal fluctuations has been intensified by the insistence on maintaining maximum interest rates lower than what the market will accept on a par basis.

(d) *Inadequate reserve credit facilities.*—The original purpose of the Federal National Mortgage Association was to provide a stabilizing force in the market by (1) reaching new investment funds through the sale of its debentures, (2) providing a market for loans in underservice areas, and (3) offering a source of liquidity to institutions carrying on large insured-loan activity. Prior to World War II, the Association served fairly well in meeting these objectives.

Recently, however, the purpose of FNMA has been directed to providing a market for economically dubious loans and to supporting the fixed, submarket interest rates.

IV. PROBLEMS TO BE SOLVED

1. Improvements in conventional financing

The conventional loan system could be made a much more flexible and useful instrumentality if State laws regarding foreclosure and investment practices were amended so as to make possible a better geographic and economic distribution of mortgage funds. To the extent that this could be accomplished, the excuse for the Federal programs would be diminished.

The difficulty is that the conventional loan system is in reality 51 systems as created by State and Territorial law, and the task of effecting the desirable improvements is a formidable one. While this task should not be neglected, it seems also desirable, pending such action, to improve the functioning of the insured and guaranteed systems. The principal steps that could be taken to achieve this end are given below.

2. Flexibility in interest rates

The greater part of the difficulties in the distribution of mortgage funds would be eliminated if interest rates on FHA and VA loans could be set in accordance with the relation of the supply to the demand for funds in the market as of the time and place in which the loans were initiated. Such flexibility in rates is essential if the insured and guaranteed systems are to be an integral, dependable feature of the mortgage market, and if we are to maintain a market of nationwide scope.

3. Secondary market facilities

Although it is not possible, so long as submarket interest rates are allowed to persist, to measure the need that might otherwise exist for additional reserve credit facilities, it seems likely that even a completely free interest rate would

not remove all the frictions in the market mechanism. It would still be doubtful that Hawaii and Massachusetts would have equal access to mortgage funds or that the transitory irregularities in mortgage funds would be entirely eliminated. On the strength of this probability, there would still remain a place for a secondary mortgage market facility.

From a practical viewpoint, it would be most feasible to confine the operations of such a facility, at least at the outset, to transactions in Government insured or guaranteed mortgage loans, which offer the minimum of difficulty in ultimate disposal to investing institutions.

If successful experience should warrant an expansion of the function of the facility to encompass other types of loans, that could be considered at a later occasion. In the meantime a greater degree of stability would be given to a sector of mortgage activity that has been representing annually 26 percent to 36 percent of all home mortgage lending and which now comprises almost 45 percent of all outstanding loans on 1- to 4-family dwellings.

II. NATURE AND FUNCTION OF A SECONDARY MARKET FACILITY

A. WHAT A SECONDARY FACILITY SHOULD AND SHOULD NOT DO

1. Purpose

The purpose of a secondary banking facility for the home-mortgage market would be to provide a reserve source of funds. To this end its purpose would be similar to that of the home loan banks. Its scope in one respect would be narrower in that it would deal only in Government insured or guaranteed loans. On the other hand, the scope might be wider than that of the banks in that it might deal with all types of institutional makers and holders of FHA and VA loans, and be enabled to discount mortgage paper without as well as with recourse and to sell its holdings to other institutions as advantageous opportunities presented themselves. Like the banks, however, its character as a reserve, or last resort, source of funds should be clearly established.

The facility should be enabled to overcome shortages of funds occasioned by adjustments in institutional loan policies and by other transient conditions in the general financial markets. It might also temporarily serve to help make a market in remote or rapidly growing areas where the customary facilities for one reason or another were unable to meet the reasonable requirements for mortgage funds. It should, within specified limits, offer lending institutions a means for obtaining liquidity and, hence, add to the attractiveness of mortgages as an investment.

In short, the purpose of the facility would be to provide a measure of breadth, stability, continuity, and confidence to the market for insured and guaranteed loans which might not otherwise prevail.

2. Limitations

Equally important to the delineation of the purposes of a secondary facility are the limitations that should be imposed on it if it is not to be misdirected from its proper task. The resources of a secondary facility should be used neither to finance a speculative expansion of the housing market nor to bolster a market that is already glutted with oversupply.

A proper functioning of the facility presupposes interest rates that either are free to move with the market or are administratively set in a true relationship to current market conditions. Under no circumstances should the facility be used as a means for supporting interest rates lower than those at which persons of good credit are generally able to borrow money.

The facility should be used with great caution as a means for supporting specialized programs. The readiness of the market to handle most of the financing of World War II defense housing without the intervention of FNMA indicates that special programs can be financed if interest rates and other terms are in line with market conditions.

B. METHOD OF OPERATION

1. Criteria

The organization, the basic powers, and the operational procedures of the facility should all be designed with the view to accomplishing the purposes of the proposed institution within the limitations prescribed for it. This is obviously a difficult achievement. Since there are no fully reliable indicators of economic trends, it cannot be possible to write into legislation any formula that

will assure that the appropriate action will be taken at a crucial time. Much must be left to judgment, as is true with the operation of the Federal Reserve System; and the best that legislation can do is to delineate as clearly as possible the areas in which judgment will be exercised, and to provide an administrative framework which will enable knowledgeable and competent men to exercise their judgment free of passing political pressures.

2. *General policies*

To assure the last resort character of its operations and to prevent its misuse for speculative purposes, the facility should deal only with the makers and holders of FHA and VA mortgages and never with mortgagors; and it should ordinarily impose a penalty on those who deal with it.

While the principle of buying cheap and selling dear should be maintained, even this need not be invariably adhered to at all times. Flexibility and maneuverability should be the keynotes of policy. In order that rigidity of practice be not mistaken for sensitive and responsible administration, the widest range of judgment should be permitted and encouraged in establishing discount rates and other conditions in connection with its transactions and in determining extent and location of its activities.

3. *Organization*

To avoid exposure to such pressures as made FNMA a prime instrument of inflation during the late 1940's, the facility should be organized as an independent corporate entity with a governing board with staggered terms of office. No official of either FHA or VA should be a member of the board, nor should these operating agencies otherwise be in a position to dominate the policies of the facility.

It would, of course, be desirable that the facility be privately financed. Although at the beginning it might be necessary to employ Government capital, as was the case with both the land-bank and home-loan-bank systems, provision should be made for its replacement from earnings or from private subscription at the earliest time practicable.

All users of the facility should be required to have a capital interest in it. A compulsory membership arrangement, like that of the Federal Reserve System, would hardly be practicable, because of the difficulty in determining the basis for membership in an institution of this kind. Subscription on the basis of a relationship to assets of the participating institution, as is the case with both Federal Reserve and home-loan-bank systems, does not appear feasible because of the great variety in the character of the capital structure of institutions making FHA and VA loans. A method of subscription on the basis of the extent to which the facility is availed of, as is followed in the land-bank system, is considered to be the method most adaptable, namely a subscription to stock in ratio to the amount of loans sold to the facility, such stock to be retireable as the loans were paid off or sold by the facility. Additional operating capital should be obtained by the issuance of debentures to the public at a ratio not in excess of 10 to 15 times the capital and surplus of the facility.

Because of the influence that mortgage lending has on the whole credit structure of the country, it is important that a close relationship prevail between the secondary market facility and the central monetary authority. Although this relationship does not have to go so far as to involve administrative supervision of the facility, the discount rate and other broad policies should be determined only after receiving the advice of the Federal Reserve Board.

Consideration has been given to the possibility of making the facility an adjunct operation of the Home Loan Bank Board instead of giving it independent administrative status. Here the problem is the domination of the Home Loan Bank Board and system by a single group of mortgage-lending institutions, the savings and loan associations, whose reserve, liquidity, and stabilization problems differ in many respects from those of other mortgage lenders. It is conceivable, however, that, if the nature of the Board were broadened to correspond to that of the Farm Credit Administration (which administers such diverse operations as the land-bank system and the intermediate credit banks), and administrative union of the hom-loan-bank system and the proposed secondary facility might be feasible, and the possibility should not be excluded from consideration. In any case, the importance of a close relationship to central credit and monetary policy should be maintained.

III. PROPOSED LEGISLATION

A. EXPLANATION

The following outline is designed to present the features of the legislation necessary to bring a secondary mortgage market facility into being and to assure the attainment of the objectives stated in the previous sections of this report.

B. OUTLINE OF LEGISLATION

1. *Title.*—An act to establish a secondary mortgage market facility.

2. *Statement of purpose.*—To create a more equable distribution of mortgage funds throughout the Nation and to reduce the variations in the amount of funds that from time to time and from place to place are available for residential mortgage loans insured by the Federal Housing Administration or guaranteed or insured by the Veterans' Administration.

(Comment: The limited purpose enunciated above follows the reasoning and recommendations in the previous discussion. It envisages an institution created to deal with identifiable problems and avoids embarking upon any vast experimental operation. It would be possible for Congress to broaden the scope of the activities of the Fund as improvements were made in State legislation and as experience evidenced capacity to deal safely on a broader basis.)

3. *Corporate structure.*—There shall be established in the District of Columbia a corporation, known as the Federal Mortgage Fund, which shall have succession until dissolved by Congress.

The Fund shall have a Board of Directors consisting of three members appointed by the President with the advice and consent of the Senate, with compensation fixed at \$15,000 per year, the Chairman of the Board to be designated by the President and to serve as chief executive officer of the Fund. Terms of the Directors shall be for 6 years, except that, at the outset, the terms shall be for 2, 4, and 6 years. The Directors shall appoint all officers and employees of the Fund, who shall serve at the pleasure of the Directors.

The Fund shall be an independent agency and shall make reports annually to the President and the Congress covering its operations and administrative policies. The Directors, however, shall receive the advice of the Board of Governors of the Federal Reserve System before issuing debentures or establishing buying and selling prices on mortgages acquired by the Fund and interest rates on loans made by it.

(Comment: The concept is one of an institution that is ultimately financed wholly with private funds and which involves no obligation on the part of the Government other than that already involved in the mortgage insurance and guaranty operations. At the same time, the institution is to be free from domination by any of the various interests in the construction or mortgage finance industries or by the governmental agencies operating the insuring and guaranteeing programs. The corporate form and administrative arrangements provided for in the legislative outline are designed to accomplish these purposes.)

4. *Advisory Council.*—In the exercise of its functions, the Directors may utilize the advice of an Advisory Council consisting of 12 members, broadly representative of the geographic regions of the Nation and of the business interests related to residential mortgage lending, to be appointed by the President for terms of 1 year, and to meet at the call of the Board not less than 3 times each year. Council members shall be compensated for time actually spent on Council business and for necessary expenses in attending meetings, according to the customary allowances for such compensation.

(Comment: The object of the proposed Council is to assure representation of industry in the policymaking process.)

5. *Paid-in capital.*—The Fund shall have an initial capital of \$50 million which shall be transferred from the capital and surplus accounts of the Federal National Mortgage Association and shall be in the form of a loan to the capital account of the Fund. The amount of this loan, with interest at the average yield on outstanding Government obligations as determined at the time of transfer, shall be repaid out of the earnings of the Fund, within a period not to exceed 10 years unless otherwise directed by Congress. No dividends should be paid to stockholders until the Federal capital has been retired.

For the privilege of doing business with the Fund, institutions eligible to deal with the Fund shall subscribe to nonvoting stock in the Fund an amount as determined from time to time by the Board of Directors but not less than 2 percent nor

more than 4 percent of the face amount of any loan made by the Fund or of the outstanding principal amount of FHA or VA mortgage loans sold to the Fund. Such stock shall be redeemable with the liquidation of the loans sold to the Fund.

Earnings in excess of required reserves and estimated requirements for administrative expenses for the succeeding year shall annually be paid into the capital account in replacement of the Treasury investment.

(Comment: The capital setup provides a simple method for accumulating private funds from those who use the facilities of the Fund and for the gradual replacement of Government by private capital.)

6. *Eligibility.*—The Fund shall be authorized to conduct loan or purchase transactions with any mortgagee approved by the Federal Housing Administration for making insured mortgage loans and with any corporation, trust, or other institutional borrower having succession that is regularly engaged in the business of making loans guaranteed by the Veterans' Administration and is approved by the Directors of the Fund. The Fund shall have the right to refuse for cause to transact business with any otherwise eligible institution.

(Comment: The eligibility requirements are designed to assure that those doing business with the Fund are competent and responsible lenders capable of servicing mortgage loans. In principle these provisions are similar to those now governing FNMA operations.)

7. *Powers.*—The Fund shall have power to adopt and use a corporate seal; make contracts; sue and be sued; establish branches as may be deemed appropriate by the Directors; conduct business in any State, Territory, or possession of the United States including the District of Columbia; issue debentures as hereinafter provided; buy, sell, and lend on the security of FHA and VA mortgage loans and otherwise invest its funds as hereinafter provided; enter into and terminate contracts for servicing mortgages in its portfolio; foreclose defaulted mortgages, or purchase title in lieu of foreclosure or accept title for release of the mortgage obligation; deal with, renovate, sell for cash or credit, rent, or otherwise dispose of any property acquired through foreclosure proceedings; and do all other things necessary or incidental to the proper conduct of its affairs.

(Comment: The requisite powers of the Fund are set forth but, at the same time, a broad range of discretion is left to its Board of Directors in establishing operating policies and procedures.)

8. *Obligations.*—The Fund shall be authorized to issue and to have outstanding at any one time notes, bonds, debentures and other obligations in an aggregate amount not to exceed 12 times the amount of its paid-in capital and in no case in excess of the outstanding principal amount of the mortgages, cash, and other assets held by it. The payment of principal and interest on such obligations shall be secured by a pledge of all assets and earnings of the Fund but shall not be otherwise guaranteed. The obligations shall be legal investments for any national bank or Federal savings and loan association and shall be eligible for purchase by the Federal Reserve banks on conditions to be established by the Board of Governors of the Federal Reserve System.

(Comment: The ratio of debentures to capital is such as to promise ready acceptance in the financial market.)

9. *Investment of funds.*—The funds of the fund shall be invested in (a) mortgage loans insured by the Federal Housing Administration or guaranteed or insured by the Veterans' Administration which have been acquired from eligible institutions under conditions of eligibility as may be determined from time to time by the fund; (b) loans made to eligible institutions on the security of such mortgage loans; (c) Government obligations; or (d) cash.

(Comment: The limitations on investment are in line with the limited purpose for which the facility is established.)

10. *Reserves.*—An amount equivalent to not less than 10 percent of net earnings shall be accumulated annually as a reserve until the reserve equals 50 percent of its paid-in capital. The reserve shall be invested in United States Government obligations or held in cash and shall not be subject to any claim upon the fund or be drawn for any purpose except to meet interest and principal payments on the fund's obligations in amounts in excess of its earnings.

(Comment: Although none of the previous legislation respecting national mortgage associations has contained a reserve requirement, on the theory that the insurance and guarantees on its investments would provide adequate protection, it is felt that both the soundness of the operation and the acceptability of the debentures would be improved if additional protection in the form of reserves were provided for.)

11. *Discounts, premiums, rate of interest.*—In connection with its purchase and loan transactions, the fund shall from time to time establish the rate of discount, if any, at which it will buy mortgage loans, the amount of premium or discount, if any, at which it will sell mortgage loans, and the rate of interest and other conditions on which it will lend its funds on the security of mortgage loans.

(Comment: It is assumed that the agencies issuing and guaranteeing mortgages will follow a policy in respect to interest rates that will assure a reasonably close relationship to market conditions. The freedom allowed the fund in establishing discounts and premiums is intended to give strength to a flexible interest rate policy.)

12. *Liquidation of Government mortgage holdings.*—The Federal National Mortgage Association shall be terminated and all its assets shall be transferred in trust to the fund for management and liquidation. All assets of the RFC mortgage company shall be transferred in trust to and managed and liquidated by the fund. All mortgage loans acquired by the Veterans' Administration under its direct lending program shall be transferred in trust to be managed and liquidated by the fund. All receipts from these trust accounts in excess of all servicing costs, all losses, and a management fee equivalent to one-twelfth of 1 percent per annum of the outstanding amount of the mortgages in the trust accounts, shall be paid to the general fund of the Treasury except that, as to mortgage loans transferred from the Veterans' Administration, the net receipts shall be paid to the account of the Veterans' Administration. No assets of the trust accounts may be sold at less than par except with the concurrence or at the direction of the Secretary of the Treasury.

(Comment: The reasons for giving these liquidating functions to the fund are to provide greater economy of administration, and to assure a more orderly market for the mortgages held by governmental agencies and the new facility.)

13. *Taxation provisions.*—Franchise, capital, reserves, investments, and other property (other than real property) held by the fund and earnings of the fund shall not be taxable by the United States or any State, Territory, or possession of the United States, or political subdivision thereof. The income from obligations issued by the fund shall be fully taxable in the hands of the holders of such obligations.

(Comment: The tax status of the fund is in general conformity with that previously proposed for national mortgage associations.)

14. *Federal depository.*—The fund shall be authorized to receive deposits of public money and to serve as a financial agent of the Government of the United States.

APPENDIX B

FINANCING PUBLIC HOUSING

A MEMORANDUM SUBMITTED BY THE MORTGAGE BANKERS ASSOCIATION OF AMERICA

The present plan of subsidizing public housing by making annual contributions sufficient to meet any deficits in the principal and interest payments on the tax-exempt bonds issued by local authorities is unlike any other Federal subsidy operation and has a number of serious objections.

1. It puts on the market a security which at once is tax-exempt and federally guaranteed, an anomaly in itself. For years the Treasury has sought to restrict the area of tax-exempt securities, yet in this case it permits an expansion of the area with Treasury endorsement. Yet the gain, ratewise, is small. The last issue of the guaranteed public housing authority 36-to-40-year bonds carried an average yield of 2.34 percent, at the same time as the average yield on high-grade municipals was 2.37.

2. The scheme provides a subsidy for those who buy the bonds as well as for those who live in the houses; and the probability is that the subsidy to the bond buyers through tax exemption is greater than that to public-housing tenants. It is doubtful that, from the Treasury's point of view, a more costly way of financing a welfare program could be devised.

3. The financing operations of the local authorities in themselves create difficulties for the Treasury's own financing operations. There is little choice in the timing of the public authority issues. Since the funds are required to replace temporary financing (also tax exempt in most cases) used to pay the development cost of projects previously authorized and built under contractual authority

granted by the statute, the issuance of the permanent financing cannot be long deferred after construction is completed. The timing of such financing may be precisely wrong in respect to that of necessary Treasury financing, as it notably was in the spring of 1953. As things now stand, if no additional public housing were put under construction than presently authorized, approximately \$500 million of tax-exempt guaranteed securities must be issued each year for the next 3 years.

4. The provision of subsidies through annual contributions puts upon the Federal budget an item of expenditure over which neither the Bureau of the Budget nor the Congress can have any control. The subsidies represent a 40-year contractual obligation, the total annual amount of which accumulates rapidly with the expansion of the program. During fiscal 1953 the amount of subsidy actually paid was \$25.9 million. During fiscal 1954, the amount will be \$43.3 million. From June 1954 on, with no further expansion of the program, the average annual contribution will be \$79.7 million. If even the current relatively low rate of expansion were continued, the amount would soon be equivalent to what would be paid out in capital grants for an equivalent program. But, while the capital grant could be varied from year to year according to budgetary considerations or the state of the economy, the annual contributions, once contracted for, are a fixed charge which cannot be varied on the initiative of the Government. A serious element of budget rigidity is thus created.

Actually, the whole plan is a subtle means of disguising the full cost of the program. The actual cost of additional public housing is concealed, because the Congress is asked to authorize not the cost but simply the carrying charges on the cost. The actual cost of the annual contribution is also concealed because a substantial amount of the cost is hidden in an incalculable loss of revenue through tax exemption.

The straightforward way of handling public housing financing would be through capital grants, which is the way in which all other subsidies for construction operations are handled.

Consideration should be given to placing this program on the same basis as that now provided for subsidies for urban redevelopment—an outright Federal grant representing two-thirds of the total required expenditure, to be paralleled with a local payment of the other one-third. If this were accomplished, the Federal outlay would still be proportionately very generous, but it would be one that would restore to the Congress much closer control and would prevent the accumulation of future trouble in terms of fixed and invariable obligations.

STATEMENT ON TITLE IV OF THE HOUSING ACT OF 1954, BY JAMES W. ROUSE, BALTIMORE, MD., ON BEHALF OF THE MORTGAGE BANKERS ASSOCIATION OF AMERICA

Mr. Chairman and members of the committee, I am grateful for the opportunity to appear before your committee and to testify to the enthusiastic support of the Mortgage Bankers Association of America for the slum clearance and urban renewal provisions of the Housing Act of 1954. Mr. W. A. Clarke, president of MBA has testified on the other sections of the bill. My comments are limited to title IV.

The MBA has supported the redevelopment program of the Housing Act of 1949 from its inception and is in full accord with the principles on which that program is based. We are encouraged by the operation of the program to date and are anxious to see our cities take advantage of the experience which has been developed in the past few years and move ahead on a broad front against slums and blight.

We can wipe out slums in American cities. We can build the vast sprawling squalid stretches of our cities into fine, clean neighborhoods where people will want to live and raise families. We can stop the spread of blight into our middle-aged residential areas.

We can do these things if we will lift our sights from piecemeal thrusts at our worst slum pockets to a well-planned, carefully organized total campaign against slums along the whole front from the first signs of blight to the last states of urban rot.

Title IV of the Housing Act of 1954 is designed for such a campaign. If and when it is enacted into law it will unfold an enormous potential for effective action in towns and cities throughout the country.

The approach to slum elimination in the past has been largely surgical. We have selected a certain number of our worst slum blocks, acquired the properties, demolished the structures and redeveloped the cleared land. This process has been important. We have not only cleared some of our worst slums, we have also learned a lot about the techniques of land assembly, relocation and re-development planning. We have built an important structure of enabling legislation in the States and cities and established redevelopment commissions with trained staffs and an accumulation of experience in urban redevelopment.

In the 4 or 5 years this process has been in operation, we have also become aware of certain clear limitations on the "surgery project" approach to slum elimination. We have learned that it is slow and expensive. If we moved at five times the demolition rate of the past 3 years, it would take over 40 years to eliminate one-half the 10 million dwelling units said to be substandard in 1950 and it would cost us \$500 million per year to do it. This is far too slow and much too expensive. We have also learned that in many instances it creates new slums almost as fast as it clears the old ones. In the absence of effective preventive programs, it crowds the former slums dwellers into other deteriorating areas and spawns new slums. It simply fans the fire further into the forest.

Thoughtful observers of the redevelopment program are not dismayed by these experiences. On the contrary, they are tremendously encouraged at the high potential which the redevelopment program has revealed and they are eager to remove its limitations, accelerate its pace, reduce its cost, and enlarge its effectiveness.

During the same period in which we have been "cutting our teeth" in redevelopment, there has been emerging in our cities an important new effort at slum elimination aimed at rehabilitating existing structures and conserving decent neighborhoods. This rehabilitation-conservation idea is new and growing. So great is the pressure in our cities for solution to the slum problem that the limited programs in rehabilitation which have been launched in some cities have been seized upon by others and lifted high as beacons of hope for effective action in slum prevention and slum elimination.

There is tremendous opportunity in this effort. Responsibly organized, it can prevent slums before they start; rehabilitate structures worth saving; remove blighting forces and regenerate good neighborhoods out of deteriorating areas not yet beyond recall.

But this effort is new and highly developmental. We are still learning the requirements for effective municipal organizations, still wrestling with enabling legislation, still pushing back the frontiers of its potential. No city in the United States has yet put together a truly effective rehabilitation-conservation program. None is even abreast of the composite knowledge and experience that has been accumulated in the past few years.

It is clear to all who study the experiences to date in urban redevelopment, rehabilitation, and conservation that they must not be operated as separate programs but should be merged as essential components of an overall program for urban renewal. There is no sharp line in a city up to which all structures should be demolished and beyond which none shall be. Salvageable structures should not be destroyed simply because they are in a demolition area. We cannot afford that kind of waste. Nor does it make sense to attempt the rehabilitation of unfit structures simply because they are in an area marked for rehabilitation.

The purpose of a slum elimination program should be to eliminate slums and blighting influences from the entire city to make the city into a community of healthy neighborhoods. To achieve that purpose there must first be a comprehensive plan for the community and for each of its potential neighborhoods. Within those neighborhoods all unfit and nonsalvageable structures should be demolished; adverse nonconforming uses condemned; congestion relieved; parks and playgrounds provided; public utilities installed, street and traffic patterns planned to protect the neighborhood and, under a vigorous program of law enforcement, all structures should be rehabilitated to an acceptable minimum standard of health safety and sanitation.

Title IV is designed to assist, promote, and require that kind of slum elimination program. It broadens the grant and loans provision of title I of the Housing Act of 1949, shifts the emphasis from demolition projects done to the regeneration of neighborhoods and the renewal of our cities. It permits the communities to obtain grants for public improvements which can so strengthen defined urban renewal areas as to make rehabilitation effective and in many instances avoid wholesale demolition.

Furthermore title IV faces the business of slum cure realistically and says that the Federal Government has no business spending money on slum clearance unless there is some reasonable assurance that the Federal grant will achieve the purpose intended. Federal assistance in the slum clearance field is intended to help cities help themselves eliminate slums. A city that is unwilling to set up a comprehensive program for slum prevention and slum elimination is simply chasing its slums from one part of the city to another. The Federal Government cannot afford to encourage or participate in that kind of waste. Therefore a "workable program—for effectively dealing with urban slums and blight" is made a precondition to Federal assistance including grants under title IV, grants for public housing and FHA insurance under section 220.

Title IV encourages a comprehensive approach to slum elimination by providing vastly broadened financial assistance for that purpose. Furthermore, it requires that such a comprehensive program be developed as a precondition to eligibility. Then it goes an important step further and sets up an Urban Renewal Service to help the cities meet the conditions which the title IV program establishes. These programs of redevelopment and rehabilitation are new and growing. It is tremendously important to have a facility for communicating the various experiences in urban renewal from city to city and to thus assist in progressive improvement of the effectiveness of the program. The Urban Renewal Service will fill this need.

In this connection, the importance of the \$5 million fund provided in section 414 merits special attention. This is a small fund as Federal finances go but it can be enormously useful. The timing in the urban renewal program is such that this fund, by accelerating the development and testing of new techniques in slum elimination, can ignite fires around the country that will light the way for hundreds of cities in the years ahead. It will tremendously speed up this entire program in its critical early years.

Title IV marks a great step forward in the battle against slums. It will find support in the cities throughout the country, among planners, builders, bankers, civic and labor leaders. There is wide agreement on the principles on which it is based. The Mortgage Bankers Association is pleased to have this opportunity to express its support.

Mr. PATMAN. Mr. Chairman, may we interrogate this gentleman briefly, before Mr. Massey proceeds? He covered the bill rather thoroughly, and I think it would be appropriate to interrogate him before we have another witness, if the chairman will permit us to do so.

The CHAIRMAN. Well, Mr. Massey and Mr. Clarke are sitting together and are making the presentation.

Mr. PATMAN. If it was the same statement he would not have testified in addition. I assume it is different.

Mr. CLARKE. Mr. Massey proposes to testify in connection with section 213.

Mr. PATMAN. Well, you mentioned the President's Advisory Committee. Has anyone prepared a statement showing the recommendations of the Advisory Committee, and then the recommendations in the President's message, and then the recommendations that are carried forward in this bill?

Mr. CLARKE. We have; yes, sir.

Mr. PATMAN. Do you have that available?

Mr. CLARKE. Yes.

Mr. PATMAN. Is it in this testimony?

Mr. CLARKE. It is not, but we can see to it that it is put in.

Mr. PATMAN. Do you have a copy of it there with you?

Mr. NEAL. We sent a copy of that statement, Mr. Patman, to every member of this committee about a week ago, but we will bring other copies up here this afternoon.

Mr. PATMAN. I ask consent that it be inserted in the record at this point, Mr. Chairman.

The CHAIRMAN. How voluminous is it?

Mr. CLARKE. It is very short.

The CHAIRMAN. Without objection, it may be inserted.

(The material referred to is as follows:)

MORTGAGE BANKERS ASSOCIATION OF AMERICA,
Washington 5, D. C., March 10, 1954.

Re H. R. 7339

HON. JESSE P. WOLCOTT,

*Chairman, Committee on Banking and Currency,
House of Representatives, Washington, D. C.*

DEAR MR. WOLCOTT: During the testimony given this morning before your committee by Mr. W. A. Clarke, Mr. Patman requested that we furnish you, for inclusion in the record, a comparative digest which the association had prepared setting forth the details of the proposed Housing Act of 1954, alongside the recommendations on the various subjects of the President's Advisory Committee on Housing.

Enclosed you will find a copy of this digest for inclusion in the record of the hearings.

This digest also includes a list of recommendations made by the President's Advisory Committee which are not mentioned, or discussed, in the proposed Housing Act.

Sincerely yours,

SAMUEL E. NEEL.

Proposed Housing Act of 1954	Report of President's Advisory Committee	Policy of Mortgage Bankers Association
TITLE I. FEDERAL HOUSING ADMINISTRATION		
101. Increases maximum for improvement and repair loans (sec. 2 (b)) on single-family units to \$3,000 and extends term to 5 years 32 days. Loan limit for structures for 2 or more families changed to \$1,500 per unit or \$10,000, whichever is greater, and term extended to 10 years 32 days.	Same recommendation.....	Approved.
102. Terminates old title I claims account (sec. 2 (f)). Authorizes FHA Commissioner to invest surplus funds of revolving title I insurance fund in Government securities.	No recommendation.....	No recommendation.
103. Terminates sec. 8 authority, transferring program to sec. 203.	Same recommendation.....	Approved.
104. Raises maximum loan amounts under sec. 203 to \$50,000 for 1- or 2-family structures, \$27,500 for 3-family, \$35,000 for 4 family; mortgage not to exceed 95 percent of the first \$8,000 of value plus 75 percent thereafter; requires at least 5 percent downpayment, to be based on estimated acquisition cost; new schedule applies to new and existing units alike, and to all 203 programs, specifies maximum limits only, with specific mortgage amounts to be prescribed by FHA. These maxima to be put into effect only upon President's authorization.	do.....	Do.
105. Authorizes the President to fix the maximum term for all sec. 203 mortgages (sec. 203 (b) (3)) at 30 years (see title II below).	Proposes statutory limit of 30 years....	Approved, with reservations as to marketability of 30-year loans. Same as committee report.
106. Fixes the maximum statutory interest rate on sec. 203 mortgages (sec. 203 (b) (5)) at 5 percent, and authorizes this to be increased not to exceed 6 percent by the FHA Commissioner. Permits the Commissioner to allow a service charge.	Would substitute new authority to maintain competitive interest rates for present statutory limits. Substantially same recommendation..	Do.
107. Amends sec. 203 (c) to provide that debentures used in payment of premium charges shall represent obligations of the particular insurance fund to which such charges are to be credited.	Same recommendation.....	Approved.
108. Terminates farm housing insurance (sec. 203 (d)) as of date of new act.	No recommendation.....	No recommendation.
109. Repeals portfolio rating section (sec. 203 (f)). Repeals President's standby authority to increase loan-to-value ratio and term (see sec. 104 and title II of this bill).	do.....	Do.
110. Adds sec. 203 (h) authorizing 100-percent disaster housing loans as previously permitted under sec. 8.	Substantially same recommendation..	Same as committee report.
111. Amends sec. 204 (a) to permit a mortgagee to receive in debentures amounts paid by it for internal revenue stamps on deeds; to permit a mortgagee to receive in debentures 74 of foreclosure costs or \$75, whichever is greater, on mortgages insured after the effective date of the new act; permits a mortgagor to make a conveyance in lieu of foreclosure direct to the FHA Commissioner.	Same recommendation.....	Approved, but suggests possibility of refinancing debentures at maturity by sale of obligations to the public.
112. Fixes debentures under secs. 203 and 213 at 10 years (sec. 204 (d)).....	Same recommendation.....	Approved.
113. Technical amendment—no substantive change.....	No recommendation.....	No recommendation.
114. Eliminates the group accounts and substitutes a general surplus account and a participating reserve account under secs. 203 and 205.	Same recommendation.....	Approved.
115. Amends sec. 207 (c) to (1) permit insurance of existing multifamily structures if located in a blighted area and if part of the loan to be used for repair; (2) extend to Guam the provision for insurance of 90 percent of replacement cost that now applies to Alaska; (3) permit the President to authorize an increase in mortgage amounts for multifamily structures with	Similar recommendation, except that committee recommended that the \$7,200, 90 percent limit which applies to projects with not less than 2 bed-	Same as committee report.

elevators to \$2,400 per room, with a maximum of \$7,500 per unit where less than 4 rooms; \$10,000 limit per unit is removed.	rooms be made to apply to projects which average 2 bedrooms.	
116. Technical amendment—no substantive change.	No recommendation	No recommendation.
117. Specifies inclusion of foreclosure costs, costs of acquisition, and costs of conveyance to the Commissioner in the certificate of claim under sec. 207 (b).	do	Do.
118. Applies labor-standard provisions to multifamily housing to be rehabilitated under sec. 220.	do	Do.
119. Increases maximum mortgage for cooperatives (sec. 213 (b)) to \$25 million if regulated as to rents, etc. The President can authorize the following maximums: (1) where 65 percent are veterans, \$2,375 per room (\$8,550 limit if less than 4 rooms); if elevator building, \$2,850 per room (\$8,900 limit if less than 4 rooms); (2) where less than 65 percent are veterans, \$2,250 per room (\$8,100 limit if less than 4 rooms); if elevator building, \$2,700 per room (\$8,400 limit if less than 4 rooms). Changes from a cost-to-a-valuation basis.	Same recommendation except that proportion of veterans is recommended to be 50 percent.	Approved, but suggests that a co-op project be permitted to start under sec. 207, with a firm commitment from FHA for 80 percent of the cost, and with the privilege of transferring to sec. 213 at a later date when the required number of cooperators have been assembled; but, if the required number cannot be secured, the project should be permitted to continue under sec. 207.
120. Deletes provision in sec. 213 (f) for an Assistant Commissioner for cooperative housing.	No recommendation	No recommendation.
121. Consolidates all mortgage insurance authorizations (sec. 217); authorizes \$1 1/4 billion annual increase in insurance authorization and permits President to authorize an additional one-half billion dollars.	Similar recommendation except with the annual increase in the authorization at \$3 billion.	Same as committee report.
122. Includes sec. 220 insurance fund within the Commissioner's authority (sec. 219) to transfer moneys between funds.	No recommendation	No recommendation.
123. Adds secs. 220 and 221, to be available only to communities presenting to the HHFA Administrator a workable program for preventing and eliminating blight.	Substantially same recommendation	Not needed; purpose of this section would be met by utilizing sec. 203 in urban renewal areas.
Sec. 220: Mortgage insurance to rehabilitate existing structures and erect new ones in designated renewal areas for which a specific plan has been established; FHA Commissioner must find that there exists the necessary authority and financial capacity to assure completion of the plan, and that such plan will assure that the standards prescribed by him will be met by the properties.		
When authorized by the President, (1) mortgage limits on 1- to 4-family dwellings would be same as for sec. 203 (see sec. 104 above); in addition, where more than 4 units but less than the number prescribed for multifamily insurance, the mortgage limit would be \$35,000 plus \$7,000 for each unit over 4; term not to exceed 30 years; (2) maximum mortgage on multifamily structures could be raised to \$2,250 per room (or \$7,200 per unit if less than 4 rooms), and, if an elevator structure, \$2,700 per room (or \$7,500 if less than 4 rooms); 90 percent loan-to-value ratio. Unless so authorized by the President, loans in this section to be made under terms in effect for secs. 203 and 207. Revolving insurance fund to consist originally of \$1 million transferred from the war housing insurance fund.		
Sec. 221: Mortgage insurance for low-cost housing for families displaced as a result of slum clearance or Government operations, where insurance is requested by the community and HHFA's eligibility requirements have been met, with the number of units needed to be determined by the FHA Commissioner.	Substantially same recommendation, except that committee recommended loans of up to \$7,600, or to \$8,600 in high cost areas.	Disapproved. 40-year loans not marketable; danger in loans to borrowers with no equity; not enough difference between these terms and those of sec. 203 to justify an additional program.
Authorizes (1) maximum mortgage amount of \$7,000 to owner-occupants, 100 percent loan, minimum of \$200 in cash, 40-year term, new or existing structures; (2) same terms as in (1) for rehabilitation of existing dwellings for more than 10 families where mortgagor is a nonprofit organization regulated as to rents and charges; (3) 85 percent, 40-year loans to builders to facilitate sales to owner-occupants under purchase contracts or less option agreements; (4) option to assign mortgages not in default after 20 years to FHA for 10-year debentures at going Federal interest rate; (5) revolving insurance fund to consist originally of \$1 million transferred from the war housing insurance fund, with no transfer of assets between this and other insurance funds.		

Proposed Housing Act of 1954	Report of President's Advisory Committee	Policy of Mortgage Bankers Association
TITLE I. FEDERAL HOUSING ADMINISTRATION—continued		
124. Puts under new sec. 222 the mortgage insurance program in connection with the sale of property under sec. 610, the insurance program to refinance existing loans under secs. 608, 903, and 908, and the insurance of mortgages assigned to the Commissioner under insurance contracts and of mortgages held by him in connection with the sale of property acquired under insurance contracts. Such loans would be insured under secs. 203 or 207.	Same recommendation-----	Approved.
125. New sec. 223 is a technical amendment to implement carrying out of new sec. 201 below. New sec. 224 authorizes FHA insurance for open-end mortgages covering 1- to 4-family dwellings, and authorizes the FHA Commissioner to require charges, including those in lieu of insurance premiums, for the insurance of open-end advances. Open-end advances are not to be taken into account in determining the aggregate amount of principal obligations under the act.	No recommendation----- Recommended the open-end clause; made no recommendation on the details.	No recommendation. Recommended a servicing fee of \$25 or 1 percent of the increase to the mortgage, whichever is greater.
126. Terminates mortgage insurance authority under title VI as of date of new act, except for those programs which are transferred to sec. 222 (see sec. 124 above).	Same recommendation-----	Approved.
127. Repeals yield insurance (title VII)-----	do-----	Do.
128. Extends military housing insurance program (title VIII) for 1 year to June 30, 1955.	do-----	Do.
129. Allows defense housing insurance authority (title IX) to expire July 1, 1954, with authority to insure refinanced mortgages transferred to sec. 222 (see sec. 124 above).	do-----	Do.
TITLE II. HOME MORTGAGE INTEREST RATES AND TERMS		
201. Authorizes the President to establish (1) maximum interest rates on FHA and VA nonfarm residential mortgage loans, not to exceed by more than 2¼ percentage points the average market yields on the Federal Government's marketable bonds of 15 years or more; these rates could be set at different levels for different classes of mortgages; (2) interest rates on FHA debentures to be issued in payment of mortgage insurance claims; (3) maximum financing charges for FHA property improvement and repair loans; (4) limits on fees and charges for FHA and VA loans; (5) maximum maturities and maximum ratios of loan-to-value for FHA and VA loans, within statutory limits; (6) maximum dollar limits per room or per unit for FHA loans, within statutory limits. Direct VA loans or FHA and VA loans for which commitments were made prior to the President's action would not be affected.	Same formula recommended for setting interest rates, but authority placed in 6-man statutory committee rather than in President. No authority proposed for controlling mortgage terms.	Same as committee report.
202. Technical amendment to Servicemen's Readjustment Act to implement carrying out of sec. 201.	No recommendation-----	No recommendation.
203. Repeals sec. 504 of the Housing Act of 1950 relating to fees and charges (see sec. 201 above)-----	do-----	Do.
TITLE III. FEDERAL NATIONAL MORTGAGE ASSOCIATION		
301. Rewrites title III of National Housing Act as follows:		
301. Purpose of facility is (a) to improve distribution of mortgage credit; and (b) to provide assistance to (1) mortgages under special housing programs and (2) mortgages generally to retard a decline in home building activity which threatens the stability of the economy.	Recommended Government-sponsored National Mortgage Marketing Corporation with \$50 million capital to be subscribed by Federal home loan banks to extent not otherwise privately subscribed. Corporation	Approves committee recommendation. Urges that managing board be truly representative of all segments of industry. Powers of Corporation should clearly exclude rights to purchase any but FHA and VA mort-
302. Recharter FNMA as a constituent agency of HHFA, and authorizes it to purchase FHA and VA mortgages or participations not to exceed \$12,500 per family unit.		

303. Capital and surplus of existing FNMA (estimated at \$70 million) would be used to capitalize new FNMA. Capital contributions of not less than 3 percent of the mortgage or participation amount would be required of all sellers to the association in connection with transactions noted under sec. 301 (a) above. In return, non-refundable convertible certificates would be issued to the sellers, to be exchanged for capital stock when Treasury stock is retired.
304. Establishes the general terms of the facility's operations with respect to activity under sec. 301 (a) above. Volume of purchases and sales, prices, charges and fees would be determined with the view that excessive use of the association's facilities should be avoided. No mortgage participations may be purchased under this section, and no advance commitments made except one-for-one contracts. Debentures could be issued up to 10 times capital, surplus, reserves, and undistributed earnings. The Secretary of Treasury is authorized to invest in such obligations up to \$50 million, plus an amount equal to reduction in FNMA present portfolio, but not more than \$1 billion, until Treasury stock in the Association is retired.
305. Establishes terms for special assistance functions under sec. 301 (b) above. President could authorize advance commitments and purchases of mortgages and mortgage participations of various types and classifications as a support for special housing programs or to retard a serious market decline. Treasury would supply funds in return for obligations of not more than 5 years maturity. President could authorize not more than \$200 million in purchases and commitments to be outstanding at any 1 time, but would have additional authority up to \$100 million to enter commitments for mortgage participation agreements for a fixed 20 percent undivided interest in each mortgage, but with a deferred participation agreement to purchase the remainder in the event of default.
306. To liquidate existing FNMA portfolio, the Association is authorized to issue to the public noncollateralized obligations against its assets. The funds so obtained would be used to reduce the existing Treasury investment. The Treasury is authorized to purchase the Association's obligations in sufficient amount to carry out the Association's liquidation functions. Such obligations would have maturities of 5 years or less and the interest rate would be based on the average rate of outstanding Government obligations. \$300 million of the present authorization of FNMA for mortgage purchases would be made available for the special-assistance program under section 303 above.
307. Separate accountability would be maintained for the (a) secondary market operations, (b) special-assistance functions, and (c) management and liquidating functions of the rechartered FNMA.
308. Board of directors of the Association to have 5 members, with the HHFA Administrator to act as chairman and to appoint the other 4 members from among the Association, the office of the Administrator, or any other Federal Government agency.
309. Sets forth the Association's general corporate powers.
310. Provides for investment of the Association's moneys.
311. Association's obligations to be legal investments and may be accepted as security for fiduciary, trust, and public funds under the Federal Government's control. Federal Reserve banks to act as fiscal agents for the Association.
312. Short title of title III: Federal National Mortgage Association Charter Act.
302. Body referred to in section 302 of the National Housing Act is the present FNMA.
303. Specifically applies to FNMA the authority of national banks to invest in obligations of national mortgage associations without limit as to total amount.
304. Authorizes Federal home loan banks and Federal savings and loan associations to invest in FNMA obligations.
305. Repeals FNMA's authority to grant preferences to FHA mortgages in the Territories and to make direct FHA loans in Alaska.
306. Terminates FNMA's authority to make advance commitments on FHA cooperative housing.

authorized to purchase and sell FHA and VA mortgages and mortgage participations from eligible institutions, which acquire stock up to 4 percent of the amount of mortgages purchased. Stock to be redeemed with accumulated dividends when mortgages are sold by Corporation. Purchase and sales prices would be set by Corporation. Corporation could issue debentures up to 12 times capital and surplus. Corporation would be required to create reserve at 10 percent of annual net earnings until reserve equaled 50 percent of paid-in capital and surplus. New 5-man Home Loan Board to be created to manage Corporation, Home Loan Bank System, and FSLIC. Corporation to have charge of liquidating FNMA.

gages and to make advance commitments. Minimum stock requirement to be set at 2 percent. Corporation to have clear power to set standards of eligibility for members.

Proposed Housing Act of 1954	Report of President's Advisory Committee	Policy of Mortgage Bankers Association
TITLE IV. SLUM CLEARANCE AND URRAN RENEWAL		
<p>411. All the amendments are designed primarily to broaden and redirect the present slum clearance and redevelopment program so as to assist not only the communities in clearing their slums, as is presently provided, but to prevent their spread by rehabilitating and improving blighted, deteriorated, or deteriorating areas. The criteria, terms and definitions of title I of the Housing Act of 1949 are changed in accordance with the broader scope of the program. In these larger areas, known as urban renewal areas, there could be carried out (in addition to the slum clearance and redevelopment now authorized) plans for voluntary repair and rehabilitation of buildings; clearance of deteriorated structures, and reconstruction of streets and other necessary improvements. Requirements with respect to local responsibility and local action would be strengthened and increased.</p> <p>The requirement that a commercial or industrial deteriorated area may be cleared with Federal assistance only if the area be redeveloped for predominantly residential purposes is eliminated. In other words, a deteriorated commercial site can be redeveloped for commercial purposes. However, there would be substituted a requirement that the project be in accordance with an urban renewal plan to achieve "such community objectives for the establishment and preservation of well-planned residential neighborhoods."</p> <p>The $\frac{1}{2}$ to $\frac{3}{4}$ formula for Federal local grants now in the law would not be changed. However, in the gross project cost might be included, in addition to those items now included, expenditures for carrying out plans for voluntary repair and rehabilitation and acquisition of property for the broader purpose indicated above, as well as the installation, construction, and reconstruction of streets, utilities, parks, playgrounds and other improvements (which need not be in a slum clearance area) necessary for carrying out the urban renewal plan.</p>	Substantially same recommendation . . .	Same as committee report.
412. Savings provision—technical amendment to permit continuance of contracts already entered into under existing authority.	No recommendation	No recommendation
413. Repeal of appropriation act provisions—technical amendment to remove existing requirements in respect to local law enforcement, now covered elsewhere.	do	Do.
414. Authorizes a special fund of \$5 million for grants to localities to assist them in testing, developing, and reporting slum prevention and elimination techniques.	Same recommendation	Approved.
TITLE V. LOW RENT PUBLIC HOUSING		
501. Extends preference in public housing, now limited to those displaced from public housing or slum clearance projects, to include also those displaced by other public actions, such as code enforcement and closing of structures, highway construction, etc.	do	Would approve continuance of public-housing program only for persons displaced by renewal operations.
502. Makes payment of 10 percent of shelter rents (unless State law prescribes, or local government agrees to, a lesser amount) in lieu of taxes mandatory for public housing projects, except where this would reduce local contribution to less than 20 percent of the Federal contribution. Permits localities to elect to charge full taxes, provided they make up in cash the difference between full taxes and 10 percent of shelter rents but not less than 20 percent of the Federal contribution. Requires that the governing body and the public be informed of total local contribution, including the difference between payments in lieu of taxes and amount that full taxes would require.	Same recommendation	Disapproves present method of subsidy and urges change to capital grant method. However, if present financing system continued, would approve the position in the committee report.

503. Provides that after projects are fully amortized, that net revenues go proportionately to Federal and local governments on the basis of their contributions, in order that in time such contributions may eventually be recovered as far as possible, and the projects be made self-liquidating.

504. Repeals labor-reporting provisions by contractors.

505. Repeals requirement for PHA determination of salaries paid to architects and technical employees.

TITLE VI. HOME LOAN BANK BOARD

601. Provides method whereby Federal Savings and Loan Insurance Corporation may be served with notice of suit anywhere, and not just in the District of Columbia. Also bars enforcement of claim against the Corporation after 3 years from date of default, or, if the Corporation denies validity of the claim, after 2 years from the date of denial.

602-3. Increases maximum loan that a Federal savings and loan association may make (beyond exception already allowed) to \$35,000, instead of the present \$20,000. Makes comparable changes as to collateral acceptable by Federal home loan bank for advances. Also provides procedures for enforcement of regulations governing Federal savings and loan associations and for appointment of conservators and receivers.

TITLE VII. URBAN PLANNING AND RESERVE OF PLANNED PUBLIC WORKS

701. Provides \$5 million to Housing and Home Finance Administrator for planning grants up to 50 percent of estimated cost to State, metropolitan, and regional area agencies for metropolitan or regional planning, and to State planning bodies to assist municipalities under 25,000 in urban planning.

702. Provides \$10 million to resume noninterest-bearing planning advances to local and State bodies for public works plans, repayable when construction is undertaken, in order that such works can be ready for construction if the economic situation should require it.

TITLE VIII. MISCELLANEOUS PROVISIONS

703. Provide for: Exemptions from preference provisions in disposition of unusual types of permanent Lanham Act projects; a consolidated report to Congress on the Agency's activities instead of assorted reports on various programs and activities; consideration to be given to the reduction of vulnerability of congested areas to enemy attack in carrying out housing programs; customary act-controlling and separability provisions.

do	Approved.
No recommendation	No recommendation.
do	Do.
do	Do.
do	Do.
Similar recommendation—no specific authorization recommended.	Same as committee report.
No recommendation	No recommendation.
do	Do.

RECOMMENDATIONS MADE BY THE PRESIDENT'S ADVISORY COMMITTEE TO WHICH THE PROPOSED HOUSING LEGISLATION DOES NOT ADDRESS ITSELF

[NOTE.—Numbers refer to numbering in committee report]

II. TO ENCOURAGE THE CONSERVATION AND RENEWAL OF DECAYING NEIGHBORHOODS

4. The present basis for geographical allocation of funds should be modified to make one-third of the capital grant funds available to those cities showing the highest level of performance in a positive overall attack on urban decay.

9. A broadly representative private organization on a national scale should be formed outside the Federal Government with congressional and/or Presidential sponsorship to mobilize public opinion in support of vigorous action by the communities in slum prevention, neighborhood conservation, and other urban renewal activities.

10. The committee urges that this private national organization encourage inquiries into the ownership and operation of slum property and the failure of cities to compel compliance with their health and housing codes. These inquiries can be an important first step in activating public opinion in support of effective slum prevention and urban renewal programs.

III. TO MAINTAIN AND IMPROVE THE EXISTING HOUSING SUPPLY

6. Appropriate administrative steps should be taken by the Federal Housing Commissioner to permit wider use of the trade-in house program as a means of upgrading the existing inventory of housing.

IV. TO ENCOURAGE PRIVATE BUILDING ACTIVITY

11. An objective and independent long-range study of prospective foreclosure and loss experience of the Federal Housing Administration's insurance programs should be made.

12. An objective and independent long-range study of probable losses on Veterans' Administration guaranteed loans should be made.

13. The Federal Housing Administration and the Veterans' Administration should consider providing special assistance to mortgagees in small communities in the preparation of applications for the insurance or guaranty of loans.

14. The Veterans' Administration should seek advice of lending institutions in revising and simplifying its regulations, and committees of lenders should be formed to place applications for Veterans' Administration direct loans with private lenders wherever practicable.

15. Congress and the Appropriations Committees should be urged to return to the principles of Public Law 387, 81st Congress, or to develop another formula designed to achieve the objective of flexibility in the operating expense budget of the Federal Housing Administration. The Federal Housing Administration would be able to operate much more efficiently if the annual amounts it was authorized to spend for administrative expenses were based on a percentage of income rather than a fixed dollar ceiling.

18. The Treasury Department and the appropriate congressional committees should be requested to study whether there are tax inequities which deter private investment in rental housing, and, based on such findings, appropriate action should be taken. The committee is impressed with the need for such an inquiry. However, since the committee had neither the time nor the competence to carry out a study of this kind, it recommends that it be undertaken by the Treasury Department.

V. TO FACILITATE THE FREE OPERATION OF THE MORTGAGE MARKET

5. The Housing and Home Finance Administrator should study proposals for the establishment of a cooperative housing mortgage corporation to assist in the production and financing of cooperative housing projects.

VI. RECOMMENDATIONS DESIGNED TO PROVIDE HOUSING FOR LOW-INCOME FAMILIES

5. Whenever feasible public housing should be built at lower densities, and the design of public housing projects should conform more closely to local dwelling patterns and construction practices. This recommendation is designed to avoid the institutionalized character of public housing and to facilitate the sale of public housing when no longer needed for low-income families.

7. Where feasible, existing sound structures, rehabilitated if necessary, should be used for public housing.

8. More attention should be paid in public housing to the problems of the aged, both in the design and size of dwellings.

VII. RECOMMENDATIONS DESIGNED TO IMPROVE THE ORGANIZATION OF FEDERAL HOUSING ACTIVITIES

1. There should continue to be a single housing agency headed by an Administrator appointed by the President by and with the advice and consent of the Senate. The Administrator should be relieved of the miscellaneous operating responsibilities now assigned to his immediate office. A reassignment of these functions is proposed in recommendation No. 3 below. The Administrator should, of course, be provided with necessary staff assistance which should include the new position of labor relations adviser. The Administrator should be given clear authority to supervise and direct, if necessary, the activities of constituent agencies where any matter of basic policy is involved. The committee is convinced that, although the heads of constituent agencies should be fully responsible for the day-to-day operations of the programs of their agencies, the Administrator must have clear and unmistakable authority to supervise constituent operations for and on behalf of the President.

2. The major housing activities of the Federal Government should be consolidated into the following five constituents:

(a) The Federal Housing Administration.

(b) The Public Housing Administration.

(c) The Urban Renewal Administration, incorporating the functions of the present Division of Slum Clearance and Urban Redevelopment and some of the functions of the present Division of Community Facilities and Special Operations. Both of these Divisions are now located in the Office of the Administrator.

(d) A Federal Home Loan Board responsible for the administration of the Federal Home Loan Bank System, the Federal Savings and Loan Insurance Corporation, and the National Mortgage Marketing Corporation.

(e) A new Housing Management and Disposition Administration responsible for the management and disposition of Lanham housing, temporary defense housing constructed under Public Law 139, 82d Congress, loans to the manufacturers of prefabricated housing, Alaska housing loans, and acquired property resulting from the activities of the Federal Housing Administration and the National Mortgage Marketing Corporation.

3. Miscellaneous activities and authorities now in the Administrator's office should be reassigned as follows:

(a) Slum clearance and urban redevelopment. This program, amended to transform and extend it into a broad program of urban renewal, should become the nucleus of a new constituent known as the Urban Renewal Administration. Staff of the Division of Community Facilities and Special Operations not otherwise transferred (see below) should be assigned to this constituent.

(b) Housing research. This program is now in liquidation and it is not recommended that it be reinstated on the former basis. Better data on the volume and types of residential construction, mortgage financing trends, etc., should be obtained through the Bureau of the Census and other data collection facilities in the Department of Commerce and the Bureau of Labor Statistics.

(c) Community facilities and special operations. This organizational unit now includes a number of miscellaneous programs. The following disposition is recommended:

(1) Maintenance and disposition of defense public works. This activity represents the windup of the Lanham Act public works provided in World War II. The remaining workload is small, and should be liquidated as rapidly as possible by staff transferred to the Housing Management and Disposition Administration.

(2) Advance planning of non-Federal public works. This activity is also in liquidation and should be concluded by the new Urban Renewal Administration.

(3) Defense community facilities and services. This is an emergency activity under Public Law 139, 82d Congress. It should be allowed to expire on June 30, 1954. Staff transferred to the Urban Renewal Administration should wind up any remaining projects as fast as possible.

(4) Alaska housing program. The need for this program has passed. Any cases in process should be delegated to the Housing Management and Disposition Administration or to the Federal Housing Administration for handling, and no new business should be accepted.

(5) Prefabricated housing loans. This program has properly been placed in liquidation. The servicing and disposition of outstanding loans should be assigned to the Housing Management and Disposition Administration.

(6) College housing program. This is not properly a housing activity. It should be transferred to the Department of Health, Education, and Welfare.

(7) School construction program. This is not a proper activity of a housing agency, and should be assigned to the Department of Health, Education, and Welfare.

(d) Disposition of Lanham housing. Although responsibility for this function vests in the Housing and Home Finance Administrator, actual operations have been delegated to the Public Housing Administration. It is a mistake to merge a program of housing disposition with one of low-rent housing. This activity should be transferred to the Housing Management and Disposition Administration.

(e) Programing of defense housing. This activity should be abandoned, with any activity necessary to its termination delegated to the Federal Housing Administration.

(f) Federal National Mortgage Association: The purchasing authority of FNMA should be terminated and the Association should be transferred to the new National Mortgage Marketing Corporation which should act as a liquidating agent to dispose of the Association's portfolio in an orderly manner.

(g) International housing activities should be transferred to the Foreign Operations Administration.

4. In place of the National Housing Council, the Administrator of the reorganized housing agency should have a statutory Advisory Board composed of the heads of the five constituents above named and a representative of the Administrator of Veterans' Affairs. The Administrator should be required to review with this Board all current major policy matters. It should be made clear, however, that in the event the Advisory Board is unable to reach a conclusion on particular policy questions or if the Administrator is unable to accept the conclusions of the Advisory Board, his own decision can be independently made and enforced.

5. The Administrator of the Housing and Home Finance Agency, the VA Administrator, and the Commissioner of FHA should be requested to work out an interagency agreement under which the Veterans' Administration would contract for the FHA to perform the technical functions of processing veterans home-loan applications under the present home loan guaranty program.

6. The Urban Renewal Administration should be charged with the responsibility of advising the Administrator concerning the programs developed by the communities to comply with requirements that a workable program to attack the problem of urban decay has been submitted. Based on such findings, it will become the responsibility of the Administrator to certify to the FHA, the PHA, and the Urban Renewal Administration those communities which are eligible for the types of Federal assistance which are conditioned upon such a certification.

Mr. CLARKE. Thank you, Mr. Chairman.

Mr. PATMAN. On page 7 of your testimony you mentioned the Advisory Committee report, and the departure from it, especially concerning the fixing of the interest rate to conform to existing rates as they change.

Now, under the recommendation of the Advisory Committee, who would compose this particular committee, and how many members would it have?

Mr. CLARKE. As I remember the Advisory Committee report, they suggested that the membership of the committee should be the Chairman of the Board of the Federal Reserve System, the Secretary of the Treasury, the Administrator of the Housing and Home Finance Agency, the Commissioner of the Federal Housing Administration, the head of the Loan Guaranty Section of the Veterans' Administration. I believe that is all.

Mr. PATMAN. And they would all be public officials?

Mr. CLARKE. That is correct.

Mr. PATMAN. And it would be their duty to take into consideration the existing mortgage rates and increase or decrease them as the facts would justify?

Mr. CLARKE. That is correct. They would be charged with the duty of doing it.

The thing that we object to, as it stands at the present moment, is no one is really charged with the responsibility. The President is given the authority.

Mr. PATMAN. I see your point. It seems to be a very reasonable one.

Mr. CLARKE. We think the thing should be set to the point where, if you are going to do it this way—and we think this is an improvement over the present system—that it should be with some group specifically charged with it, so that there is not any basis whereby anyone can duck it.

Mr. PATMAN. Is it left out of this bill, that provision?

Mr. CLARKE. Yes; it is left out.

Mr. PATMAN. It is left out entirely?

Mr. CLARKE. Yes, sir.

Mr. PATMAN. You brought up a question that we discussed yesterday about this 3 percent that the borrowers must pay into this capital fund of this new substitute for FNMA, and I believe you point out in your testimony that it will not be tax deductible to the person who pays. He will have this interest in the capital structure from which he will receive no dividend or no benefit except when the capital is finally retired, which could possibly be 20, 30, or 50 years from now. It would be that long before it was returned to the borrower.

Mr. CLARKE. It is not redeemable even then. The only thing he might get them is a little interest or dividend. That is the only thing he would get then.

Mr. PATMAN. Doesn't he get his 3 percent back?

Mr. CLARKE. No.

Mr. PATMAN. What happens to that?

Mr. CLARKE. He just keeps it there as an investment.

Mr. PATMAN. Keeps it there as an investment?

Mr. CLARKE. Yes.

Mr. PATMAN. Well, that part makes it rather hard on the borrower, the way I see it. We were talking about a \$10,000 loan yesterday. That means he will have to put up \$300 to this capital structure, and that means, too, that he will continue to pay for 25, 30, or 40 years interest on the entire \$10,000, whereas he only received \$9,700.

Mr. CLARKE. Well, of course, the theory of the thing, I think, is slightly different from that, Mr. Patman. The theory of it would be that a firm such as our own would, in order to dispose of mortgages in our portfolio, that we would—this does not permit this organization to deal directly with an individual—that our firm would invest 3 percent per thousand dollars of loan that we sold to FNMA in it.

Now, that is a complete impractical thing. From my point of view I cannot see any method of ever making it work. I cannot conceive of our firm ever doing it at all.

Mr. PATMAN. I can't understand how they are going to raise the money on it.

Mr. CLARKE. In addition to that, anything that has happened in the past in connection with operations of FNMA, it would have made

other fees and charges in addition to 3 percent and would make it a very costly affair, but the 3 percent would just drive it right out.

In other words, my vision of the FNMA as set up here is that it is geared up to do only one thing, and that is to take care of special affairs, such as 221 or some other situation of that sort.

As a normal support for the market, or to see to it that funds got in to remote or semirural areas, or, if you will, got into the matter of minority housing, and so forth and so on, I cannot see that it could be used.

Mr. PATMAN. You mentioned the return of credit controls. May I invite to your attention the attitude of this committee on that.

Real-estate-credit controls were eliminated by this committee in 1952, Committee Report No. 2177. On page 15 of that report we said:

Evidence was presented to your committee that inevitable discriminatory aspect of credit controls—namely, that they bear most heavily upon those in the lower-income groups, who have less ready cash—had in the existing situation shadowed the entire inflationary aspect.

And, of course, the proposal in this committee to restore it only received 1 vote out of the 27 or 28 members at that time. So this committee is certainly not in favor of real-estate-credit controls, as demonstrated by its vote in the past.

Mr. CLARKE. This specifically puts it back.

Mr. PATMAN. It does put it back?

Mr. CLARKE. Yes, and in addition to that, Mr. Patman, in my opinion, it puts it back very badly.

Mr. PATMAN. Worse than it was before?

Mr. CLARKE. Well, in this way: You are selecting, in this case, only the Government-aided programs through FHA and VA, as the things susceptible to credit controls. All other types of mortgage lending, all other types of banking, and so forth and so on, are completely eliminated—have nothing to do with it. So it is worse in the sense that it picks out only two particular phases of the operation and gives them the possibility of credit control at the whims of whoever may want to operate them.

Mr. PATMAN. Do you deal in the open market, in Government securities, at any time?

Mr. CLARKE. Not ourselves; no.

Mr. PATMAN. You never buy any for your company?

Mr. CLARKE. No, sir.

Mr. PATMAN. And you don't sell any?

Mr. CLARKE. No, sir.

Mr. PATMAN. You don't know what the standard margin is in the transaction of that type for the person who negotiates the purchase and sale, do you?

Mr. CLARKE. Well, I would hazard some figures in connection with it, because I have been mixed up in it a great deal.

Mr. PATMAN. I wish you would.

Mr. CLARKE. It, of course, has an effect on our operations, and, in addition to that, I happen to be a director of a life-insurance company, so, therefore, I have some idea of what is going on in connection with that.

The normal spread in connection with it, I think you would find by investigation—after all, I am having to guess a little at the present moment—is somewhere between 2 and 2½ percent.

Mr. PATMAN. Two and two and a half percent?

Mr. CLARKE. Yes.

Mr. PATMAN. Evidently we are not talking about the same thing. I am talking about the Federal Open Market Committee, for instance, buying a million dollars' worth of bonds. What would be the normal spread that the dealer would receive?

Mr. CLARKE. I don't know. I haven't the faintest idea.

Mr. PATMAN. Obviously you were not thinking about the same thing.

Mr. CLARKE. No; I haven't the faintest notion.

Mr. PATMAN. What would be the normal spread? Would it be something like two thirty-seconds, four thirty-seconds?

Mr. CLARKE. I don't know.

Mr. PATMAN. I won't pursue that, then.

I would like to invite your attention to your testimony in 1950 before the Senate committee, at which time you recommended not the 2½ spread in interest rates that is in this bill, but you recommended 2 percent. Do you recall that?

Mr. CLARKE. Yes.

Mr. PATMAN. Why would you be for 2½ percent now and 2 percent in 1950?

Mr. CLARKE. Well, I am not for 2½ percent.

Mr. PATMAN. You are not for 2½ percent?

Mr. CLARKE. No.

My personal opinion, Mr. Patman, is that there should be no strings attached to it.

Mr. PATMAN. No strings attached?

Mr. CLARKE. Yes, sir.

Mr. PATMAN. But what should be a normal spread? Is 2½ percent too much?

Mr. CLARKE. I think that is too much. I think experience would indicate that it has been somewhere between 2 and 2½ depending upon—

Mr. PATMAN. Well, it has been closer to 1½ in the past, has it not?

Mr. CLARKE. No; I don't think so. The only time it was that way, Mr. Patman, was in the days when you had, I think, really thorough control of money. In other words, before the Federal Reserve-Treasury accord, and when you had a 4-percent VA loan selling for par, and even then the Government rate, mind you now, was supposedly 2½, but it was selling at a premium, and therefore the rates actually on Governments, as I remember in those days, were about 2.3 percent.

I mean that was the basis which you applied.

Mr. PATMAN. May I just read the amendment that you suggested at that time in 1950. You stated:

Their interest, exclusive of premium charges for insurance, at a rate which shall be established semiannually by the Commissioner at 2 percent per annum in excess of the average yield during the preceding 3 months for obligations of the United States having maturities of 15 years or longer, provided that the rate so established shall be adjusted to the nearest one-eighth of 1 percent, and that in no case shall the rate so established be in excess of 5 percent per annum.

Mr. CLARKE. Yes.

Mr. PATMAN. That was the recommendation you made at the time.

Now, this proposal of 2½ percent could very well make the rate 6 percent, could it not, Mr. Clarke?

Mr. CLARKE. Well, in the first place, let me put it to you this way: The bill as set up provides it as a maximum.

Mr. PATMAN. As a maximum?

Mr. CLARKE. That is right. However, I think that it is wrong to set up any particular provisions in this connection. I mean, if you had a committee such as we are talking about that would be charged with the responsibility of this, certainly they would be operating at the market, whether it was at 2½ or 2 or 1½, or whatever it might be. And I think to set up any kind of guides in connection with it is wrong. I see no reason for putting a maximum in at all.

Mr. PATMAN. In your appendix B, attached to your testimony in the first quoted part, you refer to tax-exempt bonds.

Mr. CLARKE. That is right.

Mr. PATMAN. They are exempt as to principal and interest payments, the bonds that are proposed in the so-called public-housing provisions here.

Mr. CLARKE. Yes.

Mr. PATMAN. Yes.

Mr. CLARKE. They are the public-housing bonds. They are tax-exempt.

Mr. PATMAN. Are they like the present bonds?

Mr. CLARKE. No. What we are complaining about, or our suggestion—not complaint—is that the present public-housing bonds are tax-exempt.

Mr. PATMAN. They are tax-exempt?

Mr. CLARKE. That is right, and we think they should not be, and we proposed, therefore, a completely different procedure for doing public-housing financing.

Mr. PATMAN. I see.

Mr. CLARKE, since, by reason of your experience in not only the mortgage-banking field but in the insurance field, and in the financial field, you evidently know a great deal about the interest rates on long-term governments, and how the interest rates are fixed, don't you think that the Federal Open-Market Committee has more influence on the fixing of the rates, both short and long term, than any other one factor in the United States?

Mr. CLARKE. They certainly seem to me to have it.

Mr. PATMAN. Well, don't they have complete authority? In other words, they have unlimited power to buy bonds and sell bonds, and even to create the money to do it, manufacture the money to do it?

Mr. CLARKE. That is correct.

Mr. PATMAN. Without reference to what they have. They have just got it. They just do it on the Government's credit.

Mr. CLARKE. That is right.

Mr. PATMAN. At one time Mr. Monroney, who sat here next to me before he went to the Senate, in 1947, at a hearing before this committee, interrogated Mr. Eccles, and Mr. Eccles, I guess, was longer with the Federal Reserve Board than any other one person, and was Chairman at that time.

Mr. Monroney said—

Do you mean to say that with your present Open Market Committee, and the operation of the Federal Reserve, as it now stands, that regardless of what

the national income is, or other economic factors, that you can guarantee to us that our interest rate will remain around 2.06 percent?

Mr. Eccles said—

We certainly can. We can guarantee that the interest rate, so far as the public debt is concerned, is where the Open Market Committee of the Federal Reserve desires to put it.

You agree with that statement, do you not?

Mr. CLARKE. I do; yes, sir.

Mr. PATMAN. A hundred percent?

Mr. CLARKE. Yes, sir.

Mr. PATMAN. Thank you.

The CHAIRMAN. Are there further questions of Mr. Clarke at this point?

Mr. DEANE. Mr. Chairman.

The CHAIRMAN. Mr. Deane.

Mr. DEANE. Mr. Clarke, I am interested in a bill that will produce the maximum amount of housing. Have you come to any conclusion as to whether or not the particular bill before us will meet the desired needs of the country, so far as housing is concerned?

Mr. CLARKE. It is our opinion that it will, with the changes that we have suggested.

Mr. DEANE. It will, with the changes which you have suggested?

Mr. CLARKE. Yes. There are many features in connection with this bill that we think are very advantageous. For example the provision which would permit FHA to make loans, on the same ratio of loan-to-value on existing as on new housing. That is a new provision in connection with housing.

We think that that is very advantageous, and is very advantageous because the housing market does not differ from any other market, such as the used-car market, or the automobile market. One must be in a position where he can move a secondhand house off to someone else as he buys a new one. The ability to finance that is extremely useful. This bill takes care of that.

There is another thing in here which we think is also very useful. It authorizes the FHA to go into open-end mortgages, which we think is again useful.

There are many features in connection with this which we think are extremely useful for the general good of the public, in housing.

Mr. PATMAN. Would you ask him to expand on that open-end mortgage, please, Mr. Deane?

Mr. DEANE. I was about to do so, Mr. Patman.

Mr. Clarke, Mr. Reilly, on behalf of the American Bankers Association, yesterday had this to say:

We are opposed in principle to the addition of open-end mortgage contracts for FHA loans. There may be situations where the funds are used for capital improvement purposes, which would be helpful to a borrower, but the way is open to use for consumer credit preferences. Equities and real properties should not be used as a means for extending the debt further, which delays true ownership of a home. Open-end mortgage arrangements, unless very carefully controlled, can serve as a means for keeping the home owner constantly in debt.

Now, as you give your views in support of the open-end mortgage I wonder if you would at this same time point out in what way you feel that Mr. Reilly may be wrong or right?

Mr. CLARKE. I think he is wrong since, as I remember the provisions of the bill, the provisions of the bill specifically limit the open-end mortgage provision to only capital improvements to the house, and would not be available for the man to get money to go out and buy an automobile and a few other odds and ends. That is certainly the intent of it, and if that is the case this gives a provision to do that, and if you were in this business, Mr. Deane, the number of cases that come to us, and the homeowners who, as a result of inability to get open-end mortgage operations, get themselves into some difficulty, in which they need to make an addition to the house or need to make some improvement to the house, and being unable to get it except by refinancing, which is a very costly operation—new recording of mortgages, and so forth—are innumerable.

Mr. DEANE. I cannot be sure what Mr. Reilly stated in that connection, but, as I get it, he expressed the viewpoint that instead of taking an open-end or a second mortgage, they could come in and refinance the whole operation, and that there should not be very much additional cost.

Mr. CLARKE. Well, it is, itself, a very expensive undertaking.

Mr. DEANE. How much more expense would it involve?

Mr. CLARKE. Well, for the normal individual who, for example, in our experience, is borrowing—I am speaking now of Pennsylvania, and it would vary, of course, per State—but the normal individual coming into use, wants to get \$750 or \$800 or a thousand dollars, to do something in one way or another in connection with the house, and he cannot possibly refinance that at a cost of less than a hundred dollars. Now, that is 10 percent right off the bat, that he has to pay.

Mr. DEANE. Does the State law in Pennsylvania give you the right to enter into open-end mortgages?

Mr. CLARKE. It is one of the few States in the country where there is some question about it.

Mr. KILBURN. Would you yield?

Mr. DEANE. I yield.

Mr. KILBURN. Isn't it true that it is pretty hard, by legislation, to make a person save money who is a spender? A lot of people save all their lives, anyway, no matter what we set up. They can use the open-end mortgage and get out of debt.

Mr. CLARKE. Well, our experience is this: They come to us and ask for these increases. We have no means of doing it except by refinancing. He goes, then, to a bank and he borrows under the improvement loan plan. His costs, therefore, are very much higher than they would be under any mortgage operation in connection with it. And sooner or later he may get his costs up so high that we have a trouble case on our hands.

The thing just does not make sense that we shouldn't have an open-end operation in my opinion.

Mr. DEANE. Refer to page 6 of your testimony, Mr. Clarke.

Here you make an analysis of a \$5,000 mortgage, and the difference in principal and interest monthly payments between a 30-year and a 40-year loan. I don't believe you give there what the monthly payments would be. What would they be?

Mr. CLARKE. Yes, they are given right here. On a \$5,000 loan the monthly payment would be \$25.35 as against \$22.50.

Mr. DEANE. Are you in a position to indicate what type of house this mortgage would be on?

Mr. CLARKE. Which, this \$5,000?

Mr. DEANE. Type of construction, location, and so forth.

Mr. CLARKE. Well, of course, the \$5,000 mortgage, assuming it being a hundred percent of cost, for a new house, is impossible. I mean that animal just does not exist. You cannot build a house for \$5,000 that is habitable.

Mr. DEANE. I am thinking of a \$7,000 house.

Mr. CLARKE. At \$7,000 you can do it in some parts of the country, yes.

Mr. NEAL. Mr. Deane, it would not make any difference what kind of a house was involved, if the amount of the house was \$5,000 these figures would apply. I don't know whether I understood your question correctly.

Mr. DEANE. What about the upkeep, during that period of time? How much would that represent?

Mr. CLARKE. Well, in that type of house, probably not too much, because the man would do most of it himself. That is the general expense.

Mr. DEANE. That is all, Mr. Chairman.

Mr. MULTER. Mr. Chairman.

The CHAIRMAN. Are there further questions of Mr. Clarke at this point?

Mr. MULTER. Yes, Mr. Chairman.

The CHAIRMAN. Mr. Multer.

Mr. MULTER. Mr. Clarke, does your association consist of members who are actually investing money in mortgages, or do they broker the mortgages?

Mr. CLARKE. No, our association consists, I think, of practically every life-insurance company in the country, certainly every large mutual savings bank is a member of the Mortgage Bankers Association, and I think that I can safely say that the majority of the mutual savings banks are members of our association.

In addition to that there are mortgage companies who develop business for sale and servicing to the life-insurance companies. I suspect that our operations would be as close to normal as any others. We happen to represent 2 or 3 different life-insurance companies, and we create mortgages for their account and service them for them.

Mr. MULTER. Mr. Clarke, I would like to understand your objection to the credit controls that are contained in this bill. I do understand you are opposed to those credit controls?

Mr. CLARKE. Yes.

Mr. MULTER. Is your opposition based on the fact that it vests the President with those controls or are you opposed to any agency having those controls?

Mr. CLARKE. I am opposed to any agency having controls. I think the legislation ought to spell out what the rules are.

Mr. MULTER. I notice that you, in your appendix A, attached to your statement, set forth the manner in which you think FNMA should be operated, or the kind of operation that should operate FNMA. What is the difference between that proposal and the one in this bill?

Mr. CLARKE. Well, the one in the bill—let us take one provision which I can think of, probably as important as any, and that is the contribution in the form of stock. We propose that the users of the secondary facility put up anywhere from 2 to 4 percent in the purchase of stock, but we give the man a run for his money. We let him get it back again. In other words, when the institution has sold or disposed of the mortgages that are paid off, he gets his stock redeemed. That makes it a workable procedure. The procedure as proposed here is, in our opinion, just not workable.

Mr. MULTER. Well, if you are going to have a man subscribe to 2 to 4 percent of the capital when he buys the mortgage, and then when the mortgage is liquidated he is going to get it back, where does the capital for the corporation come from?

Mr. CLARKE. Well, of course, it would be a continuously revolving operation. And you would assume that the operation of the corporation would produce a profit, and that eventually it would produce sufficient money to have capital of its own.

Mr. MULTER. I don't follow that. If the man is going to get back what he pays into it, how will you ever get an accumulation of capital?

Mr. CLARKE. I will let Mr. Neal answer that.

Mr. MULTER. Mr. Neal?

Mr. NEAL. There are many, many differences between the type of operation contemplated in that memorandum of ours and the operation proposed in this bill.

In that memorandum of ours, and in the report of the President's Advisory Committee, it was proposed that the corporation get its initial capital by a contribution thereto by the home-loan banks—that is its original capital.

Mr. MULTER. That is the same in both, is it not, in your proposal and in the bills proposal?

Mr. NEAL. No, sir; the bill does not make that proposal at all. That proposal was made by the President's Advisory Committee.

The bill's proposal proposes capital to be subscribed by the Federal Government, largely by taking over the capital of the present FNMA.

Mr. MULTER. What difference does it make? If the Government agency is going to put in the initial capital or the Government itself is?

Mr. NEAL. Well, the home loan banks are not Government agencies, sir. We might quibble about the definition of them, but they don't consider themselves to be such. They are privately owned.

Mr. CLARK. And all the capital which they now have is private capital.

Mr. NEAL. In addition to which——

Mr. MULTER. We both have the same ultimate aim in mind, that FNMA shall be ultimately owned by private capital.

Mr. NEAL. We certainly have that objective. We don't think this bill would accomplish those objectives, sir.

Mr. MULTER. Tell me how it would be accomplished by your plan, if the man is going to put in 2 to 4 percent of the amount of the mortgage, and then be able to get that back when the mortgage is turned back or redeemed?

Mr. NEAL. Under the 2 to 4 percent proposal, that was not a proposal to acquire capital for the corporation. The proposal to acquire capital for the corporation originally was the proposal under which the home loan banks would subscribe that.

This 2- to 4-percent charge was a charge for doing business. As a matter of fact, we also proposed that a consideration be given to a requirement that a user also be required to buy and retain a certain amount of stock in the corporation, irrespective of this 2-to 4-percent charge, in addition to which there are and would be other fees and charges which FNMA has imposed and would continue to impose.

The 2- to 4-percent fee or charge was not a fee or charge destined to produce capital. It was a charge destined to take care of a situation where a man wanted a commitment but eventually did not deliver the loan called for, and if he wanted a commitment from the corporation, or wanted to do business with the corporation, he would have to own a share in the corporation.

Mr. MULTER. Under your plan how would the capital be subscribed?

Mr. CLARKE. The original capital would be subscribed by the Federal Home Loan Bank System, which is the plan of the President's Advisory Committee, and which we have accepted as a basic proposal.

Mr. MULTER. What other differences are there between your plan and that of the bill?

Mr. NEAL. Well, there are considerable, sir. It is an involved proposition.

We are going to supply the committee with a comparison of these things.

One other significant item, however, is the one where, under the bill, FNMA would be permitted to engage in secondary market operations under especially favorable terms, for special sections of FHA, such as the proposed new section 221.

We think that if they are going to have a secondary market operation at all that ought to be one kind of an operation no matter what kind of a mortgage is involved.

We do not think they ought to have especially liberal powers to support what might be unmarketable programs. But there are many other differences. It is a difference almost entirely in the way you approach the problem.

Mr. MULTER. Do I understand you correctly that you submit your plan as an alternate to the plan in the bill, but that you would much prefer to see FNMA liquidated and no secondary market, such as contemplated by this bill, established?

Mr. NEAL. Well, no, sir. I don't think that is a correct statement. We have had a committee working on the problems of the secondary market for almost two and a half years. This appendix A is the conclusions to which that committee came. Those conclusions were published 6 to 8 months ago. This document was not simply prepared for this appearance. It is a document which has been in existence that long.

Following the appearance of that document, the President's Advisory Committee came out with their report, and when they went on record as saying that while those recommendations were different from ours, we would subscribe to those recommendations.

We have always believed that some form as privately as possible operate secondary market facilities would be desirable.

Mr. MULTER. Your main point is it should be privately operated and not operated by the Government?

Mr. NEAL. That is correct.

Mr. OAKMAN. Will you yield?

Mr. MULTER. Surely.

Mr. OAKMAN. Mr. Clarke, do I understand you to say that your institution would not use the facilities of FNMA if the capital contribution clause obtained?

Mr. CLARKE. That is right.

Mr. OAKMAN. Would your firm use the FNMA facilities if the capital contribution clause was not required?

Mr. CLARKE. We might; yes, sir. In turn, however, the thing which we want to avoid with it, Mr. Oakman, is a procedure which operated in what I have referred to in here as the lush days of FNMA, at which time FNMA was just an absolutely open operation.

And I will illustrate now by our own uses of FNMA in those days. FNMA was purchasing anything which we offered to them. We were widely in the market, as far as we were concerned, in the buying of mortgages, in which we just moved them on to FNMA. That was a completely wrong operation. We shouldn't have done that. I mean we had the privilege of doing it, and we did it. We shouldn't have had the privilege.

Mr. OAKMAN. I see your point, and I think it is a good one.

Do you feel that the objective of FNMA should be to provide capital in those areas of the country where there is a dirth of mortgage money?

Mr. CLARKE. That is correct. That is the only use to which it should be put.

Mr. OAKMAN. Thank you.

Mr. MULTER. Just one other thing, Mr. Clarke.

If we are ready for a secondary market to be operated entirely by private capital, why aren't we ready for a privately operated FHA insurance program?

Mr. CLARKE. I have wondered that myself a long while, Mr. Multer. There is no reason why we shouldn't, as I see it. At a matter of fact, it is getting rapidly that way now. FHA has paid off all its operations to the Government, all the money put in, plus interest, was paid off 3 or 4 days ago, and the actuality is FHA is not now obligated to the Government at all, and my own personal opinion is it in turn should sooner or later begin to be moved over into a private organization.

Mr. MULTER. Can we take that as your personal view, or that of the association?

Mr. CLARKE. That is the association's view.

Mr. MULTER. In that respect it is diametrically opposed to that of the American Bankers Association?

Mr. CLARKE. Yes, that wouldn't surprise me, sir.

Mr. MULTER. I insist that you are right.

Mr. CLARKE. We have been in opposition to them before.

Mr. MULTER. I insist that you are right.

Mr. CLARKE. Thank you.

Mr. DEANE. One other question occurs to me that I would like to ask Mr. Clarke.

I seem to recall that you indicated that one of your members—among your members you included the large life-insurance companies—did I see where one of the large life-insurance companies

was no longer interested in large apartment areas say, in cities like Washington?

Mr. CLARKE. I don't know, to be perfectly honest with you.

Mr. DEANE. What about the activity of the insurance companies in the mortgage field at the present time?

Mr. CLARKE. They are active.

Mr. DEANE. Would you say that they are really active? How would it compare with 1 or 2 or 3 or 4 years back?

Mr. CLARKE. I think they are just as active as—well, I think we can take a look at the figures. I can't quote them but the life-insurance companies in the year 1953, which is certainly a year of tight money, put more money into mortgages than in any year except 1951.

Mr. DEANE. Is that generally all over the country, or in selected areas of the country?

Mr. CLARKE. Well, all over the country, if you want to take the definition of all over the country, as where they have already been all over the country, yes. One of the spots where there is difficulty in connection with mortgage financing is in the rural and semirural areas, in which there is, in my opinion, no one yet thoroughly geared up to service that type of business, and to operate in that field.

Mr. DEANE. Don't you think that is one of the needed fields, where mortgage money needs to find its way?

Mr. CLARKE. Mr. Deane, there is no doubt about it, and in addition to that I do know, from my own personal experiences, that there is a lot of research being done on that subject right now.

I will illustrate by our own office. We are now in the process of making a complete survey of every village, hamlet, and town in the State of Pennsylvania, and trying to work out in our own organization, if you will, a procedure and a method whereby we could cover them. It is a costly operation. The thing which I think people forget, and which is a part again of this question of flexibility of interest rates, flexibility of service charges, the tendency, of course, of all of us, where there are controls, by which you have to live within certain realms of cost, of doing it only in the spots where it is less expensive.

For instance, we can operate in the city of Philadelphia and immediate suburbs, on a very inexpensive basis. If we start to cover every hamlet and town in Pennsylvania it means we have to have men on the road, the volume of business that can be done per town is very small in relation to the volume of concentration that you get in the large cities, so it makes it a very much more costly operation.

However, we are in the process currently of studying it, and are coming up with, we hope, a procedure which will permit us to cover the State.

There are others doing the same thing. I think the thing is in the mill and being worked out. But again I think we want to take into account in doing that that it is a very costly operation, and that we must have in this thing leeway, either to interest rates or charges, or something else, which will permit of the costs of handling that type of business.

Mr. DEANE. Do you think any improvement in this legislation would aid you in reaching the objective about which you were talking?

Mr. NEAL. May I comment on that, Mr. Deane?

One of the recommendations of the President's Advisory Committee, which is not in this legislation, was the recommendation that the VA and the FHA and the Congress consider the desirability of permitting additional service charges on mortgages that are made in areas where there is no local institution to make the financing, and they recommended that some additional service charge to cover the cost of doing that business be permitted.

That recommendation did not get into this legislation. It would be very helpful if some such provision is in it.

MR. DEANE. Would you submit for my own personal study a recommendation along those lines, not for the record but to me?

MR. NEAL. I would be very happy to.

MR. DEANE. Thank you, Mr. Chairman.

THE CHAIRMAN. Mr. Clarke, what are the prospects in the mortgage money market? Do you think there are going to be available to us sufficient mortgage funds for the balance of the year?

MR. CLARKE. Mr. Wolcott, if you will permit me to hazard a guess I would say that by the end of the year 1954 we would have mortgage money running out of our ears.

THE CHAIRMAN. Are there further questions of Mr. Clarke at this time?

If not, thank you, Mr. Clarke.

Mr. Massey, you may proceed with your statement.

STATEMENT OF MAURICE R. MASSEY, PRESIDENT, PEOPLES BOND & MORTGAGE CO., PHILADELPHIA, PA.

MR. MASSEY. Mr. Chairman and gentlemen, my name is Maurice R. Massey, Jr., of Philadelphia. I am president of the Peoples Bond & Mortgage Co. in that city, and I am here today in my capacity as a member of the board of governors of the Mortgage Bankers Association to support enactment of section 119 of the bill that you are presently considering. That amendment has to do with section 213 of the National Housing Act, and if it is amended as recommended by the President's Advisory Committee, and set out in the bill, I believe that you will have a very effective mortgage financing device for all types of housing accommodations, including housing in renewal areas and housing for minority groups.

However, there is one phase of section 213 now that requires correction. The need for such correction stems not from the legislation itself, but from present FHA administrative requirements. For example, in section 213 management-type projects, involving garden-type projects or elevator-type projects, the FHA requires that a certificate may not be issued by one of its offices pursuant to a previously approved certificate of eligibility until 90 percent of the co-operators have been obtained and their required subscription prices have been fully paid.

This administrative requirement, which stems from their own procedures, cause delays that are costly to the project, the sponsoring group, and provide a major barrier to the early start of construction of otherwise desirable 213 projects.

If FHA continues in this administrative requirement it is my opinion that it is useless for sponsoring groups to endeavor to engage in further section 213 projects.

We propose an amendment to section 213 which is destined to provide convertibility between section 207 and section 213, depending upon the sales success of the project as it gets underway.

I should like to give you a specific illustration of what I am talking about. Our firm has handled a number of section 213 projects in various cities, Philadelphia, Trenton. We have one we are particularly proud of, in Detroit, Mich., which is just getting ready to start.

We have brochures, 10,000 of these brochures have gone out to the public, we built sample units on the site, in an exhibition building, we ran page ads at the beginning of our campaign, and to illustrate to you the financial substance behind this project our cosponsors in the project, aside from our company, are firms such as Kelvinator—they are Kelvinator, Westinghouse, Turner Construction Co., of New York City, Briggs Plumbing Ware, the City Bank of Detroit, the Lambreck Realty Co., and a number of other local institutions who joined with us in this endeavor to provide moderate cost housing accommodations in Detroit.

For example, our monthly carrying charges, upon completion, will be \$22 per room per month. The nearest competitive rental for equivalent accommodations in similar structures, nearby adjacent properties, runs as high as \$35 and \$40 per room per month. So we believe that it is a good housing buy for the people of Detroit.

We started that operation, we completed our sample building and opened for sale on November 1, 1953, upon receiving the FHA certificate of eligibility.

These figures may be of interest. On November 14, 2 weeks later, we had 463 sales. However, we had 107 withdrawals for net sales of 356. A month later, on December 13, we had 586 sales, with 201 withdrawals, or net sales of 385. We consider a sale an application taken and the sale entered into when the subscriber fills out the necessary FHA forms and deposits with the cooperative \$100. Then when his credit has been approved by the FHA and the board of directors of the cooperative we notify him that the balance of the subscription price is due and payable. It is then expected that he come in and pay the balance of the subscription price and then become a bona fide shareholder in the corporation.

On January 20 we had 642 sales, and our cancellations had grown to 261, for net sales of 381. We had a loss, from December to January, of four sales. On March 5 we had 691 sales, cancellations of 322, for net sales of 369. We have lost ground in the last 60 days.

Now, we argue, as financially capable sponsors, that we should be permitted to close that loan in a manner similar to section 207. For example, an 80 percent loan, and then begin construction, offer the units for sale when the property is under construction, or, even better, when the property is completed, so that the purchasers actually have a chance to see and inspect what they have subscribed for. Therefore, we recommend the following amendment to section 213, which should be included in the House bill under your consideration:

Section 213 of said act, as amended, is hereby amended by adding at the end thereof the following subparagraph (h): "The provisions of this section may be extended, at the discretion of the Commissioner, to an insured mortgage transaction initially insured under the provisions of section 207 where such project was originally intended, at the time of application for mortgage insur-

ance, to be a cooperative housing project as defined in section 213 (a) (1) and (2)."

Mr. Chairman, thank you very much.

The CHAIRMAN. Are there questions of Mr. Massey?

Mr. MULTER. Yes, Mr. Chairman.

The CHAIRMAN. Mr. Multer.

Mr. MULTER. Mr. Massey, I am sympathetic to your problem but I am wondering what may happen if you are going to get your commitment and start your construction, and then take your subscriptions from your prospective cooperative owners, after the building is completed? Aren't you going to run into trouble? Suppose you have only 10 percent of your prospective owners subscribed when you start building, and when you have completed you only get 50 percent more. With 40 percent vacancies how are you going to operate?

Mr. MASSEY. The only alternative in that case would be to abandon the cooperative project, refund the money in full to each subscriber, and own the project ourselves as equity owners.

Mr. MULTER. What happens to the mortgage?

Mr. MASSEY. The mortgage would remain fixed at the 80 percent loan. It could not be extended under that set of circumstances to a higher ratio loan as is permitted by section 213.

Mr. MULTER. Well, I am sure we wouldn't have any objection to that kind of a loan standing, then, if it were a private loan.

Mr. MASSEY. Yes.

Mr. MULTER. But if a loan was issued by FHA intended to be a cooperative loan, or a loan for a cooperative, you could very easily defeat the purpose of 213. You would have builders all over the country putting up prospective 213's which would turn into the old 608's.

Mr. MASSEY. But, you see, the difficulty is, the public will buy these units, almost, shall we say, at an impulse. Later when they realize that the project will not be completed for 18 months, or 20 months, or 2 years, they come in and want to withdraw.

Now, the sponsoring group has absolutely no alternative but to refund the money, and I consider that proper, and I know you do, too.

However, if the sponsoring group were able to close the mortgage, begin construction, then if the market were there they could sell the project as a 213 venture and extend the mortgage to the maximum provisions of 213. On the other hand, if the case were as you suggested, then the sponsoring group would become the equity owners of the project, and the 213 proposition would be abandoned. It would be a regular 207, as you might be eligible for now under the same set of conditions.

Mr. MULTER. About how many of these 213's have you handled?

Mr. MASSEY. We have placed the mortgage on several of them, and we have actively sponsored three.

Mr. MULTER. This is a comparatively new development, a large number of prospective owners backing out before you get under way.

Mr. MASSEY. Yes.

Mr. MULTER. In the 213's you have handled, did you get temporary building-loan money?

Mr. MASSEY. Yes, sir; in this particular instance the permanent mortgage has been taken by the New York Life Insurance Co. and a

Philadelphia bank in collaboration with a Detroit bank has issued a commitment for the construction loan. So we are ready. We just need a few more sales to comply with the FHA's requirements. We will probably get them, but I am inviting your attention to the need for corrective legislation so that similar sponsoring groups may not be put to the tremendous expense that we have been put to to develop a project such as this.

Mr. MULTER. Will the temporary building-loan money still be available if as much as 50 percent of your prospective owners back down?

Mr. MASSEY. Yes, sir.

Mr. MULTER. That is all.

Mr. TALLE. Mr. Chairman.

The CHAIRMAN. Dr. Talle.

Mr. TALLE. Mr. Massey, you heard the question the chairman put to Mr. Clarke a moment ago, with reference to prospective loanable mortgage funds. Do you agree with Mr. Clarke's reply?

Mr. MASSEY. Indeed I do, sir.

Mr. TALLE. Thank you, Mr. Chairman.

The CHAIRMAN. Are there further questions?

Mr. DEANE. Just one question I would like to ask, Mr. Chairman.

The CHAIRMAN. Mr. Deane.

Mr. DEANE. Mr. Massey, what about some of the projects already built, say 608's. In some places they are having rather tough sledding; isn't that true?

Mr. MASSEY. Yes; that is true, sir.

Mr. DEANE. Would it be possible to prevent the Government from having to take over the used 213's?

Mr. MASSEY. Not under the present legislation; no, sir. The present legislation pertains solely to construction to be performed, contemplated construction. As I recall 213, it is not eligible for refinancing purposes of previously built section 608 projects.

Mr. MULTER. Will you yield?

Mr. DEANE. Yes.

Mr. MULTER. You may not have to go into refinancing if the tenants of the 608 want to take it over. They can form a cooperative organization, just as any independent purchaser could do.

Mr. MASSEY. Yes, sir.

Mr. MULTER. It is a matter of the tenants being willing to do it.

Mr. MASSEY. That is right, sir.

Mr. DEANE. That is all.

The CHAIRMAN. Are there further questions of Mr. Massey?

Mr. O'HARA. Mr. Chairman.

The CHAIRMAN. Mr. O'Hara.

Mr. O'HARA. Mr. Massey, I have been very much interested in what you said about cooperatives.

You are familiar with the conditions that existed before the smash in the early thirties?

Mr. MASSEY. Yes, sir.

Mr. O'HARA. And the historical background of the cooperative in that period is pretty bad; is that right?

Mr. MASSEY. Yes, sir.

Mr. O'HARA. Now, recently there has been a trend—I have noticed it in Chicago and I presume it has obtained in some other cities—of

going back to the cooperative idea that was so popular before the smash in 1929. You have noticed that trend, of course?

Mr. MASSEY. Yes; I have, indeed.

Mr. O'HARA. And is it to that trend that you have been directing your remarks today?

Mr. MASSEY. Yes, sir.

Mr. O'HARA. I wouldn't wish to be misunderstood. I sponsored, in the 81st Congress, a cooperative housing bill which I am sure would have reduced materially the cost of construction. I believe in the right kind of cooperative effort in housing, but not the kind that has been peddled by racketeers and schemers. I have advised my friends to keep out of these present-day cooperative housing projects, at least until they have thoroughly gone into every phase.

Has my counsel to them been wise or foolish?

Mr. MASSEY. Well, I wouldn't be qualified to comment, sir. I can say this: The way FHA requires the cooperative—the corporation papers, bylaws, and subscription agreements to be drafted in connection with section 213 projects—in my opinion it is virtually a fool-proof proposition for the individual cooperator. I think it is an excellent piece of legislation, and the way that a section 213 project, for example, is designed and advised from the legal standpoint, it is a good investment for a typical subscriber.

Mr. O'HARA. I am inclined to agree with the gentleman. That is the cooperative setup as we have it now too often invites the racketeer. Sometimes it may not be a racketeer, merely an inexperienced person, which leads to the same disastrous end.

Do you hope that the suggestions you are making will be helpful in preventing disastrous consequences from cooperative housing undertakings?

Mr. MASSEY. Indeed I do, sir.

Mr. O'HARA. Thank you very much.

Mr. MASSEY. Thank you.

The CHAIRMAN. Thank you, Mr. Massey.

We have with us now Mr. James J. O'Malley, President of the First Federal Savings and Loan Association of Wilkes-Barre, Pa.

You may proceed, Mr. O'Malley.

STATEMENT OF JAMES J. O'MALLEY, PRESIDENT, FIRST FEDERAL SAVINGS & LOAN ASSOCIATION, WILKES-BARRE, PA.

Mr. O'MALLEY. My name is James J. O'Malley. I am president of the First Federal Savings & Loan Association of Wilkes-Barre, Pa. I appear here in my capacity as chairman of the Federal legislation committee of the National Savings & Loan League, and wish to express the appreciation of our committee for this opportunity to present our position on H. R. 7839. The National Savings & Loan League has over 700 savings and loan association members throughout the United States, with assets over \$5 billion. Savings and loan associations hold one-third of the home mortgages of the country and currently are doing around 38 percent of the home-mortgage financing.

The National Savings & Loan League is in accord with the aims and purposes of the bill under consideration which would contribute greatly toward providing an adequate housing supply for the country,

but believes at the same time savings and loan associations should have as broad authority as is consistent with safety to engage in home mortgage financing. Section 101 would increase the maximum loan amount from \$2,500 to \$3,000 for property improvement and repair loans under FHA title I. We believe savings and loan associations should be able to make these loans without FHA insurance if they wish. Federal savings and loan associations, however, are at present restricted on such loans to a maximum of \$1,500. We urge that Federal savings and loan associations be permitted to lend, without security, on FHA, VA, and conventional loans for property alteration, repair, and improvement up to \$3,000. The total amount of such loans would not at any time exceed 15 percent of the association's assets. This provision would increase the ability of savings and loan associations to do a better job in the home-financing field.

If certain of the liberalization provisions this bill extends to FHA lending, such as the use of open-end mortgages, were also extended to VA loans, we believe the purpose of the bill to help home financing would be considerably furthered. We suggest that the committee carefully consider this extension of authority to VA loans.

The bill applies the same mortgage terms to existing housing as is applied to new housing. In the field of new construction FHA served an important purpose in getting these homes financed. The President's Advisory Committee on Government Housing stated:

The opportunities for wider use of FHA-insured mortgages in financing purchases of existing homes are emphasized by the fact that fewer than 10 percent of existing home purchases in recent years have involved new FHA mortgages.

We think this committee should carefully consider whether there is a real need for extension of Government insurance on mortgages on existing homes. We do not consider that it is the purpose of the sponsors of this bill to use Government aid or insurance any further than is necessary. We are not here specifically opposing this section, but are merely raising the question with this committee whether this section could be utilized to jeopardize other systems or methods of home financing.

We are in accord with the provisions of the bill which gives needed flexibility in the fixing of FHA and VA interest rates. This provision may render a secondary mortgage credit facility unnecessary.

The provisions of the bill, however, in which we are primarily interested are those dealing with the Home Loan Bank Board. We are in full accord with these proposed amendments to the basic acts governing the operation of the Home Loan Bank Board and its agencies, and urge their enactment into law.

The first of these provisions is contained in section 601. This section would facilitate the service of process on the Federal Savings and Loan Insurance Corporation throughout the United States. This would obviate the necessity for persons having claims against the Federal Savings and Loan Insurance Corporation having to bring their suit in Washington or wait until an officer of the Federal Savings and Loan Insurance Corporation appears in their jurisdiction. This section would also give the Insurance Corporation a much-needed statute of limitations on the enforcement of claims against it. We are in accord with the provisions of this section.

The Federal Home Loan banks throughout the country make advances to their member associations upon the collateral security of home mortgages which under the present law cannot exceed \$20,000. Section 602 would amend the Federal Home Loan Bank Act to increase this \$20,000 figure to \$35,000. The \$35,000 figure is now roughly comparable to the \$20,000 figure when it was first put into the act back in the early thirties. We feel that this provision is urgently needed and urge its enactment.

Section 603 amends the basic act dealing with Federal savings and loan associations. The first subsection is a companion provision to section 602 and would increase the maximum home mortgage loan that a Federal savings and loan association may make within its regular portfolio from \$20,000 to \$35,000. As stated before, this \$35,000 is roughly comparable to the \$20,000 figure when it was put into the act. This would enable these Federal savings and loan associations to serve better the home-financing needs of the country. We urge its enactment.

The second subsection of section 603 would give the Board greater powers in the enforcement of its supervisory authority of Federal savings and loan associations and at the same time it would give the Federal savings and loan associations specific rights and remedies in the case of action by the Home Loan Bank Board.

The Home Loan Bank Board would be given authority by this bill to act in its own name and sue and be sued in its own name. It would authorize the Board or its representatives to administer oaths and issue subpoenas and request the court to enforce them. The Board would have authority to ask a declaratory judgment and an injunction or other relief for violation of law or regulations, or could apply to a court for enforcement of its orders. Specific authority is granted the Federal Savings and Loan Insurance Corporation as receiver for any Federal savings and loan association to buy at its own sale. Fine and imprisonment are provided for the refusal of any officer, agent, employee, or director of a Federal savings and loan association which fails to relinquish possession of the association when demanded by a conservator or like authority appointed by the Board.

The proposed amendment also grants substantial equitable provisions for Federal savings and loan associations. The grounds for appointment of a conservator or receiver are set out in the statute and notice and hearing are required and set out in the statute. The hearing is to be in the Federal judicial district where the association is located, unless it consents to another place and is to be conducted under a hearing examiner as provided by the Administrative Procedure Act. Appeal may be taken as is provided by the Administrative Procedure Act, and the review by the court is to be upon the weight of the evidence. The association may apply to a court for declaratory judgment, injunction, or other relief. The Board is subject to suit in the United States district court of the district where the home office of the association is located and may be served by serving a copy of process on any of its agents and mailing a copy of such process into Washington. A supervisory representative in charge, instead of a conservator or receiver, may be appointed when an emergency exists requiring immediate action, and his tenure of office is limited by the statute. We believe that these amendments would be of substantial

benefit, both to the Home Loan Bank Board and to the savings and loan business, and urge their enactment.

The CHAIRMAN. Are there questions of Mr. O'Malley?

Mr. McVEY. Mr. Chairman.

The CHAIRMAN. Mr. McVey.

Mr. McVEY. I should like to ask one or two questions.

I notice that you have said that Federal savings and loan associations are restricted to a maximum loan of \$1,500, while section 101 would increase the maximum loaned amount from \$2,500 to \$3,000.

What, in your opinion, is the reason for that discrepancy in amount?

Mr. O'MALLEY. Mr. McVey, I don't know what the thinking was in restricting the Federals to \$1,500, even in the beginning, when other loans were permitted up to \$2,500. But our position is that a Federal savings and loan association, being a local institution, might be, and I believe could be, and would be in better position to make the loans locally, and should be in the same relative position as any other type of loan. That is the only reason for suggesting that it ought to go up to the same amount, \$3,000.

Mr. McVEY. A president of a savings and loan association told me that he thought the Government should abolish the FHA program. What is your opinion on that subject?

Mr. O'MALLEY. Well, Mr. McVey, I wouldn't want to go that far because, speaking for myself, and also, I believe, for our organization, our fundamental interest is in trying to have as many people as we can in homes of their own, and I believe there are certain sections of the country where the FHA has done a grand job, and I don't think we would want to go as far as to say it should be abolished.

Mr. McVEY. I appreciate your opinion.

Thank you. That is all, Mr. Chairman.

Mr. MULTER. Mr. Chairman.

The CHAIRMAN. Mr. Multer.

Mr. MULTER. Mr. O'Malley, I think it might be helpful to this committee if you submitted to us a typical form of open-end mortgage that we could make part of the record. There has been a lot of discussion about it, and I have heard a lot of questions from some of my colleagues, who apparently have never used that type of mortgage, and I think it might be helpful if we had a typical form.

Mr. O'MALLEY. I would be glad to supply it. We happen to use it so we will send it to you.

Mr. MULTER. Mr. Chairman, may that be made part of the record when supplied?

The CHAIRMAN. Without objection, that may be done.

(The material referred to is as follows:)

The data furnished for the record pursuant to this request consists of forms for a mortgage, a concurrent agreement, an agreement for additional advances, and a bond. These instruments are lengthy and cover provisions other than the open-end mortgage provision. The pertinent references to the open-end mortgage in the mortgage form, and the bond form are extracted below and the concurrent agreement form and the agreement for additional advances are set forth in full. The provision in the mortgage is as follows:

"It is expressly understood and agreed, anything herein provided to the contrary notwithstanding, that the aforesaid obligation and this mortgage securing the same shall include and cover, as well, any future advancements that may be made by the mortgagee to the mortgagor at any time or times hereafter, provided that at no time may the total balance due by the mortgagor to the

mortgagee hereunder, whether the same represents, in whole or in part, the initial advance or any future advance or advances, exceed the sum of \$ _____."

The provision in the bond is as follows:

"It is expressly understood and agreed, anything herein provided to the contrary notwithstanding, that the obligation of this bond and the mortgage securing the same shall include and cover, as well, any future advancements that may be made by the obligee to the obligor at any time or times hereafter, provided that at no time may the total balance due by the obligor to the obligee hereunder, whether the same represents, in whole or in part, the initial advance or any future advance or advances, exceed the sum of \$_____."

CONCURRENT AGREEMENT

First Federal Savings and Loan Association of Wilkes-Barre, 23 West Market Street, Wilkes-Barre, Pa.

M _____

SIRS: In connection with the above mortgage of the undersigned, executed on the _____ day of _____, 19 _____, covering premises situate _____

to secure a real debt of _____, this will acknowledge that the monthly Concurrent Installments referred to in the aforesaid mortgage and its accompanying bond to be paid by the undersigned shall be in the sum of _____ Dollars, payable as provided in said bond and mortgage and subject to all the terms and provisions thereunto relating. It is further understood that the Association reserves the right from time to time to modify the amount of said monthly Concurrent Installments to be paid by the undersigned if necessary to make the same conform to the provisions in said bond and mortgage by giving written notice to the undersigned of any such modification.

Dated this _____ day _____, 19 _____.

Form No. 1

Account No. _____

AGREEMENT FOR ADDITIONAL ADVANCES

WHEREAS, the undersigned _____ executed and delivered to FIRST FEDERAL SAVINGS & LOAN ASSOCIATION OF WILKES-BARRE, of Wilkes-Barre, Pennsylvania, a certain bond and mortgage dated the _____ day of _____ 19____, for an original real debt of (\$_____) Dollars, of which the present unpaid balance is (\$_____) Dollars;

AND WHEREAS, said bond and mortgage provide for additional advances to become part of the principal indebtedness of said bond and mortgage and to be secured by said mortgage as a first lien on the property described therein, which mortgage is recorded in the Office of the Recorder of Deeds in and for Luzerne County in Mortgage Book _____ page _____;

AND WHEREAS, application has been made by the undersigned for an additional advance to be secured as aforesaid.

WITNESSETH

The undersigned acknowledge receipt of an additional advance upon the said bond and mortgage in the sum of (\$_____) Dollars, and agree that the said sum shall be charged to and become a part of the principal indebtedness of said loan account known as Mortgage Loan No. _____ upon the books of said Association, shall bear interest as provided in said bond and mortgage and shall be secured by said mortgage and subject to all the provisions thereof.

It is further agreed that the total unpaid balance, including the additional advance aforesaid is (\$_____) Dollars, and that the monthly installments (exclusive of the Concurrent Installments mentioned in said bond and mortgage) shall henceforth be at the rate of at least (\$_____) Dollars per month, payable as provided in said bond and mortgage and subject always to all the covenants, agreements and conditions as set forth in said bond and mortgage.

The undersigned further represents to the said Association that the property securing said indebtedness is free and clear of any liens and encumbrances except the aforementioned mortgage, it being distinctly understood that the granting

of the additional advance herein mentioned to be made is expressly conditional upon the correctness of said representation.

In Witness Whereof, this agreement is executed and delivered this ----- day of ----- 19--.

SIGNED, SEALED AND DELIVERED
IN THE PRESENCE OF

----- (SEAL)
----- (SEAL)
----- (SEAL)
----- (SEAL)
----- (SEAL)

ATTORNEY'S REPORT

This certifies that I have checked the various indices dealing with the record title to the property bound by the mortgage above recited from the date of the recording thereof ----- 19--, and I find no intervening liens or encumbrances. I further certify that the aforementioned mortgage secures the indebtedness thereof including the above granted additional advance as a first lien on the premises described in said mortgage.

-----, 19-----
Attorney.

Mr. MULTER. Mr. O'Malley, I think the savings and loan associations have demonstrated that you can get very wide citizen participation in our mortgage financing problem, with a profit to them. That is what you do in the main, isn't it? Your associations in the main are financing, through mortgages, homes and all of your money comes from the people who deposit with you. Those people are Mr. Average Citizen?

Mr. O'MALLEY. That is right.

Mr. MULTER. So although you are reluctant to suggest that we do away with the FHA insurance program, your organizations have demonstrated that it can be done by private enterprise?

Mr. O'MALLEY. That is our position, Mr. Multer. But in the same breath, if it is going to help some other family get a home, I don't think we would want to stand in the way.

Mr. MULTER. But you also do suggest that the time is coming, or has arrived, when we ought to reexamine the whole problem and see if private enterprise cannot take it all over?

Mr. O'MALLEY. I do.

Mr. MULTER. I notice that in the third quarter of 1953 our mortgage foreclosures have gone up about 20 percent higher than they were in 1952. I am not suggesting that we are in the midst of a real-estate depression, or anything of that kind, because even that high rate is one-tenth of the depression level of mortgage foreclosures. What I would like to have you supply to us, if you can, would be the percentage of foreclosures, or a comparative statement of foreclosures, so far as the savings and loan experience over the years has been.

Mr. O'MALLEY. If you will give us time to get such a report we would be glad to, Mr. Multer.

Mr. MULTER. Yes. It is my impression, and I hope your figures will bear it out, that your rate of foreclosures, all through the years, has been much lower than that for other institutional lenders. I would like that comparison for the record.

Mr. O'MALLEY. I will be glad to get that for you.

Mr. MULTER. Thank you.

(The data requested could not be supplied as no separate statistics are available for foreclosures of mortgages held by savings and loan associations.)

Mr. TALLE. Mr. Chairman.

The CHAIRMAN. Dr. Talle.

Mr. TALLE. Mr. O'Malley, are your associations satisfied with the central home loan bank as presently constituted?

Mr. O'MALLEY. You mean our home loan bank system, sir?

Mr. TALLE. Yes.

Mr. O'MALLEY. Very much, sir.

Mr. TALLE. Thank you.

Mr. MULTER. In line with that, may I ask a further question, Mr. Chairman, or suggest to Mr. O'Malley this fact: You commented upon the fact that the final adjudication by the Board with reference to appointment of a conservator or receiver for an association, is now subject, under this bill, to review by the courts, and the courts would be able to review it both on the law and on the weight of the evidence. I think if you read the bill, however, there is a very serious oversight in that, although they are permitted to review a temporary appointment in the courts. This bill may be subject to the interpolation that there you don't get the privilege of reviewing it on the weight of the evidence but on the law only. I think that part of the bill may need correction.

Mr. O'MALLEY. We will be glad to study that, too, Mr. Multer. That, of course, in our opinion, is in the case of emergency and it may well be that we have to go a little further, as you suggest.

The CHAIRMAN. Are there further questions?

If not, thank you very much, Mr. O'Malley.

Mr. O'MALLEY. Thank you, Mr. Chairman.

The CHAIRMAN. Our next witness is Mr. Harry Held, vice president of the National Association of Mutual Savings Banks.

Mr. Held, we are glad to have you appear before our committee. You may proceed.

STATEMENT OF HARRY HELD, APPEARING FOR THE NATIONAL ASSOCIATION OF MUTUAL SAVINGS BANKS

Mr. HELD. My name is Harry Held, and I am vice president of the Bowery Savings Bank, New York City. I am appearing here today on behalf of the National Association of Mutual Savings Banks in support of H. R. 7839, the Housing Act of 1954.

As of January 1, 1954, there were 528 mutual savings banks, all State chartered. These mutual savings banks are nonprofit organizations, without stockholders. They are operated solely for the benefit of their depositors, who receive all the earnings after the payment of necessary expenses and the setting aside of protective surpluses and reserves.

As of the first of this year, these mutual savings banks had assets of \$27,199 million and deposits of \$24,400 million. As of the same date, these mutual savings banks held \$12,792 million in mortgages, which represent 47 percent of their assets. During the year 1953 these savings banks added, in round figures \$1.6 billion to their holdings in mortgages, in contrast to \$1.5 billion in 1952.

Looking at the bill, H. R. 7839, as a whole we believe that it is a good measure and, if enacted, should be helpful to the prospective homeowner, the home builder, and the mortgage banker. The housing industry is recognized as one of the important factors in the Nation's economy. The encouragements to home financing contained in H. R. 7839 should help the housing industry to maintain a reasonably high rate of activity for the year.

In its slum clearance and urban renewal sections, the authors of H. R. 7839 have taken a fresh and vigorous approach. To what degree the new programs designed to combat urban blight will succeed it is hard to predict, but the problem is immediate and is difficult of solution. Certainly the effort should be made. In view of the proportions of H. R. 7839, we shall endeavor to be brief in our remarks and to confine them to the sections of major interest to savings banks.

Section 203 and section 207, Insurance:

The simplification of the various mortgage insurance programs under section 203 of the National Housing Act and the consolidation of the present title I, section 8, Insurance, into the section 203 framework should be helpful to both the Federal Housing Administration and to mortgage lenders generally. The various subsections, with their different provisions, have been confusing, and this simplification should work for a better understanding of the FHA programs and a quicker processing of mortgage loans.

New maximum mortgage amounts would be established for FHA insurance under section 203, with a \$20,000 limit for a 1- or 2-family residence, \$27,500 for a 3-family residence, or \$35,000 in the case of a 4-family residence. The FHA insurance under this amended program would not exceed 95 percent of the first \$8,000 of value, and 75 percent of the value in excess of \$8,000. These present ceilings are \$16,000, \$20,500, and \$25,000, respectively. See section 104 of the bill. The power to raise these maximum mortgage limits within the new limits would be vested in the President under this bill. See section 201 of the bill. This would give the President a handy instrument for assisting in the stabilization of the housing industry, in that he could raise or lower the maximum mortgage amounts, depending upon whether the country was faced with a deflationary or an inflationary condition.

What I have just said as to the benefit that may come from the new limits of insurable mortgages is true also with respect to the new general limits of 30 years on maturities and 6 percent interest on FHA loans. See section 105 and section 106 of the bill. Maturities could be adjusted up or down within the new limit, and the interest rates could even go beyond the new 6 percent limit at the direction of the president, as provided in section 201 of the bill.

This sort of flexibility has been needed for some time with regard to FHA and VA mortgages in order for them to meet changing conditions of the money market and to compete better with other investments.

The amendments contained in this bill to FHA section 207, Rental Housing Insurance, likewise have our endorsement. See section 115 of the bill. The important part of this amendment, as far as we are concerned, is the amendment to paragraph 3 of 207 (c), which would

retain the present mortgage amount limits of \$2,000 per room, or \$7,200 per family unit, less than 4 rooms, but would remove the \$10,000-per-family-unit limitation. Permissible also under this amendment would be an increase in the limitation to \$2,400 per room and \$7,500 per family unit for elevator-type multiple housing. This is a realistic change, as elevator rental properties are in demand in high-cost and crowded land areas and recognition should be given to the added expense of building them. Here again the new statutory mortgage limits under section 207 (c) (3) would not be put into effect except by Presidential direction.

FHA section 213, Cooperative Housing:

Section 119 of this bill would make certain amendments to the present law governing the insurance of cooperative housing mortgages. In the first place, the insurable maximum would be raised to \$25 million in amount if the mortgagor is regulated by Federal or State law as to rents, charges, and methods of operation. In the nonveteran cooperative projects the per-room limitation would be raised to \$2,250 and the per-family unit limitation of \$8,100 would be applicable only if the number of rooms is less than 4. A 65-percent veteran membership in the project would permit the mortgage to involve a \$2,375 per-room limitation, or an \$8,550 per-family limitation if the number of rooms does not equal or exceed 4 per unit. Here also additional allowances are made if the projects are of the elevator type.

Our association believes that the provision which would base mortgage limits on appraised values, instead of replacement costs as presently provided under section 213, is decidedly a forward step toward providing for relatively sound cooperative housing.

We are, however, not at all certain that section 213 should provide for higher basic mortgage limits than those provided under section 207. While in theory it may seem advisable to make provision for higher limits on cooperative projects than on rental projects, such higher limits might in effect lead to the promotion of unsound cooperatives under the sponsorship of speculative developers.

A basic principle in this legislation involves whether its purpose is to encourage true cooperatives or merely to enable promoters, whose motive is one of profit, to capitalize upon such development in the guise of helping the eventual cooperative owners.

Under the section 213 promotional type of cooperative, the capital risk, and, I might add, the promoter's profit, to the extent that the traffic will permit, are all borne by the mortgagee and the cooperative owners. Experience has proved that the benefits of cooperative ownership are illusionary unless the sponsorship of these projects is such that the profit motive is subordinated to a point where the cooperative owners benefit in the purchase of the land, the construction of the buildings, and, later, the management of the project.

We trust that in the future administration of section 213 considerable emphasis will be put upon providing for strong sponsorship of such projects.

The new sections 220 and 221 of the National Housing Act:

Section 123 would add two brand new mortgage programs to FHA functions. They are special-purpose mortgage programs. They could only be brought into use where the Housing and Home Finance

Administrator has received from the locality a workable program for slum elimination and slum prevention and the rehabilitation or redevelopment of the blighted areas. The Administrator must certify to FHA that either one or both of these new insurance programs could be available in the development community.

The section 220 program would authorize mortgage loans on both new and reconditioned 1- to 4-family units, with the same limits proposed for application for 1- to 4-family dwellings under section 203. This new section 220 also contemplates an insurance program for multifamily housing with maximum mortgage limits of \$2,250 per room, or \$7,200 per family unit, when the number of rooms does not equal or exceed $\frac{1}{2}$ per family unit. Here, again, recognition is given to the higher cost incident to the construction of elevator-type projects.

While we believe that the maximum mortgage limits provided under this section should not exceed those provided for rental housing under section 207, we would not raise objection to the higher limits in the interest of promoting the rehabilitation or redevelopment of blighted areas.

The maximum ratio of loan to value would be 90 percent of value, but mortgages insured under the new section 220 with respect to sales or rental housing would be subject to the section 203 or 207 mortgage-amount limitations unless the President authorizes the higher amount. Thirty years is the maximum maturity date, and even this could only be reached by Presidential direction. A special insurance fund of \$1 million would be set up as a revolving fund with the new section 220 program.

Of course, we cannot be sure that this is going to be an effective program, but we believe it has promise and we think that it should be attempted as one of the instruments to combat the spread of blighted areas. Properly administered, and we believe it will be, this might be of special assistance in some of our large crowded cities.

Also set up under section 123 of this bill is another new FHA program which would be added by section 221 to the National Housing Act. This program is especially designed to provide low-cost housing for families displaced in urban redevelopment areas, and would only be available upon local certification and upon approval by the Housing Administrator. In this program the maximum mortgage amount would be \$7,000, but it would be 100 percent mortgage insurance for a single-family dwelling where the mortgagor is the owner and occupant. Two hundred dollars would be required of the mortgagor to cover initial expenses; 85 percent builder's insurance would be available; the maturity would be a maximum of 40 years, and a service charge would be permitted. The new section 221 would also provide for the insurance of loans for the repair or rehabilitation of dwellings where 10 or more families are accommodated. If the mortgagor is a nonprofit corporation, association, or organization subject to control as to rents, charges, and methods of operation, here, too, the maximum mortgage would be \$7,000 per family unit, and not in excess of 100 percent of value, with a maximum term of 40 years.

A 40-year mortgage, especially of this type, would probably not have general acceptability among mortgage investors, including savings banks, but the added provision in this section to the effect that

the mortgagee could assign the mortgage to the Federal Housing Commissioner after 20 years, if the loan is not in default, and receive 10-year debentures equal to the unpaid balance, might create a market for this special type of insured mortgage.

In the interests of promoting the basic objectives of this section, our association would recommend its support on a trial basis.

Miscellaneous provisions under title I of this bill:

Under section 124 of the bill, some of the remnants of old FHA programs are gathered together and brought under section 203 or 207, as the case may be. This is all to the good in cleaning up the National Housing Act, and should be of assistance to those that have the duty of administering it.

Section 125 of the bill, authorizing FHA insurance of additional advances under an open-end FHA-insured mortgage, gives recognition to a growing move, and we believe a good move, among mortgagees to use this type of instrument. State laws will of necessity limit the use of this insurance in some places, but State laws can be amended if the public wishes.

Under sections 126 and 127 certain old insurance programs would be terminated. It is our understanding that there is no activity under these programs, and here, again, we believe it wise to tidy up the National Housing Act.

Section 128 provides for a 1-year extension of the military housing insurance authority, title VIII, and section 129 would stop new commitments for defense housing insurance, title IX, as of the expiration date, July 1, 1954.

Presidential authority with regard to interest rates, terms and charges:

A good bit of flexibility would be written into the FHA and VA programs by the enactment of section 201 of this bill. The President would be authorized to establish maximum rates of interest on insured or guaranteed mortgages. These interest rates might differ as to different classes of mortgages, but the maximums could not exceed the average market yields of Federal bonds having a remaining maturity of 15 years or longer, plus 2½ percent. This section also gives the President the power to adjust interest rates on FHA debentures, limits on fees and charges in connection with Government-added mortgage loans, maximum maturities, and ratios of loan to value. Within the statutory limitations he could establish maximum dollar limitations per room or per family unit under the National Housing Act. Here, again, this flexibility in the operations of the FHA programs, and the VA program should go far in helping to iron out any unusual inflationary or deflationary tendencies in the housing business.

Secondary mortgage market facility:

Section 301 is a complete rewriting of the charter statute of the Federal National Mortgage Association. Briefly stated, the re-chartered association would have three purposes: (1) To provide a degree of liquidity for existing mortgage investments, and thereby facilitate the distribution of mortgage money; (2) to provide special assistance when needed for financing special housing programs and to be used as a means of retarding any serious decline in mortgage lending and home building; and (3) to act as liquidating agency of the existing FNMA mortgage portfolio.

Mortgages purchased by the association would not exceed \$12,500 per family unit. The Secretary of the Treasury would subscribe the original capital stock of the new association, which has been estimated by the authors of this bill at about \$70 million. The plan seems to be to displace gradually this Government capital by the nonrefundable contributions payable by the users of the new mortgage association. This nonrefundable contribution, of not less than 3 percent of the amount of the mortgages sold, would be involved only in the regular secondary market operations of the new association. The statute seems to contemplate that eventually these nonrefundable contributions will be converted into stock, and that the President shall recommend to Congress necessary legislation to turn over the control and management to private owners.

The new association could purchase FHA- and VA-insured mortgages at or below the market price, and could establish fees and charges for its services, and apparently is intended to be self-supporting. The 1-for-1 program would be continued as a part of the regular secondary market operations.

The new association could issue debentures not to exceed 10 times the sum of its capital, capital surplus, general surplus, reserves, and undistributed earnings. The debentures would not be guaranteed by the United States. The Secretary of the Treasury could purchase these debentures in his discretion.

There is very little doubt that the past expansion of FNMA's operations, particularly since 1947, were influenced primarily by the retention of an inflexible and unrealistic interest rate on Government-insured and guaranteed loans until the middle of 1953. If a flexible interest rate pattern, such as proposed in this bill, had been available, and had been put into effect as the situation required, the need for a secondary mortgage market facility would have been materially minimized. We have never believed in the philosophy of using a secondary market facility to peg an unrealistic interest rate. We believe this bill recognizes the importance of a realistic and competitive interest rate on mortgage investments. If future mortgage interest rates are set on a basis whereby the yields obtainable are truly competitive in the capital market the need for a secondary market for mortgages would, for all practical purposes, be obviated. Regardless of these factors, our association voices no objection to the supplementary secondary mortgage market plan, as proposed in this bill, based upon the belief that such plan could be of some benefit in directing mortgage funds to areas of scarcity and in relieving temporary situations of lack of liquidity. Perhaps the authors of this bill have come up with the most feasible scheme for establishing a secondary mortgage facility which ultimately could stand upon its own feet, without Government investment. We do not think that it is the sole cure-all for fluctuations in the mortgage market. Of equal, and perhaps greater, assistance in maintaining a fairly steady mortgage market will be the judicious exercise of the flexible-interest-rate authority which this bill would give to the President.

The other purposes of the new association will call for very prudent management. We do not particularly like to see the reinstatement of a program, even a special-assistance program, of governmental purchases of mortgages at par. This can lend itself to abuses. We do

not oppose this provision for special-assistance authority, for we believe that the administrators of this program will profit by the past mistakes that resulted principally from unwise use of commitment authority for special-purpose programs. The liquidation of the FNMA portfolio is to be desired, but the administrators of this program must, and we feel sure that they will, exercise care in not adversely affecting the whole housing picture.

Slum clearance and urban renewal:

This part of the bill seems to aim at broadening the concept of slum clearance and urban renewal by redefining some of the important terms used in the statute to include plans and actions for rehabilitation and conservation, as well as the actual clearance of the blighted land and its preparation for reuse. We assume that this contemplates the coordinated use of the new insurance sections, 220 and 221, in conjunction with new projects. Another change is the broadened concept which would include the clearance of commercial or industrial properties, even though the cleared area will not be developed for predominantly residential purposes, if the clearing of the commercial area serves a sound community objective. There appears to be re-emphasis in the bill of local responsibility for the initiation and preparation of urban renewal plans.

We believe that this added emphasis on local responsibility is wise, as a safeguard against unnecessary projects resulting in waste of much needed public funds, both Federal and local. The changes in the concept of urban renewal plans to permit the inclusion of voluntary repair and rehabilitation work; construction of streets, utilities, playgrounds, parks, and other improvements is probably a realistic adoption of the authorities' experience in this field.

We make no attempt to comment on the low-rent public housing features of the bill other than to state the long-held position of the National Association of Mutual Savings Banks on this matter, which is: Public housing, although needed in some areas and to some degree, should be strictly confined because of the latent danger that it might destroy the initiative of families to acquire their own homes and because of the potential abuse resulting from families' continuing to avail themselves of public housing after improvement in their economic status should deprive them of this Government subsidy. The President has recommended a 4-year program of public housing construction at the rate of 35,000 units per year. We do not oppose this proposal, but we urge that particular care be taken in the administration of the program to insure that initial admissions and continued occupancy be strictly policed in order that public housing units be available for the class of persons for which they were intended.

The CHAIRMAN. Are there questions of Mr. Held?

Mr. MULTER. Mr. Chairman.

The CHAIRMAN. Mr. Multer.

Mr. MULTER. Very briefly, Mr. Held, I am pleased to have you here representing the Bowery Savings Bank, which I know and I am glad to tell my colleagues is not only one of our oldest savings banks, but one of our most progressive. You have done a very good job through the years, and I don't hesitate to publicly compliment you for it.

Mr. HELD. Thank you, Mr. Multer.

Mr. MULTER. I am also happy to see that the minority of one that I represented in urging last year standby credit controls for the President has now gotten very respectable sponsorship.

But, tell me, what has caused the change in the thinking of all of the banking fraternity? They were unanimous last year in opposing giving the President any real-estate credit controls. Why are we willing to give them to him now?

Mr. HELD. Well, under the bill I think that the provision for the flexibility of interest rate and flexibility to move up prices, as conditions warrant, probably is better set up in the President, and would provide a degree of flexibility and a cushion for the market.

Whether it would stimulate sales in the event that you had a poor sales market, is problematical. A great many factors enter into that situation. However, I think that one of the big things, one of the important factors, is the question of setting some degree of flexibility in connection with interest rates, in order to attract mortgage funds into the market as against other capital issues.

Mr. MULTER. Thank you, Mr. Chairman.

The CHAIRMAN. Are there further questions of Mr. Held?

If not, thank you for being here, Mr. Held.

The committee will stand in recess until tomorrow morning at 10 o'clock.

(Whereupon, at 12:15 p. m., the committee adjourned.)

(The committee was unable to meet on Thursday, March 11, 1954, and the next meeting was scheduled for 10 a. m., Friday, March 12, 1954.)

HOUSING ACT OF 1954

FRIDAY, MARCH 12, 1954

HOUSE OF REPRESENTATIVES,
COMMITTEE ON BANKING AND CURRENCY,
Washington, D. C.

The committee met at 10 a. m., the Honorable Jesse P. Wolcott, chairman, presiding.

Present: Chairman Wolcott (presiding), Messrs. Talle, Kilburn, Widnall, Betts, Mumma, Merrill, Oakman, Hiestand, Stringfellow, Van Pelt, Spence, Brown, Patman, Multer, Deane, O'Brien, O'Hara, and McCarthy.

The CHAIRMAN. The committee will come to order.

We will proceed with the consideration of H. R. 7839, the housing bill.

We have with us this morning Mr. Carrol M. Shanks, president of the Prudential Insurance Co.; Mr. Jewett, vice president of the Prudential Insurance Co.; and Mr. Vieser, of the Mutual Benefit Life Insurance Co., appearing for the Life Insurance Association of America.

We are very glad to have you gentlemen; proceed, gentlemen.

Mr. SHANKS. Thank you, sir.

STATEMENT OF CARROL M. SHANKS, PRESIDENT, THE PRUDENTIAL INSURANCE CO. OF AMERICA, ACCOMPANIED BY JOHN JEWETT, VICE PRESIDENT, PRUDENTIAL INSURANCE CO., AND M. A. VIESER, OF THE MUTUAL BENEFIT LIFE INSURANCE CO., APPEARING FOR LIFE INSURANCE ASSOCIATION OF AMERICA

Mr. SHANKS. My name is Carrol M. Shanks. I am president of the Prudential Insurance Co. of America, which has its home office in Newark, N. J. I am also chairman of the joint committee on economic policy of the American Life Convention and the Life Insurance Association of America, 2 associations of life-insurance companies with a combined membership of 243 companies holding approximately 98 percent of all life-insurance company assets in the United States. It is in the capacity of chairman of this joint committee that I testify here today in behalf of the life-insurance business. My associates are Milford A. Vieser and John G. Jewett. Mr. Vieser is vice president of the Mutual Benefit Life Insurance Co. of Newark, N. J., and is in charge of his company's mortgage-loan and real-estate investments. He is also chairman of the joint committee on housing and mortgage lending of the two associations mentioned earlier. Mr. Jewett is vice president of the Prudential Insurance Co. of America, and is in charge

of mortgage-loan and real-estate investments. He is also a member of the joint committee on housing and mortgage lending. We appreciate the opportunity afforded by your invitation to appear here today to discuss H. R. 7839.

The life-insurance companies are naturally greatly interested in sound national policy with respect to housing and mortgage lending. They are vitally concerned about improvement in standards of health and well-being of the American people, in which good housing plays such a prominent part. Beyond this, they are well aware of the important role which a thriving residential construction industry plays in general economic prosperity. At the same time they have an equal interest in seeing that housing is not overproduced relative to demand, thus causing all the difficulties which must eventually follow. More directly, the life companies are interested in national housing and mortgage lending policy because of their important position as investors in home mortgages.

The extent of life insurance company investments in residential mortgages:

Before turning to specific discussion of the bill, it will be helpful, I believe, to review briefly the extent of life-insurance company investment in residential mortgages.

For many years home mortgages have been an attractive investment, and the activities of the life companies in this field have been especially noteworthy. During the 7 years, 1947 to 1953, inclusive, the life companies of the Nation increased their holdings of mortgages on 1- to 4-family residences from \$2.6 billion to \$13.1 billion, or a net increase of \$10.5 billion. At the end of 1953 they held 20.1 percent of the total outstanding mortgage debt on 1- to 4-family residences.

The life-insurance companies are by far the most important investors in Government-insured and guaranteed mortgages. Their holdings at the end of 1953 of \$6 billion of FHA mortgages and \$3.6 billion of VA mortgages, for a total of \$9.6 billion of insured and guaranteed mortgages, greatly exceeded such mortgage holdings by the other principal institutional investors. During the period 1947 to 1953, inclusive, they expanded their holdings of FHA mortgages by \$4.8 billion, and their VA mortgages by \$3.3 billion, by far the greatest increase of any investor.

Finally, the life-insurance companies held close to \$3.9 billion of mortgages on multifamily housing units at the end of 1953, a substantial part of which were accounted for above in Government-insured and guaranteed holdings. These holdings are above and beyond the \$450 million invested directly at the end of 1953 in housing projects. Adding together holdings of mortgages on 1- to 4-family residences and mortgages on multifamily dwelling units, the life-insurance companies had total residential mortgage holdings of \$17 billion at the end of 1953.

This brief summary indicates the substantial role of life companies in housing and mortgage lending and demonstrates the readiness of the companies to aid the American people in the long-term financing of their housing requirements.

Despite the sharp increase in residential mortgages in recent years, life-insurance companies have by no means invested all of their funds in this field. Instead, they have continued their traditional and sound

policy of building a well-diversified investment portfolio, including the bonds and stocks of industrial enterprises, public utilities, and railroads, Government securities, State and municipal obligations, commercial and industrial mortgages, farm mortgages, foreign securities, and real estate.

Financing provided by the life companies has played an immensely important role in the postwar expansion of industrial, public utility, and transportation facilities which is of cardinal importance in our military preparedness program. The building of new plants and equipment all over the country has, at the same time, given a great stimulus to housing demand.

One interesting thing about our record is the tendency of the funds to go from those parts of the country which have generated capital to those parts of the country where there is a shortage of capital. We find that in our company, as in the life-insurance business generally, there is a surplus of capital arising above the premiums and our reserves, in the Northeast and in the older areas, and those funds are taken to the South and Southwest and the newer developing areas of the country.

With this background, I would like to comment on the provisions of H. R. 7839. We are in full accord with most of the ideas put forward in the bill which we believe are sound and should be supported. Many of the bill's provisions follow closely recommendations which the life-insurance business put forward last summer in our own statement entitled "National Policy on Housing and Mortgage Lending—A Statement of Life Insurance Company Views."

With your permission, I would like to submit this statement for the record.

The CHAIRMAN. Without objection, that may be inserted in the record.

(The material referred to is as follows:)

NATIONAL POLICY ON HOUSING AND MORTGAGE LENDING—A STATEMENT OF LIFE-INSURANCE COMPANY VIEWS

The life-insurance companies are greatly interested in sound national policy with respect to housing and mortgage lending. It goes without saying that the life companies are vitally concerned about improvement in standards of health and well-being of the American people—in which good housing plays such a prominent part. Beyond this, they are well aware of the important role which a thriving residential construction industry plays in general economic prosperity. At the same time, they have an equal interest in seeing that housing is not over-produced, thus causing all the difficulties which must eventually follow. More directly, the life companies are interested in national housing and mortgage lending policy because of their extremely important position as investors in home mortgages. Governmental policy affects the operation of the entire residential mortgage lending system of the country, so that it is natural for the life companies to have views on the various policy questions.

THE EXTENT OF LIFE-INSURANCE COMPANY INVESTMENTS IN RESIDENTIAL MORTGAGES

Before turning to the policy questions to be discussed in this statement, it will be helpful to review briefly the extent of life-insurance company investment in residential mortgages, as well as to consider some of the forces which govern their investments as a whole.

The life companies have for many years found home mortgages to be an attractive investment, but their activity in this field has been especially noteworthy during the period following World War II. During the 6 years 1947-52,

inclusive, the life companies of the Nation increased their holdings of mortgages on 1- and 4-family residences from \$2,570 million to \$11,800 million, or a net increase of \$9,230 million. This sharp increase was second only to that of \$10,750 million registered by the saving and loan associations during the same period, and it exceeded the net increase of \$4,147 million for the mutual savings banks and \$6,674 million for the commercial banks. At the end of 1952 life-insurance companies held 20.3 percent of the total outstanding mortgage debt on 1- and 4-family residences, as compared with 30.2 percent for the saving and loan associations, 19.3 percent for the commercial banks, and 10.6 percent for the mutual savings banks. The remainder was held by the Federal National Mortgage Association, individuals, and other institutional investors.

The life-insurance companies are by far the most important investors in Government-insured and guaranteed mortgages. Their holdings at the end of 1952 of \$5,681 million FHA mortgages and \$3,347 million VA mortgages, for a total of \$9,028 million of insured and guaranteed mortgages, far exceeded such mortgage holdings by the other principal institutional investors. Commercial bank holdings amounted to \$6,687 million, mutual savings banks held \$5,405 million, and saving and loan associations had \$4,304 million, of which \$3,398 million were VA mortgages. During the period 1947-52 inclusive the life-insurance companies expanded their holdings of FHA mortgages by \$4,453 million and their VA mortgages by \$3,091 million, by far the greatest increase of any investor.

Finally, the life-insurance companies held close to \$3.5 billion of mortgages on multifamily housing units at the end of 1952, a substantial part of which were accounted for above in Government-insured and guaranteed holdings. These holdings are above and beyond the \$461 million invested directly at the end of 1952 in housing projects.

Adding together holdings of mortgages on 1-4 family residences and mortgages on multifamily dwelling units, the life-insurance companies had total residential mortgage holdings of \$15.3 billion at the end of 1952, amounting to 21 percent of their total assets of \$73.4 billion.

This brief summary indicates the substantial role of life-insurance companies in housing and mortgage lending and demonstrates the readiness of the companies to aid the American people in the long-term financing of their housing requirements.

FORCES GOVERNING LIFE-INSURANCE COMPANY INVESTMENTS

Despite the sharp increase in residential mortgages in recent years, life-insurance companies have by no means invested all of their funds in this field. Instead, they have continued their traditional and sound policy of building a well-diversified investment portfolio, including the bonds and stocks of industrial enterprises, public utilities, and railroads, Government securities, State and municipal obligations, commercial and industrial mortgages, foreign securities, and real estate.

Some measure of the overall part played by life-insurance companies in the postwar period a supplier of capital funds is provided by the following figures. During 1946-52 inclusive the life companies increased their holdings of industrial and miscellaneous bonds by \$11.8 billion, public utility bonds by \$6.7 billion, railroad bonds by \$597 million, and stocks of all types by \$1.4 billion. Mortgage holdings of all types (residential, commercial and industrial, and farm) were increased by \$14.6 billion. A substantial part of this enormous increase in investments in the private sectors of our national economy was made possible by a net reduction during 1946-52 of \$10.3 billion in holdings of United States Government securities. Financing provided by the life-insurance companies has played an immensely important role in the expansion of industrial capacity we have experienced which is of cardinal importance to our military preparedness program.

Certain clearly defined objectives underlie the pattern of life-insurance company investments. The life companies are actually aware of the position of trusteeship which they assume in investing the insurance savings of some 88 million policyholders. Therefore, the foremost objective is to invest these savings with the maximum safety. This explains the high quality of life company investments and the emphasis placed upon obtaining investments free of speculative risk. It also explains the stress placed upon a well-diversified portfolio. At the same time, however, life companies labor diligently to earn the highest

possible rate of return consistent with safety of principal, for the higher the rate of investment return the lower the net cost of life insurance to policyholders. A relatively better rate of return, and hence a lower net cost for insurance, is thus at the heart of competition for sales of new policies in an industry characterized by keen competition between companies.

This vigorous competition between companies to obtain the best net yields on investments explains the sensitivity of life companies to changes in net yield on the various types of investments. The pattern of yields existing in the market at any one time on industrial bonds, utility bonds, commercial mortgages, conventional residential mortgages and Government-insured and guaranteed mortgages is in a state of delicate balance. Life companies watch this yield pattern carefully and are quick to redirect their investments into areas where net yields improve in attractiveness in response to demand and supply forces. For example, if as a result of market forces the net yield on high-grade industrial bonds should rise relative to that on home mortgages, it is natural that life company funds would tend to shift toward greater investment in industrial bonds. Of course, the requirements of a balanced portfolio will always serve to keep such shifts from going to extremes.

This sensitivity of life company investments to changing yield spreads has great social advantages because it insures as a general rule that savings will be channeled into uses where there is greatest need for them. Interest rates are merely prices paid for the use of borrowed money and like any other prices they are established basically by conditions of demand and supply in the market place. This system of interest rates has the function in our national economy of influencing the distribution of savings to their most productive uses. It is for this specific reason that, as will be discussed more fully later, all interest rates must be permitted to move freely in response to demand and supply forces. Wherever interest rates on certain loans, e. g., FHA and VA mortgages, are prevented by administrative and legislative fiat from rising during a period of capital stringency, it is only natural for capital funds to shift into markets where rates reflect demand and supply conditions.

VIEWS ON NATIONAL HOUSING AND MORTGAGE LENDING POLICY

I. THE GOAL OF NATIONAL POLICY

The record of residential construction in this country over the years indicates that the home-building industry is characterized by long cycles of activity, alternating in booms and depressions. Because of the great importance of the home-building industry in our national economy, fluctuations in this area play an important role in the problem of instability in the economy as a whole.

In view of these circumstances, it is appropriate for the Federal Government, through general credit policy, through policy with respect to the Government-insured and guaranteed mortgage program, and in other similar ways to aid in lending stability to the private home-building industry. The objective of Government policy in this regard should be to help level off the peaks and fill in the valleys in home building. This does not mean that the Government has a responsibility at any time to build houses itself; rather, its efforts should be confined to providing a general economic climate conducive to stability in private home building.

It would be a mistake to define the appropriateness for Government to exert a stabilizing influence in the housing field in terms of a rigidly fixed number of housing starts per annum; for example, the 1 million units so often cited. A rigid objective of this sort is not in keeping with the flexible free-market economy on which we place reliance. Moreover, whatever the stabilization objective, the number of housing starts each year must bear a direct relationship to such basic forces as the rate of family formation, the need for replacement of clearly substandard housing, and the ability of people to pay for housing. Whatever the general objective of stability, there must be leeway for the inevitable price and production adjustments and readjustments which are so healthy in our free-market economy.

II. THE GOVERNMENT-INSURED AND GUARANTEED MORTGAGE PROGRAM

A. *The function of FHA Mortgage Insurance*

The FHA system of home mortgage insurance is, if administered soundly and with flexibility, a desirable vehicle for lending stability to home building and mortgage lending. The idea of mortgage insurance as set forth in the preamble

of the original Federal Housing Act is basically sound, but there is evidence that the FHA program has departed from the original plan. The FHA should return to the function originally intended; namely, purely as an insuring agency to be operated on business principles and with adequate reserves in order to make its maximum contribution to a stable mortgage market.

B. Interest rate policy with respect to Government-insured and guaranteed mortgages

The fundamental cause for the present shortage of Government-insured and guaranteed mortgage financing is, along with the excess of overall demand for capital funds relative to the supply of savings, that the existing rate on these loans is not sufficiently flexible; and, although it was recently increased to 4½ percent, the insured or guaranteed mortgage is still not entirely competitive at par with rates on alternative investments. It should not be overlooked that at this rate the net yield to investors after meeting servicing and other costs is considerably below 4½ percent and is nearer 3.75 percent. Other interest rates set by competitive market forces have risen in the past several months as a result of the heavy demand for capital funds, whereas the rate on insured and guaranteed mortgages has not been permitted to adjust fully to meet changing capital market conditions.

The basic solution to the problems which we have experienced in recent years in the mortgage market is to make the insured and guaranteed rate flexible so that it can reflect and adjust fully to free market forces. This can be accomplished in the following way. The FHA Commissioner should set a maximum permissible rate which can be charged on insured and guaranteed mortgage loans, but this rate should be substantially above the current going market rate.¹ Under the ceiling of the maximum, the actual contract rates on individual insured and guaranteed mortgages would be set as a result of competitive market forces. The rates would move up or down depending on market competition and would also be allowed to reflect geographical differences in the market as well as the additional expense involved in handling a small volume of loans in smaller towns and rural areas. Despite flexibility in the contract rate on insured and guaranteed mortgages, there will always be a tendency for discounts or premiums to arise on these mortgages (as on any mortgages) as market conditions change, so that official approbation of trading of insured and guaranteed mortgages at a discount or premium is needed.

The general principle of flexible rates should also apply to rates payable on FHA debentures. Historically the FHA debenture rate has been reduced during a period in which the downpayments have been cut and the maturity of FHA loans has been extended, the latter not only making the loans less attractive but also having the additional disadvantage of leading to an extension of the maturity of FHA debentures. In order to keep the FHA mortgages competitively attractive in the general capital market where rate flexibility prevails, it is necessary to follow a flexible policy with respect to the FHA debenture rate and to permit this rate to rise in a rising interest rate market. The debenture rate at the time of making the loan should be kept in line with the general level of interest rates.

C. Federal Reserve influence on insured mortgage terms

As indicated in the preceding section, interest rates on Government insured and guaranteed mortgages, as well as conventional mortgages, should be entirely free to move in response to basic conditions of supply and demand for mortgage funds in the market and to reflect such factors as regional differences in risks, in servicing costs, and in costs of foreclosure. Within this framework interest rates will automatically exert a stabilizing influence in that they will tend to rise in a period of boom in housing and mortgage lending and to decline in a period of downturn. Any Government influence on mortgage interest rates, if needed at all, should be exerted solely through the exercise of the indirect general credit control powers of the Federal Reserve.

Aside from the rate of interest, other terms on Government insured and guaranteed mortgages, notably the amount of downpayment required and the length of the amortization period, have a direct effect upon the volume of mortgage credit. In the past these terms have been set rigidly by the Congress without much opportunity for administrative flexibility. There have been occasions in

¹ It is later recommended that the VA home mortgage program be merged with FHA, so that the FHA Commissioner would administer both the insured and guaranteed program.

recent years, for example, when Congress has moved to ease downpayments and to lengthen amortization periods at the same time that the Federal Reserve has been exercising its general credit control powers to tighten credit in an effort to combat inflation.

It would be desirable in the future for Congress to provide discretionary authority, within limits, for the FHA Commissioner to fix the various terms of the insured and guaranteed loans such as downpayment and period of amortization. In exercising such discretionary authority, the Commissioner should, of course, have an eye to stability in home building and in the economy as a whole. To insure appropriate use of his discretionary authority, the Administrator should be required to consult regularly with the Federal Reserve authorities in order to maintain consistency between general credit control policy and the non-interest-rate terms on insured and guaranteed loans.

D. Organization and administration of the Government insured and guaranteed mortgage program

Certain changes are needed in the organization and administration of the Government insured and guaranteed mortgage program as follows:

1. Both the Federal Housing Administration and the Home Loan Bank Board should be restored to independent status and should no longer be affiliated with the Housing and Home Finance Agency. With both of these agencies operating independently, the remaining need for HHFA is greatly reduced. It may be true, however, that HHFA should continue to function, at least on an interim basis, as a coordinating agency on housing and mortgage matters. For example, HHFA might serve on an interim basis to handle such matters as the disposition of Lanham Act housing, the liquidation of FNMA (as later recommended), Alaska housing, college housing, and the community-facilities program. Also, there is a real need for an improved research and statistical program by Government in the housing- and mortgage-lending field which might be assigned to HHFA.

2. Rivalry between the VA and FHA with respect to the making of loans and the liquidating of holdings involves serious disadvantages. Therefore, the VA home-mortgage program should be merged with FHA in a separate title. At the same time, the VA should retain the function of guaranteeing veterans' business loans. Aside from eliminating the dangers inherent in rivalry between FHA and VA, the merger of the VA home-mortgage operation into FHA would lead to greater efficiency and economy for the entire operation.

3. Regardless of whether recommendation No. 2 above is adopted, the VA should accept FHA appraisals and inspections as well as field service and supervision, thereby relieving the taxpayer of the cost of duplicated service and eliminating for the home-building industry all the details, difficulties, and costs entailed in dual processing. The independent appraisal operations of the VA Loan Guaranty Division should be abolished. Now that a competitive market for housing has been reestablished, VA should abandon the reasonable value test, insisting only that the veteran buyer should know the FHA valuation placed on a piece of property and should sign a declaration for VA that he has seen it.

E. Matters of detail

Apart from the recommendations already made with respect to the Government insured and guaranteed mortgage program, there are several additional recommendations dealing with the detailed operation of the program which deserve mention, as follows:

1. There does not seem to be any real economic justification for the present FHA policy of insuring a much higher percentage of mortgages for the purchase of new housing than for the purchase of older housing. Therefore, the FHA should at the present time take steps to narrow the margin. Discretion as to the terms should reside with the FHA Commissioner, who should maintain a policy of flexibility with respect to the insurance terms on new and older houses depending on economic circumstances at any given time. In the exercise of this discretionary authority the Commissioner should be required to consult with the Federal Reserve Board. Under the proposal being made here, it should be recognized that the margin of safety on the loans on older houses would be preserved in that the appraisal of the older houses would naturally reflect the difference in value of the older house as compared with the newer one.

2. The FHA should give encouragement to higher standards of space, design, construction, and land planning.

3. The various FHA titles should be completely overhauled to develop one simplified insurance pattern for all owner-occupied 1- to 4-family units and one simplified pattern for all civilian rental housing.

4. The FHA program of insuring cooperative housing should be critically reviewed. There is serious doubt whether this program is basically needed. Moreover, it should be remembered that cooperative housing projects have the serious pitfall, as shown by history, that if a small minority of the families in such a project experience financial difficulty the entire project then experiences trouble.

5. FHA procedures should be simplified to make it easier to employ FHA debentures for the payment of insurance premiums.

6. FHA should simplify its various rules and regulations in order to reduce originating and servicing costs.

7. FHA, by establishing certain standards, should lend its influence for uniformity of State law with respect to mortgage foreclosures. Costly foreclosure laws in many States add greatly to the expense of mortgage lending. It is essential that the foreclosure procedure be improved according to satisfactory standards and made uniform in the various States in the interest of lower mortgage lending costs.

8. FHA should also lend its influence to achieve uniformity of building codes in municipalities throughout the country. Much can also be done through private groups, such as the United States Chamber of Commerce, to educate municipal officials on the value of a uniform system of building costs.

III. DIRECT GOVERNMENT LOANS IN THE HOUSING FIELD

The program of direct Government loans to veterans for the purchase of homes and farmhouses is unnecessary and should be terminated. The argument which has been made for this program is that there are certain rural and remote localities in the country where private mortgage credit is unavailable so that direct Government lending to veterans is rendered necessary.

Actually, the mortgage market in the United States is exceedingly fluid and mortgage money from private lending institutions will flow, within the limits of the total supply of savings, to all communities provided that interest rates are flexible enough to reflect fully the risks and servicing costs involved. The apparent need for direct Government lending has been caused by the rigidity of the VA mortgage rate and its failure to reflect regional differences in risks, servicing costs, costs of foreclosure, and the like.

The adoption of a flexible interest rate policy on Government-insured and guaranteed loans, such as was outlined earlier, and the recognition of regional differences in risks, servicing costs, costs of foreclosure, and the like should completely eliminate, except possibly in extreme cases, any need for the direct lending program.

IV. FANNIE MAY—PUBLIC OR PRIVATE

Operations of the Federal National Mortgage Association should be terminated and the mortgages held by FNMA should be liquidated just as promptly as is consistent with orderly market conditions. Throughout the postwar period FNMA has served to provide a primary market for Government-insured and guaranteed mortgages bearing interest rates not competitive in the market. Its operations have constituted a drain on the Federal budget and have often throughout the postwar period contributed to inflationary forces in the booming housing market. If the interest rate policy on Government-insured and guaranteed loans which was outlined earlier is followed, the private lending institutions of this country—the life-insurance companies, the mutual savings banks, the commercial banks, and others—will provide an adequate secondary market for home mortgage loans.

Just as there is no real need for FNMA, assuming the adoption of flexible interest rates on Government-insured and guaranteed loans and the recognition of regional differences in risks, servicing costs, costs of foreclosure, and the like, there is likewise no need for a private national or central mortgage bank, as is currently being urged in several quarters. This private bank would at best be merely a substitute for FNMA and would still have as its basic function the purchase of Government-insured and guaranteed mortgages which, because of their failure to meet market competition, are not salable to the private lending institutions. The time has come to stop resorting to palliatives and to introduce a basic remedy—namely, real market flexibility of rates on Government-insured and guaranteed mortgages.

The idea of a private national mortgage bank has serious disadvantages. In order to obtain the funds to purchase mortgages, the bank will be required to

sell debentures, and it seems obvious that the only possible market for these debentures will be with the lending institutions which in the first instance have found the mortgages unattractive because of rate rigidity. In a period of heavy demand for capital funds, which would be the time of greatest need for the national mortgage bank, there will not be a market for the bank's debentures unless some way can be found to sell them to the banking system. However, resort to the banking system under such conditions would have serious inflationary consequences and should not be permitted in the general public interest.

V. SLUM CLEARANCE AND LOW-RENT HOUSING

It cannot be denied that in certain cities throughout the country there is a serious problem of slum clearance and low-rent housing. It is doubtful, however, that public housing is the answer to this problem. Certainly the public housing program to date has had serious shortcomings, with housing being built in places where it was not needed, and with high-income groups living in public housing projects.

The present period of high prosperity and much improved housing standards affords a good opportunity for a thorough study of why the public-housing program has failed and what basically can be done to meet the slum clearance and urban redevelopment question. This study should consider the question of whether a sound and workable basis can be devised for making it possible for private enterprise, with Federal, State, and municipal participation, to do the job.

MR. SHANKS. We like the effort which is made in a number of sections in the bill to shift from direct Government action to reliance on private financing under the FHA insurance program. This is particularly true in connection with the urban renewal and slum clearance program in title IV, and in the proposed new section 220 which I shall touch on in more detail later. We are also in general accord with the provisions of title II which would give the President the power to establish flexible maximum interest rates on VA and FHA mortgage loans, and likewise discretion in establishing other mortgage terms on a more flexible basis. We believe, however, that in the use of these discretionary powers the President should be guided by the goal of keeping VA and FHA mortgage terms competitive in the market, and that these powers should not be used as a means to employ housing policy as a pump primer for the entire economy.

We also think that most parts of title I deserve our support. For example, the provisions of section 101 dealing with property improvement and repair loans are sound. Likewise, we agree that it is sensible and desirable to give the same treatment to both new and existing homes under the FHA insurance program. We think the authorization of FHA insurance of advances in open-end mortgages has much to commend it. Moreover, we favor a number of provisions in title I which serve to simplify the FHA insurance system, but we are disappointed that the bill does not provide for eliminating the duplication of effort by the FHA and the VA in processing mortgages which is so costly to not only the mortgage borrower but also the lender and the American taxpayer.

This is but a partial list of the things we like about the bill. However, we are apprehensive about some of the broad philosophy which runs through the bill. This takes the form of a general liberalization of insured and guaranteed mortgage terms to a point which we think raises a serious question of conflict with the tenets of sound financing. Likewise, we believe that the bill leans too far in the direction of accepting the objective that the volume of housing starts must be kept going at a peak level at all costs, and that the Government should use its pro-

posed control over insured and guaranteed mortgage terms to accomplish this objective. We would like to see in the bill a recognition that regardless of a desire to stabilize the housing industry at a high level the number of housing starts each year must bear a relationship to such basic forces as the rate of family formation, the need for replacement of clearly substandard housing, and the willingness to buy.

I might point out, incidentally, that it is my personal conviction that our housing starts are going to be surprisingly high for the years to come, all the way on out.

Whatever the general objective of stability, there must be leeway for the inevitable price and production adjustments and readjustments which are so healthy in our free-market economy. In brief, we believe that Government policy should aim to help level off the peaks and fill in the valleys in home building, but at the same time it should permit building to be responsive to market forces.

I would now like to consider the new sections 220 and 221.

Section 220, providing for a carefully programmed system of rehabilitation and neighborhood conservation housing insurance, deserves the support of all institutional investors in that through the use of FHA insurance it provides a workable method for private financing to aid in arresting decay and blight in our cities. If the section is carefully administered and the various safeguards written into the bill are observed, the program has real possibilities for attracting private financing on a sound basis. As a general rule, life-insurance companies question the soundness of an amortization period running as long as 30 years, as provided in this section, but it is our view that the life-insurance companies generally will find the proposed section 220 acceptable in its present form and will, therefore, purchase these mortgages.

The life-insurance business also believes that section 221, providing for a system of mortgage insurance for relocation housing, also has real possibilities if certain amendments are made. The most glaring defect of the proposal is the provision for a 40-year amortization period. We believe that section 221 mortgages could be made acceptable to private financing institutions, without appreciably raising the monthly carrying cost on such mortgages, by reducing the amortization period to 30 years and by tightening the insurance provisions to guarantee the investor against loss at foreclosure. To illustrate our point, if we assume a \$7,000 mortgage at a 4½-percent rate amortizable in 40 years, at the end of 5 years only \$350 would have been paid in amortization; at the end of 10 years only \$791; and at the end of 20 years only \$2,037, with \$4,963 of the initial loan still outstanding. As is obvious, the rate of amortization is exceedingly slow, in fact so slow that the physical depreciation and obsolescence of the property would undoubtedly be greater than the amortization. This exposes the investor to the serious risk which no lender operating on sound lending principles would be able to assume. If we assume a \$7,000 mortgage also at a 4½-percent rate, but with a 30-year amortization period, the amount amortized at the end of 5 years is \$623; at the end of 10 years \$1,400, and at the end of 20 years \$3,598. This rate of amortization, although still quite slow in the eyes of many institutional investors, makes the loan much more acceptable.

To follow through with the illustration, the monthly carrying charge, interest, and amortization, on a \$7,000 4½ percent, 40-year mortgage is \$31.50. The monthly carrying charge on the same mortgage, but with a 30-year amortization period, is \$35.49. Thus the shorter term, making the loan sound, involves only \$4 more per month in the mortgagors payment. More important, if the loan is written on a 40-year basis the mortgagor must pay total interest of \$8,120 over the life of the loan, as compared with total interest of \$5,776 if the loan runs for 30 years. Accordingly, the 40-year loan will cost the home owner \$2,344 more in the form of interest, which is a heavy price to pay for the extended maturity. For these reasons we believe that the 40-year loan is socially undesirable, and we urge strongly that section 221 loans be placed on a 30-year basis.

By the very nature of the loan, the default experience on section 221 loans will be much less favorable than under most other FHA loans, so that the investor must be prepared for more difficult collection problems and a larger percentage of foreclosures. We believe, therefore, that to make the section 221 loans acceptable to private investors, provisions should be included to limit the lender's out-of-pocket losses at the time of foreclosure. This is a special loan program where the risk must inevitably be great, and it is, therefore, necessary to limit the losses of the lender. It would be most helpful as a practical matter to include in section 221 the same provision in effect with regard to section 608 loans, namely, that upon default the investor would have the option to assign the mortgage to FHA and to receive debentures equal to 99 percent of the unpaid balance.

We do not believe that the amendments we have suggested will interfere with the basic objectives of section 221. They will, however, make the program generally acceptable to life-insurance companies and, we feel confident, other institutional investors. If these amendments are made, we are confident that life companies and other institutional investors will purchase section 221 mortgages.

I would now like to turn to title III, calling for the rechartering of FNMA. We are firmly and vigorously opposed to the provisions of title III with the exception of those providing for the liquidation of the existing FNMA portfolio. We believe there is only one valid reason for a Government program as provided for in title III, namely, to assure the general availability of insured and guaranteed mortgage credit in small communities and remote areas and for minority groups. We are confident this can be done by private financing institutions themselves through a voluntary but well organized effort, without the Government intervention provided for in title III. I shall presently explain how such a voluntary plan would operate, but before doing so I would like to outline our reasons for opposing title III.

We are opposed in general to title III because, first, it provides for little more than a rechartering of FNMA to revive its power currently to supply Government funds in the mortgage market. Actually, it goes further in the direction of direct Government participation in the mortgage lending field than does the existing FNMA program. Secondly, it reflects a philosophy that housing must be kept going at a boom level regardless of basic market forces with respect to the demand for housing. The United States has been through a boom in housing

production and a steady rise in prices of housing, and basic market forces now suggest the need for a moderate downward adjustment in output and prices. We believe that it would be preferable to have a moderate adjustment now rather than a major break in the future, which seems inevitable if we continue to apply artificial stimuli at this time. Thirdly, provisions of the title, through continued and strengthened Government propping of the housing industry, will retard technological improvements in housing and thus will delay movement toward a lower housing-cost basis, which is so urgently needed. Finally, if, as under this title, the Government tries to perpetuate boom conditions in housing in the face of a needed readjustment, it will have an adverse effect on the occupancy and prices of our existing stock of housing, estimated at close to \$200 billion, on which the Government has a contingent liability of nearly \$29 billion in the form of mortgage insurance and guaranty.

The specific reasons which we have for opposing the special assistance function in title III are as follows:

(1) We do not believe that it is necessary for the Government to embark upon the task of direct assistance to special insured or guaranteed mortgage programs. As we indicated in connection with the proposed sections 220 and 221, if the amendments we have suggested are accepted, then private investors will purchase the mortgages under these sections.

(2) In addition to the objective of supporting special programs, it is provided that the assistance function should be employed as needed to retard or stop a decline in mortgage lending and home building. We do not believe that this function is soundly conceived, and it certainly is not necessary. It puts the cart before the horse in that if home-building activity goes into a decline it will certainly not be for lack of available private mortgage credit on a liberal basis. The reasons for any decline will be rooted in the demand for housing and will not derive from any lack of available funds.

(3) The function of the special assistance provision will in effect involve direct Government lending, with funds coming directly from the United States Treasury. The initial amount may not seem large, but we have seen how easy it was to expand FNMA once it came into being.

(4) This program is on the direct road to public control of housing and home financing. It goes beyond the Government insurance and guaranty function and is a long step in the direction of comprehensive public control. We feel that it is incompatible with the free-enterprise objective which has often been mentioned in the bill.

(5) Under this function there is no provision for a 3 percent non-refundable contribution to be required of sellers of mortgages to FNMA. The absence of this requirement, which is provided for under the secondary market function, certainly makes the dumping of mortgages with FNMA a still greater risk.

For these reasons we think that not only is there no need for the special assistance function, but it is a dangerous threat to the private financing system. We are firmly opposed to it.

Before I discuss our proposal for a voluntary effort to make residential mortgage credit generally available in all communities throughout the country, I would like to outline why we are also

strongly opposed to the proposed "secondary market" function of the rechartered FNMA, as follows:

(1) Basically, there is no need for a Government "secondary market function." Readily available statistics show the tremendous job the private mortgage financing system has done throughout the post-war period. During the past 5 years, even in 1952 and 1953, when there was supposed to be a mortgage "stringency," the number of new nonfarm dwelling units started has exceeded 1 million per year. The average number of starts per year in the 6-year period, 1948 to 1953, inclusive, is 1,112,000. Nonfarm mortgage debt on a 1- to 4-family house increased from \$18.5 billion at the end of 1945 to \$65 billion at the end of 1953, or an increase of $3\frac{1}{2}$ times. Within this total increase of \$46.5 billion, financial institutions such as life-insurance companies, mutual savings banks, and so forth, increased their holdings by nearly \$41 billion. During the period 1948 to 1953, inclusive, the total of nonfarm mortgage recordings in amounts of \$20,000 or less has averaged over \$15.5 billion per year, and the average in the past 3 years has been over \$18 billion. All but a small fraction of these mortgages have been absorbed by the private market. In reviewing these figures we can see little evidence that private mortgage financing has been less than fully adequate throughout the post-war period. We believe the figures prove that the savings institutions, the commercial banks, particularly through their warehousing loans, and individual investors, have provided an admirable private secondary market, and that FNMA is not needed for this purpose.

(2) Under the provisions of title III, the proposed FNMA secondary market function is a direct Government operation in every respect, with the provision that \$70 million of its stock is to be subscribed by the United States Treasury, and with up to \$1 billion of its obligations purchasable by the Treasury.

(3) The most extensive use of FNMA in the past, and we fear inevitably in the future if title III passes, has been under boom conditions. At other than periods of inflationary boom, as witnessed by the present time, there is plenty of legitimate residential mortgage credit available. FNMA purchases of mortgages in a boom are bound to be inflationary, as we have learned so well in the past. The FNMA operation is not a normal operation to supplement and liquify the private mortgage market; rather, it is a means to pour additional money from the United States Treasury sources into the mortgage market in a boom, when savings necessarily tend to be scarce relative to demand. Thus FNMA funds inevitably serve to promote inflationary pressures.

(4) The basic condition for a free flow of mortgage funds is flexibility of interest rates, but the FNMA secondary market operation will only tend to rigidify rates. If the President exercises the powers proposed in title II to keep FHA and VA interest rates in line with market conditions; that is, if he fixes them on the upside as well as the downside, the Government-insured and guaranteed mortgage programs will have an ample flow of funds.

I need only point out that when the money became tight a year ago, money went less into FHA and VA mortgages and went more into the conventional mortgages, where the lenders could get a higher rate.

When the FHA and the VA rates went up—I think it was in May—

and put in line with the market, after about a month or so the whole thing turned and there was then a tremendous upsurge in the money that went into the FHA and VA mortgages, and a dropping down of the money going into the conventional mortgages. It showed that you get a very quick response, when interest rates are made competitive in the market.

(5) The nonrefundable contribution of 3 percent may seem to be a real deterrent against the dumping of mortgages in the rechartered FNMA, but we see little to prevent the shifting of the contribution on to the home purchaser in the form of a higher price for the house. Since the FNMA would be used under boom conditions, it would be especially easy in a seller's market for houses to shift the contribution to the home purchaser at the time FNMA would be used.

We believe for these reasons that the provisions for a FNMA secondary market operation should not be enacted. As I indicated earlier, the only valid reason for a secondary market operation by Government is the fact that there may be certain small communities and remote areas where Government insured and guaranteed mortgage credit is not generally available, and there may be cases where credit has not been available to minority groups. We think that this problem has been exaggerated, but there is no doubt that because of great pressure on the supply of mortgage money in the postwar housing boom, because of less than full coverage by the private mortgage system, and because of high servicing costs in small communities and remote areas, it is probably true that there may be cases where persons of good credit standing have been unable to obtain credit. We believe that much can be done to correct this situation if the President exercises the powers provided in title II for flexibility of interest rates and fees and charges. Nevertheless, there may remain some element of difficulty here.

In order to provide additional assurance that this problem will be solved, we wish to propose a plan under which all types of private financing institutions, through a voluntary but well organized effort under the direction of HHFA Administrator, would undertake to see that Government insured and guaranteed mortgage credit will be available to the maximum extent possible to all good credit risks for residential loans in every community of the United States. We have embodied our plan in the draft of a bill, and I would like to give the committee copies for your study.

I believe you have copies, sir.

We believe that under the voluntary effort which we are proposing, the problem of credit unavailability in small communities and remote areas, to the extent there is a problem, can be fully solved. Our plan should be tried to see what the magnitude of the problem is. We have made a canvass of the life-insurance business and the plan has the backing of the big majority of life companies. We also are confident that other mortgage financing institutions would favor the purpose and basic ideas of the plan and would cooperate wholeheartedly.

Perhaps it would help if I were to outline the plan briefly, although I am sure you will want to read the proposed bill. The principal provisions are as follows:

(1) The basic purpose would be to facilitate the flow of funds for housing credit into remote areas and smaller communities where funds

are not available or are in inadequate supply, and to make mortgage credit generally available without regard to race, creed, or color.

(2) The plan would be limited to loans insured or guaranteed by the Government.

(3) There would be established a National Voluntary Mortgage Credit Extension Committee, under the chairmanship of the HHFA Administrator, consisting of the chairman of the Federal Reserve Board and 14 persons to be appointed by the HHFA Administrator representing each type of financing institution, the builders, and the real estate boards. The Administrator would appoint a regional subcommittee of five persons in each Federal Reserve district.

(4) The national committee would be empowered to solicit and obtain the cooperation of financing institutions in the program. It would study and review the demand for and supply of funds for residential mortgage loans in all parts of the country and would receive reports from and correlate the activities of the regional subcommittees. It would maintain liaison with the Government housing agencies and with State and local housing officials to fully apprise them of the voluntary program.

(5) Each regional subcommittee would study and review the demand for and supply of funds for residential mortgage loans in its region, would analyze cases of unsatisfied demand for such mortgage credit, and would report to the national committee the results of its study and analysis. It would also maintain liaison with officers of the FHA and VA within its own region and would request these officials to supply the subcommittee with information regarding cases of unsatisfied demand for mortgage credit involving loans eligible for FHA insurance or VA guaranty.

(6) The regional subcommittee would render assistance to any applicant for residential mortgage loans, provided that the applicant certifies that he has made a serious effort to obtain a purchaser for an insured or guaranteed mortgage loan and has been unable to do so. Upon receipt of such certification, the regional subcommittee would circularize private financing institutions in the region or elsewhere in an effort to place the loan with a private financing institution. It would undertake to handle in a similar way cases involving applications made to the VA for direct loans.

In that connection, I want to say that in New Jersey where there has been an informal committee operating, there have been no VA direct loans for many years, because that small committee has always found purchasers, investors who have taken up those loans.

My associate, Mr. Vieser, has been active in that field, as also has Mr. Murphy, who will appear here later today.

Moreover, in order to encourage small or local private financing institutions to originate insured or guaranteed mortgage loans, the subcommittee would be empowered to render assistance to such institutions in locating other private financing institutions willing to purchase these loans, thus extending a secondary market to these local originators.

(7) In the performance of its responsibilities each regional subcommittee would be empowered (a) to request the national committee to obtain for it the aid of other regional committees in seeking sources of residential mortgage credit, and (b) to request and obtain

voluntary commitments or working understandings from any one or more private financing institutions to make funds available for insured or guaranteed loans in any specified area or areas within its region in which the subcommittee found a lack of adequate credit facilities for these loans.

We hope you will give serious study to our plan because we believe it affords a way for private financing institutions to handle the problem of mortgage credit unavailability in small communities and remote areas, and for minority groups. We have given a great deal of study to this matter and we believe there is an awareness on the part of financing institutions of the desirability of our proposal. We are confident, therefore, that it can be made to work effectively.

I thank you for your courtesy in listening to our views. We would be glad to answer any questions you may have.

The CHAIRMAN. Thank you, Mr. Shanks.

Mr. PATMAN. Mr. Chairman.

The CHAIRMAN. Mr. Patman.

Mr. MULTER. Mr. Patman, will you yield for a brief statement?

Mr. PATMAN. Certainly.

Mr. MULTER. Mr. Chairman, I am very happy to have Mr. Shanks with us. I am sure it is modesty that prevents him from telling us that the Prudential is the second largest insurance company in the country today, and I dare say even though some of the other companies may feel slighted by this statement, that it is their progressive attitude that has made much good housing available through their sound mortgage facilities and programs.

I am very happy that we are able to hear Mr. Shanks this morning.

Mr. SHANKS. Thank you, sir.

Mr. PATMAN. Mr. Shanks, in your discussion of section 221, I am convinced that you have made a very logical argument in behalf of the 30-year limitation instead of the 40-year limitation, in view of the small difference in the payments each month.

I am very much impressed with your argument there. I assume that your group would not support the market, that is furnish the money to support section 221 as now written?

Mr. SHANKS. I think that there would be inclination for the private investors not to take them up on the 40-year basis.

Mr. PATMAN. But they would take them up, you have stated in your testimony, on the 30-year basis?

Mr. SHANKS. I think they would, sir.

Mr. PATMAN. What about the down payment? What would you say about that? Would you leave it as it is or would you change it?

Mr. SHANKS. Yes; our idea was to leave it as it is, sir.

Mr. PATMAN. Leave it as it is?

Mr. SHANKS. Yes.

Mr. PATMAN. The same down payment?

Mr. SHANKS. Yes.

Mr. PATMAN. Would the insurance companies buy the nonguaranteed obligations of the new FNMA? I assume from your testimony that they would not?

Mr. SHANKS. I do not believe that most insurance companies could buy them, sir, under the State laws.

Mr. PATMAN. Under the State laws?

Mr. SHANKS. Yes; I think that is right. In any event, I assume they would be short-term obligations which, by and large, we do not invest in anyway.

Mr. PATMAN. And I assume, too, that you believe that this 3 per cent contribution would be passed on to the borrower immediately?

Mr. SHANKS. I think it would in most cases, although I agree that in some cases it would be a deterrent and I think it would help in some cases where there had been more or less of an abuse of the use of FNMA. It would help in some cases, sir, but in most cases I believe it would be passed on.

Mr. PATMAN. Has the Prudential Insurance Co. bought any mortgages from FNMA in the last 6 months?

Mr. SHANKS. Bought them from FNMA?

Mr. PATMAN. Yes, sir.

Mr. SHANKS. No, sir; we have not.

Mr. PATMAN. You have not bought any?

Mr. SHANKS. No.

Mr. PATMAN. The mortgages that have been purchased, have they generally been purchased at a discount, or do you know?

Mr. SHANKS. From FNMA, sir?

Mr. PATMAN. Yes.

Mr. SHANKS. Yes, sir; there has been a discount. Most of them have been sold at a discount.

Mr. PATMAN. What is the usual discount? About 96? About 4 percent?

Mr. SHANKS. From 2 to 4 points, sir.

Mr. PATMAN. From 2 to 4 points?

Mr. SHANKS. Yes.

Mr. PATMAN. Do you buy Government bonds in the open market when you buy them?

Mr. SHANKS. Generally not, sir.

Mr. PATMAN. Where do you buy them?

Mr. SHANKS. We generally buy them on direct issuing or offering by the Treasury.

Mr. PATMAN. Suppose you need bonds when there are none being offered? Do you never buy them in the open market?

Mr. SHANKS. Oh, yes; we would buy them in the open market.

Mr. PATMAN. When you buy them in the open market what margin does the dealer usually receive in the transaction?

Mr. SHANKS. I cannot answer that specifically, but it is a very small margin.

Mr. PATMAN. I wonder if anyone with you could estimate the amount?

Mr. O'LEARY. It is in the order of one thirty-second of a point, but the margin varies from time to time depending upon the fluidity of the market and the keenness of competition.

Mr. PATMAN. That is where you buy in the open market?

Mr. SHANKS. Yes.

Bear in mind that it is a very close spread.

Mr. PATMAN. Yes, sir. Now, are you advocating any particular number of homes for any one year? I assume from your testimony that you are not, that it should be governed by the demand for the housing?

Mr. SHANKS. No; we are not advocating any particular number of homes. We think that it should have a relation to the formation of families, to the elimination of old housing, and to the market conditions. What I did say, however, is that I think it is going to run higher than most people think, the number of starts.

Mr. PATMAN. Don't you think, though, that this year you can safely predict the need for a larger number of houses than we have had in the past?

Mr. SHANKS. The need for a larger number!

Mr. PATMAN. Yes, this year, 1954.

Mr. SHANKS. No, I don't think so.

Mr. PATMAN. The need increases year by year on account of the increased birthrate in the early forties?

Mr. SHANKS. I think the need for housing this year will be less than it was after the war. We had to build for a tremendously accumulated backlog of demand. Now, as the years go on, I think the need for housing will go up gradually.

Mr. PATMAN. But you don't think there is a need for more than a million houses this year?

Mr. SHANKS. There may well be a need for more than a million houses, and I think that that need will be met by building the amount that the market will take care of.

Mr. PATMAN. What is your prediction, Mr. Shanks, as to the number of starts this year?

Mr. SHANKS. Well, we agree that it will be over a million.

Mr. PATMAN. Over a million?

Mr. SHANKS. Yes.

Mr. PATMAN. I think some of the home builders are advocating 2 million houses a year for the next 10 years.

Mr. SHANKS. Well, sir, do you want me to comment on that?

Mr. PATMAN. Yes, sir; I am provoking a comment on that.

Mr. SHANKS. All right, sir, I will try to restrain myself. Speaking seriously, Mr. Patman, if we build more under some sort of a forced draft—and it would have to be a forced draft to get 2 million houses; because we would have to pay wages in order to induce workers from other fields to acquire the skills and come into the housing field—since there is not enough of a skilled work force to build these 2 million houses, we would have to bring them in by wage increases and the supply of materials is such that if we built 2 million houses their prices would also be forced up.

The result would be, first, that we would experience a terrific and rapidly increasing trend in the price of housing, which I think is exactly the opposite of what we need.

Mr. PATMAN. If your evaluation is correct, the worst thing about it would be the inflationary condition that would result from it?

Mr. SHANKS. That would be one of the things, but apart from the general inflation would be the fact that we would get housing, which would not be the kind of housing it should be; we would get housing prices which are unnecessarily high, even in relation to the rest of the economy; and, worst of all, we would empty out a lot of our present good housing, and would demoralize the market for all of our existing stock of housing, as well as the market for new housing.

Mr. OAKMAN. Will you yield?

Mr. PATMAN. I yield.

Mr. OAKMAN. Aren't we talking about a hypothetical question? Because the avowed goal of the National Builders Association adopted earlier this year at their convention in Chicago was 1,400,000 new houses a year for the next 10 years.

Mr. PATMAN. Well, I didn't specify the name of the builders, but I understand that some of the home builders are advocating 1,900,000 houses a year for the next 10 years, which is substantially 2 million a year. I think we will have testimony like that before this committee.

Mr. OAKMAN. But the National Home Builders Association, I believe, is the official spokesman, quite representative of the building industry throughout America. I know that in our State the builders belong to the national association.

Mr. SHANKS. May I say, on that, that I have been given the figures, and I understand what they advocate is 1,300,000 new homes, and 750,000 rehabilitated homes.

Mr. PATMAN. That is right.

Mr. SHANKS. I was speaking of 2 million new homes. Rehabilitation is another thing.

Mr. PATMAN. Yes; I think you are right about that. I think the breakdown that you have given is more correct than what I stated. New and renovated homes, about 2 million.

Mr. SHANKS. Yes; altogether, that is correct.

Mr. PATMAN. On title I, the \$2,500 loan for modernization.

Mr. SHANKS. The \$2,500?

Mr. PATMAN. Yes. Does your company service any of those loans?

Mr. SHANKS. We do not make those loans, Mr. Patman. I do not believe that we are authorized to buy them. It is really a banking proposition for those loans. They are partially guaranteed, and I believe they go mainly into the banks.

Mr. PATMAN. Yes; they are what I consider riskless loans. I never heard of a bank losing anything on that; have you?

Mr. SHANKS. Well, I think the banks are pretty careful lenders.

Mr. PATMAN. But the Government is behind them.

Mr. SHANKS. Am I right that they are guaranteed only as to 10 percent of the loan?

Mr. PATMAN. The whole portfolio, but in practice they are guaranteed. They are riskless because they haven't lost anything.

Mr. SHANKS. Well, that all depends upon the conditions in the economy. However, we are for it. We approve of it. But it is not our type of lending.

Mr. PATMAN. Now, this bill proposes to increase that to \$3,000, does it not?

Mr. SHANKS. Yes.

Mr. PATMAN. How will the interest rates be staggered on that? Will it be on the same ratio as the \$2,500, or do you know?

Mr. SHANKS. I think so.

Mr. PATMAN. It would still be a 5 percent discount and 9.7 percent interest?

Mr. SHANKS. That is what I understand.

Mr. PATMAN. Don't you think that is pretty high for homeowners to pay for a riskless loan?

Mr. SHANKS. Well, it is not our field. We do not handle it so I am not an expert in it. I do not think that 5 percent is high for that type of accommodation.

Mr. PATMAN. Of course it is not 5 percent, but 9.7. I am not telling you, you know more about it than I do, but you know when you pay 5 percent discount, that is paid in advance.

Mr. SHANKS. If it is paid off monthly it comes out at a higher rate.

Mr. PATMAN. Well, to be exact, 9.7 percent.

Mr. SHANKS. Is that it? The experts say that that is right.

Mr. PATMAN. So it is 9.7 percent?

Mr. SHANKS. Yes. However, compared to consumer paper, Mr. Patman, it is not too bad.

Mr. PATMAN. Well, if you compare it to the shotgun loan office, places like that, it is very low.

The CHAIRMAN. Will you yield?

Mr. PATMAN. Yes.

The CHAIRMAN. Of course, you don't include in that shotgun category the credit unions, do you?

Mr. PATMAN. Oh, no; the credit unions are all right. They charge on the unpaid balance only.

The CHAIRMAN. Do you know what the rate of interest paid by credit-union borrowers is?

Mr. PATMAN. It could be 1 percent a month, but you only pay on the unpaid balance.

The CHAIRMAN. I understand that—

Mr. PATMAN. You get a reduction every time you pay.

The CHAIRMAN. I understand that with a 6-percent discount rate it could be 11.6 percent, or something like that, and works out to about 11.6 percent.

Mr. PATMAN. You are saying something now I never did know about the credit unions.

The CHAIRMAN. Well, you had better look that up.

Mr. PATMAN. I helped to get the Federal law through for credit unions, and I have kept up with them since that time. We have about 18,000 credit unions in the United States today, and I think they are growing more rapidly than any other financial group.

The CHAIRMAN. That is because of the rate of interest.

Mr. PATMAN. I hadn't heard that they were charging on the basis of 11 percent.

The CHAIRMAN. I think you will find it interesting.

Mr. PATMAN. I certainly will. It will be a shock to me if the chairman is correct about it. I am not disputing his word.

The CHAIRMAN. I think you should be prepared to be shocked.

Mr. MULTER. Except that it is an entirely different type of loan. It is not a mortgage or modernization loan.

Mr. PATMAN. And it is not a guaranteed loan.

The CHAIRMAN. It is a secured loan.

Mr. MULTER. Only by endorsement.

Mr. PATMAN. Are mortgage loans now being purchased at a discount in the market, Mr. Shanks?

Mr. SHANKS. They were. I think they are approaching pretty close to par now. Just about par.

Mr. PATMAN. I had some complaints a few months ago that they were having to discount these mortgages right down to about 94, in some instances. Have you heard of any going that low?

Mr. SHANKS. I do not believe we have purchased any that low, but I have heard of them going that low; yes. It is the effect of the market range that pulls the money out for them. That is true.

Mr. PATMAN. You mentioned a while ago that in May, last year, when the money market became competitive—

Mr. SHANKS. No; I believe it was in May that the rate on the VA and FHA loans was changed.

Mr. PATMAN. You know why that was, don't you?

Mr. SHANKS. I don't know what you have in mind.

Mr. PATMAN. The Open Market Committee commenced buying Government bonds for the first time in 5 months. May 11, it bought two or three hundred million dollars worth during the month of May.

Mr. SHANKS. That is right.

Mr. PATMAN. You know that has a tendency to ease the money market, don't you?

Mr. SHANKS. That is right.

Mr. PATMAN. So that made the money market competitive?

Mr. SHANKS. That eased the money market, but the principal thing that I am talking about, the difference between money going into conventional loans and into FHA and VA, was the change in the fixed interest rate on the FHA and VA mortgages.

Mr. PATMAN. Yes, sir. Do you know of any group in America that has more influence on the economic affairs of our Nation and price stability or instability, than the Federal Reserve Open Market Committee?

Mr. SHANKS. The Federal Reserve System certainly has a large influence.

Mr. PATMAN. Well, specifically, the Federal Reserve System doesn't have the influence; it is the Federal Open Market Committee, isn't it, Mr. Shanks?

Mr. SHANKS. I assume that is the way they exert their buying and selling in the market, and changing the amount of money available.

Mr. PATMAN. That is exactly right, and there are 12 men who operate it. In fact, I doubt if 3 Members of Congress could name 3 of those men, to whom Congress has delegated the complete power. Then the 12 men have delegated it to the Federal Reserve bank in New York, and the Board of Governors here have no control over who is selected to carry out that operation because it is in the hands of the private banks entirely.

Now, I believe this committee will eventually look into that.

Mr. MULTER. You mean we should.

Mr. PATMAN. Yes.

Mr. SHANKS. I would be glad to testify on that point at that time.

Mr. PATMAN. I am not asking you to testify on it now, sir, because I doubt that the insurance companies will be involved.

Mr. SHANKS. No; I don't think so. We are just more or less the victims, when the money swings up and down, because we cannot do anything about it.

Mr. PATMAN. I am involved, too, because I am one of your policyholders, and have been for 25 years.

Mr. SHANKS. That is very good.

Mr. MULTER. And we all hope you will be one for the next 50 years.

Mr. BROWN. Do you make farm loans?

Mr. SHANKS. Yes; we make all the farm loans we can make. We think that is one of the best forms of lending, and during the depression have had very good luck with farm loans.

Mr. BROWN. That is one reason your company is doing so well.

Mr. SHANKS. That is right.

Mr. SPENCE. Mr. Shanks, do you think a satisfactory home could be built for \$7,000, one on which you would be willing to lend your money, under present conditions?

Mr. SHANKS. In some areas of the country, Mr. Spence; yes, sir. In some areas in the South and West and Southwest, you can do it—they are not elaborate homes, of course, but it can be done, for \$7,000.

I also think it is possible to do it, perhaps, in some of the northern cities under conditions where the city and the Federal Government together condemn slum land and clear it, and if the land is put in at a very low value, it is possible to build such housing—row houses, if necessary.

Now, of course, \$7,000 is a small amount. You cannot get a very good house. But it is better to do something that way than to have it done through public housing, I think.

Mr. SPENCE. What would be the effect of the deterioration of the house in time?

Mr. SHANKS. Well, if it is well maintained and well built, in certain sections of the country, where the fact that it doesn't have a basement should make no difference, it should stand up.

Mr. SPENCE. Well, it largely depends upon maintenance—any kind of a house does.

Mr. SHANKS. That is right. And the people who live in it. As a practical matter, with that price of house, it would not be as good as it should be.

Mr. SPENCE. Has your company had any experience in the remodeling and renovation of old buildings?

Mr. SHANKS. We had quite a bit of experience during the depression years, a lot of experience, because we would remodel and fix up, and rehabilitate, in order to be able to resell to the borrower or sell to the public.

Mr. SPENCE. Wasn't that rather a costly process?

Mr. SHANKS. It was, but we systemized it, worked up crews of men who were specialists, and so we were able to keep it much lower than it would have been had we gone about it hit and miss.

Mr. SPENCE. Do you think you could take over an old dilapidated building in a city and remodel it at a cost of \$7,000 per family unit?

Mr. SHANKS. Well—

Mr. SPENCE. If there were more than 10 units, say, \$70,000?

Mr. SHANKS. \$7,000 per unit?

Mr. SPENCE. Yes; per family unit.

Mr. SHANKS. Yes; we can do that. We could at \$7,000 per family unit. It all depends. Some you couldn't. Some it would be better to tear down, but there would be some instances where you could. In fact, there is no question about it at all. You can do a lot of repair work for \$7,000 per family unit.

Mr. SPENCE. Well, that would largely depend on the age of the house, and other factors?

Mr. SHANKS. Yes. What I am saying is that in some cases you could and some you couldn't. But there might be some areas, partially if not fully blighted, where you could do a great deal.

Mr. SPENCE. In the large centers of population, where you want to reclaim the blighted areas, do you think that could be done?

Mr. SHANKS. I think \$7,000 per unit right in our own town of Newark would do a lot.

Mr. MULTER. But will it sustain a mortgage of \$7,000 per unit?

Mr. SHANKS. Sustain a mortgage?

Mr. MULTER. Yes; will it warrant a mortgage for \$7,000 after you have done that?

Mr. SHANKS. Well, under this section 221 we think we can do it.

Mr. SPENCE. Would you be willing to lend on that character of property?

Mr. SHANKS. We think that, with the 221, with the changes we have suggested, making it 30 years, and with some changes in limiting the out-of-pocket losses on the foreclosure, and so on, that we have suggested, that money will come forth for it.

Mr. SPENCE. The existence of a house is largely dependent upon its maintenance, as you say?

Mr. SHANKS. Yes, sir.

Mr. SPENCE. Where these people are removed from blighted areas, have homes—and they have never had homes before which they had to maintain—do you think they will maintain them as they should be?

Under the low rent public housing program, the Commission maintained the projects.

Mr. SHANKS. Yes.

Mr. SPENCE. And saw that things were kept in good condition.

What do you think would be the effect of turning these people into a house in which they would be entirely responsible for its maintenance?

Mr. SHANKS. Mr. Spence, first, these people come out of the slums. As you say, they are not accustomed to this. There is no doubt that the risk is greater, and that you will have a larger proportion that won't keep them up the way they should, and that is why it is much more than normally risky lending. That is why I say there should be some limitation on the losses upon foreclosure, and so on.

But I also want to say there is a hopeful side to it. We have found particularly with some minority groups that once people got into a place they seemed to acquire a new respect, a new self-respect, new dignity, and they do much better than you would expect them to do.

Overall, the percentage will not be as good as with other people, but it would be much better than you might think.

Mr. SPENCE. That was really the fundamental theory of the low-rent public housing, wasn't it, that in better surroundings they would better their conditions, and, finally, they would leave and seek other more desirable locations.

Now, these people cannot do that because they are saddled with a mortgage for 40 years, under the theory of this act. So they would remain there. What effect do you think that would have? Do you think that would deter them?

Mr. SHANKS. Well, a lot of these people, I think, would look on it as rent, and they would have to be there a few years, but after they had been there a few years I think a lot of them would feel they had an equity in that house and they would begin to have a small equity, and then they would tend to stick and keep it up.

We saw it to a remarkable degree, that sort of thing, over the years.

Mr. SPENCE. I think that is a fine thing, but I also think that it would be a deterrent to them trying to better their condition, because they had that equity in that house.

Mr. SHANKS. Well, of course, if they have an equity in the house, and if they keep it up, they can sell the houses. They will pass from hand to hand. So it does not necessarily have to remain always in the hands of the one family.

Mr. PATMAN. Will you yield?

Mr. SPENCE. I yield.

Mr. PATMAN. I have just received the housing starts, Mr. Shanks, for February, and last year, in January, there were 72,000 starts. This year, in January, there were 66,000. A difference of 6,000. That is for January.

Now, in February, last year, 1953, there were 79,000 starts. This year there were 73,000 starts—still a reduction of 6,000.

Mr. SHANKS. Yes.

Mr. PATMAN. So instead of being up to last year's 151,000 for the 2 months, they are 139,000 now, 12,000 less. That is a surprise to you, or is it along the lines that you expected?

Mr. SHANKS. No, I think, in view of the general conditions, it is no surprise to me, but it certainly is not due to lack of mortgage money, Mr. Patman.

Mr. MERRILL. Mr. Chairman.

The CHAIRMAN. Mr. Merrill.

Mr. MERRILL. Mr. Shanks, I was interested in your statement that when you operated a small committee similar to the type that you are suggesting in your bill here that there were no direct veterans loans made in New Jersey.

In other words, by operating a program similar to the one you are suggesting in your bill the direct loan program for veterans practically died on the vine, in New Jersey; is that right?

Mr. SHANKS. That is right, although I was not the one operating it. I have to give credit to Mr. Vieser and Mr. Murphy, and others, but it did have that effect. They worked it out by working with the VA Commissioner and the people, themselves, and in one way or another they took them up.

Mr. MERRILL. Well, since it worked that way in New Jersey do you think it would be possible to include in this bill the present provision for FNMA, but at the same time to inaugurate the program such as you have suggested, and that with your program running parallel to FNMA, if it is a better program, then it would cause FNMA to wither on the vine, without our having to destroy it, just as the veterans' direct loan program did in New Jersey?

Mr. SHANKS. I wouldn't think so, for this reason: If people can go to FNMA and have their loans taken up, then they don't have to adjust their way of building a house, giving a better value or better sales price or doing the things necessary to bring it in line so that it is a good credit operation, from the point of view of the lender.

You see there are adjustments on all sides when you have a private market situation. But if a man can always put the mortgage right into FNMA, why do it through our proposed voluntary program, why bother with it?

Mr. MERRILL. I see. I thought perhaps your success in drying up the activity of the direct veterans loans in New Jersey might give you some hope that the same thing could happen here with a parallel program working. Why is it that the parallel program working in New Jersey did eliminate effectively the direct loans for veterans in the New Jersey market, and in this case you have no hope that the two programs operating in a parallel fashion would produce the same results?

Mr. SHANKS. First, I want to say that if you had a voluntary effort like the one operating in New Jersey it would have some effect around the country in accomplishing its objective, but at the same time you would make it more difficult to operate when you have FNMA in the picture.

There it was a relatively small State, geographically, although, I think, very large in many other ways, and with a small group, that they were able to accomplish it, in that VA field, and the VA commissioner worked with them.

But countrywide, I think it would be much more difficult to do it if you had the FNMA in operation.

Also, we oppose the FNMA all apart from that, anyway.

Mr. MULTER. Will you yield, Mr. Merrill?

Mr. MERRILL. I yield.

Mr. MULTER. Mr. Shanks has pointed out a very important defect in the new FNMA as set up in this bill, and that is that under the banking and insurance laws, in almost every State in the Union, banks and insurance companies will not be able to invest in that stock. You will have to amend the laws of almost every State to make them apply. Isn't that correct?

Mr. SHANKS. I am sorry, I missed a point there.

Mr. MULTER. Under the FNMA in this bill, the purchase of FNMA mortgages from the new organization will use 3 percent of the face amount of every mortgage with which to buy stock in this new corporation. That is not a legal investment under State laws.

Mr. SHANKS. No, not for insurance companies.

Mr. MULTER. Nor for banks. So before you could make that effective you would have to change the laws in almost every State in the Union.

Mr. SHANKS. We would to have a lot of laws changed.

Mr. MULTER. Thank you, Mr. Merrill.

Mr. MERRILL. As I understand it, though, you don't see where the insurance companies would become customers of FNMA? You believe you can operate without it, don't you?

Mr. SHANKS. Well, insurance companies would not become customers of FNMA. I am speaking of the individual builders.

Mr. MERRILL. So the mere fact that the law does not entitle you to participate in FNMA under the new program would not in any way interfere with the success of the program provided it were otherwise sound. The point that Mr. Multer has raised really has no bearing upon the case, because you life insurance company people don't really use FNMA services anyway.

Mr. SHANKS. We don't as lenders, use FNMA, but it is used, of course, by the builders, principally.

Mr. MERRILL. That is right. But they could go ahead and use it. The law is not going to prevent their participation.

Mr. SHANKS. They could use it.

Mr. MERRILL. The point I am trying to get clear in my mind is that the question raised by Mr. Multer doesn't really adversely affect the effectiveness of this program if we wanted to adopt it.

Mr. SHANKS. I suppose that is right.

Mr. MULTER. Mr. Merrill, will you yield?

Mr. MERRILL. I yield.

Mr. MULTER. There is a double bar—not a double bar, but I think there are two reasons why the States may not go along with the change, and permit investment in the stock of this new FNMA, one is that FNMA is going to deal in so-called nonlegals, to the extent of them being nonguaranteed mortgages. In almost every State you have a provision applying to mortgages bought by a banking institution or by an insurance company. They can lend conventionally from two-thirds to three-fourths of the appraised value. Under this Government-insured program they can buy these Government-insured mortgages despite that limitation. They can go as high as 90 percent. That is so, isn't it, Mr. Shanks?

Mr. SHANKS. That is right.

Mr. MULTER. The second objection is when the FNMA is dealing in so-called nonlegals, that is, they are not conventional mortgages, according to the standards of the States, they are not going to permit them to buy stock in a corporation that is going to deal in nonlegals.

Mr. MERRILL. Yes; will you now straighten my thinking out on this point?

You are referring to a limitation upon life-insurance companies; isn't that right?

Mr. MULTER. And banks.

Mr. MERRILL. And banks.

Mr. MULTER. And banks. You have practically the same limitation on the banking investments as on the insurance-company investments, when dealing with mortgages.

Mr. MERRILL. I didn't realize you were addressing it to banks, too.

Mr. MULTER. It is both.

Mr. MERRILL. The life-insurance companies don't participate in the FNMA program, anyway.

Mr. MULTER. Most of them do not.

Mr. SHANKS. That is correct.

Mr. MERRILL. Now, I am very much interested in this flexibility. I think we realize that that is the key to getting private money into the market.

Do you think that this 2½ percent difference between the mortgage market and the bond market is sufficient at all times to assure a flow of private capital into the mortgage market?

Mr. SHANKS. Historically, it has been. We think it probably would be.

Mr. MERRILL. Can you think of any better way of getting the flexibility than one which has been suggested here of just letting the President fix the interest rate from time to time? We can understand that any individual will be subject to pressures and mistakes of judgment.

Is there any better way, by some formula or something, in which that adjustment could be made?

Mr. SHANKS. The only thing I have heard is the proposal of a committee of a number of heads of Government organizations to do it. I don't know whether that is better or not, because even if the President does it he probably would rely upon the advice of those same people.

I don't know of any formula. The fact that they sell above par and below par, in itself is part of that correction of interest rates, you see. Because when the money was tight, they sold below par. When money was easy, they went up, even above par. But I don't know of any real formula.

Mr. MERRILL. I think a lot of us are reluctant to place discretionary power any place, if we can avoid it, and I suppose that you folks have given a lot of thought to how best this rate could be made flexible, knowing it has to be, and you haven't come up, then, with any better solution than that offered in this bill?

Mr. SHANKS. No.

Mr. MERRILL. Now, you say that you want this program made more responsive to a free market. Do you have any suggestion other than that FNMA not be continued, that would make the whole housing program more responsive to a free market than this bill would?

Mr. SHANKS. Well, I have the alternative, which I think would be very effective, which is the one I have been suggesting, this voluntary program. I think that, if well organized, that program would have a tremendous effect in getting the money around where it should be, in the spots where it doesn't get to so well now.

But I also think that the changes we have talked about in other sections of the bill would make them salable, and with those I think we would have a working situation without the FNMA.

Mr. MERRILL. Do you think we could safely do away with FNMA if this other program went into effect, and the economy wouldn't even miss her passing; is that right?

Mr. SHANKS. I think it would handle it very well indeed, and I think the only people who would miss it would be some for whom it is probably not a good credit situation, anyway.

Mr. MERRILL. Last year—of course, I don't know how representative these builders were, but last year I know of one builder in my own home town, and I know of another in Indianapolis, who told me that they were kept going solely by VA mortgages, and by this 1-for-1 process that was used to get more money into FNMA.

That would indicate that at least last year, for a period, that without FNMA there just would not have been money for those builders.

What do you think about that situation?

Mr. SHANKS. Well, I want to say I don't know what the case of that individual builder was. Maybe he is one who would have been helped by the voluntary program I am talking about. On the other hand, it may that he was a builder who used to build 50 houses, and then got up to building a thousand or two thousand houses and he wanted to keep on at the same rate. It may be that it is not in the interest of economy or the people there that he should have kept on at that rate. I cannot say that it is bad that he wasn't able to go to the rate he would like to. We run into many instances of people who are building thousands of houses a year. They naturally want to keep

up their working force, they want to keep up their organization, and want to go ahead at that rate, and they would like to have a situation where they could also have a commitment ahead of time, where someone would take those mortgages, and they would build the houses, and whether they are occupied or not doesn't make any difference. The houses are built, the labor has been used, the materials have been used, if the houses are not filled, so what? They have still gotten their profit out of the loan.

You can't ever have a credit situation where everyone can build everything he wants at any time and make a profit. And I don't think it would be in the interests of the economy, or housing, or the price of our old stock of housing, to let that sort of thing go ahead.

Now, if this was a case of a builder where it was really a difficult situation, I have no doubt that our voluntary credit committee would have gotten something to him. But he was not in a remote area, by any means. He was certainly in touch—

Mr. MERRILL. We don't like to think it is.

Mr. SHANKS. Well, I was raised in Minnesota, which is more remote than Indiana, I suppose. I don't know.

Mr. MERRILL. I think there is a lot of imagination shown in this suggestion which you have made concerning the alerting of your total lending power where it is needed. Do you think that there is any possibility of that sort of thing coming into being short of Federal legislation to enable it?

Mr. SHANKS. I think it would have to have some sort of legislation, because, in the first place, it should be tied in with the HHFA—there should be some tying in so that you won't have Government policy and voluntary lending policies at variance.

Also, the fact is that while the plan is for extension of credit—there is no restriction, in any way, shape, or manner—in view of the Wisconsin oil cases, however, you would have difficulty in convincing people they should join anything unless it had been gone over by the antitrust people, or you had legislation.

Mr. MERRILL. I think this same idea, if applied to the whole credit structure, including banks, would probably be the most helpful development that we have had in our economy for some time.

Is there any effort to give this same idea for banks, not only on housing loans, but to stimulate and guide the whole credit for all enterprises, to places where it is needed?

Mr. SHANKS. What we have done has been confined to the housing and mortgage lending end.

But I want to say this, that these are fast-moving times, and there is a much greater awareness in our industry, and among banks, and with everyone, of the necessity for handling these problems than there ever was before, and I think we can make progress a hundred times faster than we could have a few years ago, because of that awareness. But we haven't gone into any part of it except the mortgage and housing end.

Mr. MERRILL. There is one controversy about the interest rate. I would like to clear up 1 or 2 points in my mind on that.

First of all, in your insurance companies, who gets the benefit of that interest rate, whatever the yield of the investment is?

Mr. SHANKS. You mean if we get a better interest rate return?

Mr. MERRILL. Yes.

Mr. SHANKS. It goes to our policyholders. They get it directly in the shape of better dividends, better rates, yes.

Mr. MERRILL. Now, in your company, do you have any idea as to what the average amount of investment is? I suppose you would rate it by the amount of a policy. I would like to get some idea as to the economic size, if I may call it that, of the person who is putting money into your organization?

Mr. SHANKS. Well, if you won't hold me down to having this exact, it is around \$700 per policyholder. Between six and seven hundred dollars.

There are 30 million policyholders—speaking of my company, but the others are much the same—we have 30 million policyholders, and about 38 or 39 million policies, and about 43 billion dollars of insurance in force, and it comes out to a very small amount per individual policy, six or seven hundred dollars.

Mr. MERRILL. In my mind I had always been of the impression that the people who are providing the money to be loaned, in all of these big ventures, that the actual fellow who is providing the money is usually, and in the overwhelming majority, a little fellow. Is that true or not?

Mr. SHANKS. That is absolutely true. Practically all of them are little fellows with little incomes.

Mr. MERRILL. Then when we talk about an interest rate we are talking, then, at least in the life-insurance field, and I suppose in the building and loan field as well, about an income yield to a little fellow, for his savings, for the most part, rather than profit for any big business organization? Am I right or wrong?

Mr. SHANKS. You are entirely right. In the first place, all of it goes to the policyholders. In the second place, the proportion of policyholders who have more than three or four thousand dollars of insurance is very small.

Mr. MERRILL. Would it be possible for you to provide me with any information concerning the life-insurance fraternity on that point?

Mr. SHANKS. Oh, yes, I can give you all the figures on it, and it will show that it is the little man of the country.

Mr. MERRILL. Mr. Chairman, I think since interest rates are a very definite part of this whole program; I think it would be well for the record to show something of that nature, and I would like to have that information inserted in the record, if it is proper, to show just who is the beneficiary of the yield on money loaned.

The CHAIRMAN. Mr. Shanks, if you can supply that, it may be inserted in the record.

Mr. SHANKS. I will prepare it and send it in as soon as possible, sir.

(The information referred to is as follows:)

MARCH 18, 1954.

HON. JESSE P. WOLCOTT,
House Office Building,
Washington 25, D. C.

DEAR REPRESENTATIVE WOLCOTT: During the course of Carrol M. Shanks' testimony on H. R. 7839 on March 12 before the House of Representatives Committee on Banking and Currency, there were two questions asked by committee members on which we would like to submit additional information.

Representative Merrill asked for information that would provide some measure of the "economic size" of life-insurance policyholders. This assignment is an exceedingly difficult one since, although it is obvious that with 90 million policyholders life insurance must cover the Nation as a whole, the life-insurance

business itself has not developed good information on the subject. The most useful material which has come to our attention in this connection consists of data obtained from the Survey of Consumer Finances conducted for the Federal Reserve Board by the Survey Research Center of the University of Michigan. These data cover the year 1951, but we do not believe material changes have occurred in the past 2 years. According to this survey, as shown in table 1, 77 percent of all families owned some type of life insurance. For those families with annual income under \$1,000, 46 percent had life insurance. As will be noted, the percentage of families with incomes under \$4,000 which held life insurance was very high.

TABLE 1.—*Life-insurance ownership by income classes, 1951*

Income	Percent of all families	Percent of families insured
Under \$1,000.....	13	46
\$1,000 to \$1,999.....	15	68
\$2,000 to \$2,999.....	18	76
\$3,000 to \$3,999.....	18	85
\$4,000 to \$4,999.....	15	91
\$5,000 to \$7,499.....	14	93
\$7,500 or over.....	7	93
All families.....	100	77

Table 2 shows the average premium payments of families to different income classes. It indicates that the average premium payment for all families owning life insurance was \$160.

TABLE 2.—*Average premium payments, 1951, premium-paying families*

Income	Average premium payment	Income	Average premium payment
Under \$1,000.....	\$55	\$5,000 to \$7,499.....	\$55
\$1,000 to \$1,999.....	60	\$7,500 or over.....	560
\$2,000 to \$2,999.....	90		
\$3,000 to \$3,999.....	115	All families.....	160
\$4,000 to \$4,999.....	160		

The average size ordinary life insurance policy in force in 1953 was \$2,440.

Representative Widnall requested information on life-insurance-company commitments to make mortgage loans. He desired this information for the months of January and February of this year, but unfortunately we do not as yet have the February date. We are able to supply the December 1953, and January 1954, data, compared with the same 2 months a year earlier. If it is desired, we shall supply the February data as soon as they are available, which will be in the next several days.

The statistics presented here are based on reports from 60 life-insurance companies which have about 67 percent of the total assets of all United States life companies. Table 3 below shows that total new commitments made by life insurance companies for nonfarm residential mortgage loans in the months of December 1953, and January 1954, increased substantially over the same 2 months a year earlier. This was especially true in the VA-guaranteed category.

TABLE 3.—*New commitments for nonfarm residential mortgages*

(In millions of dollars)

	Total	FHA insured	VA guaranteed	Conventional
December 1952.....	\$189.7	\$69.0	\$21.4	\$99.3
January 1953.....	116.6	33.0	11.7	71.9
December 1953.....	207.2	42.5	71.6	93.1
January 1954.....	161.9	36.1	45.5	80.3

Table 4 shows the outstanding commitments which have been made by life companies to make nonfarm residential mortgage loans. Here again the total outstanding in December 1953 and January 1954 substantially exceeds the corresponding total of a year earlier.

TABLE 4.—Commitments outstanding for nonfarm residential mortgages

[In millions of dollars]

	Total	FHA insured	VA guaranteed	Conventional
December 1952.....	650.2	233.4	114.3	302.0
January 1953.....	605.5	203.6	105.7	296.2
December 1953.....	717.8	157.4	230.5	329.9
January 1954.....	704.8	157.3	224.8	322.7

During the hearing Representative Multer asked that we supply the committee with information on the extent to which there is still duplication of effort as between the Veterans' Administration and the Federal Housing Administration in the processing of mortgage loans. The limitations of time have made it impossible to obtain useful information in this matter, but we shall continue to give the question our attention and possibly we may be able to supply some helpful information shortly.

Sincerely,

JAMES J. O'LEARY,
Director of Investment Research.

Mr. O'HARA. Mr. Chairman.

The CHAIRMAN. Mr. O'HARA.

Mr. O'HARA. Mr. Shanks, I have been very profoundly interested in your testimony. Naturally, coming from Chicago, I have a feeling of appreciation of what your company has done for our city of Chicago, and it is needless for me to say to you, sir, that you are highly regarded in Chicago, as well as your company. We feel that you are one of the partners of Chicago in the building of Chicago's future.

Mr. SHANKS. Thank you, sir.

Mr. O'HARA. I am interested in two matters that you touched upon. First, I think you suggested that there might be a difficulty, some difficulty, in getting funds for minority groups.

Mr. SHANKS. I think the problem is greatly exaggerated, but I think there may be, yes, sir.

Mr. O'HARA. Now, we have some very large Negro insurance companies, have we not?

Mr. SHANKS. We have a number of insurance companies, and a few of them are fairly sizable, yes.

Mr. O'HARA. Do they put some of their insurance moneys into real properties?

Mr. SHANKS. I assume that they do. I think they probably do.

Mr. O'HARA. I have never made inquiry along that line.

Mr. SHANKS. I don't know for certain, but I am quite sure they must put it into mortgages and similar investments.

Mr. O'HARA. I know we have in Chicago a very large Negro insurance company and I presumed that they had been putting some of their money into real-estate investments.

Now I am interested in another matter, and I may not agree with you in every one of your suggestions, but I do agree with you in this: The necessity of giving a stability to real estate, having in mind our experiences in the late twenties and the early thirties.

Mr. SHANKS. Right.

Mr. O'HARA. Where there was a boom, and the bankers wanted to put out their money and sell real-estate bonds, and everybody wanted to make money, and they overbuilt.

Mr. SHANKS. They sure did.

Mr. O'HARA. At a time of excessive prices, and then the equities were all washed out. Everybody was washed out.

Now, of course, you want to avoid a repetition of that; do you not?

Mr. SHANKS. We do, indeed.

Mr. O'HARA. And you can see a definite danger, if our construction goes on motivated by a desire on the part of builders to make money, or even on the part of politicians to contribute to warding off a recession. It can have its repercussions, which can be bad. Is that your thought?

Mr. SHANKS. That is correct. I don't object to people making money, but if you go right on regardless of the market demand, then you get a situation where eventually it is not taken up, and the sad thing is that the price and the market value of all the existing housing is destroyed also in the process.

Mr. O'HARA. I think we can be agreed on this, can we not? That back in 1929 and 1930, when the banks were popping like popcorn, that if the insurance companies had gone down, everything would have been gone.

Mr. SHANKS. It would have been much worse if they had collapsed.

Mr. O'HARA. Well, that was the agreement, wasn't it, that the insurance companies had to be saved or also everything was gone?

Mr. SHANKS. That is right.

Mr. O'HARA. And at that time your investments were in railroad stocks, which were sour, you had invested in municipal bonds, in Canada and all over this country, and they were sour—it was a pretty disastrous picture, wasn't it? A pretty dark picture?

Mr. SHANKS. Yes, it was bad, although insurance companies were in not such bad shape as you are painting, sir. It was only a question of ready cash, but that, of course, ready cash, was the problem with many types of business.

Mr. O'HARA. Certainly. Well, I think the insurance companies did a great job in a very dark hour. I happened at that period to be on the air every night, and I read constantly, the investments of the insurance companies, and I was pretty well familiar with that picture and I think in a very trying period you did a pretty good job.

Mr. SHANKS. Thank you.

Mr. O'HARA. That is, I think you showed a lot more wisdom than the bankers.

Mr. SHANKS. Well—

Mr. O'HARA. Of course, we did feel at that time that many of your investments had been guided by the bankers—that is that in giving there—well, that was my opinion. I may have been wrong.

Mr. SHANKS. Well, I want to say that was before my time. It is certainly not true today.

Mr. O'HARA. That is as I understand it. I understand that the experiences of the past have been a teacher of discipline, and from what I hear, you are doing a good job.

Now, what are you doing to protect yourselves if the real-estate market should drop badly, and the people who are renting are unable to pay the rentals, and therefore the equity holders can't hold on because the rents coming in do not meet the mortgage commitments, and we get a bad situation? What precautions are you taking for your protection?

Mr. SHANKS. We are in so much more sound shape with regard to those—I am speaking now of the insurance companies generally, not of my company only—than they were at the beginning of the 1930's, that there is no comparison.

In those days, you had short, 5-year mortgages, and you had a second mortgage, and a third mortgage top of it. And those things were falling due. And when they came due, sometimes they wouldn't be renewed, and when they were, it was at a big cost to the borrower. A lot of them were put out at inflated valuations, which shouldn't have gone that high, and as a consequence the whole thing went down like a house of cards.

Today they are all long mortgages, all amortized, each month, and all a person has to do to stay in his house is to continue his monthly payments. A second mortgage is almost nonexistent. It is practically out of the picture.

The valuation situation is much more carefully watched by the companies than it was, and I would say that while, of course, if you have a depression—anything approaching an economic depression—sure you will have a lot of foreclosures, but we would do just as we did then, we would work out the loan with the borrower, and keep him in the house and try to work it out, and generally it works out.

Furthermore, we hold more Government securities, and more readily salable securities than at that time, and generally I think the companies are on a more conservative reserve basis than at that time.

I can assure you that the life-insurance companies of the United States are in very fine shape and we would have to have a depression or a recession, or whatever you call it, away over and above and beyond anything we have ever known, including the thirties, before we would get into too much trouble.

Mr. MULTER. Will you yield?

Mr. O'HARA. I yield.

Mr. MULTER. In addition to all of that, you have FDIC which guarantees every depositor's to the extent of \$10,000, which means depositors are guaranteed practically to the extent of 99 percent of the total deposits of the country. So it is practically impossible to have a run on the insurance companies for demand for cash-surrender values.

Mr. SHANKS. That is right, and it is a very important point. Because what strapped most people was that bank situation.

Mr. O'HARA. The reason I asked the question was that you might have the opportunity of giving the answer that you did give. None of us want a recession, and we certainly don't want a depression, and I think it is just as well that we should clear up any misunderstanding.

Now, I am thoroughly familiar with the conditions attending the wreck of 1929. I was very closely informed at that time.

What you are saying, I think, has much truth in it. At that time we had a bad second mortgage situation, mortgages were generally for 3- and 5-year periods, and there were overvaluations, and I am glad you have put that statement in the record.

Now going further, I have been concerned over the method we have of selling residential real-estate properties in such cities as Chicago. That is, we take—I understand that is the system—we take the gross rentals, and multiply them by a certain arbitrary figure, so that sales are made, not on the actual value of the properties, but upon yield. You understand that is pretty generally the system of real-estate transactions in cities like Chicago?

Mr. SHANKS. Mr. Jewett.

Mr. JEWETT. I don't believe the average purchaser of real estate today would take the gross rental and multiply it by some factor to get a sales price, without taking into consideration all the other factors, that is the taxes, the operating expenses, whether the property is bringing in a high rental for the type of real estate, or a low rental for that particular type of real estate.

Mr. O'HARA. That is, of course, the reputable real-estate man, who would discourage any practice such as I have suggested, unless it were protected in the manner that you suggest?

Mr. JEWETT. Yes, sir.

Mr. O'HARA. But nevertheless, the average sale of a real-estate property in Chicago is, so I am informed, on the basis of multiplying the gross rentals by an arbitrary figure.

Mr. JEWETT. I would be surprised if that is correct.

Mr. O'HARA. You would be surprised if it were as general as I think it may be?

Mr. JEWETT. Yes, because the only person buying real estate on that basis would be very small investors and thoroughly uninformed investors. They might be informed by unscrupulous real-estate dealers that that was the way to buy, but if they thought it out they would not.

Mr. O'HARA. Having the large interests you have, of course you are doing everything you can to discourage any practice of the nature that I have suggested.

Mr. JEWETT. Absolutely.

Mr. O'HARA. I want to again thank you, gentlemen, for the opportunity that I have had to listen to your testimony. I say I may not agree with everything that you have said, but I know that you have said it from a wealth of experience, and a sincere regard for the continuing soundness of our economic status.

Mr. SHANKS. Thank you, sir.

Mr. SPENCE. Mr. Shanks, what percentage of all of your investments are in real-estate mortgages?

Mr. SHANKS. In round numbers, 40 percent; a fraction over 40 percent.

Mr. SPENCE. You have about \$17 billion invested in real-estate mortgages?

Mr. SHANKS. That is for the industry. We ourselves, our one company—are you speaking of the industry or of our company?

Mr. SPENCE. The industry.

Mr. SHANKS. The industry has about 28 or 29 percent, sir, and in housing, residential and housing mortgages, it is about \$17 billion.

Mr. SPENCE. How much has your company invested in real-estate mortgages?

Mr. SHANKS. We have a higher percentage. A little over 40 percent. And we have about \$4,400 million, I think.

Mr. SPENCE. Do you invest in all the States of the Union?

Mr. SHANKS. I don't believe there is any exception. Because we have the branch office system, and we cover the United States with it.

Mr. SPENCE. And you have facilities where applications can be made without inconvenience all over the United States?

Mr. SHANKS. Yes, we have about 120 offices and we send our men around through all the territories.

Mr. MULTER. Mr. Chairman, with Mr. Widnall's permission, may I take the witness for just two brief matters. I have a long-distance call awaiting me.

The CHAIRMAN. You may do so.

Mr. MULTER. Thank you.

Mr. SHANKS. I am in agreement with you that houses can be built in some parts of this country at a cost of \$7,000 per family unit, but I am wondering whether or not we can get any builders to do that kind of work. If they can build \$10,000 or \$12,000 or \$20,000 houses, will they build the \$7,000 houses?

I think your experience can be a guide to us if you can furnish to us a figure as to how many mortgage applications you have had for \$7,000 or less, per family unit.

Would you supply that to us, just over the last year, let's say?

Mr. SHANKS. I could supply it, but maybe Mr. Jewett can give figures now.

Mr. JEWETT. I don't believe we have that figure, because mortgage applications in our company are handled in the field. We have some 600 men in the field who can take applications, and many of them can issue mortgage commitments right on the spot. He might not take the \$7,000 case which was discussed with him verbally, or he might.

Mr. MULTER. Could you, without too much inconvenience, supply us with the record of the number of \$7,000 or smaller mortgage loans that you have made in the last year?

Mr. JEWETT. We could obtain that information. Our average loan at the moment, on housing, is about \$7,000; \$7,000 to \$8,000.

Mr. MULTER. But averaging that way does not give us the statistics we need.

Mr. JEWETT. The average new loan made last year was about \$10,000 to \$11,000, including the large places. We have a great many below \$10,000.

Mr. MULTER. I don't like to take an average figure for this statistic, because then you take in all the big ones and all the little ones. A developer like Levittown would develop a whole community with houses at less than \$10,000 per unit, and I don't think it is fair to average the house.

Mr. JEWETT. We will give you that information.

(For information requested above, see letter on pp. 493-495.)

Mr. MULTER. One other thing, Mr. Shanks, I notice that in your statement you refer to the fact that you are disappointed with the continued duplication of FHA and VA inspections in the housing field.

This committee has tried to get the agencies to eliminate duplication. In fact, the agency representatives before us last week said there was no longer duplication of inspection.

If you have any contrary information that they are still duplicating, I wish you would supply it to us, instances or areas where that is being done. We don't need any law on that. It can be done by regulation, if the Administration is alert to it.

Mr. JEWETT. We will try to give you a careful statement on it to see what the situation is, but I was under the impression that there was that duplication in valuation and inspection and that sort of thing.

Mr. MULTER. It had been called to our attention at various times and we have tried to eliminate it. If it still exists, I am sure the committee will make another effort to eliminate it.

Mr. JEWETT. We will give you a study.

(For information requested above, see letter on pp. 493-495.)

The CHAIRMAN. Mr. Widnall.

Mr. WIDNALL. Mr. Chairman, we are particularly pleased to have these gentlemen here today because we recognize them as authorities in the home financing field. We in Jersey realize how much your company and the other lending institutions in our State have been responsible for the fine building program accomplished there.

We also know that our road-building program has received terrific impetus through the financing arranged with the New Jersey Turnpike Authority.

I am very much impressed by the constructive suggestions that have been made by you here today. I would like to know this: How do you find your commitment requests coming in today, as compared with last year?

Mr. SHANKS. I think we have something right here on that, Mr. Widnall. I have them here through the first 2 months of this year.

Mr. WIDNALL. Could you give us the first 2 months of this year, as compared to the first 2 months of last year?

Mr. SHANKS. We could give it to you on authorizations, but not on actual number of requests that might have come to us.

Mr. WIDNALL. Well, let's have it on authorizations, then. If you don't have the figures readily available, could they be provided to the committee?

Mr. SHANKS. They could be provided.

Mr. BETTS. Will there be a division there as to farm authorizations and nonfarm authorizations?

Mr. SHANKS. Do you mean you want the farm loans included?

Mr. BETTS. Well, that would be helpful.

Mr. SHANKS. We can do it either way. We can give you the farm loans comparison, and also the nonfarm comparisons of the mortgage authorizations. That is what you want, isn't it?

Mr. BETTS. Yes.

The CHAIRMAN. That may be done.

(For information requested above, see letter on p. 494.)

Mr. WIDNALL. Would you have any figures that would show the failures of the applying parties to meet requirements because of credit risks or inability to meet downpayments, in comparison with the previous year?

Mr. SHANKS. I don't believe so. That never gets far enough to get into figures.

Mr. WIDNALL. What I am trying to find out is whether or not there has been any marked decrease in requests for mortgage commitments.

Mr. JEWETT. I do not believe so, and I think one record I have here for our own company might contribute to that on a number basis.

We approved or committed 7,200 loans in the first 2 months of 1953 as compared with 11,000 this year in the same period.

Mr. WIDNALL. So you have an increase of 4,000 commitments this year over last year?

Mr. JEWETT. Yes; for the same period.

Mr. WIDNALL. Which would to some extent refute the figures on national housing starts quoted earlier, I think, by Mr. Patman.

Mr. JEWETT. No; they do not represent starts. They represent commitments which will result in starts during the year.

Mr. WIDNALL. It is an advance over the previous year.

Mr. JEWETT. A big advance over the previous year.

Mr. WIDNALL. That will be felt within the next few months?

Mr. JEWETT. That is right.

Mr. WIDNALL. Do you feel that having the VA and FHA more or less competing for loans in the past has been an inflationary factor in the market?

Mr. JEWETT. Possibly so, but not in all areas and not in all instances. The VA and FHA valuations were often very close together, although made independently.

Mr. WIDNALL. Do you feel it would be a saving to the borrower in the future, and a more economical means of financing, if there were just one agency that developed the loan?

Mr. SHANKS. It would be to the country and to the borrowers and I would suppose to the lenders, too.

Mr. WIDNALL. I was particularly interested in your comments on section 221 40-year mortgage. It seems rather sound to bring attention to your low-income groups that there would be a false saving of maybe \$4 a month in monthly payments which would be more than compensated for or offset by the increased interest payments over a period of years. It certainly seems like a very sound argument against it.

Mr. SHANKS. It is a very heavy price to pay for it.

Mr. WIDNALL. That is all.

Mr. DEANE. Mr. Chairman.

The CHAIRMAN. Mr. Deane.

Mr. DEANE. Mr. Shanks, it seems that several of us are throwing in a few commercials this morning for Prudential. I recall as a college student I purchased my first insurance policy, of \$1,000, with Prudential and am glad to see you before our committee this morning.

I want to know what is the interest earned and paid by Prudential.

Mr. SHANKS. For 1953 we earned 3.50 before taxes; and, of course, you know our taxes are directly against our interest income. After taxes it was 3.28.

Mr. DEANE. Your dividend ratio—has it varied very much in the last few years?

Mr. SHANKS. Not much. It has gone up somewhat, but it hasn't gone up much.

Mr. DEANE. I don't like to refer to any area as a slum area; but, assuming that there are blighted areas and we so recognize them in the area of New Jersey, how are you coming to grips with the problem?

Mr. SHANKS. I will say that in all too many instances we haven't come to grips with it. There has been some public housing; there has been, of course, a terrific amount of building in the suburbs of small homes, and so forth; but there is a lot yet to be done.

Mr. DEANE. That represents a great number of our people, too, doesn't it?

Mr. SHANKS. Very definitely.

Mr. DEANE. I realize that a sound mortgage or financial institution like an insurance company must be necessarily careful in view of laws that require them so to be, but don't you think that is an area where we must really come to grips with the problem or continually expect the Government to spend grants for public housing?

Mr. SHANKS. I quite agree. That is why we approve of these sections 220 and 221.

It seems to us that with the changes we have suggested they would be a means whereby you could do it with private money. And, of course, that is the doing away with the slum sections and relocating the people and rebuilding the slum sections. That is very important, and if it can be done with private money that is the way it should be done.

Mr. DEANE. And you here today tell us that Prudential will enter that field actively?

Mr. SHANKS. I think the industry generally will enter the field; yes.

Mr. DEANE. How do you feel about it yourself?

Mr. SHANKS. Well, we will do some of it, but I want to say something about our lending, and I think it should apply in all cases: We look at the thing being built and see that it is a good value and don't just rely upon a guaranty. So we would try to look into this thing and try to see that we were getting good value for the houses and that they were well built instead of sitting back and saying, "We will buy them because they are guaranteed."

Mr. SPENCE. Will you yield?

Mr. DEANE. I yield.

Mr. SPENCE. What is the maximum application you would consider, Mr. Shanks?

Mr. SHANKS. For a mortgage loan?

Mr. SPENCE. Yes.

Mr. SHANKS. I will ask Mr. Jewett to answer that.

Mr. JEWETT. We have never had any established minimum. When loans get down into the \$1,500 and \$2,000 price range, they are rather expensive to handle compared to the amount of interest produced by such loans.

Mr. SPENCE. And almost all of the other insurance companies have that same character of loans?

Mr. SHANKS. Yes; we think so. There are not many loans that small.

Mr. SPENCE. Do you have many loans in the range of \$1,500 to \$2,500?

Mr. SHANKS. No, very few.

Mr. SPENCE. Very few?

Mr. SHANKS. That is correct.

Mr. SPENCE. What is the minimum loan which you assume in considerable number?

Mr. SHANKS. As a practical matter, from \$5,000 up.

Mr. SPENCE. Thank you, Mr. Deane.

Mr. DEANE. Mr. Shanks, referring to page 9 of your statement, you speak there with reference to your approach to the Fannie May problem. Would you explain in more detail the comments which you make there under No. (3)?

Mr. SHANKS. Yes; under the provision there it provides that in the case of the special assistance they could borrow the money directly or get the money directly from the United States Treasury, as I recall the bill. So that that is a direct United States Treasury program.

Mr. DEANE. That is my understanding, but I wanted to be sure that that was yours.

Mr. SHANKS. Yes.

Mr. DEANE. To what extent are you making loans in communities of five and ten thousand population for the average homeowner?

Mr. SHANKS. We are doing it very extensively. I will ask Mr. Jewett to say something on that.

Mr. JEWETT. Practically everywhere, Mr. Deane.

Mr. DEANE. And in that particular area where Fannie May has been the most useful; isn't that true?

Mr. SHANKS. I don't know. It is hard to say. It may be that some of those have had insufficient money.

Mr. DEANE. Why do you and the American Bankers Association disagree on open-end mortgages?

Mr. SHANKS. I think, Mr. Deane, Mr. Vieser points out that in many large cities, for example, as an example Los Angeles, have used Fannie May extensively. Excuse me, sir.

Mr. DEANE. My next question was as to open-end mortgages. Why do you differ with the American Bankers Association on that subject?

Mr. SHANKS. We think that open-end mortgages are something that could be very useful. In our own particular company we have as a matter of practice put them in all mortgages where we can, and where the State laws permit it, and there is a possibility with the open-end mortgage, it seems to us, whereby you can have provision for rehabilitation which would provide a much easier and cheaper method of financing.

Mr. DEANE. Do you usually require a prepayment fee for a mortgage that is paid up in advance of maturity?

Mr. SHANKS. During the first 5 years only, and it is a descending scale, and we have a fee which scales off to nothing at 5 years. When the mortgage is 5 years old it can be paid off. If there is any distress situation, they can pay it off any time, even during the 5 years.

Mr. DEANE. I was impressed with the outline beginning at the bottom of page 12 and 13 of your statement, of proposed legislation,

which would extend availability for credit in small communities. The only thing I am concerned about here and now is the large staff that would be involved in it and I am wondering if it would not be practical to think in terms of some reasonable service charge that might be added to go into that under the present law?

Mr. SHANKS. It may be that it will involve more staff than we think, and it may be that something like that would be called for, but I would rather hate to see it because in most cases these people on the committees will be representatives of the various institutions, and the chances are that the institutions will be carrying their cost whenever their man is on the committee.

Of course, if it did get to a point where it involved quite a bit of staff, then there would have to be some way of paying it.

I didn't contemplate that there would be, though, to start with, at least. However, if it worked and became an instrument over the years, there would have to be some way of paying for it.

Mr. DEANE. Thank you, sir.

The CHAIRMAN. Are there further questions?

Mr. MUMMA. Can I put in a commercial, too?

The CHAIRMAN. We are glad to have it.

Mr. MUMMA. Not referring a loan to Mr. Shanks' company, but I do know your local angle, of your men in the field, and they have done a very good job in my community, around Harrisburg.

Mr. SHANKS. Thank you.

Mr. MUMMA. I have had some experience in borrowing from insurance companies and they have always been very, very fair, even though the pleasure was mutual.

But this does make it more available for the individual man to get a mortgage, if your plan goes through. Most of the people that come to me at home—I am sort of in an interrelated business—but most of the people who come to me seem frustrated about getting a loan, and just can't get it, and it would get down to where the individual would have some directly responsible committee could go to state his case. Is that clear?

Mr. SHANKS. Yes; that is right. People would know where to send him and what to do, and all about it.

Mr. MUMMA. I have had particular experience with a minority group that wanted to get a loan. They first started with this cooperative housing, and they went from pillar to post, and they certainly ran around, and I don't know by what stroke of luck they got a proposition started and they have had terrific response. There are a lot of people in minority groups making pretty good money now.

Mr. SHANKS. Oh, yes.

Mr. MUMMA. That was my interest in this thing, to have the small fellow, or group, have something definite he or they could go to.

Mr. SHANKS. We think just the mechanics of having a place like that are very important in themselves.

Mr. MUMMA. That is correct. Now you are talking about small communities. Do you loan your money under FHA guarantee all the time?

Mr. SHANKS. Oh, no.

Mr. MUMMA. I thought it was absolutely independent.

Mr. SHANKS. We make the so-called conventional loans, and we make the FHA and the VA loans, too. We make them all. I think that is true of most companies.

Mr. MUMMA. The point I was trying to get at was this: the FHA and the VA have certain requirements as to streets, roads, curbs, and pavements, which they must fulfill.

Now, in a smaller community—well, most of the building you see now is along public roads, isn't it?

Mr. SHANKS. A lot of it is.

Mr. MUMMA. Every public road you go to now, especially I noticed that in South Carolina, Mr. Deane, about a year ago—or North Carolina—back in there, along those roads, it is all built up. And that is the way it is at home. Now, there wouldn't be any deterrent to a man getting a mortgage back there simply because he didn't have a paved street, with a curb and sidewalks in front of it. Is that your observation?

Mr. SHANKS. All those things are taken into account, but it wouldn't keep from getting a good mortgage, if it is a good sound proposition.

Mr. MUMMA. I can see, along your line of thought, everything has been developed on good business principles, and there may be one fellow you would turn down and another one you would take, is that correct?

Mr. SHANKS. That is true, but, of course, you are speaking now of our lending as we do it now. Under this proposed program, it applies only to the FHA and the VA, but our lending, our separate lending on conventional mortgages, there are no rules except that it has to be a sound, creditworthy proposition.

Mr. MUMMA. Well, you know, sometimes people moving out into the country get a terrifically cheap lot.

Mr. SHANKS. That is right.

Mr. MUMMA. And that spoils it from your viewpoint, the thing in your program is that I believe it does offer an opportunity to almost everybody.

Mr. SHANKS. That is what we think.

Mr. MUMMA. I think it is very well taken.

Mr. MERRILL. Will you yield?

Mr. MUMMA. Yes.

Mr. MERRILL. Have you discussed this idea of yours with other groups other than life-insurance companies?

Mr. SHANKS. We have discussed it, I think, with bankers, and a number of others, but we haven't had any formal discussions, nor can we give any formal statement that they approve or disapprove, but we have had good reception where we have talked about it; yes.

Mr. HIESTAND. Mr. Chairman.

The CHAIRMAN. Mr. Hiestand.

Mr. HIESTAND. Mr. Shanks, I am most appreciative for what your western home office is doing in Los Angeles, not only in supplying the money needed for the growth there, but also as an institution of citizenship.

I do have one question, however: Do you have any preference for VA loans over FHA, or standard loans?

Mr. SHANKS. I will let Mr. Jewett answer that.

Mr. JEWETT. That would depend on a great many factors—the downpayment, the type of guaranty of the VA, which is sometimes more beneficial than the FHA guaranty—also the FHA loan has a larger equity behind it than the VA loan.

Mr. HIESTAND. Would you care to generalize that VA is more desirable for your purpose?

Mr. JEWETT. There is a little greater risk factor. There is a better chance of default in a 100-percent loan than a 60-percent loan.

Mr. HIESTAND. That would make it less desirable?

Mr. JEWETT. From that viewpoint; yes.

Mr. HIESTAND. You would rather make a standard, unguaranteed loan, I presume?

Mr. JEWETT. Generally speaking, yes.

Mr. HIESTAND. Because the other factors make it more attractive.

Mr. JEWETT. That is right.

Mr. HIESTAND. But you don't hesitate to take a guaranteed loan since the guaranty may offset the other factors?

Mr. JEWETT. More than half of our residential loans are guaranteed by FHA, or the Veterans' Administration.

Mr. HIESTAND. But is there any preference in your mind for the VA over the FHA?

Mr. JEWETT. As far as the real estate is concerned, no.

Mr. HIESTAND. Thank you.

The CHAIRMAN. Are there further questions?

Mr. MCCARTHY. Mr. Chairman.

The CHAIRMAN. Mr. McCarthy.

Mr. MCCARTHY. Mr. Shanks, I note that in the statement of life insurance company views on national housing and mortgages, you state for the years 1947 to 1952 the life-insurance companies increased their holdings of mortgages on residences by \$11.8 billion net.

Could you explain? Was this a change of policy, a change of emphasis in lending policy?

Mr. SHANKS. No, because building was shut off during the time, we couldn't lend, so we were at a very low ebb. Our mortgages kept going down during the war, because of the restrictions.

Mr. MCCARTHY. In other words, then, the percentage of your portfolio in housing loans, what you now hold, is comparable to what you held before the war?

Mr. SHANKS. Oh, yes; back in the twenties the industry had over 40 percent in mortgages, and we are bringing it back up—we have always had a policy, generally of investing in mortgages.

Mr. MCCARTHY. Are you prepared now to increase the ratio or percentage of housing loans?

Mr. SHANKS. I think most insurance companies are pushing their percentages up somewhat.

Mr. MCCARTHY. What would you replace? Will you have to replace loans which you hold now? Will you dispose of Government securities or is that a trade secret?

Mr. SHANKS. In the main we would put a larger proportion of our newly available money into mortgages.

Mr. MCCARTHY. Rather than into other things?

Mr. SHANKS. That is right. But after the end of the war, there was considerable selling of Government bonds, and that money went into mortgages as well, of course.

Mr. McCARTHY. In other words, you found it more profitable to invest in housing mortgages than to leave your money in Government bonds.

Mr. SHANKS. Oh, yes. And that has always been true with insurance companies. Generally speaking, we are not Government bondholders. We have our money in the economy directly.

Mr. McCARTHY. You have reduced, I note, your net holdings in Government bonds, or Government securities, by \$10.3 billion, in this same period, up to 1952?

Mr. SHANKS. That is right.

Mr. McCARTHY. Has there been any increase in your net holdings of Government securities since then?

Mr. SHANKS. I don't believe so. I think it has stood about still.

Mr. McCARTHY. I might challenge your concession to Mr. Merrill that Minnesota is more remote than Indiana.

Mr. SHANKS. Well, I like remote places.

Mr. McCARTHY. Thank you.

The CHAIRMAN. Are there further questions? If not, we are very grateful to you gentlemen for your very valuable contribution to our studies. You have helped us a great deal and we appreciate it.

Mr. SHANKS. Thank you, sir.

The CHAIRMAN. Mr. Johnson, of the American Hotel Association, is our next witness.

Mr. Johnson, you may proceed. We are very glad to have you with us, Mr. Johnson, and you may proceed.

STATEMENT OF EARL M. JOHNSON, TREASURER, AMERICAN HOTEL ASSOCIATION

Mr. JOHNSON. Mr. Chairman and gentlemen of the committee, I am Earl M. Johnson, owner of Johnson's Rustic Resort, Prudenville, Mich., and vice chairman of the governmental affairs committee of the American Hotel Association.

I appreciate this opportunity to make a brief statement before your committee with reference to the housing program which you are now considering. We are particularly interested in the projects which have been built under section 608 and section 206, involving rental housing in multiunit structures. These apartment buildings, many of them elevator-type structures, are sometimes located in downtown areas, and lend themselves to widespread competition with hotels.

We feel very sure that it was never the intention of Congress to permit these apartment buildings, built under your insured-mortgage program, to operate as hotels, or even to permit transient rentals. But spokesmen for our industry have been appearing before you now for 3 years, and nothing happens.

The situation has been quite grave. The Federal Housing Administration reports to us that as of January 31, 1954, there were 60,375 units built under section 207, and 463,730 units built under section 608, or a total of 524,105 operating units. I can best give you the picture of our fear when I report to you that this is well over one-third of the total number of guestrooms in the entire hotel industry, based on the Bureau of the Census report of 1,549,000 hotel rooms in the country. And from unimpeachable authority we learn that

it has been quite common practice, even back in the days of 608, to design these structures in a manner which would permit fast and inexpensive conversion to residential hotels. In other words, there is a Government-assisted housing facility already potentially great enough to wreck the hotel business.

Now you are being urged to extend this program, and to liberalize mortgage insurance for rental housing. Frankly, we are distressed over the prospective impact from these activities.

This year you are being requested to increase the allowance per room, and per family unit, because of the fact that the actual real-estate costs for properties adjacent to business areas in the individual cities are so great. Heretofore, as we understand it, a 207 project could be approved for as much as \$10,000 per living unit of 5 rooms. But under the new program, a 5-room unit in an elevator-type structure could soar to a maximum allowable cost of \$12,500. You have long since passed the average valuation of low-cost housing, and are constructing properties which could effectively compete with hotels. And the very fact that the emphasis is being placed on downtown locations multiplies the impact upon us; 10 or 15 or 20 years from now, as the projects that are being constructed under this program pay out, the FHA's interest will terminate, and the owners could quickly convert to the hotel business if they chose. Two very popular hotels in Washington, D. C., were built originally with 75 to 80 percent apartment units and only a handful of transient rooms. But they have been subsequently converted almost entirely to transient units, proving that this can be done.

The bill now before your committee would increase the threats which we have heretofore experienced. Under present law, a borrower who has constructed a new building would be obliged to look ahead 20 or 30 years before he could hope to gain title to the structure, pay off the mortgage, and operate in any manner he so wished. Now, if he can take an old structure, modernize it and brighten it up, he might hope, in 5 years' time, to pay off the mortgage, and possibly convert into a hotel.

So we appear before you to express the hope that your committee may have two things in mind as you renew the authorization for this program. It is imperative that you find a way to incorporate definite safeguards into the language of the statute, to insure the fact that FHA will not permit transient rentals in any rental housing so long as the Commissioner holds the mortgage. Or, if that is impossible, we hope the Congress will incorporate in its report a clear statement to the effect that this program of governmental assistance in financing of housing is intended to furnish shelter housing for low-income families, and that such facilities should not be operated as hotels.

According to the United States Treasury, ever since 1946 hotels have shown a lesser rate of return on investment than any other service industry. And, incidentally, our occupancy has been declining steadily since 1947. Competition from publicly assisted housing developments could prove ruinous to us. Already, in 1 city known to us, and within the district of 1 of the members of your committee, 2 of these 608 apartment buildings are averaging 50 or 60 transient guests per day. This volume of business is just enough to bring the hotels

of that city down to a house count low enough to deprive them of any profit from their operations.

Up until this month, we were looking at only 608 and 207 properties, but it now develops that we have competition from some of the other forms of housing authorized by your committee.

Under title IX, some veterans' housing was built near a naval base 2 years ago. Now that base has been deactivated, and the service personnel have moved away. So we are told by FHA officials that one of the projects has converted into a motel.

For 4 or 5 years we have tried, in every way and in every manner we know how, to whip this problem administratively, and officials of the FHA have been quite sympathetic. Section 1743 (b) (1), in connection with 608 properties, provides that the Administrator may, in his discretion, regulate as to rents, charges, and methods of operation. Counsel for the FHA, however, has taken the position that this discretion relates only to determining the eligibility of the mortgagor for a loan. He contends that it does not confer power upon the FHA to impose regulations after the eligibility of the mortgagor has been approved. The agency has always required approval of all rent schedules. FHA counsel has taken the position that where an approved rental schedule provides for a monthly rent, and if one of these apartment buildings rents a room overnight for not more than one-thirtieth of the rental, the agency has no basis for compelling the operator to terminate such practice.

Now I would like to give the committee examples of how this ruling works in practice.

Just last week we brought to FHA officials once again photostatic copies indicating positive transient rentals. The agency had on file from the owner of one of those properties a recent letter, in which he had stated clearly that his property was not accepting transient rentals, and that he was instructing all members of his staff to not accept any overnight guests. But, when we present these receipts showing daily charges for a single person ranging from \$5 to \$5.50 the agency immediately says, "Well, these 2 properties do possess approved monthly rentals on certain units totaling as much as \$180, and so on the basis of one-thirtieth of a monthly rental, they might legally be charging as much as \$6." So I submit that we have no protection, nor apparent administrative relief.

Further, as evidence of the duplicity which mortgagors employ in their dealings with the agency, let me tell you about this owner, mentioned above. I refer to the man who wrote FHA, stating that he was instructing his staff to refuse transient business. We are advised that this party has renewed, for 1954, the city hotel license covering the 20 rooms which are held for transient clients. Also, the owner has waived all control over his employees by leasing the establishment to a third party who engages all staff people. Incidentally, we contend that it is a clear violation of the statute for FHA to permit subleases on insured properties. Actually, we are dealing, in this field, with a widespread scheme or conspiracy to get around the letter of the law.

And then, just last week, a new distortion occurred. The manager of one of the field offices of FHA came up with this contention. He said that it would not matter how much a 608 or 207 property charged

for a unit overnight, providing that sums charged for occasional rentals of that unit in any month's time did not total more than the approved monthly rental. Under this method of calculation, an apartment which carried an approved monthly rental of \$180 could be renting for 18 days during the month at the rate of \$10 a day, and still be entirely legal. But I am here to tell you that most of our hotels in America are renting our units less than 18 days out of a month in 1954. Certainly such practices do not conform with congressional intent to make available low-cost housing accommodations.

One project at least, that we know of, financed by FHA, has gone into direct competition with hotels. Right here in the District of Columbia, there is a property which is known as the largest apartment building in the world. It was built with mortgage insurance provided by FHA.

After construction was under way, and the architect had provided for some ground-floor rentals, including a restaurant, cocktail lounge, drugstore, and so forth, it developed that zoning ordinances on that particular street would not permit such ground-floor rentals in an apartment building. But the zoning ordinances did permit such facilities in a hotel. The FHA and the builder jointly appeared before the appropriate city officials, and asked for a variance, which would permit some slight deviation from the strict zoning requirements.

The commissioners turned them down, and told them that they should simply resort to the expediency of calling the property a hotel, and providing for a certain percentage of transient rooms. So, in effect our own governing bodies are compelling mortgagors, even against their will, to set up hotel facilities. This particular owner told one of our AHA officials recently that he was only running 42 percent occupancy in the transient rooms which he is maintaining. This represents a serious monthly loss, substantially impairing the repayment ability of the borrower. This property has just engaged a sales manager, whose duties will be to develop public luncheon and banquet and convention business. We ask this committee earnestly if such activities are to be permitted in FHA properties.

We have every reason to feel that if Congress should express the view that this weird formula of one-thirtieth of the monthly rent is not in line with congressional intent, and does not in any way measure up to the requirement for approved monthly rentals, this practice could immediately be stopped.

Of course, the moment that any of these rental structures are furnished, they become potential threats to the hotels in the vicinity. In response to our appeals on January 3, 1952, the agency adopted a new procedure in order to eliminate transient occupancy contrary to FHA policy. The agency has always emphasized forcefully the statement to borrowers that it does not permit the offering of hotel services. Yet when we repeatedly come up with photostatic copies of receipts provided for overnight transient guests, the agency's only reply is that it does not have funds with which to engage a field staff to hold down such violations. We feel that if a clearcut statement prohibiting such practices is incorporated in the act itself, or in a statement, it would go a long way toward eliminating most of these violations. Certainly, no mortgagor would care to take the risk of possibly jeopardizing his investment by an act which is clearly prohibited by the statute.

Now, gentlemen, I do not mean to complain about the staff people of the FHA. Those folks with whom we have worked for the last 4 or 5 years have tried to help us whip this situation. But it is this ruling of their own legal counsel that has robbed them of any administrative latitude which would permit them to crack down on the operators who persist in this practice.

And it does seem to us that your committee is permitting your own housing program to be dangerously distorted if this type of thing is permitted. As I understand it, your housing program is designed to serve the low-income families of America. And the low income families are not going to want, or need, transient units in an apartment building. And I am sure they don't require convention facilities.

The American Hotel Association has been very reluctant to strike out at any feature of the housing program. We have always felt that the borrower should be permitted to do anything reasonable if that was the only way he could be assured of sufficient income to repay the Government for its financial assistance in the project. However, we have pointed out before, the operators of certain of these projects have distorted the legislative intent by providing transient occupancy. Since we have not been successful in 4 years of efforts in having this practice stopped throughout the country, by administrative procedure, we are obliged to come to you and seek your assistance and to appeal to you for some statutory safeguard against this continued unfair competition.

Thank you for the opportunity to bring this statement to your attention.

The CHAIRMAN. Thank you for being here, Mr. Johnson.

Are there any questions of Mr. Johnson?

Mr. MUMMA. Are there any violations of the intent of the law in Harrisburg, Pa.?

Mr. JOHNSON. Not that we know of, sir.

Mr. BETTS. I can imagine there would be a lot of difficulty in distinguishing between what is a hotel and an apartment, quite frequently. Has your office prepared any suggested amendment that would give us some idea as to how it could be checked or corrected?

Mr. JOHNSON. We will be very happy to prepare such a statement.

Mr. BETTS. I think you have done a good job in telling us the problem, but I can see that there are a lot of difficulties involved. For instance, there are some hotels which have rooms for transients, and also rooms for permanent guests, and you get into a twilight zone there, where an actual change in the law might be a little complex.

Mr. JOHNSON. Are those properties, sir, financed by FHA?

Mr. BETTS. I don't know. I am just thinking of the legal definition.

Mr. JOHNSON. Because in our own industry we have apartment buildings where we have transient rooms, but they are not financed by FHA.

Mr. BETTS. I was just thinking that from the legal standpoint you can get into difficulties in defining those situations so as to take care of the twilight zones. I just thought it might be helpful.

Mr. JOHNSON. We will certainly do that, Mr. Betts.

The CHAIRMAN. Are there further questions of Mr. Johnson?

Mr. KILBURN. Why does counsel for the FHA allow this to go on? What is his reason?

Mr. JOHNSON. Well, it is the way he interprets it. I wonder if I may call a Mr. Ryan.

Mr. KILBURN. I don't want to go into it too much, except that from what I know of it, I have agreed with you, and I don't see why he would interpret it so.

Mr. JOHNSON. We can't understand it. After all, in the law, the statement is made, on an annual and monthly basis; nothing is said about a daily and transient rate. But he feels if the charge isn't more than one-thirtieth per night, that it still qualifies a man to operate on that transient basis.

The CHAIRMAN. It is predicated upon the fact that there is a hundred percent occupancy?

Mr. DEANE. Mr. Chairman.

The CHAIRMAN. Mr. Deane.

Mr. DEANE. I realize your problem, Mr. Johnson. I wonder if you could give to the committee the average occupancy ratio of the hotels in the cities and in areas of, say, 100,000 population.

Mr. JOHNSON. We could get that for you; yes, sir. Mr. Ryan informs me that the average hotel occupancy last month was 67 percent. That is just 1 percentage point above two-thirds. That is the average throughout the country.

Mr. DEANE. Isn't your real problem involved in the motel operation?

Mr. JOHNSON. It depends, sir. The small country town has a very great problem there.

Mr. DEANE. Well, if you go south, down United States 1, there is just 1 motel after another. I think that is your real problem.

Mr. JOHNSON. Well, it is one of many.

Mr. DEANE. You don't recognize the motels as any problem?

Mr. JOHNSON. Oh, yes, indeed. Yes, sir.

Mr. DEANE. That is the point I am trying to develop.

Mr. JOHNSON. Of course, the hotel industry has a great many problems, and one of them is that we are at the breaking point now. Hotels simply can't operate unless they have an occupancy. The services in city hotels are demanded, and yet rates are as high as anybody can afford to pay, and unless we can reach a higher occupancy, and in some cases unless we can eliminate competition that is sponsored by the Government that hotel will go to the wall.

Mr. DEANE. Are you in a position to speak to the problem as far as 608's and motels are concerned, as far as operating forces detrimental to your operation?

Mr. RYAN. Mr. Deane, it is quite simple to give a mathematical formula. There are a million motel units in America. Those have been privately financed so that is our problem. Here is half a million units Government financed and we contend that is an unfair type of competition.

Mr. DEANE. What percentage of those half million 608's are in direct competition with you today?

Mr. RYAN. They are all potential.

Mr. DEANE. But I mean who are actually in competition.

Mr. RYAN. Well, that is an impossible question. The agency has never been willing to give us a list of the 608's, so we don't even know where they all are. But we do discover that in every part of America this thing is happening, that this particular establishment, and then that establishment, is found guilty of making transient rentals.

Mr. DEANE. I repeat that I recognize the seriousness of the problem which you face, but isn't this true, that in some of the smaller communities, and even in the larger communities, this matter of parking, convenience, and also the question of fire hazard, has operated to the serious disadvantage of a great many hotel owners?

Mr. JOHNSON. Well, yes, it has, indeed, but I don't understand, sir, how that refers to the competition between Government-financed hotels.

Mr. DEANE. What I was trying to do was to be fair to owners of 608's, and also fair to hotel owners.

Mr. JOHNSON. Well, they are in competition if they take one room away from us, unless it is written into the law that they should be permitted to compete with hotels, compete with private capital, and in this one instance, where one of those properties has as many as 40 or 50 transient rentals, we can't prove that all of those rentals would have gone into the hotels or motels in that area, but certainly the percentage has hit the hotel on any one of those particular nights where they have lost that occupancy.

Mr. DEANE. Knowing the FHA officials as I do, I feel that you certainly have people who want to do the right thing. They are faced with a serious problem, too. Some of these 608's may be on the downgrade, and a lot of pressure is being put on some of these projects, to my own personal knowledge.

Mr. KILBURN. Will you yield?

Mr. DEANE. Yes.

Mr. KILBURN. It seems to me if we pass legislation to help housing for the country, that it doesn't mean that we are passing legislation to increase competition for hotels. That isn't housing.

Mr. JOHNSON. No, sir.

Mr. KILBURN. So I don't think the FHA people are interpreting it correctly.

Mr. DEANE. I wonder, Mr. Chairman, if, in executive session, we might not ask the housing agency to give us some views on the matter, so that we can really come to some accurate conclusion as to what the problem really is and determine what FHA can do to protect the hotel owners.

Mr. KILBURN. I can see what they are up against. I don't think it is fair.

Mr. JOHNSON. Because, after all, if somebody goes into one of these places overnight, somebody has to provide them with maid service to clean up the room, and we don't think it is the intent of your body to provide hotel rooms, or convention facilities, or cocktail lounges. We need some help.

Mr. DEANE. I agree with you.

Mr. BETTS. To operate a hotel you have to secure a State license; don't you?

Mr. JOHNSON. In some States, sir. You don't have to in all States.

Mr. DEANE. That is all, Mr. Chairman.

The CHAIRMAN. Are there further questions?

Mr. OAKMAN. Mr. Chairman.

The CHAIRMAN. Mr. Oakman.

Mr. OAKMAN. I would like to tell Mr. Johnson that we are glad to have him with us today, coming from the great sovereign State of Michigan.

The CHAIRMAN. Though he is not from my district or Mr. Oakman's, I am very glad to put in a plug for Mr. Johnson's district.

Mr. OAKMAN. That is right, Mr. Chairman.

But the projects which you referred to under section 608 do not apply to your own operation in Michigan?

Mr. JOHNSON. No, sir.

Mr. OAKMAN. So you are here today to speak for an industry problem?

Mr. JOHNSON. That is right.

Mr. OAKMAN. Rather than one which affects you directly?

Mr. JOHNSON. Yes, sir.

Mr. OAKMAN. This does not even affect you indirectly as an individual?

Mr. JOHNSON. In Michigan, Mr. Oakman, it doesn't affect us.

Mr. OAKMAN. Mr. Chairman, it seems to me that the gentleman offers here two very valid solutions which, as our colleague, Mr. Deane, has suggested, might well be discussed in executive session with the FHA, and that is on page 3, to the effect that the FHA will not permit transient rentals in any rental housing so long as the Commissioner holds the mortgage, or the other suggestion, that the committee incorporate in its report a clear statement to the effect that this program of governmental assistance in financing of housing is intended to furnish shelter housing for low-income families, and that such facilities shall not be used and operated as hotels.

The CHAIRMAN. I would think that from now on, we might give consideration to a provision prohibiting that and administratively the FHA could incorporate language in its contract to cover it; to the effect that the property is not to be used for hotel purposes.

Mr. OAKMAN. That, of course, Mr. Chairman, wouldn't affect—

The CHAIRMAN. I should think it could be handled under the general provisions in the act, administratively, to more clearly set forth the intent of Congress. I think we all agree that it was never the intent of Congress that the FHA would insure a commercial property. We had a lot of deliberation on that question before this committee and we have never gone into the commercial field, in FHA, and we surely wouldn't want to set up a situation which had developed at one point in FHA and RFC, where Government moneys were used to set up competition for privately financed industries to the prejudice, perhaps, of some of the industries in your district, Mr. Oakman.

Mr. OAKMAN. That is right. Mr. Chairman, do you feel that that could be made applicable to existing units, these half million units which have been referred to, as well as future units which will be constructed hereafter?

The CHAIRMAN. That is the problem, whether it can be made so, unless we find language in the existing law which would justify it.

If we find language in the existing law, and Mr. Johnson has suggested that it is there, we might reiterate in the report our intentions

in that respect. And we could provide hereafter a specific prohibition against the use of 207's as commercial properties.

I think we will find some way of dealing with the problem.

Mr. JOHNSON. Thank you, sir.

The CHAIRMAN. Thank you very much, Mr. Johnson and Mr. Ryan.

Mr. JOHNSON. Thank you, Mr. Chairman.

SUPPLEMENT TO TESTIMONY OF MARCH 12, 1954, BY EARL JOHNSON, APPEARING ON BEHALF OF THE AMERICAN HOTEL ASSOCIATION

As I have pointed out, FHA has indicated a reluctance to take any effective steps to enforce the provision against transient occupancy in its contracts with borrowers under sections 608 and 207. Probably the best way of correcting this situation is to amend the act to require FHA to file a petition for an injunction in a Federal district court within 30 days after it has received written notice of the breach of contract. If FHA fails to act within the 30-day period, the law should permit any property owner to petition the Federal district court for an injunction. I hesitate to suggest any specific statutory language to permit such injunctions. It would probably require amendments to the Judicial Code and the Administrative Procedures Act as well as the Federal Housing Act.

In addition, the law should require FHA to issue regulations to prohibit transient occupancy. I have here some language which your committee might want to consider as a specific amendment to the bill. The section numbers on the language we offer for your consideration refer to the United States Code, and not to the bill you are now considering.

1. Section 1713 (a) (1): Amend subparagraph (a) (1) so as to read as follows:

"The term 'mortgage' means a first mortgage on real estate in fee simple, or on the interest of either the lessor or lessee thereof (A) under a lease for not less than ninety-nine years which is renewable or (B) under a lease having a period of not less than fifty years to run from the date the mortgage was executed, upon which there is located or upon which there is to be constructed a building or buildings designed principally for *permanent residential use*; * * *"

2. Amend section 1713 (a) by adding a new subparagraph, reading as follows:

"(S) The term 'permanent residential use' shall mean occupancies for a term of at least one month and in no case shall occupancies or rental agreements be made for a lesser period."

3. Amend section 1715 (b), to read as follows:

"The Commissioner is authorized and directed to make such rules and regulations as may be necessary to carry out the provisions of this subchapter and *shall make and enforce rules and regulations which will insure that the rental housing is not used for other than permanent residential purposes.*"

4. Amend section 1743 (b) (2) by adding the following at the end thereof:

"It is the intent of this Act that the mortgaged property shall be designed and used only for permanent residential purposes and shall not be rented for periods of less than one month."

5. Amend section 1742, to read as follows:

"The Commissioner is authorized and directed to make such rules and regulations as may be necessary to carry out the provisions of this subchapter and *shall make and enforce rules and regulations which will insure that the rental housing is not used for other than permanent residential purposes.*"

6. Amend section 1750b (a) so that the following is added at the end of the fourth proviso: "and preventing the rental of such properties for periods of less than one month."

7. Amend section 1750f, to read as follows:

"The Commissioner is authorized and directed to make such rules and regulations as may be necessary to carry out the provisions of this subchapter and *shall make and enforce rules and regulations which will insure that the rental housing is not used for other than permanent residential purposes.*"

The CHAIRMAN. The committee will be in recess until 2:15.

(Whereupon, at 12:50 p. m., the committee recessed, to reconvene at 2:15 p. m., the same day.)

AFTERNOON SESSION

The committee met at 2:15 p. m., pursuant to adjournment, the Honorable Jesse P. Wolcott (chairman) presiding.

Present: Chairman Wolcott, Messrs. Gamble, Talle, Kilburn, McDonough, Betts, Mumma, Merrill, Oakman, Van Pelt, Spence, Brown, Patman, Deane, O'Brien, Bolling, O'Hara and McCarthy.

The CHAIRMAN. The committee will come to order.

We will proceed with the consideration of H. R. 7839.

This afternoon we have representing the United States Savings and Loan League Mr. M. K. M. Murphy, past president.

Mr. Murphy, we are glad to have you proceed.

STATEMENT OF M. K. M. MURPHY, PAST PRESIDENT, UNITED STATES SAVINGS AND LOAN LEAGUE, ACCOMPANIED BY STEPHEN SLIPHER

Mr. MURPHY. I am M. K. M. Murphy and I appear here as past president of the United States Savings and Loan League and vice chairman of the league's legislative committee. Our 62-year-old league is a nationwide organization which represents about 90 percent of the \$27 billion savings and loan business, serving more than 15 million savers and homeowners in the country. By way of further personal identification, I live in Rutherford, N. J., and I am president of the Boiling Springs Savings & Loan Association which is a relatively small neighborhood New Jersey financial institution with \$10,700,000 in assets and about 18 employees, serving 17,000 folks in our area.

My associate this afternoon is Mr. Stephen Slipher of the staff of the United States Savings and Loan League, and we are most grateful for permission to appear before you here today.

The Housing Act of 1954 is largely a home-financing bill and since savings and loan associations finance more homes than any other type of financial institution we naturally have a very deep interest in this measure. The importance of our member savings associations in the home-financing field can be underlined by noting that last year savings and loans made 38 percent of all of the home loans in the country, helping over 1 million families to home ownership.

The importance of this volume of home lending to the Nation's economy is readily apparent when it is realized that the approximately \$7½ billion of loans made by our institutions last year was greater than the combined total of all FHA and GI loans made during the same period. It is also a larger sum by \$1 billion than the combined total of home loans made by commercial banks, savings banks, and insurance companies last year.

There are two other characteristics of the savings and loan operation which I wish to emphasize. Savings and loan associations are home-financing institutions first, last, and always. About 82 percent of our assets are invested in home mortgages. Unlike most other financial institutions we have always realized, and still do, our obligation to the concept of individual homeownership and thus deemphasize any alternative investments which may be available to us; thus we are constantly in the home mortgage market.

As your committee knows, there have been several times in recent years when changes in the Government bond market have caused a

sharp reduction in the home lending activity of some of the other types of financial institutions. Another characteristic is that savings and loan associations are the only home-financing institutions that do not place primary reliance on Government guarantees or insurance of home loans. We make 75 percent of our home loans entirely on our own judgment and responsibility. All but 5 percent of the remaining loans are GI loans. We have actively cooperated in the GI home loan program where, as the committee knows, a special act of Congress has provided a method for relieving veterans of World War II and the Korean conflict of the normal downpayment requirements.

TITLE VI. SAVINGS AND LOAN AMENDMENTS

Since title VI of the bill deals directly and exclusively with savings and loan associations, I should like to comment on that section before addressing testimony to the remainder of the bill. This title provides technical and minor adjustments to savings and loan law and also adds a new provision with respect to conservator and receivership procedures.

Section 601 is a technical change having to do with the right to sue the Federal Savings and Loan Insurance Corporations. Section 602 is an adjustment in the size of the maximum loan which Federal home loan banks may accept as collateral and section 603 (1) makes the same adjustment in maximum loans by Federal associations. We support these changes.

Section 601 is a technical change having to do with the right to sue the Federal Savings and Loan Insurance Corporations. Section 602 is an adjustment in the size of the maximum loan which Federal home loan banks may accept as collateral and section 603 (1) makes the same adjustment in maximum loans by Federal associations. We support these changes.

Section 603 (2) amends subsection (d) of section 5 of the Home Owners' Loan Act to set forth in detail the procedures under which the Home Loan Bank Board may enforce its supervisory directives and appoint conservators and receivers, and it also sets forth the rights of the Federal savings and loan association involved. The United States Savings and Loan League has given very serious study to this matter for a number of years and we feel that it is very important that adequate provisions be set forth in the statute. There have been numerous conferences by our league with the Home Loan Bank Board, with various groups within the savings and loan business, and with some Members of Congress; the results of such conferences are reflected to a great extent in the language contained in this bill. We very definitely support section 603 and urge its enactment.

The United States Savings and Loan League quite naturally has a comprehensive legislative program of suggested changes in the savings and loan law. We realize that it is not appropriate to suggest the addition of elaborate legislation affecting our savings institutions in a general housing measure and accordingly we will ask the committee at some later date to give consideration to our overall program.

There are, however, four minor items which tie very closely to the purposes of the housing act and which we suggest could and should properly be included in the present measure. I have included at the

end of my statement specific language to accomplish the amendments desires. The four items are:

1. Increase in the ceiling on property improvement loans by Federal associations to \$3,000, which is consistent with section 101 of this bill.

2. Permit Federal associations with 5 percent reserves, or greater, to invest up to 10 percent of assets in homes and home sites and to make loans on land which is to be developed into housing. The purpose of this section is to permit Federal associations to directly engage in redevelopment and rehabilitation of housing and thus play a more important part in the urban renewal program set forth in the currently proposed housing act.

3. Shorten the name of the Federal Savings and Loan Insurance Corporation to the Federal Savings Insurance Corporation. Your committee has previously approved such a provision (S. 2822, 81st Cong.) and it passed the House of Representatives, but was eliminated in conference committee. Bills for this purpose have been introduced in the House (H. R. 1385, 82d Cong.) and in the Senate (S. 286, 83d Cong.). The purpose of the bill is merely to simplify the name of our insuring agency and to avoid the public misunderstanding that results from the use of the word "loan." The insurance corporation only insures the savings in our institutions and yet frequently the public feels that it is a loan insurance.

4. An amendment which would change the formula for the accumulation of reserves in insured associations. The new formula would be based on net income and would not change the present mandatory 5-percent-reserve requirement. It would result in somewhat greater accumulation of reserves and would also provide for additional reserves beyond the 20-year requirement.

We believe that these four provisions will help our savings institutions play a greater part in accomplishing the objectives of the housing act.

TITLE I. FHA

The first sections of title I deal with FHA property-improvement loans. We feel that these adjustments in ceiling and maturity will assist in the repair and rehabilitation of housing and thus implement the urban renewal program in the bill and we support these changes. The FHA title I program is, in our opinion, established on sound insurance principles in which, as should be, the lender shares the risk and the premiums cover the cost and the necessary reserves for losses.

The remainder of title I deals largely with the basic FHA program of loans for new and existing homes. Without going into all of the details, the new provisions provide for a liberalization of loan-to-value ratios, increases in maturity to 30 years, higher mortgage ceilings, and a significant new provision which permits the same liberal loans on existing homes as on new houses. It would appear that certain of these provisions have been drawn in the belief that the construction and home-building industry is entering a recession. Such a belief is certainly open to serious question. Home building is off to another banner year and our studied opinion is that, without any new legislation at all, more than 1 million new houses and apartments will be built in 1954.

During the many conferences and studies of the past year on this subject, there was a great deal of discussion of making the FHA program a truly self-supporting, private-enterprise operation, conducted on sound insurance principles. Some recognition has been given to this in the bill by the elimination of some of the minor and obsolete loan types of doubtful soundness, but basically the bill moves away from, rather than toward, a more private-enterprise operation and a sounder FHA.

Realizing the dangers to the stability of our economy which might very well eventuate from the placing of further strain on the none too strong existing reserves of FHA, may we respectfully express concern over the proposed liberalizations in this title. According to statement 9 on page 369 of the Sixth Annual Report of the Housing and Home Finance Agency, at the close of 1952, the FHA title II operation has reserves of \$122 million against loans and commitments with an outstanding balance of \$10,600,000,000, a ratio of approximately 1.2 percent. Savings and loan associations have reserves of approximately 11½ percent of the outstanding balance of their conventional loans. The difference between 11½ percent and less than 2 percent is spectacular in itself, but it also should be noted that FHA is insuring very high percentage loans running up to 95 percent with 30-year maturities as compared to loans by our institutions which may run only to 80 percent of value with 20-year maturities. Of course, the reason our reserves are higher is that we place about 1.1 percent of loan balances aside each year to meet possible future losses, whereas the FHA collects only one-half of 1 percent and puts into reserves even less than one-half of 1 percent.

We realize that there has been, and will be, a great deal of testimony in favor of this title, but we feel it only right to call the committee's attention to the substantial increase in risk to the Federal Government which will result from liberalization of loan terms in the fact of the present limited reserves. It is our wish, which we believe this committee will join, that the FHA gradually move toward, and not away from, financial solidarity and longevity. We are well aware of the frightening and disheartening repercussions to our national economy in general and the \$12 billion home-building industry in particular, should FHA because of inadequate reserves get into financial difficulties or become insolvent.

We seriously question the wisdom of liberalizing the terms of loans on existing homes. This is a field in which most lending is now conducted without any liability to the Federal Government and there should be a great deal of caution in unnecessarily involving Federal credit in this area. We may also point out that in the case of existing homes the long-term maturities and high loan-to-value ratios are of very questionable economic soundness. We doubt the advisability of 30-year maturities even in the case of new homes, much less existing homes, when consideration is given to the useful life of property, the "moving habits" of the American people, changes in family size, and the probable earning capacity of the typical borrower.

During past consideration of the FHA program we have urged and hoped for some program, at least a gradual one, which would provide for some sharing of risk by lending institutions to the end that the Government's potential liability could be gradually reduced rather

than constantly increased. Surprising as it may be, this bill actually increases the Government portion of the risk and decreases the lender's portion by liberalizing foreclosure procedures, and adjustment of debenture rates to assure their salability.

There are two new titles of FHA provided in the bill, known as sections 220 and 221. The new section 220 loans are really a relaxation of other FHA loan sections and our position would be the same as already described.

The new section 221 provides for the 40-year 100-percent loans to families displaced by slum clearance or urban renewal activities. Obviously the 40-year loan term is uneconomic and unrealistic and these loans will be made only with the most generous and costly support from the Government. Much of this support is provided in the bill. Unlike some other witnesses, we feel that such loans may be made. We do feel, however, that this section amounts to virtually direct lending by the Government, a principle which we have always opposed and which Congress has approved to date only in the case of veterans' loans.

We studied the new section 221 quite sympathetically during the past months in the belief that it was to be offered as an alternative of substitute for the public-housing program. In spite of its many dangers it does have an advantage over public housing, in our opinion, in that public ownership of property is not involved and that there is some semblance of home ownership involved. However, the program is not offered in the bill as a substitute for public housing and we understand that the Administration is asking for 35,000 public-housing units this year as contrasted to the 20,000 which the Congress approved last year.

TITLE II. MORTGAGE INTEREST RATE TERMS

Under this title the President could adjust the interest on FHA and GI loans within a range determined by the going rate on Government bonds. The need for some method of adjusting interest rates in keeping with general interest-rate patterns has been recognized for years as the only practical way in which to avoid recurring periods of "feast and famine" in the GI and FHA programs. We support this section except that we suggest that the decision on interest rates should be made by a specified committee of informed Government officials (such as was recommended by the President's Housing Advisory Committee). Technically informed Government officials such as the heads of the VA, FHA, HLB, Treasury, and the Federal Reserve are constantly in touch with money-market conditions and are in the best position to make a proper decision on mortgage rates.

We approve the repeal of section 504 of the Housing Act of 1950 as is provided in this title. This provision has caused a great deal of confusion and unnecessary complication in the housing market and has resulted in regulations which discriminate against lenders who make loans in favor of lenders who sell loans.

We believe that in any event the authority to adjust loan-to-value ratios and maturities should not apply to loans made under the Servicemen's Readjustment Act of 1944. We regard that act as a contract by which the Congress sought to provide returning veterans with a

method whereby they could buy homes within 10 years with the down-payment eliminated or substantially reduced. This is the basic feature of GI home loans and we do not feel there is any warrant for breaking faith with the veteran.

TITLE III. FEDERAL NATIONAL MORTGAGE ASSOCIATION

During the past year the United States Savings and Loan League has given a great deal of study and consideration to the secondary market problem. We have arrived at some rather definite conclusions as to the principles on which such secondary market facilities should be operated. We feel that these principles and objectives were well stated in the report of the Subcommittee on Housing Credit Facilities and the President's Housing Advisory Committee. The objectives are set forth on page 349 of the President's Housing Committee report as follows:

1. Such secondary market facility should be privately financed and should operate without expense to the Federal Government.
2. Its operations should be sufficiently sound from an economic point of view as to permit the sale of its obligations in the private market under favorable terms. Such debentures would not be guaranteed by the Federal Government.
3. It should take the form of a quasi-public corporation, operated under the direction and supervision of a board of directors, appointed by the President, and so constituted as to be in a position to prevent its being subject to pressures not consistent with its objectives.
4. With due recognition of the fact that substantial volume of funds for mortgage lending can be found only in long-term savings, it should be the primary objective of the corporation to facilitate the flow of mortgage funds to areas where needed.
5. To that end, and in order to prevent efforts to use its facilities to create a primary market instead of a secondary market, the corporation should purchase mortgages only on the basis of imposing an automatic deterrent on those using its facilities.
6. Mortgages should be purchased by the corporation with the objective of selling them to mortgage investors in other areas, and only those mortgages should be purchased which are believed by the management of the corporation to have marketability under normal conditions.
7. A reasonable financial participation should be required of the financial institutions that would use its facilities.

The proposed plan violates virtually all of these principles and we oppose it. We feel that the plan recommended by the President's Housing Committee would satisfactorily and properly meet the second market need, particularly if the flexible interest rate for FHA and GI loans becomes effective as provided in this bill. If realistic interest rates are maintained on mortgages, the secondary market operation becomes essentially one of smoothing the flow of mortgage funds and redistributing them throughout the country and that objective can be accomplished without Government funds or Government guaranty by the National Mortgage Marketing Corporation proposed by the President's committee.

TITLE IV. SLUM CLEARANCE AND URBAN RENEWAL

We commend the emphasis of this bill and the administration's program on urban renewal and slum clearance. We have long felt that the preservation, repair, rehabilitation, and improvement of exist-

ing housing was one of the most neglected phases of our national housing program. In far too many of our cities and communities no hand has been turned to enforce housing safety and occupancy laws, and the entire reliance has been on the hope and expectation that the Federal Government would come to the community and solve the problem through the building of brandnew homes. A few cities, such as Baltimore, have made a remarkable start in enforcing their housing laws and prohibiting a continuation and the renting of housing units which are clearly in violation of city laws and all standards of decency and safety.

We hope the committee will find a way in which to strengthen even further the requirements in this bill that communities undertake their full share of responsibility before requesting assistance from the Federal Government. One simple requirement would be that each community be required to show that all of its older housing had been inspected and notices of violations processed and enforced at least bi-annually. Most of our cities and States now have regular inspections of all automobiles and the safety and fireproof condition of hotels and public buildings are checked several times a year. There is no reason why the safety of the occupants of a city's apartments and homes should not be of equal concern.

If a city is unwilling to spend a nominal sum such as \$10, \$15, or \$25 to inspect a house, then the city has no right to expect the Federal Government to come in and spend \$10,000 to build a house or to assume the liability on a \$10,000 loan.

TITLE V. PUBLIC HOUSING

We consider the technical amendments to the public-housing law satisfactory and a step in the right direction. Of course, we are unalterably opposed to any expansion of public housing and have so testified before this committee many times. Since the basic policy on public housing is not covered in this bill, I will not dwell on the point further.

AMENDMENTS RECOMMENDED BY THE UNITED STATES SAVINGS AND LOAN LEAGUE AS ADDITIONS TO TITLE VI OF H. R. 7849

AMENDMENT NO. 1

Subsection (c) of section 5 of Home Owners' Loan Act of 1933, as amended, is amended by striking out the following:

"Notwithstanding any other provision of this subsection except the area restriction such associations may invest their funds in loans insured under title I of the National Housing Act, as amended, loans guaranteed or insured as provided in the Servicemen's Readjustment Act of 1944, as amended (except business loans provided by section 508 thereof and not secured by a lien on real estate), or in other loans of property alteration, repair, or improvement: *Provided*, That no such loan shall be made in excess of \$1,500 except in conformity to the other provisions of this subsection, and that the total amount of loans so made without regard to the other provisions of this subsection shall not, at any time, exceed 15 per centum of the association's assets."

and inserting in lieu thereof the following:

"Without regard to any other provision of this subsection except the area requirement such associations are authorized to invest a sum not in excess of 15 per centum of the assets of such association in loans insured under title I of the National Housing Act, as amended, or as the same may be amended; in unse-

cured loans insured or guaranteed under the provisions of the Servicemen's Readjustment Act of 1944, as amended, or as the same may be amended; and in other loans for property alteration, repair, or improvement: *Provided*, That no such loan shall be made in excess of \$3,000."

AMENDMENT NO. 2

Subsection (c) of section 5 of the Home Owners' Loan Act of 1933, as amended, is amended by the addition of the following:

"Without regard to any other provision of law, such association with general reserves, surplus and undivided profits equivalent to 5 per centum or more of their withdrawable accounts are authorized to invest a sum not exceeding 10 per centum of their withdrawable accounts in homesites and housing for sale or rental, including property acquired for the specific purpose of reconstructing, rehabilitating or rebuilding residential areas to meet the minimum standards of health and occupancy prescribed by appropriate local authorities and to make loans secured by first lien upon such properties to assist in the development thereof."

AMENDMENT NO. 3

Title IV of the National Housing Act, as amended, is hereby amended by striking out the words "Federal Savings and Loan Insurance Corporation" at each place the same appears therein and inserting in lieu thereof the words "Federal Savings Insurance Corporation."

AMENDMENT NO. 4

Subsection (b) of section 403 of the National Housing Act as amended, is amended by striking out the following: "; will provide adequate reserves satisfactory to the Corporation, to be established in accordance with regulations made by the Corporation, before paying dividends to its insured members; but such regulations shall require the building up of reserves to 5 per centum of all insured accounts within a reasonable period, not exceeding twenty years, and shall prohibit the payment of dividends from such reserves, or the payment of any dividends if any losses are chargeable to such reserves: *Provided*, That for any year dividends may be declared and paid when losses are chargeable to such reserves if the declaration of such dividend in such case is approved by the Corporation." and inserting a period and inserting in lieu thereof the following:

"Each insured institution shall allocate to reserves for losses at each dividend period a sum equivalent to at least 15 per centum of its net earnings for such period until its reserves for losses are equivalent to at least 10 per centum of all insured accounts and thereafter make such allocations to such reserves at any time its reserves for losses are less than a sum equivalent to 10 per centum of all insured accounts (but if at any time the amount in such reserves is in excess of the cumulative amount hereby required to be allocated to that time, then no allocation shall be required): *Provided*, That, if after the date of insurance of accounts, reserves for losses are less than 2 per centum in five years, 3 per centum in ten years, 4 per centum in fifteen years or 5 per centum in twenty years, in either case such insured institution shall allocate to reserves for losses at each dividend period a sum equivalent to at least 25 per centum of its net earnings until its reserves for losses aggregate the amount above specified at the time specified and thereafter make the allocations first above required."

The CHAIRMAN. Thank you, Mr. Murphy. Are there questions of Mr. Murphy?

Mr. KILBURN. I would like to ask a question.

The CHAIRMAN. Mr. Kilburn.

Mr. KILBURN. On page 5 you say the United States Savings & Loan Associations have a reserve of approximately 11½ percent of the outstanding balances of their conventional loans. Does that include the capital funds?

Mr. MURPHY. Well, as you know, sir, we have no paid-in capital except in certain of the California associations, and Ohio in particular.

But in those States where paid-in capital exists in our savings institutions, then that is included, sir.

Mr. KILBURN. In other words, what is analagous to capital funds in the ordinary savings and loan associations, is included?

Mr. MURPHY. That is right. All reserves, or paid-in capital, is included, sir.

Mr. KILBURN. Aside from your capital, do you set up reserves? Do you have any hidden reserves?

Mr. MURPHY. No; I wouldn't say we have hidden reserves.

Mr. KILBURN. That you deduct from both sides before you publish your statement?

Mr. MURPHY. No, sir. We might have hidden reserves where some of us have written down our buildings or equipment through a period of years.

Mr. BROWN. Would you make a 40-year loan under section 221?

Mr. MURPHY. I would much prefer to see it on a 30-year basis, sir.

Mr. BROWN. How is that?

Mr. MURPHY. I think some of those loans are going to be made in our business: yes, sir. I don't think it will be general throughout the country.

Mr. BROWN. It could be a good solution if anybody would make the loan, but I think most people feel like you.

Mr. MURPHY. I think they will, sir, and to the extent that it stays at 40, there will be less inducement to make such loans. If it comes down to 30, there will be greater inducement. But I wouldn't say to you, sir, that there won't be some made. That won't be accurate.

Mr. BROWN. Thank you.

Mr. MERRILL. Mr. Chairman.

The CHAIRMAN. Mr. Merrill.

Mr. MERRILL. Do you believe that the difference of 2½ percent between the bond rate and the mortgage rate is sufficient to assure the flow of private capital into this mortgage market?

Mr. MURPHY. We feel so, Congressman Merrill. Historically it has always been so, and we feel it will continue to be so.

Mr. MERRILL. You are the first person who has questioned the position that putting the power to adjust interest rates in the President was not the best possible solution. I note that you prefer that the body that will determine the amount of interest rate in various places should be a group of people other than the President.

Now would you explain your position on that?

Mr. MURPHY. Well, we agree with the President's Committee on Housing, sir, which encompassed that thought in their report. We feel that it is rather broad power to give to any one man in a peacetime economy, but over and beyond that, we feel that a committee of the five gentlemen we suggested have a background of great experience, and there is a diffusion of responsibility, which we feel is necessary to the changing of any such rates.

Mr. MERRILL. The one function of this flexible interest rate should be to assure that private capital is flowing into the places where it is needed, while at the same time the interest rate is kept as low as possible consistent with the accomplishment of that purpose, isn't it?

Mr. MURPHY. Yes, sir; that will bring money out to the market.

Mr. MERRILL. And that is a highly technical decision to make each time that you make an adjustment.

Mr. MURPHY. We feel that way, sir, and we feel that it needs a background of experience.

Mr. MERRILL. And isn't it true that placing this responsibility in a board made up of more than one person, each of whom should be a technical expert, would probably give you a more technical decision each time than if the President, exposed to all of the pressures that he must be exposed to in his total capacity, could possibly make from time to time?

Mr. MURPHY. I would agree with that statement, sir.

Mr. MERRILL. What surprises me is—and I have been raising this question with several witnesses on this: Do you have any reason for understanding why everybody else seems to be perfectly satisfied to put this highly technical, and I would say dangerous function—flexibility is necessary, but it is a highly technical thing, why nobody else has complained of it being put in the hands of one man?

Mr. MURPHY. I must plead, sir, that I can't understand the process of their reasoning. We just feel that the study that was made by experts appointed by the President, and have come up with recommendations, were right in agreement with it.

Mr. MERRILL. Can you see any disadvantage of placing the decision with respect to interest rates in the hands of a highly technical board as against placing it in the hands of the President?

Mr. MURPHY. I cannot, sir.

Mr. MERRILL. That is, there is no advantage in putting in the President's hands rather than in a board's hands?

Mr. MURPHY. No, sir, not from my viewpoint.

Mr. MERRILL. Was any reason ever advanced for changing it from the suggestion of the President's Advisory Board, and putting it in the hands of the President? The change was made, obviously, in the bill. Do you know of any argument advanced for making the change?

Mr. MURPHY. I haven't heard of any.

Mr. MERRILL. The only reason I am questioning you to this extent is that you are the first one who has come up with a suggestion that maybe that wasn't the best solution. You say the experts who advised the President did advise that it be done by a board?

Mr. MURPHY. Yes, sir, that was the opinion of the committee. I do not know the vote on that particular point within the President's housing committee, because I was not present, Congressman.

Mr. MERRILL. As I understand your point of view, the big problem, in this whole matter of finding the money to finance home building, when we do get a flexible rate, is that we do get a flexible interest rate to attract capital where needed, is that right?

Mr. MURPHY. That is right.

Mr. MERRILL. And a lot of other solutions which are now being suggested, you think, are being suggested because we have never been able to operate this program under a flexible interest rate before and we don't realize how many problems that flexible interest rate is going to solve; is that right?

Mr. MURPHY. It is certainly going to solve some, and it is going to be far less important than it now may seem to have a secondary market except as a smoothening operation.

Mr. MERRILL. Now, the interest rate is a very controversial subject, anytime it comes up in Congress, and you represent a group that finances what, almost 40 percent of the total home loans of the Nation?

Mr. MURPHY. That is correct, sir.

Mr. MERRILL. Your associations are mutual, are they, all of them?

Mr. MURPHY. Practically all. There are some institutions in Ohio and California that have stock. But they are very much in the minority.

Mr. MERRILL. Then who gets the benefit of the interest rate, insofar as your association charges an interest rate?

Mr. MURPHY. Well, eventually it would reflect itself in the return that we pay on savings accounts to the saver in our institutions, sir.

Mr. MERRILL. Then the interest rate, as it passes through your association—eventually the measure of the interest rate will also be the measure of a profit an individual will have on his savings; is that right?

Mr. MURPHY. That will be correct, except to the extent that we desire to build up reserves.

Mr. MERRILL. But eventually the depositors, or the members, whatever you call them, would have the benefit of any interest charges that you make except for expenses?

Mr. MURPHY. That is correct, sir, and additions to reserves.

Mr. MERRILL. Well, the reserves would, except for those taken out of losses, go to the members.

Mr. MURPHY. That is right.

Mr. MERRILL. That is, there is no big business profit in this interest rate; is there?

Mr. MURPHY. We do not think so, sir; no.

Mr. MERRILL. So far as the people who supply the capital for your organization are concerned, what is the average deposit? Do you know?

Mr. MURPHY. Yes; in my own institution at the close of February 28, it was \$961.20. For the Nation at large, sir, it was \$1,400.

Mr. MERRILL. Then so far as providing the money to finance 38 percent of the home-building industry—that is your part of it—then you can say that that money is coming from the little fellows and not the big fellows; can't you?

Mr. MURPHY. Very definitely, sir.

Mr. MERRILL. Do you have any factual information that would indicate that fact? I mean a table to show the size of your depositors, in the total savings and loan pictures?

Mr. MURPHY. We can easily obtain it and file it as a supplementary report. In my own institution we have approximately 14,000 accounts, with savings running around \$9½ million.

Mr. MERRILL. Mr. Chairman, I think that the source of this capital, for which interest is being charged, is more important and I would like to have in the record, as far as the savings and loan associations are concerned, this information, which would indicate just who are the people, insofar as their economic size is concerned, providing the capital for this 38 percent of the home-building industry's activity.

The CHAIRMAN. Would it be convenient for you to furnish that?

Mr. MURPHY. Certainly.

The CHAIRMAN. Without objection, it may be inserted in the record. (The information is as follows:)

Savings and loan savings accounts grouped according to size

Size of account	Percentage of total accounts ¹	Number of savings accounts ²
Less than \$1,000.....	53	7,950,000
\$1,000 and less than \$2,000.....	20	3,000,000
\$2,000 and less than \$5,000.....	15	2,250,000
\$5,000 and over.....	12	1,800,000
Total.....	100	15,000,000

¹ Percentage figures as to size of account reported by A. J. Wood Co. in its findings of a consumers' survey (1953).

² Based upon supervisory reports to the U. S. Savings and Loan League; it is estimated that at present (Mar. 15, 1954) there are 15 million savings accounts in the Nation's savings and loan associations.

Mr. MERRILL. You are from New Jersey?

Mr. MURPHY. That is correct.

Mr. MERRILL. The president of the Prudential Life Insurance Co., Mr. Shanks, testified that in New Jersey there had been a very satisfactory experience, conducted on a voluntary basis, in which the lending institutions made loans so available to the people of that State that the direct loans by the VA became practically nonexistent.

Are you familiar with that activity in New Jersey?

Mr. MURPHY. Very much so, Congressman. At least up until last night, when I left home, there had yet to be a direct loan made in the State of New Jersey.

We have a deep feeling of responsibility, as I think the savings and loan business throughout the Nation has to the veteran and to securing home ownership, and the principles we followed there are that whenever a veteran was unable to secure a loan to finance a home, and so reported to the VA, the VA got in touch with our State organization, the New Jersey Savings and Loan League, and the executive vice president or the assistant would call on one of our institutions in that area in New Jersey where the property was located and ask us to take the loan, and we have so done through the years.

It has been a highly successful operation.

Mr. MERRILL. Then this activity, which was referred to this morning, was this activity that you are mentioning now?

Mr. MURPHY. Yes, sir.

Mr. MERRILL. And the agency that handled this whole thing was simply your State association in New Jersey?

Mr. MURPHY. At State level, sir. That is right. There are about 400 of our institutions in New Jersey and they are in a State organization, and they simply called any one of us. I have made some of them, in south Jersey or north Jersey.

Mr. MERRILL. Did you have to take unsound loans in order to meet this demand?

Mr. MURPHY. No, we never found that was true. Quite frankly, occasionally a loan would be offered where the veteran, because of inadequate income, and the lack of knowledge as to what the home ownership would cost him in the way of carrying charges through the years, or where the physical property itself was bad or the location

was poor, and he not being too well acquainted with residential real estate. We would refuse to make that loan, but we would sit down and talk to the veteran and in 9 cases out of 10 he went away satisfied and came back and asked us to finance a better property, which made him happier in the long run, along with all of us.

Mr. MERRILL. And the means by which the veteran would contact your association would be through the Veterans' Administration?

Mr. MURPHY. That is the rule, and once in a while, someone in the Congress from New Jersey would receive a letter from a veteran who said he was unable to secure such a loan, and those letters were referred to our State organization, or, if you please, the Veterans' Administration in New Jersey, and eventually reached our State organization, and then we called in the veteran, sat down and talked with him, went over the type of the property he wanted to borrow on, and also what his income and job possibilities were.

Mr. MERRILL. That would mean, then, that you would be going out and servicing customers beyond the normal range of your activity?

Mr. MURPHY. Well, not beyond. Of course, we can lend in the whole State VA loans, and we might go beyond the area where we would normally lend, but we still feel that is an obligation we should undertake for the veteran, and we are proud to do it.

Mr. MERRILL. What was your reaction to this activity, as far as returns to your association were concerned? Did you think this was a worthwhile activity? Did you feel that you profited from this activity or not?

Mr. MURPHY. Well, we profited, if you use the term in the sense of satisfaction within our heart of doing the right thing. Actually, as far as securing mortgages to put on our books, we would probably in the same period of time be able to secure more mortgages in the time we took to go out in these outlying districts and pick up a loan for a veteran.

Certainly it wasn't uneconomic to us, sir.

Mr. MERRILL. What I am trying to find out is this, and it has to be an opinion from you: Do you think that this is a program that you would continue if you didn't have the threat of the VA direct loan hanging over your head? Is it something that you did in fighting back against a threat that existed? This requires a very conscientious person to give an honest answer and I am assuming that you will do that.

Mr. MURPHY. Certainly, sir, we would in our institution, even if there was no direct lending program. That responsibility to the veteran, the feeling towards the veteran, wouldn't change in our institution one bit. I am not prepared to say how 400 others would think in the State of New Jersey, but my feeling is the majority of them would continue whether there was a direct program or not.

Mr. MERRILL. You don't think, then, it is a necessity to keep the direct program on the books in order to keep you fellows on the ball?

Mr. MURPHY. No, sir; if a few drop by the wayside, we will pick up the slack.

Mr. MERRILL. You think that is really the feeling of your people?

Mr. MURPHY. Yes, sir.

Mr. MERRILL. You heard the testimony this morning with reference to this voluntary activity. I am not clear yet whether it was just

with insurance companies or whether it would be with all people participating in this mortgage market, so as to make sure that there were adequate funds all over the United States, anywhere in the United States. Have you studied that program at all?

Mr. MURPHY. Congressman, that was only presented to me about 4 days ago, on the basis of a national arrangement, so that we had no chance to consider it from an official standpoint within our national organization.

Mr. MERRILL. But as an individual?

Mr. MURPHY. But as an individual, I proposed the same thing before the American Legion 2 years ago, on a national basis, so individually I would favor it, and certainly it is far better than the proposition of continuing Fannie May which is in this bill.

Mr. MERRILL. Then you agree that the program that was submitted to us this morning by the president of the Prudential Insurance Co. is a better program than the Fannie May program that we have in the bill?

Mr. MURPHY. By far; yes, sir. Of course, in all fairness, we still don't know because it is so early. I don't think Mr. Shanks and Jim O'Leary have explored just what the reaction would be among the savings banks in the Nation, with \$27 billion of assets, the savings loans with \$27 billion, and the commercial bankers with approximately \$40 billion. To the extent that they participate, the program would be better. To the extent they don't, it wouldn't be as effective. I don't know the answer to that yet.

Mr. MERRILL. Then we would both agree that at this point, perhaps, we couldn't just wipe out Fannie May and substitute the plan that we heard of this morning, isn't that right?

Mr. MURPHY. I think it could be wiped out and put on the basis of the President's Housing Committee, which would provide for private enterprise situations, and no Government funds.

Mr. MERRILL. What do you think about the idea of putting Fannie May in, on the one hand, and this plan that was suggested this morning, or some reasonable modification of it, into the field at the same time, to see which one wins the horse race?

I remember, coming back to your success in New Jersey, in out-running the direct-loan program for veterans, I just wonder if the same enthusiasm and energy were placed in this other program on a national scale, if you couldn't outrun Fannie May in the same way.

Mr. MURPHY. Perhaps it has no direct application, but as I recall, there used to be an economic law to the effect that bad money drives out good money, and I am afraid the bad program, as we consider it to be, would drive out the good program proposed by the insurance companies. You couldn't operate the two together, I am afraid.

Mr. MERRILL. What about the direct VA loan? We know the purpose we want to achieve, but I am talking about the whole concept of public lending as against trying to make people do for themselves.

Mr. MURPHY. Of course, actually, up until this point, Congressman, the sum of money involved in direct loans is not nearly comparable to what the proposal is here in the continuation of Fannie May. And there has been a psychology of habit built up in using Fannie May, which, if it still exists, might, at least in my mind, make folks reluctant to try the program proposed by the insurance companies if the two ran simultaneously.

Mr. MERRILL. Do you see any reason why we shouldn't make an experiment of putting them both into the field at the same time?

Mr. MURPHY. I don't think it can do a bit of harm and I would hope very much, sir, that the voluntary program would be successful, and I would like to see us all cooperate in it if that is the wish of the Congress.

Mr. MERRILL. Of course, there is always this: You can try a good idea out under such adverse conditions that it doesn't look like a good idea.

Mr. MURPHY. And that could very well happen, sir.

Mr. MERRILL. With that in mind I am just wondering if you folks, who believe in this theory that you have advanced, wouldn't give some thought to the idea that maybe we could put both ideas into the field at the same time.

Mr. MURPHY. We would be happy to do that, sir. I had hoped, however, that the secondary market would take the direction of the President's Housing Advisory Committee, rather than what is in H. R. 7839.

Mr. MERRILL. Do you think that if we were to eliminate FHA, as a Government agency, that housing would still be available with the low downpayments that now exist?

Mr. MURPHY. Well, perhaps this isn't a direct answer, sir, but some of us, including myself, have felt over the period of years that the financial field at large, including all of us, the commercial banks, the insurance companies, savings banks, the savings and loan associations, should have long since set up an instrumentality such as FHA with their own funds.

In other words, actually—I may be wrong in the figures, but you have got somewhere, probably, around \$180 billion in time money and savings accounts in this country, and it seems to some of us that they ought to be working toward their own FHA and relieving the Federal Government of any responsibility, sir, and if that were done, they would go along on a reasonable program on downpayments.

Mr. MERRILL. There are some people who feel that low downpayments are bad. Then, of course, some of us feel that so long as you don't cause inflation, a low downpayment is good. We feel that it is a social policy as well as financial policy, aimed at getting young people into their homes early.

I gather you feel it is very important to get people into their own homes early and you would accept a low downpayment as a means?

Mr. MURPHY. Yes, sir, so long as it was reasonable. As a matter of fact, individually, within our institution, under the GI loan program, we try to take as small a downpayment as is possible, where the remainder of the sum is needed to furnish the home, rather than have the veteran put everything into the downpayment on a mortgage, and then have to go out and borrow on short-term rates, which might embarrass him in order to furnish the home and live in it.

Mr. MERRILL. And you think, then, that that policy, the social policy of having low downpayments so that people can get into their own homes early, could still be served with a FHA program that is completely private in its operation?

Mr. MURPHY. I don't see why not, sir, and most of the others that have testified here haven't objected to the very low downpayment. If

they believe in it that way, I don't know why they shouldn't risk their own capital.

Mr. MERRILL. But that isn't a part of the program of this bill at this time.

Mr. MURPHY. No, sir, it is not.

Mr. MERRILL. Thank you.

Mr. O'HARA. Mr. Chairman.

The CHAIRMAN. Mr. O'Hara.

Mr. O'HARA. Mr. Murphy, on page 5 of your statement, in discussing title I, you say that it appears that certain of these provisions—that is, the provisions in title I—have made the belief that the home-construction industry is heading into a recession. Then you say you do not share in that belief.

Mr. MURPHY. No, sir, we do not.

Mr. O'HARA. What is your thought as regards to the present economic conditions as reflected in the building industry?

Mr. MURPHY. Well, speaking for the residential building industry—is that what we are speaking of?

Mr. O'HARA. Yes, sir.

Mr. MURPHY. As we know, the February dollar volume is about 1.7 percent over February of last year. The rate we have achieved so far, with seasonal adjustments, would seem to indicate that we should build somewhere very close to 1,180,000 homes this year, and we feel, if that is correct, and we have reason to believe it is correct, that that justifies optimism.

Mr. O'HARA. The homes that are now building, and that have been building during the past several years, with cost of construction high, rentals and mortgage payments have been geared to existing wages, have they not?

Mr. MURPHY. For the most part that is correct.

Mr. O'HARA. Wouldn't you say it is definitely correct?

Mr. MURPHY. Yes, sir, I think so.

Mr. O'HARA. Covering 90 or 95 percent of the cases, probably?

Mr. MURPHY. Yes, sir.

Mr. O'HARA. Isn't it the fact that the wages, a family income, a family wage, rather than an individual wage, upon which these rentals and commitments are geared?

Mr. MURPHY. Generally, of course—I don't know about all financial institutions, but we place the greatest weight on the chief breadwinner of the family, the husband, sir. There's oftentimes collateral income as a result of the wife working or the children working, but we place our greatest reliance, if I understand your question, on the husband in the family, sir.

Mr. O'HARA. I know you have had wide experience and your knowledge on it would be very much more accurate than my knowledge. I am asking you, how correct is this statement, as given to me: That up to recent months, a recent period, workmen were getting, in addition to their regular wages, other money for overtime work, and that in many cases the wives were working, and also in many cases even the children working while going to high school, they would go out and make money, bringing in to add to the family earnings. Was that largely the truth up to a few months ago?

Mr. MURPHY. I think it was true in many, many cases, certainly, in our area it was true, and I think it was generally true in the country, Congressman O'Hara.

Mr. O'HARA. Now I am informed, and I am asking you to set me right as to what the facts are, that at the present time, overtime has largely been done away with, employment for the wife, helping the husband, has largely disappeared, and there is very little work left for the children members of the family. Is that pretty generally the fact as you find it throughout the country today?

Mr. MURPHY. I couldn't answer for the country, sir, and I wouldn't say it was generally true in our area. It is partially true; yes, sir,

Mr. O'HARA. Partially?

Mr. MURPHY. Certainly overtime is tending to disappear, and a number of wives have voluntarily gotten out of the employment field.

Mr. O'HARA. Would there be repercussions from that on the ability of renters to pay the established rental, or equity owners to pay their commitments, mortgage commitments?

Mr. MURPHY. I would definitely say that is true, if, in making the loan, you had allowed too much of their income to be pledged for the repayment of that loan, and to repay the taxes.

Ge generally try to keep a leeway in there, sir, so that if difficult times come, there is some leeway where a downward adjustment in their income will not jeopardize their payments.

We also try to keep a leeway as far as maturity is concerned, so that if troubled times come to a family, regardless of whether it is general or specific, because of illness or anything else, that we can call the man in and sit down and adjust his payments downward in order to see him through those difficult times, whether it be for his family loan or because of a general condition. That is our responsibility.

Mr. O'HARA. Yes, sir. And as I recall it, it was your group that came out of the depression of the late twenties and the early thirties with the best record. Am I right in that, sir?

Mr. MURPHY. Well, truth compels me to say that it is a little debatable. That depends upon what section of the financial community you are speaking of. I think we came out with a reasonably good record, sir, and I think we came out with certainly a reputation for having done everything we possibly could to preserve homeownership where there was any possibility of getting the individual to make the payment without jeopardizing the savings of our depositors.

Mr. O'HARA. I think you rendered a very good job to the very best of your ability in those troublesome times.

Mr. MURPHY. We did that, sir.

Mr. O'HARA. But those troublesome times came on, did they not, in this way: The cost of construction was high, mortgage commitments were all geared to high wages, on the theory that they would continue high, and then when wages dropped and employment dropped, honest people, having mortgage commitments, couldn't meet them, and then distress came to the bondholders and the equity holders. Is that not right?

Mr. MURPHY. I think that is a fair statement, sir; yes, sir. Everything is relative. In the late twenties those conditions prevailed.

Mr. O'HARA. Now do you not see a similarity in the spring of 1954, with conditions that obtained in midsummer of 1929?

Mr. MURPHY. That is rather a difficult question, sir. I think there are certain economic areas where that is a statement that I would accept.

Mr. O'HARA. I read in the paper today that stocks yesterday had reached just about the point they had reached in late 1929.

Mr. MURPHY. I am not sure that I follow your question. Of course, as a savings institution, we are not interested in the stock market, sir; but as far as our institutions are concerned, just as is true in the commercial bank field, there have been changes in our structure, too.

We have our accounts insured up to \$10,000 with the Federal Savings and Loan Insurance Corporation, we have a far higher degree of liquidity; by that I mean cash in Government bonds and salable securities, and we have a far greater reserve for losses, so that we, too, have strengthened our whole system.

I don't know if that is getting at your question.

Mr. O'HARA. Yes, sir; I think you have strengthened your foundations very much, and made them stronger than they were in the comparable period of the last administration of the party now in power.

Mr. MURPHY. We believe they are very much stronger now.

Mr. O'HARA. Because in the last administration of this particular party, the Democrats have enacted a good many laws that I think will be helping us now in this period of threatened storm, but this bill, I think you are correct in saying—and it is not my bill, but was introduced by the distinguished chairman of this committee, and is the administration bill, and I think that very likely they did have in mind in that title I that we might be approaching a stormy period, and it was intended to have a sail out in this, to meet the winds if they got too gusty.

You don't think that is right?

Mr. MURPHY. Well, specifically, are you referring to the—

Mr. O'HARA. I am referring to your remarks on page 5:

It would appear that certain of these provisions have been drawn in the belief that the construction and home-building industry is entering a recession. Such a belief is certainly open to serious question.

Then you go on criticizing the provisions in title I. Then going down to the third paragraph—now mind, you have already said that you see no recession coming up—

Mr. MURPHY. No, sir; not in the home-building industry.

Mr. O'HARA. In the third paragraph you say, "Realizing the danger to the stability of our economy, which might very well eventuate with the placing of further strains on the none-too-strong reserves of FHA"—isn't that a little bit inconsistent with your previous assertion that you could see no signs of recession?

Mr. MURPHY. If I may say so, Congressman O'Hara, I think it is a time element in here. Our first statement is that we feel that this legislation in part is designed to prevent a recession at this time.

Our third paragraph is basically aimed at the proposition of years ahead. We want to see a strong FHA to withstand any storms which you and I may not even be around to see, sir. But it is years ahead, as differentiated from the immediate time. Do I make myself clear?

Mr. O'HARA. Yes, sir. Now I have profound respect for you. No-

body could have greater respect for the work that you and your organization are doing, and that is why I am seeking to have you support legislation that isn't my proposed legislation, doesn't come from my party, but comes from the administration. I want to help the administration. And in this title I, apparently the administration, fearful that we might have some stormy weather ahead, is seeking to protect against it.

You would go along with this administration in that, wouldn't you?

Mr. MURPHY. Well, we just have a different approach to it. I don't think, Congressman, that we can concede that home building is going to fall off into what might be called a recession. There may be a slowing down in the number of homes that are needed a little bit—certainly the early months of this year don't show it. There should be a gradual pickup in 1956, and certainly from 1960 on in, when the war babies come along, and with the families following the war, we should have a great demand for housing, and I think it still exists as long as there isn't an overbuilding situation.

Mr. O'HARA. Yes, sir; if we get over temporary storms and gusts, we are going on to some very fine sailing. I think the weather will be sunnier beginning along about in 1956.

Mr. MURPHY. Well, I am afraid I don't follow that point, sir. I am not sure what you are alluding to.

Mr. MERRILL. Mr. Chairman, I think that reveals the basis for all of Mr. O'Hara's economic philosophy.

Mr. O'HARA. Yes; I believe the welfare of the American people—we rescued this country after the crash that happened in the late twenties, and the early thirties, it was terrible—and you are one of the boys we rescued, and I assure you that in 1956 you may be out on some island some place, but we will come to pick you up.

Mr. MURPHY. That is not a question, sir, is it?

Mr. O'HARA. Turning to your page 10, you appreciate the plight of a large part of the population in our large municipalities?

Mr. MURPHY. Certainly, and a large part of it lies with the good city fathers who refuse to enforce the laws.

Mr. O'HARA. No; I don't agree with you in that. I think the financial plight in our municipalities has come from the States reaching out to take too much money. It started when we had the sales tax. In my own State of Illinois the State has taken millions of dollars in sales tax from the city of Chicago, which has a tremendous expense for police, sewage, and all that sort of thing, which make it possible for the millions of people to live together in safety and health. The great financial burden being on the large cities, the money has largely been taken away by the State of Illinois. Nineteen sources of revenue that once belonged to the city of Chicago has now been taken over by the State of Illinois, and the State government has very little work to do. All of that has, of course, put all of our large cities in a very unhappy financial condition. It is true of Detroit, I am very sure, and all the other cities of the country, as well as Chicago.

Now, if you follow this out, and say that the Federal Government should do nothing in the direction of slum clearance and urban renewal as proposed in this legislation, until these cities—"that each community be required to show that all of its older buildings have

been inspected and notice of violations processed and enforced at least biannually"; if you held to that I am afraid it would be a long time before we could start on this very excellent program that is proposed.

Is that your thought?

Mr. MURPHY. Well, certainly, we basically feel that the city should take some responsibility for the conditions that exist, because of the mistakes that were made by the administrators of the city governments, who failed to carry out, as I said before, the ordinances for the health and safety of the people and have allowed conditions to drift and drift and drift, and we feel certainly, and I think the President's Housing Committee did, that some effort, whether it is specifically this or not—this is simply a suggestion—but that some effort should be made by the cities to assume some of this responsibility and not try to place the whole burden upon the Federal Government, and that if they sincerely want to help these folks that are located in the slums, that they should bear some of the burden and prove that they are worthy of help from the Federal Government, sir, and one of the ways they can do it may not be too costly and that is simply enforcing, on the owners of these properties, the ordinances that have probably been on the books of most of the cities for many years, and about which, in many cases, I imagine nothing has been done.

Mr. O'HARA. Well, we will probably agree that all good citizens should cooperate on the local level and on the Federal level in order that through cooperative working together we can achieve a desired end. We can agree on that.

Mr. MURPHY. I think we can agree very definitely.

Mr. O'HARA. And close the book as far as you and I are concerned at that point.

Mr. MURPHY. Thank you, sir.

The CHAIRMAN. Are there further questions?

Mr. PATMAN. Mr. Chairman.

The CHAIRMAN. Mr. Patman.

Mr. PATMAN. You mentioned, Mr. Murphy, that you felt that the number of starts now was satisfactory. Did I understand you to say that?

Mr. MURPHY. We feel that this year will be, from the early indications of the first 2 months, as good as last year, and that was generally considered quite satisfactory.

Mr. PATMAN. Were you here this morning when I read off the number of starts for January and February?

Mr. MURPHY. Yes; I was, sir.

Mr. PATMAN. Well, now, that shows that we have 6,000 fewer for January and 6,000 fewer for February. If that ratio keeps up that means nearly 72,000 houses less this year. Do you expect the ratio to pick up, or how do you account for the great reduction and how can you at the same time say it is satisfactory?

Mr. MURPHY. Well, we feel—and, of course, we could be wrong, sir. It is a matter of opinion until the year is over, but we feel, with seasonal adjustments and the spring and summer coming on, that the figure is going to end up somewhere around 1,180,000.

Mr. PATMAN. How can you say that when we are basing it upon the same months of last year?

Mr. SLIPHER. Congressman, the seasonally adjusted rate for February—

Mr. PATMAN. Well, you would have the same theory last year. It was adjusted then.

Mr. SLIPHER. I am going to get to that. January and February were relatively strong months last year.

Mr. PATMAN. Small months?

Mr. SLIPHER. Strong months in 1953.

Mr. PATMAN. Did you say strong months?

Mr. SLIPHER. Yes. So that falling slightly below then for the first 2 months of this year—

Mr. PATMAN. Is not alarming, then?

Mr. SLIPHER. Is not alarming; in fact, the seasonally adjusted rate, using February as an index, is now 1,180,000, which is quite strong.

Mr. PATMAN. What about 1952? How did January and February of that year compare with 1953 and 1954?

Mr. SLIPHER. I don't have the 1952 figures.

Mr. PATMAN. In other words, you are not disturbed about that. You still think, that after you determined the seasonal adjustment, that it will still run about 1,180,000?

Mr. SLIPHER. About that; yes.

Mr. PATMAN. Taking into consideration the fact that these were 6,000 less in both January and February?

Mr. SLIPHER. Yes.

Mr. PATMAN. You still think it would run more than a million?

Mr. SLIPHER. Yes.

Mr. PATMAN. All right.

Now, Mr. Murphy, would you or your organization buy any of these new FNMA obligations under this reorganized or rejuvenated group?

Mr. MURPHY. Do you mean under FNMA as proposed in this bill, sir?

Mr. PATMAN. Yes.

Mr. MURPHY. Would we participate in the program or buy the debentures?

Mr. PATMAN. Buy the debentures, sir.

Mr. MURPHY. Buy the debentures?

Mr. PATMAN. Yes.

Mr. MURPHY. I doubt it very much.

Mr. PATMAN. What do you think about the 3-percent contribution? Do you think it is helpful or harmful?

Mr. MURPHY. Again that is a matter of opinion. My own feeling is that the 3 percent will probably go back eventually to the buyer.

Mr. PATMAN. To the buyer?

Mr. MURPHY. Yes. When will he get it? Back to the man securing the home, sir. He will pay it.

Mr. PATMAN. In other words, the last buyer?

Mr. MURPHY. Yes.

Mr. PATMAN. The one who owns it last?

Mr. MURPHY. I don't know who will get it. I am merely saying who will pay it. It may merely be in the price of the house.

Mr. PATMAN. The borrower in the end will pay it, would he not?

Mr. MURPHY. I would think so; yes.

Mr. PATMAN. Would you sell any mortgages to this new FNMA under the setup?

Mr. MURPHY. Our institution has never sold a mortgage.

Mr. PATMAN. You keep your own mortgages?

Mr. MURPHY. Yes, sir.

Mr. PATMAN. Do you buy Government bonds occasionally when you need money?

Mr. MURPHY. Yes, sir.

Mr. PATMAN. You buy them in the open market?

Mr. MURPHY. We buy them both ways, sir, on subscription when they are offered as well as in the open market.

Mr. PATMAN. What is the margin that you usually pay when you buy Government bonds in the open market?

Mr. MURPHY. I must plead that I do not know, sir. We buy at a price net to us, and if that price is satisfactory that is what we pay for them, sir.

Mr. PATMAN. You don't know what the dealer gets?

Mr. MURPHY. No, sir; I do not. It is a bid and asked side of the market.

Mr. PATMAN. Under this new tax bill that gives the taxpayer a deduction on corporate dividends, you are acquainted with that, I assume?

Mr. MURPHY. I am not too well acquainted with it, sir, but Mr. Slipper is.

Mr. PATMAN. You know the general theory, however?

Mr. MURPHY. Yes, sir.

Mr. PATMAN. Well, suppose a taxpayer receives a hundred dollars in dividends from stocks that are, say, listed on the New York Stock Exchange. Under that bill he would get a tax deduction, wouldn't he?

Mr. MURPHY. I am afraid I don't know the bill too well.

Mr. SLIPPER. Yes; that is correct.

Mr. PATMAN. Suppose he gets a hundred dollars dividends from you. Would that be tax deductible?

Mr. SLIPPER. No; for purposes of that section, we are classed as paying interest rather than a dividend, and it would not be deductible.

Mr. PATMAN. You would not be eligible? In other words, the little savers that Mr. Merrill is talking about, the little guys, they would not get the benefit of it?

Mr. MERRILL. Will you yield?

Mr. PATMAN. I yield.

Mr. MERRILL. Isn't it true that your association doesn't pay the same corporate rate of taxes in the first place that the corporation pays?

Mr. SLIPPER. We pay the same rate that the corporations pay except that the dividends are classed as interest like bank interests and are deductible in our own association.

Mr. MERRILL. So there is not in your association the element of double taxation that exists in the corporations, and even under the new tax bill—

Mr. SLIPPER. Yes; you understand the associations pay taxes, but they are allowed to deduct the interest payments.

Mr. MERRILL. But under the new tax bill the person who is getting a dividend from a corporation, that amount of money in toto will still be paying more tax than the money earned by your association and paid to your member; right?

Mr. SLIPHER. It is possible. It is certainly taxed twice.

Mr. PATMAN. I know, but your association pays taxes?

Mr. SLIPHER. Yes.

Mr. PATMAN. And on the net income you pay income tax, don't you?

Mr. SLIPHER. On net taxable income; yes.

Mr. PATMAN. Just like any corporation pays. That is right.

The CHAIRMAN. Well, I think that is the issue, "Just like a corporation pays."

Mr. PATMAN. Well, insofar as net income is concerned—

Mr. McDONOUGH. The question, then, would be, Does your net income include the interest you pay to your shareholders?

Mr. SLIPHER. No; that is not taxed as income with us.

Mr. McDONOUGH. That is the difference.

Mr. PATMAN. Let us take a Government bond. Take a saver that is very thrifty and patriotic and wants to help his Government, and the best way in the world to keep down inflation is to have actual savers, people who have actual money, genuine money, to buy Government bonds. That is always the best, instead of letting the banks do it, or others.

Suppose this fellow buys some Government bonds, and he gets a hundred dollars interest. Under that tax bill he would not get any credit for the hundred dollars interest.

The CHAIRMAN. Mr. Patman. I think the Chair has the responsibility in this case, and if it is agreeable to the committee I am going to exercise it.

I don't believe that these questions are germane to the subject of this bill and I shall so have to hold. We have been here now for 2 weeks, we hope to finish up by the middle of next week. I hope that we don't have to discuss this whole question of taxation before these committee hearings are over.

So, I know that you will bear with me by confining your questioning to this bill, and we will discuss the tax bill when it gets before the House next week.

Mr. PATMAN. Mr. Chairman, I haven't taken up any 2 weeks before this committee. I have probably taken up 30 minutes.

The CHAIRMAN. None of us are objecting to any time which any member takes on this bill. But we don't have the tax bill before us.

Mr. PATMAN. That is all right, I will yield to the ruling of the chairman, and proceed to something else.

Now, then, you talked about the little savers, or Mr. Merrill did.

The little savers, of course, are the people who save their money and put it into organizations and associations, and I commend them for it. It is a great thing. I think it is one of the finest things in the country.

Mr. MURPHY. Thank you.

Mr. PATMAN. I would like to see them encouraged, and not retarded or harmed. At the same time you state that you are entitled to a rate of interest which is based upon the going rate of Government

bonds. Do you mean by that, the going rate of Government bonds, 15 years or more?

Mr. MURPHY. Having 15 years of maturity left to run, sir.

Mr. PATMAN. Yes; and you are in favor of this provision, setting the margin at 2½ percent.

Mr. MURPHY. As a maximum, sir.

Mr. PATMAN. As a maximum?

Mr. MURPHY. Yes.

Mr. PATMAN. Well, do you believe it should be 2½ percent? Don't you think 2 percent would be sufficient? Or one and a half percent, if you could get that, wouldn't you feel pretty safe and secure?

Mr. MURPHY. Actually the figure, I think, right now, for Governments with 15 years or more to run, I think, is around 2.54, so that we are roughly about 1.94 under your figure.

Mr. PATMAN. That is satisfactory, isn't it?

Mr. MURPHY. I think so. I think there is going to be plenty of money available. In fairness to the President's Housing Committee that evolved this 2½ percent, I think they did that so that the Congress would not feel that the sky was the limit, sir, and, of course, rates under the flexible interest rate can be reduced as well as raised, as we know.

Mr. PATMAN. And give the Congress something to do, too?

Mr. MURPHY. That is true.

Mr. PATMAN. Ordinarily, if you go before an appropriations committee, if you ask for a whole lot, and the committee feels that they have done something by cutting it down. And that would give our committee the feeling that we have done something by cutting this down.

Mr. MURPHY. I have to plead no comment there, sir.

Mr. PATMAN. All right.

On this going rate, who fixes the going rate on Government bonds of 15 years' maturity or more?

Mr. MURPHY. It is with a great deal of reluctance that I try to answer your questions, sir, being a recognized authority on monetary policies in the country, from the First District of Texas.

Mr. PATMAN. Well, I deny that right now.

Mr. MURPHY. I think the market fixes the price of money, like any other commodity.

Mr. PATMAN. All right, that is it exactly. Who fixes the market?

Mr. MURPHY. I think the Open Market Committee, through its power over the rediscount, and the Federal Reserve exercises some control on the rate, sir.

Mr. PATMAN. Of course, the one you first mentioned, the Open Market operations, constitute about 90 percent. Because when they can go in and buy a hundred billion dollars worth of bonds, and sell the same number any day, any hour, any minute, it is bound to be the group that actually fixes the long-term rates.

Now, on the rediscount rate, I don't agree because the banks are not borrowing any more. And the other day they reduced the rediscount rate again. Well, that doesn't mean a thing on earth except just like one banker testified here about a week or two ago, that when the rate was fixed, the bankers knew the pitch from that. In other words, if it goes up, they are supposed to be a little harder with money

and credit, if the rate goes down they are supposed to be a little easier with money and credit. So it is a sort of an unconversational understanding between the Federal Reserve and the private bankers of the entire Nation.

So it is strictly psychological. I think you will agree.

Last year they didn't do \$15 million worth of business, out of billions of dollars worth of business.

Mr. MURPHY. The message goes out rapidly, sir, and they don't have to notify them.

Mr. PATMAN. Sure, it goes out rapidly. It is not any going around the corner and whispering something in their ear, or talking over the telephone. It is right out in broad daylight. But everybody knows it. The bankers know it. That is what it means. Either hard money, and it goes up, or loose money and it goes down. It has been on the side of easy money since last May.

I think when you state there that you should have something based upon the going rate of Government bonds, I think it should also be said that we must recognize that 12 men—we believe we have got 12, we only have 11 now—fix that rate, and there is something I think this committee should look into, in connection with this housing bill, if you please, Mr. Chairman, in connection with this housing bill. I am in order. We have 12 men here who are fixing the going rate of Government bonds, and we should look into that and see how they fix that rate. You see under the Constitution the 160 million people delegated the power of money and credit to the 531 Members of the House and Senate.

Mr. McDONOUGH. Will the gentleman yield?

Mr. PATMAN. I yield.

Mr. McDONOUGH. Since it is, as you outlined—and you object to it—would you inform the committee what should be done instead of that?

Mr. PATMAN. That would be good, but the chairman would hold me out of order.

The CHAIRMAN. I wouldn't hold you out of order, Mr. Patman, but I may say, after what I have said before, that in these hearings it is not contemplated that we shall have the Open Market Committee before us.

Mr. PATMAN. Well, that is all right. I hadn't asked you, Mr. Chairman, for this particular hearing.

The CHAIRMAN. I thought that perhaps you were about to.

Mr. PATMAN. No; I have been turned down so much, I just don't ask any more.

Mr. McDONOUGH. Well, I gave you an opening. I would like to have your answer confined to 3 minutes. Can you answer in 3 minutes?

Mr. PATMAN. Well, now, you have a right to ask me the question, but you don't have a right to tell me how long I shall take to answer it.

Now, on this provision I was talking about, I hope the gentleman listens to this—160 million people delegate this power to 531 Members of the House and Senate.

Now, this Congress, 435 here in the House and 96 in the United States Senate, they have delegated that power to these 12 men who fix this rate.

I say, again, and I venture to say, that there are not 12 members—I will say 3 members—among the 531 who can name 7 members of that Open Market Committee. That shows that we have just kind of let them go. I am not criticizing the committee for it because I am guilty myself. I doubt that I could name them.

And I have at least given some passing attention to it, and I doubt that I could name them.

But we have just rather let them go, and I think we ought to give some attention to this Board. And when the chairman gets around to it I hope he calls those 12 men down here before us. I would like to see them and ask them some questions. I think it would be material to the housing bill.

The CHAIRMAN. I think we are setting up a subcommittee of the Joint Committee on the Economic Report, which might be glad to take you off my shoulders. The chairman of that subcommittee will be announced as soon as I get time to set it up and then you take it up with him.

Mr. PATMAN. Fine.

Now, briefly, I will answer the gentleman from California, in less than 3 minutes.

I would abolish that Open Market Committee. They have got private bankers running it. It is being run by private commercial bankers. It is just like letting the railroads run the ICC. It is just like letting the owners of TV stations run the Federal Communications Commission. It doesn't make sense, it is illogical, it is wrong, it is a violation of every government principle.

The CHAIRMAN. I wonder if the answers between committee members can't wait for executive sessions? We have a witness here.

Mr. MURPHY. I don't mind, sir. I find it interesting.

Mr. PATMAN. I would abolish that and have 12 members, public members, who serve the public interest, and not the bankers' interest, particularly, who serve the public interest, and let them do it. And I would have it in Washington and not in New York. There is no reason why the money capital should be in New York. It should be in the Federal Reserve. That is where it is today. That is where they do all this business.

Mr. SPENCE. Is the gentleman in favor of recapturing our abandoned power by telling them what to do?

Mr. PATMAN. Yes; telling them what to do and what not to do.

But now they are telling us what we have to do. They have all the power, they are footloose and fancy free, they spend all the money they want to, with no audits, no audit in 40 years.

The CHAIRMAN. Are there further questions of Mr. Murphy?

Mr. O'BRIEN. Mr. Chairman.

The CHAIRMAN. Mr. O'Brien.

Mr. O'BRIEN. This bill in title II establishes flexibility in interest rates instead of fixed interest rates we used to have; is that right?

Mr. MURPHY. Yes, for FHA and VA, sir.

Mr. O'BRIEN. Is there any place in the new bill that establishes any arithmetical figure that is a top limit on interest rates?

Mr. MURPHY. Well the formula, Congressman O'Brien—

Mr. O'BRIEN. That formula involves decisions that are made apart from Congress; isn't that right?

Mr. MURPHY. That might well be, sir.

Mr. O'BRIEN. Is there any arithmetical figure, in this bill, that establishes a top limit?

Mr. MURPHY. No, none to my knowledge, sir, except the 2½ per cent beyond the Government rate on 15-year maturities.

Mr. O'BRIEN. And the decisions, in many of the factors involved there, are made outside the Congress; isn't that right?

Mr. MURPHY. I think they are certainly influenced.

Mr. O'BRIEN. Well, certainly some of them are made outside.

Mr. MURPHY. They may be awfully close to decisions, too, Congressman.

Mr. O'BRIEN. That is all.

The CHAIRMAN. Are there further questions?

Mr. SPENCE. What is the maturity of the loans the savings and loan associations make, as a rule?

Mr. MURPHY. Generally, sir, we can, as a matter of law, go to 20 years. I would say that the average, Congressman Spence, is 15 years.

Mr. SPENCE. That is a general rule everywhere, I think, that you don't make them longer than 20 years; isn't that true?

Mr. MURPHY. That is generally true, sir, except, of course, in the pattern of VA we can go up to whatever the provision is on the guaranteed loan.

Mr. SPENCE. Do you know any savings and loan association that would make a loan for a maturity of 40 years?

Mr. MURPHY. Not to the best of my knowledge, sir.

Mr. SPENCE. That is all.

The CHAIRMAN. Mr. Murphy, we are very grateful to you for your contribution to our deliberations, on behalf of your organization.

Mr. MURPHY. Mr. Chairman, may I on behalf of Mr. Slipper and myself, and the association, thank all of you for your patience today.

Mr. McDONOUGH. I would like to say, Mr. Murphy, that I appreciate your endorsement of title 4 of the bill, and I appreciate it especially coming from you with your long experience in the savings and loan association business, because I believe it provides for more liberation and more autonomy to the Federal Savings and Loan Association than they have had heretofore, considering the great responsibility they have to so many millions of shareholders, and the many billions of dollars that they now handle.

Mr. MURPHY. We appreciate that, sir, but in actuality the gratitude should flow from us to you, sir, for your help and your patience in evolving this legislation with us, sir.

The CHAIRMAN. Thank you, Mr. Murphy.

Mr. MURPHY. Thank you, sir.

The CHAIRMAN. We have with us next, Mr. H. R. Northup, representing the National Retail Lumber Dealers Association, Mr. Northup being executive vice president of that organization. We are glad to have you.

Proceed, Mr. Northup.

**STATEMENT OF H. R. NORTHUP, EXECUTIVE VICE PRESIDENT,
NATIONAL RETAIL LUMBER DEALERS ASSOCIATION, ACCOMPANIED BY J. H. ELSE**

Mr. NORTHUP. Mr. Chairman and members of the committee, my name is H. R. Northup. I am the executive vice president of the National Retail Lumber Dealers Association, a Federation of 32 State and regional associations of retail lumber and building materials distributors, covering the 48 States of America.

I have with me Mr. J. H. Else, who is a counselor for our national association.

I wish in behalf of our industry to comment on H. R. 7893, and to say that generally speaking it seems to us to be good legislation, in that it attempts to realistically simplify and place on a more practical basis various Federal aids to private industry and our communities in reaching a solution for our many housing problems.

The economic welfare of the 26,000 retail lumber and building materials distributors in the 48 States of America depends completely upon their ability to serve the new construction and the alteration, maintenance, and repair needs of the home-buying and home-owning public, as well as the farmer.

The retail lumber and building materials distributor, in addition to being the final link in the chain of distribution of building materials between the manufacturer and the consumer, is at the same time, either in his own right or in cooperation with his contractors, the builder of a substantial proportion of the residential structures built outside the metropolitan areas of America.

He is the one principal source of supply and information with respect to the utilization of lumber and building materials for the great volume of maintenance and repair activities that are required to keep the Nation's homes and farms in good condition.

He serves the consumer not only as a supplier, a builder and an architectural adviser, but also as an adviser on sources of credit required to finance the many new construction and maintenance and repair activities which originate with him.

These facts explain the industry's concern with the policies of the Federal Government in respect to housing and the availability of mortgage funds and construction credit.

We believe that the combination of a continuing healthy new house market throughout the country, plus the market for materials and labor created by the desire of people to keep our existing housing inventory in good repair, to modernize, to keep their housing up to date, will result in a continuing high level of construction activity in these fields if the industry can depend upon a reasonably free flow of mortgage and long term consumer credit in all areas of the country.

The Federal Government can, we believe, best lend stability to the construction industry and thereby assist in the general economy, by taking such steps as would enable private industry to become assured of this free flow of credit at all times.

May we say we believe the bill before your committee heads in the direction of meeting the objectives that we seek.

We would like the privilege of commenting briefly on certain phases of the recommendations made under titles I, II, III and IV, and to

call to the attention of the committee certain other facts that we believe would make for smoother operation of the insured mortgage and loan guaranty functions of FHA and VA.

TITLE I—FEDERAL HOUSING ADMINISTRATION

MAINTENANCE, REPAIR AND MODERNIZATION CREDIT

Section 101 of title I of the bill provides for an increase in the maximum amount and terms of property improvement and repair loans. Likewise, it increases the maximum amount and the maximum terms for modernization and repair of apartments and dwellings for two or more families.

This amendment is excellent and has our wholehearted approval.

Section 125 of the bill provides for the "open-ending" of FHA insured home mortgages. This type of long-term maintenance and repair credit, while now available through many conventional lenders and insurance companies has not been previously available under the FHA program.

We heartily endorse this provision of the bill and recommend its approval.

For example, Mr. Chairman, take a homeowner whose unpaid mortgage principal has been reduced from \$10,000 down to \$7,500, and who wants to spend \$2,000 modernizing a kitchen or adding a room and bath. With an FHA title I or similar loan, the monthly payments would come to \$63.80 per month and the interest rate would be 9.6 percent.

But if the mortgage still has 10 years to run, the \$2,000 can be repaid at the rate of only \$21.22 per month, assuming the rate of interest on the mortgage to be 5 percent, provided the funds are obtained by adding the cost of the modernization job to the unpaid principal amount of the mortgage.

In other words, the unpaid balance would be increased to \$9,500 and the monthly payments over the remaining 10-year period would be increased by only \$21.22—about one-third as much as with a title I loan.

We have noted the statements of the Administrator of HHFA and the Commissioner of FHA to your committee, indicating that they approve this amendment, but also expressing their misgivings as to whether or not they could work out such a plan in FHA satisfactorily.

We would like to recommend to the committee and to these gentlemen the study of a legal bulletin of the United States Savings and Loan League, made by Mr. Horace Russell, their general counsel, who I am sure is well known to many members of this committee, dealing with the "open-end mortgage" and containing a tabulation of State positions in respect to this principle of mortgage lending, Mr. Russell's study would indicate that in every State of the Union, with one possible exception, it is possible to "open-end" mortgages to the satisfaction of the lending institutions and their customers.

I might add some further comments, Mr. Chairman, in view of the questions which have arisen during the course of your hearings, I would like to make several comments with respect to the open-ending of mortgages.

The study which I referred to by Mr. Russell describes the legal status of optional future advances as they stand today in the 49 jurisdictions, both under the mortgage laws of the State and by court decisions in these various jurisdictions.

The committee, I feel sure, would be interested in knowing that such institutions as the Prudential Life Insurance Co. of America, as was testified this morning, the National Life Insurance Co. of Vermont, the Northwestern Mutual Life Insurance Co., and the New York Life Insurance Co., open-ended mortgages, and that the third largest savings bank in America, the Dime Savings Bank of Brooklyn, will also apply this principle to its mortgages.

There is ample evidence that lending institutions of one type or another in every State of the Union, including the District of Columbia, but excepting the State of Texas, are applying the open-end principle to mortgages. In Texas, the homestead laws presently appear to prevent the use of this instrument, but in Texas we feel that a way can be found, and will be found, to make this principle of lending applied, because it is needed badly in that State.

Another problem that I think has not been adequately explained to your committee is the question of liens and title search. It would be assumed that a lending institution, before making a future advance on a mortgage, would determine the lien status of the property through a title search.

Title searches normally cost the customer anywhere from \$100 up, but today there are title companies, such as City Title Insurance of New York, Los Angeles Title of Los Angeles, Chicago Title and Trust, the Title Insurance Co. of Minneapolis, and Union Title in Indianapolis, which make these title searches for as little as ten dollars per thousand dollars of loan, and some for less than that amount.

This makes this type of loan a little more attractive to the home owner. All of these facts, we believe, prove that where there is the will, this is the most practical means of providing a form of badly needed long-term credit for modernization and repair activities.

We heartily endorse the amendments in sections 104, 105, and 106 of the bill relating to section 203 of the National Housing Act.

The CHAIRMAN. May I inquire of the staff whether Mr. Russell's study is available to us.

Mr. FINK. It is available, Mr. Chairman.

The CHAIRMAN. Very well. Please proceed.

Mr. NORTHUP. These proposals providing for equal treatment in FHA programs between existing and new housing;

To consolidate and simplify the financing of 1 to 4-family dwellings under section 203;

To increase the mortgage limits to \$20,000 on 1- and 2-family units, and adjust upward the limits for 3- and 4-family units;

And the proposal to level out the downpayment schedule so that there is no longer a downpayment penalty for those homeowners purchasing homes in the eleven to fifteen thousand dollar price brackets;

Plus the proposal to extend the mortgage to 30 years, will serve to maintain our new house volume and assist many families who need and desire new housing to obtain it with the more liberal and equitable downpayment terms.

We observe that the bill authorizes these more liberal terms only by providing discretionary authority to put these terms into effect. We recall Administrator Cole's statement before your committee that if the discretionary authority was used it would probably not be used to the full extent of the authorization.

It seems to us that if these terms are worthy of consideration they should be controlled only by statute; otherwise industry, at least that portion of the industry that relies on FHA and VA financing, would be kept in a constant state of uncertainty.

It seems to us that the discretionary authority in respect to these liberalized terms is in effect the holding over the heads of the home building industry another type of regulation "X" which would enable the administration and not the Congress to exercise a form of direct and selective control over FHA and VA lending which could be at odds with actual demand and need for housing as seen by the home-building industry.

We heartily approve section 126 of the bill which terminates certain authorities previously granted the FHA which are in general no longer useful to the housing economy.

TITLE II—HOME MORTGAGE INTEREST RATES

The provisions in this title to assure that the interest rates on insured and guaranteed mortgage loans will be adapted to current market conditions and that they will be competitive with other demands for savings is in our opinion one of the most encouraging features of this bill.

We heartily approve the provision of section 201 which would authorize the President, from time to time, to establish within certain limits maximum rates of interest on residential mortgages insured or guaranteed under the FHA and VA programs.

We believe this provision should result in assurance that residential mortgage financing will be permitted to compete for its fair share of the funds available nationally for investment.

If the FHA and VA programs are to serve their real purpose the interest rates involved in these programs must be realistic and must be allowed to rise or fall to meet the changes that occur in the investment market.

This authority, to the extent exercised, would in our opinion, assure prospective home owners seeking loans that funds for such loans would be more readily and generally available.

Assuming that Congress grants to the President authority to establish realistic interest rates in FHA and VA, and assuming this authority is exercised, the fact remains that there has been in the past and will undoubtedly be in the future certain localities in this country with a shortage of local capital for investment in residential mortgages.

This shortage, in our opinion, might well be alleviated if the Administrators of FHA and VA would recognize geographical differences in the market and permit additional originating and serving fees or charges to encourage lending institutions located in areas where there is more than an ample supply of money to make funds available for mortgages in the outlying areas.

A major problem of the industry is the unequal distribution of credit and mortgage funds rather than lack of volume of such funds available on the overall national scale.

Subsection 4 of section 201 of the bill appears to give the President the authority to establish maximum fees and charges covering the cost of the origination of mortgages and the maximum special service charges found to be appropriate by the President. However, it is not clear whether there is authority granted to vary the service charges in different areas of the country. We believe consideration should be given to the granting of this authority if such authority is not provided in the bill.

An industry we have felt that there are four major actions that might be taken by the Government which would greatly influence the construction of new housing and the repair and modernization of existing homes in all areas of the country.

First, there is a need for assurance of a realistic interest rate in the FHA and VA, which is accomplished by title II of the bill.

Second, there is a need for more adequate and longer terms for modernization and repair credit. This is accomplished in section 101 of title I of the bill and in the open-end provision in section 125.

Third, we have felt there must be some recognition of the need for additional servicing costs for mortgages made in outlying areas and towns of the country.

Fourth, we are convinced that there is a need for a secondary market facility which would provide existing and prospective mortgage lenders with a secondary market for residential mortgages. We believe that such a secondary mortgage facility would provide greater assurance of an even flow and equal distribution of mortgage funds throughout the country and would provide an additional stabilizing influence to the mortgage market. Lending institutions in outlying areas who have a limited amount of funds to invest in mortgages could use the facility to provide a turnover in such funds by disposing of mortgages to the facility.

We disagree with those who feel that provision for a flexible interest rate and an additional service charge would eliminate the necessity for a secondary mortgage facility. Time after time, over a period of years, we have been confronted with the situation where insurance companies and mutual savings banks representing large accumulations of funds in the East have for periods of time withdrawn completely from the mortgage markets in certain areas of the country.

Certainly, these companies should have this right.

However, we feel that the existence of a sound secondary market facility properly organized would serve to level off some of the peaks and valleys in the mortgage market and provide a more even flow of funds for mortgages into outlying areas.

TITLE III. FEDERAL NATIONAL MORTGAGE ASSOCIATION

We do not feel that the proposal contained in the bill will solve the industry's secondary market problem.

As we understand the purposes of a secondary market facility, they are (1) to aid in evening out variations in the volume of mortgage funds that come from the large pools of savings represented by the

banks and the life insurance companies and (2) to help make these savings more readily available in small communities and regions remote from the sources of funds.

There seems to be industry opinion that a secondary market facility should not be looked upon as a primary source of mortgage money and that it should be so administered as to discourage its use when funds are obtainable from normal sources.

In order to prevent the misuse of the facility, it is apparently felt necessary that there be some penalty involved in dealing with it. On the other hand, this penalty should not be so severe as to prevent its operation when there may be a real necessity for it.

The proposal in title III of H. R. 7839 involves a penalty of such severity as to render the plan wholly impracticable.

If we understand the proposals correctly, an institution selling mortgages to FNMA might be required to absorb a discount of one or more points, as may be determined by FNMA's estimate of the market, and, in addition, might be required to pay charges and fees for doing business with the institution—section 304a. Present charges under the 1-for-1 plan, we understand, come to 1½ percent of the outstanding amount of the mortgages sold.

On top of discounts and charges, the seller would also be required to make to FNMA a nonrefundable capital contribution equal to 3 percent of the outstanding amount of the mortgages sold—section 303b. Since this contribution carries with it a certificate convertible to stock at such time as the Government capital in FNMA might be retired—section 303c—it would be considered as the purchase of a right and therefore a capital investment not deductible for tax purposes as a business expense.

This feature becomes all the more onerous in view of the circumstance that the prompt repayment of the Government capital is an extremely unlikely contingency. Before any of the Government investment could be repaid, it would be necessary for FNMA to have accumulated from earnings, and to maintain intact, an amount of \$100 million—section 303c.

Before, however, any funds could be set aside for this purpose, it would be necessary to pay to the Treasury (1) an amount equivalent to the normal corporate income tax on its earnings—section 309c—and (2) cumulative dividends, as determined by the Treasury, taking into consideration the average yield on outstanding Government obligations—section 303a. Furthermore, funds from earnings may be set aside as reserves—section 303b.

It is difficult to see how even a beginning of the repayment of Federal capital could be made within 10 years, and it would be possible to defer it indefinitely. In any event, no dividends could be paid on the private contributions until all the Federal stock was retired. Even if the Federal stock were fully retired, there is no assurance that the private investment would obtain dividends or would be redeemable. Presumably, additional legislation would be required—section 303g.

In short, the 3-percent payment must be considered a dead loss to the contributor and, in effect, no more than a fixed, but nondeductible, discount to be added to whatever other discounts and fees FNMA might charge. The result would be a situation as difficult as that

which prevailed in the private market during the period of tightest money in 1953. It would mean to us that either the homeowner, the originating lending institution, or the builder would have to absorb these charges. None of these people would or should be forced to absorb all of these charges.

In order for the plan to be workable, it would be necessary to reduce the amount of the contribution. Possibly the answer is to change its form to capital stock, retirable at such time as the mortgages sold to FNMA were liquidated, and earning dividends at such time as the investment remained in FNMA.

This answer, we understand, has precedent in the land-bank system, in which an initial Federal investment has been successfully retired. It would constitute a sufficient drag on the total payment to the seller of mortgages to discourage use except in case of necessity but, as experience with the land-bank system has apparently demonstrated, not so great as to prevent the functioning of the institution.

By giving the seller an interest in the earnings of the facility, as well as in the ultimate disposal of his mortgages, it would encourage the offering of sound mortgages.

In a sense, the suggestion just made would make the secondary market proposal resemble that made by the President's Advisory Committee except for the fact that the initial capital would be provided by Government instead of by private industry.

Mr. Cole, we noted, in his testimony expressed some concern as to this 3-percent nonrefundable capital contribution and expressed the hope that testimony before this committee might throw some light on this subject. To that end we make the above suggestions.

TWELVE THOUSAND FIVE HUNDRED DOLLAR LIMITATION ON MORTGAGES PURCHASED

The recommendation in the bill that the facility be authorized to purchase mortgages not to exceed \$12,500 in amount is, in our opinion, not desirable. This provision would seem to channel the assistance to be given the mortgage financing industry to the \$15,000 and below price range. We believe the facility should be authorized to purchase mortgages up to the full extent of FHA and VA authorizations.

TITLE IV. SLUM CLEARANCE AND URBAN RENEWAL

The provisions of the bill designed to broaden and redirect the slum-clearance and urban-redevelopment programs in order to assist communities to meet the problems of eliminating and preventing the spread of slums and urban blight seems to be in keeping with the new approach of placing greater responsibility upon the local communities to take effective action in this regard.

We believe the provisions in the bill requiring a locality to present a reasonable program for eliminating and preventing slums and urban blight and the requirement that the Administrator make a determination that the program is satisfactory, and so certify, prior to Federal assistance, is an excellent provision.

This is at best a long, hard, tough job which we feel will, with this new approach, begin to make headway as our cities and towns realize that their's is the first responsibility.

WHY TWO SYSTEMS OF GOVERNMENT GUARANTY AND INSURANCE

One other problem of concern to our industry is the problem involved in the two systems of mortgage insurance and guaranty provided by FHA and VA.

This industry is in agreement with the recommendations of a subcommittee on FHA and VA programs of the President's Advisory Committee, which suggested in their recommendation No. 33 (pp. 65-69 of the report) that the President direct the Administrator of the Housing and Home Finance Agency, and the Administrator of the Veterans' Administration, and the Commissioner of the Federal Housing Administration, to work out an interagency agreement under which VA would contract with FHA to perform the technical functions of processing veterans' home-loan applications under the present home-loan guaranty program.

This recommendation was designed, to quote the report—

to have one agency of the Federal Government charged with the administration of the function of market analysis: land-planning requirements; valuation and appraisal; minimum property and construction standards; and property inspection.

It is our belief that the veteran and the homeowner who make use of the insurance guaranties of FHA and VA, as well as the builder and the mortgage lender, should no longer be subjected to the varying details, confusions, and costs involved in the present operation of the two parallel but differing systems of underwriting, inspection, and construction standards on loans.

We believe the consequent saving to the taxpayer and the Government is also worthy of consideration. It may be there are good reasons why this proposal was not incorporated in the legislation. Perhaps, it can be accomplished without legislation, but we strongly recommend that the committee in some manner give consideration to these recommendations.

In conclusion, Mr. Chairman, in behalf of our industry, we have the utmost confidence in, and respect for, Housing and FHA Administrator Cole, and the President's housing aims. We also recognize the importance of the FHA and VA programs, and the good they have accomplished in the residential construction field. We also are aware of the enormous task ahead in the elimination of slums, and the redevelopment of our communities.

There is little disagreement as to the ultimate aims and objectives of the President's housing program. There is, of course, some disagreement as to the best method of accomplishing these aims.

The bill before you is designed to make more readily available to more people, in more communities, the aids of the Federal Government to private industry to provide housing.

The recommendations which we have presented are consistent with these aims. We would like to see these aids made available to every one who can use them. We are concerned with the problems of people who build and wish to build in our small and middle-sized communities throughout the country.

It is here that our people are most active and it is in these types of communities that we are having our major difficulties. The problem of securing adequate mortgage and consumer credit is greatest in

these communities in contrast to the relatively easy flow of credit in our great urban and metropolitan centers.

Our suggestions are aimed principally at broadening the use of these various Federal aids in order that our industry may be better able to make a substantial contribution to a continuing prosperous housing economy.

Mr. MUMMA. That last statement about small communities, isn't it that the bankers and people who have this money are not thoroughly familiar with the project?

Mr. NORTHUP. I am not sure whether they are not familiar with it, sir, but we just don't get enough mortgage money in the small communities.

Mr. MUMMA. Is it probably due to the fact that the local builder isn't interested in it, and you get these crews of outside shingle people coming in there, and stormdoors, and the local bankers are a little afraid of them?

Mr. NORTHUP. No, I don't think that is it at all. Our problem is that in community after community—and it isn't confined to the South and West and the Southwest—I can show you communities in West Virginia where we have a portfolio of mortgages and have contracts on dealers' desks to build 8, 10, or 20 houses, but we cannot pass those mortgages on from that local community to some other source of mortgage supply, and, therefore, we don't build these next 8 houses until we can get more money out of that community.

Mr. MUMMA. I was particularly referring to your direct participation, as I imagine you are a dealer.

Mr. NORTHUP. Yes.

Mr. MUMMA. The dealer is normally afraid of his money, isn't he? You now, when these groups of people come in and put on a campaign?

Mr. NORTHUP. Yes.

Mr. MUMMA. You are afraid of those people until you get to know them, aren't you?

Mr. NORTHUP. We don't care much for them, sir.

Mr. MUMMA. And you wouldn't go to your banker and influence him to take them unless he was sure of it?

Mr. NORTHUP. Well, actually, the man you are talking about is making use of title I credit of FHA and our dealer has the right to make use of the same type of credit, as a matter of fact.

Mr. MUMMA. Yes, but you don't know whether you are going to get your money out out of that fellow because, ordinarily, he can't get his until he gets a receipt signed that the work is completed?

Mr. NORTHUP. That is correct.

Mr. MUMMA. And that is in my opinion one of the reasons why some people don't get very active in it.

Mr. NORTHUP. Yes, that may be one reason. Well, I think FHA has done a pretty good job in trying to take care of that type of man that you talk about, that comes in one night, does a job, and leaves town the next day.

Mr. MUMMA. How do they take care of him?

Mr. NORTHUP. Well, they have just revised the title I standards, and he has to wait now 2 or 3 days to get his money. So he can't

walk in one day and walk out the next with his money without paying anybody.

Mr. MUMMA. You mean so they can personally inspect?

Mr. NORTHUP. That is right, inspect the job. And they have done an excellent job in changing those regulations.

Mr. MUMMA. Who does the inspection, the banker or the FHA?

Mr. NORTHUP. The banker.

Mr. MUMMA. I have known cases where he hasn't.

Mr. NORTHUP. And we are urging our people that if the banker does not do it the dealer should do it, to make sure that it is done.

Mr. MUMMA. There is a period of time when you are very much certain.

Mr. NORTHUP. Yes.

Mr. MUMMA. I honestly believe that it is a matter of getting the local customer or contractor interested in it, that you are dealing with a man who has adequate credit. I know it was the same way when the FHA started in business. Our local builders didn't want it, but there was one fellow who was interested, and he went ahead and he is a rich man today because he promoted their program, and he was the fellow who got the commitments.

Mr. NORTHUP. Well, we are particularly interested in the problem of these small-town bankers who, in many instances, will put in a town of 8,000 people, \$12,000 of mortgage money available a month, which means if you build over two average-sized houses you are through building. If you have a market for four, the bank is not going any further than that. But if he had some place to put these, we think he would keep this money turning over and we could keep on building. It is that simple in many of these outlying communities.

That doesn't seem like a major problem, but in the aggregate when you get it in thousands of communities all over the United States, it means a lot of housing.

Mr. MUMMA. Did you hear the president of Prudential this morning?

Mr. NORTHUP. Yes, sir.

Mr. MUMMA. They are doing a good job, aren't they?

Mr. NORTHUP. Excellent.

Mr. MUMMA. They get down to towns of 8,000 population.

Mr. NORTHUP. Yes.

Mr. MUMMA. I don't know. The State of Pennsylvania can have open-end mortgages, can't it?

Mr. NORTHUP. Yes, there is some difficulty in the State if there has been a prior lien.

Mr. MUMMA. Prior to the first mortgage?

Mr. NORTHUP. Yes, but this shows that you can do it in Pennsylvania, and I have lists of organizations now doing it in Pennsylvania.

Mr. MUMMA. Say you were a banker and had a mortgage, and I came in and wanted three or four thousand dollars tacked on, you would certainly look up whether the tax liens were paid, and judgements, and so forth?

Mr. NORTHUP. Yes.

Mr. MUMMA. Well, that adds expense.

Mr. NORTHUP. Well, my point is, sir, that today these title companies are beginning to do that for \$10 a thousand dollars, where it used to cost you a hundred dollars on a \$2,000 loan to get the bank to search

title. Today these title companies are getting into this field so it costs you either \$10 or \$20 to search title on a \$2,000 loan. That is quite reasonable. And we are delighted to see the title companies doing it.

Mr. MUMMA. Do they certify and guarantee it?

Mr. NORTHUP. Yes.

Mr. MUMMA. There would be a difference between certifying it and guaranteeing it, wouldn't there?

Mr. NORTHUP. Yes, they guarantee it.

Mr. MUMMA. Then it is up to them.

Mr. NORTHUP. They are taking the risk, that is right.

Mr. MUMMA. When the banker does it the mortgage company takes it?

Mr. NORTHUP. Yes.

Mr. OAKMAN. If it is a property that has an existing mortgage, it is much more easily traceable than one that hasn't.

Mr. NORTHUP. That is right.

Mr. OAKMAN. The mortgagee usually keeps the tax bills right there in the file. It was a first mortgage when he took it, and nobody can get a priority lien except the tax collector who slips a couple on there a year, so if you have your tax bills you are in pretty good shape. It is just a routine, mechanical affair.

Mr. NORTHUP. That is right. This whole problem is another question of educating many of the lending institutions. The savings and loans have been doing this for years, but the commercial banks and many of the mortgage bankers, and, as I stated, many of the insurance companies have been doing it, but it hasn't been generally done because there has been no pressure to do it.

Now that we really need some adequate long-term credit for modernization and repair work, we believe this is the soundest way to get that credit, and the best for the customer as well as for the industry, and the owner of the primary mortgage.

Mr. OAKMAN. A spokesman for the commercial banks testified against the open-end mortgage, and he thought that the cost of clearing the old mortgage, putting a new mortgage on the property, would be—I don't think he used this word, but, in effect, incidental? Do you feel that is the case? You are not a mortgage banker?

Mr. NORTHUP. I am not a mortgage banker.

Mr. MUMMA. You are familiar with the cost of discharging a mortgage, recording the discharge, and then in our State there is a mortgage tax on the new mortgage, and a filing fee, and recording fee, and all of that—it seems to me that, as others have testified, in opposition to the testimony of our good friend from the commercial bankers, that there would be a good deal of expense.

Mr. NORTHUP. Much more so than there would be under the open-end mortgage, making use of these new title company facilities which are being made more useful to us and on a broadening scale all over the country today.

Mr. OAKMAN. Thank you.

Mr. MUMMA. Do they make a record at the courthouse when this open-end mortgage is put on?

Mr. NORTHUP. Yes, sir; they do. You get these title companies to come into a town now, with this new scheme. They are out after that business.

Mr. MUMMA. It might pay you to start your own.

Mr. NORTHUP. I think you will find this book very illuminating, sir. This is not any promotion for the idea, this is a legal discourse on the idea, and what you can do in the various States of the Union.

The CHAIRMAN. Are there further questions of Mr. Northup? If not, we are very glad to have your testimony, Mr. Northup.

Mr. NORTHUP. Thank you, sir.

The CHAIRMAN. And we very much appreciate your splendid contribution.

Mr. Ira S. Robbins, president of the National Housing Conference, accompanied by Mr. Edward F. Barry, chairman of the board.

We are very glad to have your testimony, Mr. Robbins. You may proceed.

STATEMENT OF IRA S. ROBBINS, PRESIDENT, NATIONAL HOUSING CONFERENCE

Mr. ROBBINS. Mr. Chairman and members of the committee; my name is Ira S. Robbins. I am president of the National Housing Conference, Inc. For 11 years, I served as a housing official of New York State in the administrations of both Governor Lehman and Governor Dewey. I am an attorney and presently am executive vice president of the Citizens' Housing and Planning Council of New York City.

The National Housing Conference, for which I am speaking today, is a nonprofit citizens organization founded 23 years ago. It is supported entirely by memberships and contributions, and a matter of policy does not accept memberships from official agencies of government such as local housing or redevelopment authorities receiving Federal assistance. We have appeared before this committee on questions of major housing policy over the last 20 years.

The National Housing Conference takes a comprehensive approach to the housing problem. Its interest covers the entire housing field, both private and public. It is good to be joined by an ever-increasing number of voices urging more effective slum clearance, redevelopment, and now urban renewal programs. We are delighted that representatives of the housing industry are devoting increased attention to the problem of cleaning up our cities, thereby protecting urban investments. We have always encouraged national housing programs that would assist private enterprise to increase vastly its scope of operations so as to provide homes for families of low and middle income.

We have always championed, and still do, a realistic program of low-rent public housing for families of low income, presently living under intolerable conditions, and for whom private enterprise cannot build. Indeed, without a substantial low-rent public housing program all of our best laid plans for slum clearance, redevelopment, and urban renewal are certain to fail.

With me today is Mr. Edward F. Barry, NHC's board chairman, lawyer, prominent businessman, and banker of Memphis, Tenn. Among his many public services for which he receives only spiritual compensation is that of chairman of the Memphis Housing Authority.

He is admirably qualified to answer questions you may have from the point of view of the impact of housing on a typical American city.

To conserve the time of the committee, I will not attempt detailed suggestions regarding the several titles of H. R. 7839. We have read with interest and concur in the constructive recommendations presented in excellent testimony by the American Federation of Labor, the Congress of Industrial Organizations and the National Association of Housing and Redevelopment Officials.

We of the National Housing Conference were encouraged by the overall approach of the report of the President's Advisory Committee on Government Housing Policies and Programs. The President's message on housing submitted to the Congress on January 25 was received with general enthusiasm. It struck an affirmative note in describing our national housing policy. We are, however, disappointed in the legislative recommendations that would carry out the President's policies.

Housing Administrator Albert M. Cole dwelt at some length in his testimony concerning the intensive study of the President's Advisory Committee, and of his own excellent "shirt sleeve" conferences with people representing many points of view, all interested in the housing problem.

In his first "shirt-sleeve" conference held in Washington last summer, the National Housing Conference participated. Our first questions of Mr. Cole was this:

Do you have in mind assembling all data, published and unpublished, on housing needs existing throughout the Government, and putting them in such form as to permit the President's Committee to measure whatever it recommends against the known housing needs of our country?

We repeated that question at subsequent conferences.

It seemed to us then, as it does now, that no program can be prepared to do a total job, no matter how long it may take to do it, until the job itself is defined. We did not suggest that new research be undertaken because we are fully aware that funds for gathering, sifting, and publishing basic data have been steadily curtailed. But we urged that known data be brought into focus so that the best job could be accomplished on the basis of the best information presently available.

When the administration's housing program was announced, no evidence was presented as to how large a housing program it would help to sustain. There was nothing to indicate that it had been created against a blueprint of housing needs. It was like building a house without knowledge of the site on which it was to go, the neighborhood in which it was to be built, and without clearly defined plans.

If we, outside of Government, were to comment intelligently on the recommendations of the administration, it was necessary that we do our own digging for facts so that we could judge the proposed program against the known housing needs of the American people. The National Housing Conference undertook that assignment. We obtained the services of Dr. William L. C. Wheaton, a well-known authority in the housing and planning fields and presently professor of city planning at the University of Pennsylvania, to make an analysis of housing needs which we might present to the Congress and to all of those interested in this problem. Needless to say, we had neither the time nor the resources to do original research. What we were able to do was to go to the records of the Bureau of the Census, the Housing

and Home Finance Agency, and all of its constituents and to other public and private groups, pulling together all of the data that we could assemble. We believe that this study will prove of value to the committee. I have it here for inclusion in the record, if the committee approves.

I might say, Mr. Chairman, the title is "American Housing Needs, 1955 to 1970," and I would like to leave it for inclusion in the record, if I may.

The CHAIRMAN. Is it voluminous?

Mr. ROBBINS. It is 16 pages with some tables.

The CHAIRMAN. Without objection, it may be inserted in the record. (The information referred to is as follows:)

A PRELIMINARY ESTIMATE OF HOUSING NEEDS, 1955-1970

(Prepared by Dr. William L. C. Wheaton, professor of city planning, University of Pennsylvania, for the National Housing Conference, Inc., Washington, D. C., March 11, 1954)

Acknowledgments: The author wishes to acknowledge the assistance provided by the Housing and Home Finance Agency, Office of the Administrator, Federal Housing Administration and Public Housing Administration, the Bureau of the Census, the Twentieth Century Fund, the American Federation of Labor, the Congress of Industrial Organizations, the National Association of Real Estate Boards, and the National Association of Home Builders in supplying data for this study. He is especially indebted to several of the directors of research of these organizations for critical comments and suggestions. The conclusions are, of course, those of the author.

EARLIER ESTIMATES OF HOUSING NEED

Estimates of housing need have been prepared by a large number of organizations and individuals in recent years. During the debates which preceded the adoption of the Housing Act of 1949, leaders of the home building industry or their spokesmen generally adopted the view that the sustained construction of more than 900,000 units a year was impossible or in any event undesirable. A number of estimates in the range of 600,000 to 900,000 units per year were proposed to congressional committees considering housing policy.¹ The subsequent achievements of the industry in producing nearly twice the volume suggested by these leaders is evidence of the inadequacy of their estimates.

In 1944 the National Housing Agency estimated postwar housing needs at 1,200,000 units per year. This estimate, called fantastic by some business leaders at the time, has proven to be much closer to subsequently attained levels.² On the other hand, even this estimate appears to have understated the potentials of the economy, for it assumed that a very large share of the estimated needs could be met only by the replacement of existing housing. Later and higher estimates by the Housing and Home Finance Agency are based upon similar assumptions.³ Perhaps the dominant characteristic of these estimates is their pessimism concerning the economic future of the country. This was most succinctly stated by one distinguished housing expert in a report prepared for an industry group which suggested that production levels of more than 900,000 units a year would be undesirable because they could not be sustained for more than a short period of time. This expert predicted that the construction of 1.5 million homes would produce "immense and immediate" instability. These dire consequences have not appeared in the boom building years 1950-53.⁴

¹ Hearings before the Subcommittee on Housing and Urban Redevelopment of the Special Committee on Postwar Economic Policy and Planning, pp. 1658-1676 ff., p. 1841, p. 1986, p. 2078, p. 2171 ff., p. 2210, Washington, Government Printing Office, 1946.

² National Housing Agency, Housing Needs, National Housing Bulletin No. 1, Washington, 1944.

³ Housing and Home Finance Agency, How Big Is the Housing Job?, Washington, 1951.

⁴ Miles L. Colean, Future Housing Demand, the Producers Council, Washington, 1948.

If the estimates of business leaders and official agencies have underestimated our capacity to produce and consume housing, other estimates of higher requirements have failed to be realized. Thus the National Housing Conference and the American Federation of Labor estimates of the same period, calling for the construction of 1,800,000 units or more per year assumed very high levels of replacement of existing units, and substantial programs of slum clearance and public housing.⁶ Although the Congress authorized such programs, these authorizations were subsequently reduced and have never been carried forward at the levels intended. It is now evident that all of these estimates have underestimated the market demand for new housing under conditions of full employment and high output, and have overestimated the willingness or capacity of the country to replace substandard housing through slum clearance and public housing programs.⁶

ASSUMPTIONS OF THIS STUDY

The major weaknesses of many earlier studies derive from the assumptions, stated and unstated, which underlay them. They have assumed a stable or declining national output while the postwar economy has been characterized by steadily rising employment and productivity. They were based upon population forecasts which have proven to be consistently below subsequent population growth. Estimates of family formation, too, have been substantially below ultimate levels. In their analysis of the housing market itself many of these studies have apparently underestimated the willingness of families to purchase homes, the influence of liberalized federally aided credit upon the market, and the vast extent of suburban building.

The assumptions upon which this study is based are as follows:

1. Continued expansion of our economy at a steady rate, full employment, and continuing increases in productivity.
2. Expenditures for national defense no greater than those of 1953-54.
3. Estimated high increases in population and family formation in keeping with a prosperous economy.
4. An active desire on the part of the American people for higher standards of living, including higher housing standards, but not at the expense of other essential expenditures.
5. Extension and expansion of Federal and local aids to housing to assist in achieving these goals.

These assumptions will be adhered to in the estimates of this study. It is further assumed that housing will be utilized to the fullest extent possible to stabilize economic trends and to assure continued economic expansion, in short that housing production will be maintained or increased in the event of marked downturns in economic activity.

FACTORS AFFECTING HOUSING REQUIREMENTS

Future housing requirements are a function of population growth, family formation, migration, losses of housing units, obsolescence and deterioration, undoubling of families, and vacancy and occupancy rates. These factors are influenced to a considerable extent by changing housing standards, changing market preferences, by general economic conditions, and by market demands in the light of available credit. The most important of the above-named factors are discussed in the following sections and are summarized in table 1.

Family formation

Estimates of family formation have been developed from marriage rates, less allowances for divorce, death, and other dissolutions. When so developed the estimates considerably understate housing requirements. While most, but not all marriages result in additional requirements for separate housing accommodations, few dissolutions of families result in reduced housing requirements. The

⁶ Estimates by 14 organizations and persons are summarized in U. S. Congress, 80th Cong., 1st sess., hearings of the Joint Committee on Housing, September 10-19, 1947, pp. 49-55.

⁶ For other estimates of J. Frederick Dewhurst & Associates, America's Needs and Resources, Twentieth Century Fund, New York, 1947; Charles Abrams, The Future of Housing, Harper & Brothers, New York, 1945; and XII, Law and Contemporary Problems 1, 1947.

widow, widower, or divorced person with children will usually give up separate housing accommodations only under strong economic compulsion. An increasing number of aged persons appear to prefer to maintain separate accommodations after the death of the spouse, and this is particularly true where the accommodation is suited to the need of aged persons. Old-age and survivors insurance, private pension plans, aid for dependent children, and veterans benefits for widows and orphans, are steadily raising the ability of these classes of families to maintain separate households.

Current estimates of future family formation range from as low as 275,000 per year for the remaining years of this decade to the 2 million per year estimate of the National Association of Homes Builders for the later years of the next decade.⁷ The marriage rate has fluctuated from under 1 million to over 2.2 million in the last 20 years. The range of net new social family formation shown is from 6 million to 10 million per decade. This does not include single-person families which are discussed below in connection with undoubling. If these were to be included in the estimate, the high estimate should be increased.

Migration

The migration of people from one area to another may result in increased housing requirements where in-migration is not balanced by out-migration. Those moving into the country from other countries, and those moving from areas of stable or declining population to areas of rapidly growing population create such needs.⁸ From 25 to 30 million persons move annually, and about a third of these, 8 to 10 millions, move across county lines. There is a steady movement of persons into the country, and of the rural or farm population to urban areas. Of the 10 million persons who moved across county lines in 1950, 9 million were members of families who presumably created demands for about 3 million dwellings.⁹ Since a considerable part of this movement is to urban communities in the South and West where it results in net in-migration, it must be presumed that at least between 10 and 25 percent of this movement creates new housing requirements.

TABLE 1.—Factors affecting nonfarm housing requirements per decade¹

[In millions]

	Units required for—		
	Low	Medium	High
RECURRING REQUIREMENTS PER DECADE			
Additional household formation.....	6.0	28.0	10.0
Internal migration of families.....	3.0	5.0	7.5
Replace it of annual losses.....	1.1	1.3	1.6
Replacement of units becoming obsolete or substandard.....	2.8	3.8	4.8
Total recurrent.....	12.9	18.1	23.9
NONRECURRENT REQUIREMENTS			
Replacement of units substandard in 1950.....	6.8	8.3	10.2
Undoubling of families doubled in 1950.....	1.0	1.2	1.5
Undoubling of single persons.....	.2	.8	1.2
Overcrowded families in 1950.....	.5	1.0	1.6
Adequate available vacancies, 1950.....	1.1	1.6	2.2
Total nonrecurrent.....	9.6	12.9	16.7

¹ See text for basis. Low may be low estimate or early in the 1955-65 period. High may be high estimate or late in 1955-60 period.

² United States Census Series P-20, No. 42, 1952, high. The census low of 2.75 could arise only under conditions of disastrous economic depression.

⁷ Cf. U. S. Census Series P-20, No. 42, 1952; NAHB Correlator, February 1954, pp. 4, 5. The National Association of Real Estate Boards estimates these at 700,000 per year currently. Cf. address of Charles B. Shattuck, president, 46th annual convention, November 10, 1953.

⁸ Cf. E. E. Ashley, Mobility and Migration as Factors in Housing Demand, Housing Research, October 1953.

⁹ U. S. Census Series P-20, No. 39, 1952.

Replacement of current losses

The National Housing Agency and the Housing and Home Finance Agency estimate that 40,000 homes are lost each year as a result of fire, windstorm and other types of demolition. To these annual losses there is usually added 300,000 temporary war and veterans units required to be removed during the current decade if only by their physical deterioration. Thus it is customary to estimate 70,000 units per year as current losses requiring replacement.

These estimates require radical revision if only in the light of current urban highway construction. A modern urban superhighway built through developed areas will require clearance of from 250 to as high as 1,000 homes per lineal mile. If each metropolitan area built only 1 mile of such highway each year, and if the demolition requirements in the 5 largest cities were at the upper limit and all others at the lower limit suggested above, the total would be in excess of 40,000 homes per year. In some of our largest cities, demolitions resulting from highway construction have greatly exceeded demolitions from all other causes throughout the postwar period. With urgent highway needs measured in tens of thousands of miles, and current Federal aid programs including approximately 30,000 miles, it is clear that losses from this source alone will be exceedingly high for the next two decades. For current purposes it is assumed that losses from all causes will be 1,100,000 per decade in the 1950's and 1,600,000 during the 1960's equivalent to previous estimates of loss plus 1 mile per metropolitan area in the former period and 2 miles per area in the latter.

Other losses not accounted for here include abandonments and conversions to nonresidential use. One expert estimates that the latter alone exceed all extra units gained by conversion. One group of Government officials concerned with housing statistics has reached the tentative conclusion that 200,000 units are lost each year through demolition, abandonment, and conversion, and that 100,000 are gained each year through conversion, for a net loss of 100,000 units. This estimate accords with the estimate above arrived at on other grounds.

Obsolescence and deterioration

More than 6 million of our present housing units were built before the beginning of this century, and will be 60 or more years old by the end of this decade. Many of these are now dilapidated and should be replaced immediately, but many of them are merely old, obsolete, and now deteriorating and at a rate reflecting their age. Some 1,400,000 of these units, now standard but becoming 75 years of age or older by 1960, should be replaced during the next decade.

With our present housing stock of over 50 million homes, it will be necessary to replace 500,000 units per year in order to replace homes at 100 years of age. Many hundreds of thousands of fine old homes will doubtless continue to be well maintained, and will retain historical, architectural and other qualities worth preserving. But the speculative homes of the Gothic period, and millions of drab shacks built since 1900 lack these fine qualities. Their useful life as structures, and the useful life of the neighborhoods they comprise, will be long past at 60 years. Applying this standard would necessitate the replacement of 2.8 million homes during the 1960's and 4.8 millions in the succeeding decade.¹⁹

Substandard housing in 1950

Housing standards are not fixed and invariable. A wide range of judgment is involved in determinations of substandardness. What is standard for a primitive economy (mud huts) will be substandard for a more advanced economy. Standards are therefore in part determined by resources. In a society of abundant resources and high output, standards should rise steadily. There is no apparent reason why all American families should not have good homes within the next generation. This was particularly apparent during the 1930's when idle labor and unused materials led to the adoption of Federal aids to housing. The Congress has subsequently adopted a national goal of "a decent home in a suitable living environment for every American family."

Table 2 reveals the most serious inadequacies of our housing supply in 1950. For many years official agencies have used the standards of structural soundness and lack of plumbing facilities as measures of substandardness. Opinion has varied as to whether farm or country homes which lacked running water

¹⁹ The NAREB estimate of demolition requirements is 300,000 to 400,000 per year. Cf. Shattuck, op. cit.

should be considered substandard. Under the assumptions of this study, of a rising standard of housing, it is assumed that all families, rural and urban, should have interior plumbing facilities.

According to the most recent census of housing, 10 million nonfarm dwelling units were dilapidated or lacked running water. This number includes farm residences in standard metropolitan areas. In addition to these dilapidated or substandard structures, 1.9 million other units were located in blocks containing more than 50 percent substandard units. These units contain structural and plumbing deficiencies not sufficiently serious to be recorded by the census, but their environmental substandardness is clear. They would almost certainly be demolished in any program of slum clearance.¹¹

Only 23 percent of our farm housing units meet these urban standards. Thus by census criteria and urban standards, 4.9 million farm homes are substandard. The Department of Agriculture surveys of farm housing suggest, however, that by farm standards, only 3.4 million farm homes are substandard, 2 million of which contain serious deficiencies requiring replacement, the remaining 1.4 million being remediable.¹²

Not all substandard dwellings need be demolished and replaced. A basically sound structure, lacking running water or a toilet, may be brought up to standard by relatively minor repairs and the installation of plumbing facilities if the structure is located in a sound neighborhood. On the other hand, where the structure is located in a slum, the installation of plumbing or heating facilities may be economically unsound. The rents required to finance the improvements may exceed the levels which renters are prepared to pay in slum areas. While precise data is lacking on the location and character of all housing units which are substandard because of plumbing deficiencies, data are available on 2.7 million urban units which are located in substandard areas. It is reasonable to assume that these must be replaced. The remaining 1.9 million are in relatively scattered locations and may be brought up to standard. It is further assumed that two-thirds of the rural nonfarm units which are substandard because of plumbing deficiencies may be rehabilitated. One-third would then require replacement.

Of the 3.4 million substandard farm units, 2 million with serious deficiencies are beyond repair but 0.5 million of these may be abandoned, leaving a 1.5 million replacement goal.¹³ It is assumed that all of the remaining substandard units can be rehabilitated. Thus, of the 15.3 million substandard units in 1950, a total of 10.2 million must be replaced, 4.6 million must be rehabilitated and 0.5 million abandoned.

Undoubling

In recent years the number of doubled-up families has been reduced steadily. Nevertheless, over 1.7 million social families were still without separate housing accommodations in 1950. An unknown proportion of the doubled families and single persons prefer to share housing accommodations with others for health or other reasons. For many, however, doubling-up continues because of economic necessity or housing shortage. Under conditions of sustained prosperity and more adequate social security and old age allowances, the number of doubled families should be reduced steadily. It may be assumed that under these conditions, upward of two-thirds of such families might prefer separate accommodations.

In addition to these families, there were in 1950 some 10 million adult single persons not in families of whom about one-third occupied separate households. This number may be expected to increase sharply with sustained prosperity. An important future influence upon single-person families is the growing number of aged persons able to maintain separate accommodations. If a number equivalent to one-tenth of these persons, those with incomes of over \$3,500 per year, were to establish separate households—a million additional housing units would be required. Thus the combined undoubling of families and single persons during the next decade might vary from 1.2 million (two-thirds of married doubled, no single) to 2.7 million (all married doubled and one-tenth of single).

¹¹ Slum-clearance projects to date involve clearance of 20 percent of standard units and 80 percent substandard units. The proportion in the blocks mentioned above is 28 to 72 percent.

¹² This report draws upon tabulations of census and Agriculture Department data prepared for a new edition of America's Needs and Resources, by J. Frederick Dewhurst and associates, Twentieth Century Fund, to be published in fall, 1954.

¹³ Census figures suggest 3.2 substandard farm units of which 2.4 are dilapidated.

Overcrowding

In 1950 over 6.6 million families (census households) were living in dwelling units which provided more than 1 person per room.¹⁴ Over 2½ million families were seriously overcrowded with more than 1.5 persons per room.

TABLE 2.—*Substandard housing units in the United States requiring replacement or rehabilitation by condition and location, 1950*

[Thousands]

	Substandard total	Requiring replacement	Requiring rehabilitation
Urban housing: ¹			
Dilapidated.....	2,217	2,217
Lacking plumbing or running water.....	4,721	2,725	1,996
In substandard blocks ²	1,993	1,993
Total urban.....	8,931	6,935	1,996
Rural nonfarm housing: ³			
Dilapidated.....	1,131	1,131
Lacking running water.....	1,841	614	1,227
Total rural nonfarm.....	2,972	1,745	1,227
Nonfarm total.....	11,903	8,680	3,223
Farm housing: ⁴			
Serious deficiencies.....	2,024	1,524	5 (500)
Other deficiencies.....	1,405	1,405
Total farm.....	3,429	1,524	1,405
All housing.....	15,322	10,204	5 4,628

¹ All housing in standard metropolitan areas.

² Additional units in blocks more than 50 percent substandard.

³ Nonfarm units outside SMU's.

⁴ Farm units outside of SMU's. Deficiencies based on U. S. Department of Agriculture data.

500,000 units abandoned and not replaced.

During the postwar years, several million young couples purchased small two-bedroom houses with floor areas far below those considered acceptable in prewar years. The continued high rate of births and the steady rise in the number of second, third, and fourth children born suggests that a large proportion of these owners of too-small houses already are seriously overcrowded as measured by number of persons per room, and that this number will increase.

Because of the overlap between families overcrowded and families living in substandard homes, only a quarter of the number of overcrowded homes are shown with other measures of need in the summary table. The range of estimates is from one-fourth of units containing more than 1.5 persons per room to one-fifth of units containing over 1 person per room. Under the assumptions of this study, a rising standard of housing should not require five-person families to live in two-bedroom homes. The estimates therefore leave three-fourths of the undoubling problem for future decades.

Vacancies

The number of vacancies required to permit freedom of choice in the market, and to allow for mobility has been variously estimated at from 3 to 6 percent of supply. The number of available vacancies in recent years has been only about one-fourth of the nominally vacant units, a large proportion of which are dilapidated, seasonal, or not on the market. To achieve an available vacancy rate of 3 percent it might be necessary to have at least a total of 6 percent vacancies. A further consideration is raised by our annual volume of family movements, involving nearly 28 million persons including about 3 million families in 1950-51.¹⁵

¹⁴ U. S. Census. Housing Census, vol. I.

¹⁵ A 5-percent rate is considered desirable by the realtors; cf. Shattuck, op. cit.

PROGRAMING HOUSING NEEDS

The total housing requirements shown in Table 1 suggest that we must build from 1.3 to 2.4 million units per year to meet our growing housing needs and must in addition replace accumulated deficiencies of the past of from 9 to 16 million units. Clearly all of these needs cannot be met at once, nor would it be economically wise to do so. Some of these needs tend to overlap, i. e., new family formation and undoubling, replacement of substandard houses and provision of homes for overcrowded families. Some orderly basis is required for estimating the changing volume of current housing requirements and for scheduling the replacement of existing substandard units. The first of these requirements will be served by the measure of household formation.

Household formation

Census projections of household formation involve circular reasoning to some extent since household formation is in some degree dependent upon the volume of residential construction and remodeling. Nevertheless, census definitions of households have been sufficiently loose to reflect the improvised housing conditions which families desiring separate accommodations have adopted in the past. Thus, the room or rooms with an electric hotplate and a shared bath and occupied by a man and wife are a household to the census taker. These conditions reflect an active desire for separate dwelling accommodations whether or not that goal has been reached in some more refined sense. The census household thus reflects in part the housing shortage.

Household size has declined steadily for the last generation. The decline was approximately the same in periods of prosperity and depression as is shown in table 3. This decline in average household size reflects both the smaller size of families containing two or more persons, and the larger number of single person families who desire and can afford to maintain separate housing accommodations. It is a measure also of rising standards of housing space and privacy. Continued declines in household size would reflect continued increases in housing standards in this sense.

The total future population of the United States is also shown in table 3. This is the most recent high estimate of the United States Bureau of the Census, and is thus consistent with assumptions of sustained prosperity. It should be noted that census estimates for the last 20 years have generally underestimated future population growth. Absolute and specific birth rates and marriage rates have been higher, and death rates have been lower than those used in even the so-called high projections. Under conditions of sustained economic growth, these estimates may well prove below actual growth.

Total population and average household size have been used to project housing requirements by 5 year periods from 1955 to 1970 in table 4. Using this method, it is first necessary to reduce the total population by the number of persons not in households. An arbitrary percentage, approximately that of 1950, has been used as a constant. A 20 percent increase in this constant would reduce annual construction requirements by 4 percent in 1960. The resulting population in households is divided by a straight line projection of the 1930-50 trend in number of persons per household. The result is increased by 4 percent to allow for necessary vacancies. A note to the table gives alternative estimates based upon a higher average family size and upon the assumption that family size approaches some constant in 1970.

The method suggests the number of housing units which will be required at different future dates and the annual volumes of construction required during successive 5-year periods to achieve this stock. The population used is total population, farm and nonfarm. The housing units shown as required would be necessary to accommodate future population growth, future reductions in family size, increases in the number of single persons desiring separate accommodations, and reductions in the number of nonfamily households. The measure accounts for the undoubling of families now doubled. Finally, as used here, the measure assumes the same rate of progress in the relation between population and housing that obtained during the last 20 years.

The table indicates that we will require approximately 1.43 million new units per year from 1955 to 1960, 1.65 million new units per year from 1960 to 1965 and 1.74 million new units per year from 1965 to 1970 to house our growing population adequately. It should be noted that this measure produces results which are below the medium estimates of need in table 1. The method is used, nevertheless, because it suggests time periods within which houses are needed.

Replacement rates

In addition to these requirements for new population and new families, the Nation must replace the 10.2 million substandard units requiring replacement shown in table 2. If these units were to be replaced in the period 1955-65 we would have to build nearly 2.5 million homes in each of these years. This could not be accomplished in the immediate future without inflationary pressures, unless other construction drops seriously and unless there is a substantial drop in armament production. From a purely housing standpoint, it would be undesirable to attempt any such volume of replacement until new homes are available to accommodate those displaced from substandard homes.

TABLE 3.—United States population and average household size, 1930-70

Year	Population ¹ (millions)	Average household ² size	Year	Population ¹ (millions)	Average household ² size
1930.....	122.7	4.01	1960.....	174.4	³ 3.1
1940.....	131.6	3.67	1965.....	189.9	³ 2.95
1950.....	151.6	3.39	1970.....	204.4	³ 2.85
1955.....	164.8	³ 3.35			

¹ U. S. Census, series P-25, No. 78, 1953.

² U. S. Census. P-20, No. 41, 1952; and P-20, No. 35, 1951.

³ Straight line projection of 1930-50. 1952 is 3.34.

For these reasons it would appear to be both economically and socially desirable to spread the replacement task over a 20-year period. If this were done, the volume of current construction would have to be increased steadily and rapidly, but within magnitudes which could be readily achieved by the building industry. Such a program would permit relocation to proceed in a more orderly and humane fashion, and would be more nearly in keeping with the capacity of our cities to plan for slum clearance and redevelopment.

Finally, if the replacement job is scheduled over a 20-year period, the annual volume of new building for replacement will be stabilized over a 30-year period. For by 1975, when the job of replacing our 1950 substandard homes is completed, we will have to continue replacement construction at the rate of 500,000 units per year merely to replace dwellings then becoming 70 years old. Indeed a step-up of replacement construction to a level of over 600,000 units per year would be necessary to cover the 1950-70 backlog of deteriorated dwellings during the succeeding 20 years.

Construction program

Requirements for additional residential construction for new household formation, and for replacement of units substandard in 1950, are set forth in table 5. Additional housing needs are those shown in table 4, ranging from 1.43 million in 1955-60 to 1.74 million in 1965-70. Replacement of the 10 million 1950 substandard units is spread over 20 years at 500,000 per year. To these must be added replacement of current losses here scheduled at 100,000 to 160,000 per year or somewhat below the estimates shown in table 1. The resulting new construction requirements are 2.03 million per year for the period 1955-60, 2.28 million for the period 1960-65, and 2.40 million for 1965-70. In periods after 1970 the new construction rate should be above 2.60 millions.

Some part of these requirements could be met, of course, by the conversion of existing larger homes and apartments into smaller apartment units. When such conversions are made without structural and plumbing changes, they usually produce substandard or nearly substandard units. When accompanied by structural changes and the installation of needed plumbing facilities, satisfactory housing can be provided. The total number of such potential conversions is substantial, but is proportionately small. There were only 3.3 million units in the United States in 1950 with 8 rooms or more. Most units which were suitable for conversion must have been converted during the acute housing shortages of the war and postwar years. Many others are poorly located for rental use or are in areas zoned for single-family use only, or are dilapidated. If 25 percent of these 2.7 million units are still not converted and are legally, economically, and structurally convertible, and if half of them are converted during the next 10 years, this would reduce new construction requirements by only 70,000 units per year. The smaller size of houses built since 1920 makes improbable any large volume of conversions in the future.

In addition to new construction requirements, we have an estimated 4.6 million units which were substandard in 1950 and were presumed suitable for rehabilitation. If 400,000 of these units were rehabilitated each year for the next 5 years and 600,000 per year were rehabilitated thereafter, the 1950 backlog of substandard rehabilitation units could be eliminated by 1965. By that time the large volume of obsolete dwellings becoming 60 years of age should provide opportunities for sustaining this level of rehabilitation activity.

TABLE 4.—Estimated changes in population, household size, number of households, and housing units required, 1955-70

	1955	1960	1965	1970
Population (millions) ¹	164.8	174.4	189.9	204.4
Less population not in households ¹	4.9	5.2	5.7	6.1
Population in households (millions).....	159.9	169.2	184.2	198.3
Average household size ²	3.5	³ 3.1	2.95	2.80
Number of households (millions).....	47.70	54.58	62.44	70.82
Plus vacancies, 4 percent (millions).....	1.90	2.18	2.50	2.83
Total housing units required (millions).....	49.60	56.76	64.94	73.65
Additional units required during preceding period (millions).....		7.16	8.28	8.71
Average annual construction required during preceding period (millions) ⁴		1.43	1.65	1.74

¹ Assumed 3 percent.

² Table 3.

³ A lower rate of reduction in average household size would be as follows:

Average size.....	3.15	3.0	2.90
Number households (millions).....	53.71	61.40	68.38
Total units (millions).....	55.86	65.86	71.11
Additional units (millions).....	5.44	8.00	7.25
Annual construction (millions).....	1.09	1.60	1.46

⁴ See text for explanation of relationship between family and household size. These estimates include needs arising from new family formation, undoubling, required vacancies, changes in family size, and increases in number of persons or families using separate housing accommodations.

TABLE 5.—Additional residential units needed, 1955-70

[In millions]

	1955-60	1960-65	1965-70
For additional households and vacancies.....	1.43	1.65	1.74
For replacement of 1,900 substandard dwellings.....	.50	.50	.50
For annual losses.....	.10	.13	.16
Total additional construction requirements.....	2.03	2.28	2.40

TABLE 5A.—Annual requirements for rehabilitation of existing dwelling units ¹

[In millions]

	1955-60	1960-65	1965-70
Units requiring rehabilitation.....	0.40	0.60	0.60

¹ See text for basis.

Data from the 1950 census indicate that only 500,000 of the nonfarm units which were substandard for lack of plumbing facilities are occupied by families with incomes of more than \$4,000. These should provide a ready market for modernization. An additional 500,000 units occupied by families with incomes of \$3,000 to \$4,000 may also be rehabilitated if sufficiently liberal credit is available for these purposes. The remaining 2.2 million nonfarm units, occupied by low-income families, of which 1.6 million have incomes of less than \$2,000 per year, may present greater difficulties as will the modernization of 1.4 million farm homes. Only an aggressive campaign is likely to achieve the schedule set forth above.

Schedules for slum clearance or perpetuation

The construction program outlined above requires that new housing construction be increased by 80 percent over the 1951-53 levels and by 40 percent over the 1950 level. Any lesser volume of construction however means that our slums and substandard housing will continue to accumulate and will never be reduced or eliminated. The consequences of different levels of construction and rehabilitation are summarized in table 6.¹⁵ If new construction continues at slightly above the 1951-53 average, and if in addition we can rehabilitate 400,000 to 600,000 units per year, the number of substandard units in use will increase by 2 million in the next 15 years. This means that substantially all of the 15 million units which were substandard in 1950 would still be occupied by American families in 1970.

At construction levels of 1.4 to 1.6 million units per year, approximately the 1950 rate, slight progress is made in reducing the number of substandard units capable of rehabilitation. No elimination of the 10 million units classified for replacement appears possible. At 1.6 to 1.8 million new units per year, all of these 10 million units must be continued in use until 1965 and 1 million of these can be replaced by 1970. Only if new construction is raised to 2 million units a year is real progress possible toward the elimination of units substandard in 1950. At the construction and rehabilitation rates shown in table 5 some 5 million of the present substandard units can be eliminated by 1960, but in 1970 some 5 million will still be required in use. Table 6 suggests that 2 million new units per year are essential for even slow progress toward the goal of a decent home for every family. Any lesser level perpetuates the slums.

COMPARISON OF NEED ESTIMATES

The estimates of housing need prepared by six national organizations or agencies in recent years range from 1.4 million units per year to 2.4 million units per year. The standards, methods of estimation and programs of these studies vary widely. Some include farm housing, others deal only with nonfarm housing, some cover only the period to 1960, others project needs through 1975. Table 7 presents these estimates on a comparable basis, utilizing the standards adopted by each organization. The table shows a remarkable degree of agreement as to the inadequacy of present construction levels. Current needs for new construction are 1.4 million nonfarm units per year or 27 percent above present levels in all estimates.¹⁶ Most of the estimates place current total requirements at or above 2 million units per year. A similar degree of agreement appears in the three estimates with respect to long-range requirements for new family formation. Here the range is from 1.8 to 2 million units per year.

¹⁵ Table 6 is based upon detailed schedules contained in the appendix.

¹⁶ The Fortune estimate includes maximum demands (not needs) as shown in the table. Its estimated minimum demand of 1.1, 1.6, and 1.8 million units in successive 5-year periods relates to market demand rather than replacement and new need.

TABLE 6.—*Projections of substandard units remaining in use at various levels of housing construction and rehabilitation, 1955-70*

[Millions of housing units]

Assumed construction and rehabilitation volumes	Substandard units remaining in use			
	1955	1960	1965	1970
New construction:				
1,200,000 units per year, 1955-60.....	15	14	15	17
1,400,000 units per year, 1960-70.....				
Rehabilitation:				
400,000 units per year, 1955-70.....				
New construction:				
1,400,000 units per year, 1955-60.....	15	13	13	14
1,600,000 units per year, 1960-70.....				
Rehabilitation:				
400,000 units per year, 1955-70.....				
New construction:				
1,600,000 units per year, 1955-60.....	15	12	10	9
1,800,000 units per year, 1960-70.....				
Rehabilitation:				
400,000 units per year, 1955-60.....				
600,000 units per year, 1960-70.....				
New construction:				
2,000,000 units per year, 1955-65.....	15	10	7	5
2,400,000 units per year, 1965-70.....				
Rehabilitation:				
400,000 units per year, 1955-60.....				
600,000 units per year, 1960-70.....				

Source: Appendix tables A-C.

TABLE 7.—*Comparative estimates of housing need (converted to comparable basis), 1955-70*

Organization	1955-60	1960-65	1965-70
American Federation of Labor ¹	2.1		
Adjusted for farm housing ²	2.3		
Fortune magazine ³	1.4	1.6	1.8
Adjusted for farm housing ²	1.6	1.8	2.0
Housing and Home Finance Agency ⁴	1.4		
Adjusted for farm housing ²	1.6		
National Association of Home Builders ⁵	1.4	2.0	2.0
Adjusted for farm housing ²	1.6	2.2	
National Association of Real Estate Boards ⁷	1.5		
Adjusted for farm housing ²	1.7		
National Housing Conference ⁸	2.0	2.3	2.4
Twentieth Century Fund ⁹	1.8		
United States President's Materials Policy Commission ¹⁰		1.6	
Adjusted for farm housing ²		1.8	

¹ Statement of the A. F. of L. executive council, Chicago, Aug. 12, 1953, p. 3.² 200,000 units per year added for farm housing. This is the low estimate of farm-housing needs prepared by the Housing and Home Finance Agency, compare note 4.³ Fortune, vol. XLIX No. 2, February 1954, pp. 103-4. This estimate is for market demand. A lower estimate of demand is also presented. See text note.⁴ How Big is the Housing Job, Washington, 1951, p. 13. The adjustment for farm housing is based upon p. 14.⁵ National Association of Home Builders Correlator, vol. VIII, No. 2, February 1954, pp. 4-6. The statement does not explicitly refer to farm and nonfarm housing, but is based upon nonfarm data. This estimate excludes 750,000 units for rehabilitation in lieu of replacement units which are included in other estimates. Thus comparative figures might better be 2, 2.5 for nonfarm construction. The report calls for 2 million new or "new condition" units per year.⁶ After 1970, estimate is for 2 million per year for additional new dwellings. No estimate of rehabilitation or replacement after 1965.⁷ Speech of Charles B. Shattuck, president, National Association of Real Estate Boards, New York Times, Nov. 11, 1953, p. 48. The text indicates that the reference is to housing demand, not need. It is estimated that there is demand for 1.1 to 1.4 million units. The figure quoted above is therefore the high demand.⁸ Farm housing included. Rehabilitation of .4 to .8 units excluded since these do not add to supply.⁹ Manuscript of forthcoming edition of "America's Needs and Resources"; J. Frederick Dewhurst and Associates, Twentieth Century Fund, to be published in the fall of 1954.¹⁰ Resources for Freedom, Washington, 1952 vol. I and vol. II. This estimate is the volume required for the entire period 1960-75. The estimate is presumably lower in the early years and higher in the later years.

ECONOMIC FEASIBILITY

The levels of residential construction proposed by this report are well within the limits of economic feasibility as measured by past output. In 1925 the Nation applied 6.5 percent of its gross national product to nonfarm residential construc-

tion, and in 1950, 4.4 percent of our national product was devoted to housing. These were boom years. Housing investments in other years are shown in table 8 as a percentage of national product. Over an entire building cycle, 1919-35, the average was 3.9 percent. This may be assumed to be a reasonable normal ratio of housing investment, one which can be increased substantially in favorable years.

Under the conditions assumed in this report, namely sustained economic growth, national income should increase steadily. If this increase is continued at substantially less than the rates of recent years, our gross national product should reach the levels shown in table 8. The annual rate of growth here used declines from 3.6 percent per year to 2.1 percent per year over the period in the low estimate and is stable at 3.5 percent per year in the moderate estimate. This latter rate of growth corresponds to that used by the President's Materials Policy Commission in its projection of future economic growth.⁴⁷

It is assumed that prices will be stable over this period, and that the average dwelling unit cost can be held to \$8,000 or less. This assumes that building volume will include a relatively high proportion of low- and moderate-cost units. These assumptions are substantially below current average house prices. Building costs used in production analysis are well below home prices used in consumer cost analysis. Farm construction is excluded from table 7 but is included in table 8. Modernization expenditures are therefore excluded from the latter table.

Even at relatively slow rates of growth, housing goals can be achieved at the 1919-35 ratio of residential investment and at substantially below the 1950 rate. At the rates of economic growth of the last two decades, the expenditures for housing would be reduced to 3.2 percent. In short, if we continue to spend no more of our income than we have in the past, and if our economy continues to grow at a steady rate we can afford to build from 2 million to 2.4 million homes per year in the next 15 years. Under favorable circumstances, lower ratios of expenditure will produce even more housing than these estimates require.

TABLE 8.—Gross national production and new residential construction, selected years

[Billions of dollars]

Year	Gross national production	New non-arm residential construction	Percent
1919-35 average ¹	73.8	2.9	3.9
1939 ²	187.9	7.1	3.8
1940 ²	205.7	7.6	3.7
1950 ²	320.1	14.1	4.4
1951 ²	343.6	11.5	3.3

¹ American Housing, 20th Century Fund, appendix C, table 13.

² Economic Report of the President, 1954, table G-2. Prices are in 1953 dollars.

TABLE 9.—Projections of gross national product and new residential construction, 1955-70

Period	Average projected gross national product (billions)		Number of new dwelling units (millions)	Gross cost ³ (billions)	Percent of gross national product	
	Low ¹	Moderate ²			Low	Moderate
1955-59.....	416	431	2.03	16.1	3.9	3.8
1960-64.....	472	508	2.28	18.2	3.9	3.6
1965-69.....	534	604	2.40	19.2	3.6	3.2

¹ Gross national product increased from \$390 billion in 1955 by a constant amount of \$12 billion, or at a rate declining from 3.6 to 2.1 percent per year.

² Rate assumed by the Paley Commission. Gross national product increased by 3.5 percent per year (the 1925-50 rate).

³ Assumed cost per unit is \$8,000.

⁴⁷ U. S. President's Materials Policy Commission, Resources for Freedom, Washington, 1952, vol. 1, pp. 1-10; vol. 2, pp. 96-113.

MARKETING 2 MILLION HOMES A YEAR

The marketing of 2 million homes a year will present real challenges to the housing industry and to Government. Data are lacking on many of the most important variables which will affect the willingness of people to buy or rent new homes. These include changes in the distribution of incomes, mobility, the income and price elasticity of demand for housing, and the extent of the required or desired movements to suburban areas. Intensive research on housing markets is necessary if we are to achieve our housing goals in an orderly way. Despite these limitations in our knowledge concerning the housing market, some broad relationships may be outlined with respect to the immediate future.

There appears to be a wide measure of agreement that approximately 1 to 1.2 million homes can be sold or rented under economic conditions similar to those of 1953 and with the then-available FHA and VA credit aids. Leaders of the National Association of Home Builders, the National Association of Real Estate Boards and other trade organizations have expressed such judgments repeatedly during the past year.¹⁸ These estimates accord with detailed projections made in the forthcoming 20th Century Fund study. Table 10 shows the income distribution of families of 2 or more persons in 1949-51, and also shows 42 million families distributed in proportion to 1951. The startling increase in incomes between 1949 and 1951 with its consequences for future housing markets are apparent. The number of families with incomes of over \$4,000 increased from 10.7 million in 1949 to 16.8 million in 1951. This should indicate at least 20.2 million such families before 1960. This number, at turnover rates for families purchasing homes might sustain a market of 1 million homes a year. In addition there are demands created by single persons, undoubling and mobility.

This table also emphasizes the direct relationship between full employment and housing markets. Any slackening in employment or economic growth tending to recreate the income distribution of 1949 would sharply reduce the possibilities for sustaining large volumes of new-home sales and rentals. It would normally result in price declines, decreases in construction and increases in vacancies which would defer or prevent the development of an adequate housing supply and the replacement of substandard housing.

Current marketing practices are revealed by table 11 which shows the distribution of incomes of families of two or more persons in 1951 in contrast to the incomes of buyers of new FHA insured homes.¹⁹ The table indicates that substantially no homes were sold to families in income groups comprising 30 percent of all families and that only a third of FHA buyers were in income groups representing over half of the market. This is not fully representative of all new residential construction since it appears that non-FHA homes include more higher-priced homes, and more lower-priced homes, although most of the latter may not meet FHA standards and many of them may be substandard when built. In addition, a very large proportion of FHA homes in the lower-price brackets are purchased by families who will spend more than 25 percent of their income for housing. Indeed some of these families are spending nearly 50 percent of their incomes for housing. Of the FHA buyers with incomes between \$200 and \$250 per month, 97 percent were spending more than 25 percent of their income for housing. A safe rule would be that families should not spend more than 20 percent of their incomes for housing and most families above the lowest income groups spend substantially less than this ratio. The average FHA sale requires 19.7 percent or less of the purchaser's income (for all housing expenses) in all income brackets.²⁰

These FHA-insured sales are not necessarily unsound since they apply to few families numerically (less than 30,000 units below \$3,600 income levels in 1952) and many of these families are clearly living from accumulated funds or are families whose homes are being purchased for them by others. It would be so-

¹⁸ Cf. National Association of Home Builders, NAHB Correlator, February 1954, pp. 4-6, and New York Times, January 22, 1954, p. 44; National Association of Real Estate Boards, speech of Charles B. Shattuck, president, New York Times, November 11, 1953, p. 48; Miles L. Colean, New York Times, November 13, 1953, p. 42.

¹⁹ Data are sec. 203 homes. Similar income data are not available for other titles. The price distribution of all FHA new units is wider than that here used.

²⁰ FHA data on monthly housing expenses and income-expense ratios have been used throughout this report. These data have been criticized as understating housing expense. Despite this weakness, these data are among the best and most consistent in the field, and the only adequate source on this subject. Wider publication of local data by FHA would be a distinct service.

cially unwise and economically disastrous, however, if any substantial proportion of our families began to purchase or rent homes which required such high expenditures for housing as to prevent normal expenditures for food, clothing, medical expenses and other necessities. If purchases involving more than 25 percent of income for housing are excluded from the FHA experience table, the results would be more representative of the sales and rental possibilities of enlarged private housing production under present Government-aid systems. This distribution is shown in the third column of table 11. Limitations of the data are described above. This column suggests that 80 percent of new private construction is produced for income groups representing half of the market.

If a 20 percent ratio of income to housing expense were to be utilized, these conclusions would be even more apparent and might well extend to larger proportions of the market. In addition it should be noted that national housing market data tend to set low-priced homes of the South and West against relatively higher incomes of the North and East. When new house prices are compared with family incomes on a city-by-city basis, we rarely find situations in which homes are offered at prices within the means of more than 40 percent of the families; and these are in the main already well housed and not in the market in any urgent sense for a new home. Finally, many families in these middle- and lower-income groups cannot use the lowest-priced houses produced because such homes are universally 2-bedroom homes and most of our families have more than 1 child. The disparity between incomes and housing prices is thus widened further by the factors of location and family size.

TABLE 10.—Family income distribution, 1949-51

Income	Nonfarm families, 1949 ¹	Nonfarm families, 1951 ²	1951 income distribution of 42 million families
Under \$2,000.....	10	5.6	6.8
\$2,000 to \$3,000.....	6.4	5.1	6.2
\$3,000 to \$4,000.....	6.6	7.2	8.7
\$4,000 to \$6,000.....	6.8	10.0	12.1
\$6,000 to \$10,000.....	3.8	5.4	6.6
\$10,000 and over.....	1.1	1.4	1.6
Total.....	34.7	34.7	42

¹ Unpublished HB tabulations of owner and renter occupied units, United States Census 1950. Families not reporting certain housing items are excluded from the tabulations.

² United States Census, Series P-60, No. 12, 1953. These are families of 2 or more persons, and exclude single person families. The former are believed to be more representative of heads of households shown in the 1st column.

TABLE 11.—Family incomes, 1951, and incomes of buyers of new FHA-insured homes, 1952

	1951 income ¹		1952 FHA 203 new home buyers ²	1952 FHA 203 home sales requiring less than 25 percent of income for housing ³
	All families	2 or more persons		
Under \$2,000.....	25.	16.2		
\$2,000 to \$3,000.....	15.4	14.7	2.9	.2
\$3,000 to \$4,000.....	18.9	20.8	30.1	17.9
\$4,000 to \$6,000.....	24.4	28.8	41.4	39.5
\$6,000 to \$10,000.....	12.9	15.6	42.6	37.1
\$10,000 and over.....	3.8	3.9	4.0	5.2
Total.....	100	100	100	100

¹ United States Census, PC-60 No. 12, 1953.

² HHFA Annual Report, 1952, p. 300.

³ Computed from idem.

⁴ Data adjusted to fit class interval.

A second approach to the problem of marketing a high volume of new homes is summarized in table 12. The method here used is a modification of the method developed by the National Housing Agency in its 1944 projection of housing needs. Basically, it involves a filtration of the 1950 supply, elimination of losses due to clearance and demolition, and the addition of new units during the 1950-54 period. The result is subtracted from a future distribution based upon current or past experience. Limitations in available data and in the number of market factors which can be treated in the model suggest that this method can be used only to identify broad magnitudes and relationships and should not be used to forecast actual market trends. Detailed calculations are shown in the appendix.

TABLE 12.—*Projections of nonfarm housing needed by price class under different economic assumptions and with low filtration and clearance rates and high construction volume, 1955-60¹*

[In millions]

Rent or monthly housing cost	Units needed with 1949 income distribution of 1960 families ²	Units needed with 1960 families distributed to accord with 1951 incomes ³
\$0 to \$20.....	2.3	1.5
\$20 to \$30.....	1.8	1.1
\$30 to \$40.....	1.6	.9
\$40 to \$50.....	1.8	1.0
\$50 to \$60.....	.9	.9
\$60 to \$75.....	-.2 ⁴	.6
\$75 to \$100.....	-1.6 ⁴ (1.2) ⁵	.6 (3.4) ⁶
\$100 and over.....	2.2 (.6)	2.2 (6)
Total.....	8.8	8.8

¹ Detail of method in appendix E. See text note for results of alternative assumption⁶ regarding filtration. Other assumptions, demolition of 2.5 million substandard units, 5 percent filtration, moderate current losses, 6 million units built 1950-54 and 8.8 million units required 1955-59.

² The 1960 families distributed by classes of rents and prices paid in 1950.

³ The 1960 families distributed by classes of rents and prices paid in 1950 and adjusted upward for changes in income between 1949 and 1951.

⁴ Negative quantities imply surpluses in the classes indicated. This presumes rapid filtration, price declines, and reduction of building in these price classes and the price classes immediately above.

⁵ Under alternative assumptions regarding filtration. See text note and appendix.

The method does suggest these important conclusions:

1. The current excessive production in higher priced houses, i. e., those priced to sell or rent at monthly costs of \$75 or more, will materially narrow the market for such homes in future years. To the extent that these homes filter down to the prices between \$60 and \$100 per month, they may create a surplus of such homes under unfavorable conditions. This could result in excessive filtration of higher priced units and marketing problems for new homes.

2. There is a very large market for homes at prices and rents ranging from \$60 per month downward, a market which could account for over 3 million units in the next 5 years. This is the market now not served by either private or public housing. In northern cities, it consists roughly of homes in the range of \$40-\$60 monthly cost, and in southern areas, of \$25-\$50 monthly cost.

3. Unless full employment and a steady rate of economic growth are maintained, there will appear positive surpluses in some price ranges, accompanied by softening of markets which will jeopardize all private housing production. On the other hand, a maintenance of full employment conditions could produce substantially greater markets than those shown in the table. Housing markets are highly sensitive to changes in family incomes.

4. There remains a large need for housing for low-income families, a need which is increased by 50 percent under less than full-employment income distributions. This need is at price and rent levels far below any which private construction can approach.

5. Other models of future income distributions suggest that very high levels of housing production could be maintained in all price classes if rates of redistribution of income comparable to those which occurred in 1949-51 could be repeated.

6. A stable demand for about 400,000 units of higher priced homes appears in all estimates based upon this method. If the method overstates needs in the higher price groups, this demand will appear in the price groups of \$70-\$100 per month, just below the levels shown in the table.²¹

These conclusions support the views widely recognized by industry leaders that future construction must serve the broad middle and lower income groups if it is to be maintained at high levels. Under favorable economic conditions, there appears to be a sustained demand for approximately 1 million dwellings a year in the price classes now produced by industry with current Federal aids. In addition there appears to be a need for approximately 500,000 units a year in price classes below the levels now served by the industry with present credit aids, and for 200,000 to 300,000 units per year for families requiring public housing. These nonfarm needs are supplemented by farm needs of unknown price distribution of 200,000 to 300,000 units per year.

FINANCING 2 MILLION HOMES PER YEAR

Both the construction and the marketing of new residential construction will depend upon the availability of an adequate supply of construction and mortgage funds on terms which will meet the needs of the industry and of consumers. The Federal Housing Administration prepared an estimate for the President's Advisory Committee on Government Housing Policies and Programs of the probable mortgage fund requirements for the period 1954-58, and probable volume of savings available for mortgage lending.²² These estimates are extremely conservative. They assume construction of only a million new units per year,²³ and a decline in the total volume of mortgage lending,²⁴ even under assumed conditions of prosperity in the rest of the economy. Selected measures from this report are presented in table 13. The average mortgage requirement is not to be interpreted as a function of prices alone. It is a product of the aggregate volume of new savings, repayments on existing mortgages, the volume and amount of mortgage loans on new and existing housing and prices on new and existing homes.

The same study estimates that \$9 billion annually will become available for new mortgage loans of which \$5.5 billion will be utilized by the low level of construction assumed. This would leave unutilized \$3.5 billion. In the last column of table 13 these funds have been applied to FHA's estimate of the average mortgage amount for new homes during the period. At this amount, funds would be available to finance an additional 450,000 units per year, or a total of 1,450,000 units per year. The FHA estimate of new savings is probably low and the implication of its assumed low volume of construction is that mortgage interest rates will decline sharply and that funds will be readily available. If these estimates of available funds prove correct, full utilization of such funds would tend to hold interest rates at higher levels. Thus even if savings available for mortgage loans (but a small part of total savings) were assumed to average somewhat higher than the FHA estimate, such funds would probably not be available freely and on favorable terms at construction volumes exceeding 1.5 million new units per year under current institutional arrangements for savings and mortgage lending.

²¹ The method assumes that all units in the existing supply will filter by 5 percent. In fact filtration rates will vary widely by location and price class, and recently built homes may not filter (i. e., suffer price or rent reductions) at all during the first 5 years of occupancy. If this is assumed to be true, construction requirements in the highest class interval above are sharply reduced and those in the next two classes are correspondingly increased. This would indicate a low demand (0.6) in the class over \$100 under the first assumption, and a substantial demand (1.2) in the \$75-\$100 class. Under the second assumption, demand in the over \$100 category would be the same (0.6); and in the \$75-\$100 class would jump to 3.4 million, or nearly 700,000 units a year. These shifts are shown in the appendix, table E.

²² Prospective Level of Residential Construction and Availability of Mortgage Money, 1954-58. Federal Housing Administration, 1953. These estimates and the following text deal with nonfarm financing.

²³ *Ibid.*, pp. 4, 12, 13.

²⁴ *Ibid.*, table 5.

TABLE 13.—Increases in mortgage holdings, 1950-53; new residential construction and projections, 1954-58

	1950 ¹	1952 ¹	1953 ²	FHA estimate, ³ year 1954-58	FHA estimate, additional funds available ⁴
Increases in mortgage holdings, (billions)....	7.5	6.9	7.1	5.5	3.5
New units built (millions).....	1.4	1.1	1.1	1.	(450)
Average requirement.....	\$5,400	\$6,300	\$6,500	\$5,500	(7,800)

¹ HHFA, Housing Statistics, January 1953, p. 23.

² FHA, Prospective Level of Residential Construction and Availability of Mortgage Money, 1954-58, table 6.

³ *Ibid.*, table 5. Estimate is for average year in this period.

⁴ Computed from *ibid.*, tables 5 and 6. Assumed average mortgage amount is the marginal rate assumed by FHA table.

These considerations suggest that under conditions of prosperity, ample mortgage funds may be available on favorable terms through existing channels for 1.2 to 1.4 million units a year. Additional flows of money will probably be required to meet housing goals of 1.8 million nonfarm units a year in the next few years, and in part to meet farm goals. The prospective large volume of savings, increases in corporate savings to meet corporate investment requirements, and reductions in defense financing requirements suggest that ample funds will be available in fields which have not financed housing construction in recent years. These include particularly institutional savings which have been utilized for corporate investments and institutional and personal savings which have been going into Government bonds. The fuller utilization of these savings channels may be expected to provide funds on terms acceptable to the housing market. If funds are to be diverted directly from other sources, the implied increases in interest rate would make impossible the marketing of larger volumes of new construction.

These conclusions are consistent with the marketing requirements suggested in the preceding section. A substantial market appears to exist in the higher income levels for new homes at rents and monthly prices corresponding to the present output of the industry. If larger volumes are to be produced, they must be produced at prices and on terms which will be available to income groups substantially below those now in the market for new homes. If such terms are available, and only if such terms are available, it will be possible to obtain the goal of a decent home in a suitable living environment for every American family.

APPENDIX

TABLE A.—Projections, substandard units remaining in use with housing construction at volumes of 1,200,000 to 1,400,000 units and rehabilitation of 400,000 units per year, 1955-70

(Millions of units)

	1950-55	1955-60	1960-65	1965-70
Indicated need at end of period ¹	50	56	64	73
Standard units available at the beginning of the period ²	30	35	42	49
Becoming obsolete during period ³	1	1	2	2
Net units available.....	29	34	40	47
New units, at 1.2, 1950-60; at 1.4, 1960-70.....	6	6	7	7
Rehabilitation, at 400 per year.....		2	2	2
Standard units available.....	35	42	49	56
Substandard units remaining in use ⁴	15	14	15	17

Notes follow appendix D.

TABLE B.—*Projections substandard units remaining in use with housing construction at volumes of 1,400,000 to 1,600,000 units and rehabilitation of 400,000 units per year, 1955-70*

[Millions of units]

	1950-55	1955-60	1960-65	1965-70
Indicated need at end of period ¹	50	56	64	73
Standard units available at the beginning of the period ²	30	35	43	51
Becoming obsolete during period ³	1	1	2	2
Net units available.....	29	34	41	49
New units, at 1.4, 1955-60; at 1.6, 1960-70.....	6	7	8	8
Rehabilitation, at 400 per year.....		2	2	2
Standard units available.....	35	43	51	59
Substandard units remaining in use ⁴	15	13	13	14

Notes follow appendix D.

TABLE C.—*Projections substandard units remaining in use with housing construction at volumes of 1,600,000 to 1,800,000 units and rehabilitation of 400,000 to 600,000 units per year, 1955-70*

[Millions of units]

	1950-55	1955-60	1960-65	1965-70
Indicated need at end of period ¹	50	56	64	73
Standard units available at the beginning of the period ²	30	35	44	54
Becoming obsolete during period ³	1	1	2	2
Net units available.....	29	34	42	52
New units, at 1.6, 1955-60; at 1.8, 1960-70.....	6	8	9	9
Rehabilitation, at 400, 1955-60; at 600, 1960-70.....		2	3	3
Standard units available.....	35	44	54	64
Substandard units remaining in use ⁴	15	12	10	9

Notes follow appendix D.

TABLE D.—*Projections substandard units remaining in use with housing construction at volumes of 2,000,000 to 2,400,000 units and rehabilitation of 400,000 to 600,000 units per year, 1955-70*

[Millions of units]

	1950-55	1955-60	1960-65	1965-70
Indicated need at end of period ¹	50	56	64	73
Standard units available at the beginning of the period ²	30	35	46	57
Becoming obsolete during period ³	1	1	2	2
Net units available.....	29	34	44	55
New units, at 20, 1955-65; at 24, 1965-70.....	6	10	10	10
Rehabilitation, at 400, 1955-60; at 600, 1960-70.....		2	3	3
Standard units available.....	35	46	57	68
Substandard units remaining in use ⁴	15	10	7	5

¹ From table 4.

² Approximately 45 million units in 1950, less 15 million substandard in 1950.

³ Includes 70 percent of the units becoming 60 years old in 1950-60 and 80 percent of the units becoming 60 years old in 1960-70.

⁴ Units substandard in 1950 are assumed to remain in use until no longer required. 5 million of such units estimated to require rehabilitation are eliminated by 1965 in table C, by 1960 in table D. 10 million of such units estimated to require removal are reduced after 1965 in table C and after 1960 in table D.

APPENDIX E

Projections of nonfarm housing need by price class under different economic assumptions and with low filtration and clearance rates and high construction volume

Rent or monthly housing cost	1950 supply ¹	1950-54 additions ²	Units cleared ³	Subtract filtration ⁴	Add filtration ⁵	Current losses ⁶	1955 supply ⁷	1960 A needs ⁸	5-year A needs ⁹	1960 B needs ¹⁰	5-year B needs ¹¹
\$0 to \$20.....	5.2	-----	1.1	-----	0.5	0.1	4.5	6.8	2.3	6.0	1.6
\$20 to \$30.....	5.0	-----	.6	0.5	.9	.1	4.7	6.5	1.8	5.8	1.1
\$30 to \$40.....	5.5	-----	.3	.9	1.4	.1	5.6	7.2	1.6	6.5	.9
\$40 to \$50.....	4.8	0.1	.2	1.4	1.2	.1	4.4	6.2	1.8	5.4	1.0
\$50 to \$60.....	3.8	.3	.1	1.2	1.2	-----	4.0	4.9	.8	4.9	.9
\$70 to \$75.....	4.4	.9	.1	1.2	1.9	-----	5.9	5.7	-.2	6.5	.6
\$75 to \$100.....	4.3	2.0	-----	1.9	2.9	-----	7.2	5.6	-1.6	7.8	.6
\$100 and over.....	6.6	2.7	1.1	2.8	-----	.1	6.4	8.6	+2.2	8.6	2.2
Total.....	39.6	6.0	2.5	9.9	9.9	.5	42.7	51.5	8.8	51.5	8.8
Alternative filtration assumption ¹²											
\$70 to \$75.....	4.4	-----	-----	1.2	1.9	-----	5.9	5.7	-.2	6.5	+ .6
\$75 to \$100.....	4.3	-----	-----	1.9	-----	-----	4.4	5.6	+1.2	7.8	+3.4
\$100 and over.....	6.6	-----	-----	-----	-----	-----	9.2	8.6	+ .6	8.6	+ .6

Note on method: The method here used is adapted from the 1944 study of the National Housing Agency. It is subject to the limitations therein cited, cf. Housing Needs, National Housing Bulletin No. 1, Washington, 1944. The method is useful to estimate general magnitudes only.

¹ All 1950 nonfarm units distributed by rent or price class of units reporting such information in 1950 census.

² Assumed addition of 1.2 million units per year for 5 years distributed in price classes of all new units insured by FHA in 1952 as to those in lower-priced brackets. Adjusted upward in higher brackets to account for underrepresentation of such units.

³ One-fourth of 10 million standard units as distributed in 1950 census.

⁴ Homes assumed to filter 6 percent, a low estimate because of upward filtration in 1950-52. Filtration applies to rent levels, shifting a proportion ranging from 12 percent to 30 percent of units in each class interval.

⁵ Units added for filtration.

⁶ Current losses due to fire, windstorm, etc., at 100,000 per year. The allocation to the highest class interval is arbitrary.

⁷ Remainder of 1950 supply plus estimated 1950-54 additions.

⁸ 1960 requirements if distributed in the price or rent classes of the 1950 supply.

⁹ Additional requirements to meet needs indicated in col. 8, i. e., col. 8-col. 7=col. 9.

¹⁰ 1960 requirements if redistributed to reflect changes in family income and estimated housing expenditures between 1949 and 1951. FHA income-housing expense ratios for each income group applied to the number of families moving into each higher class interval.

¹¹ Additional units required in 1960 to serve a housing expenditure pattern based upon the 1951 distribution of family income.

¹² This alternative assumption based on theory that new units do not filter during the first 5 years. See text note.

A SUMMARY—AMERICAN HOUSING NEEDS, 1955-70

Housing construction has reached record levels during the 8 years since the end of World War II. During the last 4 of these years, we have built an average of 1.2 million homes a year, an achievement far exceeding previous 4-year construction levels. On the other hand, construction volume for the last 3 years has been 20 percent below the peak of 1.4 million units built in 1950. We clearly have a capacity to build from 1.5 to 2 million homes each year. Real progress has been made in overcoming the great shortages of housing which accumulated during the war years. But little progress has been made toward eliminating the slums and substandard homes inhabited by millions of American families. We must reexamine our needs for housing in the light of these accomplishments and these deficiencies, and in the light of our vastly expanded capacity for production.

Future housing requirements must be estimated upon the assumption that the Nation will maintain full employment, will continue to expand its economy, and that our population will grow in keeping with these conditions. It is further assumed that defense expenditures will not increase, that Federal aids for housing will continue and expand, and that the Nation will desire and be able to achieve our national goal of a decent home in a suitable living environment for every American family.

The 1950 Census reveals that we have 15 million substandard homes. These homes do not measure up to reasonable American standards of living because they are dilapidated, are located in slum areas, or lack interior plumbing facilities. Ten million of these homes must be cleared and replaced. More than 4.6 million substandard units may be brought up to standard by rehabilitation and modernization. These needs are summarized in millions of units, as follows:

	Total substandard	To be replaced	To be rehabilitated
Urban.....	8.9	6.9	2.0
Rural nonfarm.....	3.0	1.7	1.2
Farm.....	3.4	1.5	1.4
Total.....	15.3	10.2	4.6

¹ 500,000 additional farm units to be abandoned.

Other housing needs arise from the formation of new families, undoubling of families who now lack separate homes, the migration of 3 million families each year, and the desire of many single persons for separate dwellings. In addition, we must replace homes which are demolished by fire or other disaster or are cleared in highway and other construction programs. Finally, many hundreds of thousands of units reach obsolescence each year. These must be replaced or our housing condition deteriorates. The sum of these annual requirements may range from 1.3 million to 2.4 million units per year. If we replace the homes which were substandard in 1950 during the next 20 years and at the same time meet our annual new needs, we must build from 2 million to 2.4 million new homes per year as follows:

	1955-60	1960-65	1965-70
For additional households and vacancies.....	1.43	1.65	1.74
Replacement of substandard.....	.50	.50	.50
Replacement of annual losses.....	.10	.13	.16
Total new units needed each year.....	2.03	2.28	2.40

If we do not achieve this level of new construction, we will never be able to clear slums and eliminate substandard housing. Indeed at present levels of construction our present substandard units will never be replaced—and we will have more substandard housing in 1970 than we had in 1950. Even if we build 2 million units a year and rehabilitate 400,000 additional units each year, 5 million American families will still be using homes which were substandard in 1950 when 1970 arrives.

New construction per year	Substandard units remaining			
	1955	1960	1965	1970
1.2 to 1.4 million.....	15	14	15	17
1.4 to 1.6 million.....	15	13	13	14
1.6 to 1.8 million.....	15	12	10	9
2.0 to 2.4 million.....	15	10	7	5

These requirements arise because the number of new families being formed each year will rise sharply after 1960. Reasonable progress toward slum elimination requires construction of 2 million new homes per year from 1955 to 1960, with increases to 2.4 million by 1965-70. Lower rates of new construction imply a deterioration of our housing standards, or such low rates of replacement that slums will not be cleared during the next two generations.

With the rapid increases in gross national production which have occurred in recent years, the production of 2 million to 2.4 million homes a year is an economically feasible goal. If national output continues to grow at the rate of the last 25 years, we can achieve our housing goals even though we spend no more of our national income for housing than we have in the past. A decreasing proportion of our output could achieve these goals. Indeed, unless we can achieve and maintain a higher level of housing production, we will be unable to maintain full employment and an expanding economy.

Recent housing production has been built to serve predominantly those families in the upper income groups. Rapid increases in family incomes have made possible the continued sale of homes to these families. In the future, however, we must increasingly produce homes for middle and lower income groups. If we are to sustain a high level of housing construction, we must produce homes in the broad price classes suggested below:

Rents or monthly purchase prices:	<i>Nonfarm homes per year</i>
0 to \$30.....	520,000
\$30 to \$50.....	380,000
\$50 to \$75.....	300,000
\$75 and over.....	560,000

This suggests that 1 million to 1.2 million homes can be sold or rented each year under the systems of financing and Federal aids now available. About 600,000 additional units of private housing should be produced and financed annually to meet the needs of middle and lower income families who are not now able to afford new homes. An additional 200,000 units of public housing are needed to meet the needs of low-income families. In addition, more than 200,000 units per year are needed by farm families to replace substandard units.

Mr. ROBBINS. Our studies show that although we have built an average of 1,200,000 homes a year over the last 4 years, construction volume during the last 3 has been 20 percent below the peak of 1,400,000 homes built in 1950. With appropriate aids, the industry clearly has the capacity to build from 1,500,000 to 2 million homes each year. Real progress has been made in overcoming the great shortages of housing which accumulated during the war years. But little progress has been made toward eliminating slums and substandard homes inhabited by millions of American families.

In looking to future housing requirements I believe that you will agree that they must be estimated upon the assumption that the Nation will maintain full employment, will continue to expand its economy and that our population will grow in keeping with these conditions.

The 1950 census reveals that we have 15 million substandard homes. They do not measure up to American standards of living because they are dilapidated, are located in slum areas, or lack interior plumbing facilities. More than 4,600,000 substandard units may be brought up to standard by rehabilitation and modernization. Ten million of these homes must be cleared and replaced. Of the total substandard units, 8,900,000 are urban, 3 million rural nonfarm and 3,400,000 are farm homes.

Other housing needs arise from the formation of new families, undoubling of families now lacking separate homes, the migration of 3 million families each year, and the desire and need of many single persons for separate accommodations. In addition, homes demolished by fire or other disasters, or cleared in highway and other construction programs must be replaced. Finally, many hundreds of thousands of units reach obsolescence each year. These must be replaced or our housing condition deteriorates. The sum of these annual requirements may range from 1,300,000 to 2,400,000 units per year. If we

replace the homes which were substandard in 1950 during the next 20 years and at the same time meet our annual new needs, we must build from 2 million to 2,400,000 new homes per year.

If we do not achieve this level of new construction, we will never be able to clear slums and eliminate substandard housing. At present levels of construction our present substandard units will never be replaced, and we will have more substandard housing in 1970 than we had in 1950. Even if we build 2 million units a year and rehabilitate 400,000 additional units each year, 5 million American families will still be using homes which were substandard in 1950 when 1970 arrives.

Recent housing production has been built to serve predominantly those families in the upper income groups. Rapid increases in family income have made possible the continued sale of homes to these families. In the future, however, if we are to sustain a high level of housing construction we must increasingly produce homes for middle and lower income groups.

The record suggests that 1 million to 1,200,000 homes can be sold or rented each year under conventional systems of financing and Federal aids now available. About 600,000 additional units of private housing should be produced and financed annually to meet the needs of middle- and lower-income families who are not now able to afford new homes. An additional 200,000 units of low-rent public housing are needed each year for the next 5 years at least, to meet the needs of low income families now living under substandard conditions. In addition more than 200,000 homes per year are needed by farm families to replace substandard units.

That, in very broad terms, is a brief glimpse at our housing needs and at what it would take to put our housing plant in order over the next 20 years. While no definitive estimate has been made as to how large a housing program might be achievable under the measure now before the Banking and Currency Committee, the most optimistic claim that we have heard for it is something just over a million homes a year. If that estimate is accurate, and it came from Administrator Cole to representatives of the press when the report of the President's Committee was announced, may I point out most respectfully that it is in no way geared to the Nation's housing need.

In the development of a comprehensive housing program to meet the Nation's housing needs, we believe it essential to adhere to the following basic principles:

1. It must provide assurances that the building industry will produce a high and stable volume of residential construction.

2. It must remove from the housing supply by demolition at least 500,000 units per year of substandard housing.

3. It must rehabilitate an additional 400,000 or more homes per year to preserve the older part of our supply of housing which must remain in use.

4. It must provide some new housing at prices or rents which are within reach of every income group. Unless this principle is adhered to, it will be impossible to rehouse families displaced by slum clearance, urban redevelopment, or enforcement programs, and families forced to move by rehabilitation programs. It is also essential in order to assure the sustained production and marketing of a high

volume of new homes. The present and past practice which makes new housing available only to families in the highest income groups tends to glut the market for such homes and produces the "boom or bust" building cycle. On the other hand, if some homes can be sold or rented to families of every income group, the market is increased manifold and production can be sustained indefinitely. Marketing some new homes to a wide range of family incomes will also serve to prevent excessively rapid deterioration of present values.

By and large a good job has been done under existing aids in providing homes for families whose annual incomes are in excess of \$5,000. A large and increasingly efficient home-building industry has come into being since World War II. Present housing aids have made that record possible.

H. R. 7839 places great emphasis on the need for urban renewal and new credit aids in an effort to achieve low-cost housing for families of low income. May I respectfully say that few if any facts have been presented to encourage us to believe that homes for sale or for rent for families of middle and low income will result from passage of this legislation.

We were dumbfounded when no provision was made for low-rent public housing in the present bill. This is the committee that considers the substance of legislation. It provides the forum where the people may meet with their elected representatives and present their views. As you well know, the Committee on Appropriations does not provide such a forum for the public. It does not make exhaustive studies into the merits of proposed legislation. Therefore, we cannot urge too strongly that when this measure is reported, the Congress will receive the judgment of this committee as to the size of a low-rent public housing program as part of the administration's total housing program.

The National Housing Conference supports the concept that urban renewal, in addition to slum clearance and urban redevelopment, is desirable. Under no circumstances should it be considered a substitute for slum clearance and urban redevelopment. We caution that the use of new terminology in this legislation may make it impossible to move ahead with new slum-clearance and urban-redevelopment programs because existing State redevelopment legislation conforms with the requirements of title I of the Housing Act of 1949.

We do feel that the trend to encourage rehabilitation is sound and that the more liberal mortgage terms recommended in section 220 for housing provided under renewal programs are generally desirable. However, we doubt if mortgage terms on old housing should be on the same basis as new.

In any substantial program whether it be called slum clearance, redevelopment, rehabilitation, or renewal, many millions of families are going to be displaced. It is generally accepted that about half of the families to be displaced under these programs have such low incomes that they cannot afford housing produced by private enterprise even with the new aids proposed in this bill, some of which are admittedly experimental.

Of one thing we may be absolutely certain. Unless provision is made for these families there will be no effective program of urban renewal, of slum clearance, or rehabilitation. That fact dictates a

low-rent public housing program to care for that need. We insist, and the figures bear us out, that if we are to make inroads on slums and do the kind of an urban renewal job that everyone agrees is desirable, it will require at least 200,000 and probably more units a year of low-rent public housing for the next 5 years at least. At the same time, slum-clearance and urban-renewal programs will require homes for families of middle and low income which can only be provided with greater Government aids, both local and national, than are recommended in the present bill. These are the facts that must be faced up to now, if there is to be a dynamic program to meet the housing needs of the American people.

Let me make it very clear that these needs must be taken into account at the inception of the program, and adequate housing must be provided for families at the time they are displaced by slum-clearance and urban-renewal operations. If slum-clearance and urban-renewal programs are tried with little or no provisions made for displaced families, we will simply shift these families from one slum to another and create new slums.

It is our purpose to be constructively critical. The National Housing Conference, in cooperation with many other public-interest national organizations, is working on a program which we hope to submit to this committee and to the Congress, and which we feel is essential if housing goals are to be met. We are not yet in a position to present final recommendations but in the meantime, we wish to offer some tentative suggestions.

Before getting into them, however, I believe it desirable to restate our common objective, namely, finding some way to obtain adequate homes for families of low and middle income, at monthly costs these families can afford to pay. We do not believe that the way to achieve that objective is by setting some arbitrary cost figure which we know to be unachievable in metropolitan areas of greatest need right at the very start. By ignoring, or reducing standards for decent family living which would be inexcusable under our economy, cheap shelter could be produced. It has been done. Zero, 1-, and 2-bedroom homes have been built at comparatively low cost for families whose need to a very large degree was for 3- or 4-bedroom homes. By ignoring minimum standards, not only for space but of basic materials, potential slums have been created. That kind of a program is neither economically or socially desirable. The proposed renewal program is aimed toward the elimination of past mistakes of this very type. By establishing an arbitrary \$7,000 cost limitation in section 221, we may be offering the industry a challenge, but we venture to predict that practically no homes meeting minimum standards for family living will be produced in the areas of greatest need.

In developing a total housing program, we feel that it is inexcusable to do so without relating it to the needs of families in the various income groups. That is why we place so much stress on the examination of need. We do so because we believe that the President, the Congress, and the American people desire to put their national house in order, and to do so they want to know what the total job requires. The challenge to the housing industry, to our financial institutions, to our Government and to all of us, is that we are faced with a job of staggering proportions. We believe that there is the ingenuity,

the desire and the ability in this country to accomplish the job. We may have to tailor it over a 20- 30- or 40-year period. But we feel we are sufficiently adult to face the facts—and that the job can be done.

It must be recognized at the outset that the Federal Government is going to have to assume certain risks. We have to believe in our country's future, we have to move ahead with the knowledge that we have the brains and the power to maintain a full economy and full employment. A strong, vital housing industry can contribute more toward the realization of that objective than any other single industry. A shelf of public works as a backstop to recession or depression is doubtless desirable. But a truly dynamic housing program which provides great social as well as economic returns will do more toward maintaining our economy, than any conceivable shelf of, or even operating public-works programs. Our national experience has taught that lesson unmistakably over the last two decades. We do not advocate a realistic housing program merely for the sake of housing, or for its social gains. We believe that it can and must be a continuing, living force in our total economy.

Having faced the facts, how do we go about the job? First of all we agree that there are minimum standards of housing for decent living below which this country cannot go. Therefore, we have to devise means for providing homes, built to adequate standards, available to families of middle and low income at different monthly costs based on the family's ability to pay.

We agree that private enterprise must be responsible for as much of the total job as possible, and to achieve that end a range of credit aids is essential in order to provide some new homes to each income group.

First, we need to maintain the present volume of private residential construction, with Federal aid, in the price classes now served by the building industry and the price classes immediately below.

The record indicates that in the Northeast and larger metropolitan areas, even small new homes cost \$10,000, and present financing plans serve families with incomes of \$5,000 and \$6,000 and a very small fraction of families with incomes of \$4,000 to \$5,000. On the other hand, the same aids in Southern, some Western, and smaller communities may make it possible for families with incomes of \$4,000 to \$5,000 to purchase acceptable homes costing \$7,000 to \$8,000.

We feel that these houses of 2 and 3 bedrooms definitely represent a standard of construction and design to be maintained. The problem is—how do we get homes of at least that standard to families with incomes below \$5,000 in the higher cost areas and below \$4,000 in low-cost areas, and do it in the framework, so far as possible, of private enterprise?

We believe that moderate increases in FHA mortgage allowances and extensions of amortization periods to 30 years for new construction, will assist this process. We believe that extension of amortization periods on old homes and provision of liberal credit for \$25,000 luxury homes will divert funds from low cost new construction and increase insurance losses. With these exceptions, however, we support the extension of FHA aids as a means for sustaining the volume of construction of homes for higher income families.

Second, there is an acute need for the expansion of private housing construction for families with incomes of from \$3,000 to \$5,000

annually. When examined on a local basis, present private housing production serves only families in the upper 40 percent of the income range. Sixty percent of our families cannot afford new houses for rent or for sale at current prices. This group includes large numbers of families now living in areas which are to be cleared or rehabilitated under this bill. Relocation housing, not now available, must be provided for them.

This need could be served in part if mortgage loans were available for 40-year terms at current interest rates of $4\frac{1}{2}$ percent. Such loans will not be made by private lending institutions at the present time. This means that such loans would have to be made by the Federal National Mortgage Association. The loans could be initiated and serviced by private lending institutions in the normal manner. Many of them could be written at $4\frac{1}{2}$ plus the FHA insurance premium, so that they could be resold to private lenders at some future date. Others would have to be written at 4 percent. These, too, might be resold when the mortgage market returns to such rates. It is possible that similar monthly costs could be achieved with a 50 percent private loan at conventional rates and a 50-percent FNMA loan at lower rates if this was deemed desirable.

Homes built under such a program would serve families with incomes of about \$1,000 below the incomes of typical families now in the market for housing. This constitutes about a fifth of all American families, a vast market, eager for better housing if it can be brought within their reach. We believe that such a program is workable, would involve no actual cost to the Government, could be limited to families in need of housing and not presently in the market, and would expand housing production substantially. We urge a program in this field of 200,000 to 300,000 homes per year.

Third, there are an additional 20 percent of our families, with moderate incomes who could still not afford new housing. These families are also found in large numbers in clearance and rehabilitation areas. A still higher proportion of them live in substandard housing. To meet their needs for new private housing will require interest rates of $3\frac{1}{2}$ over amortization periods of 40 years. With such terms, new private housing could be made available for sale or rent to families with incomes of about \$2,000 below those now served by the building industry with present credit aids.

We urge that the Federal National Mortgage Association be authorized to make such loans, obtaining the funds through sale of debentures guaranteed by the Government. A sufficient volume should be authorized to meet all relocation needs, and to bring private-housing construction under this and other programs to 1,600,000 units per year of nonfarm housing. This program would require substantial Government borrowings, all of which would be fully backed by mortgage loans. It would not involve any current appropriations, but like the GI loan program, it would involve the assumption by the Government of the risk of future losses.

Simple controls on incomes administered through normal credit channels could assure that the loans were made only for housing which served middle-income needs. We believe that many communities would be willing to grant partial tax exemption to such families for limited periods of time, particularly for those displaced by urban

renewal programs. With such Federal and local aid it would be possible to provide some new housing at income levels just above the maximum incomes allowed in public-housing projects. Such housing would permit the speedier removal of families from public housing as they reach the income limit for continued occupancy.

We believe that all of these credit aids should be made available to cooperative of other nonprofit housing ventures and that such applications should receive preference. We have over a period of many years supported, and we still do recommend the kind of cooperative housing program proposed in H. R. 7469, introduced by Congressman Bolling and referred to this committee.

We also believe that all private housing built with Federal credit aid should be built according to adequate standards of construction and design. The Federal Government should have no part in the building of substandard or partially substandard homes.

In addition to these programs of direct aid to housing I should like to enumerate briefly some other proposals which we consider essential as parts of a comprehensive program of housing and urban renewal:

1. Decisive steps are needed to establish effective metropolitan planning and market analysis. Federal grants should be coupled with strong incentives for such action on a local basis.

2. Substantial proportions of all Federal credit aids should be earmarked by law for the use of minority groups, veterans, the aging, and cooperatives.

3. The housing research program should be reactivated at once.

4. Additional credit aids are needed for farm housing and for rural nonfarm areas.

Mr. Chairman, I believe that I have made our support of low-rent public housing thoroughly clear. As the first step, we urge that restrictions placed on the public housing program in the Appropriation Acts for 1953 and 1954 be rescinded so that the provisions of the Housing Act of 1949 may again become operative.

We also urge an additional authorization for slum clearance, urban redevelopment and urban renewal programs. These projects normally require 2 to 3 years of advance planning. Thus, the failure to increase the authorization now, means that the proposed program will slow down or stop, 2 years hence. In addition, to the extent that current funds may be diverted to renewal projects, funds presently available for clearance projects will be reduced. We hope that the Congress will expand and not reduce these programs. We suggest additional authorizations of \$200 million for grants and \$400 million for loans.

Mr. Chairman and members of the committee, you have been most patient. May I express our deep appreciation for this opportunity to express our views on H. R. 7839.

The CHAIRMAN. Thank you, Mr. Robbins. Are there questions of Mr. Robbins?

Mr. SPENCE. Mr. Chairman.

The CHAIRMAN. Mr. Spence.

Mr. SPENCE. What do you consider the national needs for housing to be? How many people are housed in substandard, inadequate, unsanitary homes?

Mr. ROBBINS. Fifteen million families, sir.

Mr. SPENCE. Where are most of those?

Mr. ROBBINS. I think that we have substandard housing all over the United States. We have it in our metropolitan areas, we have it in our small communities, and we have it on our farms.

Mr. SPENCE. What has been the effect of low-rent public housing, the psychological effect? What has been the turnover of those who have been taken out of the blighted areas and put into low-rent public housing? What proportion of them have gained in their income to such an extent that they would no longer be eligible to remain?

Mr. ROBBINS. I cannot answer in terms of proportions, Mr. Spence. I can say this, that the report of the President's Advisory Committee shows that the average tenure of families in public housing is 4 or 5 years. In other words, they move out, on an average, in that period. A great many of them have increased their incomes and become ineligible.

One of our great problems, of course, is where do they go when they become ineligible because of the gap between good accommodations and public housing, and the poor housing they must go into when they move.

I might say this, which may not be a national experience, but in New York City we see that the white families who have a better opportunity to earn increased incomes, remain in public housing for a much shorter period than the Negro families, because the Negro incomes are limited.

However, I should say that, generally speaking, families are encouraged by their experience in public housing to earn increased incomes and to look for their own private housing if they can afford to purchase it.

Mr. SPENCE. Well, if they are removed because of an increase in income, they certainly can obtain accommodations that are equally as good as those they vacate, don't you think so?

Mr. ROBBINS. No, sir, I don't. I think that is one of the most serious problems we face, and that is where do the families go who are no longer eligible for public housing because of an increase in income. In community after community in this country they go back to the slums, because there is not decent housing for them to get.

Mr. SPENCE. Notwithstanding the increase in income, they are unable to be properly housed when removed from public housing?

Mr. ROBBINS. Yes, sir, for instance, supposing a family goes into public-housing project with an income of \$1,500, and suppose it is told that when it reaches \$2,000 annually it must move, which is the case in some parts of the country.

It is very difficult for a family with an income of \$2,000, or \$2,500, to find adequate accommodations, whether new or old, in the same community.

Mr. SPENCE. Well, if the turnover has been, on an average, every 5 years, if decent housing has caused them to increase their earnings, that certainly speaks well for the effect of decent housing.

Mr. ROBBINS. I want to be quite fair, Mr. Spence. I don't think we can attribute their increased earnings only to the fact that they are in better housing. I think that we have had an inflationary period, and a period of rising incomes generally, and that certainly is a large factor in the total picture.

Mr. SPENCE. That is all.

Mr. OAKMAN. Mr. Chairman.

The CHAIRMAN. Mr. Oakman.

Mr. OAKMAN. Mr. Robbins, today when you speak of a family with an income of \$1,500 annually, what would they be employed as, other than baby sitters earning \$1,500 today.

Mr. ROBBINS. I gave that as an example because I believe that in the course of our public-housing program there have been families that were admitted with earnings of \$1,500. That may have been back in 1949; it may have been back still further.

I can give you the figure of what the average income of families admitted to public housing was in the year 1952, which is somewhat higher.

In 1952 the income of all public-housing tenants, under a thousand dollars, 10.6 percent; \$1,500 to \$1,999, 17.4 percent; \$2,000—

Mr. OAKMAN. So you have only got 23 percent there total under \$2,000?

Mr. ROBBINS. Yes, sir. Now when you get to \$2,000 to \$2,400 you get another 17.7 percent.

Mr. OAKMAN. That brings you up to about 40 percent?

Mr. ROBBINS. Yes, sir. I'm sorry, I missed one, \$1,000 to \$1,499 was 17 percent, \$1,500 to \$1,999 was 18 percent, and \$2,000 to \$2,400 was 17.7 percent.

If we add those up, we get over 60 percent under \$2,400.

Mr. OAKMAN. Mr. Chairman, in my town, which happens to be Detroit, we allow a couple with no children admission to Federal subsidized housing projects with income up to \$3,100 a year, and we let them stay there until their income gets beyond \$3,600.

Now if they have children, we let them come in, if they have 1 or 2 children, with incomes of \$3,300, and to stay until they get beyond \$3,900 a year.

If there are 3 or more children, they can come in at \$3,500 and stay until their income passes \$4,200 per year.

So that it just appears to me that in my community that the Federal public subsidized housing projects are not being used for people of substandard incomes.

Mr. ROBBINS. Well, it depends on what the median incomes in Detroit are.

The question is, Can the man with a \$4,000 income in Detroit get adequate accommodations for himself and his family?

The Public Housing Administration properly makes a differentiation between the maximum income limits and the minimum admission limits in various cities in the country, based on the cost of living in those communities.

Now I would shock the committee, I think, if I told them what the incomes of families in New York City are, in some public housing projects, because of the shortage of housing for these families. New York City not only has public housing under the Federal program for families of low income which rents at about \$9 per month per room, but because private builders in New York cannot produce anything under \$30 per room per month for new housing, and mostly more than that, New York City adopted its own public-housing program where its rents are \$16.50 per room per month, and there is no possible competition with the private builders in that field.

So that in those projects in New York City you have families with incomes of \$5,000 or more, eligible and living there, because they have no place to go.

Mr. OAKMAN. How many people in the United States, how many families in the United States, have incomes of \$3,900 or less?

Mr. ROBBINS. I will be glad to give you that figure. I have it here.

Mr. OAKMAN. That is the medium figure that we use in our hometown as applicable to public housing.

Mr. ROBBINS. In 1951, 50 percent of our urban families had income of less than \$4,000.

Mr. OAKMAN. Then if we are really going to do the job, and if public housing is the only solution, as you suggest, for half of the people in the urban areas, we are going to have to build public housing.

Mr. ROBBINS. We don't recommend that at all, sir. We believe that 200,000 a year for the next 5 years is necessary, not only to take care of the families who live in the worst housing, but to get on with the program of slum clearance and urban renewal.

We have hopes that the various aids that Congress is considering will help reach lower-income families as we go along. We have suggested, for instance, a series of proposals which call for lower interest rates in Government lending to private enterprise to do this job.

Now, it is also possible that the building industry, through larger scale operations, through the use of new materials and methods, is going to be able to reach a lower-income group. We are under no circumstances advocating public housing for half of the population of the country.

Mr. OAKMAN. Well, I notice in your testimony that you have made the most conservative estimate of any witness I happened to hear, as to the number of units that will be rehabilitated and refurbished under this renewal program.

One witness testified that after a period of years, after the program got rolling and the municipalities could then see what benefits would be derived from it, that possibly there would be as many units being refurbished as there were new ones constructed, and in my town, the committee that is charged with it, very sound, responsible people, feel that that will be the case. That they will refurbish and modernize as many existing structures as they will build new ones.

Mr. ROBBINS. I think, sir, that our prognostication has been very carefully considered and that a great many people who are enthusiastic about urban renewal are not looking at some of the facts in the face. By this I mean, one, that urban renewal is to a certain extent going to diminish the housing supply. Some buildings are going to be closed up because they don't comply with the law.

Some buildings will be modernized, and will accommodate fewer families than they have now. There will be an elimination or diminution of overcrowding, so that your housing supply, to that extent, will be better, but for a lesser number of families.

Thirdly, we know from very sad experience that modernization these days increases rents very substantially, and although we may get some very desirable modernized housing, it will be for higher income groups, again increasing the problem of how do you take care of the lower income groups.

And, lately, I would like to emphasize with all my strength before this committee that although we are wholeheartedly for an urban renewal program, and always have been, as part of a comprehensive housing program, we face what we call a relocation program problem in urban renewal, just as big, if not bigger, as we face in our cities when we clear slums.

And that is a problem which is not being handled well in many communities, and which may have repercussions against the whole program.

Mr. OAKMAN. Of course in your slum clearance and redevelopment, you dispossess more families in the concentrated area, and for a longer period of time, than you would in the renewal program. By the time you condemn an area, acquire it, then clear all the buildings out, and in the process of relocating all the families, that is slow, and then you have to start with your excavation, and start from scratch, and it takes 2 or 3 years to build these big developments where you have got 2,500 units or 2,000 units in 1 development.

Now, on a redevelopment program, you don't have to put everybody out in an eight-block area on the same day or same week or same month. You can do it on a block-by-block basis. It is a continuing sustained program, and that is one of the benefits of it.

Mr. ROBBINS. That is why I don't think it is going to be as big as people say it is going to be, because it is going to have to be taken slowly.

Mr. OAKMAN. Well, I know it took us from about 1945 to now to acquire a site in Detroit and to clear it—the Jeffries project; we are just moving in the families now. We literally owned that property in 1939. We are moving in the families now. That is 15 years.

Mr. ROBBINS. Well, you had the war come along.

Mr. OAKMAN. That is correct. That held us up. But those things are very slow, and you don't move all the families out at one time.

There is another thing I think that we should consider in our planning on public housing even: We try to do the whole area as 1 project, where maybe it should be done in 6 or 8 or 12 bites.

Mr. ROBBINS. Yes; well, that is done in some of the larger metropolitan areas. A project is divided up into 2 or 3 segments. As a matter of fact, the families in area one may be moved, some of them, into the vacancies in the balance of the site. They are relocated there temporarily. The first part of the project goes up, the eligible families are moved into it, and you can go ahead and demolish the buildings in the second part.

Mr. OAKMAN. I agree with you, Mr. Robbins. Our big cities that have so much blighted area, need everything at hand, but I don't think that we are going to build public housing for everybody in America under \$3,900 income, because there won't be enough of us left to support the local governments.

Mr. ROBBINS. I would like to make my position quite clear again. We don't advocate anything of the sort. We advocate a program of 200,000 units a year for the next 5 years, for the families who cannot be possibly taken care of by even the aids that we recommend, and who are going to be displaced, to a great extent, by urban-redevelopment and urban-renewal programs.

I would like to say that you may be interested in Mr. Barry's experience in the city of Memphis, because there they have done a job

of helping the private builders, they have worked on the rehabilitation program, and they have had an excellent public-housing program, and they have had an excellent program for minority groups.

Now, I don't come from Memphis, but he can give you, in his own words, as a businessman in America, his view of that, and I think that you would be interested in hearing him. But perhaps, if there are any other questions for me first, you will want to finish up with me.

Mr. BETTS. Will you yield?

Mr. OAKMAN. I yield.

Mr. BETTS. Just one question.

You mentioned some families being taken back into a rehabilitation area. Are there ever projects where there are more families taken back?

Mr. ROBBINS. I can conceive of cases where a large, originally palatial residence, which has been neglected over many years, and which has been closed down, is remodeled and broken up into apartments for 2 or 3 or 4 or 5 families. We have those all over the country.

But, generally speaking, if we are talking about the 1- and 2-family homes that have slipped considerably, that have deteriorated but are not so bad that they ought to be demolished, I would say those are the homes that are overcrowded, where there will be less families. As soon as you take the toilets from the outside and put them on the inside, as soon as you put in bathrooms, you are reducing the amount of space and you are going to reduce the number of apartments for families. That is the experience generally.

But I would not say that always happens. But I am afraid that one of the reasons why our areas are running down, sir, and that we need an urban-redevelopment program, is overoccupancy. Overoccupancy, overcrowding, is the first sign of the blighting of a neighborhood, and we are not going to be able to really renew these deteriorating areas unless we can provide the families that are living in them, that are crowding them, with decent housing elsewhere.

And what is happening is that we get these terrific drives for law enforcement, which we need, and for neighborhood conservation, which we approve of, and for slum clearance, but we haven't either a good administrative or legal system, generally speaking, to take care of the displaced families, or we haven't got the supply within their means.

Mr. DEANE. Mr. Chairman.

The CHAIRMAN. Mr. Deane.

Mr. DEANE. I wonder if I might direct this question to Mr. Barry, on the basis of the number of families that you found ineligible, say, during last year.

Mr. BARRY. I don't have the number, I am sorry to say, but last year was a rather slow year from that standpoint. Where we ran into our real difficulty was the inflationary trend that developed after the Korean situation broke out, and we found ourselves then facing a real emergency. But we followed the procedure of trying to rid the projects of ineligible tenants as soon as possible.

Now, I would have this to say in response to the remarks that were made about the situation in Detroit. In our city a family with three children is admitted on a maximum income of \$2,600. I think, too, I should make clear my position with this committee. I have no ax to grind whatsoever. I was appointed on the Memphis Housing Com-

mission by the city commission about 18 years ago. At the time I was serving as president of the community fund in Memphis, and did serve for 7 years.

When I got into the housing study I realized that many of the things that we had been trying to do through our local relief agencies were not our problems at all. I heard it discussed in some of the testimony here today that if a person couldn't meet the rents that were required to live in houses provided by the private initiative and enterprise, then the supplement should be supplied from some welfare source.

I can't go along with that wholeheartedly because I believe that it never was the province of a relief agency to chronically administer to the rent needs of a tenant, whether they were occupying a privately owned and operated house or a publicly owned house.

Certainly I agree, as one owning extensive property in our community and engaged in the practice of law and owning a great part of one of the banks there, certainly I want to commit as much as possible of this to private initiative, but what makes me sincere and enthusiastic is this: I am convinced that even if you build a \$7,000 house, where I live, a great majority of those people who live in the so-called slum areas can't even financially support a \$7,000 house.

Now, that probably is no concern of housing. It may be the fault of our economic situation. But I know from moving in and out among those people, and all the contacts I have had with them, that a great portion of our population, living in substandard houses—and this is not criticism and no faultfinding with private enterprise at all—they simply, because of their economic handicaps, cannot measure up to the financial responsibility of that kind of a house.

Now, there isn't any fault or alarming philosophy about this to me. We subsidize them, we help them in all other phases of life. Those who criticize the public intervention in this field of need, are the same people who contribute to the private relief agencies that go into the homes, and if they don't provide shelter they supplement their needs insofar as clothing, food, and what not is concerned.

The one thing that has always concerned me that as we go in and administer to these people on a temporary basis. We give them what they need to eat. We give them what they need to wear. But we leave them where we find them.

Now, if I thought we could go back and rescue these people through the enforcement of a privately inspired initiative and program, I would say to do it all that way. But I have been realistic in my living among my people, and I have many contacts with them.

MR. DEANE. Let me interrupt, if I may. I have a letter here dated March 7, 1953, from the Wilmington (N. C.) Housing Authority. I will precede reading this by saying that the only public-housing unit in my district is one of 50 families. I am not in position to think in terms of cities or their needs, and I have generally supported it because of cities like Memphis and others, but I am conversant with the projects in North Carolina, and I now refer to this letter from the manager of a project in Wilmington, N. C., and he makes this observation:

It has been our experience that families average $4\frac{1}{2}$ years living in our projects.

How long would you say in Memphis?

Mr. BARRY. I would say that that average would apply to those projects that are occupied by the white people. Probably a much longer period than that would apply to the colored people.

Mr. DEANE. How long for the colored people?

Mr. BARRY. I don't have the figures, but I would say that they might run as long as 7 or 8 years.

Mr. DEANE. In this letter the manager goes on, "And 27.5 percent of the families who are required to move because of high income, either purchased a home of their own or moved into standard rental housing."

Do you have any statistics to indicate what percentage of those moving out of the public housing in Memphis became homeowners?

Mr. BARRY. No, I am sorry, I don't. But I do know this: we follow the course accurately, and it has not been our experience that those families who vacate public-housing units go back to slum areas, for the reason to a great extent that we adhere to the pattern of slum clearance in the building of all our projects, and we have diminished to a great extent the slum areas to which they could return.

Mr. DEANE. Are these projects in Memphis in areas which were formerly slum areas?

Mr. BARRY. We have adhered 100 percent to the pattern that we built these new projects only on slum sites, which we cleared.

Mr. DEANE. Can you answer this statement that I will read from the letter written me by Mr. Marshall, housing director of the housing authority of the city of Wilmington, when he says that:

Payments in lieu of taxes to our city of Wilmington, and to our county governments, have averaged 7.7 times greater than tax payments made on the slum property prior to the acquisition by the authority.

I know that it is a very involved formula, which involves subsidies and otherwise, but would you be in a position to tell the committee how much the average would be in Memphis?

Mr. BARRY. I don't have it percentage-wise, but on the five projects which have been completed and which were in operation in 1952, we paid the city of Memphis, for the Memphis Housing Authority, in lieu of taxes, \$128,033.61.

I regret that I don't have the figures paid in those same areas before the slum clearance. I am thoroughly familiar with those areas. Our first experience was this:

That the first area, in the depressed years, which we attempted to clear, was so ridden and infested with delinquent taxes that a great portion of those taxes would never have been paid had it not been for our public housing program.

We stepped in and paid those taxes as a part of our development program.

As I say, I don't have the percentage figure, but I can say without fear of contradiction that what we are paying in lieu of taxes today, in those areas, is far in excess of anything that those areas ever paid in taxes before they were redeveloped in the housing program.

Mr. DEANE. There is one other observation that I would like to make. I likewise made a contact with the manager of the housing authority in Raleigh, in North Carolina, and as of 1951, there were 231 dwellings for white families, and 231 dwellings for Negro families, and the executive directors pointed out to me that the incomes of the

families admitted to the Raleigh projects in the first year were very low. Negro families averaged incomes of about \$800 and white families just under \$1,000.

In the year 1951, 11 years later, the average income of Negro families who became tenants was \$1,566 and the white families, \$1,848.

I would assume and you would too, would you not, that 1952, and 1953 perhaps, would have been somewhat above those averages for both white and Negro?

Mr. BARRY. I would think so, yes, sir.

Mr. DEANE. How much more, would you say?

Mr. BARRY. I don't have the figure in mind. I believe we have a report at home which has that figure, and I would be glad to supply that on my return.

Mr. DEANE. What tenants vacate because they have become ineligible, do you work with the real-estate people in trying to rehouse them?

Mr. BARRY. We work not only with the real-estate people, we work with all other agencies in the city. Our social service exchange, which has probably as full a knowledge of the economic condition and needs of our families as anybody, and I say this by way of parenthesis, that we work wholeheartedly with them, and they work wholeheartedly with us, and with the real-estate people in their developments.

All our statistics and all our information are available to them, just as much as to us.

Mr. DEANE. So far as the present public housing feature of the present legislation is concerned, are there any recommended changes so far as public housing is concerned?

Mr. ROBBINS. There are a few, sir, but we have no objection to them. One of them refers to definitely the percentage to be paid in lieu of taxes.

Mr. DEANE. That is the one that I was coming to. You have no objection to those provisions of the bill before us?

Mr. ROBBINS. No, sir. We favor payments in lieu of taxes. There are other systems, of course, in some of the other States, and in non-Federal public housing.

For instance, in New York State there is a program of State-aided public housing where the projects pay the same taxes that were paid on the land and the old buildings that were there before the project went up. In other words, the city loses no taxes but there is no tax for the additional value created.

But, in general, throughout the country, the payments of 10 percent of shelter rent in lieu of taxes have resulted in higher return to the community and the taxes previously paid on the site. That is because so many of those sites were extremely poor and the housing on them was extremely poor.

Mr. DEANE. Mr. Barry, in closing, I know that you share with all of us the good feeling that your Congressman, Mr. Davis, of Memphis, survived the attack made upon the House by Puerto Rican assassins. I visited with Mr. Davis, at his home the other evening, and he will soon be back with us.

Mr. BARRY. He is not back in his office yet, though, is he?

Mr. DEANE. Not yet, but he soon will be.

The CHAIRMAN. Are there further questions of Mr. Robbins or Mr. Barry?

Mr. O'HARA. Mr. Chairman.

The CHAIRMAN. Mr. O'Hara.

Mr. O'HARA. I merely wanted to state to Mr. Robbins and to Mr. Barry that I have listened to their illuminating testimony with, sympathetic interest, and that I, with other members of the committee I know, are looking for that which you promise on page 6 of your statement, to the effect that you are working on a concrete program.

I hope, when you submit that to us, which I suppose you will be sending to the individual members, I hope you will do it realistically. That is, I think I agree with the gentleman in most of his thoughts with regard to what he has described as a dynamic housing program. That is what I would like to see.

But we can't expect, at this session of the Congress, everything, perhaps, that we would like, and I know that you gentlemen will have that in mind so that you may make suggestions to us that we can submit to the other members of the committee with some hope of having them incorporated in this bill to make this a better bill from your standpoint.

I appreciate very much having had the opportunity to listen to you both.

Mr. ROBBINS. Thank you.

Mr. BARRY. Thank you.

(The following data was submitted by Mr. Barry in answer to questions propounded by members of the committee:)

MEMPHIS HOUSING AUTHORITY,
Memphis, Tenn., March 19, 1954.

HON. JESSE P. WOLCOTT,
Chairman, Committee on Banking and Currency,
House of Representatives, Washington, D. C.

DEAR MR. WOLCOTT: When I testified before your committee on March 12, 1954, for the National Housing Conference, in connection with the housing legislation now being considered, you will recall that Mr. Charles B. Deane of your committee asked certain questions that related to statistical information which was not available to me at that meeting. I have since obtained the information and have listed the questions, with the answers, which are as follows:

1. In Memphis, what are the incomes, low, high, and average of tenants in the years 1950, 1951, 1952, and 1953? What were the income limits for admission and continued occupancy for the same years?

Average income, all families

Fiscal year	At admission	For entire year	As admitted		As tenants	
			Low	High	Low	High
1949-50.....	\$1,402.55	\$1,724.01	\$288	\$2,400	\$288	\$5,100
1950-51.....	1,427.38	1,664.72	360	2,592	288	4,610
1951-52.....	1,557.98	1,803.75	360	3,384	288	4,920
1952-53.....	1,647.25	1,806.63	462	3,168	468	5,865

We wish to call your attention to the highest income of families retained as tenants, because without an explanation this would be confusing. The recording of this high income would result when the tenant reported to us that another member of his family had obtained employment or that he had changed his employment and had bettered his annual salary basis. In all instances these people were ineligible and forced to move from public housing. The answer to question 3 will reflect what happened to such families when they moved from public housing.

Fiscal year	Limits for admission			Limits for continued occupancy		
	2 persons	3 or 4 persons	5 or more persons	2 persons	3 or 4 persons	5 or more persons
1949-50.....	\$1,900	\$2,000	\$2,400	\$2,375	\$2,500	\$3,000
1950-51.....	1,900	2,000	2,400	2,375	2,500	3,000
1951-52.....	1 2,200	1 2,400	1 2,600	1 2,750	1 3,000	1 3,250
1952-53.....	1 2,200	1 2,400	1 2,600	1 2,750	1 3,000	1 3,250

¹ \$100 allowance for each minor through 6 minors. This means that a family with 6 minors could be admitted with an income up to \$3,200.

Also in the case of a service-connected disability pension, the amount of pension need not be taken into consideration when figuring eligibility, but is used for computation of rent.

2. What is the average time a family stays in public housing, white and Negro?

The average white family remains in public housing approximately 38 months and the average Negro family remains in public housing approximately 59 months.

3. What happens to families forced to vacate when incomes go over the limit for continued occupancy?

In 1946 we started to keep records of families moving from public housing into homes of their own and the records indicate today that approximately 1,000 families moved out of public housing into their own home. In all instances, known to this authority, these people had increased their earning capacity to justify this move. We have created a working arrangement with realtors and developers, and especially those that built under the FHA 608 rental plan, whereby we frequently take our higher-income families and ask that the owners of the 608 projects house them and on several occasions we have taken from the owners of 608 projects hardship cases where suddenly the family is unable to pay their rent and have suffered financial catastrophe. This is as it should be to protect the private-enterprise system and to have public housing serve the less fortunate families for whom it was intended.

4. What is the percentage of those families graduating into standard housing?

This percentage would be almost 100 percent. The only exceptions would be where every effort had been made to acclimate a family to good living conditions, but through their inability to acclimate themselves to the facilities, through loose morals, they did not justify living in public housing, it could be through the eviction of such families, they might have moved back into substandard conditions. This is a rare exception and the question of morality leaves no alternative.

5. How do payments in lieu of taxes compare to those paid on the same properties prior to their use for low-rent public housing?

The Memphis program has been one of slum clearance. The authority has insisted that to build new public housing, slum areas should be cleared. This meant that on the old areas used, there was a tax on the property and the improvements thereon. In spite of this slum-clearance program, the city now receives 88.47 percent more as a payment in lieu of taxes than they did on the properties prior to acquisition for public housing.

6. How large is the Memphis program?

The Memphis program consists of 4,412 apartments and represents an approximate capital investment of \$28,647,676.

I ask that this information be included as a part of my testimony and grant permission for its inclusion in your records.

Let me thank you and your committee for your kindness and consideration during my appearance.

Very truly yours,

EDWARD F. BARRY,
Chairman, Memphis Housing Authority.

The CHAIRMAN. Thank you, gentlemen.

The committee will stand in recess until Monday morning at 10 o'clock.

(Whereupon, at 5:43 p. m., the committee adjourned to meet at 10 a. m., Monday, March 15, 1954.)

HOUSING ACT OF 1954

MONDAY, MARCH 15, 1954

HOUSE OF REPRESENTATIVES,
COMMITTEE ON BANKING AND CURRENCY,
Washington, D. C.

The committee met at 10 a. m., the Honorable Jesse P. Wolcott (chairman) presiding.

Present: Chairman Wolcott (presiding), Messrs. Talle Kilburn, McDonough, Betts, George, Mumma, McVey, Oakman, Hiestand, Stringfellow, Van Pelt, Spence, Brown, Patman, Deane, Barrett, O'Hara, and McCarthy.

The CHAIRMAN. The committee will come to order.

We will proceed with consideration of H. R. 7839.

We have with us this morning, Mr. Hughes, president of the National Association of Home Builders, and a member of the President's Advisory Committee on Housing.

We are very glad to have you with us, Mr. Hughes. I understand this is your first appearance before this committee.

Mr. PATMAN. Mr. Chairman, Mr. Hughes is from the State which I have the honor to represent. Mr. Hughes has had a very unusual experience. In the Home Builders magazine of this month there is a wonderful article about Mr. Hughes. It tells a lot about how a businessman can be successful, and what it takes. It is better than a Horatio Alger story for many reasons.

I would like permission, Mr. Chairman, at this point in the record, to insert that article.

The CHAIRMAN. Without objection, it may be received.

(The material referred to is as follows:)

FOR THEIR NEW PRESIDENT, THE HOME BUILDERS HAVE PICKED A REGULAR PAUL BUNYAN FROM TEXAS—DICK HUGHES, NEW NAHB PRESIDENT

Dick Hughes' fantastic adventures began with a tragedy even before he was born, when his whole family was caught in the devastating Snyder cyclone of May 1905. His father, his grandfather, his grandmother, and dozens of other relatives were killed. His 17-year-old mother was found 24 hours later high in the branches of a cottonwood tree 5 miles away. Her back was broken and the wonder is that she lived to give birth to a bouncing, healthy boy on November 24, 1905.

"We did not call our home a cave, we called it a dugout," says Dick Hughes in describing his humble beginnings. He went to school in White Deer, and in the evenings his great-grandmother (born in 1828) told him tales of early days on the Great Plains, and of her grandmother, a fullblooded Indian.

After high school he went to West Texas State College at Canyon. "I worked part time as a bookkeeper in a bank," says Hughes. "I worked in gas stations, as a janitor, and I also milked cows in a dairy." But a few months before graduation he had to leave college because of illness, and he never got his diploma.

After he left college he wanted an outside job to build up his health and went to an uncle for advice. His uncle told him he would never amount to anything unless he could overcome his shyness and learn to meet people. Dick asked the best way to meet people.

"Sell insurance," said his uncle, then searched his rolltop desk until he found an insurance policy with the address of a St. Louis firm. Hughes' uncle wrote the insurance company to send Dick a rate book and a salesman's manual.

Assuming the company manual had to be followed exactly, Dick scoured the town for customers from daylight until after dark. Although there were only 600 people in White Deer then, he sold \$982,000 in policies the first year, just missed qualifying for the million-dollar round table. But members of this blue-ribbon sales group were so impressed with his record and his age they voted him in anyway. Insurance was to be Dick's principal job until after 1940, when he turned builder.

Hughes got into the building business because he thought that something should be done about better housing in Pampa. Many of his friends lived in garage apartments and in the poor housing that grows up in an oilfield town. His first project was 100 houses and he sold them for \$250 down and \$17.46 a month.

Hughes formed a small company which built 1,100 houses during the war. Dick wanted to rent the houses until after the war, but his partners wanted to sell. With his share of profits from the sale of 500 houses, Dick bought out his partners.

"I had 600 houses left," Dick told a Trade Secrets group, "and by holding them until 1947 and 1948 I was able to sell them for an average of \$7,000 and put \$2,138,000 in the till. I wasn't particularly a genius. I just had guts enough to hold on. And I still sold them \$1,000 under the market."

HE WAS BORN WORKING

"Since I left college at 19 I have never drawn anybody's pay check but my own," Hughes says. "I have never slept more than 4 or 5 hours per night. This doesn't prove I'm smart—just that I have worked harder than most people."

"He was born working," one of his staff says, "and he has been working ever since." Today the 48-year-old Hughes is the head of a multimillion-dollar building enterprise that includes forests, mills, lumberyards, cabinet shops, construction operations in half a dozen southwestern communities, several subsidiary organizations dealing in titles, mortgages, insurance, several kinds of wholesale-retail distributorships including air-conditioning. He owns 2 radio stations, is treasurer of an investment firm, built and owns his office building, 2 shopping centers, and various related businesses. His best building year was 1952: 936 houses plus numerous stores. Last year he built about 600 houses, priced from \$7,000 to \$9,500. He would have built more if he had not spent so much time on NAHB business in Washington and in traveling and speaking throughout the country.

THE DICK HUGHES PLUMBING LAW

His energy enabled him to bulldoze his way through red tape and inertia to put through, a few years ago, what is often called the Dick Hughes plumbing law. Under a former Texas law a plumber had to be licensed for each town he worked in. In one town where Dick was building houses the three men on the licensing board were a plumber, his son and their helper. No other plumber could get a license and Dick felt he was being badly overcharged. Single-handed he persuaded the legislature to pass a bill licensing plumbers on a statewide basis. Overnight the price of plumbing in some towns dropped \$200. Dick was appointed chairman of the State licensing board and has held the job ever since.

He also gets full credit for the Texas decontrol of rents. Just after Congress passed a law permitting rent decontrol the Texas State Homebuilders decided to try to get the State legislature to pass a law, although there were only a few days in which new bills could be introduced. Dick took on the job; the bill passed.

This sort of service has made him "the most popular builder in Texas." All builders have come to depend on him.

"Everyone consults him," says an architect. "He's got a common touch and he's at home with everyone from the men on his job to the bank president."

CONVICTIONS AND TRACTORS

"Dick is a man of very strong convictions," says a man who has watched him work. Nowhere has his determination to carry out an impossible task been more in evidence than in his one-man slum-clearance job in Borger, Tex., in an area of shacks that had been built in the twenties after the discovery of oil (House & Home, July 1952). There were no streets, no planning, people didn't own the land their shacks were on and ranchers would not sell because of the oil. Killings were common. It was one of the last of the wideopen frontier towns.

"I had a deed to the land," says Dick, "but 1,500 families owned the shacks under an old Texas statute which smiled on squatters' rights. One old boy was particularly stubborn. We had moved dirt from around his house until his outdoor toilet sat on a high pinnacle. He finally said: 'By jiminy, Hughes, I'll have to move. My ladder is so short I can't get up to my privy.'"

Actually Hughes loaned or gave money to many families to move their houses or rent new ones. He moved 1½ million cubic yards of rocky earth, relocated some 28 miles of pipelines, put in a complete sewage system plus streets and some parks, and built nearly 2,000 houses, priced from \$3,800 to \$4,100.

As a business venture, the Borger experiment is a prime example of how to earn money the hard way; but it is typical of Hughes' concern with his community, a concern which now embraces all United States communities.

FATHER OF AIR-CONDITIONING

Hughes is generally credited with being the spark that set off the home air-conditioning explosion. He had seen mechanical air-conditioning being put into larger houses in the Southwest and decided that people in small houses should have summer comfort, too. At the first Trade Secrets meeting in the fall of 1951 he said:

"I can't get anybody to agree with me, but I think 5 years from now that houses in the Southwest without some type of refrigerated air-conditioning, even 800 square feet houses, will be as obsolete as houses without a refrigerator plug."

The trade press quoted him widely and leading manufacturers began to get interested. Then Dick began talking about the need for an air-cooled condenser that would eliminate water cooling. Now half a dozen firms have air cooling on the market.

"Our boss is thorough and extremely analytical," according to the Hughes home office. "He surprises and irritates our engineering department with his ability to analyze engineering proposals. He is also in the hair of the architects, because he is never satisfied. He is always demanding something new in design, comfort, and livability."

In his 15 years as a builder Hughes has come to typify the new breed of home-builder who is fundamentally successful because he understands banking and business, knows how the Government operates, and is a shrewd merchant. But Hughes the big businessman understands the little businessman. And his understanding has been sharpened by his younger son, 22-year-old Lynn, who went into the building business on his own 2 years ago, and who has been having the typical small builders' problems, which he brings to her father for solution.

Probably no previous NAHB president has spent so much of his time on NAHB affairs. Hughes has been a national director, regional vice president, chairman of many committees, national secretary, national treasurer, and last year was first vice president, serving in these posts under Bill Atkinson, Alan Brockbank, and Manny Spiegel. He and Rodney Lockwood were the two builder members of President Eisenhower's highly important Committee on Housing, and many of their ideas were incorporated into the final report. Dick spent far more time in Washington last year than in Pampa.

During this siege he got well acquainted with top Government men who will influence housing legislation this spring. He has been a major NAHB sparkplug in slum clearance and rehabilitation. He has a deep personal interest in NAHB's research activities and will provide strong backing for the air-conditioned village in Austin. He will bring both his experience and his drive to the new NAHB housing center in Washington, which should be finished this year. Hughes has a valuable background in dealing with mortgage problems and some highly interesting ideas which he hopes will help to furnish more mortgage money for builders in the months ahead.

"He can work 24 hours a day, 7 days a week," says a California builder, "and that's the kind of man this job calls for. Hughes is a man dedicated to the homebuilding industry and we need a man with that much fervor."

The CHAIRMAN. All right, Mr. Hughes. We will be very glad to have you proceed.

STATEMENT OF R. G. HUGHES, PRESIDENT, NATIONAL ASSOCIATION OF HOME BUILDERS, ACCOMPANIED BY JOHN DICKERMAN AND HERBERT COLTON

Mr. HUGHES. Mr. Chairman, my name is Dick Hughes, of Pampa, Tex. I build homes in several towns and cities in Texas and in Oklahoma. I am privileged to appear before you today as president of the National Association of Home Builders, the trade association of the builders of America's homes. It has a membership of 29,000, organized in 215 affiliated local associations.

You have heard a great deal of discussion about the contents of the bill before you. I do not intend to go over all that ground again. I would, however, like to give you first our concept of the housing problems which confront the Nation; second, our opinion of what should be done about solving these problems; and third, how this bill—with certain amendments—can help.

According to the most recent report of the President's Council of Economic Advisers, only 11.4 percent of expenditures went for housing in 1953. Table I.

This is attached to this statement. On the chart it is shown on my left.

This was a decline of over 21 percent from the 14.5 percent that went for housing in 1929. Our industry has provided Americans with more than 8 million new homes since World War II and, for the first time in our history, more people live in homes of their own than those who live in rented quarters. However, owners and tenants are living in these homes at a cost, in relation to their income, far less than in 1929. This is shown on chart 2 and table 2 attached to this statement.

The construction of over 8 million homes in 8 years, the reduction of 21 percent in the ratio of housing cost to income, the increasing ratio of home ownership, and the industry's important contribution to the economy could not have been attained had it not been for the assistance which Congress made possible through FHA, VA, and FNMA.

Although we have made definite forward progress, we decided recently to make a thorough and careful survey of housing in America as it is and then endeavor, to the very best of our ability, to visualize housing in America as it should be. The results of our studies revealed some startling indications of our housing needs. This is detailed in table 3 in the back of this statement, and is shown on the chart which is now before you.

1. Six million nine hundred thousand additional homes will be needed for the net new-family formations by 1960.

2. Approximately 7 million units are reported as unfit for habitation—dilapidated or lacking in private bath or toilet. This figure is expected to increase to 9,200,000 by 1960.

3. Nearly half of the houses which are considered habitable are deteriorating through lack of proper maintenance and need substantial repairs.

4. Birthrates reached 3 million in 1943 and increased to an all-time high of 4 million in 1953.

5. By the early 1960's family formations, which largely determine the demand for new homes, will jump from the current 750,000 to an annual rate of about a million and a half, and, in the following decade, are expected to increase to about 2 million per annum.

These facts have convinced us that the figure of a million homes a year—which has somehow become accepted as the standard of new-home construction volume—is too low. It seems to us self-evident that the home-building industry must be made ready for the long-range task which will soon face it. We must develop a comprehensive housing program to assure the continued production of needed new houses; to conserve the housing which is just beginning to deteriorate; to rehabilitate the slum housing which is structurally sound; to demolish the slum housing which is not structurally sound and reuse the land to its highest and best use. We have talked about it too long. Now is the time for action.

If as a nation we fail—during the next 10 years—to rehabilitate the existing slums, to stop further decay on existing houses in order to prevent the creation of more slums, and at the same time to build the needed new houses, we will be faced with an impossible task when the new-family formations reach an all-time high in the sixties.

Personally, I do not believe it is economically possible to put every American family in a new home. I cannot agree with any philosophy which would destroy structurally sound houses if they can be economically rehabilitated. Furthermore, I do not believe that every family expects to live in a new home any more than they expect to own a new automobile. However, I do believe that every American family deserves and rightfully should have the opportunity to live in a decent, safe, and sanitary house. And I believe that industry and Government should include that objective in a new national housing concept.

We heartily support the objectives of this bill because we believe that under its provisions—with our suggested amendments—such a concept can become a reality. Given the assistance which this bill provides—with the amendments outlined in principle on the following pages and detailed in an appendix attached to this statement—we believe that the home-building industry can provide an average of 2 million new or new-conditioned homes each year through a combination of increased production of new homes and the rehabilitation of structurally sound existing houses. We believe it will enable us to attain the 10-year average annual goals set by the National Association of Home Builders at our recent convention in Chicago. This program will not completely solve but it will make rapid inroads on these housing problems. I shall detail the objectives of the program and attempt to explain how the bill would assist in carrying out those goals.

1. One million four hundred thousand new housing units annually.

(a) We believe that 1 million of these homes should be larger and

even better in design, livability and eye appeal than the houses we have been producing. In order to meet this goal FHA's down-payment structure must be revamped and brought up to date.

(b) Two hundred and fifty thousand good, well-designed, smaller homes should be built annually for low-income families. We believe this goal can be attained provided the present concept of title I, section 8, is retained and certain necessary changes are made in the proposed new section 221, and further provided that the new section be expanded so as to include housing for minorities on a specially programed basis.

(c) One hundred and fifty thousand rental units should be provided under the urban redevelopment program to replace demolished slum structures.

2. Six hundred thousand homes to be provided by new-conditioning and rehabilitation of usable existing structures.

(a) Of these, 250,000 roughly would be older homes accepted by builders under a "trade-in plan" as part payment on new homes. These houses would be new-conditioned before resale. There are provisions in this bill which would make this trade-in program work. I refer to the revision in the FHA structure which would allow the same ratio of loan to value on existing properties as on new properties, and to the changes in down payments.

(b) Three hundred and fifty thousand houses to be rehabilitated annually under municipal programs of rehabilitation through law enforcement.

As stated above, conservation of the existing housing inventory which has not yet reached slum conditions is a necessary part of a comprehensive housing program. This bill provides the necessary financing tools in (1) the open-end mortgage; (2) the expanded FHA title I for repairs and improvements; (3) the same ratio of loan to value on existing properties as on new properties, and (4) the new FHA section 220.

Such a program would have a tremendous effect in supporting the economy at a high level. Its possibilities are discussed in an article in Fortune magazine for February 1954, entitled "The Insatiable Market for Housing," which I call to your attention. I would like to read a paragraph from that article:

The fact is that the housing market—barring war or depression—now holds promise of providing the great United States "growth situation" of the 1950's and the 1960's. Housing is the only 1 of the Nation's 4 largest markets—the others are food, clothing, and autos—that today has strong potentialities for growing faster than the economy as a whole. It is now close to a \$20 billion market, already larger than the auto market, and promises to become larger still. And, because new houses mean new furniture, new appliances, new stores, new highways, new schools, housebuilding is bound to play a portentous role in keeping the whole American economy prosperous.

But this demand, great as it is, will depend largely on proper mortgage financing—table No. IV.

I. Amendments required to attain 1,400,000 new homes annually.

(a) New homes:

Revision of the schedule of ratio of loan to value and maximum permissible mortgage amounts for 1 to 4 family houses under FHA, section 203; extension of the maximum term of all section 203 loans to 30 years; increase in maximum permissible amount for rental hous-

ing under section 207 and for cooperatives under section 213 are all necessary to accomplish the program we envision. However, these changes are required:

(1) Delegation of congressional authority over down payments and term of loan should be stricken.

The increases in ratio of loan to value, increases in the maximum permissible loan amount, and the longer maximum term should become effective immediately. We are opposed to make these changes conditioned on a Presidential order—suggested amendment No. 1, schedule A.

In our opinion, such a two-stage arrangement is wrong in principle as an undue delegation of congressional authority which can be justified only by existence of a clear emergency. No such emergency exists which might require action before Congress could act. The home building industry, as we believe this committee knows, by its very nature, requires a long-term basis for operations under rules well understood by builder, lender, and customer. It has been handicapped too often in the past by a constantly shifting set of rules which have, on occasion, prevented builders from planning and building projects in an orderly fashion. Such sudden changes are disruptive to the sales market. Buyers do not know from time to time how much cash savings they must accumulate. Sources of construction financing and permanent mortgage money are interrupted. Moreover, the intended result is not accomplished.

The recent experience under regulation X should prove the impossibility of using credit terms to stimulate or depress the home-building industry quickly. I have attached figures which show that the result then was the opposite from that intended—table No. V. The industry naturally tries to anticipate and outguess possible administrative moves. The complex process of planning, constructing, and marketing homes requires a long-term stable climate to operate effectively. The home-building industry cannot and should not be turned on and off like a spigot.

It should be borne in mind that the statutory ratios are maximum limits. In practice, the actual amounts accepted by FHA for particular cases of course do not always go to the maximum. They are adjusted from time to time, from area to area, and from case to case, as seems appropriate to FHA in the exercise of its responsibility in insuring the particular loan. This type of flexible, individual variation is a very different thing than a variation in the maximum by some centralized authority.

Finally, I wish to point out that the individual lender also exercises control with respect to the amount of any particular loan at any particular time. The Federal agencies—such as Federal Reserve Board and the Treasury—which control the money supply, control generally the terms under which lenders are willing to make loans. This has been thoroughly demonstrated in the past year. To control ratio of loan to value, maximum loan amounts and maximum loan terms, the Federal Reserve System need only make very slight changes in the credit controls which it already operates.

Therefore, we believe that the controls already granted FHA, which may be used nationally or on an area basis, are more equitable for

buyers and less disconcerting to builders. Add to this the general monetary controls which may be applied by the Federal Reserve, which cause lenders to increase down payments and shorten terms of amortization, and the Government has sufficient authority to properly control our industry.

We have previously urged this committee to modernize the FHA maximum limits of percentage of loan to value to bring the downpayment schedule under section 203 of the National Housing Act in line with the value of today's dollar. The present statutory limits have not been substantially amended in 10 years. Although values and consumer incomes have doubled, the downpayment now required on a \$12,000 house is 4 to 5 times the dollar amount required on the same house 10 years ago. Then a \$6,000 house could be purchased with a downpayment of \$600; today, the same house would sell for \$12,000 to \$15,000 by reason of the general rise in all price levels, and would require a downpayment of \$2,400 to \$3,000. In addition to the downpayment requirement, the purchaser, of course, must have available in cash at the time of title settlement approximately \$400 to meet closing costs and prepaid mortgage expenses. It is the general experience of builders that the typical buyer of a house in this price class rarely has more than about \$1,000 in cash to meet all his requirements.

This out-of-date FHA schedule has caused home builders to build to a mortgage pattern rather than to meet housing needs. This is illustrated in our chart showing size of owner-occupied housing by years built. As you can see, the production of housing with five or more rooms has been decreasing steadily and substantially since 1939.

The next chart, percent of bedroom needs met, was made from figures obtained in the latter part of 1949 and first part of 1950. This chart shows that, at that time, only 79 percent of those who actually needed a 3-bedroom house were able to buy it; and only 22 percent of those who needed a 4-bedroom house were able to buy it. Because of the high birthrate, since 1950, we believe that a much greater percentage is unable to buy the 3- and 4-bedroom house today.

We have just received recent figures showing that since 1950 there has been a 21.8 percent increase in 3-children families, and a 15.6 percent increase in families with 4 or more children.

In order to correct the housing trends shown in the first chart, and to meet the bedroom needs shown in the second chart, we propose the following amendments:

We believe strongly that the amendment to section 203 (b) (2) of the National Housing Act, contained in section 104 of this bill, is absolutely necessary in fairness to nonveteran home buyers, but that downpayments permitted under it would be still somewhat too high for the average customer. It should be amended in two respects:

First, to recognize closing costs and prepaid mortgage expenses as part of the cash downpayment requirement. Second, by applying the 95 percent limit to the first \$10,000 instead of the first \$8,000 of appraised value. Suggested amendment No. 2, schedule A.

A low downpayment is a historical necessity in the home market. Some years ago it was made possible by dangerous second- and third-mortgage financing. The FHA single high percentage first mortgage is a far safer way to fill this need. A study of mortgages in a typical

city in the 1920's shows that at that time 72 percent of properties carried loans over 80 percent of value and of these 55 percent were encumbered by second mortgages, and 12 percent by third mortgages. A fuller discussion of this study is attached (Table VI).

(3) Rental housing and cooperative housing:

We support the amendments to section 207 and to section 213. However, we call to the attention of this committee that the maximum dollar limits under section 207 are substantially more restrictive than those provided for cooperative housing under section 213. As a partial equalization, the limits under 207 should be \$7,500 and \$7,800, respectively.

Our builders believe that 80 percent of value, or \$2,000 per room, for non-elevator-type apartments, or \$2,400 per room for elevator-type apartments, is sufficient. It is designed to encourage larger rental units, but the restriction of \$7,200 for nonelevator type and \$7,500 for elevator-type apartments having an average of less than 4 rooms, will have a tendency to reduce the construction of units to be rented in lower brackets. For example, an apartment with kitchen, dinette, bath, and 1 bedroom, would be classed as 3½ rooms—less than 4—therefore, it would qualify for only \$7,200 nonelevator type, \$7,500 for elevator type. But this small apartment has the same basic expense in plumbing for bath and provisions for the kitchen as the larger apartment.

There is also more unusable space lost in access hallways. To offset this we are asking for an increase in these limits of \$300 per unit.

Although not covered by this bill, we would like to call to your attention a rapidly developing problem. In many areas school facilities and utility installations are utterly inadequate to provide for our growing population. Local governments have exhausted their resources and are, in many cases, seeking to slow down and even to prohibit entirely further home building within their communities. This will affect new home construction under section 221 as well. Some solution for these problems must soon be found.

This is probably not the time to suggest remedies for the entire problem. However, the school situation could, in our opinion, be substantially relieved if builders could rent to local school boards for classroom use one or more houses out of their projects. It would encourage such a practice if FHA would permit temporary use for that purpose without affecting its mortgage insurance. This would be somewhat analogous to the provisions in sections 207 and 608 for insurance of portions of rental projects for nondwelling use. We think the wording of the statute does not forbid this, but the problem is sufficiently important to warrant a clarifying amendment at this time. Suggested amendment No. 3, schedule A.

(b) Two hundred and fifty thousand small homes for low-income families.

(1) FHA title I, section 8.

We agree to the repeal of title I, section 8, in order to streamline the National Housing Act, on the specific understanding that FHA intends to continue this activity by appropriate regulations under section 203 which would permit, under that section, the same minimum construction and development requirements, service charge, and other

features now characteristic of title I, section 8—suggested amendment No. 4, schedule A.

(2) Section 221.

We also support the provision which would add a new section 221 to the National Housing Act. The bill, as written, would make units produced under this section available only to families dislocated or displaced because of programs of rehabilitation or urban redevelopment. They would be given an opportunity to own a home with a downpayment of \$200 and 40 years to amortize the loan—provided their incomes are sufficient to pay the FHA debt service, or monthly payment. Standards of qualification for such a loan will be figured by the FHA on the same ratio of income to debt service—monthly payment—as any other FHA loan. Our computations indicate that many such dislocated families could qualify for such a loan.

In the city of Detroit, under a program of redevelopment, 1,953 families were dislocated. Of these 1,953 families, 1,322 had incomes of \$2,500 or more. Eight hundred and eighty-six families had incomes of \$3,000 or more (table No. VII). On the usual FHA ratio of 25 percent of income for mortgage charges these families would easily qualify for a loan of \$7,500 under this section.

I have heard much discussion about the economic soundness of section 221. In my opinion, FHA would and could put economic soundness into these section 221 loans by increasing the insurance premium in order to place into its reserves for losses a sufficient amount to cover its increased risk. Thus this type of loan would be economically sound on the same basis as a fire-insurance company gets economic soundness by charging a larger premium on frame houses than on masonry houses.

The bill also provides that the builder may build section 221 houses and close a loan of 85 percent of value. The builder may then rent or enter into a contract for sale to dislocated families who cannot qualify to purchase the houses. When the income of the dislocated family has increased or its financial condition has improved so that they can qualify, the contract-purchaser can then close the FHA loan in his own name. This is certainly not a bonanza for the home builder, but it can be made to be sound and it can, in our opinion, provide many families with homes who, prior to this time, have not been given the opportunity to own their own home.

As we interpret this section, it would not be confined to new homes and, in larger cities, new conditioning of existing properties would be used extensively. We support the provisions of section 221 because it is a bold, new experiment to adapt the resources of home building and home lending to the problems of housing low-income families. It will give many low-income families their first opportunity to own their own home. It will give the home building industry an opportunity to prove that it can provide better housing at less per unit cost to society than under any other system.

We urge two changes. First, we strongly urge that the facilities of this section should not be confined solely to families displaced by slum clearance or rehabilitation or redevelopment projects, but should follow the recommendation of the President's Advisory Committee. It contemplated use of the section for all low-income families, whether or not displaced by slum-clearance projects, but on a limited-program

basis. It was felt that the section would be particularly useful for housing minority groups—suggested amendment No. 5, schedule A.

In our March issue of the NAHB Correlator, which has been given to you, you will find that the National Association of Home Builders has accepted the challenge of housing the minorities as one of our greatest problems. We are going to do everything we can to get something started in really a big way on minority housing.

The \$7,000 limit should be restored to \$7,600 with a possible \$8,600 in high-cost areas, which was the recommendation of the President's committee. The \$7,600-\$8,600 figure was suggested by a group of some 20 home builders presently building low-priced homes in and around such areas as Detroit, Cleveland, Pittsburgh, Boston, and New York. This group was called to Washington for the specific purpose of assisting the President's Committee to determine what the lowest attainable limit would be. It was their informed opinion, based on experience, that minimum homes could be built for \$7,600 in all but the highest cost areas. A \$600 cut below that figure will permit such construction in some areas but will pose an impossible problem in northern and eastern cities, and in other high-cost areas. For example, I have been building a 2-bedroom house for \$5,500 and am planning a 3-bedroom house to sell at \$6,750. This home is of good modern design, has central heating and a carport. I doubt, however, if it could be sold in and around a northern city at that price, but I am told that it could be duplicated within the \$7,600-to-\$8,600 range—suggested amendment No. 6, schedule A.

We have brought with us to show the committee pictures of houses in areas in New Jersey, Long Island, Detroit, Indiana, and, of course, many of them in the South and Southwest, but we have tried in particular to bring with us pictures of houses that are being built right at this time under title I, section 8, of houses that sell within the price ranges that I have been talking about.

We do not underestimate the difficulties which must be overcome to provide privately financed housing for this type of need. One of the major problems will be to overcome the present attitude of cities which frown on the construction of low-cost housing. However, we are convinced that the proposed section 221 would give the industry the opportunity to prove that it can provide housing for low-income families.

In looking over the pictures on title I, section 8, houses we are building at this time, I want to call your attention that it was only since last August that we have been able to get any title I money. It was after the half a point service charge was granted that some of the builders in some areas were able to get some title I money, and they have started back building title I houses again.

II. Amendments to provide 600,000 houses by new conditioning and rehabilitation.

A. Trade-in plan.

In order for this to operate successfully, the changes in downpayments, above referred to, must be made to apply on the same basis to existing properties as to new properties.

B. Rehabilitation through law enforcement.

More than a year ago the National Association of Home Builders created a housing rehabilitation department under the direction of

Yates Cook, creator of the now famous Baltimore plan. Under this plan some 18,000 units were rehabilitated.

The details of NAHB's program are outlined in the NAHB rehabilitation kit which has been distributed to each member of this committee. This kit clearly outlines our interest in the program. Cities across the Nation are constantly requesting Mr. Cook's services—eager to find a solution to this problem. We established a pilot rehabilitation block in New Orleans to prove that houses more than a hundred years old could be rehabilitated. We have sponsored rehabilitation training schools for city officials. The desire to rehabilitate the Nation's slums already exists. However, in the final analysis the major problem has always been, How can the program be financed?

The solution to this problem is provided in this bill.

(1) Section 220. Section 220 is one of the vitally necessary tools in the program I have described. It would permit FHA, under proper safeguards, to extend the benefit of its mortgage insurance program into areas now regarded as blighted or deteriorating, provided that the local community sets aside the area for rehabilitation and institutes a plan satisfactory to the FHA, which will assure that the entire neighborhood will be rehabilitated. This is thoroughly compatible with the FHA requirement of economic soundness and is in line with the growing movement to encourage efforts to conserve thousands of homes now being allowed to deteriorate.

(2) FHA title I.

We endorse those amendments which increase the maximum amount and the maximum term of loan under title I. These loans, as you know, are for modernization and repair. They are essential to a conservation and rehabilitation program.

The bill also contains a provision whereby loans and grants may be made to cities which have shown their willingness to help themselves in order that these slum areas may be properly replanned and provided with the necessary parks, playgrounds, schools, and utilities.

Such a comprehensive program as outlined above would require that approximately 30 percent in additional funds be channeled into mortgage financing. The National Association of Home Builders has established a new mortgage finance department, the purpose of which is threefold:

1. To find additional mortgage funds;
2. To channel them into mortgages;
3. To promote the small bank participation plan.

Two portions of this bill are of vital importance to an adequate supply of mortgage financing at terms required by the market. These are title II, which concerns itself with interest rates and mortgage terms and conditions, and title III, which provides for a revised Federal National Mortgage Association.

Interest rates: For the past several months, yields on investments of all kinds have been dropping sharply, and, to some extent, this has naturally been reflected in mortgage rates. With Treasury 3¼-percent 30-year bonds selling over 109 to yield approximately 2.65, and with Treasury 2½'s of 1967-72 selling just under par, a 4½-percent interest rate on Government-guaranteed or insured loans should be ample at this time.

It has long been the position of home builders that maximum permissible interest rates for both FHA insured and VA guaranteed loans should be the lowest feasible rate at which funds will flow into those loans in reasonable amounts, and should be at a rate to reflect the longer swings in investment yields. We do not object to Presidential power to set interest rates from time to time. The portions of this bill, however, which extend such power to down-payment requirements and maturities should be eliminated for the reasons stated earlier—suggested amendment No. 7, schedule A.

The Federal National Mortgage Association: The distribution of funds for mortgage financing throughout the country is uneven and imperfect. Particularly in the South, the Southwest, and the Far West, the supply of local capital is chronically insufficient to finance the new homes needed to keep pace with population growth. Consequently, these areas must import mortgage money.

This is graphically shown on the chart which I have before you.

The supply of capital for this purpose from areas with excess mortgage funds is subject to considerable fluctuation. Moreover, even in areas normally well supplied with capital, additional funds are sometimes required for brief occasional, or seasonal periods.

If we are to have a sound, nationwide, mortgage lending system, a central mortgage bank is essential to meet these needs. It is as necessary for mortgage credit as is the Federal Reserve System for commercial banking.

A workable mortgage reserve facility will become even more necessary to help the private mortgage lending system meet the expanded demand which we foresee for new and new-conditioned homes.

In our opinion, the proper objective of a central mortgage bank is to assist in providing an adequate and stabilized mortgage market so that homes may be provided in the volume, in areas, of the size, and at the prices that the home-buying market requires.

It is a vital instrument both to maintain the economy and to satisfy the needs of the people. Only by a governmentally supervised facility can this be done.

Although governmentally supervised, it should operate on private funds and should pay its own way. But its purpose should not be merely to accumulate a profit. The welfare of the Nation as a whole, both socially and economically, requires that it help develop a progressive, forward-looking, stable and adequate mortgage market.

We heartily concur that it should be operated on a businesslike basis, and that it should offer its facilities only at such prices and on such terms as will reasonably prevent its excessive use. But its cost to a user should not be so high nor conditions for doing business so harsh as to make it available only at terms which would be regarded as exorbitant if demanded by private lenders.

Title III of this bill fails to meet such a concept in several important respects. Unless amended it will, in our opinion, prove unworkable and possibly do more to depress than to assist the mortgage market. Its terms go far beyond those reasonably necessary to prevent excessive use and, in effect, amount to a complete denial of the facility to the very users for whom it is intended.

This is so because:

(1) The bill conceives the function of the facility to be to purchase only those mortgages which are, at the time, sought by private institutional mortgage lenders. Instead, it should authorize the association to consider the inherent soundness of the loan and the prospect that the private market will, after a time, find loans of that class acceptable. The soundness of a loan and its marketability at a particular time are not necessarily synonymous. The private market has, in turn, regarded with disfavor FHA 80 percent loans, FHA 90 percent loans, GI loans, rental housing loans, loans on cooperatives and loans on minority housing. Only a short time later, lenders have bid spiritedly for the very type of loans that they originally branded as not acceptable. The concept in this bill would have prevented purchase by the association of loans of any of these classes regardless of their inherent soundness and regardless of the fact that these loans could well have supported debentures issued against them. The profit record of FNMA is vivid proof of this. Dealing in loans which are regarded by some as inferior, FNMA has a delinquency rate that compares favorably with most lending institutions and has paid interest on its borrowings; paid a profit of \$91 million to date; accumulated additional surplus and reserves of some \$40 million; is making a profit of about two and a half million dollars a month.

(2) The association is limited to buying for immediate resale. This would make it merely a mortgage broker and provide no useful function not already served by private companies. It should be permitted to buy for eventual resale at such later time as market conditions become favorable. The association would then be able to keep itself appropriately liquid while materially assisting to stabilize mortgage conditions, which, in our opinion, it cannot do under our interpretation of the present wording.

(3) The association must buy at or below the market; require a contribution of at least 3 percent; and, in addition, charge a fee for its services. We understand Administrator Cole in his testimony a few days ago expressed concern that the 3 percent figure may be too high.

All of these requirements, taken together, would equal as of today a discount of $6\frac{1}{2}$ percent to 7 percent. This is far in excess of the charges reasonably required to prevent excessive use of the facility. Nor are such amounts needed to produce a reasonable operating surplus or to repay the Treasury over a reasonable time for the capital it provides.

On a \$12,000 loan, for example, this formula would result in a cost for permanent mortgage financing of \$750 to \$850. This equals, and probably exceeds, the extremely high discounts which characterized the mortgage market during last summer's unusual credit stringency. This, we submit, is not a proper formula for a mortgage reserve facility. We believe it should be the purpose of the Federal Government to seek to eliminate charges of this amount rather than to encourage them.

Although the lender will retain the asset represented by the convertible certificate evidencing the capital contribution required by this plan, it will be the builder who pays. In those situations in which resort to this facility will be necessary, because of lack of local mortgage credit, the builder is not likely to be in a bargaining position strong enough to avoid this.

In our opinion, the restrictive conditions written into this bill result from the unjustified assumption that its operations should be judged by the experience of the Federal National Mortgage Association in recent years. This overlooks the fact that the Federal National Mortgage Association became a problem only after it was forced to provide support to a 4 percent interest rate. We should be guided rather by the experience of FNMA during the years 1938 to 1945. During that period the association performed, with notable success, the very function which we are here discussing. It bought loans only in modest volume and balanced its purchases by a sizable amount of sales, reflecting the ebb and flow of the availability of credit.

(4) The association in the bill would be turned over to private control.

The function of the association is of such fundamental importance to the Nation's credit structure that in our opinion it must be governmentally operated although obtaining its funds from private sources. In this respect it would be generally comparable to the Federal Housing Administration, which is an entirely private fund accumulated by payments made by its users, but is, nevertheless, a Government agency. The combination of private financial interest and governmental supervision tends to give to the operation a happy combination of influences needed in a function of this nature. Moreover, the possibility of transfer to unknown owners will seriously impair marketability of the association's debentures.

In our opinion, it is necessary to amend title III in the following respects if it is to accomplish what we believe to be its intended and proper purpose.

(a) The test of eligibility of a loan for sale to the association should be its inherent soundness and the determination that loans of the same type and general class will, in the portfolio of the association, constitute a prudent basis for the sale of its debentures to private investors. Suggested amendments Nos. 1 and 5, schedule B.

(b) The Association should be authorized to buy loans at a reasonable price level, as determined by it from time to time, taking into consideration not only the market price at that time, but also the reasonably foreseeable market for mortgages of the same class, and current yields on—as well as the reasonably foreseeable price trend of—long-term Government bonds and other forms of investment—suggested amendment No. 5, schedule B.

(c) Funds from private sources, to repay the initial capital provided by the Federal Government, should be accumulated from users of the facility by requiring capital contributions equal to not more than 2 percent of mortgage sales to the Association. Such capital contributions should be nonrefundable; should be entitled to receive annual cumulative dividends equivalent to the rate of dividend paid to the Treasury upon its stock; should be convertible into stock only after all stock and all obligations of the Association held by the Secretary of the Treasury shall have been fully retired; and such stock should thereafter be entitled to cumulative dividends at a rate not to exceed 5 percent on its par value. Suggested amendments Nos. 3 and 4, schedule B.

As you can observe of a nonrefundable capital contribution on which dividends are payable as we have suggested is in effect the same

as nonvoting stock. We have gone along on the idea of a capital contribution instead of stock, both because it is so set up in the bill, and because we think it makes a little clearer to identify and understand the plan we propose for the Treasury to receive all of the earnings up until such time as the capital contribution certificates mature into stock.

However, we would have no objection to using stock instead of convertible certificates having the same terms and conditions. My understanding is that such proposal is being recommended to this committee by the National Association of Real Estate Boards.

(d) The Association should eventually operate on private financing, retiring the federally provided initial capital within a reasonable time. However, because of its fundamental importance it should not be turned over to private operation and control—suggested amendment No. 6, schedule B.

(e) Until such time as the initially provided capital is repaid the Treasury should be entitled to all earnings of the Association. Thereafter, the Association should retain its earnings—suggested amendment No. 2, schedule B.

Mr. Chairman, with your permission, I would like to explain these charts. I could give you our idea of how FNMA can be transferred from a Government-operated, Government-financed organization, to a Government-operated or supervised but privately financed organization completely in a 10-year period.

This is FNMA as it operates now, FNMA providing all of the money and supervising the buying and selling of mortgages.

I want to say that as we understand FNMA, or the provisions of the Central Mortgage Bank or new Federal National Mortgage Association, it is divided into three parts:

No. 1 is the liquidation of FNMA's existing portfolio. We agree with that, because we understand it is supposed to be liquidated on a basis that will not upset the mortgage market, either by the sale of its loans direct or by the issuance of debentures against the loans. As I will mention later, it should have a stop-gap 1-for-1 plan incorporated into its liquidation provisions.

No. 2. The second division is special assistance for special programs. With that we also agree, adding perhaps the request that consideration be given to special buying of minority loans, provided that 221 is changed so that it can handle minority loans.

But the third function is the secondary mortgage function, and that is the part which we want to deal with here at this time.

You have on your desk the tables of prospective FNMA operations as shown in these charts. They show the figures that we projected and the amount of business we proposed that this organization would do. We think we have been conservative in making our projections. We are proposing that the United States Treasury furnish the \$70 million original capital stock, that the users put up 2 percent in the stock accumulation fund every time they sell mortgages to FNMA; that FNMA issue debentures against those mortgages direct, and sell those debentures to private buyers; that FNMA pay 2½ percent to the Treasury for dividends on this stock, while the private users are accumulating the money to buy the stock from the Government, and we also propose that FNMA pay the buyers of the stock during the

period of accumulation the same 2½ percent that it pays the Government.

We have projected that this company would do \$300 million worth of business the 1st year, \$400 million the 2d, \$450 million the 3d, \$450 million the 4th, \$450 million the 5th, \$450 million the 6th, \$450 million the 7th, \$450 million the 8th, \$400 million the 9th, and \$350 million on the 10th year.

We propose that it have an outstanding debenture in approximately the same amount as its outstanding portfolio. It starts out at \$200 million. It is shown there outstanding at the end of the year, down on the chart. I won't read those figures unless you can't find yours.

At the end of 5 years of operation, projecting those figures for doing that amount of business, the users of the facility would have paid into the stock accumulation fund \$41 million.

The bank would have outstanding debentures at that time of \$650 million, would have earned surplus of \$18 million, after it paid the \$32 million income tax to the United States Treasury. At the end of 10 years the users would have accumulated \$83 million from the 2 percent subscription, \$70 million of it paid to the Treasury, and \$13 million kept as additional surplus.

In the meantime, the bank would have paid \$88 million income tax, and would have \$56 million earned surplus, and we propose at the time of transition that the capital and the surplus both be paid back to the Government, so that the sale will be clear and clean cut.

In the meantime, during the 10-year period, the 2½ percent on the \$70 million would have amounted to approximately \$17.5 million.

After that we have a bank that is supervised by the Government with private capital, the stock being owned by private individuals, and the debentures being sold to private individuals.

The association should be authorized to continue to make advance contracts under the 1-for-1 plan by extending such plan to the mortgages held for liquidation in FNMA's existing portfolio. Under the bill as written, the 1-for-1 plan can be used only with respect to the prospective portfolio to be accumulated under the new secondary mortgage-market function. But there will be no new portfolio accumulated in FNMA's hands for at least a year to form a base for a new 1-for-1 operation. During that time construction would cease in those many areas which presently depend on 1-for-1 as their sole source for the advance commitments which are essential to home building. Our suggestion would bridge the gap until the effect of the new legislation could be felt.

Incidentally, I would like to compliment this committee on its wisdom in enacting the 1-for-1 suggestion into law last year. The operation of that plan has kept home building from collapse in many areas, while at the same time upgrading FNMA's portfolio and substantially assisting to improve the price of mortgage money. Its lapse at this time would seriously disrupt the mortgage market and housing starts in many areas.

(g) The limitation of debenture-issuing authority to 10 times capital and surplus would provide sufficient funds for reasonably foreseeable needs during the first years of operation. However, at such time as the Treasury is repaid and the entire surplus turned over to it this limit may temporarily be too restrictive. Our estimates indi-

cate about \$83 million private capital at that time as against \$1 billion in debentures. Until such time as the association accumulates additional capital and surplus it will have to curtail operations. We suggest eliminating the 10 times limit or, at least, amending it to 12 times, pending actual experience.

(h) The \$12,500 limit on eligible loans will continue to discourage construction of 3- and 4-bedroom houses in many areas, although the market requires such larger homes. It should be eliminated.

To make these changes, the wording of the bill before you should be amended as is set forth in schedule B at the end of this statement.

Mortgage finance is the lifeblood of building. Title III is by far the most important part of this bill. It is vital to our \$12 billion industry and to the welfare of the entire economy that the revised FHMA work well, fairly, and soundly. With it and the other suggestions I have made, we believe we can do much to solve the Nation's housing problem and, at the same time, expand the industry to a gross volume of approximately \$18 billion.

The CHAIRMAN. Without objection, the schedule accompanying the statement will be inserted.

(The information referred to is as follows:)

SCHEDULE A—SUGGESTED AMENDMENTS TO TITLES I AND II OF H. R. 7839

Suggested amendment No. 1:

1. Section 104, page 3, commencing at line 22, strike the colon and the proviso that follows and insert a period.

2. Section 105, page 4, line 10, strike the colon and the proviso that follows and insert a period.

3. Section 115, page 11, line 18, strike the colon and the proviso that follows and insert a period.

4. Section 120, page 14, line 7, strike the colon and the proviso that follows down to and including the word "amount" in line 15.

5. Section 123, page 19, line 18, strike the colon and the proviso that follows down to and including the word "amount" in line 25.

6. Section 123, page 21, line 19, strike everything after the word "exceed" down to and including the word "exceed" in line 25.

Suggested amendment No. 2:

Amend section 104 by (1) inserting at page 3, line 18, following the figures "\$8,000," the following: "*And provided further*, That closing costs and prepaid mortgage expenses paid in cash at the time of closing shall be included in 'appraised value' for the purpose of determining the maximum permissible mortgage under this section," and (2) striking the figures "\$8,000" at page 3, lines 16 and 18 and substituting the figures "\$10,000" in both places. Section 125, page 19, lines 15 and 18 should be correspondingly amended.

Suggested amendment No. 3:

Amend section 104, page 3, by inserting, following the word "principally" at line 12, the following: "(Whether or not it may be intended to be rented temporarily for school or other community purpose)".

Suggested amendment No. 4:

Section 103, commencing at page 2, line 23, insert the following: "The Commissioner shall establish under section 203 of the National Housing Act, as amended, special standards appropriate to properties with respect to which the mortgage does not exceed \$6,000 and may permit a service charge with respect to such mortgages."

Suggested amendment No. 5:

Amend section 123, page 25, line 5 by (1) striking the word "relocating" and inserting in lieu thereof the following: "Meeting the needs of low income families that are not and cannot be met from the existing supply of all other private financing and to provide preference to," and (2) striking the words "to be so displaced" at page 25, line 15, and (3) commencing at line 21, striking the words

"the relocation of families to be so displaced and who would be" and inserting in lieu thereof "low income families."

Suggested amendment No. 6:

Amend section 123, page 26, line 18, by striking the figures "\$7,000" and inserting in lieu thereof the words and figures: "7,600 (except that such amount may be not in excess of \$8,600 in any area in which the Commissioner shall determine such higher figure to be necessary, by reason of cost levels in such area, to attain the purposes of this section)".

Suggested amendment No. 7:

Section 201, page 42, commencing at line 18 through page 43, line 18, strike numbered clause (5).

SCHEDULE B—SUGGESTED AMENDMENTS TO TITLE III OF H. R. 7839

Suggested amendment No. 1:

Amend section 301 (a) by inserting at the end thereof (page 45, line 7) a comma, and the following: "and to assist in providing an adequate and stabilized market for the financing of homes in the volume, in areas, of the kinds, and at the prices that the market for homes from time to time may require."

Suggested amendment No. 2:

Amend section 303 (a) by inserting at the end of such subsection (page 48, line 6) the following: "At such time as the capital stock held by the Secretary of the Treasury has been fully retired the then balance of the general surplus account and of the reserves of the Association shall be paid to the Secretary of the Treasury."

Suggested amendment No. 3:

Amend section 303 (b) (page 48, commencing at line 7) so that the first sentence thereof reads as follows: "The Association shall accumulate funds for its capital surplus account from private sources by requiring each mortgage seller to make payments of nonrefundable capital contributions equal to not more than 2 percent of the unpaid principal amount of mortgages involved in purchases between such seller and the Association."

Suggested amendment No. 4:

Amend section 303 (c) by inserting following the sentence which ends at page 49, line 10, the following: "Such certificates shall be entitled to cumulative dividends at the same rate as determined by the Secretary of the Treasury under subsection (a) of this section with respect to capital stock held by him, but no dividends shall be paid upon such certificates if dividend payments on the capital stock held by the Secretary of the Treasury are at the time in arrears."

Suggested amendment No. 5:

Amend section 304 (a) (p. 52), (i) by striking the words "of such quality, type, and class as to meet generally the purchase standards imposed by private institutional mortgage investors" and substituting in lieu thereof the words "inherently sound and of a type and general class which will assist in constituting a prudent base for the issuance of debentures to private investors"; and (ii), commencing at line 14, strike the words "at or below the market price for the particular class involved, as determined by the Association" and substitute in lieu thereof the following: "at a reasonable price level, as determined by the Association, taking into consideration the market price for the particular class of mortgage involved, the reasonably foreseeable market for mortgages of the same general class, and current yields on, and reasonably foreseeable price trends of, long-term Government bonds and other forms of long-term investment".

Suggested amendment No. 6:

Delete all of section 303 (g) (p. 51, line 16 to and including p. 52, line 3).

Suggested amendment No. 7:

Amend section 304 (d) by inserting at page 56, line 1, following the word "Association", the words "(including mortgages purchased out of the portfolio of the Association which is subject to management and liquidation under sec. 306 hereof)".

Suggested amendment No. 8:

Amend section 304 (b) commencing at page 53, line 12, by striking all following the word "but" through and including the word "and" at line 16.

Suggested amendment No. 9:

Amend section 302 (b) commencing at page 47, line 3, by striking everything following the word "instrumentality".

TABLE I.—Proportion of consumer expenditures for selected goods and services

	1929	1940	1950	1953	Percent change, 1929-53
Total.....	100	100	100	100	0
Auto and parts.....	4.1	3.8	6.3	6.0	+46.3
Food.....	25.0	23.7	27.4	32.4	+28.0
Subtotal.....	29.1	27.5	33.7	38.4	+32.0
Housing.....	14.5	12.8	10.2	11.4	-21.4
All other.....	56.4	59.7	56.1	50.2	-11.0

TABLE II.—Percentage servicing charges of disposable income (by years)

	1939	1946	1947	1948	1949	1950	1951	1952
Mortgage debt.....	2.7	1.8	2.1	2.0	2.3	2.2	2.3	2.4
Interest.....	1.0	.6	.7	.7	.9	.9	.9	1.0
Amortization.....	1.7	1.2	1.4	1.3	1.4	1.3	1.4	1.4
Installment debt.....	8.1	4.3	6.0	7.1	8.3	8.9	10.0	10.4
Interest.....	1.0	.4	.5	.6	.7	.8	.8	.9
Amortization.....	7.1	3.9	5.5	6.5	7.6	8.1	9.2	9.5
Mortgage and installment.....	10.8	6.1	8.1	9.1	10.5	11.1	12.3	12.8
Percent mortgage of total.....	25.0	29.5	25.9	24.7	21.9	19.8	18.7	18.8

Source: Estimates based on data from U. S. Department of Commerce, HHFA, and other sources.

TABLE III.—Housing needs to 1960

(a) Replacement or rehabilitation needed by 1960:

Urban and rural nonfarm units reported as delapidated, or lacking private bath or toilet in April 1950.....	16.9
Estimated further deterioration by 1960.....	21.4
Estimated losses.....	.6
Estimated removal of temporary units.....	.3
Total.....	9.2

(b) Increase in number needed by 1960:

Nonfarm families needing housing 1960.....	47,000
Allowance for 3 percent effective vacancy.....	1,500
Total effective supply needed in 1960.....	48,500
Effective supply in 1950.....	38,575
Total increase in number needed.....	9,925
Replacement or rehabilitation needed.....	9,200
Increase in number needed.....	9,925
Total need.....	19,125
Average per year for decade.....	1,900

¹ Based on 1950 census adjusted for census estimates of underreporting.

² Using standards explained in HHFA study, How Big?

³ New census data indicates this figure may be too low.

⁴ Assuming 5.5 million farm, 52.5 total families.

As this rate has not been maintained thus far, the average for the rest of the decade should be raised to 2,000, of which 1.1 to 1.5 should be new and 0.9 to 0.4 should be rehabilitated.

SUPPORT TO THE ECONOMY REPRESENTED BY RESIDENTIAL CONSTRUCTION

Recessions tend to start and to be aggravated by declines in private investment, rather than by declines in personal expenditures. In constant prices, gross private investment declined by over 90 percent from 1929 to 1932, while personal consumption expenditures declined 17 percent. Though residential construction dropped in large part because of the collapse of the mortgage system—which cannot occur again—it nevertheless held up much better than investment as a whole. It represented 17.7 percent of total private investment in 1929, and reportedly 55.6 percent in 1932. It was reported as being three times the support to the investment segment in 1932 (when it was needed) as in 1929. New census data just coming out indicate that there may have been a good deal of residential construction going on outside of permit areas, and that actually residential construction may have accounted for two-thirds of all private investment in 1932.

Residential construction represented 21.2 percent of private investment in 1953. If it is given a chance to return to its earlier place in the consumer budget, if bigger and better houses can again be financed, housing would represent nearly 25 percent of all private investment, and during a recession could be maintained at high levels (due to the backlog of unsatisfied demand for bigger and for better housing). This would prevent investment as a whole from declining far. This would help prevent a recession from snowballing, and make it possible to work out of difficulties in a short period.

If the value of new houses built were to be as large in relation to disposable income as they were 20 or 30 years ago, they would be 25 percent greater on the average than they are now. With the major decline in interest rate that has occurred, this would still leave the servicing cost of the capital far less in relation to income than it was 20 or 30 years ago. But it would increase private investment in housing by 25 percent and bring residential construction from 21.2 percent to 25.2 percent of all investment—assuming no change in other investment. But there would have to be changes in other investment, because this expansion in housebuilding would require more investment elsewhere to produce the larger amounts of material and equipment required. In the year 1954, for instance, this could cause an anticipated decline in capital formation to become an increase in capital formation.

This would be accomplished by increasing the limits of the 95 percent loan from \$8,000 to about \$16,000.

TABLE IV.—*Relation of investment in new housing to gross private domestic investment*

Year:	Percent residential	Year—Continued	Percent residential
1929	17.7	1942	16.5
1930	13.7	1943	17.5
1931	22.2	1944	10.4
1932	55.6	1945	10.3
1933	23.1	1946	13.9
1934	14.3	1947	20.9
1935	11.5	1948	20.1
1936	13.3	1949	24.8
1937	12.3	1950	24.0
1938	23.8	1951	18.8
1939	27.3	1952	21.1
1940	21.6	1953	21.2
1941	18.6		

TABLE V.—*Effect of credit control on applications*

1950—January	\$38, 176	1950—July	42, 170
February	38, 357	August	30, 379
March	39, 180	September	21, 192
April	35, 424	October	32, 525
May	¹ 52, 995	November	10, 852
June	30, 096	December	41, 675

¹ Rules were tightened in May.

SIZE MORTGAGES IN THE TWENTIES'

The former Division of Building and Housing, established by former President Hoover in the Department of Commerce, made studies of mortgage financing methods in use during the 1920's.

One of the financing studies made by this Division of the Department of Commerce was an elaborate analysis of financing practices in a representative major city—Cleveland, Ohio. Assessments which were an 80 percent of market, could be used as a basis for relating mortgages to the value of properties mortgaged.

A sample of 2,231 mortgaged properties was selected, and the size mortgage placed on each property was related to the corrected assessment, or true value, of the property. The following table shows the result.

TABLE VI.—Percentage distribution of the ratio of total mortgages to corrected assessment value, by mortgagor (mass builder or owner builder)

Percent	Mass builder	Owner builder	Total
Under 50.....	1	3	2
50 to 79.....	19	30	26
80 and over.....	80	67	72
Total.....	100	100	100

The ratio varied year by year. Higher mortgages were made early in the decade than were made after 1926, but even as late as 1928, when construction had dropped sharply, only 32 percent of the mortgages studied were for less than 80 percent of the estimated property value.

Another sample of 5,292 cases was used to secure information on the frequency of the use of second mortgages. It gave the following result:

Use of junior liens

	1920-29	1928	1929
First mortgages only.....	45	57	53
Two mortgages.....	55	43	47
Three mortgages.....	12	9	4

The practice of placing second and third mortgages declined after 1923, but at the end of the decade over 40 percent of homes being financed with mortgages still used junior liens.

TABLE VII.—Family income data relocation survey of the Gratiot Redevelopment Area, Detroit, Mich.

Family income, including income from rentals	Total families	A	B	C	D
Total.....	1,953	704	249	157	843
Less than \$1,000.....	136	108	1	17	10
\$1,000 to \$1,499.....	207	175		25	7
\$1,500 to \$1,999.....	125	97		22	6
\$2,000 to \$2,499.....	163	119	2	27	15
\$2,500 to \$2,999.....	436	146	57	47	186
\$3,000 to \$3,499.....	416	43	97	12	264
\$3,500 to \$3,999.....	163	10	27	3	123
\$4,000 to \$4,999.....	142	1	29	2	110
\$5,000 to \$5,999.....	73		17		56
\$6,000 and over.....	48		15		33
NR.....	44	5	4	2	33

Group A: Families eligible for permanent low-rent public housing only.

Group B: Families eligible for veterans' housing only.

Group C: Families eligible for both permanent low-rent public housing and veterans' housing.

Group D: Families ineligible for either.

TABLE VIII.—Relative use of FNMA by States relation FNMA holdings to United States average (by States)

Oklahoma.....	5.1	New Jersey.....	0.6
Florida.....	4.1	North Carolina.....	.5
New Mexico.....	3.0	Wyoming.....	.5
Texas.....	2.8	Minnesota.....	.4
Georgia.....	2.6	Alabama.....	.4
Michigan.....	2.6	Pennsylvania.....	.4
Arizona.....	2.4	Indiana.....	.3
Kansas.....	2.4	Nebraska.....	.3
Washington.....	2.3	Ohio.....	.3
South Carolina.....	2.0	Oregon.....	.3
California.....	1.9	South Dakota.....	.3
Tennessee.....	1.7	District of Columbia.....	.2
Louisiana.....	1.6	Illinois.....	.2
Idaho.....	1.5	Kentucky.....	.2
Maryland.....	1.5	West Virginia.....	.2
Arkansas.....	1.4	Iowa.....	.1
Colorado.....	1.4	Connecticut.....	.0
Utah.....	1.0	Montana.....	.0
United States average.....	1.0	Nevada.....	.0
Virginia.....	1.0	New York.....	(¹)
Missouri.....	.8	North Dakota.....	.0
Delaware.....	.7	Wisconsin.....	(¹)
Mississippi.....	.7		

¹ Less than 0.1.

TABLE IX.—Relative use of FHA by States 1952 FHA insurance per \$10,000 income to individuals (by States)

Arizona.....	\$44.88	Alabama.....	\$12.35
Utah.....	36.89	Ohio.....	11.86
Nevada.....	28.47	Maryland.....	11.49
Washington.....	28.02	South Dakota.....	11.45
Kansas.....	25.42	Kentucky.....	11.41
Louisiana.....	24.87	Mississippi.....	10.61
Idaho.....	24.51	South Carolina.....	10.44
New Mexico.....	24.24	New Jersey.....	10.38
Oregon.....	22.46	Connecticut.....	9.46
California.....	21.48	North Carolina.....	8.83
Virginia.....	21.17	Minnesota.....	8.34
Florida.....	20.32	Illinois.....	7.94
Oklahoma.....	18.30	Iowa.....	7.64
Colorado.....	18.16	Pennsylvania.....	7.59
Texas.....	17.67	New York.....	7.35
Michigan.....	16.98	Maine.....	7.16
Georgia.....	16.16	North Dakota.....	6.57
Wyoming.....	16.13	West Virginia.....	6.28
Arkansas.....	15.52	Rhode Island.....	4.51
Nebraska.....	14.29	Wisconsin.....	4.51
Montana.....	13.99	Delaware.....	4.13
Tennessee.....	13.29	New Hampshire.....	3.94
Indiana.....	12.96	Vermont.....	3.51
United States average.....	12.83	Massachusetts.....	3.05
Missouri.....	12.57	District of Columbia.....	2.79

PROSPECTIVE FNMA OPERATIONS

Charts on the following pages show the transition of the secondary mortgage market portion of FNMA from a Government-operated, Government-financed organization to a Government-operated organization using private funds. The figures used in the charts are based on the following assumptions:

(1) That the Federal Treasury will furnish the original capital in the sum of \$70 million;

(2) That users of the facility will buy certificates in the amount of 2 percent

of mortgages sold. Certificates to be exchanged for stock when total certificates equal \$70 million Treasury stock.

(3) That FNMA will pay 2½ percent to the Treasury in annual dividends on original capital and 2½ percent on all paid-in certificates;

(4) Projected purchases, sales, average portfolio are listed by years on following page:

[In thousands of dollars]

	1st year	2d year	3d year	4th year	5th year
Mortgages purchased (at 97).....	300,000	400,000	450,000	450,000	450,000
Repayments (4 percent of average portfolio).....	4,000	11,000	16,000	20,000	24,000
Sales (at 97½ percent).....	96,000	239,000	334,000	330,000	326,000
Outstanding at end of year.....	200,000	350,000	450,000	550,000	650,000
Average portfolio for year.....	100,000	275,000	400,000	500,000	600,000
	6th year	7th year	8th year	9th year	10th year
Mortgages purchased (at 97).....	450,000	450,000	450,000	400,000	350,000
Repayments (4 percent of average portfolio).....	28,000	32,000	36,000	39,000	40,000
Sales (at 97½ percent).....	322,000	318,000	314,000	311,000	310,000
Outstanding at end of year.....	750,000	850,000	950,000	1,000,000	1,000,000
Average portfolio for year.....	700,000	800,000	900,000	975,000	1,000,000

How FNMA operates - NOW

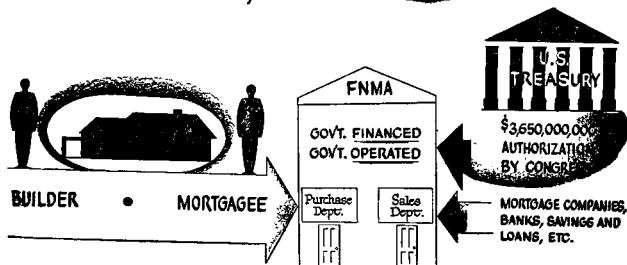

Proposed FNMA change-over
 GOVT. SUPERVISED-GOVT. FINANCED
 in 10 years to
 GOVT. SUPERVISED-PRIVATELY FINANCED

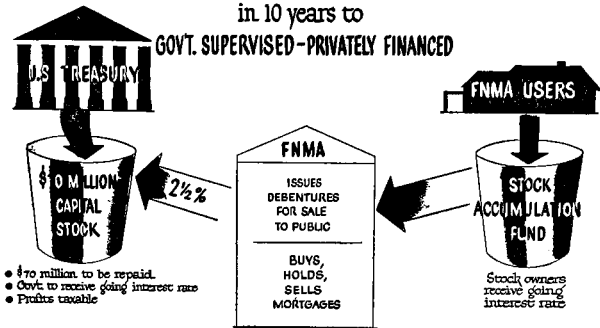

5 YEARS LATER

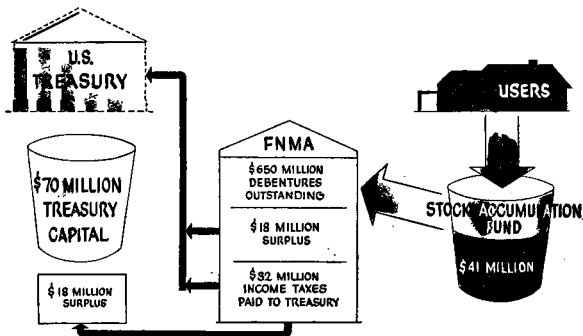

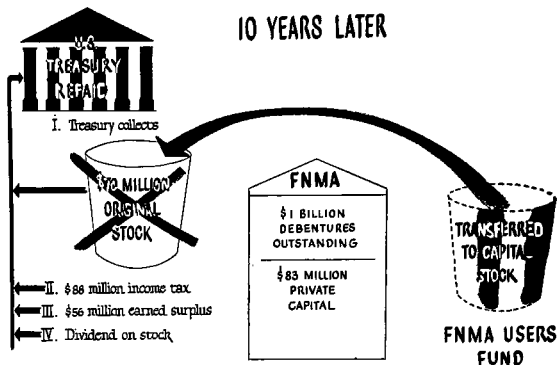

RESULTS, BENEFITS } of government supervision, private capital

1. Private capital replaces government capital
2. Adequate, progressive secondary market established
3. Channels home financing into the areas where needed at the right time in the right amounts, in the public interest, thus broadening the market for low-income and minority loans
4. Doesn't cost the taxpayer a dime
5. Taxpayer receives a profit

CONSUMER EXPENDITURES FOR HOUSING, FOOD, AND AUTOS

(PERCENT EXPENDITURES)

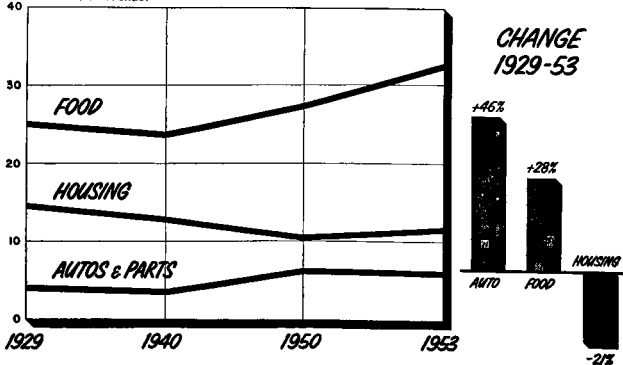

COST OF MONEY FOR HOUSING, AND FOR AUTOS AND OTHER CONSUMER DURABLES

(INTEREST AND AMORTIZATION)

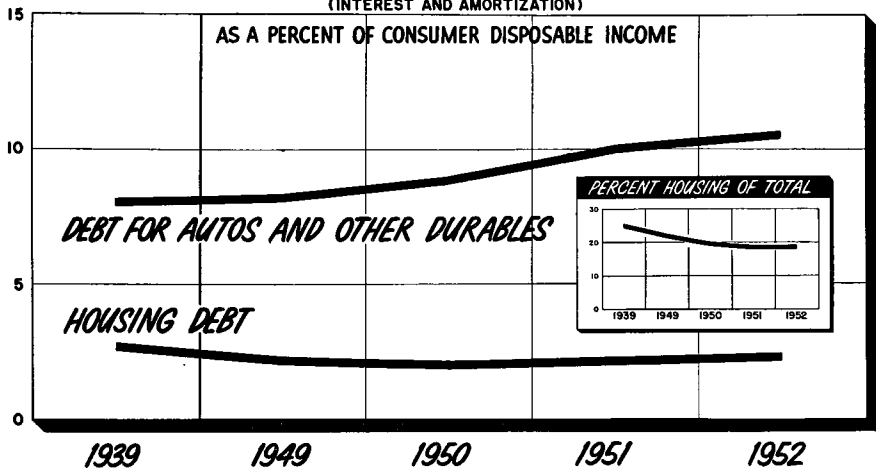

SIZE OF OWNER OCCUPIED HOUSING BY YEARS BUILT

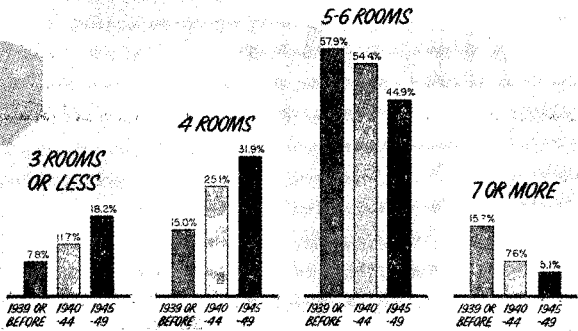

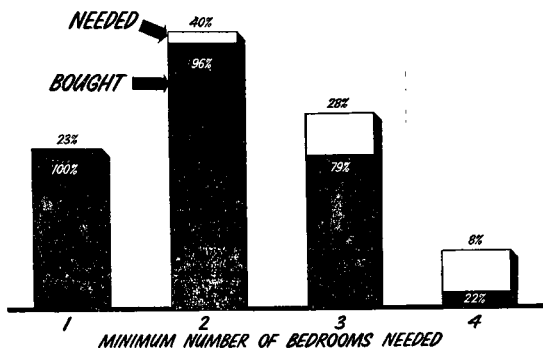
PERCENT OF BEDROOM NEEDS MET**HOUSING NEEDS TO 1960**

(MILLIONS)

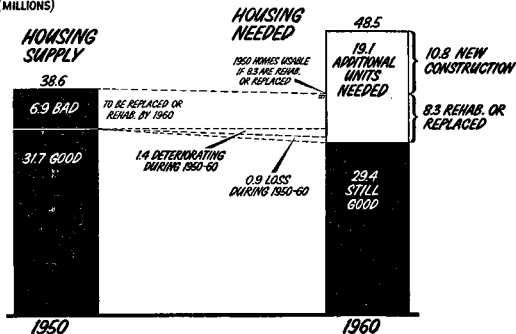

DEPENDENCE ON FNMA BY STATES

U.S. AVERAGE = 1.0

17 STATES ABOVE AVERAGE

OKLAHOMA	ALABAMA	CALIFORNIA
FLORIDA	WASHINGTON	LOUISIANA
NEW MEXICO	ARIZONA	COLORADO
TEXAS	KANSAS	MARYLAND
GEORGIA	SOUTH CAROLINA	ARKANSAS
MICHIGAN	TENNESSEE	

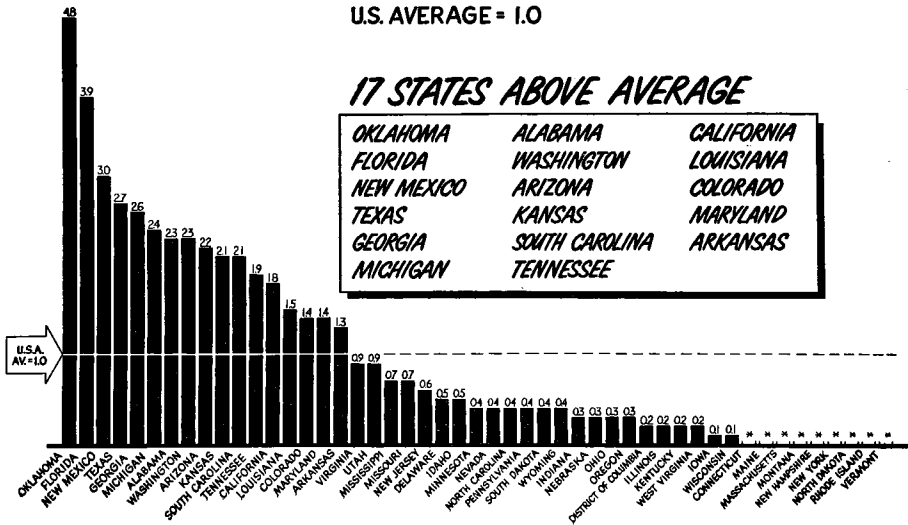

* LESS THAN 01 PERCENT

USE OF FHA, BY STATES

U.S. AVERAGE = 1.0

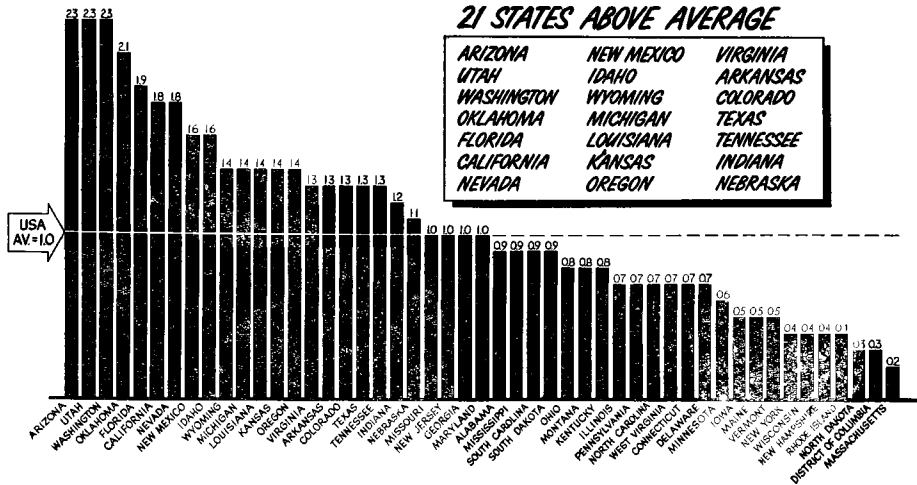

The CHAIRMAN. Are there any questions?

Mr. PATMAN. I would like to ask a question or two, Mr. Chairman.

The CHAIRMAN. Mr. Patman.

Mr. PATMAN. Mr. Hughes, I believe you are from the Congressional District that is ably represented by Mr. Walter Rogers.

Mr. HUGHES. Pampa.

Mr. PATMAN. Does he live in Pampa.

Mr. HUGHES. Yes.

Mr. PATMAN. He used to be district attorney in Burnham, didn't he?

Mr. HUGHES. Yes, sir.

Mr. PATMAN. Are you familiar with the housing starts as proposed for February?

Mr. HUGHES. As I understand it, they are down about 4 percent, but the trend on an annual basis is up.

Mr. PATMAN. Let's compare it now. That same question came up the other day and practically the same answer was given. But since that time I have gotten the figures for preceding years, and for 1950 there were 83,000 new starts; 1951, 81,000; 1952, 78,000; 1953, 79,000; 1954, 73,000.

In other words, it is down 6,000 from the preceding year and it is down 10,000 from 5 years ago. So that doesn't bear out your statement that on an annual basis it looks all right, would it, Mr. Hughes?

Mr. HUGHES. It is lower than it was in the last year, but it is starting up from the low point, which indicates, I presume, that if the increase continues, then as projected here we would come up with 1,180,000. However, I don't know whether those figures are true or not.

Mr. PATMAN. The figures are more disturbing when you consider January and February for 1953, there were 151,000 new housing starts for the 2 months, and for the same 2 months, 1954, there were 139,000, or 12,000 fewer.

Mr. HUGHES. That is correct.

Mr. MUMMA. Mr. Patman, would you yield?

Mr. PATMAN. Yes.

Mr. MUMMA. Is there a differentiation between commitments and starts? I think there are some figures here that show a remarkable number of commitments. The actual starts depend upon the weather. Being in that business I can see it has been tough.

Mr. Hughes, am I correct in that statement that the number of commitments was way up, 40,000, I think, more?

Mr. PATMAN. If you are going to bring that up, you should bring up comparable figures for preceding years.

Mr. MUMMA. I am not disputing that. I am going to the fact that you are talking about actual starts.

Mr. PATMAN. That is right.

Mr. MUMMA. That has been handicapped terrifically this winter. I just asked that question.

Mr. PATMAN. Over a 5-year period I believe we should be able to establish a reliable pattern. This has been the lowest February in that time.

Mr. MUMMA. Thank you for the time. I wanted to bring in that angle.

Mr. PATMAN. I concede there might be a difference, but I am just bringing up the starts and showing the comparable figures.

Mr. MUMMA. I figured that didn't fit in with your explanation.

Mr. PATMAN. Thank you.

The Fannie May that you are talking about here—you object to the one as proposed in the bill, do you not, Mr. Hughes, that we are now considering?

Mr. HUGHES. That is right. We approve it with amendments.

Mr. PATMAN. What is that?

Mr. HUGHES. We approve it in principle, with the amendments we suggest.

Mr. PATMAN. The amendments change it completely, don't they?

Mr. HUGHES. Not completely. We change 3 percent to 2 percent.

Mr. PATMAN. That is on the borrower's participation. You concede the borrower is the fellow that would pay that?

Mr. HUGHES. I concede the builder will pay that.

Mr. PATMAN. The builder will pay it?

Mr. HUGHES. The builder will pay it and he may pass it on to the buyer, if he can figure out a way to do it.

Mr. PATMAN. And eventually the lender will benefit from it, won't he?

Mr. HUGHES. That is my opinion.

Mr. PATMAN. But the borrower—if you have found out a way for Jones not to pay the freight, I sure would like to know it.

You are proposing a 2-percent participation instead of a 3-percent?

Mr. HUGHES. That is right.

Mr. PATMAN. If I read and understood your testimony correctly, you propose 15 major amendments to this bill; is that right?

Mr. HUGHES. I don't know whether it is 15 or not. I never counted them. I know there are quite a few.

Mr. PATMAN. The way I count them there are 15.

In your testimony you attached a table, page 32. I just want to ask you briefly about that. Do you have the table there, the table on page 32—"Effect of credit control on applications"?

Mr. HUGHES. Yes, sir.

Mr. PATMAN. This is not starts. That is where the gentleman's question comes in and it is very material. This is applications and not starts; isn't it?

Mr. HUGHES. We were trying to show, these are applications in 1950, which we are trying to show what credit controls did, and how it affected the builders' applications in the building business. How it disrupted the market.

Mr. PATMAN. I overlooked that. I thought it was 1953. It is 1950. Do you have a similar table for 1953?

Mr. HUGHES. No, sir.

Mr. PATMAN. I thought that was 1953. I will not ask you the question I expected to.

You stated in your testimony that the Federal Reserve System controlled the long-term rates; is that right?

Mr. HUGHES. I didn't understand the question.

Mr. PATMAN. I understood you to say that the Federal Reserve System controlled the long-term rates, which included mortgage rates.

Mr. HUGHES. That is my opinion.

Mr. PATMAN. I think you are correct about it, except it is not the Federal Reserve System. You know the Federal Reserve System, No. 1, is the Board of Governors supposed to be here in Washington, 7 members; there are only 6 now and 1 of their terms has expired and the 12 banks and the 12 regions and the 24 branches—and, of course, each bank has 9 directors and each branch has 7—and, then, in addition to that the Board of Governors has all the power. These regional banks don't have any power. They have no more power over monetary controls than a janitor in this building. They have no power at all. Everything has to be passed on by the Board of Governors, so the Board of Governors have power, that is true—you are right—not the Federal Reserve System, but the Board of Governors, and then the Congress passed a law giving the 12 members of the Open Market Committee the power that you speak of. So when you say "Federal Reserve System," I think you should change that to read "the Open Market Committee of the Federal Reserve System," because they are the ones that control long-term and short-term rates.

In other words, they have a Committee of 12 which has unlimited power to go into the market at any time and to purchase at any price it desires, or to sell at any price it desires, United States Government securities. They have a big backlog of \$25 billion worth they can use to operate on if they want to in their selling operations. They could buy every security in existence if they wanted to at any price they want, so I agree with you that they fix the long-term rates.

I assume that during the first part of last year, you had a difficult time getting financing, didn't you, Mr. Hughes.

Mr. HUGHES. We had a great deal of trouble.

Mr. PATMAN. The first half you did. It loosened up the last half.

Mr. HUGHES. In some areas.

Mr. PATMAN. It hasn't loosened up everywhere yet.

Mr. HUGHES. Not every place, but it is improving rapidly.

Mr. PATMAN. That is an unusual thing. The Government bonds having come back in price, almost a hundred percent across the board; they are almost back to par. Yet, the damage was done in that first half of last year when they caused those bonds to go down to 89. There is a loss of confidence somewhere, and the people haven't got that restored to where they can get the financing, although the long-term Governments have gone back to where they were a year ago, and better in some cases.

Mr. KILBURN. Will the gentleman yield?

Mr. PATMAN. Yes.

Mr. KILBURN. Is this all a question?

Mr. PATMAN. What difference does it make to the gentleman?

Mr. KILBURN. I was wondering, I thought we were supposed to question the witness.

Mr. PATMAN. Don't I have a right to do what I want to?

Mr. KILBURN. Yes. I just asked if it was a question.

Mr. PATMAN. You can make up your own mind. I don't want to be disrespectful to the gentleman, but I think a comment is worth while along that line because we are studying a very serious matter here that involves billions of dollars of the people's money and the builders' money, and the builders are trying to cooperate with us in getting a good housing program.

I think it is opportune to invite his attention to the fact that the Open Market Committee is the one that we should work with, instead of the Federal Reserve System. I believe the gentleman will agree with me that I am correct about that.

Mr. McDONOUGH. Will the gentleman yield?

Mr. PATMAN. Yes, sir.

Mr. McDONOUGH. You began your inquiry of what Mr. Hughes said by referring to his reference to the Federal Reserve System. I read on page 16 of his testimony that he says that:

A central mortgage bank is as essential to meet these needs. It is as necessary for mortgage credit as is the Federal Reserve System for commercial banking.

He was making reference there to the Fannie May central mortgage bank, which is proposed in this bill, as being correlative to the Federal Reserve System in the banking business.

He didn't say the Open Market Committee. He said the Federal Reserve System as a whole.

Mr. PATMAN. I think there is another reference, isn't there, Mr. Hughes, in here to the Federal Reserve?

Mr. HUGHES. There is another reference, an insertion that I made at the end of "C" on page 7. I don't think you have a copy of it there.

Mr. PATMAN. What did you say? That is the part I think I had reference to.

Mr. HUGHES (reading):

Finally, I wish to point out the individual lender also exercises control with respect to any particular loan at any particular time. The Federal agencies, such as the Federal Reserve Board and the Treasury, which control the supply of money, control generally the terms under which lenders are willing to make loans.

Mr. PATMAN. That is the point I referred to, Mr. McDonough.

I think you are correct, except it should not be the Federal Reserve Board of the Federal Reserve System. It is the Open-Market Committee of the Federal Reserve System composed of five private bankers representing private institutions, elected by private institutions, and under obligations to serve private bankers. They are part of that 12.

That is all, Mr. Chairman.

The CHAIRMAN. Are there any further questions of Mr. Hughes?

Mr. McVEY. Mr. Chairman.

The CHAIRMAN. Mr. McVey.

Mr. McVEY. I am interested in this very fine statement Mr. Hughes has given us. There is just one matter I should like to ask a question about.

You mentioned the shortage in school building facilities and, of course, we know that there is in this country at the present time a shortage of about 350,000 classrooms and approximately 3 out of 5 that we have are overcrowded. We do have a difficult situation with regard to school building housing.

We have always felt that this problem belonged to local officials insofar as possible, but you have mentioned it in discussing the subject and I would like to explore your opinion somewhat and find out just to what you referred when you mentioned the Government in this connection.

Mr. HUGHES. Sir, I have traveled during the past several weeks. I have been from Maine to El Paso and from Miami to Seattle, and

the No. 1 and No. 2 problems always are mortgage money and the attitudes of city governments toward home builders, builders of small houses.

In the East, in the New England area, attitudes of the city government rank No. 2 and mortgage money is, of course, second, but in the Southwest mortgage money is still the greater problem.

We are confronted with some very serious problems. There is one town in Connecticut that passed an ordinance recently which forbids the construction of new housing—all housing within city limits—another one of our members, up in Connecticut, bought two tracts of land within 13 and 15 miles of the heart of Hartford, Conn., and within 2 weeks of the time he bought the land, the ordinance had been passed which prohibited him from building any house that would cost less than \$20,000; actually, because 1 ordinance said that no house could be built unless the school tax and income was \$400 per year.

Assuming it costs \$200 to take care of a child, each house would bring in 2. In addition to that, we have the problem of expanding the utilities. All of the lots that we had that were vacant for years after the end of the war are now used up, and that is our major problem.

However, I am not at this time prepared to make any major suggestion, except to tell you, I just wanted to bring to your attention the seriousness of the problem and to suggest that the FHA be allowed to insure mortgages, and allow the builder to close the loans in his name, and rent those buildings temporarily for the use of schoolrooms. Then, when the taxable income increases in the area, or the area is built up so that it can issue bonds and build the permanent school, the builder can put in the rooms and partitions and sell the houses as individual residences.

I think it would do much to solve our problem in many areas. It is a very simple thing.

Mr. McVEY. I appreciate this explanation. I didn't know just to what you were referring. Thank you.

The CHAIRMAN. Any further questions?

Mr. SPENCE. Mr. Chairman.

The CHAIRMAN. Mr. Spence.

Mr. SPENCE. What is the housing shortage in the United States in units?

Mr. HUGHES. Well, we showed it in units on the chart. I think that was just before you came in, Mr. Spence. It is shown also in chart No. 5 in the small chart that you have.

Our statistics show that from the period 1950 to 1960, we needed new housing of 10,800,000, and approximately 8,300,000 rehabilitated units, but in the meantime we have built in excess of 4 million, so we have got about 7 million houses that are actually needed to be built between now and 1960.

Mr. SPENCE. How many people are inadequately housed in substandard housing in the United States?

Mr. HUGHES. Our figures show units of right at 7 million; nearly 20 percent of our people live in houses that don't have the facilities of an inside toilet.

Mr. SPENCE. Is there any requirement in the bill that makes it mandatory on the mortgage association to purchase eligible mortgages that are qualified for purchase?

Mr. HUGHES. Which association?

Mr. SPENCE. The National Mortgage Association.

Mr. HUGHES. For special assistance, yes, sir. The special-assistance program would require that they buy 220 and 221 loans as I understand it.

Mr. SPENCE. You don't think they can refuse?

Mr. HUGHES. It is not mandatory, but that is what they are set up to do.

Mr. SPENCE. Suppose a man came with those mortgages. Could they refuse to take them?

Mr. HUGHES. They could, but they have a right in the special-assistance program to issue commitments in advance.

Mr. SPENCE. There is no mandatory requirement that they shall purchase them, is there?

Mr. HUGHES. Not that I know of.

Mr. SPENCE. That wouldn't apply to Fannie May—the special assistance program?

Mr. HUGHES. The regular Fannie May is different. The regular Fannie May can't issue commitments in advance. They could turn down any mortgage that you send to them. They can be selective.

Mr. SPENCE. With the proposed organization set up under this bill, would there be the authority for the purchaser to purchase the eligible mortgages that he desires?

Mr. HUGHES. Yes.

Mr. SPENCE. That is all.

Mr. McDONOUGH. Mr. Chairman.

The CHAIRMAN. Mr. McDonough.

Mr. McDONOUGH. Mr. Hughes, you refer in testimony that delegation of congressional authority over downpayments and terms of loans should be stricken. You mean that the Congress should not legislate on the question of downpayments in terms of a loan?

Mr. HUGHES. No, sir. We want them to legislate in terms of downpayments and terms of loan. We want to do away with that part which gives the President standby authority to do this after the bill is passed. As we understand this bill, the change in downpayments can be made and the changes in terms of amortization can be passed into law, but then that won't become effective until the President issues the order. We want to eliminate this Presidential standby authority.

Mr. McDONOUGH. In other words, you don't want the Congress to delegate the authority to the President to control the downpayment and the terms of the loan?

Mr. HUGHES. That is right. We want the Congress to handle its own authority.

The CHAIRMAN. Are there further questions of Mr. Hughes?

Mr. MUMMA. Mr. Chairman, didn't we pass a bill at least in the House giving him that authority last summer?

The CHAIRMAN. That is right.

Mr. MUMMA. It never went to the Senate?

Mr. HUGHES. It passed the Senate.

Mr. MUMMA. He has that authority now.

The CHAIRMAN. Are there further questions of Mr. Hughes?

Mr. DEANE. Mr. Chairman, I have one question.

The CHAIRMAN. Mr. Deane.

Mr. DEANE. I don't know whether you have had the opportunity of reading the testimony of Mr. Shanks, of the Prudential Life Insurance Co.

Mr. HUGHES. We read it or scanned it briefly.

Mr. DEANE. I call your attention to his statement on page 4. He is speaking about the broad philosophy which runs through the bill. This takes the form of a general liberalization of a sure and guaranteed mortgage terms to a point which we think raises a serious question of conflict with the tenants of sound financing. Mr. Shanks goes on to say:

Likewise, we believe that the bill leans too far in the direction of accepting the objective that the volume of housing starts must be kept going at a peak level at all costs.

Do you believe that is the philosophy of the home building?

Mr. HUGHES. I believe in the direct opposite from what he is talking about there. I believe we must build the houses.

Mr. DEANE. Do you think the life-insurance companies will accept a \$7,000 loan in the noncity areas?

Mr. HUGHES. I think they will, after the pattern has been set and time has tested the loan and proven they are good stable loans, and if there is some other source to take up that margin or that difference in the actual supply of the money and the demand for mortgages.

Mr. DEANE. Where do you think the money is going to come from to take care of this type of financing?

Mr. HUGHES. Are you talking about the 221 for the low-income families?

Mr. DEANE. That is right.

Mr. HUGHES. According to this bill, I think for a while it is actually supported by the Treasury, but the way this is set up I believe private investors will buy it.

The agreement is that Fannie May will buy a 20 percent participation and the private bank furnish 80 percent with the understanding that in the event of default Fannie May will take up the 80 percent. I think time will prove that those mortgages are good mortgages, and eventually bankers will buy them.

Mr. DEANE. Did you have an opportunity to read the Washington Post of yesterday on the second precinct in the city?

Mr. HUGHES. I read the headlines on it; yes, sir.

Mr. DEANE. Do you have any comments on how to come to grips with that problem here in the shadow of the Capitol?

Mr. HUGHES. I think that the problems—I really don't know of the details of this problem, but I am sure that the objectives of this bill are designed to furnish solutions to just such problems under the 220 program, 221, and the expanded title I.

Mr. DEANE. When the thing moves into the second precinct, in the removal program, where would these tenants be placed temporarily?

Mr. HUGHES. That is one of the major problems. That is what 221 is designed for, to set up or to build houses for these families that are

displaced. Our concept definitely is that 221 will be used to a great extent to rehabilitate existing properties—not just for new properties. They buy houses in areas that are not so far from the school areas, not so far from where these people work. They clean them up and new condition them and sell them to these people on the long-term amortization basis.

Mr. DEANE. Is your understanding of the bill the same as mine, that they can go into these urban renewal areas with Federal financing and then go back in those same areas and construct commercial structures?

Mr. HUGHES. It is my understanding of the bill that they will go into areas only under 220, and only into areas that have been replanned by a local city government. This local city government may decide that they want some parks put into the areas, that they need more playgrounds, more schools, and more business grounds. This bill, as I understand it, would make loans and grants to aid those cities in doing that replanning.

Mr. DEANE. This bill is so complicated it is hard for me to keep in mind all the provisions in the bill. I am thinking of title IV of the urban renewal program.

Mr. HUGHES. You are referring to where they demolish the slums and redevelop a whole area?

Mr. DEANE. That is right, and whether or not after they are demolished, say, 75 percent of that area was occupied by tenants; yet they could go back and put 75 percent commercial structures in the same area.

Mr. HUGHES. I don't know the answer as to what ratio it can be rebuilt on. As I understand it, they could use it to its highest and best use.

Mr. DEANE. As I understand the bill, they can go back—and I stand corrected if I am wrong—and erect any number of commercial structures which they desire.

Mr. HUGHES. Yes; that is right; I think.

Mr. DEANE. Thank you.

The CHAIRMAN. Are there any further questions of Mr. Hughes?

(No response.)

The CHAIRMAN. Thank you very much for your contribution, Mr. Hughes. You may have the opportunity to revise your statement if you wish.

Mr. Levitt, we are very glad to have you this morning. You don't have a prepared statement?

Mr. LEVITT. I don't have a prepared statement. All I wanted to do was comment on a few portions of the bill, rather than go into a lengthy analysis of this which Mr. Hughes has done so ably.

The CHAIRMAN. You may proceed, then.

STATEMENT OF WILLIAM LEVITT, PRESIDENT, LEVITT & SONS, BUILDERS

Mr. LEVITT. By way of qualification and without anything personal in it, my name is William Levitt, and I am president of Levitt & Sons, which House and Home has characterized as the largest builder in the United States.

The CHAIRMAN. Your representation and accomplishments are well known.

Mr. LEVITT. As an ex-lawyer, I used it merely to qualify what comes afterward.

I think as Mr. Deane said a little while ago, this bill is so complicated that we have lost sight of what we should essentially enact right now, and I am not going to mince any words and I don't think you gentlemen would like me to.

Business in the building business particularly, as well as everything else, is plain unadulteratedly rotten right now. It has been increasingly so for quite a while, and if I tell you that we have not sold more than 1 percent of our houses in the last 6 months to a non-veteran, I think you will realize that there must be a reason for it.

We have sold a considerable amount of houses to veterans. Our figures are now 99 percent to veterans in the last 6 months. For one reason or another we do have financing and we do have a no-downpayment deal. I stress that because of the 99 percent that we have hold, practically all of them—there is no sense in my breaking down a fraction of a percent on it—are sold on a no-downpayment basis. People simply don't have money. They don't have cash.

At the same time, the building business is very inextricably wound up with our own economy. We build houses, we sell refrigerators, we sell wash machines, we sell furniture, we sell towels and everything you can think of just about, and I think in the discussion of this housing bill, not only before this committee but in the general discussion that has gone all through the country we lose sight of the fact that if the home-building industry falls down—not necessarily collapses, but falls down—it is going to drag the economy with it, whether we are not in a recession or depression or anything you want to call it, it is not for me to argue now; that business is off, I think, is an accepted fact.

So I think that if the building business could be stimulated and if we could produce, and I agree again with Dick Hughes, not on that 20 million figure, which is 20 years ago thinking, preprohibition thinking almost—but on a million and a half, or possibly more than that, I think not only will we satisfy our housing need, not necessarily to fill a demand or shortage, but a need; not only do I think we can increase as well as maintain our standard of living, but we will have accomplished something which will remove the nonveteran now—and I am speaking as a veteran—the nonveteran from becoming a second-class citizen. That is not my phrase. That was bandied around 3 or 4 years ago. That is what the nonveteran is fast becoming.

The argument—and I followed some of the testimony before this committee in the last week or 10 days—as to controlling production, that we should have the million a year and the bankers think we might overproduce, and so forth, is a little bit specious, because 20 years ago we produced 925 or 926 thousand units, I believe in the year 1926. Almost 20 years later, when our population has increased, I don't know, 40, 45, 50 percent, bankers are calling for a production of housing of only slightly more than when our population was so far down. That is simple arithmetic.

I believe that the payments, the downpayment revision called in the current bill is not good enough. I subscribe completely to the

schedule that was submitted to you earlier by Mr. Hughes, in which the first bracket—and that is the all-important bracket—should be 95 percent of \$10,000 rather than of 8, but I go a step beyond Mr. Hughes, and I say that when you propose to increase the maturity to 30 years, it should go to 35, possibly to 40, but 35 seems a reasonable figure, and let me tell you why:

On a \$10,000 house, on the proposed bill, a purchaser would pay \$900, and his interest and amortization under FHA would be \$48.87 a month. On what I am proposing, and what Mr. Hughes is proposing on the downpayment, he would only pay 500 instead of 900, but with a 35-year mortgage his carrying charges for interest and amortization would be \$47.97, or translated almost a dollar less, but almost cutting the downpayment in half. I think it is important. I think it spreads homeownership.

I have listened to a great deal and have seen, of course, in the bill this question of the \$7,000 house. I am not going to get into the issue because I think we are talking about something almost theoretical. The \$7,000 house on a nationwide basis doesn't exist. Perhaps it can be done in very mild climates, but then again if you come into slum-removal areas within the cities, the land alone almost prevents that being done. I am talking about on a realistic figure.

I believe a \$10,000 house, a good house, can be built for \$10,000 almost any place in the United States. Of course, my figures change, whether you go up or down a little bit. So I must plump for that 35-year mortgage rather than 30.

Now, the argument has been raised, that is much too long a term. Of course, you must agree that when 30 and 35 becomes then a question of ideology, but let's look at the figures on it. FHA, I think, will submit figures to you showing that over a 20-year period the average mortgage in the United States has either been paid off or satisfied or refined in something less than 10 years. Let's make it 12. Let's make it 15, 16, anything you want.

The argument then of the bankers that a 35-year mortgage, and, of course, they objected to 30 also, and I believe there may be some testimony in here that a 20-year mortgage is more desirable, is simply not thinking. It isn't looking at the facts. It isn't looking at the record.

It might be interesting to know that the University of Michigan, which prepares the reports for the Federal Reserve Board each year, published a report in 1950 which showed that the year before there were some 20 million houses, single-family houses in the United States that were owned—not rented. Of those 20 million, 11 million were free and clear; of the remaining 9 million, half of those had a 50 percent or greater equity, and the other half had equities ranging from 10 or 15 or 20 percent up to the 50 percent which I think proves the point that gradually on our system of mortgage financing and refinancing, etc., we gradually get to the point where the individual has a substantial equity and the mortgages are reduced, are satisfied.

No banker particularly wants the mortgage paid off anyhow. He would love to have a \$2,500 or \$3,000 mortgage on a \$10,000 house and so I don't get the arguments that have been advanced against a long-term mortgage. On the contrary, there are a great many good arguments in favor of the long-term mortgage. Of course, this is not

the time and place to make this question of what homeownership means against communism, and so forth, but it is a truism that a homeowner is a much better citizen and as long as he is paying that same amount of money or more in rent some place, let us hope to make him a homeowner so that you have all the collateral advantages of long terms, low downpayments, along with boosting the economy. He becomes a better citizen, we prosper by it, both economically and socially.

I have just one more thing and then I am all through. This I can't emphasize too strongly, and that is the question that was brought up and I believe this gentleman raised it a moment ago; that is the question of the delegation of your power to the executive branch.

As a builder, we can't operate that way. You did it last year. You were perfectly right, it was enacted into law last year, not only by this committee, but by the House and Senate and signed by the President. He had a standby provision there in which he could reduce downpayments. Here is what happened: The minute you passed it the newspapers selected—Congress authorized reduction of downpayments to 5 percent, so we had the buyers shriek, but you didn't authorize anything like that. You authorized the President to do it if he felt like it, but he didn't feel like it, and to this day he hasn't done it. Every report in the newspapers today on this pending legislation talks about this committee and the Senate committee holding hearings to reduce downpayments, and if this bill passes in its present form, the headlines the next day will be that Congress has reduced payments for nonveterans and you will have done no such thing. We are late already.

I testified last year at a Senate committee hearing in which I said then we were late and we were then and I said that builders had to make their plans far, far in advance. It wasn't a question of your enacting legislation in April or May, and we were ready to go into action in May or June or July, because we are not. Anything you do, for instance, practically does not affect our program, the balance of this year. We are committed. We are finished, and it may be interesting to note that we have cut our schedule for this year, and it is the first year we have done that since the war—we have cut our schedule some 25 percent from what we did last year, because we didn't think it was in the cards, and I still don't think so because of what we have seen.

That, gentlemen, is about it. I would like to see a lower downpayment, substantially in accordance with what Mr. Hughes said, an increase in the mortgage term from 30 to 35 years, which helps immeasurably, which balances this lower downpayment, against higher carrying charges, and thirdly, whatever you enact should become law.

The CHAIRMAN. Thank you, Mr. Levitt.

Are there questions?

Mr. McDONOUGH. Mr. Chairman.

The CHAIRMAN. Mr. McDonough.

Mr. McDONOUGH. You say anything we do in this bill will not change your schedule for the balance of this year?

Mr. LEVITT. It will affect it next year, but not this year.

Mr. McDONOUGH. In other words, nothing we do in this bill will stimulate your program for the balance of this fiscal year?

Mr. LEVITT. No, but it will affect it next year, because our program this year was determined last October. It had to be.

Mr. McDONOUGH. Speaking about this long-term loan on low-cost housing, don't you think the bankers, or a savings and loan association, would loan up to 50 percent on a 30-year house for a period of 10 years, which would make that house 40 years old when the loan is paid off?

Mr. LEVITT. I have my own private conceptions of lending, and on the banking theory. May I answer the question in a rather roundabout way for just a moment?

Mr. McDONOUGH. Yes.

Mr. LEVITT. If we had a house that sold for \$10,000 and we had a gentleman who wanted to buy it and who has a \$9,500 mortgage on it, and he made \$100,000 a year, so his credit is excellent, and it was uninsured no bank would buy the loan, but contrary, the banks I don't believe are kidding themselves. They may be kidding us, the builders, or anyone else, but they are in effect buying a contingent Government liability, a Government bond, and I don't think it makes any difference whether it is a 30-year loan, a 40-year loan, a 100-percent loan, or 60-percent loan. I don't think it will make any difference at all, provided that is the law and that is the routine and that is what we had. If the building fraternity were offering 35-year mortgages or 40-year mortgages and nothing else, they have to buy them. Otherwise they are out of business and when I hear these arguments that the banks frown on a long-term loan, or frown on a 100-percent loan or high percentage loan, I feel a little sick about it because I know and you know that they are buying a contingent Government bond, which they may get someday. Otherwise, they wouldn't make the loan in the first place, or whatever percentage it was. They just won't do it, or whatever the credit of the purchaser was.

Mr. McDONOUGH. In other words, you are saying that a long-term loan with a Federal insurance behind it will be purchased?

Mr. LEVITT. I don't think there is any question about it.

Mr. McDONOUGH. Up to 35 or 40 years?

Mr. LEVITT. I think you could make it 60. There wouldn't be any difference.

Mr. McDONOUGH. Say 30 years with a 10 percent downpayment?

Mr. LEVITT. As long as the interest returned to this bank is satisfactory, as long as they can make a profit on income over outgo, I don't think it makes any difference to them.

Mr. McDONOUGH. What real interest rate do they want?

Mr. LEVITT. I gave that up a long time ago trying to find out what interest rates they want. I agree with Mr. Patman, that now we have Government bonds at par. That was the argument a long while ago. Why don't we have mortgage money? Why don't we have it now? Mortgage money at par is practically nonexistent.

Mr. McDONOUGH. You stated 90 or 99 percent had been for veterans and no payment down.

Mr. LEVITT. That is right. We don't get a hundred percent loan from the bank. We pay three points for it.

Mr. McDONOUGH. To those who are nonvets that you may have sold, what was the downpayment on the \$10,000 home?

Mr. LEVITT. We don't have a \$10,000 house. Make it \$11,000 house. It was \$1,550. We have a \$9,500 house also, and that payment is about \$1,100 under existing law; \$1,100 was too much for them.

Mr. McDONOUGH. How long a period?

Mr. LEVITT. Twenty-five years.

Mr. McDONOUGH. How much interest?

Mr. LEVITT. Four and a half plus a half.

Mr. McDONOUGH. That is all, Mr. Chairman.

The CHAIRMAN. Are there any further questions?

Mr. MUMMA. I have one here.

The CHAIRMAN. Mr. Mumma.

Mr. MUMMA. Are you operating mostly at Levittown?

Mr. LEVITT. Pennsylvania.

Mr. MUMMA. That is the one you sold over in Long Island?

Mr. LEVITT. That is finished. This is Pennsylvania.

Mr. MUMMA. I read that article where the fellow did that high financing. I wondered, if that affects your selling of houses presently? In other words, have you transferred the actual selling of your houses mostly to the man who bought the group?

Mr. LEVITT. Either I don't understand you or you have got the facts a little bit mixed up. We sold out all of Levittown, N. Y., in a block.

Mr. MUMMA. Levittown, N. Y.?

Mr. LEVITT. Yes. We are operating in Pennsylvania. There is no question of competition between the two.

Mr. MUMMA. That is what I thought.

The majority of your houses are occupied by steel people or the Philadelphia officeworkers?

Mr. LEVITT. Philadelphia.

Mr. MUMMA. United States Steel has them, too?

Mr. LEVITT. No. United States Steel does not employ enough people to have filled Levittown. In Levittown, Pa., today, we have about 9,000 houses occupied. Of that, my guess on it is that Steel has seven or eight hundred.

Mr. MUMMA. They have some operation of thir own?

Mr. LEVITT. They have. They probably have another six or seven hundred there, but the majority of the houses are from the Philadelphia area.

Mr. MUMMA. I agree with you that the Government guarantee is the one that attracts most of the financing.

Mr. LEVITT. It is the only thing.

Mr. MUMMA. Under this 40-year plan they have a chance to bail out in 20 years if they have a bad deal.

Mr. LEVITT. That is right. There has been so much emphasis on this 40 years applying to the \$7,000 house. I am trying to find out who is going to build the \$7,000 house in the slum area. How is he going to build it? I don't know how. We have a reputation of building pretty low-cost housing.

Mr. MUMMA. These public housing, fireproofed and everything there costs in multiple-family houses are around twelve thousand?

Mr. LEVITT. That is right. You are talking about individual units in slum areas, which means each one takes up a piece of ground and you don't have an awful lot to being with when you start talking one-family units in slum areas.

Mr. MUMMA. I agree with you, too, as to the second-class citizen.

Mr. LEVITT. That is all wrong.

Mr. MUMMA. There are plenty of people in towns, like Philadelphia or any place, that have never been able to get the one-third down, or whatever it is. If you look them up in the financial records like the Credit Exchange, their rating is excellent, but you will find they just have never got the one-third down. I know when they do purchase a house, they become better citizens.

Mr. LEVITT. I heard one interesting thing just the other day, strangely enough from an economist working for FHA. I said, "How do you reconcile the terrific increase in savings bank deposits with the fact that people don't have money to put down as downpayments?" And he said that was what was bothering him. He said, "We found out on some spot checking that the majority of these increases and the majority of the deposits are in the name of people who already own houses; that the fellow that has not owned a house hasn't had a chance to build up any money."

Take it for what it is worth, but that is FHA's own economist.

Mr. MUMMA. Your success has been due to good building methods, as well as merchandising?

Mr. LEVITT. I would like to add one little thing here on what Mr. Hughes said about schools. I hadn't meant to mention that, but I think that that is also very important, and 100-percent right. We have cured the difficulty in our own way, but it would not apply to the average builder. We actually build the schools. We do it on a nonprofit basis, and so forth, but the school problem, wherever we have gone, and we are about to commence another undertaking, and the only question being raised by the municipal authorities is what is going to happen to schools. We can't afford them; so I think it is very important that the smaller builder be permitted to convert 2 or 3 or 4 or whatever he has to have his houses into classrooms and be permitted to finance them; that FHA grant insurance on it exactly in the same fashion as though it had been sold to an individual. It is a better security, as a matter of fact, but you have got to have schooling if there are houses. A yardstick could easily be put in by FHA, one school for X number of houses, or one for X number of houses to be used as schoolrooms.

Mr. MUMMA. The thing that worries me about these too long-term loans, in my opinion, is what percentage of your houses are frame? Are 60 percent of yours frame or is that high?

Mr. LEVITT. From construction standpoint, 100 percent.

Mr. MUMMA. Outside needs paint?

Mr. LEVITT. No. You could put asbestos shingles on it which would never need paint.

Mr. MUMMA. For those that are built near the ground?

Mr. LEVITT. That is fireproof.

Mr. MUMMA. That would be right on the ground?

Mr. LEVITT. No. It could be a little bit above. Let's presume you have normal maintenance. He would pay \$10 or \$12 a year to maintain it.

Mr. MUMMA. My point in the long term is the painting cost. I don't know what you figure costs every 5 years.

Mr. LEVITT. If you would permit me to sell you a house I could give you the argument on that quite easily. That is the difference between his paying rent and buying the house and saving carrying charges that he makes back, first of all what he makes on an income-tax deduction, he also increases his equity, call it compulsory savings and between the two he certainly has more than enough to take care of any maintenance.

Mr. MUMMA. That is theoretically true. You have this chase for the consumer's dollar. I have seen things that are very, very bad, and I know your type isn't rows or double houses.

Mr. LEVITT. No, single.

Mr. MUMMA. You run into that situation where Smith has the money to pay for painting and the fellow next door may not have.

Mr. LEVITT. I think you will find in the so-called low-cost house the average individual does it himself. He buys the paint, but he supplies his own labor. I know we have found that to be the truth, not only on painting, but a great many other items.

Mr. MUMMA. Smith may want green and the other fellow red. You can see, not in your development, because you have it pretty well, but over a period of years these row houses or multiple one-story do get to look a lot different. It sort of starts the degrading of the whole proposition.

Mr. LEVITT. That is right. You use the word "theoretical." I say it is actual. I say a man on a \$10,000 house, we have estimated the average purchaser gets approximately a \$100 income-tax deduction. That is actual cash in his pocket.

Mr. MUMMA. It is a question when he gets a pay check every month or weekly or whenever it is who gets the first and most definite cut out of it. He may save that hundred, but it doesn't necessarily mean he has to put it in the house. One fellow said we lived in automobiles.

Mr. LEVITT. The interesting part is it doesn't come every week. He gets that check at the end of the year as a refund from the Government.

Mr. MUMMA. His income tax?

Mr. LEVITT. Yes. He files deductions, and so forth, but he gets a lump sum at the end of the year.

Mr. MUMMA. It doesn't necessarily mean that something isn't pushing him more than paying the house.

Mr. LEVITT. That is up to him and mamma. I can't do anything about that.

Mr. MUMMA. That is my point. I don't know where the decision will be made. From what I see of some houses, especially multiple-row houses.

Mr. LEVITT. The distinction I am drawing is between a 30-year mortgage which this bill proposes and a 35-year mortgage. If you are right in your contention it will apply equally to 30 years.

Mr. MUMMA. It might be a little worse in 35 years, is that right?

Mr. LEVITT. That is right. It is a question of degree and I don't think that is too much, between 30 and 35, but the difference in buying, the difference in stimulating the market is tremendous. It means that you can practically cut the proposed figures you had on a \$10,000 house almost in half, and actually the carrying charges will be slightly

less on a 35-year mortgage with a one-half downpayment. That is important.

Mr. McDONOUGH. You also mentioned the fact that a large majority of the people pay out in 10 to 12 years.

Mr. LEVITT. That is not only FHA statistics, that is all banking figures. Practically all mortgages have been paid off or refinanced in 10 to 12 years. Let's presume we are going to have refinancing in 12 years. It is up to the then lender to determine what he wants to do. These mortgages we are talking about now you can bet your bottom dollar will be paid off or refinanced. I am saying 10 to 12 years and being conservative. I think FHA are 7 or 8½ years. That is on a 20-year experience.

Mr. McDONOUGH. How many new prospective buyers would be in the market if you did have satisfying financing?

Mr. LEVITT. I think it is unlimited. You have a population upcurve coming all the time. You are pretty close to the family formations, war babies, etc. You are only a few years away now. I think it is practically unlimited if you can remember that credit is the lifeblood of everything. You can't sell automobiles, washing machines, or anything else without credit. We know it because when we take a credit memorandum on every purchaser he has to give us everything that he owes on credit, and you get the television machine, the washer, and this and that, and so on. Luckily we supply washers so we can get rid of that obligation.

Mr. MUMMA. Is that all in the cost of the house?

Mr. LEVITT. Yes, we include everything in the cost of the house, including settlement fees.

Mr. BETTS. Do you believe in the open-end mortgage?

Mr. LEVITT. Yes. That is the only mortgage that makes any sense. Consider the work you are going to do after you would close title or had done before, you would have had a different house, and you could have financed it and just the very fact you closed it you say "Now, I am going to add a garage or two or something," and somebody says "You can't finance that for 25 or 35 years. That has got to be done for 7 years." It doesn't make sense. I very much believe in the open-end mortgage.

Mr. OAKMAN. Where could he get it financed for 7 years?

Mr. LEVITT. FHA, title II.

Mr. OAKMAN. You are supposed—it is proposed to extend that 3 to 5 years.

Mr. LEVITT. There is 1 for 7 years. I am trying to remember what it is. Then it is 3 years. It makes the open-end mortgage still more attractive.

Mr. OAKMAN. Mr. Chairman, just a couple of questions.

I had a very enjoyable day last spring driving up to Levittown and looking over your development there. How many homes will you eventually have when it is all filled up?

Mr. LEVITT. In Pennsylvania, 16,000.

Mr. OAKMAN. What is the average sales price of the average home?

Mr. LEVITT. There is 1 house for \$9,500, 1 house for \$11,500, and we have a small group for \$16,500. That will be less than 5 percent of the whole community.

Mr. OAKMAN. What is the monthly carrying charge of that \$9,500 home?

Mr. LEVITT. Fifty-nine dollars a month.

Mr. OAKMAN. That includes taxes?

Mr. LEVITT. That includes everything.

Mr. OAKMAN: It was a lovely clear Sunday when we were there, and we just noticed hundreds of those young veterans out there doing all sorts of work, with their wives, too.

Mr. LEVITT. There is 36,000 people that live there now.

Mr. OAKMAN. They were painting and putting in everything around the place.

Mr. LEVITT. They were.

Mr. OAKMAN. They don't hire that work done. They do it themselves.

Mr. LEVITT. That is the interesting part I want to stress.

Mr. OAKMAN. They won't do it in a rented house.

Mr. LEVITT. That is exactly the point. When we first started Levittown, N. Y., that was shortly after the war, and there was the clamor for housing. We built under 603. We built 6,000 rental units which we sold part of them, part of them this chap bought and he is selling to homeowners. Right after the 6,000 we built 12,000 more for sale, and the difference between the maintenance of the rental house and the house that was homeowner occupied is just like chalk and cheese. One was maintained beautifully. The lawns were beautiful. What painting had to be done was done. The tenant paid no attention. He said it wasn't his, why should he. The minute he becomes a homeowner the whole house is different. Its real-estate value goes up because it looks better, and is in a better neighborhood.

Mr. OAKMAN. The other thing is, in referring or recommending a 35-year mortgage, open-end, would you discriminate between the age of your buyers?

Mr. LEVITT. That unfortunately you must do. You must do that because among other things it is practically an inflexible FHA rule. The mortgage, according to FHA, and again it is somewhat unrealistic, must mature at age 70, so that a 35-year mortgage means a 35-year-old individual, if he is 40 it has to be somewhat less, 5 years less. We do that all the time now even with the current 25-year mortgage. If a man comes to us to buy a house, he is 50 years old, he gets a 20-year mortgage instead of 25. In view of FHA's own experience on the maturity of mortgages when they actually get paid up or refinanced, it doesn't make sense. On the one hand they have a set of figures, and, on the other, they become theoretical.

Mr. OAKMAN. It is your firm conviction these people want to get these homes paid for as rapidly as possible?

Mr. LEVITT. I don't think there is a question about it. We get the request from 99 out of 100, because this is 25 or 30 years can't we pay it off earlier if we can? Every single purchaser asks that question.

Mr. GEORGE. Mr. Chairman.

The CHAIRMAN. Mr. George.

Mr. GEORGE. Is it your contention that the home-buying field is practically unlimited if we lower the downpayment and extend the term of interest or the time of the mortgage?

Mr. LEVITT. From a practical standpoint, Mr. George, yes.

Mr. GEORGE. Up to 2 million homes every year?

Mr. LEVITT. I would guess so. There are so many collateral things that come in here. If, for instance, you could get the pension trusts of the United States to break down and flood the market with mortgage money, which they should do and which we all try to get them to do, and you had an abundance of mortgage money, where the mortgage money was cheap, where we didn't have to pay premiums for it, either, where you could give intrinsic value in a house rather than so many things that the customer doesn't see at all—he doesn't see that \$300 that we have to pay on a \$10,000 mortgage. That \$300 ought to be translated into something tangible in the house and some day it will. If you could do that, plus the fact of competition; when you build a million and a half or two million houses everybody is competing for that market. The result is you get more and more value. Then you have a market, just as the automobile people this year are breaking their corporate heads to bring out looks and styling, and everything else, to keep this market.

Mr. GEORGE. Do you think FNMA's operation should be curtailed?

Mr. LEVITT. I was hoping you wouldn't ask anything about FNMA because I have my own preconceived notions on that.

Mr. GEORGE. I would be interested in seeing.

Mr. LEVITT. I would take leaf out of the Canadian system. That is to set up a fund and if we can't get money the Government lends, but you will get the mortgage money. If the Government were to announce tomorrow morning we have \$5 billion we are going to lend on mortgages if you can't get it individually we would have every banker and his brother on our neck begging us to take away money.

Mr. GEORGE. I think you are right.

Mr. LEVITT. That is the simple approach. It is a little too simple. Canada does it, incidentally.

Mr. MUMMA. Do they guarantee private loans like we do?

Mr. LEVITT. Yes. The Canadian economy is in pretty good condition. They have an excellent housing commission there. It is the counterpart of our FHA.

The CHAIRMAN. Thank you, Mr. Levitt, for your contribution.

Mr. LEVITT. Thank you, gentlemen.

The CHAIRMAN. The committee will stand in recess until 2:30, subject to my being able to get permission for the committee to sit this afternoon.

(Whereupon, at 12:35 p. m., a recess was taken in the committee hearing.)

AFTERNOON SESSION

H. R. 7839

The committee met at 2:30 p. m., the Honorable Jesse P. Wolcott (chairman) presiding.

Present: Chairman Wolcott, Messrs. Talle, Kilburn, McDonough, Betts, Mumma, McVey, Oakman, Hiestand, Stringfellow, Spence, Brown, O'Hara, and McCarthy.

The CHAIRMAN. The committee will come to order.

We will proceed with consideration of H. R. 7839.

I am very glad to have back with us Monsignor O'Grady who has been with us so often. We consider you an ex officio member of this committee, Monsignor O'Grady. We would like to have you proceed. I am glad to have you back with us.

**STATEMENT OF RT. REV. MSGR. JOHN O'GRADY, SECRETARY,
NATIONAL CONFERENCE OF CATHOLIC CHARITIES**

Monsignor O'GRADY. I am glad to be back, Mr. Chairman. I appreciate your kindness, your interest, and I sort of feel at home in this discussion, I have been in it so many years—more than I would like to say.

I am, of course, very much interested in this housing movement. As I pointed out I think my friends in the home business hardly believe me when I tell them I am a conservative. I am for the free economy, you see, and sometimes they insinuate that that isn't so, and that I am quite radical, but I have to keep on denying that, and for that reason I think I have been impressed by the many things in these newer developments, and these new programs around here, and I don't want to be just merely a critic of them.

I like to look at myself more as an analyst than just a mere critic. I am hoping that these movements will work, and that these implements—new implements—that are handed to the private enterprise people may attain the purposes for which they are designed. That is my hope.

I have been, since I have returned to the country a few weeks ago, trying to get around in a number of cities to see what the picture is, and my picture is not yet as complete as I want to try to make it. I am interested in getting around and studying the housing conditions firsthand in these different cities. I spent all of yesterday and part of Saturday in the old downtown area of Cincinnati, that I have known for so many years, and I spent some time last week in going over the city of Detroit, that I have also known for many years, and I have just been trying to get up to date.

Now, when we were discussing this matter first, beginning in 1932, of course, at that time we were interested in work and housing, and I shall ever remember when we got this provision for loans and grants to local communities on housing, and Mr. Sincovitch and I were rather surprised at the ease with which that can be made a part of the Recovery Act. I think it was clear, but nobody had ever given much attention to it, I don't think General Johnson had when he agreed to put it into the bill, but at that time we thought about housing as a work program, and because it was one of the measures of a dynamic economy—at least those were the expressions we used in those days.

I have always, of course, liked to regard housing as a part of an all-over dynamic economy, and I, of course, was surprised when I got in the outskirts of Cincinnati yesterday. I find a considerable vacancy in this high-income, high-priced housing, and, of course, I find that the supply of houses in the downtown area is gradually contracting and population of the downtown area declined, and this is characteristic of many other American cities, I am quite sure—contracted until about 1950, and it has been growing ever since, and the housing supply is being reduced downtown all the time.

Of course, I realize that there is some movement of Negro families from the downtown areas, some of those in the upper middle income brackets into the outlying areas. I saw several evidences of that yesterday. I visited several of those families and talked to them about the prices they paid for their homes. They have kept up pretty well.

I hope that is so in the future, that they can maintain the houses and prevent the spread of blight to those areas. That is the challenge of Cincinnati just as is the challenge of Detroit, to prevent the spread of blight to new areas. But I am afraid Detroit has not succeeded in doing that.

We have come to regard housing for families as a part of an all-over plan for the use of city land. We need land, of course, for other purposes—for educational purposes, for recreation, for health facilities, business, communication.

We have a great deal of competition at the present time between the different interests for the use of city land and each interest has its own techniques, its own power block, and I don't know what the cure for that is. Sometimes I think I do, and we find the same division among these specialists up at the top here in Washington, too. You would never think, for instance, that PHA and the slum-clearance group belonged to the same agency, and, above all, FHA, and, of course, the greatest problem of all, as I see it today in this effort that this bill represents toward the rebuilding of our cities, is in the highway departments. They are proceeding as if there was no other interest concerned than the use of city land, as if housing didn't mean anything, and they are tearing down a man's house.

I saw them last week as they drove that highway through Detroit. It is all right while they were driving it through the places that I know so well, people who can afford to buy a \$20,000 house in the hinterland, but now they are tearing down a great number of houses for the lower middle class. They may not be the best houses, but they are just as good—they are better than many of the houses that are being repaired in Detroit at the present time, in my judgment, as far as I have been able to see them last week.

They tell me they are going to drive a new highway through the city of Cincinnati, through the whole downtown area. It will wreck thousands of housing units that they can ill afford. It will further decrease the housing supply.

That is being carried out. Chicago, of course, goes through all the formalities. They are supposed to work with housing. They work with the Public Housing Authority on a relocation program. There is very little relocation as far as I can see on the boulevard. I think they are being crowded into other areas, and you are blighting more houses.

I feel that is the greatest danger in any program of redevelopment, because there isn't any central plan for the use of land. Each one is competing. For instance, I saw yesterday again in Cincinnati three areas that have been cleaned out for a new school. I realize schools are important, and then in another place it was being cleared out for a new firehouse. Of course, many houses are demolished.

Is that going to be done by each agency independent, as if no other interest was concerned? These are the facts now. You can deny it, you can say they are not true, just as when I say that they are not relocating. I have said many times in Detroit they are not relocating anybody. They say you exaggerate. All right. I could take you to cities and streets that have been blighted in the past 2 years. How about that? Well, nobody seems to want to take it up somehow or another, and at one time we did have a little discussion out there with

one big builder. We agreed to go on a tour, but somehow or other it never matured. Our tour never matured. I wanted to get around and see what had happened in these areas.

I am not proposing any particular brand of doctrine. I am trying to report the facts. I am trying to report my observation in these different areas, and I am trying to take a new look at this matter. I think that is what this bill is designed to do.

I asked, for instance, last week in a certain area in Detroit in which now they are trying very hard—trying a sample in the enforcement of city codes. I said to one of the officials, who was along with me—one of the city officials—I said, “How long is this enforcement going to keep up?” It is a nice thing to talk about, and sometimes we get on a little bit of a crusade, but then to keep it up consistently, get the support of the police department, for instance—you can’t have any enforcement if the police aren’t with you, enthusiastically.

I remember the mayor of Chicago told about a certain area in which I was interested in the South Side. He said, “Of course, you are going to have the cooperation of the police department.” We could never get the captain to our meetings. Well, finally, we got the neighbors stirred up and developed a neighborhood group there, and we noticed the two aldermen and the captain came to our meeting, and were very enthusiastic about the program once we involved the neighborhood, and, of course, we didn’t have an easy time in developing a neighborhood organization. That is an easy thing to talk about but a difficult thing to accomplish.

There is a very strange situation today in regard to this whole housing field, and that is the difficulty of getting at the facts locally, as to what is happening. I called this matter to the attention of the President’s Committee in my two appearances before them, and I said, “If you could only get it for 10 cities, then we wouldn’t have all this speculation about it.” But we don’t have, for instance, the facts in regard to relocation. The officials in Detroit say they have a program of relocation; others say no, you don’t have any program of relocation. You have a program on paper. I have said that of the city of Chicago. You have a program on paper, but you are really not relocating people. You are making new slums.

Of course, we wouldn’t have to engage in speculation if we had the facts, and I think the facts can be made available, but I know now that they are not available at any central point, and I don’t know what the reason for that is, and I think some of the homeowners are as much at fault as anybody else. They feel they have an interest in this matter and are going through the process of organizing a relocation program. It is not a real program, I am afraid. They feel they have to defend that program. I think that is probably one of the reasons why it is so difficult to get any facts about the realities at the present time in American local communities. There is this competition for land, and you have got your schools and your health centers, your recreation groups, then your new terminal groups, the groups that are interested in new truck terminals, and you have all this struggle going on. Each one wants a piece of this land.

If there were any definite plans of approach, then I think we could develop a better approach, more constructive approach, toward this

housing program because as it stands it is very, very difficult. The real-estate people say one thing; I say another thing; and we don't seem to be able to meet. I have a great deal of hopes in the President's Committee. I thought we had made some headway; at least we would get a little bit more willingness to face the facts; and I kept on all the time saying to them, I said: "Now, I am not interested necessarily in public housing per se, but I am interested in housing people, and if you can demonstrate you can house them that is all right with me, and I welcome any constructive effort you make in this field. I am willing to try it out, but let us not try to deceive one another. Let us face the facts in regard to what you can do, above all if you are going to go ahead, because they all seem to be enthusiastic about a large program of urban redevelopment."

Sometimes I wonder about this enthusiasm. I wonder. I know in Cincinnati there is a divided opinion about the whole business. Several of the real-estate people are opposed to any program of urban redevelopment, and I wonder how much enthusiasm and how much of this is going to go on with the opposition that you get. I wonder if it sometimes is not stronger; but, as somebody reminded me recently, he said he wondered whether or not any mayor can stand more than 1 of these clearances, whether any city council can stand more than 1 of them because of the pressures.

I have heard city council meetings in Chicago and other places. They say they are a slum district. They say, "Who calls us a slum district?" Somebody downtown invented the idea. But they are not. The neighbors are here. The auditorium was filled that day with people who were protesting against it, so I don't think this is too easy a matter, and it works too easily, as many of the experts seem to think that it will.

I don't think it is so easy, and above all, this matter I think of the highway construction, of these speedways, and I think that is the toughest problem of all, as I see it today. I don't know what the solution is. I tried, for instance, with the former Administrator of the Housing and Home Finance Agency to see whether or not we could get a meeting with Mr. McDonald, who was then Chief of the Bureau of Public Roads, an excellent person. I have had an opportunity of working with him for many years, but we could never get the meetings. We never got a meeting. We didn't even talk it over, you see.

That is the situation there, as I see it, and I hope that nobody will try to deceive us that there is any planning for the families that they are displacing.

I haven't seen any evidence of any real planning. That is what is cutting into the supply of housing all the time, and that is what makes it so complex. You take it on any city the way the houses are being wrecked, and sometimes fairly good houses. Some of them are very good houses. I think in areas through which the new highway is being pushed in Detroit, I think there are many good houses even in the low-income areas. Some of them are not so good. They have been permitted to deteriorate, but this housing supply is a thing you have got to keep in mind, and I noticed my friends the home builders have been promoting the thought there is a great supply of housing waiting somewhere to be repaired. I would like to find it if there is.

I know there is some. I think what we should concentrate on is those threatened with blight rather than blighted areas. I know you can salvage a good deal even in the so-called blighted areas. I think we have been calling these areas blighted unnecessarily. That is a fact. We have been cutting into the supply of housing, and it has gotten to the point, I think, right now where there is no other way out of this situation.

Now, I say accept the continuation of some public housing, and that is what the President's committee says, that they will try this new program. Fine, let us try it out experimentally, see how this \$7,000 house will work out, with virtually no downpayment.

Well, we get into a debate in most every city about that. I have had many discussions in the past few weeks with builders, real-estate people, with lenders, about this \$7,000 house and whether or not you can build a \$7,000 house in Detroit. Maybe you can. I am willing to give it a chance, but that is what the President's committee says, "Let us give it a chance." We don't know. Let us continue some of this public housing for the time being in order to take care of these folks who are displaced by these clearances.

I don't know how they can be taken care of otherwise. I don't see the supply of houses that are waiting to be repaired. I see some, and again I want to take an optimistic view. I want to watch the program; I want to study it; I want to be in touch with it; I want to see how many they will be able to repair; but the present plans, in my judgment, as I see them, in St. Louis—and I have been greatly interested in the whole program in the city of St. Louis—they have been trying some projects in a neighborhood organization in St. Louis. I pointed out to the city planning commission, as they took me out to see the houses that they had set out, samples of their newly repaired housing, I said you price that away from the people living around here. There is nobody in this place that could service that house. I said it is just like this group of houses over here on Capitol Hill. We have had a fine repair program here, but it is not possible for any of the people who lived or have been living in these houses up to date to live in them any more, any more than they can live in Foggy Bottom or Georgetown. You have the same thing happening in many cities.

You have seen these specimens of repaired houses that have made the houses too expensive for the people in the area. I realize something has to be done in the areas, in the areas that are threatened with blight. Something must be done. I can't imagine our waiting and sitting back and letting these near downtown areas be turned into a new wilderness. That is what I pointed out many times to the mayor of St. Louis. This whole strip of 34 square miles in the near downtown area in St. Louis is going to be another wilderness pretty soon, and here you are extending your city over the city lines and reducing your tax base because when you get out in the county you have a different area altogether, a different tax structure, and the city of St. Louis will be bankrupt very soon if it is not already bankrupt, you see.

I think we must attack that problem, but I am not so sure about the present approaches to it. I have had this discussion with the experts;

and the experts downtown, just like the experts at our State capitals, think they can walk into an area and tell all the neighbors that this is the proper thing to do in the area without involving the people in the area. I don't think it is possible to do that. I don't think that sort of an approach will work. We have had to find some method of involving the neighbors, of getting them interested in their own neighbors, and they have got to have some say about it, not just get them to swallow everything that the expert says, because, as I pointed out before, the experts are frequently not in agreement as to the plan for that particular area, but I think it is awfully important that we get this done.

I see some evidences, some recognition—I see it in this bill—some recognition of that fact. I would like to see it written to every plan that is approved by Mr. Cole, the fact that the neighborhood should be encouraged to develop their own organization and thinking without having any strings tied to it.

I have been in that discussion in many cities now, and sometimes I find the neighbors up in arms against what the downtown experts want to do in that particular area. I think it is very, very important, and I think the neighbors should be reckoned with, taught to think for themselves. I think that is the great concept that is being developed around the world at the present time. People have to learn more and more of the lesson of self-help. There is an awful lot of this going on already in these areas.

I find people are getting together among themselves. There is more self-help than we realize, and more than the downtown city planners and maybe even the planners in Washington recognize.

I believe that we ought to give this program a reasonable chance of succeeding, but I am convinced that at the present time, as just my friend the late Senator Taft was convinced; through a good part of his life, he said, "As soon as you folks can find a substitute for housing these folks now, these very low income groups, and you have, of course, the next stage above, that is still a challenge. We are not providing housing in sufficient quantities for them."

I am not suggesting that Government should go into that area. I think that is a field in which we must continue to challenge private enterprise, and we must challenge the home builders and challenge the lenders and keep on challenging them until they do a better job in this field of middle-income housing. Some have used a great deal of hope for cooperative housing in this field, but somehow or other we haven't caught on yet. We have some cooperative housing in some parts of the country, but, on the whole, we haven't been too successful in the field.

Now, I think we have to, therefore, until we get a substitute—and I haven't seen any one yet; I am willing to give this new program a fair trial. I think the Government has got to be ready to buy up these mortgages, and again it has to go into that field in a considerable scale on this \$7,000 house. I notice the home builders wanted a little bit more leeway this morning. They want to go up to maybe an \$8,000 house, an \$8,500 house. Well, where do we go then with the person who can pay \$55 or \$60 a month? I don't think that \$8,500 or \$8,600 house is going to be within his reach.

I am glad the home builders are beginning to face the facts, that we are not now building for this very low-income group, and I want, therefore, to keep that in mind.

I also want to keep in mind the importance of a flexible approach in regard to this home-repair program. I think it is a desirable thing to repair existing facilities insofar as they can be repaired, but when you get some of these old-time sections about cities, in which houses have been standing for 50 to 60 years, and they have been permitted to deteriorate—unfortunately—over a number of years, their possibilities of rehabilitation aren't too great.

I do want to see this private voluntary participation in these neighborhoods, or in the efforts to rehabilitate, and to renovate and to rebuild our American neighborhoods. I think that is the only hope. I don't think it can be done by specialists. We have that same problem in other areas of life in our country at the present time. America is a Nation of specialists, and specialists are fine. They have made a great contribution to the building of this dynamic economy that has made this country truly great. This country is noted for its mechanical genius, but there are some things that mechanics cannot do, and one of them is the building of neighborhoods. Neighborhoods must be built by the people, themselves.

Thank you very much, sir.

The CHAIRMAN. Thank you, Monsignor O'Grady.

Are there questions?

Mr. OAKMAN. Mr. Chairman, I would like to say to the Monsignor that it has been a question of whether or not the city of Detroit does have a program for moving the people out of these condemned areas for rehabilitation, out there as Gratiot-Haskins. As I understand under the law you could not force a family to move out. You could not move them out, even though the city had acquired the fee to the land through the right of eminent domain in the courts, until he had acquired a place to go. I have seen those figures. I believe that you mentioned here that about a third of them were put in the public-housing project.

Monsignor O'GRADY. I have the exact figures in the statement of mine here. I can't lay my hands on them right now. I know the figures. I think they moved 1,900 families in all out of one area and they have more to move out of the other area right now.

Mr. OAKMAN. About a third of the people went into public housing and some of them bought houses?

Monsignor O'GRADY. I understand that, too.

Mr. OAKMAN. Some of them, as you say, have rented other properties that may not be much more attractive than the ones from which they have been moved. On the expressways I think they moved out just under 1,100 families last year.

Monsignor O'GRADY. There is no relocation program as I understand it on that expressway. Last year they were moving through an area of high-priced houses, but now they are reaching out into this other area which is a low-income area.

I was there last week and I saw the steamshovels at work there. There is no program there and the Housing Commission—they have no relationship with the Housing Commission on that matter. I talked to several families along there. I understand they give them

a poke every now and then, that they are ready to tear down the house and they had better get out of there. That is all they do.

On the other matter, I had quite a discussion about a year and a half ago. They keep on urging these families to get on and I finally got to move around with the people who are engaged in relocation, and I finally got them to take me to this one street and they said, "If you can get into these houses, maybe you will find the people that have moved in here themselves."

I had quite a time getting into the houses. I knocked on the door and I received some rebuffs, and finally I saw this lady coming along the street and I talked to her as nicely as I could, and asked her if she lived around there and she let me visit her home, and finally we decided to go there, and we saw this house and there were about five families living in that house. There were some of the people that moved out of the Gratiot area. I asked her if she would show me some more. When I talked about the facts this is the thing I am referring to. It is so difficult to get at the facts. I asked her if she had any friends along there we could talk to and finally she did introduce me to some of the friends and we got to see some of their houses. That is the way I studied that area, from one house to another. It was difficult to get in because they were suspicious. They knew this whole question was in debate and they didn't want to become involved in the debate.

Of course, I know some of the people in Detroit didn't like that behavior of mine, but I can't help that. I was trying to get at the facts and I was willing to let the facts speak for themselves, but I will tell you, it is my idea to get the facts in Detroit. I will tell you that now. I have said openly at times that there wasn't any relocation; that these families somehow or other found places for themselves and I am still contending the same.

I haven't seen any evidence that there is any relocation, except in the public housing, as you stated. There is no question about it. Last year in that Lafayette project, I visited several of the families that have to be moved out. Some of them will tell you: where are we going, we don't know; how soon are you going to move out, you might ask. We don't know.

They will say sometimes maybe they will give us a project. That is what they mean by public housing, they will give us a project. I have seen the same thing in Chicago. We talked to the families that moved out to the New York Life project and it is the same thing. I think that is the real issue— are we spreading blight, are these new improvements contributing to the spread of blight?

Of course, you say the public housing saves at least one family, it gives them an out, but you are eliminated entirely and then are you going to find more blight? You have to find housing for them. Are you going to find it by blighting more areas? That is my question about Detroit. I know it is a hot political question. I don't want to become involved in it.

Mr. OAKMAN. It is a very difficult one.

Monsignor O'GRADY. I know.

Mr. OAKMAN. On the expressways, the State highway department is building one and the county highway department is building another.

Monsignor O'GRADY. I thought they were all in on that big project. I thought the Federal Government, county, State, and city were involved.

Mr. OAKMAN. That is right, financially. The State is the contractor, on the one, and the Wayne County Road Commission is the builder of the other. They actually don't do the construction work but the county lets out the contract. They accepted responsibility for building the north-south one, the Lodge Expressway.

Monsignor O'GRADY. That is the one I say.

Mr. OAKMAN. The east-west one, Edsel P. Ford, is the highway department. You don't feel there is any coordination?

Monsignor O'GRADY. I don't feel there is any coordination. After all, the city of Detroit has some responsibility for housing. They assumed it by setting up a housing commission. Now, all I am saying is whether you should build those highways or not, that isn't my province to say, but we should know what that does to housing in Detroit. After all, the city of Detroit is concerned about the housing supply. I know that all these workers in Ford and General Motors will say that they need in order to move their traffic, they need speedways. I think there is a question in there between those speedways and housing of people. Which are you going to favor? In other words, it seems to me that an expressway, like the Edsel Ford or the Lodge should not be built except on the basis of all the facts in the life of Detroit. In other words, that is what I am saying. If the people of Detroit, after they know all the facts, want to decide it in a certain way, I think that is their business, but I think they certainly should know what is going to happen to families whose houses are going to be torn down, and they are not getting the facts, I am afraid, in regard to that situation.

There should be some joint planning. There is no planning. The people in the housing commission tell me there is no planning with the highway commission. They go ahead and act independently in this thing as if there were no other elements involved except the building of a highway. It seems to me that the same is true with other things that use city land and tear down houses like the school departments or the health department is in the same boat. It is the whole question as to how we are going to plan for this use of city land. We have business, we have a man's house and you have got to find a place to live. It is awfully discouraging when you find when you go through these cities as I have, and I find people crowded in, as I find them, for instance, in Chicago, safe houses—if we ever had an exact record of the fires in those houses, and the mortality, the dangers, when you crowd people into a house: a 1-family house you crowded in there 3 or 6 families and then all this speculation that goes on in the sale of that house—that is the kind of thing I would like to see people face.

Again, what the citizen is going to do about it after he faces all the facts, that is another story for him. I just want him to look at all sides of the picture. That is what I have been seeing in your cities. I know it is a tough issue in Detroit.

Mr. OAKMAN. Some of that land we condemned for the Gratiot development is now the site of the new medical college of Wayne University going up.

Monsignor O'GRADY. I know that.

Mr. OAKMAN. If we hadn't gone in and exercised the right of eminent domain I don't know where we would have put that school and they wanted it at close proximity to the receiving building and the medical college.

Monsignor O'GRADY. You have the same thing in Chicago. You have got it in St. Louis. You have the building of new medical centers. They are very important, I would say, but still I want to keep on weighing that against a man's house. In other words, a man has to have a house to live in, too. I am concerned about weighing one against the others. I think it is fine, and, of course, it makes it intriguing, and these medical centers become very popular, and they are very popular with the people. That is fine. I think these are the factors.

Mr. OAKMAN. Did you happen to see, Father, that new annex to the receiving hospital where they have this cancer clinic and hospital and the cardiac clinic in the hospital?

Monsignor O'GRADY. Yes; I have seen that, too.

Mr. OAKMAN. It is a beautiful thing. They had these cancer cases scattered all over the hospitals in the city, 1 or 2 or 3. They have brought them together, and they are given expert care; they are getting the best of everything. That is human progress, too.

Monsignor O'GRADY. I noticed in your children's hospital, too. They are trying to rebuild that area. I saw them in the repair program last week. The whole area is being rebuilt, near the women's hospital. They are trying to rebuild it. They are trying a repair program there. It is a sample. They are trying it out as an experiment. I was impressed by that, too. Yet, when I see some of these old houses in that other area, right near or back near the museum, you have got these old houses. They were fine houses in years past.

I visited a whole line of these houses. I see families living in 2 rooms, and I find families living in 1 room; and I find 1 man whose apartment I visited, he and his wife and 2 children—he told me recently they had some visitors, and they were with them for several months and couldn't find any place to live. They just moved in on them. There is a great deal of crowding in that area right now. Those are very nice houses. It is what will happen in time. That is the big question, as to what is going to happen to those houses and the whole question of enforcement in the courts is an enormously difficult problem in your city. It is a very difficult problem as I see it, to enforce the codes, among other things, in the city of Detroit. I hope that you can meet the problem. Of course, they say they have some public housing to meet the needs, and there are some 900 families they are going to move out to the Lafayette area. That is what the housing commission tells me. I don't know how many are left in the pipeline now. Some people whisper to me there aren't so many people left in the pipeline. That is the big debate behind the scenes, as to how many units are left in the pipeline.

Some people tell me there aren't over 6,000, some tell me 7,000. I haven't got all the facts in regard to that situation. Maybe you would find there aren't enough left to take care of that Lafayette area of yours. I suppose probably three to four hundred of those families could be taken care of by some additional public housing in your city.

Mr. OAKMAN. That is the East Lafayette section.

The CHAIRMAN. May I call attention to the fact that we will have to come back after the recess? Are you about through?

Mr. OAKMAN. Yes. I think it is grand that Father O'Grady concerns himself with this problem, which is economic as well as social, and as a member of this committee and as a resident of the city of Detroit, we will be more than appreciative, Father, of any suggestions that you can give us for handling this very acute problem, because there is this great national problem of rebuilding the slum areas of all of our great cities in America. We have got to do it. It is going to necessitate moving people to do it.

During the war they told us, "Don't move anybody. Don't touch your slums now. You will only aggravate things." And then in the Korean war, the same thing.

There is always a reason for not going ahead with the progress that in the end will spell real progress. The thing we have got to do in government is try to make the blow just as painless as possible.

Monsignor O'GRADY. That is the problem. The question is finding houses for these folks without further spreading the blight. You can pack them in in some other areas but then you are developing your slums. That is quite an easy thing to do.

The CHAIRMAN. I am afraid we will have to recess to answer a call of the House. We will take a recess for 30 minutes.

(Recess taken.)

The CHAIRMAN. The committee will come to order.

Mr. Oakman?

Mr. OAKMAN. I am all through, Mr. Chairman.

The CHAIRMAN. Mr. McCarthy indicated he had a question to ask Monsignor O'Grady.

Monsignor O'Grady, can you wait around for a few minutes?

Monsignor O'GRADY. Yes.

The CHAIRMAN. Mr. McCarthy wanted to speak to you. We will have Mr. Wellman on the stand and if Mr. McCarthy still wants to interrogate you, I am sure Mr. Wellman will be willing to withdraw for a few minutes.

Mr. Charles A. Wellman, of California, executive vice president of the Glendale Federal Savings and Loan Association.

We are glad to have you here and we will be glad to have you proceed.

STATEMENT OF CHARLES A. WELLMAN, EXECUTIVE VICE PRESIDENT, GLENDALE FEDERAL SAVINGS & LOAN ASSOCIATION

Mr. WELLMAN. Mr. Chairman, members of the committee, if it is satisfactory to the committee, I would like to submit the written statement for the record and comment on the major points covered by the statement.

The CHAIRMAN. That will be perfectly agreeable.

Mr. McDONOUGH. I think for the benefit of the committee members, I should say that Mr. Wellman has been identified with the savings and loan business for many years and has had rather active and interesting experience with it. I think his testimony will be valuable to the committee and whatever he may say about title 6, I would like to inform the committee that he was quite instrumental in finally developing a compromise that would satisfy the savings and loan

association, the committee, and the administration in title 6 of this bill, which has to do with revising the authority of the Home Loan Bank Board.

(The statement of Mr. Wellman is as follows:)

STATEMENT OF CHARLES A. WELLMAN

My name is Charles A. Wellman. I am executive vice president of the Glendale Federal Savings & Loan Association, a Federal savings and loan association with assets in excess of \$90 million. We are engaged in making all types of loans, including FHA, title II, VA 501, title I, FHA property-improvement loans, our own unsecured property-improvement loans, and conventional mortgages with open-end provisions. My comments today with respect to the proposed housing bill of 1954 are confined to 3 sections, to title I, and more specifically to the changes in title I of the section 203 FHA for 1- to 4-family residences, on the provision of title III respecting the reorganization of the FNMA and the provisions of title VI respecting the Home Loan Bank System.

Title I of the proposed bill makes or authorizes the President to make substantial changes and extensions in the FHA loan programs. The effect of these changes will be a considerable expansion of the use of the old title II, section 203 FHA loan. You certainly could not extend the term of a loan plan up to a maximum of 30 years, lower the downpayment requirements, extend the maximum benefits to existing housing as well as new construction, relieve the previous statutory inhibition against the use of FHA for refinancing, and not have a substantial increase in the use of the old 203 loan. Determining the desirability of making these changes is a difficult task. Certainly, however, making it easier for individuals to buy houses, for builders to build houses, for realtors to sell houses, and for lenders to make loans on houses cannot be the sole objectives of any housing legislation. The costs that are involved must also be considered and there certainly is a price tag attached to the proposed extensions which must be critically examined. With respect to the changes in title I, there are two specific elements of price which need special attention. One element is the potential cost to the Federal Government of the proposed extensions; the second element is the possible effect of the extensions on the distribution of power over and responsibility for the mortgage credit structure of the country as between the Federal Government and the private home-financing industry.

The Federal Government has a direct liability for all insured losses suffered by private lenders under the FHA plan to the extent that the specific FHA insurance fund is inadequate. Under the mutual mortgage insurance plan, the Federal Government, in effect, occupies the role of backstop. How strenuous and taxing a job the role of backstop is depends on how good a player is the insurance fund. Measuring the performance capacity of the insurance fund to cover fully all insured losses that might occur is, of course, a very difficult and complex task. No matter how carefully and comprehensively it is done, you will never come up with a precise mathematical answer. Nevertheless, unless this element of price, namely the possible cost of the Federal Government, is going to be brushed aside as totally irrelevant, such a task of measurement, with all of its limitations, must be undertaken. To measure the performance capacity of the insurance fund requires an analysis of 3 elements or 3 parts. One is the estimated risk inherent in the total portfolio, the second is the amount in the insurance reserve, and the third is the relationship between these two. The risk inherent in the portfolio is a constantly changing thing. It is affected by many factors. Most important of all, however, it is affected by the rate of growth of the portfolio and the risks inherent in the individual new loans being made.

For example, if you had a total portfolio of \$100 million of fully amortized loans and you made no new loans, the risk in that portfolio would diminish, for the unpaid loan balances would be consequently reduced. On the other hand, if you had this same portfolio of \$100 million and merely replaced the reductions in it by new loans, and the risks in the new loans were no greater than the reducing risks of the existing loans, the risks of the total portfolio would remain the same. These two illustrations, however, are not characteristic of a dynamic mortgage portfolio, nor are they characteristic of the FHA-insured operations in the past or as they are contemplated under this bill.

The bill contemplates an expansion of the total outstanding volume of mortgages insured and at the same time it changes the risk characteristics of the new

loans to be made. The stubborn fact is that increases in maximum loan amounts and extensions of the maximum term permitted materially influence the risk, even if you assume the same property and hold all other elements of risk identical.

Of course, if the insurance fund were now excessive, this would not be a critical problem. Unfortunately this is not the situation. The FHA prepared a study of the adequacy of its insurance reserves for the President's Advisory Committee on Housing. The study showed the reserves on the basis of the existing portfolio, as of June 30, 1953, to be short between \$70 million and \$100 million. Nor was the Committee satisfied with this study, excellent beginning though it was. In fact, one of the recommendations of the President's Committee was that an independent, objective, long-range study for prospective foreclosures and losses should be made. It is this evidence of a deficit in the existing reserves against the existing portfolio that makes the possible cost involved in the new proposals assume even greater significance.

How much, then, do the proposed changes in individual loan plans for the FHA title I, section 203 loan increase the possible risk? A simple illustration using the same assumptions as were employed by the FHA in its study will mathematically indicate the possible extent of the increased risk. Assume a single-family residence valued by the FHA at \$12,000. Assume a loss of the magnitude used by the FHA in its study at the end of the first 3 years of the loan. At a 4½ percent rate on a 20-year term, a loan in the amount of the maximum permitted under the now current regulations will result in a possible gross loss of approximately \$379. If you retain the same interest rate and hold the maturity of the loan still to 20 years but increase the amount of the loan from the present maximum to the maximum possible under the proposed will, which is \$1,000, you raise the possible loss to \$560. In other words, with an increase in the loan amount of slightly over 10 percent, you increase the extent of the possible loss 47.75 percent. If simultaneously with the increase in the loan amount you extend the term for only an additional 5 years, you raise the possible gross loss to \$609, an increase over the base figure of 60.69 percent.

If the objective of the FHA operation is to make it a self-supporting operation to the fullest extent possible, these costs assume critical importance. How, then, can we deal with this problem?

I would like to respectfully submit for the Congress' consideration two possible amendments which at least might help in clarifying this problem. One would be to instruct the Housing and Home Finance Agency to carry out the recommendations of the President's Advisory Committee on Housing to initiate an independent study of the possible long-term foreclosure and loan experiences and report back to the Congress. This would, of course, give a factual basis for the contingent liability of the Government on the existing portfolio. The other possible change would be to instruct the Commissioner of the FHA to increase the mutual mortgage insurance premium rate to compensate for the additional risk when the President authorizes the use by the Commissioner of the maximum increases permitted by this bill. There is certainly no magic in a set annual premium rate of one-half of 1 percent. If one-half of 1 percent is an adequate annual premium rate for loans now being insured under current regulations, it is obviously inadequate to insure loans that would be made under the maximums or even short of the maximums permitted by this bill. We should create in the FHA insurance plan a flexible premium rate dependent upon the estimated risk if the insurance of mortgages is to conform to the most elementary actuary principles.

This whole problem of potential liability, of course, is present in an even more acute form in the VA program. Here, however, the problem is complicated by the fact that the veterans' loan program is so intertwined with the whole issue of veterans' welfare. Here, too, however, a similar study should be made to enable the Congress to more properly affiliate its contingent liability.

The second element of cost is the effect the proposed bill would have upon the distribution of power over and responsibility for the Nation's mortgage credit structure. The great issue which is raised by the FHA insurance plan again for title I, section 203, loans is that it practically relieves the individual lender of any individual loss. As a result of the assumption of this burden by the FHA, it has been forced to take over the basic-lenders function of discriminating among potential buyers. This is proper. The FHA certainly cannot guarantee individual lenders against loans and simultaneously permit these same private lenders to perform the necessary underwriting functions of

measuring the desirability of each loan. When you couple this necessary assumption of power with a financing plan considerably more liberal than that permitted private lenders in the conventional-loan field, you have put together the necessary ingredients for a highly centralized politically directed mortgage system. The private lender no longer performs the classic function of a lender. One of the greatest virtues of a privately operated mortgage credit system is the real and legitimate differences that exist between private lenders as to what constitutes a good borrower, what is good security, and what is a proper loan. When you centralize all decisions on these and similar matters into a single political agency, you are creating a highly brittle and rigid mortgage structure. You are, in effect, depriving that structure of the freedom and mobility it needs and requires. Many of the complaints both Government and private lenders have received about the low FHA valuations, unrealistic minimum property requirements, and cumbersome processing procedures are an inevitable consequence of that centralized mortgage structure. Are we confronted with an either/or kind of choice? Must we have a highly centralized mortgage structure in order to have Government insurance? Personally, I do not believe we are. I think our major problem has been that we have just gone along the path of the original FHA of 1934 when in the face of the general economic climate 100-percent insurance was necessary. I do not believe that, in the run-of-mill single-family residence loan, you need 100-percent insurance. For other types of loans, for certain of the types considered in this bill, on which I am making no comment, you undoubtedly do need 100 percent. If we can eliminate 100-percent insurance, if we can more properly distribute risk of loss between the insurance fund and the private lender, we can have an insurance plan and at the same time a flexible mortgage structure. However, this is a difficult task. One possibility that certainly, to my knowledge, has never been adequately explored, is the use of the insurance plan employed by the FHA in its property-improvement loan where a portion of the portfolio is insured in each individual loan. The result is that the FHA title I property-improvement operations are not involved in determining the desirability of each individual loan. Certainly you could not convert the present FHA setup overnight from 100-percent insurance to partial insurance of the total portfolio. This bill, however, seeks to extend to existing housing the benefits previously restricted to new construction. Here is a fruitful area in which the concept of pooled insurance might properly be used.

The second major facet of the proposed housing program is contained in title III of the bill relating to the reorganization of the Federal National Mortgage Association.

Actually, there is no essential economic difference between the current FNMA operations on military, defense, and disaster housing mortgages and the proposed special assistance functions assigned the reorganized facility by section 305.

With respect to the other function of management and liquidation of the existing FNMA portfolio, the only essential change the bill makes in section 306 is the provision of subsection B for private financing as a substitute for Treasury borrowings.

I have two objections to this proposed change. First, replacement of Government debt by long-term private debt at this time would have a depressing effect on mortgage credit. The bill itself expresses official concern about an overhasty liquidation of the existing mortgage portfolio. Pushing on to the long-term capital market obligations to finance the holding of mortgage loans already made would, in my opinion, have practically the same economic effects as would the direct sale of the mortgages themselves if the conversion of the obligations into private hands was successful to any extent.

Second, to give the reorganized corporation's capital the double duty of supporting not only private financing of its secondary operation but also of what the President himself has termed "frozen investments" is risking inadequate performance by the corporation of both functions.

With the single exception of conversion of public debt into private obligations, there is certainly no reason for such a reorganization of the existing FNMA as is proposed by the bill to deal with these two major functions. Indeed, if it were not for section 304, there would certainly be no necessity to convert the present stock of the FNMA, its paid-in surplus, surplus reserves and undistributed earnings into a new stock issue to be delivered to the Secretary of the Treasury, since at present all these amounts already belong to the Government. In fact, there might well be a disadvantage in such a conversion for by converting reserves

and undistributed earnings into capital stock the Government is depriving itself of a possible cushion for the absorption of future losses which might arise in the further liquidation of the Government's existing mortgage holdings. The basic changes proposed in title III, therefore, stand or fall on the practicality of the proposed secondary market operations outlined in section 304 of the bill.

Section 304 is an attempt by the administration to create a so-called secondary market, about which there has been so much discussion in the past few years. Most of the basic difficulties created by the proposals in this section arise because there is little incentive for membership in the facility and because the facility is being called upon to purchase outright assets offered it instead of lending funds on the security of those assets. These two essential changes separate the proposals from the experience of all secondary market operations previously developed to deal with real-estate mortgages. Because of the lack of incentive for membership in the facility, it is necessary to have Government ownership of the stock at the outset, and to resort to an elaborate device to convert eventually Government ownership into private ownership.

This procedure as outlined in the bill requires the purchase of certificates by users of the facility equal to 3 percent of the dollar amount of mortgages sold the corporation. At this rate of certificate purchases, it will take the sale of \$2,333,000,000 in mortgages to retire the Government stock. Pending this retirement of Government ownership, the certificates will not receive any earnings. To attach a price tag of 3 percent to the users of the facility and, simultaneously, to require, as does section A, that the price to be paid by the association for any mortgage purchased by it under this section should be established at or below the market price for that particular class of mortgage involved is, in effect, to discount all loans purchased at the very best 3 percent below the current market price for such mortgages.

To make this discount more palatable, the 3 percent requirement could be reduced. A drop to 2 percent, however, raises the dollar amount of mortgages to be purchased by \$770 million. If the certificate-purchase requirement were set at only 1 percent of the loans sold to the facility, the corporation would have to buy \$7 billion worth of mortgages at a price still 1 percent below, at best, the current market price. To expect investors to utilize a device of this kind under these circumstances is a forlorn hope. While the investor ultimately would recover his investment in that the certificate would be convertible into stock ownership when, if, and as the Government investment is retired, this will certainly take a considerable length of time.

I personally would not place a value on the present worth of the future benefits which might accrue to an investor out of the conversion of these certificates to stock ownership.

One of the real but almost totally ignored problems of creating a genuine secondary market facility is the constant insistence that such a facility purchase outright mortgages offered to it by its member institutions. A facility which operates on the purchase principle must confine its borrowings from the money markets entirely to the long-term market. It must depend solely on its own credit position. It must assume fully the risk of return of principal, of the servicing costs of the mortgages it buys and of the abrupt changes that can and have occurred in the long-term interest rate structure. In short, once you impose upon such a facility the obligation that it operate on a purchase basis, while at the same time it must obtain funds by borrowing in the capital markets, you create the credit dilemma which has haunted all of the debates on a secondary market facility.

The dilemma can be briefly stated. Seemingly everyone wants some kind of a central mortgage facility. On the other hand, everyone is equally insistent that the proposed facility not operate as a primary lender. Unfortunately, no concise definition of the term "primary lender" is offered. However, what is obviously intended is avoidance of construction of a one-way street whereby mortgages enter the portfolio of the facility and never again emerge into the normal, everyday secondary market except as costly losses to the facility. How can this be prevented? The answer is simple but harsh.

There is only one way such a facility can operate without being a primary lender. It must operate in response to the same pecuniary incentives that motivate the investment program of any other large lender. In essence, it must operate like a private bank, a private insurance company, or a private savings and loan association. It must maintain a margin between the cost of its money

and the yields it obtains on the mortgages it purchases wide enough for it to be a genuine private institution. This fundamental operating principle does not mean that the facility must invest its funds in exactly the same way as private lenders. It does mean it must maintain a proper margin between cost and income.

For a secondary facility not to operate as a primary lender, it must consummate its purchases on the same terms and conditions as those imposed by the vast network of banks and insurance companies which today constitute the private secondary market for mortgages. The postwar FNMA purchased loans of a type and at a price higher than the private market offered; hence, it became loaded with what the President termed "frozen investments." The reason it could purchase at terms and conditions other than those offered by the private market was because its operations were animated by motives other than the pecuniary incentives which dominated the investment decisions of the private secondary market. It raised its investable funds under the protection of the Treasury at rates below the rates private investors paid for their funds. A successful Government-sponsored mortgage facility must therefore be reasonably held to the same profit and loss bookkeeping as is a large insurance company or any other purchaser of mortgages. This means there can be no subsidy, direct or indirect, by the Government to such a corporation. Such a subsidy can only operate to weaken, if not to completely destroy, the pecuniary motives which must dominate the facility's operations and, consequently, compel the facility, to operate as a primary lender.

Even with such private incentive, the facility could still get locked in through abrupt changes in the yield structure.

The critical point, however, is that secondary operations of the facility must be conducted without subsidy. Whether the proposed facility will in fact be subsidized or not depends entirely on the meaning of the separate accountability requirements of section 307 of the bill. Does the separate accountability apply to income and expenses as well as to assets and liability? What happens to any net income that may accrue to the corporation from performance of its special assistance functions and the management and liquidation of the existing FNMA portfolio? How are the expenses of operation to be allocated?

These are critical questions, for if the existing earning assets of FNMA are turned over to the new corporation and if the new corporation is charged that rate of interest the present FNMA is currently paying the Treasury, a substantial net income will be made available to the corporation. Even if this net income is not allocable to reserve and surplus accounts, it could easily be dissipated by absorbing expenses which would otherwise not be possible.

The same can be said of net income arising from performance of the special assistance function. Here again a subsidized money cost is available through the Treasury. If this is directly or indirectly made available to the corporation in its secondary operations, we would again have an indirect but nonetheless substantial subsidy to the secondary operations. As a matter of fact, in view of the bookkeeping and accounting difficulties inherent in the consolidation into one corporation of three diverse functions, two of which are subsidized, a serious question can be raised as to the desirability of a single corporation.

It would be a much cleaner, clearer operation if the secondary market operations were the sole concern of one corporation, and the subsidized operations of the proposed facility were handled by a second corporation.

One further special comment needs to be made about the operation of the special assistance function where the facility will operate in effect as a primary lender to encourage the use of certain types of mortgage plans.

Some type of incentive should be placed on lenders using the facility to absorb mortgages of the types designated so that the facility does not become a dumping ground. Subsidized insurance schemes assure builders of a ready and pressing market for houses financed under these specialized mortgage devices. Every effort should be made to require builders and lenders to assume a proportion of the risk involved in the long-term performance of such loans. It might be that a 3 percent or 4 percent deposit should be required to accompany the submission of the loans to the facility. Such a deposit could be returnable after the expiration of a period of time depending on the performance of the particular mortgage submitted. This requirement would make the original lender a partial guarantor of the soundness of its own underwriting processes and hence would partially inhibit improper use of the facility.

My final comment on the housing bill relates to title 6 and, more particularly, to section 603 wherein the Home Owners Loan Act of 1933 was amended. The amendments proposed by section 603 are the result of a long, tedious process of discussion and compromise between the interests of the administration, of certain Members of Congress, and of the savings and loan business. In these discussions, Congressman Gordon McDonough has played an important and valuable role, and the savings and loan industry and the Government owes Congressman McDonough much commendation for his patient work.

Section 603 is an excellent example of how reconciliation of the various interests of the business and of the Nation can be effected. Here the broad powers granted to the Home Loan Bank Board are spelled out in statutory form and at the same time the supervisory effectiveness of the Board is tremendously increased. The provisions of 603 give the Board for the first time a law of misdemeanor and a method of enforcing it. For too long the Home Loan Bank Board has been confronted with the awesome choice of either using a conservator to enforce its actions or of doing nothing. By the provisions of this section, the Board is, in effect, given the power to issue cease-and-desist orders after compliance with the necessary requirements of proper administrative proceedings and, in addition, is given resort to the judicial processes for the enforcement of such orders. This fills a tremendous void in the previous processes of the Board. On the other hand, however, by writing into the statute inhibitions on the use of this power and by spelling out the grounds on which conservators may be appointed, guaranties are given to the industry against arbitrary use of this enhanced power.

Mr. WELLMAN. Mr. Chairman, my remarks are directed principally concerning title I of the bill and more specifically to those provisions of title I which make substantial changes in what we term the title II, section 203, FHA loan, with the provisions of title III respecting the reorganization of the Federal National Mortgage Association and the provisions of title VI respecting the allocation of power into the Home Loan Bank Board respecting conservatorship.

There seems no question and no disagreement among all of the parties interested in this bill that title I makes substantial liberalization of the previous existing FHA title II, section 203, loan. I think Mr. T. B. King, of the Veterans' Administration, testified before this committee to the effect that these amendments would place the non-veteran in virtually the equal position respecting housing credit terms. Of course, beyond that solid point of agreement, we branch off into various disagreements that run all the way from how the FHA should be organized down through whether the President should have the various powers granted to change term and raise or lower amounts, to questions of political and economical philosophies, as to whether this bill is a step toward or a step away from private enterprise.

It seems to me, however, that the basic element of the bill and the key to reconciling these various differences of opinion is found in the validity of the FHA insurance fund itself.

Under the mutual mortgage insurance fund, to the extent that it is able to absorb the losses that are taken or would be taken, the FHA is a self-supporting operation; to the extent that the insurance fund is inadequate to cover any such losses, the FHA is not a self-supporting operation.

One of the first studies that I have seen done on the adequacy of the FHA insurance fund is found in the appendix 7, I believe it is, of the President's Advisory Committee, where the FHA made such an analysis of the adequacy of its insurance fund on section 203 in the light of certain basic assumptions, and this study revealed that the insurance

fund in terms of the portfolio that existed as of June 30, 1953, was from \$70 to \$100 million short of being an adequate amount.

The fund at the present time amounts, as I believe, to approximately 1½ percent insurance coverage against total outstanding portfolio and the recommended increase would bring it to approximately 2½ percent. However, evaluating a risk and a portfolio is not merely a matter of what the risks are at any given time. It depends on two additional elements: 1 is the volume of new mortgages that you write and 2, the risk characteristics of those new mortgages.

If you have a portfolio that is just being amortized out, your risk position is obviously decreasing. On the other hand, if you were to double your portfolio in 1 year you would be increasing your risk and more particularly would you increase it if the type of loan, new loan that you were making, represented a substantial increase in the risk.

Now, I think that the provisions of title I, the liberalizing provisions respecting loan amount and extension of amortization period represent substantial increases in risk. For instance, if you were to take the assumptions that the FHA study makes on the adequacy of its present insurance, and take the loan currently permitted under regulations, which would be on a \$12,000 property, \$9,600 loan, and write it for a 20-year term, you would have a gross risk of loss of approximately \$379. If you, on the other hand, were to increase that loan amount on that same \$12,000 property, to the maximum permitted under this bill, to \$10,600, you would have raised your loan amount about 10.86 percent, but you would have increased the amount of your possible risk by over 47 percent; if you assume a foreclosure within 3 years from the inception of the loan of the magnitude that has been assumed by the FHA in making its analysis for the President's Advisory Committee. If you were to simultaneously extend that increased loan—that \$10,600 loan—an additional 5 years, to, say, 25-year term, you would increase that risk still further—that amount of risk of loss to approximately 60 percent.

So the provisions of the bill do have a substantial effect on the adequacy of an insurance fund which already is admittedly inadequate.

Now, the problem, of course, is what do you do about that, and it seems to me that we are not confronted because of these facts with throwing the FHA insurance out the window or admitting it is a subsidized system. I think we can take certain corrective steps.

First of all, I would respectfully suggest that the committee, in the drafting of this bill, accept the recommendation of the President's Advisory Committee and instruct the Housing and Home Finance Agency to prepare and report back to the Congress an independent objective study of the possible foreclosure and loss experience of the FHA portfolio. Even the committee itself, although the FHA study was admirable, admitted it was just a beginning, and certainly if we are going to evaluate these programs we should have some concept as to the losses that might well be involved.

The second possible solution to some of these problems would be to get away from the idea that we have to always charge a half of 1 percent premium. If you are a corporation of a certain credit risk, you can borrow money at a certain rate, if you are rated a single "A" corporation you borrow money at a certain rate. If you are a little better, you can get a double "A" rating and get the money cheaper.

On the other hand, if you are triple "A," you are in the big league and get your money lower than anyone else can get it. I can see no reason why if a half of 1 percent insurance premium rate is an adequate insurance rate for the existing FHA loan plan, and if these extensions are granted, which admittedly increase the possibility of risk of loss we should hold the same insurance premium rate. If we were to increase the risk 50 percent, we should correspondingly increase the insurance rate 50 percent, which would have the effect of raising the premium rate on that type of loan from a half of 1 percent to three-quarters of 1 percent.

In other words, I think there is certainly no magic in a half of 1 percent insurance premium, and that our objective should be to develop flexibility in the operation of the FHA, not with the objective of eliminating the FHA, because I don't think anyone in the United States would disagree that the FHA has made a substantial contribution to the condition of housing and to the construction of mortgage credit, but we certainly should not keep ourselves in the rut of thinking a half of 1 percent is totally inadequate.

The second major problem that the FHA itself raises is that it insures the lender practically against any kind of loss. The result of that insurance is that the FHA of necessity has to take over the underwriting job because it is taking all the risk. It has to evaluate the desirability of each individual loan. It certainly cannot permit the individual lenders, against loss of which it is going to provide insurance. It can't allow that individual lender to perform that function. It has to perform that function itself.

Now, the result of that, of course, is that you get a highly centralized type of mortgage credit structure, and the more liberal you make that FHA loan plan the greater will be the use of that facility and the more centralized will be the direction of your mortgage lending.

One of the great virtues of a private mortgage system is that individual lenders have their prejudices and their opinions, because this is a business of prejudice and opinion. We might as well not kid ourselves on that. There are differences of opinion as to what is a good loan, what is a good borrower, what is the right kind of property; if the FHA is going to do all the underwriting, then the FHA's opinions and prejudices—and I say that without any criticism of the FHA—their opinions and prejudices as to what is a good borrower, what is a good property, what is a good loan amount are going to dominate the mortgage structure credit of the United States. It is almost inevitable. I am sure that many Congressmen as well as many individual lenders have heard lots of complaints about low FHA valuations, unrealistic minimum property requirements, and cumbersome processing procedures. Some of them are justified, some of them are not justified, but basically a good part of those complaints come out of trying to have a national mortgage system that applies throughout all the 48 States and the Territories, covering all these various types of mortgage and risk situations, out of 1 central office.

Here, again, we are confronted with the same kind of a problem, what do we do about it? Again, I feel that we are too prone to think in terms of what we did in 1934. We put 100 percent insurance plan in 1934 because the economy was flat on its back and it was the only way you could get mortgage credit into the home-building and home-

financing business, but this is 1954. Do we actually need in all classes and in all types of residential mortgages 100 percent insurance? Is there no way we can develop a system where individual lenders assume a part of the risk? If the individual lenders would assume part of the risk, the trend and tendency toward centralization of the mortgage structure would be dissipated.

I think the FHA itself has part of the answer in title I plan on property improvement loans. Here the FHA insures a percentage of a portfolio. It does not insure each individual loan. Hence, it does not have to determine the desirability of each individual loan.

By insuring a percentage of the portfolio, it throws the burden upon the individual lender to perform his classic function of determining among competing potential borrowers who is a good borrower, what is a good property, and what is a proper loan. Here again I think the FHA should examine and explore the possibilities of having different types of insurance plans, certainly under section 220 and 221 of the bill you are going to have 100 percent insurance, but in the run-of-the-mill garden variety single-family residences well located with a person purchaser, I certainly don't think we need 100 percent insurance and if we could get away from that concept we could interject flexibility, mobility into our lending structure.

So far as title III of the proposed bill is concerned, dealing with the Federal National Mortgage Association, there are three basic functions as you gentlemen are probably more aware of than am I, the special assistance function, the liquidating and management function of the existing "Fannie May" portfolio, and, of course, the third function, the so-called secondary market operation.

Basically, in my opinion, there is no reason for the elaborate procedure for converting "Fannie May" into this private corporation, if the only objectives were special assistance and the management in the liquidation of the existing "Fannie May" portfolio.

The validity of this change, this conversion of stock, surplus undivided earnings, etc., into capital stock, is justifiable only insofar as section 304 of the bill is going to work. If section 304 does not work, then there certainly is no reason for going through this elaborate conversion process. As a matter of fact, it might be better not to, for the surplus and undistributed earnings of "Fannie May" instead of then being in stock could be kept as reserves and undistributed earnings to absorb any losses that might be suffered by "Fannie May" in the subsequent liquidation of its existing portfolio, so the changes of title III in my opinion stand or fall on this secondary market operation.

The secondary market operation is something there has been a lot of conversation about, every time the mortgage market gets tight the conversation gets more aggressive and when the market gets easier the conversation on the mortgage gets to die down.

The two critical problems of the secondary market are: One, problem for membership in the vicinity, and second, it will operate on the purchase principle. Raising these two points I am, of course, assuming although I understand the home builders are not in complete agreement with me on this, that this is to be a genuine secondary market operation, not to be an investment holding company for the purpose of buying mortgages and holding them for any period of time. It is a genuine secondary market operation.

The problem of incentive of membership is a very complex one. We can't have compulsory membership like we have with the Federal Reserve System or as we have with the Federal Home Loan Bank System. We can't gear the stock requirement purchases to size, or assets. So because of those problems we have had to resort to this 3-percent discount, or stock purchase certificate plan.

In other words, the problem is, who is going to be a member of this corporation; who is going to want to be a member? What is the incentive for membership? Personally, I don't feel there will be an incentive for membership, because subsection (b) of section 304 provides that these mortgages are going to have to be purchased at or below current market price, which, of course, is going to be a little difficult to decide sometimes, but if the mortgages are purchased in accordance with the statutory standard, and then you tack on to that a 3-percent, or even a 2-percent additional discount in the form of a stock purchase plan, I think you practically eliminate the possibility of any incentive for anyone to be a member of it, but beyond that, you have, I think, an even more basic problem and that is the problem that unlike any other secondary operation, where a corporation is compelled to borrow the funds that it is going to use, you have a facility that is going to purchase assets. Now, when the Federal home-loan bank borrows money to lend to its members, it lends those funds. It thus distributes the risk between itself as the facility, and the individual borrowing member, but when you have a "Fannie May" it is not going to do that. "Fannie May" is going to go buy the mortgages, the individual seller of those mortgages is through with the transaction. He has no further connection with it, and the risk of price rises or falls have no concern of his.

The result, in my opinion, is that we have a very unique kind of an animal here—no secondary mortgage corporation in Europe to my knowledge has ever engaged in the purchase of principal. All of these corporations have operated on the lending principle and I personally would rather see the "Fannie May" used as a lending operation. It could operate on a warehousing basis, where it was warehousing mortgages, not for the 5-, 6-month period that is normally permitted to your commercial banks, but it could warehouse mortgages for an 18-month or 2-year period, lending funds on the collateral of those mortgages, which would obviate this problem of having the facility take all of the risk of market changes.

If it worked on that principle and if it charged a legitimate fee for its operations, as any warehousing lender does, it could then in effect build its own capital. It could then operate as does the Home Loan Bank System, in the short end of the market, for borrowing its funds, and in fact, it could legitimately require that the servicing fee normally permitted a lender on a long-term permanent sale of one-half of 1 percent be reduced to, say, a quarter of a percent because the facility is being operated for the benefit of the seller, who in this case would be merely a borrower.

I make these suggestions only to open up other possibilities, to this matter of how to handle the secondary market, because I think it is of great importance that any secondary market operation be conducted in a sound manner, and that failure to conduct it on that kind of a basis would do no good to the private lenders or to the Government.

My final comments are on title VI of the act, which respects the problem of conservatorship of the Home Loan Bank System. For many years the Home Loan Bank Board has been in the difficult position of having only a law of high treason. It has not had a law of misdemeanor or even a law of minor felonies. Either the Federal home-loan bank has been compelled to appoint a conservator if the individual association was not performing its functions properly, or it has had to ignore the problem. Through the very kind offices of Congressman McDonough and several of the Government staff and representatives of the industry we have worked on this problem here for many, many years and both of the National Savings and Loan Leagues have worked on this problem, and I personally want to congratulate the committee and Government for putting this section of the bill in, dealing with this matter where it gives to the Government adequate power to enforce its supervisory responsibilities, and yet at the same time puts, by writing limitations into the statute, limitation on the capricious use of that power. This title VI is in my opinion a splendid example of how problems of this type can be resolved in terms of constructive and affirmative attitudes on the part of all parties concerned.

I think it represents a real step forward for the savings-and-loan business and also for the Government.

Thank you very much.

The CHAIRMAN. Thank you, Mr. Wellman.

Are there questions of Mr. Wellman?

(No response.)

The CHAIRMAN. We are very glad to have had you.

Mr. WELLMAN. Thank you.

The CHAIRMAN. Monsignor O'Grady, I don't think we are justified in asking you to wait any longer, and so far as the committee is concerned you are at liberty to go at your will, but we want you to stay around as long as you would like.

We have with us Mr. Wallace J. Campbell, director of the Washington office of the Cooperative League of the United States of America.

Mr. Campbell, we are very glad to have you with us.

Mr. CAMPBELL. Thank you, Mr. Chairman.

STATEMENT OF WALLACE J. CAMPBELL, DIRECTOR, WASHINGTON OFFICE OF THE COOPERATIVE LEAGUE OF THE UNITED STATES OF AMERICA

Mr. CAMPBELL. My name is Wallace J. Campbell. I am director of the Washington office of the Cooperative League of the United States of America, which, as you know, is a federation of consumer and purchasing and service cooperatives. Our organization has a membership of 2 million direct dues-paying members, 2 million families, and, in addition, we have 9 million families associated with the League through the National Rural Electric Cooperative Association, both of which are full members of the cooperative league.

We have worked very closely with the Federal Housing Administration, the Housing and Home Finance Agency, and the Public Housing Administration on housing problems as they affect the hous-

ing needs of our general membership. We have also had specific interests in the cooperative housing sections of FHA, which was created under the Housing Act of 1950.

We are here today supporting the general terms of the Housing Act of 1954, H. R. 7839, even though we feel the severe housing shortage which still faces America should call for a more aggressive housing program. Your committee, however, has had so much testimony presented to it in the last few weeks on general aspects of the legislation before you that I would like to direct your attention for a few minutes to the cooperative section, generally known as section 213, which is treated in the bill before you in section 119.

The cooperative housing program of FHA might well be referred to as the stepchild of the Federal Government's housing program. Perhaps the simile of the ugly duckling would be even more appropriate. The legislation was adopted as a compromise following the campaign to secure adoption of a middle-income housing program in 1950. It was expected that the cooperative housing program, as adopted, would eventually provide for something in the neighborhood of \$50 million worth of cooperative housing. The response to the program surprised both the Federal Government's housing officials and the original sponsors of the program. As of February 28, 1954, the FHA had insured mortgages on 164 projects with a total number of family units providing housing for 26,930 families. The dollar volume of these mortgages insured totaled \$255,015,883.

The commitments, statements of eligibility, and applications in process, all classified as "active case workload," brings the number of projects to 493, the units to 56,000, and the dollar volume to \$520 million. A table containing these statistics is attached to this statement.

For purposes of comparison with other parts of the Government's overall housing program, it should be of interest to this committee to know that in the years 1951, 1952, and 1953 the number of units processed by the Rental Housing Division of FHA under section 207 totaled 18,108 housing units for a mortgage amount of \$128,883,000. In contrast, the cooperative housing section, 213, processed 25,633 units for insured mortgage value of \$242,192,000.

As you will see, the amount of housing being built under cooperative housing is substantially greater already than under the 207 rental housing section, which has been on the books for many, many years.

It is difficult to compare these with the public housing program of the same period; but during those 3 years PHA built 126,718 low-rent public housing units. A year-by-year tabulation of these figures is also attached.

I presume this only to show you in perspective the relative size of the programs under consideration.

During the last year the mortgage market for cooperative housing has been particularly tight, and even as the market has eased somewhat the available capital for cooperative projects has been hampered sharply by some unfortunate experiences on the financing of some builder-sponsored projects in New York City which have prejudiced some lending institutions against any of the 213 projects, whether builder-sponsored or those initiated by consumer or public interest groups. Your committee last week heard Harry Held, vice president

of the Bowery Savings Bank, say very pointedly that the purpose of the present act should be—

to encourage true cooperatives * * * not merely to enable promoters whose motive is profit to capitalize on such development in the guise of helping the eventual cooperative owners.

The Bowery Savings Bank has had a long history of very successful and satisfactory financing of cooperative housing projects. Mr. Held is very proud of his bank's record in that field.

In spite of the shortage of mortgage money, the cooperative section of FHA has completed commitments on mortgage insurance for 24 new projects since January 1, 1954. These totaled 877 units, with a total mortgage value of in the neighborhood of \$8 million. The projects were in New York, New Jersey, Louisiana, Oklahoma, Arizona, and Nevada.

There has been a great deal of criticism of the role of the builder-sponsor in the FHA 213 cooperative housing program. I would like to take a moment or two to try to clarify this situation. The cooperative league is not here to justify or defend the builder-sponsored cooperative projects, but we should point out that an energetic and aggressive builder, meeting the legal requirements of the cooperative section of FHA, has just as much right to build cooperative housing projects as do the consumer-sponsored organizations. While there are shortcomings to such sponsorship, it has proved to be almost universally true that the product created by these builder-sponsors has been as good or better than the average FHA-insured project. The downpayments to consumers have been lower, on the average, and because of the financing arrangements the monthly payments have been lower than for any other part of the FHA program.

In other words, even though these are not consumer-sponsored, they have turned out to be a better buy for the consumer than other forms of housing. The two most important factors responsible for this result in the builder-sponsored co-op have been the comparatively low interest rate, from 4.25 percent on management-type projects, and 4.5 percent on sales type—and 40-year amortization of mortgages, which is considerably longer than any other part of the FHA mortgage repayment program.

The impression has been given quite generally that there are no genuine consumer-sponsored projects under the 213 program. The percentage has been comparatively small, and those of us in public-interest organizations cannot be proud of our accomplishment to date; but I think some of our organizations are beginning to take advantage of the financing available under section 213.

Let me give you a few illustrations: In Oklahoma the American Legion took the initiative in sponsoring 12 cooperative housing projects under which more than 350 homes have been built in sections where cooperative housing had been unknown before. Another Legion post in New York City, FDA Post 1284, sponsored a project with 348 dwelling units, and the Jewish War Veterans in New York City have built a project in Brooklyn with 264 units.

The butchers' union in New York City sponsored the Harry Silver project, which now takes care of 288 families. In Ohio a young war veteran took the initiative in building 2 units of cooperative housing

as a public service undertaking, with about 80 families in the 2 projects. In Maryland employees of the Naval Ordnance Laboratory are well on their way toward construction of a housing project. In Fresno, Calif., a prominent builder and a local cooperative group initiated projects at the same time. They decided to unite their forces on one undertaking, and the Kavanaugh Manor project there has 124 very fine units. Another illustration is that initiated by the American Friends Service Committee in Philadelphia, which used section 213 financing to rehabilitate 52 housing units as a cooperative project.

Perhaps the most interesting and surprising development under 213 has been the growth of minority housing. The action of the Congress extending authorization of the Federal National Mortgage Association to make advance commitments for cooperative mortgages with a measure of priority for minority projects stimulated this new development. At the end of the last year 45 projects, designed primarily for Negro families, secured mortgages through FHA and FNMA totaling \$11.1 million. These will provide housing for 1,575 Negro families.

Unfortunately, the applications for prior commitments far exceeded the funds so earmarked under the legislation. When the funds were exhausted 32 projects planned for occupancy by minority groups were unable to secure commitments. These were designed to take care of an additional 1,892 families with insured mortgage amounts of \$15 million.

Here, again, I would like to give you some specific illustrations with four projects. The Dorey Miller project in New York City was built for occupancy by minority groups. It has 300 dwelling units, with the average mortgage running \$9,000. Downpayments averaged \$383 per dwelling unit, and the monthly carrying charges are \$19 per room, including utilities. The Merrick Park Gardens also in New York has 116 units. Mortgages average \$8,968, downpayments were \$889, and the monthly carrying charges averaged \$20 per room. These were extremely interesting proof that good housing with reasonable downpayments and reasonable monthly carrying charges can be made available to minority groups under this program.

Even better illustrations are the Booker T project in Maryland, just outside the District. These are single-family homes averaging \$10,000 mortgages with downpayments of \$456, and monthly payments of \$69.26 per month for the complete dwelling unit. That is per unit per month—for a complete dwelling unit. When you go into a lower-cost area you find another fine example in Kendall Homes at West Memphis, Ark. These 67 units had an average mortgage of \$6,450 with downpayments of \$150 and monthly carrying charges of \$48.50.

Now, specifically to the legislation: We are very happy to support the recommendations of the President's Advisory Committee and the legislation following it, raising the mortgage limitations from \$1,800 per room to \$2,250 per room, and applying the \$8,100 per family-unit ceiling only to units which have 4 rooms or less. This change will make it possible to build in higher-cost areas where fireproof construction is essential, and also to meet some of the other higher-cost area requirements. We are depending on FHA to see to it that the builders do not automatically raise their sights to this new level without providing dollar value.

Another change recommended in section 119 of the bill permits the Commissioner to raise the amount per cooperative housing project to as high as \$25 million if the mortgagor—cooperative—is regulated by Federal or State laws as to rents, charges, and methods of operation.

We are critical of and firmly opposed to the change from "replacement cost" to "estimated value" as set forth in the bill before you.

One of the important changes in the legislation affecting the cooperative housing program administered by the Federal Housing Administration under section 213 of the Housing Act of 1950 is a proposal made in both the Senate bill S. 2938, and the House bill H. R. 7839, now before Banking and Currency Committees of the House and Senate.

The change appears in S. 2938 on page 13, section 119, line 10, which provides that the mortgage for a cooperative housing project shall "not exceed 90 percent of the estimated value of the property or project." Similar wording appears in other sections of the bills.

Under the original section 213 of the Housing Act, the mortgage insurance was based upon replacement cost of the project. The change is an important and fundamental change in underwriting policy.

Many of the existing cooperative housing projects would not have been built if value had been the criteria rather than the replacement cost; for under present FHA practices this would provide a penalty on location, design, and increased number of rooms per unit.

In estimating the value of a property, location is often taken into account as a factor in the salability of a property or in rental of such property. In a 213 cooperative project the housing units are sold in advance of construction and are the use-property of the occupant, so that the fact of organization and construction of the project itself indicates the value of the location, whereas the value of other properties cannot be determined until consumer acceptance is established. Often a new location may be downgraded if it has to be measured in terms of estimated value at time of completion.

The question of design is also a matter in which a cooperative may suffer penalty. The tendency in cooperative projects has been to use comparatively modern design, often ahead of general acceptance of that design in a given locality. Snow Village Cooperative in Cleveland is an outstanding example of modern design in multiple family housing; the use of replacement costs makes it possible for the mortgages to be insured up to 90 percent of actual cost of the project, while estimated value leaves the question of the total insurable value up to the judgment of the FHA official who must be conservative in his judgment of eventual resale value of a given project. That resale value is of very great importance in a rental or speculative sales project, whereas in a cooperative the units are sold in advance of construction and occupancy.

The FHA underwriting procedures provide that the estimate of value is the lower of (1) estimate of replacement cost, (2) estimate of available market price, or (3) estimate of capitalized income. Since the estimate of replacement cost is also described as a top limit of value it can be seen that the proposed change can only result in a lowering of the mortgage amount for a cooperative housing project.

Almost invariably the underwriting estimate of value is determined on the basis of capitalization of income. This is a valid basis of judg-

ment for a rental project, but not necessarily valid for a cooperative housing project where liability is the chief aim of the owner-occupant.

It is quite obvious that an apartment consisting of a large number of small units provides a higher potential income for the owner and, therefore, a higher value under FHA language than an apartment containing a lesser number of larger units. This factor has tended to stimulate the production of a very large number of rental projects with a high concentration on efficiency units, and with a smaller number of bedrooms than growing families desire. Monsignor O'Grady of the National Catholic Counsel, has described efficiencies as genocide housing, as it has a tendency to cut down on family size and discourage occupancy by larger family units.

A characteristic of cooperative housing has been its emphasis on family living and the development of a larger number of bedrooms per unit. This is often at a cost to the member owner which would not be justified as an investment on the part of a building owner who must make a judgment on the basis of income on investment.

Restated in other terms, the major emphasis of a cooperative housing project must be its attempt to achieve long-range livability rather than the production of income.

The 19th annual report of the FHA reveals that during the year 1952 rental housing projects constructed under section 207, where the mortgage was calculated on an estimate of value, the average unit consisted of 4.3 rooms. Projects developed under section 213, using a basis of replacement cost, contained units with an average of 5.1 rooms. The difference is even more graphically seen in the following table showing the percentage breakdown of smaller and larger units

	Sec. 207	Sec. 213
	<i>Percent</i>	<i>Percent</i>
Units containing 4 rooms or less	71.2	19.5
Units containing more than 4 rooms	28.8	80.5
	100.0	100.0

It is our feeling that the present legislation, changing the basis from replacement cost to value, will nullify to a large extent the family livability which has been encouraged as a part of the cooperative housing program.

We, therefore, recommend that the present procedure of insuring mortgages on cooperative projects be continued on a replacement cost basis, which has proven to be an effective and valuable ingredient of the cooperative housing program.

One very unfortunate change is recommended in this legislation in section 120 which eliminates the position of assistant commissioner for cooperative housing in FHA. This deletion was made in the Appropriations Act of 1954, and the bill before you would make that permanent. There apparently was misunderstanding on the part of the Appropriations Committee as to the size and importance of the cooperative housing program. The post was stricken, apparently in the interest of economy, even though that position, and, in fact, all of the cooperative housing program, has more than paid its own way out of fees paid by the cooperative housing projects.

The President's Advisory Committee on Housing Policy made a strong recommendation that the personnel responsible for section 213 be increased to meet the needs in that field. Unfortunately, through a series of resignations, the cooperative housing staff was cut from 8 executives a little over a year ago to 2 executives today. These two men, with a small clerical staff, are trying to keep pace with the present load which has been extremely heavy, and which kept the previous staff at full workload. What has actually happened is that the field-work and supervision essential in carrying forward this program have been cut out almost completely. The builder-sponsored projects can get along with a minimum of technical assistance from FHA if they are never to become true cooperatives. Consumer-sponsored projects initiated by veterans' posts, teachers, trade unions, co-ops, and other organizations, need help, and need it badly if they are to be sound and sustaining. We feel that the elimination of the post of assistant commissioner downgrades a very important section of FHA's program, and that the cutback in staff hampers it severely.

Fortunately, we have letters from both Commissioner Guy T. O. Hollyday and Administrator Albert M. Cole, which assure us that steps will be taken under the present legislative situation to try to correct this unfortunate shortage of personnel.

In a letter dated February 3, 1954, Commissioner Hollyday wrote Jerry Voorhis, executive director of the Cooperative League—who was formerly a member of this body, as follows:

As you will recall, the First Independent Offices Appropriation Act of 1954 (Public Law 176, 83d Cong.) contained a provision specifically stating that the position of Assistant Commissioner, Cooperative Housing, was no longer authorized. It would seem, therefore, that the retention of language in the 213 statute which would make it mandatory for such a position to be established would create confusion, and that a clarification in this respect would in effect represent compliance with a directive from the Congress. Such an action does not have any relation to my views on the recommendations of the President's Advisory Committee that a much fuller staff should be provided for the service of the cooperative-housing program.

Administrator Cole wrote Jerry Voorhis on February 12, 1954:

I believe Mr. Hollyday has already written to you indicating our reluctance to submit a legislative proposal on this question which was contrary to the specific provisions of the First Independent Offices Appropriation Act of 1954. However, I want to make it clear to you that this in no way changes my agreement with the Advisory Committee's recommendations affecting section 213. Specifically, I believe the FHA should have adequate personnel available to provide to cooperative sponsors all necessary assistance in organization and operation. This, I feel sure, can be accomplished without reestablishing the position of Assistant Commissioner for Cooperative Housing.

It would provide the status which the program has grown to deserve, however, if the Congress would restore that position.

Earlier in this testimony we pointed out that a great number of minority projects were unable to secure advance commitments from FNMA. There were also a large number of builder-sponsored and consumer-sponsored projects in 26 States which could not secure mortgage commitments, even though they had met all requirements of FNMA and FHA. It would require fund extension of FNMA's advance commitments for approximately \$60 million to take care of the applications which met FHA's requirements, both as to time and technical qualifications when the legislation was adopted. To take care of all of these

projects, many of which have become hardship projects, would also require lifting the statewide limitation from \$3.5 million to \$10 million. If such an authorization is made, and we would highly recommend it, we would also suggest in making advance commitments FNMA give priority to bona fide consumer-sponsored cooperatives which are those in which the board of directors of the cooperative and the project sponsor consist of persons who purchase memberships in the cooperative and will eventually reside in the project, or who are representatives of consumer organizations or other nonprofit organizations formed to assist cooperative housing.

Among the builder-sponsored cooperatives, priority should be given for such mortgages as have the greatest difficulty in securing financing due to occupancy of the housing by minority racial groups.

It has been suggested to your committee that you authorize dual commitments under sections 207 and 213 of FHA to facilitate the mortgage procedure. We would approve of this if there are adequate safeguards to see that the procedure is not used merely for increasing the profits on a speculative project.

If the 213 program is as effective as we believe it to be, we feel that Congress should extend the mortgage insurance available under section 213 to rehabilitation of existing housing where ample safeguards are applied, and to the disposition of Government-owned housing which can be sold to cooperative associations of tenants now living in such projects.

The President's Advisory Committee on Housing also recommended that the Housing and Home Finance Agency give serious study to a proposal for the formation of a housing cooperative mortgage corporation which could pool the FHA-insured mortgages on a cooperative housing projects and issue debentures against such a portfolio. This would make it possible for retirement funds and other similar sources of finance to participate directly in the cooperative housing program, often making it possible for union pension funds and retirement funds to be used for housing for union members. Present financial requirements make that difficult, and such a mortgage corporation would facilitate increased self-help on the part of such groups in meeting their own housing needs. We would appreciate the liberty to insert in the record a proposal which we have made to Administrator Cole for his further study in this regard.

Thank you very much.

The CHAIRMAN. How voluminous is the study you refer to?

Mr. CAMPBELL. The study is six pages.

The CHAIRMAN. Without objection, that may be included and also the table attached to the prepared statement.

(The material referred to is as follows:)

KROOTH & ALTMAN,
Washington, D. C., January 7, 1954.

Mr. WALLACE J. CAMPBELL,
Cooperative League of the United States of America,
Washington, D. C.

DEAR Mr. CAMPBELL: I am sending this letter to you to accompany the submission which you are making to Mr. Albert M. Cole, Administrator of the Housing and Home Finance Agency. This letter deals with the proposal of various public interest groups for a Housing Cooperative Mortgage Corporation. It includes the revisions which we have made in our proposal since the issuance

of the President's Advisory Committee Report on Government Housing Policies and Programs.

A. NEED FOR COOPERATIVE HOUSING AND A HOUSING COOPERATIVE MORTGAGE CORPORATION

The report of the Advisory Committee states that the Housing and Home Finance Administrator should "study proposals for the establishment of a cooperative housing mortgage corporation to assist in the production and financing of cooperative housing projects" (p. 13, item V-5).

The report of the Subcommittee on FHA and VA Programs states that:

(1) "The fundamental principles of cooperative housing are workable. By banding together, families in need of housing can often obtain such housing at relatively low cost not only in suburban areas, but also in the concentrated areas of our larger cities" (p. 42).

(2) "We have found that there is only a restricted market today outside of FNMA for the mortgage paper arising out of section 213 financing" (p. 41).

(3) The subcommittee "listened to witnesses who argued for the establishment of a cooperative housing mortgage corporation to make housing loans to cooperatives. In the time available to the subcommittee, it was not possible to study this proposal in detail. We therefore suggest that the Administrator should make a careful study of this matter" (p. 42).

The purpose of this letter is to submit to the Housing and Home Finance Administrator our current proposal for the establishment of a Housing Cooperative Mortgage Corporation so that he may study it as recommended. We hope that on the basis of the modified proposal which we are now making, the Administrator will recommend that the proposed Housing Cooperative Mortgage Corporation be included as part of the legislative program for the coming session.

To the extent that cooperative housing achieves lower monthly costs and makes it possible to serve families of moderate incomes who cannot be reached through other types of private building operations, it represents a private enterprise solution to the problem of providing homes for such families of moderate income and helps fill the gap between other private building operations and subsidized public housing. The widespread interest in the cooperative housing program confirms the demand and support for it. Such a program should not be denied further progress and expansion by reason of the lack of a market for mortgages on cooperative housing—a condition confirmed by the President's Advisory Committee; rather the solution lies in finding a sound way to provide such mortgage financing. This can be done through the establishment of a Housing Cooperative Mortgage Corporation.

B. HOW OUR PROPOSED HOUSING COOPERATIVE MORTGAGE CORPORATION WOULD OPERATE

We have modified the proposal which we submitted to the FHA Subcommittee of the President's Advisory Committee by limiting its function to the purchase of FHA mortgages under section 213 of the National Housing Act, as amended. The mortgage corporation which we are now proposing would merely provide a market for mortgages insured by FHA under section 213 and in this way it would make that program operative and effective. FHA would continue to process the applications, insure the mortgages, and inspect the construction.

Following the successful pattern established by the Federal home loan banks and the Central Bank for Cooperatives which makes farm loans, the Housing Cooperative Mortgage Corporation would be created and operate in the following manner:

1. Legislation would be enacted to create the Housing Cooperative Mortgage Corporation to operate within the Housing and Home Finance Agency. Initially, the Federal National Mortgage Association would subscribe to capital stock of the corporation aggregating \$50 million. This stock would be retired from earnings of the mortgage corporation and from the proceeds of the sale of stock to housing cooperatives who would be required to subscribe to such stock concurrently with the purchase of their mortgages by the mortgage corporation. In this manner, the stock purchased by FNMA would gradually be retired and the mortgage corporation would become privately owned by the housing cooperatives. This is the same procedure followed with the Federal home loan banks in which all of the federally owned stock has now been retired. The \$50 million to be initially subscribed is the same amount of subscription which has been

recommended by the President's Advisory Committee for the National Mortgage Marketing Corporation. As a matter of procedure, it is proposed that when the amount of earnings and capital paid into the Housing Cooperative Mortgage Corporation by housing cooperatives equals \$50 million, the mortgage corporation would be required to apply any subsequent earnings or collections from subscriptions to its stock to the retirement of the stock issued to FNMA.

2. When the FHA-insured mortgage of a housing cooperative is purchased by the Mortgage Corporation, the housing cooperative would be required to subscribe to capital stock in the Mortgage Corporation in an amount equal to some prescribed percentage of the mortgage purchased. With respect to the National Mortgage Marketing Corporation, the President's Advisory Committee recommends that the amount of stock to be purchased by institutions selling mortgages to the corporation to be maintained at not more than 4 percent of the unpaid balance of such mortgages held by that Corporation, while there is a minority of the Committee which recommends that the requirement be 2 percent. Whatever percentage figure is finally established for the National Mortgage Marketing Corporation (which we believe should be 2 percent rather than 4 percent) should likewise be applicable to the Housing Cooperative Mortgage Corporation. However, the requirement would be that the housing cooperative (rather than a financial institution) purchase the stock in the Housing Cooperative Mortgage Corporation. It is recommended that the housing cooperatives be permitted to make payment for their stock subscriptions in installments over a period of 10 years.

3. The Mortgage Corporation should be authorized to issue an advance commitment to the financial institution handling the FHA application of a housing cooperative, with the housing cooperative being required to subscribe to stock in the Mortgage Corporation at the time of issuance on this advance commitment. The first payments on the stock subscription should be made at the time of the delivery of the FHA-insured mortgage to the Mortgage Corporation pursuant to its purchase commitment. It is necessary that such advance commitments be issued in order to enable construction financing to be obtained from banks and other private institutions on the basis of a take-out through permanent financing.

4. The Mortgage Corporation would purchase FHA-insured mortgages on housing cooperatives projects, using its initial capital to purchase the initial mortgages. When the Mortgage Corporation had purchased a number of mortgages, it would be authorized to issue debentures in an amount equal to the unpaid principal of the mortgages held by it. As in the case of the Committee's recommendation of the National Mortgage Marketing Association, the Housing Cooperative Mortgage Corporation would be authorized to issue debentures on the private market up to 12 times the amount of its stock and surplus, but in no event in an amount exceeding the unpaid balance of FHA-insured mortgages which it holds.

5. As was done initially with the Federal home loan banks, and with the Central Bank for Cooperatives on farm loans, these debentures should be guaranteed by the United States. Since the portfolio of the Mortgage Corporation would consist entirely of mortgages insured by FHA under section 213 in a dollar amount at least equal to the debentures issued, the basic underlying security behind the debentures of the Mortgage Corporation would include the right to have Government-guaranteed debentures issued in case of a default on any of these mortgages. Consequently, the Government guaranty of the debentures issued by the Mortgage Corporation would involve no new or additional contingent liability on the part of the United States. It would merely place the guaranty on the debenture which is to be marketed so that it will command a lower interest rate and a better and wider market. Since the underlying security in the portfolio already includes the contingent liability of the Government, it would be most unwise to sacrifice the lower interest rates and better market by not having the Government guaranty appear on the face of the debentures of the Mortgage Corporation.

6. The Government would be protected against losses on its guaranty of the debentures of the Mortgage Corporation because the debentures would only be issued against FHA-insured mortgages held by the Mortgage Corporation on which insurance premiums are paid. Such premiums provide the same protection against loss which is characteristic of the entire program of FHA insurance.

7. The primary objective of the Mortgage Corporation would be to assure the availability of mortgage money for cooperative housing projects financed under section 213. The program does not involve any cost to the Federal Government

or any subsidies. Servicing fees would be charged to cover the cost of administration of the Mortgage Corporation. The Mortgage Corporation would operate on a self-supporting basis and require no appropriations for its administrative expenses.

8. The Mortgage Corporation would be managed by a Board of five Directors appointed by the President. As the Mortgage Corporation would be a mixed-ownership corporation, with partial private ownership as soon as it makes its first mortgage purchase, there should be representation on that Board for the housing cooperatives. At least two of the Directors should be appointed from among the members of the stockholding housing cooperatives or other persons representative of housing cooperatives.

9. When all the stock owned by FNMA is retired and the housing cooperatives own all the stock of the Mortgage Corporation, all of the Directors should be appointed by the President from among such housing cooperatives or their representatives.

10. As part of its servicing of the FHA-insured mortgages which it purchases, the Mortgage Corporation would provide the assistance and supervision required to assure that cooperative housing projects are soundly operated with all necessary protections. It is recognized that cooperative housing projects require such additional assistance. The Mortgage Corporation dealing solely with housing cooperatives can gear its operations to meeting these problems. In this way, it can help develop an ever-growing strength and confidence in the cooperative housing program.

11. The debentures of the Mortgage Corporation would represent an attractive investment as they could carry a Government guaranty reflecting the guaranty underlying the portfolio of FHA-insured mortgages on cooperative housing projects. Purchasers of these debentures would not have the problems involved in owning or servicing the mortgages, but would merely clip coupons to collect interest on the debentures. We believe labor unions and other institutions interested in cooperative housing (who have been unable to purchase mortgages on cooperative housing projects) would be prepared to invest large sums in the debentures of the Mortgage Corporation because of the absence of servicing burdens and the shorter maturities of debentures. Consequently, the debentures would tap new and large sources of investment for cooperative housing which are not now available. Thus, at the same time that the Mortgage Corporation would provide an assured source of financing for cooperative housing projects, it would provide the means for securing the investment funds to be used for this purpose, through the sale of debentures.

12. In the operation of the Mortgage Corporation, a priority should be established for the purchase of mortgages of consumer-sponsored cooperatives, as distinguished from builder-sponsored cooperatives. Such consumer-sponsored cooperatives are those which have a nonprofit sponsorship where the members of the initial board of directors of the cooperative, as well as the sponsors of the project, consist of people who will purchase memberships in the cooperative and reside in the project or who are representatives of nonprofit consumer groups (such as labor unions or the National Association for the Advancement of Colored People) or organizations interested in the encouragement of consumer-sponsored cooperative housing (such as the Cooperative League of the USA or the Foundation for Cooperative Housing). The reason for such a priority is that through consumer-sponsored cooperatives of a nonprofit character, there is a fuller realization of the cooperative objective of better housing at moderate prices, produced in the interest of the consumer. As between different consumer-sponsored cooperatives, a priority should be given to projects which have the greatest difficulty in securing financing due to occupancy largely by minority groups; likewise, there should be a similar priority to such minority projects as between cooperative projects in the builder-sponsored category.

13. It is necessary that there be this separate Mortgage Corporation to purchase the FHA-insured mortgages on housing cooperatives because:

(a) It is clear that the National Mortgage Corporation would not provide a market for these mortgages. As recommended by the President's Advisory Committee, the functions of this corporation would be limited to facilitating the free operation of the mortgage market with respect to those mortgages for which a normal market exists. The subcommittee on FHA-VA problems has indicated that there is only a restricted market today for this mortgage paper. Moreover, as the National Mortgage Marketing Corporation will be owned (first partially, and later fully) by private financial institutions who were not willing

to purchase these mortgages, there is no basis for relying on their purchasing them through the National Mortgage Marketing Corporation.

(b) A separate cooperative-housing corporation is required to meet the special problems of housing cooperatives and their need for special servicing in the operation of their projects.

(c) Housing cooperatives desire to purchase stock in a Mortgage Corporation which they will ultimately own. They should be given this same privilege which is being extended to financial institutions in the case of the National Mortgage Marketing Corporation.

(d) The establishment of a separate Mortgage Corporation for housing cooperatives follows the sound precedent of the Central Bank for Cooperatives which makes farm loans, and the Federal home loan banks which service the institutions which purchased stock in those banks.

C. CONTINUANCE OF FNMA PENDING ESTABLISHMENT OF HOUSING COOPERATIVE MORTGAGE CORPORATION

14. In order to avoid any interruption in the purchase of housing cooperative mortgages insured under section 213, it is recommended that FNMA continue to function through the issuance of advance commitments for the purchase of cooperative mortgages until the Housing Cooperative Mortgage Corporation is established and ready to function. Consequently, it should continue to carry on this function until the Housing Cooperative Mortgage Corporation is ready to make such purchases of FHA-insured mortgages on cooperative housing projects.

15. It is necessary that there be an immediate increase in the authorization of FNMA for the issuance of advance commitments to purchase FHA-insured mortgages under section 213, since the \$30 million authorization was not adequate to take care of the eligible mortgages on cooperative housing projects which were covered by statements of eligibility issued by the FHA prior to September 1, 1953. That was the date specified in the FNMA legislation to establish the eligibility of such cooperative mortgages for advance FNMA commitments. Sponsors proceeded in good faith and incurred great expense on cooperative projects in the expectancy that FNMA funds would be available to purchase the mortgages on the projects. Recognizing the equities of taking care of such projects, subject to a 10 percent limitation on the amount to be allocated to any one State, it is recommended that there be an increase in the authorization from \$30 million to \$100 million, and an increase in the limit to be allocated to any one State from \$3,500,000 to \$10 million.

16. To relieve the hardship of sponsors whose projects were approved before September 1, 1953, but who failed to get a FNMA commitment because of the insufficiency of the available authorization, it is urged that separate legislation be immediately introduced to cover the necessary increase in the FNMA authorization.

17. It is recommended that in connection with this increase in authorization, a provision be included in the legislation to establish the priorities described in paragraph 12 above covering the purchase of mortgages of consumer-sponsored cooperatives, and, as between projects in this category, those occupied largely by minority groups—with a like priority to such minority projects as between cooperative projects in the builder-sponsored category.

Sincerely yours,

DAVID L. KROOTH.

Section 213.—Cooperative housing—Status as of Feb. 28, 1954

	Total number of projects	Total number of units	Total dollar volume
Mortgages insured.....	164	26,930	\$255,015,883
Commitments.....	31	1,844	16,378,450
Signed statements of eligibility.....	129	9,361	82,988,900
Unsigned statements of eligibility.....	93	7,164	63,532,800
Applications in process.....	76	10,825	102,740,040
Active case workload.....	493	56,124	520,656,073
Cases rejected.....	140	18,330	174,533,541
Cases withdrawn.....	260	20,658	202,977,848
Eligibility statements expire.....	75	5,924	53,968,050
Total case workload.....	968	101,036	952,135,512

Comparative programs

	FHA 207, rental housing housing		FHA 213, cooperative housing		PHA, low-rent public housing (units)
	Units	Amount	Unites	Amount	
1951.....	4,890	\$33,201,000	8,280	\$75,611,000	10,246
1952.....	6,043	41,843,000	9,774	91,701,000	58,258
1953.....	7,175	53,839,000	7,579	74,880,000	58,214
Total.....	18,108	128,883,000	25,633	242,192,000	126,718

The CHAIRMAN. Are there any questions of Mr. Campbell?

(No response.)

The CHAIRMAN. Mr. Campbell, we are very glad to have had you here.

Mr. CAMPBELL. Thank you.

The CHAIRMAN. You have made a contribution. Thank you very much for it.

We will stand in recess until tomorrow morning at 10 o'clock.

(Whereupon, at 4:56 p. m., the committee adjourned to meet at 10 a. m., Tuesday, March 16, 1954.)

HOUSING ACT OF 1954

TUESDAY, MARCH 16, 1954

HOUSE OF REPRESENTATIVES,
COMMITTEE ON BANKING AND CURRENCY,
Washington, D. C.

The committee met at 10 a. m., Hon. Jesse P. Wolcott (chairman) presiding.

Present: Chairman Wolcott (presiding), Messrs. Gamble, Talle, Kilburn, McDonough, Widnall, Betts, Oakman, Hiestand, Stringfellow, Van Pelt, Spence, Brown, Patman, Multer, Deane, O'Brien, Barrett, and O'Hara.

The CHAIRMAN. The committee will come to order.

We will proceed with the consideration of H. R. 7839.

We have with us this morning the American Legion, the VFW, DAV, Jewish War Veterans.

Mr. Kennedy, we will be very happy to hear from the American Legion first.

STATEMENT OF MILES KENNEDY, LEGISLATIVE DIRECTOR, AMERICAN LEGION

Mr. KENNEDY. Mr. Chairman and gentlemen of the committee, my name is Miles Kennedy. I am the legislative director of the American Legion.

I have with me, who will give the testimony for the Legion, Mr. Wilbur C. Daniel, who is chairman of our national economic commission, which has jurisdiction over housing matters in our organization.

I would like the record to show that the American Legion is very grateful to you, Mr. Chairman, and your associates on the committee for giving us this opportunity to present our views with respect to the bill H. R. 7839 which is now before you for consideration.

Mr. Daniel has two statements, both of which I would respectfully request be incorporated in the record. One statement, with your permission, Mr. Chairman, he would like to read. It is approximately 6½ or 7 pages long.

But, as I say, I respectfully request that both of them be incorporated in the record in full.

The CHAIRMAN. That will be perfectly agreeable.

I might say we are all very glad to have the American Legion before us.

Mr. KENNEDY. Thank you, Mr. Chairman.

Now, I will ask Mr. Daniel to proceed.

The CHAIRMAN. You may proceed, Mr. Daniel.

**STATEMENT OF WILBUR C. DANIEL, CHAIRMAN, NATIONAL
ECONOMIC COMMISSION, AMERICAN LEGION**

Mr. DANIEL. While we are not concerned with those provisions not affecting veterans, there are two sections which we must strongly object to in their present form. We respectfully request that they be given serious consideration by the committee.

The first provision the American Legion objects to is contained in Title II, Home Mortgage Interest Rates and Terms, section 201, pages 40, 41 of the bill.

Under the provisions of section 201 the President is authorized, without regard to any other provision of law except provisions hereafter enacted expressly in limitation hereof, to establish from time to time—

(1) the maximum rates of interest (exclusive of premium charges for insurance and service charges, if any) for various classifications of residential mortgage loans insured or guaranteed or made under the National Housing Act, as amended, or the Servicemen's Readjustment Act of 1944, as amended: *Provided*, That no such maximum rate of interest shall, at the time established by the President, exceed $2\frac{1}{2}$ per centum plus the annual rate of interest determined by the Secretary of the Treasury, at the request of the President, by estimating the average yield to maturity, on the basis of daily closing market bid quotations or prices during the calendar month next preceding the establishment of such maximum rate of interest, on all outstanding marketable obligations of the United States having a maturity date of 15 years or more from the first day of such next preceding month, and by adjusting such estimated average annual yield to the nearest one-eighth of 1 per centum.

This plan, if adopted, would change the method in which interest rates may be set on mortgages under the GI loan provisions of Public Law 346 of the 78th Congress, approved June 22, 1944, and Public Law 101 of the 83d Congress, approved July 1, 1953. The latter law amended the Servicemen's Readjustment Act of 1944 so that the Administrator of Veterans' Affairs, with the approval of the Secretary of the Treasury, may prescribe by regulation from time to time such rate of interest, not in excess of $4\frac{1}{2}$ percent per annum, as he may find the loan market demands.

When the original Servicemen's Readjustment Act, Public Law 346, 78th Congress, was written, great consideration was given by the proponents of same, in cooperation with representatives of the lending industry, the Treasury Department, and the Veterans' Administration, in the setting up by Congress of the present method of determining interest rates; and a ceiling was placed on the interest rate to be charged on VA loan guaranty mortgages so that there might not be a prohibitive interest rate charged to those who had served in the Armed Forces and to whom this legislation was intended to give assistance in reestablishing themselves on a sound economic basis.

The American Legion, after giving this problem serious consideration over a long period of time, felt that it was wise to insert this provision in the Servicemen's Readjustment Act in order to protect the veteran home buyer from excessive interest payments. To us it is crystal clear that a move is now underway to remove the protecting

ceiling also placed on said interest rates by Congress when Public Law 101 was enacted on July 1, 1953, at which time the rate was permitted to be increased to $4\frac{1}{2}$ percent. The American Legion opposed said increase in the interest rate.

The American Legion objects to the foregoing provisions as set forth in said section 201 (1) for the following reasons:

1. The American Legion recommends any change made should be by the Veterans' Administration and by no other agencies or individual.

2. The American Legion believes in the maintenance of a separate housing program for veterans under the sole jurisdiction of the Veterans' Administration. The American Legion wants the present policy continued.

3. We believe that the power to regulate interest rates should remain in Congress.

4. We submit that the phrase "the President is hereby authorized, without regard to any other provision of law"—section 201, page 40, lines 17-18—is too broad, and that only specific authority should be granted not only to the President but to any other Government official who may be concerned.

5. The American Legion is unalterably opposed to section 201 because it would unquestionably result in increase in the interest rate as fixed by Public Law 101 of the 83d Congress. In addition, the proposal carries with it a distinct possibility of discrimination between veteran home purchasers.

We would like to be permitted to invite the committee's attention to an article entitled "Easy Money Comes Back," which appeared at pages 100-102 of the February 26, 1954, issue of the U. S. News & World Report, a reputable and reliable business magazine. A true copy of said article is annexed and made a part of this statement. The article includes a chart showing interest rates average for long-term United States Government bonds for the years 1951, 1952, 1953, and 1954.

(See p. 684 for article mentioned above.)

Reference to the chart shows the percent yield for these years to be as follows:

(The chart referred to is copyrighted by U. S. News and World Report, and is not reproduced in the hearing.)

Year 1951, from $2\frac{1}{4}$ percent to nearly $2\frac{3}{4}$ percent; year 1952, from $2\frac{1}{2}$ percent to $2\frac{3}{4}$ percent; year 1953, from $2\frac{3}{4}$ percent to 3 percent; year 1954, from $2\frac{1}{2}$ percent to $2\frac{3}{4}$ percent.

As has been stated above, the interest rates on VA loans to veterans was increased to $4\frac{1}{2}$ percent pursuant to Public Law 101, 83d Congress, approved July 1, 1953. Using this $4\frac{1}{2}$ -percent rate as a base and adding the $2\frac{1}{2}$ percent increase above "average for Government long-term United States bond yield," as herein proposed, for the years 1951 to 1954, both inclusive, reference to the chart from the U. S. News & World Report readily shows that, had the maximum rate proposed under section 201 been in effect during the years in question, veterans would have had to pay the following rates of interest on their mortgages:

Year	Long-term bond yield as shown on chart	Interest rate increase proposed by sec. 201	Total interest rate veterans would have had to pay	Net increase over present 4½ percent VA rate
	Percent	Percent	Percent	Percent
1951.....	2½	2½	5¼	¾
1952.....	2½	2½	5¼	¾
1953.....	3	2½	5½	1
1954.....	2½	2½	5	½

We respectfully submit there is absolutely no reason to justify the increase proposed over the present rate of 4½ percent.

We see no reason why veterans should be required to pay increased interest rates, which are bound to follow if the provisions of section 201 are enacted.

It is our firm belief after earnest consideration of this problem that the 4½ percent rate, when viewed in connection with the additional benefits which accrue to the investor, is adequate on the present market and will be more than adequate in the near future.

Last year the money interests told us that if the rate were increased to 4½ percent they would be satisfied; now they want it to go to 5½ percent or higher; we have a strong feeling that in the not too far distant future they will be asking Congress to make the rate 6 percent. In fact, it might well go to 6 percent under the provisions of section 201 (1) of the bill.

The American Legion submits that the provisions of H. R. 7839, as now contained in section 201, page 40, lines 9 to 25, and in lines 1 to 14, both inclusive, on page 41, should be stricken in their entirety.

The other section in this bill which the American Legion objects to is to be found in title VIII, Miscellaneous Provisions, section 801, at page 104, et cetera.

Title VIII deals with the preferences now granted veterans in the purchase of surplus housing and opens wide the door for the elimination of veterans' preference in these purchases.

While we have confidence in the present Administrator of the Housing and Home Finance Agency, we must say that there are still in that agency those who feel that preference in the sale of surplus homes to veterans should be eliminated, and they have often so expressed themselves. They have absolutely no regard for the interests of veterans. Therefore, the American Legion feels that while the present Administrator may be sincere in his objectives, if he were given the power of determination in selecting surplus housing for sale under the provisions of section 801 of the bill, we are fearful that those who would actually be responsible for and really determine policy for the Administrator, will use this authority to gain their personal desires to take away from veterans their opportunities to purchase surplus housing.

It has been the privilege of our representatives to work closely with the Housing and Home Finance Agency for some time, and we have watched with a great deal of interest the sale of surplus buildings. In all our experience we have found nothing to show that veterans' preference hindered, at any time, the sale of these properties, or worked a hardship on the agency itself in its determination to dispose

of surplus buildings. In fact, in most instances we have found that there have been more buyers than buildings available for sale, and again the American Legion urges this committee to study the provisions of title VIII in order to retain veterans' preference now legally given to the qualified individual who seeks an opportunity to secure low-priced housing and establish himself in society.

We call the committee's attention particularly to the provisions of the new subsection (g)—page 104, line 20, and so forth—which states, in part:

(g) The Administrator may dispose of any permanent war housing without regard to the preferences in subsections (b) and (c) of this section * * *

Stripped of its legal meaning, this is nothing more or less than a bold attempt to knock out the preferences now granted veterans who may qualify to purchase housing of the type in question.

The American Legion strongly opposes the section 801 in its entirety, and asks that it be stricken from the bill.

There is absolutely no reason under the sun why the preferences granted veterans to obtain said housing as contained in the acts approved October 14, 1940, and subsequent thereto, should be taken away from the veterans at this time.

It is our recommendation that section 801 be omitted in its entirety and that the law remain unchanged. We submit that this is just one more indication of the campaign being waged to whittle away veterans' preference. In the 1st session of the 83d Congress attempts were made in both House and the Senate to wipe out, in their entirety, veterans' preference laws governing employment in Federal civil service by attaching riders to the appropriation bills for the Departments of Justice, State, and Commerce. Thanks to our friends on both sides of the aisle, in the House and in the Senate, these nefarious schemes were defeated.

The American Legion is alarmed and disturbed to think there are those who would seek to destroy or materially weaken the veterans' preference laws now on the statute books, and we intend to oppose any and all such attempts with all the power at our command, in keeping with resolutions duly adopted at our national conventions, and by our national executive committee.

Under the Housing Act of 1949, Public Law 171, 81st Congress, section 301, 15 (i) (b) (ii), veterans and families of veterans and servicemen did not have to comply with the standard housing factor for admission to public-housing projects. This provision expired, however, on March 1, 1954. We note no similar provision is contained in H. R. 7839.

The Housing Act of 1949 set as a requirement for occupancy that applications must show that they were living in substandard housing. The act, however, as indicated above, waived this requirement for veterans.

This was a most beneficial and proper equalization to veterans and their families, but it was of little practical value because little housing has been actually constructed under the 1949 act until recently, and this year will probably see the greatest amount completed.

Once before this waiver was continued when it expired, and there isn't any question in our minds that this preference should again be granted to qualified veterans.

We would like to be permitted to invite the committee's attention to the fact that under date of March 1, 1954, the Senate passed S. 2937, introduced by Senator Sparkman under date of February 11, 1954. Senator Sparkman's bill would have extended the period for 5 years or until March 1, 1959. However, the Senate-passed bill extends the law only to August 1, 1954.

We also call the committee's attention to H. R. 7743, a companion to S. 2937, introduced on February 4, 1954, by Congressman John C. Watts, and to H. R. 8159, introduced by Congressman Carl Elliott on March 2, 1954, both of which are now pending before this committee.

We submit that no issue of whether a person is in favor or not of public housing is involved. This only applies to public housing that has already been authorized. Adoption of the bills H. R. 7743 or H. R. 8159 would not add one additional public-housing unit, but their defeat will take away the veterans' preference.

As thousands of veterans who are not too well off financially will be affected by this legislation, we urge the committee to approve either H. R. 7743 or H. R. 8159, as a separate piece of legislation, or incorporate their provisions in H. R. 7839.

Wherefore, in closing, the American Legion respectfully requests that the committee amend the bill H. R. 7839 by—

1. Striking therefrom the provisions of section 201, now contained in lines 9 to 25, both inclusive, on page 40, and in lines 1 to 14, both inclusive, on page 41;

2. By striking therefrom the entire section 801, pages 104 and 105; and

3. By inserting the provisions of H. R. 7743 or H. R. 8159 at a proper place in H. R. 7839.

The following information was obtained from a member of the House of Representatives, who gave the American Legion permission to use the data, but requested that his name be omitted, and is copied from a letter dated March 3, 1954, written by Mr. Ralph H. Stone, Deputy Administrator for Veterans' Benefits, to answer the Congressman's inquiry regarding interest charges, as follows:

2. Congressman ——— letter requests that, based on the formula in section 201 (1), the maximum rate of interest be established for certain dates. Based upon information from the Treasury Department, which reflects yields to maturity of all marketable Government obligations maturing in 12 years or more, the maxima for the dates requested are as follows:

	<i>Percent</i>
Feb. 1, 1954-----	5¼
June 30, 1953-----	5%
Jan. 1, 1953-----	5¼
June 30, 1952-----	5¼

The Treasury Department has not made the calculations necessary to fit the precise language of the proposed section 201 (1); however, the yield (or interest rate) on the same type of securities maturing in 15 years or more would be only slightly higher (perhaps to four hundredths), and not sufficiently different to change the maxima cited above.

3. The Congressman's letter further requests that an estimate be prepared of the amount of increased interest which would have been involved on the veteran loans guaranteed by the Veterans' Administration during calendar 1953 if maximum interest rates had been in effect as allowed by section 201 (1) instead of the interest rate established by existing law. The Congressman requests that this be estimated (1) for the total permissible life of each loan and (2) during the first year of the loan's existence.

4. In order to simplify the computations involved, it has been assumed that, if the maximum permissible rate of interest were to be fixed as the actual rate, such a determination would be made as of the first of the year. Accordingly, an interest rate of $5\frac{1}{4}$ percent has been used as the presumptive interest rate on veteran loans under the provisions of the proposed section 201 (1), even though a higher maximum obtained during part of the calendar year. As a further simplification of the necessary calculations, we have assumed that all GI loans closed in the first half of the year bore the 4-percent rate and that all those closed during the last half of the year were written at $4\frac{1}{2}$ percent. Inasmuch as many 4-percent loans were actually disbursed after the maximum was increased to $4\frac{1}{2}$ percent in May 1953, the use of this assumption is not believed to affect the accuracy of our estimates materially.

5. On this basis, if a maximum rate pursuant to section 201 (1) had been in effect for the calendar year 1953 at $4\frac{1}{4}$ percent, rather than the 4- and $4\frac{1}{2}$ -percent rates actually in effect, the additional amount of interest payments to be made on account of loans guaranteed or insured by the Veterans' Administration would aggregate \$429 million over the total life of the loans. During the first year of all loans guaranteed or insured by VA in 1953, under the same conditions, the difference in interest payments would have been almost \$29 million. The average loan made to a veteran in 1953 amounted to \$9,480. For such a loan with a typical maturity of 20 years, the increase in the interest rate from $4\frac{1}{2}$ to $5\frac{1}{4}$ percent would require an additional interest payment of \$932.83 over the whole term of the loan. During the first year, the increase in interest would be \$70.72.

6. In connection with these estimates, it should be noted that the rates indicated in paragraph 2 and the rates used in estimating the increased costs are maximum permissible rates of interest. The President, under the provisions of section 201 (1) would be given authority to set the maximum rate from time to time at whatever figure was deemed most appropriate in the light of prevailing conditions, provided it did not exceed the maximum permitted.

* * * * *

Veterans deprived of preferred positions now enjoyed in respect to housing credit.

Speaking of preference in obtaining GI mortgage loans, I have read and agree with the statement submitted by Mr. T. B. King, Acting Assistant Deputy Administrator (loan guaranty), Department of Veterans Benefits, Veterans' Administration, when he appeared before your committee recently. On pages 1, 2, and 3 of his statement Mr. King makes reference to sections 104 and 105 (pp. 3 and 4) of the within bill covering amendments of title II of the National Housing Act. His statement, the last paragraph of page 2 and the first paragraph of page 3 thereof, reads as follows:

The proposed increases in loan to value ratios and the corollary reduction in the cash downpayments, together with the increase in the permissible term of the loan which will make lower monthly carrying charges possible, will make considerably more liberal financing terms possible for prospective home purchasers under the FHA program. This, of course, would tend to dilute the preference which has been available to veterans obtaining GI financing, since the amendments would place nonveterans in virtually an equal position in respect to housing-credit terms. The extent to which such dilution would take place depends, of course, upon whatever action may be taken by the President in exercising his authority under section 201 of the proposed bill. Under the bill the President must authorize the more liberal terms provided for before they become applicable to the FHA program. On the other hand, it is noted that the only action which the President could take in respect to VA guaranteed home loans would be to make GI loan terms more restrictive. If the FHA program is liberalized as contemplated in the bill all eligible veterans, including recent veterans of the Korean conflict, will be deprived to a considerable degree of the preferred position they heretofore enjoyed in respect to housing credit. Inasmuch as it is not known to what extent the President would liberalize the FHA program, the exact effect of the proposed legislation upon the preferred position of veterans in the housing market cannot be forecast.

For all practical purposes these provisions would wipe out the preferences now granted veterans in obtaining GI financing. When the Members of Congress enacted the loan provisions of the present laws they most certainly intended that veterans should be given preference in obtaining these mortgages, and we do not believe the economic status of veterans of World War II, or Korea, has improved to such an extent as to warrant the termination of such preference, thus forcing them to compete with their more fortunate fellow citizens in their quest for mortgage money.

Mr. Chairman and gentlemen of the committee, I would like to thank you for your favorable consideration of our requests, as well as for your courtesy in permitting me to appear before you.

Mr. PATMAN. Mr. Chairman, I wonder if the witness would like to insert the attached statement from the U. S. News & World Report?

The CHAIRMAN. He has already suggested it.

Mr. DANIEL. Yes, we would, sir.

Mr. PATMAN. And the table.

Mr. KENNEDY. That chart, Mr. Chairman, is a chart that I obtained from the Housing Agency, and with your permission, Mr. Chairman, I would like to have it either inserted in the record or marked for identification so that each member of the committee may have a copy.

Mr. PATMAN. I would like to see it in the record.

The CHAIRMAN. I understand it is already in the record.

Mr. PATMAN. Thank you.

(The material referred to is as follows:)

[From United States News & World Report, February 26, 1954]

"EASY MONEY" COMES BACK—DOLLARS ABUNDANT, BUT BORROWING SLOW

Credit expansion, officially promoted now as one answer to the business downturn, is slow to come.

Bank loans are easily had now—by borrowers with good credit standings—and getting cheaper. Lenders—with official blessings—are loaded up on funds.

But a sagging demand is dragging down loans and interest.

The drive by the administration to get people to borrow money and spend it is approaching a critical phase. If credit expansion doesn't get going in buoyant spring and summer months, it's believed, it may not get going at all this year.

What has happened is that businessmen and families have been showing more concern over their debts than over their needs for more goods and services. Borrowing to buy has been less popular than it once was. Interest rates have sagged, as money pumped into banks by the Government found too few borrowers.

Now, just recently, there are a few signs of a faint revival of willingness to buy "on the cuff." But official figures, even the latest, do not show it yet.

Bank loans, to nearly all classes of borrowers, are a long way from stretching the capacity—and desire—of banks to lend. Records of city banks—those reporting weekly to the Federal Reserve Board—tell the story.

Business loans—to storekeepers, manufacturers, farmers, others—expanded by less than \$600 million in the last half of last year. They had grown by nearly 2.5 billion in the last half of both 1951 and 1952. They still lag in 1954, though less noticeably.

Main reason is that businessmen have found themselves with more inventory than confidence. Buying by retailers, wholesalers and producers has been declining. More recently, consumers themselves have begun to acquire doubts and to curtail their buying, too. That has meant even less borrowing from banks.

Bank loans made to consumers by weekly reporting banks show the results. Those loans expanded by \$99 million in the last half of 1953—against 833 million in the last half of 1952.

Installment-credit reports, too, help to show how families feel about further buying involving debt. Total of such credit rose by about 800 millions in the last half of 1953, against 2.2 billions in the same period of 1952. And the same trends

show up in real-estate loans, though plans now being announced by builders for 1954 give a hint of rising demand for mortgage loans.

Government officials have used just about every monetary device available to push the easy money program adopted last spring. Before that, the Federal Reserve and the Treasury Department—in double harness—had been working overtime to make money for lending scarcer and dearer in a period regarded as inflationary. The turnabout, when it came, involved the use of a flexible money policy in a new situation—a threat of deflation.

BANKS HUNT BORROWERS, BUT RESTUDY WEAK ACCOUNTS

Federal Reserve, first, saw to it that banks were filled with plenty of the reserve funds needed for lending. That was accomplished by the purchase of billions of dollars' worth of Treasury securities. From May to December last year, Reserve bank holdings of United States securities jumped by more than \$2 billion—to the highest level in history.

Next, the Federal Reserve reduced the amount of reserves that banks were required to hold for any given volume of bank business. And the Treasury Department made plain that easy money was the order of the day.

Then, early this month, with lending still becalmed, Federal Reserve cut the interest rate that banks must pay when they borrow reserve funds from the central bank. Intent—and effect—was to make sure that all bankers understood they were not expected to be excessively critical of a customer's credit position in making a loan. Officials, it was clear, would be sympathetic to some marginal loans designed to get money into the hands of people who would spend it.

Result, for the man who wants to float a loan, is that banks and other lending institutions are loaded. Many are out scratching for business. That doesn't mean that just anybody can get a loan of any desired size. Most lenders, in fact, have been getting right with their books, too. They've been crowding delinquent customers, cutting off some poor credit risks. Still, people with good prospects of repaying find it easy to borrow.

Demand for lending money, though, continues to lag behind supply.

Interest rates—the price of borrowed money—consequently have been dropping. The chart on page 100 gives the picture, starting in early 1951—the time of the famous accord between the Treasury and Federal Reserve. Before that time, the Reserve System had been an unwilling partner in the Fair Deal administration's plan to hold interest rates down by the simple expedient of supporting Government-security prices in the open market. The accord ended that price-pegging operation.

The chart shows what happened to interest rates of Treasury bonds when the market was unpegged. Those rates rose, along with interest charges generally, and went into a steep climb early in 1953 when tighter money was the goal.

The peak, for those Treasury bonds, came in June. Now all is changed. Average yield for those bonds has dropped from 3.09 percent to 2.60.

The rate on the Treasury's 91-day bills, nearly 2.42 last June, in January dropped below 1 percent for the first time in nearly 5 years.

Rates on prime commercial paper—the unsecured I O U's of top-credit companies—have tumbled from 2¾ percent at midyear to 2 percent recently.

Ordinary short-term loans by banks to businesses, too, showed signs of cheapening in December, though banks still plan to hold their rates where possible.

Home buyers, meanwhile, have been given new hope for low-rate mortgage loans guaranteed or insured by Government after months in which lenders avoided those loans. And families hoping for conventional mortgage loans this year have gotten real encouragement.

Corporations are able to borrow on long-term bonds for rates averaging 3.24 percent, compared with more than 3.6 percent last summer.

States and localities have watched their average rate on high-grade bonds drop from just under 3 percent to 2.4 and below.

Cheapness and easy availability of lending money, though, still are not drawing crowds of people to banks.

The question that officials are beginning to ask themselves is: Just how long will people wait?

The CHAIRMAN. Are there questions of Mr. Daniel?

Mr. PATMAN. Mr. Chairman.

The CHAIRMAN. Mr. Patman.

Mr. PATMAN. Are you pleased with the so-called Fannie May provision in this bill?

Mr. KENNEDY. We accept the bill in general, Mr. Patman, with the exceptions as testified to by Mr. Daniel. We leave it to the discretion of the committee as to whether they want to adopt those provisions having to do with FNMA. We have no particular objections to it one way or the other.

Mr. PATMAN. Don't you think that you are very much concerned about this 3-percent contribution that is proposed in the reorganized or rejuvenated Fannie May?

Mr. KENNEDY. Yes; that is the item dealing with 3 percent of the various costs involved. Naturally we would like to see the costs kept down as much as possible.

Mr. PATMAN. Have you considered who will finally pay that 3 percent?

Mr. KENNEDY. Of course, the mortgagor in the final analysis will pay all the carrying charges.

Mr. PATMAN. And that will be an additional cost to the mortgagor?

Mr. KENNEDY. Yes, sir.

Mr. PATMAN. In other words, if he borrows \$10,000 to buy a home, he will actually get \$9,700, but he will continue for the next 25 or 30 years, or 40 years, whatever the time is, to pay interest on the whole amount.

Mr. KENNEDY. Yes, sir.

Mr. PATMAN. And in the end, very likely the lender will get the 3 percent back.

Mr. KENNEDY. Well, that is correct. As I said before, Mr. Congressman, we would like to see all the carrying charges kept as low as possible consistent with the thinking of the committee, but we are willing to leave that entirely to the better judgment of the committee.

Mr. PATMAN. Your forthright stand on the interest-rate increase is evidenced by the fact that you are in favor of keeping the cost down and I am very much in favor of what you had to say about this interest-rate increase. I would like to invite your attention to the fact that last year, the interest rate at one time, the going rate, was 3½ percent, instead of 3 percent. I notice the top rate you have here is 3 percent.

Mr. KENNEDY. Yes.

Mr. PATMAN. Last year, about April 1, the Treasury issued some long-term 30-year bonds at 3¼ percent. Therefore, the interest rate would be 5¾ percent, and that wouldn't include any insurance fee, would it?

Mr. KENNEDY. That is correct. Of course, as this chart shows, Mr. Congressman, in one place there it does go over 5.50 percent. I presume that is what you have reference to.

Mr. PATMAN. Yes.

The interest rate, I think, is one of the worst features about this bill. I believe Mr. King testified that heretofore, with the Guaranty Department of the Veterans' Administration—do you know Mr. King?

Mr. KENNEDY. Yes, sir. We referred to his statement, Mr. Congressman, in Mr. Daniel's supplemental statement.

Mr. PATMAN. I think one point should be stressed. That is the statement that he made, that heretofore the margin between long-term Government bonds and the going rate on mortgage lending was 1½ percent, and this would increase it to 2½ percent. That is an increase of 1 percent, and that is the part that you object to.

Mr. KENNEDY. It is one of the things; yes, sir. We object to this interest increase in general, Congressman. We feel that 4½ percent, which was established by the law approved July 1, 1953, is fair and reasonable, and we are very reluctant to see new provisions adopted whereby they could charge more by virtue of new legislation.

Mr. PATMAN. If we were to set the pattern here of granting a 1 percent increase, which this would do, and that pattern should be followed and so eventually go clear across the board, the debt of the entire Nation, including the public debt, the national debt, and the debts of all States, counties, cities, and political subdivisions, along with the private debt, aggregating about \$604 billion, it would mean \$6,400 million a year increase. That would mean that the wage earners and the people who work for a living—and most of us do—would have to divert \$6,400 million every year from buying automobiles, appliances and the comforts and necessities of life, over to the payment of interest and service charges in addition to that.

That would mean about \$40 per person, would it not?

Mr. KENNEDY. I don't quite follow that, sir, but I accept your figures.

Mr. PATMAN. Well, for a family of 5, it would mean \$200 a year which that family would have to forego using to buy the comforts and necessities of life. They would have to take it out of their earnings, and in some cases they would probably be meager earnings. They would have to take that much out and divert it to the payment of higher interest rates, so I think the Legion has made a real point here on that. I commend you for your forthright and good statement in the public interest.

Mr. KENNEDY. Thank you, sir.

Mr. DANIEL. Mr. Chairman, if I might be permitted to do so, I would like to amplify No. 5, on page 3. In addition, the proposal carries with it a distinct possibility of discrimination between veteran home purchasers.

In explanation of that, it could very well be that a veteran might purchase a home in January and pay one interest rate, and by October the market might be such that the veteran who bought a home in October might even pay an entire percentage point more on his loan than the man who bought the house back in January of the same year. That is something else that we would like to have you give serious consideration to, sir.

Mr. PATMAN. You are the economist for the American Legion, are you not, on this particular matter, Mr. Daniel?

Mr. DANIEL. Yes, sir; I am chairman of the economic commission which has jurisdiction over housing matters.

Mr. PATMAN. Well I hope, in studying this interest question—I don't want to discuss it, except just briefly—but I hope you will keep in mind that the fixing of interest rates in this country is not left to the Members of the House and Senate, but is left to 12 people. Congress did that. Congress has delegated that power to 12 people. They are public officials—in name only, some of them.

Now, 7 of those 12, the members of the Board of Governors, are in fact public officials. They are on that open market committee of 12 which fixes these interest rates. That is the only board that fixes interest rates. No other board does it. There is no other power to interfere. The 12 Federal Reserve banks can't interfere, and have no power or control over it.

Those 12 men do it. And seven of them are genuine public officials, selected by the President of the United States. But 5 of those 12 are selected by the private commercial banks and bankers. In other words, unlike the kind of democracy that we have, here is a case where a select group, which is personally and privately interested, selfishly interested, is selecting those 5 people to go on this board of 12 to fix the long-term interest rates which fixed the rate that veterans have to pay. Get the last annual report of the Board of Governors of the Federal Reserve System, under the law they do have to report the votes on open market committee policies, and you will find, there, where the private members of that board on fundamental policymaking decisions, actually outvoted the public members of the board.

So you can see that we have a situation which is against the public interest. I think the American Legion could well afford to take some interest in that.

Mr. DANIEL. We appreciate that observation and we shall.

Mr. PATMAN. Because it is against the public interest, just as if the TV operators and the radio owners had complete charge over the Federal Communications Commission. It would be comparable to the Federal Reserve and the open market committee. Or if the railroad owners had complete charge of the Interstate Commerce Commission and could fix rates as they wanted to fix them. That would be a comparable situation to what we have now in the fixing of money rates. I earnestly urge you to give consideration to that.

Mr. BROWN. Mr. Chairman.

The CHAIRMAN. Mr. Brown.

Mr. BROWN. The American Legion, as I understand it, is against sections 201 and 801, is that correct?

Mr. DANIEL. That is correct.

Mr. BROWN. In their entirety?

Mr. DANIEL. Yes, sir, that is correct.

Mr. BROWN. That is all.

The CHAIRMAN. Are there further questions of Mr. Kennedy or Mr. Daniel?

If not, thank you very much for being here, gentlemen.

Mr. KENNEDY. Thank you, Mr. Chairman and members of the committee, for the courtesy extended to us.

The CHAIRMAN. We will now hear from Mr. A. M. Downer, legislative representative of the Veterans of Foreign Wars.

STATEMENT OF A. M. DOWNER, ASSISTANT LEGISLATIVE OFFICER, VETERANS OF FOREIGN WARS OF THE UNITED STATES

Mr. DOWNER. Thank you, Mr. Chairman.

Mr. Chairman and members of the committee, the Veterans of Foreign Wars of the United States is an organization composed of 1,250,000 men who have served in the Armed Forces on foreign soil

or hostile waters in time of war or during a recognized campaign or expedition. As a veterans organization, our interest in the legislation before you is confined to those provisions of the bill which relate to the home loan program of the Veterans' Administration and other housing preferences accorded veterans by existing law. I should like to briefly discuss these aspects of the bill, but first I should like to recall some of the circumstances that led to the establishment of a veterans preference in housing.

During World War II a critical shortage of housing developed throughout the entire country. At the end of the war it soon became apparent that such housing as did exist was occupied by those who had not been in the service and the large majority of home hunters were those who had been. In addition was the fact that building costs have risen sharply and the market value of existing housing had in many instances doubled or tripled since the beginning of the war. While this was going on, those in the Armed Forces were under strict military pay scales while the civilian population enjoyed high wages and high profits.

Thus, during a period of unprecedented prosperity, the ability of the veteran to compete in this scarce market had been reduced. In recognition of these facts, the Congress very properly extended to veterans certain preferences to enable them to buy or build a home. These preferences have been of very great value to the veteran population, expedited the building of adequate housing for the Nation and have substantially contributed to the general welfare. Many veterans who have not yet found it advisable or possible to avail themselves of the preferences which Congress established are now in a position where the continuance of the program is necessary to enable them to acquire a home for themselves and their families. We hope the Congress will continue the traditional policy of veterans preference.

We believe the veteran, by his wartime service, earned the right to the preference he has been accorded. Experience has proven the VA program to be sound and has shown that the delinquency rate is about one-half the rate that prevails in nonveteran loans. At the end of the 1953 fiscal year the loan guaranty division had guaranteed 3,271,450 home loans. They estimate a potential of 6 million borrowers from the present veteran population. Since the program is limited in scope and since the payment record is so good, we are unable to see where continuation of the program constitutes any danger to our economy.

However, we believe Congress should consider very carefully before expanding the FHA program for the entire population on approximately the same liberal credit terms that apply to the VA program. We are apprehensive that such a vast program might possibly result in overbuilding to the point that it will ultimately collapse real estate values.

In addition to these general observations, I should like to briefly discuss section 201, which would delegate to the President authority to establish maximum interest rates on FHA and VA mortgages at a level not exceeding the average market yield on Government bonds plus 2½ percent. The Veterans of Foreign Wars protested when the interest rate on VA loans was increased from 4 to 4½ percent. This position was subsequently reaffirmed by a resolution of our last na-

tional encampment, held in Milwaukee, Wis., August 2 to 7, 1953. Section 201, while not directly establishing an increased rate, does authorize an additional increase and is contrary to the views of our organization.

We can see some merit to the proposition that interest rates should be flexible as to rise or decline in accordance with the many factors that influence the price and availability of money. However, we prefer to have the Congress retain its authority to establish interest rates and feel confident that the Congress will promptly act if changed conditions require the adjustment of rates.

If the Congress is to delegate authority as contemplated by section 201, it will establish in some person or group of persons an authority that will be a constant lure to investors who continually seek to increase the earnings on their invested capital. It seems certain that a person or a group of persons with such broad authority would be subjected to more pressure by such forces than would the Congress of the United States.

In addition is the fact that the Federal Reserve Board already has the authority and does fix the rate of yield on Government bonds by the simple expedient of buying and selling on the open market.

We hope Congress will not relinquish the authority it has over interest rates on Government guaranteed mortgages. We also wish to suggest that the housing subcommittee of the House Committee on Veterans' Affairs is now conducting hearings in many areas of the United States, inquiring into the availability of mortgage money, discount practices, and interest rates. Since one committee of the Congress is conducting an investigation to develop facts so that we can properly legislate in this field, it seems legislation should be delayed until that report is available.

The importance of the VA program is indicated by the fact that the VA guaranteed approximately 319,000 home loans during fiscal 1953. The average amount of these loans was \$9,480 and the average term was 20 years. The importance of the interest rate is indicated by the fact that an increase of three-fourths of 1 percent in the present rate when applied to last year's average loan would result in total increased payments of \$932.83. An increase of three-fourths over the present rate would be authorized by section 201 on the basis of the average yield on Government bonds on February 1 of this year.

Title 8 of the bill would reduce the preferences accorded veterans under existing law in the purchase of housing built by the Government during World War II as a part of the war effort. This housing was nearly all built in the years 1940 to 1943, so that which is unsold has been retained by the Government for a period of 11 to 14 years. Under existing regulations the Administrator advertises for a period of 30 days an offer to sell at a fixed price to veterans under the preference provisions and if at the end of 30 days no sale has been made, the property can then be offered to the public and sold on a bid basis. We see no reason why this 30-day delay occasioned by veterans' preference provisions should suddenly become so important in the sale of property which the Government has held for such a long period of time. Nearly all of this housing that has been sold in the past has been purchased by veterans under the preference provisions and we strongly urge the committee to continue the preferences as provided by existing law.

We appreciate very much the opportunity to appear before this committee and thank you for your kind attention to our views.

The CHAIRMAN. Thank you, Mr. Downer. We are very glad to have your views.

Are there questions of Mr. Downer?

Mr. PATMAN. Mr. Chairman.

The CHAIRMAN. Mr. Patman.

Mr. PATMAN. If I correctly interpret your testimony, you are more concerned about the loss of veterans' preference than the other provisions of the bill, Mr. Downer?

Mr. DOWNER. We are concerned about that, Mr. Patman, and the interest rate also.

Mr. PATMAN. Also the interest rate?

Mr. DOWNER. Yes, sir.

Mr. PATMAN. Do you agree with what the American Legion representative said about the interest rate?

Mr. DOWNER. Yes, sir.

Mr. PATMAN. And you are also concerned with the veterans' preference being eliminated?

Mr. DOWNER. Yes, sir.

Mr. PATMAN. And you want it extended until the present law expires, say, in 1957?

Mr. DOWNER. Yes, sir.

Mr. PATMAN. I hope you keep in mind, too, who fixes interest rates, Mr. Downer, in your consideration of these matters.

Mr. SPENCE. The veterans' preference was not only based on the fact of service to the country, but it was because veterans were placed in a disadvantageous position by being sent out of the country, losing their homes at that time, and being unable to obtain homes when they came back, isn't that true?

Mr. DOWNER. That is correct, Mr. Spence.

Mr. SPENCE. Even if there were no question of service involved, I think veterans should have a preference because of that condition.

Mr. PATMAN. They were placed at a disadvantage.

Mr. SPENCE. Yes, by reason of their service to the country.

Mr. DOWNER. That is correct.

The CHAIRMAN. Are there any further questions of Mr. Downer?

Mr. WIDNALL. Mr. Chairman.

The CHAIRMAN. Mr. Widnall.

Mr. WIDNALL. Do you find any section of the country in which the veteran finds he is unable to purchase housing because of inability to meet the necessary requirements? Is housing priced too high for the veterans now, or are the monthly payments too high?

Mr. DOWNER. I think the payments don't cause so much trouble at the present time, as the scarcity of mortgage money. I was informed 2 or 3 days ago, by counsel for the Housing Subcommittee of the House Committee on Veterans' Affairs, that conducted hearings in Los Angeles last week, that evidence before the committee there indicated that there were discounts of 4, 5, and 6 percent. In other words, that a veteran borrower would only get 94, 95, or 96 out of every hundred dollars that he executed his mortgage for, in order to get a loan.

That, of course, is a condition that varies greatly throughout the country. In some areas that is the big problem at the present time.

I think the monthly payment factors probably are not really serious, since the regulations were changed so that no downpayment is required if the lender is willing to make a loan without a downpayment.

Mr. WIDNALL. In the case that you cite, there is probably an overall commitment for two or three hundred houses on that basis, is that so?

Mr. DOWNER. I am not sure that I understand your question.

Mr. WIDNALL. When you mentioned a discount of 4 or 5 percent, whatever it was, there was probably an original commitment made covering the entire project, to the builder and not actually to the veteran.

Mr. DOWNER. That may be. My information about that particular situation is rather sketchy. I assume the report of the committee will be available before very long.

Mr. WIDNALL. What length of time do you mean by that, "before very long"?

Mr. DOWNER. Well, I assume within a matter of a few weeks. But I don't know. It depends on whether or not the committee might decide to conduct those hearings in other areas. They have already been in San Antonio, Houston, Cincinnati, Cleveland, Los Angeles—6 or 7 cities already.

I think the findings of that committee would be very important to a consideration of the interest problem.

Mr. WIDNALL. I should think it would be valuable information.

That is all, Mr. Chairman.

Mr. PATMAN. Which committee conducted those investigations?

Mr. DOWNER. The Housing Subcommittee of the House Committee on Veterans' Affairs.

Mr. PATMAN. They have conducted hearings all over the country dealing with the interest rates, and the availability of mortgage money?

Mr. DOWNER. Yes, sir.

Mr. PATMAN. And you state that in some places they are having to take 94 cents on the dollar in order to get mortgage money?

Mr. DOWNER. Yes, sir.

Mr. PATMAN. That being true, they would get \$940 out of every thousand dollars, and continue to pay interest on a thousand dollars throughout the duration of the mortgage?

Mr. DOWNER. That is true.

Mr. PATMAN. Suppose they had to pay 3 percent more, as proposed in this new reorganized and rejuvenated FNMA. That would permit them to receive only 91 cents out of the dollar, wouldn't it?

Mr. DOWNER. That is true.

Mr. STRINGFELLOW. Mr. Chairman.

The CHAIRMAN. Mr. Stringfellow.

Mr. STRINGFELLOW. Mr. Downer, I wondered if you took into consideration the regional problems which might prevail relative to the establishment of the rate of interest on VA loans.

I have specific reference to my area. There were no GI loans made in that area for about 2 years—for 1 purpose, because the 4-percent rigid rate was not competitive, and, therefore, the veterans were relying on a direct loaning program by the VA, and, of course, the funds there were not adequate.

Now, I came here to Washington, and I learned that there was a provision in the GI bill which would have enabled the VA to raise the interest rate if the VA Administrator concurred with the Secretary of the Treasury, to 4½ percent, and that had been in the bill for almost 3 years, but somewhere along the line, some vicious politics happened to be played, and that prevented many GI's in my area from getting a home who ordinarily would have been in a home and have been paying on it.

Have you taken into consideration those regional problems when you take this forthright stand in reference to the interest rate?

Mr. DOWNER. Mr. Stringfellow, we have taken them into consideration. I wouldn't say that we know what the answer is.

Of course, it would be a fine thing if there was some way we could smooth out the peaks and valleys in this availability of mortgage money throughout the country so that a veteran that lived in Utah or Texas didn't have to pay any higher interest rate and could get a loan as readily as a veteran in New England.

I don't know what the answer is. I don't know that there is an answer to it. It is a simple fact that capital is available in New England for loans in that area and is not available in the Southwest or the western areas for similar loans.

Consequently, one who wants to obtain a loan in an area where money is scarce probably has to pay a higher interest rate.

Now, I assume that such discrepancy occurs throughout the country in other matters, such as used automobiles, for example. Normally a used car will sell for a higher sum on the west coast than in the East. I don't know if there is any answer to it. I agree with you that it is an unfortunate situation. As to the matter of the recent increase to the 4½-percent rate, I agree with you absolutely that when one needs a loan in build a home it is better for him to have one at 4½ percent than not have any at 4 percent.

Mr. STRINGFELLOW. Why is it, then, that the veterans' organizations so vigorously opposed the raising of that interest rate from 4 to 4½ percent?

Mr. DOWNER. Well, we really think that at that time that the change was made, and preceding the change, there was apparently great optimism among a great many of the lenders that there was going to be an increase to 4½ percent, so "Let's not make any 4-percent loans, because, after all, the money we lend now at 4 percent, maybe in a few months we can lend at 4½ percent."

I think that situation existed. I don't mean by that to be attacking any of the lending group particularly. Certainly that is their right, if they think they can get an extra half percent on their capital, to do it. But I think that situation did exist and affected the availability of 4-percent money.

Mr. STRINGFELLOW. Well, the history of our mortgage situation in our State is that mortgage money dries up much sooner than in other areas. And I know that the lenders there would have been very happy to have made the loans if they could have taken them out of their portfolio and sold them, but they were just noncompetitive at 4 percent, and so they just did not take them.

Now, here is a situation where the will of the Congress was not carried out. You mentioned the Congress should have the authority

to set the rate of interest. Well, the Congress had placed within the bill the discretion to raise the rate to 4½ percent, but the Veterans' Administrator sat on it, and I would like to know why, because there are many veterans, especially in my area, who just didn't get homes because of that fact, and I think it was just a plain political situation in the election year.

Mr. DOWNER. Well, that may be, Mr. Stringfellow. I think the Administrator of Veterans' Affairs did what he at the time considered was in the best interests of veterans. It is a matter on which reasonable minds might differ, of course.

My views on the subject may be erroneous, but that is the official position of our organization. This matter was debated at great length at our last national encampment in Milwaukee, and then the report of our committee that had jurisdiction over the matter reported the bill out to the convention floor, and it was the subject of debate on the floor. I admit and recognize that there is a great difference of opinion on it.

Mr. STRINGFELLOW. I feel that in dealing with this item of interest rates we have got to take into consideration regional problems, we have got to be realistic; because I am a veteran, I know that you have the interest of the veterans at heart, and we all want to help them get a home; but, when we have certain actions taken which absolutely prevent the veteran from getting a home because of these regional problems, I believe we should also take that into consideration in any stand that we might take as a national organization.

Mr. DOWNER. I appreciate your attitude, Mr. Stringfellow; and I am sure we do have the same objective; and, as long as we do have, I think probably we will eventually reach a conclusion that will be at least more than partially acceptable to both of us.

Mr. STRINGFELLOW. Now, you understand that the provisions as proposed in the bill does not set the interest rate. It merely establishes a maximum.

Mr. DOWNER. Yes; I understand that.

Mr. STRINGFELLOW. And then the President can establish the interest rate in an area which will be competitive within that range.

Mr. DOWNER. I understand that. But the problem we get, it seems to me, is in regard to the differences in rates throughout the country. If we undertook, say, to set a rate in Texas that would make money available in Texas, then, if we applied that rate in New England, we would require a veteran in New England to pay a higher rate than he otherwise would have to pay.

If we established the rate in New England as the rate required to secure a loan there, then we would have a veteran in Texas paying a higher rate than a veteran in New England. It isn't a simple problem, I think.

Mr. STRINGFELLOW. It is not a simple problem, but I don't think that we have to worry too much about New England. I am not a financial expert, but the situation there is highly competitive, and I just do not believe that gives us an adequate picture.

Now, I would like to develop this veterans' preference thing just a minute.

Do you mean the overall veterans' preference legislation? Is that what you are opposing? Or just as it applies to housing? It was men-

tioned in the statement made by the American Legion that they were opposed to any tampering with veterans' preferences.

I question the wisdom of that statement because I do not believe that we should be in the business of subsidizing incompetency, whether it be a veteran or anyone else.

I believe that we should give consideration to maybe revamping veterans' preference on a more logical basis because the present veterans' preference laws, I believe, are a deterrent to the veteran rather than an asset. That is my personal opinion.

Mr. DOWNER. If you are referring to the veterans' preference in the civil service, I think there is no protection of incompetency through it, because the veteran's performance must be good or better before he is entitled to the protection of it.

In regard to this particular bill, Mr. Stringfellow, I had two points in mind in regard to preservation of the veterans' preference. One was that discussed in the last paragraph of my statement in regard to war housing.

The other is in the overall picture, in that this bill, generally speaking, makes credit available to the entire population on the same basis that it is now available to the veteran population. It gives them almost equal credit terms.

We wonder, if we are to carry on a vast nationwide program of the Government guaranteeing 95 percent of a mortgage for a period of 30 years, if we may not ultimately collapse real-estate values in this country. I don't pretend to be such an expert that I would want to take any definite position on that and try to defend it, but we merely call that to your attention as something that we think is worthy of consideration.

Mr. STRINGFELLOW. We certainly appreciate—I do, for one, at any rate—the interest of the veterans' organizations in these various problems.

Mr. DOWNER. Thank you very much, we appreciate your interest in the matter.

Mr. STRINGFELLOW. That is all, Mr. Chairman.

Mr. O'HARA. Mr. Chairman.

The CHAIRMAN. Mr. O'Hara.

Mr. O'HARA. I notice that the position taken by your organization and that taken by the American Legion are about the same.

Mr. DOWNER. I believe so, sir.

Mr. O'HARA. Have you, in your organization, talked over this with the representatives of the Legion?

Mr. DOWNER. We have really had no consultation or conferences on it to compare positions of the organizations. A time or two I have had some brief conversation with Mr. Kennedy.

I think the fact that our positions are somewhat parallel is a coincidence that frequently happens. We are both interested in the welfare of the veterans of the country.

Mr. O'HARA. Would you say that one reason that you are on the same level of understanding and advocacy is the fact that this is in an area that you have been exploring for a number of years past?

Mr. DOWNER. Yes, sir; that is correct.

Mr. O'HARA. During that period of exploration, you have heard from the rank and file of the veterans, have you not?

Mr. DOWNER. Yes, sir.

Mr. O'HARA. I have been in the veteran movement for a good many years. I am one of the original members of your organization, and that goes back a good many years.

Mr. DOWNER. I am aware of that, sir. I think you were at one time national judge advocate of our organization, is that correct?

Mr. O'HARA. I did have that distinction, but a greater distinction is that enjoyed by our distinguished chairman. I would say that the greatest department commander that the Veterans of Foreign Wars ever had is the present chairman of the committee.

Mr. DOWNER. I think that is a popular opinion, Mr. O'Hara.

Mr. O'HARA. Nothing would please me more than someday to see the chairman of this committee, commander in chief of the veterans. I hope that will come to pass.

Getting back to the subject of this bill, there were some who were more inclined to favor the bankers than the veterans, were they not?

Mr. DOWNER. Yes, sir; there was some disagreement.

Mr. O'HARA. It was a very stubborn disagreement, wasn't it?

Mr. DOWNER. Yes, sir.

Mr. O'HARA. But more and more you heard from the rank and file, is that not true?

Mr. DOWNER. That is correct; yes, sir.

Mr. O'HARA. Were there charges at the time in some quarters that the veterans organizations with historical backgrounds, were turning the veterans over to the mortgage bankers?

Mr. DOWNER. I think that charge has been made; yes, sir.

Mr. O'HARA. Then after thoroughly exploring the situation the leaders and the rank and file of the organizations took the position that you have so well presented today; is that not so?

Mr. DOWNER. Yes, sir.

Mr. O'HARA. You think that it is absolutely necessary that the Congress retain control of the fixing of the interest rate?

Mr. DOWNER. Yes, sir.

Mr. O'HARA. Now, you have complete confidence in the President of the United States, haven't you?

Mr. DOWNER. Why certainly.

Mr. O'HARA. No question about that?

Mr. DOWNER. No question whatsoever.

Mr. O'HARA. But you know that the President of the United States is a very, very busy man and that he has to delegate, and he always does delegate, many responsibilities to subordinates.

Mr. DOWNER. Yes, sir.

Mr. O'HARA. Putting it plainly, you know, do you not, that in the event of the passage of this bill in its present form, the President himself would not set the interest rate, someone would do it for him?

Mr. DOWNER. Yes, sir.

Mr. O'HARA. You don't wish to repose your trust in whoever that might be, do you?

Mr. DOWNER. And it is really not so much a matter of trust. I think we all know that that person or group of persons would be continually subjected to pressure to increase the rate. This bill, by saying not more than 2½ percent, gives a level to shoot at. I think it would be almost like an attractive nuisance to a child, having it expressed as a 2½-percent ceiling.

Mr. O'HARA. Now I am going to go into the field that my beloved colleague from Utah suggested. I want to say in the Congress we are very proud of the gentleman from Utah. We are proud of the great national honors that have been so deservedly given to him, and I appreciate his position in regard to veterans preference—perhaps no man in this Congress, no man in the country, has given more to his country than the gentleman from Utah, as a serviceman. I think his position is most admirable.

And yet I cannot agree with him. I have always thought that the veteran is entitled definitely to a preference. I could never see the consistency, when the war is on and people at home are shouting for the boys in the foxholes, and then when they get back, saying "Well, they are just like everybody else." And I read in the newspapers almost daily of some weird crimes that are committed, and they are weird crimes, and they follow every war. We take young men from the homes where they have been brought up in kindly ways. Then we make soldiers out of them, and begin by breaking down all the fine sentiments of religion and of good hearts. And they come back and we expect them to be the same normal creatures that they were if we hadn't taken them from homes and put them in theaters of war. As long as we are foolish enough to have wars, we must give attention to war's wreckagees.

So I am glad that the Veterans of Foreign Wars and the American Legion are holding steadfastly for a continuance of Veterans' preference in every proper way. And I am saying that to you, sir, as one very much older than the gentleman from Utah, and having profound respect for him, and a great understanding of the idealism and the unselfishness of his remarks, but behind my words I am putting a long lifetime of experience and observation, and I hope that always this country will hold to the tradition that the best that we have to give to our veterans is the least that in right and justice we can give.

Mr. STRINGFELLOW. Will the gentleman yield?

Mr. O'HARA. Certainly.

Mr. STRINGFELLOW. I want to thank you for the very kind remarks that you offered in my behalf, but I would like to clarify the record. I wasn't opposed to the veterans preference outright. My stand was simply that I believe, Mr. O'Hara, we should take another look at the veterans preference laws, and probably make them more consistent with the times in which we live.

I think the Congress should take another look at the veterans preference laws, because in many instances they are deterrent to the veteran rather than a means of assistance.

Mr. O'HARA. I don't think that I misunderstood the gentleman. Perhaps, in my clumsy way, I put what he had said in inaccurate words. I think I understood the gentleman as he has now expressed himself.

Thank you very much, and thank you for clarifying your position, Mr. Stringfellow.

Mr. DEANE. Mr. Chairman.

The CHAIRMAN. Mr. Deane.

Mr. DEANE. Following Mr. Stringfellow's comments with reference to interest rates, I wonder if you would discuss briefly your observation based on this, that GI mortgages are paid off in cash, whereas

FHA mortgages are paid off in debentures, whether or not that interest factor gives to GI mortgages a certain advantage, in sales on the market?

Mr. DOWNER. I don't believe I am qualified to answer your question, Mr. Deane. I have had no experience at all in the mortgage-financing field, other than some experience in farm-mortgage financing. I really don't have enough knowledge of the actual operation of that phase of the VA program to answer your question.

Mr. DEANE. That is all, Mr. Chairman.

The CHAIRMAN. Mr. Downer, I don't know whether this interests you particularly, but I think the record should be clarified in one particular point. You got your information from the counsel of the Veterans' Affairs Committee, I believe.

Mr. DOWNER. Yes.

The CHAIRMAN. As to discounts.

Mr. DOWNER. Yes.

The CHAIRMAN. And these discounts out on the coast would run as high as what, did you say?

Mr. DOWNER. My recollection, Mr. Chairman, was as high as 6 percent, 4, 5, and 6 percent. I am merely testifying from my recollection of what the counsel told me, and if you wish, I will be glad to check with him.

The CHAIRMAN. I don't think it is necessary. The point that I want to make is this: In a colloquy between you and Mr. Patman—and I think I only need to call this to Mr. Patman's attention—under the law, that discount, or any sum which the mortgagee has to pay in to the capital stock or otherwise, of FNMA, under the law cannot be passed on. It just cannot be passed on. That is under the law.

Mr. PATMAN. It cannot be passed on.

The CHAIRMAN. That is correct.

Mr. PATMAN. Who will pay it?

The CHAIRMAN. The builder or the financing institution.

Mr. PATMAN. Well, Mr. Chairman, I respectfully suggest that the borrower will pay it for the same reason—

The CHAIRMAN. Mr. Patman, he can't pay it under the law.

Mr. PATMAN. There won't be any loans made, then.

The CHAIRMAN. Yes, there will be. Because the veteran gets a certificate of reasonable value from the Veterans' Administration, and that determines the amount of the loan.

Now, what happens after the loan is made doesn't affect that certificate of reasonable value to the veteran. He can't have passed on to him any discount or charges which are directly or indirectly placed upon the builder or the financing institution.

We can't assume that the Veterans' Administration—as a matter of fact, I think we surely should have to take some very drastic action if the Veterans' Administration, in the determination of the reasonable value of a property, should add to its CRV the probable discount, and the 3 percent referred to. I surely don't want to charge the Veterans' Administration with collusion to the point where they would raise the reasonable value of the house for mortgage purposes by this 8 or 9 percent that Mr. Patman referred to. I think before you follow that through, I might suggest that you read that law, Mr. Patman.

Mr. PATMAN. I concede, Mr. Chairman, that it is a beautiful theory, but an impractical one. The borrower will pay that, one way or another. That is my honest belief, and I am basing it upon the testimony of the witnesses. As disclosed, not a single builder said he would pay that. Not a single builder testified to anything else.

The CHAIRMAN. Don't get on FHA mortgages, let's confine ourselves to VA mortgages.

Mr. PATMAN. I am talking about the new and rejuvenated Fannie May.

The CHAIRMAN. I am talking about the VA mortgages, and the illegality of passing on the discount, or this 3 percent, or whatever the committee might agree upon, to the borrower in the case of veterans' loans. It is just impossible, unless we change the law and permit them to do it. I don't assume the committee will recommend any such change in the law.

Mr. PATMAN. Well, may I suggest to the witness, he was expressing a hope that something could be done to the VA system, so a veteran on the west coast, or in the Southwest, could get mortgage money at the same rate as veterans in New York and New England?

Mr. DOWNER. Yes, sir.

Mr. PATMAN. The answer to that is a good, adequate, secondary mortgage market, and that could be established right here in Washington, D. C.

The CHAIRMAN. I think we are in agreement that that is a very desirable objective, but I merely wanted to get into the record this truth about existing law, because I think at least there was an implication in your remarks that this discount, or premium payments, or whatever we want to call them, paid into Fannie May, would be passed on to veterans.

Mr. PATMAN. I think there is a difference of understanding there, Mr. Chairman. I didn't mean to say that the veteran would just put it on the barrelhead in actual cash.

The CHAIRMAN. You said it would be passed on to him?

Mr. PATMAN. I say the borrower will pay that one way or another.

The CHAIRMAN. They couldn't under the law, Mr. Patman, unless there was collusion between the veteran, the builder, and the Veterans' Administration. There might be, conceivably, collusion between the veteran and the builder, but we can't assume that the Veterans' Administration is going to be a party to this collusion, to raise the value of the property 8 or 9 or 10 percent above what it really is worth.

The mortgage is predicated upon the certificate of reasonable value, not upon any agreement between the veteran and the builder or the financing institution. That is the value which the Veterans' Administration puts on it, and there can be no deviation from that with respect to the mortgage.

Mr. PATMAN. I want to suggest that on March 3, 1954, Mr. Cole was testifying before this committee, and Mr. Hays of Ohio, asked him this question:

Mr. HAYS. I ask this in a very friendly way. Have you had much experience with appraisal work?

Mr. COLE. No; very little, Mr. Hays, and I know in a very friendly way what you are saying, namely, that appraisals can vary. And I am well aware of the fact that sometimes appraisals vary, having to do with the need to accomplish a specific objective. I realize that.

That is the testimony of the man in charge.

The CHAIRMAN. If you go to the testimony of Mr. King, Mr. Patman, you will get there that Mr. King testified that this is giving them no problem at all. Assuming that Mr. King in his appraisals were going to be guided by the facts, and not any factors which would increase or pass on to the veteran financing charges which were not a proper part of the appraised value.

Mr. PATMAN. Well, I stand on my statement that it will either be passed on to the borrower, or the loans will not be made. And I challenge anybody to present any builder in the United States of America who will say anything else.

The CHAIRMAN. Then you don't object to my statement that I stand upon the law in this respect?

Mr. PATMAN. I certainly do not.

The CHAIRMAN. We are in agreement to that extent, then, Mr. Patman.

Mr. PATMAN. You have your opinion and I have mine.

The CHAIRMAN. All right, Mr. Downer. We are very grateful to you for your testimony.

Mr. O'BRIEN. Mr. Chairman, I have a question.

The CHAIRMAN. Mr. O'Brien.

Mr. O'BRIEN. Within your own knowledge, what is the practice of passing it to the veteran purchaser?

Mr. DOWNER. Well, sir, at the present time, in a great many areas, there still are discounts.

Mr. O'BRIEN. That are passed on to the purchaser?

Mr. DOWNER. Well, you execute a note for a thousand dollars, and you only get, say, \$940 or \$950 or \$960—the veteran actually pays that.

The CHAIRMAN. He gives a note in connection with the mortgages, doesn't he?

Mr. DOWNER. Yes, sir.

The CHAIRMAN. And that mortgage is determined on the certificate of reasonable value as set by the Veterans' Administration?

Mr. DOWNER. Yes, sir.

Mr. PATMAN. Determined as Mr. Cole, Administrator, said.

The CHAIRMAN. No; determined as Mr. King said.

Mr. PATMAN. The appraisals are sometimes made to reach a specific objective.

The CHAIRMAN. Mr. Cole has nothing to do with VA loans. He has nothing to do whatsoever with VA mortgages.

Mr. MULTER. FHA inspectors inspect and certify them. Not in all cases, but in some cases. Wherever they have FHA facilities available, VA uses their facilities.

The CHAIRMAN. Are there any further questions of Mr. Downer? If not, thank you very much, Mr. Downer.

Mr. DOWNER. Thank you, Mr. Chairman.

The CHAIRMAN. We next have Mr. Charles E. Foster, legislative representative of the Disabled American Veterans.

Mr. Foster, we are very glad to hear from you.

STATEMENT OF CHARLES E. FOSTER, ASSISTANT NATIONAL DIRECTOR OF LEGISLATION, DISABLED AMERICAN VETERANS

Mr. FOSTER. Thank you, Mr. Chairman.

Mr. Chairman and members of the committee, the Disabled American Veterans is appreciative of the opportunity afforded us to appear before you this morning relative to our position on the bill H. R. 7839, the Housing Act of 1954. Our interest in the bill before you is confined to those provisions which have a bearing, directly and indirectly, on the home-loan program of the Veterans' Administration, and the housing preferences accorded veterans by existing law.

In enacting Public Law 346, commonly known as the GI bill, together with its amendments, the Congress has enabled approximately 4¼ million World War II and Korean veterans to acquire residential and farm dwellings for themselves and their families. Time has proven that the home-loan provisions of the GI bill has been both a social and economic gain to the Nation as a whole. Socially, because it has enabled millions of young veterans to start their families in the environment of a new home; economically, because it has been a stimulus to the building trades and the repayment record of these veterans' loans is without equal in the history of lending institutions.

At the present time there are still many millions of World War II veterans and Korean veterans who are now, or shortly will be, in the market for homes or farms, under the same credit terms. The DAV is alarmed that the amendments to title II of the National Housing Act, as proposed by H. R. 7839 will impair the credit preference veterans now enjoy by extending virtually the same preference to non-veterans as well. In other words, if the Congress extends this credit preference, as provided in the bill, to everyone the preference will cease to exist. As a veterans' organization we are irrevocably committed to the proposition that veterans are a special class. Operating on this premise, we must necessarily oppose the cancellation of a veterans' preference by the somewhat unique approach of extending such preference to everyone. We may be criticized that this is a selfish position to take but, as an organization representing America's war-time disabled, we sincerely feel that we have no alternative.

We are likewise opposed to section 201 of the bill, beginning on line 9, page 40, of the bill. If enacted, it would authorize officials of the executive branch of the Government to regulate the maximum interest rate which may be established from time to time on residential and farm mortgage loans guaranteed by the Veterans' Administration. The section provides that the rate of interest may not exceed 2½ percent plus the annual rate of interest determined by the Secretary of the Treasury by estimating the average yield to maturity on outstanding marketable obligations of the United States having remaining maturity of 15 years or more, adjusted to the nearest one-eighth of 1 percent.

The DAV vigorously opposed the increase in the rate of interest of GI guaranteed home and farm loans from 4 to 4½ percent. We have the utmost confidence in the elected Representatives of the people serving in the Congress of the United States and deplore the delegation of authority by Congress to officials in the executive branch of the Government to tamper with the interest rate on GI home loans. We have to recognize that such officials are far more susceptible to pressure

from groups seeking an increase in the interest rates and we sincerely believe that if the Congress had not delegated authority to the Administrator of Veterans' Affairs and the Secretary of the Treasury to increase rates of interest on GI home and farm loans that the rates today would still be 4 percent.

If the provisions of section 201 had been in effect during the calendar year 1953 the interest rate on GI guaranteed loans would have been $5\frac{1}{4}$ rather than the prevailing 4 and $4\frac{1}{2}$ percent. On the basis of the number of loans guaranteed by the Veterans' Administration during this time, the increased cost to the veteran would have aggregated \$429 million over the life of the loans. Looking at it from another angle, and taking the figure of \$9,480 as the average loan made to veterans in 1953, the increase in the interest rate from $4\frac{1}{2}$ to $5\frac{1}{4}$ percent would have cost each veteran an additional interest payment of \$932.83 for a 20-year loan. The increase in interest during the first year on a 20-year loan in the amount of \$9,480 would have been \$70.72.

We therefore urge the Congress not to take any action which might tend to increase the interest rate on GI guaranteed loans by delegating authority to the executive branch of the Government to fix or determine the prevailing rate of interest. We should remember there are still many millions of veterans in this country who will be in the market for homes and farms within the next few years. These veterans should have the same opportunity as those who have already used their entitlement to GI guaranteed loans.

The DAV endorses the provision contained in section 203 of the bill to repeal section 504 of the Housing act of 1950, as amended. At the time of the adoption of section 504 the DAV urged the Congress not to enact it because it would take away from the Veterans' Administration the authority to regulate the fees and charges that lenders may impose directly against veterans obtaining GI guaranteed loans. We still believe that the Veterans' Administration should have such authority and, therefore, recommend that the committee favorably consider section 203 of the bill.

Title VIII of the bill would appear to eliminate the preference accorded veterans by existing law to acquire Government-built housing. Inasmuch as this preference is of but 30 days' duration we cannot see any justification for discontinuing the present veteran preference in the acquisition of surplus Government-built housing.

In addition to the foregoing, we present for your consideration a proposed amendment to section 502 (b) of the Housing Act of 1948. Under section 502 (b) of the Housing Act of 1948, the Public Housing Administrator, at his discretion, can exclude the amount paid to veterans for service-incurred disability or death in determining eligibility for admission to public-housing units. However, disability and death compensation is considered as income in determining their rent of such prospective tenants. We recommend to the Congress that section 502 (b) of the Housing Act of 1948 (42 U. S. C., sec. 1404 (a)) be amended, by adding at the end thereof the following:

In determining net income for the purpose of establishing the rent to be charged a tenant in a low-rent housing project assisted pursuant to the United States Housing Act of 1937, the Public Housing Administrator shall exclude any amount paid by the United States Government to such tenant for disability or death occurring in connection with military service.

We also recommend for your consideration that section 15 (8) (b) of the Housing Act of 1937, as amended, be amended by striking out "not later than 5 years after March 1, 1949," and inserting "not later than March 1, 1959." This provision of the law, which expired March 1 of this year, extended a preference to veterans and servicemen applying for admission to low-rent housing. Our proposed amendment would renew and continue such preference until March 1, 1959.

Again, I wish to express my thanks to the chairman and members of this committee for allowing us the opportunity to present our views with respect to the bill, H. R. 7839.

The CHAIRMAN. Thank you very much for being here, Mr. Foster. Are there questions of Mr. Foster?

Mr. PATMAN. Do you take the same position that the other veteran organizations take in connection with the increased interest rate?

Mr. FOSTER. Definitely; yes, sir.

Mr. PATMAN. I want to state that, since your organization has been under attack, I have complete confidence in you. I know something about your organization, and have, ever since it was organized. These attacks are unwarranted, so far as I know, and I think it is a great organization and doing a fine public service. You have always been useful to me and to the congressional committees on which I have served since I have been in Congress. I want to express my appreciation to you particularly for the help that your organization has given to Congress in this and other matters.

Mr. FOSTER. Thank you for that, Mr. Patman.

I might say that the Veterans' Affairs Committee is at the present time working on a report relative to the charges that were made against us, and that report probably will be published within the next few weeks.

I feel certain that that report will bear out the fine statement you have just made.

Mr. PATMAN. And your organization will be exonerated, I am sure, because it is entitled to be.

Mr. FOSTER. Well, the report is based on the facts in the transcript, and there is no other answer.

Mr. PATMAN. At any rate, my admiration for your organization and confidence in it have not been lessened by these unwarranted and scandalous attacks.

Mr. FOSTER. I appreciate that, sir.

The CHAIRMAN. Are there further questions?

If not, thank you very much.

Mr. FOSTER. Thank you, Mr. Chairman.

The CHAIRMAN. Mr. Bernard Weitzer, national legislative director of the Jewish War Veterans.

We are very glad to have you, Mr. Weitzer, and you may proceed.

STATEMENT OF BERNARD WEITZER, NATIONAL LEGISLATIVE DIRECTOR, JEWISH WAR VETERANS OF THE UNITED STATES OF AMERICA

Mr. WEITZER. Mr. Chairman and members of the committee, I am grateful for the privilege of presenting to you, once again, the viewpoint of the Jewish War Veterans of the United States of America on

the housing problem and particularly, to comment on the bill introduced by your chairman, H. R. 7839, as a step toward the solution of the problem.

There are some features which I should like to see changed in view of the resolution passed at our 58th annual convention held in Chicago September 2-6, 1953. That resolution reaffirmed our support for the Housing Act of 1949 as amended by bills which went through your committee. I want to emphasize that characterization of such amendments. For we also passed, for the third or fourth time, a resolution at that convention opposing legislative amendments by riders on appropriations bills, such riders as have wreaked havoc in the functioning of the Housing Act of 1949.

In accordance with the convention-approved resolution on housing, I respectfully request that you modify the President's authority to adjust interest rates on FHA- and VA-insured mortgages, and to fix in the bill the rate for VA mortgages at a maximum of 4 percent, and the maximum for FHA mortgages at 4½ percent.

I must similarly request that the Veterans' Administration retain its power to establish the limits on fees and charges for VA-aided residential-mortgage loans. Likewise, the weakening of the veterans' preference provisions for admission to low-rent housing as provided in section 501 should be changed.

The amendments proposed in sections 119 and 120 are a mixture of good and bad. The proposal for the increase to as much as \$25 million in an FHA-insured cooperative-housing mortgage may be valuable in some instances, particularly in the builder-sponsored type of project. However, changing from a cost basis to a valuation basis in the amount of the mortgage will certainly cause difficulties in some cases. The amount of the mortgage under the changed basis would often be reduced and therefore call for a higher downpayment which is naturally an obstacle to the prospective cooperators. This can be substantiated by the former assistant commissioner for cooperative housing, who has had frequent opportunities to compare the effects on the mortgage amounts of the change proposed.

Furthermore, in these two sections of H. R. 7839, it is proposed to ratify an appropriations bill rider which has been a serious factor in slowing down the progress of cooperative housing. The original bill very clearly defined the need for helping cooperators to get together and organize cooperative-housing projects. Practically all such prospective cooperators find themselves frustrated by the complexities of real-estate transactions and the problems which are common to getting together and moving ahead with reasonable speed to progress toward the objective of a cooperative building project. Competent, disinterested advice is essential, but the regular FHA field staff, generally, has little knowledge about the opportunities afforded to cooperators by section 213. It was much easier for them to deal with the experienced contractors, builders, and real-estate men who talked their language and with whom they had had much experience.

For the foregoing reason, section 213 provided for an assistant commissioner for cooperative housing and a staff to help cooperators, directly, and even more to train FHA field employees to deal sympathetically and helpfully, with the cooperative projects brought to their FHA regional field offices. That operation paid off in dollars

and cents return to the Government because the fees collected on the projects outran, by a considerable amount, the outlays for the assistant commissioner's office, staff, and the work done by the FHA employees in the field and at the home office. Nevertheless, an appropriations bill rider stalled the whole operation without giving your important committee an opportunity to study and discuss the subject and thereby, in my humble opinion, usurped a proper function of your committee. H. R. 7839 would appear to confirm such usurpation by abdication. In line with our 58th annual convention resolution, I respectfully ask that you remove this provision from H. R. 7839 eliminating the assistant commissioner for cooperative housing, and thereby carry out the original intent of section 213.

In contradistinction to the readiness to buttress the Appropriations Committee rider regarding the assistant commissioner for cooperative housing, is the failure to include in H. R. 7839 a reaffirmation of the original provision of the National Housing Act of 1949 for 135,000 public-housing units per annum, and also the failure to include in H. R. 7839 authorization for the 35,000 public-housing units per annum for each of the next 4 years which is recommended in President Eisenhower's housing message. In line with the housing resolution passed at our 58th annual convention, I respectfully request that you insert a section in H. R. 7839 affirming the goal of the Housing Act of 1949 for 135,000 public-housing units per year and a section definitely authorizing the number of public-housing units requested by President Eisenhower in his message. Your failure to do this will be an invitation to the Appropriations Committee, once again, to write housing legislation by riders on its appropriations bills.

In general, insofar as H. R. 7839 departs from the National Housing Act of 1949, I feel that our convention resolution would call for some opposition, but there are many proposals in H. R. 7839 which are undoubtedly of good intention.

Section 101 of the bill increasing the amount and the time for repayment of property improvement and repair loans certainly belongs in the good-intentions category. However, it is a mistake to suppose that anywhere in the near-time future this provision will have a marked effect either in improving rundown city areas or in providing any larger amount of housing units for those who need them. The probable effect will be jacking up the rents so that current occupants will, in many cases, be forced into even poorer quarters. What is more, should there be any increased interest in such improvements and in the placement of loans under section 101 it would be necessary to have a new breed of FHA field employees to process such loans and a new group of contractors to do such work. Builders and contractors accustomed to work on complete new houses do not easily adjust either their thinking or their operation to go after such improvement business and set themselves up to carry out the work effectively or efficiently.

Section 221 of the bill, although fully entitled to be included in the good-intentions category, is admittedly of no use to that part of our population living in the highly populated metropolitan areas where high land costs admittedly make a \$7,000 house impossible. People in such areas will certainly not be able to benefit from the provision of this section. It has not been made entirely clear just where a

\$7,000 house is feasible, and whether a \$7,000 house can be reasonably expected to outlast the 40-year mortgage term. Bankers and lenders, thus far, have shown no hot desire to acquire such mortgages. That such \$7,000 houses with 100 percent mortgages running for 40 years can meet the needs of those who are eligible for public housing is completely out of the question. In some areas it is possible that there can be such houses available to meet the needs of the lower middle-income families—those whose monthly earnings range from about \$275 to \$325. That is based on the figures in exhibit 8, page 94, of the President's Advisory Committee report of December 1953.

As I recall it, that showed that monthly costs would run about \$62.50 per month.

In considering the feasibility and the possibilities of this section, it is well to remember that it took mass production housebuilding methods in what was practically an assured housing market to put up the houses at Morrisville, near the Fairless works of United States Steel, at a sales price of \$10,000 to \$10,500 for a no-basement, 3-bedroom house, with a living room, kitchen including a dining nook, 1 bathroom and carport. A similar mass building effort at Leavittown, Long Island, produced a slightly less desirable house without a carport at a price range which started at \$7,990 and in succeeding years, as building materials costs and labor building costs increased, moved first up to \$8,990 and subsequently to \$9,990. It is doubtful that the ordinary moderate-sized speculative builder can match this performance even on low-priced land at the \$7,000 level.

It is a good idea to provide as in title III to aid bankers and other lenders, to set up their own association to insure a secondary market for mortgage loans. The opportunity to do so on their own initiative without Federal assistance has not heretofore appealed to such lending institutions. However, it is essential to keep FNMA in business for the indeterminate future and I believe that in order to avoid future large appropriations to enable FNMA to perform its functions as a secondary mortgage market it would be desirable to carry out a program somewhat as follows:

1. Organize a corporation under the auspices of FNMA or FHA which would hold in escrow as many hundred million dollars worth of FHA and VA mortgages as are now held by FNMA and which cannot be promptly sold to lenders who would hold such mortgages permanently.

2. To have such a corporation issue debentures secured by the mortgages held in escrow to sell to the general public—such debentures to be in amounts of \$500, \$1,000, and \$5,000 carrying an interest rate of about $3\frac{1}{4}$ to $3\frac{3}{8}$ percent. The difference between such an interest rate and the interest rate on the VA and FHA mortgages held in escrow, would take care of servicing the mortgages and the paperwork involved. The testimony as to such costs was given by bankers and lenders at a special hearing of the Senate Banking and Currency Committee where representatives of lenders from all parts of the country had an opportunity to express their views on the mortgage interest rates, and the net returns to the lenders.

In summary, I would say that there is an opportunity for a housing bill which will truly meet the need of the people for housing as they were recognized by the late Senator Taft so recently as in the spring of

1953 at the National Housing Conference meeting at the Statler Hotel. Furthermore, the housing program stimulated by such a bill could take up the slack in our current economic situation very effectively.

Thank you for this opportunity to appear before you.

The CHAIRMAN. Thank you, Mr. Weitzer.

Are there questions of Mr. Weitzer?

Mr. MULTER. Mr. Chairman.

The CHAIRMAN. Mr. Multer.

Mr. MULTER. Very briefly, Mr. Chairman. Mr. Weitzer, you have been before our committee many times, and we have always been very happy to have you here. You have always been helpful.

Do you know in what areas of the country you can get any \$7,000 homes built?

Mr. WEITZER. Well, I occasionally see papers from various parts of the country where there are houses for \$7,000, but it is difficult to get from the ads just what kind of houses they are, whether they are the sort of houses that would last 40 years, or whether they are the sort of houses on which anybody would give a 100-percent 40-year mortgage, even under Government insurance.

I am not in a position to say. All that I can go by is that I have talked with many people who have seen the Levittown and Morrisville houses, and I know that that was a tremendously successful building operation, but there was practically no speculation involved. Every modern, efficient, large-scale method of production was applied.

Levitt Brothers, I think is the name of the firm, were able to get building materials at the lowest prices, they set up their own wholesale operation and dealer operation in order to overcome the present restrictions which the building materials dealers and the building material wholesalers put on having manufacturers sell direct to a builder, and with all of that they apparently were able to put up a decent house, but the price had to be around \$10,000, or better.

Now, I don't know just what the lot costs were there.

Mr. MULTER. I think in the Long Island area they were able to put up a very small one-bedroom house for just under \$9,000.

Mr. WEITZER. That is what I say, the Long Island houses were smaller, but even that was considered quite a performance. It was considered a remarkable feat. So I am a little dubious about the feasibility of this \$7,000 house in the first place, and in the second place, I am certainly dubious about the implications that I have heard in the testimony here that this thing is going to remove the need for public housing, that this is the answer to the problem on which this Congress has worked for a great many years and on which Senator Taft worked, with Senators Ellender and Wagner. Finally, in 1949, a real bill had gotten through, and that bill has been fought, and hamstrung, and mutilated by appropriations bill riders so as to knock out its usefulness in every possible way, and so as to slow up the provision of the public housing that in the opinion of our organization is essential to meet the need of a small percentage of the people who just, for one reason or another, don't seem to be able to earn enough to pay the full economic rent. The question is whether they are going to rot in the slums or have an opportunity to get into a decent environment to raise American children in an American atmosphere.

Mr. MULTER. Agreeing that we need a \$7,000 house, and assuming that you can build a good \$7,000 house, and assuming further that you can get mortgage money for that \$7,000 house, have you seen any indication where there are any builders who are willing to build that \$7,000 house?

Mr. WEITZER. Well, I think the experience of the last 8 or 9 years—since the end of World War II—indicates that the builder is going to get into building houses where he can make the most money and, of course, those who are equipped and have the know-how to build houses at \$20,000 or \$25,000 or \$35,000, they are certainly not going to go down in the lower groups.

Mr. MULTER. From what you know of this industry, certainly a builder can, with the same effort, and with very little more money invested, build a \$10,000 house and make more profit than he can building a \$7,000 house.

Mr. WEITZER. Well, that is just a matter of business. These fellows have to make a profit if they are going to stay alive, so they are going to go for the profit where it is easiest to make. We can't expect them to be philanthropists. They have got to make a living just as do the carpenters and bricklayers they hire.

Mr. MULTER. Nobody can blame them for that.

Mr. WEITZER. So their emphasis is going to be where they can make the money most easily and most plentifully.

Mr. O'BRIEN. Will you yield?

Mr. MULTER. I yield.

Mr. O'BRIEN. When Mr. Hollyday was testifying, on the same subject, he said, "The city of Detroit and New Orleans were trial cities for putting that into effect." Do you think that is a realistic program in the city of Detroit, \$7,000 homes, 100 percent mortgages, 40-year duration?

Mr. WEITZER. Unfortunately I wasn't here when he testified and didn't see a copy of his testimony, but I think I have seen some advertisements of houses, apparently way out in the outskirts of Detroit, that were advertised for, I think, \$7,990.

Mr. O'BRIEN. Of course we are talking about urban renewal. I take it from your testimony here that you don't consider that a realistic program. Now, I would like to ask you this question: Are there any changes that you would consider might make it a realistic program?

Mr. WEITZER. Well, I am not a technician on what kind of housing will last and what the housing would cost. My testimony has been based on observations that I made a great many years ago when I traveled all over the country in connection with some work for the National Retail Lumber Dealers Association and, of course, costs then were a lot different than they are now. They used to think then that they could put up a pretty good house for six or seven thousand dollars. That same house today would cost fifteen or sixteen thousand dollars.

Mr. O'BRIEN. Do you think a \$7,000 maximum mortgage would warrant a 40-year loan in our northern cities?

Mr. WEITZER. I don't know who would make the loan. I heard some of these bankers talk about it, and they certainly didn't talk as though they wanted to make those loans.

Mr. O'BRIEN. I think that answers my question in that regard.

But would you want to suggest any modifications of that program? For instance, what maximum would provide a realistic program?

Mr. WEITZER. That would be pretty hard to say because, you see, the point is that you are getting into a situation here where the monthly cost, on the basis of the interest rates computed by the President's committee, and \$8,000 home, as I recall, runs up to close to \$73.

Mr. O'BRIEN. Seventy-three dollars a month?

Mr. WEITZER. Yes. You are getting to a point there where a fellow has to have a pretty good job to meet those costs, even if he does not have to have any money for a downpayment. If you are going to put it up to \$9,000 you add another \$10 a month and you have got an \$85 a month, approximately, rental per month. That might help the people in that classification of wage-earning capacity, the people who can pay that much rent.

Mr. O'BRIEN. But the \$7,000 house, in one of the typical northern cities, is a sort of a dream house. It is all right if you can get them to build it.

Mr. WEITZER. Yes. My point is that I don't think it fits into the picture. In a very great part of the country that thing is admittedly out of the question. Mr. Cole said as much here when he testified, and when we discussed this thing in the course of these shirt-sleeve conferences that he referred to. He admitted it there, in the same way.

It certainly sounds attractive, and in some parts of the country it may be feasible. I don't think it is in the more largely populated areas, certainly of the North.

Mr. O'BRIEN. That is all.

Mr. MULTER. If you are going to try to use it in lieu of public housing, it is a worst thing because it becomes almost a misrepresentation. Because, assume you can get a builder who will build for \$7,000, assume you get a 100-percent mortgage for \$7,000, even running over the 40 years, that is going to cost at least \$60 a month, I think \$62 a month, to carry.

Mr. WEITZER. That is right.

Mr. MULTER. If you are going to try to give that to the family in the public housing project you have got 71 percent of the families, of all families, earning less than \$2,500 a year. You have 93 percent of families of 1 person, and 79 percent of 2-person families, earning less than \$2,000 a year.

How can those people buy a \$7,000 house and pay \$60 a month for it?

Mr. WEITZER. Well, that is exactly the point that I made. The implications that seemed to me to be in some of the testimony, were that this was similar to public housing, and the President thought that 35,000 units a year were going to be sufficient. I think that was presumably predicated on this \$7,000 house. And I think that is pure fantasy.

Mr. MULTER. First, you have to get a builder to build, a mortgagor who will lend, and then boost the income of the person in the public-housing project so he can buy.

Mr. WEITZER. I don't know who is going to boost the income.

Mr. MULTER. I don't know, either. I would like to do it but I don't know how.

The CHAIRMAN. Are there further questions?

Mr. WIDNALL. Mr. Chairman.

The CHAIRMAN. Mr. Widnall.

Mr. WIDNALL. One comment: I, too, feel that it would be very difficult to build a \$7,000 house in most communities in the United States, but addressing my remarks to your comments on Levittown, didn't they have some unusual expenses there? They started from scratch and had to provide all the community facilities, sewage disposal, water, and everything else which would involve unusual expense, that the average builder would not have to face.

Mr. WEITZER. Well, of course, what you come to is this: You start out and provide the needed facilities, and your final cost, the builder figures, is less than trying to buy the land, pay the price of the lots in the areas where you have the facilities. The plus value is that this is out in the country. Of course, it is no longer country now, with all these houses there., I lived not far from where Levittown now is, on the south shore of Long Island, for many years. That was very nice country. Now you have these thousands of houses, and the country atmosphere has disappeared.

Of course, another thing you have is, if you are going to get on this cheap land, you have a transportation problem unless you can build right in the heart of the city. If you are going to condemn land and turn it over to some builder who will put a \$7,000 house on it and charge him nothing for the land, then if a \$7,000 house can be built on land that costs nothing, you might conceivably get a house that could outlast a 40-year mortgage.

They tell me that these Levittown houses will stand up more than 40 years. Of course, that is still to be determined. They used some new and original methods of construction, and some new materials. Say you could get a Levittown established in the heart of some big city, where you could put up a thousand houses on an area which had been cleared of slums, in some parts of the country perhaps you could arrive at this \$7,000 house. The city would condemn the land, pay the owners for it, and turn it over for free to the builder that was going to put up the \$7,000 houses. That is about the only possibility that I see of that being done in any of the large metropolitan areas of the North.

I am not suggesting it should be done. You asked me how it could be done. That might be one way to do it.

Mr. WIDNALL. Thank you, sir.

The CHAIRMAN. Thank you very much, Mr. Weitzer, for your testimony.

Our next witness is Mr. Clair W. Ditchy, president of the American Institute of Architects.

We are very glad to have you, Mr. Ditchy. You may proceed.

Mr. DITCHY. Thank you very much, Mr. Chairman.

STATEMENT OF CLAIR W. DITCHY, PRESIDENT, THE AMERICAN INSTITUTE OF ARCHITECTS, ACCOMPANIED BY LOUIS JUSTEMENT

Mr. DITCHY. Mr. Chairman and gentlemen, I am Clair W. Ditchy, a practicing architect of 5 West Larned Street, Detroit, Mich. I am appearing here as president of the American Institute of Architects to discuss H. R. 7839, the Housing Act of 1954.

The American Institute of Architects is a national professional organization which geographically covers the country. Its 116 chapters and 11 State organizations are located in every State of the Union and in certain United States possessions. The organization's membership of nearly 10,000 registered architects comprises the majority of all practicing architects in the country. The institute is qualified to express the views of the profession.

The institute has long-term interest and a deep concern with matters of housing and urban redevelopment. Over the years individual members and special committees of our organization have studied many aspects of the problems involved in this complex field. Many of the solutions, which have been adopted, have resulted in part, at least, from our efforts.

In 1947 Mr. Louis Justement, who has accompanied me here today, headed an American Institute of Architects committee that developed a plan for an urban renewal administration, similar in many respects to the current proposals. The Justement report and recommendations were adopted in 1947 as the long-range policy on urban planning and housing for the American Institute of Architects.

We are pleased to see in this legislation an urban renewal plan which, although it might not be entirely identical to the urban renewal administration at one time propounded by the American Institute of Architects is, nevertheless, in its aims and objectives, entirely in tune with the thinking of the architectural profession.

Two distinguished members of our organization, Past President Ralph Walker of New York, and Paul Williams of Los Angeles, served as members of President Eisenhower's Advisory Committee on Government Housing Policies and Programs. With this special background, and after further thoughtful study, the institute's board of directors, meeting in Washington last week, adopted the following policies regarding the Housing Act of 1954.

The American Institute of Architects wholeheartedly supports the objectives of the Housing Act of 1954. We have, however, a number of suggestions to make concerning some of the provisions of the bill. We wish to make it clear that we endorse the bill, as a whole, and that our endorsement of the bill is not conditioned upon the acceptance of these suggestions. For ease of reference we have set forth our comments below under the various titles of the bill:

Title I. Federal Housing Administration: Most of the amendments proposed under this title will tend to bring cost limitations in line with present-day construction costs, to simplify administration, to abolish or transfer certain housing emergency measures, and to abolish the program for yield insurance that has never been used. We heartily concur in all of this portion of title I.

We seriously question, however, the advisability of section 221. We are opposed to the underlying principle contained in this section for 40-year 100-percent loans with no down payment. It seems contrary to the maintenance of sound incentives for ownership. A further comment by one of our members, Henry Churchill of Philadelphia, who is an eminent authority in the housing field, is as follows: "The thinner the equity, the greater the danger come hard times; the longer the mortgage, the shoddier the construction; the longer the mortgage, the greater the buyer's cost; the shoddier the construction, the higher the

upkeep; the higher the upkeep the greater the slum potential." Let us not on the one hand establish a broad forward-looking program of urban renewal and, on the other, permit and even encourage the slums of the future.

Title II. Housing mortgage interest rates and terms: We agree fully with this title.

Title III. Federal National Mortgage Association: Architects are perhaps less qualified to express an opinion on this feature of the bill than they are with respect to the other phases of the legislation. In general, however, we do not favor the secondary mortgage market plan as proposed in the present bill. We suggest its reconsideration along the lines recommended by the President's Advisory Committee on Government Housing Policies and Programs.

Title IV. Slum Clearance and Urban Renewal: In many respects this is the utmost important part of the legislation from the point of view of developing a long-range program. We believe that the provisions of this bill are all distinct improvements on the Housing Act of 1949. Especially noteworthy and praiseworthy is the new definition for "urban renewal project" which recognizes the problems posed by commercial and industrial slums as well as residential slums.

When the legislation on urban redevelopment was being considered in 1949, we were fearful that its inclusion in a housing bill would place an excessive emphasis on housing. The American Institute of Architects believed then—and we believe now—that housing is only a part of the urban renewal problem and that, logically, a division of slum clearance and urban renewal should not be subordinated to a Federal housing agency. If the two functions are to be joined administratively, the relationship might well be reversed. Housing could, quite properly, be made a division of an urban renewal administration.

The institute fully endorses the urban renewal plan as contained in title IV. We believe that it will broaden the present slum clearance and redevelopment program and that it will assist communities in taking effective action to meet their overall problems of urban renewal; they will be enabled, not only to eliminate and prevent the spread of slums and urban blight, but to rehabilitate those areas that are worth saving.

We believe that section 414 is a wise provision as it will tend to permit experimentation in a new field in which new ideas should be encouraged and tested on a small scale before being accepted as a basis for action on a large scale.

Title V. Low-rent public housing: We concur in this title in its entirety and wish especially to commend the changes in the provisions concerning preferences for admission to low-rent housing.

As a very long range program, we believe that it may ultimately be possible to house all of our citizens adequately without the necessity of public housing. But this would necessitate great changes in our present system of amortizing FHA mortgages and presuppose a long-continued rise in the American standard of living.

Under the conditions which now exist—conditions which are likely to continue for some years to come—we believe that public housing is a necessary part of a complete program for urban renewal and housing.

Title VI. Home Loan Bank Board: We have no comment on this portion of the bill.

Title VII. Urban Planning and Reserve of Planned Public Works: We favor the objectives sought by this title with respect to both urban planning and a reserve for planned public works. The aid for urban planning would be appropriate under the Division of Slum Clearance and Urban Renewal but the aid for advance planning of public works might be more appropriate under some other department in the Federal Government. In any event, we believe that the aid extended to localities will involve a minimum of Federal control—and no control with respect to design.

In conclusion, we wish to express our gratification concerning the methods which have been used by the administration in developing a housing policy. The study which has been given by the many experts chosen to serve on the President's Committee on Housing has produced a program which is essentially sound and will be supported by the country at large. It is not revolutionary and it does not abolish many of the housing functions which have been developed under preceding administrations. It seeks, instead, to weed out the needless functions and to improve the administration of those functions which are retained. We heartily concur in the program as a whole.

Mr. Chairman, we appreciate the opportunity of appearing before you.

The CHAIRMAN. We are very, very happy to have had your testimony, Mr. Ditchy.

Are there questions of Mr. Ditchy?

Mr. O'BRIEN. Mr. Chairman.

The CHAIRMAN. Mr. O'Brien.

Mr. O'BRIEN. Mr. Ditchy, you refer to the report of the American Institute of Architects on page 1 of your statement. I don't know what that is, but is it compact enough to be included in our hearings, and do you think it would be helpful?

Mr. DITCHY. Having the author here, I would like to refer your inquiry to him.

Mr. JUSTEMENT. It is quite lengthy, Mr. O'Brien. It is about, I think, 30 or 35 pages long.

Mr. O'BRIEN. That might be too lengthy to be included.

Mr. JUSTEMENT. I would be glad to furnish you with copies.

The CHAIRMAN. Would you make it available to the committee members?

Mr. JUSTEMENT. We will be glad to make it available to you, sir.

The CHAIRMAN. We will be glad to have it.

Thank you very much, Mr. Ditchy, and Mr. Justement.

That concludes the testimony of witnesses for today. We will proceed tomorrow morning and, without objection, the committee will stand in recess until tomorrow morning at 10 o'clock.

(Whereupon, at 12:32 p. m., the committee adjourned to meet at 10 a. m., Wednesday, March 17, 1954.)

HOUSING ACT OF 1954

WEDNESDAY, MARCH 17, 1954

HOUSE OF REPRESENTATIVES,
COMMITTEE ON BANKING AND CURRENCY,
Washington, D. C.

The committee met at 10 a. m., the Honorable Jesse P. Wolcott, chairman, presiding.

Present: Chairman Wolcott (presiding), Messrs. Gamble, Talle, Kilburn, McDonough, Widnall, Betts, D'Ewart, Mumma, McVey, Hiestand, Van Pelt, Spence, Brown, Patman, Multer, Deane, Adonizio, Hays, and O'Hara.

The CHAIRMAN. The committee will come to order.

We will proceed with the consideration of H. R. 7839.

We have with us this morning the National Association of Real Estate boards, represented by Mr. Waltemade, chairman of the Washington committee, Mr. Summer of Newark, N. J., and Mr. Burns of Los Angeles, Calif.

We are very glad to have you back with us, gentlemen, and we are very happy to have your testimony.

If it is agreeable to the committee, you may proceed without interruption with your presentation. At the conclusion of your presentation the committee members may want to ask you some questions in connection with it.

Mr. WALTERMADE. Thank you, Mr. Chairman.

STATEMENT OF HENRY G. WALTERMADE, CHAIRMAN, REALTORS' WASHINGTON COMMITTEE, NATIONAL ASSOCIATION OF REAL ESTATE BOARDS, ACCOMPANIED BY ALEXANDER SUMMER, NEWARK, N. J., PAST PRESIDENT, NATIONAL ASSOCIATION OF REAL ESTATE BOARDS, AND MEMBER OF THE PRESIDENT'S ADVISORY COMMITTEE ON HOUSING; AND FRITZ B. BURNS, LOS ANGELES, CALIF., CHAIRMAN, BUILD AMERICA BETTER COUNCIL, NATIONAL ASSOCIATION OF REAL ESTATE BOARDS

Mr. WALTERMADE. Mr. Chairman and members of the committee, I am Henry G. Waltemade, chairman of the realtors' Washington committee of the National Association of Real Estate Boards. I am president of Henry Waltemade, Inc., with offices in New York, a trustee of the Dollar Savings Bank of the City of New York, the fifth largest savings bank in the country, and a director of the Manhattan Life Insurance Co., and a member of the real estate mortgage committees of both institutions. I have been actively engaged in all phases of the real-estate industry for more than 30 years.

The realtors' Washington committee is the legislative committee of the National Association of Real Estate Boards. Our association consists of more than 51,500 realtor firms who are members of 1,151 local real-estate boards in all 48 States.

We are most appreciative of this opportunity to present the views of our association with respect to the important housing legislation now before you. All of the subjects covered in the bill have been considered from time to time by the national conventions of our association, and the views to be expressed and amendments proposed herein have been under study for several years.

Following my testimony, which will be limited to titles I and II of the bill, we should like to present Mr. Alexander Summer of Newark, N. J., a past president of the National Association and a member of the President's Advisory Committee on Housing Policies and Programs, to discuss the secondary mortgage market provisions of title III. After Mr. Summer's testimony we should like to have Mr. Fritz Burns of Los Angeles Calif., chairman of the build America better council of the national association, discuss the slum clearance and urban renewal provisions of title IV. These latter two titles are probably the most important in the bill and we are proud to present such eminently qualified persons to testify with respect to them.

Before proceeding to the FHA amendments, may I state that our association concurs generally in the objectives sought by this legislation. These objectives were appropriately characterized by the President in his housing message to the Congress, that—

Needed progress can best be made by full and effective utilization of our competitive economy with its vast resources for building and financing homes for our people.

During the course of this testimony we shall suggest certain amendments which we believe will improve the workability of certain FHA sections.

The proposed amendments to the FHA mortgage insurance system substantially follow the recommendations of the President's Advisory Committee, and unquestionably will make that system a far more effective device for the construction of new and acquisition, and repair of existing housing for many people seeking adequate homes for their families. The bill recognizes the importance of modernizing and rehabilitating the thousands of homes which almost daily are withdrawn from the Nation's inventory of acceptable housing because of needed repairs. The increase in the maximum permitted mortgage amounts as well as the permissible terms will greatly aid in accomplishing the desired objectives. Also the proposals for eliminating differences in the terms of the debentures offered in payment of the insurance and in allowances of foreclosure costs applicable to certain sections of the National Housing Act will materially assist in meeting these objectives.

The increase in the maximum mortgage limits and maturity for section 203 loans, and the increase in limits for section 207 loans will bring both of these important sections closer to the broad market coverage role they were intended to play when first enacted in 1934. The Federal Housing Administration is a self-supporting operation, and the benefits of the insurance system should be distributed as widely as possible. Also the wider range of its activity increases

opportunities to distribute risk and thus improve the stability of the system.

However, we note that the amendment to section 207 would extend that section to existing construction located in slum or blighted areas, as defined in the act, provided that part of the loan is used for repair and rehabilitation as the FHA may require. "Slum or blighted area" is a rather restricted term, while section 220, which for all practical purposes is a more liberal 207, is not so restricted because it is applicable to designated urban renewal areas. It is very likely that people relocated from urban renewal areas may desire housing outside such areas which may not necessarily be slum or blighted areas. We believe that it would be essential not to restrict the application of section 207 to existing housing in such areas, but to permit the Commissioner to apply the section to particular structures without requiring that the structures be located in a slum or blighted area. This could be accomplished by deleting lines 18 and 19 on page 10 of the bill.

The availability of sections 207 and 220 for existing housing on the same basis as new construction will help increase the availability of considerable adequate rental housing for families of low and moderate income. For obvious reasons satisfaction of total housing demands cannot be met entirely by new construction. Adoption of this provision will underscore FHA's service to the whole mortgage market, not just a part of it. Repair and rehabilitation of existing housing will likewise be stimulated by this recommended approach to the insurance of loans on existing dwellings, and thus prevent creation of slums at their source.

While the title I, section 8, loan insurance authority is to be terminated because of the liberalized section 203 program there is nothing in the latter section which insures that the section 8 authority will be duplicated therein. Perhaps the committee might wish to clarify the intent of the Congress in this respect so that FHA will make certain exceptions from its minimum construction requirements for housing normally financed under this section and, if necessary, authorize a service charge to compensate for additional costs of making and servicing small loans. There is ample authority for this, and both of these factors are now part of the title I, section 8, loan authority.

We also recommend that the mortgage limits for this type of housing should be \$7,600, the same limit which we are recommending for section 221.

In order to maintain stability in the home building market we urge an amendment whereby outstanding FHA commitments on the day of enactment of this bill would be able to take advantage of the changes in the maximum limits, permissible terms, and ratios of loan to value provided in this legislation.

This I cannot emphasize too greatly because right now there are a great many projects being held up, applications being held up, awaiting the outcome of this bill. And certainly we urge this amendment.

Before leaving sections 203 and 207, it is noted that the proposed maximum mortgage limits and ratios of loan to value will go into effect not upon enactment of this bill but upon the exercise of discretionary authority by the President. Such authority, even when exercised, may not result in the increase in these mortgage amounts to their maximum limits. In the interest of long-range stability for the home

building and marketing industry our association believes that the objectives of the bill would be better served by making the date of enactment the effective date of these new limits. More will be said on this point in our review of title II.

With respect to cooperative projects under section 213, we suggest that the FHA could materially assist this program by permitting developers to start construction pursuant to firm commitments under section 207 and later change the commitments to section 213. We believe this is desirable because probably the greatest obstacle to getting started on a 213 project is the impracticability of bringing 90 percent of the members of the proposed cooperative into agreement while the project is in the planning stage. We feel this could be accomplished administratively, and respectfully suggest that an expression on this point might well be inserted in the committee report.

I might say we know that the requirements of section 207 are stricter than those of 213. Permitting construction under 207 first, and later changing to 213 as the project is completed, would in no way harm the loan, because the building would be of a better type than if originally constructed under 213 requirements. There is a great deal of difficulty in getting the number of prospective purchasers to sign up in the planning stage before they can see the actual building. This led to quite a few abuses that are well known in the industry.

We recommend that mortgage commitments under section 213 continue to be based upon percentage "of the amount which the Commissioner estimates will be the replacement cost of the property or project when the proposed improvements are completed." In the proposed amendments the criterion would be changed to "estimated value" which, because of the establishment of FHA valuation regulations, would lead to confusion and possible impediment of cooperative housing projects.

That is quite evident because we know in a cooperative project, income cannot be capitalized. Therefore the valuation should be the replacement cost of the project.

The proposed section 220 is essential to the success of the urban renewal provisions of the bill. We cannot overemphasize the importance of its enactment to the fulfillment of the broad objectives of this bill. Mr. Fritz Burns, chairman of our Build America Better Council, will discuss section 220 further in his testimony on the urban renewal provisions of the bill.

We are pleased to add our endorsement to section 221 which provides for 100 percent mortgage insurance with 40-year maturities for housing persons "displaced by governmental action" such as slum demolition, urban renewal, condemnation for reasons of health, and so forth. However, we believe that the \$7,000 mortgage limit may very likely preclude the use of this section in many of the urban areas where the need is greatest. We recommend, therefore, that the limits be increased to \$7,600 with authority for the FHA commissioner to increase the limit by an additional \$1,000 in high-cost areas. We respectfully invite the committee's attention to the recommendations of the President's Advisory Committee, which sets forth these suggested limits.

We see in section 221 for the first time a recognition by Government of this device for meeting the housing needs of very low-income people by helping them to become homeowners. We believe it is better to

assist these families to own their homes than to try to make them tenants of subsidized Government-owned housing.

Homes acquired under this section may carry a mortgage with a maturity period as long as 40 years. These homes will also be paying full local taxes for that 40 years, unlike public housing for which the Federal Government is pledged to pay subsidies for 40 years, and which housing during that period does not pay local taxes.

I might just deviate for a moment, Mr. Chairman, to say that much has been said in the press and in discussions of this section of the bill, that it could not apply to the metropolitan areas of our country.

I would like to say that, speaking with knowledge of New York City particularly, that this could apply in New York City. True, it would not apply in the East Sixties and East Eighties. It is not meant to apply there. But certainly it could apply to the northeast sections of the Bronx, Staten Island, and certain sections of Queens.

Only a few weeks ago the housing authority proposed a project known as the Kingsland Houses, in that section of the northeast Bronx in the two-fare zone along the old Boston & Westchester Railroad cut, where the land is 16 to 40 cents a square foot assessed valuation. It had passed the city planning commission, but was then going to go before the Board of Estimate. Because the owners in that area banded together, 700 or 800 in number, in a small area, the housing authority withdrew the proposal.

Only last week the Castle Hill Houses, a section on that was formerly temporarily improved with quonset huts for veterans, where the average value of the land was about 40 cents per square foot—and I know that because I made the original appraisal for the housing authority for that particular plat—they proposed a public-housing project. The owners in the entire area objected to it. After testimony of 4 hours, with only 4 people for it, in 4 minutes the Planning Commission approved it. It is now before the Board of Estimate and was to be acted upon the following day but because of the objections the Board of Estimate adjourned it for 2 weeks.

These are two areas where section 221 definitely could apply because the land is anywhere from 16 cents to 50 cents per square foot assessed value. The environment is that of 1- and 2-family houses, no apartment houses in the area, and I say these would be ideal locations for the operation of section 221. I am speaking specifically of the Bronx, but the same would apply to certain sections of Queens and Staten Island.

So I believe that this section could be operative. It is not just theory. We definitely believe that it has a place and could also operate in urban communities.

Public housing we know goes up in the air 12 or 15 stories. Under section 221 we would be giving these people an opportunity to do things that they haven't been able to do in public housing. In public housing everything is done for the tenants. The children who have some mechanical aptitudes, or like to go out and plant some grass, or have a pet in the backyard, or cut the grass, can't do that because everything is done for them. Most of the people living there are mechanically inclined, and yet they have no opportunity of using their skills in public housing. In a section 221 home they could improve their own property. Maintenance could be practically nil because they

could maintain it themselves. They would be building up for themselves not only a small equity, financial equity, but greater than that they would be building up a moral equity.

You hear a great deal about juvenile delinquency. I want to say from firsthand knowledge that we know the New York City Housing Authority has requested, and has had to request, additional policing for the projects which were said to eliminate slums and improve conditions so as to stamp out juvenile delinquency.

My brother, up until the time he went on the bench, the first of the year, was in the district attorney's office. I therefore, have some little firsthand knowledge of what is happening in the public housing projects, and I am specifically familiar with those in the Bronx.

At the same time we mustn't lose sight of the fact that under this section we would be obtaining full normal taxes, and it would go a long way toward preventing municipal insolvency which under the trend of public housing will certainly lead to that.

Mr. SUMMER. In addition to that we feel that under section 221 there should be a provision which makes the mortgage payable in case of resale. The entire purpose of 221 is to take care of those requiring relocation. It is not meant as a stimulus to the home-building industry at all, but, rather, to provide a full local taxpaying facility for those who are being relocated, and who cannot pay an economic rent or buy a home under the normal methods of financing.

It is designed also to provide housing for minority groups who do not often have an opportunity to go out in the suburbs or rent wherever they would like to rent.

The moral equity that Mr. Waltemade mentioned, I think is a very important thing. When a man plants a tree and a woman plants some shrubs, they won't easily give that up. They won't walk away from something they have created themselves.

Similarly, a man who builds his own workbench and an outdoor fireplace with his own hands, won't walk away from it. But the important point is this, gentlemen: Under public housing those who are being helped, have everything supplied—the decorating done for them, the grass cut for them, and there is absolutely nothing they can do to help themselves. It is all done for them.

And if the man happens to have children who have mechanical aptitudes, those kids just can't do anything. They can't even go out and cut the grass. Home ownership provides an incentive for human relations that is so important, and not merely a cold, mechanical method of helping people help themselves. Let us never forget there are many people in minority groups who are not in need of assistance as such, but in need of opportunity, many of them economically being able to pay the freight, but do not have the opportunity.

That is why we recommend, in the case of a resale, to prevent abuses, and rackets, in this thing, that the mortgage become payable, and that any purchaser thereafter must arrange his own financing through established methods, whether it be title II, conventional mortgages or otherwise.

If that were not done this would be used as a subterfuge to use those people who need help merely as a tool. I don't want to take up any more time because Mr. Waltemade will testify further.

Mr. WALTERMADE. I might say there is also an objection raised to section 221 asserting that it is not going to take care of the very low income group. I want to say that public housing, of course, was never intended for that purpose, because those making such a low income that they are practically on relief are, I know in New York City, not admitted to public housing.

I don't think it was ever the intent of Congress that it be so. I just want to refer to a statement in the Congressional Record of April 19, 1949, made by Senator Sparkman, who said:

This does not, however, mean that public housing should be used as a program of monetary relief for families who have no income or incomes that are far below the level of bare subsistence. There is a function of welfare and relief agencies to provide such families with the bare minimum of subsistence.

So I think public housing, or any other type of housing, was never meant to take the place of welfare, because we are always going to have those in the country who require, temporarily if not permanently, welfare assistance.

In section 220, at the bottom of page 18 of the bill, up to the top of page 20, we see a possible loophole, whereby the public housing authorities might borrow up to \$50 million for a housing project, which would be then tax free and operated as a housing authority development. Under section 221 it applies up to about \$5 million, and that portion of the bill is on page 27.

I think those sections should be deleted or revised so as to prevent such abuse of these two sections.

Our association is pleased to note that provision for the open-end mortgage is contained in the bill. With sympathetic administration of this section we are confident that considerable dividends will be apparent in future years in rehabilitation, modernization, and expansion of existing housing. However, in reading this section we note that there is no limit to the amount of the advance, unless it is to be fixed by regulation.

We recommend, therefore, that the proposed section 224 be amended so as to limit the advance or advances to an amount which, when added to the unpaid principal balance due on the mortgage at the time of application, would not exceed the original principal obligation of the mortgage.

Before leaving the FHA part of this bill, our association respectfully invites the committee's attention to recommendations No. 11 and No. 12 of the President's Advisory Committee on Housing. They are:

11. An objective and independent long-range study of prospective foreclosure and loss experience of the Federal Housing Administration's insurance programs should be made.

12. An objective and independent long-range study of probable losses on Veterans' Administration guaranteed loans should be made.

We urge that such long-range studies be undertaken and that appropriate authority and direction for these be contained in the bill.

Title II of the bill might best be divided into two parts for the purpose of this presentation. First, the title would place in the President authority to adjust the interest rates on FHA-insured and VA-guaranteed mortgages. The maximum rates would be established from time to time to reflect market conditions, thereby assuring a

better flow of mortgage money throughout the country. The interest rates would be established by the President at different levels for different classes of mortgages, and such levels could not exceed the average market yields on Federal marketable bonds having a remaining maturity of 15 years or longer by more than 2½ percent. The market yield for such Government obligations at present is running in the area of 2½ percent.

We applaud the objectives sought in this part of title II, but respectfully recommend that the committee substitute the recommendations of the President's Advisory Committee on Housing, which called for the creation of a committee empowered and directed to review constantly the demand and supply of funds for home mortgages in all parts of the country and, from time to time, to confirm or revise by majority vote the maximum interest rates on FHA and VA mortgage loans not to exceed the formula set forth in this bill.

This committee would consist of (1) the Administrator of the Housing and Home Finance Agency, who shall be the chairman, (2) the Chairman of the Home Loan Bank Board, (3) the Commissioner of the Federal Housing Administration, (4) the Assistant Deputy Administrator for Loan Guaranty of the Veterans' Administration, (5) the Chairman of the Board of Governors of the Federal Reserve System, and (6) the Secretary of the Treasury.

We sincerely believe this to be a far more effective method for accomplishing the necessary flexibility. At the same time it would avoid the directing of pressure toward the President or any single Government official to whom might be delegated the task of reaching a decision.

We believe that approval of this amendment will give the FHA and VA systems the desired flexibility to insure the maximum effectiveness of these two housing programs. Another advantage flowing from the proposed flexibility would be to minimize unfortunate discount practices with their resultant hidden costs to veterans and other home purchasers. It is important also to bear in mind that such a committee would be an instrument through which interest rates could be lowered as well as raised, depending on market conditions.

This proposed committee should also be given the authority to revise the charges that may be made for the expense of originating FHA and VA mortgages, and the rate of interest on debentures issued by FHA in settlement of foreclosure claims.

There is probably no other phase of our national housing programs which has been the subject of so much misunderstanding as the interest rate problem relating to FHA and VA loans, particularly the latter. Interest rate levels are determined not by individual lenders or groups of lenders, but by the competitive nature of our economy which finds home purchases, business, and Government competing in the money market. Competition creates fluctuations in the supply of money at any given time, and in the final analysis it is the price which determines its availability for any given purpose. We sincerely believe that the flexible formula recommended here will prove of immeasurable benefit in attracting investment funds into the FHA and VA market. We commend it to your favorable consideration.

The second part of this title would give the President authority to adjust maximum mortgage maturities, mortgage limits, and ratios of

loan to value on FHA as well as VA loans, notwithstanding any statutory limits provided in the National Housing Act and the Servicemen's Readjustment Act. There is an attempt here to apply the pattern of flexibility to whatever it might attach—interest rates, downpayments, maturities—as though flexibility for one must necessarily follow flexibility for another. However, there is an essential difference between flexibility for interest rates, on the one hand, and flexibility for downpayments, on the other. It is a general principle that interest rates on Government-insured loans should not predetermine the market but should follow it. For example, interest rates should be at the lowest possible level which would still result in the flow of sufficient money. However, downpayments and maturities, on the other hand, should predetermine the market. In the interest of long-range stability for the housing market, we strongly urge the committee to eliminate this standby authority as contained in paragraph (5) of section 201.

In opposing this part of title II of the bill we want to emphasize again the importance of permitting increases in FHA mortgage limits and ratios of loan to value, provided for in this bill, to take effect upon enactment. In the interests of stabilizing the homebuilding and lending segments of our economy it is essential that definite positive action be taken rather than more standby authority created. Standby authority may very likely bring about harmful uncertainty in the market as builders and lenders sit back and wait for a more favorable atmosphere, and, similarly, would-be home purchasers would very likely follow the same approach.

Mr. Summer will carry on from here, Mr. Chairman.

MR. PATMAN. Could we ask questions of this gentleman, Mr. Chairman? I just wanted to ask him about 1 or 2 points that he brought up.

THE CHAIRMAN. I wish to meet the committee's wishes in the matter. These gentlemen are all representing the National Association of Real Estate Boards, and they are dividing up the subjects for their own convenience. I had hoped that we could conclude the statement before we started to ask questions. The three of them will be present to answer questions.

Is that agreeable with you, Mr. Patman? If it is agreeable with you Mr. Summer will proceed.

MR. PATMAN. I would rather ask questions as they get through on each subject, Mr. Chairman. However, if the chairman wants to do it that way, it is all right with me.

THE CHAIRMAN. You can put a check mark opposite the subject matter and come back to the question later.

MR. PATMAN. I don't want to disrupt the chairman. I know he has a difficult job in getting the hearings completed, and I want to cooperate with him.

THE CHAIRMAN. I thought it might make for more orderly and expeditious procedure to proceed in that way, Mr. Patman.

MR. SUMMER. Mr. Chairman, my name is Alexander Summer. I am past president of the National Association of Real Estate Boards, and a member of the President's Committee on Housing. I am a head of the Alexander Summer Mortgage Co., and the head of a real-estate brokerage business in New Jersey.

Before I get into the specific statement I wish to point out that which we all know, and that is to emphasize that the main purpose of this entire bill is to provide adequate housing for all Americans, and an essential of that is an adequate flow of mortgage funds.

Of equal importance is a desire to maintain a healthy economy; a healthy building economy is essential to the economy of the entire Nation. In order to maintain that building economy it is necessary to have an adequate supply of mortgage funds.

Now, the ascending spiral of municipal insolvency partially can be checked, at least, by the removal of slums, and this cannot be accomplished, and it has been proven in the past that it has never been accomplished, without adequate mortgage financing and risk capital. The heart of the entire slum-clearance program is adequate risk capital and adequate mortgage financing.

What is adequate mortgage financing? It isn't enough to implement FHA with more realistic sections and amendments. When we get through with a fine bill it is still theoretical and still on paper unless money flows, and the answer, and the only answer, to make this program a success is to give risk capital confidence, and to make available a realistic and a steady and reliable source of mortgage financing.

In the past this has been a series of up-and-down movements, partially brought about by market conditions and often brought about by legislation.

Now, what will make mortgage money flow on a sound basis? Gentlemen, I think it might artificially create a depression in this country immediately, if the bill embodies standby authorities.

We have found, from a bitter experience, that where legislation creates standby authorities, which offer a more realistic treatment, both capital and mortgage lending will hold back, and wait and see what will be adopted. We have seen evidence of it already, and I think the standby provisions of this bill are the surest way to start a downward spiral in our economy. I think this committee, in its recommendations to the Congress, should decide what it wants to recommend and make that the law. Otherwise, I think we are contributing, artificially, to a situation that need not be, and should not be, in face of the established need for housing, of such a big segment of the American people, who are not now adequately housed.

I agree that you cannot establish interest rates in advance, there must be statutory provision—but I think that an established Board, created by Congress, should be ready to function, and the reason the Secretary of the Treasury and the Federal Reserve Board should be on there is because we had situations, 5 years ago, where lenders were paying builders 5 points premium for borrowing money. If you borrow a hundred thousand dollars from me, I would give you \$5,000. That should have been reflected in a lower interest rate to benefit the owners and the tenants of property.

Similarly, last year, when you couldn't get mortgage money in many cases, interest rates should have found an upward level to make mortgage money flow.

Now, there is just so much money in our economy. We need some for financing our United States Government, we need some for industry and commerce, and we need some for mortgage loans. By having a board represented by the Treasury of the United States and the

Federal Reserve and these other groups, FHA, HHFA, then you have a group of men who can sit around a table and not permit mortgage money to run away with an unfair portion of our money in our economy nor permit it to be the stepchild, as it was last year.

We also know, if such a board were created and met at fixed intervals such as June 1 and December 1, every lender in the country would stop lending in April to see what that board would do about interest rates in June. Instead of that we, on the President's Committee, have recommended that this board meet at the call of the chairman and, without advance notice, adjust interest rates according to the needs of that time not only for mortgage lending but as to its place in the entire financial needs of the Nation.

Therefore, I think that is the only practical vehicle to continue to provide a steady flow of mortgage money and to give the benefits of lower interest rates to the owner and to the tenant and not to the builder.

That is No. 1. That is one thing necessary to make mortgage money flow, removal of standby authorities.

No. 2 is realistic interest rates not only on mortgages but on debentures and the term of debentures. And this six-man committee should have that function, again to see that it plays a proper role in the money economy of this Nation.

And it is just as important that a really workable and practical secondary mortgage facility be created, and I will touch on that in a moment.

Some other things that are necessary to make mortgage money flow—some are included in the bill and some are not. Another is to provide for loans in small and isolated communities. We have small communities in States throughout this Nation that, because of their isolation or because of their small size, the big lenders cannot afford to make loans to them because they cannot afford to service those loans. So we have recommended three things to make mortgage money flow in those small communities. One is to give the FHA Commissioner authority to provide for an extra service charge annually, if necessary, but not to exceed a fixed amount to make mortgage money flow there.

No. 2, to permit, in the initial commitments of FHA, participation so that these small institutions who have only so much money can get participations from the big banking institutions of the major cities.

And, thirdly, the need for technical assistance. I admit this is administrative, but I think this committee should recognize the need for technical assistance by FHA and VA to the lenders in these small communities.

It is so complicated and so involved that for the few loans involved there hasn't been justification for having experts on hand to study all the many requirements.

I think your recommendation of two-thirds of the closing costs is a commendable one. I think also the simplification and streamlining of FHA processes is necessary, and the establishment of sound actuarial methods in establishing FHA reserves; and the recommended study has that in mind.

Now, insofar as the secondary mortgage facility is concerned, I have already touched on the fact that mortgage lending in this country has seen cycles, scarcity of money, artificial Government regula-

tions, the economy not permitting sufficient mortgage money to flow. We feel that any consideration of the long-range needs of the housing industry must recognize fluctuations in the mortgage market and the maldistribution of mortgage money because many eligible purchasers could not finance during the last few years.

We are all familiar with the peaks and valleys; and, therefore, we think the answer is, one, a practical adjustment of interest rates and, secondly, a true secondary mortgage facility to be operated without unnecessary restrictions and in such a manner that the initial Government capital will be progressively replaced by private capital.

The first recent legislation introduced on this subject was H. R. 6614, by Mr. Stringfellow, a member of this committee. Our association endorsed the principles of that bill and still believes that the secondary market as set forth in that bill presents the framework for an ideal secondary market because of its planned decentralization operations and because it contemplates activity with respect to all types of real-estate mortgages.

However, we recognize that the creation of a secondary mortgage market facility which will truly function as such must be almost an evolutionary process. Confidence in the capital structure, obligations, appraisal standards, and so forth of, and the machinery for, such a facility cannot be created overnight.

We are most anxious that a workable facility be created and begin functioning as soon as possible in order to avoid any further disruption to the mortgage economy. That is why we have adjusted our sights to the framework presented in title III of this bill, trusting that experience with the FHA and VA mortgage markets will in time, under the study and observation of both Government and private interests, reach out to encompass also conventional mortgage loans. But that is something for future consideration.

In our study of the proposed title III we have noted several features which we consider to be inherent weaknesses. Some of them would tend to restrict FNMA's operations unduly. Although the bill underscores private ownership as an ultimate objective, the formula to bring this about is nebulous and speculative. We are, therefore, suggesting several amendments for the consideration of this committee. I will discuss them in the order in which they appear in the bill.

A. Limitation on mortgage amount: Section 302 (b) provides that there shall be a \$12,500 limit per living unit on the principal obligation of any mortgage offered for sale to the Association. We would offer no objection to the imposition of such a restriction in section 305 of the bill, relating to the special-assistance functions of the Association, which has as its primary objective assistance to lower-cost housing. However, we believe that the provision is entirely too restrictive.

There has been some talk that the recommendation to increase maximum loans to \$20,000 is approaching the field of luxury housing. When FHA was established in 1934, the maximum was \$16,000. Twenty thousand dollars today, on a 50-cent dollar, is equivalent to \$10,000 in 1934, and we submit that a \$20,000 mortgage today is more conservative, is 63 percent of what a \$16,000 mortgage was in 1934. And it would certainly make a better portfolio to have not only the

low cost and low rent mortgages go into this secondary facility but also the other type of loans.

The secondary market operations should not be conducted solely to benefit the financing of lower-cost housing, particularly when the limit is below that contemplated as the maximum for FHA under other provisions of this bill. The funds used for the purchase of mortgages will have been borrowed from private sources, and the operations will be conducted according to business standards. We recommend that the maximum permitted limits be the same as those ordinarily applicable to FHA.

B. Capitalization: Section 303 of the bill provides that the Secretary of the Treasury would initially hold all the stock of the rechartered Association—approximately \$70 million—representing the present capital and surplus. The users of the facility would be required to pay 3 percent of the unpaid principal amount of the mortgages offered for sale to the facility as nonrefundable capital contributions. Subsequently, according to the bill, these capital contributions, represented by convertible certificates, would be converted into capital stock of the Association, but not until all of the capital stock held by the Treasury had been retired. In view of the fact that the Association will not necessarily operate a par market, as it has in the past, we believe that the 3-percent nonrefundable capital contributions coupled with the market discount on mortgages—particularly those covering properties located in the outlying areas which may be as much as 2 or 3 or more points below par, plus a FNMA service charge—would almost certainly deter mortgage lending where it is most needed. We think the requirement should be 2 percent.

We strongly urge that the bill be amended to provide for two different types of stock. The Treasury should receive preferred stock on which it would be entitled to cumulative dividends as the bill presently provides. The users of the facility should receive common stock on which they would receive dividends when earnings permitted, and even after the Government-held stock has been fully retired the dividends on such common stock may not exceed in the aggregate 5 percent of the par value of such outstanding common stock. These latter limitations are already in the bill. Both types of stock would be non-voting for reasons which I will subsequently set forth.

The bill provides for the ultimate substitution of private financing for Government financing, and we sincerely believe that this ultimate objective would be better served by providing for the immediate issuance of stock to the users of the facility instead of convertible certificates.

It has been estimated that it will take 8 to 10 or more years to retire all of the Treasury-owned stock. Inasmuch as the capital of the Association would be made up of funds from both the Treasury and private sources, the Association would be a mixed-ownership Government corporation. It would be appropriate that not only the Government but also private stockholders participate in its ownership. The capital structure itself could not be impaired by the mixed-ownership status, because the bill contains a provision that the stock, other than stock held by the Treasury, may not be retired if, as a consequence, the amount remaining outstanding would be less than \$100 million.

Section 303 (b) would give the Association authority to impose charges or fees for its services with the objective that all costs and expenses of its operations should be within its income derived from such operations. That language could reasonably give rise to the inference that the fees and charges were to be sufficient to cover all the expenses of operation. As the facility will have other sources of income, we believe some restriction should be placed on the amount of fees or charges that may be imposed in order to lessen the impact of the 2-percent capital contribution and the discount which very likely will prevail in the areas which need the services of the Association.

We recommend, therefore, that the charges or fees be limited to one-half of 1 percent.

This means that a mortgagee selling his portfolio to this Association would be compelled to buy 2 percent of stock and pay a fee of one-half of 1 percent, which totals $2\frac{1}{2}$ percent, and, in addition, would be faced with whatever discounts may be affecting that type of mortgage at that time.

Section 303 (g) provides that after all of the capital stock of the Association held by the Treasury has been retired, the Housing and Home Finance Administrator would suggest enabling legislation providing for transfer to the owners of the then outstanding capital stock the assets and liabilities of the Association along with its control and management, in order thereby to make the facility a privately owned, operated, and directed institution.

We believe that the bill should be amended in order that the transfer to private ownership would be self-executing and gradual, although the corporation should retain a measure of Government supervision even after the facility is privately owned. When the Treasury stock has been retired, all of the remaining capital will represent the paid-in subscriptions of private sources. Thus there would already have occurred, in fact, the complete substitution of private capital funds for Government capital funds. Certainly, there is no fundamental reason why it should be necessary to delay for many years the details of legislation that are of immediate concern to the mortgagees who, after the creation of this facility, would be expected to make capital contributions to support the facility's operations. Self-executing provisions in the bill for such future changes as are appropriate will constitute an additional incentive for immediate private participation and will bring closer to reality the ultimate objective of a privately financed secondary mortgage market facility.

We believe that Government supervision, as distinguished from direction and control, over the facility should be continued. Government supervision—perhaps by the Housing and Home Finance Administrator—along the lines of that exercised by the Federal Reserve System and Farm Credit Administration, would underscore the public character of its operations. We recommend, therefore, that subsection (g) of section 303 be deleted from the bill.

As to the market price of mortgages purchased, section 304 (a) provides that the Association would purchase mortgages "at or below the market price for the particular class of mortgages involved, as determined by the Association." In this connection I would like to quote the following from the minority report of the subcommittee on housing credit facilities of the President's Advisory Committee on Housing:

In my opinion the objectives of such a facility should be not merely the accumulation of maximum profit. It is equally important that it accomplish its only reason for being—the provision of an adequate and stabilized market so that homes may be provided in the volume, in areas, and of the kinds, and at the prices that the market demands. The facility should be so organized and its board of directors instructed by the Congress to operate in such fashion as to avoid becoming a primary mortgage buyer. To accomplish this the Board would necessarily have to conduct the operation of the facility in the light of the market for its debentures and of the current or reasonably foreseeable market (after a period of seasoning) for the loans which it buys.

And when we say homes, we include rental facilities. We do not believe that idea is reflected in the bill.

We believe the bill does not reflect any consideration of the reasonably foreseeable market and the period during which the mortgage will be seasoned while it is held in the facility's portfolio. Obviously, there are times when this consideration may be a proper one in a secondary mortgage market operation. For example, the market price of a GI mortgage covering New Mexico property might be five points below par. The existence of such substantial discount might reflect overproduction and justifiably result in temporary termination of mortgage lending.

If that is the reason the Association should not buy that mortgage.

On the other hand, should the officers of the Association conclude that the large discount results from lack of availability of adequate mortgage funds, it could more realistically fulfill the functions of a secondary market if it were not limited to purchasing mortgages at or below the market price. The facility, therefore, should it conclude that a mortgage covering New Mexico property for which the market price was 95 might be sold to an institutional investor—after a brief period of seasoning—at 97, 98, or perhaps par, should be permitted to consider this factor in determining the price at which it will purchase mortgages.

It is true that it may not increase. But that after all is the function of a secondary mortgage facility.

We also believe it would be unfortunate to retain any provision in the bill indicating that FNMA might buy below the market price. The indication that FNMA might buy below the market could conceivably have the effect of depressing the market. We recommend, therefore, that section 304 (a) be amended so as to permit the Association to purchase mortgages at or near the market price but not above par.

This would still not prohibit the Association from buying under the market price, but it certainly would not have the psychological effect of broadcasting to the entire economy that it is prepared to buy below the market price. At or near the market price, but not above par, would accomplish everything it is intended to accomplish, without the psychological distraction.

As to limit of debentures. Section 304 (b) provides that the facility may issue its debentures at such rates and on such terms as may be determined by the Association with the approval of the Treasury, in an amount outstanding at any one time not in excess of 10 times the sum of its capital, capital surplus, general surplus, reserves, and undistributed earnings. This is a specific limitation, although the bill then goes on to impose, quite properly, a second specific limitation that the outstanding obligations may not exceed at any one time the

aggregate of the unpaid balance due to the mortgages held in its secondary market portfolio plus cash and Government bonds. We feel that the debentures of this Association will be readily marketable, and that the 10 to 1 limitation might very well unduly and unnecessarily restrict the operations of the facility at a time when and in a field where it would be most needed.

Gentlemen, we must realize, and I quote from General Nelson, in charge of the redevelopment program of the New York Life Insurance Co., Mr. Nelson said that all the life insurance companies combined in this country do not have enough money to finance the rehabilitation and rebuilding of the slums of America, and up to this point we are talking about the same sources of mortgage money that we have always talked about, namely, the mortgage companies, the banks, the savings and loans, and the life-insurance companies, primarily, and probably some trusts.

But the idea of offering debentures to the public is to obtain, if possible, a new source of mortgage money.

If the removal of the slums, and the study of that will indicate the vast job that is necessary, a job that Government at both Federal and local level could never afford to do, if it indicates the need for private capital and lending, and if we are to make any inroads into the clearing of our slums, we need lots of mortgage money and, therefore, we recommend that the debentures be sold on the basis of at least 15 to 1, rather than 10 to 1. We need new money. If this program is not to be enacted, all right. But if it is, we need new money.

We recommend, therefore, that the limitations applicable to the secondary market operations of the Association for the issuance of its debentures be at least on a 15 to 1 basis.

As to the board of directors. Regarding the composition of the board of directors, we propose an amendment which like several others already referred to would tend to bring closer to reality the objective of ultimate substitution of private capital for Government capital. True, we propose making the Association a mixed-ownership Government corporation, but it must be borne in mind that private financial participation will commence on the day the Association begins business. There is every likelihood that, in a year or two, an appreciable portion of the capital stock of the Association will be owned by private individuals and corporations making use of the facility.

We believe, therefore, that the Board of Directors should consist of 7 persons to be appointed by the President without restriction initially as to their Government or non-Government status. When half of the Government-held stock has been retired, approximately \$35 million, at least 3 of such members would be replaced by appointment from among stockholders from the mortgage lending, residential real estate, or home-building industry. When all of the Government-held stock has been retired, then we propose that all of the Directors be appointed by the President from among the stockholders and be broadly representative of the mortgage lending, real estate, and home building industries.

In this connection we recommend that not more than one Director be appointed from a particular industry. However, with respect to the mortgage-lending industry, its various segments such as savings

and loan associations, commercial banks, life-insurance companies, and so forth, should each be considered a separate industry for this purpose.

Gentlemen, I cannot overemphasize the importance of this. Because it is entirely possible that a certain segment of the lending industry would have the capital to buy such a huge segment of stock that it would dominate the facility and have a selfish reason for limiting its activities, so that it would not represent or accomplish the purpose for which it is truly intended.

And I think it is of the utmost importance that this particular paragraph receive your serious consideration.

As to the Advisory Council, we also propose that a subsection (b) be added to section 308, to create an Advisory Council of the Federal National Mortgage Association consisting of 15 members, 3 of whom shall be the president of FNMA as Chairman, the Secretary of the Treasury, or his designee, the Chairman of the Board of Governors of the Federal Reserve System, or his designee. Twelve members shall be appointed by the Administrator for 3-year staggered terms, such appointments being made from among persons who are experienced in and broadly representative of residential mortgage lending, real estate, and home building. We believe such an Advisory Council would prove invaluable, since the members of the Council would bring to the Association the views not only of their individual segments of this great industry, but also those of the Nation geographically. We commend the creation of such a Council to your sympathetic consideration.

I sincerely believe, having sat around the table with labor union leaders, with life-insurance people, with bankers, with veterans' representatives, that I have a better understanding of their viewpoints, and they may have a better understanding of ours. And sitting 9 weeks on the President's Advisory Committee has been a great education, in understanding it, and I believe such an Advisory Council, while it has no official authority to act, would prove invaluable in making this function work in a practical manner.

Taxable status of the Association: We strongly urge that section 309 (c) be amended to avoid double taxation on the earnings of this secondary mortgage market facility. For one thing, the earnings of FNMA will for some years be needed to build up substantial reserves against any losses which might result from depressed market conditions.

Up to now we have had only a rising market, since FHA was created. The importance of creating a really substantial reserve cannot be overemphasized when one considers that the secondary market operations of FNMA may very likely be called upon to provide the necessary mortgage liquidity for section 220 and section 221 loans when their marketability is once established. Also, this double taxation would defer for years the substitution of private capital for Treasury financing. All dividends, interest received on obligations of the Association, salaries and per diems, would be taxable to the recipients thereof, and all real estate acquired as a result of its secondary market operations should be subject to local taxation.

We feel that every dollar that comes out of this facility into corporate or private hands should be taxable, but I cannot sufficiently em-

phasize the need of building up tremendous reserves for the entire program. And I think a hundred million dollars, as time goes on, will not be adequate, and I recommend, certainly, a study of this whole picture, and double taxation would definitely deter that.

It is more than double taxation. If, for instance, a mortgage company, which is a corporation, buys stock in the facility in order to sell some of its portfolio, if there were double taxation they would pay on the Association profit and then, when it, as a corporation, receives a dividend, a portion must be paid in taxes for a number of years, and then when it is distributed to the stockholders of this mortgage-lending company they again would pay full taxes on the dividends.

We sincerely believe that the objectives of this bill, particularly the urban-renewal program, would be much better served by avoiding this double taxation and its resultant drain on the basic solidity of the Association. We feel that this approach is a sound and equitable one, and certainly consistent with the public-purpose role of the Association.

That is the key to it. This has a public purpose. Any individual corporation should pay taxes, but the Association should use all the reserves and capital it can in building up solidity and a sounder organization.

Status of FNMA as a Government corporation. We recommend that section 302 be amended by providing that the Association shall be deemed to be a mixed-ownership Government corporation within the meaning of that term as used in the Government Corporation Control Act until all Treasury financial participation has been replaced by private capital. As a mixed-ownership corporation during this period, the Federal National Mortgage Association, being organized for business-type operations, would be permitted to make such expenditures of its funds as are necessary to carry on such business-type operations without being subjected to the sort of expenditure restrictions imposed on ordinary Government agencies by appropriations acts, etc.

Special Assistance Functions: We have one comment to make with respect to the special assistance functions of the Association. We must recognize that both the section 220 and section 221 loans are the loans contemplated by this special assistance function, for it is quite possible that such loans may not, for a time at least, be readily marketable on the private investment market. We know that if the urban renewal program gets under way, as it surely will after enactment, well over a hundred cities, in our opinion, will endeavor to come within the scope of the bill's operations as soon as possible.

We believe that the \$200 million limit on outstanding obligations and the \$100 million limit on participations are so small as to prevent these sections from accomplishing the objectives contemplated by the act. It is the very heart of the slum-prevention program, and we recommend that the committee give serious consideration to very substantially increasing this authorization in order to provide FNMA with the most effective means of accomplishing the far-reaching objectives of the urban-renewal program.

Mr. Chairman, it is well nigh impossible to achieve full accord among all groups with respect to the organization and functions of a secondary mortgage market facility.

There are many groups that fear its competition. I believe it is so designed that it will not represent true competition, but merely be a

standby facility, which the economics of this country have proven is needed from time to time.

I am confident, however, that this committee, the Congress, and all segments of the real-estate industry, as well as Government-housing officials, are anxious to bring about the creation of a truly workable secondary mortgage market facility.

The differences are not fundamental, but reflect if anything the recognition by people in our industry of the need for a secondary market facility, and their concern lest the proposed facility prove to be unworkable. If that were to happen, the progress of the home-building industry would be retarded in its growth at a time when the continuance of such progress means so much to the economy of our country. We sincerely believe that the amendments which we are proposing will provide a workable secondary mortgage market facility and will give to our industry the stability, the confidence, and the means for continued accomplishment, thereby bringing closer to reality our common goal of decent, adequate housing for all Americans.

Mr. WALTERMADE. Mr. Chairman, Mr. Fritz Burns, of Los Angeles, president of our Build a Better America Council, will discuss the remainder of the bill.

Mr. BURNS. Mr. Chairman and gentlemen of the committee, my name is Fritz B. Burns, of Los Angeles. I am a builder, although in the last year or so I have regarded as an honor the opportunity to serve on the National Association of Real Estate Boards. In that capacity I have visited 2 or 3 dozen cities throughout the United States, have spoken at various meetings in at least half of the States of the Nation, and my personal purpose, I might say, was to find out whether people were really interested, at the grassroots, in doing something about eliminating the slums and the blighted areas, and I can say this: that I have found that there is a very definite ground swell, you might call it, throughout the Nation at the present time, aiming at really doing something about this matter of slums that we have talked so much about in past years.

The reasons why this becomes a very ripe idea at the present time are various. They range all the way from the concern which downtown businessmen have about the decentralization of the cities, to the concern that mayors and city councils have as to how they are going to preserve the tax structure of their cities, the concern that the people as a whole have today regarding the housing and welfare of their fellow man, so that I really feel that at this time the most important thing we need—we need the financing tools that Mr. Summer has so ably spoken about, but I believe that the important thing to the people about the housing legislation, are those portions of the act that will make it possible to rehabilitate and revitalize these old neighborhoods, and these slum neighborhoods about which there has been so much talk, and comparatively little action.

I find that people do want to protect their properties. Now, we as realtors have some very definite ideas about property ownership. We are jealous of property rights, but at the same time we believe that with the ownership of the property goes a responsibility. We believe that the man that owns the property is the man that is responsible for its condition. We believe that tenants must cooperate with the owners in maintaining properties to the best of their ability, and not taking that

wear-and-tear clause too literally, and the objectives which we have aimed at in our build-America-better program are stated here in the lower half of page 20. I am not going to stick exactly to this text, if it is all right with you, Mr. Chairman, because in the interests of saving time I think I can move along a little faster, but the six objectives which we have here—

Mr. SUMMER. Mr. Chairman, may I request that the testimony prepared by Mr. Burns be inserted in the record, his prepared statement.

Mr. WALTEMADE. He is a real free enterpriser and we can't regiment him into a prepared statement.

The CHAIRMAN. Without objection, it may be incorporated.

Mr. WALTEMADE. Thank you, Mr. Chairman.

(The statement of Mr. Burns is as follows:)

Mr. Chairman and members of the committee, I am Fritz B. Burns of Los Angeles. I am here as chairman of the Build America Better Council of the National Association of Real Estate Boards. This council is the unit within our association that works with our member real-estate boards throughout the country in civic programs to attack the problem of slum, blight, and unfit housing conditions through local government action.

My comments will be directed to those portions of the bill under consideration dealing with neighborhood conservation, rehabilitation, urban renewal, and slum clearance.

We feel that the extension of the FHA program of mortgage insurance into urban renewal areas as provided for in section 123 of the bill, and expansion of the FHA loan-insurance program for home modernization and repair under the terms of section 101, will provide a major stimulant to improvement in the condition of the Nation's existing housing inventory.

Our members who have been working with municipal officials in developing vigorous programs for enforcement of city ordinances and housing standards have found that when this work is done on a block-by-block and neighborhood basis, it invariably generates a great deal of voluntary improvement over and above that which is required by law—provided owners of property in the area can get financing for thoroughgoing improvement and modernization. The lack of available financing for these people is the particular difficulty in local rehabilitation programs that is reported most frequently to us.

With mortgage insurance made available for the older areas that are undergoing urban renewal treatment rehabilitation and modernization will accompany its use in the areas that need it most. The changes in terms of home repair loans that are eligible for FHA insurance will put rehabilitation and modernization within reach of more people who need, and will use, the financing so made available.

We believe that the proposed new section 220 of the National Housing Act should include language that will limit its application to urban renewal areas in cities in which firm enforcement of adequate city ordinances on housing standards will be in force—and not merely planned—at the time mortgages on property in such areas are insured by the Federal Housing Administration.

We have come to the point at which modernization and rehabilitation of family dwellings should account for a bigger volume of work than does our total new home production at its present high level. Full use of the FHA loan insurance program in connection with urban renewal programs, as proposed in the bill, will help realize this important goal. It will bring widespread improvement in housing standards through the incentive it will provide for self-help. It will be good for the cities through its power to accelerate the growing trend to overcome neglect of housing right where it occurs. It will be healthy for the Nation in the part it will play to sustain our high level of employment and general economic activity.

Our work in this general field has convinced us that the solution to the problem of deteriorated urban areas can be found in no single remedy, but requires a coordination of six specific kinds of action within a specifically defined neighborhood and on the basis of a specific neighborhood plan:

1. Rehabilitation of housing that is below local standards, at the expense of property owners, in voluntary repair and modernization and through firm enforcement of city ordinances specifying health, safety, and sanitary standards for housing.

2. Demolition of slum structures which are unfit for sound rehabilitation and which are a direct danger to the public health and safety, at the expense of the property owners, through enforcement of city codes.

3. Systematic public improvement to schools, streets, parks, sewers, street lighting, and to municipal refuse collection, traffic, and other facilities.

In other words, we believe that the municipality has a definite responsibility, and too often these second hand neighborhoods get second hand treatment.

4. Replanning, rezoning and replatting of cleared and long-vacant sites in connection with closing of some streets and widening of others for a better protected, healthier, more livable, more attractive, and more convenient neighborhood environment.

5. Acquisition by the municipality of structures and uses of land which obstruct and prevent carrying out a neighborhood conservation program for the sole purpose of removing such adverse structures or land uses. We do not believe this necessitates public acquisition of the land underlying such structures or use.

6. Attracting investment in new construction, as well as in rehabilitation and modernization, within the area.

Very much the same view is taken in title IV of the bill under consideration. The new term it introduces, "urban renewal," means substantially the process of applying these various activities in coordination. The bill revises and broadens the functions of title I of the Housing Act of 1949, in the light of practical experience, recognizing that typical problem areas in our cities do not have to become targets of peacetime blockbusters to be made into safe, healthy, pleasant, and attractive neighborhoods. Destruction of buildings and reuse of the land is proposed as one of the coordinated processes for selective use where it is genuinely needed, and not as an indiscriminate treatment for the whole neighborhood.

We believe that this broadening and redirecting of the title I program will bring vastly greater dividends in tangible improvement to city areas per dollar of Federal funds lent or granted to cities than would be possible with a continuation of title I of the Housing Act of 1949 as it now stands.

The President's Advisory Committee on Housing pointed out on page 111 of its report:

"If we continue only at the present rate of clearance and rely on demolition alone to eliminate slums, it will take us something over 200 years to do the job."

We need the kind of program that can get the job done in something more like 10 years than 200. The very vastness of the job indicates that however helpful Federal loans and grants to cities may be as an aid in planning, and to provide worthwhile demonstrations, they cannot be spread widely enough to become our needed solution to the typical usual slum and blight problem.

Our clear need is for a method of financing the city's urban renewal costs in planning, in public works, and in acquiring and removing adverse land uses, that does not depend on Federal grants.

We have suggested such a method. It proposes using the benefit assessment principle in urban renewal areas under specific State enabling legislation that will also include additional law-enforcement powers to put cities in position to do this job under their own power. While this approach to a solution of the city's financing problem would not require Federal grants or loans of money, it would require Federal cooperation to the extent of insuring benefit assessment bonds issued by the cities, on the basis of an insurance premium, in order to provide good marketability for the bonds at favorable interest rates.

We intend to present the suggested enabling legislation to the State legislatures when most of them meet in 1955. The proposal will necessarily undergo varied adaptation to existing constitutional and statutory requirements in the various States. At that time we believe we will be in a position to recommend specific measure looking to Federal insurance of neighborhood conservation benefit assessment bond issues, and trust that we may then have the opportunity of presenting them to the Congress.

Introduction of new construction in urban renewal areas on cleared or long-vacant sites brings vigor into the urban renewal process as nothing else can. Any impressive success in bringing new capital investment into these renewal areas that are dependent on it will, we are convinced, require revision of Federal revenue laws in two respects.

We are proposing that when an owner demolishes a structure in an urban renewal area, the residual appraised value of the structure be regarded as the

loss it actually is, and that the owner be permitted to deduct such residual value as a loss, in 1 year or over a period of up to 5 years, in calculating his Federal income tax.

With respect to new construction or capital improvement of existing structures in urban renewal areas, we are proposing amendments to Federal revenue laws that will permit such investments in such areas to be depreciated for income tax purposes at a rate of not to exceed 20 percent in any 1 year.

These measures, coupled with the proposed extension of the mortgage insurance program can, we believe, bring new investment and new construction into urban renewal areas on a scale that we cannot even hope for on the basis of federally aided write-down in land values over large urban areas.

It being clear that Federal loans and grants can deal effectively with only a fraction of the Nation's total slum and blight problem, it is our recommendation that in the administration of the improved and broadened program provided for in title IV of the bill, the emphasis be placed on aiding communities in planning urban renewal programs, in demonstration of the urban renewal concept, and in dealing with unusually difficult problems.

In its admirable policy of providing incentive for locally initiated effort, we believe that title IV can be improved with regard to its eligibility requirements for advances, capital grants, and the proposed section 220 FHA program. In making advances to cities for surveys and plans, section 101 of the Housing Act of 1949, as the pending bill would amend it, requires the Administrator simply to "give consideration" to correction action that the city is taking through its existing powers and resources.

After the city has made its plans and comes back for a capital grant, which may be a year or so following receipt of the advance for planning, the city can apparently be considered eligible for the grant by presenting to the Administrator a "workable program," including an "official plan of action," for using local resources to eliminate slums and blight and prevent their spread. The definition of "Urban renewal area" in section 411 of the bill contains nothing that would require active local housing law enforcement as a requisite for eligibility for the FHA section 220 program.

The language of the bill (p. 73, lines 4-18) seems to require not so much performance as the prospect of action.

In a recent address to the St. Louis Chamber of Commerce, HHFA Administrator Albert M. Cole, said that in his judgment a city cannot have a "workable plan" until it is "prepared to set forth on an aggressive program of code improvement—and enforcement—and to see that its housing is brought within at least minimum decent standards * * *"

We heartily concur in Mr. Cole's judgment and believe that such a local code enforcement program should be in active and vigorous operation—not merely planned—before a city can be considered eligible for an advance or a capital grant under title IV, or for the FHA section 220 program proposed in title I. While ordinance enforcement is no cure-all for the problems we are discussing, it is clearly recognized by the authors of the bill and by our industry as the most important single tool we have in eliminating blight and slum and preventing their spread.

Since there is no good reason why any city should delay enforcement of ordinances containing modern, adequate, and reasonable standards of health, safety, and sanitation for dwellings, we believe the language of the bill should not admit the possibility of Federal loans or grants to a city that has not actively begun firm enforcement of this important body of local law.

We feel that this is particularly important with regard to local ordinances governing density of occupancy. Illegal overcrowding not only exploits people, and in itself produces slum conditions, but through its bootleg profits builds up unlawful earnings that can tremendously increase the capitalized value of such structures for which the public may be expected to pay an outrageous and unwarranted price when they are acquired in eminent domain procedures.

In order to tighten the language of the bill to insure that local housing law enforcement is made a requisite for the Federal programs discussed here, we respectfully recommend that in the definition of "urban renewal area," the word "and" on line 12, page 80, be stricken, and that immediately following the words "under this title" on line 13, page 80, there be added—

"and (3) in which the local government is actively and regularly engaged in enforcing local ordinances containing adequate standards of health, safety, sanitation, and density of occupancy for dwellings."

To carry out this recommendation, it is further proposed that the phrase on lines 23 and 24, pages 71 and 72, "give consideration to the extent to which" be stricken, and that there be substituted therefor the phrase: "first find that" and that the phrase "official plan of action" on lines 5 and 6, page 73, be amended to read: "official plan of action in active operation."

In the interests of good planning of urban renewal programs with insurance that such plans are coordinated with planning for the community as a whole, we believe that the "workable plan" required for any aid to a city under title IV of the bill under consideration, or under the proposed section 220 of the National Housing Act, should require that there be a city plan and an urban renewal plan consistent with it.

This program, of course, we believe that the property owners should assume their share of the responsibility, we believe that it is extremely essential that local cities and communities enforce their laws, because one of the most essential things in a law-enforcement program, or rather in a rehabilitation program, is the knowledge—this is comparatively simple, but it is very important—is the knowledge of one man, who owns a house in a blighted area, that he can feel free to do a voluntary rehabilitation of his own property, knowing that his neighbors are going to be compelled to maintain some sort of minimum standards themselves.

There already have been some very definite responses and some very encouraging progress made in many cities throughout the Nation. Through this Build-America-Better program that I have mentioned, some sort of activity has already been generated in nearly 200 cities and towns throughout the Nation.

Now, in some of those cities, for instance, this report dated March 10, from Fort Worth, Tex., refers to the citizens committee appointed by the mayor to study housing rehabilitation. It states that the committee has completed its study. Attached to the letter is probably a 20-page report regarding this study and the recommendations which it is making to the mayor for the initiating of a law enforcement and rehabilitation program in Fort Worth.

In the city of Atlanta, there is a letter from the inspector of buildings dated February 19 in that city, during the year 1953, where they have such a program under way. It states there have been 4,248 dwelling units repaired, and 463 dwelling units demolished.

These programs have been accomplished against rather difficult odds, and without the assistance of the major part of any program, and the part that is directly of interest to this committee, namely, the part of financing. Therefore, we heartily recommend and support all of the phases of this housing bill, and most particularly, as far as my personal testimony is concerned, most particularly those portions of the bill that will add and facilitate and aid in the financing of rehabilitation of older buildings, in older neighborhoods, and the construction of new buildings in these older neighborhoods—either on the sites that are now vacant, or the sites that will be made vacant and by reason of some of the demolition work that will always occur in connection with a law-enforcement program.

We believe that new buildings, new dwelling units, and new apartments can be built in older neighborhoods. I think that in connection with urban redevelopment, so-called, in the past, and now to be known as urban renewal, there has been too great an emphasis on the necessity for creating an entire environment, by complete demolition, the complete leveling to the ground of an entire area of 40 acres or so, in order to create an environment.

We believe that the Federal funds for urban renewal should be concentrated on picking out what we refer to as the slum pockets in these neighborhoods, the particularly spoiled apples, out of the barrel, or maybe even picking out some of the spotted portions of these apples, so that the balance of the neighborhood, the balance of the barrel, can be rehabilitated by the voluntary, or by the enforced regulations as called for by the housing laws.

I think that, obviously, when we realize that the single largest asset of our Nation is constituted by the value of the houses and buildings of this Nation, that anywhere from 15 to 25 percent of those areas are in various states of blight or slum conditions, if you start contemplating complete demolition and rebuilding of those areas, building for building, it would not only take, as is set out in the report of the President's Advisory Committee, a period of 100 or 200 years, but it would take sums of money that are so huge as to be almost incalculable.

Our objective is to try to do this job within the foreseeable future. We take the position that we can hardly afford to let another generation grow up under slum condition.

Our answer may not be a perfect one. It is not as perfect as the idea of completely destroying the neighborhood in order to rebuild it perfectly. But that kind of perfection would, at best, in our lifetime, only affect a fraction of the job that has to be done, and would leave behind it a huge debt, even when only doing the job partially.

We are thinking more in terms of rebuilding and rehabilitating, and bringing up to better standards, all of our living accommodations, all of our older buildings, within the foreseeable future—possibly within the next 5 or 10 years.

In Los Angeles, we have a slogan "No slums by 1960." That is a little ambitious, but we believe we can do that, and if we eliminate the slums, then we certainly will have no longer any slum dwellers.

The purpose of my making those comments is this: We believe that in connection with the expenditure of funds for urban renewal, the grants that are contemplated under what is now title IV of the new bill, that they should be granted to cities only under specific considerations that those cities actually are pursuing a real honest to goodness law-enforcement program of their own.

We believe that the wording should be strengthened in that connection in the present bill. In the present bill it says that these funds shall be available to cities if they have a plan for law enforcement.

Well, I think that that is too mild at this stage of the game. Cities have had a plan for enforcement of the housing laws for years, but they have done too little about them, and we have some suggested wording in that connection.

Mr. McDONOUGH. Is that a recommended amendment to the bill?

Mr. BURNS. Yes, sir.

Mr. McDONOUGH. Recommended by whom?

Mr. BURNS. By the National Association of Real Estate Boards.

Mr. McDONOUGH. I would like to say for the benefit of the committee, Mr. Chairman, that Mr. Burns is a constituent of mine, and has a record, I think, of one of the larger home building agencies in the United States, having constructed around 20,000 houses, and to have this testimony from him, to rehabilitate existing neighborhoods, where he has built altogether heretofore in new subdivisions in the outlying sections of the cities, is very encouraging as far as the real estate board is concerned, because it shows that they are not only looking to rebuilding what we have, but also to providing new buildings in the suburbs. I want the committee to know that Mr. Burns is giving us testimony we haven't heard before from a large new builder of new houses.

Mr. BURNS. Thank you, Mr. McDonough.

The whole purpose of this legislation is actually to make sure that local communities, before they are given the advantages of the Federal legislation designed for the purpose of aiding in the rehabilitating or urban renewal of these neighborhoods, that the local communities should actually be conducting a practical law enforcement program of their own.

The CHAIRMAN. I might say that the witnesses will have an opportunity to extend and revise their remarks for the record.

Does that conclude the statement?

Mr. WALTEMADE. Yes, sir.

The CHAIRMAN. Are there any questions of these gentlemen by members of the committee?

Mr. GAMBLE. Mr. Chairman, I think this is one of the finest presentations that we have had by the National Association of Real Estate Boards, and I would like to thank them for their cooperation and for the way they have presented their case.

Mr. McDonough, you were telling us about Mr. Burns. Mr. Burns was very, very helpful to the Joint Committee on Housing in the 80th Congress. I think you were here the day Ginsburg interfered with our schedule, were you not, Mr. Burns?

Mr. BURNS. I was indeed.

Mr. GAMBLE. I remember you came on and we had to cut down time, and I inadvertently said something to you about giving you 15 or 20 minutes, and you said "I came all the way from the west coast to testify." So I apologized and you went on.

Mr. McDONOUGH. Mr. Burns, as I understand your rehabilitation and urban renewal program, you want the cities to lay the foundation for any Federal aid that may be extended by active cooperation in enforcing the safety and sanitary regulations, along with the other laws that will assure the Federal Government that they are not going into an area and taking over the whole thing by themselves, but that they are going into an area where there is cooperation between the governing body, city council, or whatever may be the agency, and the Federal Government.

But do I understand that you prefer that the cities do this without aid from the Federal Government if they can?

Mr. BURNS. I don't believe that they can, Congressman McDonough, without the aid of FHA insurance, as specifically mentioned in several portions of our presentation, and also without the aid of the urban renewal grants, but we advocate that such money be used to stimulate an increased activity in that city, so that maybe for every dollar of Federal funds that is spent there would be a hundred dollars spent locally in revitalizing an entire area, by using the Federal funds to pick out the specific slum pockets, rather than, as we have seen in some cities, just wiping the whole slate clean and in many instances destroying very suitable housing that had another length of life remaining.

We consider that it would be wasteful.

Mr. McDONOUGH. Of course, there are areas, in large congested, highly populated cities, that need additional recreation areas which they don't have, which would probably require the removal of certain of those structures, in order to provide it, along with school facilities, and so forth.

Mr. BURNS. We think that is the ideal way to use the Federal funds, to pick out these slum pockets for the purpose you might say of loosening up the congestion, and making it possible to have playgrounds and other community facilities.

Mr. McDONOUGH. You think the encouragement on the part of an individual, who may find an area in a city, and is willing to finance the rehabilitation of old homes, and sell them on his own, is discouraging unless there is some general overall planning?

Mr. BURNS. Positively.

Mr. McDONOUGH. I recall you informing me that you did some experimenting along those lines, in an area of Los Angeles that I know very well is blighted.

Mr. BURNS. Yes.

Mr. McDONOUGH. But that is too expensive for an individual to attempt to do that without some aid from the Federal Government, in FHA insured loans, and cooperation in the overall planning of the city.

Mr. BURNS. These older neighborhoods have been virtually black-listed in the past. In other words, it was impossible to get any kind of FHA loan, other than, of course, a title I repair loan. Those loans were possible, but substantial loans that would really enable a person

to do a complete job of rehabilitation, or to build on a vacant lot in an older neighborhood—it was impossible to get FHA insurance, and, of course, as you know, with respect to conventional loans, uninsured loans, many lending institutions just normally follow the FHA pattern. So those neighborhoods were. I would say, probably inadvertently blacklisted as far as FHA was concerned.

Mr. McDONOUGH. In other words, the builders went out into the new areas on the outskirts of the city and built another city, practically, because they had wide-scope planning, open acreage, and they could plan accordingly.

Mr. BURNS. Even to the extent of where some cities are now suffering from that decentralization, and it is probably time for the pendulum to swing the other way, and to start rebuilding the inner core of our cities. But by rebuilding I do not necessarily mean tearing down and starting over again. Many of these houses have an additional 40 or 50 years of life, purely by being rehabilitated.

Mr. McDONOUGH. We have had that experience in Los Angeles, where I know there are places as much as 35 miles away from the downtown area, where people go back and forth to their work. And there are many areas within the city limits which, if rehabilitated, would provide adequate and modern housing for new additional home seekers.

Do you have any figures that might give us a nationwide estimate of how many additional units might be constructed in this next year under this plan?

Mr. BURNS. It will relate, of course, to the encouragement given to the program in this proposed legislation, but I have talked to many people, statisticians, manufacturers of building materials and appliances, who are keenly alerted to this possible market, to men who are interested in employment—labor leaders and so forth—and I would say that a cross-section of their beliefs would indicate that this rehabilitation program could exceed, could even exceed the new housing program that we have had even during the past boom years.

In other words, we have almost 50 million dwelling units in our total housing inventory, and it isn't hard to conceive that in that 50 million units, there is as much of an opportunity for work and activity, as there is in the construction of an additional million or so of new units.

Mr. McDONOUGH. In other words, you say that there is evidently need for an additional million units of rehabilitated homes in addition to the million or more new homes this year?

Mr. BURNS. Yes. I am not thinking purely of the creation of additional units. I am thinking of the money that can be spent on the existing units in bringing them up to standard.

In some instances that will be purely what you might call a wind-and-weather treatment, merely bringing them up to present-day standards of health, safety, and sanitation.

But in other instances, it will be a complete modernization job, including the garbage disposals, metal cabinets, and all the way down the line.

Mr. McDONOUGH. Thank you, Mr. Burns.

Mr. SUMMER. Mr. Chairman, may I say something on this subject?

The CHAIRMAN. Yes.

Mr. SUMMER. I think we have overlooked one very important point, too, and that is the vast cost to the Federal Government and to the cities, when slum clearance is brought about through exploitation.

We know that many slums are the result of decay. But many of them are part of a program of deliberate exploitation, and as a member of the President's Committee I was shocked to find that in many cases there is an unholy alliance between city hall and the ownership of slums, and the ownership of slums can be anyone in our economy and often is, and, therefore, the entire program was designed to have the Federal Government help cities that will help themselves.

Now, a centralization of code enforcement is the only practical way you will ever accomplish code enforcement. Today, in slum clearance, there is illegal occupancy where sometimes 5 or 6 families live in a unit that should be occupied by 1 family. We find a whole family in one room. And by capitalizing that occupancy, the Federal Government and the cities have paid through the nose for illegal occupancy.

Therefore, if the cities, before any money is available, do two things, I think you will accomplish a great deal.

No. 1, a master plan, because lenders will not go into an area unless there is a master plan, which, because only 2 percent of our housing inventory every year is new housing, must entail largely a rehabilitation program, but must also have new housing.

Secondly, enforcement of codes, particular occupancy codes, because in enforcing those codes, you then, if you have to condemn property, are paying the true value, and not an illegal or fictitious value, which is sometimes many times the true value.

And in so doing you are saving the insolvency of the cities, because today, in slums, with tax base reduced and taxes very greatly reduced, you have increased services, because of disease, juvenile delinquency, crime, and fire. Through the enforcement of codes, through the adoption of a master plan before any Federal help is forthcoming, or Federal cooperation, you thereby increase the fiscal solvency of your cities, and some of the cities are facing a genuine dilemma. I don't want to get off the subject without pointing out that this program envisions a great deal of rental housing as well as sale housing, because in some of your greater cities, rental housing is a greater need, and sometimes it is impossible to create ownership in all cases, though we favor it wherever possible.

Mr. WIDNALL. Mr. Chairman.

The CHAIRMAN. Mr. Widnall.

Mr. WIDNALL. I would like to commend the three witnesses for their excellent presentation. I am particularly pleased to see Mr. Summer here. He is a resident of the district adjoining mine, and we in New Jersey know of the tireless efforts that he has made not only to improve the standards of his own association, but to obtain decent housing and better housing for the people of America.

I am particularly pleased by the testimony that has been given about making the slums unprofitable. About a year and a half ago I was in Puerto Rico, and couldn't help but see the contrast between Puerto Rican slums and American slums. There the slums are unprofitable. They are squatter slums. Nobody owns them.

Here in America, to our eternal disgrace, we haven't within the cities, done the job that we could through code enforcement. And I

am particularly pleased to see how you have pointed that up today, Mr. Summer. It is something that should be brought to the attention of the American people and the governing bodies in our major cities.

Mr. MULTER. Mr. Chairman.

The CHAIRMAN. Mr. Multer.

Mr. MULTER. Since we are all taking time out to compliment the gentlemen, may I add my compliments, too. You gentlemen have always, you and your association, presented a good case. We haven't always agreed on methods and procedures and details, but I think we always have agreed that the ultimate desire was better homes for the greatest number of people of our country.

I would like to have you tell me, any one of you gentleman, if you can, how you are going to build any more houses under title IV than under title I. How you are going to clear any more slums under one than the other. What is there in one title that is going to give you any more slum clearance than in the other?

In other words, what can you do under title IV that you haven't been able to do under title I?

Mr. SUMMER. I will be glad to try to answer that, sir.

First, under the 1949 act, as fast as slums were cleared, it was necessary to cause people to move out of those slums, and as fast as they were cleared, new slums were created, in another part of the city, and where you cleared an area, oftentimes the use of the property thereafter had fewer families in it, less density, than the original section.

So that, in clearing one slum, and spending millions and sometimes hundreds of millions of dollars, you have only moved the slums to other areas, and we feel very strongly that your bill makes several provisions that never existed before.

Number one, it provides financing for existing structures, housing built during the war and since the war has already started down the road of decay. They are already starting to be slums. So by providing adequate financing for existing housing, you take the first step, and one that doesn't cost money, and that is the prevention of slums.

The second step that is provided here, which was not in the 1949 act, is that as a prerequisite to any Federal funds or local matching thereof, that the city face up to its problems.

Now, the Federal Government cannot in its wisdom, in Washington, in any bureaucracy, made up of the most intelligent and sincere people of America, lay out a formula that would apply equally to New York City and Houston, Tex., or to Birmingham, and Seattle. Therefore, a program which calls for initiative by the city, and which provides for Federal cooperation under certain basic conditions, is, I think, a much sounder approach.

Thirdly, this program recognizes the fact that only two-point-something percent of our entire housing inventory can be new in any one year and doesn't try to rebuild the entire slum area.

I think that is a realistic approach, and I think in that connection that it is very important to point out that if there are, as the 1949 census showed, 3 million families in metropolitan areas earning \$2,000 a year or less, another million and a half families, at that time, earning \$2,000 a year or less who owned their homes—your present subsidy on public housing, and I will use the figures presented by public-housing, comes to \$39.60 per unit—that is per family per unit.

Mr. MUMMA. Per month?

Mr. SUMMER. Yes; per family per month. The Federal subsidy—this is from page 313 of the subcommittee report, and on the committee was the chairman of the CIO housing committee, and on the committee were people representing the public housing group, the Federal subsidy, based on the 1949 act—the earlier acts were somewhat less, but the present housing fits this formula, and we personally think these figures of loss of local taxation are very low—Federal subsidy, \$26.90, lost through tax exemption on the sale of public-housing bonds, \$4.20 per family per month, administrative, Federal administrative costs, per family per month, \$2, and using their figures, which my research proves are very inadequate, the difference between normal real-estate taxes, per family per month, and the payment in lieu of taxes, the difference is \$6.50 a month, which represents a subsidy of \$39.60 per family per month.

Multiply that by 40 years, and you have a total subsidy of \$19,000.

I am not going to the fact that the tenants pay an average of \$30 a month rent, which carried out shows another payment of \$15,000 per unit, which brings the overall figure to \$34,000 per family, but that totals, gentlemen, \$7½ billion, and that accommodates, including public housing authorized and not yet completed, 394,000 families.

Now, according to the census, there are 3 million families earning less than \$2,000 a year, and to take one more moment of your time to show how we cannot afford to dissipate our dollars in the face of the need, if that were translated into dollars, you could afford to give away—not that I advocate this—1,069,400 houses free at \$7,000 each, which would then pay full local taxes, and save the cities from insolvency.

Now that, of course, is not a recommendation, but it is interesting to point out that the \$19,000 a unit, which does not include the tenant's payment, and which is not the true figure in my opinion, but is their figure, is enough to subsidize a family—this is per family—at \$10 a month for 158 years, or \$20 a month for 79 years, or \$25 a month for 63 years, or \$50 a month for 31 years.

Putting it another way, since 1949, incomes have increased. I believe that of the 3 million families earning less than \$2,000 per year, only a fraction of them may ever need subsidy, because many of them have since bettered their lot, but if we assume that there were 1,200,000 families needing subsidy in this country, you could afford to pay them \$30 per month per family for 10 years, and still save more than \$3 billion under that program—\$4 billion less than the present subsidy.

I merely point these things out—

Mr. MUMMA. Did you say millions or billions?

Mr. SUMMER. Billions. You would reduce the subsidy more than \$3 billion if you paid 1 million people \$30 per month per family for 10 years, to give a chance to this program to operate.

Mr. MÜLTER. Did you multiply that to get the aggregate of \$30 a month for 1,200,000 families for 10 years?

Mr. SUMMER. Yes, sir.

Mr. MÜLTER. What does it amount to?

Mr. SUMMER. Thirty dollars a month for 10 years for 1.2 million families is \$4,300,000,000.

The point I am making is this: Why should 13 percent of the 3 million people that fit into that category have the benefit of assistance, and the other 87 percent receive no benefit?

If we do believe that all Americans should be adequately housed, I believe the concentration of people in structures, good, sound, well-built structures, subsidized for 40 years, is not the answer for several reasons.

Number one, children growing up in those subsidized houses grow up as American citizens expecting housing subsidies as a matter of course. And you can't blame them.

If a man wants to do something to help himself—and we have a case in Ohio where a fellow in a public housing unit wanted to paper his bedroom. He couldn't do it. He can't do anything to help himself, and his children can't do anything to help themselves. And we think a program which enables the American family, or gives it the opportunity to help itself, is a commendable one.

And I merely showed you these figures to show how much more wisely those dollars could be spent, and I agree, that there will be in our economy, always, people who need subsidy in some form or other. That time has always been and always will be, though as time goes on the need for it lessens. And we have failed to consider a very important point, gentlemen, and that is minority groups.

There are in slum areas many people who can't afford, as I said before, to pay an economic rent, or to buy a property, and they are forced into public housing not because of economic causes, but because they have nowhere else to live. And we think that should be rectified. In my statement of New Jersey I have evidence where over-income families are paying up to \$170 a month, and one fellow was put out because of overincome, and within a week he had a place, and they said, "How come?" He said, "I had an \$18,000 house, but I was renting it."

We can show you where public housing is not limited to the under-income families, but covers the field of over-income families as well. In Newark, with over 60 vacancies in public housing, they have since built three or four thousand other units and they have had to employ people to go around to industry and beg industry to supply people to fill these units.

I admit there are many people who sincerely believe in public housing. I talked to the League of Women Voters last night. I believe many people are sincere, and who have felt with justification there was no other solution, but now they are coming forth with a program where money will be available for new housing and rehabilitation of housing, and the need for public housing that was genuine in some cases will no longer exist. But I do think indigent families should always be helped.

Mr. MULTER. That was a nice statement against public housing, but it has nothing to do with my question. What in this bill calls for public housing as of this moment? Is there a single section in this bill calling for public housing?

Mr. SUMMER. No, sir, I am trying to point out, sir—

Mr. MULTER. Now let's get, if we may continue a few minutes more, to the question I asked. How you are going to do anything, what is there in title IV that is going to help you or make it more possible to

clear slums? You have two distinct problems: One is clearing the slums, the other is taking care of the indigent.

Let's try to keep them separate.

Mr. SUMMER. All right.

Mr. MULTER. We agree that the indigent must be taken care of and that slums must be cleared. What in title IV will make it possible for you to clear more slums than under title I?

Mr. SUMMER. No. 1, a prerequisite, that before Federal grants are available, or before FHA financing in rehabilitation is available, that the cities must first enforce its codes, including occupancy codes. That will prevent the creation of new slums, in tearing down areas to remove slums. I think that is a most important point.

No. 2, the adoption of an overall master plan, which obviously must take into consideration the income of the families who are being displaced, and where they will go, and we have got to face up to that problem.

The third is, we must face up to the minority problem.

Now, specifically answering you, under the 1949 act there was no requirement to enforce codes, there was no requirement for a master plan, which is essential if money is to go in.

Mr. MULTER. But the Federal Government can't make localities enforce their codes.

Mr. SUMMER. I don't think the Federal Government should go into a city and tell them what to do.

Mr. MULTER. Or a State. Those are purely matters of local legislation, State, and municipal and local enforcement.

Mr. SUMMER. Right. All the Federal Government can do is to say, "Before we grant you any aid, or before we recommend that FHA mortgage financing can be made available in this area, you must meet certain basic conditions," and that is the key, I think, to making the program work as compared to the 1949 act, which merely moved the slums into another area.

The CHAIRMAN. Mr. Multer, if it is agreeable to you, and without objection, may I inquire of the gentlemen if it is convenient for them to be back this afternoon?

Mr. WALTEMADE. If it is your desire, we will be glad to, Mr. Chairman.

The CHAIRMAN. If it is agreeable to the committee, we will stand in recess until 2:30 this afternoon.

(Whereupon, at 12:16 o'clock p. m., the committee recessed until 2:30 o'clock p. m. the same day.)

AFTERNOON SESSION

The committee reconvened at 2:30 p. m., pursuant to its morning recess, Hon. Jesse P. Wolcott (chairman) presiding.

Present: Chairman Wolcott, Messrs. Gamble, Talle, Kilburn, McDonough, Betts, Mumma, McVey, Oakman, Hiestand, Spence, Brown, Multer, Deane, O'Brien, Dollinger, and O'Hara.

The CHAIRMAN. The committee will come to order.

We will continue the hearings on H. R. 7839. I believe Mr. Multer had the witnesses when we adjourned.

Mr. MULTER. Thank you, Mr. Chairman.

Now, we have heard considerable during the course of these hearings about doing something for the minorities. I think you made a very nice statement, gentlemen, about doing something for the minorities. What in this bill is going to do anything for the minority groups, to give them some housing?

Mr. SUMMER. I will be glad to make reference to it, Congressman.

No. 1, for the first time in the history of this Nation there has been a guaranteed mortgage facility made available, in slum areas, subject, I hope, to several conditions I mentioned this morning.

Mr. MULTER. Let me stop you a moment. You say in slum areas. Do you mean to clear the slums and put up these \$7,000 houses? They will be made available to the minority groups?

Mr. SUMMER. May I explain that?

Mr. MULTER. Yes.

Mr. SUMMER. It is impossible to take any one segment of this slum rehabilitation or slum removal program, and isolate it completely, but the recommendation for section 221 is as follows:

No. 1, it is limited, for relocation purposes.

No. 2, it must be programed. By that I mean there must be a study made by the FHA Commissioner as to the number of people or families being relocated, how many of them are not minority groups and will have no trouble because of their income, to rent or buy existing houses.

Mr. MULTER. Let me stop you a moment. In all of this law, that we have been writing all through the years, we have never said specifically, to any of the agencies, you must build X percentage of this housing for minority groups. We have always had the assurance of the agencies, and it was given in good faith, that they would do their utmost to provide housing for the minority groups. I think you put your finger on it a moment ago, and then passed over it, though not purposely. If you can't get the mortgage money for the minority group housing you won't get the majority group housing.

Mr. SUMMER. I agree with you.

Mr. MULTER. Guaranty or no guaranty.

Mr. SUMMER. I agree.

Mr. MULTER. All we have done through the years is to set up a method for guaranteeing mortgages. But the difficulty has always been with the minority groups, not being able to get the mortgage money. Isn't that so?

Mr. SUMMER. That has been the difficulty, sir. And I think that is why your secondary mortgage facility is so important, because in the event it is impossible—I don't think it will be impossible, but in the event you don't get sufficient mortgage money to properly house minority groups, there should be a facility which makes it possible to do so.

Mr. MULTER. Yes, but the secondary mortgage market brings additional money into the market by buying up the existing mortgages and turning them into cash so there is more money to be loaned. If in the first instance the institutions won't lend to minority groups, the secondary mortgage market won't bring more money into the market for that purpose.

Mr. SUMMER. I happen to be the recipient by a colored group known as the Franklin D. Roosevelt Association, 2 years in a row, of the award of the year for providing, financing, and arranging for housing for colored people, new housing, under title 608.

We do find there are organizations or institutions willing to loan on that type of housing, but up to the present the difficulty has not been exactly lack of mortgage funds. It has been a combination of two things: Lenders unwilling to lend in the area selected, because the area is not generally a sound area but was a declining area.

And many of those lenders today, with or without the second-mortgage facility, would lend provided FHA insured the mortgage, if the area was not on a downward grade. Now, the whole purpose of this program is to have rehabilitation areas enforcing codes and the like—I won't go into all the details—but a master plan, to reverse the trend of downward grade to an upward grade and under those conditions mortgage lenders are interested.

But I can readily understand that they are responsible to their stockholders, or if it is a mutual company, to the investors, and they could be criticized for lending in an area that was on its way down, and this whole program is designed to reverse that downward trend to a better trend through enforcement of codes. So it is a combination of those things, Congressman.

Mr. MUMMA. Will you yield?

Mr. MULTER. I yield.

Mr. MUMMA. Isn't that due to some gimmicks in the guaranty of the FHA, that if the mortgage is in default they can't just say, "Here, FHA, pay us off." There are certain gimmicks in there that make it hard to get your money back in a case of default, aren't there?

Mr. SUMMER. To answer you on that point, there were several things that have caused the problem.

First, the cost of foreclosure was assumed by the lender.

Secondly, the FHA itself, under its underwriting policies, refused to lend in a declining area. That is the basis of good underwriting.

And this whole program is not designed to ignore good underwriting or good lending principles, but rather to take the necessary steps to upgrade an area, upgrade a city and make it a sound investment rather than an unsound one. I don't think we could criticize FHA for that.

But your lenders did face a loss themselves in case of foreclosure, and they faced further criticism from stockholders and depositors, as the case may be.

Mr. MULTER. And you are going to have the same difficulty under this bill if this is enacted in its present form.

Mr. SUMMER. I don't agree with you.

Mr. MULTER. Because you are limiting these new \$7,000 houses to those slum areas.

Mr. SUMMER. I might say that this particular section 221 is limited to those areas, but—

Mr. MULTER. Why should it be? If the area is a bad area and you want to clear the slums out, and there is cheaper ground somewhere else where you can put up the houses, why not put them up in a nearby place rather than there?

Mr. SUMMER. You can, sir. It is part of the same community and as I understand it, it is limited, however, to those who are being relocated. As I interpret it, I don't think it is spelled out that it must be in that location specifically.

Secondly, other sections, 220, make available more liberal financing in the area, in addition to section 221.

If you look at section 220 it affords financing for rehabilitation, for new apartment construction, for new home construction, under terms more liberal than existed before.

Mr. MULTER. That is right.

Mr. SUMMER. Now going back to your basic question, of minority groups—and I think it is a very important point and I don't want to sidestep it, dodge it, or gloss over it—I believe that those people must be adequately housed, that we can't forever dodge the problem and we have got to face it head on, and I think the solutions, in some areas—and that is why we have spelled out to the committee the importance of letting the city make its program and not have any Federal agency create the program within a city—

Mr. MULTER. Then you are not going to get it under this law because this says the site must be approved by the Commissioner, and you give him the veto power and that is the power of selection. The municipality can come in with 40 sites and he can say nothing doing until you pick the one he wants. This bill won't give the municipality home rule.

Mr. SUMMER. I don't defend the phraseology except to say that as we understand the purpose of the act and if it isn't so spelled out it should be amended, it is that if he had assistance, in the form of grants, or Federal insuring of mortgages, should be subject to the city facing up to its problem in two specific fields.

Mr. MULTER. And the local community should make the selection of the site. It should be its responsibility.

Mr. SUMMER. It should be the local community's responsibility; yes.

Mr. MULTER. I can understand where the Commissioner might possibly be given the right to say, "I don't agree with you, this is going to be a bad site," and come forward and try to show why it is a bad site, but to give him the right, absolute right, to approve or disapprove is going to give him the right of selection.

Mr. SUMMER. May I give you an illustration which requires some consideration.

In the city of Passaic, for instance, a group came in and wanted grants under rehabilitation. They proposed taking an existing park, putting in sewers, streets, and so forth, and building houses there, so that the people could move out of an adjoining area, which was a slum area, and should be demolished.

And then plan to tear those down and make of that a park. Well, that particular program, which involved a two-thirds contribution by the Federal Government, resulted in several million dollars of unnecessary expenditure, so that if you take away completely the Commissioner's right to approve or disapprove I believe that you will have many cases of dissipation of necessary funds.

Now, I don't know the answers to all of it, sir, but I would say, fundamentally, that we have got to give the cities as much as possible, so long as it is bringing about a better situation, by not moving slums from one section to another, as much freedom and initiative as possible consistent with sound money-granting or money-lending principles.

Mr. MULTER. Now let's go on to another facet of this problem.

I think you will agree that your slum areas are in the big city areas. Am I right?

Mr. SUMMER. Not entirely; no, sir. Slums exist in the small cities, in many small cities, and slums are on the way in many suburban areas.

Mr. DEANE. I agree with you, Mr. Summer.

Mr. SUMMER. They are more spectacular in the big cities.

Mr. GAMBLE. Will you yield?

Mr. MULTER. Certainly.

Mr. GAMBLE. In this rehabilitation, isn't there much more interest today than there has been before?

Mr. SUMMER. Yes, sir. I think Mr. Burns can answer that question.

Mr. GAMBLE. It seems to me there is much more interest in the subject and you hear much more about it than before you started your work, Mr. Burns.

Mr. BURNS. Very, very definitely. It is not attributable, I don't think, to any 1 person or any 1 group.

Mr. GAMBLE. It is education, isn't it?

Mr. BURNS. It is just something that is on the move at the present time. It is the result of a number of things. The concern about decentralization, the concern about the gradual deterioration of the property values in a city, wherein their tax revenue becomes less and less unless they increase the tax rate, the concern about reemployment, in some areas. People are looking for a new market, you might say, for not only employment, but for some of the things that go into construction.

Construction in this country today, so far as our housing supply is concerned, has just about reached a balance in my opinion, and vacancies are appearing in many areas, not alarmingly so, but an indication that we have reached a balance in our housing supply.

I think that in answer to some of this discussion that has been going on here and in which Mr. Summer so ably represented our viewpoint, I would like to point out that in this entire problem I don't believe that we are ever going to solve it by relying upon new construction alone, regardless of who builds it. The idea of adding to our total housing supply, of 1 million a year, when our entire inventory is close to 50 million houses, and by that comparatively small contribution of new housing, trying to solve the problems of slums and blighted areas, and all of the signs of the past, is something that is actually impossible, and any program that limits our solution to this overall program, any program which limits it solely to new construction, or strains it through new construction, is never going to accomplish anything within the foreseeable future.

I think that the answer to our lowest income people is in the rehabilitation of the used housing of this Nation. I think it is the great answer to the minority question also.

Mr. MULTER. A large segment of the real-estate industry has devoted itself to that and has done a good job. That is why you are asking for \$5,000 instead of \$3,000 as the limit for modernization loans, and asking for open-end mortgages; isn't that so?

Mr. BURNS. Correct.

Mr. GAMBLE. Now, opposite page 21, on our blueprint for neighborhood conservation pamphlet, you have a picture of rehabilitated houses. Can you furnish to us what the rents were in those houses before they were reconverted, or rehabilitated, and what they are now?

Mr. BURNS. Not on those particular ones, but we are talking about the existing housing supply, you are talking about a great range of houses. They not only range in age, but they range in location, they range in size, and they range in condition. In some instances—

Mr. GAMBLE. Can you give us any figures showing what rents are paid in these reconverted or modernized houses?

Mr. BURNS. Well, I was going to go into several categories. In some instances, the landlord already is charging a maximum rent, but he is giving an inferior product.

Mr. GAMBLE. I am not trying to get into the question of rent control, whether we should or should not have it.

Mr. BURNS. I understand.

Mr. GAMBLE. I am just trying to find out what the average rent scales are in those houses so we will know what segment of the population is going to be taken care of and to what extent, by these reconversions and modernizations.

Mr. BURNS. Any figure that I would give you would fit some situation. We do know that the average rent, according to the 1950 census—I am sure you are familiar with that—for nonfarm dwelling units, was \$35 a month, or if you include heat and utilities, \$42 a month.

Now, that probably is 10 or 15 percent lower than it is at the present time, but in some of these remodeling jobs, where they do a 100 percent not only remodeling and bringing up to standard, but where you would go into Georgetown and really do the place over, as an illustration, there could be a substantial increase in rent. In other areas—

Mr. GAMBLE. We will take an area like Georgetown. You are not going to get any people out of the slums there. It is going to be above their means.

Mr. BURNS. That is right.

Mr. WALTERMADE. Congressman, I think you have reference to some of these jobs completely modernized in New York City, where they have been \$5 a room prior to modernization and after that, \$20 and \$35, on the East Side. Of course, that is not what we are hitting at. Because that doesn't provide any housing for the type of people we are discussing here.

We don't believe it is necessary to completely modernize and rehabilitate. What we want to do is rehabilitate, but it is not necessary to completely modernize, as we know those jobs have been done in New York City.

I think the main thing is to make the thing sanitary and clean and eliminate fire hazards and give them individual toilets and bathroom facilities, which some do not have, and which can be done under this type of loan.

Mr. SUMMER. I would like to say specifically that the United States census figures show that there are, in this Nation, 10,262,000 dwelling units either dilapidated or deficient in plumbing. But, of course, the manner in which the census was made led the committee to conclude, based upon careful research and consultations with the Census, that there are approximately 6,800,000 dwelling units in the United States that are definitely substandard and require more than just a moderate expenditure to bring them up to a reasonable standard.

That will give you an idea of the overall picture.

Now, as to your answer, as to what the rents will be before and after, as you know, whenever the FHA insures a mortgage on a property which is for rent, the FHA establishes also what that rent ceiling shall be, and those rents cannot be raised so long as that mortgage is guaranteed by the FHA unless the FHA is given evidence of a justifiable reason; and the FHA in turn may increase those rents or may refuse to increase them or may modify the request, as the case may be.

But I don't believe there are nationwide or even local statistics specifically answering your question, but my guess would be in some cases they have gone up considerably and in other cases haven't gone up at all, and in some cases very little, which is not a very satisfactory answer.

Mr. GAMBLE. Is it a fair assumption to say that in those modernizations and rehabilitations, after you had done that work, wherever you have done it in those areas throughout the country, that those apartments or dwelling units that are thereby recreated or made habitable are not such that are available to that 16½ percent of our population that earned \$1,499 a year or less?

Mr. SUMMER. That is a fair statement, sir. However, the median rent of the Nation, I think, is something like \$33 a month; and I believe that, if we adopt a nationwide program of slum prevention, slum rehabilitation, and slum clearance, the very volume of the operation will for a time, by its very nature, cause some undoubling, cause occupancy codes, or lack of occupancy enforcement is one of the troubles.

But, as also has been proved through the years, as that supply catches up, rents taper down. But, under the proposed recommendations of the financing here, there is a second safeguard to which I referred; namely, the FHA has the right to establish a ceiling based upon underwriting approaches. And the fact still remains that there will always be people in our economy who will need subsidies, and my only concern has been that 13 percent have absorbed all the subsidy, which is more than enough to take care of the entire problem.

Mr. BURNS. Congressman, I would like to—I presume that your question is this, that if all of our dwelling units are substantially rehabilitated there will be a substantial increase in rent, or there could be. That may not be your—Mr. Gamble. My point is this: The top segment of our economy doesn't need any help from the Congress, and I don't think they are looking for any, so far as housing is concerned.

The lowest segment, that we are now trying to take care of in part in housing, in public housing, will always need our attention and our help, no matter whether you give them a direct subsidy or you give them public housing. In the old days we sent them to the poorhouse. They have got to be taken care of somehow.

Then there is that very large in-between group, about 70 percent of our population, that needs housing. They need help from the Government by way of subsidies or guaranteed programs and the help of your industry and of the lending fraternity of the country so that they can get the housing.

I am concerned that this bill doesn't accomplish that purpose. Let me ask you this in line with that: We call for \$7,000 houses, 40-year mortgages. We have been told here time and time again during these

public hearings that you won't get anybody to lend money for 40 years on those \$7,000 houses.

Mr. McDONOUGH. It has been contradicted several times, too, by eminent authorities.

Mr. MULTER. I think the weight of authority is that you will get no such mortgages for 40 years. You gentlemen are doing the building. You represent the builders and the men who sell the houses and place the mortgages.

What do you think? Do you think you can get a \$7,000 mortgage on a 40-year term?

Mr. SUMMER. I think this, that, in the first place, \$7,000, if it were the ceiling, does not offer a proper solution because, if you fail to take into consideration high-costs areas, you are automatically eliminating this form of relief to the housing problem in slum areas in the great concentrations of cities that probably need it the most.

So my first comment is that \$7,000 as a ceiling, in my opinion, will not do the job.

Now, I have prepared some figures here. I will answer you first, however, about the lenders. When FHA first came into being, the great majority of lenders did not go into the program, and it took considerable time before the program took hold, and FHA today is recognized. Now, whenever a new section of FHA comes out, it again creates a problem, and that is why a standby facility is always advisable.

There are, however, many lenders who have stated very definitely they would be interested because the recommendation States that at the end of 20 years the lender has the option of exchanging the balance of the mortgage for debentures, so that, in effect, it is a 20-year commitment and not a 40-year commitment.

But you can't lay too much stress upon actual experience. Now, the VA loan, when it was a hundred percent—it is true we had a rising economy—but it was also predicted that the moment the housing supply would approach fulfillment, that they would all go to foreclosure. Well that hasn't happened. Why? Because there is such a thing that is more important than percentage safeguards, and that is what I touched on earlier this morning, moral equity, and particularly with minority groups who have never had an opportunity to have something themselves.

These figures I think will interest you and I think will more or less lend hope as to the success of such a program. I am taking a \$7,000 house now. The interest and principal on the mortgage and the FHA insurance comes to \$36.12 a month; the taxes I am estimating at \$10 a month; and various hazard insurance at \$1.50 a month, which is \$47.62 a month.

In the beginning the savings are less, and later they are more. But the average savings throughout the entire period, dividing 480 months into the mortgage, is \$14.50.

So that, regardless of whether it is \$5 or \$3, they are building up something. Then, when they build a workbench or outdoor fireplace, have created an equity, have created a risk insurance that is greater than any that any financial institution can possibly create; and that is especially true of minority groups. There is terrific pride in those people if given an opportunity.

Mr. MULTER. What is the tax rate in the city of New York?

Mr. SUMMER. I don't know.

Mr. WALTEMADE. About 3.60 now.

Mr. MULTER. So in the city of New York, at 3.60, \$120 is less than half of what the actual tax rate would be, and that is just real estate, without water charge and sewer charge.

Mr. SUMMER. That is right.

Mr. MULTER. And every other large city approaching that size, Chicago, Boston, Philadelphia, Los Angeles, your tax rate is over that, isn't it?

Mr. WALTEMADE. There are two factors that need recognition. In many cities you are not assessed, whether it is right or wrong, at a hundred percent.

Also, it is true that we are talking national averages and that is your major cities where your taxes are higher your income average is also higher.

Mr. MULTER. You see, that is the trouble when we talk average about a house like this.

Mr. WALTEMADE. That is right.

Mr. MULTER. Where could you build that house?

Where will a builder build that house for \$7,000? In what areas?

Mr. McDONOUGH. California.

Mr. WALTEMADE. Mr. Multer, we are recommending in your testimony that \$7,000 be raised to \$7,600 with an additional thousand dollars in those high-cost areas.

Mr. MULTER. Which would be \$8,600?

Mr. WALTEMADE. Yes, sir.

Answering your question directly as to whether the institution would take these 40-year guaranteed loans—

Mr. MULTER. Let's take one thing at a time. You raise it to \$8,600, and \$8,600 in the high-cost areas, and it is no longer \$62 a month but closer to \$70 a month.

Mr. SUMMER. On the \$8,600 house, increasing the taxes another couple of dollars a month, the total payments, interest, and principal, \$44.38; taxes, \$12; hazard insurance, \$1.50, \$57.88, average saving, \$17.90, or a net of \$39.98; but the obligation is \$57.88 plus heat and utilities.

Mr. DEANE. Will you yield?

Mr. MULTER. Yes.

Mr. DEANE. Some of you are members of the President's Advisory Committee and if you have this publication I refer you to page 94, where it estimated monthly mortgage payments, on a \$6,000, 40-year mortgage. On the \$7,000, the estimated total monthly housing expenses total \$72.92.

On the \$8,000 house, it is \$70.70?

Mr. WALTEMADE. As I have said before, I did not include heat or utilities.

Mr. MULTER. Let's include the utilities, because you can't live in a house without the utilities.

Mr. WALTEMADE. That is right.

Mr. DOLLINGER. Can we find out something else? Will these houses last 40 years?

Mr. MULTER. You see they don't have to last 40 years because the Government is going to return the capital at the end of 20 years.

Mr. DOLLINGER. Or the owner might rebuild the house.

Mr. MULTER. Yes, sir.

Mr. GAMBLE. You might have another slum at the end of 40 years.

Mr. MULTER. That is right.

Mr. GAMBLE. On a \$7,000 basis.

Mr. MULTER. Mr. Deane suggests that I call your attention to what John A. Reilly of the American Bankers Association said speaking for his association. He opposed the 40-year loans on the ground they would not be justified by sound business or economics.

I am willing to assume you can get a 40-year mortgage, and I am willing to assume you can get the mortgage for the \$7,000 house or \$8,000 house. I think you gentlemen agree that you are not going to get any builders who will build the \$7,000 house. You might get a \$7,600 house, or you might get an \$8,600 house.

Am I right?

Mr. WALTERMADE. That is correct.

Mr. SUMMER. After I am through, I will ask Mr. Burns to answer that, but this might be of interest to you. The difference on the monthly payments for interest and principal, which is the only difference, between a 40-year mortgage and a 30-year mortgage, the increases from \$36 and \$12 a month, on a \$7,000 house, to \$39.20 a month. It is approximately 50 cents a thousand dollars difference, and however the life of the mortgage, and the average monthly saving is also greater, and because the owner pays less interest.

But I have mixed feelings about that. I find that 50 cents a thousand dollars a month, or \$5½, to some people, makes a big difference. On the other hand, from an underwriting viewpoint, the difference between 30 and 40 years is not very great, in dollars.

Mr. MULTER. But the point Mr. Deane and I were trying to make was whether it was the \$8,000 house, not the \$8,600 house, at monthly payments for utilities and everything that goes into it, is \$70.70 a month, and for \$7,000, it is \$62.92 a month. You are not going to get the housing for the people whom you want to house. They are not going to be able to afford it.

Mr. SUMMER. I will answer you this way: As I said earlier, there are 3 million people, according to the 1950 census, earning less than \$2,000 a year, who are renting, who live in metropolitan areas.

With the present total subsidy, currently under obligation, that would be sufficient to pay all of those people—not that I am advocating this as the way to do it—at the local level, all 3 million of them, \$20 a month for 10 years, which would reduce the figure shown here, which I think in some cases may be high, to \$50, or you could pay them \$30 a month for 1,200,000 families, which is a whole lot more than 390,000 families, at local level, and reduce it down to \$40 a month and let the city assume the obligation, because the city pays it in the long run anyway.

In the State of New Jersey, for instance, the Congressional Record shows that in 1948 we paid into the Federal Government, or rather received from the Federal Government, in the form of aid, whether public housing or farm assistance, a total of \$114,500,000. That was paid into the State of New Jersey in 1948, and some of that was public-housing assistance.

That same year the citizens of the State paid into the Federal Treasury \$1,272,000, or about 11 to 1. Well, obviously, our defense

needs, our post office—at that time not being self-supporting, and still not—and many other functions of the Federal Government, require much of that money, but at the same time, where does the money come from, if subsidy is needed? It comes right back to the city. That is where the money is paid. And the city could—

Mr. MULTER. You are not suggesting that we use the subsidy to pay for these \$7,000 houses, are you?

Mr. SUMMER. I am not suggesting anything except that I am trying to avoid the most expensive means of doing it—

Mr. MULTER. I don't think you ought to try to convince us we ought to give subsidies when we are trying to work out a program without subsidies. Let's stick to the program we are trying to work out to get housing for the people who don't want to be subsidized and which you and I think ought not to be subsidized. Mr. Shanks, of the Prudential Insurance Co., points out to us that on a \$7,000 40-year mortgage at 4½ percent, assuming you would get it at that rate, the 40-year loan will cost the homeowner \$2,344 more in the form of interest than a 30-year mortgage.

Mr. SUMMER. I am not fighting you on the differential, sir.

Mr. MULTER. Well, now then, let's get back for a moment to whether or not we can produce these \$7,000 houses. What do you think would be a fair profit to a builder who is building the \$7,600 house?

Mr. SUMMER. Mr. Burns is a builder, but before he answers you I want to say this: That the building industry tries and has a moral obligation, to help meet a general need, and whatever its normal profits might be, it should certainly be whittled down on a program like this.

Mr. MULTER. No Member of this Congress expects any builder to cut his profit or do his work without profit because he is a public-spirited citizen, and I don't think any builder is going to do it. He is going to stay in this business because he can make a fair profit, and nobody is going to try to deny that to him.

And nobody in this committee or in this country is going to say he shouldn't have a fair profit.

Mr. SUMMER. I am not a builder, so that I am not speaking for myself, but I do know there are some builders, and I agree with you, for the great majority that is not true, will definitely feel it is a part of their responsibility in connection with their overall operations. Mr. Burns is a builder who has established records for building low-priced houses in great numbers, and I think Mr. Burns is better qualified on the building end than I am.

Mr. MULTER. Mr. Burns, would you mind telling us what a fair profit would be to a builder putting up a \$7,600 house?

Mr. BURNS. I am assuming that a dozen or so builders who advertised in the Los Angeles Times last Sunday, of houses selling, with the lot, for less than \$8,000, at least started out to make a fair profit. Maybe sometimes the discounts that they unexpectedly paid to get their money interfered with that.

Mr. MULTER. At the best break he could get, what would be a fair profit per house?

Mr. BURNS. I don't believe I can answer that question for you. Sometimes a builder makes more than he does at other times. If you would like to have me state as to whether or not I think houses will be built under this section 221, I think the answer is yes and no.

I think they will be built—

Mr. MULTER. You can say "Yes," and I can say "No." Unless we explore everything that goes into it, we can't come to a fair conclusion.

Mr. BURNS. All right. Geographically, I think in some areas these houses would be built. In other areas, I question it.

Some places you probably would be able to get the money, in other areas, probably not.

This is not a new argument. This is an argument you always get into when you try to figure out how to build new housing for the lowest-income people. It is an upside down approach, in my opinion, and I don't know as you will ever get a completely satisfactory answer. I think that this section 221 will make some contribution to the overall picture, but I think that we must realize that as of today, one-fourth of our rents, in this Nation, are less than \$35 a month. There is nothing particularly wrong with our rent schedule. It is the condition that those houses are in, and I think we have to make an all-out attack on improving the conditions of those houses.

Mr. MULTER. I agree with you. Now, let's talk about the new houses we are going to build. We are going to try to rehabilitate the others, and modernize them and all of that, and side by side with that we want to build new houses. Do you agree that the maximum need for housing is in the field between \$7,000 and \$10,000? Per family unit?

Mr. BURNS. I don't think that is the maximum need, sir.

Mr. MULTER. Where is the maximum need?

Mr. BURNS. I think that for people who want houses in that bracket—of course, you can't dictate what people want, if they want a new one and won't take an old one, that is something else again, but I believe the best solution to the low-income family is the used house, properly placed in condition.

Mr. MULTER. What are we going to do with the medium income family, the family in between, the middle-income group family. They need housing too, don't they?

Mr. BURNS. Yes, sir.

Mr. MULTER. What housing would they need? Is it the housing in the \$7,000 to \$10,000 per family unit?

Mr. BURNS. Well, we are speaking in generalities as to middle incomes and so forth. I visualize the middle-income people as those who probably would buy a house from \$10,000 to \$18,000.

Mr. MULTER. What is their average earnings?

Mr. BURNS. I think the median income, for that group that I am talking about, is probably a range from \$4,000 to \$6,000 a year.

Mr. SUMMER. The United States census clearly states that in 1949 there were 3,092,000, I think it is, families renting who earned \$2,000 a year or less, in nonfarm areas.

Another million and a half who owned their homes, who earned \$2,000 or less in nonfarm areas.

Mr. MULTER. We have those figures. That is the third time you are telling us that. That has nothing to do with the problem.

Mr. BURNS. You said 70 percent of them needed help, though.

Mr. MULTER. No, I said that almost 70 percent of the people in this country are earning less than \$5,000 a year.

Mr. BURNS. I didn't understand you correctly.

Mr. MULTER. Is there a large demand or a great demand in the country for housing at \$20,000 per family unit, one family unit?

Mr. BURNS. No, I would not say that is a large demand.

Mr. MULTER. Will you agree with me that there is a much larger profit in building a \$20,000 house to house 1 family, than in an \$8,600 house or a \$7,600 house?

Mr. BURNS. There should be.

Mr. MULTER. Let's be fair. There is.

Mr. BURNS. There is; yes, sir.

Mr. SUMMER. Except this, at the end of the year, it depends on how many you build of each. Namely, you can build 500 houses at \$7,000, or you may build 50 houses or 25 houses at \$20,000.

So that profit is not necessarily measured per house, but it is measured in the year's operations.

Mr. MULTER. So you think this bill should have a provision permitting mortgages on 1-family dwellings at \$20,000, guaranteed mortgages, and at the same time, having that kind of a provision in there you are going to get the other houses built for \$7,600 or \$8,600.

Mr. SUMMER. Yes, sir.

Mr. MULTER. You think you will?

Mr. SUMMER. There is a limit to the market.

Mr. WALTEMADE. Mr. Multer, it has been my experience in serving on mortgage boards of institutions loaning money, that just as soon as you provide the financing there will be all the builders in the world to go ahead and build. We know that America has been built up by the speculative builder. He keeps on building just as long as he can get financing. With financing available on this section, there will be builders to go ahead and build on that plan.

The answer to your question before of whether or not there would be loaning institutions that would loan on this at 40 years, I might say right now, they are making conventional loans from 20 to 30 years, so certainly there will be no difficulty in getting them to take 40-year loans that are guaranteed.

Mr. MULTER. The bankers' representatives and the insurance companies' representatives said no. Shanks was here, president of Prudential, talking for his group, he said they would not do it, that it is bad business, and Reilly speaking for the bankers said it is bad business, where are you going to get that mortgage money?

Mr. WALTEMADE. I am sitting on boards now where we are taking a hundred percent guaranteed loans. We are taking it by the millions.

Mr. MULTER. But not in 40-year loans.

Mr. McDONOUGH. Let's correct the record. I don't think Mr. Multer wants to convey that Mr. Shanks said those mortgages would not be purchased.

Mr. MULTER. He said his company won't take them.

Mr. McDONOUGH. I recall Mr. Levitt saying definitely that if a loan for 40 years, on a 7 or 8 thousand dollar house, is guaranteed by the Federal Government, even if that were 60 years, that bank's industry would pay itself.

Mr. MULTER. That is what Mr. Levitt said. The lenders said differently.

Mr. McDONOUGH. Mr. Levitt has to seek that kind of financing and he is one of the big builders of the Nation, so I don't think it is fair for the record to show that these types of mortgages will not be marketable.

Mr. MULTER. Mr. Levitt is a reputable and fine builder and I will take his word as to what it costs to put up a building, what it will sell for, but when he speculates on whether he can get a 40-, 50-, or 60-year mortgage, I want to hear that from the men lending the money.

Mr. WALTEMADE. Mr. Levitt has never had any difficulty getting financing.

Mr. MULTER. But hasn't yet sought 40-year mortgage?

Mr. WALTEMADE. Because it wasn't available under this section.

What makes you think that a 40-year guaranteed mortgage won't be acceptable when conventional loans are being taken for 20 and 30 years.

Mr. MULTER. Maybe the bankers and insurance men are more farsighted on that subject than the men proposing this. Because wherever you get communism in a country it is because the Government is going to own the homes and buildings and one way to have that happen is to have a bad insurance program where the Government will have to step in and take over the homes and I don't want to see that happen. The insurance companies and the banks don't want to see it, because if that does happen, it is the end of our capitalistic system.

Mr. WALTEMADE. The greatest way to prevent communism in this country is to make a private home available to the greatest number possible.

Mr. MULTER. Right.

Mr. WALTEMADE. And just as soon as a man owns his own home he is certainly not going to be a Communist.

Mr. MULTER. But make it available to him so he is going to own it, and it is going to be his to keep, not to lose.

Mr. WALTEMADE. Under 221 he is building up an equity of \$15 a month, a financial equity, besides the moral equity we have spoken of.

Mr. MULTER. You are assuming he has got his 40-year mortgage and you are assuming you have got the builder who is going to put up the \$7,000 house.

Mr. McDONOUGH. Mr. Multer, you just made a very definite statement, that you were opposed to the Government owning the houses people live in. Still you are advocating public housing, more than 3,500 units.

Mr. MULTER. Yes, sir, because 16 percent of the population in this country are entitled to have decent housing and we have to house them. You have a choice, either you send them to a poorhouse or you give them decent housing. I want to give them decent housing so they can bring up their kids to have a better opportunity than they had.

Mr. McDONOUGH. Then you shouldn't oppose a possible \$7,000 house where it can be built anywhere in the United States and financed.

Mr. MULTER. I am not opposing that. I am asking you to produce a builder who will build it and a lending institution that will lend the money.

Mr. McDONOUGH. The survey made by the Research Department of the Housing Administration showed that this type of house, across the country, varying from \$8,800 in Baltimore, the same type of house could be built in California for \$6,100.

Mr. MULTER. Are they building them?

Mr. McDONOUGH. Oh, yes.

Mr. MULTER. And they are getting mortgage money?

Mr. McDONOUGH. Oh, they must be selling them or they wouldn't build them. As far as the profit you are worrying about, it is a cinch that the man who builds a \$7,000 house is going to build more of those houses than he would a \$15,000 house.

Mr. MULTER. In precisely what area are these houses? \$6,100 houses with FHA-guaranteed mortgages?

Mr. McDONOUGH. I didn't say they are building \$6,100 houses. I said they can be built, the standard house of the Research Department.

Mr. MULTER. I agreed with you and I agreed with everybody who came in here and said you can build a house for \$7,000. I wanted to see the builder who will come forward and say I will build it, and the lender who will lend on it.

Mr. McDONOUGH. Mr. Burns told you that in last Sunday's Los Angeles papers several builders were offering houses at less than \$8,000.

Mr. BURNS. May I say this: That for your typical FHA transaction, for a new house, in 1952, the median mortgage insured was \$8,273. Now, that isn't positive proof on this subject, but it shows that we have done a lot of building at an average that would indicate that many of these houses were insured for amounts in the neighborhood of \$7,000.

But, if I might say, gentlemen, I think the tail was wagging the dog, because I don't believe that any appreciable dent on this entire problem is going to be made, either through the new housing contemplated by this section 221, or through new housing in general.

I think that these families that you are concerned about—and, believe me, they are the concern of all of us—these people today are living in rented—if we are talking about the lower 25 percent of our rental units, that lower 25 percent is from \$35 on down.

Our only concern is the condition of those houses, and we believe that those houses, those dwelling units, can be restored to standard conditions, and I do not believe that you are going to have any great acceleration of rents. Now, that is a statement that probably calls for a little explanation, but, after all, we have got to realize that there are some economics to this picture, and rents are really the function of supply and demand, and whereas it might be of some disappointment to a landlord to think that maybe he is not going to recoup on an extensive scale for his investments, there are many landlords who, to protect their property, or even to continue getting the rents that they are getting today, have got to do something about bringing their houses up to standards.

There are also many tenants who are already paying rents that entitle them to a standard house. And if you visualize, theoretically, that as of today every dwelling unit in this Nation had an extra thousand dollars spent on it, it would not necessarily mean that you would have a great or even any acceleration in your rent levels.

Now, there will be different types of situations, and there will be instances where a house is completely renovated and the rent will increase. There will be other instances, as I say, where in the continued adding to our housing supply, and with supply being in balance with demand, you might find that many a landlord is concerned about being able to preserve his existing rents.

Mr. MUMMA. Mr. Multer, may I suggest that in this magazine of the Federal Housing Administration called Portfolio, on pages 15,

16, and 17, there are numbers of houses that have been built under \$7,000, and it also gives the section and the people who took the mortgages.

Mr. SUMMER. I would like to say, too——

Mr. MULTER. Does it say how many there were, and in what area?

Mr. MUMMA. Here is one, 230; here is another one, 94, here is another one, 50.

Mr. MULTER. In what areas?

Mr. MUMMA. These were all in Detroit, but it is certainly a high-cost district.

Mr. SUMMER. Mr. Chairman, specifically answering three of your questions, Mr. Multer, the life-insurance companies also opposed a hundred percent VA loans, but later on made them. They also opposed FHA when it was first created, and later on became a very vital part of the FHA program.

And as to what builders will do, the charts are available to show that family formations, due to the depression drop in margins, for the next few years, are taking a sharp drop, which means that builders, if they are to stay in business, must build where there is a demand, and clearing the slums is certainly a demand.

Now, I was told here, just a few minutes ago, by one of our men from Florida, that there were being advertised, in Jacksonville, in the newspapers, and we would be glad to send you copies of those ads, houses at \$6,150, including the land. I was also advised——

Mr. MULTER. Are they FHA insured?

Mr. SUMMER. I will have to ask Mr. Command to answer that. I am told that that is true.

And Mr. Albert of Grand Rapids, Mich., tells me that the National Homes are advertising prefabricated houses, including the lot, at \$6,000 each.

Mr. McDONOUGH. Where?

Mr. SUMMER. The sales price is \$6,000, and this is in Michigan, but I understand they are available in other parts of the country.

Mr. MULTER. Those \$6,000 and \$6,100 houses, particularly those in Jacksonville, or near Jacksonville, they are not our urban houses. They are the rural and suburban houses. Am I not right?

Mr. SUMMER. Jacksonville is a city, sir.

Mr. MULTER. I know it is.

Mr. SUMMER. Jacksonville has a slum.

Mr. MULTER. But those houses are built under title I, with rural and suburban area standards. I am talking about urban standards as against rural and suburban standards. There is a big difference.

You are not going to get any of these houses to help you in your slum areas if you are going to build them in accordance with rural area standards. If you are going to change it and move these people out there, I am for it. I am for spreading the population. But this law is not going to do it.

Mr. SUMMER. I agree with you.

Section 221 in itself will not do it. It is a contribution to the solution.

Mr. Burns touched on another solution, namely, fixing up houses so that all people——

Mr. MULTER. But it is not fair to tell us about \$6,000 and \$6,100 houses in suburban and rural areas when we are talking about urban areas.

Mr. SUMMER. And title 220 provides financing for multifamily houses for rent in urban centers. So that your solution is in several directions.

No. 1, your rehabilitation; No. 2, section 221, where effective; and, thirdly, under section 220, which is both for sale and for rent, and provides adequate financing so that people can afford to build for rent, and they cannot build for rent for a market that does not exist. They must build in a price range, and the FHA will see to that, where there is a market. Otherwise, there is no justification for building them. And with the family formations going down rapidly until 1957, I can assure you the builders do not intend to get out of business.

The CHAIRMAN. Are you through, Mr. Multer?

Mr. MULTER. Yes.

Mr. HIESTAND. Mr. Chairman.

The CHAIRMAN. Mr. Hiestand.

Mr. HIESTAND. I wanted a brief answer, if I might have it, from one of these gentlemen, and I might join my colleagues in my very high opinion of their total presentation, and the logic in the thinking, as well as the actual factual presentation.

I would like to know, from Mr. Burns, if you please, who is thoroughly sold on the fact that one of the biggest parts of our problem is rehabilitation, this question:

Does this bill, in accordance with your remarks, now satisfy you that the fraternity, the profession, can go ahead and do this big job for our Nation under the provisions of this bill?

Mr. BURNS. Yes, Congressman Hiestand. I don't suppose there is any bill that is perfect. I think it takes a combination of things in order to make this so-called all-out attack on the 8 or 10 million houses that are in bad shape in this country.

Mr. HIESTAND. Well, this provides the mechanics or the means for it?

Mr. BURNS. Yes, this does provide the means for it, and I think will be a highly successful program. I think that the same acceleration of activity that has occurred on the outskirts of cities, or on the periphery, by virtue of FHA-insured loans, I think that same activity can be expected in the closer-in areas provided it is supported with a local law-enforcement program, which I understand will be made a condition precedent. It is touched on in the bill, and I mentioned it this morning, I believe, that it should be reemphasized or made stronger in the bill, that the cities do have to do something locally.

In that manner you will give assurance to these people. You might say most of this work is going to be almost voluntary, or will be voluntary, providing the owners have the means of financing.

Then with respect to urban and renewal funds, now title IV, formerly title I, I think with that condition precedent in these cities, that they have to do everything that they can locally, that one of the big achievements of this program with respect to title IV will be to multiply the benefits to be derived from the expenditure of that money, so that you will not just simply have a comparatively small area completely rehabilitated—I mean completely rebuilt, but you will

have—the work that city will do should generate maybe a hundred times as much expenditure as the amount of the Federal grant, which, incidentally, from the standpoint of national economics, should be a very interesting sidelight of this program which I don't think has been too much touched on today, the terrific expenditures that could be involved with an overall renovation program of our Nation as a whole.

Mr. HIESTAND. Thank you very much.

Mr. Waltemade, down at the bottom of your testimony, on page 5, you have some remarks with regard to section 221, and some side remarks, where you indicated that there may possibly be a method of preventing the imposition of public housing into communities where it is not wanted by the people.

Would you kindly tell me, if you will, how a community can avoid an imposition of public housing upon them if they don't happen to want it?

Mr. WALTEMADE. Well, this one instance that I refer to is the King-son Houses, which is in the area of the northeast Bronx; it was a 1- and 2-family home community. The people just got together, held a mass meeting in the local Catholic Church, and all the other churches co-operated, and there were seven or eight hundred that were just hanging from the rafters, objected to it.

In coming in they asked me to say a few words. I said to them, "If this group will keep together, and if you are honest in your objectives in wanting to oppose the public housing coming into this private-home community, there is no political body that will override you," and the answer was that the public-housing authority withdrew the proposal of the housing in this area rather than go before the board of estimates with it.

I say the people, themselves, I think, in areas where they don't believe there should be public housing, they, themselves, can get together and object strenuously, and I say in this particular case it was done.

In the case of Castle Hill Houses, although the planning commission had 450 people and many witnesses opposing, with only 4 people in favor of it, and 4 hours of testimony, took 4 minutes to approve it, which shows that their decision was predetermined prior to any hearing, and I think the thing to do is have a referendum on these things. It should be submitted to the local communities, as to whether or not they want the public housing in that area. I think the people are entitled to vote upon it and a referendum would be the answer to that.

Mr. HIESTAND. Thank you very much.

There is one other angle to it, however: Supposing it has already been inflicted upon a community, and the community has voted and does not want it. How can it get rid of it?

Mr. WALTEMADE. I will ask Mr. Burns to answer that.

Mr. BURNS. As you know, Congressman, we had a situation—

Mr. HIESTAND. I thought he might have a formula that we hadn't yet used.

Mr. BURNS. We were finally successful in Los Angeles in getting a substantial portion of the public housing program canceled, but there is no formula at the present time that permits that being done without the consent and agreement of the Public Housing Administration.

Mr. HIESTAND. And if they decline you are licked?

Mr. BURNS. That is right.

Mr. WALTEMADE. I think means should be provided whereby these public-housing units could be offered for sale to private enterprise, and get the Government out of this business. And I think some means should be provided whereby the communities, if they so desired to get rid of the existing public housing, should be able to dispose of it to private enterprise, or dispose of it to tenants, if it is small housing, to get it back into private ownership, and to be taxpaying to the municipalities.

Mr. DOLLINGER. What about the rents to be paid when it becomes private ownership? Would the rents go up?

Mr. WALTEMADE. There might be a slight increase in rentals. Because we know for a fact, Congressman Dollinger, that in public-housing projects right in our own county of the Bronx, where they are renting generally from \$9 to \$12 a room; we know that in the low-rental projects they are charging as high as \$15 or \$16 a room, and even charging for utilities, where the income of tenants has increased. The public-housing authority has taken upon itself to increase these rentals. We don't have that power in private enterprise.

Mr. DOLLINGER. Is that Federal, that you are speaking of, or State?

Mr. WALTEMADE. It is Federal. Patterson houses, Melrose houses, in the lower Bronx.

Mr. McDONOUGH. If a plan were devised where the Federal public-housing units now located in the various cities of the United States could be offered for purchase by the cities, counties, or private enterprise, if they were sold to the cities and counties, they could probably continue to subsidize them, but if sold to private enterprise, under the present scale they would certainly have to increase the rent because private enterprise could not maintain the difference between the amount of subsidy now supplied and the low rent that they are permitted to charge.

Mr. WALTEMADE. That is correct, sir.

Mr. McDONOUGH. However, the question of whether the cities or counties of the various States of the Union want to assume that obligation, and get the Federal Government out, is another thing.

We did correct our situation in Los Angeles after a long fight, by reducing the total number of units to be built, and also by amending the State Housing Act by putting the public-housing authority under the control of the local elected body. They are now subject to direction by the city council and are removable by the city council. Before that they were very autocratic in their administration of public housing affairs, and defied the city and the State and the county authorities.

Mr. SUMMER. Mr. Chairman, I would like to give Mr. Hiestand another suggestion in answer to his question, namely, that if the local public-housing units were to pay normal taxes, if they were required to pay normal real-estate taxes, and the city's contribution to the Federal Government, or to meet the Federal Government's subsidy, namely, 20 percent, be in the budget each year, then I believe it would become of public interest, and the people in the community would want to know that those who live in there really need that sort of assistance.

I think your very practical, honest American way of doing it is to put it in your budget every year. As it is now it is hidden, and the taxpayers of the community have no idea what they are paying locally for public housing. And I think paying normal taxes is the solution to at least making the public aware, and I think you will find that they will have closely scrutinized those living there, to make sure they are eligible.

Mr. WALTERMADE. Mr. Hiestand, you know that referendum is nothing new. In the 1949 Act it was 132 to 132, and the Chairman broke the tie or we would have had it at that time.

The CHAIRMAN. Are there further questions of these gentlemen?

Mr. DOLLINGER. Mr. Chairman.

The CHAIRMAN. Mr. Dollinger.

Mr. DOLLINGER. Mr. Burns, you were speaking of the \$7,000 house before. I would like to know how many rooms that would contemplate.

Mr. BURNS. Speaking of the Los Angeles area, the \$7,000 house usually contemplates 2 bedrooms and a carport. Just remembering what I can from last Sunday's ads, at \$8,650 there are houses being offered in quantity with 3 bedrooms. In the San Francisco Bay area a house that is known nationally, being built by a chap we refer to as Flattop Smith, merely because of his haircut, he is producing a 4-bedroom house at, I think, \$8,350. That is within a hundred dollars or two.

Mr. DOLLINGER. Now, on your \$7,000 house, would you say that the average rent per month is about \$67 or \$70 a month?

Mr. BURNS. The average payments, including utilities.

Mr. DOLLINGER. That is right.

Mr. BURNS. Yes.

Mr. SUMMER. The advisory committee came up with a total of \$62. Ninety-two dollars, including utilities, heat, hazard insurance, and other extraneous items, and amortization of the mortgage.

But that isn't the requirement in connection with the actual mortgage payments.

Mr. DOLLINGER. But your minimum would be \$62.50, upward, for that kind of a house?

Mr. SUMMER. Your \$7,000 mortgage would provide for payments on interest, principal, FHA insurance, and another item for reserves, of \$36.12 a month. The difference is made up of taxes, hazard insurance, and so on.

Mr. DOLLINGER. Mr. Burns, I would like to find out, if you can tell me, what kind of a person would go into this \$7,000 house? I mean in connection with his earning capacity. What is the rental per month of those people? Are they the \$35-a-month rental people that you were speaking about a while ago?

Mr. BURNS. I wouldn't say that the person who is paying \$35 a month rent, for the reason that he cannot afford to pay any more, is the man that could buy the \$7,000 house, obviously.

Mr. DOLLINGER. The reason I ask—

Mr. BURNS. I think for those low-income people, again, I think their answer is in the existing housing properly brought up to standard.

Mr. DOLLINGER. Well, you have sold \$7,000 houses, or you know people who have?

Mr. BURNS. Correct.

Mr. DOLLINGER. When you sell a house of that kind don't you get some information from him as to what he earns, and what rent he pays now?

Mr. BURNS. Yes, indeed.

Mr. DOLLINGER. What is the rent scale of those people?

Mr. BURNS. I would say that those are people whose earnings must be—I know this is not the direct answer, but their earnings would have to be around \$250 a month.

Now, just what rent they would be paying is a question. I have some actual figures on \$10,000 houses. We sold them to people who previously had been paying an average rent of around \$50. We worked out a little analysis showing that whenever we sold a new house, an apartment, some place was released at a rent of around \$50.

People usually will stretch themselves a bit more to buy a house than in the rent they are paying.

Mr. DOLLINGER. What is the average monthly rent for a person buying a \$10,000 house?

Mr. BURNS. That was the illustration I gave.

Mr. DOLLINGER. You said they were paying \$50 before they bought the house. But when they bought the \$10,000 house what were their monthly carrying charges?

Mr. BURNS. Well, that would bring them up to probably, including taxes and everything, about \$75 a month.

Mr. BROWN. Will the gentleman yield?

Mr. DOLLINGER. Surely.

Mr. BROWN. When you speak about building a house for \$7,000 or \$7,600, or \$8,600, does that also include the lot?

Mr. BURNS. Yes.

Mr. BROWN. Some lots are much more costly than others.

Mr. BURNS. That is correct.

Mr. SUMMER. Under FHA standards at present, if the FHA had a legitimate buyer, they would require that, to live in this \$7,000 house he must earn \$59 a week.

Does that answer your question?

Mr. DOLLINGER. Partly it does.

Now, I think people in that wage scale usually have gone along with the theory that they will not pay more than 1 week's earnings for the rent for a house per month. Isn't that correct, Mr. Waltemade? Isn't that the theory people usually work on, that a week's salary will be the rent?

Mr. WALTEMADE. That used to be the scale.

Mr. DOLLINGER. It isn't any more?

Mr. WALTEMADE. No.

Mr. DOLLINGER. I am trying to find out what kind of a person will buy a \$7,000 house. How many people in this country are able to make the purchase? Will they extend themselves to pay twice as much rent per month, when they buy their house, as what they are paying now?

Mr. SUMMER. I would like to say this, gentlemen: One of our greatest problems, as has been brought up today, is minority housing. Many of the people who will be relocated in code-enforcement program, and in a redevelopment program, are minority people who are

not necessarily of the lowest income, but who still have difficulty in finding a place to live, and I think that is a very substantial answer to the problem of housing minority groups, who are necessarily underincome families.

Mr. DOLLINGER. That is right. That may be one of the reasons that this bill is being pushed, but I disagree that this bill will assure minority housing. I think Mr. Multer pointed that out before, but I would like to stress it further—until I am satisfied that a minority person could go to a bank and/or a builder and say, "I want to build a house in the district of my choice, and I want financing," if that situation would occur and the bank would make such a loan then we would have minority housing.

Mr. SUMMER. Having been one of the persons who has financed minority housing, and did it many years ago, I will say to you that mortgage money will be available for minority housing so long as the area in which the loan is to be made is not an area on the downgrade.

Mr. DOLLINGER. Or if it doesn't conflict with another community of people who may disagree or refuse to live with minority people.

Mr. SUMMER. But under this proposal, to have the city face up to its responsibility before it is eligible for this type of lending, and I won't review the various basic prerequisites, it will stop the downgrade of the cities and start it upgrade, which is the only real barrier, sir, to more private money being made available for minority housing.

Mr. DOLLINGER. Mr. Summer, I don't raise that question.

Mr. SUMMER. I realize that.

Mr. DOLLINGER. What I am trying to find out, on the basis of economics, pure and simple, is this: Whether a man who is paying \$35 a month rent, who earns \$2,000 a year, would go into a district and buy a house for \$7,000, and overextend himself to pay twice what he is paying now?

Mr. SUMMER. He shouldn't buy it.

Mr. DOLLINGER. What people will you get to buy the \$7,000 house?

Mr. SUMMER. I just finished telling you—

Mr. DOLLINGER. Your answer doesn't give me the information. I think it gives me part of the information, but it does not give sufficient information for me to be satisfied that the average person who makes \$50 a week will go into those houses.

Mr. BURNS. I would say that just by and large a person would have to be making at least \$250 a month or, as we said a while ago, \$60 a week, and anybody making less than that has got to look to the existing housing supply.

Mr. DOLLINGER. And the person who wants to double his present rent would want to buy a house better than the \$7,000 house. He would want to move into something which is better than what he has now, and I don't think a \$7,000 house would give him what he wants.

Mr. SUMMER. The proposal is only for relocation purposes. This house that we are talking about, under the proposed bill, is limited to relocation. That means that people are forced to move, and I might say that it is dangerous to use a monthly figure, because in certain parts of the country \$190 a month is adequate, and other parts of the country you may need \$275 a month income, depending on your tax situation, and other factors, and cost of construction.

These are ceilings, sir. This doesn't mean they must be \$7,000 or \$8,600, as we recommend in high-cost areas. That is merely the ceiling, and your demand is what will dictate the price range, and, in turn, affects the monthly carrying charges.

And I insist that Mr. Burns has the answer when he says that the very lowest income group—I don't mean the indigent, but the very low income group, should live, until their economic means improve, in housing that is up to standard.

We don't advocate anyone living under conditions as they have been. But I can see no justification, when our entire housing supply, that is new every year, is somewhere around 2 percent or more, certainly under 3 percent, that everybody must live in new housing. It just does not add up.

Mr. DEANE. I am interested to know what the age would be of this person who would buy a \$7,000 house?

Mr. SUMMER. I believe you will find that again the FHA, in underwriting mortgages, takes into consideration the age of the borrower.

Under the present system, where it provides for 20-year loans, and a man is 50 years old or 55 years old, they don't say you can't have this mortgage because we don't think you will be alive 20 years from now. They don't subtract the length of the mortgage from his age, or add to it, to determine whether or not he will be alive at the end of the term.

Mr. DEANE. You don't take into consideration the age of the borrower in the loans that you recommend?

Mr. SUMMER. It should be taken into consideration; yes, sir; but there are many factors that must be taken into consideration. No. 1, is he the sole producer in the family? No. 2, what type of work is he doing, and how old is he? Naturally if it is a man who is 65 years old, and he is the sole earner in the family, I don't think FHA is justified in its underwriting department to recommend guaranteeing that loan. I agree with you.

Mr. O'HARA. Will the gentleman yield for one question?

Mr. DOLLINGER. I yield.

Mr. O'HARA. What will you do with a man over 65? Take him out and shoot him?

Mr. SUMMER. No, sir.

Mr. O'HARA. Answer the question, please.

Mr. SUMMER. I will answer your question. I am one of those who have insisted that the economy of our Nation is such that no person should be compelled to live in the streets or under conditions which I have witnessed and found further information on in this Eisenhower committee, and that where he is attempting to pay his maximum, and there is no housing available, I think it is up to the community to make it possible for that person to live in decent shelter, and I believe the American way to do it is not to segregate them in large numbers, but to help him out, and make it possible for him to live in decent housing.

That is why we have recommended the enforcement of codes, sir.

Mr. O'HARA. Are you against public housing?

Mr. SUMMER. Because it allows 13 percent of the people to usurp all of the funds that could accommodate a hundred percent of the people who need help, and still would leave a surplus of \$4 billion on top of that.

I think it is a dog-in-the-manger program in that it absorbs so much subsidy that is more than sufficient to take care of the entire problem. I don't think the segregation of human beings is the American way, sir.

Mr. O'HARA. Then for the people past 65, and those in the low-income group, you have words of kindness, but when any suggestion is made of something to help them you find many reasons why it isn't practical?

Mr. SUMMER. I made a suggestion, sir. I have made the suggestion that it be the community's responsibility to see that that man does live in adequate housing. It doesn't mean he must live in brandnew housing, necessarily, but it must be housing that meets a minimum standard.

I don't think that is the role of the Federal Government.

Mr. O'HARA. Why are you so bitter against public housing?

The CHAIRMAN. Mr. O'Hara, may I call attention to the fact that it is 4 o'clock, and we have spent 2 hours this morning developing their opposition to public housing. Now I hope that you won't start that all over again, because some of us have to get home and get to bed.

Mr. O'HARA. This being St. Patrick's Day, and wishing to participate in the remarks in the House, I did leave the committee in season to reach the floor at the time of convening. I am sorry I missed out on the public housing discussion.

The CHAIRMAN. Well, we have enjoyed this, but I think we should have some sympathy for these men who have been sitting here since 10 o'clock this morning. They have been very tolerant, but I am commencing to feel a little sorry for them.

Mr. DOLLINGER. Mr. Chairman, I forgot to welcome my friend from the Bronx, Henry Waltemade. I may disagree with him, but I like him.

The CHAIRMAN. When you read the record tomorrow morning, Mr. O'Hara, if you don't find that question is sufficiently answered by the gentleman, he will probably be glad to come back.

Mr. O'HARA. Mr. Chairman, I am afraid I am taking the time of the committee to no purpose, because I know I can't convert the witnesses and I know they can't convert me.

The CHAIRMAN. Thank you, Mr. O'Hara.

Mr. DEANE. Mr. Chairman, since Mr. Shanks, of the Prudential Life Insurance Co., testified the other day, previous to his testimony I had the urge to build more and more houses. I wonder if his philosophy, practically speaking, isn't sound. The Congress and the home builders and the real-estate people are pushing and pushing and pushing for more and more houses. Do you think that is a sound philosophy?

Mr. SUMMER. I will be glad to answer that, sir. I think FHA is to be complimented on a very sound underwriting policy, and one of the tests is, in a given area, the determination as to whether there is a market for that house.

Mr. DEANE. Right on that point, my observation is that more and more housing is going into the heavily populated areas, and the areas where housing is really needed it is not being built.

Mr. SUMMER. I am one of those who made recommendations, sir, for a 10-point program to make it possible for money to flow into the so-called isolated areas and smaller communities.

Mr. DEANE. I am impressed with the idea advanced that some service charge that would not be abused, would help to channel houses into the areas where they are needed.

Another factor that disturbs me is that in 1953 there were 21,473 non-farm real-estate foreclosures. That is the highest since 1950. I wonder if it isn't time for us to begin to take stock of our housing. Stop pointing our fingers necessarily at public housing, or the supporters of public housing pointing fingers at us, but to try to arrive at what is the right approach that we should have. Because I don't believe the President would come in and recommend a broad housing program, which includes public housing as well as other features, if he wasn't sincerely interested in the overall picture.

Mr. SUMMER. I would say, No. 1, the best price control regulating the prices of houses, and the best rent control, regulating the rents on rental housing, is a reasonable surplus so that people can pick and choose, and again bargain for space.

I am not speaking of a 10-percent vacancy, but I think that the soundest thing that could happen to the housing economy of this Nation is a surplus up to 5 percent, in both rental housing and for-sale housing. That is the most effective price control there has ever been.

Secondly, I concur that if in a given area, in a given price bracket, there exists a vacancy, then lending in that particular area should stop and FHA has had the reputation of keeping its pulse on that.

My only criticism would be that a little vacancy is the healthiest thing in the world to bring prices and rents down.

Mr. BURNS. I would like to add to that, if I might, Mr. Deane, and Mr. Chairman: I believe that this continuous production on a boom scale justifies some conservative viewpoint, as you indicate, has been expressed by some of the men in the lending business.

I do not believe that we could continue to add—this is my personal opinion—to our present housing supply, on the scale that we have, without at this time taking some steps to demolish those houses or that portion of our housing inventory which is worn out.

That does not—to do that, you don't have to visualize any wholesale exodus of populations. We have got to realize first that we just add to this housing supply at the rate of 2 percent a year, and maybe a 10th of 1 percent a year of demolition, would be a help in sustaining the new market, the continuous new market. But I think that we are at a point when, after we have arrived at this normal vacancy factor that Mr. Summer speaks of—and I think we are approaching that—that we must rely upon a demolition program to sustain our new production.

Mr. DEANE. Well now, what I am afraid of is that you are going to see business structures rise where rental housing, poor rental housing, formerly existed.

Mr. BURNS. Not necessarily. Demolition probably is a badly chosen word on my part, because you visualize a sort of blockbusting, and that is really not what we are thinking about.

It is picking out the old ramshackle dwelling that has seen its best days, but probably is in a close-in area, probably has convenient transportation facilities, maybe is even within walking distance of down-

town, and eliminating that ramshackle building and replacing it with a new structure.

The idea that you can't inject new housing into older areas is a misconception. We find that going on in our downtown areas all the time, where we have the very highest values, and in apartment areas, where you have high values. An old building is torn down and a new one is put up. I think in most instances in these older neighborhoods, that the new building will probably be a rental building, rental units, and probably, by reason of the fact that it is an older neighborhood, but now rehabilitated, I would say that those rental units would be on the low side, and there is in this bill provision for financing rental units in these older areas.

Mr. McVEY. Mr. Chairman.

The CHAIRMAN. Mr. McVey.

Mr. McVEY. I am only going to take a moment, and I should like to take the discussion away from public housing because this bill is concerned with slum areas to a great extent.

Before doing that I want to say that I was interested in what Congressman Dollinger said a moment ago, when he gave us the formula that a week's wages should pay for a month's rent.

I have great respect for that formula, but I am afraid some of the Congressmen are paying too much for rent.

I want to go back to this report of Mr. Burns for just a moment.

You have quoted, Mr. Burns, from the President's Advisory Committee report on housing, on page 111: "If we continue only at the present rate of clearance and rely on demolition alone to eliminate slums, it will take us something over 200 years to do this job."

Now I have always been interested in research and documentation. I am wondering if the committee had any documentation for that particular statement or were the figures just picked out of the air?

Mr. BURNS. I explored the statement to some degree. Frankly, Congressman, I don't think it makes much difference whether it would take a hundred years or two hundred, but I explored it to the extent where, what they were talking about, in making that statement, was doing the job on a basis of complete demolition to the extent of razing the area to the ground, tearing the buildings down, replanning the area and building it new, at the present rate of what was formerly known as urban redevelopment and is now known as urban renewal.

Mr. McVEY. Of course, in 200 years we may develop a great many more slums.

Mr. BURNS. It would be a losing proposition. You never could catch up with yourself.

Mr. SUMMER. The complete summary of that is on page 111 of the President's Advisory Committee report.

Mr. McVEY. I was interested in that 200-year figure.

Mr. SUMMER. But to save the Committee's time, I suggest that you have this report.

Mr. McVEY. I don't think it is necessary.

Mr. SUMMER. It breaks it down right to a unit and how that figure is arrived at, and it wasn't a bald guess, sir.

Mr. BURNS. If we defer the job to the extent of where another generation has to be brought up in the slums, that is very serious. I think our program should be aimed at eliminating the slums within the next 5 or 10 years.

Now as far as perfecting certain areas, and tearing everything down and putting curves into straight streets, and so forth, I would rather leave that until we have done the first part of the job.

Mr. McVEY. It certainly shows that it is a tremendous job and some of it will have to be done by our grandchildren.

Mr. BURNS. I don't imagine they will mind doing part of it. I don't suppose they would like to have to do their part of the job and also pay for our part. I think that is the thing we should watch out for.

Mr. McVEY. You have a point there. That is all, Mr. Chairman.

The CHAIRMAN. Are there further questions of these gentlemen? If not, we are very grateful to you for this very valuable contribution to our considerations, and the tolerance which you have shown to our questions, which you have answered very fully and very frankly. Thank you very much.

Mr. WALTEMADE. Mr. Chairman, may I just apologize that my associates and myself sometimes inadvertently and in our enthusiasm have failed to address the Chair in our remarks, and we want to thank you and the committee for the thoughtful consideration given to us; we appreciate the opportunity of appearing before you, as we always have.

We want to assure you that the National Association of Real Estate Boards will continue in its effort to cooperate with this Committee and the members of this committee, and further I might state that if our staff can be of any assistance to you, and if any of our remarks want any further development, we will be glad to supplement our testimony.

You only have to call upon our staff to do so.

The CHAIRMAN. Thank you.

We next have Mr. DuLaurence of the National Apartment Owners Association.

We are very glad to have you with us, Mr. DuLaurence.

Mr. DuLAURENCE. Thank you very much, Mr. Chairman. I shall try to be as brief as possible.

STATEMENT OF HENRY DuLAURENCE, CHAIRMAN, LEGISLATIVE COMMITTEE, NATIONAL APARTMENT OWNERS ASSOCIATION, INC.

Mr. DuLAURENCE. My name is Henry DuLaurence, and I am chairman of the legislative committee of the National Apartment Owners Association. My home is Cleveland, Ohio. The National Apartment Owners Association appreciates the privilege of being permitted to give its views on the proposed housing bill under consideration.

At the outset, I would like to say that we are unalterably opposed to Government's interference or participation in activities which are part of or competitive to private business. We believe that none of these activities should be continued by Government unless they are absolutely essential to the national welfare and cannot be provided just as efficiently and economically by private enterprise.

The housing bill now being considered is very broad in scope. It includes "aid in the provision and improvement of housing, the elimination and prevention of slums, and the conservation and the develop-

ment of urban communities." It will affect our banks, savings and loans, and mortgage banking institutions. The National Apartment Owners Association will limit itself to the consideration of its effect on our present supply of housing.

I would like to emphasize that we believe it highly desirable and extremely beneficial to have virtually every American family own its own home. We believe the family and society benefit through home ownership. Nevertheless since the Second World War we have been living under laws designed for the encouragement of home construction and ownership. We have had increasingly generous provisions for higher financing and lower downpayments. We must face the fact that some time, if we have not already done so, we will reach a point where all these seeming benefits will work a great disfavor to their recipients, and a hardship on the entire Nation.

In coming here as a representative of the association, I wish to emphasize that, of necessity, I must speak for all housing, whether privately owned or rental. Private and rental housing are joined together with the common purpose of furnishing homes for our people. What affects one segment of our housing very quickly affects the other. With but minor exceptions their economic life is inseparable.

In our considerations we are deciding not only the fate of future housing but, more importantly, solving the fate of our present housing as well. There are approximately 43 million non-farm-housing units. This total is composed of approximately 24 million owner-occupied units, 18 million tenant units, with about 1 million unclassified. These 43 million housing units are the Nation's largest single asset. It is larger than any industry in the country and may well be of more value than all industries combined.

The importance of maintaining the values of our present stock of housing becomes evident when we realize that to 24 million families the equity in their home is their largest asset. Any situation which may adversely affect the values of their homes will in turn affect the financial stability of their owners and the Nation.

This bill is of equal interest to some 7 million citizens, owners of the 18 million rental units in the country. To a large extent this property represents the savings of the great American middle class. These people are equally anxious to prevent a chain reaction causing vacancies, cheaper housing, cheaper rents, followed by a deflation in the values of homes and rental property.

We have studied the report of the President's Advisory Committee on Housing, and have been impressed by the diligent effort it represented and the laudable purposes which it liberally expressed. However, I would also like to suggest that a well-planned housing program could help keep our economy on an even keel. Conversely, an ill-conceived plan could further emphasize our excessive inventory in all goods and throw us into a serious depression.

In considering this problem we should remember the significant fact that virtually every serious depression in this country has occurred when there was a recession in industry coupled with a recession in real estate. The depressions of the 1840's, 1870's, 1890's, and 1930's are examples of this economic phenomenon.

I have brought a chart along to show just exactly what I mean, and what has occurred.

At the top you will notice the 2 different charts, 1 of business activity, which is the well-known Cleveland Trust chart, and the other is on real-estate activity, which is the Roy Wenslick chart.

You will notice, and we do know—we have had some very serious depressions—especially in the 1870's, in the 1890's, and, of course, in the 1930's. In each case where we have had a business recession, plus real-estate recession, we have had a serious depression. In each case the real-estate recession has followed an excessive building of houses.

You will notice in this chart that over these valleys and hills, in the real-estate activity chart, you have an idealized cycle of $18\frac{1}{3}$ years. Give and take 1 or 2 years more or less, the crest of a real-estate boom, down to the valley in the recession, back up to the crest of the boom, is approximately 18 years. This chart is a chart representing the business activity and the real-estate activity for the last 100 years of our country.

Interestingly enough, if this chart were long enough you would find the same cycle going along from the year 1800 on. This cycle has continued on that basis over periods of 18 years, and you would find that the valleys and the crests of the booms were very similar, and corresponded with the depressions and recessions in business.

Now, I think in considering what we should do with this housing bill, we should recognize just exactly where we are in this cycle. This chart has been drawn up to January 1, 1954. You will notice that at the present time we are on the downgrade of our real-estate cycle, a cycle that has lasted for 150 years. We have also, as we know, constructed more housing in the last 8 years than in any other 8-year period in the history of our country.

Recently we have had some questionable repercussions in business, plus a large housing construction program and I think that we should recognize the fact that we may be in a vulnerable spot if we espouse and permit a forced increase in the construction of housing.

Recessions and booms in real estate have occurred in periodic cycles of fairly equal length. This is the longest perceptible business cycle and takes almost a generation to complete. Although undoubtedly affected by other business conditions, they are generally considered to occur independently of them. Consequently, we must come to the conclusion that a depression in real estate occurs for the normal causes, the existence of a buyer's market, which is caused by overproduction or excessive inventory.

The recession or boom in housing is further accentuated by two important characteristics seldom found in other commodities.

1. Homes cannot follow demand. Build too many homes in one city and you have a real-estate depression in that city regardless of how great the demand might be a hundred miles away. This can be cured only by the natural growth of population or the natural collapse of old houses in the community, both of which take a long time.

2. Housing is very sensitive to overproduction. Almost every commodity is susceptible to increased consumption except housing. No family can use more than one house in a given community. Consequently, too many houses does not mean more use of housing but

rather a vacancy of housing, thus affecting adversely the value of other housing in the community.

I have taken the liberty of considering some of the economic fundamentals of housing in order to emphasize the importance of housing and the ease of overproduction once supply and demand have come into balance. That it would be highly undesirable to undermine the value of the average family's and the Nation's largest asset cannot, I believe, be disputed.

Are we overbuilt?

One of the characteristics of a building boom is that it seems to feed on itself. Even at its crest most people see the need for more building and are fully convinced that it will continue. I think this is our situation today. Before we decide to go along with the crowd we must consider the following:

1. That the building boom has continued for over 8 years.
2. That much of this building has been fostered by increasingly liberal credit terms.
3. That we have more housing per capita than ever before in our history. If we occupied our housing as we did in 1940 we would have 6,500,000 vacant units, or 13 percent vacancy.
4. That the growth of our housing compared to the growth of our adult population indicates phenomenal growth in housing. Between 1940 and 1952 our adult population increased 14 million; our housing 12,700,000.
5. That our marriage rate has been going down for several years. At the present time it is at the lowest rate in 14 years.
6. That there will be fewer young people of marriageable age for the next few years than in the past few years.
7. That normal economic conditions will cause a contraction in the use of housing.
8. The clearance of slum housing and the rebuilding of slums will not prevent our overbuilt condition. However, it will give us a chance to build some extra units for direct replacement.
 - a. The need for rehabilitation is far greater than housing replacement.
 - b. We have a larger percentage of good housing in the country than ever before. It will be difficult to determine how much replacement we will need, and where, pending normal occupancy.

We can see there is ample evidence that we may be past the crest of the housing boom and evidence that we may be overbuilt. The provisions of our housing bill must be limited so that the civic benefits may be available without causing a surplus and destroying the value of existing housing.

We would like to discuss the various provisions of H. R. 7839, 83d Congress, 2d session. We are familiar with housing because housing is our business. More so we believe than the builder who builds the housing for sale, the real-estate broker who sells the housing for his commission, and the mortgagor who finances the transaction for his interest return. We are the ones who own and operate housing, it is our responsibility and our problem. We have the following suggestions, by section:

Section 101, title I, provides for repair and rehabilitation loans. We believe that this section provides for sound and beneficial help

to many homeowners. These loans are designed to encourage repairs and rehabilitation. Easily available they are made on a short-term basis.

We think that this financing should not only be easily available but easily payable. There is a great deal of sound, well-built housing in substandard areas which cannot be mortgaged because of its location. This prevents the repair or rehabilitation of property which otherwise could be saved. Maintenance and modernization of such property should be encouraged by easy long-term payments. A first mortgage will give ample protection. The increased maturity period will cut down the burdensome payments required by short maturity dates. Consequently, we offer the following proposal:

1. In the case of property without mortgage the maturity date may be increased to 10 years for single dwellings and 15 years for multiple unit dwellings where such loans may be secured by first mortgage collateral.

Providing money for rehabilitation is excellent, but we do not believe it goes far enough. Money is only one of the tools necessary for the repair and rehabilitation of property, but money is worthless without the know-how, ability, and understanding of how it should be spent. To remedy this problem we make the following suggestion:

2. That architectural advice be made available for contemplated improvements. That this be provided for a modest sum and that it be a preliminary requisite for the obtaining of such a loan.

On the next 2 pages, I have 2 examples of rehabilitations. They were included to show that it is possible to have a rehabilitation of a piece of property, and that it can be done very cheaply.

I think that a great deal of money has been wasted in these title I loans with ill-conceived rehabilitations such as brick siding, and asbestos siding, which, as a matter of fact, deteriorates the home a good deal more than it was when it started to be repaired.

Much of it is very expensive. It cannot be painted. It gets dirty, and after a certain time nothing can be done with it. I have actually seen a great many homes in Cleveland that supposedly have been rehabilitated, which will have become slum property forever, because of this stuff that was put on.

Mr. McDONOUGH. Mr. DuLaurence, on this example you have here, you say a few months later and approximately \$849. Was that just the refacing of the building?

Mr. DuLAURENCE. The refacing of the building cost \$849, as you see it. The rehabilitation before and after.

Mr. McDONOUGH. What about the interior?

Mr. DuLAURENCE. I haven't included any figures on the interior, because of the fact that it would be impossible to show the development of the interior.

But let's use this example that you have spoken of. If this property were refaced with asbestos siding, or some of the material that they use for that purpose, it would cost 2 and 3 times as much as this \$849, wouldn't look nearly as well, and in 4 or 5 years the owner would find that it had been a complete waste of money.

The next page shows another rehabilitation of a house that was built during the 1870's. You will notice that it received a great many unflattering remarks at the time of the contemplated improvement. It was rehabilitated for the sum of \$680, as you see here, and it made

a remarkable difference, and an improvement that will last. That is why we suggest that people must be given help and guidance at the same time they are loaned this money for their rehabilitation work.

3. That more rigorous rules be established to protect the homeowner from dishonest builders and unprincipled contractors. I believe the need for this suggestion needs no explanation.

SECTION 203—TITLE II HOME FINANCING

This section increases the amounts which may be loaned on 1 to 4 family dwellings in the following manner: 1 and 2 family, from \$16,000 to \$20,000; 3 family, from \$20,500 to \$27,500; 4 family, from \$25,000 to \$35,000.

We object to increasing of these loanable amounts, not so much because this tends to be inflationary, but because this insures mortgages on houses which closely approach the luxury class. A \$20,000 mortgage represents a house valued at no less than \$24,500, the house of a \$10,000 to \$12,000 a year executive.

Even if we do agree that this high-income-bracket housing classification has a right to Government help, I think we would also agree that easy credit of this kind frequently permits owners to overbuy or purchase a home which their income really doesn't permit. If we owe people a duty of helping them buy homes, we also owe them the duty of keeping them from getting head over heels in debt. Under the present law a house of just over \$19,000 can be purchased under FHA insurance. That would seem ample for the ordinary needs of the average citizen.

HOME OWNERSHIP ENCOURAGED

For the reasons already mentioned we do not believe that a decrease in downpayments is either advisable or economically sound at the present time. Nevertheless, if this committee finds that there is a need for their further reduction then we have a suggestion which we believe is practical and which will cure the dilemma. This would tend to accomplish both objectives, that is, be economically sound and reduce the required downpayments.

We suggest that a special provision be made in the case of homes between the \$8,000 and \$15,000 price range. That these homes be sold under trusted mortgages or land contracts as follows:

1. Reduction of the original downpayment to one-half of schedule but in no event less than 5 percent.
2. Providing for enlarged or special amortization payments for the first 3 years, to take care of the difference.
3. At the end of the special amortization period the owner will obtain a deed to the property subject to normal financing.

We offer this as a possible solution to the pressure for lower downpayments but do not believe the insurable amounts should be increased nor the downpayments reduced.

SECTION 213—COOPERATIVE HOUSING

This section provides for loans used for the construction of cooperative housing.

We believe it rather unfortunate that this section has been expanded to encourage families, especially veterans, to enter into this form of home ownership. When housing is scarce this may appear a desirable way of procuring a home.

Unfortunately the cooperative fails to do this on many counts. Except in a very few places and under unusual circumstances it has proved itself a poor investment. Its resalability is poor both as to facility and price. Neither physically nor psychologically does it give the feeling of home or home ownership. We think it poor judgment to encourage people to invest money in what has proven to be something of a white elephant in the past and what may well be one again in the future.

ARE THE COOPERATIVES FAVORED?

We fail to understand why the cooperative has the most liberal financing provisions in the bill. The housing provided seems to be the least desirable if past experience is any criterion. Actually this bill provides far more liberal financing to the cooperative than to the individual homeowner or private apartment operator.

Section 203, single to 4-family, 95 percent of first \$8,000, then 75 percent, 30 years financing.

Section 207, private multifamily, 80 percent loan, 30 years financing.

Section 213, Cooperative multifamily, 90 and 95 percent, 40 years financing.

It is difficult to see who can gain from this admittedly questionable promotion with the exception of the builders.

SECTION 220—REHABILITATION AND URBAN RENEWAL

This section provides for financial assistance in the rehabilitation of existing dwelling accommodations and the construction of new dwelling accommodations as an aid in the elimination of blight and slum conditions, and in the prevention of the deterioration of property located in an urban renewal area.

We believe that every reasonable means should be given cities not only to rebuild their slum areas, but to prevent the deterioration now in or closely approaching the twilight zone. We subscribe with all the conditions set forth in section 220 of the contemplated bill. We would like to suggest 1 or 2 others which we believe would be of great help.

EXPERT ADVICE NECESSARY

I do not believe that I am maligning people when I say that most people do not know how to redecorate, rehabilitate or remodel a home on a sound economic basis. They frequently know what they like, but invariably do not know how to achieve it. Consequently, a great deal of money is wasted through poor rehabilitation, poor planning, useless construction, which, once the newness wears off, causes worse looking slums than we had before. We suggest:

1. That every city certifying under section 220 hire or provide for the services of at least one architect, whose duty it will be:

(a) To furnish examples of modernized facades of the types of homes indigenous to the city, and

(b) To provide architectural advice to prospective rehabilitators at moderate cost.

The importance of this cannot be overemphasized.

SIMPLE SLUM PREVENTION

We have discussed the elimination and the prevention of slums for many years. We have discussed the so-called causes of slums, but we have failed to do the one thing which will do more to prevent slums than any one thing provided for to date.

Slums are blamed on many things, for a fundamental analysis shows that these are not the basic causes but rather contributing factors or symptoms of slums. It would be foolish to say that aged buildings cause slums—or that locations cause slums—or that foreigners or colored people cause slums, or that a dense occupancy causes slums. The Housing Committee mentioned neglect by city governments as a cause for slums.

Reduced to its lowest common denominator the cause of slums is a loss in the desirability of a house, a location, or a district. It is wrong for us to think it is age—are the New England towns to be considered as slums? It is wrong for us to think it is location—are the rebuilt parts of New York to be considered slums? It is wrong for us to think it is people as such. If we check some of the other so-called causes we will find that most of them are symptoms rather than the causes of slums.

SAVE THE EXTERIOR AND YOU SAVE ALL

I have already mentioned the cause of slums as a loss of desirability which in turn is caused by a loss of eye appeal. What is the first thing that happens to start neighborhood deterioration? Do the roofs leak, does the plumbing give out, do porches sag, are windows broken, are lawns overgrown? The first move toward deterioration starts when 1 or 2 or 3 houses on the street are unpainted and unkept and remain so to the obvious discouragement of their neighbors.

Those who have had the opportunity to watch neighborhoods disintegrate will remember that exterior painting is the first thing to be discarded once a neighborhood starts down the path toward slums. If we are to save our neighborhoods from a few penurious owners and a few avaricious landlords, we will follow the forward step of many European cities. They have found the solution in local laws compelling proper maintenance of the exterior of their buildings. Consequently, our second recommendation is as follows:

2. Every city requesting certification will be asked to pass a local ordinance requiring the refinishing of all painted surfaces of the exteriors of all buildings 1 coat no less than once every 5 years unless waived for cause by the city building department.

Every citizen should be held responsible for the condition of the premises on which he lives regardless of whether he is landlord or tenant. Too many cities have ordinances which hold only the property owner responsible for the debris and litter on the premises. To help prevent slums the tenant must and should be held equally responsible. Local city councils back away from passing such ordinances for

obvious reasons. Consequently, we have the following recommendation:

3. That every city requesting certification be required to pass an ordinance, if they do not already have one, making the occupants of premises responsible for any debris, rubbish, or litter found on those premises.

FULL INCENTIVE

We believe that every incentive must be used to encourage the rebuilding of urban renewal areas. Consequently, we are in accordance with the provision of section 220 which increases, as added inducement for such rebuilding, the loans available from the 80 percent of section 207 to 90 percent permitted under this section. For the same reason we think it is a mistake to place any limitation on rents in these structures.

We believe that rents should not be controlled here for several reasons. The difference in benefits between sections 207 and 220 are not sufficiently great to encourage the prospective builder to choose the renewal area rather than the suburban area. Rent control itself is wrong in principle and favors the unscrupulous and dishonest operator. In addition we believe that rent control is unnecessary because the area itself will preclude the charging of unreasonable rents.

I would like to add there that I think we should give the builder, in these areas, extra encouragement by giving him an extra large depreciation charge on his building.

SECTION 220 (D), PARAGRAPH 2, SUBSECTION (B) (P. 18), BELIEVED UNFAIR COMPETITION

Under a liberal construction almost any instrumentality whether it be Federal, State, municipal, or private, whether it be a limited dividend or redevelopment or housing corporations or nonprofit organizations either public, quasi-public, or private could become organized and start construction under this provision of section 220. It could become another form of public housing.

This would make it undesirable, in fact impossible, for private enterprise to compete. If it is the avowed purpose of this bill to have private enterprise carry on the urban renewal program, then this provision (sec. 220 (d), par. 2, subsec. B, p. 18) should be deleted.

SECTION 221—RELOCATION

This is the section which provides for the system of relocating families displaced as a result of governmental action in a community which has certified to the commissioner according to this act. We would like to make the following suggestions:

1. The same limitation be placed on section 221 that was placed on 220; briefly, the required services of an architect.

2. That this type of financing provided under section 221 be available only in certified renewal areas.

(a) Under the generous provisions of this section people will be encouraged to rebuild the core of the city. Given an alternative they would obviously pick some other location.

(b) The 95-percent financing provisions for a \$7,000 home under section 203 would obviate any great hardship to anyone desiring to leave the renewal area.

(c) This would encourage home ownership in renewal areas which would be a beneficial situation for the entire area.

Section 221, paragraph (d), subsection 3, provides that a nonprofit corporation or association regulated under Federal or State laws, or by political subdivisions of State or agencies thereof, may borrow money for the construction and operation of housing. The preference given public or quasi-public organizations is obvious. The private builder is granted financing of 85 percent of appraised value on individual homes—the public association is granted 100-percent financing of appraised value and up to \$5 million in funds.

In addition this public organization could build any place at 100-percent financing, while the private builder under section 220 will be restricted to slum renewal areas at 90-percent financing. We object to the inclusion of this provision for several reasons:

1. Because we believe it permits unfair competition with private enterprise.

2. Because it will discourage the entrepreneur from constructing and operating housing in renewal areas.

3. Because the 100-percent financing coupled with a nonprofit organization "regulated or supervised under Federal or State laws" makes this very closely related to public housing. This provision could be used to circumvent limitations placed on the construction of public housing.

This section 221, paragraph (d), subsection 3, should be deleted in its entirety.

PUBLIC HOUSING

We regret that the need for more public housing will not be reviewed this year. It has become more and more apparent that public housing is not being occupied by the indigent or the needy but by people in moderate circumstances who could provide for themselves. The relief client, the pensioner, the public charge, is the exception rather than the rule.

Frankly it is impossible to determine just exactly who occupies public housing and the legal right to their being there. Nor are the financial operations available for review. The directors of public housing are reluctant to divulge any information concerning both their tenancy and their operations. Inasmuch as these are quasi-public institutions subsisting on public money, we believe that Congress should make it mandatory for all public housing directors to make available their books for review to responsible organizations.

We believe that public housing should be made available to the people for whom it was meant. All public housing now standing and under construction should be available under priority to:

1. Indigent families supported by relief.
2. Veterans dependent principally on their pensions or disability payments.
3. Any dwellings left over should be available to the lowest economic tenth of the community.

Unless this is provided the existence of public housing cannot be reconciled. When these limitations are adopted we can then determine with comparative accuracy our need for future public housing, if any.

We believe that all Lanham housing should be sold or disposed of as quickly as possible. There is little or no reason for the continuation of Government operation of this type of housing at the present time. Many public housing administrators refuse to relinquish their control of these housing units for private or personal reasons or as a matter of ideology. However, they have served their purpose and their sale will not diminish the amount of housing available for the American public. They should be sold as soon as possible—in any event within the next 12 months.

In conclusion, we have discussed the various provisions of the bill concerning rehabilitation, slum elimination, and urban renewal. We believe that this program is practical and that thereby sound civic goals can be achieved. However, as we stated previously, money is not the only tool necessary to insure the success of this program. We need planning and guidance for the borrowers to insure actual improvement to their homes.

Occupants must be held responsible for the exterior housekeeping of their premises. We must recognize that responsibility for exterior maintenance must be mandatory upon the owner if we are to prevent future slums.

We do not believe that the present generous provisions for the financing of homes should be increased at this time. We are maintaining a very high rate of construction. Any overproduction would be deflationary, thereby wiping out the slim equities of the very homeowners created by this bill.

At the beginning of our testimony we suggested that we would limit our consideration of the housing bill to its possible impact on our existing housing inventory. I use the word "inventory" purposely in the hope that it will remind us of our superabundant inventory in other products. These inventory problems are tremendous—and they are rising every day—not only in farm products but in so many commodities such as autos, steel, and so forth.

If there is any purpose for my being here it is in the hope that I have shown you that housing can stand just so much of the hypodermic needless before it too can be overbuilt. In fact, I hope I have shown you that the overproduction of butter is child's play compared to the overproduction of housing. Butter spoils in a relatively short time—but it takes years to work off an overbuilt housing situation.

I hope I have shown you that in considering this bill we are deciding not so much the future of the housing to be built as the future of the 43 million nonfarm housing units now on hand. And if, at this critical stage, we are to become concerned, let us also be concerned with the 30 or more million homeowners who have had the courage and thrift to save for their homes as well as with the few who haven't.

Under this bill we believe we may increase the construction of housing abnormally. We maintain such abnormal stimulation is the most dangerous thing possible to our economy. We are debasing the biggest asset owned by the majority of our people—their home. We are

endangering its value, its desirability and the financial standing of all homeowners.

This bill, unless substantially modified, offers a sure method for deliberately creating overbuilding, overfinancing, abnormal rise in private debt, and, as the end result, a financial depression caused by inability of the borrowers to meet their mortgage obligations. Basic housing is now available to everyone at very small effort through modest savings. Little more can be asked or should be granted.

The CHAIRMAN. Thank you very much, Mr. DuLawrence.

Mr. DuLAWRENCE. On the next page I have added a few statistics, which I will offer as part of the evidence.

The CHAIRMAN. They may be incorporated as part of your remarks. (The statistics referred to are as follows:)

STATISTICS

Population and housing comparisons

Population increase:	Percent
1940-50-----	14.5
1940-53-----	22.0
Housing increase:	
1940-50-----	23.2
1940-50-----	35.0

Population:	<i>Adult population and housing</i>
1940—14 years and over-----	101,000,000
1952—14 years and over-----	115,000,000
Housing units:	
1940-----	37,300,000
1952-----	50,000,000
Increase adult population, 14 million plus; increase housing, 12,700,000, (Census, p. 20, No. 41) (Census, HC-8, No. 1).	

Persons:	<i>Population per dwelling unit</i>
1940-----	T T T
1953-----	A A A
(Census, p. 20, No. 41.)	

Married couples in our households

1946-----	26,600,000
1952-----	35,000,000
Comparison:	
Increase married couples-----	8,400,000
Increase housing-----	12,700,000

Number of vacant dwelling units of housing used as in 1940

Vacant units-----	6,500,000
Vacancy factor, percent-----	13+

The CHAIRMAN. Are there questions of Mr. DuLawrence?

If not, thank you very much for your contribution, Mr. DuLawrence. I am sorry you have had to wait around so long.

Mr. Shaw, of the Trailer Coach Association. You may proceed, Mr. Shaw. We are very glad to have your testimony.

STATEMENT OF E. R. SHAW, FOR THE TRAILER COACH ASSOCIATION, LOS ANGELES, CALIF., ACCOMPANIED BY RALPH KAUL, CONSULTANT AND REPRESENTATIVE, TRAILER COACH ASSOCIATION, AND PAT McCORMICK, GENERAL COUNSEL, TRAILER COACH ASSOCIATION

Mr. SHAW. My name is E. R. Shaw, and I am president of the Columbia Trailer Co., Van Nuys, Calif. I am also a member of the board of directors of the Trailer Coach Association, which includes manufacturers, suppliers, dealers, and park operators in the trailer-coach mobile homes industry, principally in the Western States. I am appearing today in behalf of this association and have with me Mr. Ralph Kaul, its consultant and representative in Washington, D. C., and Mr. Pat McCormick, general counsel.

With us today also are representatives of the Mobile Homes Manufacturers Association, which represents the manufacturers mainly in the Midwest and East, and the Mobile Home Dealers National Association. These associations have collaborated with us in developing the industry's legislative program and proposals and are here today to support them.

Our purpose in appearing before you is to obtain the recognition of this industry as a part of our national housing resources, and to eliminate the discrimination against more than 2 million occupants of mobile dwellings who are now deprived of the benefits of the National Housing Act.

I have briefly summarized (1) the need to include the mobile home in the housing law; (2) how this need can be met within the existing framework of FHA statutes and procedures; and (3) the advantages that would accrue to the public, advantages, as I will show later, that can be obtained without subsidies or cost to the taxpayer.

With your permission, Mr. Chairman, I can present this summary to the committee in about 10 minutes.

First, I would like to call the committee's attention to a very startling fact: As it now stands, the National Housing Act completely neglects the Nation's most important low-cost housing resource, the trailer coach mobile dwelling. Under section 8 of title I, the National Housing Act recognizes low-cost housing as that costing \$6,000 or less. Approximately 6,000 such houses have been built each year in recent years under FHA mortgage insurance, and this has been the bulk of the fixed-to-site housing in the low-cost category. During those same years, about 80,000 mobile dwellings in the same low-cost category were built and sold in the United States annually. In other words, about 90 percent of the market for low-cost housing has been met by mobile dwellings.

Essentially, we are dealing with a situation in which the law has not caught up with the facts. In the 1930's when Congress was first considering and enacting housing legislation to provide better credit terms for home ownership, there was no such thing as a trailer coach mobile home. The trailer coaches of that day were small, partially equipped vacation units connected with motor touring, and the trailer parks were usually camping facilities for transient vacationists. But the industry has changed greatly during the past 15 years, and more particularly during the postwar period. Today it is

an important segment of the housing industry. Some 800,000 trailer coaches are providing permanent homes for more than 2 million people. These people are living in trailer coaches because they find their housing needs are best met that way.

The modern trailer coach mobile home has been developed to meet high standards of living. It has become, by apartment standards, a livable 2-bedroom dwelling unit with a fully equipped bathroom and kitchen, and includes all the essential house furnishings. The modern trailer park is developing into an attractive, suburban development with landscaping, recreation areas, and utilities equal in every respect to the average garden apartment.

Mobile dwellings are the best housing solution for some people and the only solution for many others.

People in all walks of life and income groups live in trailer coach mobile dwellings. It is the best housing solution for most of these people and for some it is the only solution.

Mobile homes are the homes of military personnel who are enabled to have their families with them wherever stationed in the United States, of defense workers and their families, of newlyweds, of retired folks, of construction and agricultural workers and others in mobile or semimobile employment. For many of these workers it is their only practical solution for family living and home ownership.

Now let us examine why these people need equal consideration with others under FHA. Let us take an example of a family that can afford only a \$6,000 house, in other words the FHA low-cost house. Under section 8 of title I, if they buy a fixed-to-site house, they would have to pay only \$250 down and \$31 a month for interest and amortization; and would have 30 years to pay off the mortgage at an interest rate of 5 percent including FHA insurance premium.

On the other hand, if the family needs and buys a mobile dwelling, they will be called on to pay one-fourth to one-third down and the balance in 3 to 5 years at 5 to 6 percent discount. Assuming the most liberal terms under present lending practices this family would have to pay for a \$5,000 trailer coach \$1,250 down and \$78 a month. On top of this they would have to pay \$25 a month for a trailer-park rental making a total of \$103 a month. What starts as low-cost housing in total price becomes high-cost housing in monthly payments.

The manufacturers and dealers of mobile dwellings are also at a disadvantage as compared with the builders of fixed-to-site housing. When a family buys a dwelling under FHA, the builder and realtor immediately get their money. When a mobile dwelling is sold, the dealers in many areas are called upon to deposit 5 percent of the purchase price as non-interest-bearing collateral to secure the loan for the mobile-home family.

These disadvantages are despite the fact that trailer-coach loans involve negligible risks. Whereas in recent years the FHA has been experiencing net losses of about $\frac{1}{2}$ of 1 percent on loans made for property improvements, the lending institutions financing trailer coaches have experienced losses of less than $\frac{1}{4}$ of 1 percent. In view of this excellent credit record there could be no objection to mobile dwellings as an unsound FHA credit risk.

The mobile-home industry does not seek the identical terms that FHA gives to low-cost, fixed-to-site housing. Nor does it oppose

pending amendments to grant even more generous terms to such housing. But we are seeking adjustment of the adverse credit relationship.

This, we believe, can be accomplished within the framework of the present law and without conflicting with other amendments.

There are two basic proposals: First, we are proposing that title I, section 2 of the National Housing Act be broadened to include the trailer coach mobile dwelling. Under this title lending institutions are partially insured against losses on loans which do not involve appraisals, mortgages or long-term financing.

The procedure and terms of title I are applicable to mobile dwellings with the following safeguards and limitations: Insured loans should be limited: (1) Only to those meeting high construction standards, (2) to \$5,000 per loan or 75 percent of the purchase price whichever is less, and (3) a maximum term of 7 years.

Our second proposal is to include trailer parks under the rental housing mortgage insurance of title II, section 207 on the same basis as the garden-type apartment.

With trailer parks, as with the mobile dwellings, we recommend reasonable safeguards, namely: (1) A high standard of construction, (2) a \$1,000 maximum loan per trailer space and a \$300,000 maximum per mortgage, and (3) a term of amortization reasonably comparable with rental housing.

Now, let us consider how the family in the foregoing example would benefit from these proposals.

First, the total monthly payments would be reduced from \$103 under present terms to \$85 a month which is more in line with reasonable housing costs and ability to pay.

There would be additional indirect benefits. The more liberal terms for trailer-park financing would be translated into improved facilities, perhaps at lower rentals, and finally, the family would be in a better position to trade in its present home because the financing of used mobile dwellings would also be improved.

We believe these proposals are clearly in the public interest.

First, they remove the penalty against a free choice by Americans to select housing that best fits their particular needs. We are talking about the really low-cost housing of our times. A Housing Act which overlooks this fact is simply not doing the job for which it is intended.

Secondly, the proposals will encourage a strong mobile-housing resource for national security. Millions of taxpayers' dollars have been spent in housing arrangements that have outlived their usefulness at the original site but could not be moved to places where they were subsequently needed.

Defense production has been constantly hampered by housing shortages. Should the uncertainties of the international situation result in new housing dislocations, the mobile-homing resources may well prove to be a decisive factor on the homefront.

Third, the proposed amendments will improve general property values and community relations by encouraging modern standards for trailer-coach dwelling.

Wherever substandard conditions do exist in trailer parks this proposed legislation would permit private enterprise to do the job of property improvement and modernization.

Fourth, in this far-flung industry, the effect of providing more reasonable credit terms will be to sustain employment in more than 150 factories employing, with their component suppliers, nearly 100,000 workers.

When consideration is given to the 3,000 dealers and more than 12,000 park operators in the country, the economic benefits are further evident.

Finally, I would like to make this point unmistakably clear: there are no subsidies involved in this proposal. Not a cent of cost to the taxpayer. Not a cent to tack on to the national debt.

We are talking here of extending credit on secured loans with reasonable limitations and conditions. In our opinion the insurance premiums which the FHA will receive would very substantially exceed the losses. This will be a fully self-supporting and self-amortizing program.

That completes my prepared statement, Mr. Chairman. With your permission, I would like to file attachments which include a draft of the specific amendments we are supporting:

Attachment A—Proposed amendments to include mobile dwellings in the National Housing Act.

Attachment B—Master draft, National Housing Act, title I, section 2; and title 2I, section 207; showing proposed amendments to include mobile dwellings and parks.

Attachment C—Summary outline of proposal (1 page).

Attachment D—Basic facts on trailer coach mobile homes industry and market.

Attachment E—Questions and answers concerning proposed legislation for mobile dwellings.

(Attachment A)

PROPOSED AMENDMENTS TO INCLUDE MOBILE DWELLINGS IN THE NATIONAL HOUSING ACT FOR CONSIDERATION OF THE BANKING AND CURRENCY COMMITTEE OF THE SENATE AND HOUSE OF REPRESENTATIVES, 2D SESSION, 83D CONGRESS, IN CONNECTION WITH H. R. 7839 AND S. 2938

To aid in the provision of housing for families in essential and migratory occupations and to encourage the growth of a mobile housing resource for national security by extending certain credit insurance provisions of the National Housing Act to occupants of trailer coach mobile dwellings.

FEDERAL HOUSING ADMINISTRATION

Amendments of title I of National Housing Act

Section 2 (a) of the National Housing Act, as amended, is hereby amended by striking out the period at the end of the first sentence and inserting the following: "and for the purpose of financing trailer coach mobile dwellings by owner-occupants thereof."

Section 2 (b) of said act, as amended, is hereby amended—(1) by striking out the semicolon at the end of the clause numbered (1) and inserting the following: "or for the purpose of financing mobile dwellings exceeds 75 percent of the purchase price or \$5,000, whichever is less;"; (2) by inserting in clause numbered (2) the following: "or for mobile dwellings seven years and thirty-two days," between the words "days" and "except".

Section 2 (c) of said act, as amended, is hereby amended by inserting in paragraph numbered (2) the words "or mobile dwelling" immediately after the phrase "any real property".

Amendments of title II of National Housing Act

Section 207 (a) of said act, as amended, is hereby amended—(1) by inserting in paragraph numbered (1) a comma followed by the words "including facilities

for trailer coach mobile dwellings" immediately following the phrase "designed principally for residential use"; (2) by striking out the period at the end of paragraph numbered (6) and inserting the words "or space in a trailer court or park properly arranged and equipped to accommodate a trailer coach mobile dwelling."

Section 207 (c) of said act, as amended, is hereby amended by inserting in paragraph numbered (3) the words "or not to exceed \$1,000 per space or \$300,000 per mortgage for trailer courts or parks" immediately following the parenthesis and words "four per family unit".

(Attachment B has been filed with the committee.)

(Attachment C)

**SUMMARY OUTLINE PROPOSAL TO INCLUDE TRAILER COACH MOBILE HOMES AND PARKS
IN NATIONAL HOUSING ACT**

(A) FHA credit insurance should be extended because mobile homes:

(1) Supply 90 percent of the low-cost market under \$6,000.

(2) Are permanent housing for nearly 2 million people.

(3) Are high quality with 2 bedrooms, bathrooms, complete kitchens and household equipment as compared with some FHA houses and apartments with 1 bedroom, no inside sanitary facilities, and no stoves, refrigerators, or furnishings.

(4) Are only housing solution to many essential migratory occupations.

(5) Owners are good credit risks to whom existing FHA procedures can readily be applied.

(b) Under this proposed legislation:

(1) FHA would insure lending institutions against losses up to 10 percent on mobile home loans on same basis that property improvement loans are now insured, fixing the maximum loan at 75 percent of the purchase price or \$5,000, whichever is less, and providing a maximum term of 7 years.

(2) FHA would insure mortgages on trailer parks on the same terms as garden apartments provided that no loan could exceed \$1,000 per trailer space and no mortgage could exceed \$300,000.

(3) All trailer coach mobile dwellings and parks would meet minimum standards established by FHA.

(C) Advantages:

(1) Will enable home ownership by essential workers requiring high-quality low-cost mobile housing.

(2) Will encourage a strong mobile housing industry and resource for national security.

(3) Will improve general property values and community relations by encouraging modern standards for trailer coach dwelling.

(4) Will sustain employment in the many factories throughout the Nation, producing trailer coaches, parts, supplies, and among dealers and trailer-park operators.

(5) Will be a fully self-supporting and self-amortizing FHA program not requiring an increase in taxes or national debt.

(Attachment D)

BASIC FACTS ON TRAILER COACH MOBILE HOME INDUSTRY AND MARKET

Prepared by The Kaul Company, Washington, D. C., for the Trailer Coach Association.

The trailer coach mobile dwelling is home to more than 2 million Americans. Today, the bulk of low-cost housing is provided by trailer coaches. Yet the National Housing Act—still rooted to the concepts of 1934 when the trailer coach was only a partially equipped shelter for vacationists—makes no provision whatever for this tremendously important part of the Nation's housing resources.

This anachronism must be ended. The needs of the purchasers of low-cost housing, and the defense, emergency and essential civilian uses of mobile dwellings can be met only by an amendment which will bring our housing legislation up to date.

In the public interest, the Trailer Coach Association presents the basic facts and a specific proposal for amending the National Housing Act so that the people who live in trailers can receive equal consideration for FHA insured loans with the people who live in nonmobile low-cost dwellings.

Did you know that the trailer coach mobile dwelling is supplying the bulk of the really low-cost housing today?

As evidenced by section 8 of title I of the National Housing Act, the really low-cost dwelling is one that sells for \$6,000 or less.

Less than one-half of 1 percent of fixed-to-site FHA insured dwellings built in the last few years are in the category of really low-cost housing. Put another way, about 6,000 really low-cost fixed-to-site homes are being produced under FHA annually and these are the bulk of nonfarm dwellings in this price category. By contrast, there has been an annual production of more than 80,000 trailer coach mobile dwellings selling for less than \$6,000 each.

This means that about 90 percent of the market for really low-cost homes—the kind for which section 8 of title I was intended—are actually being supplied by trailer coaches.

This is all the more startling when account is taken of two other facts:

1. The price of a trailer coach mobile dwelling includes furniture and complete equipment. The typical fixed-to-site low-cost home requires a large additional investment in equipment and furnishing.
2. The terms of financing trailer coach mobile dwellings—by reason of their being overlooked heretofore in Federal housing legislation—have been unreasonably harsh in comparison with the very generous terms provided by the Congress for low-priced fixed-to-site dwellings.

Does it make sense or is it fair to provide generous terms under FHA guaranty to the small number of low-cost housing purchasers who choose the fixed-to-site dwellings and to ignore the 90 percent who prefer and need the low-cost trailer coach mobile dwellings?

More than 2 million people have found the trailer coach mobile houses the best answer to their housing needs

At the time Congress was first considering and enacting legislation to provide credit on reasonable terms for home ownership, there was no such thing as a trailer coach mobile dwelling. The total retail sales of trailer coaches in 1930 amounted to only \$1.3 million and practically all of that was for vacationists.

By 1952, purchases of trailer coaches amounted to \$320 million, an increase of 300 times, and today almost all of the trailer coaches are purchased for year-round, permanent dwellings.

It is not simply chance but choice that has made the trailer coach mobile dwelling the fastest-growing segment of the housing industry and, indeed, one of the very fastest growing industries in the country.

More than 2 million people live in three-quarters of a million trailer coach homes because they find their needs met better that way.

In 1937, vacationers accounted for about 50 percent of trailer coach purchasers. Many more vacationers are purchasing trailer coaches today than 17 years ago but the vacationer is only 1 percent of today's trailer coach market. Ninety-two percent of today's purchases are for dwelling purposes. They are the homes of military personnel and their families, of defense workers and their families, of newlyweds, of retired folks, of construction workers and others in mobile or semimobile employment.

About 60 percent of trailer coach buyers are workers in defense and essential civilian industries. Some of these in construction, crop harvesting and other essential migratory occupations have no alternative—the trailer coach is the only practical solution for living with their families.

Others choose mobile dwellings to increase their employment security and reduce the risk of losing their investment in a home.

As economic conditions change and their jobs in one location are finished, they are not tied down by fixed-to-site housing commitments and thus influenced to remain in and add to a pool of local unemployment. Workers in mobile dwellings can move to wherever their skills are needed and thus assist the economy in its continual readjustment and assist themselves to continuous employment.

And remember this: The mobile dwelling owners no longer have to buy or rent under conditions of local boom; nor do they have to unload their houses when local employment conditions take a turn downward and there is a local

oversupply of housing. In this respect the mobile dwelling investment is a sounder investment.

Thus, the defense worker and the essential civilian worker—the purchasers of 3 out of 5 trailer coaches today—are assured of more continuous employment, avoidance of boomtown overpayments and of ghost-town liquidations, and, at the same time, are saving on current housing costs because no other form of housing matches the trailer coach dwelling in low costs.

Military personnel purchase 1 out of every 4 trailer coaches sold today. For the serviceman the trailer coach dwelling has many advantages. No longer need he rent converted barns and chicken coops or other substandard quarters at exorbitant prices. No longer need he speculate on the length of his assignment at any one station and hurriedly sell a home if he gets orders to report elsewhere. He and his family can continue to live in their own home, moving quickly and easily to anywhere in the country where he may next be stationed. His current living costs are lower and his payments help build a good family saving—the equity in his mobile home. The feeling of having a succession of quarters, none of which can be called home, is replaced. The comfortable completely equipped and furnished modern trailer coach dwelling is home to the serviceman and his family regardless of the installation to which he is assigned.

The older folks have taken to trailers in large numbers. Retired people are accounting for 10 percent of trailer-coach purchases. Typically, the retired couple desires independence; the trailer-coach dwelling is easy to keep and provides a practical home which can be brought along for visits to children. Also the retired couple usually has an adjustment problem; new interests are found in trailer-coach living to supplement the feeling of being discarded by the workaday world. In modern trailer parks in every part of the country, retired couples are making new friends, enjoying new hobbies, and sports. Then again, the ability to avoid the extremes of hot summers and cold winters is of particular importance to older people; many retired couples are enjoying the opportunity of being in a pleasant climate the year round. For the modern retired couple, no other housing possesses anything like these advantages of the trailer coach mobile dwelling.

Newlyweds are taking to trailer coach living in increasing numbers. Buying a trailer coach does not present the same awesome decision to the newlyweds that is involved in buying a fixed-to-site home, particularly when consideration is given to the fact that the trailer-coach dwelling comes equipped with furniture and, in fact, with almost everything but linens and dishes. First of all, the cost is lower. Secondly, it does not cut off the opportunity to try out other jobs and lines of business that may open up in other communities. It reduces housekeeping chores, a factor of particular importance, when the young housewife is continuing to work. And when a child comes, the young wife finds the trailer coach home in a modern trailer park—an ideal combination of a compact, well-ordered, small home in a garden-type of community.

The National Housing Act has failed to take account of these developments. The failure to note the tiny industry of the 1930's was understandable. Today, however, a failure to accept the trailer-coach mobile dwelling as a part of the housing program would be a failure to recognize the low-cost branch and the fastest growing branch of the industry. More important it would mean continued discrimination against the families of defense and essential civilian workers, military personnel, and against retired people. More than 2 million people have found that the trailer coach mobile dwelling is meeting their housing needs best. Two hundred thousand persons are joining the trailer-coach population each year. These are Americans who are looking forward to the same treatment that Congress has provided other homeowners in the National Housing Act.

Why handicap millions of people who need and prefer trailer-coach mobile dwellings?

The decision to recognize the trailer-coach mobile dwelling as a part of the housing resources of the country entitled to the benefits of the National Housing Act cannot be deferred. It is not a transitory problem. The trailer-coach mobile dwelling is an essential part of the modern industrial and farm economy and society.

An important fact is that 2 out of 3 purchasers of trailer-coach mobile dwellings have owned such dwellings previously. About 90 percent of the purchasers of trailer-coach mobile dwellings are planning to live in them for at least 5 years and many of the purchasers are planning to live in them indefinitely.

A breakdown of the trailer-coach market gives further proof that we are dealing with permanent growing trends and with problems which are not transitory and must be faced by the Congress.

One-fourth of the purchasers of trailer-coach mobile dwellings are under 30 years of age and 60 percent are under 40. The encouragement of home ownership in the early formative years is basic in our national housing policy.

Newlyweds are an important and growing part of the market for trailer-coach dwellings.

On the other end of the age spectrum, the increase in older people in our national population is one of the basic economic facts of our time. Some 12 million people are in the 65-and-over age group. By 1980 they will number 22 million. The immensely favorable and growing demand for trailer coach mobile homes for retired couples promises therefore not merely to continue but to increase sharply in coming years.

As long as we have national defense to worry about, the serviceman subject to repeated reassignment within the United States will have the choice of having a succession of dwellings but no home or of taking his home and family along with him. Experience is showing that an increasing number will be choosing the trailer-coach mobile dwelling.

Finally, in a dynamic economy, many defense and essential civilian workers will continue to have the problem of relocating from where the economy no longer needs their skills to the places where the economy will need them. The average family income of the trailer coach population is about \$5,000 a year. In periods of less-than-full employment, the divergence is likely to increase on account of the ability of the trailer coach family to seek out the areas of greatest economic strength. Thus, this segment of the trailer coach market will also continue to be strong and to grow.

The fact is that the trailer coach mobile dwelling is here to stay. The people who live in them and the people who would like to live in them are an important segment of our population.

To a family which has chosen a trailer coach for a home, there is no sense whatever in being excluded from the financing assistance which the Federal Government provides other homeowners. The offhand objections of trailer-coach critics are easily answered:

1. *The trailer coach is not real property.*—The distinctions that have been evolved between real and personal property are far less pertinent than the fact that the trailer coach is used as a dwelling like any other housing. There is no reason in our day and age why the National Housing Act should not make provision for all low-cost housing whether in the legal concept of real property or not. Incidentally, the trailer park which is indisputably real property—closely akin to a garden-apartment property in the function of renting out space—is also completely neglected in the National Housing Act.

2. *It would be risky to lend money on housing that doesn't stay put.*—No such thing. The experience of banks and other lending institutions which have made loans to trailer-coach dealers and their customers demonstrates that such loans are safe and not risky. Only 1 percent of these banks and lending institutions experienced losses involving more than one-half of 1 percent of the loans made. That is a remarkable record backed up by the fact that the trailer coach is a low-cost dwelling and that its owner can move to areas of employment demand.

3. *The trailer-coach purchaser doesn't need the benefits of the National Housing Act.*—Had it not been for the disadvantageous credit terms, many more people would be enjoying the advantages of trailer-coach mobile dwellings today. Also, many people in defense areas would have bought a mobile dwelling rather than rely on the Government to furnish them public housing at the taxpayers' expense. The purchaser of a \$6,000 fixed-to-site house under section 8 of title I puts down only \$250 and under the long-term FHA-insured mortgage pays less than \$31 a month. For a \$5,000 mobile dwelling, the purchaser might have to lay out \$1,667 and would have monthly payments to pay of about \$100 plus an average of about \$25 for ground rent and utilities. At the end of several years, of course, the trailer-coach purchaser will be in a much better position than the fixed-to-site homeowner who will have to continue his payments for many more years. However, the intitial financial lead of purchasing a trailer-coach mobile dwelling is a hardship for most purchasers and prohibitive for many. It would cost the United States Government nothing to provide the same kind

of credit insurance for trailer-coach purchasers as it does for such purposes as property improvement.

The trailer coach mobile dwelling needs and deserves FHA credit guaranties such as are extended to the low-cost housing or property improvements. Until the National Housing Act is amended to accomplish that purpose, millions of Americans are penalized for exercising a choice in selecting the type of dwelling most suited to their own needs.

A proposal to the Congress of the United States for legislative recognition of the trailer coach dwelling as an essential part of the national housing resources.

Congress can remedy the major credit difficulties of the trailer coach mobile dwelling purchaser by amending the National Housing Act in two ways:

1. To authorize FHA to insure lending institutions against losses of up to 10 percent of their outstanding loans to finance the purchase of trailer coaches for occupancy as dwellings by their owners: Provided that each such loan shall not be for a term of more than 7 years or exceed \$5,000 or 75 percent of the purchase price of the trailer, whichever is less; and that the dwellings are certified to the lenders as meeting minimum FHA standards for trailer coach mobile home construction.

2. To authorize FHA to insure mortgage loans to finance the construction or sale of trailer parks meeting FHA minimum standards: Provided that no loan shall exceed \$1,000 per trailer space or \$300,000 in the aggregate; and that the term of the loan shall not exceed 30 years.

The first of these amendments is patterned along the general lines of title I, class 1 (a) of the National Housing Act and the second follows the general lines of section 207 of title II. These tested provisions of the existing law have provided assistance to homeowners and builders without loss to the United States Government. In the same way, they can be adapted constructively for trailer coach mobile dwellings and trailer coach parks.

The results will benefit the people of every State

The benefits of the proposed amendments will be of lasting advantage, not only to the purchasers of trailer coaches but also to the public at large:

1. Trailer coaches are sold by 3,000 dealers, in every State. Very substantial quantities are sold in Ohio, Indiana, Michigan, Texas, Illinois, Pennsylvania, California, New York, Iowa, and Florida.

2. The 150 manufacturers of trailer coaches—whose plants are located in Illinois, Michigan, Indiana, Ohio, Wisconsin, and California and other States—are mostly in the small-business category, employing an average of somewhat more than 100 employees per company. They are heavy purchasers of parts and equipment from the lumber industry, the automotive parts industry, the appliance industry, the housefurnishings industry, and others.

3. The 12,000 trailer parks are widely distributed over the country, with a significant number located in such States as California, Florida, Arizona, and Texas. Under the proposed amendment, with its provision for the establishment of FHA standards, these parks will develop into an increasingly valuable community asset.

4. Finally, and most important, there are no housing facilities better adapted for emergencies than the trailer coach mobile dwelling. The trailer coach use during the river flood disaster of 1952, the trailer coach use during such emergency housing shortages as existed at Paducah and Savannah River atomic installations are just two examples. Should natural or military disaster strike, the trailer coach dwelling would be the most useful type of housing in our national resources.

Sober consideration of the public interest fully supports the legislative proposals for the inclusion of the trailer coach mobile dwelling within the provisions of the National Housing Act.

(Attachment E)

QUESTIONS AND ANSWERS CONCERNING PROPOSED LEGISLATION FOR MOBILE DWELLINGS

(Prepared by the Kaul Co., Washington, D. C., for the Trailer Coach Association)

The proposed inclusion of trailer-coach and trailer-park financing under the credit insurance provisions of the National Housing Act naturally gives rise to

some basic questions about the industry's practices and experience. The following questions and answers are intended to provide information for those seeking to understand the practical effect of the proposal.

Q. To what extent does the trailer-coach mobile home supply the market for low-cost housing?

A. According to the Sixth Annual Report of the Housing Agency, some 6,200 houses costing less than \$6,000 each were built under FHA insurance in 1952. This represents the bulk of nonfarm housing in this cost category. The 83,000 trailer-coach mobile dwellings sold that year under \$6,000 each constitute about 90 percent of the housing in this low-cost category.

Q. Who are the people that live in trailer-coach mobile homes?

A. More than 2 million people, the families of service personnel, defense workers, construction workers, agricultural workers, and others in mobile or semi-mobile occupations; newlyweds; retired folks. Most of these people live permanently or indefinitely in trailer-coach dwellings. About 2 out of 3 trailer coach dwellings are sold to people who have lived in such dwellings previously.

Q. What are the terms now for trailer coach financing and how would it be if it were included as proposed under title I of the National Housing Act?

A. There are some \$400 million of outstanding loans on trailer coaches. Present terms provide for downpayment of one-fourth to one-third of price, 3- to 5-year term, 5- to 7-percent discount. Under proposal, eligible loans would require downpayment of 25 percent and would have a maximum term of 7 years and interest would be at 5-percent discount.

Q. How are trailer parks now financed and how does it compare with what is proposed?

A. Trailer parks are now financed under a great variety of terms and conditions. Mortgages not infrequently call for 6 percent interest with repayment in 15 years or less.

Q. Are trailer coaches now included in the National Housing Act?

A. Under the Defense Housing Act, Public Law 189, the Housing Administrator was authorized to buy trailer coaches as temporary defense housing, but this authority expires June 30, 1954, and its renewal is not being sought in the pending Housing Act of 1954. The trailer-coach mobile dwelling has never been included in the homeownership FHA credit-insurance program.

Q. As a practical matter, isn't it true that there just is no shortage of trailer-coach financing at this time?

A. Frequently money is not available at reasonable terms and conditions when compared with what is available for fixed-to-site housing. The terms and conditions of financing are often reminiscent of those which are more appropriate when trailer coaches were tourist items and were financed along the lines of automobile financing. What is needed is financing on terms which will permit this low-cost housing to be purchased with reasonable downpayments and reasonable monthly payments. That kind of financing is practically nonexistent now.

Q. Have you made any estimates of the volume of loans that would be made under your proposals?

A. FHA insurance is used in only one-sixth of the loans for property improvements. By analogy when we take into account downpayments of 25 percent, it seems reasonable that FHA-insured loans probably would amount to about \$50 million of a total of 350 or 400 million dollars of sales.

Q. Can you illustrate how the trailer coach buyer would benefit from the proposal?

A. Let us look at a family which is buying a trailer coach for \$5,000. Under the most favorable financing generally available today the buyer would make a downpayment of \$1,250 and would pay \$78 a month on the 5-year loan. To this is added about \$25 a month for trailer space, bringing total payments to \$103 a month.

Under the proposal, assuming the same downpayment, monthly payments on the 7-year loan would be \$60 a month and total payments \$85 a month, a reduction of \$18 a month.

In addition, there would be the indirect benefits from improved trailer park facilities, perhaps at lower rent. The family would also have a better chance to trade in their present trailer dwelling because the sale of used trailers would be helped by the proposed legislation.

Q. Will it be necessary to increase the FHA authorization under this proposal?

A. We think not: Title I has an authorization of \$1,750 million and it revolves rapidly due to the relatively short term of loans. On December 30, 1953, au-

thorizations were \$226 million in excess of commitments. FHA trailer-coach loans would utilize only a small proportion of such authorization or surplus available for commitment.

The trailer park resource represents an investment of roughly \$550 million. The addition and modernization each year is estimated at least 10 percent or \$50 million. Even if one-third of this amount required FHA insurance, it would have a negligible effect on the billions of dollars in authorizations under title II.

Q. How do the banks feel about this?

A. We know that there are some banks that would welcome the opportunity to get into this line of financing with the encouragement of FHA insurance. But it must be made clear that the proposal involves no compulsion whatever; banks may and many surely will continue to engage in financing trailers without coming under the FHA insurance. The proposal merely provides banks with alternative arrangement, which they may choose to adopt or not as they see fit same as they now do with FHA and GI loans for housing construction and improvement.

Q. Is the credit of the mobile home purchaser equal to that of other homeowners?

A. Inasmuch as the question is directed to the risk which FHA would assume if its operations were extended to cover the financing of trailer coaches, it may be well to compare trailer-coach experience with property improvement loan experience under class 1 (a). From 1934 to date, FHA has paid claims amounting to about 2 percent of the amount of loans insured. Recoveries against claims run to about 50 percent of claims paid, leaving unrecovered losses of about 1 percent and unrecovered losses amount to less than one-half of 1 percent.

According to a study prepared by the Mobile Homes Manufacturers Association, only 1 percent of the institutions extending credit in this field had loss ratios of as much as one-half of 1 percent. Approximately 93 percent had no losses at all. Assuming that the 1 percent of the banks which had losses in excess of one-half percent actually had average losses of as high as 2 percent, then the average loss for all of the banks would be less than one-twentieth of 1 percent.

The largest trailer-coach lender (\$31 million volume) stated that its loss ratio was one-eighth of 1 percent. Another institution stated that in 7 years it never had a loss. Another institution experienced a loss of one-half of 1 percent over a 15-year period and one-fourth of 1 percent for the year 1953. Another institution reported that in connection with an extension of credit in the amount of \$2 million its loss ratio amounted to one-fortieth of 1 percent.

Inherently the trailer-coach loans have certain advantage over class 1 (a) property-improvement loans: (a) They are almost invariably secured; (b) trailer-coach owners have a higher than average income per family; (c) the trailer coach, by reasons of its mobility, represents choice collateral, whereas the value of property improvements may be dissipated by adverse charges in a particular location.

Q. Is 7 years a reasonable term for trailer-coach finance? What is the practical life of a trailer coach?

A. The modern trailer-coach mobile home originated after World War II, that is the coaches with fully equipped bathrooms, bedrooms, and kitchens. The coaches sold in 1946 are being lived in and there is an active secondhand market. A trailer coach built to present-day industry standards has a life well in excess of 10 years.

Q. What is meant by construction standards of the modern trailer coach?

A. In recent years the industry association has developed standards of good construction and has policed these standards with inspection and approval. The industry has worked with government agencies such as HHFA, Public Health Service, Department of Commerce, and others in developing trailer-coach and trailer-park standards consistent with technical requirements of the Government. The requirements of the National Plumbing Code Underwriters Laboratories, and others have been used to the extent applicable. It is believed that FHA would have little trouble in establishing minimum requirements for mobile dwellings and parks.

Q. Aren't some trailer parks a pretty sad example of good housing?

A. Some are indeed. Our concept is that modern mobile home park is the same as the suburban garden apartment except that the tenant owns his housing unit and rents the space and the utilities. All the essential requirements for planning and good quality construction such as FHA minimum property requirements, national plumbing code and regulation of the National Underwriters,

would apply to trailer parks just as they apply to apartments. The establishment of such standards to trailer parks by FHA would have the effect of raising standards wherever substandard conditions exist.

Q. Is it proposed that small vacation trailer be included in the housing law?

A. The proposal is intended for trailer-coach mobile dwellings fully equipped for permanent, year round occupancy. The industry would cooperate with FHA in defining the size, quality and equipment necessary to assure that the purpose would be served. However, our thinking is that any unit that meets this standard should be eligible just as summer homes in Vermont and winter homes in Florida get FHA financing even though they are not guaranteed to be occupied continuously 12 months of the year.

Q. Do you intend that repairs or improvements of trailers be financed under FHA insurance?

A. We think repairs and improvements of trailer-coach dwellings should be subject to FHA insurance in a manner that is analogous to the repair and improvement of fixed-to-site dwellings, under such administrative conditions as the FHA may find desirable.

Mr. SHAW. I also would like to introduce Mr. Lee Painter, president of the Mobile Dealers National Association, and Mr. Bill Welch, financial consultant of the Mobile Home Manufacturers Association in Chicago, who are here in support of the proposals, and with us to answer any questions that the committee may have.

The CHAIRMAN. Thank you, Mr. Shaw.

Are there any questions of Mr. Shaw?

Mr. McDONOUGH. I think a little explanation of the amendments might be in order, Mr. Chairman, if it doesn't take too long. I don't want to take too much time of the committee.

Mr. McCormick or Mr. Kaul, can either one of you give us an explanation of the amendments?

Mr. McCORMICK. I think Mr. Kaul is better prepared to answer that question, Mr. McDonough.

Mr. KAUL. Mr. Chairman, the amendments, it was our intention to propose inclusion of mobile dwellings, and the trailer parks, with the least possible changes in the existing act.

As shown in attachment A of our prepared statement, in the purposes of title I, it would involve simply writing in that this title would have for a purpose the financing of trailer coach mobile dwellings for owner-occupants thereof. We are not proposing that for rental housing. The limitations and safeguards that are included, we feel that \$5,000 would represent a maximum loan on the trailer coaches, which I believe are averaging in price in the Nation, about \$4,000 of the type of trailer coach mobile dwelling that we would propose to have included in the act.

We are not referring to the small, partially equipped vacation trailers, but the larger trailers.

Mr. McDONOUGH. Should that further specify, then? As you say, 75 percent of the purchase price, or \$5,000, whichever is less, which should represent so many square feet of area. Otherwise, that may be misunderstood.

Mr. KAUL. Yes, that could be included in a limitation of the statute, though our thought on it was that the FHA Commissioner, with his authority to prescribe the space requirements, equipment requirements, and so on, that that sort of detail might better be handled as a regulatory matter by the Commissioner than included as a statutory limitation.

The other provisions or suggested amendments are minor, simply to include in the title a reference to mobile dwellings at those points where it would be necessary to include it in the purposes of the title.

Under title II, mobile dwellings, to be lived in, have to be located on sites. It is our concept that the trailer park fits into the category of the suburban, garden-type apartment and should be brought up to the construction of livability requirements that we usually think of in connection with such apartments.

This simply includes the facilities for trailer-coach mobile dwellings within the definition of facilities covered by section 207 of title II. The limitations suggested here are based on an average cost of about \$1,000 per trailer space in the country. Trailer spaces range in cost from about \$750 in very low-cost areas, to around \$1,800 in the higher-cost areas.

Mr. McDONOUGH. Per year?

Mr. KAUL. Per trailer space.

Mr. McDONOUGH. Per trailer space?

Mr. KAUL. Yes.

Mr. McCORMICK. That is construction cost, Mr. McDonough, to the owner.

Mr. McDONOUGH. For facilities?

Mr. KAUL. Yes, sir.

Now, a thousand-dollar limitation, we feel, would place a very reasonable limitation on the amount of the insured loans that would be made for that purpose. Also, trailer parks range in size from 50, for the very small ones, from an operating standpoint, to around 500 for the largest ones.

It was our feeling that a \$300,000 maximum mortgage would be a reasonable limitation to place on the size of the project that would be covered by this amendment.

Mr. McCORMICK. Mr. Chairman, I wonder if I might add only this, and I think it is of the greatest importance: At the present time there are literally thousands of people in the various walks of life, and in the various phases of employment, that trailer life suits, that are anxious to buy mobile homes, and they are unable to do so, for the very good reason that the downpayments presently required, because of present-day financing, and the interest charges, are too much for them to meet. And the proposals that we make here today will make available this type of living to those thousands of people—and I speak of people who are engaged in very essential industry; we are acutely aware of it on the west coast, and in other parts of the country, where we have the migratory-worker problem, that provides a home for him, which really he has never had before, it provides a peculiarly adapted home for the soldier and his family who is moved from base to base, and others in like walks of life.

Mr. McDONOUGH. You say that the loan should not last more than 7 years; is that correct?

Mr. KAUL. On the trailer coach mobile dwelling. On the trailer park financing, it is real estate, real property, and the facilities of a trailer park do not depreciate any more rapidly than apartment houses.

Mr. McDONOUGH. On the mobile units, you say 7 years?

Mr. KAUL. Yes.

Mr. McDONOUGH. What has been your experience—probably Mr. Shaw can answer this—what is the life of a trailer coach mobile unit, useful life?

Mr. SHAW. The present-day construction, which has existed in the last 5 years, I would say would make its usable life a minimum of about 15 years.

Mr. McDONOUGH. So that 7 years is about half of the usable life?

Mr. SHAW. Yes.

Mr. GAMBLE. Aren't you going pretty far afield when you get to loaning under a housing act money for a trailer park?

Mr. McCORMICK. May I answer that question, Congressman?

Mr. GAMBLE. Yes, I am just asking for information.

Mr. McCORMICK. I do not believe so, for this reason, sir: The mobile home is only usable in a trailer park. It is a part and parcel of it, because it has to have the facilities that are provided in that park, electricity, gas, light, heat, and those other utilities that are provided. So that we think that it is an integral part of it.

Mr. GAMBLE. They provide heat, too; did you say?

Mr. McCORMICK. They provide heat as well; yes, sir. As a matter of fact, I wonder—I don't mean to impose upon this committee, or any of its members, but there was a time not too long ago when I wasn't too familiar with exactly what a mobile home constituted, and it is amazing, the proportions that they have assumed. They are livable homes. They comprise bedrooms, bathrooms, kitchens, living rooms; they are insulated, they are well lighted, they are well heated—as a matter of fact, there was an experience recently up in one of our northwestern States in which the temperature dropped down to around—I hesitate to say it, but I think it was somewhere around 34 degrees below zero—and families were yet able to live and live moderately comfortably, within a well-insulated and heated trailer.

Mr. GAMBLE. I know how you build them. I happen to live up in New York State on the Albany road, and I see a lot of them coming down from New England, heading toward Florida, and they seem to be all sizes, and getting bigger.

Mr. McCORMICK. Yes, they are.

Mr. GAMBLE. Some of them are awfully good looking.

Mr. McCORMICK. Our experience has been, Mr. Chairman, that these mobile homes are moved most infrequently. Of course, the retired person, if he is fortunate enough, moves his trailer to the beach in the summertime and to the desert in the winter.

On the other hand, the worker leaves his trailer where he finds his employment.

Mr. McDONOUGH. What you are talking about is the man who uses this as a home, as a regular facility, and not a luxury, but for housing himself when he is on the job?

Mr. McCORMICK. That is correct.

Mr. McDONOUGH. Let us separate those that would, for instance—well, the retired element from the working element. How many of these units are used by people who have to make their living by moving a unit like this, say, every 6 months or so?

Mr. KAUL. Well over half, Congressman.

Mr. McDONOUGH. Well over half of the total number. And the total number is what?

Mr. KAUL. Over 2 million people live in them.

Mr. McDONOUGH. In other words, over 2 million people live in them, and about half of them are the type of migratory agricultural or construction workers, or people in other categories who have to earn a living by living in these units, and using these units for homes?

Mr. KAUL. Yes, sir. May I add a very significant point. The people that are buying trailer coaches are present owners of trailer coaches. It is estimated that 60 percent of the people that buy a trailer coach now own one, which means that they are becoming permanent housing for the people who have, either no other practical solution for home ownership, or the people who have tried them and now prefer to live in the trailer coach mobile dwellings as their permanent-housing solution.

The CHAIRMAN. Thank you very much, gentlemen.

I think one of the most interesting chapters in the financing field has been written with respect to mobile housing.

Mr. Oakman, perhaps you don't know it, but a great percentage of mobile housing is built within a periphery of 200 miles of Fort Huron, Mich. The Michigan National Bank has set up a financing solution which is very unique, and that is what you had reference to in this 5-percent reserve which you spoke about.

Mr. McCORMICK. That is right.

The CHAIRMAN. I think I was told at one time by the president of the bank that the percentage of loss, though these units can be moved from 1 section of the country to the other, is less than a fraction of 1 percent.

Mr. McCORMICK. That is right.

The CHAIRMAN. Thank you.

Mr. Arthur Goldman, who was to have appeared before the committee today, is ill and is now hospitalized, and has asked Mr. Miles Coleman to present Mr. Goldman's statement to the committee. Mr. Goldman has done a considerable amount of work on the open-end mortgage, and his statement contains many aspects of the matter which will be of interest to the committee.

In the statement is contained a list of institutions which have been making mortgages in various States for some time. The statements have been made available to the committee, and without objection, the statements and the attachments will be inserted in the record.

(The material referred to is as follows:)

STATEMENT BY ARTHUR SWORN GOLDMAN

Mr. Chairman and members of the committee, my name is Arthur Sworn Goldman. I am a building economist. I am grateful for the opportunity to appear today to discuss with you section 125 of H. R. 7839, which deals with the adoption by FHA of the open-end mortgage.

The VA in its regulations has recognized additional advances under an open-end mortgage guaranteed by it, if the additional advance has its prior approval.

For the past 10 years, working with various building-industry groups, I have been studying a relatively unknown type of financing. This financing offers the same kind of encouragement to the homeowners who want to maintain or modernize their properties that FHA and VA long-term insured and guaranteed mortgages offer to people who want to buy new houses.

Under this type of financing, called the open-end mortgage, a homeowner can get the money to pay for his alterations from the holder of his original mortgage, and can pay for the alterations, not over the 3-year amortization maximum provided under FHA title I, but over the remaining term of his mortgage.

There are literally millions of homeowners today who cannot afford to adequately maintain, modernize, or add to their homes because the monthly payments on a title I loan for more than \$1,000 are too steep.

As you know, \$2,000 borrowed under title I would have to be paid back over a 3-year period at the rate of \$63.80 a month. A typical homeowner may already be paying \$57 a month on a \$7,000 mortgage. Adding an additional payment of \$63.80 would bring his monthly payment to over \$120 a month.

This outsized payment is clearly out of the reach of the majority of the homeowners. Proof: In 1952, according to the latest Federal Reserve survey, 56 percent of all nonfarm homeowners had incomes of less than \$5,000 a year.

Thus needed property repairs and improvements are neglected or cut down, and the hard-pressed owner is obliged to settle for the cheapest materials and the most inadequate equipment available.

The new baby, quite often the third or fourth, is shoved into one or the other of the two bedrooms, and we have a classic beginning of blight. Frequently the owner in the lower-income bracket makes the needed modernization, finances it with short-term credit, overextends himself, and is forced into default. (And we have another classic beginning of blight.)

Two facts from the 1953 Federal Reserve survey on consumer finance statistically underline the statements above:

1. In 1952, 40 percent of the nonfarm homeowners did not spend a penny for home improvements or maintenance.
2. The average expenditure of the families who did make any expenditures for repairs and modernization was only \$242 in 1952.

I do not mean to imply that FHA title I has not been a useful and effective instrument. It has, and it will continue to be. The homeowner who can afford it would be well advised: (1) to pay cash or, if not (2) to use short-term credit such as title I with a 9.7 percent interest. Title I costs the homeowner less in dollar outlay than a long-term amortized loan.

However, there is also a very real and continuing need in our economy for long-term realty credit that will enable the average American to own and keep up, without strapping himself, the most expensive purchase he is likely to make in his life.

How many of the millions of low- and middle-income families, who now own homes, could have bought them on the 3-year credit term prevalent in the twenties?

I believe we can all agree that FHA title I, together with the VA, have proved the most effective credit instruments ever devised. However, FHA, unlike VA, does not carry through to its logical conclusion the basic principle that has made it one of the bulwarks of a mass housing market—that there can be no mass consumption or mass production of housing without long-term credit.

FHA fails to provide adequate modernization credit for millions of low- and moderate-income families who bought FHA insured houses. It requires that architectural provision be made for a future third bedroom, but it closes its eyes to how the homeowner of modest means is to finance the third bedroom. Two-thirds of the houses put up in 1947 and 1948 had two bedrooms. Incidentally, children born last year numbered almost a million. Third and fourth babies have been coming along in very large numbers. It is easy to see why these two-bedroom homes are inadequate.

FHA is not the only institution that has not adequately provided for needed home modernization. Most of the institutions that make conventional amortized loans, with the exception of a group of progressive savings and loan associations and a sprinkling of savings banks, insurance companies, and commercial banks, are equally myopic.

So a no man's land exists in the home modernization credit field for many homeowners. And the home modernization market is in the same state, relatively, that the new house market was in prior to the advent of FHA and VA.

And yet all these years we have had at our disposal an easy and inexpensive means of enabling the homeowner of modest means to improve his property. It is the open-end mortgage or, in more legal parlance, the mortgage that provides for optional additional advances. In legal terms, the open-end mortgage is a

contract between a lender and a borrower providing that future borrowings after the original loan be secured by the original mortgage.

In less legal terms, it is a mortgage which contains a provision permitting the homeowner to borrow additional sums from his lender for the purpose of the repair, remodeling, or improvement of the house covered by the mortgage.

The advances are secured by the original mortgage so that the trouble and expenses of refinancing the mortgage is eliminated. The sums advanced are normally paid back over the remaining life of the mortgage, though the term of the mortgage is frequently extended instead. Usually the interest rate for the additional advance is the same as the original mortgage rate.

Many people are under the impression that the open-end mortgage permits the homeowner to reborrow only the money he has paid off on the mortgage. But this is not the case, as I shall explain later.

Let's take Homeowner Smith. He was foresighted enough to insist on an open-end mortgage when he borrowed \$10,000 on his 2-bedroom house. At the time his third child was expected, his mortgage was paid down to \$7,000. Smith went to his lender and asked if he could reborrow \$2,000 for a new bedroom and pay the advance back over the balance of the life of the mortgage.

In just about every State in the Union, except Texas, if Smith had a mortgage with a progressive savings and loan association or with Prudential or National Life Insurance of Vermont, he could get his \$2,000 advance without refinancing the mortgage.

The \$2,000 spread over the 10-year life remaining on this mortgage would cost him \$20.74 a month. I am assuming a 4½ percent interest rate. If Smith financed it through a title I loan, it would cost him \$63.80 a month.

If Smith had bought his house in 1948 with a 25-year mortgage, he still could get a \$2,000 advance today, even though his mortgage had not been paid down \$2,000—that is, providing his mortgage secured future advances up to a total stated amount. It could have read \$12,000. (For example, the Kentucky statute provides that additional advances shall not exceed \$2,000 in addition to the original amount loaned.)

The monthly cost to Smith under these circumstances would only be \$12.66, since in effect he would be paying his \$2,000 back over the balance of the life of the mortgage—in this case, 20 years.

Only about 20 percent of the open-end mortgages written today make express provision for open-ending beyond the original amount of the mortgage. Yet, legally there is little reason why this provision could not be generally adopted in just about every State in the Union.

It was William Levitt who first proposed this type of open-ending in 1946. He said then, "Today we have to tell our buyer, 'If you want to improve your house next year by adding another bedroom, you will have to pay for the improvement with short-term credit at 9.6 percent interest.'

"If I had included the extra bedroom in the first place, FHA would have taken it into account in determining the size of the mortgage. But FHA won't take it into account if the third bedroom is added 2 days or 2 years after the transaction is completed.

"It would be a very helpful thing if we could get a mortgage which would let us say to our customers, 'We have arranged your financing so that when your income increases and you want to add value-increasing improvements, you can get the money quickly at low interest with 20 years to pay it back, even beyond the original total of the mortgage and even before you have created more equity by paying your mortgage down.'"

While it is well known that VA permits additional advances under the mortgage, it is less well known that VA stands ready any time after the closing of the original loan to guarantee supplemental loans beyond the amount of the original mortgage, to cover improvements as well as repairs and maintenance. VA's approval will be given only to the original lender and only on condition that the veteran has indicated his ability to meet the extra obligation.

Since it obviously makes sense to the Smiths of the country, you may ask why the open-end mortgage is not more widely used. Actually, it is growing in use at the rate of \$100 million a year. Last year one-half billion dollars' worth of this credit was advanced. Contrast this with its \$34-million performance in 1943.

Here are the reasons why it is not as widely used as it could be:

1. Not enough consumers know about it. Not enough mortgage lenders know about it. And not enough dealers, realtors, builders, architects, and all the other people to whom America's homeowners turn for information know about it.

2. There is an awful lot of misinformation about its legality. Curiously enough, the laws of the land, as reflected in court decision and in the statutes, are far ahead of the thinking of most mortgage lenders. For with the possible exception of mortgages on homesteads in Texas, there is no legal doubt in the minds of many distinguished attorneys that a lender, anywhere in the United States, can readvance funds under a properly drawn instrument and have these funds secured by the original mortgage.

With your permission, Mr. Chairman, I shall leave with you a representative list of some of the lending institutions that have been making open-end mortgages for years. You will notice that just about every State in the Union is represented.¹

The only problems arise in connection with the costs of making additional advances. If the costs of the title search in a community are reasonable, then no problem arises. If they are too costly, then lending institutions that are anxious to extend long-term credit for needed home repairs can, in the majority of States, ignore the title search because an additional advance in superior to intervening liens, without actual notice of other liens.

Frankly, I don't see why FHA needs to concern itself with the lien status, any more than VA does, because that rests entirely with the mortgagee.

FHA doesn't concern itself with the variation in title costs under its title II program.

The use of the open-end mortgage provision in insured mortgages would in no way after the responsibility of the mortgagee, in the event of foreclosure, to make available to FHA a satisfactory title in exchange for debentures.

3. It takes a long time to get lending institutions to accept change. The acceptance of new concepts in the especially rigid field of real property is a particularly slow process.

But the mortgage form (and the deed of trust which is its equivalent in many States) according to Herbert Colton, former Assistant General Counsel of FHA, does from time to time respond to the evolutionary process. He points to the FHA insured mortgage as the most striking example.

He says that public opinion following the real-estate collapse in the 1930's demanded new mortgage financing concepts to correct the glaring weaknesses inherent in short-term loans bearing a low percentage to value and supplemented by secondary loans. In response, FHA developed and pioneered a new mortgage form. Its practicality, soundness and even the constitutionality of FHA itself was questioned by some. Legal thinking, however, quickly conformed to public opinion.

(I might add that savings institutions which were forbidden by State law in the 1930's from making loans for more than 66% percent of value quickly effected statutory changes which made exceptions of guaranteed and insured loans. But not all institutions conformed quickly. It took one of America's major financial institutions 10 years to accept the new-fangled idea of FHA.)

Mr. Colton goes on to say: "The current intense interest in conservation and rehabilitation of residential property now points up the lack of a satisfactory legal instrument for facilitating that kind of work. The open end properly used, offers a flexible legal form well adapted to this purpose."²

4. Perhaps the greatest deterrent to progress in the past has been the expense of making advances in some of the larger metropolitan markets.

Nearly all of the legal confusion has arisen from trying to solve this problem. Here is how the problem arises.

Let us go back to Mr. Smith. He asks his mortgage lender for the \$2,000 and the mortgage lender is quite willing to oblige, but he cannot let Mr. Smith have the advance unless it has the same first lien status as the original loan. The mortgagee, and quite properly so, has to satisfy his lawyer and his bank examiner that the homeowner has not put any subsequent lien on his house that might come between the first mortgage and the modernization advance. Otherwise, the lender would have a third deed of trust on his hands.

In other words, a title search and sometimes title insurance is required, and these procedures cost money.

It is no problem in most of the smaller communities of America, because attorneys' fees and abstract fees rarely run more than \$15 or \$20; even in such major markets as Chicago, Los Angeles, Minneapolis, or Cincinnati this is true.

¹ See item 1 in references: List of Lending Institutions.

² See item 2 in references: Reprint from House and Home, July 1953.

And in some of the high-cost areas, savings and loan associations either absorb some of the costs in order to keep the charges to the homeowner low, or they employ attorneys on a yearly basis to handle the bring-down search.

These institutions take an affidavit from the homeowner that there are no liens against the property. (This is done in States where the lending institution is convinced that the advance takes priority over intervening liens without notice.) These institutions operate, and very successfully, in a business risk basis. However, they personally know the homeowners with whom they do business and they also are in a position to readily determine the amount of equity each homeowner has.

Let's take a large metropolitan market where the cost of a search plus title insurance can be considerable—northern New Jersey, for instance. Here the search and insurance for a \$1,000 advance can run as high as \$100. Obviously, a homeowner would have to have a hole in his head before he would borrow \$1,000 and pay \$100 in fees.

To get around this situation, the New Jersey Savings & Loan League introduced an amendment to the Savings and Loan Act in the State legislature. As a result the Savings and Loan Act was amended, setting up a statutory open-end provision. Savings and loan associations were given permission to make additional advances up to \$1,000 or the amount the principal had been reduced, whichever is the lesser, without a title search. The statute recites that:

"All persons who acquire any rights in or liens upon the mortgaged real estate subsequent to the recording of any association's mortgage should hold such rights and liens up to the additional loans."

Not to be outdone, the savings banks of New Jersey had the Savings Bank Act amended to provide advances up to \$2,500. The ferment carried over into other States.

The Maryland statute was amended for all institutions, provided first lien statutes on advances for repairs, alterations, or improvements up to the original amount of the mortgage or \$500, whichever is the lesser.

The North Dakota statute was amended to permit savings and loan associations to make advances for maintenance, repairs, or modernization up to the original amount of the mortgage or \$2,500, whichever is the lesser.

In Massachusetts and New Hampshire, the amended statutes do not favor any particular class of mortgagor, but give or attempt to give first lien status for advances up to the original amount of the mortgage.

Actually, while the statutes passed to date do give partial relief to the homeowner, the net effect has been to hamper rather than help the program. Restricting advances to \$500 or \$1,000 defeats the real value of an open-end mortgage program. Obviously, these advances are too limited to help a homeowner who wants to undertake an extensive modernization program.

Restricting advances to the original amount of the mortgage will eliminate many of the 8 million families who bought houses after the war. Their mortgages, in most cases, have not been paid down enough.

Horace Russell, the outstanding authority on the open-end mortgage, believes that it would probably have been better to depend on the common law, which in nearly all States permits advances beyond the original amount of the mortgage, providing a maximum limit is spelled out in the mortgage. (The purpose of stating a specific amount: To put the world on notice.)

What a boon this would be to the millions of people who bought two-bedroom houses in the years after the war, and whose financial status has improved enough to afford the extra monthly payment a \$1,000 to \$3,000 home modernization would entail.

What, then, is the answer to reducing the cost of making additional advances in high-cost areas? Many attorneys, including Horace Russell, believe that in the majority of the States a title search isn't necessary. He says that in 31 States of the Union, those which by mortgage law or court decision follow the majority or California rule, no title search is necessary. Reason: The courts in those jurisdictions have ruled that an optional advance is superior to an intervening claim if the mortgagee had no actual notice or knowledge of the intervening lien. The only way for the priority of optional future advances to succumb to intervening liens is for the intervening lienor to prove that the mortgagee has actual notice or knowledge of the intervening lien at the time the advance was made.³

³ See item 3, p. 84, in references: Legal Bulletin.

Twelve States and the District of Columbia, according to Russell, probably follow the majority rule. However, because decisions are few, inconclusive, or incomplete in these States, and many times based on poorly drafted contracts, many prudent lenders will require a title search in the absence of a decision both clearly defined and directly in point, although an affidavit is usually relied upon where the advances are relatively small amounts.⁴

Four States, Illinois, Michigan, Ohio, and Pennsylvania follow the minority or Michigan rule, that the lien of an optional advance is inferior to subsequent incumbrances, even though it is made without actual notice of the intervening interest. Therefore a title search is unavoidable.⁵

Horace Russell contends that Texas follows the majority rule. He claims the law is well settled that property capable of being mortgaged may be made the subject of a valid open-end mortgage, and that optional future advances provided for therein, have full priority over subsequent liens whether such advances are made before or after attachment of the junior lien. However, he points out that a validly established homestead is incapable of being mortgaged in Texas, except for purchase money, taxes, work and material spent for improvement, and for improvement only when a lien consented to by a wife is given in the same manner as when selling or conveying a homestead. It would appear that an open-end form could be used for materials and work, but that in every instance when money is disbursed the association must purchase the vendor's lien, tax lien, or mechanic's lien, as the case may be, and advance no amount in excess of that actually used for proper purposes.

Now, while a great number of attorneys for local lending institutions in the 31 States subscribe to Horace Russell's view that a title search is not necessary, these attorneys (and they include some who like to wear both belts and suspenders) usually insist that the borrower sign an affidavit, swearing that there are no liens against the property and that he is still the owner. This is especially true if the client is an out-of-State institutional investor, who cannot hope to know each homeowner personally.⁶

Here is their reasoning:

1. A person who was the original mortgagor but who has since sold the property might fraudulently seek an advance;

2. An intervening lienor may have notified an employee of a lending institution in accordance with the law. But this employee may have failed to pass the information along to the mortgage officer, or the registered letter may have been misplaced.

So in the absence of court-tested statute, even though the common law is favorable, some lenders are going to insist on a search.

For these institutions, the problem then of the cost of a search is still with us. However, there are some very hopeful signs on the horizon. As the open-end mortgage increases in popularity, more and more title companies are establishing very reasonable rate schedules for the search and the insurance. And the title companies are discovering that it is profitable business.

The pioneer in this movement is the Los Angeles Title & Trust Co., one of the largest of the west coast companies. In 1925 it established special rates to make possible inexpensive financing for home modernization. It charges \$10 for a \$1,000 advance (this includes search and insurance), \$12.40 for a \$2,000 advance, and \$13.60 for a \$3,000 advance.

The service is so popular that nearly all of the lenders in southern California use it even though the California law is very favorable.

Chicago Title & Trust Co. is another example of an enlightened institution. It literally enjoys a monopoly in the Chicago metropolitan area, because the city of Chicago's realty records were destroyed in the Chicago Fire, and the Chicago Title & Trust's vaults were fireproof. Yet this public-spirited company established a special schedule of its fees for open-end mortgage advances: \$10 for the first \$1,000, \$15 for \$2,500.

The City Title Insurance Co. of New York, one of the pioneers in this movement, will insure advances for any lender in the United States for \$5 per \$1,000—a minimum charge of \$10. This company, working with the attorneys of Dime Savings Bank of Brooklyn, have even developed an insurable modification agreement that permits Dime Savings to open-end all of its \$400 million portfolio of existing loans, even though they contain no open-end provision.⁷

⁴ See item 3 in references: pp. 84-85, Legal Bulletin.

⁵ See item 3 in references: p. 85, Legal Bulletin.

⁶ See item 3 in references: pp. 105-106, Legal Bulletin.

⁷ See item 4 in references: Reprint from House and Home, December 1952.

Time and competition, in my opinion, will take care of most situations. The need for legislation at the State level will in the main disappear. Frankly, I should hate to see title companies, who serve a very necessary economic function in our economy, deprived of legitimate fees.

I suspect we will have to correct some of the hastily conceived faulty and too restrictive statutes. We will have to clarify the law in a few States such as Wyoming, Delaware, and Massachusetts. In Texas, either the homestead law will have to be changed or the practice of financing modernization through the purchase of vendor's, tax or mechanic's liens and a consolidation with the original mortgage will have to be encouraged through a reduction in the title insurance schedule now established by State law in many of the metropolitan areas of Texas. In the smaller communities of Texas, where the rates are not fixed by law, lenders and homeowners are accomplishing the same goal as open-ending does.

PROGRESS OF THE PROGRAMS

To begin with, the practice of making advances was confined to savings and loan institutions in rural and semirural communities. Very frequently the only assets a family possessed were the equity of its home and land. When Johnny went off to college, the homeowner got an advance to take care of his tuition. When mother had a new baby, the obstetrical bill was paid in the same way. When a successful crop came in, and this may have been 3 or 4 years later, the loan was paid down because the homeowner treasured his home. It served as his piggy bank. The practice grew because losses through the practice were almost nonexistent; the benefits to both borrower and lender obvious.

Today, not only savings and loan associations but also life-insurance companies and savings banks are enthusiastic supporters of the program. This is significant because it is considerably less profitable for an out-of-state institution to make advances, especially if the advance asked for is small. The cost of the paperwork alone would eat up the interest on a \$500 advance. Prudential, National Life of Vermont, and Northwestern Mutual are writing the open-end provision into all their mortgages. And just a week or so ago, another of the big four—New York Life—joined them.

In announcing its move, here is what Vice President Manning Brown had to say: "It could be a great advantage to the entire economy, especially in periods of decline in new construction. It would help take up the slack in a recession and may be a useful instrument in preventing neighborhood decay."

He goes on to say, "In addition to providing a greater outlet for investment funds (which also means a larger servicing portfolio for the correspondent), it can reduce relative servicing and overhead costs each time an outstanding loan balance is raised."

"It tends to protect the lender's seasoned loan against refinancing with some other lenders. It encourages the borrower to keep his original loan or to apply to the first lender when he seeks any new refinancing."

"When readvances are spent for home improvements or repairs, they improve the security behind the lender's entire outstanding mortgage balance on the property."

"And," adds L. Douglas Meredith, executive vice president of National Life of Vermont, "The borrower has not strapped himself with a high-cost short-term loan to cover the cost of needed repairs or improvements. It also enables the homeowner to buy both material and equipment that he could not afford on short-term credit. Inferior materials would either run him into excessive maintenance costs or make him let his property deteriorate, either of which is bad for lenders."

Incidentally, New York Life will probably allow maximum reborrowing in excess of the original amount of the mortgage except in States where legal technicalities make it inadvisable.

Last year \$500 million worth of additional advances were made and the United States Savings & Loan League predicts that savings and loan associations of the United States will do a half billion dollars' worth in 1954.

And the surface has just barely been scratched, judging from a recent Federal Reserve Board Survey. It shows that as of January 1949, one-half of the 9 million families who own mortgaged homes have equities of 50 percent or more in their properties. The equities claimed by the nine million families amount to \$48,600 million.

And if we are to take into account all possible methods of long-term financing of homes now free and clear, as well as advancing under old mortgages or recast-

ing them, the credit potential is staggering. For according to this same Federal Reserve Board survey, the 20 million nonfarm families who own homes, claim equities totaling \$148 billion—and 11 million of the 20 million own their homes free and clear.

Now, while we are not advocating that every homeowner should rush out and mortgage his debt-free home, it is comforting to know that low-income homeowners (and remember they represent 56 percent of United States families) now have the means of financing needed modernization in good times or bad on terms that won't strap them. The homeowner who can afford it would be well advised to pay cash or use short-term credit.

Debt-free homeownership is a fine thing. It is a tribute to the thrift and good sense of our people that more than half of them own their homes free and clear. However, in many cases the home investment represents the owner's entire savings and assets. And if the owner chooses to make liquid part of this investment (to keep up his home) through the use of the long-term mortgage rather than borrowing on high-cost short-term credit, I don't believe this is an unwise practice.

Of course, he could choose not to maintain his home, but the net result would be a depletion of his equity and also the equity of the man next door.

To us the chief importance of the long-term mortgage credit is the opportunity it holds for recognition of the mortgage as a social instrument of prime importance. Every lender knows that one chief reason for foreclosure is the homeowner's tendency to overload himself with installment credit. The use of the mortgage as a basic credit instrument for home modernization would establish the local mortgage lender as a permanent credit counselor to the homeowner of limited means.

An official of one of the west coast's leading financial institutions that specializes in short-term credit told me this story that highlights the need of separating the sales from the lending function: A mutual friend of ours not too long ago put up a thousand very attractive, inexpensive homes for minority steelworkers near San Francisco. For the first time in their lives the Negro occupants of these homes became eligible for credit because they were men of property. Within a few days after these poor folks moved in, a hoard of dynamiters came knocking on their doors.

"How would you like some of this (synthetic) brick siding put on over that ugly redwood siding," or, "How would you like this barbecue pit? Just sign this title I form and we will take care of the rest."

They did. Before the year was out, a good number of these innocents were over their heads in debt. Nor did the short-term credit outfits who made these unnecessary title I loans even bother to check with each other to see if the homeowners were overextended. They were protected against loss up to 10 percent.

As a result, a number of these unfortunate people contracted to pay monthly installments, including the mortgage payments, that exceeded their incomes. And you can guess what happened under the circumstances.

If the homeowner had gone to his mortgage lender, the lender would have talked him out of dealing with disreputable fly-by-night operators, and out of making a lot of useless expenditures. Or, if modernization was needed, the lender would have helped him with an additional advance.

If credit is understood in its fullest importance to our whole economic system, there would seem no safer or more intelligent way to employ it than to relate it to the prime security owned by the majority of United States families—a house and land.

In conclusion, I hope that you will not only see fit to give FHA authority to insure additional advances but will consider liberalizing the provisions of the Servicemen's Readjustment Act relative to such supplemental lending for purposes of repair or improvement of veterans' homes.

Bert King points out: "As the law now provides, the Veterans' Administration cannot extend guaranty coverage comparable to the proposed FHA program without a change in the existing statute, since the \$7,500 entitlement currently available to veterans under section 501 (b) of the act is restricted to loans for the purchase or construction of residential property to be occupied by the veteran as his home. Consequently, additional entitlement for supplemental loans for the alteration or improvement of the veteran's home is available only if he used less than \$4,000 of his entitlement in connection with the purchase or construction of his home. In recent years most veteran home purchasers have used at least \$4,000 of their entitlement in connection with the original purchase of the

home, and accordingly have no entitlement available for alteration or improvement advances. Naturally, lender interest in making such advances would be stimulated if some additional guaranty protection for such advances were obtainable. Furthermore, the housing needs of a large segment of the 3 million families who have obtained homes with the assistance of GI financing have changed materially due to increasing family size, and in many cases there has been an improvement in the economic status of these homeowners. It is to be borne in mind also that in many instances a substantial reduction in the mortgage debt has taken place since the home was purchased. Those veterans are now in a position to undertake the responsibility entailed in financing improvements and alterations in their homes. If a lender is willing to make a GI supplemental loan, the veteran obtains the advance on a low-cost, long-term repayment basis, and the primary loan is not jeopardized by the high carrying cost of short-term improvement loans. Such a result could be obtained in many cases by removing the existing limitation on the use of the currently authorized \$7,500 maximum by a simple amendment to section 501 (b) of the Servicemen's Readjustment Act of 1944, as amended, permitting the \$7,500 maximum to apply to loans for alterations, improvements, and repairs, as well as the purchase and construction of residential property and by removing the April 20, 1950, date limitation."⁸

REFERENCES

- Item 1. List of some lending institutions making additional advances.
 Item 2. Can FHA Insure Open-End Mortgages? article reprinted from *House and Home*, July 1953.
 Item 3. Legal Bulletin, published by the United States Savings and Loan League, September 1953 issue, featuring, *The Flexible Mortgage Contract*, by Horace Russell and William Prather.
 Item 4. Dime Savings Bank of Brooklyn Writes Open-End Mortgages Clause Into All Its Family House Mortgages, article reprinted from *House and Home*, December 1952.
 Item 5. Open-End Mortgage: Good Business Bet, Not a Legal Problem, article reprinted from *House and Home*, September 1953.

The CHAIRMAN. I think perhaps the committee will be interested in Mr. Goldman's statement in connection with the testimony which we have had concerning the use to which open-end mortgages have been put in the various States which authorize them.

The committee will stand in recess until tomorrow morning at 10 o'clock.

(Whereupon, at 5:34 p. m., the committee adjourned.)

(The following statements were submitted to the committee:)

CONGRESS OF THE UNITED STATES,
 HOUSE OF REPRESENTATIVES,
 Washington, D. C., March 6, 1954.

HON. JESSE WOLCOTT

House of Representatives, Washington, D. C.

DEAR JESS: Enclosed you will find a letter addressed to me by Mr. B. J. Staal, treasurer of the Holland Furnace Co., which company, as you know, is located in my congressional district.

Mr. Staal, on behalf of the Holland Furnace Co., has requested that his letter in reference to H. R. 7839 be included in your committee's hearings on this proposed legislation. I hope and trust that Mr. Staal's letter can be made a part of the hearings. As you will note, the Holland Furnace Co. does endorse the administration's proposals for title I with a specific recommendation concerning the breakoff problem.

With kind personal regards and very best wishes.

Sincerely,

GERALD R. FORD, JR.,
Member of Congress.

⁸ From statement of T. B. King, Acting Assistant Deputy Administrator (Loan Guaranty), Department of Veterans' Benefits, Veterans' Administration. Under the VA supplemental loan procedure, open-end mortgage provisions may be utilized for such purposes, but additional guaranty coverage of the advances made under open-end mortgage is available only to the extent that the veteran has unused guaranty entitlement available.

HOLLAND FURNACE CO.,
Holland, Mich., March 5, 1954.

Re Housing Act of 1954, H. R. 7839.

HON. GERALD R. FORD,
House of Representatives,
Washington 25, D. C.

DEAR SIR: During the lifetime of the Federal Housing Administration, this company has financed under Title I—Property Improvement and Repair Loans a total in excess of \$265 million.

We heartily endorse the administration's program of not only continuing FHA, but also making certain amendments which should stimulate full employment and production. Our company alone employs several thousands of workers who will be benefited by these amendments. Over the industry this number can be multiplied into hundreds of thousands who will be kept gainfully employed.

The proposed amendment under the above-mentioned section whereby the maximum term of such loans would be increased from 3 years and 32 days to 5 years and 32 days, with a maximum of \$3,000 instead of \$2,500, meets with our hearty endorsement.

Loans under this section are made to homeowners who have equity in their property. Since it is obvious that homeowners are a dependable class of purchasers, we not only endorse a 5-year and 32-day maximum term, but we feel that this should be passed without any restrictive clause. There may be some thought of a breakoff point where, for example, loans under \$1,000 would be subject to 3 years and over \$1,000 to the 5-year maximum. We believe that such determinations, if any, should be established by banking interests and industry rather than through an arbitrary law or regulations to be enforced by FHA.

We believe it practically impossible to establish an arbitrary breakoff point on a nationwide basis which would work equitably and fairly to cover the individual homeowners' needs at the local level. Furthermore, such an arbitrary figure, if it is to be policed by FHA, would necessitate extra Federal controls instead of less of them. It should be the responsibility of banking interests and industry to devise sales plans within the scope of the amended act which would be patterned to fit the pocketbook of the individual homeowner. Only then can the amendments assure the maximum good for the most people.

Our company sincerely believes that the Federal Housing Administration has done an excellent job. We also believe that the present administration is taking another forward step to improve the benefits under the Housing Act, which should stimulate and increase full employment and production in the housing field.

Respectfully submitted.

B. J. STAAL, *Treasurer*.

STATEMENT OF LEE C. BEAN, CHAIRMAN, LEGISLATIVE COMMITTEE,
WHERRY HOUSING ASSOCIATION

Gentlemen, my name is L. C. Beane and I am chairman of the legislative committee of the Wherry Housing Association. The Wherry Housing Association is an association of owners of military housing financed under title VIII of the National Housing Act. The owners in the association represent approximately 40,000 of the 71,766 units which were completed and in operation as of December 31, 1953.

There is a very pressing need for housing at military installations which cannot, at this time, be deemed to be a permanent part of the Military Establishment and eligible for title VIII mortgage insurance. The Wherry Housing Association would like to recommend for your consideration amendments to the National Housing Act which, in our opinion, would enable private enterprise to furnish necessary and adequate housing for personnel at installations which cannot qualify for Wherry housing under the present provisions of the National Housing Act by reason of the fact that the installations requiring housing cannot be certified as a permanent military installation. The activity at these installations is for an indeterminate duration, maybe 10 or even 25 years or possibly longer. We think title VIII can also provide housing at many of this type of installations.

In order to provide housing at installations which cannot be certified as permanent, it is recommended that section 803 be amended to add to the present insurance provisions a program for housing at Military Establishments when

there is a need to provide adequate housing for the personnel at such installation and there is no present intention to substantially curtail activities at such installation.

Eligible mortgages under title VIII may not exceed 90 percent of the amount which the Federal Housing Commissioner estimates will be the replacement cost of the property or project when the proposed improvements are completed or \$8,100 per family unit for such part of such property or project as may be attributable to dwelling use, except that in exceptional cases where the Secretary of Defense and the Federal Housing Commissioner concur that the needs would be better served by single-family, detached, dwelling units, the mortgage may involve a principal obligation not to exceed \$9,000 per family unit for such part of the property as may be attributable to such dwelling units.

It appears that in order to assure the success of this proposed program it will be necessary to increase the existing authorized insured mortgage limitation from its present 90-percent limitation to 95 percent of the amount which the Commissioner estimates will be the replacement cost of the property or project when the proposed improvements are completed. This increase is designed to minimize the increased hazard to the sponsor for his making the said investment in the required housing on a base which cannot be certified as permanent.

The existing dollar limitation of \$8,100 per family unit for such part of the property or project as may be attributable to dwelling use, with the additional proviso for a mortgage of \$9,000 per family unit where it is determined that a single-family, detached dwelling would better serve the need should be adequate under the proposed program.

It appears that the amendment would require several provisions substantially as follows:

1. After the last word in section 803 (b) (2) delete the period and substitute a semicolon and add the following:

"and provided further, That where the installation is not a permanent part of the Military Establishment and the Secretary of Defense or his designee shall have certified to the Commissioner that such installation is an essential part of the Military Establishment, the mortgage shall be insured under this title."

2. In section 803 (b) (3) (B) delete the word "and" after the semicolon and insert the following:

"except that where the Secretary of Defense or his designee certifies that the installation is an essential part of the Military Establishment the mortgage may involve a principal obligation not to exceed 95 percent of the amount which the Commissioner estimates will be the replacement cost of the property or project when the proposed improvements are completed; and."

3. Delete section 803 (b) (2) (C) and substitute the following:

"(C) not to exceed an average of \$8,100 per family unit for such part of such property or project as may be attributable to dwelling use where such family unit is for an installation that is a permanent part of the Military Establishment; and

"(D) not to exceed an average of \$8,550 per family unit for such part of such property or project as may be attributable to dwelling use where such family unit is for an installation which is an essential part of the Military Establishment.

"*And provided further*, That where the Secretary of Defense or his designee in exceptional cases certifies and the Commissioner concurs in such certification that the needs would be better served by single-family detached dwelling units the mortgage may involve a principal obligation not to exceed \$9,000 per family unit for such part of such property as may be attributable to such dwelling units."

The association recommends that the proposed Housing Act of 1954 specifically limit the rate of interest which may be charged on a title VIII loan to 4½ percent per annum. This is extremely important as interest rates in excess of that amount will defeat the purpose of the military housing program by requiring rentals in excess of the ability of the intended tenants to pay. Each one-quarter of 1 percent increase in interest rates on a \$8,100 mortgage increases monthly rentals to tenants by approximately \$1.80. As an example a 4½ percent interest will require \$3.58 per unit per month more rent than a 4 percent interest rate for the identical housing accommodations and a 5 percent interest rate would raise the rentals \$7.17 per unit per month. An analysis, showing the effect of increased interest rates is attached.

The only alternative would be to reduce the size and quality of the house to the extent that it would not be desirable permanent type of accommodations and

defeat the purpose of the legislation to provide adequate low rental housing for military personnel.

It is therefore recommended that there be inserted after line 14, page 41, of section 201 of the bill the following:

"Notwithstanding the provisions of this section, mortgages insured under title VIII of the National Housing Act shall bear interest (exclusive of premium charges for insurance) at not to exceed $4\frac{1}{2}$ per centum per annum of the amount of the principle obligation outstanding at any time.

Experience indicates that the Government financed secondary mortgage market is essential to the successful operation of any military housing program. There is no question that such would even more so be the case in respect to continued use of the title VIII program herein proposed. The proposed Housing Act of 1954 contemplates the recharting of the Federal National Mortgage Association, substituting private financing for Federal funds. In order to provide adequate financing at reasonable interest rates and thus assure the feasibility and workability of this proposed program, it is recommended that there be added to section 306 of the proposed Housing Act of 1954 the following:

"Notwithstanding subsections (a) and (b) of this section, the Association is authorized to enter into advance commitment contracts to purchase, and to purchase mortgages with respect to which the Federal Housing Commissioner has issued a commitment to insure or a statement of eligibility under title VIII of the National Housing Act, as amended. Any advance commitment contract under this subsection shall provide for purchase in the amount of the insurance commitment. However, no mortgage may be purchased for an amount exceeding the principle balance thereof, plus accrued interest, at the time of purchase."

The proposed Housing Act of 1954 contemplates the extension of title VIII for a period of 1 year. In order to permit sufficient time to properly determine the need for military housing and to permit adequate planning and processing, it is recommended that section 126 of the proposed Housing Act of 1954 be amended to read as follows:

"Section 803 (a) of the said Act, as amended, is amended by striking out *And provided further*. That no mortgage shall be insured under this title after July 1, 1954, except (A) pursuant to a commitment to insure issued on or before such date, or (B) a mortgage given to refinance an existing mortgage insured under this title and which does not exceed the original principle amount and unexpired term of such existing mortgage."

The 1-year limitation in the act is present due to the custom that has grown up in this type of legislation which follows the pattern set in title VI, section 608, as well as title IX. The limitation as applied to the military program should be removed for the following reasons:

1. Military programing and development of bases required more than 1 year due to the contingencies of the availability of public works funds to complete the base structures.

2. The development of a housing project normally requires more than 1-year of planning, engineering, and legalwork.

3. The military program requires that the plans be developed and paid for from appropriated funds and reimbursed from construction or mortgage funds at the closing. The military departments cannot conscientiously spend appropriated funds in the processing period left in any year for such if you make it reasonably certain that a commitment could not be obtained prior to the automatic expiration of the insuring authority.

4. Removal of the automatic cutoff date will not cause increased numbers of projects but will develop better projects in that adequate time may be given to planning and development to ensure the military will receive the best housing for the rent dollar.

5. The limitations proposed in the bill adequately limit the Government insurance risk. Consequently, there would appear to be no real benefit gained by continuing the yearly cutoff on the Wherry program.

It is recommended that the provision for a cost certification, added to section 803 (b) of the National Housing Act by section 10 (b) of Public Law 94, 83d Congress, be eliminated. This provision requires the mortgagor under a title VIII FHA-insured mortgage to agree to certify either (a) that the amount of the actual cost to him of the physical improvements on the property equaled or exceeded the proceeds of the mortgage, or (b) the amount by which the proceeds of the mortgage loan exceeded the actual cost of the physical improvements. In the latter case, the mortgagor would be required to agree to repay to the

mortgagee, within 60 days after the certification, any excess of the amount of the mortgage loan over the actual cost of the improvements.

Under the bid procedures which the Department of Defense is presently following in respect to the award of title VIII certificates of need, the requirement for a cost certification is needless. It is our recommendation that this provision be eliminated from title VIII.

Title VIII was designed to provide housing for military personnel under the private enterprise system and in keeping with the private-enterprise system we deem it essential to make provision for and create incentive for efficient, well organized know-how in the planning, construction, and management of said housing. The sponsor is required under the present statute to give a firm bid price for the providing of the said housing and further is required to put forth his private funds to augment any deficiencies in the amounts allowed for in said bid to complete and provide the housing. When a sponsoring organization is a successful bidder under the bid procedure, he is, generally speaking, receiving less mortgage money than the maximum mortgage the FHA is willing to insure. All of this constitutes the normal calculated risk of the sponsor under the private enterprise system. The present statute further provides that in the event the sponsor is successful in completing his project at something less than the amount of the mortgage, which is predicated on his bid, he is required to return same within 60 days. The association takes the stand that this final statutory requirement is inequitable and defeats the private-enterprise system of competitive bidding.

Mortgagees are not particularly interested in acceleration and mortgage payments through this method. They are primarily interested in money invested in order to receive the return. The military departments, on the other hand, receive no reduction in rent due to the efficiency of the builder. Consequently, whether he makes or loses money in the project is of no particular practical importance to the prospective tenants, to the mortgagee, or the FHA.

Effect of increased interest rates on average Wherry housing mortgage of \$8,100

Percent rate	Rate per \$1,000 amortization and interest	Amortization and interest per \$8,100 mortgage	Insurance	Total payment per \$8,100 mortgage	Cumulative increase (PUPM base)	Vacancy		Installment (months)
						3%	7%	
						Rent increase		
4		\$37.13	\$3.38	\$40.51				391
4½	4.791667	38.81	3.38	42.19	\$1.68	\$1.79	\$1.86	381
4¾	5.0	40.50	3.38	43.88	3.37	3.58	3.74	374
5	5.20833	42.19	3.38	45.57	5.06	5.38	5.61	362
5½	5.41667	43.88	3.38	47.26	6.75	7.17	7.48	353
5¾	5.625	45.56	3.38	48.94	8.43	8.96	9.34	345
6	5.8333	47.25	3.38	50.63	10.12	10.76	11.22	337
6¼	6.041667	48.94	3.38	52.32	11.81	12.55	13.09	330
6½	6.25	50.63	3.38	54.01	13.50	14.35	14.97	323
6¾	6.45833	52.31	3.38	55.69	15.18	16.13	16.83	317
7	6.66666	54.00	3.38	57.38	16.87	17.93	18.70	310

NOTE.—See the following:

Mgmt. Vacancy
 1.97×97=94.09 percent.
 2.97×93=90.21 percent.

STATEMENT OF MRS. JENCY PRICE HOUSER, NATIONAL ORGANIZER FOR PERMANENT HOUSING DESIGNED FOR OCCUPANCY BY SINGLE PERSONS

Mr. Chairman, my name is Mrs. Jency Price Houser, national organizer for Residence at Ease Association and the Cause of Permanent Housing Designed for Occupancy by Single Persons.

We have been active in the development of mutual housing plans on a national basis but principally in Detroit, Mich., and Washington, D. C., for the purpose of providing permanent housing designed for occupancy by single persons.

We are coming back to Congress for assistance after having advocated the passing of paragraph (g) of section 213 of the National Housing Act in 1950. Now, we wish to support enactment of section 119 of H. R. 7839 (Cooperative Housing, section 213 of the former act), with regard to which we have the following two suggestions to make:

1. In connection with section 213, Management Type Projects, there is an administrative requirement under FHA that needs an amendment, because FHA requires that a commitment may not be issued pursuant to a certificate of eligibility until 90 percent of the cooperators have been obtained and their required subscription prices have been fully paid. This seems to us to be too costly, delaying the obtaining of a sponsor for this type of building. Moreover, it seems to be a great handicap since the lining up of would-be tenants before any financing or building can be started has led to much misunderstanding and violent criticism on the part of those who are accustomed to projects being built under section 207, which allows for buildings to be sponsored first and the tenants found afterward. Even officials have considered it a misrepresentation to act on this part of the legislation, which requires 90 percent of the cooperators before a certificate of eligibility can be obtained, and it has become quite an imputation of wrongdoing that there are prospective tenants but no building.

It is therefore recommended that section 213 be amended to provide for the issuance of the commitment to a sponsoring group, in the same manner and with the same provisions as are permitted under section 207, but providing means for a special trust.

2. Our second suggestion is that paragraph (g) of section 213 of the National Housing Act of 1950 should be expanded into a whole section, embodying the provisions under section 207 and the special trust. Section 213 (g) reads as follows:

"Nothing in this act shall be construed to prevent the insurance of a mortgage under this section covering a housing project designed for occupancy by single persons, and dwelling units in such a project shall constitute family units within the meaning of this section."

There should be provided a means, through the special trust, of making use of private investment capital for long-term loans at low interest rates for financing the development of housing projects designed for single people as members of nonprofit organizations. This trust should make possible the investment of private capital through the same type of guaranty as has been so successfully used in the mortgage-insurance system of the Federal Housing Administration. The trust should also be so designed as to make this program a self-sustaining program, similar to the FHA, with adequate protection to the Government by a specific insurance fund reserve for possible losses, to be built up by an annual premium charge of one-quarter of 1 percent of the outstanding loan balance paid by the borrowers, and by additional protection against possible losses, in the form of a cushion of private capital supplied by the borrowers through the purchase of units in the trust, in an amount equal to 20 percent of the original principal amount of the loan. The Government should supply the initial capital through the purchase by the Secretary of the Treasury of up to \$10 million of capital stock in the trust, or encourage private individuals to do so. However, when the privately subscribed share capital reaches \$5 million, the Government stock would be retired, dollar for dollar, as additional private share capital was paid in. The \$10 million of capital initially supplied by the Government would thus be replaced with \$15 million of privately subscribed share capital. (This private share capital could be supplied by beneficiaries or others, including States or municipalities.)

The total amount of obligation which the trust should issue and have outstanding at any one time should be limited to \$100 million, all of which would be private investment. Of this maximum authorization, \$10 million should become available by July 1, 1954.

This program should use essentially the same form of organization as is used in the case of the Federal home-loan banks. It would combine the best features gained in the course of more than 15 years' experience with the FHA and the Federal home-loan banks—two of our successful means of Government assistance to private enterprise in housing.

Secondly, we suggest it should provide for the necessary technical assistance and advice in the organization of self-help housing trusts and similar nonprofit organizations, and for the planning, financing, development, construction, and operation of the various housing projects.

Thirdly, we feel strongly that it should make limited financial assistance, in the form of preliminary advances of funds, available to soundly organized self-help housing trusts and similar nonprofit organizations to enable them to develop specific plans for their housing projects.

As far as we know, ours is the only organization devoting itself to paragraph (g) of section 213 of the Housing Act of 1950, and we are making strenuous efforts against heavy odds to promulgate this program, which is so much needed by at least 2 million persons.

An analysis of this need and of our efforts to meet it is in a separate document submitted herewith.

HOUSING DESIGNED FOR SINGLE PEOPLE—THE NEEDS OF 2 MILLION

There are at least 2 million American citizens for whom we believe that housing should be specially designed; and some of them are already in dire need of it. These people are very worthwhile citizens, and yet are pushed around by circumstances to an unsuspected extent, especially as they get older.

We are referring to the single women in America who are over the age of 30 or so; institutions like the YWCA take care of those who are below that age. It quite often happens that, as a single woman gets near the retiring age, she is asked to leave accommodations where she has lived, possibly for many years.

So as to be modest and within range of possibility, and also to allay any thought of our trying to take on more than we can fulfill, only 4 percent of the need is what we are expecting to help, which is 1 person in 25.

The needs of single people have been curiously omitted from housing debates. We think that there should be housing specially designed for those having passed the age of 30, and so designed that the tenant may expect to continue living there in old age. There are definite points where housing designed for single people must differ from housing designed for families, and we have spent time, energy, thought, and money in developing a model design to meet the needs of such people.

We were forced to consider the housing of single people from a national standpoint. A local project was too small to interest those with big money. Even from a national standpoint it is proving difficult; but it would have been impossible from a local standpoint only. Legislative people as a whole are not interested unless something has a national aspect, because it must touch their own constituents. An architect is interested when his work may be reproduced often enough for him to receive sufficient remuneration for the expense of providing the first plan on a nonprofit basis. The same is true with regard to organization, legislation, contracting, financing, and all other phases of development.

The persons for whom we are catering are women living alone, many of whom have spent their lives working conscientiously outside the home, or women whose husbands have died and whose children are on their own (or would be if they were not obliged to live together for lack of just such housing as that which we are aiming at providing), or widows who have never had any children. Single men and women often occupy houses or apartments which could serve for whole families just in need of such accommodation.

Privacy and undisputed ownership, even though their tenancy is limited to one room, will be deeply appreciated by the tenants and do much to lessen the strain which, in later life, might lead to unbalance and possibly becoming a ward of the State. One room is all that is essential for a single person's happiness, if it is the kind of room we mean to provide, and it is all that is wise for an aged person to be responsible for. There will be a healthful sense of security in being sure of one's own place permanently. There is safety in company for person and property, and there are also certain big advantages which the tenants will appreciate as they become old. A great deal of research has been undertaken on the kind of housing best suited to single people.

Much research has also been done on methods of financing, and the founders of the project originally expected that a sponsor would be forthcoming to supply the equity needed for getting a mortgage insured by the Federal Housing Administration. It was not found easy, however, to obtain such sponsors. The middle-income housing act which was voted on in the spring of 1950 and lost by 3 votes, originally provided for the setting-up of a giant revolving fund which would, of course, have provided money with which to build, and rapidly. The trust fund plan we propose would build upon a sounder and more mutual foundation, we think.

One of the original features of this project is that of lining up the prospective tenants before a building is started. This is in accordance with section 213 of the National Housing Act of 1950, but unfortunately doing this has led to much misunderstanding and violent criticism on the part of those who are accustomed to projects being built under section 207, which allows for buildings

to be sponsored first and the tenants found afterward. It has even led to officials stating that a sponsor has no place in the plan. Hence the preference for section 207.

This is a very modest effort to set forth the values of the cause of housing for single people, which was born in a spirit of self-helpfulness and brought up through the unselfish devotion of many who contributed services with either no reward or at most very little. If the same effort had been paid for on a normal commercial scale, it would have cost many times as much as all the actual cash made available.

Ours is a plan to meet new needs, in the same way as the return of a large number of veterans from the First World War presented a new social problem to the Nation and led to the present highly developed DAV association and Veterans' Administration.

Statistics show that there are more single people in the country than there have ever been—that they will increase in numbers—and that some 20 years of life expectancy have been added to them. We believe we are, so far, the pioneers of housing specially designed for this group of citizens.

NATIONAL FARMERS UNION,
Washington 5, D. C., March 15, 1954.

HON. JESSE P. WOLCOTT,
Chairman, House Committee on Banking and Currency,
House Office Building, Washington, D. C.

DEAR CONGRESSMAN WOLCOTT: Enclosed are copies of a statement in support of H. R. 7902 introduced by Congressman Robert E. Jones, Jr., Eighth District, Alabama, and referred to your committee on February 16.

We urge that this bill which extends the authorities of title V of the Housing Act of 1949 be given favorable consideration.

I request that the enclosed statement of Mr. James G. Patton be inserted in the record of your hearings.

Sincerely yours,

JOHN A. BAKER,
Assistant to the President.

FINANCING FARM HOMES—STATEMENT OF JAMES G. PATTON, PRESIDENT, NATIONAL FARMERS UNION

For decades there has been a growing realization of the importance of housing to the health and the social and material well-being of people and a recognition that the public interest requires special ways and means of enabling low-income groups to gain access to better housing facilities. For the most part, however, inadequate housing has been associated with city or urban dwellers from the public point of view. This apparently is just as true today as it was when major attention was first focused on the problem of providing adequate housing in the early thirties. Little thought is being given to the rural housing situation now. The administration's program is deficient in the substantial neglect of the whole problem of rural housing. Yet the fact is that farm dwellings in general are inferior to those of urban families.

A far greater percentage of farm families live in substandard homes than do urban families. Nationwide, 1 out of every 5 farm families live in a house so dilapidated that it needs to be completely replaced or have major repairs. In contrast, only about 1 out of 20 urban homes are so classified.

The Farmers Union recognized the need for financial assistance to both farm and city dwellers when the Housing Act of 1949 was passed by the Congress. The need still exists for further assistance to low income families, with particular emphasis on the low income families on the farms of the Nation. The rural families who need housing credit of the type heretofore available through the Farmers Home Administration, pursuant to title V of the Housing Act of 1949 can be divided into three groups.

The first group is that of capable young farmers with little accumulated money or other resources who are finding it more and more difficult to meet the increasing capital requirements of farming. The increasing cost of operating essentials such as machinery, fertilizer, insecticides, and fuel, plus the lack of housing credit on terms geared to the income from farming, means that most of these families are destined to spend their most productive years in grossly inadequate homes.

This period in most cases extends beyond the years of greater family need—the years when children are in the home.

The second group is made up of families who have been unable to obtain the credit needed to construct or make changes in existing service buildings which must be done if they are to keep pace with changing agricultural patterns. For example, for a family to shift successfully from a one-crop system of farming to a diversified program in which dairy cattle, beef cattle, swine, or poultry are included, or a combination of such enterprises, requires adjustments in housing facilities.

The third group are families living in rural areas but who because of inadequate land resources or other reasons are not engaged in farming on a full-time basis. Among the majority of these families, farming operations of a subsistence nature are carried on to supplement whatever income is earned from off-farm sources. Families of this type would be eligible for housing credit under title V of the Housing Act if the agricultural commodities produced for home use or sale have an annual gross value of at least \$400 based on 1944 commodity prices.

Before families may receive farm-housing loans under this act, they must be farm owners, be unable to get a loan from conventional sources and lack the necessary capital to make the needed improvements. Although tenants and farm laborers are not eligible, owners may borrow to repair or build houses or other farm buildings for the use of tenants and farm laborers.

The original act authorized appropriations of \$275 million to be made available for credit to rural families. Only about one-third of this amount was actually made available. The building material shortage held up the programs for 2 years. The Farmers Union strongly urges that the balance of amount authorized under the original act be made available.

The farm-housing loan program has been embraced by rural families throughout the Nation. Inquiries and requests for loans began coming in weeks before funds were available at the inception of the program in 1949. More than 21,700 written applications were made in local offices of the Farmers Home Administration between the date of the first loan, November 17, 1949, and June 30, 1950. Less than 4,000 loans were made during this period. This interest on the part of rural families has not subsided. The scope of the program has been limited only by the funds available. During the 1953 fiscal year the demand for farm housing loans was so heavy that funds were exhausted in most States in the fall and early winter. Lending activity was suspended in February 1953 because applications from eligible families were far in excess of the funds available.

Families numbering 19,082 have benefited from the \$94,356,000 of farm-housing funds that have been made available. With these funds they built or repaired over 16,000 farm homes, almost 14,000 farm-service buildings and 7,200 water systems.

The largest number of new homes have been constructed in the Southern States where the need is greatest. The average cash cost of the new homes was only \$6,377 a relatively low figure because most families used materials produced locally and contributed to the building of the house with their own labor. The practicality of the program is illustrated in the many cases in which salvaged material and timber, sand, gravel, and stone came from the farm. The value of labor and material furnished by participating families averaged \$650.

Among the improvements made were additional rooms, new roofs, porches, steps, and repainting and installation of modern conveniences. Improvements in the form of modern conveniences included running water in 1,235 homes, electricity in 1,043, both fixtures in 1,171, hot water heaters in 699, and central heating in 402. The average cost of repairs and improvements was only \$2,711 including \$389 in labor and materials contributed by the families.

Repayments on farm-housing loans are scheduled by the Farmers Home Administration according to the amount advanced and the family's ability to pay. The largest loans, those made for new construction, have been set up for period of 20, 25, or 33 years, and the smaller loans, those made for repairs and improvements, have been set up for 5, 10, or 15 years. As of January 31, 1953, 95 percent of the borrowers had paid all that was due, and 28 percent had paid an average of \$215 in advance of scheduled payments. Although none of the loans have matured, 877 have been repaid in full. About 150 of these loans were repaid when borrowers were able to obtain refinancing from banks or other conventional sources.

The repayment record of these families is of particular significance when consideration is given to the fact that they did not have sufficient resources to

meet the credit requirements of conventional lenders for a construction or improvement loan.

As can be readily seen, these families need only adequate credit on reasonable terms to demonstrate that they are good credit risks.

We have accomplished marvels of production during the past years beginning with World War II. To bring about the orderly transition to a peacetime economy, we must maintain and increase this production. One of the ways to maintain and increase production is to make broad plans in the housing field. Where during the 10 years before the war an average of less than 275,000 nonfarm houses were built each year, we should now set a goal of over 1,500,000 houses a year, including farm and nonfarm units. Instead of investing about \$1 billion a year in the building of housing, we must invest \$7 or \$8 billion a year. But such a program cannot be developed through timidity such as that displayed by those who fail to recognize the housing needs of our rural people. On the other hand, the type of rural housing program I visualize will be developed through new, bold measures.

The kind of growth we need cannot all take place on credit supplied by private sources. Public funds are needed to raise the housing standards on the farm. Long-term loans at low interest rates, such as those provided for in title V of the Housing Act of 1949, are needed to stimulate the construction of housing for farmers and other low-income groups—who do not need subsidy, but who cannot obtain credit from private lenders. We cannot have a well-rounded housing program unless the credit needs of farm families are adequately met.

The kind of public and farm housing program I am referring to creates a market for the products of private industry. I believe also that a comprehensive program of public housing will stimulate housing demands. These demands will in turn open a bigger market for private home builders.

The effect of an adequate rural housing program in providing employment must not be overlooked. It has been estimated that 505 man-hours of skilled labor and 500 man-hours of unskilled labor, a total of 1,005 man-hours, is represented in labor at the site for the complete construction of a house. While no estimate is available for the hours of labor in off-site construction or related activities in the building of a rural house, the figures available as a result of the USHA urban program are significant. These show that the urban housing program requires 360 man-hours of direct labor for every \$1,000 of development cost and 530 man-hours of indirect off-site labor for every \$1,000 of development cost.

The economic and social problems associated with inadequate housing on 20 percent of our Nation's farms are too great to be carelessly pushed aside.

The idea that privation and hardship necessarily are a part of farm life or that moral fibers are strengthened by such living standards was accepted during the settling of the country, but today farm families want and are entitled to the same conveniences that city people enjoy.

Farm families of today no longer accept the idea that because they chose farming as a way of life they need to live in homes that are inconvenient, inadequate, and substandard. Government loan guaranties and insurance have encouraged private capital to finance improved housing for our city and urban families on a substantial scale. When private credit was not available, direct Government loans have been provided. What farm families want and need is a like opportunity to finance farm buildings and improvements.

There is no question as to the effectiveness of the farm housing program as it has been administered by the Farmers' Home Administration. There is no question that this program has been a vitally essential part of our national housing program which has had as its objective the progressive improvement of our housing standards with the eventual realization of a decent home for every American family.

The National Farmers Union urges that S. 2949 and H. R. 7902, recently introduced by Senator John Sparkman and Congressman Robert E. Jones, Jr., Eighth District, Alabama, to extend title V of the Housing Act of 1949, be given favorable consideration in the hearings now being held.

STATEMENT OF FERN M. COLBORN, SECRETARY, SOCIAL EDUCATION AND ACTION,
NATIONAL FEDERATION OF SETTLEMENTS AND NEIGHBORHOOD CENTERS, Re
H. R. 7839

The National Federation of Settlements and Neighborhood Centers is an organization made up of nearly 300 local units in some 86 cities across the United

States. There is never a business meeting of our national organization, but that a resolution favoring an adequate housing program is adopted. We consider an adequate housing program to be one that provides for families of all income levels in the field of housing.

We would urge you to strengthen the bill now being considered by your committee in the following ways:

We doubt if the private housing program as envisioned in titles I and II amendments of the new bill will provide the amount of housing estimated. We believe that a larger program should be envisioned so that we may be assured of sufficient housing for an increasing population, and as a means of undergirding the economic needs of our country at this time.

We are pleased to see the section on slum clearance, urban redevelopment and renewal program in the bill. It is our opinion that the sponsors of the bill are overoptimistic as to what can be accomplished by this program. The lack of an adequate housing program has put a wear and tear upon the present housing supply so that houses are worn out considerably ahead of their usual life span. This we are aware of in every city wherein we work because we know how houses are being overused, building codes disregarded, and a doubling up far beyond any time in the history of our Nation, so that once this program gets underway we think that the number of buildings that can be rehabilitated and made livable, can only be done at such great expense that they will of necessity turn out to be housing in a considerably higher cost category than the bill envisions.

A further concern that we have regarding this program is that the slum clearance program will displace many more low-income families than the rest of your program provides rehousing for. We have already had many sad experiences with title I of the Housing Act of 1949, where communities have disregarded their responsibility to find housing for those displaced. We should not create other hardships with this legislation unless more protection is put into this bill, this is exactly what will happen.

Our great disappointment is that you have failed to provide for a proper public-housing program in the bill, but that this is left purely to the Appropriations Committee. In our opinion you certainly should ask for more public-housing units to be built each year than was envisioned in the Housing Act of 1949. Our population is now larger and the need is greater due to the fact that the Housing Act of 1949 was not carried out.

The substitute experimental program in place of public housing which offers home ownership to low-income families for a long mortgage payment with a minimum downpayment is in our opinion shortchanging the low-income and housing consumer. What house built for \$7,000 today will hold up for 40 years? In an economy where one-half of all families have incomes of \$3,420 or less and 25 percent of this number, incomes less than \$2,000, is it reasonable to assume that these families with the present high cost of living will be able to maintain mortgage payments of \$62 per month? Moreover, for how many of these families is home ownership desirable? We provide in our economy an abundance of housing, both for rental and sale, for the consumer who can pay \$80 per month and up so that free competition can operate. We do not provide even sufficient housing for the low income consumer let alone providing for a competitive market. In our opinion public housing must provide for a much larger proportion of the population than we have thus far. These are problems that must be met. They should be met in the Housing Act of 1954.

STATEMENT OF JOSEPH H. EHLERS, FIELD REPRESENTATIVE, AMERICAN SOCIETY OF CIVIL ENGINEERS

My name is Joseph H. Ehlers. I am field representative of the American Society of Civil Engineers and am making this statement on behalf of that society.

The American Society of Civil Engineers, with a membership of about 37,000, is the oldest national engineering society in the United States with branches throughout the country. It is the technical society most actively concerned with the designing of engineering public works and shares an interest in public buildings with the American Institute of Architects.

Our interest in this bill lies particularly in section 702 entitled "Reserve of Planned Public Works." I will limit my observations to that section. It is grouped with section 701 "Urban Planning" in title VII of the bill. The con-

nection between the two sections is remote. My remarks deal principally with the matter of the authorization to the Housing and Home Finance Administrator, in addition to supporting the basic concept of advance planning.

Despite the fact that we hold the present Administrator of the Agency in high regard and greatly admire the forceful manner in which he is attacking the housing problem, we do not believe that the Federal direction of a reserve of planned public works, as a matter of principle, is a proper function of the Housing and Home Finance Agency. This is particularly true of such a program designed to stimulate construction activity whenever the economic situation makes this desirable. We do favor the concept of advance planning both of housing as well as of all types of public works. We concur in the statements made by Administrator Cole in his testimony on this section of the bill.

Public works activities involving the design of water supply and sewerage plants, roads, bridges, and other engineering works should never be considered as mere adjuncts to housing activities. They have little relationship to and require a different type of personnel from slum clearance activities. They should not be placed in charge of agencies dealing with public housing and slum clearance activities of the Federal Government. They affect not only metropolitan development but also rural and State development. The planning and Federal approval of public works of this nature should be under the direction of Federal agencies professionally experienced and qualified in these special fields.

In the December 1953 report of the President's Advisory Committee on Government Housing Policies and Programs, the advance planning of non-Federal public works is referred to only as an activity in liquidation. The new program of section 702 had not then been considered. The same principle would seem to apply to it as to the agency's school building program about which the President's Committee had this to say, "It is the conclusion of the Committee that this is not a proper activity of a housing agency. It should be assigned to the Office of Education, Department of Health, Education, and Welfare." A similar conclusion was reached about the college housing program.

The advance planning and other programs of the Bureau of Community Facilities were assigned to the Housing Agency for liquidation, several years ago, following the abolition of the Federal Works Agency. At that time several groups most familiar with the subject, including the American Institute of Architects and the National Society of Professional Engineers, expressed disapproval of the assignment of this planning and community facilities work to the Housing Agency even for the purpose of liquidation. Our organization did not comment at the time since the work was only to be liquidated. Now that its reactivation is proposed, we feel that we should express our views.

Assignment of such work as this to the Housing and Home Finance Agency seems to violate the principle laid down by the Commission on the Organization of the Executive Branch of the Government in 1949. That principle was to assign the engineering work to the agency dealing with the basic function, e. g., transportation, public health, education, etc. In accordance with this principle, the Bureau of Public Roads was transferred to the Department of Commerce. Responsibility for the planning of other projects has been assigned to the agencies dealing with the basic functions involved—housing to the Housing and Home Finance Agency, provision of office space to the Public Buildings Service, airports to the Civil Aeronautics Administration, and so forth. The major exception seems to be certain planning and building programs now handled in the Housing and Home Finance Agency which are of vital concern to the newly created Department of Health, Education, and Welfare.

Since about 80 percent of the work under the advance planning program now nearing completion relates to educational, sanitary, or health facilities, the Department of Health, Education, and Welfare is far more concerned with the type of work involved than is any other agency. Comprehensive planning in these fields is among the already recognized responsibilities of this Department. Able engineers are already on its rolls. Public Law 139, 82d Congress—assigned the functions in connection with community facilities planning relating to health, refuse disposal, sewage treatment, and water purification to the Public Health Service. Stream pollution abatement and hospital planning have also been assigned to it.

Thus, if the proposed advance planning were limited to health and educational facilities, it would constitute a comprehensive program for the types of work for which advance planning is most urgently needed. Of the 20 percent not

included in such a limited program, many facilities such as firehouses, police stations, etc., can be designed in a reasonably short time and should not be the subject of Federal advances for advance planning.

The proposed advance-planning program of section 702 is by no means an overall program, but would simply be one segment of a public-works reserve, principally the segment relating to health and educational facilities. Coordination between highway, airport, educational, and other construction used to stimulate activity in any recession would need to be provided, regardless of which agency handles the program.

If a public-works program should be undertaken to stimulate construction, some billions of dollars of projects would be required. A glance at the work undertaken from 1934 to 1938 will indicate how remote such a program is from housing. The Public Works Administration during this period was concerned with such projects as New York's Triborough Bridge and Lincoln Tunnel, costing nearly \$100 million; sewage-disposal plants for Cleveland, Chicago, New York, and the Twin Cities costing over \$100 million, as well as others in dozens of cities; great bridges spanning the Ohio, the Missouri, and other great waterways throughout the country; educational buildings, State buildings, courthouses, dams, and power projects; even such enterprises as the New York-Washington electrification of the Pennsylvania Railroad. If the need again arises, the establishment of some similar supervisory agency would appear to be a logical development.

Advance planning of public works was devised to lessen the delays in commencing construction work needed for economic stimulation. The greatest part of the delay often occurs in making preliminary economic analyses, foundation studies, and acquiring of land rather than in making final plans. Fully completed designs may become obsolete before construction is started because of changed requirements and improvements in technology. This is especially true at a time of high prospective construction activity such as the present, because an emergency public-works program is principally helpful for stimulating a depressed construction industry rather than for remedying unemployment situations that may occur in other industries. A considerable part of the proposed advance planning should therefore consist of careful preliminary planning so developed that final plans can be completed in a few additional months. Incidentally, I have urged this in connection with previous advance-planning programs. Mr. Cole agrees with this view. An agency that specializes in a particular field is more competent to deal with such basic preliminary work than one concerned largely with having a reserve of blueprints. Thus, for example, the Public Health Service is intimately concerned with the basic planning of water-treatment and sewage facilities and hospitals.

The American Society of Civil Engineers favors sound advance planning for the purpose stated in section 702. This work of the Division of Community Facilities should be kept separate from that of divisions handling slum-clearance planning. The President's Committee on Government Housing Policies, under the chairmanship of Mr. Cole, recently recommended the transfer of all the functions of this division to other divisions or to other agencies. The major projects in the architectural field (hospitals, schools, etc.), either are presently handled in or are recommended for transfer to the Department of Health, Education, and Welfare. The same policy should apply even more forcefully to engineering projects. It would be logical to assign the program proposed in section 702 to the Department of Health, Education, and Welfare as a program of advance planning for sanitary, health, and educational facilities. Inasmuch as the President's Advisory Committee on Housing has recommended transfer of the personnel engaged on the presently most active work of this Division to the Office of Education, it would be logical to transfer the Division of Community Facilities to the Department of Health, Education, and Welfare to be maintained as a unit for carrying on the proposed advance planning work in addition to these continuing programs, in close cooperation with the Public Health Service and the Office of Education. The authorization in section 702, should, we believe, be to the Secretary of Health, Education, and Welfare; or to the President to assign to agencies along the lines of their major responsibilities.

NATIONAL SOCIETY OF PROFESSIONAL ENGINEERS,
Washington 5, D. C., March 4, 1954.

Hon. JESSE P. WOLCOTT,
*Chairman, House Committee on Banking and Currency,
House of Representatives, Washington 25, D. C.*

DEAR MR. WOLCOTT: The National Society of Professional Engineers has noted with great interest the introduction and present consideration of H. R. 7839, a bill to aid in the provision and improvement of housing, the elimination and prevention of slums, and the conservation and development of urban communities.

Our interest is particularly in connection with the portion of title VII of the legislation, which would provide an authorization of \$10 million to resume non-interest bearing planning advances to local and State bodies for public works plans, repayable when construction is undertaken, in order that such works can be ready for construction if the economic situation should require it.

The National Society of Professional Engineers has been interested in the advance planning programs since their inception as part of the War Mobilization and Reconversion Act of 1944, and we indicated our support of the continuation of these programs in 1947 and again in 1949. Many of our engineer members have had an opportunity to perform professional services in connection with the previous advance planning programs, and for that reason we feel that our organization is in a fair position to comment upon the previous programs and the desirability of reviving a similar program at this time. On three separate occasions the board of directors of the National Society of Professional Engineers has considered the matter of supporting the programs and this consideration has resulted in approval in each case.

It may be in order at this point to state that the National Society of Professional Engineers is composed of 39 member State societies, which, in turn, include numerous local chapters in all parts of the Nation (now numbering over 350 such local chapters). All of the more than 32,000 members are registered under the engineering registration laws of one or more of the States.

Based on our experience as outlined and the comments of our members who have participated actively in the advance planning programs, we desire to inform the committee of our continued support of the principles of a program for advance planning of non-Federal public works.

Our past and present support of the advance planning program has been predicated on the finding that the programs have been fairly and efficiently administered and that the relationship of professional engineers to the administration was handled on a professional basis by those experienced and qualified as professional engineers and construction experts.

It will be recalled that the program was first administered by the Federal Works Agency through its Bureau of Community Facilities and later by the same Bureau which had been transferred to the General Services Administration. Reorganization Plan No. 17 of 1950 transferred the administration of the advance planning program from GSA to the Housing and Home Finance Agency. This society opposed that transfer on the basic ground that the future success of the program would be jeopardized by having it administered through an agency which has a primary mission in the housing field as distinguished from the public-works field; a real and substantial difference in philosophy of operation and administration. Our position on the question did not prevail. The advance planning function has been in a state of liquidation in the Housing and Home Finance Agency for the past several years. Inasmuch as the program was being liquidated it did not seem too urgent that any further steps should be taken to retain the advance planning program administration in a proper agency.

However, now that the program is to be reactivated, it becomes a matter of deep concern to us that the new authorization will retain it in the Housing and Home Finance Agency. Rather than repeat our somewhat extensive comments on this question, we enclose a copy of our letter of January 21, 1954, to the Honorable Albert M. Cole, Administrator, Housing and Home Finance Agency, and Chairman of the President's Advisory Committee on Government Housing Policies and Programs. The letter was a comment on certain portions of the Advisory Committee's recent report, and a copy of the letter was sent to the President.

Since our letter to Mr. Cole was written, the anticipated revival of the advance planning program has become a reality and the problem therefore becomes more urgent and immediate. In addition to the possible solutions of alternative administrative location of the advance planning program outlined in our letter to Mr. Cole, an additional possibility has appeared. That is the proposed Public

Facilities Administrator in the Executive Office of the President, as suggested in the Public Facilities Act of 1954, introduced on February 8, 1954, by Senator Douglas (S. 2913) and Representative Bolling (H. R. 7766).

We have been advised by Mr. Cole that our views will be given the most careful consideration and by Gov. Sherman Adams, of the White House staff, that the President had referred our comments to Dr. Arthur Burns, of the Council of Economic Advisers.

It is hoped that your committee will give serious consideration to the question of the administrative location of the advance planning program. The National Society of Professional Engineers will be most pleased to provide any additional information at our disposal or consult with you or any member of the committee, or designated representatives, to further consider this matter. We request that this letter and the enclosure be included in the record of the hearing before the committee.

With sincere appreciation for your consideration,

Very truly yours,

PAUL H. ROBBINS, P. E.,
Executive Director.

REDEVELOPMENT BUILDERS OF NEW YORK,
New York, N. Y., March 10, 1954.

HON. JESSE P. WOLCOTT,

*Chairman, Banking and Currency Committee,
House of Representatives, Washington, D. C.*

DEAR CONGRESSMAN WOLCOTT: On behalf of the Redevelopment Builders of New York, I would appreciate the opportunity of presenting for the record of your hearings on the Housing Act of 1954 our views and comments with respect to this proposed legislation and particularly its provisions for expanded action for the renewal of American cities. We are an association of the private building organizations engaged in carrying out privately financed redevelopment projects on a full taxpaying basis under the New York City slum-clearance program. Consequently we are already dealing at firsthand with the problems of rebuilding blighted and rundown city areas on a basis that will transform living conditions and will constitute a sound outlet for private-investment funds. The comments set forth below are based on our practical experience in this field and are presented with the thought that they may be of help to your committee in its consideration of this legislation.

At the outset, we would like to endorse strongly the basic provisions of the Housing Act of 1954 with respect to urban renewal and redevelopment and the accompanying FHA amendments designed to facilitate private investment in such undertaking. We believe that, with certain minor amendments and administrative interpretations, these provisions are workable and would provide a substantial stimulus to the job of revitalizing American cities.

SECTION 220

From the standpoint of private enterprise participation in the rehabilitation and redevelopment of blighted areas, the most important new provision in the Housing Act of 1954 is section 220. In our opinion, the authorization of mortgages covering up to 90 percent of the value of multifamily developments in urban renewal areas is fully justified in view of the greater obligations which private developers must assume in undertaking such projects as compared with the conventional development of suburban apartments on open land.

Likewise, we endorse the provision for higher mortgage allowances for elevator construction. These will permit a realistic reflection in FHA mortgage financing of the higher cost of such construction and will correct the situation whereby redevelopment builders have been called upon to develop high-rise elevator buildings within the mortgage ceilings designed for less costly garden-apartment structures. There are, however, several matters which we would like to call to your attention from the standpoint of accomplishing in full the objectives of section 220.

FHA valuations.—We have no objection to the language in section 220 setting forth the basis on which the FHA valuation of multifamily projects will be determined. However, if the objective of section 220 is to be accomplished, we believe it is essential that the mortgage commitments issued by FHA actually represent 90 percent of the overall cost of a project, including land and all other expenses. In our opinion, this means that the findings of the Housing and Home

Finance Administrator and of the Federal Housing Commissioner in approving areas for such projects should be conclusive evidence that the location is fully acceptable to the FHA for mortgage-insurance purposes and furthermore that the housing market in the area is accepted by the FHA as sufficient to support the type of housing accommodations called for by the redevelopment plan. Clearly private enterprise cannot be expected to proceed with projects in such areas if the FHA valuation is less than the replacement cost of the project or if the FHA's determination of maximum rents is less than the amount needed to carry such replacement cost in accordance with the established FHA procedures.

Maximum term of mortgages.—Under section 220, the maximum term of mortgages on multifamily structures is left to the discretion of the Federal Housing Commissioner. We urge that either by regulation or by statute, such maximum term be placed at 40 years on elevator structures and 50 years on fireproof structures, both on a level annuity basis. Such terms would be justified by the greater durability of these types of construction and would substantially offset the higher construction costs of these types of buildings from the standpoint of the rent levels necessary to carry the project. Under the FHA's present regulations for rental housing projects insured under section 207, the annual initial debt service on an apartment representing a mortgage investment of \$10,000 is \$675. By contrast, annual debt service on a level annuity 40-year mortgage (which is permitted by FHA under sec. 213) is \$560 or a reduction of \$115 or 16 percent. On a 50-year level annuity mortgage, the debt service would be \$524, a reduction of \$151 or 22 percent.

Maximum mortgage for projects with an average of less than 4 rooms per unit.—The mortgage limitations in section 220 for multifamily projects with an average of less than 4 rooms per dwelling unit are definitely out of line with the comparable provisions in section 207 and section 213 and should be changed if section 220 is to be workable for projects in locations where the best plan and the market demand call for smaller apartments. For larger apartments, the bill would set maximum mortgages of \$2,000 a room under section 207, \$2,250 a room under section 213 and \$2,250 under section 220 for walkup construction and \$2,400, \$2,700, and \$2,700, respectively, for elevator construction. These allowances properly reflect the 80-percent mortgage under section 207 and the 90-percent mortgage under section 213 and section 220. On the other hand, for projects consisting of smaller apartments, the maximum mortgage per dwelling unit under section 220 is limited to \$7,200 for walkup construction, and \$7,500 for elevator construction, the same dollar limits as under section 207 and comparing with \$8,100 and \$8,400 under section 213. Obviously these limits under section 220 should be raised to \$8,100 and \$8,400 to maintain comparability with section 207 and section 213.

Specific reference to redevelopment.—Since section 220 is intended to cover new construction in urban renewal areas as well as rehabilitation, the language of subsection (d) requiring "a specific plan of rehabilitation and conservation" appears too narrow and the word "redevelopment" should be added.

Eligibility of present title I redevelopment projects for section 220 mortgage insurance.—We assume that it is the intent of the Housing Act of 1954 that slums and blighted areas already being prepared for redevelopment under title I of the Housing Act of 1949 may qualify for mortgage insurance under section 220, provided the locality presents to the Administrator a satisfactory workable program for the prevention and cure of blight as called for by section 101 (c) of the act. If this were not so, then there would presumably be a delay of at least 2 years before the benefits of section 220 could become effective in stimulating private rebuilding, taking into account the time required to plan and initiate new projects subsequent to the enactment of the Housing Act of 1954, and to prepare sites for rehabilitation or redevelopment.

FNMA support for section 220 mortgages.—We endorse the provisions of section 301 (b) and section 305 of the Housing Act of 1954 authorizing Federal support through the Federal National Mortgage Association of mortgages financing special housing programs in the public interest. We assume that it would be the Government's policy to utilize this authority, if necessary, to assure ready financing for projects in urban renewal areas. We are in agreement with the objective that insured mortgages on redevelopment projects as well as on other housing developments should command a ready private market without further Federal support. However, we believe it is essential that a federally supported secondary mortgage market be available in reserve for qualified undertakings in the public interest, such as redevelopment projects, in the event that normal private financing channels for such undertakings are temporarily blocked.

SECTION 213

We are in agreement with the proposed changes in the mortgage allowances for cooperative housing projects insured under this section and believe that such projects are in many cases well suited for the redevelopment of blighted areas. We would also like to recommend a further change in the provisions of section 213 which we believe would greatly improve the workability of this program. This would take the form of authorizing the issuance of an 80-percent mortgage commitment under section 207 for the construction financing of a project, with the developer being extended the option of transferring this commitment to a section 213 mortgage upon the completion of the project and the sale of its dwelling units to qualified members of a cooperative corporation in accordance with FHA regulations. This would eliminate the necessity under present regulations of selling at least 90 percent of the dwelling units in a section 213 project before the start of construction, which has represented one of the principle marketing problems in connection with this worthwhile program. Since such an arrangement presumably would require legislative authorization, we recommend your consideration of including such authorization in the Housing Act of 1954.

Transfer of existing FHA insurance commitments to the provisions of the Housing Act of 1954.—In the interest of expediting progress on redevelopment projects already being processed by the FHA, we recommend that appropriate steps be taken to permit the transfer of commitments issued under the existing provisions of sections 207 and 213 to the more favorable basis authorized by the Housing Act of 1954, in the event of final passage of that legislation. In New York City, there are several projects at or near the point of commitment and it would clearly expedite the development of those projects, if their sponsors could be assured of equitable participation in the more advantageous terms provided by the pending legislation.

Sincerely,

FRED TRUMP, *President.*

STATEMENT OF NATIONAL COUNCIL OF JEWISH WOMEN, NEW YORK 36, N. Y.

The National Council of Jewish Women is a voluntary association of over 100,000 individual members, whose primary objective is the promotion of the general welfare. Under our community welfare program our sections in some 246 communities throughout the United States are carrying on projects designed to meet the needs of the community. Because of their intimate contact with community problems, they have long ago recognized the vital importance of decent housing to the development of better communities.

The realization that good housing is one of the fundamental needs of any community caused our members to adopt a resolution in support of public housing in 1911. Since then our organization urged the adoption and actively supported proposals for a national housing policy consistent with the objective of a decent home for all Americans. The Housing Act of 1949 as it relates particularly to public housing and urban redevelopment, was strongly supported by our members.

We followed carefully the deliberations of the President's Advisory Committee on Government Housing Policy and Programs and were pleased to note that the Committee recognized the public housing program as an important and integral part of an overall national housing policy. Recently Mr. Albert M. Cole, the Administrator of the Housing and Home Finance Agency who also served as Chairman of the Advisory Committee, had this to say when he discussed the Federal Government's role in housing:

"It is imperative that we all realize at once—as did the Advisory Committee—that we cannot attack these problems piecemeal. We have a comprehensive program of three essential and interrelated parts which cannot be considered independently. * * *

"By treating the improvement of houses and neighborhoods, and the clearance of slums, as a whole on the one hand, and the supply of all types of housing, new and old, as a whole on the other hand, I think we establish the basic premises to enable families to improve their housing conditions and thus, for cities to improve their standards.

"But the free flow of families from undesirable into desirable houses and neighborhoods as they are made available presupposes that all these families

are able to do just that. Most of our families can, of course, buy or rent adequate homes on the private market. But unfortunately there are still large numbers in all our cities who cannot do so. Their incomes are too low. * * *

"These are the people whose housing problems constitute one of the most serious roadblocks we have to the clearance and prevention of slums and to the renewal of our cities. Their problems must be solved, or we have just failed to solve the problems of slums and blight. * * *

"If we expect to clear slums and renew our cities, the housing problems of these families must be squarely faced and solved."

In view of this demonstrated need, it is difficult to understand why the bill now pending before your committee (H. R. 7393) does not recognize the needs of those who need housing most.

The Housing Act of 1949 authorized the construction of 135,000 public housing units a year. It is now estimated that in order to meet the need 200,000 units a year should be constructed. In spite of the growing need for this type of housing, Congress last year took action which will virtually liquidate the program unless the provisions contained in the independent offices appropriation bill are repealed. The Housing Act of 1949 was considered and recommended by the Banking and Currency Committee which is charged with the responsibility of developing and recommending national housing programs. It would seem, therefore, that the responsibility for changes in the programs recommended by the Housing Act of 1949 should not be delegated to the Appropriations Committee whose sole responsibility is to deal with the expenditure of Federal funds.

The bill before your committee provides for an urban renewal program which is designed to clear and prevent slums. In order to carry out this program successfully, there must be some way to provide homes for those who will be displaced. The only aid provided in the pending bill, for those who will be displaced by urban renewal, is the program of low-cost housing produced through private means. The feasibility of constructing \$7,000 homes has been seriously questioned by a number of witnesses before your committee, and it has been stated by those who are familiar with the situation that in many parts of the country it would be impossible to do so. Furthermore, the Administrator of the Housing and Home Finance Agency stated that "It would be misleading to say that we can make anything like enough such low-cost private housing available for these people right now or in the immediate future * * *." He further stated, "The solution to their problem is the immediate crux of our whole effort to clear slums."

It would seem to us, therefore, that the entire program of urban renewal cannot be successful unless a substantial public housing program is authorized by Congress. We respectfully urge your committee to amend the pending bill in such a way as to permit the construction of the number of public housing units required to take care of the needs of those who are not able to avail themselves of housing produced through private means.

STATEMENT OF A. LEE PAINTER, PRESIDENT OF THE MOBILEHOME DEALERS NATIONAL ASSOCIATION, BEFORE THE HOUSE BANKING AND CURRENCY COMMITTEE IN REGARD TO THE BILL H. R. 7839, THE HOUSING ACT OF 1954

Mr. Chairman and members of the committee, my name is A. Lee Painter and I am president of the Mobilehome Dealers National Association with offices at 39 South LaSalle Street, Chicago, Ill. Our association consists of more than 500 dealers of mobile homes located in approximately 43 States. I am president of the American Trailer Co. and have been actively engaged for many years as a mobile-home dealer and mobile-home park operator in Virginia, Maryland, and the District of Columbia.

Our association is very much concerned that the comprehensive housing program presented in H. R. 7839 makes no reference to the mobile-home industry and thereby denies it the recognition which it has earned as the housing source for more than 2 million Americans, for it is approximately that number of people to whom the mobile home is a permanent dwelling unit.

Since World War II the mobile-home industry has earned its place as part of the housing resources of the country. The 1952 total industry production was 83,054 and the 1953 production was approximately 77,000. Surely an industry which has contributed so much—more, for example, than the prefabricated homes industry—deserves proper recognition in comprehensive legislation which pur-

ports to treat of the entire housing problem of the Nation. The mobile-home industry has a claim to such recognition on at least two counts.

First, the mobile home represents the most satisfactory low-cost housing which private enterprise has been able to produce. The mobile home is a compact complete housing unit with an average total cost to the purchaser of from \$4,000 to \$5,000. It is a completely furnished 2-bedroom unit with all modern conveniences. This committee has already raised serious question as to the results, if any, of the proposed section 221 with its 100 percent 40-year loan for a \$7,000 unfurnished house. There is considerable question, for example, whether such section will be able to produce housing in the urban areas where the need for relocating people from urban renewal areas would be the greatest. With the assistance of the amendments proposed by our association, many of these people will be able to obtain adequate mobile homes at monthly payments which they can afford. In this way the problem of relocating "displaced persons" from urban renewal areas will be solved and the greatest obstacle to urban redevelopment would be surmounted. For example, the application of the FHA mortgage insurance system, in the manner to be set forth later in this statement, would bring this low-cost housing within the reach of the lowest income group and certainly obviate the necessity for further public housing with the many disadvantages which are inherent in Government-owned shelter. Just think, the approximately 200,000 public-housing units in existence today will require an average annual subsidy from the American taxpayer or approximately \$80 million per year for 40 years. Of course, we would not suggest it, but the subsidies for only 5 years would be enough to give 200,000 low-income families a completely furnished 2-bedroom mobile home without charge and without further cost to the Government. Think then of the tremendous savings which would inure to the already hard-pressed taxpayer by enabling these low-income people to purchase through FHA insurance this ideal low-cost mobile housing, thus giving them the opportunity to build up some equity in their own homes instead of paying rent to the Government.

Secondly, the mobile home industry production should be maintained at its present level of approximately 80,000 units per year not only to meet the demand for these units from low-income groups, retired people, migratory workers, servicemen, etc., but to be in a position to meet the temporary housing needs of an augmented Military Establishment and stepped-up defense production force in the event of a national emergency. The mobile home industry in 1950 was called upon to supply thousands of mobile homes as military housing; and more than 25 percent of its production for several years went to servicemen and their families desirous of living in the only type of housing which assured the family being together as the serviceman shifted from station to station. The approximately 125,000 servicemen's families living in mobile homes at the present time attests to the great contribution made by this industry and to its acceptance as adequate housing for servicemen.

However, there is one stumbling block to the continued stability of this industry and that is the inadequacy of existing financing facilities, the identical problem which, in the early thirties brought about the creation of the Federal Housing Administration. Present financing facilities for mobile homes, like conventional mortgage financing of the 1920's require too large a downpayment (about one-third of the retail price) and too short a maturity period (3 to 5 years). The result is to narrow the market thereby denying mobile homes to many people who need such housing because of their occupation, service, retired, or migratory status.

We strongly recommend that the mortgage insurance system under title I be amended so as to provide mortgage insurance for mobile homes up to 75 percent of the purchase price or \$5,000 whichever is the lesser, and for a maturity period of 7 years and 32 days, the same maturity period that will apply to the proposed modernization loans under this title. The proposed mobile home mortgage insurance under this title is patterned after the mortgage insurance for modernization loans of \$3,000 for 5 years and 32 days. Considering that the latter loans are unsecured and enjoy a dignified position among banking institutions it is certainly logical that mobile home financial paper will be readily acceptable by such institutions.

We also recommend that section 207 be amended so as to provide for mortgage insurance for mobile home parks or developments not to exceed \$1,000 per space with an aggregate maximum for each park of \$300,000. A mobile home park is improved real estate and with proper appraisal standards, to be promulgated by the Federal Housing Administration, would prove a worthy adjunct

to the mortgage insurance system and would be the means whereby the mobile home industry could satisfy the great demand for adequate mobile home parks.

We are pleased to join the Mobile Homes Manufacturers Association and the Trailer Coach Association in recommending these proposed amendments. The amendments which we suggest are attached as part of this statement and we commend them to your favorable consideration.

PROPOSED AMENDMENTS TO INCLUDE MOBILE DWELLINGS IN THE NATIONAL HOUSING ACT FOR CONSIDERATION OF THE BANKING AND CURRENCY COMMITTEE OF THE SENATE AND HOUSE OF REPRESENTATIVES, 2D SESSION, 83D CONGRESS, IN CONNECTION WITH H. R. 7839 AND S. 2938

To aid in the provision of housing for families in essential and migratory occupations and to encourage the growth of a mobile housing resource for national security by extending certain credit insurance provisions of the National Housing Act to occupants of trailer coach mobile dwellings.

FEDERAL HOUSING ADMINISTRATION AMENDMENTS OF TITLE I OF NATIONAL HOUSING ACT

SEC. 101. Section 2 (a) of the National Housing Act, as amended, is hereby amended by striking out the period at the end of the first sentence and inserting the following: "and for the purpose of financing trailer coach mobile dwellings by owner-occupants thereof."

SEC. 102. Section 2 (b) of said Act, as amended, is hereby amended (1) by striking out the semicolon at the end of the clause numbered (1) and inserting the following: "or for the purpose of financing mobile dwellings exceeds 75 percent of the purchase price or \$5,000 whichever is less;" (2) by inserting in clause numbered (2) the following: "or for mobile dwellings seven years and thirty-two days," between the words "days" and "except".

SEC. 103. Section 2 (c) of said Act, as amended, is hereby amended by inserting in paragraph numbered (2) the words "or mobile dwelling" immediately after the phrase "any real property".

Amendments of title II of national housing act

SEC. 104. Section 207 (a) of said Act, as amended, is hereby amended—

(1) by inserting in paragraph numbered (1) a comma followed by the words "including facilities for trailer coach mobile dwellings" immediately following the phrase "designed principally for residential use".

(2) by striking out the period at the end of paragraph numbered (6) and inserting the words "or space in a trailer court or park properly arranged and equipped to accommodate a trailer coach mobile dwelling".

SEC. 105. Section 207 (c) of said Act, as amended, is hereby amended by inserting in paragraph numbered (3) the words "or not to exceed \$1,000 per space or \$300,000 per mortgage for trailer courts or parks" immediately following the parenthesis and words "four per family unit".

STATEMENT OF THE MOBILE HOMES MANUFACTURERS ASSOCIATION, CHICAGO, ILL.

Two million Americans are housed today in more than 750,000 mobile homes. Included in this figure are about 125,000 service families who find the answer to their housing problem in this type of dwelling. If all these 2 million mobile home-dwellers were to locate in the same area, it would create overnight the sixth largest city in the United States.

Mobile homes today represent the best example of successful, low-cost, unsubsidized, prefabricated housing.

Though the industry is some 23 years old, it became prominent first in the period of World War II. Trailers, as they have generally been known, date back to 1930 when total sales represented some \$1.3 million. By 1937 this figure had grown to \$17 million.

At war's end in 1945, sales for trailers in the United States totaled \$39 million and leaped in 1946 to \$114 million as their utility for housing began to be realized by the general public. This upswing in use continued through 1948, in which year sales totaled \$204 million. In 1953 mobile home sales totaled \$320 million.

Last year, production of mobile homes was just under 77,000 units. However,

this was down somewhat from 1952 production of 83,000 units, and 1948, which was the high year, with 85,000 units' production.

It was in the period of World War II that the trailer really began to outgrow its name and become in fact, a mobile home and to be so used. In the early days of the war, the Government purchased for the use of defense workers and other essential personnel, some 35,500 trailer homes. An additional 2,500 units for special purposes such as offices, laundries, etc., were bought by the Government.

These units did yeoman service throughout the war, particularly in such jobs as housing personnel who were rushed into Oak Ridge to build the first atomic energy production center.

It has been estimated that during the war, and down to 1950, these Government-owned units were moved on the average of 11 times. This figure alone would indicate the utility of mobile housing and its adaptability to many requirements. In the postwar period, these trailers were utilized effectively in meeting the needs of the returning veteran, and in meeting similar problems.

It might be pointed out that similar uses have been found for trailers in civilian disaster areas such as Texas City in 1947; the Vanport, Oreg., flood of 1948; Kansas City flood in 1951; and similar emergency requirements. In the recent past, great reliance was placed upon mobile housing for the workers at the Savannah River atomic energy installation and at Portsmouth, Ohio. The Defense Housing Act of 1950 provided for the Government purchasing of mobile homes.

While this demonstrates beyond question the great utility of this type of housing in unique situations, it is therefore, more significant to note that over 90 percent of the mobile-home owners today use them as permanent homes. Sales figures for the past several years show a substantial majority of mobile-home sales going to military personnel and defense workers. For example, a survey showed that in the first 6 months of 1951, these 2 groups bought 93 percent of all mobile homes sold. This was, of course, stimulated by the Korean crisis. However, there is every reason to believe that about 70 percent of all sales today are being purchased by these groups.

It is reasonable to conclude that the advantages of a permanent home that travels with the family as the military or job requirements dictate, have brought the mobile home into high prominence in the thinking of a large and substantial segment of our population.

With this upsweep in demand, there has been, of course, a revolution in design and conception of mobile home living. It is difficult to assess cause and effect in such a picture, but the manufacturers are satisfied that much of the public acceptance of this type of housing must be attributed to the comfort and adequacy of the modern mobile home.

Pre-World War II trailers seldom reached 20 feet in length. Little housing was expected from this trailer beyond vacation needs. Even by 1948, only 17 percent of the trailers sold were 30 feet or longer. This 17 percent grew to 64 percent in 1951, to 74 percent in 1952, and remains about the same today. (Length is a standard consideration in mobile homes, for highway requirements in moving, etc., limit their width to 8 feet and their height to 14 feet; hence, growth of trailer size is limited to length.)

Production last year found 20 percent of the 35-foot class, by far the largest grouping.

It seems certain that the trend to larger sizes will continue and the era of the 40-foot trailer is not far away.

Pricewise, the mobile home represents the most housing for the least money available today. Last year, the average unit cost was \$4,200. In price range, the mobile home dweller has the choice of models ranging from \$2,800 up to \$6,000, furnished with the essentials of housing from cooking to bathing. Two-bedroom units are commonplace and bathtub and shower bathing almost standard equipment. Complete electrical equipment is included, and toilet facilities. The modern mobile home has a kitchenette with refrigerator and stove arrangements that leave nothing to be desired. The air-conditioned mobile home will, no doubt, be introduced shortly.

It should be noted too, that the mobile home comes equipped with all furnishings, thus providing at these low prices, an answer to two problems for the homemaker, i. e., a house and its furniture and furnishings.

Comparing industry production and sales figures with FHA's report on its low-cost (under \$6,000) houses it appears that mobile homes are supplying about 90 percent of this market. Only about 6,000 such fixed-to-site houses are

produced under section 8 of title I of the National Housing Act each year whereas about 80,000 mobile homes are produced and sold each year.

Contrary to common belief, the desire to travel is not the prime motivation of mobile-home dwellers. Mobile or semimobile occupation workers make up the largest class of current mobile-home buyers (about 60 percent), followed by military personnel (25 percent), as mentioned earlier. Retired people make up a third definite class (about 10 percent) and the rest are lumped as miscellaneous. Their average annual income in 1950 was \$4,500 as compared to the national average of \$3,313. This past year, their income approached \$5,000, still far above the national average. About 40 percent of the mobile-home dwellers have children. Statisticians figure it at over 2.5 persons per mobile home.

Further statistics on the mobile home dweller show that 3 out of 5 of them are under 40 years of age, with 25 percent of the mobile population being young married couples. One in eight has passed 60 years of age. And finally, 14 out of 20 of these mobile dwellers now say they plan to live indefinitely in a mobile home.

This seems reasonable when the surveys show that 2 out of 6 such mobile dwellers have lived this way more than 5 years and 3 out of 6, or 50 percent, have lived "mobile" from 2 to 5 years.

In this connection, the most significant figure developed out of last year's sales showed that over 60 percent were repeat sales. These were people who had owned at least one other mobile home.

That mobile-home living is now an established part of our American way of life appears, therefore, beyond question. It leaves only the matter of how this group is to be fitted into the general housing picture.

Clearly there is a considerable economic gain for our society to have available, a moving or movable body of skilled labor that can be concentrated quickly and easily when it is needed. Sociologically, it would seem equally clear that it is desirable that this group be able, by virtue of mobile housing, to keep the family unit intact. Each of these considerations as part of the other. Society, as a whole, has the economic resources of the skilled groups who can move. The standard of living and family conditions of this group of mobile workers are assuredly better as they take their families and literally their home with them.

There is the same consideration in the case of the military. Here, however, we must confess that the authorities in the services have only in varying degrees seen fit to accept the mobile housing in their plans. They have taken the restricted view that mobile housing is acceptable only for emergency and/or temporary housing.

Because of this rather negative attitude, it is significant that some 125,000 service families now own their own mobile housing. Moreover, the services have, in the face of inadequate available commercial facilities, constructed many of their own courts for parking servicemen's mobile homes. Congressional committees such as the so-called Preparedness Subcommittee from time to time during the Korean crisis, recommended that the services provide more facilities for trailers and mobile homes in the face of the housing emergency. Recent policy statements by the Department of the Army have improved this situation considerably.

It would seem that the same considerations might apply to the services as did in the case of the Savannah River atomic energy installation where mobile housing was largely relied upon to furnish housing for family workers. These could be, and were, rolled away at the end of their period of need, thus avoiding the danger and the waste of creating substandard areas or slums through left-over temporary housing.

In the case of military personnel who buy their own mobile homes (we are not urging purchases by the services, incidentally) they take them with them as they move from base to base, or as they return to civilian life at the end of their tour of duty.

As for the retired people who now make up 10 percent of the mobile home users, over 200,000 people, there seems little doubt that this group will grow. Increased life expectancy, as we know, has increased tremendously the size of our retired population. Social-security and general prosperity have made mobile living available and attractive to this group. The simplicity of mobile living with its refinement of convenience makes it most attractive to older people.

The ability to follow the seasons and to take their home with them has a great attraction for these people, as it would for almost anyone.

From the rough and uncertain beginnings of the early 1930's our industry has grown to more than 150 companies. However, no one of them does as much as 10 percent of the business. There is keen competition and cost manufacturers make several models.

The process of manufacture is actually assembly, which has built up necessarily a large group of suppliers. Perhaps 500 suppliers can be said to be doing a substantial business with the mobile home builders.

Although design varies from model to model, the modern trailer is built of steel, aluminum, and high-grade wood construction. It is certain that the useful life of the modern trailer is far beyond its proposed mortgage or loan life.

The financing of mobile homes has been a somewhat slowly developing feature of the industry. Many problems have had to be faced, including the mobility of the mortgaged property, an uncertain depreciation rate for used units, etc.

It is estimated now that there is about \$400 million of mobile home paper in circulation. While it is a growing field for lending institutions, it is only very recently that it could be said that more than a few were participating. The one single feature in this industry that has brought more credit facilities into the picture, has been the development of the trailer into a mobile home. The increased usage of these units as homes has done much to win the confidence of the bankers and other.

This, plus the obviously solid character and income status of the average mobile home dweller and the outstanding record of minimum defaults on the paper, has reassured the lenders.

Nevertheless, it is clear that more capital is required in the future if this industry is to continue to expand. We are, of course, certain that Federal recognition of mobile homes as housing, such as this legislation would provide, will assist tremendously in attracting more capital. We believe too, that it is only fair that Federal Housing should include this very substantial group of our citizenry, and what is available to others in the form of governmental housing assistance should, in principle be available to them.

The average installment sale contract for a mobile home today is running about \$3,000 for new units and \$1,400 for used. Typical terms are one-third down, 3 to 5 years on the balance. Interest rates range between 5 and 8 percent discount, or $9\frac{1}{2}$ to $15\frac{1}{2}$ percent simple interest.

A recent survey of banks and finance companies elicited replies from 274 who handle mobile home paper. Two hundred and fifty-five of these replies reported no losses or negligible losses. Fifteen reported losses less than one-half of 1 percent. The largest reporting lending institution which carries currently about \$31 million in mobile home paper, calculated its loss ratio at one-eighth of 1 percent.

Overall, the loss ratio on mobile home paper is estimated at less than one-fourth of 1 percent. This is indeed an impressive record.

Despite this outstanding record for mobile home paper, and the efforts that our organization has put forth in bringing it to the attention of the lending authorities in this country, we are still concerned that our sources of credit will prove inadequate in the future. Because of our concern for the future, we are urging your careful consideration of the amendments before you today. We believe these amendments would be most helpful because mobile homes, which in unit cost represent low-cost housing, become high-cost housing due entirely to high financing requirements.

If mobile housing is able, by this legislation, to qualify for the rates now provided in title I of $4\frac{1}{2}$ to 5 percent discount, it would mean a reduction of 20 to 35 percent of this financing cost.

The establishment of a 7-year pattern for this financing would similarly achieve a reduction of 35 percent in the monthly payment. For example, if a contract of \$4,000 is assumed—4 years at 6 percent discount—under present-day terms it requires a monthly payment of \$109 including insurance.

Under the terms of the suggested amendments the loan term is extended to 7 years at 5 percent discount. This would result in a monthly payment of \$69, a reduction of \$40 per monthly payment.

This leads naturally to the situation of the mobile home court operators who, to date, have had to rely almost entirely upon equity financing and which is inadequate to the need.

Mobile homes, of course, need a site, just as any other housing, which means they have to have available to them utility connections, water, sewerage, and electricity. We have included them in our request for legislation because, in

logic, the availability of sites for mobile home owners becomes a literal measure of the market. There is no advantage to owning a mobile home if no adequate home sites are available.

The Mobile Homes Manufacturers Association long ago recognized the necessity of mobile home court development including layout, sanitation, and appearance, and inaugurated a continuing program for their improvement. Within our organization, the Park Division of MHMA, we have drafted standards for court design and construction and provided a system of inspection with recognition to courts meeting these standards. We publish a guide for the use of mobile home dwellers rating the various facilities and detailing their features. About 4,000 mobile home parks or courts meet MHMA standards today, though at least double this number of courts are in existence.

Total estimated investment in trailer parks in the United States is thought to be close to \$200 million. Seemingly large, this figure is not surprising when it is considered that the average cost in a thoroughly modern park is \$1,000 per mobile home site. This includes cost of roads, sanitary and electrical facilities to each site, utility buildings, landscaping, and others, not including the cost of the land itself.

With upward of 77,000 new mobile home units being produced and sold annually, the need for new court facilities presents a requirement of close to \$77 million for court financing. At present there are no adequate mortgage funds to assist in meeting this need. To date, 98 percent of these facilities have been financed by equity capital.

As in the case of the mobile home itself, the parking courts have been slow to establish themselves in financial circles. Here again, the attitude of banks and lending institutions can be traced to their early observation of trailers, courts, and their users. Formerly, trailer courts were established only along main highways and depended almost entirely on transients for business. Today, transient occupancy is but a fraction of 1 percent of the business of the vast majority of mobile home courts. Courts are built now where housing is needed, and where mobile home dwellers are likely to find employment. Courts have been established near military installations where family housing is critical or nonexistent. Thus they become a definite housing resource.

We know of no national organization of park operators which is prepared to speak on behalf of legislation for assisting mobile home court expansion. Our interest, of course, is obvious in this matter but we are handicapped to that extent. It is perhaps necessary to say, too, that figures on the cost of practical and desirable courts are difficult to obtain. Naturally, they vary from one location to another, depending upon the availability of utilities, topography, soil conditions and such.

We can pledge, however, our wholehearted cooperation with FHA in establishing standards for such facilities if this legislation is passed. We have available a sizable body of research and experience in this field which we would place at the disposal of the Agency in attaining this objective. The facts are clear and official recognition that mobile home courts have a place in the housing resources of the country such as would be afforded by this legislation, would do much to encourage lending authorities to study this type of loan.

In brief form, this is the history and the size of this industry today and the people it serves. What we have tried to outline here, are the salient facts which we believe established the reasons for your considering bringing mobile housing into the purview of the National Housing Act. We believe that such legislation is important as aiding the maintenance of a mobile body of workers whose jobs necessarily take them from place to place and from job to job. The economy is aided in this fashion and the workers themselves are better off economically and socially with the maintenance of the family unit. Similar considerations apply to the military personnel who prefer mobile dwellings.

We believe that the maintenance of a strong mobile homes industry is in the interest of the national security. Mobile homes have long since proved their worth in emergency situations. No other facility can produce so much good housing in such a short time and move it to the site of the requirement.

Federal recognition of mobile homes as housing within the purview of the Housing Act will encourage and assist in attracting capital and the acceptance of mobile homes and mobile home court paper by the lending authorities. Such a program, as is proposed here, will result in no added burden upon the taxpayer, and is self-amortizing. The outstanding credit record of the industry is most reassuring. The acceptance by such a large segment of the population of mobile

housing should be persuasive to the Congress when considering the fairness and equity of including mobile housing in the Federal Housing program.

We have presented the foregoing because we believe that too few people appreciate the size of the mobile population in the United States today and its makeup. We believe too, that too few people appreciate its future and its potential contribution to the welfare and satisfaction of our people.

Housing has long been the preoccupation of people and of governments. Some have handled it well, others badly. Poor handling of housing policy has caused more blight upon the world's societies than almost any nonwar activity. We hope that this has been helpful in your consideration of the Federal Housing program.

HOUSING ACT OF 1954

THURSDAY, MARCH 18, 1954

HOUSE OF REPRESENTATIVES,
COMMITTEE ON BANKING AND CURRENCY,
Washington, D. C.

The committee met at 10 a. m., Hon. Jesse P. Wolcott, chairman, presiding.

Present: Chairman Wolcott (presiding), Messrs. Talle, Kilburn, Betts, D'Ewart, George, McVey, Merrill, Oakman, Stringfellow, Van Pelt, Spence, Brown, Patman, Multer, Deane, O'Brien, Dollinger, Barrett, Hays, and O'Hara.

The CHAIRMAN. The committee will come to order.

We will proceed further with the consideration of H. R. 7839.

We have several Members of Congress here this morning who wish to testify.

We will hear first from our distinguished colleague, Mr. Javits. We are very glad to have you proceed, Mr. Javits.

Mr. JAVITS. Thank you, Mr. Chairman.

STATEMENT OF HON. JACOB K. JAVITS, A REPRESENTATIVE IN CONGRESS FROM THE STATE OF NEW YORK

Mr. JAVITS. Mr. Chairman, I ask unanimous consent to revise and extend my remarks. Mr. Chairman, I have a hearing at 10 over which I am myself presiding, and I hope the Chair will therefore indulge me if I try to proceed as quickly as I can.

The CHAIRMAN. Very well.

Without objection, all of the witnesses this morning will have the privilege of revising and extending their remarks.

Mr. JAVITS. Mr. Chairman, the overall approach in the bill which is before the committee and which represents in essence the administration's housing program, is very commendable and is making unquestionably, or is an effort to make a real contribution to the continuance of the level of construction which is so essential as a fundamental basis for our economy.

My suggestions to the committee will be rather sharply divided into two parts.

First, any suggestion—and I am sure the committee has had a great many—with respect to the established building level running around a million housing starts per year, and, second, the subject which is much more directly tied in with the position I have taken in the Congress continuously, the problem of housing for the lower-income groups, and the income groups in the lower middle levels, and also

housing for minority groups, which suffer from discrimination and segregation practices.

Now, very briefly, on the part of the bill with which the bill is mainly concerned, that is the housing which sells for around \$10,000 and upward, certainly not less than \$8,000 or \$9,000, and which represents the backbone of the million housing starts a year; the bill has, I understand, been subject to criticism by the people who do the building on the ground that it does not contain within its terms the maturities, interest-rate provisions, and downpayment provisions which will tell them exactly how they can do business, and they claim that they have got to plan so far ahead and this is really a very serious drawback to them.

Those builders that I know, and I know some who are quite large, claim that they are doing their business almost exclusively with veterans. I am a veteran myself, and deeply devoted to veterans' housing, but it is a fact that that isn't the only class in our community that needs housing, and, therefore, I would hope that the committee would give some attention to the point of view of those people, and will endeavor to establish limits in the bill, rather than leaving them either to the President or the Commissioner, which will enable them to do some extensive forward planning.

I might say that I analyzed the bill and find that at the very least I hope that the committee will want to straighten out the inconsistencies between some of these provisions being dependent upon whether the President acts, and others of these provisions being dependent upon the discretion of the Commissioner.

It seems to me that that is at least one elementary thing which should be clarified, and that one or the other authority should be vested with complete authority, but I hope that more clear indication would be given to the industry as to how they can proceed.

I understand that their desire is to raise the limits so that they can get a mortgage for 95 percent on a \$10,000 house. That is a mortgage up to 95 percent of the value on a \$10,000 house and, of course, that was somewhat the intent of the power given the President in the last bill, to have a 5 percent downpayment on \$12,000 homes.

I would like to leave that subject with the point that it is important to enable them to do forward planning, and to give rather strict attention to their desires in that connection.

They are also interested, as I understand it, in an allowable 35-year mortgage, and I am sure this figure has been produced before the committee, but I would like to include it in my testimony, that 41 percent of all United States homes are 35 years old and older, so that it doesn't represent any material increase of the risk to at least have an allowable of 35 years, and, of course, we are all very anxious to get the carrying charges as low as possible, and to get as far as possible into the lower-income group capability.

I am sure also the committee is well aware of this rather classic division of our society into three parts: The one-third earning from \$2,000 to \$4,000 a year, which urgently needs attention in terms of housing; then the one-third earning in the four- to six-thousand-dollar range, which has largely been able to get into the housing field in terms of ownership because of the building since the war, and the backbone of the increase in homeownership which is so gratifying to

us all, and I think this committee, Mr. Chairman, can claim a great deal of credit in the constant facilitation of homeownership for people in that bracket.

In short, I am not pleading that anything less be done in that bracket. I am rather concentrating such help as I can give to the committee in terms of help which we can give to people who are in a lower income bracket. That has been a constant problem here.

Now, the need, of course, is extremely urgent and very difficult. Everybody knows his own community. In New York City we have 500,000 really substandard housing units, and an overwhelmingly difficult relocation problem. I am all for slum clearance and urban development, and we have one of the great projects in the country in my own community, which, incidentally, is financed by Columbia University and the great cultural institutions which surround it, the various seminaries, the Riverside Church—it is quite a distinguished civic effort in slum clearance.

Yet in that project—and it is symptomatic of our situation, I had to work very hard on behalf of the people who live there to be sure that the project which the colleges and other people were interested in was teamed up with a public housing project, otherwise the relocation problem would have been absolutely impossible.

We have about 56,000 families to relocate in New York City alone, of whom the most conservative estimate is that close to a half will have to go into public housing. So that is a real problem.

I would like to come, then, Mr. Chairman, to my fundamental point in this testimony, which is the public housing approach. I think the problem of figures has been settled for us now by the administration putting forward this 4-year program of 35,000 units per year. As the chairman knows, I am well acquainted with the history of this, and I know that the Appropriations Committee has taken over the writing of the number of public housing units.

Mr. Chairman, they may have done it, but that doesn't make it right. It is the function of this committee. I think the most valid argument made against that approach by the Appropriations Committee has been that it is not considered in terms of overall housing needs of the country, or even in terms of the housing program, which the Appropriations Committee is in no position to do. This is the committee which ought to write the ticket in that connection, and I hope very much, Mr. Chairman, that the committee will see fit to do that.

The Housing Act of 1949 is, of course, an authorization. Anything else that the committee sees fit to do will, of course, be an authorization. But it will be an authorization which is based upon findings of fact by a committee charged with the responsibility in this very field. I believe it will be persuasive to the Congress and House of Representatives because it is in pursuance of part of the administration's own policy.

And so, Mr. Chairman, I hope that this committee will not be dissuaded from undertaking to act in the public housing field by the fact that the Appropriations Committee has assumed that power, but that this committee will undertake that responsibility.

I believe it is the strong weight of responsible opinion in the country that the administration's program of 35,000 public housing

units per year is certainly minimum. Certainly Mr. Cole's advisory committee was not prejudiced in favor of public housing, and after going through the whole situation from stem to stern they felt that there still remained a marginal need, and they sought every way they could to satisfy it, and they came to the conclusion that it just could not be satisfied except with some kind of a program of that character.

I believe that the idea of a 40-year mortgages for \$7,000 homes is a good idea, but it is very experimental. All the banking people, I understand, said that it is very unlikely that any such program can actually be put into effect. The people don't want chimeras or illusions or provisions in bills, they want housing programs starting from the bottom up, and, I believe, and I respectfully submit to the Chair, that this committee should act in that public housing field, especially as it will be implementing the administration's program.

Just a word about FNMA in that connection, while we are talking about the 40-year \$7,000 homes: I know what the proposal is for FNMA, and, again, I believe that FNMA can serve an enormously useful function; I believe that it can raise money from the public, but I have had occasion, in the course of professional activity, to sound out some of the great institutions of the country having enormous pools of money that ought to be available for mortgages—really enormous, in the billions—on this question of mortgage money, and I believe, Mr. Chairman, from that experience, which is professional and quite aside from my function as a Congressman, that the only way that the FNMA can be successful in terms of making mortgage money available in the way in which the President's program, and the bill contemplates that it should, is if these debentures are guaranteed, and Mr. Chairman, I don't see why we should hesitate to provide that in view of the fact that we haven't hesitated to provide for tens of billions of dollars in guaranties of the mortgages themselves, without feeling that that added appreciably to the liability of our country, because the security is so sound.

Therefore, I think that it is necessary to get money into FNMA in order to facilitate mortgage lending, and the debenture idea, and the idea of ownership by those who sell mortgages to FNMA is very sound. Why we can't go that extra step and assure success through having the debentures, themselves, guaranteed, I don't know.

Now, Mr. Chairman, just one final word on the minority housing situation. That has come in for a good deal of attention; though I don't agree with the way in which it has had attention, nevertheless such part of it as has been done by the housing Administrator has been done sincerely and with a real effort to make progress in terms of housing for minorities, especially for Negroes.

I believe, however, that the real way in which to do it, the fundamental way in which to do it, is not alone to endeavor to interest builders through the various means which the housing authorities have, in constructing projects which will be available to minorities. I believe the real way to do it is once and for all to end any FHA aid to projects which are segregated.

And interestingly enough, Mr. Chairman, this is not, as I understand it, a southern problem. On the contrary the segregation problem is much greater in the North, in terms of housing, than it is in the South.

Mr. Chairman, I make this assertion for a fundamental reason: A survey by the National Association of Home Builders—and I have it here, and it is in their March 1954 issue—shows that the principal impediment to the construction of housing for minorities is the unavailability of mortgage financing. That is shown on page 11 of their survey, and it is headed “Reasons for lack of activity in this field were quite diverse,” but shows which stood out most prominently were: Lack of mortgage financing, 40 percent.

Certainly that is a very material part of the whole difficulty.

And, Mr. Chairman, I submit that if neighborhoods are nonsegregated, if people of all colors can move into them, then the mortgage money situation no longer become a factor. It is a factor in terms of neighborhoods which will be largely available to minorities. It would cease to be a factor if the minorities took their place in all neighborhoods in the modest proportions in which they figure in all neighborhoods—certainly in the North, where their proportion is in no case more than about 10 percent.

Mr. MULTER. May I interrupt you there for a moment: How would you implement or effectuate or enforce that kind of a provision?

Mr. JAVITS. I believe the provision can be enforced by the terms of the mortgage guaranty, and that is what I am talking about, and I think that can be done administratively.

Mr. MULTER. Would you be more specific?

Mr. JAVITS. I believe that the mortgage guaranty can provide that the policy pursued in the renting or sale of homes shall be without discrimination as to race, creed, or color, and the Commissioner would receive complaints of violation on that score.

Mr. MULTER. Let us assume we have that language in a form that you and everybody else agrees will accomplish the purpose. How is that going to compel the lender to lend the money? That is the problem. You said the survey shows it, and I agree with you, and everybody else does.

Mr. JAVITS. Right.

Mr. MULTER. The difficulty is in getting the lender to lend the mortgage money. We have got the guaranties in the act now. Suppose we write all sorts of additional language that the guaranty will not apply unless this general situation is followed, and the intent is followed, and everything else, that there be no discrimination. How are you going to make the lender lend the money to a nonsegregated project?

Mr. JAVITS. If the rule is universal, there are no loans except with the nonsegregated provision.

Mr. MULTER. You and I are in agreement as to what we want to accomplish.

Mr. JAVITS. May I finish?

Then the lender has only this choice: He will stop any kind of lending to any project because any project, no matter where he lends, will contain this provision. Sometimes you have to have a showdown between the Government and lenders.

Mr. MULTER. Suppose the provision is there.

Mr. JAVITS. Yes.

Mr. MULTER. The provision is there, and the builder is putting up a segregated project. He doesn't say it is segregated. He simply

puts up a project and everybody who comes there who is not white is turned away. Every minority group is turned away, when they come looking for a house to buy or an apartment to rent. There is nothing in the documents to say they are going to discriminate.

How can you make the lender hold back his money?

Mr. JAVITS. The guaranty will not apply. The lender will not be covered by an FHA guaranty if there is proof of the fact that there is segregation or discrimination followed in that project, and if that is universal then lenders have a choice of lending without an FHA guaranty, or with it. That is my point in saying you have to have a showdown on this thing, and the only way to have a showdown is to make it universal.

Mr. MULTER. I am afraid all the language in the world would not accomplish our purpose until you get the lender to do as they are beginning to do now, and that is for the lender to lend the money to these projects. As long as they sit back and say, "We won't lend on these projects," all the language in the world is not going to make them do it.

Mr. JAVITS. I make the point—and I know my colleague and I are in agreement—only that if the rule is universal, which is the fundamental point I make, then you have a choice only of the lender being on strike against FHA guaranties, and that showdown you have got to have.

That concludes my statement, Mr. Chairman.

The CHAIRMAN. Thank you, Mr. Javits.

Mr. MULTER. One other point if I may, Mr. Chairman.

Mr. JAVITS. I have a hearing of my own.

Mr. MULTER. Just one question. Have you presented your views on public housing to the Appropriations Committee?

Mr. JAVITS. I understand that the Appropriations Committee doesn't hold hearings of this character. I am glad you prompted me. I will present my views.

Mr. MULTER. I don't know what the reaction of this committee is going to be. I have already pointed out that unless we write back into the law affirmative provisions we will get no housing.

Mr. JAVITS. I just testified to that.

Mr. MULTER. But as of yesterday the off-the-record opinion was that the Appropriations Committee is not going to appropriate any money for public housing, that is for new starts in public housing and unless somebody goes to work there, even if we get the authorization here we will still have no money for it.

Mr. JAVITS. Well, you are and I am sure I will, and I hope there will be many others like us.

Thank you, Mr. Chairman.

The CHAIRMAN. Thank you, Mr. Javits.

Congressman Jones, we are very glad to have you here this morning.

Mr. JONES. Thank you, Mr. Chairman.

STATEMENT OF HON. ROBERT JONES, A REPRESENTATIVE IN CONGRESS FROM THE STATE OF ALABAMA

Mr. JONES. Mr. Chairman and members of the committee, I appreciate the opportunity I have been afforded to discuss with you the continuation of title V of the Housing Act of 1949.

I have not had the pleasure of appearing before this committee since that date, because there has been, under an amendment, a continuation of that act for an additional year, through fiscal 1954.

When the President transmitted the budget to the Congress, there was omitted any reference to funds to be made available for the rural housing program.

Mr. Chairman, I was very apprehensive that the administration intended to neglect the housing needs of our farm people. And I was under that fear and apprehension for some time, until the Secretary, Secretary Benson, in a speech at Tuskegee, Ala., stated that the program had been a tremendous success, and in substance he stated that it would be a policy of this administration to continue the farm housing program. The administrative agency that is charged with the responsibility of carrying out the rural housing provisions of the 1949 act, that is.

Mr. SPENCE. Will the gentleman yield?

Mr. JONES. Yes, sir.

Mr. SPENCE. Have you a breakdown of the loans that were made by the Farm Loan Administration?

Mr. JONES. A breakdown of the total amounts of money made available, Mr. Spence? Or do you have the various categories of loans that were made? Do you have reference to loans that were made for housing, for chickenhouses, and that sort of thing?

Mr. SPENCE. I think they made 18,401 loans, 7,675, the total amount for \$93,992,000. I have a breakdown of that that I would be glad to insert with your testimony.

Mr. JONES. I would appreciate it very much because I do not have a breakdown of the specific characters of the loan, because under the provisions of the act, the loans under title V could be made for water systems, for barns, for any appurtenances belonging to an orderly farm unit.

Mr. DEANE. Mr. Chairman, will Mr. Spence yield at this point?

Mr. SPENCE. I would like to have this breakdown inserted in the record at this point.

The CHAIRMAN. That may be done.

Will you yield to Mr. Deane?

Mr. SPENCE. I yield.

Mr. DEANE. On that point, Mr. Jones, I have a letter dated February 16, 1954, from Mr. McLeaish, the Administrator of the Farmers Home Administration, giving me this information:

As of the end of January, the reports received from our State offices indicate that there are on hand 5,020 applications for farm-housing loans, and of this amount, 1,971 are from veterans. Applications on hand multiplied by \$5,100 (the estimated average-size loan for the 1954 fiscal year), would amount to \$29,116,000. The farm-housing funds remaining unobligated for the 1953-54 fiscal year are \$3,219,226. Loans are in process which will use these funds by April 1 of this year.

Mr. JONES. There has been a ready acceptance, on the part of the farmers, to utilize this program, which is attested by the fact that in my own State of Alabama all the funds allotted to that State have been obligated within 60 days, and there are pending in the Southern States far more applicants than there would be money to satisfy their needs.

Going back now, Mr. Chairman, to the act of 1949, it made available or authorized \$275 million for farm-housing purposes. About one-third of this amount was actually made available. There was a curtailment due to the fact of the Korean war, and that curtailed the general-housing program not only in the rural areas but throughout the country.

In 1954, there were made available \$19 million, and as the gentleman from North Carolina has just stated, there were unexpended some \$3 million.

Now, over 19,082 farm families have benefited from the amounts that have been made available through this program. There has been a phenomenal program in this sense, Mr. Chairman, that less than 5 percent of all accounts are delinquent. Over 35 percent of the loans made are in advance of their due date—that is, payments have been made in advance of the time that they were due.

A farm-housing program is unique in that it takes into account the orderly and proper management of a farm unit.

The home, on a farm, is unique in that it serves as a home, his workshop, his community center, and, Mr. Chairman, there is no American home that serves as a greater citadel of democracy than the farm homes, where our people, residing in those homes, are sound and safe in their thinking, and their influence on the democratic way of life is a bulwark that we must recognize.

And so it would seem to me that it would be a wise and sound policy for the Government to continue to give opportunity for people to create for themselves, and fashion for themselves, a better way of life, to increase their economic income, to increase their usefulness, to increase, Mr. Chairman, their pride in home ownership. And I hope that this committee will see fit to continue this program, a program that has been demonstrated, time and time again, to be successful—and I mean completely successful.

I could give a breakdown of these figures, but I know that the committee is just as familiar with them as I am, and I hope that we will have a continuation of this program to provide decent, safe, and sanitary living conditions for our farm people.

Thank you.

Mr. SPENCE. Mr. Chairman, I have a breakdown of the activities of the Farmers' Home Administration, and the loans that have been made by States to the various persons. I would like to have that incorporated following Mr. Jones' statement.

The CHAIRMAN. It may be incorporated at this point.

(The information is as follows:)

FARMERS' HOME ADMINISTRATION, UNITED STATES DEPARTMENT OF AGRICULTURE
Farm housing program data from inception of program through Dec. 31, 1953

State and Territory	Number loans made		Amount loaned		Average amount loaned		Grants	
	Veteran and non-veteran	Veteran only	Veteran and non-veteran	Veteran only	Veteran and non-veteran	Veteran only	Number	Amount
	(1)	(2)	(3)	(4)	(5)	(6)	(7)	(8)
United States total.....	18,401	7,675	\$93,992,181	\$30,819,108	\$5,108	\$5,188	1,785	\$363,674
Alabama.....	1,022	502	5,509,475	2,802,396	5,391	5,582	88	41,760
Arizona.....	100	33	722,462	251,015	7,225	7,607
Arkansas.....	971	438	3,209,342	1,419,134	3,305	3,240	80	31,421
California.....	449	198	2,734,762	1,173,054	6,091	5,925
Colorado.....	212	101	1,232,162	602,578	5,812	5,966	2	750
Connecticut.....	34	15	142,082	64,417	4,179	4,294	3	1,250
Delaware.....	5	1	26,290	5,100	5,258	5,100
Florida.....	357	203	2,100,878	1,196,646	5,885	5,895	3	1,475
Georgia.....	1,164	546	5,716,975	2,752,180	4,911	5,041	32	15,127
Idaho.....	338	121	2,095,506	750,456	6,200	6,202	4	1,900
Illinois.....	336	122	1,328,605	433,169	3,954	3,551	1	455
Indiana.....	302	113	1,539,997	613,875	5,099	5,493
Iowa.....	355	95	1,667,289	488,405	4,697	5,141
Kansas.....	267	103	1,419,791	531,248	5,318	5,188	1	500
Kentucky.....	424	192	2,227,883	1,055,420	5,254	5,497	9	4,320
Louisiana.....	640	265	3,322,580	1,403,117	5,192	5,295	19	9,450
Maine.....	263	109	1,049,715	399,057	3,991	3,661	17	8,500
Maryland.....	137	51	736,046	287,165	5,373	5,631
Massachusetts.....	20	6	97,043	31,300	4,852	5,217
Michigan.....	414	171	2,002,630	866,094	4,837	5,065	7	3,500
Minnesota.....	304	96	1,262,580	361,770	4,153	3,768	7	3,200
Mississippi.....	1,145	564	4,860,853	2,406,339	4,245	4,267	144	65,635
Missouri.....	883	381	3,218,484	1,398,627	3,645	3,671	122	4,470
Montana.....	189	77	1,140,615	462,725	6,035	6,009	1	500
Nebraska.....	362	142	1,653,595	705,858	4,568	4,971	1	500
Nevada.....	25	9	180,807	62,750	7,232	6,972
New Hampshire.....	15	10	57,420	42,045	3,828	4,204	2	765
New Jersey.....	145	43	740,953	240,943	5,110	5,603
New Mexico.....	238	100	1,357,541	570,475	5,704	5,705	1	500
New York.....	165	58	908,547	320,290	5,506	6,043	1	446
North Carolina.....	739	309	4,229,947	1,780,397	5,724	5,762	5	2,460
North Dakota.....	196	67	1,239,038	426,387	6,322	6,364
Ohio.....	190	88	873,480	369,458	4,597	4,198	6	2,920
Oklahoma.....	960	367	4,847,383	1,833,676	5,049	4,996	5	2,260
Oregon.....	204	76	1,332,914	453,866	6,534	5,972
Pennsylvania.....	353	182	1,495,857	782,419	4,238	4,299	9	4,110
Rhode Island.....	2	1	5,570	3,140	2,785	3,140
South Carolina.....	613	319	3,597,104	2,064,680	5,868	6,472	2	700
South Dakota.....	216	66	1,139,024	367,273	5,273	5,565
Tennessee.....	585	259	3,040,455	1,394,213	5,197	5,383	27	13,475
Texas.....	1,158	415	6,673,353	2,425,767	5,763	5,845	157	75,280
Utah.....	264	4	1,654,674	537,207	6,268	6,715	1	500
Vermont.....	18	8	71,375	15,365	3,965	3,841
Virginia.....	326	167	2,122,887	1,124,077	6,512	6,731	3	1,500
Washington.....	207	98	1,412,972	681,734	6,826	6,956	2	800
West Virginia.....	246	114	1,575,047	790,436	6,403	6,934	6	2,750
Wisconsin.....	289	87	1,328,991	418,855	4,599	4,814	3	1,500
Wyoming.....	141	54	817,672	332,790	5,799	6,163
Alaska.....	1	1	1,000	1,000	1,000	1,000
Hawaii.....	101	22	825,950	145,135	8,178	6,597
Puerto Rico.....	296	38	1,369,450	170,585	4,627	4,489	122	57,995
Virgin Islands.....	15	1	75,130	3,000	5,009	3,000	2	1,000

1 This number includes 108 individuals who also received loans reported in column 1.

MR. JONES. There is one additional point I would like to bring to the attention of the committee, and that is that before the enactment of title V in the 1949 act, there had been an insured loan program for rural housing.

As long as that program was available to our farmers, we found that it was not being used nor employed by them, the simple reason

being that the farmer is not the articulate fellow that our businessman is, and so when he gets a certificate and carries it to a bank or lending institution and he finds that money is not available, he immediately loses heart, and therefore does not prosecute his possibilities under the insured loan program.

The first year of this program, more money was loaned than was loaned in any 5 preceding years under the insured loan program. So if we talk about rural housing, if we expect to continue to carry out a rural housing program, we need not kid ourselves by thinking that an insured loan program will succeed. It never has succeeded, not only with the housing program, but any other type of insured loan program for the farmer.

Mr. BROWN. Mr. Chairman.

The CHAIRMAN. Mr. BROWN.

Mr. BROWN. I wish to state that the gentleman has made a splendid presentation of his views. I certainly see the need, the continued need for building these houses in the rural areas. I want to congratulate the gentleman on his efforts throughout the years on behalf of the farmers and people who reside in the rural sections of the Nation.

Mr. JONES. Thank you. I had the pleasure of being with Mr. Brown in the first rural housing loan to be made in the State of Georgia, and I was impressed with the dramatic accomplishment that was made by that farm family, by taking them out of a little shack, and placing them in a respectable, decent home, and I am quite sure that those in the State who have been the beneficiaries of this program are making a contribution to the community and cultural life of his State.

Mr. BROWN. I want to say that on the occasion referred to the capable gentleman from Alabama made one of the most eloquent and interesting speeches I have ever heard.

Mr. JONES. Thank you.

Mr. PATMAN. I, too, want to congratulate the gentleman, Mr. Chairman, for his interest in rural housing. Over the years he has been in the forefront of this work and has been very helpful to the Nation as a whole.

Mr. MULTER. Mr. Chairman, may a city boy get his word in here?

The CHAIRMAN. Mr. Multer.

Mr. MULTER. We, too, appreciate your work. We know that the farmers of the country appreciate your work, and for this city boy, I want to tell you I think I understand your problem, and you will be assured of my cooperation in helping bring about the very fine purposes you have in mind, and which you have had in mind through the years.

Mr. PATMAN. Mr. Chairman, in view of Mr. Multer's statement, I want to take this opportunity to commend the members from the cities, generally, like Chicago and New York, for their support of the rural programs. I suspect that if you were to examine the record, you would find members from these city districts who have a better voting record for the farmers than some members from the farm districts. I know they have to carry a burden, as their opponents, whether Democrats or Republicans, will certainly use it against them, but they certainly can defend themselves by showing that it is to the interest of the country to help the farmer.

I am not picking out any political party. There are members of both parties from these great cities who have in the past, and are now, supporting the rural programs, whether housing, support prices for farmers, or anything else, because they realize it is in the interests of the entire Nation.

Mr. SPENCE. Most of these loans which have been made under the Farmers' Home Administration could not have been made under the Bankhead-Jones Act, isn't that true?

Mr. JONES. Yes, sir, that is true. There is one provision in the bill that provides for additional acquisition of acreage, provided, of course, that it is necessary to secure a sound investment for the construction of the farm dwelling or farm building.

These loans are supervised, Mr. Spence, by the local representative of the Farmers' Home Administration, and unless there is a pursuance of a sound farming program on this farm, then he cannot qualify for a loan.

So it is unlike other types of loans. There is continuous supervision and help to the borrower, because it is in the interests of the Government to see that he improves his economic status to the point where he can make his repayments in due course.

Mr. SPENCE. Well, if this act is not carried on, there is no legislation on the books at all that would supplant it in any way or furnish the relief to the farmers that this has furnished, isn't that true?

Mr. JONES. That is true. And I might add that there has been, under the Bankhead-Jones Act a general curtailment of the acquisitions of farms for the tenants due to the fact that the inflated cost of land has been so excessive that there has been a feeling, in the administration, both in this administration and prior administrations, that we should not put the farmer at a greater handicap, and therefore, that we should not have the same enthusiasm for placing the farmer in a position where he cannot discharge his obligation.

Mr. DEANE. Mr. Chairman.

The CHAIRMAN. Mr. Deane.

Mr. DEANE. I wonder, Mr. Jones, if we are not passing through a change in philosophy, so far as rural housing is concerned. I don't believe that we have had before our committee a representative from the Farmers' Home Administration on this subject.

The CHAIRMAN. We will have one this morning, Mr. Deane.

Mr. DEANE. But as I study the law, the Bankhead-Jones Act is basically for the tenant farmer. The submarginal tenant farmer who has been unable to get financing. Is that true?

Mr. JONES. That was the philosophy embraced in the Bankhead-Jones Act, and, of course, the administration has kept that foremost principle alive by giving loans, or making loans, available to those who show aptitude and willingness to better themselves as farmers by farm ownership.

Mr. DEANE. Under the proposed amendments to the Bankhead-Jones Act—I am reading now from a statement that I saw coming from the Farmers' Home Administration, made before the Senate committee, that one of the principal reasons for the lack of loan volume under title I of the Bankhead-Jones Farmer Tenant Act has been the reluctance of the private lenders to provide capital at the existing interest rate of 3 percent to the lender.

In other words, we are increasing the interest rate to approximately 5 percent under the Bankhead-Jones Act, with the expectation that the private lending market would come in and give this housing.

Do you feel, Mr. Jones, that the proposed amendments to the Bankhead-Jones Act will bring needed rural housing to your State?

Mr. JONES. I don't think any insured program is going to be successful with the farm program.

Mr. DEANE. I understand the principal objection to the extension of title V has been that city dwellers are the folks who are profiting mainly by title V.

I can't speak for other sections other than my own district, but the first loan made under title V was in my congressional district, and I know that while this individual may have had part-time work in a mill, or may have worked in the town, the loans have been made to individuals whose basic livelihood, in the main, was on the farm. And I would like your comment, because I think here we have the key reason why title V has not been extended.

Mr. JONES. Mr. Deane, it is my opinion, based upon the observation of the operation of the program, that the Farmers' Home Administration has been very wise in not making loans to part-time farmers. We tried to make that requirement in the original bill, of setting certain standards that we expected of the farmers, and if his income was to be derived from sources other than farming, then he would not fit into this type of program.

Mr. DEANE. The Department of Agriculture recommends amendments to the Bankhead-Jones Act, not only involving the increase in interest rates, but that the act be amended to provide for second mortgages.

What do you think of that procedure?

Mr. JONES. I wish that I could give some considered judgment about it, but I have not studied the situation, and I am not familiar enough with the proposal to say.

Mr. DEANE. Well, as a general policy.

Mr. JONES. As a general policy I am against the increase of the 4 to 5 percent, because the 4 percent has worked out satisfactorily. I know of no objection to the 4 percent figures.

If we couldn't get 4 percent, and we would lose the program, why naturally, it would be better to take what little you can get.

Mr. DEANE. Mr. Chairman, I, too, want to commend Mr. Jones for his interest in the farmers.

Mr. JONES. Let me say, to the question that you have been pursuing, Mr. Deane, the great need, on a comparative basis, of housing in this country, is on the farm. Only 1 out of 12 houses on the farms of this country, only 1 out of 12, has indoor toilets and running water.

The average loan made under this act, as I recall, is about \$6,500. We are getting a better house, we are getting a cheaper house, in an area where slums really exist, and that is on the farms of this country.

I wish that we had more study of rural housing. As far as I know, the University of North Carolina, the University of Wisconsin, and Cornell University are the only institutions that have made any study whatsoever of farm housing.

In the study of Cornell University, in 1949, it was found that in the Northern States the average home was 76 years old.

In the New England States of Maine, New Hampshire, and Vermont, the average life of the home, in 1949, was 95 years. So you can readily see that those homes could not be of modern standards or possessing the things that we would normally expect a home to contain, such as running water, indoor toilets, and the basic sanitary requirements.

In the 12 Southeastern States, what we call the Cotton Belt, there lives one-half of the rural population of America, the lowest income group in America today—the so-called cotton farmer. How are we going to improve living standards if we don't have available a loan program that recognizes the economic situation that exists in those States?

Mr. DEANE. Mr. Jones, do you know who is opposing this program? Do you know why the title V was left out of the bill?

Mr. JONES. I haven't heard any complaints against the program. I didn't know there were any.

Mr. DEANE. Even if the interest rate under the Bankhead-Jones Act is increased I doubt the lending institutions will make insured rural loans. For example, I am now reading from a letter from Administrator Higley of the Veterans' Administration, giving me the facts on the loan guaranty program for 1953.

"There were 322,160 VA home loans. There were only 1,455 VA farm loans." This is an indication to me that the insured farm loan program is not attractive to lenders.

Mr. JONES. There is no demand on the part of the farmer for an insured program. He just doesn't think along those lines. In every type of loan program, insured loan program, it hasn't been successful for the farmer.

You will recall that under the REA Act, there was a provision for loans for water systems. So far as I know no loans are being made under that provision. At least I haven't heard of any.

Mr. DEANE. Thank you.

The CHAIRMAN. Are there further questions of Mr. Jones? If not, thank you very much, Mr. Jones.

Mr. JONES. Thank you very much, Mr. Chairman.

I would like, Mr. Chairman, to insert a short statement on this subject in the record.

The CHAIRMAN. That may be done.

(The information is as follows:)

When the Housing Act of 1949 was passed, we recognized the need for financial assistance to both farm and city families living in substandard homes if these families were to have an opportunity to obtain decent and adequate housing.

Title V of the act specifically authorized loans to farm owners to enable them to build, modernize, or repair their homes and farm service buildings needed to operate their farms profitably. The original act authorized annual appropriations for 4 fiscal years, beginning July 1, 1949. Although the law was amended in 1952 to extend the appropriation authorities for an additional year, no provision for loan appropriations was made beyond the 1954 fiscal year.

The bill I have introduced would extend and place on a continuing basis the authorities of title V of the Housing Act of 1949. Recognizing that loan authorizations for farm housing purposes are dependent, in part, upon economic conditions and other budgetary considerations, this bill authorizes appropriations and borrowing authority in such amounts as Congress may from time to time determine.

The original act authorized appropriations of \$275 million for farm housing purposes. Only about a third of this amount was actually made available. The general curtailment of nondefense Government expenditures associated with

the Korean campaign, as well as certain building-material shortages that existed in past years, are the principal reasons why the farm housing program did not reach its anticipated volume. The amount available for the 1954 fiscal year was \$19 million. The demand for these loans was so great that almost all of the funds were committed within 6 months. The Farmers' Home Administration has received thousands of applications that now are unsatisfied because the farm housing funds were exhausted at such an early date.

Nearly 19,082 farm families have benefited from the \$94,356,000 of farm housing funds that have been made available. With these funds they built or repaired over 16,000 farm homes, almost 14,000 farm service buildings, and 7,200 water systems. In my home State of Alabama, 724 families have received farm housing loans to build new and modern homes and 208 additional families repaired and modernized their homes. In addition, 368 farm service buildings and 623 water systems have been financed with farm housing funds. Through December 31, 1953, \$5,509,475 had been loaned to Alabama farmers for these purposes.

This is a mere beginning in solving the problems of substandard housing on our Alabama farms but it does demonstrate the effectiveness of the farm housing loan authorities in meeting a critical need of farm families for construction credit.

That Alabama farmers want better housing is shown by the fact that the demand for these loans was so great during the past year that 80 percent of the funds allotted to Alabama were obligated within 2 months.

The cost of these new homes has been exceptionally low. To a person accustomed to the price of city homes, it seems almost unbelievable that farm families should be able to build good, substantial homes at an average cash outlay of less than \$6,500. While these homes are modest in design, they do meet all the generally accepted requirements of decent, safe, and sanitary living.

Low cash cost when compared with similar urban homes results from a number of reasons. One is the fact that there is no land cost involved. Another is that the borrower and his family ordinarily are able to contribute a substantial amount of labor, and a third is that in many cases borrowers have been able to utilize such materials as timber, sand, gravel or stone from their own farms or else obtain such materials from local sources at a low cost.

Low cost, however, does not mean low quality. Each of these homes is required to meet the construction standards of the Farmers Home Administration. These standards protect the borrower against faulty construction and the Government against an unsound investment. The standards are flexible enough to permit a farmer to use his skills and ingenuity to build at minimum cost the kind of a home of which he and his family are justifiably proud.

In addition to providing financing for farm homes, the farm housing program offers farm families an opportunity to build or improve service buildings needed to put their farms on a paying basis, and to operate them more efficiently.

A fourth of the farm housing funds have been used for purposes such as building dairy barns and milking parlors, general purpose barns, poultry houses and for installing water systems. While this has not been the largest field of activity of the housing program it has been a highly significant one. Through it some farmers have been able to put their units on a paying basis; others have been able to make necessary changes in their farm buildings to meet the changing requirements of our present day agriculture; and others have needed to change their building facilities to use more efficiently their family labor and their land.

The nature of the farming business—one in which the family home and income producing activities are inseparably joined—makes this authority an important phase of our farm housing program.

The level of living of farm families depends upon the productivity of their farm. When through the addition or modernization of farm service buildings farm families of moderate means, such as the ones to whom farm housing loans are made, are able to increase their income, they are better able to pay the cost of a decent home.

These housing loans to farm families who are unable to obtain their credit from the usual sources are sound investments. During the 4 years that the farm housing program has been in operation, borrowers have established a commendable repayment record. As of January 31 of this year, less than 5 percent of the borrowers had not paid in full the amounts that had become due on their loans. Approximately one-third had paid more than was due.

I am particularly proud of the repayment record established by the borrowers in Alabama. Of the almost 1,000 farm housing borrowers who had payments

due at the end of 1953, less than 1 percent had not paid the full amount due on their loan by January 31, 1953. These few are the families who did not have sufficient resources to meet the credit requirements of conventional lenders for a construction loan. However, as soon as they make sufficient financial progress to qualify for a loan from another source they will be required to refinance their Government loans with private or cooperative lending institutions. They only need adequate credit on reasonable terms and an opportunity to prove that they are good credit risks. When the construction work is finished and the loans become seasoned, private credit agencies can and will carry the remaining debt.

The farm housing program is not in competition with private and cooperative credit, but rather it is an integral part of our total credit system that will enable farm families to have homes comparable to those enjoyed by city residents. I think we will all agree that a high percentage of our city families are well housed today because they have been aided in their home purchase or improvement through Government financed, insured or guaranteed programs.

I take considerable pride in the fact that it was an Alabama World War II veteran who received the first farm housing loan made under the Housing Act of 1949. I wish all of you could have seen the transformation that took place on his farm when the ramshackle and dilapidated house that was too worn out to repair was replaced by a modern six-room home complete with running water, bath, and up-to-date kitchen.

Both the appearance of the farmstead and the efficiency of the farming operations were further improved by the addition of a new barn and the installation of a pressure water system.

All this was done with a \$4,300 farm housing loan coupled with careful planning to use most advantageously the materials that could be salvaged from the wornout buildings that were replaced.

I mention this first farm housing loan because it is both a typical example of the shocking condition of many of our farm homes and a dramatic demonstration of how such a condition can be remedied by a soundly conceived and efficiently administered farm housing program.

Although the inadequacy of farm homes has been less conspicuous and perhaps less publicized than the slums in the cities, a far greater percentage of our farm families are living in substandard houses than is true of urban families. Nationwide 1 out of every 5 farm families is living in a house that is so dilapidated that it either needs to be replaced or else needs major repairs. In Alabama only 1 farm family out of 12 has the commonly accepted convenience of a private toilet, bath, and hot running water. One out of four families live in homes having less than four rooms. A high percentage of Alabama farm homes are not only inadequate, but 1 out of every 3 needs major repairs or needs to be replaced.

The economic and social problems associated with inadequate housing on a fifth of our Nation's farms are too great to be brushed aside. The idea that privation and hardship necessarily are a part of farm life was commonly accepted during the years when our country was being settled, but today farm families want, and I believe they are entitled to it, the same conveniences that city people enjoy.

Farm families for one reason or another frequently have deferred home improvements until they had paid for their farms. The idea has prevailed among both farmers and lenders that the house was something to be improved out of savings and that it wasn't prudent for the farmer to borrow to give his family a decent home. This postponement of home improvements frequently extended beyond the years of greatest family need—the years when the children were at home. Particularly during these years, the household duties of farm wives meant hard labor and drudgery without such commonly accepted conveniences as electricity, running water, and efficiently designed and equipped kitchens.

This postponement of home improvements was largely because of economic necessity and not by choice. All too frequently farm families never did accumulate enough money to build a decent home. The possibilities of obtaining a long-term amortized loan to build a new home were exceedingly scarce; consequently, many of these families were forced to patch and continue to live in rundown and inadequate homes.

Today, farm families no longer accept the notion that because they chose farming as a way of life they need to live in homes that are inconvenient and inadequate. To the extent that private and cooperative credit sources can meet the building credit needs of farm families they should be encouraged to do so.

Government loan guaranties and insurance have encouraged private capital to finance improved housing for our city families on a substantial scale. When private credit was not available direct Government loans have been provided. What farm families want and need is a like opportunity to finance farm building improvements.

The farm housing section of the Housing Act of 1949 gives this opportunity to the farm families who cannot obtain their financing from private or cooperative sources. The limited funds that have been made available under this act have proved its effectiveness in helping farm families of modest means improve their homes. We need to extend these authorities. They are an essential part of our national housing program which has as its objective the progressive improvements of our housing standards with the eventual realization of a decent home and suitable living environment for every American family.

Mr. JONES. Again let me state to the committee I appreciate the opportunity of appearing on behalf of rural housing. Thank you.

The CHAIRMAN. Mr. Lantaff.

STATEMENT OF HON. WILLIAM C. LANTAFF, A REPRESENTATIVE IN CONGRESS FROM THE STATE OF FLORIDA

Mr. LANTAFF. Mr. Chairman, I appreciate the opportunity of appearing before this committee to call to your attention a very small and somewhat minor bill that I introduced last year, pertaining to military housing. With it in connection with a work of which I am a member, we ran into quite a problem at various military installations with reference to the construction of bachelor officers quarters. Bachelor officers quarters cost approximately \$240,000. Normally, that is one of the first things that is stricken from the appropriations bill. In many of our installations and bases there is a great need for these bachelor officers quarters, but as I have mentioned before, they cost some \$240,000, and normally in an attempt to cut expenses the Appropriations Committee eliminates that item from the bill.

When Homestead Airbase was reactivated in Miami, Fla., on a permanent basis, 2 years ago, and construction was started there, the same thing happened. The bachelor officers quarters were eliminated, and I received letters from one or more individuals in my community suggesting that the title VIII provisions of the Wherry Act be extended to cover bachelor officers quarters.

The question was posed to me as to why private enterprise couldn't go in and build these BOQ's under the provision of title VII of the Housing Act, on the same way that multiple-family housing was being constructed, and that private enterprise was willing to do the job and it would save the Government having to appropriate that money in the public-works program of the military budget.

I then took that idea up with the Air Force, because the Air Force was involved at the Homestead Airbase, and the Air Force said that no particular thought had been given to it, but about a month later came back and said there was no reason why it couldn't work. The only minor objection that they had to it was the fact that if the BOQ requirements, on a base, dropped under the officers' requirements for BOQ quarters, that there might be a problem of renting to civilians on the base or outsiders. But they thought that the advantages to the Air Force of being able to go ahead with their BOQ program, utilizing private enterprise, would more than outweigh those advantages.

And so this bill which you have before you, H. R. 6667, was actually prepared for me by the Department of the Air Force.

I talked with some of the officials in the Air Force this morning, as to whether or not they had any change of heart about this particular bill, and they said no, that they thought it would be a very helpful amendment to the title VIII of the bill.

That, Mr. Chairman, is about all there is to that bill. I think that it will enable private enterprise, however, to construct a needed facility for the Air Force without the requirement of our having to appropriate approximately \$240,000 per BOQ, which, as I pointed out, is always stricken from the appropriation bill, and that is one of the great needs of all the services today.

Mr. BETTS. Did you say \$240,000?

Mr. LANTAFF. The cost varies. That is about an average cost for a 40-unit bachelor officers' quarters.

The Secretary of Defense, as I recall it, has stated that the cost per unit should not exceed \$6,000. In this bill, it states \$9,000 per unit—up to \$9,000 per unit—which, as I recall it, is the same per unit cost authorized for the multiple family housing.

The CHAIRMAN. Thank you, Mr. Lantaff.

Mr. MULTER. Mr. Chairman.

The CHAIRMAN. Mr. Multer.

Mr. MULTER. Mr. Lantaff, I am sure we appreciate your calling this to our attention. But tell me, are there any parts of the country where the cost of the unit may run as high as \$9,000? I am not talking now about Alaska or outside of the continental United States, but within the United States; are there any areas where it would run that high?

Mr. LANTAFF. No, sir. I think, in fact, that the \$9,000 figure is an outside figure. The \$9,000 figure was used to track the other provisions with reference to multiple-family housing.

Actually, the most expensive bachelor officers' quarters that we ran into was out at El Toro Air Force Base, Calif., where the cost was \$7,076 per man.

After our report the Secretary of Defense issued a directive that no bachelor officers' quarters housing would be approved which exceeded the cost of \$6,000 per man.

Mr. MULTER. Thank you.

The CHAIRMAN. Thank you very much for being here, Mr. Lantaff.

Mr. LANTAFF. Thank you, Mr. Chairman.

The CHAIRMAN. Mr. Watts.

STATEMENT OF HON. JOHN C. WATTS, A REPRESENTATIVE IN CONGRESS FROM THE STATE OF KENTUCKY

Mr. WATTS. Mr. Chairman, members of the committee, I appreciate the opportunity of appearing before this committee for a short time this morning. I am here in support of H. R. 7743, which I introduced in the House, and S. 2937, which was introduced in the Senate by Senator Sparkman, and which passed the Senate on March 1, 1954.

These 2 bills are identical except in 1 minor particular, in that they seek to amend section 15 of the United States Housing Act of 1937.

In the 1949 amendment of that housing act, a proviso was laid down, under which people could apply for admittance to public housing. It was divided into two categories. First, that they had to have an income under or between certain limits, and, secondly, that they had to come from what is known as substandard housing.

The 1949 act provided that the second section, that is requiring that they come from substandard housing, would not be applicable to veterans for a period of 5 years after March 1, 1949. Of course, that expired this March, March 1, 1954, and I introduced this bill on, I believe it was, February 4, 1954, for the purpose of trying to prevent that from expiring.

The local housing people that I have talked to have told me that this was worked very well, that it has provided needed housing for our veterans, and I think that there is a real need for continuation of it. If it was good law in the first place, it certainly seems to me that it would be good law to extend it for three reasons.

We are having many veterans now who are returning from the Korean conflict who have never had an opportunity to occupy public housing. Another thing, many public housing units—I know one in my own community of Lexington, Ky., is only now being completed—some of the units are even not yet available for occupancy, and veterans have never had an opportunity to apply for admission to those.

Many veterans who are just recently married have never needed a home before, and will be needing those homes, and if the President's program of constructing 35,000 new housing units is carried out, there will be more units that I think should be made available to veterans.

I know of no opposition to the bill. I would like to presume on the good nature of the committee by making a couple of suggestions, however. One is that the bill could be handled in the Housing Act which is now before you.

The other is that you could pass the Senate bill, which I referred to, and I believe the latter would be the better procedure, because while it appears that your committee is about ready to report this bill to the House and probably will get rather prompt action on it, we don't know what the situation will be in the Senate and it may be some 3 or 4 months before the bill clears the Senate, if the committee sees fit to include a provision of this kind in the Housing Act.

In the meantime, for those 3 or 4 months, veterans have been stopped from—not stopped from applying, but this waiver has become non-effective as far as they are concerned.

Mr. Chairman and members of the committee, that is all I have to say about it. I hope the committee will give it earnest consideration.

The CHAIRMAN. Thank you.

Mr. SPENCE. The veteran has been in a peculiar disadvantageous position because of his absence from the country and not being able to make any provision for housing, isn't that true?

Mr. WATTS. That is true, and too many housing units are just now being completed in many communities.

Mr. KILBURN. Is this public housing?

Mr. WATTS. Yes, sir.

Mr. MULTER. Mr. Chairman.

The CHAIRMAN. Mr. Multer.

Mr. MULTER. What you are seeking to do here is to continue the provision in existing law with reference to whatever public housing has been built or may be built?

Mr. WATTS. That is right. I am trying to renew it. It has expired. It expired March 1, and at the present time is not operative, and the local managers tell me that they have received instruction from the housing officials in Washington to no longer honor that provision.

Mr. MULTER. Congressman, did I understand you to approve the President's suggestion that we build at least 35,000 new public housing units each year for the next 4 years?

Mr. WATTS. Yes, sir; I do.

Mr. MULTER. Do you realize that in this bill we have no provision for public housing at all, as of this moment?

Mr. WATTS. Well I haven't made a comprehensive study of your bill, as the members of your committee have.

Mr. MULTER. I think the committee will agree that there is, as of now, nothing in this bill calling for any additional public housing, and I don't know whether you were in the committee room this morning when I said that the off-the-record opinion as of yesterday was that the Appropriations Committee would appropriate no money for new public housing starts. So if your area needs it, and you think the country needs it, I suggest you go to work on the Appropriations Committee.

The CHAIRMAN. Are there further questions? If not, thank you, sir.

Mr. WATTS. Thank you, Mr. Chairman.

The CHAIRMAN. We have the Resident Commissioner of Puerto Rico, Mr. Fernós-Isern.

Commissioner, we are very glad to have you proceed.

STATEMENT OF HON. A. FERNÓS-ISERN, RESIDENT COMMISSIONER OF PUERTO RICO

Mr. FERNÓS-ISERN. Mr. Chairman, in the first place I thank the committee for this opportunity to present my views on this bill, really only on one particular aspect of it.

In general, of course, I would say that Puerto Rico is one of the areas where laws like this have shown their worth. The work done in Puerto Rico has been splendid. But I am addressing myself this morning to just one particular aspect of the bill. I refer to H. R. 7839, page 87, where the word "State" is defined, to include the several States, the District of Columbia, and the Territories and possessions of the United States.

Since the 25th of July 1952, Puerto Rico has been organized as a Commonwealth, and there has been a question raised as to whether laws that make reference to Territories and possessions apply or do not apply to Puerto Rico, since the Commonwealth status is recognized as something by itself.

As to laws that were in effect in Puerto Rico before July 25, 1952, I think there would be little question that unless they are inconsistent with the law that created the Commonwealth they would continue to apply. However, that matter has not been solved as yet, and is under study.

As to laws passed after July 25, 1952, the question seems to be much more important. The implication would seem to be that unless the Commonwealth was also included the idea that Territories and possessions only were mentioned might be interpreted as meaning that Puerto Rico was excluded.

This matter also is being studied as to some laws that have been passed, and which carry the language in the way it is in this bill.

Therefore, since we are so anxious to make sure that the law would apply to Puerto Rico, I wish to express our interest in having Puerto Rico expressly included.

It has been suggested that, by making some statement in the report, this question could be taken care of. But this would lead into another matter. The implication then might be that Commonwealth is no different from Territory and possession. This would have, I think, a bad effect in many ways—psychologically, it would have a bad effect in Puerto Rico, and it might have in other directions.

I wish to state to the committee that last fall I was honored by being appointed as alternate delegate to the U. N. to take up the question of the change of status in Puerto Rico, and we had some debates there in the various bodies of the U. N., until the matter came up to the General Assembly, and as a result of our efforts there the General Assembly passed a very complimentary resolution to the United States for the good work done in Puerto Rico, full recognition of the fact that Puerto Rico is a Commonwealth and has self-government, so that it is not included any more in the Territories and possessions, which are subject to report to the U. N. by the United States under the charter.

So I believe that it is in the public interest that this recognition of the Commonwealth of Puerto Rico could be made whenever possible, so that we may give full credit to the United States for the good deeds that it has always done for Puerto Rico.

I would also state that there are some that still find fault with the present status of Puerto Rico, and one of their arguments is that the Commonwealth status is nothing else but a disguised status of colonialism.

I want also to add a few words of thanks to the distinguished member of this committee who brought this matter to my attention, and who has given a great deal of thought and time to this matter, Mr. O'Hara.

Thank you, Mr. Chairman.

The CHAIRMAN. Thank you, Mr. Commissioner.

I don't think there is any question but what it is intended to include Puerto Rico. Have you given consideration to the introduction of legislation which would remove this doubt with respect to the status of Puerto Rico in all acts which have heretofore covered Puerto Rico in those acts as possessions?

Mr. FERNÓS-ISERN. Yes, sir, Mr. Chairman. I am working on a bill that would take care of laws enacted before 1952, and laws enacted from 1952 to the time this act might be enacted, clarifying the application of laws that didn't carry the word "Commonwealth."

The CHAIRMAN. I think we can cover it in some way.

Mr. FERNÓS-ISERN. But I would add that—while this act, if it passes—it might be very wise not to let one bill so important as this be open to any question.

Mr. MERRILL. Mr. Chairman.

The CHAIRMAN. Mr. Merrill.

Mr. MERRILL. As I understand it, you have a double purpose here, though, in appearing before the committee. You do want the Commonwealth of Puerto to receive the benefits of the act. That is one thing.

Mr. FERNÓS-ISERN. Yes, sir.

Mr. MERRILL. But the other thing that you would like to get established in all congressional acts is this: That Puerto Rico no longer wants to be referred to and thought of in terms of either a Territory or a possession. That is, in gaining the advantages of the act by being included in the word "possessions" you feel that you would be depriving Puerto Rico of a certain status before the world in having to accept that particular nomenclature as describing its status now that you have achieved Commonwealth status. Am I right in that?

Mr. FERNÓS-ISERN. You are right, sir. I would say that I would rather try to prevent the implication that recognition is not being given, as it is being otherwise given, to the status of Puerto Rico, by classifying it as a Territory or possession in any given law.

I might add, if I may, that right now in the Senate there is a debate on the statehood bills for Hawaii and Alaska, and time and again question of Commonwealth status has come up, and, generally, it is being recognized in the debate that Commonwealth status is something different from Territorial possession. So it is being widely recognized.

Mr. MERRILL. The point I am trying to make is that you cannot achieve the purpose that you are seeking merely by being assured that the language we now have in the bill will give you the coverage of the act. That doesn't achieve your purpose.

Mr. FERNÓS-ISERN. Not completely.

Mr. MERRILL. If the purpose of this Nation is to be served in having given to Puerto Rico Commonwealth status, then we as a Congress are going to have to recognize from time to time that there is a distinct difference between Commonwealth status and being a Territory or possession.

Mr. FERNÓS-ISERN. At least not do anything that might indicate that Congress does not recognize it.

Mr. MERRILL. Well, you really believe that you have been elevated, as a governmental unit—your status has been improved, both for yourselves and in the eyes of the world, by having been made a Commonwealth rather than remaining a possession or Territory?

Mr. FERNÓS-ISERN. Absolutely, without any question.

Mr. MERRILL. And we can achieve the maximum effect of our action, both for your nation and for America, by making clear in every action of the Congress that this new status which you have is something distinct and apart and above a possession or Territory; isn't that right?

Mr. FERNÓS-ISERN. That is correct. I would only add that we are American citizens ourselves.

Mr. MERRILL. Oh, yes; that is right.

Now, I see the point that you have in mind, and I am very much in sympathy with it. There is no use going through the business of creating a Commonwealth if we are then going to say that, really, by all legislation that Congress passes, oh, yes, it is a Commonwealth

in name, but a Commonwealth is nothing more than a Territory or possession. If we do that, we have defeated the whole purpose of creating the Commonwealth.

Mr. FERNÓS-ISERN. I agree with you.

Mr. MERRILL. And we certainly don't want to do that, because we take pride in what we have done. So I am in sympathy with that whole thing. I think we should establish the fact that Territories and possessions do not mean Commonwealth, because Commonwealth is a step upward, I may say, in the dignity of a political unit.

But are you willing, then, in order to achieve this psychological effect, which I deem to be most important, are you willing to have established, for all time in the future, that when they use the words "territory and possessions," you are excluded, so that you will be compelled from now on and forever to fight the battle and make sure that the extra words "and Commonwealth of Puerto Rico" are included in every bill? Because once we do make a distinction, which I think should be made if we are to achieve the aims in creating the Commonwealth, once we establish the distinction your office is going to have the burden from now on to make sure that the words "and Puerto Rico" are in every bill.

Mr. FERNÓS-ISERN. I think we would have to take that risk.

Mr. MERRILL. And you would be willing to assume that risk in order to achieve recognition by Congress that the Commonwealth of Puerto Rico cannot be included in the more general term of "territory and possessions"?

Mr. FERNÓS-ISERN. That is correct.

Mr. MERRILL. Thank you.

Mr. O'HARA. Mr. Chairman.

The CHAIRMAN. Mr. O'Hara.

Mr. O'HARA. I take especial interest in this from the fact that Puerto Rico came to us in connection with the Spanish-American War. We have always said that the Spanish-American War was fought and won without any element of national selfishness. Cuba is free, the Philippines are free, and the people of Puerto Rico, of their own free will, as shown by an overwhelming majority in a popular election, chose a continuing alliance with us as a Commonwealth of the American Union.

Heretofore we have had States, Territories, and possessions. Now, we have a Commonwealth. It is setting a new pattern. I dare say that the Commonwealth of Puerto Rico is only the forerunner of many commonwealths, peoples of other lands in future seeking and obtaining alliance with us, with the commonwealth status.

So I have been very much interested that there should be in our laws a clear definition of commonwealth. I do not think the old definition suffices. It should include States, Territories, Commonwealths, and possessions. Or at the present time this could cover States, Territories, and possessions, including the District of Columbia and the Commonwealth of Puerto Rico.

I am glad we have had with us today the distinguished Resident Commissioner. We all know the stature of the Commissioner; how he is regarded in Puerto Rico, and how highly he is esteemed in Washington. It is no overstatement to say that the compact leading to the Commonwealth of Puerto Rico is a tribute to his tremendous

popularity and to his tremendous ability. Certainly all of us in the Congress appreciate the great stature of the Resident Commissioner of Puerto Rico. I believe Dr. Fernós-Isern, one court, I think you told me, in Boston, in some proceeding had passed on the question of the legal meaning of "commonwealth"?

MR. FERNÓS-ISERN. The Boston circuit court, in passing on a matter incidental to a lawsuit which hasn't been definitely decided, at least intimated or made reference to the fact that apparently Puerto Rico was to be considered as a State in a generic sense, although not a member State of the Union, but in compact with the Union. Words to that effect.

MR. O'HARA. The distinguished gentleman from New York, Mr. Gamble, when we discussed this last, thought that because the Commonwealth is so recent that there may have been no judicial determinations. This is the only time that you are familiar with that the matter has reached any court?

MR. FERNÓS-ISERN. There have been some decisions by the United States court in Puerto Rico, which have gone up to the Boston circuit court. It is a matter that is still under judicial consideration.

MR. O'HARA. And you are fearful that unless "commonwealth" is included in the definitions in new laws, such as the Housing Act, that there will be some uncertainty because of later judicial determinations that may hold against the present theory?

MR. FERNÓS-ISERN. That is correct, sir.

MR. O'HARA. Thank you very much, Commissioner.

MR. TALLE. Mr. Chairman.

THE CHAIRMAN. Dr. Talle.

MR. TALLE. Mr. Resident Commissioner, assuming that your bill is enacted into law by the Congress, what will be the political relationship between the United States Government and Puerto Rico?

MR. FERNÓS-ISERN. The political relationship is already established. The bill I am contemplating wouldn't change at all that relationship. The bill I am contemplating is only to clarify the question of whether laws, which make reference to States, Territories, and possessions, but not to the Commonwealth of Puerto Rico, should or should not apply in Puerto Rico.

That is the only question the bill I have in mind now would take care of. But the relationship between Puerto Rico and the United States was established by the law that authorized the creation of the Commonwealth.

In general, if the Congressman wants me to briefly state the relationship, it is that emanating from a compact which was enacted—the terms of which were enacted into law by the Congress and accepted by the people of Puerto Rico in a plebiscite. So the present relationship between Puerto Rico and the United States is the result not only of the decision of the Congress, but of the acceptance by the people of Puerto Rico.

It is certainly government by consent, and under the terms of compact the people of Puerto Rico adopted their own constitution, which later was ratified by the Congress, within the framework of the compact, and the constitution creates a Puerto Rican Commonwealth, which to all intents and purposes acts exactly as a State government.

The difference between the Commonwealth of Puerto Rico and a State of the Union, fundamentally, from a constitutional standpoint, is that a State, of course, is a member of the Union within the Constitution of the United States. Puerto Rico is not incorporated constitutionally into the United States except through this compact. But in practice the laws of the United States, general laws, applicable generally in the States, apply in Puerto Rico. In other words, Congress has the power to legislate concerning Puerto Rico, exactly as it has the power to legislate for the whole Union.

Mr. MULTER. Except that you cannot vote?

Mr. FERNÓS-ISERN. That, of course, is not a matter of congressional law, but of Constitution and, of course, Puerto Rico does not vote for President or does not elect Senators or Members of the House, except a Resident Commissioner.

Mr. TALLE. It appears, then, that the question is, What is a commonwealth?

Mr. FERNÓS-ISERN. That is precisely it, although we adopted the constitution which we adopted under the name "Commonwealth," and this has been ratified by the Congress. There has been no definition of the general category of commonwealth, as yet, and that is what the bill I am thinking of would do. It would define what a commonwealth is. It would do actually for commonwealths what has previously been done concerning territories.

We know what a territory is. We know what a possession is. Those categories have existed for a long time and are well identified in law. The category "commonwealth" has never been created, Puerto Rico is the first one. I think now would be proper to make a definition of what is meant by "commonwealth" in the law, and how do laws of the United States apply in commonwealths. That would be, of course, always to have a relationship with what the compacts say.

Mr. TALLE. Thank you.

Mr. MULTER. Mr. Chairman.

The CHAIRMAN. Mr. Multer.

Mr. MULTER. Commissioner, up to the present time the housing acts have been interpreted as applying to Puerto Rico, have they not?

Mr. FERNÓS-ISERN. That is correct.

Mr. MULTER. All you are asking is to make sure they continue to apply?

Mr. FERNÓS-ISERN. That is right. But the acts heretofore applicable have been enacted before 1952, so the question never arose.

Mr. MERRILL. Will you yield?

Mr. MULTER. I yield.

Mr. MERRILL. I think that isn't exactly right. The Commissioner is here not only for the purpose of making sure that the Housing Act applies; he is also here to try to get application of the Housing Act to Puerto Rico without having to have Puerto Rico be accepted in the general term of "territory" or "possessions." There is a psychological thing that he is fighting for here over and above merely getting the benefit of the Housing Act; isn't that right?

Mr. FERNÓS-ISERN. That is correct. I have both reasons in mind.

Mr. MULTER. I understand that. But actually, so far as the law is concerned, there is no real change in the substantive law that you seek.

Mr. MERRILL. But he wants to get that without the status of territory or possession.

Mr. MULTER. I understand.

Mr. FERNÓS-ISERN. I understand the intention of the committee has been to have the law apply in Puerto Rico, anyhow. So all I am asking is that we may be sure that no judicial interpretation may later find that although the intent was to include Puerto Rico, that Puerto Rico was actually included, and, second, that in order to include Puerto Rico it may not be necessary to continue to apply to it as a possession, because of the reasons already given.

Mr. MULTER. The housing acts previously enacted have been of tremendous help in helping the housing conditions in Puerto Rico, have they not?

Mr. FERNÓS-ISERN. I know of many good things done by the United States in Puerto Rico, but I don't know of any one that I would dare say is better than what has been done by the Housing Act.

Mr. MULTER. Thank you.

The CHAIRMAN. Are there further questions of the Commissioner? If not, thank you very much, Mr. Commissioner.

The CHAIRMAN. Mr. McLeaish.

STATEMENT OF HON. R. B. McLEAISH, ADMINISTRATOR, FARMERS HOME ADMINISTRATION, ACCOMPANIED BY HENRY C. SMITH, DEPUTY ADMINISTRATOR, FARMERS HOME ADMINISTRATION; CHARLES BERNARD, BUDGET PLANNING OFFICER; AND KENNETH SCOTT, DIRECTOR OF AGRICULTURAL CREDIT

Mr. McLEAISH. My name is R. B. McLeaish, Administrator, Farmers Home Administration, and I am accompanied by Mr. Henry C. Smith, Deputy Administrator of the Farmers Home Administration, and Mr. Charles Bernard, budget planning officer, and I would like to introduce to the committee Mr. Ken Scott, who has just been appointed a Director of Agricultural Credit.

With the consent of the chairman, I would like to read a statement.

Mr. PATMAN. Mr. Chairman, may I ask if he has filed a statement showing the number of loans made last year? And I want a breakdown as to the first half and last half of last year.

Mr. McLEAISH. We will place that in the record, sir.

Mr. PATMAN. You don't have it available?

Mr. McLEAISH. I don't have it broken down between the first and last halves.

The CHAIRMAN. Mr. Patman, may we proceed in the regular order?

Mr. PATMAN. Mr. Chairman, I can't stay.

The CHAIRMAN. It is unfortunate.

Mr. PATMAN. I know; it was unfortunate yesterday.

The CHAIRMAN. These other members have to stay here.

Mr. PATMAN. That is all I want. I want a breakdown put in the record for the first half and the last half, by months. That is all I want out of this witness.

(The information requested was not received in time for printing of this volume.)

The CHAIRMAN. All right, Mr. McLeaish, you may proceed.

Mr. McLEAISH. Mr. Chairman, title V of the Housing Act of 1949 authorizes the Secretary of Agriculture to extend financial assistance to owners of farms to enable them to construct, improve, alter, repair, or replace dwellings and other farm buildings on their farms, to provide them, their tenants, lessees, sharecroppers, and laborers with decent, safe, and sanitary living conditions and adequate farm buildings.

Since the approval of the act on July 15, 1949, a total of \$99,074,000 has been made available for loans and \$1,050,000 for grants. This total of \$100,124,000 compares to \$385,000,000 authorized in the act, as amended, through the fiscal year 1954. From inception of the program to December 31, 1953, a total of 18,401 loans for \$93,992,181 had been made to eligible farm owners. In addition, grants totaling \$363,674 had been made to 785 farm owners, 108 of whom also received loans within the total of 18,401, reported above.

For the purpose of extending financial assistance under the act, section 501 defines a "farm" as—

a parcel or parcels of land operated as a single unit which is used for the production of one or more agricultural commodities and which customarily produces or is capable of producing such commodities for sale and for home use of a gross annual value of not less than the equivalent of a gross annual value of \$400 in 1944, as determined by the Secretary.

Under this definition, many city workers living in suburban areas or on part-time farms are eligible for assistance and have applied for farm housing loans. Approval of loans to these individuals depletes the limited loan funds otherwise available for assistance to bona fide full-time farm owners whose housing needs generally are much more acute. It has been very difficult to administer the program under these conditions. The city workers living in suburban areas or on part-time farms are clearly eligible and usually have a source of income for repayment more stable than the full-time farm owner. If ample loan funds were available for all applicants, this would not be a major administrative problem; but with only limited funds it has been difficult to direct the program toward assistance to bona fide full-time farmers.

Section 503 of the act provides for the making of loans to farm owners whose income from the farm is not then sufficient to make annual payments on a loan for the necessary improvements, provided that adjustments in the farming practices, enlargement of the farm, or other development would increase the repayment ability within a period of 5 years. Enlargement and development loans are authorized under these circumstances. This section further provides that contributions in the form of credits on the loan account may be made for a period of 5 years if the borrower is unable to make full payment of the annual installment. Section 504 provides for the making of a loan or a combination loan and grant to applicants not eligible under sections 502 and 503 for minor repairs and improvements to dwellings and other farm buildings in order to remove hazards and make the buildings safe and sanitary. This section also provides for enlargement and development loans "in order to encourage adequate family-size farms." Applicants seeking to enlarge or develop their farms into adequate family-size farms under either of sections 503 or 504 may secure assistance of this type through the provisions of title I of the

Bankhead-Jones Farm Tenant Act, as amended. Because of this conflict, and the large number of applications for assistance by farm owners with income sufficient to make full repayment of the loan, the Farmers Home Administration in the latter part of fiscal year 1953 discontinued making loans under sections 503 and 504.

The Bankhead-Jones Farm Tenant Act, under which direct loans are made and loans made by private lenders are insured, has as its specific objective the encouragement of family-size farms. A strengthening of title I of the Bankhead-Jones Farm Tenant Act through changes such as proposed in S. 1276, 83d Congress, would in many ways serve the need for better farm housing and other farm buildings of applicants now applying for assistance under title V of the Housing Act of 1949. One of the principal reasons for the lack of loan volume under title I of the Bankhead-Jones Farm Tenant Act has been the reluctance of private lenders to provide capital at the existing interest rate of 3 percent to the lender. S. 1276 would largely correct this situation by increasing the rate to not to exceed 4 percent. An additional 1-percent insurance charge would continue to be charged the borrower and would be available to the Government for insurance and administrative expenses. The Department has two additional revisions in the Bankhead-Jones Farm Tenant Act that it is recommending, which if enacted will assist in rendering better service to family-type farmers for building improvements. These revisions are:

1. Elimination of the requirement that title I loans must be secured by first mortgages. This will permit the making of direct loans and insuring loans by private lenders on the security of second mortgages. This will result in more farmers being assisted with the same appropriation for direct loans and will permit many private lenders an opportunity to retain their mortgage interest in the farms.

2. Provision that title I loans may be insured up to 100 percent of the fair and reasonable value of the farm. The act now provides that the insurance authority is limited to 90 percent. These revisions will place the insurance authority on the same basis as direct loans.

In discussions with the Bureau of the Budget and other interested Government agencies, questions have been raised concerning these recommendations that have not been finally resolved. These relate to the proposed insurance of second mortgages. As soon as these questions are resolved drafts of legislation covering these proposed revisions will be submitted.

The Department is in favor of legislation providing ample credit on a reasonable basis for better housing for bona fide farmers. On July 14, 1953, the Department transmitted proposed legislation to the Congress which would extend the present provisions of title V of the Housing Act of 1949 on an indefinite basis. However, after further consideration it now believes, and recommends, that S. 1276, with the proposed revisions discussed in this statement, would provide ample credit on family-size farms and would be preferable to continued utilization of the authority of title V of the Housing Act of 1949.

As indicated, the proposed revisions the Department of Agriculture is recommending have not been finally agreed upon by the Bureau of the Budget and other interested Government agencies. We are unable, therefore, to say that the proposal has the approval of the Bureau of the Budget.

The CHAIRMAN. Are there questions of these gentlemen?

Mr. SPENCE. Mr. Chairman.

The CHAIRMAN. Mr. Spence.

Mr. SPENCE. I judge from what you say that you feel that the existing law in its present state would not be sufficient to furnish the accommodations received by the farmers under the present act; is that true?

Mr. SMITH. The proposed amendments, Congressman, relate more to the volume of business rather than the type of business.

Mr. SPENCE. But without the amendments you suggest, there would be no adequate relief for the farmers, as provided by the Farmers' Home Administration?

Mr. SMITH. The Bankhead-Jones Farm Tenant Act has adequate provisions from the standpoint of the type of loan, to assist with the rural housing problem, but these amendments would enable the Department to step up the volume of business under the Bankhead-Jones Farm Tenant Act.

Mr. SPENCE. What provisions do you recommend for amending the Bankhead-Jones Act to make it adequate to meet the needs?

Mr. SMITH. Three provisions; one is that the interest rate be adjusted—

Mr. MULTER. You mean increased, don't you?

Mr. SMITH. Yes; increased so that more private lenders would be invited into the insured mortgage field. That is one proposed amendment.

The second is that the Department be given authority to make direct loans or to insure loans on a second mortgage basis. At the present time it is limited to first mortgages.

The third provision is that the Department be given authority to insure mortgages up to 100 percent of the fair and reasonable value of the farm on which the loan is being made.

Mr. SPENCE. How would that differ from the present act, if you had those three amendments? What advantages would be given to the farmer over those contained in the present act?

Mr. SMITH. The advantage, Congressman, would be that with those changes in the Bankhead-Jones Farm Tenant Act it was felt that the volume of loans would be greater and greater assistance could be rendered bona fide farmers under the Bankhead-Jones Farm Tenant Act, and the Department would be in a better position to serve more farmers, from a housing standpoint, from a farm buildings standpoint.

Mr. SPENCE. In other words, the law would be comparable to the present law?

Mr. SMITH. Yes.

Mr. SPENCE. But the law hasn't yet been amended, and it is uncertain whether it will be amended. The process of legislation is uncertain.

Mr. SMITH. At the present time we estimate that approximately 65 percent or 70 percent of the housing loans that are being made under the title V provision of the Housing Act are being made on the same type farm, same size and character farm, that is also being served under the Bankhead-Jones Farm Tenant Act. So actually and essentially the Department's position amounts to this: That there is, in essence, no need for the duplicate lending authority. It is preferable to make the needed changes in the Bankhead-Jones Farm Tenant Act,

to make it more adaptable to this rural credit problem. That would make it possible, then, to eliminate the duplicate lending authority. That is, in essence, the Department's position on it.

Mr. MULTER. Mr. Chairman.

The CHAIRMAN. Mr. Multer.

Mr. MULTER. I may misunderstand your statement, sir, but there would appear to me to be several inconsistencies. Possibly you can straighten me out and we can eliminate them, if I misunderstand what you say.

Let us take, first, S. 1276. I understand you are in a somewhat embarrassing position with reference to that because the Budget Bureau has not yet said that they approve of that. Now, then, are you merely calling those two things to our attention, or are you recommending that those two changes be made which appear at the bottom of page 2 and the top of page 3 of your statement?

Mr. SMITH. The Department of Agriculture is recommending those two changes, sir. But they have not been finally approved by the Budget Bureau.

Mr. MULTER. Of course, after you refer to the fact that the Budget Bureau has not approved, you say "as soon as these questions are resolved drafts of legislation will be submitted."

Mr. SMITH. Yes, sir.

Mr. MULTER. Are you suggesting that we wait until those proposed revisions are sent up, or should we nevertheless act on your suggestion without the approval of the Budget Bureau?

Mr. SMITH. We are merely explaining to you what position we are in today, Congressman, on the point.

I would like to make this point, though, in connection with that. Senate bill 1276 only has 1 of these 3 features in it, sir. That Senate bill only includes the matter of adjusting interest rates. The two additional proposals are the proposals now pending with the Budget Bureau.

Mr. MULTER. Let us take the interest question. Your Department is recommending an increase in the interest rate to 4 percent.

Mr. McLEAISH. Congressman, that legislation, S. 1276, passed the Senate at the last session, and on insured mortgages, particularly, an interest rate of 3 percent is purely idealistic. It is not realistic at all. It is not producing any money. And a 4-percent net is certainly not too high, a 5 percent interest rate. I have been paying it all my life, and am paying it now.

Therefore, if we can get money at 4 percent, and I have been assured by a group of bankers that 4 percent would attract quite a bit of money into this farm-mortgage program.

Mr. MULTER. Do you think these farmers can afford to pay the additional 1 percent?

Mr. McLEAISH. I don't know what they are doing over the country. At home they pay 5, 6, 7, and 8.

Mr. MULTER. Can you burden them now with an additional 1 percent of interest when they are earning less than before, to rehabilitate their farms and make them more productive? Can we afford to increase their expenses any more?

Mr. McLEAISH. If the lower rate is not producing any mortgage money at all—

Mr. MULTER. What good is more mortgage money to a farmer who is getting less income and can hardly live today? Don't you think we should improve that condition, first?

Mr. McLEAISH. I think we better improve his earning capacity.

Mr. MULTER. That is what we are talking about.

Mr. McLEAISH. Nevertheless, if you want to finance a farm—the Government's funds are limited, we come up and guess each year, as has been done in the past—to cover the services of the Farmers Home Administration among more farmers who need it, we need to attract more money into the picture.

Mr. MULTER. Maybe this city boy just cannot understand the economics of the farm situation. We are told that warehouses are bursting with products from the farm, we can't move them into the market, the farm income is at the lowest it has ever been in recent years.

The CHAIRMAN. Wait a minute.

Mr. McLEAISH. I question that.

The CHAIRMAN. I think we should correct the record in that respect. I don't think that you want to say that the farm income is the lowest that it has ever been.

Mr. MULTER. Well, is my information wrong?

The CHAIRMAN. Yes, very apparently it is wrong.

Mr. McLEAISH. I think so.

It was off for the last year from 2 years ago, and has been going off for the last 2 or 3 years, but it isn't the lowest it has ever been.

Mr. MULTER. Then what of this cry that we have been getting? Are the city boys being fooled by this business about farm income dropping off—

The CHAIRMAN. No, if you say dropping off, all of us farmers will go along with you.

Mr. MULTER. I would like to understand, Mr. Chairman.

The CHAIRMAN. But you cannot say that farm income is the lowest it has ever been.

Mr. MULTER. Is the cry that we are getting that the farmer isn't just making as much profit as he was making before?

The CHAIRMAN. That is perfectly all right. We will go along with that. He is not making as much profit, but you said his income is the lowest it ever has been. That is not true.

Mr. MULTER. Let us find out. Is the farmer prospering in the country today?

Mr. McLEAISH. Title V loans are 4 percent and always have been.

Mr. MULTER. I will go back to the interest in a moment. Let me get straightened out on this: Is the farmer in the country prospering today?

Mr. McLEAISH. Well, I wouldn't say that he is as prosperous as he has been for the last 8 or 9 years.

Mr. MULTER. Is he prospering?

Mr. McLEAISH. Certainly, by the standards of the thirties, a lot more prosperous.

Mr. MULTER. How about by the standards of the forties?

Mr. McLEAISH. Well, now, I don't have figures before me, but there were some parts of the forties when he wasn't as well off as he is now.

Mr. MULTER. Obviously there are farmers who need help or we wouldn't have enacted this farm program to begin with, that we are talking about now.

Now, you tell us, on the one hand, in this statement, that because there are some part-time farm owners who have outside income they have gotten all of the loans, and there hasn't been enough money to go around to meet the needs of the others; am I right?

Mr. McLEAISH. Congressman, since I have been here we have had applications from employees, full-time employees, of the Government Printing Office, for loans on small plots of land outside of Washington, in the rural areas. We have had applications from a railway mail clerk down in Texas who bought a little piece of land and wants us to build him a home and under this title V he is eligible and he pointed it out to us very strongly.

Mr. MULTER. Did he get the money?

Mr. McLEAISH. If we had authorized it he would have gotten as much as a man with 160 acres, a full-time farmer.

Mr. MULTER. What interest did he pay?

Mr. McLEAISH. Four percent.

Mr. MULTER. Why do you have to increase the rate? Why do you suggest increasing from 3 to 4 if they are paying 4 percent?

Mr. McLEAISH. It has been testified to here this morning, of the large number of loans which Farmers Home Administration has not been able to make, and it is a fact, they haven't.

Mr. MULTER. Hasn't been able to make them—why?

Mr. McLEAISH. Because the appropriate funds were not sufficient to go around.

Mr. MULTER. At what rate were they made?

Mr. McLEAISH. They were made at 4 percent.

Mr. MULTER. That 3 percent must be increased to 4 percent to get more money?

Mr. McLEAISH. On these insured loans—that is what I am speaking about—when you go to a private insurance company 3 percent is their net return. The Farmers Home Administration gets one-half of 1 percent for administration and the insurance fund a half of 1 percent so the net return to the lender is only 3 percent.

Mr. MULTER. Were these loans made by these lending institutions?

Mr. McLEAISH. No, sir; not in any volume.

Mr. MULTER. They were not made?

Mr. McLEAISH. Sir, we got some from Negro insurance companies who did it purely as a matter of racial pride. We have got a few from some of the States, and State retirement funds as a matter of State pride, but as far as getting them on the basis they should be, no, they haven't been available.

Mr. MULTER. Let me see if I understand you. Are there two separate problems involved here, one getting an increased appropriation to give you enough money for all of the loans, those of the part-time farmer and the full-time farmer, and a separate problem on getting an additional increased rate to get additional guaranteed loans? Are there 2 problems, or is it 1 problem?

Mr. McLEAISH. Well, I think we have the problem of getting additional funds. It is my information that Farmers Home has never had appropriated to it enough money to make loans for all the applications it has had.

Mr. MULTER. And those loans were made at 4 percent?

Mr. McLEAISH. Those loans were made at 4 percent.

Mr. MULTER. And you are not asking to increase that?

Mr. McLEAISH. Yes, we will have to make them both on the same basis. You cannot say to one man over here, now because we are getting insurance money for you that you have to pay an extra 1 percent, and because of the Government is lending it to the man over here—

Mr. MULTER. Why worry about the fellow who wants another 1 percent interest, if you are exhausting your present authorization? Do you need any more money at the existing rate?

Mr. McLEAISH. We are not worrying about the man who wants the extra 1 percent. We are worried about the farmer who hasn't got a farm because we haven't got money to lend to him.

Mr. MULTER. Isn't the fault of that one of administration, at least in part? If it is a fact, as you say in this statement, that you loaned to the part-time farmer because he had outside income and used up your appropriations that way, and ignored the fellow who was a full-time farmer and needed help, isn't that the fault of your administration that you did not take care of the farmer who needed help?

Mr. McLEAISH. No; and I think before I came with this Farmers Home Administration that the policy had been adopted to discontinue making those part-time farmer loans, but prior to that time there had been quite a few made.

Mr. OAKMAN. Will you yield?

Mr. MULTER. Surely.

Mr. OAKMAN. I noticed a very short time ago that the farm income was increased by about \$6 billion last year because of part-time employment that people living on farms had found in factories in the general areas where they lived. That would mean a great mass of people. Are you going to discriminate against the farmer if he goes in and works in a factory 40 hours a week for a few months of the year?

Mr. McLEAISH. No; that is not our thought at all. Here is a man who is primarily a farmer. He has a farm and is a bona fide farmer and because of either weather conditions or employment conditions he leaves the farm, maybe he leaves his family on it, and goes and gets a job. We are not intending to discriminate against him.

What we are trying to do is to get away from the fellow whose full-time employment is as a railway mail clerk or accountant, or something else, and who only gets this little piece of land for the purpose of having a country home. They are not farmers.

Mr. MULTER. Now, look, we have a direct farm-loan policy—a farm-loan policy of direct loans to the farmer, haven't we?

Mr. McLEAISH. Yes; for the purchase of farms.

Mr. MULTER. And that is where you need an additional authorization for more money. Am I right? Do you need more money for your direct-loan policy?

Mr. SMITH. Yes, Congressman.

Here is essentially what our position is with respect to title V, and that is what is before us now: The manner in which title V has been administered here in the last couple of fiscal years amounts to serving bona fide farm owners with housing loans where they cannot get loans from private credit sources. To that extent that really duplicates

the authority that exists in the Bankhead-Jones Farm Tenant Act to either insure or make direct loans.

Now, it is—

Mr. MULTER. Where you make the direct loan, you have been making it at 3 percent?

Mr. SMITH. Four percent.

Mr. MULTER. Which is the 3-percent loan?

Mr. SMITH. Now, our position is—the Department's position is—that by making these minor revisions in the Bankhead-Jones Farm Tenant Act that the Department would thereby be in position to serve better and more family size farm owners under the Bankhead-Jones Farm Tenant Act, and by that method would not need the authority contained in title V of the Housing Act.

Mr. MULTER. There is a direct-loan policy where you charge the farmer 4 percent?

Mr. SMITH. That is right.

Mr. MULTER. That is Government money going to him at 4 percent?

Mr. SMITH. That is right.

Mr. MULTER. In addition to that you have these guaranteed loans where the interest rate is 4 percent, but you charge the lender 1 percent for our Government guaranty?

Mr. SMITH. That is right.

Mr. MULTER. You are suggesting that be increased from 4 to 5 percent so the lender can get his net of 4 percent and the Government still get its 1 percent for the guaranty?

Mr. SMITH. That is right.

Mr. McLEAISH. We have been told it would.

Mr. MULTER. Of course at more expense to the farmer.

Mr. McLEAISH. That is right.

Mr. MULTER. And that expense he is going to pass on to the consumer because he is not going to pay it?

Mr. McLEAISH. Well, the same applies when labor gets a raise: The consumer pays it.

Mr. MULTER. That is right. That is what I have been saying. A lot of people have been laughing at me. Every time you increase the interest rate it is an increase in living costs right across the board. Your suits cost more, your food costs more, and your rent costs more.

Mr. SMITH. At the present rate of our insured loans the farmer is not being given the privilege of the loan because the private lender won't make the loans at the low interest rate. It seems right to give the farmer the choice, if the lender will make the loans at the increased rate. The farmer can then take the loan if he desires to pay the additional interest rate.

Mr. MULTER. Let me go back again a moment to what is the present policy. I would like to know what is the present policy of your Administration with reference to the loans as between the part-time farmer and the full-time farmer. What is your policy on that?

Mr. SMITH. At the present time the Farmers' Home Administration has discontinued making the 504 loan, and also the 503 loan.

The loans under the Housing Act are made under section 502 and under the present policies those applicants are declared eligible who are bona fide farmers, who are making a substantial production of agricultural commodities on their farms.

Mr. MULTER. They are the ones who are now getting the loans?

Mr. SMITH. Yes.

Mr. MULTER. And you need more money for that?

Mr. SMITH. That is right.

Mr. D'EWART. Would the gentleman yield?

Mr. MULTER. Yes.

Mr. D'EWART. I would like to say that I have had an opportunity to work with Mr. McLeaish as he has served the farmers of my State, and his agency steps in where other loaning institutions cannot go, and picks up the balance there, and he has been most cooperative in working out difficult problems for the farmers of my State, and I think I can say that his agency has done, in fact, a very good job, not only on straight FHA loans, but also on the distress loans that they have been handling for the last year. They have been handling them in as businesslike a way as possible considering they only step in where other agencies will not go. I think that should be recognized. Their repayments have been good, and they have tried to provide a real service to those farmers who cannot get credit anywhere else.

Mr. MULTER. I am glad you made that comment because I meant nothing personal in my questions. It doesn't matter to me whether it was a Democratic administration or Republican administration, if anything wrong had been done. It appeared that something had been done wrong, and I wanted to be sure it is corrected, because I think the first man who should be helped on the farms is the man devoting his full time to farming. If there is a choice I think they should get the preferential treatment, if there is any.

Mr. McLEAISH. That is our feeling, Congressman.

Mr. TALLE. My experience with the Farmers Home Administration has been similar to that of the gentleman from Montana. I am well pleased with what the Farmers Home Administration has done in my district located in northeastern Iowa.

Mr. McLEAISH. Thank you, Mr. Talle.

Mr. TALLE. Now, if I may turn to something else for just a second, since we are looking around for definitions of farmers here, when I was a youngster on the farm there was a publication known as Farm, Stock, and Home. I was learning to read at the time, and I found an interesting definition. It said, "A farmer makes his money on the farm and spends it in town. The agriculturalist makes his money in town and spends it on the farm."

Now, this fellow who builds this little country home is giving you a little trouble?

Mr. McLEAISH. Yes, sir.

Mr. TALLE. But he really isn't a farmer.

Mr. McLEAISH. He is not a farmer by any sense of the word.

Mr. TALLE. A small-scale agriculturalist.

Mr. McLEAISH. Well, to be frank with you, they tell us they are going to go into the chicken-raising business, or they are going to raise strawberries, but they have never raised anything in their life before. But they want a loan.

Mr. TALLE. I think your agency is doing a good job.

Mr. McLEAISH. Thank you.

Mr. MULTER. Mr. Chairman, may I continue briefly?

The CHAIRMAN. Mr. Multer.

Mr. MULTER. Now, you probably know that in the housing bill, for a long time, in the Housing Act, there is a provision for loans for so-called modernization and rehabilitation. The present limitation is \$3,000 and a 3-year term, and we are seeking to increase it to \$5,000 and a 5-year term. Those are unsecured loans, but guaranteed.

Now, from what you say, apparently you don't have a similar program for the farmer.

Mr. McLEAISH. No, we don't, and, incidentally, I have had 2 of those type loans, Mr. Congressman, and the rate has been 5 percent to me on those.

Mr. MULTER. I am not concerned with what the rate would be.

Mr. McLEAISH. Yes, but I know the type of loan.

Mr. MULTER. That rate necessarily must be a little higher than the others, because you do not have any real-estate security.

Mr. McLEAISH. That is right.

Mr. MULTER. You are suggesting here that apparently, to do that same job for the farmer as is being done on those loans, that you take a second mortgage.

Mr. McLEAISH. Not exactly. The second mortgage is just a little bit better than an open note.

Mr. MULTER. But why isn't the same principle applicable to the farmer? Why shouldn't he get the same benefit if he needs modernization? Why shouldn't we get the same kind of loan under the same guaranty?

Mr. SMITH. Congressman, aren't those home-improvement loans that you refer to under the Housing Act, aren't they also available to farm people?

Mr. MULTER. I thought that you gentlemen were suggesting they weren't. If they are, then why do you need this second mortgage authority?

I think that is much better than the second-mortgage authority.

Mr. SMITH. The point about the second-mortgage authority that we are asking for—I think it is entirely a different type of loan that we are proposing to make to a farm owner than is referred to in that particular section of the Housing Act.

You see, our loan on the farm may include the erection of a new dwelling on the farm; it may include only a repair job on the dwelling; it might very well include funds for other farm buildings and, in addition, may include funds for development of pasture and for the fencing of the farm, and that type of improvement, in addition to the improvements to the dwellings and farm buildings. So the average size, Congressman, of our farm-housing loans have run \$5,500, so we are actually talking about a little different type of loan to the farm owner than is referred to in that section of the Housing Act for urban dwellers.

Mr. MULTER. I don't see the real distinction. I can understand where the city man will improve his house by building another bedroom onto it, and the farmer, instead of building a bedroom onto his house, may build another barn. Theoretically, however, it is the same thing; the farmer is improving his land and his means of income and his home, while the city man just has the home to improve.

But I can't see why the same principles should not apply. Every mortgage that you place, I am sure, has a provision in it that covers the land, the improvements thereon, and any improvements thereafter affixed or erected thereon.

Mr. SMITH. Yes, sir.

Mr. MULTER. It is the same for a city house as for a farmhouse. If the farmer is going to add something to that, why don't you do it the same way as under the modernization program for the city man?

Mr. SMITH. The unsecured insured loan that you have reference to under the Housing Act is a short-term loan. I believe at the present time it is limited to 3 years.

Mr. MULTER. That is right.

Mr. SMITH. The loans under title V of the Housing Act are 33-year loans, and those under the Bankhead-Jones Act are 40-year loans. And it is necessary, in making that loan, to tie the indebtedness to the farm on which the improvements are made.

Mr. DEANE. Mr. Chairman.

The CHAIRMAN. Mr. Deane.

Mr. DEANE. Mr. McLeaish, I want to thank you for your courtesies in furnishing me considerable information on the rural housing program, as carried on by your agency, under title V, which the agency would drop and attempt to use the Bankhead-Jones Act. I am not against the Bankhead-Jones Act, but what we are interested in is being sure that we have the facilities that will continue to make available to the rural man suitable housing, which he hasn't had.

You have referred here to Senate bill 1276. The hearings on that were before the Agricultural Committee of the Senate; isn't that so?

Mr. McLEAISH. Well, the bill has passed the Senate.

Mr. DEANE. Well, I mean the hearings were before the Senate committee; is that right?

Mr. McLEAISH. Yes, sir.

Mr. DEANE. Now, the original Bankhead-Jones Tenant Act cleared the House through the Committee on Agriculture. Have you appeared before the Committee on Agriculture of the House advancing the amendments here proposed?

Mr. McLEAISH. No, I haven't appeared before the House committee. I don't know whether it had any hearings yet.

Mr. DEANE. No hearings have been held.

Mr. McLEAISH. On that bill.

Mr. DEANE. Mr. Chairman, the question of committee jurisdiction is involved. Senate bill 1276, which would amend the Bankhead-Jones Farm Tenant Act, comes from the Senate Agriculture Committee. It seems to me, the House Committee on Agriculture, which committee has not seen fit to take up a companion bill to S. 1276, should first determine the facts.

Mr. McLEAISH. If I am not mistaken, that happened about the time I came to Washington, there was a companion bill introduced in the House, as well as the Senate. I don't recall the number of that. But S. 1276 has been passed by the Senate.

Mr. DEANE. There have been no hearings held in the House on that particular bill?

Mr. McLEAISH. Not that I know of.

Mr. DEANE. Getting right down to the meat of it, I wonder why you are not asking for title V to be extended? Is it because of the basic philosophy, so far as the tenant, and the individual who is now receiving aid, or who has received aid under title V?

Mr. SMITH. Only farm owners were eligible for assistance under title V. Title V was not designed to convert tenants into owners, sir.

Mr. DEANE. That is what I am driving at. Those individuals who have received—you mentioned a mail clerk awhile ago—loans—haven't the great majority of the loans made under title V largely been to individuals engaged in agriculture? A few of the applicants may have a part-time job in a mill, but they are engaged in basic agricultural pursuits?

Mr. SMITH. That is true with respect to the loans that have been made during the past 2 fiscal years.

Mr. DEANE. Are you advancing the theory that your problem is, and the reason you are leaving title V is, that you haven't had enough money to carry out the program? Is that right?

Mr. SMITH. We have had adequate funds to make some loans to bona fide farmers. We haven't had adequate funds to serve both the city worker who lives in the country and also to serve the farmer.

Mr. DEANE. Then it comes right down, as Mr. Multer said a few minutes ago, to the fact that the basic problem is a matter of administration.

Mr. SMITH. It is very difficult, Congressman, when the agency has funds, to make loans under title V of the Housing Act, it is very difficult as an administrative matter to declare ineligible a city worker who by the act is eligible.

Mr. DEANE. I know in my community there are a great many textile mills, and one of the great problems these days, as Mr. Multer said, is this: The Secretary of Agriculture said here some days ago that farming represented only 5 percent of the national income, and the Secretary stated that that was too low. Frankly the farmer has been forced to go to work in the mills at night, and on their farms in the daytime, to make ends meet.

Isn't it true that under the Bankhead-Jones Act you can make direct as well as insured loans?

Mr. SMITH. That is true.

Mr. DEANE. Isn't it also true that the greater majority of your loans have been direct rather than insured loans?

Mr. SMITH. That is right.

Mr. DEANE. Due to the fact that the mortgage market hasn't been interested in the insured loan. Has it been due to the 40-year period, or what?

Mr. McLEAISH. It has been due to the interest rate. In other words, in those mortgages made in the last few years there has been an agreement that Farmers Home would pick them up in 5 years if the mortgagors wanted to turn them over. That is an administration decision.

But the 3 percent has been the point, and that applies to some State school retirement funds which did come in for a while at 3 percent, and only last year notified our agency that unless the rate was moved up to at least 3½ percent they weren't interested any further.

Mr. DEANE. I have been very much concerned about the interest rates, and I want to see every banker and every lender secure a fair return, but you gentlemen are primarily, I would think, interested in the farmer; isn't that true?

Mr. SMITH. That is right.

Mr. McLEAISH. I have been one myself for the last 25 years.

Mr. DEANE. Now, if you are faced with an administrative problem in administering title V, why don't you recommend amendments that would strengthen it, and bring you to the end that your applicants would be the type of bona fide farmers that you want?

Mr. SMITH. Congressman, we don't see the necessity for the duplicate lending authority, since we can serve bona fide farmers, insofar as need for credit for housing and other farm buildings is concerned, under the Bankhead-Jones Farm Tenant Act; we don't see the necessity for the continuation of the same authority in title V of the Housing Act.

Mr. DEANE. Will you continue to make direct loans under the Bankhead-Jones Farm Tenant Act?

Mr. SMITH. Yes; to the extent that we have annual appropriations, sir.

Mr. DEANE. Well, basically, then, so far as free enterprise, or the philosophy of lending is concerned, you are not departing from the philosophy of loans under title V on direct loans?

Mr. SMITH. That is right.

Mr. McLEAISH. That is to bona fide farmers.

Mr. DEANE. Well, I am interested only in bona fide farmers under title V.

One other question: Would you recommend that this housing for farmers be brought under the Housing and Home Financing Agency?

Mr. McLEAISH. I don't quite understand that one.

Mr. DEANE. Well, would you be in favor of bringing the farm housing program—

Mr. McLEAISH. You mean under the Federal Housing Administration?

Mr. DEANE. That is right.

Mr. McLEAISH. Well, now, the Federal Housing Administration has done, at least to me, some of that kind of financing. I think they have the authority to do some of it.

Mr. DEANE. What I am asking is, would you be willing to surrender the housing program that you are administering to the FHA?

Mr. McLEAISH. No; we would not want to surrender the authority that we have under the Bankhead-Jones Tenant Act. In other words, we would not want to be deprived of financing a bona fide farmer under the Bankhead-Jones Tenant Act because we can give him the kind of terms he needs, as far as years are concerned, whereas your FHA guaranteed loans are pretty much short-term propositions.

Mr. DEANE. I agree with you that you will not make very many loans under title I, because of the seasonal income of the farmers. These loans that you have been making under title V, some of them, I imagine, are on a quarterly basis, or semiannual basis; is that true?

Mr. SMITH. The repayments have been annual payments, sir.

Mr. DEANE. Whereas under title I the payments are on a monthly basis?

Mr. SMITH. Yes.

Mr. DEANE. And you will not have very many, if any, of those particular loans, and likely those particular loans would be made to men who have other income, other than on the farm.

Mr. McLEAISH. Yes; either that or men who are pretty affluent farmers.

Mr. DEANE. That is right.

Thank you very much.

The only warning that I would sound, Mr. Chairman, is the fact that I am skeptical that our rural housing program would be sufficient, under the Bankhead-Jones Act, even with amendments.

The CHAIRMAN. Are there further questions of Mr. McLeaish or Mr. Smith?

If not, thank you very much, gentlemen, for your assistance.

Mr. McLEAISH. Thank you, Mr. Chairman, and members of the committee.

The CHAIRMAN. There are certain statements which have been submitted.

Without objection, the staff may have consent to insert in the record all the statements and matters which they might think would be helpful to the committee in connection with this study.

I believe that concludes the public hearings on H. R. 7839.

Mr. MULTER. Mr. Chairman, you will recall that I asked one of the agencies to furnish to us for the record forms of the open-end mortgage. I don't know whether it will serve any purpose to add them to the record.

The CHAIRMAN. I think we have it in Mr. Collins' testimony of yesterday.

Mr. HALLAHAN. We have a booklet which incorporates some forms which would be available to each member of the committee.

Mr. MULTER. Yes; I don't think there is any point in placing them in the record, then.

Mr. HALLAHAN. We could do this: Extract that part of the mortgage form which deals with this matter.

Mr. MULTER. That would be a good idea because the documents themselves are fairly lengthy.

Mr. HALLAHAN. Yes. The references are fairly small.

(Open end mortgage provisions, discussed above, appear at p. 453.)

The CHAIRMAN. I wonder if it wouldn't be advisable to let the matter jell a little over the weekend before going into executive session, because I assume all the members of the committee will want an opportunity to read the transcript of the hearings and mark them up.

So we will close the public hearings as of now, and we will stand in recess until Monday morning at 10 o'clock; we shall go into executive session.

(Whereupon, at 12:28 p. m., the committee adjourned.)

(The following statements were submitted to the committee:)

STATEMENT SUBMITTED BY LT. GEN. WILLARD S. PAUL (RETIRED), ASSISTANT TO THE DIRECTOR FOR NONMILITARY DEFENSE, OFFICE OF DEFENSE MOBILIZATION

Mr. Chairman and members of the committee, the following statement is submitted in support of H. R. 7839, with particular reference to sections 803 and 701.

The Office of Defense Mobilization is concerned with this proposed legislation because of the impact of Federal housing programs on the attractiveness of

American cities as targets for enemy attack. We believe that sections 803 and 701 of the bill before you, taken in conjunction with its other provisions, will enable the Administrator of the Housing and Home Finance Agency to foster progressive reduction in the target value of these cities and thus lessen the likelihood that they will be the objects of enemy action.

It is well known that a large portion of this country's industrial capacity, both in terms of production facilities and trained labor forces, is now concentrated in a limited number of our major cities. The 1950 census revealed that two-fifths of the Nation's entire population and over half of all persons employed in manufacturing lived in the 40 largest metropolitan areas. Despite the current trend to the suburbs, most of the homes of those people and the facilities used in production lie within the lethal range of attack which a ruthless enemy might launch against our cities.

Such concentration in limited areas is a continuing source of danger to this country. Fortunately, it can be materially lessened over the years if the future growth of American cities is guided into proper channels.

As is well known to this committee, the United States is now undergoing a period of great expansion. The construction rate for urban dwellings is running in excess of a million units a year and the building of homes and apartments is being matched by the construction of stores, factories, schools, churches, streets, and all the other elements that make up city structure; the equivalent each year of a complete new metropolitan community the size of Philadelphia.

The more this new construction is concentrated in the already densely populated sections of our larger cities, the more profitable they become as enemy targets and the more vulnerable to crippling damage becomes the Nation that depends on them for a substantial part of its industrial production. Conversely, the more this new construction can be used to decrease densities in central cities and build up outer suburbs and smaller cities outside of the potential damage areas, the less attractive become the central targets. The more the American industrial and population target is diluted, the more difficult it is to attack decisively and hence the less likely it is to be attacked at all.

For the past several years, the Federal Government has urged industrialists to locate new defense-supporting plants a safe distance from potential target zones in major cities and this movement has had wide support. But industry cannot operate without labor and there is need for definite encouragement to builders to erect housing in outlying suburbs and communities that serve the dispersed factories.

Action is also needed to hold the density of new in-town housing developments to the lowest practicable level and to improve standards of spacing and construction so as to minimize the threat of blast damage and conflagration. We believe that much can be accomplished in that direction within the framework of the proposed housing bill.

Section 803 of the bill states that all Federal agencies having powers, functions or duties with respect to housing shall exercise them, consistent with applicable provisions of law, so that they will "facilitate progress in the reduction of the vulnerability of congested urban areas to enemy attack." This enables the Administrator to utilize the various measures under his jurisdiction in a manner to promote national security.

The President's Advisory Committee on Government Housing Policies and Programs, on page 11 of its report, recommended that "A close relationship should be established between housing and defense officials and when defense criteria affecting urban vulnerability are established, studies should be made of all housing programs to insure conformance. Additional legislation should be proposed if necessary." The recommended studies are being undertaken by staff members of the agencies concerned. If these studies indicate that housing legislation should be modified or new legislation introduced to accomplish the desired purpose, appropriate recommendations will be made.

Section 701 of H. R. 7839 is of particular interest in this regard because it would tend to stimulate State and local action to plan for lowered urban vulnerability on a metropolitan basis. Workable and adequate plans for reducing the target value of major cities generally can be worked out most effectively in terms of the entire trade territory. When this is done, new industrial, commercial and residential growth in the outer portions of the territory can be developed in a way that will contribute to the city's economic support without increasing its target value.

Unfortunately, the outer areas in which new growth is most appropriate are often the ones least equipped by past experience to deal with urban problems

and there often is no agency with sufficiently broad jurisdiction to plan and guide the development of all parts of the trade territory as a single economic unit. The provisions of section 701, through the stimulus of Federal aid, should help to overcome that deficiency.

It is not our purpose at this time to suggest specific measures for the reduction of urban vulnerability that might be taken under this bill. They will be the responsibility of the departments and agencies exercising housing functions and, in many cases, are still to be worked out on the basis of the studies to which we referred earlier. It is our belief that H. R. 7839 and particularly sections 803 and 701 will provide opportunities for constructive action, which will promote security against attack and improve the Nation's peacetime supply of housing at the same time.

STATEMENT OF WILLIAM E. MURRAY IN BEHALF OF FLORIDA SUN DECK HOMES CO.,
LEISURE CITY, FLA.

In 1949 Florida Sun Deck Homes Co. of Miami began to get inquiries from people who desired to retire and come to Florida to live out the remainder of their days. Since this was nothing particularly new in the history of Florida, not much attention was paid to it. The requests, however, continued to come in increasing volume, and, in 1950, some investigation was made on the subject of retirement housing. To find out if there was a demand for this or not, we placed ads in the leading papers east of the Missouri River. We expected to get some replies. What we got was so great that no matter how the letter was addressed, we got it. Mail sack after mail sack of inquiries came in. The mail clerks did a remarkable job, for there were letters simply addressed "Florida Sun Deck Retired Homes" and nothing more, yet we received them. On the first ad that we placed in these papers we received over 50,000 inquiries. The amount is way over 200,000 now and still climbing. Let us say to you that we are very certain that if any of the congressional offices got 50,000 letters about one subject, you would try to do something about it. Since this demand is general and nationwide, it is felt that you are entitled to know what was done. This demand on the part of our neighbors throughout the United States was indeed a challenge.

With what little resources we had for research, it developed that the concept of retirement had changed materially in the last number of years. We found that employers have set up an arbitrary retirement age of 65 where wage earners have to retire whether they want to or not. It appeared that some type of housing would be needed to take care of these particular classes of our citizens since they were no longer in a position to pay the rents which are in effect throughout the country. We felt, personally, that anything we could do to provide a retirement home for people, to which they could look forward with a ray of hope rather than dread, was a worthwhile contribution to America. In the consideration of this problem, there are certain human traits that must not be ignored.

We were able to determine that the vast majority of people who retire do not want to move from the locality in which they live. This is due to the fact that they wish to be near their family ties and among friends of many years standing. It does not mean, however, that what they want is the answer to what they can do. During the last 15 years people planning to retire have placed their money into those investments that 15 years ago seemed to be a source of a good income in the future. These investments have simply not worked out. For example, in the late thirties, savings and loan associations paid dividends of 4 percent and 5 percent. Now they are from $2\frac{1}{2}$ to $3\frac{3}{4}$ percent. This means that the anticipated income has been cut around 30 percent, but this is indeed not the worst side of the picture. While the income went down, the cost of living went up. Hence, due to the situation which many of these people now find themselves in, they are obliged to forego the luxury of what they want to do, and must follow some way out of their economic plight.

We also found that there were many people who wanted to get away from the cold weather in certain parts of the country and be able to enjoy a less severe climate.

Therefore, we went to work on the problem, and since no other subdivider or developer in the United States had ever tackled or attempted to do this sort of a job, there was no criteria to work from or to.

The FHA did not have any records with which to give a rating from the credit standpoint. Indeed, it was a shock to some lenders to have a mortgage offered to them, from a man and wife who were over 65, to run for 25 years. Now, on

snap judgment, all of us who have negotiated loans on houses would dismiss a loan application for 20 to 30 years from a person over 65 with the thought that the applicant was sure optimistic if he thought he would live that long. However, a careful study indicates that it is not so out of order as it would first appear to be, particularly in a project such as Leisure City. For every retired person who dies there is a constant increasing number of people who are retiring, and they can, and do, buy the equity in the house. We have had some deaths. The houses were resold to other people who had retired, and so the chain goes on and on.

As was said above, the FHA did not have any records with which to give a rating from the credit standpoint, and there was simply not available any credit experience for this type of buyer. Now, they do have some credit background, and it is good. No borrower under the FHA loans is delinquent. Most of them are paid several months in advance, and they seem to want their monthly payments in the hands of the lender on or before the 1st rather than on the 15th of the month. Neither did the FHA have the amortization tables worked out for the low loans that some of these people needed. These things have been overcome now.

We were able to get several hundred acres which were selected for what we thought to be sound reasons. If we were to take care of people on a low monthly payment, we obviously had to get away from high-priced land; yet we had to be close enough to a community so that they could have access to churches and merchants dealing in the necessities of life. The land which we selected was 2½ miles northeast of Homestead, Fla., and on U. S. 1.

We did not know what kind of housing facilities or what kind of housing units people who were going to retire would prefer. After considerable experimenting, offering various types of floor plans which ranged from a 2-room, 1-bath house with 1 bedroom and 1 living room that was also the kitchen and dining room, to a 7-room, 2-bath house with a swimming pool; we have found that the average couple does not want to lower their standard of living. What they want is comfort * * * but they do want limited space. They do not want a lot of rooms to take care of. We found out that these people desire a very large living room; 1 bedroom which must be of good size; a kitchen-dining combination of not less than 80 square feet; a good tiled bathroom; and ample closet space. Indeed, the people buying these houses demand larger closet space than that which the FHA minimum property requirements specify. They also want a carport and plenty of room in the utility room. These people are very insistent that there be plenty of window space to afford sunlight and ventilation.

There seems to be some pretty sound reasoning on the part of these people in their desire for a one-bedroom house. It cannot be stated too strongly that the love and affection these people have for their children and other relatives is great; yet they do not want to issue a standing invitation for their relatives and friends to come down and use that extra bedroom in the winter. Rather than have two very small bedrooms, they want a large one, with the extra space in the living room. They want just 1 bedroom to take care of, not 2; and just 1 bedroom to furnish, not 2. Any demand for the second bedroom seems to be met by the use of modern sofas in the living room.

There are a great many people in Leisure City who can afford to own houses over \$30,000, yet they want one bedroom. When company comes, they simply take them over to one of the very modern motels that have been built or enlarged, within a mile of their home. It works out fine for everyone. In fact, since we started this development, two large motels have been built, and every other one within a mile, enlarged.

Along with the creation of the type of house these people want, a certain lending pattern developed which seems to run very consistently throughout the entire development of over 500 houses. These people pay more cash on the down-payment than has been the custom for the last 8 years.

In section 1 of Leisure City, which consisted of 311 houses, the number who paid cash, or so much cash that all they needed was a 50-percent direct-reduction loan, was 21 percent. These direct-reduction loans were made by one of the Federal savings and loan associations. The interest range was from 5 to 6½ percent. The term from 7 to 15 years. In section 2, the percentage is reaching 44 percent. Our experience tells us that these figures on cash sales and low conventional loans are the keystone of the proposed legislation we are suggesting. It is the answer to the repayment of construction funds.

In the consideration of the amount of loan, the fixed income is more important than any other factor. A 95-percent loan on a fixed income is far better than a 60-percent loan where the buyer can be laid off or be the victim of the other

hazards of employment. Therefore, while it is desirable, of course, to have a small downpayment to take care of those who do not have large amounts of cash for a downpayment, the percentage of the loan is not the important factor. The most important item to consider when these loans are being negotiated is "How much will it cost for housing per month?" In this area, it would appear that \$40 is the correct amount; in other sections of the country it will have to be from \$10 to \$15 per month more. This should include:

Interest; amortization; FHA insurance fee
 Service charge, if any; hazard insurance; taxes
 Sewer charge; water

The consideration of this program must be on a national basis. The reasons for some of the lower housing expenses in Florida are:

1. SAVINGS IN COST OF FUEL

There is a great saving in the cost of fuel to keep the house comfortable. Florida Sun Deck Homes Co. takes violent exception with those organizations and people who claim you do not need heat. In all our houses we put in a wall-type vented gas heater so that if the occupants need heat, they can have it. It is very true that there are winters after winters in which no heat is ever required; but then again there are days, occasionally, when the temperature takes a drop and heat should be available.

Florida Sun Deck Homes took the position that they were trying to do something for people who have reached that age in life where their resistance is not so great, and that they should, therefore, remove, or at least cut down the chances for contracting severe colds by living in a house that for 2 or 3 days might be cold. In a winter where we have the most severe cold spell of record, the cost of heating one of these houses will run about \$12. This, of course, is a great monly saving over those sections of the United States which require some kind of heat from October until the middle of April.

2. REAL-ESTATE TAXES

Another thing which is to the advantage of those people who come to Florida is the fact that the State constitution provides for homestead exemption to everyone who will apply for it up to \$5,000 of the assessed valuation. Out of the 600 houses which we have built or are constructing in this development, those retired people who applied for homestead exemption in Leisure City paid no real-estate tax. Of course, it must also be stated that if the homeowner does not apply for homestead exemption, he then has to pay taxes; and these will run approximately \$95 a year.

3. CLOTHING

In many sections of the country the climate demands several changes of wearing apparel. This can be little or of great deal, but in our end of the United States there is little call for heavy clothing.

4. HEALTH

Mr. Frank A. Vellanti, president, and Mr. Thomas F. Palmer, secretary, of the Florida Sun Deck Homes Co., took the position that the most favorable climate throughout the year should be selected for the location of a retired village. The reason for this was that they knew such a climate would substantially reduce the budget of people making Leisure City their home. They further realized that such healthy climates lessen the burdens on all health facilities, both public and private.

Florida Sun Deck Homes Co. also found that people who are growing much older prefer to live in a house which is free from the dangers of fire and hurricanes. Therefore, they continued to build their solid concrete house reinforced with steel, which has the lowest insurance rate of any building in south Florida.

It must be borne in mind that the question of providing houses for those people who are to retire either willingly or unwillingly, presents a very serious challenge to the entire housing program of the United States. A check by the committee with the Department of Labor will verify the fact that the many pension plans inaugurated in the 1930's will turn out an astonishing number of retirees, beginning in 1954. When the committee adds that to the increasing number who

will become eligible for social-security benefits; and also takes into consideration the increase in life span in the country due to medical advancements as well as more favorable working conditions; it becomes very apparent that housing for the aged is more than ever a major problem.

Since we pioneered this particular type of housing, and since we have built and are building more than any other builder or developer in the United States, we want to present to the Congress some very definite thoughts for legislation which will be applicable anywhere in the 48 States and which we believe to be the soundest approach to this problem.

We feel that a very good job was done in starting this development with the limitations then in effect under the National Housing Act. At that time the only financial tool we had to operate with was a title I mortgage in the sum of \$4,750, and we were allowed 25 dual commitments carrying an insured loan to the builder of \$4,150. With this miserable amount of money available, we had to engineer the entire project, cut streets, put up bonds that the streets would be finished, provide a water system, and hope that the first 25 houses built would be sold. Believe us, those hardy individuals who purchased the first 25 houses were indeed pioneers in the true sense of the word. When we look back, we marvel at what was done with so little. We would never undertake such a program again, even in spite of the experience we have obtained under title I, section 8, of the National Housing Act. Such limited financial backing is not enough. This is not a single-shot operation where a few commitments can be obtained, and to start such a program is fraught with danger both to the builder and the home buyer.

Some system similar to that which is now done under the defense housing law, should be worked out whereby the developer could lay out a master plan, go forward with his water and sewage system, plan roads and build a sufficient number of homes, assured that his project will be a success. We cannot think of anything more discouraging than to get 25 or 50 people into a retirement area where they have had sound and good reasons to believe that eventually hundreds of people of their age group would form a community, only to have it abandoned because the developer could not withstand the terrific initial expenses. Therefore, we feel that legislation should be enacted into a law setting up—

1. An insured mortgage of not less than 2 million and not more than 5 million; and not in excess of \$6,300 per family unit; the mortgage to run for 12 years; the amortization on the unpaid balance to start not later than 24 months from the date of recording; the mortgage to carry release clauses and shall provide for the insuring of individual mortgages for 40 years at 4½ percent to applicants that are approved by the FHA as to credit.

2. Such a mortgage should provide for the construction of all the off-site requirements where they are needed, such as (a) streets; (b) sidewalks; (c) gutters; (d) water; (e) sewage-disposal system; (f) a sheltered "community gathering place" of not less than 2,000 square feet for the first 100 families, and additional 1,000 square feet for each additional 100 families.

3. The mortgage should be only available to a developer when he can furnish to the insuring office a valid lease from merchants who will assure that the area will have the following minimum places of business: (a) A grocery store; (b) a place to buy meats; (c) a drug store; (d) a lease from some doctor or physician setting forth that he will open an office.

It is also felt that definite means of transportation from any project to the nearest town where more general shopping is available and to churches and places of amusement, is required.

The regulations should also stipulate that the developer had to assure that there would be gas, electricity, telephones, mail service, street lights, in the development.

In some cases, the developer, or sponsor, may have to install a sewer system and water system. Since the cost of these will come from the proposed mortgage, the question of who will own and operate these items can, it appears, be best answered by causing each property owner to belong to a nonprofit, cooperative association that will hold title to and maintain the community meeting place, the water system, if any, and the sewage system, if any.

It is further felt that in the rating of these mortgage applications, greater allowance should be given to those units which are designed to withstand the hazards of nature and man. In other words, if the builder makes the houses safer for those people who are not as able to take care of themselves in case of

fire, earthquake, hurricanes and such contingencies, as is the very much younger generation, he should be given a better mortgage.

The mortgage should also provide such system of allowing the person who is to retire within 10 years from now to be purchasing the property while he or she is still gainfully employed and allowing the rents obtained from such a property to reduce the principal. The present mortgage pattern of the Federal Housing Administration sets up no procedure for the reduction of the amount of monthly payments due to the fact that the mortgage has been reduced.

We have received probably 10,000 letters from people who want to have such a system worked out. While this would call for a complete new system of accounting on the part of the Federal Housing Administration, we know very definitely that there are a great many people in the United States who are very thrifty and would like to have some sort of an insured mortgage worked out whereby for the several years prior to retirement they can purchase their future living unit, rent it out, pay a little each month over and above the rent so that when the day comes for them to retire, the amount of money they must pay each month will be of a less amount.

For example, let us take a house that has the \$6,300 mortgage on it. The total carrying charges in our area would be around \$40 per month. Such accommodations are renting by the year for \$60 per month. Assume that the buyer pays an additional \$20 per month on the carrying charges of the house. At the end of 5 years, to amortize the mortgage out in the balance of the 40 years at 4¼ percent, his monthly payment would drop to \$36 from \$40. If he paid for 7 years, the monthly carrying charges would be reduced from \$40 to \$29.50. If he paid for 10 years the monthly carrying charges would be 70 cents per day. This is one feature which we cannot urge too strongly, and we do trust that the professional staff of your committee and the Accounting Division of the Federal Housing Administration can work out a declining monthly balance payment to be available to retired people.

While this presentation has been based on retired people, it should be very definitely remembered that any community of three or four hundred people who are all retired is not a desirable condition. There should be some younger blood in the community. Therefore, we feel that the legislation should set forth a policy that while this section is set up primarily for, it is not limited to, those people who are retired and are receiving a fixed income from investments, pensions, annuities and/or social security benefits.

Any project such as outlined above calls for considerable attention and thought about recreation facilities—activities that will occupy the mind—possibly part-time work on income producing hobbies—adult educational programs.

The reduction of the tremendous pressures being built up for increases under both social security and retirement benefits in private industry, resulting from a changed economy can be accomplished if, through FHA underwriting, sufficient mortgage moneys can be made available for a developer undertaking a retirement village. It can then be shown that adequate housing can be provided for retiring people at a price they can presently afford.

When a disgruntled citizen who says he cannot survive on the \$130 to \$140 per month can be directed to places in the country where he can live on that amount—and in a new house or apartment—you have eliminated a part of his reasons for complaint, and he can face the declining years still retaining that basic requirement of good citizenship, namely, he is paying his own way.

STATEMENT OF H. B. FOSTER, MANAGER, BRICK AND TILE SERVICE, INC.,
GREENSBORO, N. C.

My name is H. B. Foster. I serve as general manager of an association of North Carolina clay-products manufacturers known as Brick and Tile Service, Inc., with headquarters in Greensboro, N. C.

Since North Carolina produces approximately one-twelfth of all the brick in the United States, and since a large part of this production goes into residential construction, we naturally have a big interest in housing and are closely associated with the home-building industry. Because of this close association we have made a few observations which we hope are worthy of consideration in connection with the proposed changes in the terms of financing homes.

First, I should like to make it clear that these comments are not intended as criticism of the Wolcott bill. Rather, they are offered in a sincere effort to help this bill correct certain situations which already exist as the result of what might be termed the changing times.

Two notable changes have occurred in the housing field since the original governmental long-term mortgage insurance. First and most obvious is the great increase in total building cost and land values; second is the shift of construction volume from the individually tailored home to the mass-produced speculative house constructed to sell, too often on a let-the-buyer-beware basis.

Net result of these changes has been a drastic lowering of the sights on what constitutes low-cost housing. Formerly a man could build a home worthy of pride and worthy of the responsibility of a long-term mortgage at a price considered by the FHA commitment schedule to be low-cost housing; i. e., in the minimum-downpayment bracket. Now he must accept whatever is offered him by the builder who caters to that price bracket unless he can find more cash for the higher downpayment of a more desirable house.

In our talks with speculative builders in the low-cost market we have developed the definite impression that the amount of cash required of the customer is the dominating force behind their planning. Some of these builders admit privately that they would like to incorporate more quality into the minimum house, but by so doing they would put the house in a bracket where the downpayment requirement would be proportionately much higher and too much of the added cost would have to be paid for in cash.

This brings up our major recommendation regarding the Wolcott bill. Though this bill generally reduces all downpayment, with which we take no issue, we do not think that the percentage of downpayment should jump drastically at \$8,000, so that for every thousand dollars above that figure the buyer must have 5 times as much cash as for each thousand below that arbitrary line of demarcation. Certainly no one can expect much of a home below \$8,000 at today's prices. Yet unless the formula is changed thousands will be built and sold to those who would assume the mortgage responsibility of a more desirable home but cannot pay down the 25 percent cash required for that extra desirability. In short, people will continue to be forced to buy below their needs, their tastes, and their future earning power because of this arbitrary quintupling of the downpayment percentage at \$8,000.

Of course, the answer in your mind right now may well be that any such customer should not let his tastes exceed his pocketbook. Certainly that would be true in talking about purchasing an automobile or a television set which is subject to trading in a year or two. But a home sold on 20-to-30-year Government-guaranteed mortgage is a bad risk if the purchaser is dissatisfied to the extent that he regards his long-term agreement as a temporary expedient to be bettered as soon as possible. And I'll assure you that many purchasers of the cracker boxes built since World War II do not delude themselves into thinking that they now live in the home they expect their grandchildren to visit.

Therefore, it is recommended that the minimum down payment percentage—whatever is finally agreed upon—not be limited to \$8,000 but continue to a more reasonable value such as perhaps \$12,000 or even \$15,000 which is still far from the luxury class at current prices. This should encourage a better quality of housing * * * which is a better investment for the purchaser; a better asset for the communities involved; and a far better mortgage risk for the Government than the future slums now being created for those who are short on cash but may be long on credit reliability.

Some of the foregoing relates to our second thought concerning the proposed change in length of mortgage life to 30 years, or more.

I recall quite well the sound arguments which brought about the then radical long-term mortgage of 25 years. General tenor of them was that a house is still a house after 25 years, so why expect the purchaser to pay it off in a fraction of that time.

I wonder if the same argument could be applied to some of the houses built in the last 7 or 8 years. Are they good mortgage risks for 30 years?

In order to preclude the ridiculousness of a 30-year mortgage on a 10-year structure I suggest that the maximum mortgage life be reserved for those homes which have a reasonable chance to outlive the mortgage, based upon ample consideration for the construction methods and materials used. This means a

different set of construction criteria more stringent than present FHA minimum property requirements for structures qualifying for maximum amortization time.

In summary, the time for stimulating housing of just any kind has passed. Slight modifications to the bill under consideration can foster better housing conditions by encouraging quality of construction, and can better protect the public liability represented by long-term mortgage insurance.

STATEMENT OF EFREM A. KAHN, JAMAICA, N. Y.

Mr. Chairman and members of the committee, it is a privilege and an honor to appear before you today to discuss certain portions of H. R. 7839 before you for consideration, particularly those sections which deal with cooperative housing, generally known as section 213 of the proposed Housing Act of 1954.

I wish to state that I have been actively identified with the 213 cooperative program since its inception and, together with my associates, have completed during the last 2 years over 4,000 multiple-dwelling units under said program in the county of Queen, city of New York, aggregating insured loans in excess of \$35 million.

I also happen to be the chairman of the labor-management group of the electrical industry of the city of New York, which group has sponsored and is now in the process of completing a 2,000-unit multiple-family project in the county of Queens under the limited-dividend corporate laws of the State of New York.

Presently I am engaged as a builder-sponsor in processing a 213 project to be located in Queens County on approximately 140 acres, which site has been assembled over a period of the last 14 months and which project it is anticipated will accommodate approximately 2,700 families of the middle-income group. It is also anticipated in connection with this project that the FHA-insured loans will approximate \$27 million.

The proposed legislation, particularly in regard to increases in maximum insurable loans, as provided in section 119 of the proposed amendments amending section 213, is a step forward and commendable and no doubt will encourage the initiation of cooperative projects. The 213 program is a worthwhile endeavor in that the much-needed housing accommodations for the middle-income group is furnished at less cost than any other comparable FHA program except public housing. The increased maximum insurable mortgage limits, if granted, would make possible for the middle-income group to acquire their dwelling accommodations at a cost within their means.

The proposed bill authorizes the President to establish, pursuant to section 201, the greater maximum amount as provided in the proposed amendment. This is not satisfactory as this discretionary power would create a serious problem in the planning of any large-scale cooperative project. It is essential for the proper planning and financing of such a project to have determined in advance the amount of the FHA-insured loan. It would be to the advantage of the program that the maximum insurable loans be established in the present proposed bill without the necessity of obtaining the authorization of an increase from the President.

Section 119 of the proposed act, dealing with cooperative housing, provides that the insurable loan shall be based on the estimated value of the property or project instead of, as formerly provided, on the replacement cost.

Insofar as this change pertains to section 213, cooperative housing, I believe it to be impracticable, unless there is a definite provision that replacement cost and valuation are one and the same. Under the existing criteria used by the FHA in determining value under section 207 (if the same basis of computation is to be used under section 213), there is a difference between valuation and replacement costs. This comes about because, in addition to the replacement cost analysis, a criteria based on capitalization is used. As all cooperative housing under section 213 is erected on a nonprofit basis, it would be impossible to create value under the existing tables of capitalization. For the same reason value could not be based on comparability. It seems to me that the only basis of computation, to determine the maximum insurable loan, is by replacement cost as provided in the existing law since a nonprofit cooperative corporation does not lend itself to basing mortgages on a valuation basis as there is no profit motive.

In the proposed amendment allowing for increases for veteran membership, there is eliminated increases based on the percentage of veteran membership.

The proposed amendment permits the increase only if 65 percent of the members are veterans. By reason of the elimination of the pro rata increase based on the percentage of veterans, I believe the requirement should be lowered from 65 percent to 50 percent. In the New York area, particularly Queens County, I have confirmed that it is becoming increasingly difficult to obtain the required percentage of veterans in order to obtain the maximum insurable loan.

To further strengthen cooperative housing I would recommend that section 213 be further amended so as to permit the sponsor-builder to file an application for a cooperative housing project and have same processed so that a commitment could be issued without the necessity of first obtaining applications and approval of the purchasers of 90 percent of the number of units contained in the project. This would eliminate the necessity of selling the stock in the cooperative corporation prior to the initial loan closing. It would greatly speed up the building processes if a builder-sponsor were able to receive a commitment prior to the sale of the apartments. The project could then be erected and the sale of the apartments could take place during construction. The payments received for the sale of the stock would be held in escrow until the project was completed, and, upon completion, said funds would be paid over to the builder-sponsor as reimbursement for equity capital advanced by him out of his own funds on behalf of the cooperative corporation. Upon completion of the project and reimbursement to the builder-sponsor the stock purchased by the cooperators would be issued. This would afford a greater protection to the cooperators for any moneys that may have been paid for their stock by reason of the fact that until the project was completed all funds paid by the cooperators would be held in escrow.

I also would respectfully recommend that in connection with title III, Federal National Mortgage Association, some provision should be made so as to permit FNMA to issue prior commitments in connection with 213 cooperative housing projects where mortgage loans to be guaranteed by the FHA are not readily obtainable from private lending institutions.

STATEMENT OF WILLIAM L. RAFSKY, HOUSING COORDINATOR, CITY OF PHILADELPHIA, PA.

The economic soundness and civic vitality of Philadelphia depend upon renewing the city's physical plant, particularly housing. The social and human cost, together with the sapping of economic strength brought about by sub-standard housing are, I am sure, well known to the members of this committee. The President's Advisory Committee on Government Housing Policies and Programs summarized the direct financial burden of slums to a number of cities throughout the country, including Philadelphia.¹

The hidden costs, particularly to human beings, are far more devastating, even though they cannot be fully measured by the dollar sign. Indicative of the high price of inferior housing is the fact that in 1953, 65.3 percent of all police arrests were of individuals who resided in Philadelphia's officially certified blighted areas, which contain only 25.3 percent of the city's population. (See table 1 attached.) Similar statistics on juvenile arrests reveal that unless our slums are removed, significant numbers of our future juveniles from these areas are doomed to a life of crime. Despite the fact that the cause of crime is usually far more complex than physical environment, it would be ostrichlike to ignore the fact that in the third largest city in the country, arrests of juveniles residing in deteriorated neighborhoods were 46.4 percent of the total, as compared to the area's juvenile population of 25.2 percent of the entire city (table 1). Similarly, our losses of life and property by fire, our health, and our welfare problems are concentrated in districts where sub-standard housing predominates. From the longer range point of view, Philadelphia's survival depends upon the solution to this problem.

Recognizing the seriousness of the situation, we determined to do everything we could locally to eliminate our rundown residential areas and to provide decent shelter for all. The city already has an extensive program underway:

¹ A Report to the President of the United States, the President's Advisory Committee on Government Housing Policies and Programs, December 1953. Appendix 2--Report of the Subcommittee on Urban Development, Rehabilitation and Conservation, exhibit 4, Notes on the Cost of Slums to Local Governments, pp. 151-154.

(1) The Philadelphia City Planning Commission maintains high standards which private builders must follow in developing unused land.. The Commission makes every possible effort to prevent future slums from arising in Philadelphia.

(2) Operating under the authority of the State statute, and with Federal funds provided under title I of the Housing Act of 1949, the Philadelphia Redevelopment Authority has demolished 761 substandard dwelling units. An additional 1,320 such units will be razed in 1954. By the end of this year, 1,003 new dwelling units will have been constructed as a result of the work of the authority. Plans which have already been approved will in the next few years greatly increase this total, including some 12,000 units for one redevelopment area alone, the Eastwick project in southwest Philadelphia.

(3) Although not as great in emphasis, the rehabilitation of existing houses has also been part of the redevelopment authority's program.²

(4) The Philadelphia Housing Authority has completed 4,648 number of low-rent dwelling units since the inception of the Federal program in 1937. By the end of 1954 the total of such units will be 9,157. It now manages 9,336 dwellings constructed under the various Federal programs. Project planning work is continuing with the aid of city funds in anticipation of the resumption of the Federal public-housing program.

Nor is the city relying on previous accomplishments and existing levels of programs in its fight against blight. Within the past few months additional programs have been launched and plans made for an all-out comprehensive attack on the problem.

1. A new position, housing coordinator, has been created directly under the mayor to bring together the various agencies now working in the field in order to supply a unity of purpose and an effective pooling of resources. It was felt that the good work of the different agencies, both city and State, was piecemeal and uncoordinated.

2. A new housing code, bringing up to date the existing law adopted in 1915, is now pending in the city council and its adoption is expected shortly. It will substantially increase minimum housing standards, eliminating, for example, all outside toilets. In addition, revision of our health, fire, plumbing, and building codes are all underway.

3. Our zoning ordinance of 1933 is being overhauled. One of its primary objectives is to prevent the type of building activity which tends to downgrade residential areas.

4. Even prior to the introduction of the present legislation, the city started to draft experimental programs applying our entire enforcement machinery to achieve slum clearing, rehabilitation, and conservation. Within the next few weeks we plan to select pilot neighborhoods in which these procedures will be tested. The overall program will be developed with the aid of private groups, both civic and private, including the real estate board and the Home Builders' Association.

5. Our commission on human relations is developing a program aimed at providing decent shelter for all groups in the city regardless of race, creed, or color. It is particularly concerned in its preliminary operation in finding out what factors have produced a concentration of minority groups in blighted neighborhoods.

In short, we are marshaling the full force of local government to meet a critical situation.

As a city which is the center of a vast economic area, we believe that the Commonwealth of Pennsylvania also has an important responsibility in meeting our housing needs. For that reason, a legislative program calling for the State's participation and assistance in the housing field will be submitted to the next session of the legislature in January of 1955, as well as to the candidates who are seeking State office this year.

Yet in spite of all this concerted activity and these plans to cope realistically with the major problem, we know from both experience and careful review that the city of Philadelphia, like most large urban centers in the country, cannot do the job itself. We just do not have the financial capacity even to make a dent in correcting bad housing because of the heavy fiscal burden we must assume in carrying out the necessary municipal functions affecting safety, health, and welfare, and because our authority to levy taxes is hemmed in by

² For details on Philadelphia's rehabilitation activity, see A Report to the President of the United States, op. cit., exhibit 2, Slum Prevention Through Conservation and Rehabilitation, Jack M. Siegel and C. William Brooks.

our State constitution. This position, recognized by Congress in 1949, is amply documented in the report of the President's Advisory Committee on Government Housing Policies and Programs.³ Ironically, the cities single largest source of income, real estate, is in danger because of our slum problem. It will take Federal aid to break this vicious cycle.

We welcome the approach used in the proposed Housing Act of 1954 because it recognizes the limitation of cities in providing remedies for inferior shelter. The bill has a number of constructive features, which we hope will be adopted. These provisions, however, do not go far enough in the approaches and methods endorsed.

I. URBAN RENEWAL

The increased emphasis on urban renewal, as including rehabilitation and conservation as well as redevelopment, gains our wholehearted support. Philadelphia took advantage of the language in title I of the Housing Act of 1949 and has already carried out a rehabilitation program in addition to its redevelopment work. Yet at the end of 5 years, only a little more than 2 percent of the 103,410 dwelling units in redevelopment areas have been removed at a cost of \$3,939,775.

Rehabilitation of existing homes is an important weapon in the arsenal needed to fight deterioration, but it does not add to the new housing supply which is so necessary to meet the condition of overcrowded slum neighborhoods. If the program is not handled with extreme care, there is the danger that the remedy will be patchwork in that it merely postpones the date of obsolescence, thereby making the money used an unsound investment. It is of the utmost importance, therefore, not to substitute rehabilitation for blocks and areas which require redevelopment. The key is the amount of money to be appropriated to carry out what should be an enlargement of an existing program, rather than a shifting of emphasis. The subsidy available is of specific concern in rehabilitation because the monthly housing cost or rent of the existing dwelling will tend to increase.

The President's recommendation to allot \$97 million for urban development and redevelopment in 1955 does not in any way come near the necessary wherewithal to work on a problem of the magnitude of substandard shelter. Even without the new stress on rehabilitation and conservation, the Housing Act of 1949 calls for \$250 million in loan funds per year, and \$100 million annually for capital grants. Unless the appropriations are substantially increased, we can only resign ourselves to having blight continue to outstrip new or rehabilitated homes.

II. LIBERALIZATION OF MORTGAGE INSURANCE TERMS

The increase in the loan-value ratio and maximum amounts of mortgages which may be insured by FHA, as well as the extension of the maximum statutory term to 30 years of all mortgages will undoubtedly be of some help in preventing any significant decline in new housing starts. At this stage of the economy such bolstering of the home construction market will be helpful. Housing Administrator Albert M. Cole estimates that the proposed legislation would result in about 1 million new-home starts in the United States, a significant decline from the past few years. When the approximately 200,000 net gain from conversions is added, the total is scarcely sufficient to meet the need created by new households and by replacement of structures demolished or destroyed. Since the funds recommended for urban renewal will merely continue that program at a snail's pace, the families who live in the 10 million substandard nonfarm homes in the United States can neither turn to the Government nor to the private-building industry to provide what is universally agreed to be a necessity of life—housing with minimum standards of decency.

From the point of view of the urban community, the existence of large numbers of substandard housing is not merely another unmet need. Housing cannot be placed in a deep freeze; continued wear and tear means that neglect results in a growing backlog. Unless checked now, blight will erode the economic base of our large cities.

These nationwide conditions, when translated to Philadelphia, pose a thorny question. In 1953 Philadelphia added 8,900 dwelling units, exclusive of public housing, to its supply; 5,255 of these units were in new construction. (See table

³ A Report to the President of the United States, op. cit., exhibit 10, A Statement on Problems of Capacities in Local Financing of Slum Clearance.

2.) The supply of privately created dwelling units is hardly sufficient to keep up with the need as measured by the formation of new households and homes destroyed in Philadelphia. (It is estimated that the city's immigration and out-migration cancel each other.) Except for public housing, therefore, we have not been able to reduce the unfilled needs of families having substandard shelter. The proposed Housing Act of 1954 offers us little encouragement in that regard. The present legislation fails completely to recognize that we must produce housing within the financial capability of our low and middle-income groups.

According to the United States census, 75.7 percent of Philadelphia families had incomes below \$5,000 per year as of 1949. Even if a generous 25 percent upward adjustment is made, at least 65 percent of these families still fall below the \$5,000 level. The cheapest of the new homes selling in Philadelphia is \$10,000. An estimate by realtors of the average price of existing homes sold in Philadelphia last year was \$8,400. The rentals for newly constructed dwelling units tend to run \$85 per month and upward. A survey⁴ conducted last September in Philadelphia revealed that the vacancy ratio in rental units based on a sample study was less than 2 percent. For all intents and purposes, therefore, existing units at low rentals are not available.

The President's Advisory Committee⁵ found that in most cities rent, heat, and utilities fell below 20 percent of the total budget cost. If one takes the median family income for Philadelphia, \$2,069, as reported by the United States census for 1949, makes a 25 percent upward adjustment to bring it in line with the present, and then applies the 20 percent formula suggested by the President's Committee, the average family in Philadelphia would not be in a position to spend more than \$60 a month for its housing costs. If a house, which costs as little as \$7,000 requires a monthly housing expense of \$62.92,⁶ half of Philadelphia's families have no real housing market to speak of and can only turn to the oldest existing homes when they are put up for sale.

The almost hopeless impossibility of this condition is more clearly seen when one looks at the incomes of families who live in Philadelphia's blighted areas. A special study made at our request reveals that even with the 25 percent upward adjustment of the 1949 census figures, the median family group is in the \$2,000 to \$2,500 category (table No. 3). To meet this difficult situation, the proposed legislation has come up with only a stopgap suggestion which will undoubtedly prove impractical for cities like Philadelphia. The proposed new section 221 to the National Housing Act, providing for FHA 100 percent insurance on a \$7,000 home with a mortgage term of 40 years, will have little significance for us. It is difficult to foresee how any builder can construct a home in Philadelphia at this price. Furthermore, the monthly housing cost of \$62.92, as listed in the report of the President's Advisory Committee, places it out of the price range of the families who are in greatest need of housing. It is questionable, in the first place, whether mortgage money would be made available to finance such construction.

Little reliance can be placed on the amendments to section 208 of the National Housing Act insuring up to 95 percent of the value of existing homes for mortgage periods up to 30 years. Aside from the prevailing high prices, even for other than new dwellings, there is no assurance that either FHA or private lending facilities will provide the maximum terms for such housing, particularly for older homes whose prices are lower.

What is needed is a fresh approach, and perhaps the extension of existing approaches far beyond their present limits in order to find the answers for housing for low- and middle-income families. The entire field of incentives and subsidies has to be explored. Perhaps more can be done in reducing down-payments by encouraging direct loans to home purchasers. Builders might be given better terms on construction loans through Government guaranties. More aggressive mortgage market facilities might stimulate an increased flow of funds and bring the interest rate down. More might be done to provide greater incentives for mortgage loans, which result in carrying charges in line with the resources of the \$3,000- to \$5,000-per-year income group. Since large-scale build-

⁴ Percentage Vacancy of Habitable Dwelling Units in Philadelphia, September 15, 1953. Government Consulting Service, Institute of Local and State Government, University of Pennsylvania, Philadelphia.

⁵ Op. cit., appendix 3, Subcommittee on Housing for Low-Income Families, exhibit 4: Estimated cost to maintain families at a level of adequate living.

⁶ Op. cit., appendix 1, Subcommittee on FHA-VA Programs, exhibit 8: Estimated monthly mortgage payment and housing expense on typical mortgages insured under proposed sec. 221.

ing has brought about some reduction in construction costs, encouragement might be given to home builders to pool their resources and to engage in extensive development projects. Building standards and building practices should be continually reviewed in order to eliminate unnecessarily expensive procedures. More encouragement could be given to cooperatives. A continuing research program might be able to uncover new building techniques, which would also result in lower costs.

III. PUBLIC HOUSING

With all this, however, the housing needs for families with annual incomes of \$2,500 or less can only be met by large-scale low-rent public housing. I understand that this matter has been referred to another congressional committee. It is difficult, if not impossible, to consider housing legislation without taking into account the total picture. Much of the proposed legislation, particularly as it pertains to urban renewal, cannot be productive unless it is accompanied by an extensive public-housing program. As the Philadelphia income study of families of blighted areas shows (table 3), more than half the families in slum neighborhoods are eligible for public housing.

The cooperative agreement between the Philadelphia Housing Association and the Federal Government calls for 10,000 dwelling units under the Housing Act of 1949. Thus far, only 4,509 have been constructed or are under construction. Philadelphia could undoubtedly use 70,000 low-rent public-housing units, based on the income study to which reference was previously made. At the very least, therefore, it is hoped that Congress would return to authorizing 135,000 public-housing units a year, instead of the 35,000 recommended by the President.

IV. PROBLEM OF MINORITIES

No housing legislation like the proposed act before this committee can accomplish its objective without providing opportunity for shelter to all groups in our society, regardless of race, creed, or color. The inability of minority groups to obtain decent shelter is a condition which is not unique to Philadelphia. A recent study of Philadelphia's Negro population⁷ points up the problem sharply for our city. Of the 72,113 dwelling units classed as substandard in 1950, 46 percent or 33,471, are occupied by nonwhites. Almost one-half of all nonwhite families in areas certified for redevelopment compared with less than one-eighth of the white families.

The only possible approach to meeting this confining situation that one can see in the proposed act is the authority to be given to the rechartered Federal National Mortgage Association. The special type of assistance which FMNA can provide is not specified, but one assumes that the President can determine that a program to make available housing for minority groups would be in the public interest and eligible for aid under the proposed amendment to section 301 of the National Housing Act. In that case, however, it will be competing for limited funds with special housing programs, such as veterans, co-ops, defense, housing for the aged, housing for displaced persons, and others.

We cannot lick the slum-housing problem in Philadelphia unless special attention is given to this situation. It would seem desirable, therefore, to have FHA give high priority to meeting this need. The Federal Government could use its influence through FHA in seeing to it that mortgage money is made available in much greater amounts, on a nondiscriminatory basis. To ignore this aspect of our slum problem could only produce an unrealistic shelter program.

From the point of view of the means of the city of Philadelphia, the Housing Act of 1954 is not a sufficient answer. We welcome a number of its constructive features. The test as to whether it will contribute to better housing depends upon:

- (1) Appropriating sufficient moneys to carry out all aspects of the program, particularly urban renewal.
- (2) New and fresh approaches to providing housing at prices within the means of low- and middle-income families.
- (3) A substantial low-rent public-housing program.
- (4) An opportunity for housing, with at least minimum standards, for all groups in our society.

⁷ Philadelphia's Negro Population, Facts on Housing, prepared by the Philadelphia Housing Association for the Commission on Human Relations, October 1953.

We believe that these requirements are not only Philadelphia's but most of the large cities in the country. We hope that your committee will take the necessary steps to amend the legislation along the lines suggested.

TABLE 1.—Comparison of arrests based on residence in blighted versus non-blighted areas, city of Philadelphia, 1953

Blighted areas ¹ (comprising 8 police districts)	All age groups				Juvéniles—7 to 12			
	Police district	Population 1950 census	Number of arrests	Rate per 1,000 population	Rank	Population 1950 census	Number of arrests	Rate per 1,000 population
6th.....	41,604	18,793	451.7	2	6,419	447	69.6	1
9th.....	45,644	4,167	91.3	3	5,496	272	49.5	3
16th.....	82,657	4,941	59.8	6	9,671	474	49.0	4
17th.....	96,394	4,714	48.9	8	15,478	448	28.9	7
19th.....	40,831	7,908	193.7	1	3,047	205	67.3	2
23d.....	105,157	9,187	89.1	7	16,196	699	43.2	5
33d.....	71,135	5,191	73.0	5	10,917	305	27.9	3
42d.....	41,552	2,222	53.5	9	6,944	153	22.0	11
Total.....	522,974	57,126	109.2	-----	74,168	3,003	40.5	-----
Other areas (comprising 16 police districts):								
Total.....	1,541,819	30,304	19.6	-----	219,790	3,475	15.8	-----
Entire city (comprising 24 police districts):								
Total.....	2,064,793	87,430	42.3	-----	293,958	6,487	22.0	-----

¹ Areas declared blighted by the City Planning Commission of the City of Philadelphia fall in the police districts here cited. Since there is no exact correlation between boundaries of the police districts and the boundaries of certified blighted areas, allowance was made for overlapping into fringe areas. It should also be noted that two areas were completely omitted: the Aramingo area, which is principally an industrial community, and the Rittenhouse-Germantown area, which constitutes only a small part of several census tracts, which are not generally blighted.

TABLE 2.—Dwelling units added 1950-53 by year of permit

[All dwelling units according to the United States census, 1950-599,495]

Year	Private construction	Public construction	Total construction	Conversion net gain	Demolition	Net gain
1950.....	12,310	-----	12,310	5,048	426	16,932
1951.....	6,399	215	6,614	4,203	254	10,563
1952.....	5,815	1,347	7,162	3,950	526	10,586
1953.....	5,255	2,224	7,479	3,688	1,094	10,073
Total, 1950-53.....	29,779	3,786	33,565	16,889	2,300	48,154

¹ Of these, 761 were razed as result of permits issued to the housing and redevelopment authorities.

NOTE.—Estimated total dwelling units in Philadelphia, Jan. 1, 1954 (including those under construction), 647,649.

Source: Philadelphia Housing Association, October 1953.

TABLE 3.—Total income received during 1949 by families and unrelated individuals in certified redevelopment areas and Philadelphia

Income range	All Philadelphia	Certified redevelopment areas ¹
Less than \$500	88,950	28,723
\$500 to \$999	39,120	14,651
\$1,000 to \$1,499	41,465	13,607
\$1,500 to \$1,999	44,295	12,954
\$2,000 to \$2,499	65,005	16,442
\$2,500 to \$2,999	61,600	12,494
\$3,000 to \$3,499	72,595	10,623
\$3,500 to \$3,999	48,160	6,012
\$4,000 to \$4,499	42,420	4,661
\$4,500 to \$4,999	27,520	2,994
\$5,000 to \$5,999	47,010	4,508
\$6,000 to \$6,999	25,570	2,222
\$7,000 to \$9,999	29,265	2,439
\$10,000 and over	15,585	1,222
Income not reported	53,085	—
Median income	2,869	—
Median income range	—	\$1,500-\$1,599

¹ 2 areas were completely omitted: the Aramingo area, which is principally an industrial community, and the Rittenhouse-Germantown area, which constitutes only a small portion of several census tracts, which are not generally blighted. The boundaries of redeveloped areas are close to but do not coincide exactly with those of census tracts.

Source: Philadelphia City Planning Commission, Mar. 15, 1954.

STATEMENT OF JERRY BIALAC, VICE PRESIDENT, RENTAL DEVELOPMENT CORPORATION OF AMERICA

My name is Jerry Bialac, of Beverly Hills, Calif. My specialty is rental housing. Together with my father, Samuel G. Bialac and our associates, we plan, build, and operate low-, medium-rent apartment projects. I have the honor and privilege of appearing before you for the second time to present, as a private citizen, the opinions of many of my colleagues and myself and we feel that through our practical experience and specialized study of the rental housing field and the mortgage market relative to rental housing, we may be able to contribute material that may help you in your endeavors to improve the housing bill before you and solve serious inadequacies in the universally important industry I serve.

I want to thank you for the courteous, helpful treatment I received on my first appearance before this important body. I return, confident and at ease, knowing that my suggestions will receive full consideration. This is doubly reassuring as I seem to be the only one testifying to any length on the vital rental problem.

Last year I predicted a great decline in FHA housing starts. This came to pass. This year, in spite of the slow start of the first 2 months, will be the biggest year in housing starts since the war. The reason being, there will be plenty of financing available. Unfortunately this is only a temporary condition and as the ever-changing financial cycle runs on and demands on money increase from other sources, less and less will be available to the builders and construction will again slow down. This need not happen. You have heard expert testimony before me on the huge number of living units needed in future years and a smooth flow fulfilling that need could be realized with the proper secondary or support market that would be brought into play when needed, not as a competition to private financing but rather as an aid to it.

A fine start has been made on this under title III of this bill. However, while the basic idea behind this is sound and could solve the problem, it is a obvious, by the many changes and criticisms of the actual workings and fees, which you have heard in previous testimony by both the builders and the bankers, and which I shall not repeat now, that a more extensive study be made of the section. As the revision of FNMA now stands, for rental housing at any rate, it only offers to give the builder a push as he stands on the precipice overlooking the chasm of certain failure. I therefore respectfully submit:

1. That FNMA should be continued in its present form for another year. With a renewal of a plan similar to the 1-1 program but changed to a ratio of 9 to 10.

In other words, for every mortgage of \$100 bought, a certificate would be issued for a \$90 commitment. This would allow FNMA to diminish its portfolio by 10 percent. No further funds would be necessary if FNMA would be allowed to sell short-term debentures secured by its portfolio.

2. A commission of experts be appointed to investigate further and recommend more realistic fees and make further recommendations to perfect this very complicated and controversial title III of the housing bill which, I am sure, can become very workable for everyone.

Even distribution of mortgage money

I am sure that you gentlemen who are from the South, Middle West, and Far West have heard many times from your constituents that the farther away from New York, the more difficult it is to get financing for a mortgage and the greater discount you must pay. This is not because the mortgages are not just as desirable but the mortgagees are reluctant to expand any substantial sums in areas which are not thoroughly familiar to them and where they have to rely on others for servicing and general supervision of their investment. They naturally consider these greater risks.

One of the greatest hazards to our housing economy is growing daily. While the center of population moves westward at an accelerated pace, the center of finance remains in the Far East. Therefore we suggest:

3. That the term of the debentures that would be issued (only in case of failure of a project) would decrease and the interest rate increase proportionately with the distance from the point of origin of the loan to the city that the actual project would be built.

For example, the present debentures under 207 are for a term of 10 years, at 2½ percent. Under the proposal loans made in New York to a project in New York or near proximity would be entitled to debentures at that rate. A loan made in New York to a project in Indiana would get 9-year debentures at 2½ percent and a loan made in New York to a project in Portland, Oreg., would receive 8-year debentures at 3 percent. These rates are only arbitrary; the actual rates would be set by the Housing Administrator and would compensate the lender for his additional risk and would divert the flow of moneys more realistically into their proper markets.

TITLE II, SECTION 115

We support paragraphs 1 and 2 of title II, section 115, and the first part of paragraph 3, up to and including \$2,400 per room for elevator-type structures.

As builders of large-scale apartments we have concentrated mostly on garden-type structures because of the more realistic financing-to-cost ratio and the availability of land close in to the heavily populated area. However, in an alarmingly short time, because of the large tracts of buildings filling in these areas and the fantastic pyramiding of land costs, which make the per-unit price economically unwise, we are forced farther and farther away from the center of the city. The dangers of this condition are multifold. First, it is forcing more and more people to rely on their cars for transportation to their jobs in already overly congested streets; secondly, it is forcing the population to spread out, adding to the great and ever-increasing load on the school system's shortages of schools and has made proper patrolling by police departments impossible. I could go on and on, but I'm sure that isn't necessary.

The cure for this condition lies in more elevator-type structures which can stand the higher land cost by dividing the cost of the land into many more units.

A step in the right direction has been taken by increasing the allowable room mortgage amount to \$2,400 in the elevator-type structures which is a 17-percent increase over room mortgage amount of walkup apartments (the actual difference in cost is over 20 percent), but then cancels this gain by limiting it to only \$7,500 per family unit which amounts to only a 4-percent increase when the average room count is under 4. In order to make the provision workable the figures must be changed proportionately (17 percent). Therefore, this section should be corrected to read:

4. That in elevator-type structures the mortgage amount limitation be \$2,400 per room and \$8,500 per family unit (less than 4 rooms). This increase would be in exact proportion to the walk-up structures.

5. We are opposed to the proviso that present statutory mortgage limits would continue unless the President has prescribed higher limits. These higher limits are needed now and should be incorporated in this bill.

Clarification of present statute

In the President's Advisory Committee on Housing Report, page 40, recommendation No. 14, reads as follows:

"Your subcommittee recommends that section 207 of the present statute be amended to clarify the authority of FHA to insure loans up to 90 percent of value but not in excess of \$7,200. The statute is presently interpreted to restrict this special aid to projects in which all units have two or more bedrooms. The subcommittee recommends that this be changed to projects in which the average number of bedrooms is not less than two per unit."

TITLE II, SECTION 128

6. We are in favor of eliminating any termination date on this section as we feel it fulfills a definite need in the rental field.

The construction industry in this country has grown far beyond the position it formerly occupied and is now one of the most important industries in the United States today. I include all phases of construction in this category, housing, commercial, road-building, dams, and general construction which takes in construction of public buildings, schools, defense factories, etc.

The economic growth, health, defense, education, and wealth of this country are all directly dependent on this industry, yet, the Government does not fully recognize or make full use of the mighty, but now disassembled arm.

A Department of Housing and Construction should be set up and a new Cabinet post of Secretary of Housing and Construction created. I know this is not pertinent to this bill, but we felt by bringing it to the attention of your Action Committee, at this time, that the movement would start. The choice of a Secretary of Housing and Construction is ready-made and proven in the present Housing Administrator, Mr. Albert Cole.

I again thank you for your consideration.

STATEMENT OF JOHN H. MOORE, EXECUTIVE DIRECTOR, UNITED COMMUNITY DEFENSE SERVICES, INC.

The United Community Defense Services wishes to take this opportunity to express for the record its concern regarding the continuing acute situation of many communities affected by a concentration of defense activities and their need for special measures to assist them in meeting the housing and related requirements of a rapidly expanding population. Specifically we wish to express support for certain features of H. R. 7839 but also to request that it be amended to extend the provisions of title IX (Defense Housing Act) of the National Housing Act and title III of the Defense Community Facilities and Services Act of 1951.

The United Community Defense Services is a federation of national voluntary agencies extending aid and service to communities affected by a heavy concentration of defense activities. Our own activities are financed entirely by voluntary contributions and are directed largely to facilitating local community adjustment to defense-created conditions. As a result of the work of our own UCDS field representatives and those of our affiliate organizations in over 400 such communities, however, we have had an excellent opportunity to observe the local impact of Federal decisions and policies and the extent to which Federal aid is necessary in their solution.

In titles VIII and IX of the National Housing Act and in the Defense Community Facilities and Services Act of 1951, the Congress recognized the responsibility of the Federal Government to aid defense communities in providing the necessary housing and related facilities, such as water supply and sewage-disposal facilities, without which community expansion is impossible. This has been a necessary aspect of defense policy, since expansion of the Military Establishment and defense production could not move forward without an adequate labor supply, and labor supply—in a free society and especially in peacetime—cannot be attracted to the centers of defense production without the basic necessities of family living. Fundamental among these basic necessities is a decent place to live, within reasonable distance of the place of employment, at a nonexploitive rent and supplied with community services which are a normal and accepted part of the American standard of living. Repeatedly in our work we have seen examples of situations where defense activity was delayed,

rendered more costly by reason of heavy labor turnover, or reduced in efficiency by the necessity to utilize labor less skilled than the job properly required because acute housing shortages made it impossible to attract or retain the needed labor supply.

It is obvious from the President's messages to the Congress and from the continuing tension in the world situation that the defense program must continue to utilize a considerable share of our productive capacity. The President's budget message shows 68 cents of every Federal budget dollar going into our national security programs. Moreover, it is clear from this same message that considerable readjustment in the specific implementation of defense policy must be anticipated as a result of the basic strategic decision to rely more heavily on airpower and nuclear weapons than in the past. The very development of those weapons in itself involves continuing readjustment in military installations and in plant location and expansion.

The Atomic Energy Commission, in its 14th semiannual report, stated that its monthly constructions costs would reach "a peak of about \$130 million during the early part of 1954. They will then approximate 5 percent of total estimated United States new construction expenditures." The importance of this to the present discussion is indicated in a recent reply to a UCDS inquiry in which the Atomic Energy Commission stated its policy of relying on nearby communities, aided by such Federal measures as those whose extension we now urge, to meet the housing and related needs of these workers.¹

Our own field representative, working in the vicinity of the Pike County, Ohio, Atomic Energy installation, sends us one example of continuing need when he reports that defense-housing construction is now virtually complete, that there are virtually no vacancies in the area, and nearly 10,000 workers still to come.

Another type of continuing dislocation resulting from changes in our military strategy is reported by one of our agencies in terms of an acute situation in the vicinity of Camp Carson, Colo., which has recently been obliged to absorb the personnel of Camp Atterbury, Ind., as a result of the so-called New Look in defense policy. This type of military relocation—with its accompanying changes in defense-production requirements—is certain to create a continuing pattern of population shift and community dislocation.

In view of these facts, it would seem extremely short-sighted to permit these two basic legislative authorities to expire on June 30, 1954. In view of the difficulty of predicting the exact and detailed nature of defense-housing needs in the future or the capacity of private enterprise to meet such unpredictable needs when they arise, it would appear to us to be the better part of wisdom to continue these two authorities, at the very least on a standby basis (as was recommended by the President's Advisory Committee on Government Housing Policies and Programs with respect to Wherry Act military housing under title VIII). It is basic to the very nature of a defense program to be prepared in advance against all possible contingencies.

On the broader front, we recognize that it is fundamental to meeting the special housing needs created by defense adjustments that there should exist a sufficient total supply of housing, credit arrangements favorable to adequate and flexible private housing construction or renovation, aids to communities in carrying out their own planning responsibilities, and—where necessary—provision for public housing to meet the otherwise unmet housing needs of low-income groups. To the extent that the President's housing program and the Housing Act of 1954 carry out these objectives, we wish to express our support.

We should like to comment particularly on the value of title VII, providing grants to State, metropolitan, or regional area agencies for metropolitan or regional planning, and to State planning bodies to assist municipalities under 25,000 population in urban planning. It is our own observation that this is one of the most urgent needs of small communities in adjusting to rapid expansion due to defense or other Federal activity. In one instance of extreme urgency (the Savannah River area) we ourselves financed a physical planning survey, but our resources are not adequate for such a function except on a demonstration basis. In another locality of rapid industrial expansion (Bucks County, Pa.) we have had an opportunity to observe the value of State-financed planning services. Problems of incorporation, of zoning, of taxing and property assessment, of districting for various types of services, of physical planning in the extension of roads, water, sewage, and other facilities of related economic and social adjust-

¹ Copy of AEC letter appended at end of statement.

ment are all basic to the orderly development of defense-affected communities. In the long run, a relatively small investment of Federal funds in this type of service will pay large dividends not only in social well-being but in the efficiency of the labor supply on which our whole defense program depends. We should like to urge also that authority be restored to the Housing and Home Finance Agency to conduct research in this matter of community needs and adjustments. Such studies in the past have proved most useful in assisting both communities and Federal defense agencies to make a smooth transition.

Our experience in UCDS has brought home to us very forcibly one characteristic of contemporary American life which bears directly on all aspects of economic, social, and governmental policy, i. e., its extreme fluidity. Not only is a high degree of adaptability demanded of our productive machinery in order to maintain our economic health and meet changing needs—including our defense needs—but a high degree of mobility is demanded of our people. Census figures are most revealing on this latter score. For example, it is reported that in the past 3 years 15 million people have changed residence as a result of defense activities. Two-thirds of all adults in most American cities were born somewhere else. About one-third of all adults living in a typical city can be expected to move within the next 10 years.

A logical concomitant of this extensive migration is the rapid change in population distribution with rates of community growth which in some instances reach fantastic proportions. For example: Augusta, Ga., which had 71,500 people in 1950, doubled its population in 1 year; Moses Lake, Wash., doubled in 2 years; Richmond, Calif., has 5 times as many people as in 1940.

This tremendous mobility of population, much of it caused directly or indirectly by Federal defense policy and activity, spotlights three basic points which we should like to make in conclusion with respect to Federal housing policy in general and the pending bill in particular:

1. It is essential to the national welfare and to the success of the defense effort that the Federal Government assume a positive leadership in aiding both private enterprise and local communities to meet the housing and related needs of this shifting population.

2. It is essential that such a program, while facilitating homeownership for those families whose situation makes this desirable, also recognize that an adequate supply of rental housing is important as a facilitating and equalizing factor in this highly fluid situation.

3. It is likewise essential to recognize that in some situations where speedy action is essential or where the particular housing need is temporary (as in the case of construction projects) the regular processes of private enterprise and Government may not be adequate to meet the specific need at hand. In view of the unpredictability of future defense developments, the basic importance to their success of a mobile labor supply, and the Federal stake in the successful solution of this problem, we strongly urge the continuation beyond June 30, 1954, of both title IX of the National Housing Act and title III of the Defense Community Facilities and Services Act of 1951.

UNITED STATES ATOMIC ENERGY COMMISSION,
Washington, D. C., January 19, 1954.

Mr. JOHN H. MOORE,

Executive Director, United Community Defense Services,

New York, N. Y.

DEAR MR. MOORE: This is in response to your letter of December 11 in which you express the interest of your organization in learning the extent to which Atomic Energy Commission contractors are encouraged or permitted to include within their contracts the cost of services to their employees and families in such areas as health, welfare, counseling, recreation, and housing.

It is the policy of the Commission at its various installations to rely upon Federal grants, loans, and guaranties available to local bodies and private enterprise under national legislation such as the Defense Housing and Community Facilities and Services Act of 1951 and Public Laws 815 and 874 to relieve school, housing, and other community facility deficiencies which are attributable to the construction and operation of the atomic-energy plant. The Commission's policy is in accord with that of the administration; namely to assure the availability of housing and related community services and facilities for its employees through reliance on programs of Federal assistance which are uniform as to national policy and which are administered by agencies of prime technical competence.

The policies outlined above apply to all AEC installations except the communities of Oak Ridge, Tenn.; Richland, Wash.; and Los Alamos, N. Mex., which the Commission now owns and operates. It is the Commission's intent to dispose of these three communities when and as quickly as practical circumstances permit, after which the policies outlined above will apply.

To the extent that services may be required in the other fields about which you inquire and for which there is no legislation or designated agency responsibility, it is the policy of the Commission to permit its contractors to use their usual personnel practices within reasonable limits established by the Commission.

In any case where the circumstances warrant, the AEC will use its existing authority to meet the needs of its employees where the Federal agencies are unable for any reason to supply such assistance.

Sincerely yours,

WALTER J. WILLIAMS,
Deputy General Manager.

X

HOUSING ACT OF 1954

HEARING BEFORE THE COMMITTEE ON BANKING AND CURRENCY HOUSE OF REPRESENTATIVES

EIGHTY-THIRD CONGRESS

SECOND SESSION

ON

H. R. 7839

A BILL TO AID IN THE PROVISION AND IMPROVEMENT
OF HOUSING, THE ELIMINATION AND PREVENTION OF
SLUMS, AND THE CONSERVATION AND DEVELOPMENT OF
URBAN COMMUNITIES

MARCH 2, 3, 4, 5, 8, 9, 10, 12, 15, 16, 17, AND 18, 1954

Printed for the use of the Committee on Banking and Currency



UNITED STATES
GOVERNMENT PRINTING OFFICE
WASHINGTON : 1954