

# Earth First!

Climbers Guild



VOL. 2

ANCHORING, ROPE STRENGTHS, PHYSICS,  
AND OTHER TECHNICAL INSIGHTS.

# VOL. 2 ANCHORING, ROPE STRENGTHS, PHYSICS, AND OTHER TECHNICAL INSIGHTS.

*This pamphlet deals with rigging in trees. While most of the information presented here is applicable to other situations keep in mind that it was written with tree rigging as its focus.*

The purpose of this pamphlet is to help individuals who have a basic understanding of rope work and rigging to expand their working knowledge of rope. It is critical that people understand everything in this booklet before they start teaching other people or attempt to do any rigging. Those of us that do rigging in direct action settings have a responsibility not only to the individuals that trust their lives to our knowledge, but also to the campaign we are working in. Unsafe situations in rope work are never acceptable. Granted, unless you have the luxury of being funded by a wealthy organization you have to make due with what is available. But there is no excuse for unsafe rigging. The absolute first step in becoming a rigger is to understand the forces at work when dealing with complex or even simple rope systems.

A good place to start is with a discussion about rope. The two types of rope that are typically used in our circles are dynamic and static. There is also specific arborist rope but for the sake of uniformity we will only be discussing static rope.

What's the difference and why do we use static rope? Dynamic stretches, if shock loaded (a load suddenly placed on the rope i.e. if the rope catches someone from a free fall.) you could see as much as a 35% stretch. Static is designed to minimize stretching under load. It would be impossible to have a 0% stretch when dealing with rope but generally you will only encounter a stretch of about 6% when dealing with static rope. Arborist rope is static with very low stretch as well. The exact amount of stretch

<b>rope size (diameter)</b>	<b>typical breaking strength</b>
3mm	380 lbf. (1.7kN)
4mm	745 lbf. (3.3kN)
5mm	1,350 lbf. (5.5kN)
6mm	1,600 lbf. (6.8kN)
7mm	2,200 lbf. (9.3kN)
8mm	3,500 lbf. (14kN)
9mm	4,300 lbf. (16.2kN)
10mm	5,700 lbf. (25.4kN)
11.1mm(7/16")	7,000 lbf. (30kN)
12.7mm(1/2")	9,000 lbf. (40kN)
16mm (5/8")	15,000 lbf. (66.7kN)
25mm (1" webbing)	4,500 lbf. (25kN)

and the strength of the rope will vary between rope manufactures but the numbers here are just a rough average.

*Before we go much further a brief note on what kN means. kN is the abbreviation for kilo-newtons, a measurement of force. Named after Sir Isaac Newton, the newton is the force of Earth's gravity on an apple with a mass of about 102 g. The kN is 1,000 newtons or phrased in a way that might make more sense to you:*

**1 kn = 224.81 pounds of force (lbf)**

So, what's with the stretch and why don't we want it? Dynamic rope is used in Rock climbing where, if a fall occurs, it could potentially be a very large distance and a climber would need its shock absorbing. Static rope is used for rappelling and other systems involving constant tension on the rope and there is little chance of a shock load. Static ropes are more durable and resistant to abrasion (tree bark). When climbing in the context of forest defense you should always have a safety attached so that if it is loaded, it will catch instantly and not allow a free fall and subsequent shock load. A force of more then 6kN on the human body can cause serious harm. Search and Rescue groups around the world recognize this number in all their rigging techniques. The force of a fall grows exponentially until the weight reaches terminal velocity. This is relevant to us in the fact that a fall of 4-6 feet can easily generate more then 6kN of force dependent on the mass and velocity of the person. Meaning... a 4 foot fall, if taken just wrong, can break your back.

Keep in mind that the laws of physics apply equally to falling objects such as figure eights and carabineers. If any climbing gear falls from a significant height a serious evaluation must be made of whether or not to retire the item. Figure 8 descending devices are especially fragile in this regard. If you drop gear or knock a branch down you need to yell to the ground to warn them. "Heads up" isn't the best choice because most people will just look up. Something that imparts the impending impact like yelling "HEADACHE" works well. On that tip, if you hear "HEADACHE" being yelled from a tree, don't look up. Get away from the tree.

### **HARNES PATHOLOGY**

While on the subject of safety it seems prudent to mention the bodily effects of restricted blood flow due to harness wear, aka harness pathology. We are not talking about normal use of a harness, we are talking about what

can happen if a person becomes prone and motionless for a period of time while hanging in a harness.

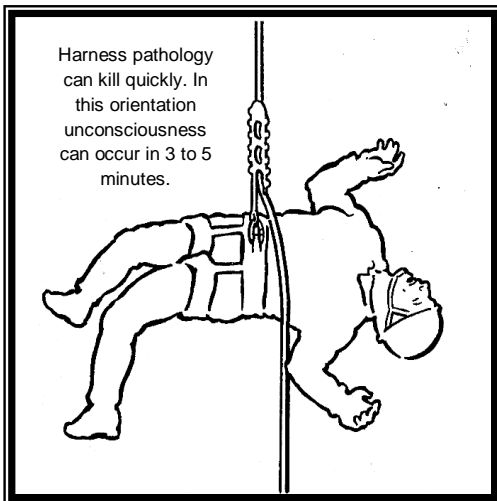

If blood flow is significantly restricted to the extremities then toxins can build up and the removal of the harness will then allow those toxins to slam into the heart potentially causing cardiac arrest. This has been known to happen after only 10 minutes. If someone becomes limp in the harness then the first step is to get them down as quickly as possible.

Rescue techniques are complex and not something that can properly covered in only a

few pages. Familiarizing oneself with basic rescue techniques is something that all serious climbers will do. A few resources to check out are the cmc website at [www.cmcrescue.com](http://www.cmcrescue.com). They are a company that manufactures rescue gear as well as publishing books on the subject and offering classes. Upon completion of the classes you get a handy certificate that is recognized by all search and rescue organizations. Another good book to check out is "Climbing Self-Rescue: Improvising Solutions for Serious Situations" by Andy Tyson and Molly Loomis.

You may be put into a situation where someone needs help and you'll have to use your own best judgment in getting the person to the ground. One thing to remember is **NEVER BELAY OFF YOUR OWN HARNESS!** The first rule in belaying someone or something else is that your belay point (the anchor the belay device is attached to) must be fixed. If you belay someone off your own harness and for what ever reason the system becomes shock loaded you will be pulled off your feet and will most likely lose control of the belay. Worse case scenario you could be pulled off a cliff or out of a tree.



## ROPE CARE AND STORAGE

First off, NEVER STEP ON YOUR ROPE. A very important thing to keep in consideration when rigging. By stepping on the rope you are working in all kinds of dirt, sand and other debris that will then go to work sawing the fibers of your rope. A long standing tradition is that if you catch someone standing on your rope then they owe you a root beer! When setting lines in trees it is important to keep an eye on the amount of rope

that is left on the ground. It is much safer in the long run if you make it a standard practice to tie anchors with the excess in the tree instead of it hanging out on the ground, waiting to get stepped on. If there is extra hanging you can coil it up so the excess hangs instead of lying on the ground. On this same note it is also a good idea to occasionally wash your rope. Use a very mild soap like Doctor Broners and run your rope thru the delicate cycle on a barrel washing machine (you should avoid using a washing machine with the central agitator). Don't use heavy detergents or bleach and don't run your rope thru a dryer. Let it line dry preferably not in direct sunlight. Never put a rope away if it is wet. Mildew could form on it and effectively destroy the rope. **Mildew = Rope Destruction.** Keep this in mind if doing rigging in the rain and while putting gear away after an action.

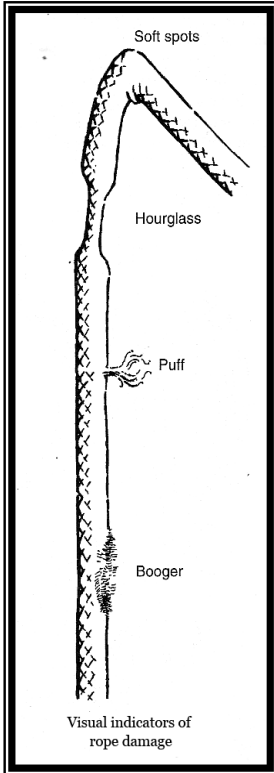

A few signs of a compromised rope are soft spots, an hourglass shape, puffs, and boogers (a little fraying is to be expected but if you can see the core then the rope is done). Knots compress ropes when under tension. If a double fisherman's, figure eight, etc. has been under tension be aware that the rope may be significantly weakened at the spot where the knot was tied. Some folks cut their rope just past old anchor knots to be safe. It should go with out saying

A few signs of a compromised rope are

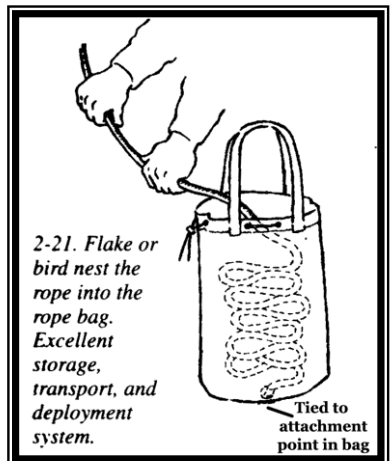

that you want to keep your rope as far away from acids as possible. Nowhere near that car battery you power the radios with or the store of AA's for headlamps.

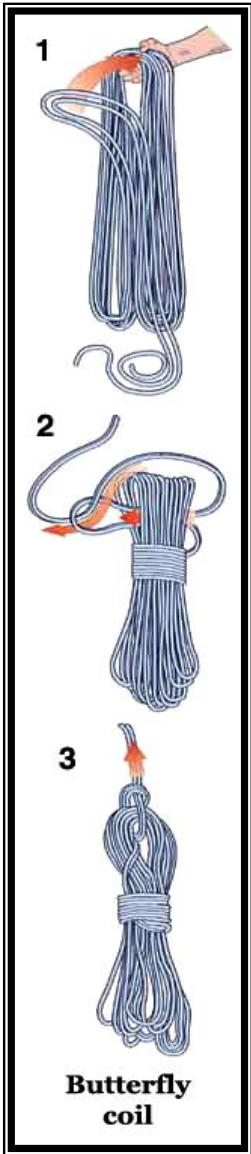

Use a rope log to keep track of how old ropes are and what kind of action they have seen. Most new ropes come with a little pamphlet that includes a rope log and it is always a good idea to mark your personal ropes with tape at the end so they don't get lost in the mess of communal gear.

Rope storage is very important. If you try to coil a rope by just wrapping it around your arm you can put a lot of twist into the rope which can cause it to become a big knotted mess when you try to uncoil it. The best way to store and travel with rope is to stuff it into a rope bag. The rope bag can be any type of bag from a fabric grocery store bag to a nice hiking pack. The rope bag should have an attachment point for the rope inside it so when the rope is being pulled out the end won't get away from you. This method works great for climb lines all the way to small diameter throw lines. If you don't have a bag then you can either

butterfly coil the rope or chain it. Try both methods out and see which one you like best.

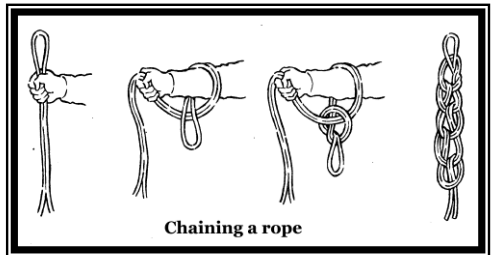

### **KNOTS**

Ya gots to know knots... Lots and lots of knots. At the end of this booklet you will find a couple of pages of knots that are especially important. If you want to really know your knots you are going to need to get a knot book. There are tons out there but one I really like is "The Book of Knots" by Geoffrey Budworth & Jason Dalton. Also pick up the Earth First Climber's Guild Knot Compendium.

A knot must be dressed properly before you can consider it reliable. An improperly dressed knot can degrade knot strength by up to 50%. Also if a knot is loaded improperly then it can also dramatically reduce knot strength. The most abused knot in forest defense is the butterfly. The butterfly is a fun knot to know but its practical uses in the context of forest defense are limited. It is the best knot to use when dealing with a 3-Way pull but it is often used in a situation where the pulling force is 2-Way. In these instances the proper knot to use is an inline eight. Know your knots and know what knot to use where.

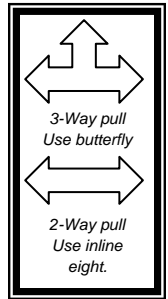

<b>a few common knots and the percentage of rope strength degradation. (results will differ with different rope types)</b>			
Figure 8 follow through	19% lost	Water knot (webbing)	36% lost
Figure 8 on a bight	20% lost	Figure 8 loop (Webbing)	30% lost
Double Figure 8 loop	18% lost	<b>rope with a loop in it. (pulled end to end)</b>	
Inline Figure 8	25% lost		
Butterfly	25% lost	Figure 8 loop	35% lost
Bowline	33% lost	Inline Figure 8 loop	41% lost
Double Fisherman	21% lost	Butterfly loop	31% lost

### **FRICION**

*(Your best friend and your worst enemy)*

What keeps your prussic from sliding down the line? Friction. But, what can cause major rope wear and potentially deadly situations? Friction. We rely on friction to climb ropes when using knots like prusiks and klemheists. These knots only work when they are a certain percentage smaller (about 30%) then the rope that they are attached to. **You want to use a rope at least 4mm smaller for your prusiks then the rope that you are climbing.** Meaning, If your climb line is 1/2" (12.7mm) then you should not use rope larger then 8.5mm to tie your prusiks with. While this is the largest size you should use it is not to say that this is the size of rope that you would want to use. The most common sizes to use when prusiking are 5mm, 6mm, and 7mm. What you use is purely a question of personal preference. I like to use 6mm rope because I find that 5mm can have a tendency to synch down so hard it is difficult to loosen and that 7mm is more likely to slip slightlv once weightd.



Now for the bad. The best way I have found to demonstrate just how destructive friction can be to rope is by doing what I call the 10 second demo. Go and get 2 lengths of old rope that you don't mind destroying. The lengths should be about a meter long each, and the type of rope doesn't really matter because the point will get across no matter what you are using. Have one person hold both ends of one of the lengths. Loop

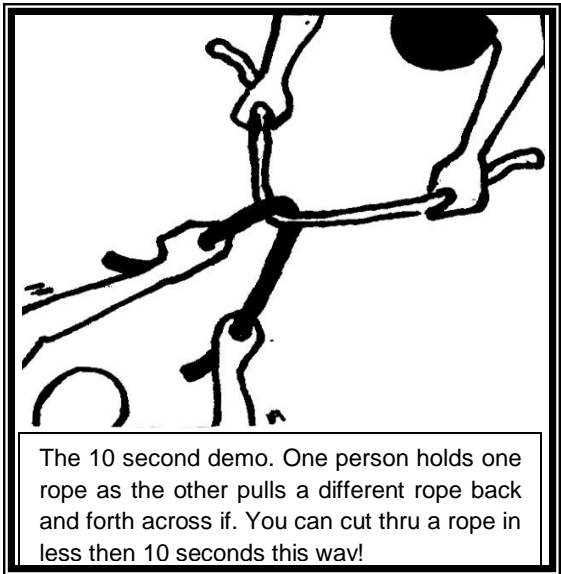

the other rope through and hold one end in each hand. Tell your fellow demonstrator to brace them self and begin to saw the section of rope they are holding with your section. If you are aggressive enough with your sawing you should be able to cut thru the other rope in about 10 seconds! Different times for different ropes but you get the idea. Rope on rope friction like this should be avoided at all costs. This is especially important for all anchors and rigging. Any time a rope crosses another rope there should be some sort of protection. A collection of old garden hose is good to have around to use as a sheath over rope at any points where it comes into contact with a possible friction source (another rope, a branch, an edge of a platform or a hole thru a platform, etc). You can also use tubular webbing for a little extra protection for rope if hose is not readily available.

A large collection of screw links is just about essential when doing any rigging. In my with about a dozen them in just about rope on rope friction. stockpile of climb cases steel links that hardware store will Friction is also ropes are impacting



rigging bag I carry a pouch good sized screw links. I use every anchor to eliminate You should try to get a rated steel links but in most you would get at any suffice.

A consideration in how your the tree you are climbing. Avoid pulling loads up by just running a rope over a branch. In a pinch use a



carabineer preferably a large diameter pulley. If the tree is softwood you can easily cut through the bark and into the cambium layer (the layer under the bark that the tree uses to pass along nutrients). If the cambium is badly damaged you can kill the section of tree beyond the cut. Some arborist climbing methods involve running a rope over a branch and getting up the tree by pulling down on one end of the rope. These methods generate a massive amount of friction on the branch and while many trees can handle this fiction without a problem (hardwood deciduous trees) many trees would be heavily damaged (softwood coniferous trees). Be attentive to the amount of wear you are causing on a tree. It would be a tragic irony if in the process of trying to save a tree we end up killing it thru our own actions.

### ANCHORS



There are many ways to tie anchors but they are almost all based on a few basic principles. When dealing with trees you really need to have a basic understanding of the strengths and weaknesses of the species you are with witch you are dealing. Softwood conifers are usually much faster growing then hardwood deciduous trees and therefore you might want to be a bit more careful with your anchors if branches are involved. Generally as a rule you should not use a branch as a main line anchor point. Use the trunk of the tree, it is guaranteed to be stronger then any branch growing from it. I've stepped on braches in

trees that I was sure would hold my weight only to have them break under my foot while much skinnier braches have held. I won't even consider using a branch in any rigging capacity unless it is as thick as my leg with no signs of rot and lots of green healthy growth. Even then it is always preferable to anchor lines directly to the trunk of the tree. The specifics of platform setting for tree sits and blockades are gone over in later Climber Guild volumes but for now we will cover the basics. To start off, Girth Hitching (or "choking") is not an acceptable practice for anchoring climb lines. There are instances where hanging from a choked line is necessary (Girth Hitching up

a tree or flag pole) but a choked rope should never make an appearance as part of a mainline anchor. The most basic anchor and the most useful is called a “Tensionless Anchor” or “High Strength Tie-Off” depending on who you ask. “High Strength Tie-Off” is the preferred term, being that the title “Tensionless Anchor” can be somewhat misleading. To anchor using a HSTO you simply loop the rope around the tree a minimum of 2 times (3 to 5 times if the tree is a smaller diameter.) and tie the rope off to itself using a carabineer to prevent any unwanted rope on rope friction. Taking into consideration that the weakest point in any rigging system is the knots or tight bends a rope may go through. The HSTO creates no deviation in the mainline and the entire force of the load is passed into the wraps and our old friend friction holds the weight leaving little of the load for the knot.

Because of the friction and constriction of the line it is only polite to protect the tree with a piece of canvas, and this piece of canvas will also protect your rope from things like tree sap. A protective sheath is not a crucial element of the anchor so if you don't have one then don't worry about it to much.

HSTOs are useful for everything from a main climb line on a tree to anchoring the ends of a tree to tree traverse (covered in a later volume). The HSTO will hold perfectly well if tied on a main trunk of a tree with no branches. If tied in this manner then the rope sag will place a greater amount of force on the connection point but as long as you are using a carabineer or steel link you will be fine. The only other thing to remember is wrap the rope up if the force is pulling down and wrap down if the force is pulling up (note the direction the rope is wrapped in the illustration for a downward pulling force).

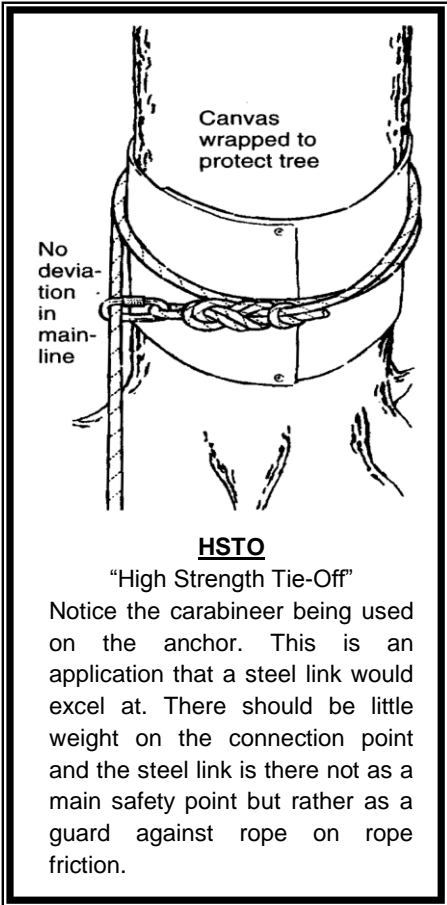

Notice the carabineer being used on the anchor. This is an application that a steel link would excel at. There should be little weight on the connection point and the steel link is there not as a main safety point but rather as a guard against rope on rope friction.

Another anchor that is a must know is the “Wrap 3 pull 2”. You would use this anchor anytime you are clipping a line to the anchor (as in tree platform rigging) as opposed to tying the anchor with the line itself (as in a HSTO). Webbing is the preferred material for a Wrap 3 pull 2 but climb line can be used. Polypropylene rope (truck rope) is never acceptable as the main anchor for any structure. The ‘wrap’ is just how many times the webbing goes around the anchor point and the ‘pull’ is how many of those wraps you are pulling with a load. You can do a wrap 4 pull 2 or wrap 5 pull 2 but after that the amount of wraps becomes redundant.

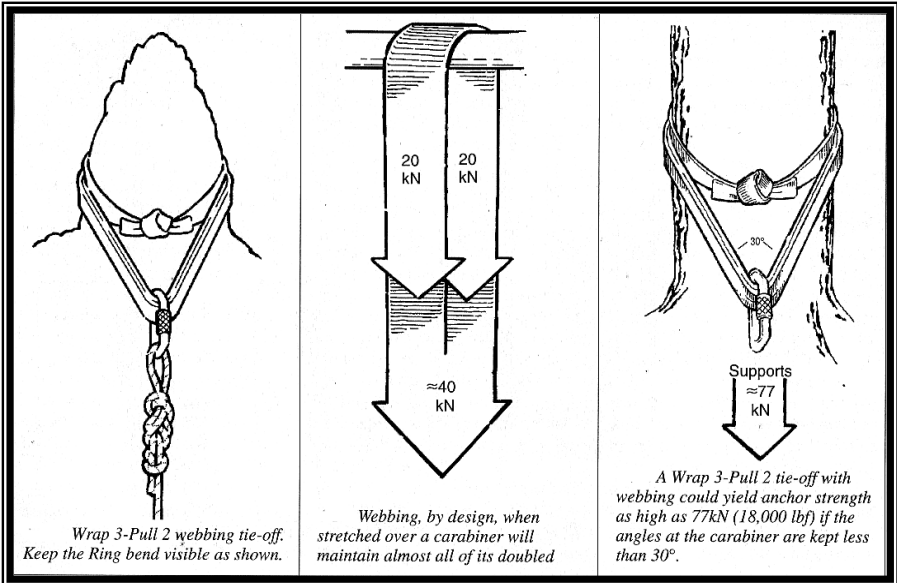

### DIRECTIONAL FORCES

To be a competent rigger you must understand load percentages and multipliers. One of the most direct applications of multiple anchor rigging in the forest defence context is tree to tree traverses. When rigging a traverse you do not want it to be super tight. One big factor is tree sway. If two multi ton trees are tied together tightly by a rope then every time the wind blows and those two trees sway in slightly different directions the rope is getting shock loaded by a tremendous force. Also, you do not want to have a rope traverse pulled too tightly because as you see in the table, as the angle of the rope when loaded approaches 180 degrees the the load on either anchor will increase dramatically. If a 200 pound person were to cross a traverse pulled to an extreme angle of 170 degrees that person would be putting 230,000 pounds of pressure on each anchor! While you will never be

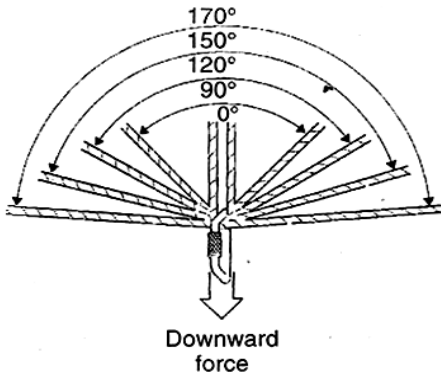

**Tension in Multiple Anchor Rigging**  
Table 4-1

Angle	Resulting Leg Tension*
170°	1150%
150°	200%
120°	100%
90°	70%
0°	50%

\*on each leg relative to downward force

*The force on a rope or cable approaches infinity the closer the angle gets to 180°. Due to the elasticity in rope this event will never happen.*

able to make a rope that tight without some serious mechanical help a good rule to follow is the 120 rule. Simply stated **you want all your multiple anchor rigging (traverses) to have an angle of no more than 120 degrees when weighted.** Our 200 pound climber will put 100% of their weight (200 pounds) on each anchor if the traverse angle is 120 degrees. However the same climber will put 400 pounds on each anchor of a 150 degree traverse. A saggy traverse is harder to cross but a overly tight traverse can become extremely hazardous over time. Never use truckers hitches or mechanical devices to tighten traverses that are going to be left up for any amount of time and always use high strength tie-offs.

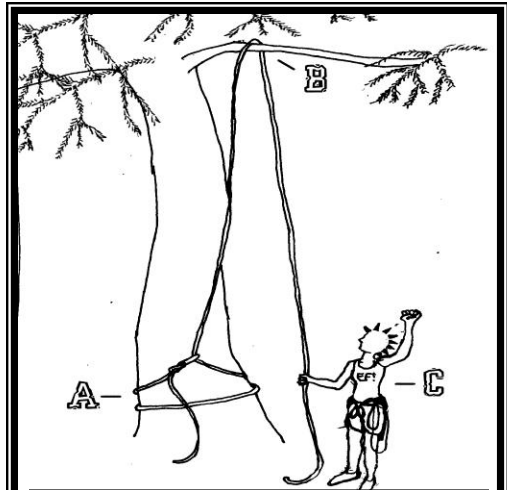

The rope is anchored to the base of the tree (A) then goes over the branch (B) then dangles to the ground. Our 200 lbs climber (C) will exert 200 lbs force on the anchor at the base of the tree, but 400 lbs on the branch

A similar principle is employed when talking about



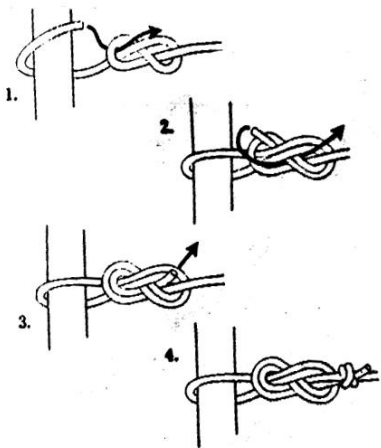
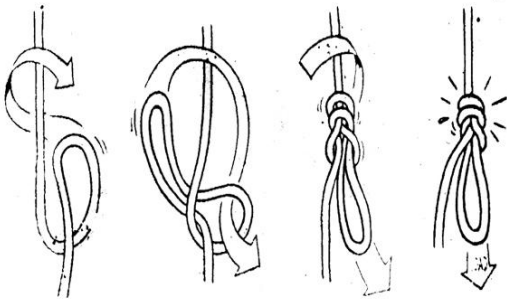

Figure 8 follow through



In-Line Figure 8

# KNOTS

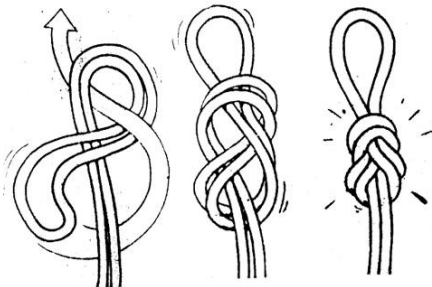
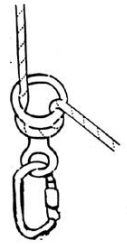

Figure 8 on a bight



Girth Hitch on a Carabineer



Properly faced Eight.

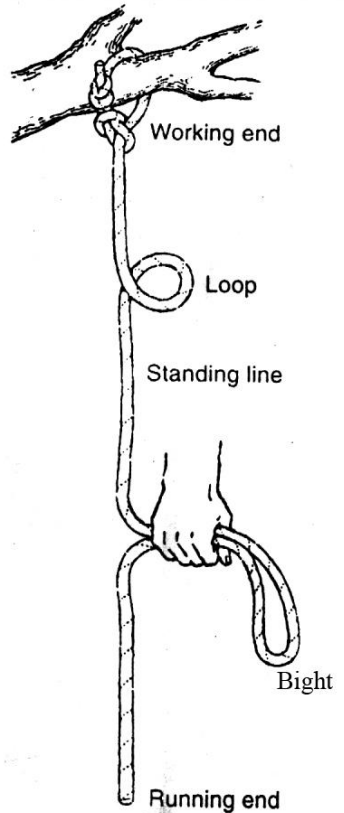

Parts of the rope.

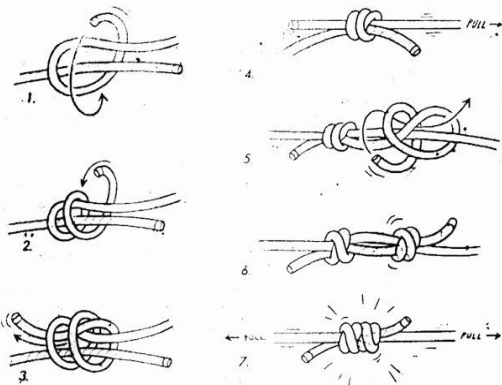

Double Fisherman

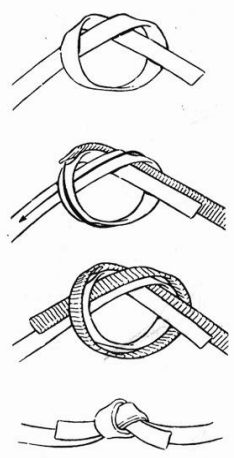

Water Knot (Ring Bend)

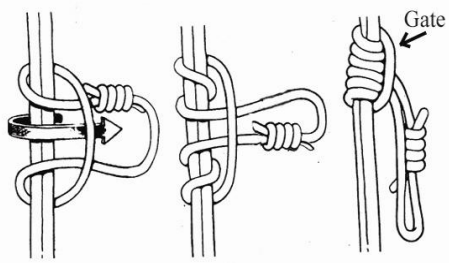

Prusik



A  
N  
C  
H  
O  
R  
S

Girth Hitching will down grade rope strength by 1/3 to 1/4.

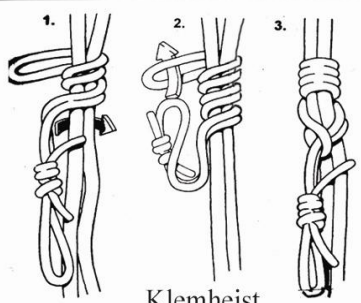

Klemheist

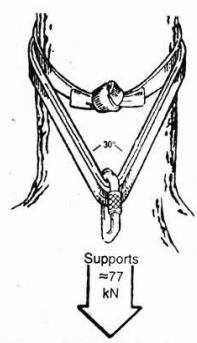

a Wrap 3-Pull 2 tie-off could yield anchor strength as high as 77kn (18,000 LPN) if the angles are kept less then 30

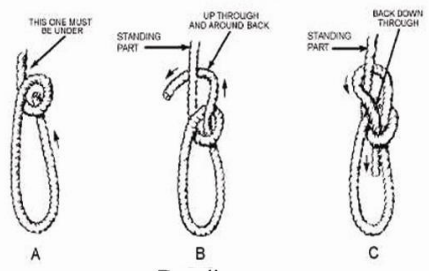

Bowline





# Who we are and Why this exists.

We are a group of climb trainers representing multiple bioregions that have come together in order to put forth a series of in-depth orientation packets detailing the safest way possible to climb and rig rope structures in the forest. We are out there putting our lives on the line in order to defend what we believe in. It is of the utmost importance that we stay safe while doing this. It is our hope that in putting these packets out a more universal safety protocol will develop. Knowledge of safe climbing methods isn't something that should only be held by a small minority of "trainers". This is the second packet in the series and it is open to amendments and changes. Please copy this and distribute it widely. If you have comments or questions or would like an electronic copy of this packet you can get ahold of us Via E-mail at:

**EFclimbers.net**  
**EFclimbers@gmail.com**

# STAY SAFE

THIS IS VOL 2, FIRST EDITION. NOV 2007

