Lumberyard
Developer Guide
Version 1.6



Lumberyard: Developer Guide

Copyright ©

Table of Contents

Lumberyard for Programmers	1
AI	4
AI System Concepts	4
AI System Overview	5
Pathfinding Costs	8
Sensory Models	11
Flight	16
AI C++ Class Hierarchy	16
AI System Concept Examples	17
AI Bubbles System	19
Message Display Types	19
Specifying Notification Display Types	19
AI Tactical Point System	21
Tactical Point System Overview	21
TPS Query Execution Flow	22
TPS Querying with C++	23
TPS Querying with Lua	24
TPS Query Language Reference	26
Point Generation and Evaluation	28
Integration with the Modular Behavior Tree System	30
Future Plans and Possibilities	31
Navigation Q & A	32
Big Triangles and Small Links Between Them	32
Path Following	32
Auto-Disabling	32
Path Following	33
Goalop "Followpath"	33
COPTrace::ExecuteTrace and COPTrace::Execute	33
COPTrace::Execute2D	34
Movement System	34
Using the Movement System	34
Potential Improvements	35
Auto-Disable	35
Global auto-disable	36
Per-AI auto-disable	36
AI Scripting	36
Communication System	36
Factions	42
Modular Behavior Tree	43
Repoints	85
Signals	86
Animation	97
Animation Overview	97
Linear Animations	97
Interactive Animations	98
Scripted Animations	99
Animation Events	100
Marking Up Animations with Events	100
Receiving Animation Events in the Game Code	100
Limb IK Technical	100
Setting Up	100
Using LimbIK from Code	100
Animation Streaming	101
Animation Data	101
Animation Header Data	101

Animation Controller Data	101
Animation Debugging	103
Layered Transition Queue Debugging	104
CommandBuffer Debugging	107
Warning Level	108
Fall and Play	108
Time in the Animation System	109
Segmentation	110
Playback Speed	111
Segmented Parametric Animation	111
Animation with Only One Key	111
Direction of Time	112
Time within Controllers	112
Asset Builder API	113
Builder Modules	113
Creating a Builder Module	113
Main Entry Point	114
Lifecycle Component	115
Creating a Builder	116
Message Logging	119
Asset Importer (Preview) Technical Overview	120
Architecture and Concepts	120
Other Components	122
Core Libraries	122
FBX Importer Example Workflow	122
Possible Asset Importer Customizations	123
AZ Modules (Preview)	124
Comparing AZ Modules to Legacy Modules	124
A Self-Aware Method of Initialization	125
Relationship with the AZ Framework	126
Smarter Singletons	126
Current Lumberyard AZ Modules	126
LmbrCentral	126
LmbrCentralEditor	126
Parts of an AZ Module, Explained	127
The Module Class	127
The EBus	128
The System Component Class	129
Calling the Module from External Code	132
System Components	132
Smart Initialization Order	132
Easily Configurable Components	133
Writing System Components	133
Required System Components	134
Gems and AZ Modules	134
Structure of a Gem	134
Waf Integration	135
Gems Built as AZ Modules	135
Creating an AZ Module That Is Not a Gem	135
A. Start with a Gem	135
B. Modify the AZ Module Declaration	136
C. Remove CryEngine References (Optional)	136
D. Modify the Wscript and Waf Spec Files	137
E. Configure Your Project to Load the New Module	138
F. Add the Module's Public Interfaces to Your Project's Include Paths	138
Configuring System Entities	139
Application Descriptor Files	142
The AZ Bootstrapping Process	143

AZ Code Generator	143
Workflow Summary	144
WAF	145
Clang	145
Intermediate JSON Data	145
AZ Code Generator and Python	146
Template Drivers and Template Rendering	146
Generated Files	147
AZ Code Generator Integration with Waf	148
AZ Code Generator Parameters	151
Code Generation Templates	154
Template Drivers	157
Custom Code Generator Annotations	161
Waf Debugging with AZ Code Generator	165
Template Driver Debugging	171
Debugging the AZ Code Generator Utility	172
Intermediate JSON Data Format	173
Callback References	176
Entity System Script Callbacks	176
Default State Functions	176
Script State Functions	176
Game Rules Script Callbacks	178
Cloud Canvas	180
Features	180
Example Uses	180
Tools	181
Knowledge Prerequisites	181
Pricing	182
Cloud Canvas Core Concepts	182
Prerequisites	182
AWS, Cloud Canvas, and Lumberyard	183
Amazon Web Services Supported by Cloud Canvas	183
Cloud Canvas Resource Management	185
Cloud Canvas Resource Manager Overview	186
The Role of AWS CloudFormation	187
Tutorial: Getting Started with Cloud Canvas	188
Prerequisites	189
Step 1: Sign up for AWS	189
Step 2: Create an AWS Identity and Access Management (IAM) User for Administering the Cloud Canvas Project	189
Step 3: Sign in as Your IAM User	191
Step 4: Enabling the Cloud Canvas Gem (extension) Package	191
Step 5: Add Administrator Credentials to Lumberyard	192
Step 6: Initializing Cloud Canvas from the Command Line	193
Step 7: Locating and Adding Resource Groups	194
Step 8: Creating Deployments	195
Step 9: Inspecting Your Resources in AWS	196
Step 10: Using IAM to Administer a Cloud Canvas Team	197
Step 11: Remove Cloud Canvas Functionality and AWS Resources	198
<i>Don't Die</i> Sample Project	198
Setup	199
Viewing Lambda Code in Visual Studio	202
Deleting the AWS Project Stack	203
AWS Services Used	204
Using Cloud Canvas	204
Cloud Canvas Tools in Lumberyard Editor	205
Editing Cloud Canvas Files	206
Initializing Cloud Canvas Resource Manager	207

Managing Cloud Canvas Profiles	208
Understanding Resource Status Descriptions	209
Using the Cloud Canvas Command Line	209
Viewing the Cloud Canvas Progress Log	224
Working with Deployments	225
Working with JSON Files	233
Working with Project Stacks	234
Working with Resource Groups	235
Cloud Canvas Flow Graph Node Reference	245
Cloud Canvas Configuration Nodes	245
Cognito (Player Identity) Nodes	248
DynamoDB (Database) Nodes	250
Lambda (Cloud Functions) Node	256
S3 (Storage) Nodes	257
SNS (Notification Service) Nodes	259
SQS (Message Queuing Service) Nodes	262
Static Data (PROTOTYPE) Nodes	263
Resource Definitions	267
Resource Definition Location	267
project-settings.json	268
user-settings.json	270
project-template.json	271
deployment-template.json	276
deployment-access-template.json	278
The project-code Subdirectory	285
resource-group\{ <i>resource-group</i> } subdirectories	285
resource-template.json	285
The lambda-function-code Subdirectory	289
Resource Deployments	289
Configuration Bucket	290
Resource Mappings	291
Using Mappings in AWS Flow Nodes	291
Using Mappings with the AWS C++ SDK	292
Using Mappings in Lambda Functions	292
Custom Resources	293
CognitoidentityPool	293
EmptyDeployment	294
ResourceGroupConfiguration	294
LambdaConfiguration	295
PlayerAccess	296
Access Control and Player Identity	297
Project Access Control	297
Player Access Control	298
Lambda Function Access Control	298
Player Identity	300
AWS Client Configuration	305
Configuring AWS Flow Graph Nodes	305
Configuring Using C++	305
Using Configured Clients from C++	306
Component Entity System	308
Creating a Component	308
Component Example	308
Component Elements	309
Reflecting a Component for Serialization and Editing	310
Serialization	313
Editing	313
Attributes	314
Change Notification Callbacks	315

Slices and Dynamic Slices	316
Anatomy of a Slice	317
Working with Dynamic Slices	317
Instantiating Dynamic Slices	318
Controller Devices and Game Input	320
Action Maps	320
Initializing the Action Map Manager	320
Action Map Manager Events	320
Receiving Actions During Runtime	321
CryInput	321
IInput	321
IInputEventListener	321
SInputEvent	322
IInputDevice	322
Setting Up Controls and Action Maps	323
Action Maps	323
Action Filters	325
Controller Layouts	325
Working with Action Maps During Runtime	325
Default Controller Mapping	326
Key Naming Conventions	327
CryCommon	329
CryExtension	329
Composites	330
Shared and raw interface pointers	330
GUIDs	330
ICryUnknown	331
ICryFactory	332
ICryFactoryRegistry	333
Additional Extensions	333
Glue Code Macros	335
CryExtension Samples	340
Using Extensions	341
Implementing Extensions Using the Framework	343
CryString	353
How to Use Strings as Key Values for STL Containers	353
Further Usage Tips	354
ICrySizer	354
How to use the ICrySizer interface	354
Serialization Library	354
Tutorial	355
Use Cases	358
Demo and Video Capture	367
Capturing Video and Audio	367
Preparation	367
Video Settings	367
Starting and Ending the Video Recording	369
Audio Settings	369
Configuration Files	370
Recording Time Demos	371
Overview	371
Recording Controls	371
Related Console Variables	372
Entity System	373
Entity Property Prefixes	373
Creating a New Entity Class	374
Entity Pool System	376
Editor Usage	377

Static versus Dynamic Entities	377
Entity Pool Definitions	377
Entity Pool Creation	379
Creating and Destroying Static Entities with Pools	380
Creating and Destroying Dynamic Entities with Pools	382
Serialization	383
Listener/Event Registration	384
Debugging Utilities	385
Entity ID Explained	385
Adding Usable Support on an Entity	386
Overview	386
Preparing the Script	386
Implementing IsUsable	386
Implementing OnUsed	387
Entity Scripting	387
Structure of a Script Entity	387
Using Entity State	390
Using Entity Slots	392
Linking Entities	393
Exposing an Entity to the Network	394
Event Bus (EBus)	397
Bus Configurations	397
Single Handler	397
Many Handlers	398
EBus with Addresses and a Single Handler	399
EBus with Addresses and Many Handlers	401
Synchronous vs. Asynchronous	402
Additional Features	403
Usage and Examples	403
Declaring an EBus	403
EBus Configuration Options	404
Implementing a Handler	405
Sending Messages to an EBus	406
Retrieving Return Values	406
Return Values from Multiple Handlers	407
Asynchronous/Queued Buses	407
File Access	408
CryPak File Archives	408
Features	408
Unicode and Absolute Path Handling	408
Layering	408
Slashes	409
Special Folder Handling	409
Internals	409
Creating a pak file using 7-Zip	409
Dealing with Large Pak Files	409
Accessing Files with CryPak	410
Tracking File Access	416
CVars	416
Where invalid access is defined	417
Graphics and Rendering	418
Render Nodes	418
Creating a New Render Node	418
TrueType Font Rendering	422
Supported Features	422
Useful Console Commands	423
Generating Stars DAT File	423
File Format	423

Anti-Aliasing and Supersampling	424
Controlling Anti-Aliasing	424
Controlling Supersampling	426
Lua Scripting	427
Lua Scripting Reference	427
Common Lua Globals and Functions	427
EntityUtils Lua Functions	431
Math Lua Globals and Functions	434
Physics Lua Functions	444
VR Lua Functions	445
Integrating Lua and C++	448
Accessing Script Tables	448
Exposing C++ Functions and Values	448
Lua Script Usage	449
Running Scripts	449
Reloading Scripts During Runtime	450
Lua Editor	450
Tutorial: Using Lua Editor for Debugging with Lumberyard Editor	450
Maintaining Separate Search Results	453
Editing	454
Perforce Integration	455
Using the Lua Remote Debugger	456
Performing Tasks in the Lua Remote Debugger	456
Using the Lua XML Loader	457
XML Data	457
Loading and Saving a Table from Lua	459
Data Types	459
Enums	459
Example	460
Recommended Reading	460
Networking System	461
Getting Started with Multiplayer	461
Setting up a Multiplayer Server	461
Hosting a Level	462
Connecting to the Server	462
Console Command Summary	462
Sample Project	463
Session Service	464
Starting and Stopping the Session Service	464
Hosting a Session	464
Searching for Sessions	466
Joining a Session	466
Reacting to Session Events	469
Cloud Hosting with GameLift	470
Carrier	470
Channels and Message Priorities	470
Customizable Classes	470
CarrierDesc	471
Synchronizing Game State Using Replicas	473
Replicas	473
Replica Chunks	476
Data Sets	479
Remote Procedure Calls (RPCs)	480
Replica Manager	482
Marshaling and Unmarshaling	483
Binding Game Objects to the Network Using Components	484
Using OpenSSL	489
Limitations	489

Implementation Support	489
Cipher	490
Building with Encryption	490
Enabling Encryption	491
Controlling Bandwidth Usage	493
Controlling the Send Rate	493
Bandwidth Limiter	494
Controlling Burst Length	494
Prioritization of Replica Updates	494
Tuning Bandwidth at Runtime	495
Network Serialization and Aspects	495
Aspects	496
Profiles	496
RMI Functions	496
Ordering RMI Functions	497
Ordering Rules	497
RMI Function Flags	497
Examples	498
Physics	499
Geometries	499
Geometry Management Functions	499
Physical Entities	500
Creating and managing entities	501
Functions for Entity Structures	503
Common Functions	504
Living Entity-Specific Functions	506
Particle Entity-Specific Functions	507
Articulated Entity-Specific Functions	508
Rope Entity-Specific Functions	510
Soft Entity-Specific Functions	510
Collision Classes	511
Setup	511
Code	512
Types	512
Filtering the collision	513
Interface	513
Functions for World Entities	513
Advancing the Physical World Time State	513
Returning Entities with Overlapping Bounding Boxes	514
Casting Rays in an Environment	515
Creating Explosions	516
Profiler	517
Profiler Tutorial	517
Registering Your Application	518
Launching Profiler	518
Capturing Data	518
Inspecting Data	520
Playing Back Data	522
Exporting Data	527
Creating and Using Annotations	527
Using Annotations	528
Creating Annotations	529
Viewing Annotations in Trace Messages Profiler	530
Using Profiler for Networking	531
Prerequisites	531
Carrier Profiler	531
Replica Activity Profiler	532
Using the Profiler for CPU Usage	539

Understanding the Tree View	540
Controlling the Display	540
Using Profiler for VRAM	542
Notes	542
Understanding the Captured Data	543
Inspecting the Data	543
Using GridHub	545
Registering an Application in GridHub	545
Viewing and Configuring GridHub	545
Troubleshooting GridHub	547
ScriptBind Reference	548
ScriptBind Engine Functions	548
ScriptBind_AI	548
ScriptBind_Entity	617
ScriptBind_Movie	672
ScriptBind_Particle	673
ScriptBind_Physics	676
ScriptBind_Script	679
ScriptBind_Sound	682
ScriptBind_System	683
ScriptBind Action Functions	710
ScriptBind_Action	710
ScriptBind_ActionMapManager	724
ScriptBind_ActorSystem	726
ScriptBind_GameStatistics	727
ScriptBind_GameToken	729
ScriptBind_Inventory	730
ScriptBind_ItemSystem	732
ScriptBind_Network	735
ScriptBind_UIAction	735
ScriptBind_Vehicle	747
ScriptBind_VehicleSeat	754
ScriptBind_VehicleSystem	755
ScriptBind_Boids	756
CanPickup	756
CreateBugsFlock	757
CreateFishFlock	757
CreateFlock	757
EnableFlock	758
GetUsableMessage	758
OnBoidHit	758
OnPickup	759
SetAttractionPoint	759
SetFlockParams	759
SetFlockPercentEnabled	760
System	761
Memory Handling	761
Hardware Memory Limitations	761
Choosing a Platform to Target	761
Budgets	762
Allocation Strategy with Multiple Modules and Threads	762
Caching Computational Data	762
Compression	762
Disk Size	762
Total Size	762
Address Space	763
Bandwidth	763
Latency	763

Alignment	763
Virtual Memory	764
Streaming	764
Streaming System	764
Low-level Streaming System	764
Streaming and Levelcache Pak Files	770
Single Thread IO Access and Invalid File Access	772
High Level Streaming Engine Usage	772
Text Localization and Unicode Support	773
Terminology	774
What encoding to use?	775
How does this affect me when writing code?	776
How does this affect me when dealing with text assets?	777
Utilities provided in CryCommon	777
Further reading	778
CryLog	778
CryLog Logging Functionality	778
Verbosity Level and Coloring	778
Log Files	779
Console Variables	779
CryConsole	780
Color coding	780
Dumping all console commands and variables	780
Console Variables	780
Adding New Console Commands	781
Console Variable Groups	781
Deferred execution of command line console commands	783
CVar Tutorial	784
Lumberyard Blog, Forums, and Feedback	786

Lumberyard for Programmers

The Lumberyard Developer Guide is intended for programmers or anyone working directly with the Lumberyard code.

This guide includes the following sections:

- [AI \(p. 4\)](#)

Describes a variety of AI features that process navigation and individual and group behaviors, and describes convenient tools such as a Visual AI debugger, behavior tree visual editor, and a visual flow graph editor.

- [Animation \(p. 97\)](#)

Contains tools to create both linear (video) and interactive animation. Interactive animation conveys AI and avatar (player) behavior, with sequences dependent on player choices in gameplay.

- [Asset Builder API \(p. 113\)](#)

Use the asset builder API to develop a custom asset builder that can process any number of asset types, generate outputs, and return the results to the asset processor for further processing. A custom builder can be especially useful in a large project that has custom asset types.

- [Asset Importer \(p. 120\)](#)

A new FBX Importer enables you to bring single static FBX meshes and single materials into Lumberyard, and provides an abstraction layer that you can extend to accept other input formats.

- [AZ Modules \(Preview\) \(p. 124\)](#)

AZ modules are new, Amazon-created code libraries that plug into Lumberyard games and tools. These AZ modules implement specific initialization functions. When a Lumberyard application starts, it loads each AZ module and calls the corresponding initialization functions.

- [Callback References \(p. 176\)](#)

Describes the callbacks for the [Entity System \(p. 373\)](#) and for GameRules scripts.

- [Cloud Canvas \(p. 180\)](#)

Cloud Canvas is Lumberyard's technology for connecting your game to Amazon Web Services. With Cloud Canvas, you can use AWS to implement cloud-hosted features and create asynchronous

multiplayer games. Using AWS means you no longer have to acquire, configure, or operate host servers to implement connected gameplay.

- **[Component Entity System \(p. 308\)](#)**

The component entity system is a new Amazon-created way of creating components that is superior to (and that will eventually replace) the legacy [Entity System \(p. 373\)](#).

- **[Controller Devices and Game Input \(p. 320\)](#)**

Describes Lumberyard's support for input devices such as keyboards, mice, and joysticks, and shows how to set up controls and action maps.

- **[CryCommon \(p. 329\)](#)**

Describes game engine interfaces, including CryExtension, which you can use to refactor Lumberyard features into extensions for ease of use; CryString, which is a custom reference-counted string class; and a serialization library, which separates user serialization code from actual storage format and makes it easy to change formats.

- **[Demo and Video Capture \(p. 367\)](#)**

Describes how to use Lumberyard Editor or the Lumberyard standalone Launcher to record benchmarking videos and capture audio.

- **[Entity System \(p. 373\)](#)**

Describes the creation and management of entities, which are objects placed inside a level that players can interact with. This section contains topics such as creating a new entity class, entity pools, and entity scripting.

- **[Event Bus \(EBus\) \(p. 397\)](#)**

Event buses are Lumberyard's general purpose system for dispatching messages. EBus minimize hard dependencies between systems, are event-driven (which eliminates polling), handle concurrency well, and enable predictability by providing support for the ordering of handlers on a given bus.

- **[File Access \(p. 408\)](#)**

Describes how to compress game content files and how to track invalid file reads that can potentially stall the performance of a game.

- **[Graphics and Rendering \(p. 418\)](#)**

Lumberyard's shading core uses the same physical parameters that are used in high end film rendering pipelines. This section covers render nodes, true type font rendering, and the star data used in sky rendering. It also describes how to control anti-aliasing so that you can produce graphics from very sharp images to softer blurred images.

- **[Lua Scripting \(p. 427\)](#)**

Lua is Lumberyard's scripting language. This section contains a Lua scripting reference and provides topics on Lua script usage, Lua and C++ integration, the Lua remote debugger, and the Lua XML Loader.

- **[Networking System \(p. 461\)](#)**

Describes GridMate, Lumberyard's networking subsystem, and contains topics on multiplayer setup, the session service, controlling bandwidth usage, and synchronizing game state using the GridMate replica framework.

- **[Physics \(p. 499\)](#)**

Describes the Lumberyard physics system and how to interact with the physics engine. This section shows you how to create a physical world object, fill the world with geometries and physical entities, and control the entities with the functions described.

- **Profiler (p. 517)**

Profiler is a Lumberyard tool that can capture, save, and analyze network, CPU, and VRAM usage statistics. You can use the saved data to analyze network usage frame by frame, fix problems in the use of network bandwidth, and optimize the performance of your game.

- **System (p. 761)**

Contains topics on memory handling, streaming, localization, logging, and console tools.

AI

This section describes the AI system. It includes a general overview of key concepts, describes system components, and provides an AI scripting manual.

This section includes the following topics:

- [AI System Concepts \(p. 4\)](#)
- [AI Bubbles System \(p. 19\)](#)
- [AI Tactical Point System \(p. 21\)](#)
- [Navigation Q & A \(p. 32\)](#)
- [Path Following \(p. 33\)](#)
- [Movement System \(p. 34\)](#)
- [Auto-Disable \(p. 35\)](#)
- [AI Scripting \(p. 36\)](#)

AI System Concepts

Key features of the AI system include the following:

Navigation

- Navigation with little or no assistance from the designers
- Multi-layer navigation (flying, swimming, zero-gravity) or simple 2D navigation
- Smart objects for special navigation and interactions

Individual AI

- Easy-to-use static and dynamic covers (such as behind movable vehicles)
- Dynamic tactical points (such as cover points, ambush points, patrol waypoints)
- Behavior trees, to select behaviors based on values of Boolean variables
- Customizable perception (such as vision, sound, memory, sixth sense)

Group and Global AI

- Group behavior trees, to define group tactics

- Formations, to move AI characters in some orderly fashion
- Factions (such as friends, neutrals, enemies)
- Visual flow graphs of game logic, with macro-nodes for reused sub-flow graphs

MMO-ready

- Support for streaming big maps

User-friendly

- Visual AI debugger to log signals, behavior changes, goal changes, user comments
- Behavior tree visual editor
- Visual flow graph editor and debugger (with visual flow propagation and break points)

This section includes the following topics:

- [AI System Overview \(p. 5\)](#)
- [Pathfinding Costs \(p. 8\)](#)
- [Sensory Models \(p. 11\)](#)
- [Flight \(p. 16\)](#)
- [AI C++ Class Hierarchy \(p. 16\)](#)
- [AI System Concept Examples \(p. 17\)](#)

AI System Overview

This section outlines basic concepts related to the AI system.

Navigation

- Default navigation system
 - Triangulation
 - 2D terrain-based navigation
 - Uses cylindrical objects (such as trees) and forbidden areas
 - Navigation modifiers
 - Human waypoints – Need to be place manually but connections can be generated automatically
 - Flight – Information about navigable volumes for flying entities
 - Volume – General volume navigation, such as for oceans
- Multi-layer navigation system
- Smart object system: allows AI agents to move in special ways
- AI territories & waves
 - Control number of active AI agents (through flow graph logic)
 - Activate, deactivate, and spawn all AI agents assigned to a territory using a single FG node
 - AI waves can be attached to AI territories and allow independent AI activations
 - AI waves automatically handle entity pool issues for assigned AI agents, such as loading/unloading

In general, a search is time-sliced to use 0.5 ms per AI frame (configured using the console variable `ai_PathfinderUpdateTime`). Options for pathfinding techniques include high priority, straight, and

partial. Updates for human waypoints are heavy but time-sliced. The navigation graph is optimized but needs memory. Navigation data is generated offline in Editor. With multi-layer navigation, the navigation mesh is regenerated when the designer modifies the map.

Decision Making

- Behavior selection system – Uses behavior trees to select AI behaviors
- Cover system – Provides AI agents with static and dynamic covers
- Smart object system – Allows AI agents to interact with their environment
- Interest system – Allows AI agents to perform intelligent actions when not alerted

Tactical

- Tactical point system (TPS) – Allows AI agents to ask intelligent questions about their environment (such as where to hide or where to attack)
- Faction system – Determines levels of hostility between AI agents
- Group coordination system – Uses coordination selection trees to select group behaviors
- Formation system – Allows AI agents to move in formations
- Cluster detector – detects clusters of points in space and subdivides them into separate groupings that satisfy specific properties (using a modified K-mean algorithm); used with AISquadManager to group different AI agents into dynamic squads

World-Interfacing

- Signals – To trigger events and/or change behaviors
- Perception system
 - Perception handler (legacy, usually per game)
 - Target track system – Uses configurable ADSR envelopes to represent incoming stimuli
- Communication system – Allows AI agents to play sound/voice/animation events

Development Environment

The design and development environment includes the following components:

- Game object model – Entity, movement controller, extensions
- Actor & vehicle system – Health, camera, IK, weapons, animation, etc.
- Flow graph – Visual definition of game logic
- AI debug renderer – HUD, geometric primitives, text labels, graphs, etc.
- Editor
 - AI entities – Properties, flow graphs, scripts
 - Entity archetypes – Templates for properties of individual AI agents
 - AI shapes – AI territories, AI paths, forbidden areas
 - Navigation – Navigation modifiers used instead of triangulation
 - Cover surfaces – CoverSurface anchors to indicate where cover should be
 - Visual AI debugger – Recording AI signals, active behaviors, goals, stimuli, etc.
- Scripting with Lua
 - Entity definitions (including entity flow graph nodes)
 - AI behavior definitions

- Group behavior definitions
- Library or shared Lua code (game rules, basic entities)
- Blackboards to share information globally or among groups
- Examples of AI functionality available in Lua:
 - AI.Signal
 - AI.FindObjectOfType
 - AI.GetAttentionTargetType (Visual, Memory, Sound, None)
 - AI.GetAttentionTargetAIType (Actor, Grenade, Car, etc.)
 - AI.GetRefPointPosition
 - AI.DistanceToGenericShape
 - AI.SetBehaviorVariable (to change behavior)
 - AI.CanMelee
 - AI.RecComment (make comment for Visual AI Debugger)
- Scripting with XML
 - Behavior/coordination trees
 - AI communications
 - Items (e.g., weapons)
- Entity system
 - Spatial queries – GetPhysicalEntitiesInBox()
 - AI agents and vehicles are entities in the Entity system
 - To spawn an entity, its Entity class is required – Can be defined either using the .ent file in Game \Entities OR through a C++ call to RegisterFactory() in game code
 - An entity pool can be used to limit the number of active AI agents per each specified Entity class.
- AI Debugger and AI Debug Draw
 - Use AI Debugger to track multiple features, including active behavior, signal received, attention target, comments, etc.
 - ai_DebugDraw
 - 1 – Basic info on AI agents (selected by ai_DrawAgentStats)
 - 74 – All of the navigation graph (can be slow)
 - 79 – Parts of the navigation graph around the player
 - ai_statsTarget <AI name> – Detailed info for the specified AI
 - ai_DebugTargetTracksAgent <AI name> – Perception information on the specified AI
 - ai_Recorder_Auto – Record AI activity in Editor game mode for AI Debugger
 - ai_DebugTacticalPoints – Debug TPS queries
 - ai_DrawPath <AI name> – Draw the path of the specified AI (optionally specify "all" for all AI agents)
 - ai_DrawPathFollower – Draw the actual path being followed
 - ai_DrawSmartObjects – Display smart objects and their classes and attributes
 - ai_DebugDrawEnabledActors – List currently enabled AI agents.

Execution Context

- AI update is called every frame, but are fully updated only at ~10Hz
- Some AI subsystems use independent time-slicing (pathfinding, tactical point, dynamic waypoints updating, smart object, interest, and dead bodies removal)
- Some services can be called synchronously from game code (such as tactical point system (TPS) queries)

Pathfinding Costs

For agents to behave in a believable way, they need to find paths that are appropriate for their current state. Sometimes these paths will take the most direct route; other times they will be longer paths to maximize use of roads, cover, or other properties of the environment. The current system needs to be extended to support this. The pathfinding system uses A* to find minimal-cost paths.

The cost of a path is given by the sum of the costs of the links that make up that path. Currently the cost traversing a link in the navigation graph is normally simply the physical (3D) length of that link. However, the A* implementation makes it easy for the requester to modify these distance-based costs with simple code changes to extend the current system. For example, the cost of traveling between two road nodes can be scaled by a factor of 0.1 so that road-traveling agents have a strong preference for finding road-based paths.

The cost of a path link connecting two graph nodes should be determined by two sets of properties:

- Link properties, including the path's length.
- Pathfinding agent properties in relation to link properties. For example, a stealthy agent might evaluate a link passing through trees as a lower cost-per-unit-length than one passing along a road. However, the same agent might reach a different conclusion when leading a convoy containing vehicles.

In general, the cost of a link is determined by the product of these two factors: the link-length multiplied by a relative cost-per-unit-length. The latter is what needs to be determined.

Problem: Calculating Costs at Run Time

We want to use the same navigation graph for different kinds of agents. This means that link cost should be calculated at run time by combining the inherent link properties with the agent properties.

Link properties

Associate these properties with each link:

Link.Length

Length of the link (in meters).

Link.Resistance

The link's resistance to traversal. A road would be close to 0, off-road would be larger, water deep enough to require swimming might be close to 1.

Link.Exposure

How exposed the link is. Trees and dense vegetation would be close to 0, low vegetation would be larger, and a road/open space would be close to 1.

Link.DeepWaterFraction

Fraction of the link that contains deep water (e.g., > 1.5m).

Link.DestinationDanger

Additional "danger value" associated with the destination node. A dead body might be 1. This value can be stored in the destination node itself to save memory.

Agent properties

Associate these properties with each agent (normally set when the agent is created):

Agent.CanTraverseTriangular

True/false indicator determining if the agent can traverse triangular nodes.

Agent.CanTraverseWaypoint

True/false indicator determining if the agent can traverse waypoint nodes.

Associate these properties with an agent if relevant for the link type:

Agent.CanSwim

True/false indicator determining if the agent can swim.

Pathfinder request properties

Associate these properties with each agent pathfinder request:

Agent.TriangularResistanceFactor

Extra link cost factor when the link is of type Triangular and its resistance is 1.

Agent.WaypointResistanceFactor

Extra link cost factor when the link is of type Waypoint and its resistance is 1.

Agent.RoadResistanceFactor

Extra link cost factor when the link is of type Road and its resistance is 1.

Associate these properties with an agent pathfinder request if relevant for the link type (note: if a path link has different start/end node types, the result is obtained by averaging):

Agent.SwimResistanceFactor

Extra link cost factor when the link deep water fraction is 1.

Agent.ExposureFactor

Extra link cost factor when the link's exposure is 1.

Agent.DangerCost

Extra link cost when the link danger value is 1.

All link properties, except for Link.DestinationDanger, are calculated when the triangulation is generated. Link.DestinationDanger is initially set to 0 and then calculated as the game runs. For example, whenever a character dies, each link going into the death node will have its DestinationDangerCost incremented by 1. This will cause an agent with Agent.DangerCost = 100 to prefer paths up to 100m longer (assuming no other path cost differences) in order to avoid this death node. These link modifications need to be serialized to support load/save.

In addition, extra costs can be calculated at run time. For example, an extra cost associated with exposure could be added when an agent wishes to find a path that avoids the player; this can be done by using raycasts in the A* callback that calculates costs.

When determining pathfinding costs, there are two problems that need to be solved:

- How should the link properties be calculated?
- How should the link and agent properties be combined to give a numerical cost for traversing each graph link?

Keep in mind that link properties represent the average nature of the environment over the length of the link. If the region has not been triangulated reasonably finely, this may negatively impact the quality of pathfinding results. If the impact is significant, it may be necessary to add additional triangulation points.

An additional issue to consider: should pathfinding differentiate between variable visibility conditions, such as night vs. day or fog vs. clear weather? This would involve splitting the link exposure into terms derived from physical cover and shadow cover. Given the number of links involved, adding too much

information of this type to each link should be considered carefully. A simpler solution might be to have stealthy agents be less likely to request a stealthy path in these conditions, or to set the agent's `ExposureFactor` lower.

Solution

Calculating link properties

Because link resistance is only dependant on the actual type of nodes involved in the link, it can be stored in a lookup table. Here's an example set of resistance values for each node type:

Node type	Resistance
Triangular-no-water	0.5
Triangular-water	1.0
Waypoint	0.6
Road	0
Flight/Volume	0

Note

- Consider adding a separate resistance for Flight/Volume in underwater terrain.
- For links between nodes of different types, the resistance values can be averaged.

The `Link.Exposure` value, which is stored in the link, is determined by the environment properties sampled over the length of the link. For triangular, waypoint and volume navigation regions, this can be done by firing rays from points along the link. (This is done by using `IPhysicalWorld::RayWorldIntersection` and checking for `HIT_COVER | HIT_SOFT_COVER` with `COVER_OBJECT_TYPES`.) It does not make sense to try to get a really accurate value, because in practice the beautified path will not follow the link directly.

Combining link and agent properties

Link cost must account for intersections between link properties and agent properties. For example: if a link is marked as containing deep water and the agent cannot swim, the link should be treated as impassable.

A factor representing the extra costs associated with travel resistance and exposure will be calculated, and the total link cost should be set as follows:

```
Cost = Link.DestinationDanger * Agent.DangerCost + (1 + Factor) *  
Link.Length
```

where

```
Factor = Agent.[link-type]ResistanceFactor * Link. [link-type]Resistance +  
Agent.ExposureFactor * Link.Exposure
```

Consider this scenario: with no exposure/destination costs, and assuming that road links have `Link.Resistance {{0}}` while off-road links have `Link.Resistance {{0.5}}`, then in order to make road

travel ten times more attractive than off-road (such as if the agent is a car), the agent could have `Agent.TriangularResistanceFactor` set to $\{(10-1)/0.5\}$ (or 18) and `Agent.RoadResistanceFactor` set to 0.

If the agent is a human character that always moves at about the same speed whether or not it is on or off a road, then it could have both `Agent.TriangularResistanceFactor` and `Agent.RoadResistanceFactor` set to 0.

Assuming the agent can traverse deep water or is not affected by water (such as a hovercraft), `Agent.SwimResistanceFactor` could be set to 0. For a human agent, this factor might be set to a value as high as 3.0, so that the agent will take significant detours to avoid swimming across a river.

Sensory Models

Overview

This topic describes the modelling and principal operation of the sensors implemented in the Lumberyard AI system. These include the visual sensors, sound sensors, and a general-purpose signalling mechanism.

Sensory information is processed during a full update of each enemy (the actual time that a sensory event was received is asynchronous). These sensors are the only interface the enemy has with the outside world, and provide the data that the enemy will use to assess their situation and select potential targets. All sensors are completely configurable, and they can be turned on/off at run-time for any individual enemy.

Vision

The visual sensory model is the heart of the AI system. It is an enemy's most important sense. The model is designed to simulate vision as realistically as possible, while still maintaining a low execution cost, using a combination of compromises and optimizations.

During a full update for an individual enemy, the system traverses all potential targets from the enemy's point of view and runs each one through a visibility determination routine. All targets that survive this filtering procedure are placed in a visibility list that is maintained until the next full update. For a target to persist as "visible" it must pass the visibility test in each full update. Targets that change from visible to not visible during an update are moved to a memory targets list. If a previously visible target becomes visible again, it is moved from the memory target list back to the visibility list. Memory targets have an expiration time to simulate the enemy "forgetting" the target; this time interval is determined by several factors, including the threat index of the target and the length of time it was visible. Visible targets are given the highest priority and will become the current attention target even if there is another target with a higher threat index. This approach simulates the natural tendency of humans to act based on what they see faster than on what they remember (or hear).

Visibility Determination

The visibility determination routine determines whether a target is considered visible to an enemy. It is run against each of the enemy's potential targets during a full update.

Identifying Targets

Visibility determination can be very CPU intensive; to mitigate this cost, only potential targets are evaluated for visibility. There is a mechanism to register any AI object as an object that should be included in the visibility determination (including user-defined objects). This includes objects such as the grenades in Lumberyard, flashlights, etc. There are also special objects called attributes, which will be discussed in more detail later in this topic.

To be considered a potential target, an AI object must be:

- currently active
- of a different species than the enemy (enemies don't need to keep track of members of their own team)

In addition, the visibility determination test is performed automatically against the player, even if the player is of the same species as the enemy. This rule ensures that the player is accurately specified as an object type and is always taken into account when checking visibility.

The game developer can also designate certain AI object types for visibility determination. These user-defined types are added to a list maintained by the AI system identifying object types to be included in the visibility check. Objects can be freely added to and removed from this list, even from script. To include an object in the list, specify an assessment multiplier to the desired object type. For example, refer to the file `aiconfig.lua`, which can be found in the `/scripts` directory. For more about assessment multipliers, see the topics on threat assessment.

Checking Visibility

Each potential target identified is evaluated for visibility using a series of tests. In situations where the player is facing a single species, no visibility determination is performed between AI enemy objects, only against the player. Key measures determining visibility include:

Sight-range test

This check is done first, as it is fast and cheap to filter out all AI objects that are outside the enemy's sight range. This is done by comparing the distance between enemy and target against the enemy's sight range value.

enemy sight range

Floating point value that determines how far the enemy can see (in meters); the value represents the radius of a sphere with the enemy at the center.

Field-of-view test

Objects that are inside the enemy's sight range sphere are then checked for whether they are also inside the enemy's field of view (FOV).

enemy field of view

Floating point value that determines the angle of the enemy's visibility cone (in degrees); the cone's tip is at the enemy's head and extends outward in the direction the enemy is facing.

The FOV is the angle that determines how far the enemy can see to the left and to the right of his current forward orientation (that is, the scope of his peripheral vision). For example, an FOV of 180 degrees means that the enemy can see everything which is 90 degrees or less to the left and 90 degrees or less to the right of the direction in which he is currently facing. An FOV of 90 degrees means that he can see 45 degrees or less to the left and 45 degrees to the right of his current forward orientation. The FOV check is performed using a simple dot product between the enemy's orientation vector and the vector created as the difference between the positions of the potential target and the enemy. The resulting scalar is then compared to the value of the FOV. Note that by using a conical shape, FOV is not limited to 2D representations.

Physical ray test

Objects that survive the two initial checks are very likely to be seen. The next check is an actual ray trace through the game world, which is an expensive process. Because the low layer of the AI system

performs distributed updates over all frames, it is very seldom that a large number of rays needs to be shot per frame. Exceptions include scenes with a high number of objects belonging to different species and huge combat scenes, such as those with more than 20 participants per species.

The visibility physical ray is used to determine whether there are any physical obstacles between the enemy and the target. It originates from the head bone of the enemy character (or if the enemy does not have an animated character, it originates from the entity position – which is often on the ground) and is traced to the head bone of the target (if it has one, otherwise the entity position is used). If this visibility ray hits anything in its path, then the target is considered not visible. If the ray reaches the target without hitting any obstacles, then the target has passed this tests and can be added to the visibility list for this update.

Not all obstacles are the same. The physical ray test distinguishes between hard cover and soft cover obstacles. For more information on how cover type affects enemy behavior, see the section on soft cover later in this topic.

Perception test

This test is for player AI objects only (and other AI objects as defined by the game developer). Once the player has passed all the visibility tests for an enemy, this final test determines whether or not the enemy can see the player object. Each enemy calculates a perception coefficient for the player target, which ultimately describes the likelihood that the enemy can see the target.

perception coefficient (SOM value)

Floating point value (between 0 and 10) that defines how close the enemy is to actually seeing the target.

The perception coefficient is calculated based on a range of factors, including the distance between enemy and target, height of the target, and whether the target is moving. The value must reach the maximum value (currently 10) before it can receive a definite visual stimulus--that is, see the target.

For more details on how a perception value is derived, see the section on calculating perception later in this topic.

Soft Cover Visibility and Behavior

The physical ray test also evaluates the surface type of obstacles when determining visibility. The AI system can discriminate between two types of surfaces: soft cover and hard cover. The primary difference in a physical sense is that game players can pass through soft cover but cannot pass through had cover. Players can hide behind soft cover objects but the visibility determination is slightly "skewed" when a target is behind a soft cover object rather than a hard cover object or just in the open. When determining a target's visibility behind soft cover, the AI system takes into account whether or not the enemy already identified the target as "living" (not a memory, sound or other type of target). If the enemy does not have a living target, then the soft cover is considered equal to hard cover and normal visibility determination is performed. This occurs when the enemy is idle--or when the enemy is looking for the source of a sound but has not yet spotted it.

However, the behavior is slightly different when the enemy already has a target identified. During the physical ray test, if only soft cover is detected between the enemy and their target, then the target will remain visible for short length of time--between 3 and 5 seconds. If the target remains behind soft cover during this time, the enemy will eventually lose the target and place a memory target at the last known position. However, if the target leaves soft cover within this time, then the timer is reset and normal visibility rules are put into effect.

This behavior simulates the following example: when a soldier perceives that the target has run inside a bush, they do not immediately forget about it because they can make out the target's silhouette even inside the bush. But following a target like that is difficult over time, and after a while the soldier will lose track of the target. The same rules apply to covers made of penetrable cover, like wood, but the

rationale is a bit different. If a target runs behind a thin wooden wall, the soldier knows that bullets will still pierce the wall, so for a short time the target's position is still known, and the enemy continues to shoot through it. This can make for some really intense situations in a Lumberyard game.

In order for this process to work in a closed and rational system, all surfaces in the game need to be properly physicalized (wood, grass, and glass should be soft cover, while rock, concrete, metal should be hard cover). This is consistently done in Lumberyard.

Perception Calculation

Unlike visibility between AI agents, visibility of player objects to enemy AI agents in Lumberyard is not an on/off switch. This added layer of complexity is designed to allow for variations in game playing style (such as action versus stealth). Perception allows the player to make a certain number of mistakes and still be able to recover from them. (This is one of the reasons why a player AI object is specifically defined even in the lowest layer of the AI system hierarchy.) It is not used with other AI objects, where "switch" vision is used (that is, the target is visible as soon as a ray can be shot to its position). Note that it is possible to declare some AI objects should also trigger use of a perception coefficient.

An enemy is given a perception coefficient that describes how close the enemy is to actually seeing a particular target. The initial value of the perception coefficient is 0 and increases or decreases based on a defined set of rules. If a player target passes all prior visibility tests, the enemy begins applies the perception coefficient. Once the maximum value has been reached, the player target is visible to the enemy. This statement contains several corollaries:

- Each enemy has a perception coefficient for each player target it is processing.
- Each enemy will receive notification that the player target is visible only after the perception coefficient reaches maximum value.
- The perception coefficient of two different enemies are unrelated, even for the same player target.
- There is no game-level perception coefficient (that is, a value that determines how any enemy perceives a player target), although this information could be derived by statistics.

When an enemy starts receiving notification that a player target is passing the visibility determination routine, it begins calculating the perception coefficient. This is done by evaluating the following factors, all of which impact the rate at which the coefficient increases. Keep in mind that a player target must still pass all other phases of the visibility determination routine before the perception coefficient is applied.

Distance

Distance between the enemy and the player target has the highest influence on perception. The closer the player target is to the enemy, the faster the coefficient rises, while greater distances cause the coefficient to rise slower. The increase function is a basic quadratic function. At distances very close to the enemy, the time to reach maximum perception is almost non-existent and the target is instantly seen. In contrast, a player target may be able to move more freely along the boundaries of the enemy's sight range, as the perception value rises more slowly.

Height from ground

This factor takes into account the player target's distance above the ground. The rationale for this behavior is that a prone target is much harder to spot than one who is standing upright. The AI system measures the distance of the target from the ground based on the "eye height" property of an AI object. This property is set when the AI object is initialized, and can be changed at any time during execution of the game. If enemies and players are represented in the game by animated characters, the eye height is calculated using the actual height of the character's head bone. This factor influences the rate of increase in the perception coefficient as follows: if the player target has a height above ground of less than one meter, the increase due to distance is lowered by 50%.

Target motion

The perception coefficient is affected by whether or not the player target is moving. Movement attracts attention, while stationary targets are harder to spot. This factor influences the rate of

increase in the perception coefficient as follows: if the player target is standing still, the increase due to other factors is lowered by additional 50%.

Artificial modifiers

Additional values can define how fast the perception coefficient increases. Some affect all enemies in the game world, while some affect only particular targets. An example of a modifier that affects all enemies is the console variable `ai_SOM_SPEED`. Its default value varies depending on a game's difficulty level, but it provides a constant multiplier that is applied on top of all other calculations, and it applies to all enemies. In contrast, it is possible to set a custom multiplier for a specified object type that is used only for certain player targets; however, this setting is limited to the lowest level of the AI system and is not available for tweaking.

The effect of perception is cumulative while the target is considered visible to the enemy. A floating point value is calculated based on the factors described above, and each time the enemy fully updated, this value is added to the perception coefficient (along with an updated visibility determination). So, for example, a player target that is within the enemy's range of sight might remain unperceived by the enemy significantly longer if they are crouching and motionless.

At the same time, a non-zero perception coefficient can fall back to zero over time if value is not increased constantly with each full update. For example, a player target might become visible for a few seconds, raise the coefficient up to 5, and then break visual contact. In this scenario, the coefficient will drop slowly to zero. This scenario was implemented to reward players that tactically advance and then pause before continuing; players can wait for the coefficient to drop to zero before continuing to sneak.

A statistical overview of the perception coefficients of all enemies for a player is used for the HUD stealth-o-meter, showing as a small gauge to the left and right of the radar circle in the HUD. It represents the highest perception coefficient of the player across all enemies that currently perceive him. In effect, it shows the perception coefficient of the one enemy that is most likely to see the player. so, a full stealth-o-meter does not mean that all enemies see the player; it means that there is at least one enemy that can. An empty stealth-o-meter means that currently no enemy can see the player.

Attribute Objects

An attribute object is not a full AI object; instead, it is more of a special helper that can be attributed to an existing AI object. The attribute is a special class of AI object, specifically defined at the lowest level in the AI system. Every attribute object must have a principal object associated with it. The principal object can be any type of an object (including puppet, vehicle, player, etc..) but cannot be an attribute.

Attributes can impact visibility determination. When an enemy determines that it sees an attribute object, the system will switch the attribute with the principal object before adding it into the visibility list of the enemy. Thus, an enemy who sees an attribute will believe it is seeing the principal object attached to the attribute.

Essentially, attributes are a systematic way of connecting certain events to a single target. For example, a player switches on a flashlight and the beam hits a nearby wall. The light hitting the wall creates an attribute object associated with the principal object, which is the player. In this scenario, the player is hidden, but because an enemy sees the attribute object (the light on the wall), it will in fact "see" the player. The rationale is that enemies have enough intelligence to interpolate the origin of the light ray and thus know the player's position.

This feature is also used with regard to rocks, grenades, rockets etc. It can be extended to add more features to a game; for example, a target might leave footprints on the ground that evaporate over time. The footprints spawn attribute objects, which enable any enemy who sees them to perceive the location of the target who left them. Another application might be blood tracks.

To ensure that attribute objects are included in the visibility determination, they must have an assessment multiplier set. Refer to `aiconfig.lua` in the `Scripts\AI` directory to see where the AI system defines the multiplier for attribute objects.

Flight

Use these archetypes and flow nodes in conjunction with entities to control flying vehicles. See these archetypes in the characters archetype library:

- **CELL/Helicopter.Regular**
- **Ceph/Dropship.Regular**
- **Ceph/Gunship.Regular**

The following flow nodes to be used with these entities are found under the Helicopter category.

FollowPath

This flow node sets the current path that the flight AI uses.

- When the AI is not in combat mode.
 - If the AI is set to loop through the flow node path, the AI tries to go from its current location to the closest point of the path and then follows it to the end. The node outputs indicating that the AI has reached the end of the path is sent once only.
 - Without looping, the AI tries to go from its current location to the beginning of the path and then follows it to the end.
- When the AI is in combat mode.
 - If the target is visible, the path is used to position the AI in the best location to attack the target. It is also used to navigate between positions within the path.
 - If the target is not visible, the path is used as a patrol path. Where possible, it simplifies setup to have paths in combat mode be set to loop.

EnableCombatMode

This flow node enables or disables the AI's ability to position itself within the combat path in order to engage and shoot at its current target. By default, an AI is not in combat mode until it's explicitly allowed to go into combat mode.

- When an AI is in combat mode and has identified a target location, it will try to reposition itself within the current path to a position from which it can engage.
- Any character of an opposing faction is a good candidate for a target.

EnableFiring

This flow node enables or disables the ability of the AI to shoot at its current target when in combat mode. By default, an AI is allowed to fire when in combat mode until it's explicitly disabled using this node.

AI C++ Class Hierarchy

C++ classes for AI objects are structured as follows.

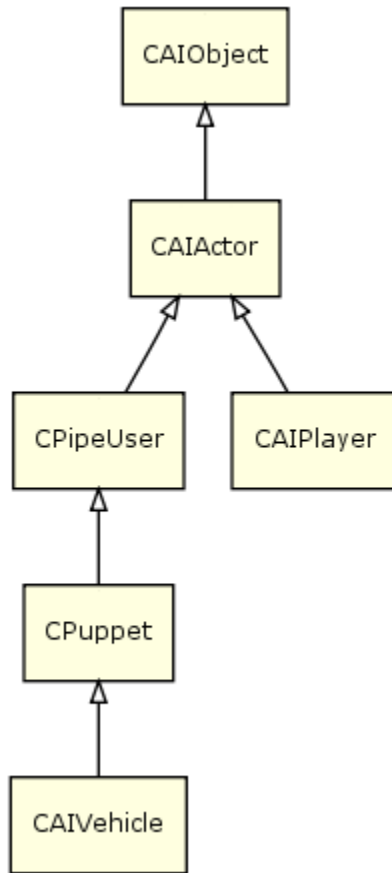

CAIObject

Defines basic AI object properties (entity ID, position, direction, group ID, faction, etc.)

CAIActor

Basic perception and navigation, behavior selection, coordination, blackboard, AI territory awareness, AI proxy

CAIPlayer

AI system's representation of an actual game player

CPuppet

Aiming, firing, stances, covers, a full-fledged AI agent

CAIVehicle

Vehicle-specific code

AI System Concept Examples

This section includes the following topics:

- [AI Multi-Layered Navigation \(p. 18\)](#)
- [Individual AI: Dynamic Covers \(p. 18\)](#)
- [Individual AI: Tactical Points \(p. 18\)](#)
- [Group and Global AI: Factions \(p. 19\)](#)
- [Group and Global AI: Flow Graphs \(p. 19\)](#)

AI Multi-Layered Navigation

Useful AI debug draw:

- ai_useMNM=1
- ai_DebugDraw=1
- ai_DebugDrawNavigation=1
- ai_DrawPath=all
- ai_DrawPathFollower=1

Individual AI: Dynamic Covers

Example: CoverSurface and HMMWV

This example shows the use of dynamic covers that are generated offline and adjusted during run time.

Useful AI debug draw:

- ai_DebugDraw=1
- ai_DebugDrawCover=2
- [AI/Physics] is on

Individual AI: Tactical Points

Example: A very shy civilian who always wants to hide from the player

- Tactical point system (TPS) query:

```
AI.RegisterTacticalPointQuery({
    Name = "Civilian_HideFromEnemy",
    {
        Generation =
        {
            cover_from_attentionTarget_around_puppet = 25
        },
        Conditions =
        {
            reachable = true,
        },
        Weights =
        {
            distance_from_puppet = -1,
        },
    },
});
```

- Useful AI debug draw:
 - ai_DebugTacticalPoints=1
 - ai_StatsTarget=Grunt1
 - ai_TacticalPointsDebugTime=10
- For more realism, add the following before goalop TacticalPos:

```
<Speed id="Sprint"/>
```

Group and Global AI: Factions

Example: AI formations of different factions

Place on a map three grunts of the following factions. Note who is hostile to who.

- grunts
- assassins
- civilians

For example:

```
<Factions>
  <Faction name = "Players">
    <Reaction faction- "Grunts" reaction="hostile"/>
    <Reaction faction- "Civilians" reaction="friendly"/>
    <Reaction faction- "Assassins" reaction="hostile"/>
  </Faction>
  <Faction name="Civilians default="neutral"/>
  ...
</Factions>
```

(see Game/Scripts/AI/Factions.xml)

Group and Global AI: Flow Graphs

Flow Graph Editor allows non-programmers to build global AI logic visually. Experiment with flow graph debugger features, such as signal propagation highlighting and breakpoints.

AI Bubbles System

The AI Bubbles system collects AI error messages for level designers to address. This system streamlines the debugging process by helping to track down which system(s) are connected to a problem. To use the AI Bubbles system, programmers need to push important messages into the system, which will then provide notification to the level designers when a problem is occurring.

Message Display Types

Message include a set of information (agent name, position, etc.) that help the designer to understand that something is wrong in the normal flow. Message notifications can be displayed in any of the following ways:

- Speech bubble over the AI agent
- Error message in the console

```
[Error] Asset for animation-name 'stand_tac_recoilloop_scar_shoulders_add_1p_01' does not exist for Model objects/characters/human/generic/skeleton
Compile ParticlesNoMat@ParticleVS(RT400)(VS) (50 instructions, 5/8 constants) ...
[Warning] AI: Grunt.AlienGrunt2 - Pos:(1165.090088 1362.962036 27.040705) - Message: I m not inside a Navigation area for my navigation type.
CItem::FindCachedAnimationId: Num Entries: 67, Memory: 1340
[Error] Asset for animation-name 'stand_tac_recoilend_scar_shoulders_add_1p_01' does not exist for Model objects/characters/human/generic/skeleton
```

- Blocking Windows message box

Specifying Notification Display Types

Use one of the following ways to specify a display type for error messages:

Console

ai_BubblesSystem

Enables/disables the AI Bubbles System.

ai_BubblesSystemDecayTime

Specifies the number of seconds a speech bubble will remain on screen before the next message can be drawn.

ai_BubblesSystemAlertnessFilter

Specifies which notification types to show to the designer:

- 0 - No notification types
- 1 - Only logs in the console
- 2 - Only bubbles
- 3 - Logs and bubbles
- 4 - Only blocking popups
- 5 - Blocking popups and logs
- 6 - Blocking popups and bubbles
- 7 - All notifications types

ai_BubblesSystemUseDepthTest

Specifies whether or not the notification needs to be occluded by the world geometries.

ai_BubblesSystemFontSize

Specifies the font size for notifications displayed in the 3D world.

C++

In C++, use the method `AIQueueBubbleMessage()` to define how to display the message notification.

Method signature:

```
bool AIQueueBubbleMessage(const char* messageName, const IAIObjct*  
pAIObject, const char* message, uint32 flags);
```

Parameters:

messageName

String describing the message. This is needed to queue the same message error more than once. (The message can be pushed into the system again when it expires is deleted from the queue.)

pAIObject

Pointer to the AI object that is connected to the message.

message

Text of the message to be displayed.

flags

Notification type. This parameter can include one or more flags; multiple flags are separated using a pipe (`|`).

- `eBNS_Log`
- `eBNS_Balloon`
- `eBNS_BlockingPopup`

Example:

```
AIQueueBubbleMessage("COPStick::Execute PATHFINDER_NOPATH non continuous",  
  pPipeUser, "I cannot find a path.", eBNS_Log|eBNS_Balloon);
```

Lua Script

```
local entityID = System.GetEntityIdByName("Grunt.AlienGrunt1");  
  AI.QueueBubbleMessage(entityID,"I cannot find a path.");
```

AI Tactical Point System

The Tactical Point System (TPS) provides the AI system with a powerful method of querying an AI agent's environment for places of interest. It includes the GetHidespot functionality and expands on the "hide" goalop.

TPS is a structured query language over sets of points in the AI's world. Using TPS, AI agents can ask intelligent questions about their environment and find relevant types of points, including hidespots, attack points, and navigation waypoints. The TPS language is simple, powerful, and designed to be very readable.

For example, this query requests all points that match the following criteria:

- Generate locations within 7 meters of my current location where I can hide from my attention target.
- Only accept places with excellent cover that I can get to before my attention target can.
- Prefer locations that are closest to me.

```
hidespots_from_attentionTarget_around_puppet = 7  
coverSuperior = true, canReachBefore_the_attentionTarget = true  
distance_from_puppet = -1
```

TPS uses a highly efficient method to rank points, keeping expensive operations like raycasts and pathfinding to an absolute minimum. Queries are optimized automatically.

This section includes the following topics:

- [Tactical Point System Overview \(p. 21\)](#)
- [TPS Query Execution Flow \(p. 22\)](#)
- [TPS Querying with C++ \(p. 23\)](#)
- [TPS Querying with Lua \(p. 24\)](#)
- [TPS Query Language Reference \(p. 26\)](#)
- [Point Generation and Evaluation \(p. 28\)](#)
- [Integration with the Modular Behavior Tree System \(p. 30\)](#)
- [Future Plans and Possibilities \(p. 31\)](#)

Tactical Point System Overview

Key features of the Tactical Point system (TPS) include:

- Use of a structured query language
 - Powerful and quick to change in C++ and Lua

- Query support for a variety of point characteristics, beyond conventional hiding places behind objects:
 - Points near entity positions
 - Points along terrain features
 - Points suggested by designers
 - Arbitrary resolutions of nearby points in the open or on terrain
- Query combinations, such as:
 - "Find a point somewhere behind me AND to my left, AND not soft cover, AND not including my current spot"
 - "Find a point hidden from my attention target AND visible to the companion"
- Preferential weighting, such as:
 - Find a point nearest to (or furthest from) a specified entity
 - Balance between points near an entity and far from the player
 - Prefer points in solid cover over soft cover
- Query fallback options, such as:
 - Prioritize good cover nearby; if none exists, go backwards to any soft cover
- Query visualization:
 - See which points are acceptable and which are rejected, as well as their relative scores
 - See how many expensive tests are being used by a query and on which points
- Automatic query optimization
 - Understands the relative expense of individual evaluations comprising queries
 - Dynamically sorts points based on potential fitness, according to weighting criteria
 - Evaluates the "fittest" points first, in order to minimize the use of expensive tests
 - Recognizes when the relative fitness of a point indicates that it can't be beat, in order to further reduce evaluations
 - Provides framework for further optimization specific to architecture, level, or locale

In addition to these key feature benefits, this framework offers these advantages from a coding perspective:

- Separates query from action
 - Arbitrary queries can be made at any time without changing the agent's state
- Query language is easy to expand
- Easily adapted for time-slicing (and in principle multi-threading):
 - Progression through query is fine-grained
 - Progress is tracked as state, so it can be easily paused and resumed
- Provides mechanism for delaying expensive validity tests on generated points until needed

TPS Query Execution Flow

The following steps summarize the definition and execution stages of a TPS query. Note that only stages 3 and 4 have a significant impact on performance.

1. Parse query:
 - Parse query strings and values.
 - This step is usually performed once and cached.
2. Make query request:
 - Query is made using C++, ScriptBind, goalops, etc.

- A query is stateless; it does not imply a movement operation.
3. Generate points:
 - Create a set of candidate points.
 - Point candidates are based on the query's Generation criteria.
 4. Evaluate points (this is by far the most intensive stage):
 - Accept or reject points based on Conditions criteria.
 - Assign relative scores to points based on Weights criteria.
 5. Consider query fallbacks:
 - If no point matches the Conditions criteria, consider fallback options.
 - Where there is a fallback, return to step 3.
 6. Visualize points:
 - If visualization is required, draw all points to screen.
 - Include point data such as its accepted/rejected status and relative scores.
 7. Return results:
 - Return one or more points, if any fit the query conditions.
 - Each point is returned as a structure that describes the selected point.

There are some optimizations possible that depend on the execution flow. For example, relevant query results can be cached between fallback queries.

TPS Querying with C++

These C++ interfaces allow you to use TPS from other C++ code and within goalops. Lua queries are translated through it.

There are two C++ interfaces:

- Internal - For use only within the AI system
 - Uses a CTacticalPointQuery object to build queries
 - Allows you to create or adapt queries on the fly
 - Provides greater access to relevant AI system classes
- External - For use from any module
 - Suitable for crossing DLL boundaries
 - Simpler, not object-oriented, just as powerful
 - Uses stored queries for efficiency

Internal Interface Syntax

In the example below, some parsing is obviously taking place here. This is crucial to the generality of the system.

```
// Check for shooter near cover using TPS
static const char *sQueryName = "CHitMiss::GetAccuracy";
ITacticalPointSystem *pTPS = gEnv->pAISystem->GetTacticalPointSystem();
int iQueryId = pTPS->GetQueryID( sQueryName );
if ( iQueryId == 0 )
{
    // Need to create query
    iQueryId = pTPS->CreateQueryID( sQueryName );
}
```

```
pTPS->AddToGeneration( iQueryId,  
"hidespots_from_attentionTarget_around_puppet", 3.0f);  
pTPS->AddToWeights( iQueryId, "distance_from_puppet", -1.0f);  
}  
pTPS->Query( iQueryId, CastToIPuppetSafe( pShooter->GetAI() ),vHidePos,  
bIsValidHidePos );
```

TPS Syntax Examples

The following examples and explanations illustrate the use of TPS query syntax. For a more detailed discussion of the TPS query language, see the topic on TPS Query Language Syntax and Semantics.

```
option.AddToGeneration("hidespots_from_attTarget_around_puppet", 50.0)
```

This query request is expressed as generation criteria and specifies a float to represent distance. The query is broken up into five words:

- "hidespots" indicates that generated points should be positioned behind known cover as is conventional
- "from" and "around" are glue words to aid readability
- "target" specifies the name of the object to hide from
- "puppet" identifies a center location that points will be generated around
- The float value indicates the radial distance, measured from the center location, that defines the area within which points should be generated

Note that no raycasts are performed at this stage. We have here considerable flexibility, for example, how we choose to hide from a player: (1) somewhere near the player, (2) somewhere near us, or (3) somewhere near a friend. We can also specify a completely different target to hide from, such as an imagined player position. By providing flexibility at the point generation stage, we can support more powerful queries and allow users to focus computations in the right areas.

```
option2.AddToConditions("visible_from_player",true)
```

This query request is expressed as condition criteria, so we can expect a Boolean result. The query specifies points that are visible to the player, which is curious but perfectly valid. The term "visible" specifies a ray test, with "player" specifying what object to raycast to from a generated point.

```
option2.AddToConditions("max_coverDensity",3.0)
```

This query is expressed as a condition, so we can expect a Boolean result. The term "Max" specifies that the resulting value must be compared to the given float value--and be lower than. The term "coverDensity" identifies this as a density query (measuring the density of things like cover, friendly AI agents, etc.) and specifies measurement of covers.

```
option1.AddToWeights("distance_from_puppet",-1.0)
```

This query is expressed as a weight component; the query result will be a value between zero and one (normalized as required). Boolean queries are allowed to indicate preference (such as primary cover over secondary cover), with return values of 0.0 for false and 1.0 for true.

This query component indicates a preference for points at a certain location relative to an object. The term "distance" identifies this as a distance query, with the given float values specifying the distance amount. The term "puppet" identifies the object to measure the distance from.

TPS Querying with Lua

In Lua, there are two ways to use the TPS:

- Scriptbinds allow you to use TPS queries from a Lua behavior and have the results returned as a table without any side-effects. This can be useful for higher-level environmental reasoning, such as:
 - Choose behaviors based on suitability of the environment (for example, only choose a "sneaker" behavior if there's lots of soft cover available).
 - Run final, very specific tests on a short list of points, rather than adding a very obscure query to the TPS system.
 - Enable greater environmental awareness (for example, tell me three good hidespots nearby, so I can glance at them all before I hide).
- With goal pipes, you can use goalops to pick a point and go there, using a predefined TPS table:
 - Use a "tacticalpos" goalop, which is equivalent to a previous "hide" goalop.
 - Use fallback queries to avoid lists of branches in goalpipes.
 - More flexible goalops can be provided to decouple queries from movement.

Both methods define query specifications using the same table structure, as shown in the following example:

```
Hide_FindSoftNearby =
{
  -- Find nearest soft cover hidespot at distance 5-15 meters,
  -- biasing strongly towards cover density
  {
    Generation= {   hidespots_from_attentionTarget_around_puppet = 15 },
    Conditions= {   coverSoft = true,
                   visible_from_player = false,
                   max_distance_from_puppet = 15,
                   min_distance_from_puppet = 5},
    Weights =     {   distance_from_puppet = -1.0,
                   coverDensity = 2.0},
  },
  -- Or extend the range to 30 meters and just accept nearest
  {
    Generation = {   hidespots_from_attentionTarget_around_puppet = 30 },
    Weights =     {   distance_from_puppet = -1.0}
  }
}
AI.RegisterTacticalPointQuery( Hide_FindSoftNearby );
```

Note

Registering a query returns a query ID that then refers to this stored query.

Querying with Scriptbind

The following script runs a query using an existing specification. See comments in `Scriptbind_AI.h` for details.

```
AI.GetTacticalPoints( entityId, tacPointSpec, pointsTable, nPoints )
```

Querying with Goalops

The following script runs an existing query. Because queries can have fallbacks built in, branching is usually unnecessary (the branch tests are still supported).

```
AI.PushGoal("tacticalpos",1, Hide_FindSoftNearby);
```

TPS Query Language Reference

There are ways to define a query in both C++ and Lua (and potentially in XML), but the same core syntax is used. This page formally defines the TPS query language, with query components expressed in Generation, Conditions or Weights, and defines and discusses the query language semantics.

Query Syntax

Note

Non-terminal symbols are in bold. Not all of the symbols are implemented, but are shown for illustration.

```
Generator ::= GenerationQuery '_' 'around' '_' Object
Condition ::= BoolQuery | (Limit '_' RealQuery)
Weight ::= BoolQuery | (Limit '_' RealQuery) | RealQuery
GenerationQuery ::= ( 'hidespots' '_' Glue '_' Object)
                  | 'grid' | 'indoor'
BoolQuery ::= BoolProperty | (Test '_' Glue '_' Object)
BoolProperty ::= 'coverSoft' | 'coverSuperior' | 'coverInferior' |
                'currentlyUsedObject' | 'crossesLineOfFire'
Test ::= 'visible' | 'towards' | 'canReachBefore' | 'reachable'
RealQuery = ::= RealProperty | (Measure '_' Glue '_' Object)
RealProperty ::= 'coverRadius' | 'cameraVisibility' | 'cameraCenter'
Measure ::= 'distance' | 'changeInDistance' | 'distanceInDirection' |
            'distanceLeft' | 'directness' | 'dot' | 'objectsDot' | 'hostilesDistance'
Glue ::= 'from' | 'to' | 'at' | 'the'
Limit ::= 'min' | 'max'
Object ::= 'puppet' | 'attentionTarget' | 'referencePoint' | 'player'
         | 'currentFormationRef' | 'leader' | 'lastOp'
```

Query Semantics

Note

- "Tunable" denotes that the exact values used should be possible to tweak/tune later.
- "Real" means that it returns a float value (rather than a boolean).

Objects

puppet

AI agent making a query

attentionTarget

Object that is the target of the AI agent's attention

referencePoint

AI agent's point of reference, perspective

player

Human player (chiefly useful for debugging and quick hacks)

Glue

from | to | at | the

Glue words used for readability in a query statement. Each query must have a glue word, but it has not active function and the parser doesn't distinguish between them. Readability is encouraged to aid in debugging and long-term maintenance.

Generation

Hidespot

Individual point just behind a potential cover object with respect to a "from" object (as in "hide from object"). There is typically one point per cover object. Use of this symbol should generate multiple points behind large cover objects and cope with irregularly shaped and dynamic objects.

Around

A glue word with special meaning. This word should be followed by the name of an object around which to center the generation radius.

Conditions/Weight Properties (use no object)

These properties relate to a specified point:

coverSoft

Boolean property, value is true if the specified point is a hidespot using soft cover.

coverSuperior

Boolean property, value is true if the specified point is a hidespot using superior cover.

coverInferior

Boolean property, value is true if the specified point is a hidespot using inferior cover.

currentlyUsedObject

Boolean property, value is true if the specified point is related to an object the puppet is already using (such as the puppet's current hide object).

coverRadius

Real (float) property, representing the approximate radius of the cover object associated with the specified point, if any, or 0.0 otherwise. When used for condition tests, returns an absolute value in meters. When used as a weight, returns a normalized value, mapping the range [0.0-5.0m] to [0.0-1.0]. (Tunable)

coverDensity

Real property, representing the number of potential hidespots that are close by to the specified point. When used for condition tests, returns an absolute value representing an estimate of the number of hidespots per square meter using a 5m radius sample. When used as a weight, returns a normalized value, mapping the range (0.0-1.0) to [0.0-1.0] (hidespots per square meter). (Tunable)

Conditions/Weight Test/Measures (require object)

These properties relate to a specified object, such as `distance_to_attentionTarget` or `visible_from_referencePoint`.

distance

Real (float) measure, representing the straight-line distance from a point to the specified object. When used for condition tests, returns an absolute value in meters. When used as a weight, returns a normalized value, mapping the range [0.0-50.0m] to [0.0-1.0]. (tunable)

changeInDistance

Real (float) measure representing how much closer the puppet will be to the specified object if it moves to a certain point. Takes the distance to the specified object from the current location and subtracts it from the distance to the object from the proposed new location. When used for condition tests, returns an absolute value in meters. When used as a weight, returns a normalized value, mapping the range [0.0-50.0m] to [0.0-1.0]. (tunable)

distanceInDirection

Real (float) measure representing the distance of the point in the direction of the specified object. Takes the dot product of the vector from the puppet to the point and the normalized vector from the

puppet to the object. When used for tests, returns an absolute value in meters. When used as a weight, returns a normalized value, mapping the range [0.0-50.0m] to [0.0-1.0]. (tunable)

directness

Real (float) measure representing the degree to which a move to a certain point approaches the specified object. Takes the difference in distance to the object (`changeInDistance`) and divides it by the distance from the puppet to the point. Always uses the range [-1.0 to 1.0], where 1.0 is a perfectly direct course and negative values indicate movement further away from the object.

Limits

min | max

Limits can be used to test a real value in order to produce a Boolean. Useful for conditions that can also be used as coarse Weights; for example, the condition `MAX_DISTANCE = 10` can be used to express that a distance of less than 10 is preferable, but without favoring nearer points in a more general way.

Failing Queries

There are a few different ways queries can fail, and it's important to understand how each case is handled.

- **No points matched the conditions of the query.** This is a valid result, not a failure; the AI can move to fallback queries or try a different behavior.
- **The query does not make sense in the context of an individual point.** Sometimes a query doesn't make sense for a certain point or at a certain time. In this case, the query tries to return the "least surprising" results. For example: a query about a point generated in the open asks "is this soft cover?" The result will be "false", because this isn't any kind of cover. Query names should be chosen carefully to help avoid potential confusion.
- **The query does not make sense in the context of the puppet, at this time and for any point.** As with the point context issue, the query tries to return the "least surprising" results. For example: a query about a puppet asks "am I visible to my attention target?" when the puppet doesn't have an attention target. The query could return false, but it would disqualify every point. This case will usually indicate a code error--the puppet should have an attention target at this point, but does not. Note: This situation can cause a similar problem in the point generation phase, with a query like "generate hidespots from my attention target". both of these situations are flagged as code errors.
- **The query failed due to a code error.** You can test for errors in the TPS queries and raise them there also. For example, a query or combination hasn't been fully implemented yet or is being used as a kind of assert to test variables.

Point Generation and Evaluation

An AI agent makes a TPS point generation query in order to generate a set of points for consideration. Once generated, each point can be evaluated based on its position and any available metadata.

Generating Points

Input

The following information are required to generate points:

- Specific criteria defining the types of points to generate.
- A central or focal position around which to generate points. This might be the current position of the puppet itself, an attention target, or some other given position.

- For some queries, the position of a secondary object, such as a target to hide from.

It is possible to specify multiple sets of point generation criteria. For example, a query might request point generation around both the puppet and an attention target.

Processing

Based on the input, TPS begins generating points to evaluate. All points fall into two main types:

- Hidepoints. These are generated based on the following calculations:
 - Hideable objects
 - Generated only if a position to hide from was provided
 - Hidepoints represent final positions, for example calculating positions behind cover
 - Using the object and delaying finding an actual point is a possibility
- Open points. These are generated based on query specifications and the following calculations:
 - Usually on terrain, but may be on surfaces, etc.
 - Resolution/pattern (such as triangular with 1-meter spacing)
 - Potentially may perform more general sampling to find an exact point, but an initial resolution is still required
 - Radial/even distributions

Output

The result of a point generation query is a list of point objects. Each point object includes the point's position and available metadata, such as any associated hide objects.

Evaluating Points

Once a generation query generates a set of points, they can be evaluated. Point evaluation tries to establish the "fitness" of each point, that is, how well the point matches the specified criteria. The goal is to choose either one good point, or the best N number of good points.

Input

The following elements are required to evaluate points:

- List of candidate points from the point generator
- Point evaluation criteria:
 - Boolean – Condition criteria used to include or exclude a point independently of any other points
 - Weight – Criteria that, combined, give a measure of fitness relative to other points (those included by the boolean criteria)

Processing

The primary goal is to find an adequately good point as quickly as possible. Often, "adequately good" also means "the best", but there is a lot of potential for optimization if a user-specified degree of uncertainty is allowed.

The order of evaluation has a non-trivial and crucial impact on query efficiency. As a result, evaluation uses the following strategy to minimize the number of expensive operations:

1. Cheap booleans, with an expense on the order of one function call or some vector arithmetic. These allow the system to completely discount many points without significant cost. For example: *Is this point a primary or secondary hidespot? Is this point less than 5 meters from the target?*

2. Cheap weights, with an expense similar to cheap booleans. These allow the system to gauge the likelihood that a given point will eventually be the optimal choice; by focussing on points with a high likelihood, the number of expensive tests can be reduced. For example: *closeness_to_player* * 3 + *leftness* * 2.
3. Expensive booleans, approximately 100 times costlier. These are yes/no questions that will require expensive calculations to answer, but further eliminate points from contention. For example, the question *Is this point visible by the player?* requires an expensive ray test.
4. Expensive weights, with an expense similar to expensive booleans. These help to rank the remaining points. For example: *nearby_hidepoint_density* * 2

Algorithmic Details

It turns out that the system can go further with this by interleaving the final two steps and making evaluation order completely dynamic. Unlike conditions (booleans), weights don't explicitly discount points from further evaluation. However, by tracking the relative "fitness" of points during evaluation, we can still employ weights to dramatically reduce evaluations by employing two basic principles:

- Evaluate points in order of their maximum possible fitness, to fully evaluate the optimal point as quickly as possible.
- If, based on the initial weight evaluation, a point can be established as better than any other point, then immediately finish evaluating it against the remaining conditions. If the point passes all condition criteria, then it is the optimal point and no other points need to be evaluated. In addition, this point does not need to be evaluated on any remaining weights.

This implementation is based on a heap structure that orders points according to their maximum possible fitness and tracks the evaluation progress of each point separately. Each weight evaluation collapses some of the uncertainty around the point, adjusting both the minimum and maximum possible fitness. If the weight evaluation scored highly, the maximum will decrease a little and the minimum increase a lot; if it scored badly, the maximum will decrease a lot and the minimum increase a little.

In each iteration, the next most expensive evaluation is done on the point at the top of the heap, after which the point is re-sort into place if necessary. If all evaluations on a point have been completed and it still has the maximum possible fitness, then it must be the optimal point. This approach tends towards evaluation of the optimal point with relatively few evaluations on all other points.

Output

The result of point generation evaluation is a single point or group of *N* number of points, and the opportunity to request all metadata leading to its selection. As a result, behaviors can adapt their style to reflect the nature the hidepoint received.

Integration with the Modular Behavior Tree System

From inside the Modular Behavior Tree (MBT), the **<QueryTPS>** node can be used to call pre-defined TPS queries by name. The **<QueryTPS>** node will return either success or failure.

The most common usage pattern involving the **<QueryTPS>** node is to use it in conjunction with the **<Move>** node inside a **<Sequence>** to determine the status of a specified position. The example below illustrates a call to a pre-defined TPS query called **SDKGrunt_TargetPositionOnNavMesh**, with the expected inputs. If the query succeeds, the AI agent will move to the queried position.

```
<Sequence>
  <QueryTPS name="SDKGrunt_TargetPositionOnNavMesh" register="RefPoint" />
  <Move to="RefPoint" speed="Run" stance="Alerted" fireMode="Aim"
  avoidDangers="0" />
```

```
</Sequence>
```

The definition of the pre-defined query **SDKGrunt_TargetPositionOnNavMesh** is as follows.

```
AI.RegisterTacticalPointQuery({
    Name = "SDKGrunt_TargetPositionOnNavMesh",
    {
        Generation =
        {
            pointsInNavigationMesh_around_attentionTarget = 20.0
        },
        Conditions =
        {
        },
        Weights =
        {
            distance_to_attentionTarget = -1.0
        },
    },
});
```

Future Plans and Possibilities

The following topics represent potential areas of development for TPS.

Higher-level environmental reasoning

One possible application of TPS: rather than simply using TPS to choose a point and move to it, there is the potential for some nice environmental deductions based on results.

For example: The player runs around a corner, followed by an AI puppet. When the AI puppet turns the corner, the player is no longer visible. The puppet queries TPS for places it would choose to hide from itself, with the following possible results.

- TPS returns that 1 hidepoint is much better than any other. This is because there's a single large box in the middle of an empty room. The AI puppet assumes the player is there and charges straight at the box, firing.
- TPS returns that there are several good hiding places. This is because there's a stand of good cover trees. All the hidepoints are stored in a group blackboard, and the AI puppet (or a group) can approach each spot in turn to discover the player.

This scenario is workable with some extra code, and much easier when built upon TPS.

Sampling methods

When generating points in the open, generate points in a grid or radially around objects and treat each point individually. This supports a basic sampling method. Where an area must be sampled, some kind of coherency in the evaluation functions can be assumed, and so could use some adaptive sampling approaches instead.

Dynamic cost evaluation

A crucial aspect of optimizing TPS involves adjusting the relative expense function of queries. The costs of evaluations will vary across platforms, levels, and even locations within levels, and will change over time as the code changes. It is critical to make sure that the evaluation order is correct, to prevent more expensive evaluations from being favored over cheaper ones. The need to profile the evaluation function in all these difference circumstances suggests an automatic profiling solution at run-time.

In addition, the relative weighting of weight criteria should also be considered; a cheap query may not be worth doing first if it only contributes 10% of the final fitness value, while an expensive query that contributes 90% may actually save many other evaluations.

Relaxing the optimality constraint

When evaluating points the maximum and minimum potential fitness is always known at every stage; this provides the error bounds, or a relative measure of uncertainty about the point.

It may make sense to relax the optimality constraint and accept a point when it becomes clear that no other point could be significantly better. For example, the minimum potential fitness of a point may be less than 5% lower than the maximum potential fitness of the next best point. This information could be used to stop evaluation early and yield a further performance saving.

Navigation Q & A

Big Triangles and Small Links Between Them

Q: I have created a big flat map, placed an AI agent on it, and generated AI navigation triangulation. I noticed that the AI agent doesn't always take the shortest straight path from point A to point B. Why?

A: To illuminate the issue, use the following tools:

- AI debug console variable `ai_DebugDraw` set to "74". This value draws the AI navigation graph. (Note: a value of 79 will run faster, but limits the result to the area close to the player (with 15 m).
- AI debug console variable `ai_DrawPath` set to "all". This variable draws AI agent paths, including links (the corridors between adjacent triangles).
- The **Ruler** tool in Editor, used to visualize paths. You don't even need actual AI agents on the map to run experiments. (Note: this tool is located between **Snap Angle** and **Select Object(s)**.)

The AI navigation triangulation is intended to be fast and have a small memory footprint. One of the decisions made in this regard was to use 16-bit signed integers to store corridor (or "link") radius measurements between two adjacent triangles. Using centimeters as the unit of measure, this means that the maximum link radius is 32767 cm (327.67 m). When an AI agent moves to another triangle, it can only go through this corridor, which is naturally very narrow if the triangles are still very large. This problem does not exist for triangles with edges less than $2 * 327.67 = 655.34$ m.

This problem can only appear in the very initial stages of map development. Every forbidden area, tree or other map irregularity makes triangulation more developed, which results in more triangles that are smaller in size. As a result, the problem goes away.

Path Following

Q: How does path following actually work? Where to start?

A: See the topic on [Path Following](#) (p. 33).

Auto-Disabling

Q: How do you keep patrols always active, regardless of their distance from the player?

A: See the topic on [Auto-Disable](#) (p. 35).

Path Following

This topic provides some high-level insight on how path following is done in Lumberyard. To illustrate some concepts, we'll use the relatively simplistic example of Racing HMMWVs, which is a good representation of classic path following as presented in many AI texts.

Path following with Racing HMMWVs adheres to the following sequence.

1. Get the closest (to the AI agent) point on path.
2. Get the path parameter of this point. Paths usually have some kind of parametrization, $t \rightarrow (x,y,z)$.
3. Add a certain value, usually called a "lookahead", to this parameter.
4. Get the path point that corresponds to this new parameter. This is called the look-ahead position.
5. Use this point as the navigation target.
6. If the vehicle is stuck, beam it straight to the closest point on the path.

Goalop "Followpath"

Use the goalop *followpath* to instruct an AI agent to follow a path. You can observe this sequence in action by setting a breakpoint at the beginning of a call to `COPFollowPath::Execute`. In the call stack window in Visual Studio, you'll be able to see the update operations for all (active) AI agents being called as part of the AI system update procedure. This action in turn calls the execute operations of the currently active goalops being run by the AI.

`COPFollowPath::Execute` accomplishes the following tasks:

- Uses the goalop *pathfind* to find a path leading to the beginning of a path. Optionally, it finds a path to the closest point on a path using a parameter passed to the *followpath* goalop.
- Traces the path by following it using the goalop *trace*
- Listens for the signal "OnPathFollowingStuck" to make sure the AI agent isn't stuck

The goalops *pathfind* and *trace* are commonly used for navigational goalops, including *approach* and *stick*.

COPTrace::ExecuteTrace and COPTrace::Execute

`COPTrace::ExecuteTrace` is used to clean up path-following issues, including handling edge cases and smart objects. The core of this call is as follows:

```
IPathFollower* pPathFollower = gAIEnv.CVars.PredictivePathFollowing ?
    pPipeUser->GetPathFollower() : 0;
bTraceFinished = pPathFollower ? ExecutePathFollower(pPipeUser, bFullUpdate,
    pPathFollower) : Execute2D(pPipeUser, bFullUpdate);
```

`COPTrace::Execute` does the same work plus a bit more. For the AI following a path, when its lookahead position hits the end of the path, this operation sends the signal "OnEndWithinLookAheadDistance" to the AI. In the sample scenario, this allows our racing HMMWVs to start looking for a new path to follow while they're still moving along the current path. Normally AI agents stop moving when the path following process is completed. The following Lua script is also useful to maintain movement:

```
AI.SetContinuousMotion(vehicle.id, true);
```

COPTrace::Execute2D

This operation can be used as a fallback if an AI agent (CPipeUser, at least) doesn't have a path follower. COPTrace::Execute2D accomplishes the following tasks:

- Gets the lookahead path position and the path direction at this position.
- Executes a maneuver, if necessary. For example, it makes cars go backwards to make a U-turn.
- Considers a number of reasons to slow down, including:
 - The angle between current and desired (aforementioned path direction) directions.
 - The curvature of the path.
 - Approaching the end of the path.
 - Approaching the top of a hill.

It then sets members *fDesiredSpeed* and *vMoveDir* of the AI agent's SUBJECTSTATE structure, which are brought to the game code later. For an example of how this data can be used for actual steering, take a look at CVehicleMovementArcadeWheeled::ProcessAI.

Note that COPTrace::Execute2D is not the only operation that sets *vMoveDir*. For example, obstacle avoidance code can overwrite it.

Movement System

Key priorities for the AI Movement system include the following features.

- Robust and predictable. Navigation can be very unreliable, with no guarantee that a character will carry out the requested movement and end up at the desired destination. This is a very organic problem with no clear resolutions. The AI Movement system solves this by providing more explicit information about failure reasons.
- Central, clear ownership and easy debugging. Rather than having contextual movement information – style, destination, requester, etc. – tied to a specific goalop and getting lost when a behavior switch occurs, Lumberyard maintains this information in a central location and separated from the goalop. In practice, a movement request can be sent from anywhere and the movement system handles it centrally. when the goalop requester is no longer interested, it simply cancels the request. This doesn't mean the character stops immediately and all information is lost, it just means that interest in the request has expired.
- Planning. In Lumberyard, logic is handled in blocks for ease of use and organization. Movement blocks are responsible for their own isolated tasks, such as FollowPath, LeaveCover and UseSmartObject. A collection of blocks in sequence make up a plan, which is produced by a controller with a string-pulled path as input. This types of organization helps clarify a larger picture about what is being processed right now and what is coming up.

Note

This system is still a work in progress, and it's design was focused on solving some critical problems with an existing code base. It may not be suitable for all game titles.

Using the Movement System

Using the movement system is pretty straightforward. Create a MovementRequest object with information about the destination, style and a callback. Queue it in MovementSystem and receive a MovementRequestID. Use this if you want to cancel the request. Then wait for MovementSystem to process to your request. Once your request is processed, you'll be notified via the callback.

Here's what's happening internally to process your request:

1. Once MovementSystem receives your request, it creates an internal representation of the character, called a MovementActor. This is a container for all internal states and the proxy to all external states/ logic related to a character. It binds a MovementController to the actor. Currently there's only one controller available – GenericController, which is the result of what was done before. (The term "controller" is also used on the game side for a similar but different entity. These entities may be merged in the future, and multiple types of controllers added, such as for the Pinger, Scorcher, or BipedCoverUsed.)
2. MovementSystem informs the controller that there's a new request to start working on. GenericController kicks off the path finder.
3. Once the pathfinding result is in, the GenericController produces a plan that it starts to follow.
4. When the GenericController finishes the last block in the plan, it informs MovementSystem that the task is finished.
5. MovementSystem notifies the requester of success, and moves on to the next request.

Potential Improvements

The following areas of improvement or enhancement are under consideration:

- Change request processing. Currently there is a request queue, with movement requests processed one at a time, in FIFO order. Requests are immutable, so it's impossible to change a request once it's been queued; as a result, the only option is to cancel a request and queue a new one. These issues could be resolved by removing the request queue and allowing only one request at a time. If a request comes in while one is already being processed, interrupt the current one and report it.
- Validate a pipe user before proceeding with the update.
- When a UseSmartObject block detects that the exact positioning system fails to position a character at the start of a smart object, it reports this failure through the agent's bubble and in the log. It then resolves the problem by teleporting the character to the end of the smart object and proceeds to the next block in the plan.
- The GenericController is only allowed to start working on a new request while it is executing a FollowPath block. It then shaves off all subsequent blocks so that the actor doesn't find itself in the middle of a smart object when planning takes place. This could be improved by allowing the controller to produce a part of the plan, looking further ahead, and then patch it with the current plan.
- The plan isn't removed when a request is canceled. This is because a subsequent 'stop' or 'move' request should follow the cancellation. However, until this request has been received, the controller has no way to know what to do.
- The pathfinding request is being channeled through the pipe user, and the result is returned to the pipe user as well as stored in `m_path`. This path is then extracted by the movement controller. It would be better if the pathfinder could be employed directly by the movement controller and skip the pipe user as a middle layer.
- The movement controller code would fit better on the game side, since that's where the information about the characters should live. It could be merged with the movement transitions that are handled on the game side.
- Being able to pull out a movement request at any time makes the code slightly more complex, because we can't rely on that fact that the controller is always working on a request that still exists. It may be better to keep the request, flag it as abandoned and clear the callback.
- The code could be improved by separating planning and plan execution into two different code paths instead of one.

Auto-Disable

You can save CPU time by not updating distant AI agents. Use the auto-disable feature to controlled updates either on a per-AI basis or globally.

Global auto-disable

- To control auto-disable for all vehicles: use the console variable `v_autoDisable`.
- To control auto-disable for all AI agents: use the console variable `ai_UpdateAllAlways`.

Per-AI auto-disable

Per-AI auto-disable is controlled by the entity property `AutoDisable`. Refer to the Lumberyard User Guide for more details on AI and vehicle entities. You can also change this property (and behavior) at run time.

- C++: `pAIActorProxy->UpdateMeAlways(true);`
- Lua: `AI.AutoDisable(entity.id, 1);`
- In Flow Graph Editor: turn **AI:AutoDisable** on or off for each AI.

AI Scripting

This collection of topics describes how to handle some key AI capabilities using scripting.

This section includes the following topics:

- [Communication System \(p. 36\)](#)
- [Factions \(p. 42\)](#)
- [Modular Behavior Tree \(p. 43\)](#)
- [Refpoints \(p. 85\)](#)
- [Signals \(p. 86\)](#)

Communication System

AI communication is about playing sound/voice and/or animations at the right times in the course of the game.

Setting up communication for an AI agent requires the following steps:

- General set up:
 - Define communication channels. Channels are used to track the status of communication events for an AI.
 - Define communications. Communications detail specifically what activity should occur (and how) when the communication is called for. Communications are grouped into configurations.
 - Set up voice libraries. Voice libraries support localized dialogs, subtitles, and lip-syncing.
- Specify communication types for an AI using AI properties:
 - Point an AI's `CommConfig` property to a communication configuration, which contains the set of communications for that AI.
 - Point an AI's `esVoice` property to a voice library to use for that AI.
- Trigger a communication event:
 - Specify the name of a communication channel for the event.
 - Specify the name of a communication to fire.

Communications, channels, and voice libraries are defined in a set of XML files. At game start-up, the directory `Game/Scripts/AI/Communication` and all subfolders are scanned for XML files containing these configurations.

Defining Communication Channels

A communication channel determines whether an AI can play a communication at a given moment, depending on whether or not the communication channel is occupied. Channels are a self-contained concept, independent of other AI communication concepts. They have a sole purpose: to be in one of two possible states, "occupied" or "free".

AI communication channels are defined in an XML file stored in `Game/Scripts/AI/Communication`. The SDK includes a template channel configuration XML file, called `ChannelConfig.xml`. Communication channels are configured in a hierarchy of parent and child channels. The hierarchical structure determines how a channel's occupied status affects the status of other channels (for example, a parent of an occupied child channel).

Channel Elements & Attributes

Communication channels are defined in a `<ChannelConfig>` element with the following attributes:

name

Channel name.

priority

minSilence

Minimum time (in seconds) that the channel should remain occupied after a communication has been completed.

flushSilence

Time (in seconds) that the channel should remain occupied after it has been flushed. This value overrides the imposed silence time (**minSilence**) after playing a communication. If not specified, the value set for **minSilence** is used.

actorMinSilence

Minimum time (in seconds) to restrict AI agents from playing voice libraries after starting a communication.

ignoreActorSilence

Flag indicating that AI agent communication restrictions from the script should be ignored.

type

Type of communication channel. Valid values are "personal", "group" or "global".

Example

`Game/Scripts/AI/Communication/ChannelConfig.xml`

```
<Communications>
  <ChannelConfig>
    <Channel name="Global" minSilence="1.5" flushSilence="0.5"
type="global">
      <Channel name="Group" minSilence="1.5" flushSilence="0.5"
type="group">
        <Channel name="Search" minSilence="6.5" type="group"/>
        <Channel name="Reaction" priority="2" minSilence="2"
flushSilence="0.5" type="group"/>
        <Channel name="Threat" priority="4" minSilence="0.5"
flushSilence="0.5" type="group"/>
      </Channel>
    </Channel>
  </ChannelConfig>
</Communications>
```

```
        <Channel name="Personal" priority="1" minSilence="2"
actorMinSilence="3" type="personal" />
    </Channel>
</ChannelConfig>
</Communications>
```

Configuring Communications for an AI

Communication configurations determine what communication activity AI agents can perform and how it will manifest. Communications for a particular type of AI are grouped into configurations. For example, your game might have both human and non-human AI agents, each with its own set of communication activities. In this scenario, you might group all the human communications into a configuration object named "human" while communications for non-humans might be grouped into a "non-human" configuration. For a particular AI, you'll specify the configuration to use with the AI's *CommConfig* property. With this configuration structure, you can define a communication (such as "surprise") differently in each configuration so that, when triggered, the communication activity fits the AI involved.

For each communication, you also have the option to define multiple variations of action and specify how the variations are used.

AI communication channels are defined in one or more XML files stored in `Game/Scripts/AI/Communication`. The SDK includes a template channel configuration XML file, called `BasicCommunications.xml`.

Communication Elements & Attributes

Communications are configured using the following elements and attributes:

Config

Communication configurations are grouped into `<Config>` elements and use the following attributes. Each configuration must contain at least one communication.

name

Configuration name, which can be referenced in the AI's *CommConfig* property.

Communication

A communication is defined in a `<Communication>` element with the following attributes. Each communication should contain at least one variation.

name

Communication name.

choiceMethod

Method to use when choosing a variation. Valid values include "Random", "Sequence", "RandomSequence" or "Match" (uses only the first variation).

responseName

responseChoiceMethod

Similar to **choiceMethod**.

forceAnimation

Boolean flag.

Variation

Each variation is defined in a `<Variation>` element with the following attributes.

animationName

Animation graph input value.

soundName**voiceName****lookAtTarget**

Boolean flag indicating whether or not the AI should look at the target during the communication.

finishMethod

Method that determines when communication is finished, such as after the communication type has finished or after a time interval. Valid values include "animation", "sound", "voice", "timeout" or "all".

blocking

AI behavior to disable during communication. Valid values include "movement", "fire", "all", or "none".

animationType

Valid values include "signal" or "action".

timeout

Example

Game/Scripts/AI/Communication/BasicCommunications.xml

```
<Communications>
<!--sound event example-->
  <Config name="Welcome">
    <Communication name="comm_welcome" finishMethod="sound"
blocking="none">
      <Variation soundName="sounds/dialog:dialog:welcome" />
    </Communication>
  </Config>
<!--example showing combined animation + sound event (needs state using
action/signal in the animation graph)-->
  <Config name="Surprise">
    <Communication name="comm_anim" finishMethod="animation"
blocking="all" forceAnimation="1">
      <Variation animationName="Surprise" soundName="sounds/
interface:player:heartbeat" />
    </Communication>
  </Config>
</Communications>
```

Setting Up Voice Libraries

To support localized dialogs, subtitles, and lip syncing, you need to set up voice libraries. Once set up, you can assign a voice library to an AI (or entity archetype) using the AI's `esVoice` property.

Voice libraries are defined in a set of XML Excel files stored in `GameSDK/Libs/Communication/Voice`. The SDK includes a template voice library file at `GameSDK/Libs/Communication/Voice/npc_01_example.xml`.

Each voice library must include the following information.

Language

Localization type for this library.

File Path

Location where the sound files for this library are stored.

Signal

Communication name associated with a sound file.

Sound File

File name of a sound file, listed by signal.

Example

Comment field used to describe or illustrate a sound file.

Example

GameSDK/Libs/Communication/Voice/npc_01_example.xml

Language	American English	
File Path	languages/dialog/ai_npc_01/	
Signal	Sound File	SDK NPC 01 Example
<i>see</i>		
	see_player_00	i see you
	see_player_01	hey there you are
	see_player_02	hey i have been looking for you
<i>pain</i>		
	pain_01	ouch
	pain_02	ouch
	pain_03	ouch
<i>death</i>		
	death_01	arrhh
	death_02	arrhh
	death_03	arrhh
<i>alerted</i>		
	alerted_00	watch_out
	alerted_01	be careful
	alerted_02	something there

Setting Communication for an AI

An AI's communication methods are set using the AI agents properties. You can set AI properties in several ways. For information about using the Lumberyard Editor to set AI properties, see "Using Database View to Set AI Communication" in the Lumberyard User Guide).

Set the following properties:

- *CommConfig* – Set this property to the name of the communication configuration you want this AI to use. Communication configurations are defined in XML files in `Game/Scripts/AI/Communication`, using `<Config>` elements.
- *esVoice* – Set this property to the name of the XML file containing the voice library you want this AI to use. Voice libraries are defined in XML files in `GameSDK/Libs/Communication/Voice`.

Turning Animation and Voice Off

Communication animation and/or voice can be turned off for an AI agent using the agent's Lua script (as in the example below) or the entity properties in Lumberyard Editor Editor.

Example

```
Game/Scripts/Entities/AI/Shared/BasicAITable.lua
```

```
Readability =  
{  
    bIgnoreAnimations = 0,  
    bIgnoreVoice = 0,  
},
```

Triggering a Communication Event

To trigger a communication event, use the goalop *communicate* with the following attributes. Note that communication animations are not played if the AI is currently playing a smart object action.

name

Name of the communication to trigger (sound, voice, and/or animation). Communication names are defined in an XML file referred to by the `CommConfig` property of this AI.

channel

Communication channel being used by this AI. An AI's communication channel is defined in an XML file in `Game/Scripts/AI/Communication`.

expiry (expiry)

Maximum allowable delay in triggering the communication when the communication channel is temporarily occupied. If a communication can't be triggered within this time period, it is discarded.

To trigger communications using flow graph logic, use the Flow Graph node **AI:Communication**.

Example

```
<GoalPipe name="Cover2_Communicate">  
    <Communicate name="comm_welcome" channel="Search" expiry="0.5"/>  
</GoalPipe>
```

Debugging

To get debug information on AI communication issues, use the following console variables (ai_DebugDraw should be set to "1"):

- ai_DebugDrawCommunication
- ai_DebugDrawCommunicationHistoryDepth

- ai_RecordCommunicationStats

Debug output is shown in the console as illustrated here:

```
Playing communication: comm_welcome[3007966447] as playID[84]
CommunicationPlayer::PlayState: All finished! commID[-1287000849]
CommunicationManager::OnCommunicationFinished: comm_welcome[3007966447] as
playID[84]
CommunicationPlayer removed finished: comm_welcome[3007966447] as playID[84]
with listener[20788600]
```

Troubleshooting

[Warning] Communicate(77) [Friendly.Norm_Rifle1] Communication failed to start

You may get this message or a similar one if your AI's behavior tree calls a communication but the communication configuration is not set up properly. In this example message, "77" refers to line 77 in your AI's behavior tree script (or goalop script). This line is probably communication trigger such as this:

```
<Communicate name="TargetSpottedWhileSearching" channel="Reaction"
expiry="1.0" waitUntilFinished="0" />
```

Some things to check for::

- Does the specified communication name "TargetSpottedWhileSearching" exist in your communication configuration files (XML files located in `Game/Scripts/AI/Communication/`)?
- Check the *CommConfig* property for the AI. Is it set to the name of a `<Config>` element defined in your communication configuration files? If so, is the communication name "TargetSpottedWhileSearching" defined inside this `<Config>` element? This issue, calling communications that aren't configured for the AI is a common source of this error.
- Check the communication's variation definition. Does it point to a resource (animation, sound) that exists? If using a voice library, does it point to a valid voice library file name?

Factions

AI agents use factions to determine their behavior when encountering other AI agents. There are a base set of behaviors such as neutral, friendly and hostile. For example, when an AI in the "Grunt" faction encounters an AI in the "Players" faction, the encounter will be hostile. Players encountering "Civilians" will be friendly, etc.

To set up faction communications:

- Create an XML file that defines all the factions in your game and their reactions to each other (see the example). This file should be placed in `\Games\Scripts\AI\`. The SDK includes a template faction XML file, called `Factions.xml`.
- Set the Faction property for all of your AI agents to one of the defined factions. You can also set factions using Flow Graph

Example: Faction setup

```
Factions.xml
```

```
<Factions>
  <Faction name="Players">
    <Reaction faction="Grunts" reaction="hostile" />
    <Reaction faction="Civilians" reaction="friendly" />
    <Reaction faction="Assassins" reaction="hostile" />
  </Faction>
  <Faction name="Grunts">
    <Reaction faction="Players" reaction="hostile" />
    <Reaction faction="Civilians" reaction="neutral" />
    <Reaction faction="Assassins" reaction="hostile" />
  </Faction>
  <Faction name="Assassins">
    <Reaction faction="Players" reaction="hostile" />
    <Reaction faction="Civilians" reaction="hostile" />
    <Reaction faction="Grunts" reaction="hostile" />
  </Faction>
  <Faction name="HostileOnlyWithPlayers" default="neutral">
    <Reaction faction="Players" reaction="hostile" />
  </Faction>
  <Faction name="Civilians" default="neutral" />
  <Faction name="WildLife" default="neutral" />
</Factions>
```

Modular Behavior Tree

Modular behavior tree (MBT) is a collection of concepts for authoring behaviors for artificial intelligent (AI) agents in your game. Instead of writing complicated code in C++ or other general purpose programming language, MBT lets you describe AI behaviors at a high level without having to think about mechanics such as pointers, memory, and compilers. MBT concepts and implementation are optimized for rapid iteration and re-use.

Core Concepts

Conceptually, MBT is based on two key objects: the *node* and the *tree*.

Node

The node is the most fundamental concept; it is a building block that can be combined with others to build behaviors. A node consists of a block of code that represents a simple task. All nodes have the same interface: when processed, they carry out a task and either succeed or fail.

Nodes can be standalone or may have child nodes, which are processed as part of the parent node processing. When processed, the success of a parent node often (but not always) depends on the success of each child node.

Nodes follow several common patterns, such as action, composite, and decorator nodes. These common node patterns are more fully described in later in this topic.

Game developers can create the nodes needed for their game. In addition, Lumberyard provides a set of standard nodes for general use. These include nodes for tasks related to AI, animation, flying, and common game activities, as well as generic nodes useful when building behaviors, such as for timeouts and looping tasks. These provided nodes are documented in the [Modular Behavior Tree Node Reference \(p. 53\)](#).

Tree

Behaviors are constructed by building trees of nodes, collections of individual tasks that, when positioned as a root with branches that extend out into leaves, define how an AI agent will behave in response to input.

Common Node Patterns

Action Nodes

An action node represents some sort of simple action. Action nodes might cause the AI agent to speak, play an animation, or move to a different location.

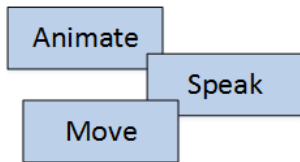

Composite Nodes

A composite node represents a series of actions to be performed in a certain order. Composite nodes consist of a parent node and two or more child nodes. Whether or not a child node is processed (and in what order) can depend on the success or failure of previously processed nodes. Common composite patterns include sequential, selector, and parallel.

Sequential node

This composite pattern describes child nodes that are processed consecutively in a specified sequence. All child nodes are processed regardless of whether the previous child node succeeded or failed. For example, a sequential node might cause an AI monster to point at the player, roar, and then run toward the player. In this pattern, each child node in the sequence must succeed for the next child node to start processing; if any child node fails, the parent node immediately fails and processing is stopped.

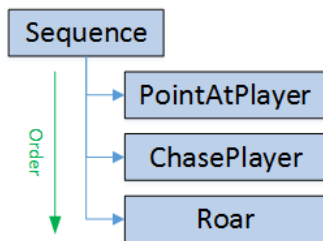

Selector node

This composite pattern describes child nodes that are processed consecutively and in sequence only until one succeeds. As soon as one child node succeeds, the parent node succeeds immediately and stops processing child nodes. If all child nodes are attempted and all fail, the parent node fails. This pattern is useful for setting up AI agents to try multiple different tactics, or for creating fallback behaviors to handle unexpected outcomes.

Imagine, for example, that we want our AI monster to chase the player, but if it can't reach the player it should scream "Come and fight me, you coward!" To implement this scenario, a selector parent node is set up with two children, one for each possible action. The parent node first processes the "chase player" child node. If it succeeds, then the selector node stops there. However, if the "chase player" node fails, then the parent node continues and processes the "taunt player" child node.

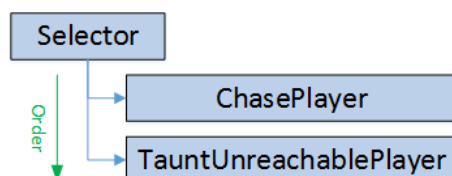

Parallel node

This composite pattern describes child nodes that are processed concurrently. In this scenario, imagine we want our AI monster to scream and chase the player at the same time rather than one after the other.

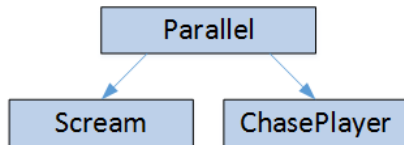

Decorator Nodes

A decorator node represents some sort of functionality that can be added to another node and behaves regardless of how the other node works or what it does. Common decorator functionality includes looping and limiting concurrent functionality.

Looping

Looping functionality can be used to process any other node multiple times. Rather than creating custom nodes every time you want to repeat a task, you can wrap any node in a parent loop decorator node. By setting a parameter for the loop node, you can dictate the number of times the child nodes will be processed. Each time the child node succeeds, the loop node count is updated and the child node is re-processed. Once the loop count meets the set parameter, the loop node succeeds.

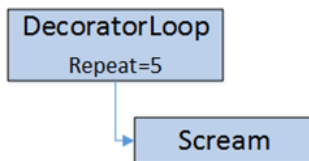

Limiting concurrent users

This functionality lets you specify how many users should be allowed to concurrently use a specified node. It is a good way to ensure variations in behavior among a group of AI agents. A typical scenario illustrating this function is as follows: The player is spotted by a group of three monsters. You want one monster to sound an alarm while the others chase the player.

Limiting concurrent users works with a selector node, which steps through a sequence of child nodes until one succeeds. By wrapping one of a selector node's child nodes in a limit decorator node, you can cause the child node to fail due to concurrent users, which in turn causes the selector node to move to the next child.

To handle the scenario described, the selector node would have two child nodes, "sound alarm" and "chase player". The "sound alarm" node is wrapped in a limit node, with the user limit set to 1. Monster #1 flows through the selector node to the limit node; as there is no one currently using the "sound alarm" node, the Monster #1 takes this action. The limit node records that one AI agent is processing the child node, so effectively locks the door to it. Monsters #2 and #3 also flow through the selector node to the limit node, but because the limit node has reached its limit of user, it reports a failure. Consequently, the selector node moves on to the next child node in the sequence, which is "chase player". So monsters #2 and #3 chase the player.

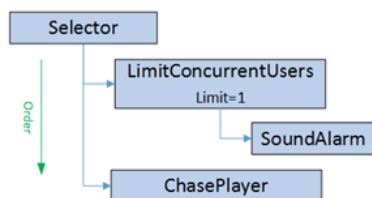

Describing Behavior Trees in XML

Behavior trees are described using XML markup language. Behavior trees are hot-loaded every time the user jumps into the game in the editor.

The following XML example describes the behavior tree for a group of monsters. In this example, only one monster at a time is allowed to chase the player. The remaining monsters stand around and taunt the player.

```
<BehaviorTree>
  <Root>
    <Selector>
      <LimitConcurrentUsers max="1">
        <ChasePlayer />
      </LimitConcurrentUsers>
      <TauntPlayer />
    </Selector>
  </Root>
</BehaviorTree>
```

C++ Implementation

You'll find all MBT code encapsulated in the BehaviorTree namespace.

Understanding the Memory Model

MBT has a relatively small memory footprint. It accomplishes this by (1) sharing immutable (read-only) data between instances of a tree, and (2) only allocating memory for things that are necessary to the current situation.

Memory is divided into two categories: configuration data and runtime data. In addition, MBT uses smart pointers.

Configuration data

When a behavior tree such as the following example is loaded, a behavior tree template is created that holds all the configuration data shown in the example. This includes a sequence node with four children: two communicate nodes, an animate node, and a wait node. The configuration data is the animation name, duration, etc., and this data never changes.

```
<Sequence>
  <Communicate name="Hello" />
  <Animate name="LookAround" />
  <Wait duration="2.0" />
  <Communicate name="WeShouldGetSomeFood" />
</Sequence>
```

Memory for the configuration data is allocated from the level heap. When running the game through the launcher, this memory is freed on level unload; alternatively, it is freed when the player exits game mode and returns to edit mode in Lumberyard Editor.

Runtime data

When spawning an AI agent using a behavior tree, a behavior tree Instance is created and associated with the agent. The instance points to the behavior tree template for the standard configuration data, which means that the instance contains only instance-specific data such as variables and timestamps.

When the tree instance is accessed for the AI agent, it begins by executing the Sequence node. If the core system detects that this is the first time the behavior has been run for this AI agent, it allocates a runtime data object specifically for this node and agent. This means that every AI agent gets its own runtime data object when executing a behavior tree node. The runtime data object persists as long as the AI agent is executing a node (this can be several frames) but is freed when the AI agent leaves a node.

Memory for runtime data is allocated from a bucket allocator. This design minimizes memory fragmentation, which is caused by the fact that runtime data is usually just a few bytes and is frequently allocated and freed. The bucket allocator is cleaned up on level unload.

Smart pointers

MBT uses Boost smart pointers to pass around data safely and avoid raw pointers as much as possible. Memory management is taken care of by the core system. (While there are circumstances in which a *unique_ptr* from C++11 would work well, Lumberyard uses Boost's *shared_ptr* for compatibility reasons.)

Implementing an MBT Node

To implement a new MBT node in C++, you'll need to do the following tasks:

- Create the node
- Expose the node to the node factory
- Set up error reporting for the node

Creating a node

The following code example illustrates a programmatic way to create a behavior tree node. When naming new nodes, refer to [Recommended Naming Practices \(p. 52\)](#).

```
#include <BehaviorTree/Node.h>

class MyNode : public BehaviorTree::Node
{
    typedef BehaviorTree::Node BaseClass;

public:
    // Every instance of a node in a tree for an AI agent will have a
    // runtime data object. This data persists from when the node
    // is visited until it is left.
    //
    // If this struct is left out, the code won't compile.
    // This would contain variables like 'bestPostureID', 'shotsFired' etc.
    struct RuntimeData
    {
    };

    MyNode() : m_speed(0.0f)
    {
    }

    // This is where you'll load the configuration data from the XML file
    // into members of the node. They can only be written to during the
    loading phase
    // and are conceptually immutable (read-only) once the game is running.
    virtual LoadResult LoadFromXml(const XmlNodeRef& xml, const LoadContext&
context)
```

```
{
    if (BaseClass::LoadFromXml(xml, context) == LoadFailure)
        return LoadFailure;
    xml->getAttr("speed", m_speed);
    return LoadSuccess;
}

protected:
    // Called right before the first update
    virtual void OnInitialize(const UpdateContext& context)
    {
        BaseClass::OnInitialize(context);

        // Optional: access runtime data like this
        RuntimeData& runtimeData = GetRuntimeData<RuntimeData>(context);
    }

    // Called when the node is terminated
    virtual void OnTerminate(const UpdateContext& context)
    {
        BaseClass::OnTerminate(context);

        // Optional: access runtime data like this
        RuntimeData& runtimeData = GetRuntimeData<RuntimeData>(context);
    }

    virtual Status Update(const UpdateContext& context)
    {
        // Perform your update code and report back whether the
        // node succeeded, failed or is running and needs more
        // time to carry out its task.

        // Optional: access runtime data like this
        RuntimeData& runtimeData = GetRuntimeData<RuntimeData>(context);
        return Success;
    }

    // Handle any incoming events sent to this node
    virtual void HandleEvent(const EventContext& context, const Event& event)
    {
        // Optional: access runtime data like this
        RuntimeData& runtimeData = GetRuntimeData<RuntimeData>(context);
    }

private:
    // Store any configuration data for the node right here.
    // This would be immutable things like 'maxSpeed', 'duration',
    // 'threshold', 'impulsePower', 'soundName', etc.
    float m_speed;
};

// Generate an object specialized to create a node of your type upon
// request by the node factory. The macro drops a global variable here.
GenerateBehaviorTreeNodeCreator(MyNode);
```

Exposing a node

To use the newly created node, you'll need to expose it to the node factory, as shown in the following code snippet.

```
BehaviorTree::INodeFactory& factory = gEnv->pAISystem-  
>GetIBehaviorTreeManager()->GetNodeFactory();  
ExposeBehaviorTreeNodeToFactory(factory, MyNode);
```

Setting up error reporting

Use the class `ErrorReporter` to report errors and warnings in the new node. It will let you log a printf-formatted message and automatically include any available information about the node, such as XML line number, tree name, and node type.

```
ErrorReporter(*this, context).LogError("Failed to compile Lua code '%s'",  
code.c_str());
```

Variables

Variables are statically declared in XML, with information about how they will change in response to signals from AI agents (named text messages within the AI system).

The following code snippet illustrates the use of variables to receive input from the AI system. In this example, the AI agent takes action based on whether or not it can "see" the target.

```
<BehaviorTree>  
  <Variables>  
    <Variable name="TargetVisible" />  
  </Variables>  
  <SignalVariables>  
    <Signal name="OnEnemySeen" variable="TargetVisible" value="true" />  
    <Signal name="OnLostSightOfTarget" variable="TargetVisible"  
value="false" />  
  </SignalVariables>  
  <Root>  
    <Selector>  
      <IfCondition condition="TargetVisible">  
        <Move to="Target" />  
      </IfCondition>  
      <Animate name="LookAroundForTarget" />  
    </Selector>  
  </Root>  
</BehaviorTree>
```

Lua Scripting

Lua code can be embedded in a behavior tree and executed along with the tree nodes. This is useful for running fire-and-forget code or for controlling the flow in a tree. It's useful for prototyping or extending functionality without having to create new nodes.

The code is compiled once when the level is loaded in pure game to reduce fragmentation. Only code for behavior trees that are actually used in that level will be compiled.

All Lua nodes provide access to the *entity* variable.

- `ExecuteLua` runs a bit of Lua code. It always succeeds.

```
<ExecuteLua code="DoSomething()" />
```

- `LuaWrapper` inserts a bit of Lua code before and after running child node. The post-node code is run regardless of whether the child node succeeded or failed.

```
<LuaWrapper onEnter="StartParticleEffect()" onExit="StopParticleEffect()">
  <Move to="Cover" />
</LuaWrapper>
```

- `LuaGate` uses a bit of Lua code to control whether or not a child node should be run. If the Lua code returns true, the child node is run and `LuaGate` returns the status of the child node (success or failure). If the code returns false or fails to execute, the child node is not run, and `LuaGate` returns failure.

```
<LuaGate code="return IsAppleGreen()">
  <EatApple />
</LuaGate>
```

- `AssertLua` lets you make a statement. If the statement is true, the node succeeds; if it's false the node fails.

```
<Sequence>
  <AssertLua code="return entity.someCounter == 75" />
  <AssertCondition condition="TargetVisible" />
  <Move to="Target" />
</Sequence>
```

Timestamps

A timestamp identifies a point in time when an event happened. A lot of AI behavior depends on tracking the timestamp of certain events and measuring the amount of time from those points. For example, it can be useful to tie behavior to how long it's been since the AI agent was last shot at or hit, when it last saw the player, or how long it's been since moving to the current cover location.

Timestamps can be declared as mutually exclusive, that is, both timestamps can't have a value at the same time. For instance, `TargetSpotted` and `TargetLost` can both have a value because the AI agent can't see a player and at the same time consider them lost. With exclusive timestamps, when one timestamp has a value written to it, the other timestamp is automatically cleared.

The following code snippet illustrates the use of timestamps.

```
<BehaviorTree>
  <Timestamps>
    <Timestamp name="TargetSpotted" setOnEvent="OnEnemySeen" />
    <Timestamp name="ReceivedDamage" setOnEvent="OnEnemyDamage" />
    <Timestamp name="GroupMemberDied" setOnEvent="GroupMemberDied" />
  </Timestamps>
  <Root>
    <Sequence>
      <WaitUntilTime since="ReceivedDamage" isMoreThan="5"
orNeverBeenSet="1" />
      <Selector>
        <IfTime since="GroupMemberDied" isLessThan="10">
          <MoveCautiouslyTowardsTarget />
        </IfTime>
        <MoveConfidentiallyTowardsTarget />
      </Selector>
    </Sequence>
  </Root>
</BehaviorTree>
```

```
</Root>  
</BehaviorTree>
```

Events

Communication with AI agents is done using AI signals, which essentially are named text messages. Signals such as `OnBulletRain` and `OnEnemySeen` communicate a particular event, which, when broadcast to other AI agents, can be reacted to based on each AI agent's behavior tree. This design allows AI behavior to remain only loosely coupled with AI signals. AI signals are picked up and converted to MBT events, then dispatched to the root node, which passes them along down the running nodes in the tree.

```
<Sequence>  
  <WaitForEvent name="OnEnemySeen" />  
  <Communicate name="ThereHeIs" />  
</Sequence>
```

Debugging and Tree Visualization

This section provides help with debugging behavior trees by providing a tree visualization view during debugging. This view allows you to track an AI agent's progress through the tree as the game progresses.

"Slashing" Agents

This feature allows you to view the behavior tree for a specific AI agent in `DebugDraw`. To enable this feature:

1. Set `ai_DebugDraw` to 0 or 1 (default is -1).
2. Select the AI agent you want to view a behavior tree for:
 - Place the selected AI agent in the center of the camera view and press the numpad "/" key.
 - Call `"ai_DebugAgent closest"` to select the agent closest to the camera.
 - Call `"ai_DebugAgent centerview"` to select the agent closest to the center of the camera view (same as slash).
 - Call `"ai_DebugAgent <AgentName>"` to select a specific agent by its name.
 - Call `"ai_DebugAgent"` without a parameter to remove the tree visualization.

The tree visualization displays the AI agent's name at the top of the screen and identifies the agent on the screen with a small green dot. Tree nodes are displayed and color coded as follows, with line numbers from the XML file shown on the left.

- White – nodes with custom data
- Blue – leaf nodes, which often carry special weight when debugging
- Gray – all other nodes

Adding Custom Debug Text

Tree visualization supports custom node information. This allows you to get a more in-depth view of the currently running parts of a behavior tree. For example, you can see the name of the event that the `WaitForEvent` node is waiting for, or how much longer `Timeout` is going to run before it times out.

To use this feature, override `GetDebugTextForVisualizer`, as follows.

```
#ifdef STORE_INFORMATION_FOR_BEHAVIOR_TREE_VISUALIZER
```



```
virtual void GetDebugTextForVisualizer(  
    const UpdateContext& updateContext,  
    stack_string& debugText) const  
{  
    debugText.Format("Speed %f", m_speed);  
}  
#endif
```

Logging and Tracing

Tracing log messages is a critical tool for diagnosing problems. Lumberyard provides native support for logging, as shown in the following code snippet.

```
<Sequence>  
    <QueryTPS name="CoverFromTarget" _startLog="Finding cover"  
    _failureLog="Failed to find cover" />  
    <Move to="Cover" _startLog="Advancing" _failureLog="Failed to advance"  
    _successLog="Advanced" />  
</Sequence>
```

(The reserved attributes `_startLog`, `_successLog`, and `_failureLog` are automatically read in.)

Log messages are routed through an object deriving from the `BehaviorTree::ILogRouter` interface. This allows you to determine where the logging messages end up. For example, one option would be to route the info to a personal log and store a short history of log messages for each AI agent; with this approach, log messages can be displayed when debugging as part of an AI agent's tree visualization.

The AI Recorder also retains all log messages; use this tool to explore sequences of events.

Compiling with Debug Information

To compile a game with debug information, you need to define `DEBUG_MODULAR_BEHAVIOR_TREE`.

```
#if !defined(_RELEASE) && (defined(WIN32) || defined(WIN64))  
# define DEBUG_MODULAR_BEHAVIOR_TREE  
#endif
```

Viewing Completed Trees

When a behavior tree finishes executing—either by failing or succeeding all the way through the root node, a notification is displayed in the console window along with a list of recently visited nodes and their line numbers.

[Error] Modular Behavior Tree: The root node for entity 'HumanSoldier' FAILED. Rebooting the tree next frame. (124) Move. (122) Selector. (121) Sequence.

Note that in the example above the tree will be rebooted in the next frame. This suggests that the behavior tree was not designed to handle a failure at this point.

Recommended Naming Practices

The following suggestions help streamline code clarity and communication in a development team.

Naming Nodes

For action nodes, use names that identify the action the node will perform. These are usually action verbs.

Good

- Loop
- Animate
- LimitConcurrentUsers
- ExecuteLua
- Shoot
- AdjustCoverStance

Bad

- Fast
- PathPredictor
- Banana
- Script
- ActivationProcess

Naming Timestamps

Name timestamps based on the event they're related to. Because timestamps describe an event that has already happened, use the past tense (TargetSpotted, not TargetSpots).

- TargetSpotted
- ReceivedDamage
- GroupMemberDied

Modular Behavior Tree Node Reference

This section contains reference information on modular behavior tree (MBT) node types. MBT node types are organized here based on the system they are defined into.

It is possible to expose MBT nodes from anywhere in Lumberyard code. A node can have parameters that configure the behavior of its execution. If an invalid value is passed to the node, causing the node's parsing to fail, an error message is written to either `Editor.log` or `Game.log`.

Node Index

Generic Nodes (p. 55)

- [Loop \(p. 55\)](#)
- [LoopUntilSuccess \(p. 55\)](#)
- [Parallel \(p. 56\)](#)
- [Selector \(p. 56\)](#)
- [Sequence \(p. 57\)](#)
- [StateMachine \(p. 57\)](#)

- [State & Transitions \(p. 58\)](#)
- [SuppressFailure \(p. 58\)](#)
- [Timeout \(p. 59\)](#)
- [Wait \(p. 59\)](#)

[AI Nodes \(p. 59\)](#)

- [AdjustCoverStance \(p. 60\)](#)
- [Aim \(p. 60\)](#)
- [AimAroundWhileUsingAMachingGun \(p. 60\)](#)
- [Animate \(p. 61\)](#)
- [AnimationTagWrapper \(p. 61\)](#)
- [AssertCondition \(p. 62\)](#)
- [AssertLua \(p. 62\)](#)
- [AssertTime \(p. 62\)](#)
- [Bubble \(p. 63\)](#)
- [CheckIfTargetCanBeReached \(p. 63\)](#)
- [ClearTargets \(p. 64\)](#)
- [Communicate \(p. 64\)](#)
- [ExecuteLua \(p. 64\)](#)
- [GroupScope \(p. 65\)](#)
- [IfCondition \(p. 65\)](#)
- [IfTime \(p. 66\)](#)
- [Log \(p. 66\)](#)
- [Look \(p. 66\)](#)
- [LuaGate \(p. 67\)](#)
- [LuaWrapper \(p. 67\)](#)
- [MonitorCondition \(p. 68\)](#)
- [Move \(p. 68\)](#)
- [Priority & Case \(p. 69\)](#)
- [PullDownThreatLevel \(p. 70\)](#)
- [QueryTPS \(p. 70\)](#)
- [RandomGate \(p. 70\)](#)
- [SendTransitionSignal \(p. 71\)](#)
- [SetAlertness \(p. 71\)](#)
- [Shoot \(p. 71\)](#)
- [ShootFromCover \(p. 73\)](#)
- [Signal \(p. 73\)](#)
- [SmartObjectStatesWrapper \(p. 73\)](#)
- [Stance \(p. 74\)](#)
- [StopMovement \(p. 74\)](#)
- [Teleport \(p. 75\)](#)
- [ThrowGrenade \(p. 75\)](#)
- [WaitUntilTime \(p. 76\)](#)

CryAction Nodes (p. 76)

- [AnimateFragment \(p. 76\)](#)

Game Nodes (p. 76)

- [InflateAgentCollisionRadiusUsingPhysicsTrick \(p. 77\)](#)
- [KeepTargetAtADistance \(p. 77\)](#)
- [Melee \(p. 78\)](#)
- [ScorcherDeploy \(p. 79\)](#)
- [SuppressHitReactions \(p. 80\)](#)

Flying Nodes (p. 80)

- [Hover \(p. 80\)](#)
- [FlyShoot \(p. 81\)](#)
- [WaitAlignedWithAttentionTarget \(p. 81\)](#)
- [Fly \(p. 81\)](#)
- [FlyForceAttentionTarget \(p. 83\)](#)
- [FlyAimAtCombatTarget \(p. 83\)](#)
- [HeavyShootMortar \(p. 83\)](#)
- [SquadScope \(p. 84\)](#)
- [SendSquadEvent \(p. 84\)](#)
- [IfSquadCount \(p. 85\)](#)

Generic Nodes

These nodes provide the basic functionality of MBT.

Loop

Executes a single child node a specified number of times or until the child fails its execution.

Parameters

count

Maximum number of times the child node will be executed. If left blank, it is assumed to be infinite and the node will continue running until failure.

Success/Failure

The node SUCCEEDS if the maximum number of repetitions is reached. The node FAILS if execution of the child node FAILS.

Example

```
<Loop count="3">
  <SomeChildNode />
</Loop>
```

LoopUntilSuccess

Executes a child node a specified number of times or until the child node succeeds its execution.

Parameters

attemptCount

Maximum number of times the child node will be executed. If left blank or set to ≤ 0 , it is assumed to be infinite and the node will continue running until success.

Success/Failure

The node SUCCEEDS if the child SUCCEEDS. The node FAILS if the maximum amount of allowed attempts is reached.

Example

```
<LoopUntilSuccess attemptCount="5">
  <SomeChildNode />
</LoopUntilSuccess>
```

Parallel

Executes its child nodes in parallel.

Note

- A maximum number of 32 child nodes is allowed.
- When success and failure limits are reached at the same time, the node will succeed.

Parameters

failureMode

Method to use to evaluate when the node fails. Acceptable values include "any" or "all". Default: "any".

successMode

Method to use to evaluate when the node succeeds. Acceptable values include "any" or "all". Default: "all".

Success/Failure

When `successMode` is set to "all", the node SUCCEEDS if all the child nodes SUCCEEDS.

When `successMode` is set to "any", the node SUCCEEDS if any of the child nodes SUCCEED.

When `failureMode` is set to "any", the node FAILS if any of the child nodes FAILS.

When `failureMode` is set to "all", the node FAILS if all of the child nodes FAIL.

Example

```
<Parallel successMode="any" failureMode="all">
  <SomeChildNode1 />
  <SomeChildNode2 />
  <SomeChildNode3 />
</Parallel>
```

Selector

Executes its child nodes consecutively, one at a time, stopping at the first one that succeeds.

Parameters

None.

Success/Failure

The node executes the child nodes in sequential order and SUCCEEDS as soon as one of the child SUCCEEDS. Once the node succeeds, the child nodes that follow are not executed. The node FAILS if all the child nodes FAIL.

Example

```
<Selector>
  <SomeChildNode1 />
  <SomeChildNode2ToExecuteIfSomeChildNode1Fails />
  <SomeChildNode3ToExecuteIfSomeChildNode2Fails />
</Selector>
```

Sequence

Executes its child nodes one at a time in order.

Note

A maximum of 255 child nodes is allowed.

Parameters

None.

Success/Failure

The node SUCCEEDS if all the child nodes SUCCEED. The node FAILS if any of the child nodes FAILS.

Example

```
<Sequence>
  <SomeChildNode1 />
  <SomeChildNode2 />
  <SomeChildNode3 />
</Sequence>
```

StateMachine

Executes child nodes of type `State` one at a time. The first child node defined is the first to be executed. The current status of a `StateMachine` node is the same as that of the child that is currently being executed.

Parameters

None.

Success/Failure

The node SUCCEEDS if the current `State` child node SUCCEEDS. The node FAILS if the current `State` child node FAILS.

Example

```
<StateMachine>
  <State />
```

```
<State name="State1" />
<State name="State2" />
</StateMachine>
```

State & Transitions

Executes the content of its BehaviorTree node. This node can transition to another state (or itself). If a State node is instructed to transition into itself while running, it will first be terminated, re-initialized, and then updated again.

A State node has the following characteristics:

- Is a basic block of a StateMachine node.
- MUST have a BehaviorTree node.
- MAY have a Transitions element.

Transitions

Transitions elements are described inside a State node, and can contain the definitions of as many transitions as are needed. The transitions elements are not MBT nodes. If a transition specifies a destination state that doesn't exist, an error message will be displayed when parsing the MBT node.

Parameters

<State /> elements must include the following parameters:

name

Name of the state. It must be unique within the scope of the StateMachine it is in.

<Transition /> elements must include the following parameters:

onEvent

Name of the event that may cause the transition to happen. These events are of type AISignal.

to

Name of the state to transition to.

Success/Failure

The node SUCCEEDS if the content of the BehaviorTree node SUCCEEDS.

The node FAILS if the content of the BehaviorTree node FAILS.

Example

```
<State name="StateName">
  <Transitions>
    <Transition onEvent="EventOrTransitionSignalName" to="OtherStateName" />
  </Transitions>
  <BehaviorTree>
    <SomeChildNode />
  </BehaviorTree>
</State>
```

SuppressFailure

Owns and executes one child node. This node will succeed regardless of whether the child node succeeds.

Parameters

None.

Success/Failure

The node always SUCCEEDS once the child node has been executed.

Example

```
<SuppressFailure>  
  <SomeChildThatCanFail />  
</SuppressFailure>
```

Timeout

Fails once a certain amount of time has passed.

Parameters

duration

Amount of time (in seconds) before failure occurs.

Success/Failure

The node FAILS if it runs for more than the amount of time specified in the `duration` parameter.

Example

```
<Timeout duration=5" />
```

Wait

Succeeds once a certain amount of time has passed.

Parameters

duration

Amount of time (in seconds) before the request succeeds.

variation

Maximum additional amount of time that may be randomly added to the value of `duration`, in the range `[0, variation]`. Setting this value causes the wait time to have random variations between different executions of the node.

Success/Failure

The node SUCCEEDS once it has run the duration specified (plus random variation).

Example

```
<Wait duration="5" variation="1" />
```

AI Nodes

These nodes provide MBT functionality for the AI system.

AdjustCoverStance

Updates the AI agent's cover stance based on the maximum height at which its current cover is effective.

Parameters

duration

(Optional) Length of time (in seconds) the node will execute. Set to **continuous** to specify an unlimited time span.

variation

(Optional) Maximum additional time (in seconds) that may be randomly added to the value of **duration**, in the range [0, **variation**]. Setting this value causes the wait time to have random variations between different executions of the node.

Success/Failure

The node SUCCEEDS if execution of the child runs the length of the specified duration. The node FAILS if the child is not in cover.

Example

```
<AdjustCoverStance duration="5.0" variation="1.0"/>
```

Aim

Sets a location for the AI agent to aim at, and then clears the location when the node stops executing.

Parameters

at

Location to aim at. Allowed values include:

- RefPoint
- Target

angleThreshold

(Optional) Tolerance angle for aim accuracy.

durationOnceWithinThreshold

(Optional) Amount of time (in seconds) to continue aiming.

Success/Failure

The node SUCCEEDS after aiming at the desired location for the specified duration, if the location is not valid or if the timeout elapses.

Example

```
<Aim at="Target" durationOnceWithinThreshold="2.0" />
```

AimAroundWhileUsingAMachineGun

Updates the aim direction of the AI agent when using a mounted machine gun.

Parameters

maxAngleRange

(Optional) Maximum angle to deviate from the original direction.

minSecondsBetweenUpdates

(Optional) Minimum amount of delay (in seconds) between updates.

useReferencePointForInitialDirectionAndPivotPosition

Boolean.

Success/Failure

The node does not succeed or fail.

Example

```
<AimAroundWhileUsingAMachineGun minSecondsBetweenUpdates="2.5"  
  maxAngleRange="30" useReferencePointForInitialDirectionAndPivotPosition="1" /  
>
```

Animate

Sets the AI agent to play an animation.

Parameters

name

Animation to be played.

urgent

(Optional) Boolean indicating whether or not to add the urgent flag to the animation.

loop

(Optional) Boolean indicating whether or not to add the loop flag to the animation.

setBodyDirectionTowardsAttentionTarget

(Optional) Boolean indicating whether or not to change the AI's body target direction to face the attention target.

Success/Failure

The node SUCCEEDS when the animation has finished playing, or if the animation failed to be initialized.

Example

```
<Animate name="LookAround" loop="1" />
```

AnimationTagWrapper

Adds an animation tag to the execution of a child node and clears it at the end.

Parameters

name

Animation tag to be set.

Success/Failure

The node returns the result of the execution of its child node.

Example

```
<AnimationTagWrapper name="ShootFromHip">
```

```
<Shoot at="Target" stance="Stand" duration="5" fireMode="Burst" />  
</AnimationTagWrapper>
```

AssertCondition

Checks whether or not a specified condition is satisfied.

Parameters

condition

Condition to be checked.

Success/Failure

The node SUCCEEDS if the condition is true, otherwise it FAILS.

Example

```
<AssertCondition condition="HasTarget" />
```

AssertLua

Executes a Lua script that returns true/false and translates the return value to success/failure. The result can be used to build preconditions in the MBT.

Parameters

code

Lua script to be executed.

Success/Failure

The node SUCCEEDS if the Lua script returns a value of true, otherwise it FAILS.

Example

```
<AssertLua code="return entity:IsClosestToTargetInGroup()" />
```

AssertTime

Checks whether or not a time condition is satisfied.

Parameters

since

Name of the time stamp to check for the condition.

isMoreThan

Condition statement used to test whether the time stamp is greater than a specified value. Cannot be used with the parameter `isLessThan`.

isLessThan

Condition statement used to test whether the time stamp is less than a specified value. Cannot be used with the parameter `isMoreThan`.

orNeverBeenSet

(Optional) Boolean indicating whether or not to set the node to succeed if the time stamp was never set.

Success/Failure

The node SUCCEEDS if the time condition is true, and FAILS if it is false. If the specified time stamp was not previously set, the node FAILS, unless the parameter `orNeverBeenSet` is true, in which case it SUCCEEDS.

Example

```
<AssertTime since="GroupLostSightOfTarget" isLessThan="10"  
  orNeverBeenSet="1" />
```

Bubble

Displays a message in a speech bubble above the AI agent. See [AI Bubbles System \(p. 19\)](#).

Parameters

message

Message string to be shown in the speech bubble.

duration

Number of seconds to display the message. Default is 0.0.

balloon

Boolean indicating whether or not to display the message in a balloon above the AI agent. Default is true.

log

Boolean indicating whether or not to write the message to the general purpose log. Default is true.

Success/Failure

The node SUCCEEDS immediately after having queued the message to be displayed.

Example

```
<Bubble message="MessageToBeDisplayedAndOrLogged" duration="5.0"  
  balloon="true" log="true" />
```

CheckIfTargetCanBeReached

Checks whether or not the AI agent's attention target can be reached.

Parameters

mode

Target to check for. Allowed values include:

- UseLiveTarget
- UseAttentionTarget

Success/Failure

The node SUCCEEDS if the target can be reached, otherwise it FAILS.

Example

```
<CheckIfTargetCanBeReached mode="UseLiveTarget" />
```

ClearTargets

Clears the AI agent's targets information.

Parameters

None.

Success/Failure

The node always SUCCEEDS.

Example

```
<ClearTargets />
```

Communicate

Sends a request to the communication manager to play one of the AI agent's communications. See [Communication System \(p. 36\)](#).

Parameters

name

The name of the communication to be played.

channel

The channel on which the communication is to be set.

waitUntilFinished

(Optional) Specifies if the execution should wait for the end of the communication before finishing.

timeout

(Optional) The threshold defining the maximum amount of seconds the node will wait.

expiry

(Optional) The amount of seconds the communication can wait for the channel to be clear.

minSilence

(Optional) The amount of seconds the channel will be silenced after the communication is played.

ignoreSound

(Optional) Sets the sound component of the communication to be ignored.

ignoreAnim

(Optional) Sets the animation component of the communication to be ignored.

Success/Failure

If the node is set to wait, the node SUCCEEDS when the communication is complete. Otherwise, it SUCCEEDS once the timeout elapses.

Example

```
<Communicate name="Advancing" channel="Tactic" expiry="1.0"  
waitUntilFinished="0" />
```

ExecuteLua

Executes a Lua script.

Parameters

code

Script to be executed.

Success/Failure

The node always SUCCEEDS.

Example

```
<ExecuteLua code="entity:SetEyeColor(entity.EyeColors.Relaxed)" />
```

GroupScope

Makes execution of a child node conditional on entering the AI agent in a group scope. Groups allow a limited number of concurrent users.

Parameters

name

Name of the group scope to enter.

allowedConcurrentUsers

(Optional) Maximum number of simultaneous users allowed in the specified group scope.

Success/Failure

The node FAILS if the AI agent cannot enter the group scope; otherwise, it returns the result of executing the child node.

Example

```
<GroupScope name="DeadBodyInvestigator" allowedConcurrentUsers="1">  
  <SendTransitionSignal name="GoToPrepareToInvestigateDeadBody" />  
</GroupScope>
```

IfCondition

Executes a child node if a specified condition is satisfied.

Parameters

condition

Condition statement to be checked.

Success/Failure

If the condition is satisfied, the node returns the result of executing the child node. If the condition is not satisfied, the node FAILS.

Example

```
<IfCondition condition="TargetVisible">  
  <Communicate name="AttackNoise" channel="BattleChatter" expiry="2.0"  
    waitUntilFinished="1" />  
</IfCondition>
```

IfTime

Executes a child node if a time condition is satisfied.

Parameters

since

Name of the time stamp to check for the condition.

isMoreThan

Condition statement test whether the time stamp is greater than a specified value. Cannot be used with the parameter `isLessThan`.

isLessThan

Condition statement test whether the time stamp is less than a specified value. Cannot be used with the parameter `isMoreThan`.

orNeverBeenSet

(Optional) Boolean indicating whether or not to set the node to succeed if the time stamp was never set.

Success/Failure

If the time condition is true, the node returns the result of executing the child node. It FAILS if the time condition is false. If the specified time stamp was not previously set, the node FAILS, unless the parameter `orNeverBeenSet` is true, in which case it SUCCEEDS.

Example

```
<IfTime since="FragGrenadeThrownInGroup" isMoreThan="5.0" orNeverBeenSet="1">  
  <ThrowGrenade type="frag" />  
</IfTime>
```

Log

Adds a message to the AI agent's personal log.

Parameters

message

Message to be logged.

Success/Failure

The node always SUCCEEDS.

Example

```
<Log message="Investigating suspicious activity." />
```

Look

Adds a location for the AI agent to look at, and clears it when the node stops executing.

Parameters

at

Location to look at. Allowed values are:

- ClosestGroupMember
- RefPoint
- Target

Success/Failure

This node does not succeed or fail.

Example

```
<Look at="ClosestGroupMember" />
```

LuaGate

Executes a child node only if the result from running a Lua script is true.

Parameters

code

Lua script to be executed.

Success/Failure

The node SUCCEEDS if the result of the Lua script is true, and FAILS if the result is not true. On success, the node returns the result of executing the child node.

Example

```
<LuaGate code="return AI.GetGroupScopeUserCount(entity.id,
'DeadBodyInvestigator') == 0">
  <Animate name="AI_SearchLookAround" />
</LuaGate>
```

LuaWrapper

Runs a Lua script before and/or after the execution of a child node.

Parameters

onEnter

(Optional) Script to be executed at the start.

onExit

(Optional) Script to be executed at the end.

Success/Failure

The node returns the result of executing the child node.

Example

```
<LuaWrapper onEnter="entity:EnableSearchModule()"
onExit="entity:DisableSearchModule()">
  <Animate name="AI_SearchLookAround" />
</LuaWrapper>
```

MonitorCondition

Continuously checks the state of a specified condition.

Parameters

condition

Specifies the condition to be checked.

Success/Failure

The node SUCCEEDS when the condition is satisfied.

Example

```
<MonitorCondition condition="TargetVisible" />
```

Move

Moves the AI agent from its current position to a specified destination. If the destination is a target, then the end position is updated if it is not reached when the target moves. See [Movement System \(p. 34\)](#).

Parameters

speed

Speed of movement. Allowed values include:

- Walk
- Run
- Sprint

stance

Body stance while moving. Allowed values include:

- Relaxed
- Alerted
- Stand (default)

bodyOrientation

Direction the AI agents body should face during the move. Allowed values include:

- FullyTowardsMovementDirection
- FullyTowardsAimOrLook
- HalfwayTowardsAimOrLook (default)

moveToCover

Boolean indicating whether or not the AI agent is moving into cover. Default is false.

turnTowardsMovementDirectionBeforeMovingx

Boolean indicating whether or not the AI agent should first turn to the direction of movement before actually moving. Default is false.

strafe

Boolean indicating whether or not the AI agent is allowed to strafe. Default is false.

glanceInMovementDirection

Boolean indicating whether or not the AI agent can glance in the direction of movement. If false, the AI agent will always look at its look-at target. Default is false.

to

Movement destination. Allowed values include:

- Target - Current attention target.
- Cover - Current cover position.
- RefPoint - Current reference position.
- LastOp - Position of the last successful position-related operation.

stopWithinDistance

Distance from the target that the AI agent can stop moving. Default is 0.0.

stopDistanceVariation

Maximum additional distance that may be randomly added to the value of `stopDistanceVariation`, in the range `[0, stopDistanceVariation]`. Setting this value causes the stop distance to vary randomly between different executions of the node. Default is 0.0.

fireMode

Firing style while moving. Allowed values are listed for the [Shoot \(p. 71\)](#) node.

avoidDangers

Boolean indicating whether or not the AI agent should avoid dangers while moving. Default is true.

avoidGroupMates

Boolean indicating whether or not the AI agent should avoid group mates while moving. Default is true.

considerActorsAsPathObstacles

Boolean indicating whether or not an AI agent's pathfinder should avoid actors on the path. Default is false.

lengthToTrimFromThePathEnd

Distance that should be trimmed from a pathfinder path. Use positive values to trim from the path end, or negative values to trim from the path start. Default is 0.0.

Success/Failure

The node SUCCEEDS if the destination is reached. The node FAILS if the destination is deemed unreachable.

Example

```
<Move to="Target" stance="Alerted" fireMode="Aim" speed="Run"
  stopWithinDistance="3" />
```

Priority & Case

Prioritizes to selects from a set of possible child nodes to execute. Within a `<Priority>` node, each child node is listed inside a `<Case>` node, which defines a condition statement. A child node is selected and executed based on (1) the first child to have its condition met, and (2) in the case of ties, the order the child nodes are listed in. All but the last child must have a condition statement; the last child listed is the default case, so its condition must always be true.

Parameters

The `<Priority>` node has no parameters.

The `<Case>` node has the following parameters:

condition

Condition statement used to prioritize a child node.

Success/Failure

The node returns the result of the executed child node.

Example

```
<Priority>
  <Case condition="TargetInCloseRange and TargetVisible">
<Melee target="AttentionTarget" />
  </Case>
  <Case>
<Look at="Target" />
  </Case>
</Priority>
```

PullDownThreatLevel

Lower's the AI agent's perception of the target's threat.

Parameters

to

Success/Failure

The node always SUCCEEDS.

Example

```
<PullDownThreatLevel to="Suspect" />
```

QueryTPS

Performs a TPS query to find a tactical position for the AI agent, and waits for a result. See [AI Tactical Point System \(p. 21\)](#).

Parameters

name

Name of the TPS query to run.

register

Location to store the result of the TPS query. Allowed values include:

- RefPoint
- Cover (default)

Success/Failure

The node SUCCEEDS if the TPS returns a tactical position, or FAILS if it does not find a tactical position.

Example

```
<QueryTPS name="queryName" register="Cover" />
```

RandomGate

Executes a child node (or not) based on random chance.

Parameters

opensWithChance

Probability to use to determine whether the child node will be executed. Allowed values include floats 0.0 to 1.0.

Success/Failure

The node FAILS if the child node is not executed. If it is executed, the node SUCCEEDS AND returns the result of the execution of its child node.

Example

```
<RandomGate opensWithChance="0.5">  
  <ThrowGrenade type="frag" />  
</RandomGate>
```

SendTransitionSignal

Sends a signal, destined for a state machine node on the behavior tree, with the explicit intent of causing a change of state.

Parameters

name

Name of the signal to be sent.

Success/Failure

This node does not succeed or fail.

Example

```
<SendTransitionSignal name="LeaveSearch" />
```

SetAlertness

Sets the AI agent's alertness level.

Parameters

value

Alertness level. Allowed values include integers 0 to 2.

Success/Failure

The node always SUCCEEDS.

Example

```
<SetAlertness value="1" />
```

Shoot

Sets the AI agent to shoot at a target or location.

Parameters

duration

Length of time (in seconds) the AI agent should continue shooting.

at

Location to shoot at. Allowed values include:

- AttentionTarget
- ReferencePoint
- LocalSpacePosition

fireMode

Firing style. Allowed values include:

- Off - Do not fire (default).
- Burst - Fire in bursts at living targets only.
- Continuous - Fire continuously at living targets only.
- Forced - Fire continuously at any target.
- Aim - Aim only at any target.
- Secondary - Fire secondary weapon (grenades, etc.).
- SecondarySmoke - Fire smoke grenade.
- Melee - Melee.
- Kill - Shoot at the target without missing, regardless of the AI agent's aggression/attackRange/accuracy settings.
- BurstWhileMoving - Fire in bursts while moving and too far away from the target.
- PanicSpread - Fire randomly in the general direction of the target.
- BurstDrawFire - Fire in bursts in an attempt to draw enemy fire.
- MeleeForced - Melee without distance restrictions.
- BurstSwipe - Fire in burst aiming for a head shot.
- AimSweep - Maintain aim on the target but don't fire.
- BurstOnce - Fire a single burst.

stance

Body stance while shooting. Allowed values include:

- Relaxed
- Alerted
- Crouch
- Stand

position

(Required if the target is a local space position) Local space position to be used as the target.

stanceToUseIfSlopesTooSteep

(Optional) Alternative stance style if the slope exceeds a specified steepness. Allowed values are the same as for `stance`.

allowedSlopeNormalDeviationFromUpInDegrees

(Optional) Maximum allowed steepness (in degrees of inclination above horizontal) to set the primary stance. At positions that exceed this slope, the alternative stance is used.

aimObstructedTimeout

(Optional) Length of time (in seconds) the AI agent's aim can be obstructed before the node will fail.

Success/Failure

The node SUCCEEDS if it executes for the specified duration. The node FAILS if the aim is obstructed for longer than the specified timeout.

Example

```
<Shoot at="Target" stance="Crouch" fireMode="Burst"  
duration="5" allowedSlopeNormalDeviationFromUpInDegrees="30"  
stanceToUseIfSlopeIsTooSteep="Stand" />
```

ShootFromCover

Sets the AI agent to shoot at the target from cover and adjusts its stance accordingly.

Parameters

duration

Length of time (in seconds) the node should execute.

fireMode

Firing style. Allowed values are listed for the [Shoot \(p. 71\)](#) node.

aimObstructedTimeout

(Optional) Length of time (in seconds) the AI agent's aim can be obstructed before the node will fail.

Success/Failure

The node SUCCEEDS if it executes for the specified duration. The node FAILS if the AI agent is not in cover, if there's no shoot posture, or if the aim is obstructed for longer than the specified timeout.

Example

```
<ShootFromCover duration="10" fireMode="Burst" aimObstructedTimeout="3" />
```

Signal

Sends a signal to the AI system. See [Signals \(p. 86\)](#).

Parameters

name

Name of the signal to be sent.

filter

(Optional) Signal filter to use when sending the signal, which determines which AI agents will receive it.

Success/Failure

The node always SUCCEEDS.

Example

```
<Signal name="StartedJumpAttack" />
```

SmartObjectStatesWrapper

Sets the states of certain smart objects immediately before and/or after the execution of a child node.

Parameters

onEnter

(Optional) Smart object states to set at the start.

onExit

(Optional) Smart object states to set at the end.

Success/Failure

The node returns the result of executing the child node.

Example

```
<SmartObjectStatesWrapper onEnter="InSearch" onExit="-InSearch">  
  <Animate name="LookAround" />  
</SmartObjectStatesWrapper>
```

Stance

Sets the stance of the AI agent.

Parameters

name

Primary stance style. Allowed values include:

- Relaxed
- Alerted
- Crouch
- Stand

stanceToUseIfSlopelsTooSteep

(Optional) Alternative stance style if the slope exceeds a specified steepness. Allowed values are the same as for *stance*.

allowedSlopeNormalDeviationFromUpInDegrees

(Optional) Maximum allowed steepness (in degrees of inclination above horizontal) to set the primary stance. At positions that exceed this slope, the alternative stance is used.

Success/Failure

The node always SUCCEEDS.

Example

```
<Stance name="Crouch" allowedSlopeNormalDeviationFromUpInDegrees="30"  
  stanceToUseIfSlopeIsTooSteep="Stand" />
```

StopMovement

Sends a request to the Movement system to stop all movements. See [Movement System \(p. 34\)](#).

Note

This may not immediately stop the AI agent The Movement system may be dependent on animations and physics that dictate a 'natural' stop rather than an immediate cessation of movement.

Parameters

waitUntilStopped

Boolean indicating whether or not the node should wait for the Movement System to finish processing the request.

waitUntilIdleAnimation

Boolean indicating whether or not the node should wait until the Motion_Idle animation fragment begins running in Mannequin.

Success/Failure

The node SUCCEEDS if the stop request has been completed.

Example

```
<StopMovement waitUntilStopped="1" waitUntilIdleAnimation="0" />
```

Teleport

Moves the AI agent when both the destination point and source point are outside the camera view.

Parameters

None.

Success/Failure

The node always SUCCEEDS.

Example

```
<Teleport />
```

ThrowGrenade

Triggers the AI agent to attempt a grenade throw.

Parameters

timeout

Maximum length of time (in seconds) to wait for the grenade to be thrown.

type

Grenade type to throw. Allowed values include:

- emp
- frag
- smoke

Success/Failure

The node SUCCEEDS if a grenade is thrown before it times out, otherwise the node FAILS.

Example

```
<ThrowGrenade type="emp" timeout="3" />
```

WaitUntilTime

Executes until a time condition is satisfied.

Parameters

since

Name of the time stamp to check for the condition.

isMoreThan

Condition statement used to test whether the time stamp is greater than a specified value. Cannot be used with the parameter `isLessThan`.

isLessThan

Condition statement used to test whether the time stamp is less than a specified value. Cannot be used with the parameter `isMoreThan`.

succeedIfNeverBeenSet

(Optional) Boolean indicating whether or not to set the node to succeed if the time stamp was never set.

Success/Failure

The node SUCCEEDS if the time condition is true. If the specified time stamp was not previously set, the node FAILS, unless the parameter `succeedIfNeverBeenSet` is true, in which case it SUCCEEDS.

Example

```
<WaitUntilTime since="BeingShotAt" isMoreThan="7" />
```

CryAction Nodes

These nodes provide MBT functionality for CryAction features.

AnimateFragment

Plays a Mannequin animation fragment and waits until the animation finishes.

Parameters

name

Name of the animation to play.

Success/Failure

The node SUCCEEDS if the animation is correctly played or if no operation was needed. The node FAILS if an error occurs while trying to queue the animation request.

Example

```
<AnimateFragment name="SomeFragmentName" />
```

Game Nodes

These nodes offer game-specific MBT functionality. These allow a game with multiple character types to trigger specific logic and perform actions involving each type's peculiarities. Game-specific nodes not likely to be good for "general use" will probably need customization for each game.

Character types are defined in a Lua file, which contains a table of settings for game nodes.

InflateAgentCollisionRadiusUsingPhysicsTrick

Enlarges an AI agent's capsule radius for collisions with a player. This node employs a trick in the physics system inflate the capsule radius for agent-player collisions while leaving the radius unchanged for collisions between the agent and the world.

Note

This trick is entirely isolated within this node. The node does not clean up after itself, so the capsule remains inflated after it has been used.

This trick works as follows:

1. Sets the player dimensions with the agent-vs.-player collision radius. The physics system is multi-threaded, so there's a short wait while until the player dimensions are committed.
2. Periodically inspects the player dimensions to check that the agent-vs.-player collision radius has been successfully committed. This can sometimes fail to happen, such as when the AI agent is in a tight spot and can't inflate.
3. Once the agent-vs.-player radius has been committed, goes into the geometry and sets the capsule's radius in place, using the agent-vs.-world radius. This will not affect the agent-vs.-player dimensions.

Parameters

radiusForAgentVsPlayer

Size of capsule to use when calculating collisions between the AI agent and the player.

radiusForAgentVsWorld

Size of capsule to use when calculating collisions between the AI agent and the world.

Success/Failure

The node does not SUCCEED or FAIL. Once executed, it continues running until it is out of the scope of the executed nodes.

Example

```
<InflateAgentCollisionRadiusUsingPhysicsTrick radiusForAgentVsPlayer="1.0"  
radiusForAgentVsWorld="0.5" />
```

KeepTargetAtADistance

Keeps the live target at a distance by physically pushing the target away when it is within a specified distance. This node is useful when there is some sort of action close to the player and you want to avoid clipping through the camera. Use of this node is preferable over increasing the AI agent's capsule size, which will also affect how the character fits through tight passages. This node is generally used in parallel with other actions that need to be performed while the player cannot come too close to the AI agent; for example, when playing an animation on the spot that can move the AI agent without moving the locator, causing camera clipping.

Parameters

distance

Minimum distance allowed between the player and the AI agent.

impulsePower

Amount of impulse used to keep the player at least at the minimum distance.

Success/Failure

The node does not SUCCEED or FAIL. Once executed, it continues running until it is out of the scope of the executed nodes.

Example

```
<KeepTargetAtADistance distance="1.8" impulsePower="1.5" />
```

Melee

Triggers a melee attack against the AI agent's target. The melee attack is performed if the following condition are satisfied:

- If `failIfTargetNotInNavigationMesh` is set, the target must be on a valid walkable position. Some melee animations can move the character to a position outside the navigable area if trying to melee a target outside the navigation mesh.
- If the target is not within the threshold angle specified by the entity Lua value `melee.angleThreshold`.

Parameters

target

Target of the melee attack. This parameter could be set with the AI agent's `AttentionTarget` or a generic `RefPoint`.

cylinderRadius

Radius of the cylinder used for the collision check of the hit.

hitType

Type of hit that will be reported to the game rules. Default is `CGameRules::EHitType::Melee`.

failIfTargetNotInNavigationMesh

Boolean indicating whether or not the node should try to melee a target that is outside the navigation mesh.

materialEffect

Name of the material effect used when the melee attack hits the target.

Success/Failure

This node succeeds regardless of whether or not a melee attack is executed and, if it is, whether or not the attack damages the target. This is because a failure in this node is not important for behavior tree logic. If it's important for the game to react to this situation, a fail option can be added.

Example

```
<Melee target="AttentionTarget" cylinderRadius="1.5" hitType="hitTypeName"
materialEffect="materialEffectName" />
```

Lua table settings

The Lua table `melee` contains the following settings:

```
melee =
{
    damage = 400,
```

```
hitRange = 1.8,  
knockdownChance = 0.1,  
impulse = 600,  
angleThreshold = 180,  
},
```

damage

Amount of damage a melee attack inflicts on the target.

hitRange

Height of the cylinder used to check whether or not the melee attack can hit the target.

knockdownChance

Probability that a successful melee attack knocks down the player.

impulse

Amount of impulse applied to the player in the case of a successful melee attack.

angleThreshold

Maximum angle allowed between the AI agent's direction of movement and the direction of a path between the AI agent and the target for melee attack to be attempted.

ScorcherDeploy

Manages how the Scorcher character type handles certain activity while deploying or undeploying as part of its shooting phase. This node relies on some external Lua scripts and various signals to work properly, but is useful in obfuscating some common functionality in the AI libraries.

Before and after the node runs, the following Lua functions are called: `EnterScorchTargetPhase()` and `LeaveScorchTargetPhase()`. When the node starts running, the "ScorcherScorch" animation tag is requested by Mannequin. When the node stops, if it stops normally, the "ScorcherNormal" tag is requested again. If it is terminated prematurely, it is up to the behavior tree script to define a proper exit strategy, such as requesting the "ScorcherTurtle" tag.

On requesting animation tags, the node waits for the following animation events to be received (this ensures that the transition blend animations are not interrupted):

1. "ScorcherDeployed" – when the scorcher is ready to start firing
2. "ScorcherUndeployed" – when the scorcher is again ready to walk around

The node encapsulates the following child nodes: `RunWhileDeploying` and `RunWhileDeployed`, each of which can contain exactly one child node.

RunWhileDeploying

Causes activity to happen while the Scorcher is in the process of deploying, that is, getting ready for an attack. As an example, this node might be used to control aiming before actually shooting.

The node will continue running until one of the following events occur, after which the node will be forcefully stopped:

- `ScorcherFriendlyFireWarningModule` sends one of these signals to the entity: "OnScorchAreaClear" or `OnScorchAreaNotClearTimeout`
- Mannequin animation sequence sends a "ScorcherDeployed" signal
- An internal timeout elapses

The node does not support any parameters. The node SUCCEEDS or FAILS depending on whether the child node succeeds or fails. The node is allowed to SUCCEED prematurely.

RunWhileDeployed

Controls actual aiming and firing during an attack. Duration and execution of the attack is controlled via this node.

The node does not support any parameters. The node SUCCEEDS or FAILS depending on whether the child node succeeds or fails. The node is allowed to SUCCEED prematurely. If the node SUCCEEDS, this triggers the parent node to start the undeployment sequence.

Parameters

maxDeployDuration

Length of time (in seconds) to allow the "RunWhileDeploying" child node to run. Default is 2.0.

Success/Failure

The node SUCCEEDS if the entire deploy and undeploy sequence is completed. The node FAILS if either the RunWhileDeploying or RunWhileDeployed nodes FAILED.

Example

```
<ScorcherDeploy maxDeployDuration="1.0">
  <RunWhileDeploying>
    <SomeChildNode>
  </RunWhileDeploying>
  <RunWhileDeployed>
    <SomeOtherChildNode>
  </RunWhileDeployed>
</ScorcherDeploy>
```

SuppressHitReactions

Enables or disables the Hit Reaction system for the AI agent.

Parameters

None.

Success/Failure

The node SUCCEEDS or FAILS based on success or failure of its child node.

Example

```
<SuppressHitReactions>
  <SomeChildNode />
</SuppressHitReactions>
```

Flying Nodes

These nodes provide MBT functionality related to flying vehicles.

Hover

Causes a flying AI agent to hover at its current position.

Parameters

None.

Success/Failure

The node does not SUCCEED or FAIL. Once executed, it continues running until forced to terminate.

Example

```
<Hover />
```

FlyShoot

Allows the AI agent to shoot at its attention target when possible from its current position.

If the AI agent's secondary weapon system is used, the node will only open fire if the weapons are able to hit close enough to the target. Otherwise normal firing rules are applied.

Parameters

useSecondaryWeapon

Boolean indicating whether or not the secondary weapon system (such as rocket launchers) should be used. Default is 0.

Success/Failure

The node does not SUCCEED or FAIL. Once executed, the AI agent continues to shoot until forced to terminate.

Example

```
<FlyShoot useSecondaryWeapon="1" />
```

WaitAlignedWithAttentionTarget

Waits until the AI agent is facing its attention target.

Parameters

toleranceDegrees

Maximum angle (in degrees) between the attention target and the forward direction of the AI agent to consider the AI agent to be "facing" the attention target. Allowed values include the range [0.0,180.0]. Default is 20.0.

Success/Failure

The node SUCCEEDS if the angle between the AI agent's forward direction and its attention target is within the allowed range. The node FAILS if the AI agent has no attention target.

Example

```
<WaitAlignedWithAttentionTarget toleranceDegrees="40" />
```

Fly

Allows an AI agent to fly around by following a path. Paths should be assigned to the AI agent using Flow Graph.

Parameters

desiredSpeed

Speed of movement (in meters per second) along the path to move along the path. Default is 15.0.

pathRadius

Radius of the path (in meters). While flying, the AI agent tries to stay within this distance from the path's line segments. Defaults is 1.0.

lookAheadDistance

Distance (in meters) to look forward along the path for 'attractor points' to fly to. Default is 3.0.

decelerateDistance

Distance (in meters) from the end of the path that the AI agent starts to decelerate. Default is 10.0.

maxStartDistanceAlongNonLoopingPath

Maximum distance (in meters) to look ahead for the closest point to link with another path. This parameter is used to link with non-looping paths; for example, it is useful to prevent the AI agent from snapping to the new path at a position that seems closer but is actually behind a wall after a U-turn. Defaults is 30.0.

loopAlongPath

Boolean indicating whether or not the AI agent should follow a path in an endless loop. Default is 0.

startPathFromClosestLocation

Boolean indicating at what point the AI agent should start following a path. Default is 0.

- 1 - at its closest position
- 2 - at the first path waypoint

pathEndDistance

Distance (in meters) from the end of the path that this node should start sending arrival notification events. Defaults is 1.0.

goToRefPoint

Boolean indicating whether or not the current reference point should be appended to the end of the path. Default is 0.

Success/Failure

The node SUCCEEDS if the AI agent reached the end of the path. The node FAILS if no valid path was assigned to the AI agent.

Example

```
<Fly lookaheadDistance="25.0" pathRadius="10.0"  
decelerateDistance="20.0" pathEndDistance="1" desiredSpeed="15"  
maxStartDistanceAlongNonLoopingPath="30" loopAlongPath="0" goToRefPoint="1"  
startPathFromClosestLocation="1" />
```

Lua table settings

The following properties in the AI agent's Lua script table can override the default XML tags. This will allow for changes to be made at run-time through (Flow Graph) scripting.

When	Lua variable	XML tag
Each node tick	Helicopter_Speed	desiredSpeed
Node activation	Helicopter_Loop	loopAlongPath
Node activation	Helicopter_StartFromClosestLocation	startPathFromClosestLocation

Upon arrival, the following events will be emitted:

- ArrivedCloseToPathEnd
- ArrivedAtPathEnd

FlyForceAttentionTarget

Keeps an attention target on a flying vehicle by force. The attention target is acquired during each tick of the node from the `Helicopter_ForcedTargetId` Lua script variable. When the node is deactivated, a `ForceAttentionTargetFinished` event is emitted.

Parameters

None.

Success/Failure

The node does not SUCCEED or FAIL. Once executed, it continues to force the attention target until deactivation.

Example

```
<FlyForceAttentionTarget />
```

FlyAimAtCombatTarget

Aims a flying AI agent at its target, taking into account special aiming adjustments for weapons.

Parameters

None.

Success/Failure

The node does not SUCCEED or FAIL. Once executed, it continues to force the AI agent to rotate its body towards the attention target until termination.

Example

```
<FlyAimAtCombatTarget />
```

HeavyShootMortar

Controls shooting the mortar (or Heavy X-Pak) weapon. It tries to simplify and centralize the pre-condition check and initialization of the weapon, plus re-selection of the primary weapon.

Parameters

to

(Optional) Shooting target. Allowed values include:

- Target (default)
- Refpoint

fireMode

(Optional) Type of firing. Allowed values include:

- Charge (default)
- BurstMortar

timeout

(Optional) Maximum time (in seconds) to continue shooting. Default is 5.0.

aimingTimeBeforeShooting

(Optional) Time (in seconds) to spend aiming before starting to shoot. Value must be longer than the global timeout. Default is 1.0.

minAllowedDistanceFromTarget

(Optional) Minimum distance (in meters) to the target required to start shooting. Default is 10.0.

Success/Failure

The node FAILS if the weapon is closer to the target than the value of `minAllowedDistanceFromTarget`. The node FAILS if there are obstructions less than two meters in front of the weapon; a cylinder check is done to avoid this. The node FAILS if the timeout is reached. The node SUCCEEDS if the shooting SUCCEEDS.

Example

```
<HeavyShootMortar to="RefPoint" fireMode="Charge"
  aimingTimeBeforeShooting="2" timeout="7" />
```

SquadScope

Makes execution of a child node conditional on adding the AI agent to a squad scope. Squads allow a limited number of concurrent users.

Note

The dynamic squad system uses the AI system's cluster detector. This tool is used with `AISquadManager` to group AI agents into dynamic squads.

Parameters

name

Name of the squad scope to enter.

allowedConcurrentUsers

(Optional) Maximum number of simultaneous users allowed in the specified squad scope. Default is 1.

Success/Failure

The node SUCCEEDS when the child SUCCEEDS. The node FAILS if the AI agent can't enter the squad scope or if the child FAILS.

Example

```
<SquadScope name="SomeScopeName" allowedConcurrentUsers="5">
  <SomeChildNode />
</SquadScope>
```

SendSquadEvent

Sends an event to squad members only.

Note

The dynamic squad system uses the AI system's cluster detector. This tool is used with `AISquadManager` to group AI agents into dynamic squads.

Parameters

name

Name of the event to be sent.

Success/Failure

The node always SUCCEEDS after sending the event.

Example

```
<SendSquadEvent name="SomeEventName" />
```

IfSquadCount

Makes execution of a child node conditional on whether or not the number of squad members meets a specified condition. Although all parameters are optional, at least one parameter must be used.

Note

The dynamic squad system uses the AI system's cluster detector. This tool is used with `AISquadManager` to group AI agents into dynamic squads.

Parameters

isGreaterThan

(Optional) Condition statement used to test whether the number of squad members exceeds a specified value.

isLesserThan

(Optional) Condition statement used to test whether the number of squad members is under a specified value.

equals

(Optional) Condition statement used to test whether the number of squad members exactly equals a specified value.

Success/Failure

The node SUCCEEDS if the number of squad members satisfies the specified condition statement, and FAILS if not.

Example

```
<IfSquadCount isGreaterThan="1">  
  <SomeChildNode />  
</IfSquadCount>
```

Repoints

A repoint, or reference point, is a special AI object used by goalpipes. It primarily specifies a position and, as needed, a direction. The following examples illustrate how repoints are used.

Example 1: Updating a repoint involving sub-goalpipes

In this example, a repoint position is set, and a goalpipe is created containing three goalops: Locate, Stick, and Signal. Using the repoint, Locate sets a value called LASTOP, which is used in Stick to pinpoint a destination.

Notice that the goalop Stick is defined as "+stick". This ensures that Stick is grouped with the previous goalop (Locate). As a result, if the interrupting goalpipe affects values that Stick depends on (such as LASTOP), it will return to the appropriate goalop to update the dependent values.

```
ACT_GOTO = function(self, entity, sender, data)
```

```
if (data and data.point) then
    AI.SetRefPointPosition(entity.id, data.point);

    -- use dynamically created goal pipe to set approach distance
    g_StringTemp1 = "action_goto"..data.fValue;
    AI.CreateGoalPipe(g_StringTemp1);
    AI.PushGoal(g_StringTemp1, "locate", 0, "refpoint");
    AI.PushGoal(g_StringTemp1, "+stick", 1, data.point2.x,
        AILASTOPRES_USE, 1, data.fValue); -- noncontinuous stick
    AI.PushGoal(g_StringTemp1, "signal", 0, 1, "VEHICLE_GOTO_DONE",
        SIGNALFILTER_SENDER);
    entity:InsertSubpipe(AIGOALPIPE_SAMEPRIORITY, g_StringTemp1, nil,
        data.iValue);
end
end,
```

Example 2: Using an AI anchor to set a reppoint

In this example, the Smart Object system spots a relevant AI anchor using `OnBiomassDetected`. This anchor is used to set both the position and direction of the reppoint. As a result, the AI agent walks to the reppoint, turns to the indicated direction, and then selects the next goalpipe.

```
OnBiomassDetected = function(self, entity, sender, data)
    entity:SetTargetBiomass(sender);
    entity:SelectPipe(0, "AlienTick_ReachBiomass");
end,
```

```
function AlienTick_x:SetTargetBiomass(biomass)
    self.AI.targetBiomassId = biomass.id;
    AI.SetRefPointPosition(self.id, biomass:GetWorldPos());
    AI.SetRefPointDirection(self.id, biomass:GetDirectionVector(1));
end
```

```
<GoalPipe name="AlienTick_ReachBiomass">
    <Speed id="Walk"/>
    <Locate name="refpoint"/>
    <Stick distance="0.3" useLastOp="true"/>
    <Signal name="OnBiomassReached"/>
</GoalPipe>
```

```
OnBiomassReached = function(self, entity)
    entity.actor:SetForcedLookDir(AI.GetRefPointDirection(entity.id));
    entity:SelectPipe(0, "AlienTick_CollectBiomass");
end,
```

Note

The tag `<Group>` was not used in this example because this particular goalpipe is not intended to be interrupted (which is not generally the case).

Signals

The Lumberyard AI system includes a fully customizable Signal system that enables AI entities to communicate with each other. Communication consists of signal events that can be sent by an AI agent to another single agent (including itself), or to a group of AI agents currently active in the game.

This topic describes how to send and receive signals between AI agents.

[Signals Reference \(p. 89\)](#)

Sending Signals

Signals are sent from an AI agent's behavior to one or more other AI agents using the method `AI:Signal()`.

```
AI:Signal(Signal_filter, signal_type, *MySignalName*, sender_entity_id);
```

Signal_filter

Group of AI agents to receive the signal. Allowed values include:

- 0 – AI agent specified with the `entity_id` parameter (usually but not always the sender itself).
- `SIGNALFILTER_LASTOP` – AI agent's last operation target (if it has one).
- `SIGNALFILTER_TARGET` – AI agent's current attention target.
- `SIGNALFILTER_GROUPOONLY` – All AI agents in the sender's group (same group id) within communication range.
- `SIGNALFILTER_SUPERGROUP` – All AI agents in the sender's group (same group id) within the whole level.
- `SIGNALFILTER_SPECIESONLY` – All AI agents of the sender's species within communication range.
- `SIGNALFILTER_SUPERSPECIES` – All AI agents of the sender's species within the whole level.
- `SIGNALFILTER_HALFOFGROUP` – Half the AI agents in the sender's group, randomly selected.
- `SIGNALFILTER_NEARESTGROUP` – Nearest AI agent in the sender's group.
- `SIGNALFILTER_NEARESTINCOMM` – Nearest AI agent in the sender's group within communication range.
- `SIGNALFILTER_ANYONEINCOMM` – All AI agents within communication range.
- `SIGNALID_READIBILITY` – Special signal used to make the recipient perform a readability event (sound/animation).

signal_type

Type of signal, which determines how the recipient will process it. Allowed values include:

- 1 – Recipient processes signal only if it is enabled and not set to "ignorant" (see `AI:MakePuppetIgnorant()`).
- 0 – The entity receiving the signal will process it if it's not set to ignorant.
- -1 – The entity receiving the signal will process it unconditionally.

MySignalName

The actual identifier of the signal. It can be any non-empty string; for the signal recipient, it must exist a function with the same name either in its current behavior, its default behavior or in the `Scripts/AI/Behaviors/Default.lua` script file in order to react to the received signal.

entity_id

The entity id of the signal's recipient. Usually you may want to put `entity.id` (or `self.id` if it's called from the entity and not from its behavior), to send the signal to the sender itself, but you can also put any other id there to send the signal to another entity.

Receiving Signals

The action to be performed once a signal is received is defined in a function like this:

```
MySignalName = function(self, entity, sender)
```

self

The recipient entity's behavior.

entity

The recipient entity.

sender

The signal's sender.

This function is actually a callback which, exactly like the system events, can be defined in the recipient entity's current behavior, the default idle behavior (if it's not present in current behavior) or in the `Scripts/AI/Behaviors/Default.lua` script file (if not present in the default idle behavior).

As for system events, a signal can be used also to make a character change its behavior; if we add a line like the following in a character file:

```
Behaviour1 = {  
    OnEnemySeen    = *Behaviour1*,  
    OnEnemyMemory = *Behaviour2*,  
    &#8230;  
    MySignalName  = *MyNewBehaviour*,  
}
```

This means that if the character is currently in `Behaviour1`, and receives the signal `MySignalName`, after having executed the callback function above it will then switch its behavior to `MyNewBehaviour`.

Signal Example

A typical example is when a player's enemy spots the player: its `OnEnemySeen` system event is called, and let's suppose he wants to inform his mates (The guys with his same group id). In his default idle behavior (i.e., `CoverAttack.lua` if the character is `Cover`), we modify its `OnEnemySeen` event like this:

```
OnEnemySeen = function( self, entity, fDistance )  
    -- called when the enemy sees a living enemy  
  
    AI:Signal(SIGNALFILTER_GROUPONLY, 1, "ENEMY_SPOTTED",entity.id);  
end,
```

Here we have defined a new signal called `ENEMY_SPOTTED`.

The next step is to define the callback function. Let's assume the other members in the group have the same character, we then add the callback function to the same idle behavior in which we have just modified `OnEnemySeen`.

```
ENEMY_SPOTTED = function (self, entity, sender)  
    entity:Readability("FIRST_HOSTILE_CONTACT");  
    entity:InsertSubpipe(0, "DRAW_GUN");  
End,
```

This will make the guys (including the signal sender itself, who has the same behavior) change their animation and producing some kind of alert sound (readability), and then draw their gun. Notice that by modifying its idle behavior, we create a default callback which will be executed for any behavior the character is in. Later on, we may want to override this callback in other behaviors. For example, if we

wanted the character to react differently whether it's in idle or attack behavior, we'll add the following callback function in the `CoverAttack.lua` file:

```
ENEMY_SPOTTED = function (self, entity, sender)
    entity:SelectPipe(0, "cover_pindown");
End,
```

Where "cover_pindown" is a goalpipe that makes the guy hide behind the nearest cover place to the target.

We can extend this to other characters: if there are group members with different characters (i.e. Scout, Rear etc) and we want them to react as well, we must add the ENEMY_SPOTTED callback also to their idle/attack behavior. Finally, we want the guys to switch their behavior from idle to attack if they see an enemy.

We'll then add the following line to the character (`Scripts/AI/Characters/Personalities/Cover.lua` in the example):

```
CoverIdle = {
    &#8230;
    ENEMY_SPOTTED = *CoverAttack*,
},
```

Behavior Inheritance

If specific signals are to be used in more than one behavior, there is an inheritance mechanism. Behavior classes can either directly inherit a more general implementation by keyword `Base = [CRYENGINE:ParentBehaviorName]` or indirectly, as a character's Idle behavior as well as the default behavior (defined in file `DEFAULT.lua`) are considered as fallback behaviors if a signal is not implemented in the current behavior.

Signals Reference

A typical signal handler looks something like this:

```
OnEnemySeen = function(self, entity, distance)
    -- called when the AI sees a living enemy
end,
```

Parameters `self` (behavior table) and `entity` (entity table) are passed to every signal. Additional parameters are specific to the signal being used.

See also: `\Game\Scripts\AI\Behaviors\Template.lua`.

Perception Signals

The following signals are sent to AI agents when perception types of their attention targets change.

Note that `AITHREAT_SUSPECT < AITHREAT_INTERESTING < AITHREAT_THREATENING < AITHREAT_AGGRESSIVE`.

No Target

Name	Parameters	Description
OnNoTarget		Attention target is lost

Sound

Sound heard (no visible target).

Name	Parameters	Description
OnSuspectedSoundHeard		Threat is AITHREAT_SUSPECT
OnInterestingSoundHeard		Threat is AITHREAT_INTERESTING
OnThreateningSoundHeard		Threat is AITHREAT_THREATENING
OnEnemyHeard		Threat is AITHREAT_AGGRESSIVE

Memory

The target is not visible and is in memory.

Name	Parameters	Description
OnEnemyMemory		Threat is AITHREAT_THREATENING
OnLostSightOfTarget		Threat is AITHREAT_AGGRESSIVE
OnMemoryMoved		Threat is AITHREAT_AGGRESSIVE and its location or owner has changed

Visual

The target is visible.

Name	Parameters	Description
OnSuspectedSeen		Threat is AITHREAT_SUSPECT
OnSomethingSeen		Threat is AITHREAT_INTERESTING
OnThreateningSeen		Threat is AITHREAT_THREATENING
OnEnemySeen	distance	Threat is AITHREAT_AGGRESSIVE
OnObjectSeen	distance, data	AI sees an object registered for this signal. data.iValue = AI object type (e.g. AIOBJECT_GRENADE or AIOBJECT_RPG)
OnExposedToExplosion	data	AI is affected by explosion at data.point
OnExplosionDanger		Destroyable object explodes

Awareness of Player

Name	Parameters	Description
OnPlayerLooking	sender, data	Player is looking at the AI for entity.Properties.awarenessOfPlayer seconds. data.fValue = player distance
OnPlayerSticking	sender	Player is staying close to the AI since <entity.Properties.awarenessOfPlayer> seconds

Name	Parameters	Description
OnPlayerLookingAway	sender	Player has just stopped looking at the AI
OnPlayerGoingAway	sender	Player has just stopped staying close to the AI

Awareness of Attention Target

Name	Parameters	Description
OnTargetApproaching		
OnTargetFleeing		
OnNewAttentionTarget		
OnAttentionTargetThreatChanged		
OnNoTargetVisible		
OnNoTargetAwareness		
OnSeenByEnemy	sender	AI is seen by the enemy

Weapon Damage

Name	Parameters	Description
OnBulletRain	sender	Enemy is shooting
OnDamage	sender, data	AI was damaged by another friendly/unknown AI. data.id = damaging AI's entity id
OnEnemyDamage	sender, data	AI was damaged by an enemy AI. data.id = damaging enemy's entity id

Proximity

Name	Parameters	Description
OnCloseContact		enemy gets at a close distance to an AI (defined by Lua Property "damageRadius" of this AI)
OnCloseCollision		

Vehicles

Name	Parameters	Description
OnVehicleDanger	sender, data	vehicle is going towards the AI. data.point = vehicle movement direction, data.point2 = AI direction with respect to vehicle
OnEndVehicleDanger		
OnTargetTooClose	sender, data	attention target is too close for the current weapon range (it works only if AI is a vehicle)

Name	Parameters	Description
OnTargetTooFar	sender, data	attention target is too close for the current weapon range (it works only if AI is a vehicle)
OnTargetDead		

User-defined

Custom signals can be sent when an attention target enters or leaves certain ranges. This is configured using the following Lua functions:

```
AI.ResetRanges(entityID);
AI.AddRange(entityID, range, enterSignal, leaveSignal);
AI.GetRangeState(entityID, rangeID);
AI.ChangeRange(entityID, rangeID, distance);
```

Weapon-Related Signals

Name	Parameters	Description
OnLowAmmo		
OnMeleeExecuted		
OnOutOfAmmo		
OnReload		AI goes into automatic reload after its clip is empty
OnReloadDone		reload is done
OnReloaded		

Navigation Signals

Pathfinding

Name	Parameters	Description
OnEndPathOffset	sender	AI has requested a path and the end of path is far from the desired destination
OnNoPathFound	sender	AI has requested a path which is not possible
OnPathFindAtStart		
OnBackOffFailed	sender	AI tried to execute a "backoff" goal which failed
OnPathFound	sender	AI has requested a path and it's been computed successfully

Steering

Name	Parameters	Description
OnSteerFailed		

Smart Objects

Name	Parameters	Description
OnEnterNavSO		
OnLeaveNavSO		
OnUseSmartObject		

Navigation Shapes

Name	Parameters	Description
OnShapeEnabled		
OnShapeDisabled		

Tactics Signals

Tactical Point System

Name	Parameters	Description
OnTPSDestNotFound		
OnTPSDestFound		
OnTPSDestReached		

Cover

Name	Parameters	Description
OnHighCover		
OnLowCover		
OnMovingToCover		
OnMovingInCover		
OnEnterCover		
OnLeaveCover		
OnCoverCompromised		

Groups Signals

Name	Parameters	Description
OnGroupChanged		
OnGroupMemberMutilated		
OnGroupMemberDiedNearest		

Formation

Name	Parameters	Description
OnNoFormationPoint	sender	AI couldn't find a formation point
OnFormationPointReached		
OnGetToFormationPointFailed		

Group Coordination

Group target is the most threatening target of the group.

Name	Parameters	Description
OnGroupTargetNone		
OnGroupTargetSound		
OnGroupTargetMemory		
OnGroupTargetVisual		
PerformingRole		

Flow Graph Signals

These are signals sent by corresponding Flow Graph nodes when they are activated.

Name	Parameters	Description
ACT_AIMAT		AI:AIShootAt
ACT_ALERTED		AI:AIAlertMe
ACT_ANIM		AI:AIAnim
ACT_ANIMEX		AI:AIAnimEx
ACT_CHASETARGET		Vehicle:ChaseTarget
ACT_DIALOG		AI:ReadabilityDialog (also sent by Dialog System)
ACT_DIALOG_OVER		Sent by Dialog System
ACT_DUMMY		
ACT_DROP_OBJECT		AI:AIDropObject
ACT_ENTERVEHICLE		Vehicle:Enter
ACT_EXECUTE		AI:AIExecute
ACT_EXITVEHICLE		Vehicle:Exit, Vehicle:Unload
ACT_FOLLOW		AI:AIFollow
ACT_FOLLOWPATH		AI:AIFollowPath, AI:AIFollowPathSpeedStance, Vehicle:FollowPath

Name	Parameters	Description
ACT_GRAB_OBJECT		AI:AIGrabObject
ACT_GOTO		AI:AIgoto, AI:AIgotoSpeedStance, and the AI Debugger when the user clicks the middle mouse button.
ACT_JOINFORMATION		AI:AIFormationJoin
ACT_SHOOTAT		AI:AIShootAt
ACT_USEOBJECT		AI:AIUseObject
ACT_VEHICLESTICKPATH		Vehicle:StickPath
ACT_WEAPONDRAW		AI:AIWeaponDraw
ACT_WEAPONHOLSTER		AI:AIWeaponHolster
ACT_WEAPONSELECT		AI:AIWeaponSelect

Other Signals

Forced Execute

Name	Parameters	Description
OnForcedExecute		
OnForcedExecuteComplete		

Animation

Name	Parameters	Description
AnimationCanceled		

Game

Name	Parameters	Description
OnFallAndPlay		

Vehicle-related

Name	Parameters	Description
OnActorSitDown	Actor has entered a vehicle	

Squads

Name	Parameters	Description
OnSomebodyDied		

Name	Parameters	Description
OnBodyFallSound		
OnBodyFallSound		
OnUnitDied		
OnSquadmateDied		
OnPlayerTeamKill		
OnUnitBusy		
OnPlayerDied		

Name	Parameters	Description
OnFriendInWay	sender	AI is trying to fire and another friendly AI is on his line of fire
URPRISE_ACTION		
OnActionDone	data	AI action of this agent was finished. data.ObjectName is the action name, data.iValue is 0 if action was cancelled or 1 if it was finished normally, data.id is the entity id of "the object" of the AI action

Animation

This section describes Lumberyard's Animation system. It includes discussions of key concepts and provides information on working with the system programmatically.

This section includes the following topics:

- [Animation Overview \(p. 97\)](#)
- [Animation Events \(p. 100\)](#)
- [Limb IK Technical \(p. 100\)](#)
- [Animation Streaming \(p. 101\)](#)
- [Animation Debugging \(p. 103\)](#)
- [Fall and Play \(p. 108\)](#)
- [Time in the Animation System \(p. 109\)](#)

Animation Overview

One of Lumberyard's goals is to push the boundaries of animations, which are all rendered in real time. Lumberyard provides tools to create both linear and interactive animations:

- Linear animation is the kind of animation seen in movies and cut-scenes, which play as a video.
- Interactive animation is used to convey AI and avatar (player) behavior, with sequences dependent on player choices in gameplay.

There is a big difference between how each type of animation is incorporated into a game, although this difference may not be obvious to the player, who simply sees characters moving on-screen. The key difference is in the decision-making process: who decides what a character on the screen is going to do next?

Linear Animations

In linear animation, the decision-making process happens inside the head of the people designing the animation. During this process, an animator has direct control over every single keyframe. They don't need to deal with collision detection, physics and pathfinding; characters only run into walls or collide with each other when the animator wants them to. AI behavior does not need to react to player behavior; the person who writes the storyboard decides how intelligent or stupid the characters are. To show interactions between characters, you can put them in motion-capture suits and record their performances.

A linear animation sequence needs to show action from a single camera angle because the audience won't be moving during the animation; as a result, animators don't need to deal with transitions and motion combinations; they control every aspect of the motion clip. Because everything is fixed and predictable, it's possible to guarantee a consistent motion quality. Animators can always go back and adjust details in the scene, such as add or delete keyframes, adjust the lighting, or change the camera position.

The technical challenges with creating linear animation primarily involve rendering issues, such as not dropping the frame rate and ensuring that facial and body animations are in sync.

All linear animations in Lumberyard are created with Track View Editor.

Interactive Animations

Creating interactive animations presents significantly tougher challenges. Animators and programmers do not have direct control over a character's on-screen movements. It is not always obvious where and how the decision-making process happens. It is usually a complex combination of AI systems, player input, and sometimes contextual behavior.

By definition, interactive animation is responsive. It looks visibly different depending on an individual user's input and adapts automatically to actions on the screen. Moving from linear animation to interactive animation requires more than just a set of small tweaks or a change in complexity—it requires a completely different technology under the hood. With interactive animation, an animator cannot precisely plan and model a character's behavior. Instead, animators and programmers develop a system that allows them to synthesize motion automatically and define rules for character behavior.

Automatic motion synthesis is a crucial feature in making animation more interactive. A system that synthesizes motion must be very flexible, because it is difficult to predict the sequence of actions that a character may take, and each action can start at any time.

Imagine, for example, a character moving through an outdoor environment. At a minimum, the designer needs to specify the style, speed, and direction of the character's locomotion. There should also be variations in motion while running uphill or downhill, leaning when running around corners or carrying objects of different sizes and weights—the character should run faster while carrying a pistol than when hefting a rocket launcher. It might also be necessary to interactively control emotional features such as happiness, anger, fear, and tiredness. Additionally, the character may need to perform multiple tasks simultaneously, such as walking in one direction, turning head and eyes to track a bird in another direction, and aiming a gun at a moving object in third direction. Providing unique animation assets for every possible combination and degree of freedom is nearly impossible and would involve an incredibly large amount of data. A mechanism for motion modifications is needed to keep the asset count as low as possible.

Developing such a system involves close collaboration and a tight feedback loop between programmers, animators, and designers. Problems with the behavior and locomotion systems (either responsiveness or motion quality) are usually addressed from several sides.

Interactive animation can be divided into two categories: **Avatar control** and **AI control**. In both cases, animators and programmers have indirect control over the actual behavior of a character in gameplay, because decision making for the character's next action happens elsewhere. Let's take a closer look at the situation in game environments.

Avatar control

An avatar character is controlled by the game player, whose decisions determine all of the avatar's actions. The locomotion system takes the player's input and translates it on the fly into skeleton movements (using procedural and data-driven methods). With avatar control, high responsiveness is the top priority, while motion quality might be limited by the game rules. This means that many well-established rules for 'nice'-looking animations are in direct conflict with the responsiveness you need for certain types of gameplay.

The quality of animations as executed on the screen depends largely on the skills and decisions of each player controlling the character—they decide what the avatar will do next. Because a player's actions are unpredictable, motion planning based on predictions is not possible. Complex emotional control is not possible (and probably not needed). It's only possible on a raw level, such as soft punch versus an aggressive punch. However, it might be possible to let the player control the locomotion of the avatar, and to let the game code control the emotional behavior of the avatar by blending in "additive animations" based on the in-game situation.

In all these scenes, the player is controlling the character with a game pad. The character's presentation on the screen is using animation assets created by animators.

AI control

For AI characters, the decision-making process happens entirely inside the game code. Game developers design a system to generate behavior, which acts as an intermediary between the game creators and players. For the system to perform this task, it is necessary for game designers to explicitly specify behavioral decisions and parameters for AI characters, including a clear definition of the rules of movements for each character type. Interactive animation for AI characters is much harder to accomplish than animations for avatars, but at the same time it offers some (not always obvious) opportunities to improve motion quality. High responsiveness is still the primary goal but, because character choices happen inside the game code, it is possible in certain circumstances to predict a character's actions. If the AI system knows what the AI character wants to do next, then it is possible to incorporate this knowledge into motion planning. With good motion planning, interactive animation might be able to use more classical or 'nice' animation rules. As a result, AI control can have a somewhat higher motion quality than avatar control, though at the cost of having more complex technology under the hood.

The only source of uncertainty in such a prediction system is the player: the AI reacts to the player, and predicting the player's actions is impossible. As a result, it's nearly impossible to create the right assets for every in-game situation, and this in turn makes it impossible to guarantee a consistent motion quality. For an animator working on interactive animation, it can be a significant problem to have no direct control over the final animation—it's never clear when the work is complete. This is one reason why the linear animation in movies and cut-scenes look superior, and why interactive animations can be troublesome.

Lumberyard tackles the problem with interactive animation in multiple levels:

- In the low-level CryAnimation system library, the engine provides support for animation clips, parametrized animation, and procedural modification of poses. Animations can be sequenced together or layered on top of each other in a layered transition queue.
- In the high-level CryAction library, the CryMannequin system helps to manage the complexity of animation variations, transitions between animations, animations that are built up out of many others, sequencing of procedural code, links to game code, and so on.

Scripted Animations

Because interactive animation is much more difficult than linear animation, many games blur the line between cut-scenes and in-game actions by using interactive scripted sequences.

In this case, characters act on a predefined path. The quality of this kind of motion can be very high. Because it is not fully interactive, animators have more control over the entire sequence, a kind of manually designed motion planning. These are perfectly reasonable cheats to overcome hard-to-solve animation problems. It may be even possible to script the entire AI sequence to allow near-cut-scene quality. The action feels interactive and looks absolutely cinematic, but it is actually more an illusion of interactivity.

In the game Crysis, Crytek designers made use of scripted animations in many scenes. In the "Sphere" cut-scene, the Hunter is shown walking uphill and downhill and stepping over obstacles. This is a

scripted sequence where the assets were made for walking on flat ground, but Crytek used CCD-IK to adapt the character's legs to the uneven terrain. In the "Fleet" cut-scene with the Hunter on the carrier deck, the player can move around while the Hunter is fighting other non-playing characters.

Both scenes look and feel highly interactive but they are not. The Hunter doesn't respond to the player and the player cannot fight the Hunter. The scenes are fully linear and scripted, basically just animated background graphics. These sequences were created in Track View Editor. Some of them used the Flow Graph Editor. When the cut-scene is over, the Hunter turns into an AI-controlled interactive character.

Animation Events

Animations in Lumberyard can be marked up to send custom events at a specific time in an animation. This markup is used for time-aligned blending; for example, to match footplants in animations. Another application of animation events is to spawn particle effects at the right moment.

These events can also be used by a variety of systems that need to receive information about when an animation has reached a certain point, such as in combination with a melee system.

Marking Up Animations with Events

Events for animations are stored in an XML file that is loaded when the character starts up. For this to happen automatically, the database must be included in the `chrparams` file.

Receiving Animation Events in the Game Code

Animation events are passed on to the game object once they have been triggered. The Actor and Player implementations both handle these animation events. See either `Actor.cpp` or `Player.cpp` for the function:

```
void AnimationEvent(ICharacterInstance *pCharacter, const AnimEventInstance &event)
```

Limb IK Technical

Lumberyard's animation system allows the setup of IK chains for characters.

When an IK chain is active, the system calculates the joint angles in the chain so that the end effector (typically a hand or foot) reaches the target position.

Setting Up

IK chains are defined in the `chrparams` file.

Using LimbIK from Code

To activate a Limb IK chain from outside the Animation system, use the function `SetHumanLimbIK`, accessible through the `ISkeletonPose` interface. The `SetHumanLimbIK` function needs to be called in each frame in which you want the IK chain to be active. The name of the Limb IK chain is defined in the `chrparams` file:

```
ISkeletonPose& skeletonPose = ...;  
skeletonPose.SetHumanLimbIK(targetPositionWorldSpace, "RgtArm01");
```

Animation Streaming

Animation is very memory-intensive and tends to use a large amount of resources. Limited memory budgets, high numbers of animated joints, and requirements for high animation quality make it wasteful for a project to keep all animations constantly loaded in memory.

Lumberyard's animation system alleviates this issue by streaming in animation resources (file granularity level) when needed, and unloading them when not needed. Streaming of asset files is achieved by using the DGLINK [Streaming System](#). Streaming assets in and out allows the system to keep only the needed resources in memory—which is done at the expense of complexity, as you must now plan how and when animation resources are used.

Animation Data

Animation data usage is divided into two main sections:

- The **header** section contains generic information for an animation (filename, duration, flags, etc).
- The **controller** section contains the animation curves. For each joint involved, this section contains information on all the position and orientation values that the joint needs in order to play that animation. Even when compressed, controller data can easily take up more than 95% of the total memory required for an animation.

Animation Header Data

Header data for animations is stored in CAF files and in the `animations.img` file.

CAF files contain the header information on a single animation, while `animations.img` contains header information for all animations in the build. The `animations.img` is obtained as a result of processing all the animations with the Resource Compiler.

The engine usually loads all the animation files' headers from the `animations.img` file instead of loading from individual files (reading the information from individual files can considerably slow down loading time).

Because of the extreme size difference between controllers and headers, Lumberyard streams only the controller data in and out of memory. The header data for all animations is kept at all times in memory, as it is practical to have that information available at all times.

Note

During development—for example, when working with local animation files—you must disable usage of `animations.img` and load the header information from individual CAF files instead. To do so, set the `ca_UseIMG_CAF` console variable to 0 before the engine starts.

Animation Controller Data

The controller data for animations is stored in CAF files or DBA files.

- CAF files contain controller information for a single animation.
- DBA files contain controller information for a group of animations.

When a DBA is loaded, controllers for all animations contained in that DBA are available until the DBA is unloaded. For this reason, it is useful to group animations that are used together in the same DBA. An extra benefit of putting similar animations together in a DBA is that equal controllers are only stored once. This reduces the memory usage of your animations.

Loading Controller Data

The animation system properly plays animations only when their controllers are in memory.

If controller data is not available when playback of an asset is requested, the animation system streams it in from disk. Streaming of controller data is performed asynchronously—the animation system does not wait until after asset playback is requested. This prevents stalling the system.

If high level systems fail to notify the animation system that they require controller data (see the preload functions section), the animation system does not know that an asset is required until it is requested to play. This is dangerously close to when the controller data is needed. If the controller data is not available in time, it typically leads to visual glitches, which can sometimes be observed, for example, only the first time an animation is played.

Therefore, it is important to have controller data streamed in before playback of an animation is requested. This minimizes undesired glitches that occur while waiting for animation streaming to end.

The amount of time required for streaming to complete depends on many factors, such as the current system load, streaming speed of the target system, size of the resource that needs to be loaded, and so on.

Unloading Controller Data

The animation system will not unload controller data that is currently in use.

It is possible to prevent unloading of animation data entirely by setting `ca_DisableAnimationUnloading` to 1.

Controllers in CAF files are unloaded after the system detects that they are no longer in use. To prevent controllers in CAF files from being unloaded, set `ca_UnloadAnimationCAF` to 0.

Controllers in DBA files remain in memory until a certain amount of time passes after the animations in them are used. However, if the DBA is locked, controllers are not unloaded until the lock status is set back to 0.

To change the time that the animation system waits to unload controllers in DBA files, use the following cvars:

- `ca_DBAUnloadUnregisterTime` – Timeout in seconds after the last usage of a controller and all animations using that DBA; when this timeout is reached, the DBA marks their controller data as 'unloaded'.
- `ca_DBAUnloadRemoveTime` – Timeout in seconds after the last usage of a controller in a DBA; when this timeout is reached, the DBA performs an actual unload from memory. This value should be greater than or equal to `ca_DBAUnloadUnregisterTime`.

The following section describes how to lock individual resources in memory to prevent the system from unloading them.

Preloading and Keeping Controllers in Memory

Preload functions are performed by high level systems or user code (usually game code), as these contain most of the information on when and how assets are accessed. For example, trackview looks a number of seconds ahead in the timeline for any animations that appear, and calls the preload functions.

Preloading Controllers in DBA files

To preload and trigger the streaming of a DBA file:

```
gEnv->pCharacterManager->DBA_PreLoad(dbaFilename, priority);
```

To trigger the streaming of a DBA file, and request a change to the locked state (which specifies whether it should be locked in memory):

```
gEnv->pCharacterManager->DBA_LockStatus(dbaFilename, lockStatus, priority);
```

To unload all controller data in a DBA from memory (unloads data only if none of the controllers are currently being used):

```
gEnv->pCharacterManager->DBA_Unload(dbaFilename);
```

Note

To make the system automatically load and lock a DBA file while a character is loaded, use the `flags="persistent"` in the `chrparams` file.

Preloading Controllers in CAF files

To increase the reference count of a CAF file:

```
gEnv->pCharacterManager->CAF_AddRef(lowercaseAnimationPathCRC);
```

Controllers for a CAF file start streaming in when its reference count goes from 0 to 1.

To decrease the reference count of a CAF file:

```
gEnv->pCharacterManager->CAF_Release(lowercaseAnimationPathCRC);
```

Controllers for a CAF file are unloaded by the animation system only after the reference count reaches 0 (the animation system, when playing a CAF file, also increases this reference count, so that an animation is not unloaded while in use).

To check whether the controllers for a CAF file are loaded:

```
gEnv->pCharacterManager->CAF_IsLoaded(lowercaseAnimationPathCRC);
```

To synchronously load the controllers for a CAF file:

```
gEnv->pCharacterManager->CAF_LoadSynchronously(lowercaseAnimationPathCRC);
```

Synchronously loading CAF assets is strongly discouraged unless absolutely necessary, as it will likely result in stalls.

Animation Debugging

Several tools are available for debugging animation issues.

Layered Transition Queue Debugging

You can enable on-screen debug information to see which animations are queued and playing, as well as information about the applied pose modifiers and IK.

Show Per Entity

To show the transition queue for all the character instances of a specified entity:

```
es_debuganim <entityname> [0 | 1]
```

<entityname>

Name of the entity to debug. In a single player game, the player is typically called "dude." Note that the GameSDK example player has both a first person and a third person character instance.

[0 | 1]

Specify 1 or no second parameter to turn it on for this specific entity. Specify 0 to turn it off.

Examples

To turn on debugging for a player with the entity name "dude":

```
es_debuganim dude 1
```

To turn off debugging for an entity called "npc_flanker_01":

```
es_debuganim npc_flanker_01 0
```

Show Per CharacterInstance

You can show the transition queue for all character instances or the ones that have a specific model name.

```
ca_debugtext [<modelname-substring> | 1 | 0]
```

<modelname-substring>

Shows information for all character instances whose modelname contains the specified string.

[0 | 1]

If 1 is specified, all character instances are shown. If 0 is specified, the debug text is turned off.

Examples

To show information on all character instances with "player" in their model name:

```
ca_debugtext player
```

To turn off all transition queue information:

```
ca_debugtext 0
```

Interpreting the Output

Each animation in the transition queue is displayed as in the following example. Key elements of this display are described following the example.

```
AnimInAFIFO 02: t:1043 _stand_tac_idle_scar_3p_01 ATime:0.84 (1.17s/1.40s)
  ASpd:1.00 Flag:00000042 (-----I-K----) TTime:0.20 TWght:1.00 seg:00
  inmem:1
(Try)UseAimIK: 1 AimIKBlend: 1.00 AimIKInfluence: 1.00 (Try)UseLookIK: 0
LookIKBlend: 0.00 LookIKInfluence: 0.00
MoveSpeed: 4.49 locked: 1
PM class: AnimationPoseModifier_OperatorQueue, name: Unknown
...
LayerBlendWeight: 1.00
...
ADIK Bip01 RHand2RiflePos_IKTarget: 0.24 Bip01 RHand2Aim_IKTarget: 1.00 Bip01
LHand2Aim_IKTarget: 0.00
```

Text Color

- When an animation is not yet active, it is in black or green.
- When an animation is active, it is in red or yellow.

Or in detail:

- Red Channel = Animation Weight
- Green Channel = (layerIndex > 0)
- Alpha Channel = (Weight + 1)*0.5

AnimInAFIFO Line (one per animation)

```
AnimInAFIFO 02: t:1043 _stand_tac_idle_scar_3p_01 ATime:0.84 (1.17s/1.40s)
  ASpd:1.00 Flag:00000042 (-----I-K----) TTime:0.20 TWght:1.00 seg:00
  inmem:1
```

AnimInAFIFO 02

Layer index (decimal, zero-based)

t:1043

User token (decimal)

_stand_tac_idle_scar_3p_01

Animation name (alias) of the currently playing animation, aim/look-pose or bspace

ATime:0.84 (1.17s/1.40s)

ATime:XXXX (YYYYs/ZZZZs)

- XXXX = Current time in 'normalized time' (0.0...1.0) within the current segment
- YYYY = Current time (seconds) within the current segment
- ZZZZ = Expected duration (seconds) of the current segment

ASpd:1.00

Current animation speed (1.0 = normal speed)

Flag:00000042 (-----I-K----)

Animation Flags

Flag:XXXXXXXX (+ybVFx3nSIKTRLM)

The first number is the animation flags in hexadecimal

Between parentheses you see the individual flags:

```
Flags  
0x008000CE_TRANSITION_TO_ANIM  
0x004000ROOT_PRIORITY  
0x002000REMOVE_FROM_FIFO  
0x001000TRACK_VIEW_EXCLUSIVE  
0x000800CE_SKELETON_UPDATE  
0x000400ENABLE_MULTILAYER  
0x000200FRAME_SAMPLE_30Hz  
0x000100LOW_ANIM_RESTART  
0x000080CE2IDLE  
0x000040MOVE  
0x000020START_AFTER  
0x000010START_AT_KEYTIME  
0x000008TRANSITION_TIMEWARPING  
0x000004REPEAT_LAST_KEY  
0x000002ANIMATION  
0x000001MANUAL_UPDATE
```

TTime:0.20

Transition Time

Total length of transition into this animation in seconds (this is static after pushing the animation)

TWght:1.00

Transition Weight

Current weight of this animation within the transition (0 = not faded in yet, 1 = fully faded in)

seg:00

Current segment index (zero-based)

inmem:1

Whether or not the animation is in memory (0 basically means it's not streamed in yet)

Aim/Look-IK Line

```
(Try)UseAimIK: 1 AimIKBlend: 1.00 AimIKInfluence: 1.00 (Try)UseLookIK: 0  
LookIKBlend: 0.00 LookIKInfluence: 0.00
```

(Try)UseAimIK: 1

Whether Aim IK is turned on or not (set using PoseBlenderAim::SetState)

AimIKBlend: 1.00

Weight value requested for Aim IK (could go up and down based on fade times, etc.)

AimIKInfluence: 1.00

Final influence weight value of AimIK (== smoothed(clamped(AimIKBlend)) * weightOfAllAimPoses)

(Try)UseLookIK: 0

Whether Look IK is turned on or not

LookIKBlend: 0.00

Weight value requested for Look IK (could go up and down based on fade times, etc.)

LookIKInfluence: 0.00

Final influence weight value of LookIK (== smoothed(clamped(LookIKBlend)) * weightOfAllLookPoses)

Parameter Line(s) (only for blend spaces)

```
MoveSpeed: 4.500000 locked: 1  
TravelAngle: 0.000000 locked: 0
```

MoveSpeed: 4.500000

Value for the specified blend space parameter (MoveSpeed in this case)

locked: 1

Whether or not the parameter is locked (= unable to change after it is set for the first time)

PoseModifier Lines (if running)

```
PM class: AnimationPoseModifier_OperatorQueue, name: Unknown
```

Displays which pose modifiers are running in this layer. Shows the class as well as the name (if available).

LayerBlendWeight Line (not on layer 0)

```
LayerBlendWeight: 1.00
```

The weight of this layer (0.00 - 1.00)

ADIK Line(s) (only if animation driven IK is applied)

```
ADIK Bip01 RHand2RiflePos_IKTarget: 0.24 Bip01 RHand2Aim_IKTarget: 1.00 Bip01  
LHand2Aim_IKTarget: 0.00
```

Displays a list of the animation driven IK targets and their current weight. For more detailed position/rotation information, use the separate cvar `ca_debugadiktargts 1`.

CommandBuffer Debugging

At the lowest level, the animation system executes a list of simple commands to construct the final skeleton's pose.

These commands are, for example, "sample animation x at time t, and add the result with weight w to the pose". Or "clear the pose".

To enable on-screen debug information to see what is pushed on the command buffer (for all characters), use the following command:

```
ca_debugcommandbuffer [0 | 1]
```

Warning Level

To control when the animation system produces warnings using the `ca_animWarningLevel` cvar:

```
ca_animWarningLevel [0 | 1 | 2 | 3]
```

0

Non-fatal warnings are off.

1

Warn about illegal requests.

For example, requesting to start animations with an invalid index.

2

Also warn about things like 'performance issues.'

For example, animation-queue filling up. This might 'spam' your console with a dump of the animation queue at the time of the issue.

3 (default)

All warnings are on. This includes the least important warnings; for example, a warning when playing uncompressed animation data.

Fall and Play

"Fall and Play" activates when a character is ragdollized (on an interface level, it is called `RelinquishCharacterPhysics`) with a >0 stiffness. This activates angular springs in the physical ragdoll that attempts to bring the joints to the angles specified in the current animation frame. The character also tries to select an animation internally based on the current fall and play stage. If there are none, or very few, physical contacts, this will be a falling animation; otherwise it will be the first frame of a standup animation that corresponds to the current body orientation.

Standup is initiated from outside the animation system through the fall and play function. During the standup, the character physics is switched back into an alive mode and his final physical pose is blended into a corresponding standup animation. This, again, is selected from a standup anims list to best match this pose.

Filename convention for standup animations: When an animation name starts with "standup", it is registered as a standup animation. Also, a type system exists which categorizes standup animations by the string between "standup_" and some keywords ("back", "stomach", "side"). You can control which type to use with `CSkeletonPose::SetFnPAnimGroup()` methods. At runtime, the engine checks the most similar standup animation registered to the current lying pose and blends to it.

Some example filenames:

- `standUp_toCombat_nw_back_01`
- `standUp_toCombat_nw_stomach_01`

While the character is still a ragdoll, it is also possible to turn off the stiffness with a `GoLimp` method.

Time in the Animation System

The Animation system uses different units of 'time,' depending on the system. How those units of time compare is best explained using an example.

The definition of 'frames': The Animation system uses a fixed rate of 30 frames per second (fps). Of course, games can run at higher frame rates, but some operations in the Editor that use the concept of 'frames'—or operations that clamp the animation duration to 'one frame'—assume a frame rate of 30 fps.

Assume then that you have an animation with a duration of 1.5 seconds. This means that the animation has 46 frames (note that this includes the final frame). So, in the case of Real Time, assume an animation starts at time 0, has no segmentation, and is played back at normal speed. However, rather than using Real Time, the Animation system typically uses Animation Normalized Time. This is compared with Real Time in the following table:

Frame Index	Real Time (seconds)*	Animation Normalized Time**
0	0.0 s	0.0
1	0.033.. s = 1/30 s	0.022.. = 1/45
..
30	1.0 s	0.666.. = 30/45
..
44	1.466.. s = 44/30 s	0.977.. = 44/45
45	1.5 s = 45/30 s	1.0

* Real time is used to define duration:

- Duration = lastFrame.realTime - firstFrame.realTime. That's 1.5s in our example.
- `IAnimationSet::GetDuration_sec()` returns the duration of an animation.

Note: For a parametric animation, this returns only a crude approximation—the average duration of all its examples, ignoring parameters or speed scaling.

- `CAnimation::GetExpectedTotalDurationSeconds()` returns the duration of an animation that is currently playing back.

Note: For a parametric animation, this returns only a crude approximation, assuming the parameters are the ones that are currently set and never change throughout the animation.

- No function exists that returns the Real Time of an animation. To calculate that, you must manually multiply Animation Normalized Time with the duration.

** Animation Normalized Time:

- Time relative to the total length of the animation.
- Starts at 0 at the beginning of the animation and ends at 1 (= RealTime/Duration = Keytime/LastKeyTime).
- Used by functions such as `ISkeletonAnim::GetAnimationNormalizedTime()` and `ISkeletonAnim::SetAnimationNormalizedTime()`.
- Is not well-defined for parametric animations with examples that have differing numbers of segments. For more information, see the following section, Segmentation.

Segmentation

In practice, the animation system does not use Animation Normalized Time; this terminology was used to make the introduction easier to understand. Typically, Segment Normalized Time is used. To understand Segment Normalized Time, you must first understand segmentation.

For time warping (phase matching) purposes, animations can be split into multiple segments. For example, to time warp from a walk animation with 2 cycles to a walk animation with 1 cycle, you have to annotate the first animation and split it into two (these are segments). To achieve this segmentation, you must add a segment1 animation event at the border between the cycles.

Note

An animation without segmentation has exactly 1 segment, which runs from beginning to end.

Segmentation introduces a new unit for time, Segment Normalized Time, which is time relative to the current segment duration.

Extending our example further, observe what happens when a segment1 animation event at 1.0s is added to split the animation into two segments.

Frame Index	Real Time	AnimEvents	(Animation) Normalized Time	Segment Index*	Segment Normalized Time**
0	0.0 s		0.0	0	0.0
1	0.033.. s		0.022..	0	0.033.. = 1/30
..
30	1.0 s	segment1	0.666..	1	0.0
..
44	1.466.. s		0.977..	1	0.933.. = 14/15
45	1.5 s		1.0	1	1.0

* Segment index:

- Identifies which segment you are currently in. Runs from 0 to the total number of segments minus 1.
- While an animation is playing, you can use `CAnimation::GetCurrentSegmentIndex()` to retrieve it.
- When using `ca_debugtext` or `es_debuganim`, then this index is displayed after "seg:".

** Segment normalized time:

- Time relative to the current segment's duration.
- 0 at the beginning of the segment, 1 at the end (only 1 for the last segment, as you can see in the table).
- While an animation is playing, you can use `CAnimation::Get/SetCurrentSegmentNormalizedTime()` to get or set the Segment Normalized Time.
- As the names suggest, `CAnimation::GetCurrentSegmentIndex()` retrieves the current segment index and `CAnimation::GetCurrentSegmentExpectedDurationSecondsx()` retrieves the duration of the current segment.

- When representing time within parametric animations, it is more convenient to use Segment Normalized Time than Animation Normalized Time; therefore, Segment Normalized Time is used at runtime.
- AnimEvent time is specified using Animation Normalized Time (except for the special case of parametric animation; see the following section).
- When using `ca_debugtext` or `es_debuganim`, Segment Normalized Time is displayed after "ATime:". Following that, the real time within the segment and the segment duration are displayed within the parentheses.

Playback Speed

Playback speed does not impact the functions that compute duration of playing animations, such as `CAnimation::GetExpectedTotalDurationSeconds()` or `ISkeletonAnim::CalculateCompleteBlendSpaceDuration()`.

Segmented Parametric Animation

Animation Normalized Time, Segment Index, and Duration all create ambiguity for segmented parametric animations. This is because each example animation within the parametric animation can have its own number of segments. To avoid ambiguity, animation events in or on segmented parametric animations use Segment Normalized Time. As a result, an animation event will be fired multiple times (once per segment) during the animation.

- `ISkeletonAnim::GetAnimationNormalizedTime()` uses a heuristic: It currently looks for the example animation with the largest number of segments and returns the animation normalized time within that example.
- `ISkeletonAnim::GetCurrentSegmentIndex()` uses a different heuristic: It currently returns the segment index in the example animation, which happens to be the first in the list.

Given this, we are considering redefining the above based on the following observation: You can define the total number of segments in a parametric animation as the number of segments until repetition starts.

So, say you have a parametric animation consisting of 2 examples—one with 2 segments and the other with 3 segments. This will start to repeat after 6 segments (the lowest common multiple of 2 and 3). However, you can uniquely identify each possible combination of segments using any number from 0 to 5.

The Character Tool uses this method to achieve a well-defined duration. The `ISkeletonAnim::CalculateCompleteBlendSpaceDuration()` function calculates the duration until the parametric animation starts to repeat (assuming the parameters remain fixed). It reverts to the regular `GetExpectedTotalDurationSeconds()` implementation for non-parametric animations so that the function can be used in more general situations.

Animation with Only One Key

Normally your animations have at least two keys. However, when you convert these into additive animations, the first frame is interpreted as the base from which to calculate the additive, leaving only 1 frame in the additive animation (this means that, in respect to the asset, both the start and end time of the asset are set to 1/30 s).

Functions retrieving the total duration of this animation will return 0.0 (for example, `IAnimationSet::GetDuration_sec()`, `ISkeletonAnim::CalculateCompleteBlendSpaceDuration()`, and `CAnimation::GetExpectedTotalDurationSeconds()`).

However, for playback purposes, the animation system handles these animations as if they have a duration of 1/30th of a second. For example, Animation Normalized Time still progresses from 0 to 1, while real time goes from 0 to 1/30th of a second. `CAnimation::GetCurrentSegmentExpectedDurationSecondsx()` also returns 1/30th of a second in this case.

Direction of Time

Time typically cannot run backward when playing an animation. You can move time backward only if you do it manually by setting the flag `CA_MANUAL_UPDATE` on the animation and using `CAnimation::SetCurrentSegmentNormalizedTime`. See the example `DGLINK CProceduralClipManualUpdateList::UpdateLayerTimes()`.

Time within Controllers

Different units are used for controllers that contain the actual key data and are used for animation sampling.

Frame Index	Real Time	I_CAF Ticks*	Keytime**
0	0.0 s	0	0.0
1	0.033.. s	160	1.0
..
30	1.0 s	4800	30.0
..
44	1.466.. s	7040	44.0
45	1.5 s	7200	45.0

* I_CAF Ticks:

- Used within I_CAF files to represent time
- There are 4800 I_CAF ticks per second (this is currently expressed by the fact that `TICKS_CONVERT = 160` in `Controller.h`, which assumes 30 keys/second)

** Keytime

- Used at runtime to pass time to the controllers for sampling animation
- Used within CAF files to represent time
- A floating point version of 'frame index'
- Can represent time in between frames
- Use `GlobalAnimationHeaderCAF::NTime2KTime()` to convert from Animation Normalized Time to Keytime
- All animation controllers in the runtime use Keytime

Animation assets can also have a `StartTime` other than 0.0s—this complicates matters slightly, but only for the controllers. Typically, for everywhere but the controllers, time is taken relative to this `StartTime`.

Asset Builder API

The asset builder API and builder SDK are in preview release for Lumberyard 1.5, and are subject to change as they undergo improvements.

You can use the asset builder API to develop a custom asset builder that creates your own asset types. Your asset builder can process any number of asset types, generate outputs, and return the results to the asset processor for further processing. This can be especially useful in a large project that has custom asset types.

Builder Modules

A builder module is a `.dll` module that contains a *lifecycle component* and one or more *builders*. The lifecycle component is derived from `AZ::Component`. The builders can be of any type and have no particular base class requirements.

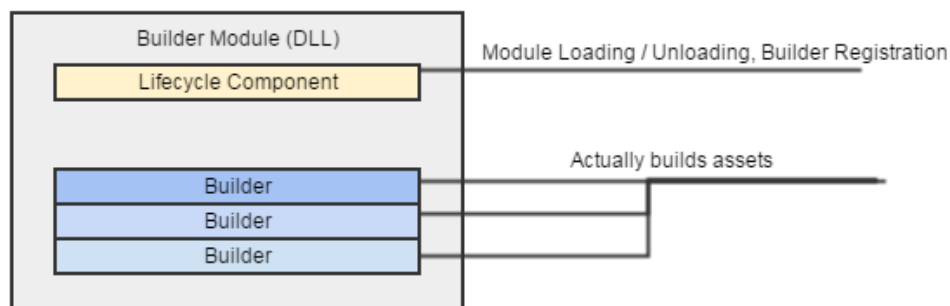

The job of the lifecycle component is to register its builders during the call to `Activate()` and to make sure that resources that are no longer being used are removed in the calls to `Deactivate` and `Destructor`.

Creating a Builder Module

To create a builder module, you must perform the following steps.

- Create the exported `.dll` entry point functions and invoke the `REGISTER_ASSETBUILDER` macro, which creates a forward declaration for the entry point functions.
- Register your lifecycle component's `Descriptor`
- Add your lifecycle component to the `Builder` entity
- Register your builder instances when your lifecycle component's `Activate()` function is called
- Shut down safely

Note

A complete example of a builder module is in the Lumberyard `dev\Code\tools\AssetProcessor\Builders` directory. We recommend that you follow the commented example as you read this documentation. The asset builder SDK is located in the Lumberyard directory `\dev\Code\Tools\AssetProcessor\AssetBuilderSDK\AssetBuilderSDK`.

Main Entry Point

The following code shows an example of a `main.cpp` file for an asset builder module.

```
#include <AssetBuilderSDK/AssetBuilderSDK.h>
#include <AssetBuilderSDK/AssetBuilderBusses.h>

// Use the following macro to register this module as an asset builder.
// The macro creates forward declarations of all of the exported entry points
// for you.
REGISTER_ASSETBUILDER

void BuilderOnInit()
{
    // Perform any initialization steps that you want here. For example, you
    // might start a third party library.
}

void BuilderRegisterDescriptors()
{
    // Register your lifecycle component types here.
    // You can register as many components as you want, but you need at least
    // one component to handle the lifecycle.
    EBUS_EVENT(AssetBuilderSDK::AssetBuilderBus, RegisterComponentDescriptor,
    ExampleBuilder::BuilderPluginComponent::CreateDescriptor());
    // You can also register other descriptors for other types of components
    // that you might need.
}

void BuilderAddComponents(AZ::Entity* entity)
{
    // You can attach any components that you want to this entity, including
    // management components. This is your builder entity.
    // You need at least one component that is the lifecycle component.
    entity->CreateComponentIfReady<ExampleBuilder::BuilderPluginComponent>();
}

void BuilderDestroy()
{
    // By the time you leave this function, all memory must have been cleaned
    // up and all objects destroyed.
    // If you have a persistent third party library, you could destroy it
    // here.
}
```

```
}
```

Lifecycle Component

The lifecycle component reflects the types that you want to serialize and registers the builder or builders in your module during its `Activate()` function.

The following shows example code for the lifecycle component.

```
//! This is an example of the lifecycle component that you must implement.
//! You must have at least one component to handle your module's lifecycle.
//! You can also make this component a builder by having it register itself
    as a builder and
    making it listen to the builder bus. In this example it is just a
    lifecycle component for the purposes of clarity.

class BuilderPluginComponent
    : public AZ::Component
{
public:
    AZ_COMPONENT(BuilderPluginComponent, "{8872211E-F704-48A9-
B7EB-7B80596D871D}")
    static void Reflect(AZ::ReflectContext* context);

    BuilderPluginComponent(); // Avoid initializing here.

    //////////////////////////////////////
    // AZ::Component
    virtual void Init(); // Create objects, allocate memory and initialize
        without reaching out to the outside world.
    virtual void Activate(); // Reach out to the outside world and connect to
        and register resources, etc.
    virtual void Deactivate(); // Unregister things, disconnect from the
        outside world.

    //////////////////////////////////////

    virtual ~BuilderPluginComponent(); // free memory and uninitialized
        yourself.

private:
    ExampleBuilderWorker m_exampleBuilder;
};
```

In the following example, the `Activate()` function registers a builder, creates a builder descriptor, and then provides the details for the builder.

```
void BuilderPluginComponent::Activate()
{
    // Activate is where you perform registration with other objects and
    systems.

    // Register your builder here:
    AssetBuilderSDK::AssetBuilderDesc builderDescriptor;
    builderDescriptor.m_name = "Example Worker Builder";
```



```
builderDescriptor.m_patterns.push_back(AssetBuilderSDK::AssetBuilderPattern("*.example",
AssetBuilderSDK::AssetBuilderPattern::PatternType::Wildcard));
    builderDescriptor.m_createJobFunction =
AZStd::bind(&ExampleBuilderWorker::CreateJobs, &m_exampleBuilder,
AZStd::placeholders::_1, AZStd::placeholders::_2);
    builderDescriptor.m_processJobFunction =
AZStd::bind(&ExampleBuilderWorker::ProcessJob, &m_exampleBuilder,
AZStd::placeholders::_1, AZStd::placeholders::_2);

    builderDescriptor.m_busId = ExampleBuilderWorker::GetUUID(); // Shutdown
is communicated on this bus address.
    m_exampleBuilder.BusConnect(builderDescriptor.m_busId); // You can use a
global listener for shutdown instead of
                                                                    // for each
builder; it's up to you.

    EBUS_EVENT(AssetBuilderSDK::AssetBuilderBus, RegisterBuilderInformation,
builderDescriptor);
}
```

Notes

- The example calls an [EBus](#) to register the builder. After you register a builder, the builder receives requests for assets from its two registered callback functions.
- If the application needs to shut down, the asset processor broadcasts the `Shutdown()` message on the builder bus using the address of the registered builder's UUID.
- Your builders do not have to be more than functions that create jobs and then process those jobs. But if you want your builder to listen for `Shutdown()` messages, it must have a listener that connects to the bus.

Creating a Builder

Your next step is to create a builder. You can have any number of builders, or even all of your builders, inside your module. After registering your builders as described in the previous section, implement the two `CreateJobFunction` and `ProcessJobFunction` callbacks.

The following example code declares a builder class:

```
#include <AssetBuilderSDK/AssetBuilderSDK.h>

class ExampleBuilderWorker : public
AssetBuilderSDK::AssetBuilderCommandBus::Handler // This handler delivers
the "shut down!"

    // message on another thread.
{
public:
    ExampleBuilderWorker();
    ~ExampleBuilderWorker();

    //! Asset Builder Callback Functions
    void CreateJobs(const AssetBuilderSDK::CreateJobsRequest& request,
AssetBuilderSDK::CreateJobsResponse& response);
    void ProcessJob(const AssetBuilderSDK::ProcessJobRequest& request,
AssetBuilderSDK::ProcessJobResponse& response);
```

```
////////////////////////////////////  
    //!AssetBuilderSDK::AssetBuilderCommandBus interface  
    void ShutDown() override; // When this is received, you must fail all  
    existing jobs and return.  
  
////////////////////////////////////  
  
    static AZ::Uuid GetUUID();  
  
private:  
    bool m_isShuttingDown = false;  
};
```

The asset processor calls the `ShutDown()` function to signal a shutdown. At this point, the builder should stop all tasks and return control to the asset processor.

Notes

- Failure to terminate promptly can cause a hang when the asset processor shuts down and restarts. The shutdown message comes from a thread other than the `ProcessJob()` thread.
- The asset processor calls the `CreateJobs(const CreateJobsRequest& request, CreateJobsResponse& response)` function when it has jobs for the asset types that the builder processes. If no work is needed, you do not have to create jobs in response to `CreateJobsRequest`, but the behavior of your implementation should be consistent.
- For the purpose of deleting stale products, the job that you spawn is compared with the jobs spawned in the last iteration that have the same input, platform, and job key.
- You do not have to check whether a job needs processing. Instead, at every iteration, emit all possible jobs for a particular input asset on a particular platform.
- In general, in the `CreateJobs` function, you create a job descriptor for each job that you want to emit, and then add the job to the list of job descriptors for the response.

The following code shows an example `CreateJobs` function.

```
// This function runs early in the file scanning pass.  
// This function should always create the same jobs, and should not check  
// whether the job is up to date.  
  
void ExampleBuilderWorker::CreateJobs(const  
    AssetBuilderSDK::CreateJobsRequest& request,  
    AssetBuilderSDK::CreateJobsResponse& response)  
{  
    // The following example creates one job descriptor for the PC platform.  
    // Normally, you create a job for each platform that you can make assets  
    for.  
    if (request.m_platformFlags & AssetBuilderSDK::Platform_PC)  
    {  
        AssetBuilderSDK::JobDescriptor descriptor;  
        descriptor.m_jobKey = "Compile Example";  
        descriptor.m_platform = AssetBuilderSDK::Platform_PC;  
  
        // You can also place whatever parameters you want to save for later  
        into this map:  
        descriptor.m_jobParameters[AZ_CRC("hello")] = "World";  
    }  
}
```

```
        response.m_createJobOutputs.push_back(descriptor);  
        response.m_result = AssetBuilderSDK::CreateJobsResultCode::Success;  
    }  
}
```

The asset processor calls the `ProcessJob` function when it has a job for the builder to begin processing:

```
ProcessJob(const AssetBuilderSDK::ProcessJobRequest& request,  
           AssetBuilderSDK::ProcessJobResponse& response)
```

`ProcessJob` is given a job request that contains the full job descriptor that `CreateJobs` emitted, as well as additional information such as a temporary directory for it to work in.

This message is sent on a worker thread, so the builder must not spawn threads to do the work. Be careful not to interact with other threads during this call.

Warning

Do not alter files other than those in the temporary directory while `ProcessJob` is running. After your job indicates success, the asset processor copies your registered products to the asset cache, so be sure not to write to the cache. You can use the temporary directory in any way that you want.

After your builder has finished processing assets, your response structure should list all of the assets that you have created. Because only the assets that you list are added to the cache, you can use the temporary directory as a scratch space for processing.

The following code shows an example `ProcessJob` function.

```
// This function is called for jobs that need processing.  
// The request contains the CreateJobResponse you constructed earlier,  
// including the  
// keys and values you placed into the hash table.  
  
void ExampleBuilderWorker::ProcessJob(const  
    AssetBuilderSDK::ProcessJobRequest& request,  
    AssetBuilderSDK::ProcessJobResponse& response)  
{  
    AZ_TracePrintf(AssetBuilderSDK::InfoWindow, "Starting Job.");  
    AZStd::string fileName;  
  
    AzFramework::StringFunc::Path::GetFullFileName(request.m_fullPath.c_str(),  
    fileName);  
    AzFramework::StringFunc::Path::ReplaceExtension(fileName, "example1");  
    AZStd::string destPath;  
  
    // Do all of your work inside the tempDirPath.  
    // Do not write outside of this path  
  
    AzFramework::StringFunc::Path::ConstructFull(request.m_tempDirPath.c_str(),  
    fileName.c_str(), destPath, true);  
  
    // Use AZ_TracePrintF to communicate job details. The logging system  
    // automatically places the  
    // text in the appropriate log file and category.  
  
    AZ::IO::LocalFileIO fileIO;
```

```
    if (!m_isShuttingDown && fileIO.Copy(request.m_fullPath.c_str(),
destPath.c_str()) == AZ::IO::ResultCode::Success)
    {
        // If assets were successfully built into the temporary directory,
push them back into the response's product list.
        // The assets that you created in your temporary path can be
specified using paths relative to the temporary path.
        // It is assumed that your code writes to the temporary path.
        AZStd::string relPath = destPath;
        response.m_resultCode = AssetBuilderSDK::ProcessJobResult_Success;

        AssetBuilderSDK::JobProduct jobProduct(fileName);
        response.m_outputProducts.push_back(jobProduct);
    }
    else
    {
        if (m_isShuttingDown)
        {
            AZ_TracePrintf(AssetBuilderSDK::ErrorWindow, "Cancelled job %s
because shutdown was requested", request.m_fullPath.c_str());
            response.m_resultCode =
AssetBuilderSDK::ProcessJobResult_Cancelled;
        }
        else
        {
            AZ_TracePrintf(AssetBuilderSDK::ErrorWindow, "Error during
processing job %s.", request.m_fullPath.c_str());
            response.m_resultCode = AssetBuilderSDK::ProcessJobResult_Failed;
        }
    }
}
```

Notes

- So that critical files are not missed, the editor is blocked until all jobs are created. For this reason, you should execute the code in `CreateJobs` as quickly as possible. We recommend that your code do minimal work during `CreateJobs` and save the heavy processing work for `ProcessJob`.
- In `CreateJobs`, you can place arbitrary key–value pairs into the descriptor's `m_jobParameters` field. They key–value pairs are copied back when `ProcessJob` executes, which removes the need for you to add them again.
- All of the outputs for your job should be placed into your temporary workspace. However, if you just need to copy an existing file into the asset cache as part of your job, you can emit as a product the full absolute source path of the file without copying it into your temporary directory first. The asset processor then copies the file into the cache and registers it as part of the output of your job. All other files are moved from your temporary directory into the asset cache in an attempt to perform an atomic cache update in case your job succeeds.

Message Logging

You can use `BuilderLog(AZ::Uuid builderId, char* message, ...)` to log any general builder related messages or errors, but `BuilderLog` cannot be used during job processing.

For job related messages, use `AZ_TracePrintf(window, msg)`. This function automatically records the messages in the log file for the job.

Asset Importer (Preview) Technical Overview

The Lumberyard Asset Importer and the FBX Importer are in preview release and are subject to change.

This topic provides a high-level technical overview of the Lumberyard Asset Importer architecture and its core libraries. The preview release of the Asset Importer features:

- A new FBX Importer (built entirely from scratch) that makes it easier for you to bring single static FBX meshes and single materials into Lumberyard. For information on how to use the FBX Importer tool, available from Lumberyard Editor, see [FBX Importer](#) in the [Amazon Lumberyard User Guide](#).
- An abstraction layer that you can extend to accept other input formats.

You can use the abstraction layer to add support for older formats like OBJ and DAE, or for custom data formats. A generic layer of data called the *scene graph* enables this extensibility, as explained in the following section.

Architecture and Concepts

Following are the key concepts and components of the Lumberyard Asset Importer.

FBX – File extension for Autodesk’s [filmbox](#) file format. This is a general use container file for many types of data commonly used in video game development. Most modeling packages have the ability to export the FBX file format natively. The preview release of the Lumberyard Asset Importer supports this format.

Importer – Code that takes input data creates a *scene graph* (Lumberyard’s generic tree-based representation of data) or *scene manifest* from it. For example, you might implement an `FbxSceneGraphImporter` that can construct a scene graph from an FBX file. Alternatively, you could have a `JsonManifestImporter` that constructs a scene manifest from a JSON file.

Scene – This is an abstraction that contains a scene graph tree data structure and a scene manifest. The scene manifest contains metadata about the scene graph.

Scene graph – A generic tree-based representation of data. The scene graph is a layer of data between an intermediate 3D asset (like FBX) and the Lumberyard engine. A scene graph is composed internally of *scene nodes* which optionally contain data in the form of a *data object*.

Scene node – A node within a scene graph that may contain data in the form of a data object, or exist solely for hierarchical reasons. A node's name is made unique in the scene graph by concatenating all its parent nodes and delimiting them with a '.' For example, if a node named `root` has the two children `child1` and `child2`, the full node names are `root`, `root.child1`, and `root.child2`. Even if another node has a child named `child2`, the full name is unique because of the hierarchy.

Data object – A generic container for data which supports **RTTI** (run-time type information) and casting through the `AZ_RTTI` system. This is the basic unit of storage used by both the `SceneManifest` key-value-pair dictionary and the `SceneNode` internal data payload. The `DataObject` class provides limited *reflection* support for editing of class data, but not serialization to file.

Scene manifest – This is a flat dictionary of metadata about a scene graph. This metadata will be mostly in the form of *groups* and *rules*, but supports generic and anonymous data provided by the user as well. All data is stored as key-value-pairs, with the key being a string, and the value being a `DataObject`.

Groups – These structures, managed by a scene manifest, contain rules that specify how to process scene graph data so that game data files can be generated. The current version of the Asset Importer supports *mesh groups*, which can generate CGF and MTL files.

Rules – These structures, contained in groups, specialize the handling of asset processing or display information like metadata or comments to the user. For example, you might create rules to change the vertex indexing bit count or provide positional or rotation offsets in the files that are output. The current version of the Asset Importer supports the rule types *origin*, *advanced mesh*, *material*, and *comment*.

Exporter – Code that takes data from a scene graph or scene manifest and changes it into another data format. For example, you might have a `CgfSceneExporter` that exports scene graph data using instructions from the scene manifest into the `CContentCGF` structure in memory. You could use `CgfExporter`, which allows the creation of static geometry files. You could also have a `JsonManifestExporter` that writes the data contained in a scene manifest into a JSON file on disk.

The following diagram illustrates the relationships among the components described.

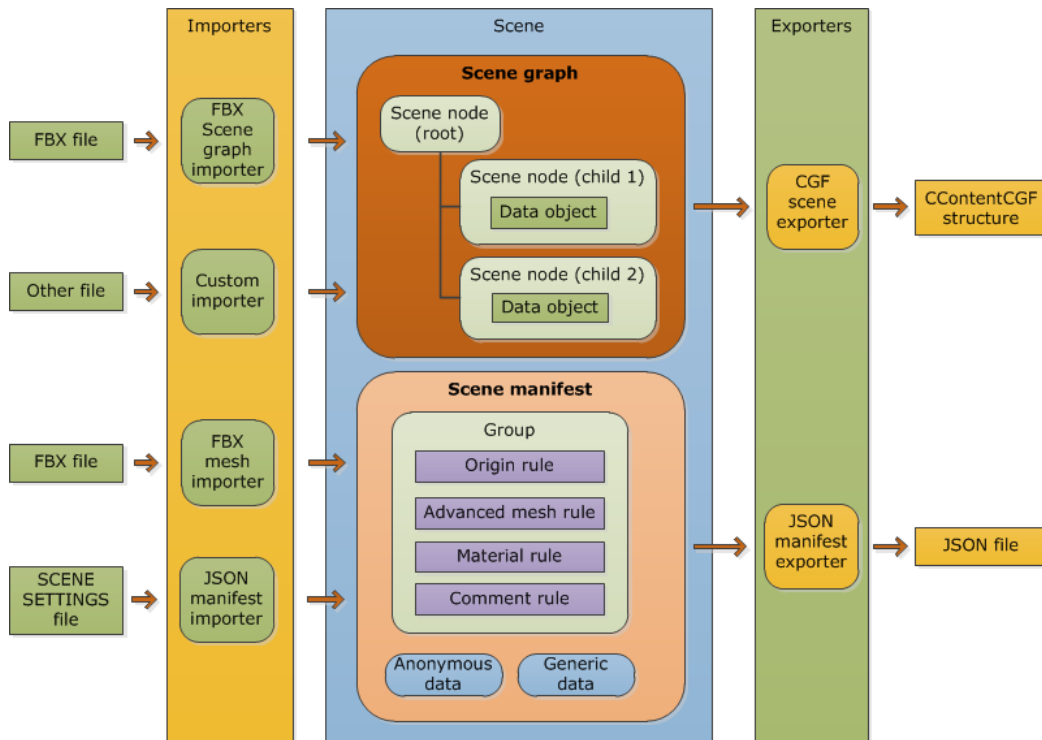

Other Components

Asset Processor – The Asset Importer uses the [Lumberyard Asset Processor](#). The asset processor runs in the background looking for changes in source data like FBX files or their metadata like `.scenasettings` files. When source or metadata files are added, removed, or changed, the asset processor automatically reprocesses the source data and outputs game data in a cache directory.

Reflection – The Lumberyard engine supports a robust and performant reflection system built on the `AZ_RTTR` system of `AzCore`. The Asset Importer and associated systems display data through the Lumberyard `ReflectedPropertyGrid` UI system that is part of the `AzToolsFramework`. The `AzToolsFramework` is a common UI framework for displaying and editing class data.

Core Libraries

Following are the core libraries of the Asset Importer. The name of each library is followed by its directory location in parentheses.

SceneCore (`\dev\Code\Tools\SceneAPI\SceneCore`) – This library contains common data storage structures, specifically: `Scene`, `SceneGraph`, `SceneManifest`, and `DataObject`. It also contains interfaces for currently supported `Group`, `Rule`, and `SceneNode` data types. It contains basic iterators that can be used to easily iterate through `SceneGraph` or `SceneManifest` data. Finally, it contains basic importers and exporters common to all use cases.

FbxSceneBuilder (`\dev\Code\Tools\SceneAPI\FbxSceneBuilder`) – This library enables the loading of FBX data and its conversion into `SceneGraph` data. For convenience, it includes the full source of the lightweight pass-through `FBXSdkWrapper`. The `FBXSdkWrapper` includes the importer for FBX data so that `SceneCore` does not require a dependency on the FBX SDK. This is the suggested model if you want to extend the `SceneAPI` codebase to support file formats that have dependencies on specialized libraries.

SceneData (`\dev\Code\Tools\SceneAPI\SceneData`) – This library contains the concrete implementations provided with the Lumberyard Asset Importer for `Group`, `Rule`, and `SceneNode` data types. These implementations are provided in a separate library that illustrates how you can extend or implement your own rule sets by using the `SceneCore` library. The `SceneData` library also contains factories for generating different types of data.

EditorAssetImporter (`\dev\Code\Sandbox\Plugins\EditorAssetImporter`) – This is the Lumberyard Editor plugin that allows the editing of scene manifests. It uses the `FbxSceneBuilder` and `SceneCore` libraries to read and write data defined in the `SceneData` library to disk when the user requests it. Currently, `EditorAssetImporter` supports only files that have the `.fbx` file extension. Other `SceneBuilder` implementations could support additional file types.

ResourceCompilerScene (`\dev\Code\Tools\rc\ResourceCompilerScene`) – The Resource Compiler (`rc.exe`) plugin uses the instructions from `SceneManifest` to process `SceneGraph` and generate game data. The Resource Compiler uses the `FbxSceneBuilder` and `SceneCore` libraries to read, write, and store data in a format defined by the `SceneData` library. The Resource Compiler is currently associated with the `.fbx` file extension. Other importers, if implemented, could translate data from non-FBX sources into `SceneGraph` data.

FBXSdkWrapper (`\dev\Code\Tools\SceneAPI\FBXSdkWrapper`) – As mentioned, this is a wrapper around the FBX SDK provided for convenience and testing. If you have an internal FBX serialization and storage model, you can use this library to replace it with the Autodesk FBX SDK.

FBX Importer Example Workflow

The following workflow illustrates how these libraries might work together in a production environment.

1. You open the Lumberyard Editor and launch the **FBX Importer**. The importer loads the `EditorAssetImporter.dll` Lumberyard Editor plugin. Note: For information on how to use the FBX Importer, see [FBX Importer](#).
2. Using the FBX Importer file browser, you choose an FBX file that has been output from the modeling package. The FBX Importer (a specialized importer contained in `FbxSceneBuilder`) creates a `SceneGraph` that contains the equivalent of the data in the `.fbx` file.
3. If this is the first time you are importing the `.fbx` file, an empty `SceneManifest` is also created. If you have already imported the file, the `JsonManifestImporter` loads the corresponding `.scenestettings` file from the same directory and creates a new `SceneManifest`.
4. Using the Asset Importer UI, you create groups that define the output files that the Lumberyard Asset Importer will create. The groups specify names for the output files and the target nodes in the `SceneGraph` that will generate the data for the output files. You also create rules to change how the output files are processed.
5. When you have created all the desired groups and rules for the scene graph, you click **Import**. This creates or overwrites the scene manifest by saving it to a `.scenestettings` file in the same location as the `.fbx` file you loaded. For example, if `character.fbx` is loaded, a `character.scenestettings` file is created in the same directory. `JsonManifestExporter` performs this operation. If an MTL file does not exist, `MaterialExporter` generates a default MTL file.
6. The Asset Processor detects the creation of, or any change to, the `.scenestettings` file and calls the Resource Compiler (`rc.exe`) so that the `.fbx` file will be reprocessed.
7. The Resource Compiler detects the `.fbx` file type, recognizes that it has a `ResourceCompilerScene` plugin module that processes `.fbx` files, and runs the plugin.
8. The `ResourceCompilerScene` plugin creates a scene graph and scene manifest that contain data equivalent to the data in the `.fbx` file. The plugin parses the groups and rules in `SceneManifest` and calls specialized exporters that use these groups and rules to write the scene graph data to game data files.
9. When the Resource Compiler completes, the MTL and the CGF files for the models are in the correct location and ready for use in your game.

Possible Asset Importer Customizations

Because `SceneGraph` and `SceneManifest` are flexible and extensible constructs, you can use them to easily process additional data types. The `DataObject` structure, which allows RTTI-based handling of arbitrary data, is key to this flexibility. Following are some customization examples:

- **Input File Types:** To process file types other than FBX, you implement a new importer that generates a `SceneGraph` from an arbitrary data format.
- **Input File Data:** Because the `SceneNode` in `SceneGraph` accepts arbitrary data payloads in the form of RTTI enabled `DataObject` structures, you build a `SceneGraph` structure to handle specialized or anonymous data unique to your team.
- **Custom Asset Processing Instructions:** Because `Group` and `Rule` are implemented as pure virtual interfaces, you easily customize them with instructions specific to your project.
 - Because the `SceneManifest` supports anonymous data like strings and numbers, the code you require for prototyping is kept to a minimum.
 - You extend or replace the basic concrete implementation of the `SceneData` library to fulfill your team's specific asset processing requirements.

AZ Modules (Preview)

AZ modules are in preview release and subject to change.

AZ modules are code libraries designed to plug into Lumberyard games and tools. An AZ module is a collection of C++ code built as a static or dynamic library (.lib or .dll file) that implements specific initialization functions. When a Lumberyard application starts, it loads each module and calls these initialization functions. These initialization functions allow the module to connect to core technologies such as reflection, serialization, [event buses \(p. 397\)](#), and the [Component Entity System \(p. 308\)](#).

Modules are not a new concept in Lumberyard. In fact, the Lumberyard game engine is a collection of older style modules. These legacy modules have served the game engine well, but they have a number of shortcomings which are addressed by AZ modules, as presented in the next section.

Lumberyard currently supports both legacy modules and AZ modules but going forward will use AZ modules. Beginning in Lumberyard 1.5, a gem can contain AZ module code. Creating a new gem is the easiest way to get up a new AZ module up and running.

Note

AZ is the namespace of the AZCore C++ library upon which AZ modules are built. The letters AZ refer to Amazon; the term is a preview name that has nothing to do with [Amazon Availability Zones](#) and may be subject to change.

Comparing AZ Modules to Legacy Modules

AZ modules have significant advantages over legacy modules, as the following table shows:

Topic	Legacy Modules	AZ Modules
Compatibility	Modules can be converted to AZ modules with no loss of functionality.	Anything that can be done in a legacy module can also be done in an AZ module. Most AZ module code could live within a legacy module, but legacy modules are not likely

		to be compatible with future AZ module-based Lumberyard tools.
Ease of adding services (singleton classes) to modules	Adding services usually requires editing files in <code>CryCommon</code> . A file for the singleton's class interface must exist in the <code>CryCommon</code> directory, and a variable to hold the singleton in <code>gEnv</code> must exist.	Modules create components and attach them to the system entity. No editing of game engine files is required.
Ease of use for low-level application features	Modules load late, which prevents them from contributing low-level features to an application. All critical features must be in a single module that loads before others.	Modules load early in the application's startup sequence and are initialized in discrete stages. This allows <i>any</i> module to provide a low-level feature at an early stage that other modules can take advantage of later.
Exposure of properties	Modules have no uniform way to let users control settings for their service. Some services read settings from <code>.xml</code> files in the assets directory, which must be edited by hand.	AZ modules expose the properties of system components to the Lumberyard reflection system. The reflection system makes information about these properties available to all other components.
Game engine dependency	Modules must run in the game engine and are difficult to extend for use in tools that do not have game code.	Modules are not specific to the game engine and can be used outside it.
Initialization functions	Function parameters are specific to <code>CryEngine</code> .	Function parameters are specific to the AZ framework; for more information, see the following section.
Order of initialization	Singleton code often depends on services offered by other singletons, so modules must be initialized in a very particular order. However, the order is not obvious. If someone is unfamiliar with the code in the modules, their loading order is difficult to ascertain.	Each module explicitly states its dependencies on system components. After all system components are examined, they are sorted according to these dependencies and initialized in the appropriate order. Each module is a first-class citizen.

A Self-Aware Method of Initialization

Legacy modules are loaded in a particular order. Because `CrySystem` is loaded and initialized before the game module, it must provide all low-level systems such as logging and file I/O that a subsequent module might depend on. The game module itself cannot provide such low-level systems because it's initialized too late.

AZ modules, on the other hand, are all loaded as early as possible, and then initialized in stages. Because each module explicitly states its dependencies on system components, all system

components can be examined beforehand, sorted according to dependencies, and [initialized in the appropriate order \(p. 132\)](#). This makes it possible for low-level functionality (like a custom logging system) to be implemented from a game module. For more information about the initialization order of components, see [The AZ Bootstrapping Process \(p. 143\)](#).

Relationship with the AZ Framework

AZ modules are designed to work with the AZ framework, which is a collection of Lumberyard technologies such as reflection, serialization, [event buses \(p. 397\)](#), and the [component entity system](#). The AZ framework supports game development but can also be used outside it. For example, Lumberyard tools like the Setup Assistant, [Asset Processor](#) and the component entity system use the AZ framework and AZ modules, but contain no game code. When the Resource Compiler builds slices, it loads AZ modules to extract reflection information about components within them.

AZ modules are code libraries that are built to use the AZ framework. When an AZ framework application loads an AZ module, the AZ module knows how to perform tasks such as gathering reflection information about the data types defined within that library.

Smarter Singletons

AZ modules build their services (which are singleton classes) by using the same component entity system that Lumberyard uses to build in-game entities. A module simply places a system component on the system entity. This solves many of the problems associated with singletons in legacy modules.

The GUI in Lumberyard Editor uses the reflection system to expose the properties of entities (gameplay components) to designers. In the same way, Lumberyard uses the reflection system to expose the properties of system components so that you can customize your settings for a particular game. Because system components are really no different from gameplay components, you can [use the Project Configurator to edit the properties of system components \(p. 139\)](#) just as you edit the properties of in-game components.

Current Lumberyard AZ Modules

The [gems \(p. 134\)](#) provided with Lumberyard are all built as AZ modules. In addition, there are two AZ modules that are not built as gems.

LmbrCentral

`LmbrCentral` contains components that wrap functionality from legacy modules. For example, the `MeshComponent` utilizes `IRenderNode` under the hood. `LmbrCentral` is used by game applications.

LmbrCentralEditor

Components can have editor-specific implementations that integrate with technology not available in the game runtime environment. Therefore, a separate module, `LmbrCentralEditor`, is used by Lumberyard Editor. This module contains all the code from `LmbrCentral`, plus code that is only for use in tools. The `LmbrCentralEditor` module is not for use in standalone game applications.

Parts of an AZ Module, Explained

AZ modules are in preview release and subject to change.

An AZ module has three key components: a class that inherits from `AZ::Module`, one or more public facing event buses, and a system component class.

This page describes module initialization, the use of system components as singletons, how EBus calls communicate with this singleton, and how to call the module externally after you have created it.

The Module Class

Each AZ module must contain a class that inherits from `AZ::Module`. When the module is loaded by an application, an instance of the class is created very early in the application's lifetime and its virtual functions are called at the appropriate times as the application goes through its [bootstrapping process](#) (p. 143). This class [reflects](#) (p. 310) the components declared in the module and adds critical components to the system entity.

The following skeleton code shows the basic structure of an `AZ::Module` class.

```
namespace AZ
{
    /**
     * AZ::Module enables static and dynamic modules (aka LIBs and DLLs) to
     * connect with the running \ref AZ::ComponentApplication.
     *
     * Each module should contain a class which inherits from AZ::Module.
     * This class must perform tasks such as reflecting the classes within
     * the module and adding critical components to the system entity.
     */
    class Module
    {
    public:
        Module();
        virtual ~Module();

        /// Override to require specific components on the system entity.
        virtual ComponentTypeList GetRequiredSystemComponents() const;
    };
}
```

The `AZ::Module` class exposes all points of integration with the AZ framework as virtual functions. These points of integration have been created as virtual functions on a class so that, whether initialization code is in a static or dynamic library, it's written the same way as much as possible. The very first actual initialization calls do need to be different for static and dynamic libraries. Lumberyard provides a macro to define this uninteresting glue code and let you write the interesting initialization code within your `AZ::Module` class.

We recommend that your `AZ::Module` class contain as little implementation code as possible. When the `AZ::Module` class is created, the application is just starting up and many systems are unavailable. If the `AZ::Module` class spawns a singleton or manager class, there is no guarantee that the systems on which this singleton relies will be ready for use. Instead, you should build your singletons as Lumberyard [system components](#) (p. 132), which can control their initialization order.

Beginning in Lumberyard 1.5, gems are built using AZ modules. The following example "HelloWorld" AZ module was made by [creating a new gem](#). The `CryHooksModule` class in this example is a helper wrapper around `AZ::Module` and provides your entire module access to `gEnv`.

```
// dev/Gems/HelloWorld/Code/Source/HelloWorldModule.cpp
#include "StdAfx.h"
#include <platform_impl.h>

#include "HelloWorldSystemComponent.h"

#include <IGem.h>

namespace HelloWorld
{
    class HelloWorldModule
        : public CryHooksModule
    {
    public:
        AZ_RTTI(HelloWorldModule, "{39C21561-D456-413F-8C83-4214F6DBC5A5}",
        CryHooksModule);

        HelloWorldModule()
            : CryHooksModule()
        {
            // Create descriptors for components declared within this module.
            m_descriptors.insert(m_descriptors.end(), {
                HelloWorldSystemComponent::CreateDescriptor(),
            });
        }

        // Add required system components to the system entity.
        AZ::ComponentTypeList GetRequiredSystemComponents() const override
        {
            return AZ::ComponentTypeList{
                azrtti_typeid<HelloWorldSystemComponent>(),
            };
        }
    };
}

// DO NOT MODIFY THIS LINE UNLESS YOU RENAME THE GEM
// The first parameter should be GemName_GemIdLower
// The second should be the fully qualified name of the class above
AZ_DECLARE_MODULE_CLASS(HelloWorld_010c14ae7f0f4eb1939405d439a9481a,
    HelloWorld::HelloWorldModule)
```

The EBus

External code can call into your module, and receive events from your module, through the module's public [event buses \(p. 397\)](#) (EBus). The EBus allows simple and safe function calls between different modules of code.

A new gem comes with one EBus by default, as shown in the following example.

```
// dev/Gems/HelloWorld/Code/Include/HelloWorld/HelloWorldBus.h
#pragma once
#include <AzCore/EBus/EBus.h>
```

```
namespace HelloWorld
{
    class HelloWorldRequests
        : public AZ::EBusTraits
    {
    public:

        ///////////////////////////////////////////////////////////////////
        // EBusTraits overrides
        // These settings are for a "singleton" pattern.
        // A single handler can connect to the EBus.
        static const AZ::EBusHandlerPolicy HandlerPolicy =
AZ::EBusHandlerPolicy::Single;
        // A single address exists on the EBus.
        static const AZ::EBusAddressPolicy AddressPolicy =
AZ::EBusAddressPolicy::Single;

        ///////////////////////////////////////////////////////////////////

        // Put your public methods here
        virtual void SayHello(const char* name) = 0;
    };
    using HelloWorldRequestBus = AZ::EBus<HelloWorldRequests>;
} // namespace HelloWorld
```

Calls to this EBus are handled by the system component, as described in the following section.

The System Component Class

Any major systems in your module that require a singleton should be built as system components. New gems come with a system component by default. The system component class is created during application startup and attached to the system entity (see `GetRequiredSystemComponents()` in `HelloWorldModule.cpp`).

In the current example, the system component class handles calls to the public EBus declared in `HelloWorldBus.h`. The following code shows the `HelloWorldSystemComponent` class.

```
// dev/Gems/HelloWorld/Code/Source/HelloWorldSystemComponent.h
#pragma once
#include <AzCore/Component/Component.h>
#include <HelloWorld/HelloWorldBus.h>

namespace HelloWorld
{
    // The HelloWorldSystemComponent is placed on the system entity
    // and handles calls to the HelloWorldRequestBus.
    class HelloWorldSystemComponent
        : public AZ::Component
        , protected HelloWorldRequestBus::Handler
    {
    public:
        // Every component definition must contain the AZ_COMPONENT macro,
        // specifying the type name and a unique UUID.
        AZ_COMPONENT(HelloWorldSystemComponent,
" {72DFB0EE-7422-4CEB-9A40-426F26530A92}");

        static void Reflect(AZ::ReflectContext* context);
    };
}
```

```

        static void
        GetProvidedServices(AZ::ComponentDescriptor::DependencyArrayType& provided);
        static void
        GetIncompatibleServices(AZ::ComponentDescriptor::DependencyArrayType&
        incompatible);
        static void
        GetRequiredServices(AZ::ComponentDescriptor::DependencyArrayType& required);
        static void
        GetDependentServices(AZ::ComponentDescriptor::DependencyArrayType&
        dependent);

    protected:

    ////////////////////////////////////////
        // AZ::Component interface implementation
        void Init() override;
        void Activate() override;
        void Deactivate() override;

    ////////////////////////////////////////

    ////////////////////////////////////////
        // HelloWorldRequestBus interface implementation
        void SayHello(const char* name) override;

    ////////////////////////////////////////
    };
}
// dev/Gems/HelloWorld/Code/Source/HelloWorldSystemComponent.cpp
#include "StdAfx.h"
#include <AzCore/Serialization/SerializeContext.h>
#include <AzCore/Serialization/EditContext.h>
#include "HelloWorldSystemComponent.h"

namespace HelloWorld
{
    void HelloWorldSystemComponent::Reflect(AZ::ReflectContext* context)
    {
        // Reflect properties that developers may want to customize.
        if (AZ::SerializeContext* serialize =
        azrtti_cast<AZ::SerializeContext*>(context))
        {
            serialize->Class<HelloWorldSystemComponent, AZ::Component>()
                ->Version(0)
                ->SerializerForEmptyClass();

            if (AZ::EditContext* ec = serialize->GetEditContext())
            {
                ec->Class<HelloWorldSystemComponent>("HelloWorld", "Says
                hello")
                    ->ClassElement(AZ::Edit::ClassElements::EditorData, "")
                    -
                >Attribute(AZ::Edit::Attributes::AppearsInAddComponentMenu, AZ_CRC("System"))
                    ->Attribute(AZ::Edit::Attributes::AutoExpand, true)
                    ;
            }
        }
    }
}

```

```
void
HelloWorldSystemComponent::GetProvidedServices(AZ::ComponentDescriptor::DependencyArrayType
provided)
{
    provided.push_back(AZ_CRC("HelloWorldService"));
}

void
HelloWorldSystemComponent::GetIncompatibleServices(AZ::ComponentDescriptor::DependencyArra
incompatible)
{
    // Enforce singleton behavior by forbidding further components
    // which provide this same service from being added to an entity.
    incompatible.push_back(AZ_CRC("HelloWorldService"));
}

void
HelloWorldSystemComponent::GetRequiredServices(AZ::ComponentDescriptor::DependencyArrayTyp
required)
{
    // This component does not depend upon any other services.
    (void)required;
}

void
HelloWorldSystemComponent::GetDependentServices(AZ::ComponentDescriptor::DependencyArrayTy
dependent)
{
    // This component does not depend upon any other services.
    (void)dependent;
}

void HelloWorldSystemComponent::Init()
{
}

void HelloWorldSystemComponent::Activate()
{
    // Activate() is where the component "turns on".
    // Begin handling calls to HelloWorldRequestBus
    HelloWorldRequestBus::Handler::BusConnect();
}

void HelloWorldSystemComponent::Deactivate()
{
    // Deactivate() is where the component "turns off".
    // Stop handling calls to HelloWorldRequestBus
    HelloWorldRequestBus::Handler::BusDisconnect();
}

void HelloWorldSystemComponent::SayHello(const char* name)
{
    AZ_Printf("HelloWorld", "Hello %s, you certainly look smashing
tonight.", name);
}
}
```

For more information about system components, see [System Components \(p. 132\)](#).

Calling the Module from External Code

To call your module, invoke your public function through EBus. This example uses the `SayHello` function.

```
#include <HelloWorld/HelloWorldBus.h>

void InSomeFunctionSomewhere()
{
    // ...
    // Invoke the call through EBus.
    EBUS_EVENT(HelloWorld::HelloWorldRequestBus, SayHello, "Bruce");
    // ...
}
```

System Components

AZ modules are in preview release and subject to change.

A traditional game engine contains many singleton classes, each in charge of a major system. In Lumberyard, these singletons are built using the same [component entity system](#) that powers gameplay entities. When an application is starting up, a *system entity* is created. Any components placed on this entity are known as *system components*. The system entity always has the ID `AZ::SystemEntityId(0)`.

When you build singletons as Lumberyard system components, you are using a powerful suite of complementary technologies that facilitate problem resolution through established patterns. This topic describes system components in detail.

Smart Initialization Order

As a game engine grows in size, it tends to develop many singleton classes. A singleton class often requires communication with other singletons to function. This means that the order in which singletons are initialized is very important. In Lumberyard we solve this by building singletons as components.

A component can declare which services it provides, and it can declare which other services it depends on. When components are activated, they are sorted according to these declared dependencies, ensuring proper initialization order.

The following example shows two components that Lumberyard has ordered for initialization.

```
class AssetDatabaseComponent : public Component
{
    ...

    static void GetProvidedServices(ComponentDescriptor::DependencyArrayType&
    provided)
    {
        provided.push_back(AZ_CRC("AssetDatabaseService"));
    }

    ...
};
```

```
class AssetCatalogComponent : public AZ::Component
{
    ...
    static void
    GetRequiredServices(AZ::ComponentDescriptor::DependencyArrayType& required)
    {
        required.push_back(AZ_CRC("AssetDatabaseService"));
    }
    ...
};
```

The example shows how `AssetDatabaseComponent` is activated before `AssetCatalogComponent`. In the `AssetDatabaseComponent` class, the `GetProvidedServices` function reveals that the class provides a service called `AssetDatabaseService`. In the `AssetCatalogComponent` class, the `GetRequiredServices` function reveals that `AssetCatalogComponent` depends on `AssetDatabaseService`. Lumberyard understands this dependency and orders the initialization order accordingly.

For more information about the initialization order of components, see [The AZ Bootstrapping Process \(p. 143\)](#).

Easily Configurable Components

Often, a singleton has settings that are configurable for each game. It can be difficult for a low-level singleton to access configuration data because the system used to process this data hasn't yet started. Therefore, low-level singletons often rely on simple data sources such as command line parsers or `.ini` files.

A system component can expose its configuration through [AZ reflection](#). The [Advanced Settings dialog box in the Project Configurator \(p. 139\)](#) uses this feature to enable you to configure system components on a per-game basis. The Project Configurator saves an [application descriptor file \(p. 142\)](#) that contains the settings for each system component, and this file is used to bootstrap the application and configure each component before it is activated. This is the same technology that the [Entity Inspector](#) uses to configure gameplay entities in the Lumberyard Editor. For more information, see [Configuring System Entities \(p. 139\)](#).

Writing System Components

To designate a component as a system component, rather than a gameplay component, you must set the `AppearsInAddComponentMenu` field to `System` when you reflect to the `EditContext`.

The following example code designates the `MemoryComponent` as a system component.

```
void MemoryComponent::Reflect(ReflectContext* context)
{
    if (SerializeContext* serializeContext =
        azrtti_cast<SerializeContext*>(context))
    {
        ...
        if (EditContext* editContext = serializeContext->GetEditContext())
        {
            editContext->Class<MemoryComponent>("Memory System", "Manages
            memory allocators")
                ->ClassElement(AZ::Edit::ClassElements::EditorData, "")
                    ->Attribute(AZ::Edit::Attributes::AppearsInAddComponentMenu, AZ_CRC("System"))
        }
    }
}
```

```
    }  
  }  
}
```

Required System Components

Often, a module requires the existence of a system component. This requirement can be established through the module's `GetRequiredSystemComponents()` function. Any component type declared here is guaranteed to exist when the application starts.

In the following example, the `OculusDevice` component is required by the Oculus Gem.

```
GetRequiredSystemComponents()  
AZ::ComponentTypeList OculusGem::GetRequiredSystemComponents() const override  
{  
    return AZ::ComponentTypeList{  
        azrtti_typeid<OculusDevice>(),  
    };  
}
```

If a system component is optional, you can add it from [Advanced Settings in the Project Configurator](#) (p. 139).

Gems and AZ Modules

AZ modules are in preview release and subject to change.

The gems system was developed to make it easy to share code between projects. Gems are reusable packages of module code and/or assets which can be easily added to or removed from a Lumberyard game. Gems also promote writing code in a way that is more modular than that found in legacy libraries. For example, each gem has its own include folder for its public interface code files. Gems also come with package management metadata such as semantic versioning and the ability to state dependencies on other gems.

Structure of a Gem

A gem's directory contents are organized as follows:

```
GemDirectory/  
  Assets/  
    (assets usable to projects)  
  Code/  
    Include/  
      (public interface code files)  
    Source/  
      (private implementation code files)  
    Tests/  
      (code files for tests)  
    wscript (waf build info)  
    gem.json (gem metadata)
```

Waf Integration

Each game project must explicitly list the gems that it uses. When the [Waf build system](#) runs, it builds only those gems which are actively in use. Waf also makes a gem's `include/` directory accessible to any gems or projects that explicitly depend upon the gem.

Gems Built as AZ Modules

Beginning with Lumberyard 1.5, all gems that ship with Lumberyard are built as AZ modules. When you build a gem as an AZ module, the gem uses the initialization functions expected by the AZ framework. An AZ module gem has public interfaces that are [event buses](#) (p. 397) and is better integrated with the new [component entity system](#). Although legacy gems are still supported, it is highly recommended that you use gems based on AZ modules going forward. For information on migrating a legacy gem, see [Converting Your Gems](#).

When you use the Project Configurator to enable or disable a gem, Lumberyard updates the [application descriptor file](#) (p. 142) accordingly to ensure it references all AZ modules. If you edit the `dev\<project_asset_directory>\gems.json` list of gems by hand, you can use the following command to bring the application descriptor file up to date:

```
dev\Bin64\lmbre.exe projects populate-appdescriptors
```

About Gem Versioning

The `GemFormatVersion` value is versioning for how a gem is built. Gem version numbers like `0.1.0` refer to the gem's API version.

Gems from Lumberyard 1.4 and earlier (legacy gems) all have a `GemFormatVersion` value of 2. Starting in Lumberyard 1.5, all the gems included with Lumberyard are AZ modules and have a `GemFormatVersion` value of 3. This tells Lumberyard that the gem is an AZ module and that it should be loaded accordingly.

A gem may also have an API version number like `0.1.0`. This is independent of the `GemFormatVersion`. The API version alerts your users to API changes. If the API version number changes, then users of the gem may need to make changes to their code. For example, the Rain Gem will stay at version `0.1.0` until its API changes. If you were using the Rain Gem from Lumberyard 1.4, you can still use the Rain Gem from Lumberyard 1.5 without changing any of your data or code.

For more information about gems, see [Gems](#) in the [Amazon Lumberyard User Guide](#).

Creating an AZ Module That Is Not a Gem

AZ modules are in preview release and subject to change.

Beginning with Lumberyard 1.5, gems are AZ modules, so the preferred way to build an AZ module is to simply create a new gem. However, if your project requires an AZ module that must not be built as a gem, follow the steps provided here.

A. Start with a Gem

Because gems have all the required code for an AZ module, it's easier to create a gem first and then modify it not to be a gem. As an added convenience, the new gem names the code for you in an intuitive way. For an explanation of the code that you get in a new gem, see [Parts of an AZ Module, Explained](#) (p. 127).

To create and modify a gem

1. First, create a gem by performing the following steps:
 - a. Go to your Lumberyard `\dev\Bin64\` directory, then run `ProjectConfigurator.exe`.
 - b. Select your project (the default is **SamplesProject**).
 - c. Click **Enable Gems**.
 - d. Click **Create a New Gem**.
 - e. Type the name for your new module. (The example on this page uses the name "HelloWorld".)
 - f. Click **Ok**.

2. Move and rename the `code` directory from the new gem to your desired location. For example, move the directory

```
dev/Gems/HelloWorld/Code
```

to

```
dev/Code/<optional subfolder>/HelloWorld
```

3. To remove the remaining noncode pieces of the gem, delete the directory `dev/Gems/HelloWorld`.

B. Modify the AZ Module Declaration

AZ modules that are not gems must not have UUIDs in their names, so you must modify the gem's `.cpp` file accordingly.

To modify the `.cpp` file

1. Remove the code that looks like the following:

```
// DO NOT MODIFY THIS LINE UNLESS YOU RENAME THE GEM
// The first parameter should be GemName_GemIdLower
// The second should be the fully qualified name of the class above
AZ_DECLARE_MODULE_CLASS(HelloWorld_010c14ae7f0f4eb1939405d439a9481a,
    HelloWorld::HelloWorldModule)
```

2. Replace the `AZ_DECLARE_MODULE_CLASS` declaration with one that follows this syntax:

```
AZ_DECLARE_MODULE_CLASS(HelloWorld, HelloWorld::HelloWorldModule)
```

The first argument (`HelloWorld`) is a unique identifier to be included in your `project.json` file, and should match the `target` field of your `wscript`. You will do these steps later. The second argument is the same fully qualified name of the class already defined in your `.cpp` file.

C. Remove CryEngine References (Optional)

If your module does not access code from CryEngine (for example, it does not access `gEnv`), perform these additional steps.

To remove CryEngine references

1. Make the following changes to your `.cpp` file (in this example, `HelloWorldModule.cpp`).

- a. Remove `#include <platform_impl.h>`
 - b. Remove `#include <IGem.h>`
 - c. Add `#include <AzCore/Module/Module.h>`
 - d. Change `HelloWorldModule` to inherit directly from `AZ::Module` instead of from `CryHooksModule`.
2. Remove the following include statement from the `StdAfx.h` file:

```
#include <platform.h> // Many CryCommon files require that this be
included first.
```

D. Modify the Wscript and Waf Spec Files

Next, you must modify the default wscript file to remove gem-specific commands, add your module directory to the wscript file, and add your module to the appropriate [waf spec files](#).

To modify the wscript and waf spec files

1. Modify the wscript contents to resemble the following:

```
def build(bld):
    bld.CryEngineModule(
        target          = 'HelloWorld',
        vs_filter       = 'Game', # visual studio filter path
        file_list       = 'HelloWorld.waf_files',
        platforms       = ['all'],
        configurations   = ['all'],
        pch              = ['source/StdAfx.h'],
        use              = ['AzFramework'],
        includes        = ['include', 'source'],
    )
```

2. Modify the wscript in a parent directory so that waf recurses your module's directory, as in the following example.

```
# ...

SUBFOLDERS = [
    # ...,
    'HelloWorld'
]

# ...
```

3. To enable waf to build your module, add the module to the appropriate waf spec files in your Lumberyard directory (`dev_WAF_specs*.json`), as in the following example:

```
{
    // ...
    "modules":
    {
        // ...
        "HelloWorld"
    }
    // ...
}
```

```
}
```

E. Configure Your Project to Load the New Module

When your project launches, it loads the modules listed in the `dev/<project_assets>/Config/Game.xml` file (the `Editor.xml` file is used when the Lumberyard Editor is launched). These files are automatically generated and should not be edited by hand.

To configure your project to load your AZ module

1. To ensure your non-gem module is included in these automatically generated lists, add the following lines to your `project.json` file (path location `dev/<project_asset_folder>/project.json`):

```
{
  // ...
  "flavors": {
    "Game": {
      "modules": [
        "LmbrCentral",
        "HelloWorld"
      ]
    },
    "Editor": {
      "modules": [
        "LmbrCentralEditor",
        "HelloWorld"
      ]
    }
  }
}
```

Note

The flavors section may be missing from your project. If it is not present, Lumberyard assumes that the `LmbrCentral` module is used for `Game`, and that the `LmbrCentralEditor` module is used for `Editor`.

2. From the `dev` directory, run the following command from a command prompt.

```
Bin64\lmb.exe projects populate-appdescriptors
```

This command modifies the `Game.xml` and `Editor.xml` files to list the `HelloWorld` module.

F. Add the Module's Public Interfaces to Your Project's Include Paths

Finally, to make your AZ module's public interfaces available to the rest of your project, you must inform them project of your module's `include` directory.

To make your AZ modules public interfaces available to your project

- In your project's `wscript` file, edit the `includes` line to point to your project's `include` directory, as in the following example.

```
# ...  
includes = [..., bld.Path('Code/Engine/HelloWorld/include')],  
# ...
```

Configuring System Entities

AZ modules are in preview release and subject to change.

A single *system entity* lives at the heart of every Lumberyard application. This entity's components, known as [system components \(p. 132\)](#), power major systems within Lumberyard. You can use the **Advanced Settings** dialog of the Project Configurator to choose the components for your project and configure them. Editing a system entity is like editing an entity in the [Entity Inspector](#).

To configure system entities

1. Compile a profile build of your project so that the Project Configurator can load your project's compiled code.
2. Go to your Lumberyard `\dev\Bin64\` directory, and then launch `ProjectConfigurator.exe`
3. In Project Configurator, select your project.
4. Click **Advanced Settings**.

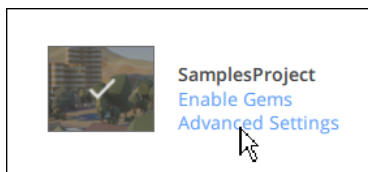

The first time a system entity configuration is loaded, you are prompted to add any required components that are missing from the system entity.

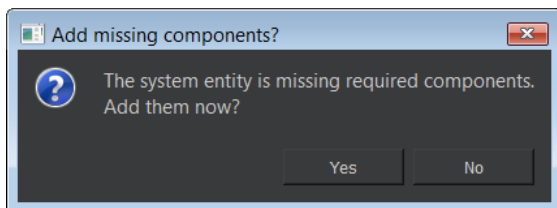

Some system components are optional, and some are required. Both the Lumberyard engine and the gems used by your project may require certain components.

5. Click **Yes**. Even if you decline, the required components are created at run time.
6. Use the **Project** option at the top of the **Advanced Settings** dialog box to select the project that you want to edit. For the **Configuration** option, choose **Game** if you want to make changes to the Game (launcher) system entity, or **Editor** to modify the `Editor` system entity.

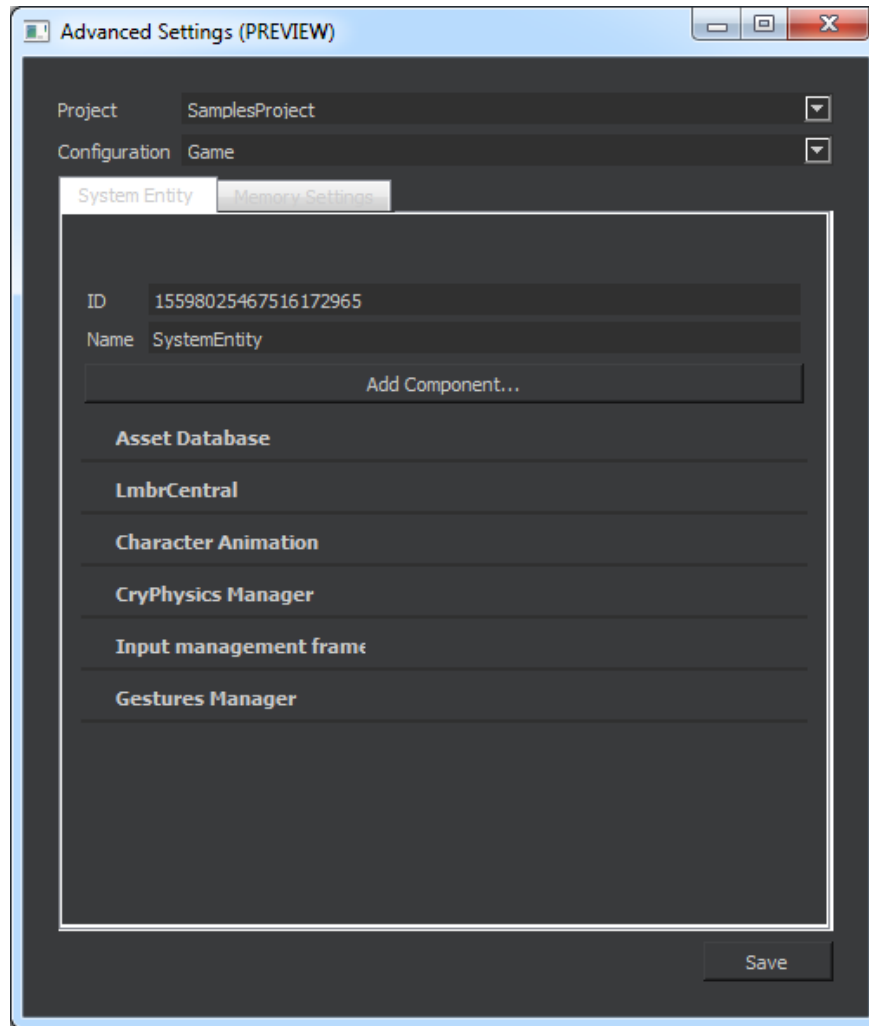

The **System Entity** tab lists components that have been added.

7. Click **Add Component** to select from a variety of components to add.

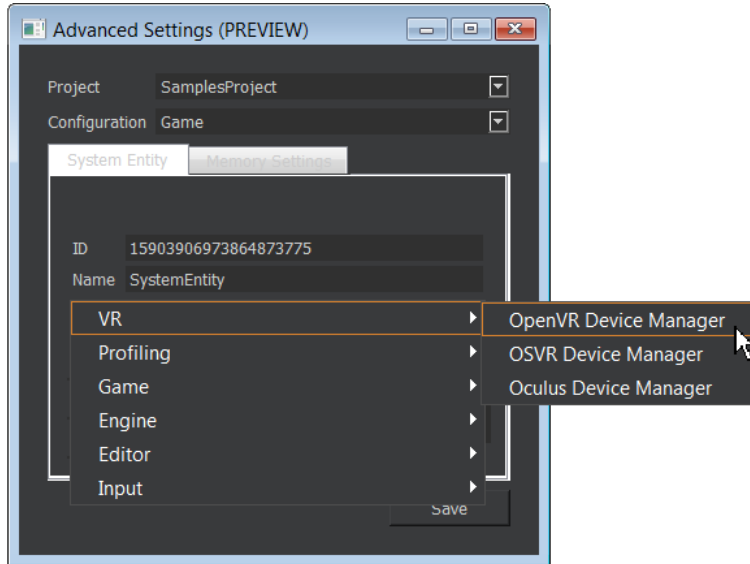

- To remove a component, right-click the component in the list and choose **Remove Component** "`<ComponentName>`".
- On the **Memory Settings** tab, expand **System memory settings** to configure system memory options.

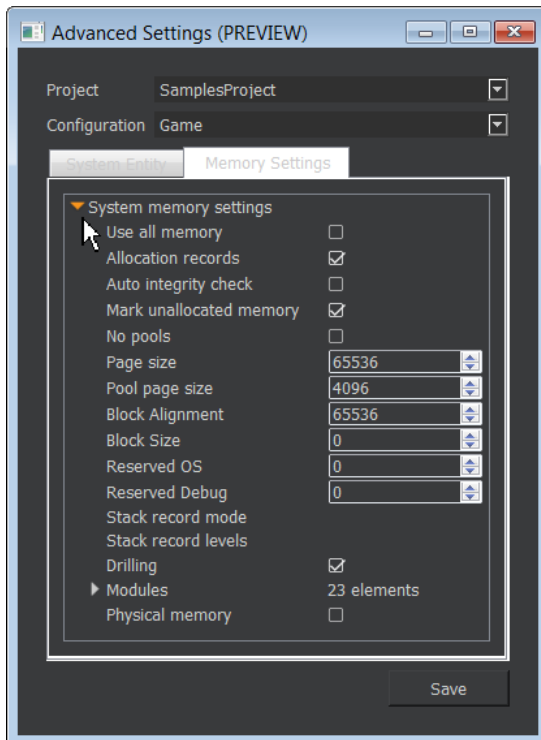

- Click **Save** to save your changes to disk. The changes are saved to an application descriptor file, described next.

Application Descriptor Files

When you edit a system entity's configuration by using the **Advanced Settings** dialog box of Project Configurator, you are actually editing an application descriptor file.

Application descriptor files are new to Lumberyard 1.5 and list all modules that a project uses. Currently, each project requires two application descriptor files in its asset directory:

```
dev/<project_asset_directory>/Config/Game.xml
```

```
dev/<project_asset_directory>/Config/Editor.xml
```

In the Project Configurator **Advanced Settings** dialog box, these files correspond to the **Game** and **Editor** options in the **Configuration** menu.

The following example shows the beginning of a Game.xml file. Both the Game.xml file and the Editor.xml file have the same structure.

```
<ObjectStream version="1">
  <Class name="ComponentApplication::Descriptor"
  type="{70277A3E-2AF5-4309-9BBF-6161AFBDE792}">
    <Class name="bool" field="useExistingAllocator" value="false"
    type="{A0CA880C-AFE4-43CB-926C-59AC48496112}"/>
    <Class name="bool" field="grabAllMemory" value="false" type="{A0CA880C-
AFE4-43CB-926C-59AC48496112}"/>
    <Class name="bool" field="allocationRecords" value="true"
    type="{A0CA880C-AFE4-43CB-926C-59AC48496112}"/>
    <Class name="bool" field="autoIntegrityCheck" value="false"
    type="{A0CA880C-AFE4-43CB-926C-59AC48496112}"/>
    <Class name="bool" field="markUnallocatedMemory" value="true"
    type="{A0CA880C-AFE4-43CB-926C-59AC48496112}"/>
    <Class name="bool" field="doNotUsePools" value="false" type="{A0CA880C-
AFE4-43CB-926C-59AC48496112}"/>
    <Class name="bool" field="enableScriptReflection" value="true"
    type="{A0CA880C-AFE4-43CB-926C-59AC48496112}"/>
    <Class name="unsigned int" field="pageSize" value="65536"
    type="{43DA906B-7DEF-4CA8-9790-854106D3F983}"/>
    <Class name="unsigned int" field="poolPageSize" value="4096"
    type="{43DA906B-7DEF-4CA8-9790-854106D3F983}"/>
    <Class name="unsigned int" field="blockAlignment" value="65536"
    type="{43DA906B-7DEF-4CA8-9790-854106D3F983}"/>
    <Class name="AZ::u64" field="blockSize" value="0"
    type="{D6597933-47CD-4FC8-B911-63F3E2B0993A}"/>
    <Class name="AZ::u64" field="reservedOS" value="0"
    type="{D6597933-47CD-4FC8-B911-63F3E2B0993A}"/>
    <Class name="AZ::u64" field="reservedDebug" value="0"
    type="{D6597933-47CD-4FC8-B911-63F3E2B0993A}"/>
    <Class name="char" field="recordsMode" value="2" type="{3AB0037F-
AF8D-48CE-BCA0-A170D18B2C03}"/>
    <Class name="unsigned char" field="stackRecordLevels" value="5"
    type="{72B9409A-7D1A-4831-9CFE-FCB3FADD3426}"/>
    <Class name="bool" field="enableDrilling" value="true" type="{A0CA880C-
AFE4-43CB-926C-59AC48496112}"/>
    <Class name="AZStd::vector" field="modules" type="{2BADE35A-6F1B-4698-
B2BC-3373D010020C}">
      <Class name="DynamicModuleDescriptor" field="element"
      type="{D2932FA3-9942-4FD2-A703-2E750F57C003}">
        <Class name="AZStd::string" field="dynamicLibraryPath"
        value="LmbrCentral" type="{EF8FF807-DDEE-4EB0-B678-4CA3A2C490A4}"/>
```

```
</Class>  
[...]
```

The list of system components in the application descriptor file corresponds to the list of components on the **System Entity** tab in the **Advanced Settings** dialog box. Each component can have its own settings. The application descriptor file also contains properties that determine how to allocate memory. These correspond to the settings on the **Memory Settings** tab in the **Advanced Settings** dialog box.

The AZ Bootstrapping Process

AZ modules are in preview release and subject to change.

An AZ framework application initializes modules based on the dynamic libraries listed in the [application descriptor file \(p. 142\)](#), and the static libraries referenced from the `CreateStaticModules()` function.

When an `AzFramework::Application` starts, the following order of events takes place:

1. The executable starts.
2. The `AzFramework::Application` class is initialized. It takes a path to an application descriptor file and a pointer to a function that will create the `AZ::Modules` from static libraries.
3. The application bootstraps itself just enough to read the application descriptor file.
4. The application descriptor file is read to get memory allocator settings and the list of dynamic libraries to load. Lumberyard is not yet able to read the system entity from the file.
5. Lumberyard shuts down the bootstrapped systems, configures them according to the settings it just loaded, and starts these systems back up.
6. Each dynamic library is loaded.
7. Each dynamic library's `InitializeDynamicModule()` function is run, which attaches the DLL to the global `AZ::Environment`.
8. Each static library's `AZ::Module` instance is created using the function pointer passed in during step 2.
9. Each dynamic library's `AZ::Module` instance is created by its `CreateModuleClass()` function.
10. Each AZ module's `RegisterComponentDescriptors()` function is called. Now the application knows how to serialize any components defined within a library.
11. The application descriptor file is read again to extract the system entity along with its components and their settings.
12. Each AZ module's `GetRequiredSystemComponents()` function is called. If any components are missing from the system entity, they are added.
13. The system entity is activated, and all of its system components are activated in the proper order.

At this point, initialization has been completed and the game is running.

AZ Code Generator

AZ Code Generator is a command line utility that generates source code (or any data or text) from specially tagged source code. You can use it when the structure of the code that you want to generate is known beforehand and therefore capable of having templates made for it. For example, you could generate boilerplate code for serialization or reflection.

AZ Code Generator parses a list of existing C++ source files and/or header files and generates intermediate data in JSON format. It passes the intermediate data to a series of templates.

The templates provide the format for the code that is generated. Templates make increased coding efficiency possible because they enable automatic updates of boilerplate code. When a template is updated, all related generated code is regenerated on the next build. This removes the need to update the glue code manually or to use error-prone find and replace operations.

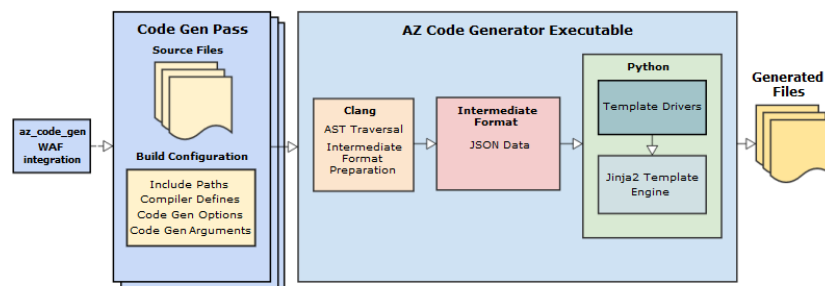

Topics

- [Workflow Summary \(p. 144\)](#)
- [WAF \(p. 145\)](#)
- [Clang \(p. 145\)](#)
- [Intermediate JSON Data \(p. 145\)](#)
- [AZ Code Generator and Python \(p. 146\)](#)
- [Template Drivers and Template Rendering \(p. 146\)](#)
- [Generated Files \(p. 147\)](#)
- [AZ Code Generator Integration with Waf \(p. 148\)](#)
- [AZ Code Generator Parameters \(p. 151\)](#)
- [Code Generation Templates \(p. 154\)](#)
- [Template Drivers \(p. 157\)](#)
- [Custom Code Generator Annotations \(p. 161\)](#)
- [Waf Debugging with AZ Code Generator \(p. 165\)](#)
- [Template Driver Debugging \(p. 171\)](#)
- [Debugging the AZ Code Generator Utility \(p. 172\)](#)
- [Intermediate JSON Data Format \(p. 173\)](#)

Workflow Summary

The following steps describe how AZ Code Generator works with Waf to generate code.

1. The Waf build system invokes AZ Code Generator for the `.h` and `.cpp` source files specified in the `wscript` file.
2. AZ Code Generator runs one or more passes over the specified files.
3. Each pass includes the following:
 - a. AZ Code Generator uses the Clang front-end compiler to produce an abstract syntax tree (AST) for each provided source file. The Clang parser attempts to compile the input. For increased speed, Clang can be instructed to not follow `#include` statements and to suppress all errors.
 - b. The AST is translated into an intermediate JSON format.

- c. The intermediate JSON object is passed into a template driver in the form of a Python script and then into a Jinja2 template. Each driver and template implements specific code generation tasks.
 - d. The template driver performs any desired preprocessing on the intermediate JSON object.
 - e. The intermediate JSON is then passed to Jinja2 templates.
 - f. Each template driver can have an arbitrary number of templates which can output to an arbitrary number of output files. Multiple templates can have the same output file or different output files as desired by the template driver creator.
4. AZ Code Generator returns a list of generated files to the Waf build system.
 5. The Waf build system completes the build process, including the autogenerated code in the build.

The following sections provide more detail about this process.

WAF

The AZ Code Generator is fully integrated into the [Waf build system](#). You can use the Waf `az_code_gen` feature to invoke the AZ Code Generator. We recommend you use Waf rather than the command line to start the `AzCodeGenerator.exe` utility.

For examples and more information about the Waf integration, see [AZ Code Generator Integration with Waf \(p. 148\)](#).

Clang

The front end of the AZ Code Generator is a [Clang](#) parser/compiler for C++ source code. AZ Code Generator uses Clang to parse source code (which may include user-defined tags) and generate the intermediate JSON data object. AZ Code Generator fully controls Clang's parser and compilation phase so that it can selectively suppress or enable features such as diagnostics. This gives AZ Code Generator the flexibility to ignore source code that might otherwise fail to compile and still attempt to generate a complete intermediate object.

Intermediate JSON Data

The Clang front end compiler outputs an intermediate JSON data structure that the generator passes to templates for further processing. An example intermediate JSON data object follows.

```
[
  {
    'name' : 'Component',
    'qualified_name' : 'AZ::Component',
    'fields' : [],
    'bases' : [],
    'meta' : {
      'path' : 'D:\\Repo\\Ly\\branches\\AzComponents\\Code\\Tools\\
\\AzCodeGenerator\\CodeGenTest.h'
    },
    'type' : 'class',
    'annotations' : {},
    'methods' : []
  },
  {
    'name' : 'TestingClass',
    'qualified_name' : 'TheNamespace::TestingClass',
    'fields' : [
      {
```

```
        'type' : 'float',
        'name' : 'm_field2',
        'qualified_name' : 'TheNamespace::TestingClass::m_field2',
        'annotations' : {}
    }
],
'bases' : [
    {
        'name' : 'Component',
        'qualified_name' : 'AZ::Component'
    }
],
'meta' : {
    'path' : 'D:\\Repo\\Ly\\branches\\AzComponents\\Code\\Tools\\
\\AzCodeGenerator\\CodeGenTest.h'
},
'type' : 'class',
'annotations' : {},
'methods' : [
    {
        'params' : ['type', 'int', 'name', 'version'],
        'name' : 'CreateArgumentAnnotation',
        'qualified_name' :
'TheNamespace::TestingClass::CreateArgumentAnnotation',
        'annotations' : {}
    }
]
}
]
```

For complete syntax of the intermediate JSON data object, see [Intermediate JSON Data Format \(p. 173\)](#).

AZ Code Generator and Python

AZ Code Generator depends on Python 2.7 to run template drivers and render [Jinja](#) templates. The Python C API is used to extend Python with methods in the `azcg_extension` module that permit template drivers to report dependencies, errors, and useful informational output. In Windows, Python 2.7 is included in the Lumberyard `dev/Tools/Python` directory. On OS X, AZ Code Generator uses the version of Python that is included with the operating system.

Note

To debug Python C API calls when using AZ Code Generator, you must download [CPython](#) and make a build for the platform on which you want to debug.

Template Drivers and Template Rendering

You can use template drivers written in Python to alter the intermediate data structure prior to passing it to the template engine. After preprocessing, the template driver may direct the Jinja2 template engine to render one or many templates, depending on the generated code that is desired.

AZ Code Generator uses the [Jinja2](#) template engine, which is downloaded by the Python [easy_install](#) script in the `\\dev\\Tools\\Python\\2.7.11\\windows\\Scripts` directory and copied into the Lumberyard `3rdParty\\jinja2` directory. Lumberyard also provides a `jinja_extensions` module, which contains helper methods that you can use inside templates. These extensions are stored in the `dev/Code/Tools/AzCodeGenerator/Scripts/jinja_extensions/` directory. For examples and more information about Jinja templates, see [Code Generation Templates \(p. 154\)](#).

Generated Files

The following sample output was generated from a serialization template. The reference JSON object has been formatted for readability.

```
////////////////////////////////////  
////////////////////////////////////  
// THIS CODE IS AUTOGENERATED, DO NOT MODIFY  
////////////////////////////////////  
////////////////////////////////////  
#include "stdafx.h"  
#include <AZCore/Rtti/ReflectContext.h>  
#include <AZCore/Rtti/Rtti.h>  
#include <AZCore/Serialization/SerializeContext.h>  
#include <AZCore/Math/Vector3.h>  
#include "D:/Repo/Ly/branches/AzComponents/Code/Tools/AzCodeGenerator/  
CodeGenTest.h"  
namespace Components  
{  
    void TestingClassReflect(AZ::ReflectContext* reflection)  
    {  
        AZ::SerializeContext* serializeContext =  
azrtti_cast<AZ::SerializeContext*>(reflection);  
        if (serializeContext)  
        {  
            serializeContext->Class<TestingClass>()  
                ->SerializerForEmptyClass() ;  
        }  
    }  
}  
////////////////////////////////////  
/*  
// Reference JSON object  
[ {  
    'name': 'Component',  
    'qualified_name': 'AZ::Component',  
    'fields': [  
  
    ],  
    'bases': [  
  
    ],  
    'meta': {  
        'path': 'D:\\Repo\\Ly\\branches\\AzComponents\\Code\\Tools\\  
\\AzCodeGenerator\\CodeGenTest.h'  
    },  
    'type': 'class',  
    'annotations': {  
  
    },  
    'methods': [  
  
    ]  
    },  
    {  
        'name': 'TestingClass',  
        'qualified_name': 'TheNamespace::TestingClass',  
        'fields': [  

```



```
{
  'type': 'float',
  'name': 'm_field2',
  'qualified_name': 'TheNamespace::TestingClass::m_field2',
  'annotations': {

  }
},
'bases': [
  {
    'name': 'Component',
    'qualified_name': 'AZ::Component'
  }
],
'meta': {
  'path': 'D:\\Repo\\Ly\\branches\\AzComponents\\Code\\Tools\\
\\AzCodeGenerator\\CodeGenTest.h'
},
'type': 'class',
'annotations': {

},
'methods': [
  {
    'params': [
      'type',
      'int',
      'name',
      'version'
    ],
    'name': 'CreateArgumentAnnotation',

    'qualified_name': 'TheNamespace::TestingClass::CreateArgumentAnnotation',
    'annotations': {

    }
  }
]
}]
*/
```

AZ Code Generator Integration with Waf

AZ Code Generator is fully accessible for any Waf target as the feature `az_code_gen`. The `dev/Code/Tools/waf-1.7.13/lmbrwaf/lib/az_code_generator.py` file contains the core of the Waf integration code. It includes the `az_code_gen` feature that can be used by any `wscript` file.

The minimum required information is a list of the files to pass into the code generator and at least one template driver. This list feeds the code generator one file at a time and invokes the templates specified by the driver. The files output from the driver are added as dependencies of the build task. Output files also have the option to be reinjected back into the C++ build for compilation. Output file paths are automatically added as include paths both for the current target build and as `export_header` entries. This allows written source code to reference the generated source code from both internal and external targets.

Topics

- [Basic Integration \(p. 149\)](#)

- [Advanced Integration \(p. 149\)](#)
- [Input Files \(p. 150\)](#)
- [Template Drivers \(p. 150\)](#)
- [Command Line Parameters \(p. 150\)](#)
- [Waf Specific Options \(p. 151\)](#)

Basic Integration

In the `wscript` file for the target requiring generated code, add the `az_code_gen` feature as follows.

```
features = ['az_code_gen'],
```

Next, specify the files to pass as input to the code generator, as in the following example.

```
az_code_gen = [  
    {  
        'files' : ['MySourceFile.h'],  
        'scripts' : ['MyTemplateDriver.py']  
    }  
],
```

The paths given are relative to the target path in both cases.

Whenever the specified target is compiled, a code gen task is generated that passes in the `MySourceFile.h` file to the code generator and invokes the `MyTemplateDriver.py` file to control the output. For information on how to write a template driver, see [Template Drivers \(p. 157\)](#).

Advanced Integration

The AZ Code Generator Waf integration uses passes to define the code generator tasks to be run during build time. Each pass determines the set of files, drivers, and environment settings with which to run the code generator. Currently, all passes are run in parallel without any dependency checking between passes.

The following example shows the configuration of multiple passes.

```
az_code_gen = [  
    {  
        'files' : ['MyCode/MySourceFile.h'],  
        'scripts' : ['MyCode/MyTemplateDriver.py']  
    },  
    {  
        'files' : ['MyOtherCode/MyOtherSourceFile.h'],  
        'scripts' : ['MyOtherCode/MyOtherTemplateDriver.py']  
    }  
],
```

This example generates the following two code gen tasks.

1. Pass in the `MyCode/MySourceFile.h` file to the code generator and invoke the `MyCode/MyTemplateDriver.py` file to control the output.
2. Pass in `MyOtherCode/MyOtherSourceFile.h` to the code generator and invoke `MyOtherCode/MyOtherTemplateDriver.py` to control the output.

Input Files

Each pass provides a list of files to be used as input to the code generator. This list may also contain string paths, nodes, and lists. Top level string paths and nodes are passed individually to the code generator. Note the following:

- If you provide a list, all files or nodes contained in that list are used by the code generator at the same time. This allows for maximum flexibility, but typical usage is one input per task.
- The overhead of the Waf task and AZ Code Generator bootstrapping can be significant. To improve performance, you can pass in multiple input files in one list.
- The code generator invokes the same Clang and template driver pipeline for each input file.

The following example shows several input file specifications.

```
# Finds this file relative to the build context source node
'files' : [bld.srcnode.find_or_declare('Code/Framework/AzCore/Tests/
CodeGen.h')],

'files' : [
# Pass both MyClass.h and MyClass.cpp at the same time to code generator to
get more
# information about MyClass than just the header. Note the nested lists.
  ['MyClass.h', 'MyClass.cpp']
]

'files' : [
  # Any and all variations are allowed, but because lists provide only one
  layer of grouping,
  # lists are allowed only at the top level.
  'MySourceFile.h',
  'MyOtherSourceFile.cpp',
  bld.srcnode.find_or_declare('Code/Framework/AzCore/Tests/CodeGen.h'),
  ['MyClass.h', 'MyClass.cpp']
]
```

Template Drivers

To specify template drivers to use for each code gen pass, provide a list of string paths, relative to the target path, as in the following example.

```
'scripts' : [
  '../../../../Framework/AzFramework/CodeGen/AzClassCpp.py',
  '../../../../Framework/AzFramework/CodeGen/AzEBusInline.py',
  '../../../../Framework/AzFramework/CodeGen/AzReflectionCpp.py',
  '../../../../Framework/AzFramework/CodeGen/AzClassInline.py'
],
```

Command Line Parameters

All command line parameters for the code generation utility can be specified in each code gen pass by providing a list of arguments, as in the following example.

```
'arguments' : [
  '-OnlyRunDiagnosticsOnMainFile=true',
  '-SuppressDiagnostics=false',
```

```
'-SuppressErrorsAsWarnings=false',  
'-output-redirectation=file',  
],
```

For a full list of parameters, see [AZ Code Generator Parameters \(p. 151\)](#).

Waf Specific Options

The Waf integration provides additional options that can be specified in a list for each code gen pass, as in the following example.

```
'options' : ['PrintOutputRedirectionFile'],
```

`PrintOutputRedirectionFile` – This option, when used in combination with the `-output-redirectation=file` parameter, directs Waf to provide AZ Code Generator a path to save extra output during code generation. The path to this file is listed per task during the build if errors occur.

AZ Code Generator Parameters

For best results, pass the options for AZ Code Generator in to the Waf build system. However, you can also specify the parameters for `AzCodeGenerator.exe` on the command line.

Topics

- [Waf Parameters \(p. 151\)](#)
- [Clang Compilation Parameters \(p. 151\)](#)
- [Intermediate Data \(p. 152\)](#)
- [Front End \(p. 152\)](#)
- [AZ Code Generator Parameter List \(p. 152\)](#)

Waf Parameters

Most parameters for AZ Code Generator are specified by the Waf integration. Parameters such as input, output, and include paths are automatically detected and forwarded. Other AZ Code Generator parameters control how AZ Code Generator deals with the source code input and the intermediate data that is generated.

Specify any of these in the `arguments` section of the `az_code_gen` pass in the `wscript` file.

Clang Compilation Parameters

The following `AzCodeGenerator.exe` parameters apply to Clang compilation.

Parameter	Description
<code>- SuppressIncludeNotFoundError</code>	Suppresses unknown <code>#include</code> statements at compile time.
<code>- OnlyRunDiagnosticsOnMainFile</code>	Ignores build warnings and errors on all except the main file specified for compilation.
<code>- SuppressDiagnostics</code>	Ignores build warnings and errors on all files.
<code>- SuppressErrorsAsWarnings</code>	Downgrades any build errors to warnings. Allows Clang to succeed even if there are errors.

Intermediate Data

To include information about code outside of the input file in the intermediate JSON data, use the following option.

```
-inclusion-filter=<wildcard filter for files to allow>
```

Front End

You can choose the front end to use by specifying either the `-Clang` (the default) or `-JSON` option.

AZ Code Generator Parameter List

The following list shows all AZ Code Generator parameters.

Usage: `AzCodeGenerator.exe` [options]

Option	Category	Description
<code>-Clang</code>	General	Uses the Clang compiler front end.
<code>-clang-settings-file=<string></code>	Code Parsing	The path to the file that contains Clang configuration settings.
<code>-codegen-script=<string></code>	Python	The absolute path and file name of the code generation script to invoke.
<code>-debug</code>	General	Enables debug output.
<code>-debug-buffer-size=<uint></code>	General	Buffers the last <i>n</i> characters of debug output until program termination. The default is 0, which specifies immediate printout.
<code>-debug-only=<debug string></code>	General	Enables a specific type of debug output.
<code>-define=<string></code>	Code Parsing	Specifies a preprocessor definition.
<code>-DelayedTemplateParsing</code>	AST Traversal	Template tokens are consumed and stored for parsing at the end of the translation unit.
<code>-EnableIncrementalParsing</code>	AST Traversal	Enables incremental processing.
<code>-force-include=<string></code>	Code Parsing	List of headers to forcibly include in Clang parsing.
<code>-help</code>	General	Displays basic options in categorized format.
<code>-help-hidden</code>	General	Displays all available options in categorized format.
<code>-help-list</code>	General	Displays basic options in list format.
<code>-help-list-hidden</code>	General	Displays all available options in list format.
<code>-include-path=<string></code>	Code Parsing	The header include path.

Option	Category	Description
<code>-inclusion-filter=<string></code>	Code Filtering	Specifies a wildcard filter so that files other than those specified by <code>input-files</code> are parsed by Clang into intermediate data.
<code>-info-output-file=<filename></code>	General	File to which to append <code>-stats</code> output.
<code>-input-file=<string></code>	Code Parsing	(Required) Path to input file relative to the value of <code>input-path</code> .
<code>-input-path=<string></code>	Code Parsing	(Required) The absolute path to input folder. All <code>input-file</code> paths must be relative to this folder.
<code>-intermediate-file=<string></code>	Code Parsing	Path to a file that stores the JSON AST from Clang parsing.
<code>-JSON</code>	General	Uses raw JSON input for the front end.
<code>-noscripts</code>	General	Disables the running of codegen scripts.
<code>-OnlyRunDiagnostics</code>	Clang Compiler	Runs diagnostics (error and warning checking) only on the main file that is compiled. Ignores errors and warnings from all other files.
<code>-output-path=<string></code>	Code Parsing	(Required) The absolute path to the output folder.
<code>-output-redirection</code>	Output	Redirects output and error messages from Clang and Python internal utilities. Options: <code>=none</code> – No output redirection. Clang and Python output to <code>stdout</code> and <code>stderr</code> . <code>=null</code> – Redirect Clang and Python to null, effectively suppressing output. <code>=file</code> – Redirect Clang and Python to disk. Use <code>redirect-output-file</code> to specify the path.
<code>-output-using-json</code>	Output	Outputs using JSON objects instead of plain text. Use this option to ease parsing for calling applications.
<code>-print-all-options</code>	General	Prints all option values after command line parsing.
<code>-print-options</code>	General	Prints nondefault options after command line parsing.
<code>-python-debug-path=<string></code>	Python	Path to Python debug libraries and scripts for <code>AzCodeGenerator.exe</code> to use in debugging.
<code>-python-home=<string></code>	Python	(Required) The equivalent of the <code>PYTHONHOME</code> environment variable, which is ignored.
<code>-python-home-debug=<string></code>	Python	The equivalent of the debug Python <code>PYTHONHOME</code> environment variable, which is ignored.
<code>-python-path=<string></code>	Python	The path to Python libraries and scripts for <code>AzCodeGenerator.exe</code> .

Option	Category	Description
<code>-redirect-output-file=<string></code>	Output	The file path for redirected output. Use in combination with the <code>-output-redirection=file</code> option. The default file name is <code>output.log</code> .
<code>-resource-dir=<string></code>	Code Parsing	The path to the resource directory for Clang.
<code>-stats</code>	General	Enables statistics output from program (available with asserts). Use the <code>-info-output-file=<filename></code> option to specify the output file.
<code>-SkipFunctionBodies</code>	AST Traversal	Does not traverse function bodies.
<code>-SuppressDiagnostics</code>	Clang Compilation	Hides Clang compilation diagnostic information.
<code>-SuppressErrorsAsWarnings</code>	Clang Compilation	Suppresses compilation errors during parsing by reporting them as warnings.
<code>-SuppressIncludeNotTraversed</code>	AST Traversal	Suppresses <code>#include</code> not found errors.
<code>-track-memory</code>	General	Enables <code>-time-passes</code> memory tracking. Performance may be slow when this option is used.
<code>-v</code>	General	Outputs verbose debug information.
<code>-version</code>	General	Displays the version of <code>AzCodeGenerator.exe</code> .
<code>-view-background</code>	General	Executes the graph viewer in the background. This option creates a <code>.tmp</code> file that must be deleted manually.

Code Generation Templates

AZ Code Generator uses the [Jinja2](#) template engine for Python to render its output. The Jinja template engine outputs plain text with embedded variable and logic statements.

Jinja templates are designed to be highly readable and mimic the overall structure of the desired output. They are processed top to bottom. Any text outside of the control block in the template is sent directly to the output.

The following are some example templates. For more information about creating Jinja templates, refer to the [Jinja Template Designer Documentation](#).

Topics

- [Simple Example \(p. 154\)](#)
- [Complex Example \(p. 155\)](#)
- [Template Data \(p. 156\)](#)

Simple Example

A Jinja template can use text variables to replace text at predetermined locations in the output, as in the following example:

```
// Here's a {{ variable_name }} !!  
int {{ variable_name }} = {{ variable_value }};
```

In this example, the Jinja template is given the following input.

```
{  
  'variable_name' = 'foo',  
  'variable_value' = 42  
}
```

The following output results.

```
// Here's a foo !!  
int foo = 42;
```

Complex Example

Jinja allows for fairly complicated logic, branching and looping control structures. The following example template generates a class that has the public and private variables specified by the input:

```
// This class is auto-generated!  
class {{ class.name }}  
{  
public:  
    virtual ~{{ class.name }}() = default;  
  
{% if class.members is defined %}  
    {% for member_var in class.members if member_var.visibility is 'public' -  
    %}  
        {{ member_var.type }} m_{{ member_var.name }}{{ if member_var.value is  
defined }} = {{ member_var.value }}{{ endif }}};  
        {%- endfor %}  
{% endif %}  
private:  
{% if class.members is defined %}  
    {% for member_var in class.members if member_var.visibility is 'private'  
-%}  
        {{ member_var.type }} m_{{ member_var.name }}{{ if member_var.value is  
defined }} = {{ member_var.value }}{{ endif }}};  
        {%- endfor %}  
{% endif %}  
};
```

In this example, the Jinja template is given the following input.

```
{  
  'class' : {  
    'name' : 'MyClass',  
    'members' : [  
      {  
        'name' : 'foo',  
        'type' : 'int',  
        'visibility' : 'public'  
      },  
    ],  
  },  
}
```



```
{
  {
    'name' : 'bar',
    'type' : 'long',
    'visibility' : 'public',
  },
  {
    'name' : 'secretSauce',
    'type' : 'float',
    'visibility' : 'private',
    'value' : '98.6f'
  }
]
}
```

The template produces the following output.

```
// This class is auto-generated!
class MyClass
{
public:
    virtual ~MyClass() = default;

    int m_foo;
    long m_bar;
private:
    float m_secretSauce = 98.6f;
};
```

Template Data

The data that is available to the template is fully controlled by the Python [template driver \(p. 157\)](#).

The following table lists the variables that are automatically added to the Jinja environment.

Variable	Description
extra_data	Python object that contains data returned by the apply_transformations (p. 158) method of the template driver.
extra_str	String that contains the contents of <code>extra_data</code> in JSON format.
json_object	Python object that contains the decoded intermediate JSON after it has been processed by the template driver.
json_str	String that contains the encoded intermediate JSON after it has been processed by the template driver.

For information about the intermediate output, see [Intermediate JSON Data Format \(p. 173\)](#).

Note

Because Jinja contains a limited feature set, attempting to do complex data transformations in Jinja templates produces overly complicated and generally unreadable templates. For this reason, we recommend that you perform any major data manipulation in the template driver before it is passed into the Jinja template engine. For more information, see [Template Drivers \(p. 157\)](#).

Template Drivers

Template drivers are Python scripts that process the intermediate JSON data and route it into the Jinja2 output templates. The scripts preprocess the data from the Clang front end, execute the template rendering, and control where the generated output is written to disk.

These scripts are usually called by one or more code gen passes in WAF `wscript` files. Each Python script can reference multiple templates. This offers great flexibility in implementation, especially when multiple templates rely on the same preprocessed data.

Topics

- [Specifying Drivers in Waf \(p. 157\)](#)
- [Creating a Template Driver in Python \(p. 157\)](#)
- [Minimal Template Driver \(p. 159\)](#)
- [Rendering Templates \(p. 159\)](#)
- [Configuring Automatic Build Injection \(p. 160\)](#)
- [Preprocessing Intermediate Data \(p. 160\)](#)

Specifying Drivers in Waf

Drivers are specified by file name in each code gen pass. The file path is relative to the root of the `wscript` target. All drivers are invoked on each input file.

The following shows the structure of a sample Waf entry.

```
'az_code_gen' = [  
  {  
    'files': [ <files to gen> ],  
    'scripts': [ <list of script file paths relative to current wscript  
                  folder> ]  
  }  
]
```

For more details on how to specify passes, see [AZ Code Generator Integration with Waf \(p. 148\)](#).

Creating a Template Driver in Python

To create a template driver in Python, you must import the `TemplateDriver` base class and override its methods. The code for the class can be found in the `dev/Code/Tools/AzCodeGenerator/Scripts/az_code_gen/base.py` file.

This class is automatically injected into Python by AZ Code Generator and only needs to be imported as `az_code_gen.base`, as in the following example.

```
from az_code_gen.base import *
```

Methods to Override in the TemplateDriver Class

To implement your template driver, override the following methods in the `TemplateDriver` class.

`add_dependency`

Call the `add_dependency` method to manually add a dependency to the `az_code_gen` task in Waf. The file path given should be absolute so that the render template can specify additional dependencies

that Waf does not automatically include. These dependencies might be external data files used to render the templates, or files that were used to generate the input data.

Syntax

```
add_dependency(self, dependency_file)
```

apply_transformations

Override the `apply_transformations` method to manipulate the raw JSON object, which is passed in as the `obj` parameter. Manipulations are performed in place on the object. The object is then forwarded through the pipeline and is eventually passed to `jinja_args` of `render_templates`. Any object returned by this method is provided to the Jinja environment as `extra_data`.

Syntax

```
apply_transformations(self, obj)
```

For an example of this method, see [Preprocessing Intermediate Data \(p. 160\)](#).

get_expected_tags

Override the `get_expected_tags` method to return a list of tags that must be found in any input file. If the required tags are not present, this driver is skipped.

Important

This method is deprecated as of Lumberyard v1.6. After Lumberyard v1.6, all scripts will be processed regardless of expected tags, and `get_expected_tags` will not be invoked.

Syntax

```
get_expected_tags(self)
```

render_template_to_file

Renders a template to disk. This method also adds the value of `output_file` as a dependency of the `az_code_gen` task in Waf.

Syntax

```
render_template_to_file(self, template_file, template_kwargs, output_file,  
    should_add_to_build=False)
```

Parameters

Parameter	Description
<code>template_file</code>	Specifies the path to a template relative to the directory that contains the template driver <code>.py</code> file.
<code>template_kwargs</code>	Specifies a dictionary of key–value pairs to be passed to Jinja. Generally this should be treated as a passthrough variable for the <code>jinja_args</code> given to <code>render_templates</code> , but you can add additional key–value pairs.
<code>output_file</code>	Specifies the target file for the rendered Jinja output. The path is relative to the target output folder.

Parameter	Description
<code>should_add_to_build</code>	A Boolean value that specifies whether Waf should add this file to the C++ build and linker. The default is false.

render_templates

Override `render_templates` to invoke template rendering by calling `render_template_to_file`.

Syntax

```
render_templates(self, input_file, **jinja_args)
```

Parameters

Parameter	Description
<code>input_file</code>	The path relative to the input path that is used to invoke Clang.
<code>jinja_args</code>	The raw data from the intermediate JSON object after the template driver performs preprocessing on the object.

Minimal Template Driver

The minimum code required for a template driver is to derive from the `TemplateDriver` base class and implement a factory function to construct the template driver.

```
from az_code_gen.base import *

class MyTemplateDriver(TemplateDriver):
    pass

# Factory function - called from launcher
def create_drivers(env):
    return [MyTemplateDriver(env)]
```

The `az_code_gen` module is automatically provided by AZ Code Generator. It contains the `TemplateDriver` and other useful methods from the `base.py` file.

The `create_drivers` function simply forwards the Jinja environment that is used to render templates. However, you can alter the function to perform other work when the driver is instantiated.

Note

The above bare-bones implementation works but does not generate any output.

Rendering Templates

To generate some output, you must implement the `render_templates` method, as in the following example.

```
from az_code_gen.base import *

class MyTemplateDriver(TemplateDriver):
    def render_templates(self, input_file, **jinja_args):
```

```
        self.render_template_to_file("MyTemplate.tpl", jinja_args,
        'GeneratedCode.cpp')

# Factory function - called from launcher
def create_drivers(env):
    return [MyTemplateDriver(env)]
```

The `render_templates` method takes the relative `input_file` path and any arguments that were passed in from the `AZCodeGenerator.exe` utility. The `input_file` path usually contains inputs such as the intermediate `json_object` created by Clang.

Template drivers can extend this information by implementing the `apply_transformations` method. For more information, see [Preprocessing Intermediate Data \(p. 160\)](#).

The `render_template_to_file` method takes a template file and argument key–value pairs to pass into the template engine directly and an output path to write the template engine render output to disk.

Configuring Automatic Build Injection

At this point, the example generates a minimal `.cpp` file. The example above does not compile or link the `.cpp` file. This is appropriate if you intend to include the generated code manually using an `#include` in another file.

To inject the generated file automatically, add the `should_add_to_build` parameter to the `render_template_to_file` method and pass the parameter the value of `true`. The `should_add_to_build` parameter informs Waf that the generated file needs to be built and linked into the current target.

Note

Using the `should_add_to_build` parameter is not recommended for header files or other generated files that are not C++ code that must be compiled and linked.

The following example shows some build injected output.

```
from az_code_gen.base import *

class MyTemplateDriver(TemplateDriver):
    def render_templates(self, input_file, **jinja_args):
        self.render_template_to_file("MyTemplate.tpl", jinja_args,
        'GeneratedCode.cpp', should_add_to_build=True)

# Factory function - called from launcher
def create_drivers(env):
    return [MyTemplateDriver(env)]
```

Preprocessing Intermediate Data

Some cases require preprocessing of the intermediate data for easier consumption by the template engine. To do this, implement the `apply_transformations` method in your template driver. You can use this method to access the intermediate JSON data object directly before it gets passed to `render_templates`. An example follows.

```
from az_code_gen.base import *

class MyTemplateDriver(TemplateDriver):
    def render_templates(self, input_file, **jinja_args):
```

```
        self.render_template_to_file("MyTemplate.tpl", jinja_args,
        'GeneratedCode.cpp')

    def apply_transformations(self, obj):
        obj['my_custom_data'] = 42

# Factory function - called from launcher
def create_drivers(env):
    return [MyTemplateDriver(env)]
```

For information on the contents of the `obj` variable, see [Intermediate JSON Data Format \(p. 173\)](#).

Custom Code Generator Annotations

You can provide additional data to your template driver by attaching annotations and tags to your source code.

Topics

- [Reference Annotations \(p. 161\)](#)
- [Helper Macros \(p. 161\)](#)
- [Example Annotations \(p. 162\)](#)

Reference Annotations

When you create custom code generator annotations, it is a good idea to refer for examples to the existing annotations in the `dev/Code/Framework/AZCore/AZCore/Preprocessor/CodeGen.h` file. The existing annotations use macros extensively as a workaround for the lack of proper annotations in C++.

Clang provides an `annotate` attribute that can be read at parse time. You can use the helper macros provided to create new annotations, as in the following example.

```
__attribute__((annotate("<Some string here>")))
```

This attribute is wrapped with a macro that converts its contents into strings that can be parsed by the AZ Code Generator utility.

Helper Macros

AZ Code Generator has two helper macros for annotations: `CreateAnnotation` and `CreateArgumentAnnotation`.

CreateAnnotation

`CreateAnnotation` is the core macro that exposes the underlying Clang `annotate` attribute. The macro definition follows.

```
#define CreateAnnotation(annotation) __attribute__((annotate(annotation)))
```

Any argument passed to `CreateAnnotation` must be a string.

CreateArgumentAnnotation

The `CreateArgumentAnnotation` macro is commonly used for annotation macros. The macro definition follows.

```
#define CreateArgumentAnnotation(annotation_name, ...)
CreateAnnotation(AZ_STRINGIZE(annotation_name) "("
AZ_MACRO_SPECIALIZE(AZ_SPACIZE_, AZ_VA_NUM_ARGS(__VA_ARGS__), (__VA_ARGS__))
)")
```

The `CreateArgumentAnnotation` macro takes an `annotation_name` argument and a number of variable arguments. The values passed to the variable arguments are collapsed into a single string for parsing by the AZ Code Generator.

Example Annotations

This section provides example annotations. One example forwards arguments to the underlying macro, one places an annotation inside a class, and one injects code back into the originating file.

Simple Annotation

The following example creates a new annotation called `AzExample` that forwards its arguments to the underlying macro.

```
#define AzExample(...) CreateArgumentAnnotation(AzExample, __VA_ARGS__)
```

In this example, the private and public name of the annotation is the same. However, the external and internal names do not have to match.

You can attach the `AzExample` annotation to most items in C++, as in the following example.

```
class ExampleClass
{
    AzExample(description("I am data!"))
    int m_myData;
}
```

The tags inside the annotation are placed in JSON format in the generated intermediate data object, as in the following example. Some data has been removed for readability.

```
{
  "type": "class",
  "name": " ExampleClass",
  "annotations" : {},
  "fields": [
    {
      "name": "m_myData",
      "annotations" : {
        "AzExample" : {
          "description" : "I am data!"
        }
      }
    }
  ]
}
```

Class Annotation Example

The following example directs the AZ Code Generator utility to attach a free-floating annotation to a class.

```
#define AzExampleClass(...) CreateArgumentAnnotation(AzExampleClass,  
Class_Attribute, __VA_ARGS__) int AZ_JOIN(m_azCodeGenInternal, __COUNTER__);
```

`AzExampleClass` – Specifies the annotation name `AzExampleClass` (instead of `AzExample`, as in the previous example).

`Class_Attribute` – Specifies that the AZ Code Generator utility should attach the attribute to the class that contains the annotation. The annotation will belong to the `annotations` property of the class object.

`__VA_ARGS__` – Specifies additional parameters that are converted into a single string and passed into the AZ Code Generator utility for parsing.

`int AZ_JOIN(m_azCodeGenInternal, __COUNTER__)` – `AZ_JOIN` is a helper macro that takes two macro-level entries and joins them together without converting them to strings. Because Clang requires annotation attributes be attached to a function or variable, this example uses `AZ_JOIN` and a temporary integer member variable to do this. The temporary integer member variable is subsequently ignored.

Adding the new annotation to the previous example produces the following code:

```
//Class Annotation Example  
class ExampleClass  
{  
    AzExampleClass(description("I am an example class!"));  
    AzExample(description("I am data!"))  
    int m_myData;  
}
```

This produces the following intermediate JSON object. Some data has been removed for ease of comprehension.

```
"type": "class",  
"name": "SampleClass",  
"annotations" : {  
    "AzExampleClass" : {  
        "description" : "I am an example class!"  
    }  
},  
"fields": [  
    {  
        "name": "m_myData",  
        "annotations" : {  
            "AzExample" : {  
                "description" : "I am data!"  
            }  
        }  
    }  
]  
]
```

Generated Code Injection Example

The following example shows how to automatically inject generated code back into the original file. The example extends the previously created `AzExampleClass` annotation by injecting code into the example class.

```
#if defined(AZ_CODE_GENERATOR)
```



```
#   define AzExampleClass(ClassName, ...)
CreateArgumentAnnotation(AzExampleClass, Class_Attribute,
  identifier(ClassName), __VA_ARGS__) int AZ_JOIN(m_azCodeGenInternal,
  __COUNTER__);
#else
#   define AzExampleClass(ClassName, ...)
  AZ_JOIN(AZ_GENERATED_CODE_, ClassName)
#endif // AZ_CODE_GENERATOR
```

The updated annotation adds a new required parameter called `ClassName`, which is an identifier that is used to inject the code. The identifier is passed in to Clang as `identifier(ClassName)`, and the data is provided to the intermediate JSON.

Up until this point, the annotation macro outside of `AZ_CODE_GENERATOR` has been blank. The next step is to have it expand to the identifier of the code generated macro so that when the generated file is put in an `#include` statement, the macro annotation is replaced by the generated code.

To implement this, the example sets the macro to become `AZ_JOIN(AZ_GENERATED_, ClassName)`. As before, `AZ_JOIN` in this example renders this as `AZ_GENERATED_CODE_ExampleClass`. The `ClassName` parameter provides a name at compile time for the generated macro.

Note

It is not required that `ClassName` be the actual name of the class where the annotation is used. Other annotations that use this mechanism can simply require any unique identifier.

When the previous example code is updated, the following code is produced:

```
class ExampleClass
{
    AzExampleClass(ExampleClass, description("I am an example class!"));
    AzExample(description("I am data!"))
    int m_myData;
}
```

This code produces the following intermediate JSON. Note the new identifier annotation on the class. Some data has been removed for readability.

```
"type": "class",
"name": "SampleClass",
"annotations" : {
  "AzExampleClass" : {
    "identifier" : "ExampleClass",
    "description" : "I am an example class!"
  }
},
"fields": [
  {
    "name": "m_myData",
    "annotations" : {
      "AzExample" : {
        "description" : "I am data!"
      }
    }
  }
]
```

This result doesn't compile until the following template code used with the annotation produces the desired macro.

```
{% if class.annotations.identifier is defined %}
#define
  AZ_GENERATED_CODE_{{ asStringIdentifier(class.annotations.identifier) }}\
public: \
{# This method is injected for all classes with the AzExampleClass annotation
#}
bool IsExampleClass(void) { return true; }
{% endif %}
```

This code generates the following code for injection:

```
#define AZ_GENERATED_CODE_ExampleClass \
bool IsExampleClass(void) { return true; }
```

If the generated header is placed in an `#include` statement in the original code, any code in this macro will be injected into `ExampleClass`.

Waf Debugging with AZ Code Generator

You can debug the integration output of Waf's Python scripts by using PyCharm and a few key debugging entry points. For more information about Waf integration itself, see [AZ Code Generator Integration with Waf](#) (p. 148).

Topics

- [Prerequisites](#) (p. 165)
- [Identifying and Configuring Debug Output](#) (p. 165)
- [Setting Up PyCharm for Debugging Waf](#) (p. 166)

Prerequisites

Before you start, follow the instructions for [Setting Up PyCharm for Debugging Waf](#) (p. 166). The PyCharm debugger must be set up to debug `lmbw_waf` before you can continue.

Identifying and Configuring Debug Output

All AZ Code Generator Waf integration output is prefixed with `az_code_gen`. To see additional output from both task creation and task execution, add `--zones=az_code_gen` to the Waf command line. This exposes the commands that invoke AZ Code Generator and are useful for debugging the AZ Code Generator utility itself. For more information, see [Debugging the AZ Code Generator Utility](#) (p. 172).

Debugging Wscript Configuration

To debug most configuration problems, it is best to set a breakpoint in the `create_code_generator_tasks` method in `Code\Tools\waf-<version>\lmbwaf\lib\az_code_generator.py`. This method is called for each wscript file that uses the `az_code_gen` feature. It directly interprets the given passes and generates an `az_code_gen` task for each input file in each pass.

Debugging `az_code_gen` Task Creation

The `create_az_code_generator_task` feature creates `az_code_gen` tasks. It gathers most information and inserts it into the task. Each task gets added to the `az_code_gen_group` Waf task to ensure it is executed prior to other tasks.

Debugging az_code_gen Task Execution

The `run` and `handle_code_generator_output` commands are important points in task execution.

The `run` command takes the available information and generates a Clang-style arguments file prefixed with the `@` symbol. The arguments file is passed on the command line to the AZ Code Generator utility.

`handle_code_generator_output` - The AZ Code Generator utility returns a JSON object with one or more entries that are parsed by `handle_code_generator_output`. If the AZ Code Generator utility returns an invalid, non-JSON response due to errors during execution, the Waf task returns the error message `No JSON-Object could be decoded`. To discover the return value that could not be handled, run the command outside of Waf.

Setting Up PyCharm for Debugging Waf

PyCharm is an integrated development environment for Python which includes a graphical debugger that is useful for debugging Waf.

To set up PyCharm and Waf for debugging

1. Download [PyCharm Community Edition](#).
2. Start PyCharm.
3. At the welcome screen, choose **Open Directory**.
4. From the Lumberyard root directory, navigate to any branch that contains a `_WAF_` or `dev` directory. There should be a file called `wscript` and `waf_branch_spec.py` under this folder.
5. Configure the Python interpreter.
 - a. Choose **File, Settings, Project:dev, Project Interpreter** to open the project interpreter page.
 - b. Click the gear icon on the right of the **Project Interpreter** and choose **Add Local**.

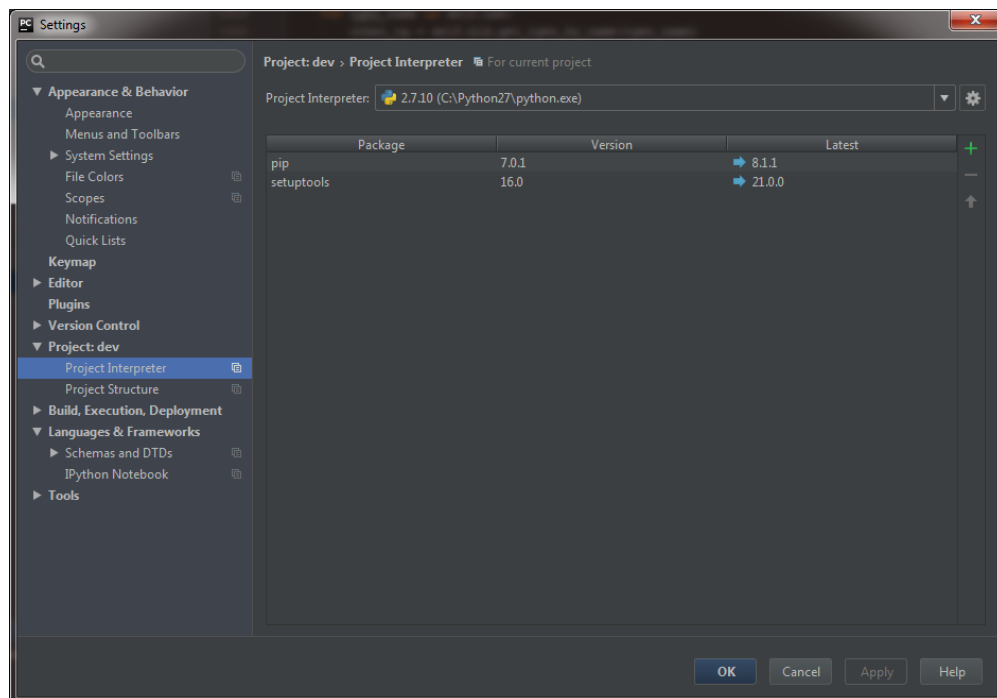

- c. Navigate to the folder where `python.exe` resides. The Python executable file must be in the same folder as the project or you may have issues running Waf.

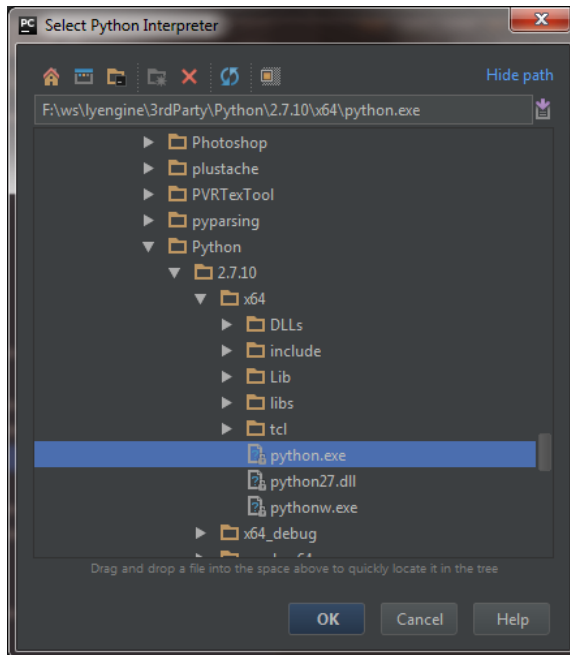

6. Set up a debugging profile for Waf.
 - a. To set up Waf for debugging, use the project explorer in the left pane. If you don't see the project explorer, press **Alt+1**). Navigate to the `Code/Tools/waf-<version>` node and expand it. You should see a file called `Imbr_waf` inside this node.

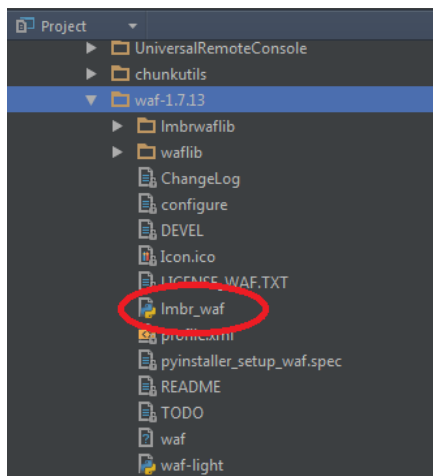

- b. Right-click **Imbr_waf** and choose **Create Imbr_waf**

Note

The **Indexing...** operation must finish before the option appears. You can verify status in the bar at the bottom.

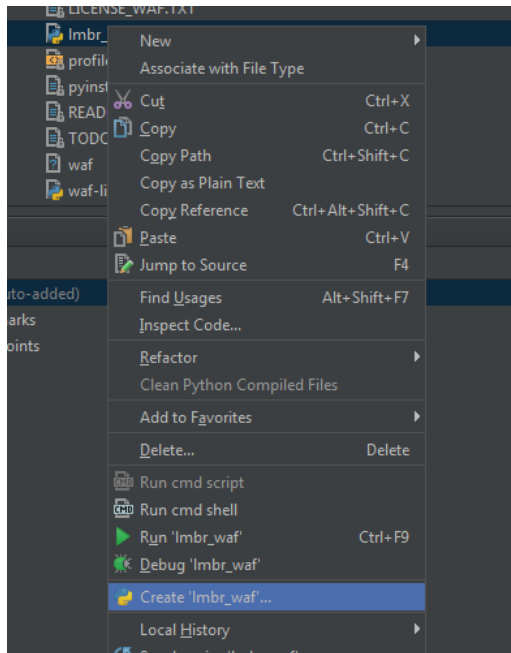

- c. In the **Create Run/Debug Configuration** dialog, ensure that the following values are configured correctly:
- **Single instance only** should be selected.
 - **Script Parameters** is the command to use to run Waf for the run/debug session.
 - **Python Interpreter** should be the interpreter that you specified earlier.
 - The **Working directory** must be the root of the project (for example, the `dev` directory).

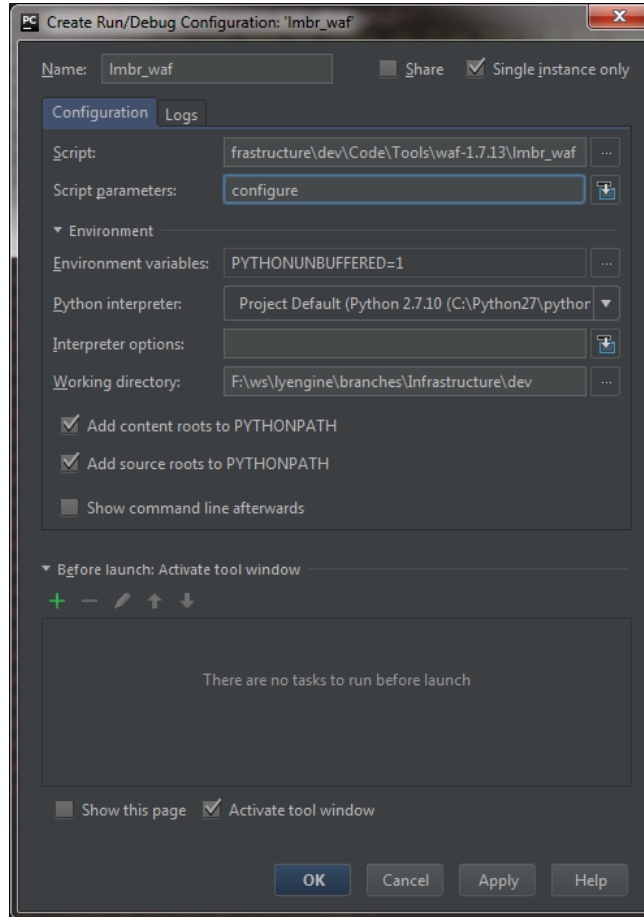

Next, you must to set up `wscript` files as debuggable Python files. Waf uses files called `wscript` to define the build rules per project. These are dynamically loaded Python modules that can be debugged like any other Python module.

- d. Choose **File, Settings, Editor, File Types, Python**.
- e. To add a registered pattern for `wscript`, choose **Python** in **Recognized File Types**.

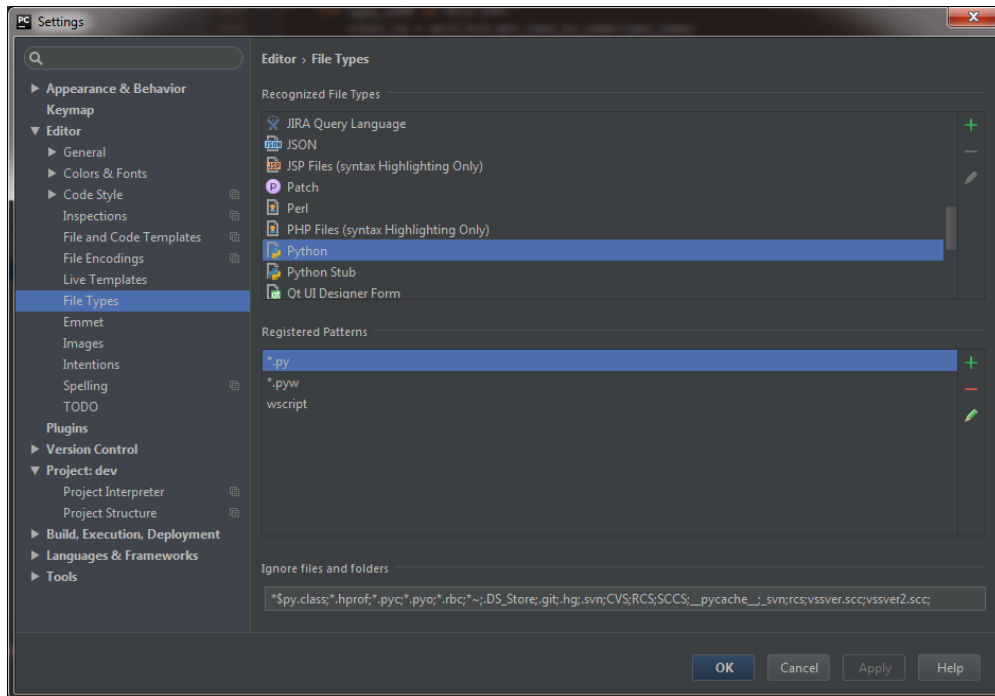

- f. Under **Registered Patterns**, click the green plus sign (+).
- g. In the **Add Wildcard** dialog box, type in `wscript`.

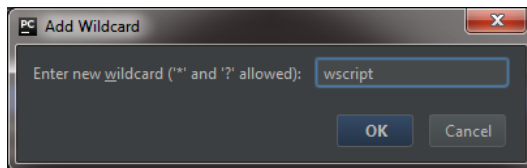

7. Make sure **IncrediBuild** is turned off.
 - a. Open the `_WAF_/usersettings.options` file.
 - b. Verify that `use_incredibuild` is set to `false`, as in the following example.
`use_incredibuild = False`
8. (Optional) Enable file outlining.

By default, file outlining is switched off in PyCharm. This feature facilitates navigation in the source files, as the following image shows.

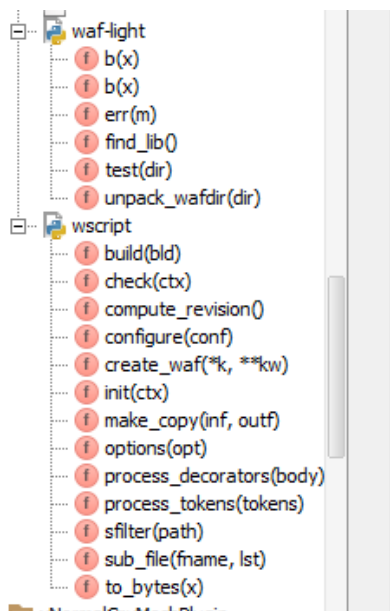

To enable file outlining, right-click the **Project** tab and choose **Show Members**.

Template Driver Debugging

Because template drivers are run from the AZ Code Generator executable using Python, you can't debug them directly. However, you can debug your driver and template code (and even Jinja2 itself) by using the `debug.py` file included with AZ Code Generator.

To debug a template driver with a Python debugger like PyCharm or Visual Studio

1. Set the debugger to execute the `Bin64\azcg\debug.py` file. This file launches the utility to generate input JSON and emulates a code-generation pass in Python so that you can debug as if you were attached to the utility.
2. Set the working directory to `Bin64\azcg`.
3. Type the arguments for `AzCodeGenerator.exe` into a file with one argument per line. Or use a Waf-generated arguments file as described in [Waf Debugging with AZ Code Generator \(p. 165\)](#).
4. Set the arguments file, prefixed with `@`, as the argument to the script.

The following arguments are required:

- `-codegen-script` – Absolute path to the driver script that you want to debug.
- `-input-path` – Absolute path on which source file paths are based. Usually this path is the same as the location of the `wscript` for a given target.
- `-input-file` – Relative path from input path to the source file that is used for input.
- `-output-file` – Absolute path where generated code will be written.

After you have completed the preceding steps, you should be able to launch your debugger and set breakpoints in your driver script.

For complete AZ Code Generator parameter information, see [AZ Code Generator Parameters \(p. 151\)](#).

Debugging the AZ Code Generator Utility

When using Waf and the AZ Code Generator utility, you will most likely need to [debug Waf Python scripts \(p. 165\)](#) and your [template drivers \(p. 171\)](#). You can also debug the AZ Code Generator utility itself, although it is less likely that you will need to do so. You can debug the AZ Code Generator utility by using Visual Studio in Windows or Xcode in OS X.

Topics

- [Prerequisites \(p. 172\)](#)
- [Debugging the AZ Code Generator Utility from the Waf build \(p. 172\)](#)
- [Setting Visual Studio Debug Arguments \(p. 173\)](#)
- [Setting Xcode Debug Arguments \(p. 173\)](#)

Prerequisites

The preliminary steps that you need to take depend on your operating system.

Windows Debugging

To debug AZ Code Generator using Visual Studio in Windows, you must generate a Visual Studio HostTools solution (.sln) file.

To generate a Visual Studio HostTools solution file

1. Run the following command line from the `dev` folder.

```
libr_waf.bat configure --enabled-game-projects= --specs-to-include-in-project-generation=host_tools --visual-studio-solution-name=HostTools
```

2. In Visual Studio, open the `dev/Solutions/HostTools.sln` file.

OS X Debugging

To enable Waf support for Xcode, perform the following steps to generate an Xcode project.

To generate an Xcode project

1. Open the `dev/_WAF_/specs/all.json` file.
2. Temporarily add `AzCodeGenerator` to `modules`.
3. Run `./libr_waf.sh configure` to regenerate the Xcode project.
4. Open the `dev/Solutions/LumberyardSDK.xcodeproj` file.

Debugging the AZ Code Generator Utility from the Waf build

To debug the AZ Code Generator Utility from the Waf build, you must find the arguments file generated by Waf.

Waf generates an arguments file that is passed to AZ Code Generator as a command line parameter. All command line parameters from Waf for AZ Code Generator are contained inside the arguments file. This file is useful for debugging specific Waf AZ Code Generator invocations. To make the arguments file that you use available to Waf, add the `--zones=az_code_gen` option to the Waf command line.

When you use the `--zones=az_code_gen` option, the output looks like the following.

```
lmb_r_waf build_win_x64_release -p all --zones=az_code_gen
[ 1/3150] az_code_gen (win_x64|release): BinTemp\win_x64_release\Code
\Launcher\WindowsLauncher\GameSDKWindowsLauncherStaticModules.json
14:24:17 az_code_gen Invoking code generator with command:
g:\lyengine\System\dev\Bin64\azcg\AzCodeGenerator.exe @g:
\lyengine\System\dev\BinTemp\win_x64_release\CodeGenArguments
\arguments_file_ee625f9186107e30ab3126cc30cc9b49.args
```

In this example Waf output, the following is the arguments file.

```
@g:\lyengine\System\dev\BinTemp\win_x64_release\CodeGenArguments
\arguments_file_ee625f9186107e30ab3126cc30cc9b49.args
```

Setting Visual Studio Debug Arguments

To set up debugging of AZ Code Generator from Visual Studio, perform the following steps.

To debug AZ Code Generator from Visual Studio

1. Perform the steps to set up Windows debugging as described in [Prerequisites \(p. 172\)](#).
2. In the **Visual Studio Solution Explorer**, right-click **AzCodeGenerator**, and then select **Properties**.
3. Under **Debugging**, paste the path to the arguments file into **Command Arguments**.
4. Click **OK** to close the **Property** window.
5. Rightclick **AzCodeGenerator** and then click **Set as StartUp Project**.
6. Press **F5** to launch the debugger.

Setting Xcode Debug Arguments

To set up debugging of AZ Code Generator from Xcode, perform the following steps.

To debug AZ Code Generator from Xcode

1. Perform the steps to set up OS X debugging as described in [Prerequisites \(p. 172\)](#).
2. In Xcode, under the **Product, Scheme** menu, choose **AzCodeGenerator**.
3. At the bottom of the **Product, Scheme** menu, choose **Edit Scheme**.
4. Under **Arguments**, add a new entry to **Arguments Passed On Launch** that contains your debug arguments.
5. Under **Info**, from the **Executable** drop down, select **Other**.
 - a. Navigate to the directory `dev/BinMac64.Debug/azcg/AzCodeGenerator`.
 - b. Click **Choose**.
6. **Close** the scheme editor.
7. Choose **Product, Run** to launch the debugger.

Intermediate JSON Data Format

The following JSON shows the intermediate data format consumed by Jinja2 user-defined templates.

```
{
  "meta": {
    "path": "<Path/To/Code/Generator/Input/File.ext>"
  }
}
```

```
},
"objects": [
  {
    "name": "<Name of class/struct>",
    "qualified_name": "<Fully qualified name of class or struct>",
    "fields": [
      {
        "type": "<member variable type>",
        "canonical_type": "<member variable canonical type>",
        "name": "<member variable name>",
        "qualified_name": "<fully qualified member variable
name>",
        "annotations": {
          "<annotation name>": {
            "<annotation variable name>": "<annotation
variable value (can be empty string)>",
            ...
          },
          ...
        }
      },
      ...
    ],
    "traits": {
      "isAbstract": <true if abstract class, false if concrete>,
      "isPOD": <true of plain old data type; otherwise, false>,
      "isPolymorphic": <true if polymorphic type; otherwise, false>
    },
    "bases" : [
      {
        "name" : "<Base Class Name>",
        "qualified_name" : "<Fully qualified name of base class>"
      },
      ...
    ],
    "meta": {
      "path": "<Path/To/File/Containing/This/Object.ext>"
    },
    "type": "<\"class\" or \"struct\">",
    "annotations": {
      "<annotation name>": {
        "<annotation variable name>": "<annotation variable value
(can be empty string)>",
        ...
      },
      ...
    },
    "methods": [
      {
        "name" : "<method_name>",
        "qualified_name": "<Fully qualified name of method>",
        "is_virtual": <true if virtual method; otherwise, false>,
        "annotations": {
          "<annotation name>": {
            "<annotation variable name>": "<annotation
variable value (can be empty string)>",
            ...
          },
          ...
        }
      },
      ...
    ]
  },
  ...
],
...
}
```

```
        "access": "<Access level of method, one of: public,  
private, protected>",  
        "params" : [  
            {  
                "type" : "<parameter type>",  
                "canonical_type" : "<parameter canonical type>",  
                "name" : "<parameter name>"  
            },  
            ...  
        ],  
        "uses_override": <true if override keyword is present;  
otherwise, false>,  
        "return_type": "<return type of method>"  
    },  
    ...  
]  
},  
...  
]
```

Callback References

This section provides script callback information for the Entity system and game rules.

This section includes the following topics:

- [Entity System Script Callbacks \(p. 176\)](#)
- [Game Rules Script Callbacks \(p. 178\)](#)

Entity System Script Callbacks

This topic describes all callbacks for the Entity system. Use of these callbacks functions is not obligatory, but some cases require that entities behave properly within the Lumberyard Editor. For example, the `OnReset` callback should be used to clean the state when a user enters or leaves the game mode within the Lumberyard Editor.

Default State Functions

Callback Function	Description
OnSpawn	Called after an entity is created by the Entity system.
OnDestroy	Called when an entity is destroyed (like <code>OnShutDown()</code> gets called).
OnInit	Called when an entity gets initialized via <code>ENTITY_EVENT_INIT</code> , and when its <code>ScriptProxy</code> gets initialized.
OnShutDown	Called when an entity is destroyed (like <code>OnDestroy()</code> gets called).
OnReset	Usually called when an editor wants to reset the state.
OnPropertyChange	Called by Lumberyard Editor when the user changes one of the properties.

Script State Functions

Callback Function	Description
OnBeginState	Called during <code>Entity.GotoState()</code> after the state has been changed (that is, after <code>OnEndState()</code> is called on the old state).

Callback Function	Description
OnBind	Called when a child entity is attached to an entity. Parameters include: <ul style="list-style-type: none"> • script table for the child entity
OnCollision	Called when a collision between an entity and something else occurs. Parameters include: <ul style="list-style-type: none"> • script table with information about the collision
OnEndState	Called during <code>Entity.GotoState()</code> while the old state is still active and before <code>OnBeginState()</code> is called on the new state.
OnEnterArea	Called when an entity has fully entered an area or trigger. Parameters include: <ul style="list-style-type: none"> • areald (int) • fade fraction (float) This value is 1.0f if the entity has fully entered the area, or 0.0f in the case of trigger boxes.
OnEnterNearArea	Called when an entity enters the range of an area. Works with Box-, Sphere- and Shape-Areas if a sound volume entity is connected. Takes <code>OuterRadius</code> of sound entity into account to determine when an entity is near the area.
OnLeaveArea	Called when an entity has fully left an area or trigger. Parameters include: <ul style="list-style-type: none"> • areald (int) • fade fraction (float) This value is always 0.0f.
OnLeaveNearArea	Called when an entity leaves the range of an area. Works with Box-, Sphere- and Shape-Areas if a sound volume entity is connected. Takes <code>OuterRadius</code> of sound entity into account to determine when an entity is near the area.
OnMove	Called whenever an entity moves through the world.
OnMoveNearArea	Called when an entity moves. Works with Box-, Sphere- and Shape-Areas if a sound volume entity is connected. Takes <code>OuterRadius</code> of sound entity into account to determine when an entity is near the area.
OnProceedFadeArea	Called when an entity has recently entered an area and fading is still in progress. Parameters include: <ul style="list-style-type: none"> • areald (int) • fade fraction (float)
OnSoundDone	Called when a sound stops. Parameters include: <ul style="list-style-type: none"> • soundId (int) The ID of the sound played, which was provided with the request to play the sound.
OnStartGame	Called when a game is started.
OnStartLevel	Called when a new level is started.

Callback Function	Description
OnTimer	Called when a timer expires. Parameters include: <ul style="list-style-type: none"> • timerId (int) The ID of the time, provided by <code>Entity.SetTimer()</code>. • period (int) Length of time, in milliseconds, that the timer runs
OnUnBind	Called when a child entity is about to be detached from an entity. Parameters include: <ul style="list-style-type: none"> • script table for the child entity
OnUpdate	Called periodically by the engine on the entity's current state. This assumes the console variable <code>es_UpdateScript</code> is set to 1.

Game Rules Script Callbacks

This topic provides reference information on callbacks used with the GameRules scripts.

Callback Function	Description
OnAddTaggedEntity	Called when a player is added as a tagged player on the minimap. Called on the server only. <ul style="list-style-type: none"> • shooterId – Entity that tagged the target player. • targetId – Tagged player.
OnClientConnect	Called when a player connects. Called on the server only. <ul style="list-style-type: none"> • channelId
OnClientDisconnect	Called when a player disconnects. Called on the server only. <ul style="list-style-type: none"> • channelId
OnClientEnteredGame	Called when a player enters the game and is part of the game world. Called on the server only. <ul style="list-style-type: none"> • channelId – Channel identifier of the player. • playerScriptTable – The player's script table. • bReset – Boolean indicating whether or not the channel is from the reset list. • bLoadingSaveGame – Boolean indicating whether or not the call was made during a saved game loading.
OnDisconnect	Called when the player disconnects on the client. Called on the client only. <ul style="list-style-type: none"> • cause – Integer identifying the disconnection cause. See <code>EDisconnectionCause</code>. • description – Human readable description of the disconnection cause.
OnChangeSpectatorMode	Called when a player changes the spectator mode. Called on the server only. <ul style="list-style-type: none"> • entityId – Player who made the change. • mode – New spectator mode (1=fixed, 2=free, 3= follow).

Callback Function	Description
	<ul style="list-style-type: none"> • targetId – Possible target entity to spectate. • resetAll – Boolean indicating whether or not to reset player-related things like the inventory.
OnChangeTeam	<p>Called when a player switches teams. Called on the server only.</p> <ul style="list-style-type: none"> • entityId – Player who switched teams. • teamId – New team identifier.
OnExplosion	<p>Called when an explosion is simulated. Called on the server and client.</p> <ul style="list-style-type: none"> • pos – Position of the explosion in the game world. • dir – Direction of the explosion. • shooterId • weaponId • shooter • weapon • materialId • damage • min_radius • radius • pressure • hole_size • effect • effectScale • effectClass • typeId • type • angle • impact • impact_velocity • impact_normal • impact_targetId • shakeMinR • shakeMaxR • shakeScale • shakeRnd • impact • impact_velocity • impact_normal • impact_targetId • AffectedEntities – Affected entities table. • AffectedEntitiesObstruction – Affected entities obstruction table.

Cloud Canvas

Cloud Canvas is a visual scripting interface to AWS services. With Cloud Canvas you can build connected game features that use Amazon DynamoDB, AWS Lambda, Amazon Simple Storage Service (Amazon S3), Amazon Cognito, Amazon Simple Notification Service (Amazon SNS), and Amazon Simple Queue Service (Amazon SQS). With Cloud Canvas, you can create cloud-hosted features such as daily gifts, in-game messages, leaderboards, notifications, server-side combat resolution, and asynchronous multiplayer gameplay like card games, word games, and ghost racers. Cloud Canvas eliminates the need for you to acquire, configure, or operate host servers yourself, and reduces or eliminates the need to write server code for your connected gameplay features.

Features

Cloud Canvas offers a wide range of helpful components:

- Tools to enable a team to build a game with cloud-connected features.
- Flow graph nodes to communicate directly from within the client to AWS services such as Amazon S3, Amazon DynamoDB, Amazon Cognito, AWS Lambda, Amazon SQS, and Amazon SNS.
- Tools to manage AWS resources and permissions that determine how developers and players access them.
- Management of AWS deployments so that development, test, and live resources are maintained separately.
- Methods for players to be authenticated (anonymous and authenticated). Players can be authenticated from a variety of devices and access their game data by logging in with an Amazon, Facebook, or Google account.

Example Uses

Consider the many ways you can use Amazon Web Services for connected games:

- Store and query game data such as player state, high scores, or world dynamic content: [Amazon S3](#) and [DynamoDB](#)

- Trigger events in real time and queue data for background processing: [Amazon SQS](#) and [Amazon SNS](#)
- Execute custom game logic in the cloud without having to set up or manage servers: [AWS Lambda](#)
- Employ a daily gift system that tracks user visits and rewards frequent visits: [Amazon Cognito](#), [Amazon S3](#), [DynamoDB](#), [AWS Lambda](#)
- Present a message of the day or news ticker that provides updates on in-game events: [Amazon Cognito](#), [Amazon S3](#), [AWS Lambda](#)

To see how Cloud Canvas uses AWS services in a sample project, see [Don't Die Sample Project](#) (p. 198). For a tutorial on Cloud Canvas, see [Lumberyard Tutorials](#).

Tools

You can access Cloud Canvas functionality by using any of the following:

- **Flow Nodes** – For designers to leverage the AWS cloud. For detailed information on the Cloud Canvas flow graph nodes, see the [Cloud Canvas Flow Graph Node Reference](#) (p. 245).
- **Cloud Canvas C++ APIs** – For software development.
- **Using the Cloud Canvas Command Line** (p. 209) – For managing resource groups, mappings, deployments, and projects.
- **Cloud Canvas Tools in Lumberyard Editor** (p. 205) – For managing AWS resources, deployments, and credentials, and for navigating directly to the AWS consoles supported by Cloud Canvas.

To see how AWS services used for the *Don't Die* sample project, see [Don't Die Sample Project](#) (p. 198).

Knowledge Prerequisites

You need the following to take advantage of Cloud Canvas:

- **An understanding of AWS CloudFormation Templates** – Cloud Canvas uses the [AWS CloudFormation](#) service to create and manage AWS resources. Our goal is for Cloud Canvas to minimize what you need to know about AWS CloudFormation and AWS in general.
- **Familiarity with JSON** – Cloud Canvas leverages JSON for storing configuration data, including AWS CloudFormation Templates. Currently, you'll need to be familiar with this text format to work with the Cloud Canvas resource management system. A JSON tutorial can be found [here](#).

Topics

- [Pricing](#) (p. 182)
- [Cloud Canvas Core Concepts](#) (p. 182)
- [Cloud Canvas Resource Manager Overview](#) (p. 186)
- [Tutorial: Getting Started with Cloud Canvas](#) (p. 188)
- [Don't Die Sample Project](#) (p. 198)
- [Using Cloud Canvas](#) (p. 204)
- [Cloud Canvas Flow Graph Node Reference](#) (p. 245)
- [Resource Definitions](#) (p. 267)
- [Resource Deployments](#) (p. 289)

- [Resource Mappings](#) (p. 291)
- [Custom Resources](#) (p. 293)
- [Access Control and Player Identity](#) (p. 297)
- [AWS Client Configuration](#) (p. 305)

Pricing

Cloud Canvas uses AWS CloudFormation templates to deploy AWS resources to your account. Although there is no additional charge for Cloud Canvas or AWS CloudFormation, charges may accrue for using the associated AWS services. You pay for the AWS resources created by Cloud Canvas and AWS CloudFormation as if you created them manually. You only pay for what you use as you use it. There are no minimum fees and no required upfront commitments, and most services include a free tier.

For pricing information on the AWS services that Cloud Canvas supports, visit the following links.

[Amazon Cognito Pricing](#)

[Amazon DynamoDB Pricing](#)

[AWS Lambda Pricing](#)

[Amazon S3 Pricing](#)

[Amazon SNS Pricing](#)

[Amazon SQS Pricing](#)

To see pricing for all AWS services, visit the [Cloud Services Pricing](#) page.

To see the AWS services used for the *Don't Die* sample project, see [Don't Die Sample Project](#) (p. 198).

Cloud Canvas Core Concepts

Cloud Canvas helps you manage cloud resources and connect your game with the AWS cloud. Understanding its concepts will benefit anyone on your team who interacts with the cloud-connected components of your game, including designers, programmers, and testers.

This section covers the following:

- What Cloud Canvas is and how it relates to your AWS account
- The Amazon Web Services that Cloud Canvas supports
- How Cloud Canvas helps you manage your resources
- How your game can communicate with the cloud through the flow graph visual scripting system
- How a team can collaborate on a game that has cloud-connected resource groups

Prerequisites

Before reading this topic, you should have a basic understanding of the [Lumberyard engine](#) and the [flow graph system](#).

AWS, Cloud Canvas, and Lumberyard

Amazon Web Services (AWS) is an extensive and powerful collection of cloud-based services. You can use these services to upload or download files, access databases, execute code in the cloud, and perform many other operations. A cloud service saves you the trouble of maintaining the infrastructure that it relies on.

Cloud-Based Resources

When you want to use an AWS cloud service, you do so through a resource, a cloud-based entity that is available for your use, help, or support. Resources include a database, a location for storing files, the code that a service runs, and more.

When you create a resource, it exists in the cloud, but you can use it and manage its content. You also specify the permissions that individuals or groups have to access or use the resource. For example, you might allow anyone in the public to read from your database but not write to it or modify it.

Resource Groups

In order to create a connected game feature such as a high score table, you create a resource group in Cloud Canvas. The resource group defines the AWS resources that your feature requires. Each connected game feature therefore is implemented as a resource group in Cloud Canvas.

AWS Accounts

Your resources are owned by an AWS account. The AWS account allows you and your team to share access to the same resources. For example, your team's AWS account might own a database resource so that you and your teammate can both work with the same database.

You, or someone on your team, is an administrator. The administrator creates the AWS account for your team and gives individuals on the team access to the account's resources.

Lumberyard, Cloud Canvas, and Flow Graph

Cloud Canvas is a Lumberyard Gem (extension) that enables your Lumberyard games to communicate with AWS resources. To integrate the communication with Amazon Web Services directly into your game logic, you use Lumberyard's flow graph visual scripting system.

The flow graph nodes that you create use Cloud Canvas to make the actual calls from your game to AWS resources. For example, when a player's game ends, you can add flow graph nodes to submit the player's score to a high score table in the cloud. Later, you can use flow graph to call the high score table to request the top 10 scores.

Amazon Web Services Supported by Cloud Canvas

Several AWS offerings are available through Cloud Canvas that can enhance your game.

File Storage in the Cloud

For storing files in the cloud, Cloud Canvas supports Amazon Simple Storage Service (Amazon S3). Amazon S3 offers a storage resource called a bucket, which you can think of as a large folder. You can build a directory structure in an Amazon S3 bucket just like a directory on a local computer. Amazon S3 buckets have a number of uses in games, including the following:

- Storing files that your game can download. These files can be levels, characters, or other extensions for your game. You can add new files after your game has shipped. Because your game uses Cloud

Canvas to download and integrate this content, your customers do not need to download a new client.

- Your game can upload user-generated content. For example, your game might take a screenshot whenever a player beats the last boss. Cloud Canvas uploads the screenshot to your bucket, and your game makes the screenshot available on a website or to other players of the game.

Databases

For storing data like a person's name, phone number, and address in the cloud, Cloud Canvas supports the Amazon DynamoDB database service. Amazon DynamoDB operates on resources called tables. These tables grow and adapt as you build and iterate your game.

Here are some ways in which you can use Amazon DynamoDB table resources in your game:

- Track account details and statistics for a player. Give each player a unique ID so that you can look up a player's hit points, inventory, gold, and friends.
- Add or remove fields to accommodate new resource groups in your game.
- Perform data analyses. For example, you can run complex queries to find out how many players have unlocked a particular achievement.
- Manage game-wide resource groups or events such as a querying a high score table or retrieving a message of the day.

Executing Cloud-Based Logic

For executing code in the cloud, Cloud Canvas supports the AWS Lambda service. AWS Lambda executes resources called functions. You provide the code for a Lambda function, and your game calls the Lambda service through Cloud Canvas to run the function. The Lambda service returns the data from the function to the game.

Your Lambda functions can even call other Amazon Web Services like Amazon DynamoDB and perform operations on their resources. Following are some examples:

- **Submit a high score** – A Lambda function can accept a player's ID and new score, look up the player ID in the database, compare the score with existing scores, and update the highest score if necessary.
- **Sanitize your data** – A Lambda function can check for malicious or unusual input. For example, if a player tries to upload a new high score of 999,999,999 when the best players can't reach 1,000, your Lambda function can intercept the submission and either reject it or flag it for review.
- **Perform server-side authoritative actions** – Cloud Canvas can call your Lambda functions to control in-game economies. For example, when a player tries to purchase an item, your Lambda function can check a database to verify that the player has enough money to pay for the item. The function can then deduct the amount from the player's account, and add the item to the player's inventory.

Identity and Permissions

For managing the identity of the player and controlling access to AWS resources in the cloud, Cloud Canvas supports the Amazon Cognito service.

Amazon Cognito can create unique anonymous identities for your users tied to a particular device. It can also authenticate identities from identity providers like Login with Amazon, Facebook, or Google. This provides your game with a consistent user IDs that can seamlessly transition from anonymous use on a single device to authenticated use across multiple devices. Consider these examples:

- Players start playing your game anonymously and store their progress locally on their device. Later, to "upgrade" their experience, you ask them to be authenticated through one of the login providers mentioned. After players provide an authenticated ID, you can store their progress in the cloud, and they can access their progress across multiple devices.
- You can specify which AWS resources players are allowed to access. For example, you can enable the "Get the Latest High Scores" Lambda function to be called not only by your game, but by anyone, including external websites. But you could specify that the "Submit High Scores" function only be called by players of your game so that your high score table remains secure. You can use Cloud Canvas to manage these permissions.

Cloud Canvas Resource Management

In addition to communicating with Amazon Web Services, Cloud Canvas can also help you manage your resources. Amazon Web Services can help create and manage any cloud resources that a game resource group needs. Once you implement the resource group you can use Cloud Canvas deployments to manage the resources for development, test, and live versions of your game. For more information, see [Cloud Canvas Resource Manager Overview \(p. 186\)](#).

Defining the Resources

You can create cloud resources by using AWS CloudFormation templates. [AWS CloudFormation](#) is an Amazon Web Service with which you can define, create, and manage AWS resources predictably and repeatedly by using templates. The templates are JSON-formatted text files that you use to specify the collection of resources that you want to create together as a single unit (a stack).

In a template, each resource gets its own AWS CloudFormation definition in which you specify the parameters that govern the resource. AWS CloudFormation templates are beyond the scope of this topic, but for now it's enough to understand that you can define (for example) a template with an Amazon DynamoDB table and two AWS Lambda functions. For an example AWS CloudFormation template that creates an Amazon DynamoDB table, see the [AWS CloudFormation User Guide](#).

Deployments

While you are working on a new resource group, your quality assurance team might have to test it. You want to provide a version of your resource group that the test team can use while you continue to work on your own version. To keep the corresponding resources of the different versions distinct, Cloud Canvas gives you the ability to create separate deployments. Deployments are distinct instances of your product's features.

In a scenario like the one described, you might create three deployments: one for the development team, one for the test team, and one for live players. Each deployment's resources are independent of each other and can contain different data because (for example) you don't want the data entered by the test team to be visible to players.

With Cloud Canvas you can manage each of these deployments independently of one another, and you can switch between deployments at will. After making changes, you can use Cloud Canvas to update your feature or deployment and update the corresponding AWS resources.

Team Workflow Using Deployments

The following workflow example illustrates how Cloud Canvas deployments work:

1. The test team finds a bug. You fix the bug in your Lambda code.
2. You switch to the dev deployment and upload the new version of the Lambda function. The Lambda code in the test and live deployments remain untouched for now, and they continue working as is.

3. After you are satisfied that the bug has been fixed, you update the Lambda code in the test deployment. The test team can now test your fix. The live deployment continues unchanged.
4. After the test team approves the fix, you update the live deployment, propagating the fix to your live players without requiring them to download a new version of the game.

Communicating with Cloud Resources using Flow Graph

As your game communicates with its AWS resources, you can use Lumberyard's flow graph system to implement the interaction between your game and AWS. Cloud Canvas-specific flow graph nodes function just like other flow graph nodes, but they make calls to AWS services. For example, if your feature uses two Lambda functions that are needed in different situations, you can use the Lumberyard flow graph system to specify that the functions get called under the appropriate conditions in your game.

You can also use flow graph to take appropriate actions depending on the success or failure of a function. For example, your function might return failure when no Internet connection exists, or when the function lacks sufficient permissions to contact the resource. Your game can parse any failures and handle them appropriately, such as asking the user to retry or skip retrying.

When you have multiple deployments, Cloud Canvas keeps an internal mapping of friendly names to AWS instances so that your game knows which AWS resources to use. Cloud Canvas maps the currently selected deployment to the corresponding set of resources.

Thus, when you release your game to customers, you use a deployment specifically set aside for live players. If you are using the dev version of one feature and switch your deployment to test, your game calls the Lambda function associated with the test deployment.

Managing Permissions Using Cloud Canvas

Managing permissions is an important part of building a secure cloud-connected game. Maintaining separate and distinct permissions is important in the phases of development, testing, and production. You can apply permissions to your development and test teams, to the AWS resources that your game uses, and to the players of your game. A key objective is to secure your game's AWS resources against hackers and other forms of abuse.

You can use permissions to specify exactly who is allowed to do what to the AWS resources that are part of your game. For example, if you have a game feature that uploads screenshots, you can create an Amazon S3 bucket to store the screenshots. You can set permissions for the game to be able to write (send files) to the bucket, but not read from the bucket. This prevents inquisitive users from examining the files that have been uploaded. On the other hand, you can give your team members permissions to read files from the bucket so that they can review and approve them. With Cloud Canvas you can also set the permissions for individual deployments. For example, live and test deployments can have different permission sets.

Like features, you can define permissions through AWS CloudFormation templates. The permissions are applied any time that you update your cloud resources using the Cloud Canvas resource management tools.

For more information, see [Access Control and Player Identity \(p. 297\)](#).

Cloud Canvas Resource Manager Overview

Game development is an inherently local activity. You have a local copy of your game code, assets, and other resources. You build, test, and tweak over and over on your local computer.

The cloud is different. It is an alien environment. You put resources "out there" that the game depends on. But those resources don't live on your computer system. The process of using and modifying the resources in the cloud isn't the same as for resources that are local.

Cloud Canvas Resource Manager bridges this gap. It lets you have local *descriptions* of the AWS resources in the cloud that your game needs and provides ways to create and interact with the actual instances of those resources in AWS. Your resource could be a database table, a file storage bucket, or code that runs in response to an event.

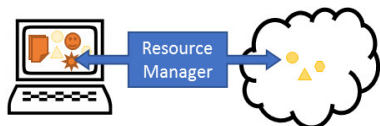

For team projects, the source code and assets that you are using likely come from a source control system. The changes you make are shared with other people who work on the project through that source control system. Different people can be working at the same time with different versions ("branches") of the code and with different versions of assets without interfering with each other.

When you develop a game that uses cloud resources in AWS, those resources may be shared by different people who work on the game at the same time. Sometimes you need different versions of those resources to exist in the cloud. You also want to ensure that the people developing the game use the version of the resources in the cloud that matches the version of the code and assets they are working with.

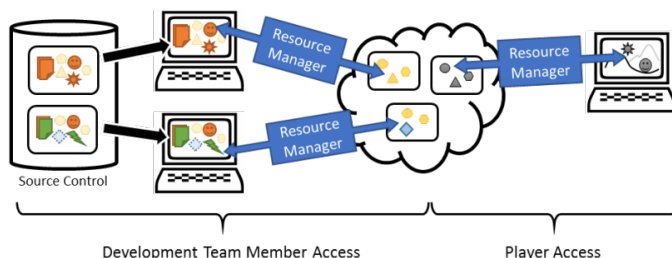

After the game is released, the players will use a production copy while your team uses another, private copy to work on bug fixes and new content.

You'll also want to do the following:

- Be sure that players cannot access the development versions of game resources
- Prevent the development team from making changes that could break the released game
- Protect player information like e-mail addresses from unauthorized access by team members

The **Cloud Canvas Resource Manager** provides the tools you need to do the following:

- Maintain descriptions of the AWS resources that your game depends on
- Create as many copies of the AWS resources as needed for your releases and development teams
- Help you secure access to those resources

The Role of AWS CloudFormation

The **Cloud Canvas Resource Manager** integrates the use of [AWS CloudFormation](#) into the Lumberyard game development environment. With AWS CloudFormation you can maintain descriptions of the AWS resources you need in text file templates that you can check into your source control system. These descriptions can be branched and merged along with the rest of your game

code and assets. When you need actual instances of the resources to be created in AWS, **Cloud Canvas Resource Manager** passes the descriptions to AWS CloudFormation, which uses the template files to create, update, or delete resources in AWS to match the descriptions.

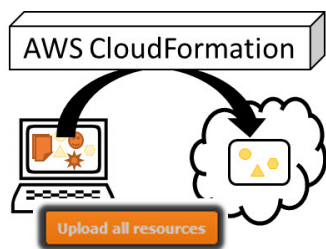

You can use resource manager to organize your descriptions into any number of **resource groups**. Each group can describe all the resources needed by a game feature, such as a high score tracking system. For details, see [Resource Definitions](#).

With resource manager you can create as many **deployments** of the resources as you need. You could have a deployment for the dev team, another for the QA team, and another for the released game, or any other arrangement that suits your needs. Each deployment contains a complete and independent instance of all of the project's resources. Deployments are implemented using AWS CloudFormation **stack** resources. For details, see [Resource Deployments](#).

You can choose the deployment that you want to work with in Lumberyard Editor. For example, if you create a "QA" deployment and use it to test your game, Lumberyard Editor automatically maps the references to resources in your game code and [Flow Graphs](#) to the "QA" instance of those resources.

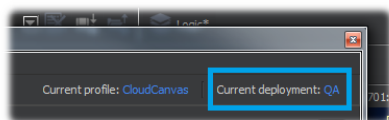

Similarly, you can also specify the deployment to be used for release builds of the game. For details, see [Resource Mappings](#).

Each deployment comes with an AWS managed policy and an AWS role that you can use to grant specific AWS users and groups access to that deployment. For example, players are granted access to specific resources within a deployment. For details, see [Access Control and Player Identity](#).

Tutorial: Getting Started with Cloud Canvas

This tutorial walks you through the steps of getting started with Cloud Canvas, including signing up for an Amazon Web Services (AWS) account, providing your AWS credentials, and using the command line tools to initialize Cloud Canvas. At the end of the tutorial you will have used your AWS credentials to administer a Cloud Canvas-enabled Lumberyard project.

Specifically, this tutorial guides you through the following tasks:

- Obtain an Amazon Web Services account.
- Navigate the AWS Management Console.
- Create an AWS Identity and Access Management (IAM) user with suitable permissions to administer a Cloud Canvas project.
- Get credentials from your IAM user and type them into the Cloud Canvas tools.
- Use the command line tool to initialize a Lumberyard project for use with Cloud Canvas.
- Dismantle the project, removing all AWS resources that were allocated by Cloud Canvas.

Prerequisites

Before starting this tutorial, you must complete the following:

- [Install a working version](#) of Lumberyard Editor.
- Set up a Lumberyard project with the Cloud Canvas Gem (extension) enabled.
- Read through the [Cloud Canvas introduction](#) and Cloud Canvas concepts.

Step 1: Sign up for AWS

When you sign up for Amazon Web Services (AWS), you can access all its cloud capabilities. Cloud Canvas creates resources in your AWS account to make these services accessible through Lumberyard. You are charged only for the services that you use. If you are a new AWS customer, you can get started with Cloud Canvas for free. For more information, see [AWS Free Tier](#).

If you or your team already have an AWS account, skip to [Step 2 \(p. 189\)](#).

To create an AWS account

1. Open <https://aws.amazon.com/> and then choose **Create an AWS Account**.
2. Follow the instructions to create a new account.

Note

- As part of the sign-up procedure, you will receive a phone call and enter a PIN using your phone.
 - You must provide a payment method in order to create your account. Although the tutorials here fall within the [AWS Free Tier](#), be aware that you can incur costs.
3. Wait until you receive confirmation that your account has been created before proceeding to the next step.
 4. Make a note of your AWS account number, which you will use in the next step.

You now have an AWS account. Be sure to have your AWS account number ready.

Step 2: Create an AWS Identity and Access Management (IAM) User for Administering the Cloud Canvas Project

After you confirm that you have an AWS account, you need an AWS Identity and Access Management (IAM) user with adequate permissions to administer a Cloud Canvas project. IAM allows you to manage access to your AWS account.

AWS services require that you provide credentials when you access them to verify that you have the appropriate permissions to use them. You type these credentials into Lumberyard Editor as part of setting up your project.

The IAM user that you will create will belong to a group that has administrator permissions to install the Cloud Canvas resources and make them accessible through Lumberyard. Administrative users in this group will have special permissions beyond the scope of a normal Cloud Canvas user.

In a team environment, you—as a member of the administrator's group—can create IAM users for each member of your team. With IAM you can set permissions specifically for each person's role in a project. For example, you might specify that only designers may edit a database, or prevent team members from accidentally writing to resources with which your players interact.

For more information on IAM and permissions, see the [IAM User Guide](#).

This section guides you through IAM best practices by creating an IAM user and an administrator group in your account to which the IAM user belongs.

Create an IAM User and an Administrator Group

It's time to create your IAM administrative user.

To create an IAM user in your account

1. Sign into the AWS Management Console and open the IAM console at <https://console.aws.amazon.com/iam/>.
2. In the navigation pane, click **Users**.
3. Click **Add user**.
4. For **User name**, type a user name. This tutorial uses the name *CloudCanvasAdmin*. The name can consist of letters, digits, and the following characters: plus (+), equal (=), comma (,), period (.), at (@), underscore (_), and hyphen (-). The name is not case sensitive and can be a maximum of 64 characters in length.
5. Select the checkbox next to **Programmatic access**.
6. Select the check box next to **AWS Management Console access**, select **Custom password**, and then type the new password in the text box.

Note

When you create a user for someone other than yourself, you can select **Require password reset** to force the user to create a new password when first signing in.

7. Click **Next: Permissions**.
8. Click **Create group**.
9. In the **Create group** dialog box, type the name for the new group. The name can consist of letters, digits, and the following characters: plus (+), equal (=), comma (,), period (.), at (@), underscore (_), and hyphen (-). The name is not case sensitive and can be a maximum of 128 characters in length. This tutorial uses the name *CloudCanvasAdministrators*.
10. In the **Policy name** list, select the check box next to **AdministratorAccess**. This policy provides the necessary permissions for creating and administering a Cloud Canvas project.

Warning

The **AdministratorAccess** policy allows almost all permissions within the AWS account and should be attached only to the administrator of the account. Otherwise, other team members could perform actions that incur unwanted charges in your AWS account.

11. Click **Create group**.
12. Back in the list of groups, select the check box for your new group if it is not already selected. If necessary, click **Refresh** to see the group in the list.
13. Click **Next: Review** to review your choices. When you are ready to proceed, choose **Create user**.

Your IAM user is created along with two important credentials: an access key and a secret access key. Later, you will enter these credentials into Cloud Canvas in order to access the AWS resources in your project.

14. Click **Show** to view your secret access key and password, or click **Download .csv** to download the credentials in a `.csv` file. You can also click **Send email** to receive login instructions by email. Make sure you preserve the credentials in a safe place before you proceed. After this point, you cannot view the secret access key from the AWS Management Console.

Important

Do not share your credentials with anyone. Anyone with access to these credentials can access your AWS account, incur charges, or perform malicious acts.

15. You have now created an IAM user called *CloudCanvasAdmin* and a *CloudCanvasAdministrators* administrator group to which the user belongs. To confirm this, click **Groups** in the navigation pane. Under **Group Name**, click *CloudCanvasAdministrators*. The *CloudCanvasAdmin* user appears in the list of users for the group.

In this tutorial, you add only one IAM user to the administrator group, but you can add more if required.

Step 3: Sign in as Your IAM User

Now you're ready to try out your new user.

To sign in as your IAM user

1. Get the AWS account ID that you received when you created your AWS account. To sign in as your *CloudCanvasAdmin* IAM user, use this AWS account ID.
2. In a web browser, type the URL `https://<your_aws_account_id>.signin.aws.amazon.com/console/`, where *<your_aws_account_id>* is your AWS account number without the hyphens. For example, if your AWS account number is *1234-5678-9012*, your AWS account ID would be *123456789012*, and you would visit `https://123456789012.signin.aws.amazon.com/console/`.

For convenience, you might want to bookmark your URL for future use.

3. Type the *CloudCanvasAdmin* IAM user name you created earlier.
4. Type the password for the user and choose **Sign In**.

You are now successfully signed into the AWS Management Console.

Note

Throughout the tutorial, you must be signed into the AWS Management Console. If you are signed out, follow the preceding steps to sign back in.

Step 4: Enabling the Cloud Canvas Gem (extension) Package

Cloud Canvas functionality is enabled in Lumberyard through a [Gem package](#). Gem packages, or Gems, are extensions that share code and assets among Lumberyard projects. You access and manage Gems through the [Project Configurator](#).

This section of the tutorial shows you how to use the SamplesProject, and how to enable the Cloud Canvas Gem package in a new project if you are not using the SamplesProject.

Cloud Canvas in the SamplesProject

The default SamplesProject is already configured to use the Cloud Canvas Gem package. If you are using the SamplesProject, no additional steps are needed. Go to [Step 5: Add Administrator Credentials to Lumberyard](#) (p. 192).

Enable Cloud Canvas in a New Project

If you are working on a new project, follow these steps to enable Cloud Canvas functionality.

Note

Adding the Cloud Canvas Gem package to a project that is not already configured requires rebuilding the project in Visual Studio.

To enable Cloud Canvas in a new project

1. Launch `ProjectConfigurator.exe` from your Lumberyard `dev\Bin64\` binary directory.
2. Click **Enable packages** to navigate to the Gems packages screen.
3. Ensure that the check box for the **Cloud Canvas (AWS)** Gem package is checked. If it is already checked, close the **ProjectConfigurator** and go to [Step 5: Add Administrator Credentials to Lumberyard \(p. 192\)](#).
4. Click **Save**, and then close the **ProjectConfigurator**.
5. If you had to add the Cloud Canvas (AWS) Gem to the project, open a command line window and run `lmbx_waf configure` to configure your new project.
6. Recompile and build the resulting Visual Studio solution file. Your Lumberyard project is now ready for Cloud Canvas.

Step 5: Add Administrator Credentials to Lumberyard

In order to begin managing a Cloud Canvas project, you add the IAM user credentials that you generated earlier to a profile that Cloud Canvas can easily reference. To do this, you can use either Lumberyard Editor or a command line prompt.

To enter your credentials in Lumberyard Editor

1. In Lumberyard Editor, click **AWS, Credentials manager**.

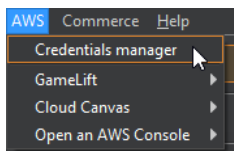

2. In the **Credentials Manager** dialog, click **Add profile**.

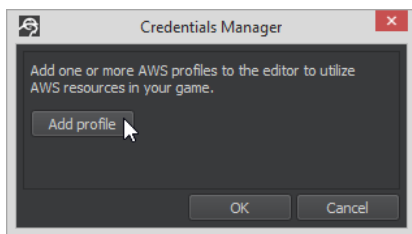

3. In the **Add profile** dialog box, enter the information requested. For **Profile name**, type a name of your choice (for example, `CloudCanvasAdminProfile`). For **AWS access key** and **AWS secret key**, type the secret key and access key that you generated in [Step 2 \(p. 189\)](#).

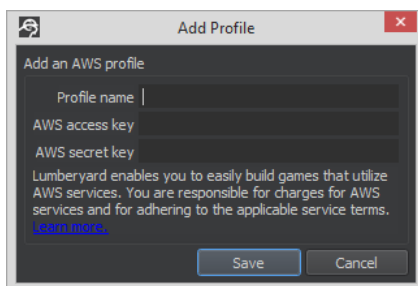

4. Click **Save**.

5. In **Credentials Manager**, click **OK**.

To add your credentials by using the command line

1. Open a command line window and change to the root Lumberyard directory, which is the `dev` subdirectory of your Lumberyard installation directory (for example, `C:\lumberyard\dev`).
2. Type the following at the command prompt, and then press **Enter**. Replace `<profile-name>` with a name of your choice (for example, `CloudCanvasAdminProfile`). Replace `<secret-key>` and `<access-key>` with the secret key and access key that you generated in [Step 2](#) (p. 189).

```
lmbr_aws add-profile --profile <profile-name> --make-default --aws-secret-key <secret-key> --aws-access-key <access-key>
```

The profile name is now associated with your credentials, and saved locally on your machine in your AWS credentials file. This file is normally located in your `C:\Users\<user name>\.aws\` directory. As a convenience, other tools such as the [AWS Command Line Interface](#) or the [AWS Toolkit for Visual Studio](#) can access these credentials.

The profile has also been established as your default profile for Cloud Canvas. The default profile eliminates the need to specify the profile each time you use Lumberyard Editor or run an `lmbr_aws` command.

Important

Do not share these credentials with anyone, and do not check them into source control. These grant control over your AWS account, and a malicious user could incur charges.

You have now created a profile for administering a Cloud Canvas project.

Step 6: Initializing Cloud Canvas from the Command Line

In this step, you configure your Lumberyard project to use Cloud Canvas capabilities. It sets up all of the initial AWS resources required by Cloud Canvas. You perform this step only once for any project.

To initialize Cloud Canvas

1. If you are using `SamplesProject` and have checked Lumberyard into source control, ensure that the `<root>\SamplesProject\AWS\project-settings.json` file has been checked out and is writeable. If you are using a new project, this file will be created during the initialization process, along with other files in the project's `AWS` directory.
2. Open a command line window and change to your Lumberyard `\dev` directory.
3. You must provide Cloud Canvas with the region to which AWS resources will be deployed. Cloud Canvas requires selecting a region that is supported by the [Amazon Cognito](#) service. You can check the availability of this service by visiting the [Region Table](#). This tutorial deploys resources to US East (N. Virginia), which supports Amazon Cognito.

Type the following command:

```
lmbr_aws create-project-stack --region us-east-1
```

The command initializes the contents of the `<root>\<game>\AWS` directory and creates the resources Cloud Canvas needs in order to manage your project in your AWS account.

Wait until the initialization process is complete before you proceed. The initialization process can take several minutes.

Note

The initialization process has to be done only once for a given Lumberyard project.

4. You can see the resources created in your AWS account by typing the following command:

```
lmbr_aws list-resources
```

5. If you are using source control, check in the contents of the `<root>\<game>\AWS` directory so that other users on your team can access the AWS resources.

Your Lumberyard project is now ready to use Cloud Canvas.

Step 7: Locating and Adding Resource Groups

Cloud Canvas lets you organize the AWS resources required by your Lumberyard project into any number of separate resource groups. This step shows you how to locate the **DontDieAWS** resource group already defined for you by the SamplesProject. If you're using a different project, it also shows you how to add a resource group and optionally add some example resources.

Locating the Resource Group Defined by SamplesProject

The SamplesProject defines a single resource group named "DontDieAWS". The resource definitions for this resource group are found in the `<root>\SamplesProject\AWS\resource-group\DontDieAWS\resource-template.json` file. This file is an AWS CloudFormation template. It will be used to create the AWS resources required by SamplesProject in the next step of this tutorial.

You can see that the resource group is part of SamplesProject by typing the following at the command prompt, and then pressing **Enter**.

```
lmbr_aws list-resource-groups
```

Adding a Resource Group to a New Project

To add a resource group to a new project

1. If you have checked your Lumberyard project into source control, ensure that the `<root>\<game>\AWS\deployment-template.json` file has been checked out and is writeable.
2. Add a new resource group definition by typing the following command:

```
lmbr_aws add-resource-group --resource-group Example --include-example-resources
```

After executing this command, the resource definitions for the resource group can be found in the `<root>\<game>\AWS\resource-group\Example\resource-template.json` file. This file is an AWS CloudFormation template. It will be used to create the AWS resources required by your project in the next step of this tutorial.

3. You can see that the resource group is part of the Lumberyard project by typing the following command:

```
lmbr_aws list-resource-groups
```

Step 8: Creating Deployments

To create the AWS resources in your AWS account for a project resource group, you create a Cloud Canvas deployment. Cloud Canvas allows you to create any number of deployments. Each deployment will have a complete and independent set of the resources needed by your Lumberyard project. This can be useful when you want to have (for example) separate development, test, and production resources for your game. This step shows you how to create a deployment for a project.

Note

Only project administrators (anyone with full AWS account permissions) can add or remove deployments.

Create a deployment from Cloud Canvas Resource Manager

1. If you have checked your Lumberyard project into source control, ensure that the `<root>\<game>\AWS\project-settings.json` file has been checked out and is writeable.
2. In Lumberyard Editor, click **AWS, Cloud Canvas, Cloud Canvas Resource Manager**.

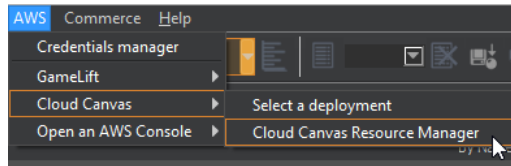

3. In the **Cloud Canvas configuration** navigation pane, expand **Administration (advanced)**, and then select **Deployments**.
4. In the details pane, click **Create deployment**.

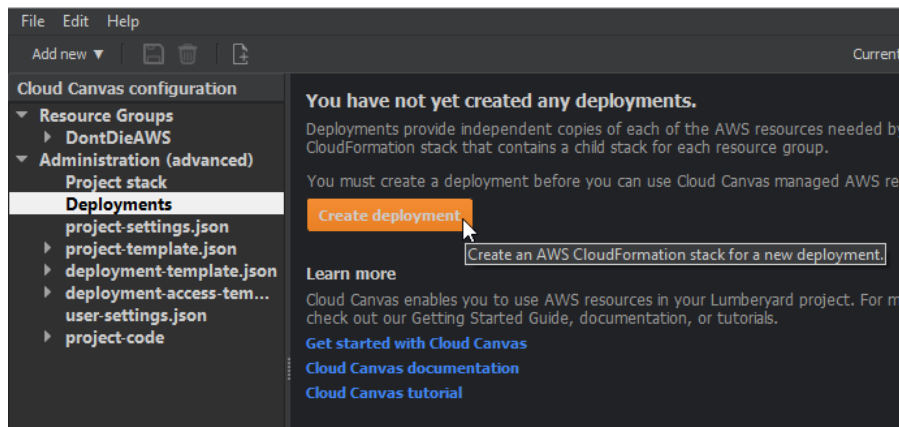

5. In the **Create deployment** dialog, provide a name for the deployment.

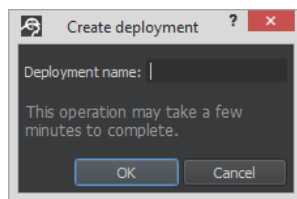

Lumberyard appends the name that you provide to the project stack name to create an AWS CloudFormation stack for the deployment.

6. Click **OK** to start the deployment creation process.

In the Resource Manager navigation tree, a node for the deployment appears under **Deployments**. In the detail pane, the [Viewing the Cloud Canvas Progress Log \(p. 224\)](#) provides details about the creation process.

7. To make the deployment the default, see [Making a Deployment the Default \(p. 229\)](#).

Create a deployment from the command line

1. If you have checked your Lumberyard project into source control, ensure that the `<root>\<game>\AWS\project-settings.json` file has been checked out and is writeable.
2. Create a deployment by typing the following command:

```
lmbr_aws create-deployment --deployment TestDeployment
```

3. You can see that the deployment is now part of the Lumberyard project by typing the following command:

```
lmbr_aws list-deployments
```

4. To make the deployment that you created the default deployment in Lumberyard Editor, type the following command:

```
lmbr_aws default-deployment --set TestDeployment
```

5. You can see the resources created with the deployment by typing the following command:

```
lmbr_aws list-resources --deployment TestDeployment
```

Step 9: Inspecting Your Resources in AWS

This step in the tutorial shows you the AWS CloudFormation stacks that the previous steps of this tutorial created for you.

To inspect your resources in AWS

1. In a web browser, use your IAM credentials to sign in to the AWS Management Console (see [Step 3 \(p. 191\)](#)).
2. Ensure the AWS region, which appears on the upper right of the console screen, is set to the one that you specified when you had Cloud Canvas deploy its resources in [Step 6 \(p. 193\)](#). If you selected the region in this tutorial, you will see **N. Virginia**.
3. Click **Services, CloudFormation**.
4. Note that a number of other stacks have been created as a result of the previous tutorial steps. If a stack update operation is still under way, the stack will show the status **UPDATE_IN_PROGRESS**. Otherwise, the status shows **CREATE_COMPLETE**. You may need to click **Refresh** to update the status.

The next step shows how, as an administrator, you can grant your team members access to Cloud Canvas.

Step 10: Using IAM to Administer a Cloud Canvas Team

In this step, you create Cloud Canvas IAM users for your team, create a group for your users, attach a Cloud Canvas managed policy to the group, and then add the users to the group. This helps you manage your users' access to AWS resources.

The policies that Cloud Canvas creates for your IAM users are much more restrictive than those for an administrator. This is so that your team members don't inadvertently incur charges without administrator approval.

As you add new resource groups and AWS resources to your project, Cloud Canvas automatically updates these managed policies to reflect the updated permissions.

Create IAM users

You start by creating one or more IAM users.

To create IAM users

1. Sign in to the AWS Management Console using your *CloudCanvasAdmin* credentials (see [Step 3 \(p. 191\)](#)).
2. Click **Services, IAM**.
3. In the navigation pane, click **Users**.
4. Click **Create New Users**.
5. Type IAM user names for each team member.
6. Be sure that the **Generate an access key for each user** check box is checked.
7. Click **Create**.
8. Choose the option to download the access key and secret access key for each user. The keys for all users that you created are downloaded in a single `.csv` file. Make sure you preserve the credentials in a safe place now. After this point, you cannot view the secret access key from the AWS Management Console. You must deliver each user his or her keys securely.
9. Click **Close**.

Create a group

Next, you create an IAM group for the newly created users.

To create a group for the Cloud Canvas IAM users

1. In the left navigation pane of the IAM console, click **Groups**.
2. Click **Create New Group**.
3. Give the group a name. This tutorial uses the name *CloudCanvasDevelopers*.
4. Click **Next Step**.
5. To find the IAM managed policy that Cloud Canvas created for you, click the link next to **Filter** and click **Customer Managed Policies**.
6. Select the check box next to the policy that includes your project name. If you are using the SamplesProject, the name begins with **SamplesProject-DontDieDeploymentAccess**.
7. Click **Next Step**.

8. Review the proposed group that you are about to create.
9. Click **Create Group**.

Add IAM users to a group

Finally, you add your IAM users to the group you just created.

To add your Cloud Canvas IAM users to the group

1. If it is not already selected, click **Groups** in the left navigation pane.
2. Click the name of the newly created *CloudCanvasDevelopers* group (not the check box adjacent to it).
3. If it is not already active, click the **Users** tab.
4. Choose **Add Users to Group**.
5. Select the check boxes next to the IAM users that you want to belong to the *CloudCanvasDevelopers* group.
6. Click **Add Users**. The team's user names now appear in the list of users for the group.
7. Open the `credentials.csv` file that you downloaded earlier. Securely deliver the secret and access keys to each user in the group. Stress the importance to each user of keeping the keys secure and not sharing them.
8. Have each user in the *CloudCanvasDevelopers* group perform the following steps:
 - a. In Lumberyard Editor, click **AWS, Cloud Canvas, Permissions and Deployments**.
 - b. Type a new profile name and his or her access and secret access keys.

Important

As an administrator, it is your responsibility to keep your team and your AWS account secure. Amazon provides some best practices and options for how to manage your team's access keys on the [Managing Access Keys for IAM Users](#) page. You are encouraged to read this thoroughly.

For information regarding limits on the number of groups and users in an AWS account, see [Limitations on IAM Entities and Objects](#) in the [IAM User Guide](#).

Step 11: Remove Cloud Canvas Functionality and AWS Resources

To remove the Cloud Canvas functionality and AWS resources from your project, see [Deleting Cloud Canvas Deployments and Their Resources](#) (p. 232).

Don't Die Sample Project

This sample project shows how you can use the AWS Cloud Canvas Resource Management system and AWS Lambda for a game. *Don't Die* also uses Project Configurator, which is a standalone application included with Lumberyard that you use to specify to the Waf Build system the game project and assets (Gems) that you want to include in a build.

AWS resources used in the *Don't Die* project may be subject to separate charges and additional terms. There is a free tier for all the AWS services used in this project. See the end of this topic to learn more about AWS services used in this project.

Setup

Setting up the sample project involves a few tasks.

Creating the AWS Project Stack

All AWS resources associated with *Don't Die*, such as DynamoDB tables, S3 buckets, and Lambda, are created through the Cloud Canvas Resource Management system. The cloud-connected features of *Don't Die*, such as High Score and Daily Gift, will not work until you set up their associated AWS resources. Before you can set up the resources, you must:

- Have an AWS account with administrator permissions credentials.
- Make your AWS account available for use with Lumberyard Editor and the Cloud Canvas command line if you have not yet done so. To do this, perform one of the following:
 - Use the Lumberyard Editor **Credentials Manager** to add an AWS profile. For more information, see [Managing Cloud Canvas Profiles](#) (p. 208).
 - At a command line prompt on the Lumberyard `\dev` folder, type the following:

```
lmbr_aws add-profile --aws-access-key {accesskey} --aws-secret-key {secretkey} --profile {profilename} --make-default
```

Replace `{accesskey}` and `{secretkey}` keys with the corresponding keys from your AWS account. Replace `{profilename}` with a name of your choice for the profile. The `--make-default` argument optionally makes this set of credentials your default profile when you use the Cloud Canvas command line.

Note

When you use **Credentials Manager**, the profile that you specify becomes the default.

- Ensure that **SamplesProject** is selected in Project Configurator, which you can run from Lumberyard folder location `\dev\Bin64\ProjectConfigurator.exe`. This configuration points the AWS Resource Management System to `\SamplesProject\AWS`, which contains all the files, templates, and project code for creating the required AWS resources.
- In Project Configurator, ensure that the **Cloud Canvas Gem** and the **Static Data Gem** are enabled.
- Ensure that the `SamplesProject\AWS\project-settings.json` file is writable. During the resource setup process, the Amazon Resource Name (ARN) for the AWS CloudFormation stack is added into this file.
- Select the region where the AWS resources will live. *Don't Die* relies on a service called Amazon Cognito for player identity, which is currently only supported in the following regions: US East (N. Virginia) (us-east-1), EU (Ireland) (eu-west-1), and Asia Pacific (Tokyo) (ap-northeast-1). This example uses US East (N. Virginia).

To create the project stack

1. From a command line prompt on the Lumberyard `\dev` folder, type the following (the example assumes that you are using the US East region):

```
lmbr_aws create-project-stack --region us-east-1
```

Creating the stack will take a few minutes.

Next, you will create a deployment, which is a complete set of your game's cloud resources. You can have separate [deployments](#) (p. 289) that correspond to the different stages of a release (for example, an internal deployment for developers, and a release deployment for players). To keep your project simple, you will create just one deployment.

2. From the same command line prompt, type the following to create a deployment called "DontDieDeployment":

```
lmbr_aws create-deployment --deployment DontDieDeployment
```

Test the Game

At this point you can test the game and its AWS connected High Scores feature. You can run the game either from Lumberyard Editor or from the standalone SamplesProject launcher.

To run the game from Lumberyard Editor

1. Open Lumberyard Editor.
2. In the **Welcome to the Lumberyard Editor** dialog, click **Open Level**.
3. In the **Open a Level** dialog, choose **Levels, Samples, Dont_Die**, and then click **Open**.

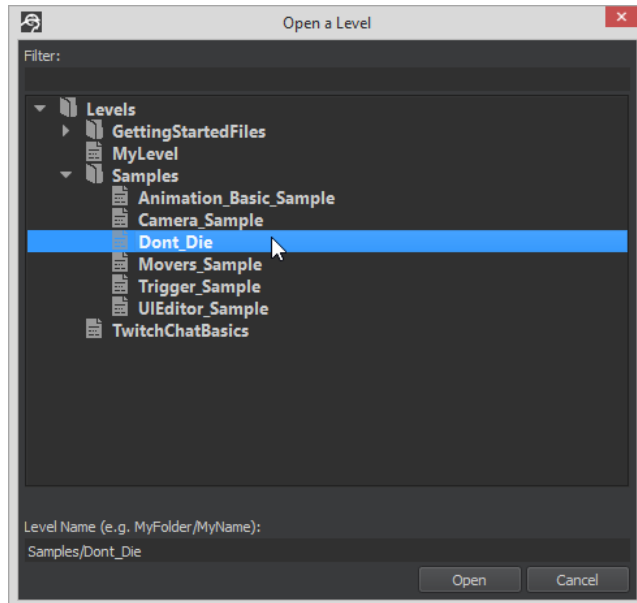

4. To upload the resources for your game, do one of the following:
 - On the command line, type

```
lmbr_aws upload-resources
```

- In Lumberyard Editor, perform the following steps:

1. Click **AWS, Cloud Canvas, Cloud Canvas Resource Manager**.

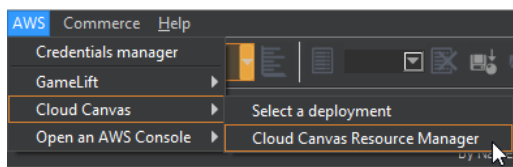

2. In **Resource Groups**, click **Upload all resources**.

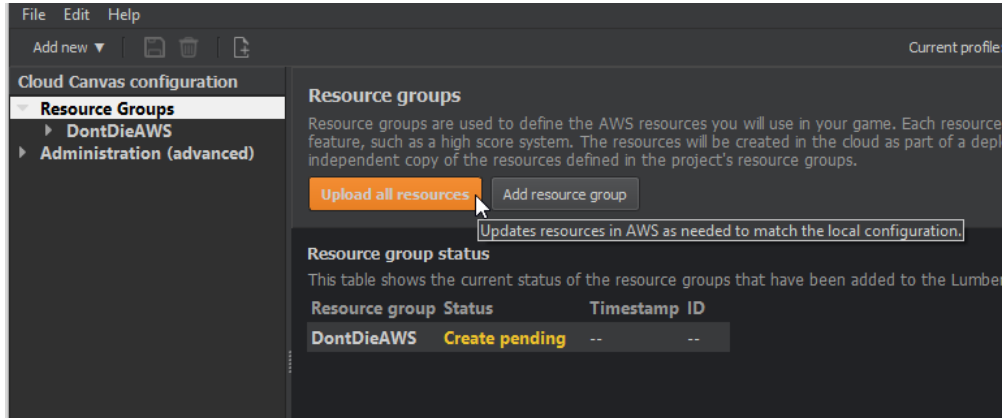

3. Exit Lumberyard Editor and restart it.

Note

This step and the next are workarounds for a bug that will be fixed in a later release.

4. Follow the previous steps to load the **Dont_Die** level in Lumberyard Editor.
5. To play the game in Lumberyard Editor, press **Ctrl-G**.

Your high scores will be recorded in the cloud and will reappear if you play again.

You can also run the game from the SamplesProject standalone launcher, although a few more steps are required.

To run the game from the standalone launcher

1. In Lumberyard Editor, click **File, Export to Engine** or press **Ctrl-E** to export the level.
2. In Lumberyard Editor, click **AWS, Cloud Canvas, Cloud Canvas Resource Manager**.
3. In **Cloud Canvas Resource Manager** navigation tree, expand **Administration (advanced)**, and then select **project-settings.json**. You can use resource manager to edit the JSON text, or open the `dev\SamplesProject\AWS\project-settings.json` file and edit the file with a text editor.
4. Under the line

```
"DefaultDeployment" : "DontDieDeployment" ,
```

add the line:

```
"ReleaseDeployment" : "DontDieDeployment" ,
```

5. Save the file.
6. At a command line prompt, run the command

```
lmbr_aws update-mappings --release
```

7. Run the program `dev\Bin64\SamplesProjectLauncher.exe`.
8. Type `~` (the tilde character) to open the SamplesProject launcher console.
9. In the console, type

```
map dont_die
```

and then press **Enter**.

The game opens directly in the SamplesProject launcher so that you can play it. Your high scores will be recorded in the cloud and will reappear if you play again.

Viewing Lambda Code in Visual Studio

You can view the Lambda source code for the *Don't Die* project in Visual Studio 2013. However, you must install the following tools first:

- [AWS Toolkit for Visual Studio](#)
- [Node.js](#)
- [Node JS Tools for Visual Studio 2013](#)

Acquiring the Mappings File

All of the Lambda code in the Don't Die project refers to AWS resources by friendly names like "High Score Table." Lambda functions use a mappings file to translate friendly names to the physical names of the actual AWS resources in your account. This file is generated by the AWS Resource Management System but is only inserted in the Lambda function right before the system uploads the code to AWS. In order to run the Lambda functions from Visual Studio, copy the mappings file locally, as follows:

To acquire the mappings file

1. Open the AWS Lambda console at <https://console.aws.amazon.com/lambda/>.
2. Filter for **DontDie** and click the linked name of one of the Lambda functions in the list (one function should contain the text `DontDieMain`). The detail page for the function appears.
3. Click **Actions**, and then click **Download function code**.
4. Download the `.zip` file to your computer.
5. Open the `.zip` file and extract the `CloudCanvas` directory together with the `settings.js` file in it to the `\dev\SamplesProject\AWS\resource-group\DontDieAWS\lambda-function-code\` directory. This file enables Visual Studio to find the correct resources for the Lambda function.
6. To view the solution, open the `dev\SamplesProject\AWS\SamplesProjectAWS.sln` file in Visual Studio.

Lambda Code Overview

Within the Visual Studio project, under the apps folder, there is a folder called `don't-die-main`. This folder contains the `don't-die-main` Lambda function that is used throughout the game. The function executes commands such as `start-game`, `end-game`, and `get-high-score-table` that are sent to it from the client, and then it sends back the result. Commands can be batched together in an effort to minimize the number of calls to other AWS services. For example, if two commands that update the player table are sent together, the Lambda function combines the commands into a single DynamoDB update.

The `don't-die-main` folder contains three files: `_sampleEvent.json`, `_testdriver.js`, and `app.js`. The first two files are not uploaded to AWS (this is controlled by the `.ignore` file) but are

used for local testing only. The `_sampleEvent.json` file contains test data that represents the data that the client sends. The `_testdriver.js` file executes the Lambda code locally, emulating the AWS service that calls the Lambda function. Both files are generated by the AWS toolkit, although they have been somewhat modified. The third file, `app.js`, contains the entry point for the `exports.handler` Lambda function in this sample.

To test the Lambda function locally, right-click the `_testdriver.js` file, select **Set as Node.js Startup File**, and click **Debug > Start Debugging**.

The general behavior of the Lambda function is as follows:

- Each time the `dont-die-main` Lambda function is executed, a `DontDie` object is created, and `Start` is called on it.
- The `DontDie` object waits for each game system in the `systemModuleList` array to initialize.
- If a game system has a set of static data that it relies on, it tries to load it. If AWS executes the Lambda function on a computer on which the Lambda function has been recently used, it uses the data already loaded from the previous execution.
- After all game systems are initialized, the commands sent by the client are executed. This step corresponds to the code in the `app.js` file.
- After all commands have executed serially, `Finish` is called on the `DontDie` object. This call gives each game system a chance to save any changes to state that have been made. For example, if player data has changed, it is saved to DynamoDB.

Deleting the AWS Project Stack

After ensuring that your Amazon S3 bucket is empty, you can delete your deployment, resources, and project stack.

Empty Your S3 Bucket

Don't Die creates one Amazon S3 bucket. Before you can delete the project stack, ensure this S3 bucket is empty. Otherwise, the AWS Resource Management system cannot delete the S3 bucket, which blocks it from deleting the project stack.

Note

The following steps are necessary only if you manually added files to the Don't Die **mainbucket**. If you didn't add any files, you can skip this step.

To empty an S3 bucket

1. Sign in to the AWS Management Console and open the Amazon S3 console at <https://console.aws.amazon.com/s3/>.
2. Find the **samplesproject** bucket that has **mainbucket** somewhere in the title, and click that bucket.
3. Select each item in the bucket, and then click **Actions, Delete**.

After the Amazon S3 bucket is empty, you can delete the project stack.

Remove Your Deployment and its Resources

To remove your deployment, its resources, and your project stack, you can use either the **Cloud Canvas Resource Manager** or the Cloud Canvas command line to delete the **DontDieDeployment**. For steps, see [Deleting Cloud Canvas Deployments and Their Resources \(p. 232\)](#).

AWS Services Used

The *Don't Die* sample project implements game back-end features on AWS. By default, this project uses the services listed in the table below. When you use certain features in the sample project, you are using the AWS services that power them. You can add additional services by customizing the templates or writing your own templates.

When you initialize the *Don't Die* sample project, you are prompted to deploy AWS services to your account by using the included AWS CloudFormation templates.

There is no additional charge for using Cloud Canvas. AWS resources you use for *Don't Die* may be subject to separate charges and additional terms. You pay for AWS resources created using Cloud Canvas, such as Lambda functions, DynamoDB tables, and IAM in the same manner as if you created them manually. You only pay for what you use, as you use it; there are no minimum fees and no required upfront commitments, and most services include a free tier.

AWS Services Table

Feature	AWS Services Used
Setup	AWS CloudFormation , Lambda , DynamoDB , Amazon S3 , Amazon Cognito , IAM
Message of the Day example	AWS CloudFormation , Lambda , DynamoDB ,
Achievements example	AWS CloudFormation , Lambda , DynamoDB ,
High Scores example	AWS CloudFormation , Lambda , DynamoDB , Amazon S3
Daily Gift example	AWS CloudFormation , Lambda , DynamoDB ,
Item Manager example	AWS CloudFormation , Lambda , DynamoDB ,
Mission example	AWS CloudFormation , Lambda , DynamoDB ,

Using Cloud Canvas

Cloud Canvas provides a rich set of tools for Lumberyard Editor and for the command line that you can use to create and manage the cloud connected features of your game.

You can use these tools to define and manage the AWS resources in your Lumberyard project, including the following:

- [Initializing \(p. 207\)](#) a Lumberyard project with Cloud Canvas functionality
- Managing the [resource deployments \(p. 289\)](#) and [resource groups \(p. 183\)](#) (connected features) for your project
- Updating the contents of your Lumberyard game project
- Previewing and [editing \(p. 206\)](#) the AWS CloudFormation templates that [define \(p. 267\)](#) the AWS resources for your game.

Topics

- [Cloud Canvas Tools in Lumberyard Editor \(p. 205\)](#)
- [Editing Cloud Canvas Files \(p. 206\)](#)
- [Initializing Cloud Canvas Resource Manager \(p. 207\)](#)
- [Managing Cloud Canvas Profiles \(p. 208\)](#)
- [Understanding Resource Status Descriptions \(p. 209\)](#)

- [Using the Cloud Canvas Command Line](#) (p. 209)
- [Viewing the Cloud Canvas Progress Log](#) (p. 224)
- [Working with Deployments](#) (p. 225)
- [Working with JSON Files](#) (p. 233)
- [Working with Project Stacks](#) (p. 234)
- [Working with Resource Groups](#) (p. 235)

Cloud Canvas Tools in Lumberyard Editor

Lumberyard Editor provides tools that make it easy for you to connect your game to AWS. To get started, click **AWS** in the Lumberyard Editor toolbar:

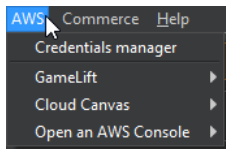

The **AWS** menu has the following options:

- **Credentials manager** – Select or manage one or more AWS profiles that provide credentials required to access your AWS account. For more information, see [Managing Cloud Canvas Profiles](#) (p. 208).
- **GameLift** – Use the Amazon GameLift service to rapidly deploy and scale session-based multiplayer games with no upfront costs. For more information, see [Amazon GameLift](#). The **GameLift** menu itself also has links to more information.
- **Cloud Canvas** – The **Cloud Canvas** menu has the following options:

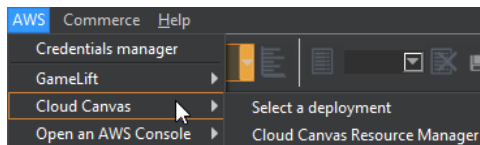

- **Select a deployment** – Specify the set of AWS resources for the project that you want Lumberyard Editor to work with. For more information, see [Making a Cloud Canvas Deployment Active](#) (p. 228).
- **Cloud Canvas Resource Manager** – Define and manage the AWS resources for your Lumberyard project. For a conceptual introduction to resource manager, see [Cloud Canvas Resource Manager Overview](#) (p. 186).
- **Open an AWS Console** – Get quick access to the main AWS Management Console and to consoles for Amazon Cognito, DynamoDB, Amazon S3, and Lambda:

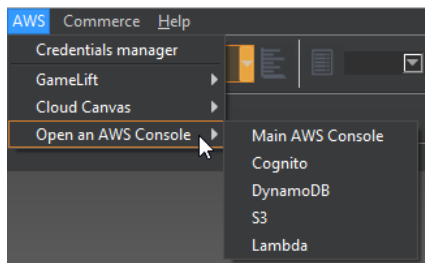

These links use your currently active AWS profile to connect to AWS. You can use the [Managing Cloud Canvas Profiles](#) (p. 208) to select which profile is active.

Editing Cloud Canvas Files

The navigation pane in the **Cloud Canvas Resource Manager** dialog contains a number of nodes that represent text files that are stored on disk. The `resource-template.json` (p. 233) node is one example.

The child nodes of template files each represent one section of the parent node template file. These child nodes can help you locate and edit the resource definition sections of the parent node template file.

Using the Internal Editor

When you select a text file node in the navigation pane, the file content and text editing options are shown in the detail pane of **Cloud Canvas Resource Manager**. You can use the detail pane to view and edit the contents of the file. Use the **Edit**, **Search** menu item to search for text, and the **Previous** and **Next** buttons to navigate from one match to the next. After you have modified a file, you can save it by clicking **Save** in the toolbar or by choosing **File, Save**.

Note

The changes that you make in the template file child nodes are always saved to the parent node template file.

Using an External Editor

You can use an external script editor instead of the **Cloud Canvas Resource Manager** to edit files. You can specify which editor to use in Lumberyard Editor.

To specify an external script editor

- In Lumberyard Editor, click **File, Global Preferences, Editor Settings, General Settings, Files, External Editors, Scripts Editor**.

To open a file in an external script editor

- Right-click the file in the navigation pane and choose **Open in script editor**:

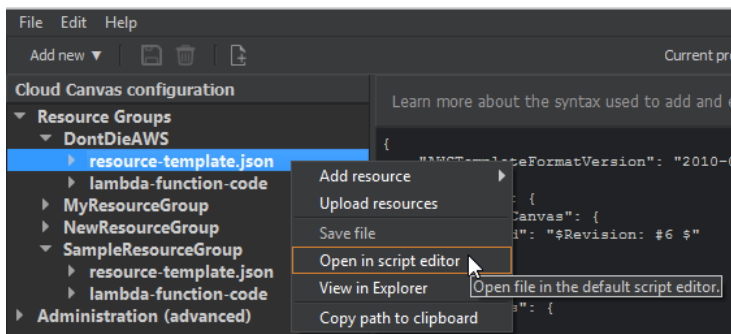

To copy the path of the template file to the clipboard, right-click the file in the navigation pane and choose **Copy path to clipboard**.

Notes

Note the following:

- Opening a child node of a template file in a script editor opens the full (parent) file for editing.
- If your project files are under source control, Lumberyard prompts you to check out files before they can be edited. The source control icon on the toolbar dynamically displays the status of a selected file in source control.
- If the contents of the file change on disk while there are unsaved changes in the editor, Lumberyard prompts you to load the updated contents from disk and replace the modified contents in the editor.

Initializing Cloud Canvas Resource Manager

When you perform an operation that requires an AWS account, and no account has been associated with your Lumberyard project, the **Initialize Cloud Canvas Resource Manager** dialog prompts you for the required information.

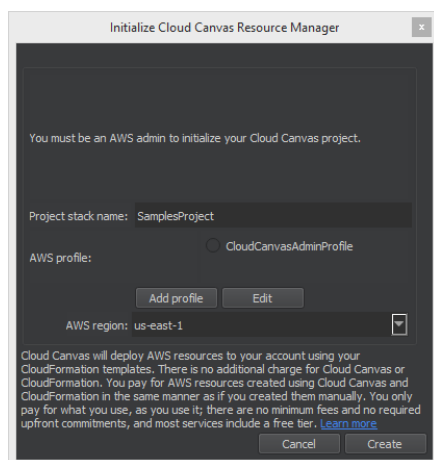

To initialize Cloud Canvas Resource Manager

1. When prompted to initialize the **Cloud Canvas Resource Manager**, provide the following information:
 - For **Project stack name**, type the name of an [AWS CloudFormation stack](#) that you will create. The stack will contain the AWS resources that **Cloud Canvas Resource Manager** will use for your project. By default, Lumberyard uses the name of your project for the stack name. A stack with the name that you specify must not already exist in your AWS account for the region you select.
 - For **AWS Credentials**, select from the list of available profiles or create a new one. If you have no [AWS profiles](#) on your computer, you are prompted for an AWS secret key and an AWS access key. You can also edit an existing one.

In order to use Lumberyard with AWS, you must provide administrative credentials for your AWS account either directly, or through an AWS profile. For information on how to get these credentials from AWS, see the [Getting Started with Cloud Canvas Tutorial](#).
 - For **AWS region**, specify the AWS data center where your resources will reside. You must choose a region that supports all the AWS services that your game uses. The region you choose must also support the Amazon Cognito service, which Lumberyard uses to establish player identity, and AWS CloudFormation, which Lumberyard uses to create and manage resources. For more information about the capabilities of different regions, see [AWS Regions and Endpoints](#).
2. Click **Create** to start the initialization process. In the navigation tree, the [Working with Project Stacks \(p. 234\)](#) node is selected, and in the detail pane, the [Viewing the Cloud Canvas Progress Log \(p. 224\)](#) shows the progress of the initialization.

Managing Cloud Canvas Profiles

Use the **Credentials Manager** in Lumberyard Editor or the command line to manage one or more AWS profiles that provide the credentials required to access your AWS account.

The profile is saved locally on your machine in your AWS credentials file. This file is normally located in your `C:\Users\<user name>\.aws\` directory. The [AWS Command Line Interface](#) and the [AWS Toolkit for Visual Studio](#) can access these credentials.

Important

Do not share these credentials with anyone, and do not check them into source control. These grant control over your AWS account, and a malicious user could incur charges.

For more information, see [AWS Security Credentials](#).

To open Credentials Manager

- To open **Credentials Manager**, do one of the following:
 - In Lumberyard Editor, click **AWS, Credentials manager**.

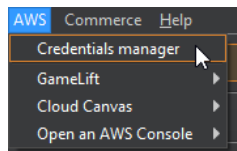

- In **Cloud Canvas Resource Manager**, click the name of the current profile in the Resource Manager toolbar:

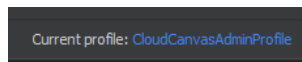

You can use the **Credentials Manager** to select an existing AWS profile, edit an AWS profile, or add a new AWS profile.

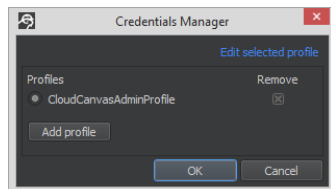

To edit an existing AWS profile, click **Edited selected profile**. To add an AWS profile, click **Add profile**.

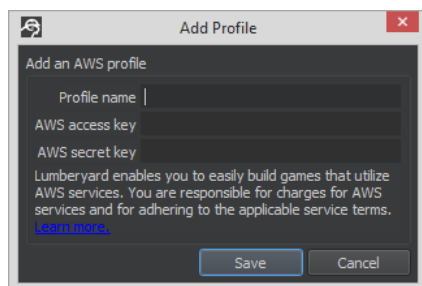

When adding or editing a profile, Lumberyard prompts you for the following:

Profile name – The name used for the profile.

AWS Secret Key – The AWS secret key needed to access the account.

AWS Access Key – The AWS access key needed to access the account.

To add your credentials by using the command line

1. Open a command line window and change to the root Lumberyard directory, which is the `dev` subdirectory of your Lumberyard installation directory (for example, `C:\lumberyard\dev`).
2. Type the following at the command prompt, and then press **Enter**. Replace `<profile-name>` with a name of your choice (for example, `CloudCanvasAdminProfile`). Replace `<secret-key>` and `<access-key>` with the secret key and access key of your AWS account.

```
lmbr_aws add-profile --profile <profile-name> --make-default --aws-secret-key <secret-key> --aws-access-key <access-key>
```

The `--make-default` option establishes the profile as your default profile for Cloud Canvas. The default profile eliminates the need to specify the profile each time you use Lumberyard Editor or run an `lmbr_aws` command.

Understanding Resource Status Descriptions

The status of AWS resources is displayed in the **Cloud Canvas Resource Manager** in places such as the progress log. The following list provides descriptions of common resource status codes. To see the reason for the current status, you can pause your mouse on the status text in the resource manager.

Create pending – The resource is defined in the local configuration but doesn't exist in AWS.

Create in progress – The resource is in the process of being created in AWS.

Create complete – The resource has been successfully created in AWS.

Create failed – The resource could not be created in AWS.

Update in progress – The resource is in the process of being updated in AWS.

Update complete – The resource was successfully updated in AWS.

Update failed – The resource could not be updated in AWS.

Delete pending – The resource is not defined in the local configuration but it does exist in AWS.

Delete in progress – The resource is in the process of being deleted in AWS.

Delete complete – The resource has been deleted in AWS.

Rollback in progress – An operation has failed and AWS CloudFormation is attempting to restore the resource to its previous state.

Rollback failed – A rollback has failed. The AWS resources in a CloudFormation stack that have this status are in an inconsistent state. You may have to delete and recreate the stack.

Using the Cloud Canvas Command Line

Cloud Canvas provides the `\dev\lmbr_aws.cmd` command line tool for working with AWS resources. The tool invokes Python code that is located in the `\dev\Tools\lmbr_aws` directory.

Syntax

```
lmbrr_aws {command} {command-arguments}
```

{command} is one of commands in the command summary section that follows. *{command-arguments}* are the arguments accepted by the command. Arguments common to most commands are listed in the [Common Arguments \(p. 210\)](#) section. Arguments unique to a command are listed in the detail section for the command.

Configuration

The tool gets its default AWS configuration from the same `~/.aws/credentials` and `~/.aws/config` files as the AWS command line tools (for information, see [Configuring the AWS Command Line Interface](#)). The `lmbrr_aws` tool does not require that the AWS command line interface be installed.

Environment Variables

As with the AWS command line tools, the default AWS configuration can be overridden by using the following environment variables.

- `AWS_ACCESS_KEY_ID` The access key for your AWS account.
- `AWS_SECRET_ACCESS_KEY` The secret key for your AWS account.
- `AWS_DEFAULT_REGION` The default region to use; for example, `us-east-1`.
- `AWS_PROFILE` The default credential and configuration profile to use, if any.

Configuration Arguments

The following arguments can be used to override the AWS configuration from all other sources:

- `--profile {profile}` The AWS command line tool profile that is used.
- `--aws-access-key {access-key}` The AWS access key that is used.
- `--aws-secret-key {secret-key}` The AWS secret key that is used.

Common Arguments

Most of the `lmbrr_aws` commands accept the following arguments, in addition to their own individual arguments:

- `-h` or `--help` – Display help for the command.
- `--root-directory {root}` – Identifies the `Lumberyard\dev` directory. The default is the current working directory.
- `--aws-directory {aws}` – Identifies the `{game}\AWS` directory to use. The default is the value of the `sys_game_folder` property from `{root}\bootstrap.cfg` with `AWS` appended.
- `--game-directory {directory}` – Location of the game project directory. The default is `{root}\{game}` where `{game}` is determined by the `sys_game_folder` setting in the `{root}\bootstrap.cfg` file.
- `--user-directory {user}` – Location of the user cache directory. The default is `{root}\Cache\{game}\AWS` where `{game}` is determined by the `sys_game_folder` setting in the `{root}\bootstrap.cfg` file.
- `--verbose` – Shows additional output when executing commands.

Command Summary

This topic describes the following commands:

- [add-login-provider \(p. 211\)](#) – Add a player login provider to the Amazon Cognito identity pool configuration.
- [add-profile \(p. 212\)](#) – Add an AWS profile to the AWS command line tool configuration.
- [add-resource-group \(p. 213\)](#) – Add a group of related resources to the project.
- [create-deployment \(p. 213\)](#) – Create an independent copy of your project's resources.
- [create-project-stack \(p. 213\)](#) – Create the AWS resources needed for a Lumberyard project. If the `{game}\AWS` directory contains no resource definitions, default resource definitions are created.
- [default-deployment \(p. 214\)](#) – Show or set the default deployment.
- [default-profile \(p. 215\)](#) – Set, clear, or show the default profile from the AWS command line tool configuration.
- [delete-deployment \(p. 215\)](#) – Delete an independent copy of your project's resources.
- [delete-project-stack \(p. 216\)](#) – Delete a project stack. This command will not delete projects with deployments.
- [import-resource \(p. 216\)](#) – Import a resource to a resource group.
- [list-deployments \(p. 217\)](#) – List all deployments in the local project.
- [list-importable-resources \(p. 217\)](#) – List all supported resources currently existing on AWS.
- [list-mappings \(p. 217\)](#) – Show the logical to physical resource name mappings.
- [list-profiles \(p. 218\)](#) – List the AWS profiles that have been configured.
- [list-resource-groups \(p. 218\)](#) – List the resource groups for the project.
- [list-resources \(p. 218\)](#) – List all of the resources associated with the project.
- [protect-deployment \(p. 220\)](#) – Mark a deployment as protected.
- [remove-login-provider \(p. 220\)](#) – Remove a login provider from your player access template.
- [remove-profile \(p. 221\)](#) – Remove an AWS profile from the AWS command line tool configuration.
- [remove-resource-group \(p. 221\)](#) – Remove a resource group from the project.
- [rename-profile \(p. 221\)](#) – Rename an AWS profile in the AWS command line tool configuration.
- [update-login-provider \(p. 221\)](#) – Update an existing login provider to your Player Access template, so that you can connect your application to Amazon Cognito.
- [update-mappings \(p. 222\)](#) – Update the logical to physical resource name mappings to reflect the current default deployment.
- [update-profile \(p. 223\)](#) – Update an AWS profile.
- [update-project-stack \(p. 223\)](#) – Update the AWS resources used by a Lumberyard project.
- [upload-resources \(p. 224\)](#) – Upload and apply changes made to local `resource-template.json` files.

Commands

Following are details of the `lmbc_aws` commands.

[add-login-provider](#)

Add a player login provider to the Amazon Cognito identity pool configuration. Login providers allow your game's players to log in using their social network identity, such as Facebook or using their Amazon user identity. For more information, see [Access Control and Player Identity \(p. 297\)](#).

In addition to the [Common Arguments \(p. 210\)](#), the `add-login-provider` subcommand accepts the following arguments:

- `--provider {provider-name}`

Required. The name of the provider. The name must be `amazon`, `google` or `facebook`, or, if you are using a generic OpenID provider, a name that you choose.

- `--app-id {application-id}`

Required. The application id from your login provider (this is usually different from your client ID).

- `--client-id {client-id}`

Required. The unique application client ID for the login provider.

- `--client-secret {client-secret}`

Required. The secret key to use with your login provider.

- `--redirect-uri {redirect-uri}`

Required. The redirect URI to use with your login provider.

- `--provider-uri {provider-uri}`

Optional. The URI for a generic open ID connect provider. This is only use for generic OpenID providers.

- `--provider-port {provider-port}`

Optional. The port your provider listens on for its API. This is only used for generic OpenID providers.

- `--provider-path {provider-path}`

Optional. The path portion of your provider's URI. This is only used for generic OpenID providers.

This command saves its configuration in a `player-access/auth-settings.json` object in the project's configuration bucket so that the `ProjectPlayerAccessTokenExchangeHandler` Lambda function can access it.

Note

You must run `lmb_aws update-project-stack` after running this command so that the [PlayerAccessIdentityPool Resource \(p. 285\)](#) configuration is updated to reflect the change.

add-profile

Add an AWS profile to the AWS command line tool configuration.

In addition to the [Common Arguments \(p. 210\)](#), the `add-profile` subcommand accepts the following arguments:

- `--aws-access-key {accesskey}`

Required. The AWS access key associated with the added profile.

- `--aws-secret-key {secretkey}`

Required. The AWS secret key associated with the added profile.

- `--profile {profilename}`

Required. The name of the AWS profile to add.

- `--make-default`

Optional. Make the new profile the default profile.

add-resource-group

Add a `ResourceGroupConfiguration` and AWS CloudFormation stack resources to your `deployment-template.json` file. The added resources will be similar to the [HelloWorldConfiguration Resource \(p. 278\)](#) and [HelloWorld Resource \(p. 278\)](#) in the example `deployment-template.json` (p. 276) file.

The command also creates a `{game}\resource-group\{resource-group-name}` directory with a default `resource-template.json` file and `lambda-function-code` subdirectory.

In addition to the [Common Arguments \(p. 210\)](#), the `add-resource-group` subcommand accepts the following argument:

- `--resource-group {resource-group-name}`

Required. The name of the resource group to add.

- `--include-example-resources`

Optional. Includes "Hello World" example resources.

create-deployment

Create a complete and independent copy of all the resources needed by the Lumberyard project.

In addition to the [Common Arguments \(p. 210\)](#), the `create-deployment` subcommand accepts the following arguments:

- `--deployment {deployment-name}`

Required. The name of the deployment to create.

- `--enable-capability{capability}`

Optional. A list of capabilities that you must specify before AWS CloudFormation can create or update certain stacks. Some stack templates might include resources that affect permissions in your AWS account. For those stacks, you must explicitly acknowledge their capabilities by specifying this parameter. Possible values include: `CAPABILITY_IAM`.

- `--confirm-aws-usage`

Optional. Confirms that you know that the `create-deployment` command will create AWS resources for which you may be charged and that may perform actions that can affect permissions in your AWS account. If not specified, you are prompted for confirmation.

create-project-stack

Initialize Cloud Canvas resource management for a Lumberyard project. This includes creating a set of default [Resource Definitions \(p. 267\)](#) in the `{root}\{game}\AWS` directory and a AWS CloudFormation stack that contains the resources that the Cloud Canvas resource manager uses to manage your game resources.

In addition to the [Common Arguments \(p. 210\)](#), the `create-project-stack` subcommand accepts the following arguments:

- `--stack {stack-name}`

Optional. The name used for the project's AWS CloudFormation stack. The default is the name of the `{game}` directory.

- `--confirm-aws-usage`

Optional. Confirms that you know this command will create AWS resources for which you may be charged and that it may perform actions that can affect permissions in your AWS account. Also disables the prompt for confirmation during the command's execution.

- `--enable-capability {capability} [{capability} ...]`

Optional. A list of capabilities that you must specify before AWS CloudFormation can create or update certain stacks. Some stack templates might include resources that can affect permissions in your AWS account. For those stacks, you must explicitly acknowledge their capabilities by specifying this parameter. Possible values include `CAPABILITY_IAM`.

- `--files-only`

Optional. Writes the default configuration data to the `{game}\AWS` directory and exits. The directory must be empty or must not exist.

- `--region {region}`

Required. The AWS region in which the project stack will be created.

Note

The `region` option can be used only with the `create-project-stack` and `list-importable-resources` commands.

How `create-project-stack` works

1. The `create-project-stack` command creates the project's AWS CloudFormation stack using a bootstrap template that defines only the [Configuration Bucket \(p. 290\)](#) resource.
2. The [project-template.json \(p. 271\)](#) file and the zipped up contents of the [project-code subdirectory \(p. 285\)](#) are uploaded to the [Configuration Bucket \(p. 290\)](#).
3. An AWS CloudFormation stack update operation is performed by using the uploaded `project-template.json` file. The `project-code.zip` file is used to create the Lambda function resources defined by the `project-template.json` file.

Note

- If the `{root}\{game}\AWS` directory is empty or does not exist, `create-project-stack` creates the directory if necessary and copies the contents of the `{root}\Tools\lmb_r_aws\AWSResourceManager\default-project-content` directory to that directory.
- `create-project-stack` fails if a stack with the specified name already exists in the configured AWS account and region. In this case you can use the `--stack` option to specify a different name for the project stack.
- `create-project-stack` fails if the `{root}\{game}\AWS\project-settings.json` file has a non-empty `ProjectStackId` property. The `ProjectStackId` property will be set to the project's AWS CloudFormation stack ID after the project stack is created in step 1.
- If the stack update process in step 2 fails on the first attempt, you can retry by using the `update-project-stack` command.

default-deployment

Set or show the default deployment.

In addition to the [Common Arguments \(p. 210\)](#), the `default-deployment` subcommand accepts the following arguments:

- `--set {deployment}`

Optional. Sets the default to the provided deployment name.

- `--clear`

Optional. Clears the defaults.

- `--show`

Optional. Shows the defaults.

- `--project`

Optional. Applies `--set` and `--clear` to the project default instead of the user default. Ignored for `--show`.

Only one of the `--set`, `--clear`, and `--show` arguments is allowed.

If `--set` or `--clear` is specified, this command updates the `{root}\user\AWS\user-settings.json` file. If `--project` is provided, the `{root}\{game}\AWS\project-settings.json` file is updated.

default-profile

Set, clear, or show the default profile in the AWS command line tool configuration.

In addition to the [Common Arguments \(p. 210\)](#), the `default-profile` subcommand accepts the following arguments:

- `--set {deploymentname}`

Optional. Set the default profile to the provided deployment name.

- `--clear`

Optional. Clear the default profile.

- `--show`

Optional. Show the default profile.

delete-deployment

Delete a complete and independent copy of all the resources needed by the Lumberyard project.

In addition to the [Common Arguments \(p. 210\)](#), the `delete-deployment` subcommand accepts the following argument:

- `--deployment {deployment-name}`

Required. The name of the deployment to delete.

- `--enable-capability{capability}`

Optional. A list of capabilities that you must specify before AWS CloudFormation can create or update certain stacks. Some stack templates might include resources that can affect permissions in your AWS account. For those stacks, you must explicitly acknowledge their capabilities by specifying this parameter. Possible values include: `CAPABILITY_IAM`.

- `--confirm-resource-deletion`

Optional. Acknowledges that the command will permanently delete the resources belonging to the specified deployment. If not specified, the user is prompted to confirm the deletion.

Note

AWS CloudFormation cannot delete stacks that define Amazon S3 buckets that contain data. To allow project stacks to be deleted, the `project-template.json` file specifies a `DeletionPolicy` of `Retain` for the configuration bucket. This causes AWS CloudFormation to not delete the bucket when the project stack is deleted. After the project stack has been deleted, the command removes all the objects from the configuration bucket and then deletes the bucket.

delete-project-stack

Delete the AWS CloudFormation stack that contains your project's resources. You must delete all of the project's deployments before deleting the project stack. After deleting the project stack, you must create a new project stack before you can use AWS CloudFormation resource manager for your project.

In addition to the [Common Arguments \(p. 210\)](#), the `delete-project-stack` subcommand accepts the following argument:

- `--confirm-resource-deletion`

Optional. Confirms with the user that this command will delete all the AWS resources used by the AWS CloudFormation resource manager to manage your game's AWS resources. Also disables the default prompt for confirmation when the command is run.

AWS CloudFormation cannot delete stacks that define Amazon S3 buckets that contain data. To allow project stacks to be deleted, the `project-template.json` file specifies a `DeletionPolicy` of `Retain` for the configuration bucket. This causes AWS CloudFormation to not delete the bucket when the project stack is deleted. After the project stack has been deleted, the command removes all the objects from the configuration bucket and then deletes the bucket.

import-resource

Import a resource to a resource group.

In addition to the [Common Arguments \(p. 210\)](#), the `import-resource` subcommand accepts the following arguments:

- `--type {dynamodb|s3|lambda|sns|sqs}`

Optional. The type of the AWS resource to import. Choose from `dynamodb`, `s3`, `lambda`, `sns` or `sqs`.

- `--arn ARN`

Required. The ARN of the AWS resource to import.

- `--resource-name {resource-name}`

Required. The name of the resource to import.

- `--resource-group {resource-group}`

Required. The name of the resource group to import.

- `--download`

Optional. If specified, downloads the contents of the Amazon S3 bucket.

list-deployments

List all deployments in the local project.

Example output:

Name	Status	Reason Timestamp	Id
-----	-----		-----
-----			-----
AnotherDeployment	CREATE_PENDING	Resource is defined in the local project template but does not exist in AWS.	
Development	CREATE_COMPLETE		03/04/16 18:43:11 arn:aws:cloudformation:us-east-1:<ACCOUNTID>:stack/foo-hw-Development- ZDLXUB7FKR94/8e6492f0-e248-11e5-8e7e-50d5ca6e60ae
User Default Deployment:	(none)		
Project Default Deployment:	Development		
Release Deployment:	(none)		

list-importable-resources

List all supported resources currently existing on AWS.

In addition to the [Common Arguments \(p. 210\)](#), the `list-importable-resources` subcommand accepts the following arguments:

- `--type {dynamodb|s3|lambda|sns|sqs}`

Required. The type of the AWS resource to list. Choose from `dynamodb`, `s3`, `lambda`, `sns` or `sqs`.

- `--region {region}`

Optional. The AWS region of the resources. The default value is the region of the project stack, if it exists.

Note

The `region` option can be used only with the `list-importable-resources` and `create-project-stack` commands.

list-mappings

Show the logical to physical resource name mappings.

Example output:

Name	Type	Id
-----	-----	-----
-----		-----
HelloWorld.SayHello	AWS::Lambda::Function	foo-hw-
Development-ZDLXUB7FKR94-HelloWo-SayHello-1FADMFNE5M1CO		
PlayerAccessIdentityPool	Custom::CognitoIdentityPool	us-
east-1:108f6d6a-f929-4212-9947-a03269b9582e		
PlayerLoginIdentityPool	Custom::CognitoIdentityPool	us-
east-1:3020e175-0ddd-4860-8dad-1db57162cbb2		

```
ProjectPlayerAccessTokenExchangeHandler  AWS::Lambda::Function  foo-hw-  
ProjectPlayerAccessTokenExchangeHandler-1BG6JJ94IZAUV  
account_id                               Configuration  
  <ACCOUNTID>  
region                                   Configuration  us-  
east-1
```

list-profiles

List the AWS profiles that have been configured.

list-resource-groups

List all the resource groups found in the local deployment template and in the selected deployment in AWS.

In addition to the [Common Arguments \(p. 210\)](#), the `list-resource-groups` subcommand accepts the following argument:

- `--deployment {deployment-name}`

Optional. The name of the deployment to list resource groups for. If not given, the default deployment is used.

Example output:

```
Name          Status          Reason  
-----          -  
-----  
-----  
-----  
AnotherResourceGroup  CREATE_PENDING  Resource is defined in the local  
deployment template but does not exist in AWS.  
HelloWorld           CREATE_COMPLETE  
                                03/04/16 18:42:57  
arn:aws:cloudformation:us-east-1:<ACCOUNTID>:stack/foo-hw-Development-  
ZDLXUB7FKR94-HelloWorld-WSGZ15EUWX52/9b909d20-e238-11e5-a98d-50fae987c09a
```

list-resources

List all of the resources associated with the project.

In addition to the [Common Arguments \(p. 210\)](#), the `list-resources` subcommand accepts the following arguments:

- `--stack-id {stackid}`

Optional. The ARN of the stack to list resources for. Defaults to project, deployment, or resource group id as determined by the `--deployment` and `--resource-group` parameters.

- `--deployment {deployment-name}`

Optional. The name of the deployment to list resources for. If not specified, lists all the project's resources.

- `--resource-group {resource-group-name}`

Optional. The name of the resource group to list resources for. If specified, `deployment` must also be specified. If not specified, all deployment or project resources are listed.

Example output:

Name	Status	Timestamp	Id	Type
Configuration				AWS::S3::Bucket
CREATE_COMPLETE	03/04/16 18:38:25	foo-hw-configuration-vxaqlg44s0ef		
Development				AWS::CloudFormation::Stack
CREATE_COMPLETE	03/04/16 18:43:11	arn:aws:cloudformation:us-east-1:<ACCOUNTID>:stack/foo-hw-Development-ZDLXUB7FKR94/8e6492f0-e238-11e5-8e7e-50d5ca6e60ae		
Development.HelloWorld				AWS::CloudFormation::Stack
CREATE_COMPLETE	03/04/16 18:42:57	arn:aws:cloudformation:us-east-1:<ACCOUNTID>:stack/foo-hw-Development-ZDLXUB7FKR94-HelloWorld-WSGZ15EUWX52/9b909d20-e238-11e5-a98d-50fae987c09a		
Development.HelloWorld.Messages				AWS::DynamoDB::Table
CREATE_COMPLETE	03/04/16 18:41:24	foo-hw-Development-ZDLXUB7FKR94-HelloWorld-WSGZ15EUWX52-Messages-W8398CX6EB7C		
Development.HelloWorld.PlayerAccess				Custom::PlayerAccess
CREATE_COMPLETE	03/04/16 18:42:54	CloudCanvas:PlayerAccess:foo-hw-Development-ZDLXUB7FKR94-HelloWorld-WSGZ15EUWX52		
Development.HelloWorld.SayHello				AWS::Lambda::Function
CREATE_COMPLETE	03/04/16 18:42:45	foo-hw-Development-ZDLXUB7FKR94-HelloWo-SayHello-1FADMfNE5M1CO		
Development.HelloWorld.SayHelloConfiguration				Custom::LambdaConfiguration
CREATE_COMPLETE	03/04/16 18:42:39	CloudCanvas:LambdaConfiguration:foo-hw-Development-ZDLXUB7FKR94-HelloWorld-WSGZ15EUWX52:SayHello:6e3be3f1-933b-47b7-b3f6-21a045cbdda7		
Development.HelloWorldConfiguration				Custom::ResourceGroupConfiguration
CREATE_COMPLETE	03/04/16 18:40:39	CloudCanvas:LambdaConfiguration:foo-hw-Development-ZDLXUB7FKR94-HelloWorld		
DevelopmentAccess				AWS::CloudFormation::Stack
CREATE_COMPLETE	03/04/16 18:44:58	arn:aws:cloudformation:us-east-1:<ACCOUNTID>:stack/foo-hw-DevelopmentAccess-14RNG9550IZMJ/f56ff7f0-e238-11e5-a77e-50d5cd148236		
DevelopmentAccess.Owner				AWS::IAM::Role
CREATE_COMPLETE	03/04/16 18:44:38	foo-hw-DevelopmentAccess-14RNG9550IZMJ-Owner-1H1MHLAZOKELJ		
DevelopmentAccess.OwnerPolicy				AWS::IAM::ManagedPolicy
CREATE_COMPLETE	03/04/16 18:43:23	arn:aws:iam::<ACCOUNTID>:policy/foo-hw-Development/foo-hw-DevelopmentAccess-14RNG9550IZMJ-OwnerPolicy-1CE1PRKWZCVRW		
DevelopmentAccess.Player				AWS::IAM::Role
CREATE_COMPLETE	03/04/16 18:44:33	foo-hw-DevelopmentAccess-14RNG9550IZMJ-Player-1JXYH5PPO434S		
DevelopmentAccess.PlayerAccess				Custom::PlayerAccess
CREATE_COMPLETE	03/04/16 18:44:49	CloudCanvas:PlayerAccess:foo-hw-DevelopmentAccess-14RNG9550IZMJ		
DevelopmentAccess.PlayerAccessIdentityPool				Custom::CognitoIdentityPool
CREATE_COMPLETE	03/04/16 18:44:41	us-east-1:108f6d6a-f928-4212-9947-a03269b9582e		
DevelopmentAccess.PlayerLoginIdentityPool				Custom::CognitoIdentityPool
CREATE_COMPLETE	03/04/16 18:44:43	us-east-1:3020e175-0ded-4860-8dad-1db57162cbb2		
DevelopmentAccess.PlayerLoginRole				AWS::IAM::Role
CREATE_COMPLETE	03/04/16 18:44:33	foo-hw-DevelopmentAccess-14RNG95-PlayerLoginRole-70M854BKMJBL		

```
DevelopmentConfiguration
Custom::DeploymentConfiguration CREATE_COMPLETE 03/04/16 18:40:17
CloudCanvas:DeploymentConfiguration:foo-hw:Development
ProjectPlayerAccessTokenExchangeHandler AWS::Lambda::Function
CREATE_COMPLETE 03/04/16 18:40:39 foo-hw-
ProjectPlayerAccessTokenExchangeHandler-1BG6JJ84IZAUV
ProjectPlayerAccessTokenExchangeHandlerRole AWS::IAM::Role
CREATE_COMPLETE 03/04/16 18:40:33 foo-hw-
ProjectPlayerAccessTokenExchangeHandlerRo-T0E7MYI0B67N
ProjectResourceHandler AWS::Lambda::Function
CREATE_COMPLETE 03/04/16 18:40:08 foo-hw-ProjectResourceHandler-
XAP5CBAMQCYP
ProjectResourceHandlerExecution AWS::IAM::Role
CREATE_COMPLETE 03/04/16 18:40:02 foo-hw-ProjectResourceHandlerExecution-
K24FL427PVZM
```

protect-deployment

Marks a deployment as protected and issues a warning when a user (for example, a developer or tester) attempts to connected a development game client to live resources. For more information, see [Using Protected Deployments](#) (p. 231).

In addition to the [Common Arguments](#) (p. 210), the `protect-deployment` subcommand accepts the following arguments:

- `--set {deployment-name}`

Optional. Specifies that the deployment is protected.

- `--clear {deployment-name}`

Optional. Specifies that the deployment is not protected.

- `--show`

Optional. Displays a list of the deployments that are currently protected.

Note

To display the protected status of deployments, you can also use either the [list-deployments](#) (p. 217) or [list-mappings](#) (p. 217) command.

remove-login-provider

Remove a player login provider from the Amazon Cognito identity pool configuration.

In addition to the [Common Arguments](#) (p. 210), the `remove-login-provider` subcommand accepts the following argument:

- `--provider {provider-name}`

Required. The name of the provider.

The `remove-login-provider` command saves the configuration in a `/player-access/auth-settings.json` object in the project's configuration bucket so that the `ProjectPlayerAccessTokenExchangeHandler` Lambda function can access it.

Note

You must run `lmbr_aws update-project-stack` after running this command so that the [PlayerAccessIdentityPool Resource](#) (p. 285) configuration is updated to reflect the change.

remove-profile

Remove an AWS profile from the AWS command line tool configuration.

In addition to the [Common Arguments \(p. 210\)](#), the `remove-profile` subcommand accepts the following argument:

- `--profile {profile-name}`

Required. The name of the AWS profile to remove.

remove-resource-group

Remove a resource group's `ResourceGroupConfiguration` and AWS CloudFormation stack resources from your `deployment-template.json` file. You must update your deployment stacks before the resources defined by your resource group can be removed from AWS.

The command does not delete the `{game}/resource-group/{resource-group-name}` directory.

In addition to the [Common Arguments \(p. 210\)](#), the `remove-resource-group` subcommand accepts the following argument:

- `--resource-group {resource-group-name}`

Required. The name of the resource group to be removed.

AWS CloudFormation cannot delete stacks that define Amazon S3 buckets that contain data. To allow project stacks to be deleted, the `project-template.json` file specifies a `DeletionPolicy` of `Retain` for the configuration bucket. This causes AWS CloudFormation to not delete the bucket when the project stack is deleted. After the project stack has been deleted, the command removes all the objects from the configuration bucket and then deletes the bucket.

rename-profile

Rename an AWS profile in the AWS command line tool configuration.

In addition to the [Common Arguments \(p. 210\)](#), the `rename-profile` subcommand accepts the following arguments:

- `--old {old-profile-name}`

Required. The name of the AWS profile to change.

- `--new {new-profile-name}`

Required. The new name of the AWS profile.

update-login-provider

Update a player login provider in the Amazon Cognito identity pool configuration. Login providers allow your game's players to log in using their social network identity, such as Facebook, or using their Amazon user identity. For more information, see [Access Control and Player Identity \(p. 297\)](#).

In addition to the [Common Arguments \(p. 210\)](#), the `update-login-provider` subcommand accepts the following arguments:

- `--provider {provider-name}`

Required. The name of the updated provider. The name must be `amazon`, `google` or `facebook`, or, if you are using a generic OpenID provider, the name that you chose when the provider was added.

- `--app-id {application-id}`
Optional. The application ID from your login provider (this is usually different from your client ID).
- `--client-id {client-id}`
Optional. The unique application client ID for the login provider.
- `--client-secret {client-secret}`
Optional. The secret key to use with your login provider.
- `--redirect-uri {redirect-uri}`
Optional. The redirect URI to use with your login provider.
- `--provider-uri {provider-uri}`
Optional. The URI for a generic open id connect provider. This argument is used only for generic OpenID providers.
- `--provider-port {provider-port}`
Optional. The port the provider listens on for the provider's API. This argument is used only for generic OpenID providers.
- `--provider-path {provider-path}`
Optional. The path portion of the provider's URI. This argument is used only for generic OpenID providers.

The `update-login-provider` command saves its configuration in a `/player-access/auth-settings.json` object in the project's configuration bucket so that the `ProjectPlayerAccessTokenExchangeHandler` Lambda function can access it.

Note

You must run `lmbr_aws update-project-stack` after running this command so that the [PlayerAccessIdentityPool Resource \(p. 285\)](#) configuration is updated to reflect the change.

update-mappings

Update the friendly name to physical resource ID mappings to reflect the current default deployment or the release deployment.

In addition to the [Common Arguments \(p. 210\)](#), the `update-mappings` subcommand accepts the following arguments:

- `--release`
Optional. Causes the release mappings to be updated. By default, only the mappings used when launching the game from inside the editor are updated.

The command looks in the [resource-template.json \(p. 285\)](#) file for `Metadata.CloudCanvas.PlayerAccess` properties on resource definitions. It then queries AWS CloudFormation for the physical names of those resources in the current default deployment. If the `--release` option is specified, the release deployment is queried.
- `--deployment {deployment-name}`
Optional. Exports a mapping file for the specified deployment to the `{project_directory}\Config` directory in the format `{deployment-name}.awsLogicalMappings.json`.

When you run a game launcher such as the one at `dev\Bin64\SamplesProjectLauncher.exe`, you can choose the mapping to use by using the `-cc_override_resource_map` option. For more information, see [Selecting a Deployment with a PC Launcher \(p. 231\)](#).

update-profile

Update an AWS profile.

In addition to the [Common Arguments \(p. 210\)](#), the `update-profile` subcommand accepts the following arguments:

- `--aws-access-key` *{accesskey}*

Optional. The AWS access key associated with the updated profile. The default is to not change the AWS access key associated with the profile.

- `--aws-secret-key` *{secretkey}*

Optional. The AWS secret key associated with the updated profile. The default is to not change the AWS secret key associated with the profile.

- `--profile` *{profilename}*

Required. The name of the AWS profile to update.

Note

To make an existing profile the default profile, use the [default-profile \(p. 215\)](#) command.

update-project-stack

Update the project's AWS CloudFormation stack.

In addition to the [Common Arguments \(p. 210\)](#), the `update-project-stack` subcommand accepts the following arguments:

- `--confirm-aws-usage`

Optional. Confirms that you know this command will create AWS resources for which you may be charged and that it may perform actions that can affect permission in your AWS account. Also disables the prompt for confirmation done during the command's execution.

- `--enable-capability` *{capability}* [*{capability}* ...]

Optional. A list of capabilities that you must specify before AWS CloudFormation can create or update certain stacks. Some stack templates might include resources that can affect permissions in your AWS account. For those stacks, you must explicitly acknowledge their capabilities by specifying this parameter. Possible values include `CAPABILITY_IAM`.

How `update-project-stack` works

1. The [project-template.json \(p. 271\)](#) file and the zipped up contents of the [project-code subdirectory \(p. 285\)](#) are uploaded to the [Configuration Bucket \(p. 290\)](#).
2. An AWS CloudFormation stack update operation is performed by using the uploaded `project-template.json` file. The `project-code.zip` file is used when creating the Lambda function resources defined by the templates.

Note

The `update-project-stack` command fails if the `{root}\{game}\AWS\project-settings.json` file does not exist or does not have a valid `ProjectStackId` property.

upload-resources

Update a resource group's AWS CloudFormation stack in a specified deployment.

In addition to the [Common Arguments \(p. 210\)](#), the `upload-resources` subcommand accepts the following arguments:

- `--deployment`

Required. The name of the deployment to update.

- `--resource-group`

Required. The name of the resource group to update.

- `--confirm-aws-usage`

Optional. Confirms that you know this command will create AWS resources for which you may be charged and that it may perform actions that can affect permissions in your AWS account. It also disables the default confirmation prompt that occurs during the command's execution.

- `--enable-capability {capability} [{capability} ...]`

Optional. A list of capabilities that you must specify before AWS CloudFormation can create or update certain stacks. Some stack templates might include resources that can affect permissions in your AWS account. For those stacks, you must explicitly acknowledge their capabilities by specifying this parameter. Possible values include `CAPABILITY_IAM`.

The [resource-template.json \(p. 285\)](#) file and the zipped up contents of the [lambda-function-code subdirectory \(p. 289\)](#) are uploaded to the [Configuration Bucket \(p. 290\)](#). An AWS CloudFormation stack update operation is then performed by using the uploaded template file. The `lambda-function-code.zip` file is used when updating the Lambda function resources defined by the resource template.

Viewing the Cloud Canvas Progress Log

The **Cloud Canvas Resource Manager Progress log** shows the progress of AWS CloudFormation stack updates. During the update, the progress log expands from the bottom of the detail pane to display the progress of the update. You can adjust the amount of space the log uses by dragging the divider line between the panes.

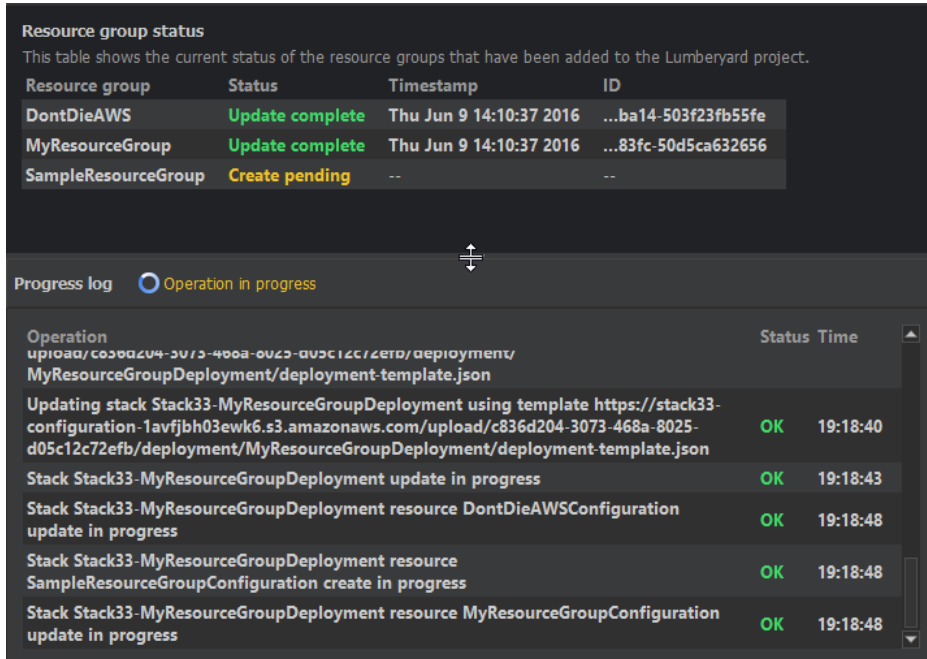

To hide the progress log, drag the divider downward.

Working with Deployments

A deployment is an independent copy of the AWS resources that your game uses. Deployments are useful for maintaining a safe separation among game lifecycle phases such as development, test, and production. In the resource manager navigation pane, the **Deployments** node shows you the status of your project's deployments. You can also use it to create a new deployment.

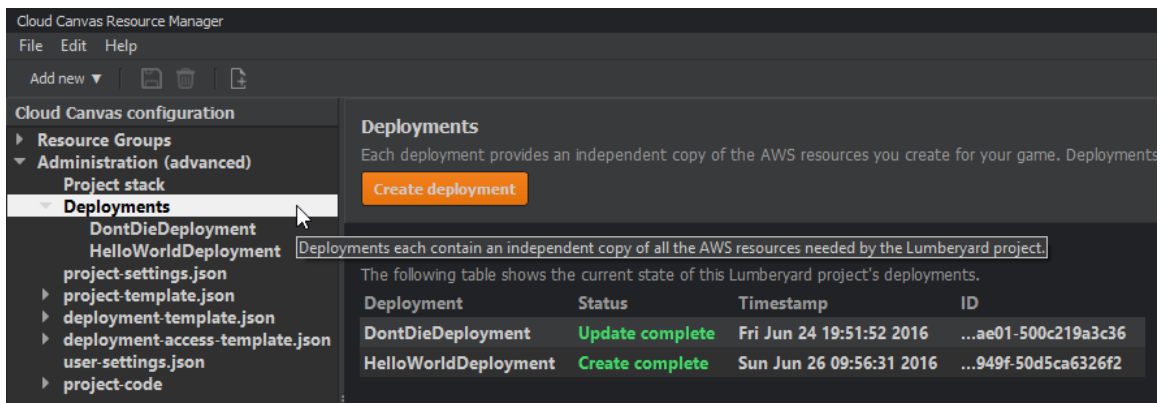

Note: If the **Deployments** node is selected when no AWS profile is configured, Lumberyard prompts you to provide a profile. The status of the project's deployments cannot be displayed unless a profile is provided. For more information, see [Managing Cloud Canvas Profiles \(p. 208\)](#).

Create Deployment

Click **Create deployment** to start the creation of a deployment:

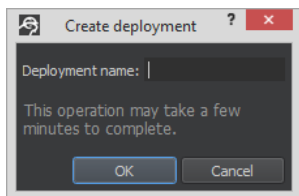

When uploading resources for the first time, you may see this version of the dialog:

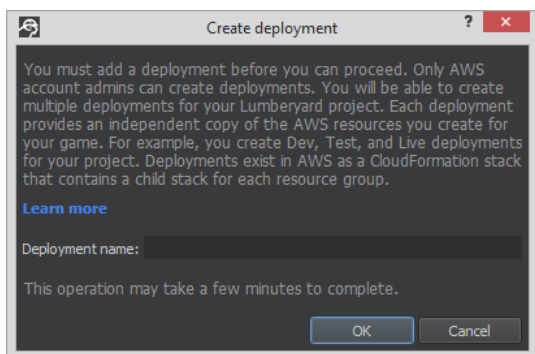

Provide a name for **Deployment name**. Lumberyard appends this name to the project stack name to create an AWS CloudFormation stack for the deployment.

To start the deployment creation process, click **OK**. In the resource manager navigation pane, a node for the deployment appears under **Deployments**. In the detail pane, the [Viewing the Cloud Canvas Progress Log \(p. 224\)](#) provides details about the creation process.

Deployment Status Table

The **Deployment status** table shows the status of the AWS CloudFormation stack for each deployment. **Deployment** shows the deployment name. For descriptions of the remaining fields in this table, see [Stack Resources Table \(p. 235\)](#) in the [Working with Project Stacks \(p. 234\)](#) section.

Individual Deployment Nodes

The child nodes of the **Deployment** node each represent one of the Lumberyard project's deployments. When a **Deployment** node is selected, the detail pane shows the current status of the selected deployment.

A deployment provides an independent copy of each of the AWS resources needed by a game.

Dev deployment

Status	Created	Updated	ID
Create complete	6/10/2016 9:12 PM	--	...890c-500c21311262

[Upload all resources](#) [Delete deployment](#)

Stack resources

The following table shows the status of the stack's resources in AWS.

Resource Name	Type	Status	Timestamp
DontDieAWS	AWS::CloudFormation::Stack	Create complete	Fri Jun 10 21
DontDieAWS.DontDieMain	AWS::Lambda::Function	Create complete	Fri Jun 10 21
DontDieAWS.DontDieMainConfiguration	Custom::LambdaConfiguration	Create complete	Fri Jun 10 21
DontDieAWS.MainBucket	AWS::S3::Bucket	Create complete	Fri Jun 10 21

Progress log Operation succeeded

Operation	Status	Time
Stack Stack33-Dev-Access resource PlayerLoginIdentityPool create in progress	OK	21:17:16
Stack Stack33-Dev-Access resource Owner create complete	OK	21:17:21
Stack Stack33-Dev-Access resource PlayerAccessIdentityPool create in progress: Resource creation Initiated	OK	21:17:21
Stack Stack33-Dev-Access resource PlayerLoginIdentityPool create in progress: Resource creation Initiated	OK	21:17:21
Stack Stack33-Dev-Access resource PlayerAccessIdentityPool create complete	OK	21:17:21
Stack Stack33-Dev-Access resource PlayerLoginIdentityPool create complete	OK	21:17:21
Stack Stack33-Dev-Access resource PlayerAccess create in progress: Resource creation Initiated	OK	21:17:27
Stack Stack33-Dev-Access resource PlayerAccess create complete	OK	21:17:27

Note

If a **Deployment** node is selected when no AWS profile is configured, Lumberyard prompts you to provide a profile. The status of the project's deployments cannot be displayed unless a profile is provided. For more information, see [Managing Cloud Canvas Profiles \(p. 208\)](#).

Individual Deployment Status Table

The **<Deployment Name> deployment status** table shows the status of the AWS CloudFormation stack for the selected deployment. For descriptions of the contents of this table, see [Project Stack Status Table \(p. 234\)](#) in the [Working with Project Stacks \(p. 234\)](#) section.

Upload All Resources

Click **Upload all resources** to start the process of modifying, creating, or deleting resources in the current AWS deployment so that they match your local definitions for all resource groups.

Delete Deployment

Click **Delete deployment** to start the process of deleting the deployment's resources from AWS. The resources defined by all resource groups will be deleted.

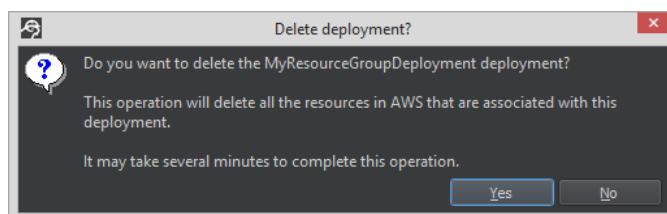

For more information about deleting deployments, see [Deleting Cloud Canvas Deployments and Their Resources](#) (p. 232).

Stack Resources Table

The **Stack resources** table shows the status of each of the resources defined by all the resource groups for the selected deployment. For descriptions of the fields in this table, see [Stack Resources Table](#) (p. 235) in the [Working with Project Stacks](#) (p. 234) section.

Topics

- [Making a Cloud Canvas Deployment Active](#) (p. 228)
- [Testing Different Mappings](#) (p. 230)
- [Using Protected Deployments](#) (p. 231)
- [Deleting Cloud Canvas Deployments and Their Resources](#) (p. 232)

Making a Cloud Canvas Deployment Active

You can select the deployment that you want Lumberyard Editor to consider active. The active deployment is the deployment that you work with in Lumberyard Editor. Lumberyard Editor uses the active deployment's resources when you launch your game. When you select the [Working with Resource Groups](#) (p. 235) node or an [Individual Resource Group](#) (p. 237) node in the **Cloud Canvas Resource Manager** navigation pane, the status information that appears corresponds to the active deployment.

You can also select the deployment that you want to be active by default for all team members.

Note

To select a deployment, you must have initialized **Cloud Canvas Resource Manager** to work with your AWS account and created a deployment. For more information, see [Initializing Cloud Canvas Resource Manager](#) (p. 207) and [Create Deployment](#) (p. 225).

Making a Deployment Active

You have several ways to make a deployment active in **Cloud Canvas Resource Manager**.

To make a deployment active

- To make a deployment active, do one of the following:
 - In Lumberyard Editor, click **AWS, Cloud Canvas, Select a deployment**.

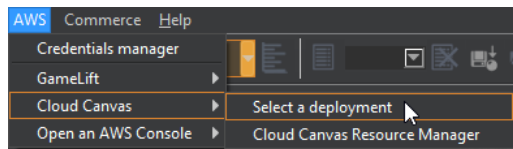

- In the **Cloud Canvas Resource Manager** toolbar, click the name of the current deployment, or click **(none)** if none is configured:

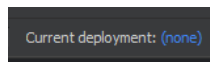

When prompted, choose the deployment that you want to make active:

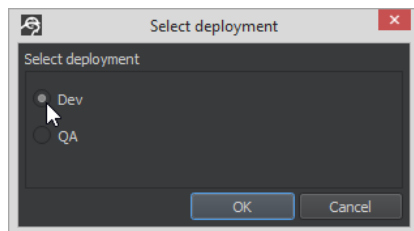

One or more of the deployments may be marked **protected**. For more information, see [Using Protected Deployments](#) (p. 231).

- In the **Cloud Canvas Resource Manager** navigation pane, right-click the deployment that you want to make active, and then click **Make active deployment**:

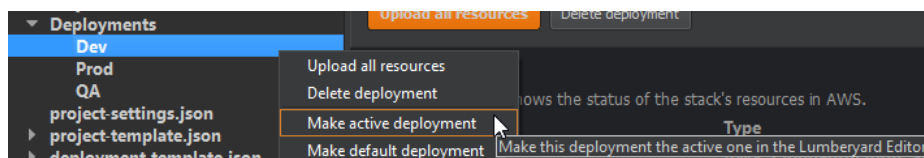

Making a Deployment the Default

You can use the **Cloud Canvas Resource Manager** to make a deployment the default.

To make a deployment active by default for all team members

1. In Lumberyard Editor, click **AWS**, **Cloud Canvas**, **Cloud Canvas Resource Manager**.

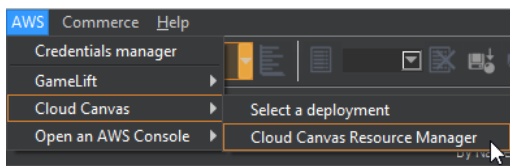

2. In the **Cloud Canvas configuration** navigation tree, expand **Administration (advanced)**, and then expand **Deployments**.
3. Right-click the deployment that you want to make the default, and then click **Make default deployment**:

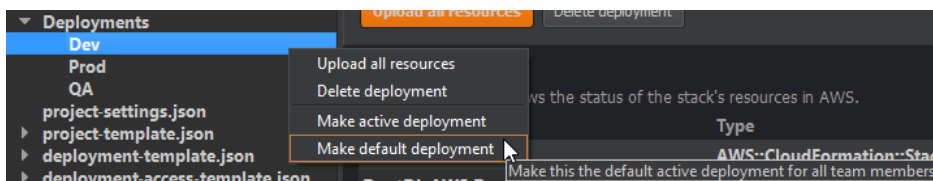

To use the command line to make a deployment the default

- To use the command line to make a deployment the default, type the following command:

```
lmbr_aws default-deployment --set <deployment name>
```

Testing Different Mappings

To test your client with different Cloud Canvas resource deployments, you can export mappings by using Cloud Canvas Resource Manager or the `lmbcr_aws` command line.

To export a mapping from Cloud Canvas Resource Manager

- In Resource Manager, do one of the following:
 - Left click a deployment and click **Export Mapping** in the main window.
 - Right click the name of a deployment name the list, and then select **Export Mapping** from the context menu.

The following image shows both options.

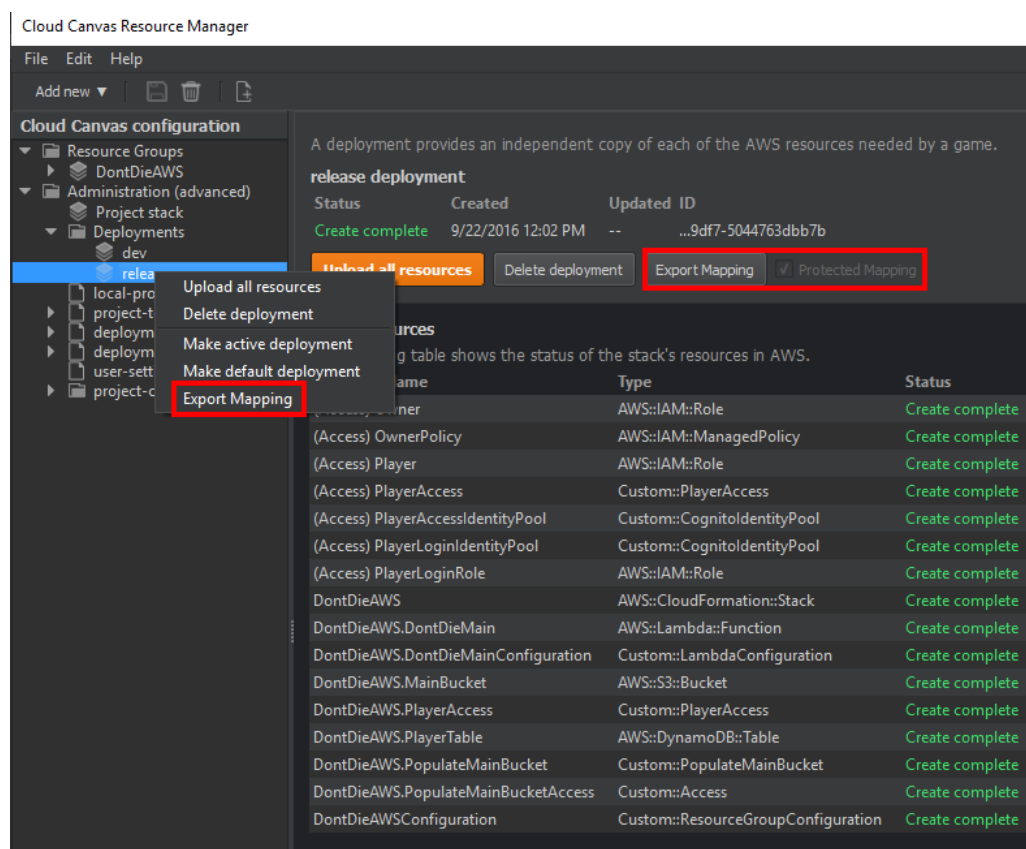

To exporting a mapping from the command line

- Type the following command, where `<name>` is the name of your deployment.

```
lmbcr_aws update-mappings --deployment <name>
```

The mapping file for the specified deployment is created in the `<project_directory>\Config` directory and has the format `<deployment_name>.awsLogicalMappings.json`.

Tip

Using the command line to export mappings makes it easy for you to create scripts for testing or development.

Selecting a Deployment with a PC Launcher

After you have exported one or more mappings, you can choose the mapping to use when you run a game launcher such as the one at `dev\Bin64\SamplesProjectLauncher.exe`.

To direct the launcher to use a specific deployment, use the command line option `cc_override_resource_map`, as in the following example.

```
SamplesProjectLauncher.exe -cc_override_resource_map Config  
\dev.awsLogicalMappings.json
```

The argument for the `cc_override_resource_map` parameter specifies the mapping file that you want to use.

If you have exported a single mapping file to the launcher, the launcher uses that mapping file by default. If you have exported multiple mapping files to the launcher, you must select a mapping by using the `cc_override_resource_map` parameter. If you don't specify a mapping after multiple mappings have been exported, the launcher gives an error message, and no mapping is loaded.

Using Protected Deployments

You can use Cloud Canvas to mark specific deployments as protected. Protected status makes it more difficult for users (typically, testers or developers) to inadvertently connect a development game client to live resources.

When a user starts a protected game, a message box notifies the user that he or she is attempting to use a protected deployment. The user is given the option to not connect before any potentially harmful data is transmitted.

The protection feature purposely uses a message box that "breaks" automation. If the scripts that run tests are configured to use a protected deployment, the Lumberyard client will not continue without human intervention.

When Protected Deployments Are Detected

When a game is run from Lumberyard Editor, protection is always detected. When a game is run from a Windows launcher, protection is detected only when the launcher is running in debug mode.

Marking a Deployment as Protected

Currently, you must set the protection from the `lmbrr_aws` command line tool by using the `protect-deployment` command.

The `protect-deployment` command uses the following parameters.

- `--set <deployment_name>` – Specifies that the deployment is protected.
- `--clear <deployment_name>` – Specifies the deployment is not protected.
- `--show` – Displays a list of currently protected deployments.

To display the protected status of deployments, you can also use either the `list-deployments` or `list-mappings` command.

Viewing Protected Status in Cloud Canvas Resource Manager

In Cloud Canvas Resource Manager, you can view, but not change, the status of protected deployments. The ability to change the protected status of deployments from Lumberyard Editor is planned for a future release.

Note

Setting a deployment to protected does not prevent you from deploying or deleting resources by using Cloud Canvas Resource Manager or the `lmbr_aws` command line tool; it only enables the warning functionality. For this reason, be careful not to make unnecessary changes to critical deployments. A more comprehensive model for protecting deployments is planned for a future version of Lumberyard.

Deleting Cloud Canvas Deployments and Their Resources

To remove Cloud Canvas functionality from your Lumberyard project and the AWS resources related to it, you can use **Cloud Canvas Resource Manager** or the Cloud Canvas command line.

Warning

Only administrators should perform these actions. If you remove all AWS resources managed by Cloud Canvas for your Lumberyard project, the players of your game will not be able to access any of the Cloud Canvas resource groups that implement your game's cloud connected features.

To use Cloud Canvas Resource Manager to delete Cloud Canvas deployments and their resources

1. If you have checked Lumberyard into source control, ensure that the `<root>\<game>\AWS\project-settings.json` file has been checked out and is writeable.
2. In Lumberyard Editor, choose **AWS, Cloud Canvas, Cloud Canvas Resource Manager**.
3. In the **Cloud Canvas configuration** navigation pane, expand **Administration (advanced)**, and then expand **Deployments**. The list of the deployments in the project appears.
4. Select the deployment to delete and click **Delete deployment**.

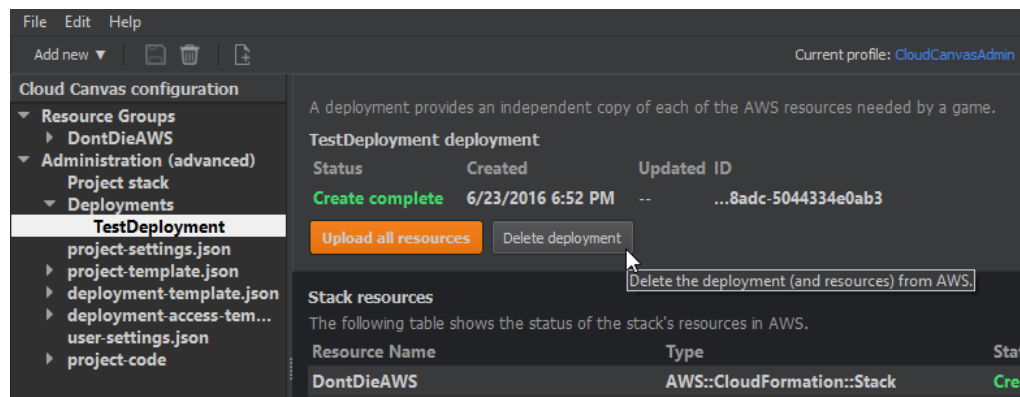

5. When prompted to confirm, click **Yes** to start the process of deleting the deployment's resources from AWS. The process might take a few minutes.
6. To remove all of the project's resources from AWS, follow the same steps to delete each of the project's deployments.

To use the command line to delete Cloud Canvas deployments and their resources

1. If you have checked Lumberyard into source control, ensure that the `<root>\<game>\AWS\project-settings.json` file has been checked out and is writeable.

2. Open a command line prompt and change to your the Lumberyard `\dev` directory.
3. Determine the project's deployment names by typing the following command:

```
lmbr_aws list-deployments
```

4. Type the following command for each of the deployments that you want to delete:

```
lmbr_aws delete-deployment --deployment <deployment name>
```

Note

To remove all Cloud Canvas functionality from your project, use the `delete-deployment` command to delete all of deployments that were listed by `list-deployments`. Then remove the project stack as described in the step that follows.

5. After you have deleted all deployments, you can delete the resources that Cloud Canvas uses to manage your project by typing the following command:

```
lmbr_aws delete-project-stack
```

This removes all AWS resources that are related to your Cloud Canvas project.

Working with JSON Files

Some of the nodes in the **Cloud Canvas Resource Manager** navigation pane represent JSON template or settings files for your project. The content of these files is described in detail in [Resource Definitions](#). When you select one of these nodes in the navigation pane, the detail pane shows the contents of that file. You can edit the file directly in the resource manager or use an external editor. For more information, see [Editing Cloud Canvas Files \(p. 206\)](#).

In the navigation pane, some template file nodes have child nodes. Each of the child nodes represents one section of its parent node template file. These child nodes make it easier to find and edit the corresponding sections of the parent node template file. Any changes that you make in a child node are always saved in the corresponding section of the parent template file.

The following template is found in each resource group under the **Resource Groups** node:

resource-template.json

Each resource group has a **resource-template.json** node and a **lambda-function-code** child node. The `resource-template.json` file defines the group's resources. For more information, see [Resource Definitions](#). In the navigation pane, each of the nodes under **resource-template.json** represents one of the resources defined in a section of the `resource-template.json` file.

The following templates are found under the **Administration (advanced)** node:

project-settings.json

The `project-settings.json` file contains project configuration data. For more information, see [Resource Definitions](#).

project-template.json

The `project-template.json` file defines the resources used by **Cloud Canvas Resource Manager**. For more information, see [Resource Definitions](#).

deployment-template.json

The `deployment-template.json` file defines the AWS CloudFormation stack resources for each of the projects resource groups. For more information, see [Resource Definitions](#).

deployment-access-template.json

The `deployment-access-template.json` file defines the AWS CloudFormation stack resources that control access to each deployment's resources. For more information, see [Resource Definitions](#) and [Access Control and Player Identity](#).

user-settings.json

The `user-settings.json` file contains user specific settings. For more information, see [Resource Definitions](#).

Working with Project Stacks

When you select the **Project stack** node in the **Cloud Canvas Resource Manager** navigation pane, the detail pane shows information about the AWS CloudFormation stack that Cloud Canvas is using.

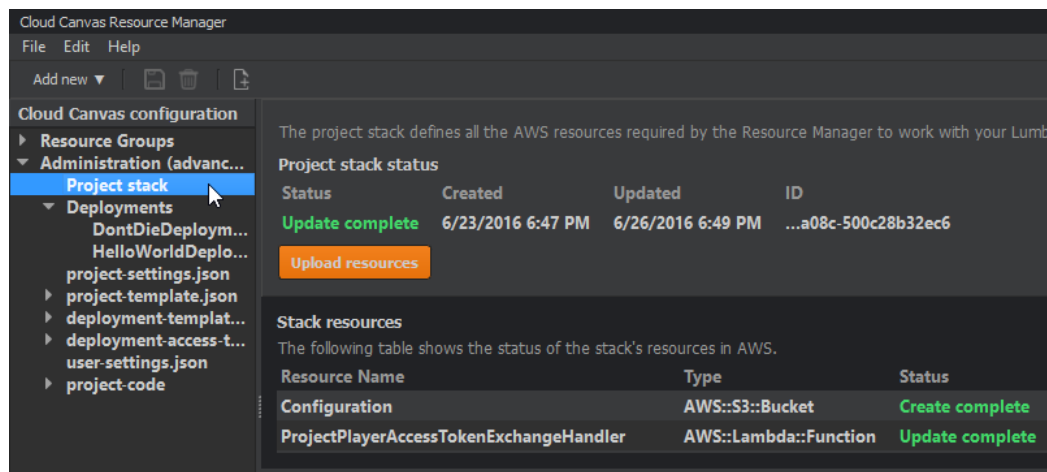

Note the following:

- If you select a project stack node and no AWS profile is configured, Lumberyard prompts you to provide one. A profile is required for Lumberyard to display the status of your project's resources. For more information, see [Managing Cloud Canvas Profiles \(p. 208\)](#).
- If you select the **Project stack** node when the project has not been initialized for use with Cloud Canvas, Lumberyard prompts you to initialize the project and create a project stack. For more information, see [Initializing Cloud Canvas Resource Manager \(p. 207\)](#).

Project Stack Status Table

The **Project stack status** table shows the status of the AWS CloudFormation stack that contains the resources used by your project's resource groups.

The screenshot shows a close-up of the 'Project stack status' table in the Cloud Canvas Resource Manager interface.

Status	Created	Updated	ID
Update complete	6/6/2016 4:33 PM	6/6/2016 4:34 PM	...a09f-50fa5f2588d2

This table has the following columns:

Status – The status of the AWS CloudFormation stack. See [Understanding Resource Status Descriptions \(p. 209\)](#) for a description of the values this column may have. To see additional status information, pause your mouse on the status indicator.

Created – The time the stack was created.

Updated – The time the stack status was updated.

ID - A truncated version of the AWS ID for the stack. To see the full ID, pause your mouse on the truncated ID.

Upload Resources

Click **Upload resources** to start the process of modifying, creating, or deleting resources in AWS so that they match your local definitions of them.

Stack Resources Table

The **Stack resources** table shows the status of the resources that your project is using.

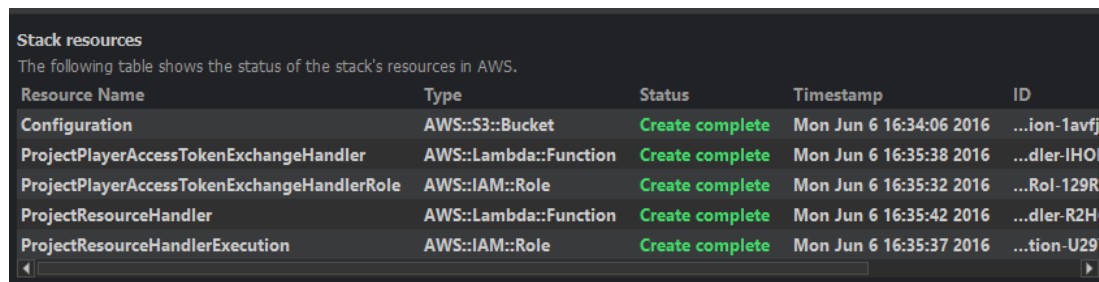

Resource Name	Type	Status	Timestamp	ID
Configuration	AWS::S3::Bucket	Create complete	Mon Jun 6 16:34:06 2016	...ion-1avfj
ProjectPlayerAccessTokenExchangeHandler	AWS::Lambda::Function	Create complete	Mon Jun 6 16:35:38 2016	...dler-IHOI
ProjectPlayerAccessTokenExchangeHandlerRole	AWS::IAM::Role	Create complete	Mon Jun 6 16:35:32 2016	...RoI-129R
ProjectResourceHandler	AWS::Lambda::Function	Create complete	Mon Jun 6 16:35:42 2016	...dler-R2H
ProjectResourceHandlerExecution	AWS::IAM::Role	Create complete	Mon Jun 6 16:35:37 2016	...tion-U29

This table has the following columns:

Resource Name – The logical name of the resource. You can reference the resource in [Flow Graph nodes](#) by adding this resource name to the resource group name.

Type – The type of the resource (for example, a Lambda function, Amazon S3 bucket, or a custom resource).

Status – The current condition of the resource. For a description of the possible status values, see [Understanding Resource Status Descriptions \(p. 209\)](#). To see additional status information, pause your mouse on the status.

Timestamp – The time of the most recent change.

ID - A truncated version of the AWS ID for the stack. To see the full ID, pause your mouse on the truncated ID.

Working with Resource Groups

When you select **Resource Groups** in the **Cloud Canvas Resource Manager Cloud Canvas configuration** navigation pane, the detail pane shows the status of the resource groups that belong to the current deployment of your project. Note the following:

- If you select **Resource Groups** and no AWS profile is configured, Lumberyard prompts you to provide one. A profile is required for Lumberyard to display the status of your project's resources. For more information, see [Managing Cloud Canvas Profiles \(p. 208\)](#).

- If you select **Resource Groups** and deployments exist but no deployment is active, Lumberyard prompts you to select one. For more information, see [Making a Cloud Canvas Deployment Active](#) (p. 228).

Resource Groups

The **Resource Groups** detail pane lists the resource groups in your current deployment:

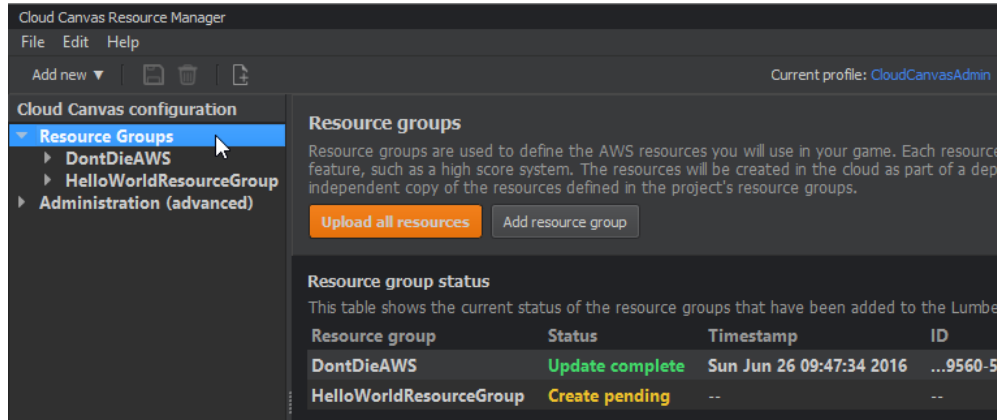

The **Resource Groups** detail pane has the following options:

Upload all resources

The **Upload all resources** option starts the process of modifying your resources in AWS as needed to match all of the definitions in all of your local resource groups. As the update proceeds, resource groups with the status of **Create pending** will change to **Create complete**. The update might take a few minutes.

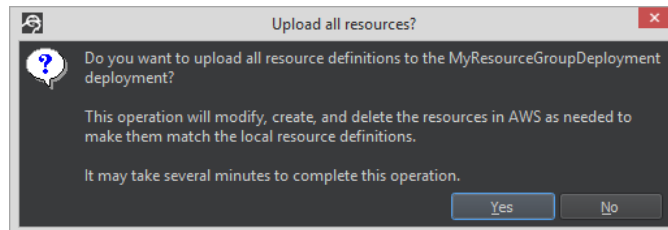

Note the following:

- If you have not yet initialized your Lumberyard project with an AWS account for the resources that you want to upload, Lumberyard prompts you to do so. To prepare your Lumberyard project for use with AWS, you must be the administrator of the AWS account that you use. For more information, see [Initializing Cloud Canvas Resource Manager](#) (p. 207).
- After you have initialized the project, Lumberyard prompts you to create a deployment for it. A deployment creates all the AWS resources specified by your resource group definition. For more information, see [Create Deployment](#) (p. 225).

For information about the **Progress log**, see [Viewing the Cloud Canvas Progress Log](#) (p. 224).

Add resource group

Use the **Add resource group** option to add a new resource group definition to your Lumberyard project. A resource group definition represents a single game feature like a high score system. The definition specifies the AWS resources that the feature will use.

Clicking **Add resource group** opens the **New resource group** dialog:

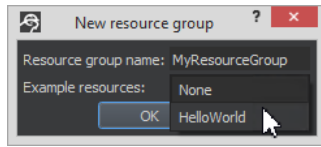

Provide the following information:

- **Resource group name** – The name of the resource group. The name must be alphanumeric. Lumberyard uses this name to create an AWS CloudFormation stack resource definition in the [deployment-template.json](#) file.
- **Example resources** – (Optional) Choose to include example resources in the resource group. You can study the examples to see how resources are defined in a resource group, or modify the examples to turn them into a feature for your project.

Resource group status

The **Resource group status** table shows the status of the AWS CloudFormation stack of each resource group in the active deployment. **Resource group** shows the resource group name. For descriptions of the remaining fields in this table, see [Stack Resources Table \(p. 235\)](#) in the [Working with Project Stacks \(p. 234\)](#) section.

Individual Resource Group

Each child node of **Resource Groups** represents a resource group in your Lumberyard project. When you select one of these resource groups, the detail pane shows the status of the resource group.

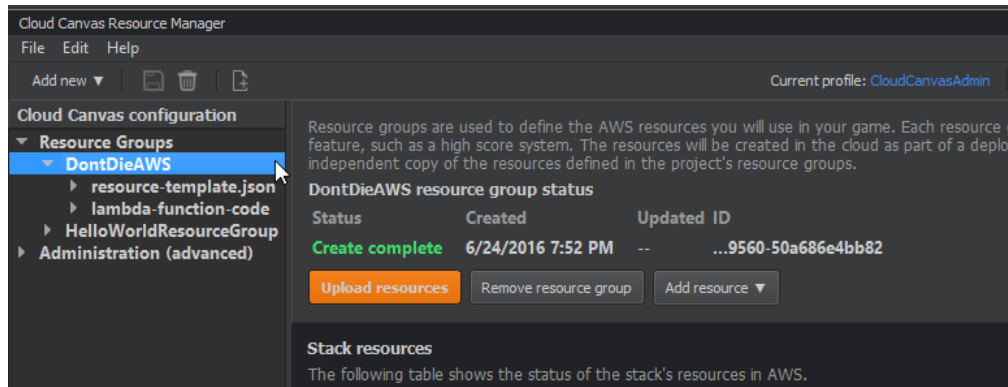

Note the following:

- If you select a resource group and no AWS profile is configured, Lumberyard prompts you to provide one. A profile is required for Lumberyard to display the status of your project's resources. For more information, see [Managing Cloud Canvas Profiles \(p. 208\)](#).
- If you select a resource group and deployments exist but no deployment is active, Lumberyard prompts you to select one. For more information, see [Making a Cloud Canvas Deployment Active \(p. 228\)](#).

Adding Resources in a New Resource Group

When you create a resource group, the group does not yet have any AWS resource definitions. Use the **Add resource** option to add one:

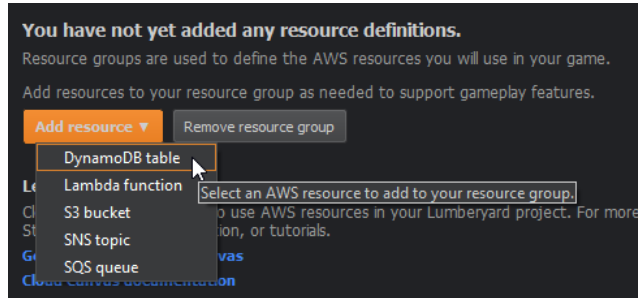

The definitions are created locally and only describe the AWS resources that you want to use. The resources themselves are not created in AWS until you click **Create resources**:

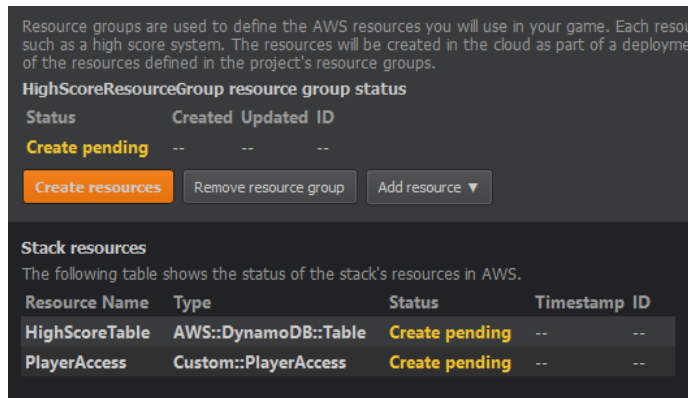

Individual Resource Group Status

You can use a resource group's status pane to manage the resource group. The following image shows the status details for the **DontDieAWS** resource group:

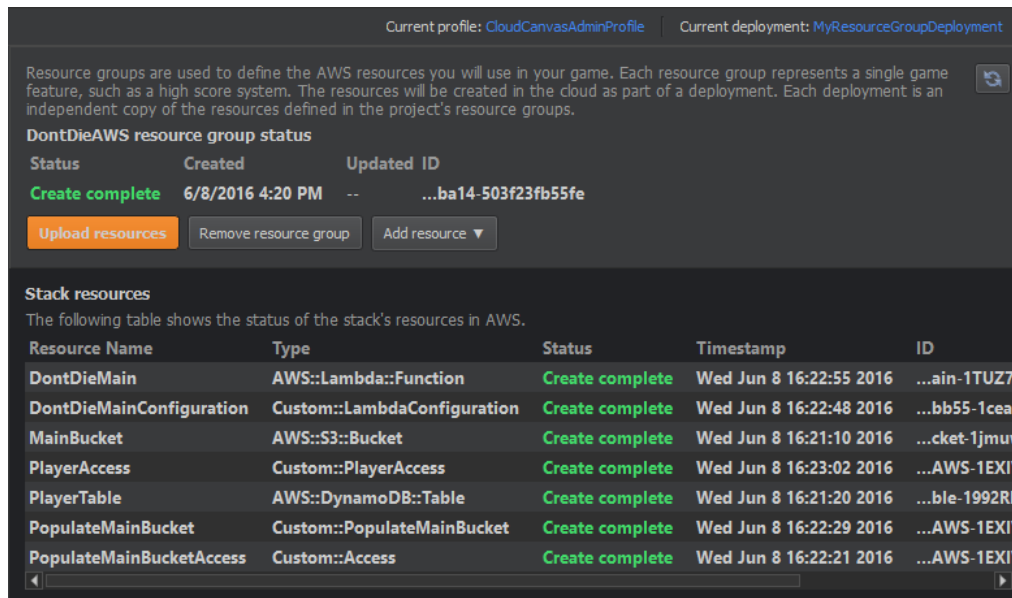

The status pane for a resource group has the following options:

Upload resources

After you have created one or more resource definitions, you click **Upload resources** to start the process of creating the resources in AWS specified by the local resource definitions that you created with the **Add resource** option.

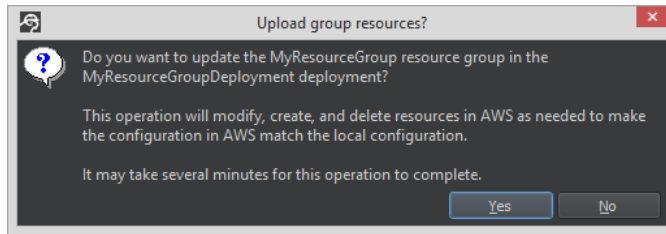

As the update proceeds, the resources with the status of **Create pending** will change to **Create complete**.

Note the following:

- If you have not yet initialized your Lumberyard project with an AWS account for the resources that you want to upload, Lumberyard prompts you to do so. To prepare your Lumberyard project for use with AWS, you must be the administrator of the AWS account that you use. For more information, see [Initializing Cloud Canvas Resource Manager](#) (p. 207).
- If you do not yet have a deployment for your project, Lumberyard prompts you to create one. A deployment creates all the AWS resources specified by your resource group definition. For more information, see [Create Deployment](#) (p. 225).

Remove resource group

Click **Remove resource group** to remove the selected resource group from your local configuration.

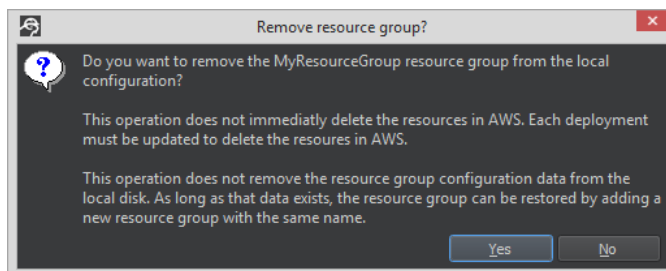

To delete the actual resources from AWS, use the **Delete resources** option as described in the section that follows.

Note

The remove resource operation does not remove the resource group's configuration data from the local disk. As long as that data exists on disk, you can restore the resource group by adding a new resource group with the same name.

Delete resources

The **Delete resources** option appears after you have removed a resource group from your local configuration (for example, by using the **Remove resource group** option) when the resources defined by the resource group still exist in AWS.

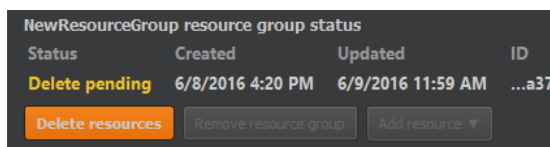

When you click **Delete resources**, Lumberyard prompts you to confirm the deletion of resources in AWS for the deployment that is currently active in Lumberyard Editor:

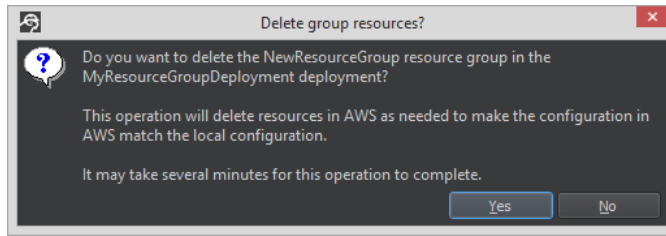

After you click **Yes**, the deletion operation may take several minutes to complete.

Stack resources

The **Stack resources** table shows the status of each of the AWS resources that you defined for the resource group. For descriptions of the fields in this table, see [Stack Resources Table](#) (p. 235) in the [Working with Project Stacks](#) (p. 234) section.

resource-template.json

For information about this node, see [Working with JSON Files](#) (p. 233).

lambda-function-code

The **lambda-function-code** node and its child nodes correspond to the `lambda-function-code` directory in your project. The `lambda-function-code` directory contains the code that implements the AWS Lambda function resources defined by your resource group. For more information, see [lambda-function-code Directory](#). Also see related information for the [project-code](#) (p. 240) node.

project-code

This node is located at the bottom of the **Administration (advanced)** section in the resource manager navigation tree. The `project-code` directory contains the code that implements the AWS Lambda function resources that **Cloud Canvas Resource Manager** uses. For more information, see [Resource Definitions](#). The **project-code** node contains file and directory child nodes. Click a file node to see or edit its contents in the detail pane. For more information, see [Editing Cloud Canvas Files](#) (p. 206).

Importing Resource Definitions into Cloud Canvas

You can use the Cloud Canvas resource importer to add definitions of existing AWS resources to a Cloud Canvas resource group. You can add resources by using the Cloud Canvas Resource Manager in Lumberyard Editor or at a command line prompt.

Importing Resources using Lumberyard Editor

In Lumberyard Editor, you can import a resource by specifying an [Amazon Resource Name \(ARN\)](#) or by choosing from a list.

To import a resource by using an ARN

1. From the Lumberyard Editor top menu, choose **AWS, Cloud Canvas, Resource Manager**.
2. In the navigation pane, select a resource group.
3. In the detail window, click **Import resource, Import using ARN**. You can also open the context (right-click) menu for the resource in the navigation pane and choose **Import resource, Import using ARN**.

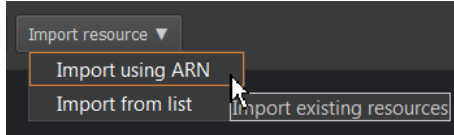

4. In the **Import using ARN** dialog box, provide the ARN and name of the resource that you are going to import. Both are required.

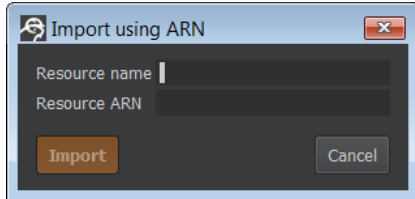

After you have provided both items of information, the **Import** button is enabled.

5. **Import.**

To import a resource by choosing from a list

1. From the Lumberyard Editor top menu, choose **AWS, Cloud Canvas, Resource Manager**.
2. In the navigation pane, select a resource group.
3. In the detail window, choose **Import resource, Import using ARN**. You can also open the context (right-click) menu for the resource in the navigation pane and choose **Import resource, Import using ARN**.

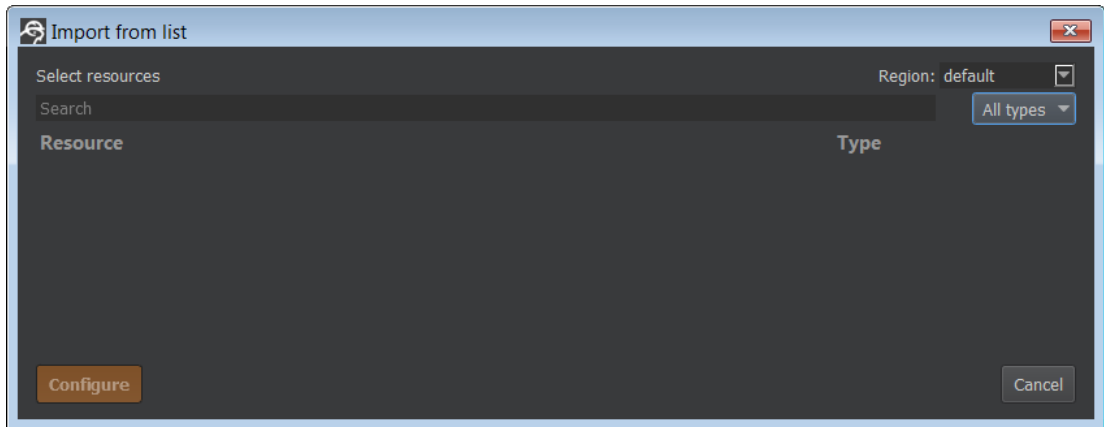

4. In the **Import from list** dialog box, choose the AWS Region of the resource for **Region**. The default value is the region of the project stack if it exists. Resources start loading in the list as soon as you choose a region that has importable resources.

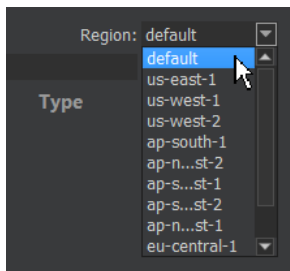

5. You can use the AWS service selector to filter the resources by service, and then use the **Search** box to filter resources by name.



6. Select the check box to the left of each resource that you want to import.

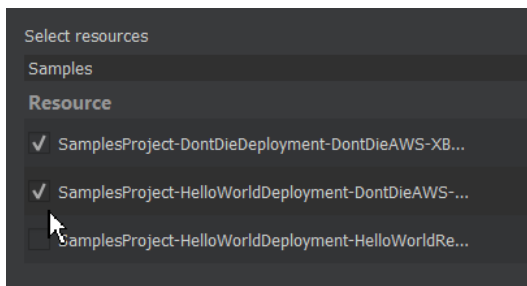

7. **Configure.**
8. In the **Configuration** dialog box, provide a reference name for each resource, or accept the default. The default name is the original name of the resource on AWS.
9. To delete a selected resource from the list, open the context (right-click) menu for the resource and choose **Delete**.

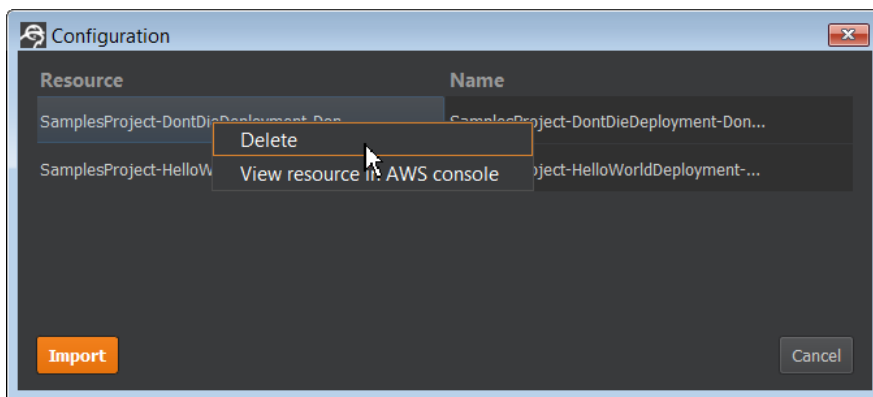

10. When you are ready, click **Import**. A progress bar displays. An **Import Error** message informs you of any errors that occur.

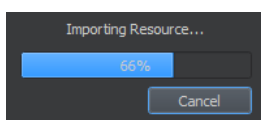

11. Click **X** to close the **Import from list dialog** box. The resources that you imported are listed in the details pane of Cloud Canvas Resource Manager.

Importing Resource Definitions Using the Command Line

To list and import resources using the Cloud Canvas command line, see [list-importable-resources](#) (p. 217) and [import-resource](#) (p. 216).

Understanding Resource Definitions

When you use the Cloud Canvas resource importer to import the definition of a resource, it is important to understand that you are importing the resource's definition, not the resource itself. For example, suppose you use the AWS console to create a high score table in DynamoDB called Table A. You create a game client that uploads scores, and send out the client to your players. Table A begins to populate with data from the users who play your game.

You then decide to use Cloud Canvas to manage your resources and deployments. Using the Cloud Canvas Resource Manager, you import Table A because it has the exact configuration values that you want, and it has worked well for your use cases.

When you create a deployment with the imported resource, the deployment contains Table B, which is a new table with Table A's structure but not its data. Table B is managed by Cloud Canvas and has the same behavior as Table A. However, Table B is not a reference to Table A, and it does not have Table A's data or history. Keep this distinction in mind when you import resource definitions.

Automatically Imported Resource Definitions

Some of the existing resources that you select might be related to other resources. For example, Lambda functions can respond to events from the selected triggers. You can use event notifications from an Amazon S3 bucket to send alerts or trigger workflows. Cloud Canvas imports the related resources for you automatically.

Cloud Canvas uses the following naming conventions for automatically imported resource definitions.

Source	Naming Convention	Example Name of Imported Resource
DynamoDB table, Lambda function, Amazon SNS topic, Amazon SQS queue	<code><resource_name></code> + "AutoAdded" + <code><resource_type></code> + <code><counter></code>	LambdaFunctionAutoAddedtable0
Lambda function configuration resource	<code><lambda_function_name></code> + "Configuration"	LambdaFunctionConfiguration
Lambda function policy resource	<code><lambda_function_name></code> + "Permission"	LambdaFunctionPermission
DynamoDB table Lambda function event source	<code><DynamoDB_table_name></code> + "EventSource"	DynamoTableEventSource

Resources Supported for Import

The following sections list the resource attributes and related resources that Cloud Canvas imports for each supported AWS service.

Dynamo DB Tables

For DynamoDB tables, Cloud Canvas imports the following resource attributes:

- AttributeDefinitions
- GlobalSecondaryIndexes
- KeySchema
- LocalSecondaryIndexes
- ProvisionedThroughput
- StreamSpecification

Amazon S3 Buckets

For Amazon S3 buckets, Cloud Canvas imports the following resource attributes:

- CorsConfiguration
- LifecycleConfiguration
- NotificationConfiguration
- Tags
- VersioningConfiguration
- WebsiteConfiguration

For Amazon S3 buckets, Cloud Canvas also imports the following related resources:

- Lambda functions
- Amazon SQS queues
- Amazon SNS topics

Lambda Functions

For Lambda functions, Cloud Canvas imports the following resource attributes:

- Code
- Description
- Handler
- MemorySize
- Role
- Runtime
- Timeout
- VpcConfig

For Lambda functions, Cloud Canvas also imports the following related resources:

- Lambda function configurations
- Lambda function permissions
- DynamoDB tables
- Event source mappings

Amazon SNS Topics

For Amazon SNS topics, Cloud Canvas imports the following resource attributes:

- DisplayName
- Subscription

For Amazon SNS topics, Cloud Canvas also imports any Lambda functions that are related resources.

SQS Queues

For SQS queues, Cloud Canvas imports the following resource attributes:

- DelaySeconds
- MaximumMessageSize
- MessageRetentionPeriod
- ReceiveMessageWaitTimeSeconds
- RedrivePolicy
- VisibilityTimeout

Cloud Canvas Flow Graph Node Reference

This section provides a reference of the flow graph nodes available for Cloud Canvas.

- [Cloud Canvas Configuration Nodes](#) (p. 245)
- [Cognito \(Player Identity\) Nodes](#) (p. 248)
- [DynamoDB \(Database\) Nodes](#) (p. 250)
- [Lambda \(Cloud Functions\) Node](#) (p. 256)
- [S3 \(Storage\) Nodes](#) (p. 257)
- [SNS \(Notification Service\) Nodes](#) (p. 259)
- [SQS \(Message Queuing Service\) Nodes](#) (p. 262)
- [Static Data \(PROTOTYPE\) Nodes](#) (p. 263)

For general information on how to use flow graph nodes, see [Flow Graph System](#).

Cloud Canvas Configuration Nodes

You can use these flow graph nodes to configure Cloud Canvas settings.

Topics

- [ApplyConfiguration node](#) (p. 245)
- [SetConfigurationVariable node](#) (p. 246)
- [ConfigureProxy node](#) (p. 246)
- [GetConfigurationVariableValue node](#) (p. 247)
- [SetDefaultRegion node](#) (p. 247)

ApplyConfiguration node

Applies AWS configuration to all managed clients.

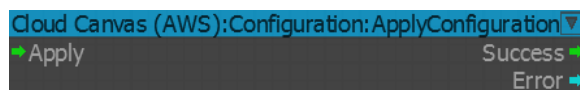

Inputs

Port	Type	Description
Apply	Any	Applies the current AWS configuration to all managed clients

Outputs

Port	Type	Description
Success	Any	Activated upon a successful operation
Error	String	Activated upon an error being detected; the value of the port is the error message

SetConfigurationVariable node

Sets a configuration parameter value.

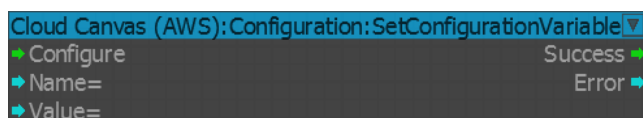

Inputs

Port	Type	Description
Configure	Any	Sets the parameter value
Name	String	Name of the parameter to set
Value	String	Value to which the parameter will be set; may contain <code>\$param-name\$</code> substrings

Outputs

Port	Type	Description
Success	Any	Activated upon a successful operation
Error	String	Activated upon an error being detected; the value of the port is the error message

ConfigureProxy node

Sets the proxy configuration used by all AWS clients.

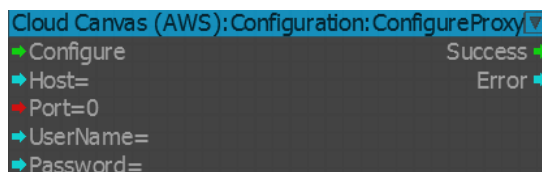

Inputs

Port	Type	Description
Configure	Any	Sets the proxy configuration

Port	Type	Description
Host	String	Proxy host
Port	Integer	Proxy port
UserName	String	Proxy user name
Password	String	Proxy password

Outputs

Port	Type	Description
Success	Any	Activated upon a successful operation
Error	String	Activated upon an error being detected; the value of the port is the error message

GetConfigurationVariableValue node

Inserts configuration value parameters into a string.

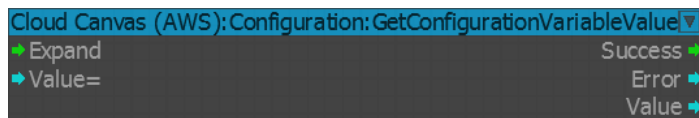

Inputs

Port	Type	Description
Expand	Any	Expands parameter references
Value	String	Value containing <code>\$param-name\$</code> substrings

Outputs

Port	Type	Description
Success	Any	Activated upon a successful operation
Error	String	Activated upon an error being detected; the value of the port is the error message
Value	String	Value with <code>\$param-name\$</code> substring replaced by parameter values

SetDefaultRegion node

Sets (overrides) the region for all AWS clients in the current project.

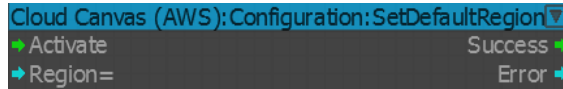

Inputs

Port	Type	Description
Activate	Any	Sets the region for all AWS clients in the current project
Region	String	The region name to set as the default region for all AWS clients

Outputs

Port	Type	Description
Success	Any	Activated upon a successful operation
Error	String	Activated upon an error being detected; the value of the port is the error message

Choose **Apply** if you want to apply the configuration change to all AWS clients immediately. If **Apply** is set to **false**, you must add an [ApplyConfiguration](#) (p. 245) flow node to activate the changes.

Cognito (Player Identity) Nodes

Use Amazon Cognito to configure player identity with these flow graph nodes.

Topics

- [ConfigureAnonymousPlayer](#) node (p. 248)
- [ConfigureAuthenticatedPlayer](#) node (p. 249)

ConfigureAnonymousPlayer node

Creates an anonymous identity on the device in your AWS account.

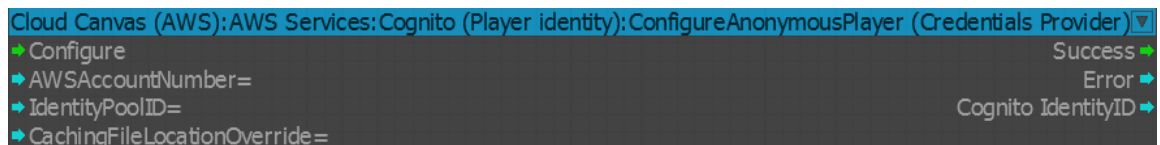

Inputs

Port	Type	Description
Configure	Any	Configure your game to use Amazon Cognito for anonymous players
AWSAccountNumber	String	Your AWS account number. This is needed to access Amazon Cognito.
IdentityPoolID	String	The unique ID of your Amazon Cognito identity pool. To create an identity pool ID, sign in to the AWS Management

Port	Type	Description
		Console and use the Amazon Cognito console at https://console.aws.amazon.com/cognito/ .
CachingFileLocationOverride	String	If specified, causes the Amazon Cognito ID to be cached to the path specified instead of to <code><HOME_DIR>/.aws/.identities</code> .

Outputs

Port	Type	Description
Success	Any	Activated upon a successful operation
Error	String	Activated upon an error being detected; the value of the port is the error message
CognitoIdentityID	String	The unique ID of the user

The first time the player runs the game and this node is triggered, an anonymous ID is generated for the player. This ID is persisted locally, and future runs of the game use the same identity.

ConfigureAuthenticatedPlayer node

Creates an authenticated identity on the device in your AWS account.

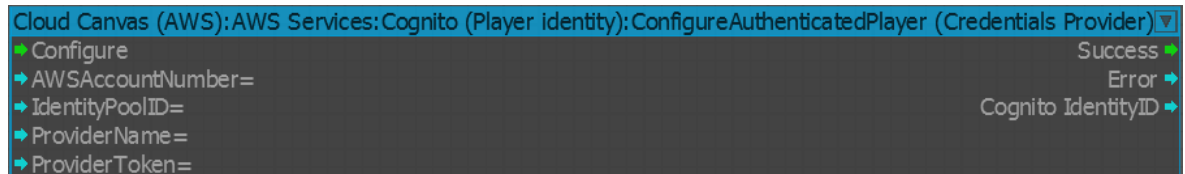

Inputs

Port	Type	Description
Configure	Any	Configure your game to use Amazon Cognito with the values specified.
AWSAccountNumber	String	Your AWS account number. This is needed for configuring Amazon Cognito.
IdentityPoolID	String	The unique ID of your Amazon Cognito identity pool. To edit your identity pool ID, open the AWS Management Console and choose Cognito .
ProviderName	String	Specifies the provider that authenticates the user
ProviderToken	String	Provider token with which to authenticate the user

Outputs

Port	Type	Description
Success	Any	Activated upon a successful operation

Port	Type	Description
Error	String	Activated upon an error being detected; the value of the port is the error message
CognitoIdentityID	String	The unique ID of the user

The first time the player runs the game and this node is triggered, an authenticated ID is generated for the player. The same ID is returned any time the user logs in with the same account, even on a second device.

DynamoDB (Database) Nodes

You can use these flow graph nodes to connect your game to Amazon DynamoDB.

Topics

- [AtomicAdd node \(p. 250\)](#)
- [DeleteItem node \(p. 251\)](#)
- [GetItem node \(p. 251\)](#)
- [PutItem node \(p. 252\)](#)
- [Query node \(p. 253\)](#)
- [ScanTable node \(p. 254\)](#)
- [UpdateItem node \(p. 255\)](#)
- [GetStringSet node \(p. 256\)](#)

AtomicAdd node

Add a number to an attribute in DynamoDB and return the number.

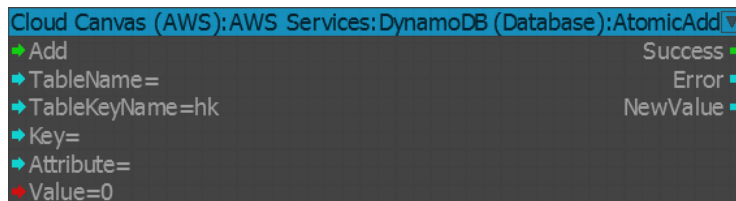

Inputs

Port	Type	Description
Add	Any	Writes the <code>val</code> specified in the Value port to DynamoDB
TableName	String	The name of the DynamoDB table to which to write
TableKeyName	String	The key name used in the table
Key	String	Specifies the key to which to write
Attribute	String	Specifies the attribute to which to write

Port	Type	Description
Value	Integer	Specifies the value to write

Outputs

Port	Type	Description
Success	Any	Activated upon a successful operation
Error	String	Activated upon an error being detected; the value of the port is the error message
NewValue	String	The value of the attribute after the addition.

This is an atomic operation. You do not need to create the attribute before you use it.

DeleteItem node

Deletes a record in DynamoDB.

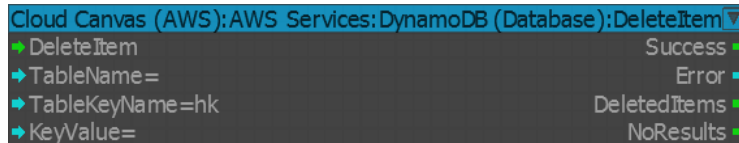

Inputs

Port	Type	Description
DeleteItem	Any	Deletes the specified item from DynamoDB.
TableName	String	The name of the DynamoDB table from which to delete
TableKeyName	String	The key name used in the table
KeyValue	String	Specifies the key to delete

Outputs

Port	Type	Description
Success	Any	Activated upon a successful operation
Error	String	Activated upon an error being detected; the value of the port is the error message
DeletedItems	Any	Activated when matches were found to delete
NoResults	Any	No matching results were found

GetItem node

Gets values from DynamoDB.

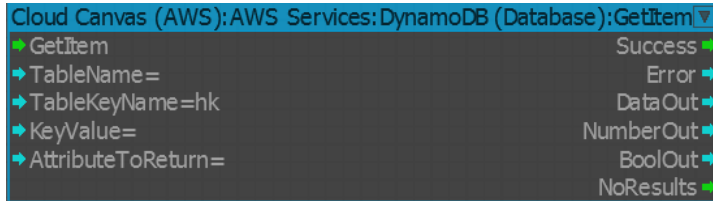

Inputs

Port	Type	Description
GetItem	Any	Retrieves the item specified from DynamoDB
TableName	String	The name of the DynamoDB table from which to read
TableKeyName	String	The key name used in the table
KeyValue	String	Specifies the key to read
AttributeToReturn	String	Specifies the attribute to read

Outputs

Port	Type	Description
Success	Any	Activated upon a successful operation
Error	String	Activated upon an error being detected; the value of the port is the error message
DataOut	String	String data that was read from DynamoDB
NumberOut	String	Number data that was read from DynamoDB
BoolOut	String	Boolean value that was read from DynamoDB
NoResults	Any	No matching results were found for the table, key, and attribute specified

PutItem node

Writes values to DynamoDB.

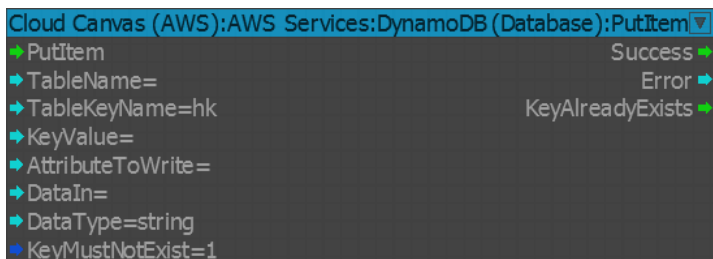

Inputs

Port	Type	Description
PutItem	Any	Writes the item specified to DynamoDB
TableName	String	The name of the DynamoDB table to which to write
TableKeyName	String	The key name used in the table
KeyValue	String	Specifies the key to write
AttributeToWrite	String	Specifies the attribute to write
DataIn	String	The data to write
DataType	String	The data type that the data will be written as
KeyMustNotExist	Boolean	When true, specifies that the key must not already exist; the default is true. Setting this to false allows you to overwrite an existing key in the table, including all of its existing attributes, and replace them with the new key and attribute values.

Outputs

Port	Type	Description
Success	Any	Activated upon a successful operation
Error	String	Activated upon an error being detected; the value of the port is the error message
KeyAlreadyExists	Any	The key already exists; no change was made

Query node

Queries values in DynamoDB.

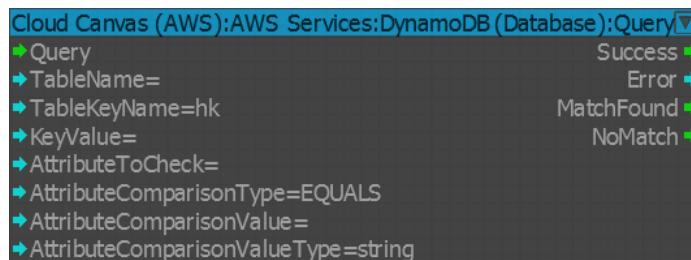

Inputs

Port	Type	Description
Query	Any	Queries table data in DynamoDB
TableName	String	The name of the DynamoDB table to query

Port	Type	Description
TableKeyName	String	The name of the table key to query
KeyValue	String	The value of the key to query
AttributeToCheck	String	The attribute to query
AttributeComparisonType	String	The comparison type to make against the attribute; the default is EQUALS. Other possible values are GREATER_THAN, GREATER_THAN_OR_EQUALS, LESS_THAN, LESS_THAN_OR_EQUALS.
AttributeComparisonValue	String	The value to compare against the attribute
AttributeComparisonValueType	String	The data type of AttributeComparisonValue (string, bool, or number); the default is string

Outputs

Port	Type	Description
Success	Any	Activated upon a successful operation
Error	String	Activated upon an error being detected; the value of the port is the error message
MatchFound	Any	A match was found
NoMatch	Any	No match was found

ScanTable node

Scans for entries which pass a comparison test in DynamoDB.

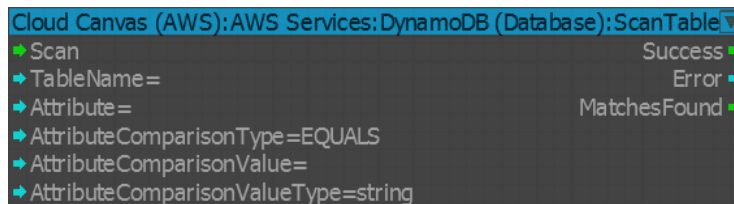

Inputs

Port	Type	Description
Scan	Any	Scans for matches in DynamoDB table data using the specified attributes
TableName	String	The name of the DynamoDB table to scan
Attribute	String	The attribute to query for
AttributeComparisonType	String	The comparison type to make against the attribute; this defaults to EQUALS.
AttributeComparisonValue	String	The value to compare against the attribute

Port	Type	Description
AttributeComparisonValue	String	The data type of AttributeComparisonValue (string, bool, or number); the default is string

Outputs

Port	Type	Description
Success	Any	Activated upon a successful operation
Error	String	Activated upon an error being detected; the value of the port is the error message
MatchesFound	Any	The number of matches found on a successful scan

UpdateItem node

Updates attribute values of an existing item in DynamoDB.

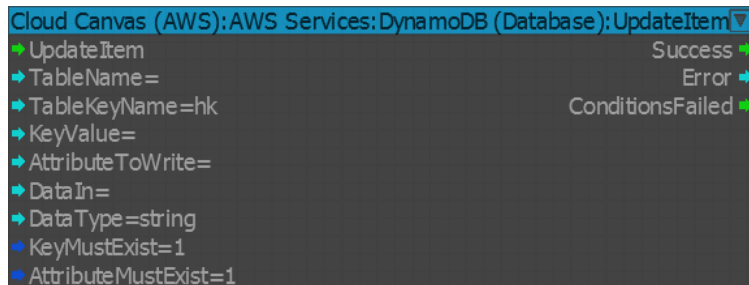

Inputs

Port	Type	Description
UpdateItem	Any	Updates an item in DynamoDB
TableName	String	The name of the DynamoDB table to use
TableKeyName	String	The name of the key in the table
KeyValue	String	The value of the key to write
AttributeToWrite	String	The attribute to write to
DataIn	String	The data to write
DataType	String	The data type to write the data as
KeyMustExist	Boolean	True if the key specified must already exist in the table; the default is true.
AttributeMustExist	Boolean	True if the attribute must exist for the key specified; the default is true

Outputs

Port	Type	Description
Success	Any	Activated upon a successful operation
Error	String	Activated upon an error being detected; the value of the port is the error message
ConditionFailed	Any	Key or attribute not found (either the <code>KeyMustExist</code> or <code>AttributeMustExist</code> condition failed)

GetStringSet node

Retrieves the members of a string set.

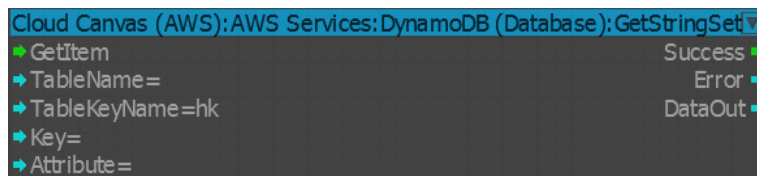

Inputs

Port	Type	Description
GetItem	Any	Reads data from DynamoDB
TableName	String	The name of the DynamoDB table to use
TableKeyName	String	The name of the key in the table
KeyValue	String	The value of the key to write
AttributeToWrite	String	The attribute to write to

Outputs

Port	Type	Description
Success	Any	Activated upon a successful operation
Error	String	Activated upon an error being detected; the value of the port is the error message
DataOut	String	The data read from DynamoDB. The DataOut port fires once for each member of the set.

The success port indicates that all members of the set have been output.

Lambda (Cloud Functions) Node

You can use this flow graph node to invoke AWS Lambda functions.

Invoke node

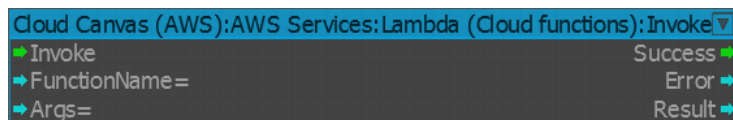

Inputs

Port	Type	Description
Invoke	Any	Invokes a Lambda function, optionally providing JSON data as arguments through the Args port. For more information, see AWS Lambda Invoke Request Syntax .
FunctionName	String	The name of the Lambda function to call
Args	String	The input data that will be sent to the Lambda function call as arguments in JSON format. For more information, see AWS Lambda Invoke Request Syntax .

Outputs

Port	Type	Description
Success	Any	Activated upon a successful operation
Error	String	Activated upon an error being detected; the value of the port is the error message
Result	String	The data that was output by the Lambda function if no error occurred

S3 (Storage) Nodes

You can use these flow graph nodes to download and upload files from the Amazon Simple Storage Service (Amazon S3), and to generate a public URL that points to a specific location in Amazon S3.

Topics

- [DownloadFile node \(p. 257\)](#)
- [UploadFile node \(p. 258\)](#)
- [GeneratePublicUrl node \(p. 259\)](#)

DownloadFile node

Downloads a file from Amazon S3.

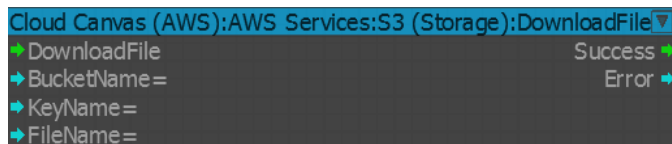

Inputs

Port	Type	Description
DownloadFile	Any	Reads file data from an Amazon S3 bucket

Port	Type	Description
BucketName	String	The name of the Amazon S3 bucket to use
KeyName	String	The name of the file to download from Amazon S3
FileName	String	The filename to use for the downloaded object

Outputs

Port	Type	Description
Success	Any	Activated upon a successful operation
Error	String	Activated upon an error being detected; the value of the port is the error message

UploadFile node

Uploads a file to Amazon S3.

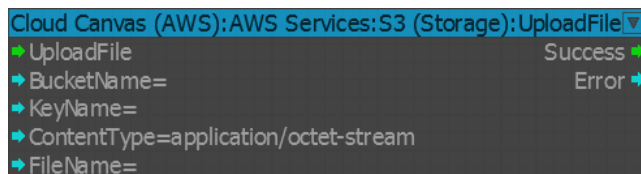

Inputs

Port	Type	Description
UploadFile	Any	Uploads a file to an Amazon S3 bucket
BucketName	String	The name of the Amazon S3 bucket to use
KeyName	String	What to name the uploaded object on Amazon S3. If this value is not updated on subsequent uses, the existing Amazon S3 object is overwritten.
ContentType	String	The mime-content type to use for the uploaded object (for example, <code>text/html</code> , <code>video/mpeg</code> , <code>video/avi</code> , or <code>application/zip</code>). The type is stored in the Amazon S3 record. You can use this type to help identify or retrieve a specific type of data later. The default is <code>application/octet-stream</code> .
FileName	String	The name of the file to upload

Outputs

Port	Type	Description
Success	Any	Activated upon a successful operation

Port	Type	Description
Error	String	Activated upon an error being detected; the value of the port is the error message

GeneratePublicUrl node

Generates a presigned URL that points to an Amazon S3 location that you specify.

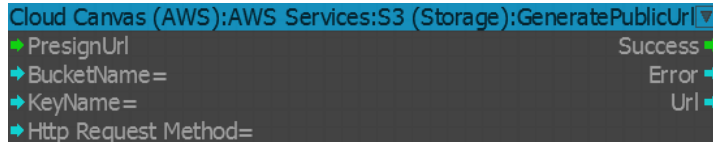

Inputs

Port	Type	Description
PresignUrl	Any	Generates a presigned URL for the Amazon S3 location specified
BucketName	String	The name of the Amazon S3 bucket to use
KeyName	String	What to name the uploaded object on Amazon S3. If this value is not updated on subsequent uses, the existing Amazon S3 object is overwritten.
Http Request Method	String	The HTTP method against which to presign (DELETE, GET, POST, or PUT)

Outputs

Port	Type	Description
Success	Any	Activated upon a successful operation
Error	String	Activated upon an error being detected; the value of the port is the error message
Url	String	The signed URL

SNS (Notification Service) Nodes

You can use these flow graph nodes to process Amazon Simple Notification Service (Amazon SNS) messages.

Topics

- [ParseMessage node \(p. 260\)](#)
- [Notify node \(p. 260\)](#)
- [CheckArnSubscribed node \(p. 261\)](#)
- [SubscribeToTopic node \(p. 261\)](#)

ParseMessage node

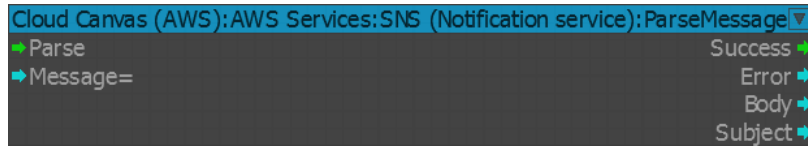

Inputs

Port	Type	Description
Parse	Any	Extract the subject and body text in JSON format from an Amazon SNS message
Message	String	The JSON message to deserialize.

Outputs

Port	Type	Description
Success	Any	Activated upon a successful operation
Error	String	Activated upon an error being detected; the value of the port is the error message
Body	String	The message body
Subject	String	The message subject

Notify node

Publishes messages to an Amazon SNS topic.

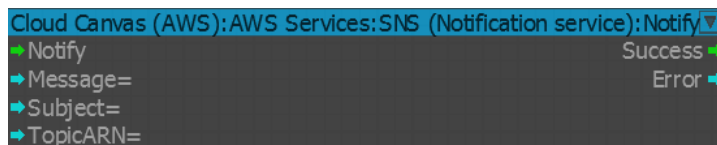

Inputs

Port	Type	Description
Notify	Any	Sends a notification to an Amazon SNS topic
Message	String	The message to send
Subject	String	The subject of the message
TopicARN	String	The Amazon Resource Name for your Amazon SNS topic

Outputs

Port	Type	Description
Success	Any	Activated upon a successful operation
Error	String	Activated upon an error being detected; the value of the port is the error message

CheckArnSubscribed node

Checks if an ARN is subscribed to an Amazon SNS topic.

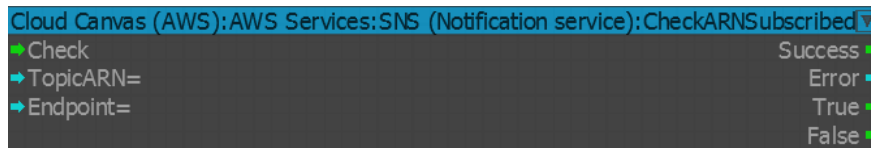

Inputs

Port	Type	Description
Check	Any	Checks if an ARN is subscribed to an Amazon SNS topic
TopicARN	String	The Amazon SNS topic ARN to check
Endpoint	String	The endpoint to check for subscription to the specified topic. The endpoint can be an email address, an Amazon SQS queue, or any other endpoint type supported by Amazon SNS.

Outputs

Port	Type	Description
Success	Any	Activated upon a successful operation
Error	String	Activated upon an error being detected; the value of the port is the error message
True	Any	The ARN is subscribed to the Amazon SNS topic
False	Any	The ARN is not subscribed to the Amazon SNS topic

SubscribeToTopic node

Subscribes to an Amazon SNS topic.

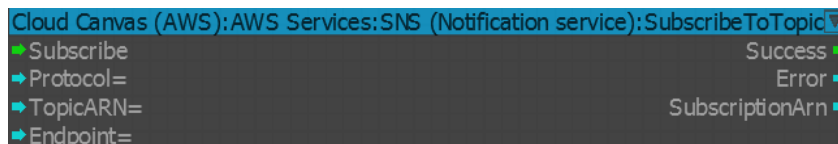

Inputs

Port	Type	Description
Subscribe	Any	Subscribes to a topic to receive messages published to that topic. For more information, see Subscribe to a Topic .
Protocol	String	The protocol of the endpoint to which to subscribe
TopicARN	String	The ARN of the Amazon SNS topic to which to subscribe
Endpoint	String	The address of the endpoint to subscribe (for example, an email address). For information on sending to HTTP or HTTPS, see Sending Amazon SNS Messages to HTTP/HTTPS Endpoints .

Outputs

Port	Type	Description
Success	Any	Activated upon a successful operation
Error	String	Activated upon an error being detected; the value of the port is the error message
SubscriptionArn	String	The ARN of the created subscription

For more information on Amazon SNS, see the [Amazon Simple Notification Service Developer Guide](#).

SQS (Message Queuing Service) Nodes

You can use these flow graph nodes to start polling AWS queues and to push messages to AWS queues.

Topics

- [PollAndNotify node \(p. 262\)](#)
- [Push node \(p. 263\)](#)

PollAndNotify node

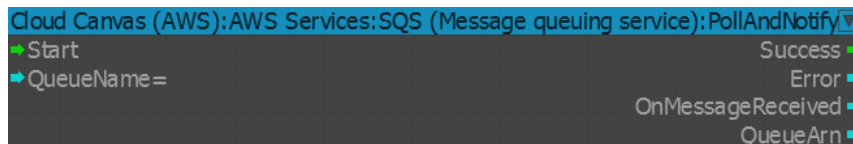

Inputs

Port	Type	Description
Start	Any	Start polling an AWS queue

Port	Type	Description
QueueName	String	The name of an AWS queue that has already been created

Outputs

Port	Type	Description
Success	Any	Activated upon a successful operation
Error	String	Activated upon an error being detected; the value of the port is the error message
OnMessageReceived	String	The most recent message on the stack
QueueArn	String	The ARN (Amazon Resource Name) of the queue

Push node

Pushes a message to an AWS queue

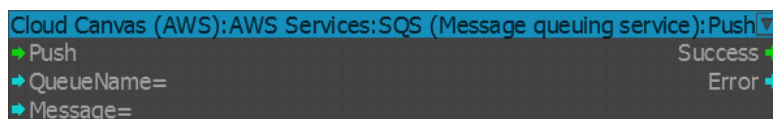

Inputs

Port	Type	Description
Push	Any	Pushes a message to an AWS queue
QueueName	String	The name of an AWS queue that has already been created
Message	String	The message to send

Outputs

Port	Type	Description
Success	Any	Activated upon a successful operation
Error	String	Activated upon an error being detected; the value of the port is the error message

Static Data (PROTOTYPE) Nodes

Static Data is a Lumberyard system for managing game data that changes less frequently through monitored Amazon S3 buckets. You can use these flow graph nodes to update or query your buckets at will and/or monitor them at regular intervals for changes.

Topics

- [Add Monitored Bucket node \(p. 264\)](#)
- [Get Static Data node \(p. 264\)](#)
- [Load Static Data node \(p. 265\)](#)
- [Remove Monitored Bucket node \(p. 266\)](#)
- [Request Bucket node \(p. 266\)](#)
- [Set Update Frequency node \(p. 267\)](#)

Add Monitored Bucket node

Adds an Amazon S3 bucket to monitor.

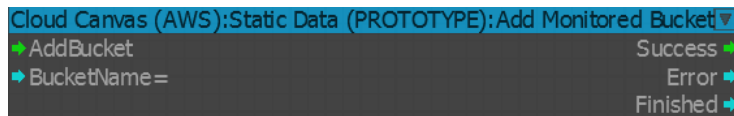

Inputs

Port	Type	Description
AddBucket	Void	Adds a bucket to watch for updates
BucketName	String	The name of the Amazon S3 bucket to watch

Outputs

Port	Type	Description
Success	Any	Activated upon a successful operation
Error	String	Activated upon an error being detected; the value of the port is the error message
Finished	String	The bucket was added

Get Static Data node

Retrieves a field from a static data definition.

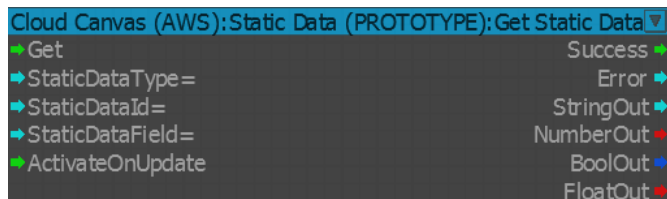

Inputs

Port	Type	Description
Get	Void	Retrieves a value from static data

Port	Type	Description
StaticDataType	String	The type of the static data to retrieve
StaticDataId	String	The identifier for the static data definition in the table
StaticDataField	String	The field name of the data to retrieve
ActivateOnUpdate	Void	Fire the node again the next time an update of the data takes place

Outputs

Port	Type	Description
Success	Any	Activated upon a successful operation
Error	String	Activated upon an error being detected; the value of the port is the error message
StringOut	String	The output of a string field
NumberOut	Integer	The output of a numeric field
BoolOut	Boolean	The output of a Boolean
FloatOut	Integer	The output of a floating point numeric field

Load Static Data node

Attempts to load static data of the type specified.

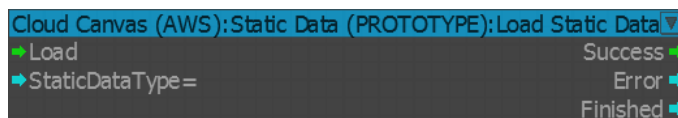

Inputs

Port	Type	Description
Load	Any	Load a type of static data
StaticDataType	String	The type of static data to load

Outputs

Port	Type	Description
Success	Any	Activated upon a successful operation
Error	String	Activated upon an error being detected; the value of the port is the error message
Finished	String	Finished attempting to load

Remove Monitored Bucket node

Removes a bucket name from the list of monitored buckets.

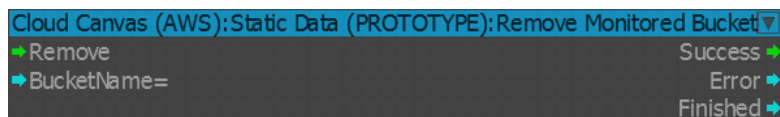

Inputs

Port	Type	Description
Remove	Any	Removes a bucket from the list of monitored buckets
BucketName	String	The name of the bucket to remove

Outputs

Port	Type	Description
Success	Any	Activated upon a successful operation
Error	String	Activated upon an error being detected; the value of the port is the error message
Finished	String	Finished removing the bucket

Request Bucket node

Requests an update of a specific bucket, or of all monitored buckets.

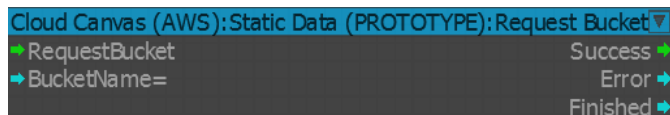

Inputs

Port	Type	Description
RequestBucket	Any	Requests an update of a specific bucket or of all monitored buckets
BucketName	String	The name of the bucket for which to request an update. To request updates for all buckets, leave this value blank.

Outputs

Port	Type	Description
Success	Any	Activated upon a successful operation

Port	Type	Description
Error	String	Activated upon an error being detected; the value of the port is the error message
Finished	String	Finished sending the request

Set Update Frequency node

Sets or clears a recurring timer to poll monitored buckets.

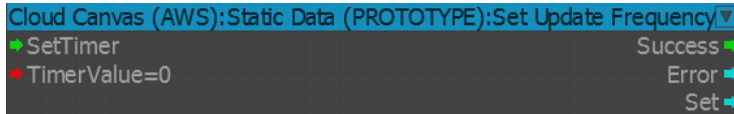

Inputs

Port	Type	Description
SetTimer	Void	Sets a recurring timer to the value specified in TimerValue
TimerValue	Integer	The time interval at which to poll. Possible values are from 0 to 100. A value of 0 clears the timer; 0 is the default.

Outputs

Port	Type	Description
Success	Any	Activated upon a successful operation
Error	String	Activated upon an error being detected; the value of the port is the error message
Set	String	The timer has been set

Resource Definitions

Resource definitions are specifications in the form of AWS CloudFormation template files that determine the resources (for example, DynamoDB databases, Lambda functions, and access control information) that will be created in AWS for the game. Game code and flow graphs use AWS resources and expect those resources to exist and to be configured in a specific way. The resource definitions determine this architecture and configuration.

Resource Definition Location

A description of the resources required by the game is stored in files under the `{root}\{game}\AWS` directory, where `{root}` is the Lumberyard installation `\dev` subdirectory and `{game}` is the directory identified by the `sys_game_folder` property in the `{root}\bootstrap.cfg` file. For example, if your game is the SamplesProject, your resource definition path might be `C:\lumberyard\dev\SamplesProject\AWS`. These files should be checked into the project's source control system along with your other game code and data.

The default `{game}`\AWS directory contents are created by the `lmbr_aws create-project-stack` (p. 213) command.

In addition, some user-specific configuration data is kept in the `{root}`\Cache\`{game}`\pc\user\AWS directory. The contents of this directory should not be checked into the project's source control system.

The following shows the contents of these AWS directories.

```
{root}\{game}\AWS\  
  project-settings.json  
  project-template.json  
  deployment-template.json  
  deployment-access-template.json  
  project-code\  
    (Lambda function Code)  
  resource-groups\  
    {resource-group}\  
      resource-template.json  
      lambda-function-code\  
        (Lambda function Code)  
  
{root}\Cache\{game}\pc\user\AWS\  
  user-settings.json
```

Each of these .json files is described in the following sections.

project-settings.json

The `project-settings.json` file contains project configuration data. The structure of this file is as follows:

```
{  
  "{key}": "{value}",  
  "deployment": {  
    "{deployment}": {  
      "{key}": "{value}",  
      "resource-group": {  
        "{resource-group}": {  
          "{key}": "{value}"  
        }  
      }  
    }  
  }  
}
```

The `{key}` and `{value}` pairs represent individual settings. The pairs at the root apply to the project. The pairs under `{deployment}` apply to that deployment. The pairs under `{resource-group}` apply to that resource group. Either or both of `{deployment}` and `{resource-group}` can be `*`, to indicate the settings they contain apply to all deployments or resource groups, respectively. Settings under a named entry take precedence over settings under a `*` entry.

An example `project-settings.json` settings file follows.

```
{  
  "ProjectStackId": "arn:aws:cloudformation:us-west-2:...",  
  "DefaultDeployment": "Development",  
}
```

```
"ReleaseDeployment": "Release",
"deployment": {
  "": {
    "resource-group": {
      "HelloWorld": {
        "parameter": {
          "WriteCapacityUnits": 1,
          "ReadCapacityUnits": 1,
          "Greeting": "Hi"
        }
      }
    }
  },
  "Development": {
    "DeploymentStackId": "arn:aws:cloudformation:us-west-2:..."
    "DeploymentAccessStackId": "arn:aws:cloudformation:us-west-2:..."
    "resource-group": {
      "HelloWorld": {
        "parameter": {
          "WriteCapacityUnits": 5,
          "ReadCapacityUnits": 5
        }
      }
    }
  }
}
```

ProjectStackId Property

The `ProjectStackId` property identifies the [AWS CloudFormation stack](#) for the project. This stack contains the resources used by Cloud Canvas to manage your Lumberyard project.

The `ProjectStackId` property is set by the [create-project-stack \(p. 213\)](#) command. If for some reason you want to associate the project with an existing project stack, you can use the AWS Management Console to look up the stack's ARN and paste it into the `project-settings.json` file (navigate to AWS CloudFormation, select the stack, select **Overview**, and then copy the value of the `Stack Id` property).

DefaultDeployment Property

The `DefaultDeployment` property identifies the deployment that is to be used by default when working in Lumberyard Editor. The `DefaultDeployment` property in the [user-settings.json \(p. 270\)](#) file overrides this setting. The project and user defaults can be set using the `lmb_aws default-deployment (p. 214)` command. The `DefaultDeployment` setting is also used by the `lmb_aws update-mappings (p. 222)` command.

ReleaseDeployment Property

The `ReleaseDeployment` property identifies the deployment that is to be used in release builds of the game. The `ReleaseDeployment` setting is used by the `lmb_aws update-mappings (p. 222)` command.

DeploymentStackId Property

The `DeploymentStackId` property identifies the [AWS CloudFormation stack](#) for a deployment. The project's resource groups are children of these stacks. For more information, see [Resource Deployments \(p. 289\)](#).

The `DeploymentStackId` property is set by the [create-deployment \(p. 213\)](#) command. If for some reason you want to associate the deployment with an existing deployment, you can use the AWS Management Console to look up the stack's ARN and paste it into the `project-settings.json` file (navigate to AWS CloudFormation, select the stack, select **Overview**, and then copy the value of the `Stack Id` property).

DeploymentAccessStackId Property

The `DeploymentAccessStackId` property identifies the AWS CloudFormation stack for the resources that control access to a deployment.

The `DeploymentAccessStackId` is set by the [create-deployment \(p. 213\)](#) command. If for some reason you want to associate the deployment with an existing deployment stack, you can use the AWS Management Console to look up the stack's ARN and paste it into the `project-settings.json` file (navigate to AWS CloudFormation, select the stack, select **Overview**, and then copy the value of the `Stack Id` property).

parameter Property

The `parameter` property provides the values for resource template parameters. The property must be in the following format.

```
{
  ...
  "parameter": {
    "{template-parameter-name-1}": {template-parameter-
value-1},
    ...
    "{template-parameter-name-n}": {template-parameter-
value-n}
  }
  ...
}
```

user-settings.json

The `user-settings.json` file contains user-specific configuration data.

File Location

The `user-settings.json` file is found at `{root}\Cache\{game}\pc\user\AWS\user-settings.json`. It is not in the `{root}\{game}\AWS` directory along with the other files described in this section because it should not be checked into the project's source control system.

An example `user-settings.json` file follows.

```
{
  "DefaultDeployment": "Test",
  "Mappings": {
    "HelloWorld.SayHello": {
      "ResourceType": "AWS::Lambda::Function",
      "PhysicalResourceId": "MyGame-Test-xxxxxxxxxxxxxx-HelloWorld-
yyyyyyyyyyyyy-SayHello-zzzzzzzzzzzz"
    }
  }
}
```

DefaultDeployment Property

The `DefaultDeployment` property identifies the deployment that is to be used by default when working in Lumberyard Editor. The `DefaultDeployment` property in the `user-settings.json` file overrides the property from the `project-settings.json` (p. 268) file. The project and user defaults can be set using the `lmbc_aws default-deployment` (p. 214) command.

Mappings Property

The `Mappings` property specifies the mapping of friendly names used in Lumberyard Editor to actual resource names. For example, the **DailyGiftTable** DynamoDB table would get mapped to a name like `SamplesProject-DontDieDeployment-78AIXR0N004N-DontDieAWS-1I1ZC6YO7KU7F-DailyGiftTable-1G4G33K16D8ZS`.

This property is updated automatically when the default deployment changes or when the default deployment is updated. It can be refreshed manually by using the `lmbc_aws update-mappings` (p. 222) command.

project-template.json

The `project-template.json` file is an [AWS CloudFormation template](#) that defines resources that support the Cloud Canvas resource management system.

An example `project-template.json` file follows.

```
{
  "AWSTemplateFormatVersion": "2010-09-09",

  "Metadata": {
    "CloudCanvas": {
      "Id": "$Revision: #6 $"
    }
  },

  "Parameters": {
    "ConfigurationKey": {
      "Type": "String",
      "Description": "Location in the configuration bucket of
configuration data."
    }
  },

  "Resources": {

    "Configuration": {
      "Type": "AWS::S3::Bucket",
      "DeletionPolicy": "Retain",
      "Properties": {
        "VersioningConfiguration": {
          "Status": "Enabled"
        },
        "LifecycleConfiguration": {
          "Rules": [
            {
              "Id": "DeleteOldVersions",
              "NoncurrentVersionExpirationInDays": "2",
              "Status": "Enabled"
            }
          ]
        }
      }
    }
  }
}
```

```

        {
            "Id": "DeleteUploads",
            "Prefix": "uploads",
            "ExpirationInDays": 2,
            "Status": "Enabled"
        }
    ]
}
},
"ProjectPlayerAccessTokenExchangeHandlerRole": {
    "Type": "AWS::IAM::Role",
    "Properties": {
        "AssumeRolePolicyDocument": {
            "Version": "2012-10-17",
            "Statement": [
                {
                    "Effect": "Allow",
                    "Action": "sts:AssumeRole",
                    "Principal": {
                        "Service": "lambda.amazonaws.com"
                    }
                }
            ]
        },
        "Policies": [
            {
                "PolicyName": "PlayerAccessTokenExchange",
                "PolicyDocument": {
                    "Version": "2012-10-17",
                    "Statement": [
                        {
                            "Sid": "WriteLogs",
                            "Effect": "Allow",
                            "Action": [
                                "logs:CreateLogGroup",
                                "logs:CreateLogStream",
                                "logs:PutLogEvents"
                            ],
                            "Resource": "arn:aws:logs:*:*:*"
                        },
                        {
                            "Sid": "GetAuthSettings",
                            "Action": [
                                "s3:GetObject",
                                "s3:HeadObject"
                            ],
                            "Effect": "Allow",
                            "Resource": [
                                { "Fn::Join": [ "",
[ "arn:aws:s3:::", { "Ref": "Configuration" }, "/player-access/auth-
settings.json" ] ] }
                            ]
                        }
                    ]
                }
            },
            {
                "Sid": "DescribeStacks",
                "Action": [

```

```

"cloudformation:DescribeStackResources",
"cloudformation:DescribeStackResource"
    ],
    "Effect": "Allow",
    "Resource": [
        "*"
    ]
    }
    ]
    }
    }
},
"ProjectResourceHandlerExecution": {
  "Type": "AWS::IAM::Role",
  "Properties": {
    "AssumeRolePolicyDocument": {
      "Version": "2012-10-17",
      "Statement": [
        {
          "Effect": "Allow",
          "Action": "sts:AssumeRole",
          "Principal": {
            "Service": "lambda.amazonaws.com"
          }
        }
      ]
    },
    "Policies": [
      {
        "PolicyName": "ProjectAccess",
        "PolicyDocument": {
          "Version": "2012-10-17",
          "Statement": [
            {
              "Sid": "WriteLogs",
              "Effect": "Allow",
              "Action": [
                "logs:CreateLogGroup",
                "logs:CreateLogStream",
                "logs:PutLogEvents"
              ],
              "Resource": "arn:aws:logs:*:*:*"
            },
            {
              "Sid":
"ReadAndWriteUploadedConfiguration",
              "Effect": "Allow",
              "Action": [
                "s3:GetObject",
                "s3:PutObject"
              ],
              "Resource": { "Fn::Join": [ "",
[ "arn:aws:s3:::", { "Ref": "Configuration" }, "/upload/*" ] ] }
            }
          ]
        }
      ]
    }
  }
},

```

```
        {
            "Sid": "DescribeStacksAndResources",
            "Effect": "Allow",
            "Action": [
                "cloudformation:DescribeStackResources",
                "cloudformation:DescribeStackResource",
                "cloudformation:DescribeStacks"
            ],
            "Resource": [
                "*"
            ]
        },
        {
            "Sid": "ManagePlayerAndFunctionRoles",
            "Effect": "Allow",
            "Action": [
                "iam:CreateRole",
                "iam>DeleteRole",
                "iam:GetRole",
                "iam>DeleteRolePolicy",
                "iam:PutRolePolicy"
            ],
            "Resource": { "Fn::Join": [ "",
                [ "arn:aws:iam::", { "Ref": "AWS::AccountId" }, ":role/", { "Ref":
                "AWS::StackName" }, "/*"] ] }
        },
        {
            "Sid": "CreateUpdateCognitoIdentity",
            "Effect": "Allow",
            "Action": [
                "cognito-identity:*"
            ],
            "Resource": { "Fn::Join": [ "",
                [ "arn:aws:cognito-identity:", { "Ref": "AWS::Region" }, ":", { "Ref":
                "AWS::AccountId" }, ":identitypool/*" ] ] }
        },
        {
            "Sid": "ReadPlayerAccessConfiguration",
            "Effect": "Allow",
            "Action": [
                "s3:GetObject"
            ],
            "Resource": { "Fn::Join": [ "",
                [ "arn:aws:s3:::", { "Ref": "Configuration" }, "/*player-access/auth-
                settings.json" ] ] }
        }
    ],
    "ProjectResourceHandler": {
        "Type": "AWS::Lambda::Function",
        "Properties": {
```

```
        "Description": "Implements the custom resources used in this
project's templates.",
        "Handler": "custom_resource.handler",
        "Role": { "Fn::GetAtt": [ "ProjectResourceHandlerExecution",
"Arn" ] },
        "Runtime": "python2.7",
        "Timeout" : 90,
        "Code": {
            "S3Bucket": { "Ref": "Configuration" },
            "S3Key": { "Fn::Join": [ "/", [ { "Ref":
"ConfigurationKey" }, "project-code.zip" ] ] }
        }
    },
    "ProjectPlayerAccessTokenExchangeHandler": {
        "Type": "AWS::Lambda::Function",
        "Properties": {
            "Description": "Implements the token exchange for oAuth and
openid used for player access.",
            "Handler": "auth_token_exchange.handler",
            "Role": { "Fn::GetAtt":
[ "ProjectPlayerAccessTokenExchangeHandlerRole", "Arn" ] },
            "Runtime": "python2.7",
            "Code": {
                "S3Bucket": { "Ref": "Configuration" },
                "S3Key": { "Fn::Join": [ "/", [ { "Ref":
"ConfigurationKey" }, "project-code.zip" ] ] }
            }
        }
    }
}
```

ConfigurationKey Parameter

The `ConfigurationKey` parameter identifies the location of configuration data in the configuration bucket. The parameter value is set by Cloud Canvas when you use the template to update the AWS CloudFormation stack.

Configuration Resource

The `Configuration` resource describes the [Amazon S3 bucket](#) that is used to store project configuration data.

ProjectPlayerAccessTokenExchangeHandlerRole Resource

The `ProjectPlayerAccessTokenExchangeHandlerRole` resource describes the [IAM role](#) that is used to grant permissions to the `ProjectPlayerAccessTokenExchangeHandler` resource.

ProjectResourceHandlerExecution Resource

The `ProjectResourceHandlerExecution` resource describes the [IAM role](#) that is used to grant permissions to the `ProjectResourceHandler` Lambda function resource.

ProjectResourceHandler Resource

The `ProjectResourceHandler` resource describes the [Lambda function](#) that implements the AWS CloudFormation custom resource handler that implements the custom resources used in the project's AWS CloudFormation templates. The code for this Lambda function is uploaded from the `{game}\AWS\project-code` directory by the `lmb_aws create-project-stack` (p. 213) and `update-project-stack` (p. 223) commands. For more information, see [Custom Resources](#) (p. 293).

ProjectPlayerAccessTokenExchangeHandler Resource

The `ProjectPlayerAccessTokenExchangeHandler` resource describes the [Lambda function](#) that implements the token exchange process for player access. The code for this Lambda function is uploaded from the `{game}\AWS\project-code` directory by the `lmb_aws create-project-stack` (p. 213) and `update-project-stack` (p. 223) commands. For more information, see [Access Control and Player Identity](#) (p. 297).

deployment-template.json

The `deployment-template.json` file is an [AWS CloudFormation Template](#) that defines a child [AWS CloudFormation stack](#) resource for each of the project's resource groups. As described below, each resource group is an arbitrary grouping of the AWS resources that a game uses.

An example `deployment-template.json` file follows.

```
{
  "AWSTemplateFormatVersion": "2010-09-09",
  "Metadata": {
    "CloudCanvas": {
      "Id": "$Revision: #4 $"
    }
  },
  "Parameters" : {
    "ProjectResourceHandler": {
      "Type": "String",
      "Description": "Service token of the custom resource handler."
    },
    "ConfigurationBucket": {
      "Type": "String",
      "Description": "Bucket that contains configuration data."
    },
    "ConfigurationKey": {
      "Type": "String",
      "Description": "Location in the configuration bucket of
configuration data."
    },
    "DeploymentName": {
      "Type": "String",
      "Description": "The name of the deployment associated with this
stack."
    },
    "ProjectStackId": {
      "Type": "String",
      "Description": "The ARN of the project stack associated with this
deployment."
    }
  }
}
```

```
    },
    "Resources": {
      "HelloWorldConfiguration" : {
        "Type": "Custom::ResourceGroupConfiguration",
        "Properties": {
          "ServiceToken": { "Ref": "ProjectResourceHandler" },
          "ConfigurationBucket": { "Ref": "ConfigurationBucket" },
          "ConfigurationKey": { "Ref": "ConfigurationKey" },
          "ResourceGroup": "HelloWorld"
        }
      },
      "HelloWorld": {
        "Type": "AWS::CloudFormation::Stack",
        "Properties": {
          "TemplateURL": { "Fn::GetAtt": [ "HelloWorldConfiguration",
"TemplateURL" ] },
          "Parameters": {
            "ProjectResourceHandler": { "Ref":
"ProjectResourceHandler" },
            "ConfigurationBucket": { "Fn::GetAtt":
[ "HelloWorldConfiguration", "ConfigurationBucket" ] },
            "ConfigurationKey": { "Fn::GetAtt":
[ "HelloWorldConfiguration", "ConfigurationKey" ] }
          }
        }
      }
    },
    "Outputs": {
      "StackName": {
        "Description": "The deployment stack name.",
        "Value": { "Ref": "AWS::StackName" }
      }
    }
  }
}
```

Parameters

The `deployment-template.json` file has the following parameters. The parameter values are provided by Cloud Canvas when it uses the template to update an AWS CloudFormation stack.

ProjectResourceHandler Parameter

The `ProjectResourceHandler` parameter identifies the custom resource handler Lambda function used for the project.

ConfigurationBucket Parameter

The `ConfigurationBucket` parameter identifies the configuration bucket.

ConfigurationKey Parameter

The `ConfigurationKey` parameter identifies the location of configuration data in the configuration bucket.

DeploymentName Parameter

The `DeploymentName` parameter identifies the deployment name associated with this stack.

ProjectStackId Parameter

The `ProjectStackId` parameter identifies project stack associated with this deployment.

Resources

The `deployment-template.json` file defines two resources:

HelloWorldConfiguration Resource

The `HelloWorldConfiguration` resource describes a [ResourceGroupConfiguration \(p. 294\)](#) custom resource that is used to configure the `HelloWorld` resource.

The `deployment-template.json` file contains a similar `ResourceGroupConfiguration` resource for each of the project's resource groups.

HelloWorld Resource

The `HelloWorld` resource describes the [AWS CloudFormation stack](#) that implements the project's `HelloWorld` resource group.

The `deployment-template.json` file contains a similar AWS CloudFormation stack resource for each of the project's resource groups.

Outputs

The `Outputs` section of the template defines values that the template generates.

deployment-access-template.json

The `deployment-access-template.json` file is an [AWS CloudFormation Template](#) that defines the resources used to secure a deployment.

An example `deployment-access-template.json` file follows.

```
{
  "AWSTemplateFormatVersion": "2010-09-09",
  "Metadata": {
    "CloudCanvas": {
      "Id": "$Revision: #6 $"
    }
  },
  "Parameters": {
    "ProjectResourceHandler": {
      "Type": "String",
      "Description": "The the project resource handler lambda ARN."
    },
    "ConfigurationBucket": {
      "Type": "String",
      "Description": "Bucket that contains configuration data."
    },
    "ConfigurationKey": {
      "Type": "String",
      "Description": "Key that contains the current upload location."
    }
  }
}
```

```
    },
    "ProjectPlayerAccessTokenExchangeHandler": {
      "Type": "String",
      "Description": "ARN for the lambda that the login cognito-identity pool needs access to."
    },
    "ProjectStack": {
      "Type": "String",
      "Description": "The name of the project stack."
    },
    "DeploymentName": {
      "Type": "String",
      "Description": "The name of the deployment."
    },
    "DeploymentStack": {
      "Type": "String",
      "Description": "The name of the deployment stack."
    },
    "DeploymentStackArn": {
      "Type": "String",
      "Description": "The ARN of the deployment stack."
    }
  },
  "Resources": {
    "OwnerPolicy": {
      "Type": "AWS::IAM::ManagedPolicy",
      "Properties": {
        "Description": "Policy that grants permissions to update a deployment stack, and all of it's resource group stacks.",
        "Path": { "Fn::Join": [ "", [ "/", { "Ref": "ProjectStack" } ], "/", { "Ref": "DeploymentName" }, "/" ] } },
        "PolicyDocument": {
          "Version": "2012-10-17",
          "Statement": [
            {
              "Sid":
"ReadProjectDeploymentAndResourceGroupStackState",
              "Effect": "Allow",
              "Action": [
                "cloudformation:DescribeStackResource",
                "cloudformation:DescribeStackResources",
                "cloudformation:DescribeStackEvents"
              ],
              "Resource": [
                { "Fn::Join": [ "",
[ "arn:aws:cloudformation:", { "Ref": "AWS::Region" }, ":", { "Ref": "AWS::AccountId" }, ":stack/", { "Ref": "ProjectStack" }, "/*" ] ] },
                { "Fn::Join": [ "",
[ "arn:aws:cloudformation:", { "Ref": "AWS::Region" }, ":", { "Ref": "AWS::AccountId" }, ":stack/", { "Ref": "ProjectStack" }, "-*" ] ] },
```

```

    { "Fn::Join": [ "",
[ "arn:aws:cloudformation:", { "Ref": "AWS::Region" }, ":", { "Ref":
"AWS::AccountId" }, ":stack/", { "Ref": "DeploymentStack" }, "/*" ] ] },
    { "Fn::Join": [ "",
[ "arn:aws:cloudformation:", { "Ref": "AWS::Region" }, ":", { "Ref":
"AWS::AccountId" }, ":stack/", { "Ref": "DeploymentStack" }, "-*" ] ] }
    ]
  },
  {
    "Sid": "InvokeProjectResourceHandler",
    "Effect": "Allow",
    "Action": [
      "lambda:InvokeFunction"
    ],
    "Resource": [
      { "Ref": "ProjectResourceHandler" }
    ]
  },
  {
    "Sid":
"ReadAndWriteDeploymentAndResourceGroupConfiguration",
    "Effect": "Allow",
    "Action": [
      "s3:PutObject",
      "s3:GetObject"
    ],
    "Resource": [
      { "Fn::Join": [ "", [ "arn:aws:s3:::",
{ "Ref": "ConfigurationBucket" }, "/upload/*/deployment/", { "Ref":
"DeploymentName" }, "/*" ] ] }
    ]
  },
  {
    "Sid": "UpdateDeploymentStack",
    "Effect": "Allow",
    "Action": [
      "cloudformation:UpdateStack"
    ],
    "Resource": [
      { "Fn::Join": [ "",
[ "arn:aws:cloudformation:", { "Ref": "AWS::Region" }, ":", { "Ref":
"AWS::AccountId" }, ":stack/", { "Ref": "DeploymentStack" }, "/*" ] ] }
    ]
  },
  {
    "Sid":
"CreateUpdateAndDeleteResourceGroupStacks",
    "Effect": "Allow",
    "Action": [
      "cloudformation:CreateStack",
      "cloudformation:UpdateStack",
      "cloudformation>DeleteStack"
    ],
    "Resource": [
      { "Fn::Join": [ "",
[ "arn:aws:cloudformation:", { "Ref": "AWS::Region" }, ":", { "Ref":
"AWS::AccountId" }, ":stack/", { "Ref": "DeploymentStack" }, "-*" ] ] }
    ]
  },
  },

```

```

    {
      "Sid":
"FullAccessToDeploymentAndResourceGroupResources",
      "Effect": "Allow",
      "Action": [
        "dynamodb:*",
        "s3:*",
        "sqs:*",
        "sns:*",
        "lambda:*"
      ],
      "Resource": [
        { "Fn::Join": [ "", [ "arn:aws:dynamodb:",
{ "Ref": "AWS::Region" }, ":", { "Ref": "AWS::AccountId" }, ":table/",
{ "Ref": "DeploymentStack" }, "-*" ] ] },
        { "Fn::Join": [ "", [ "arn:aws:s3:::",
{ "Ref": "DeploymentStack" }, "-*" ] ] },
        { "Fn::Join": [ "", [ "arn:aws:sqs:",
{ "Ref": "AWS::Region" }, ":", { "Ref": "AWS::AccountId" }, ":", { "Ref":
"DeploymentStack" }, "-*" ] ] },
        { "Fn::Join": [ "", [ "arn:aws:sns:*:",
{ "Ref": "AWS::AccountId" }, ":", { "Ref": "DeploymentStack" }, "-*" ] ] },
        { "Fn::Join": [ "", [ "arn:aws:lambda:",
{ "Ref": "AWS::Region" }, ":", { "Ref": "AWS::AccountId" }, ":function:",
{ "Ref": "DeploymentStack" }, "-*" ] ] }
      ]
    },
    {
      "Sid": "PassDeploymentRolesToLambdaFunctions",
      "Effect": "Allow",
      "Action": [
        "iam:PassRole"
      ],
      "Resource": [
        { "Fn::Join": [ "", [ "arn:aws:iam::",
{"Ref": "AWS::AccountId"}, ":role/", {"Ref": "ProjectStack"}, "/", {"Ref":
"DeploymentName"}, "/*"] ] }
      ]
    },
    {
      "Sid": "CreateLambdaFunctions",
      "Effect": "Allow",
      "Action": "lambda:CreateFunction",
      "Resource": "*"
    }
  ]
},
"Owner": {
  "Type": "AWS::IAM::Role",
  "Properties": {
    "Path": { "Fn::Join": [ "", [ "/", { "Ref": "ProjectStack" },
"/", { "Ref": "DeploymentName" }, "/" ] ] },
    "AssumeRolePolicyDocument": {
      "Version": "2012-10-17",
      "Statement": [
        {

```

```
        "Sid": "AccountUserAssumeRole",
        "Effect": "Allow",
        "Action": "sts:AssumeRole",
        "Principal": { "AWS": { "Ref": "AWS::AccountId" } }
    }
  ],
  },
  "ManagedPolicyArns": [
    { "Ref": "OwnerPolicy" }
  ]
},
},
"Player": {
  "Type": "AWS::IAM::Role",
  "Properties": {
    "Path": { "Fn::Join": [ "", [ "/", { "Ref": "ProjectStack" } ],
"/", { "Ref": "DeploymentName" }, "/" ] ] },
    "AssumeRolePolicyDocument": {
      "Version": "2012-10-17",
      "Statement": [
        {
          "Effect": "Allow",
          "Action": "sts:AssumeRoleWithWebIdentity",
          "Principal": {
            "Federated": "cognito-identity.amazonaws.com"
          }
        }
      ]
    }
  }
},
},
"PlayerAccess": {
  "Type": "Custom::PlayerAccess",
  "Properties": {
    "ServiceToken": { "Ref": "ProjectResourceHandler" },
    "ConfigurationBucket": { "Ref": "ConfigurationBucket" },
    "ConfigurationKey": { "Ref": "ConfigurationKey" },
    "DeploymentStack": { "Ref": "DeploymentStackArn" }
  },
  "DependsOn": [ "Player" ]
},
},
"PlayerLoginRole": {
  "Type": "AWS::IAM::Role",
  "Properties": {
    "AssumeRolePolicyDocument": {
      "Version": "2012-10-17",
      "Statement": [
        {
          "Effect": "Allow",
          "Action": "sts:AssumeRoleWithWebIdentity",
          "Principal": {
            "Federated": "cognito-identity.amazonaws.com"
          }
        }
      ]
    }
  }
},
},
```

```
    "Policies": [
      {
        "PolicyName": "ExchangeTokenAccess",
        "PolicyDocument": {
          "Version": "2012-10-17",
          "Statement": [
            {
              "Sid": "PlayerLoginExecution",
              "Effect": "Allow",
              "Action": [ "lambda:InvokeFunction" ],
              "Resource": { "Ref":
"ProjectPlayerAccessTokenExchangeHandler" }
            }
          ]
        }
      }
    ],
    "PlayerLoginIdentityPool": {
      "Type": "Custom::CognitoIdentityPool",
      "Properties": {
        "ServiceToken": { "Ref": "ProjectResourceHandler" },
        "AllowUnauthenticatedIdentities": "true",
        "UseAuthSettingsObject": "false",
        "ConfigurationBucket": { "Ref": "ConfigurationBucket" },
        "ConfigurationKey": { "Ref": "ConfigurationKey" },
        "IdentityPoolName": "PlayerLogin",
        "Roles": {
          "unauthenticated": { "Fn::GetAtt": [ "PlayerLoginRole",
"Arn" ] }
        }
      }
    },
    "PlayerAccessIdentityPool": {
      "Type": "Custom::CognitoIdentityPool",
      "Properties": {
        "ServiceToken": { "Ref": "ProjectResourceHandler" },
        "AllowUnauthenticatedIdentities": "true",
        "UseAuthSettingsObject": "true",
        "ConfigurationBucket": { "Ref": "ConfigurationBucket" },
        "ConfigurationKey": { "Ref": "ConfigurationKey" },
        "IdentityPoolName": "PlayerAccess",
        "Roles": {
          "unauthenticated": { "Fn::GetAtt": [ "Player",
"Arn" ] },
          "authenticated": { "Fn::GetAtt": [ "Player", "Arn" ] }
        }
      }
    }
  }
}
```

Parameters

The deployment access stack defines parameters that identify the deployment and other resources that are needed to set up security for the deployment. A value for each of these parameters is provided by Cloud Canvas when a deployment is created.

Resources

This section describes the resources defined in the example `deployment-access-template.json` file.

OwnerPolicy Resource

The `OwnerPolicy` resource describes an [IAM Managed Policy](#) that gives owner level access to the deployment. The AWS account administrator always has full access to the deployment, but may want to limit other users' access to specific deployments. That can be done by attaching `OwnerPolicy` to an [IAM User](#) (or you can use the `Owner` role, which is also defined by the deployment access template).

Owner access includes the following:

- The ability to update the deployment and all of its resource groups.
- Full access to the group's resources created for the deployment.

For more information, see [Project Access Control \(p. 297\)](#).

Owner Resource

The `Owner` resource describes an [IAM role](#) with the `OwnerPolicy` attached.

For more information, see [Project Access Control \(p. 297\)](#).

Player Resource

The `Player` resource describes the [IAM role](#) that determines the access granted to the player. For example, for the game to invoke a Lambda function, the player must be allowed the `lambda:InvokeFunction` action on the Lambda function resource.

The role's policies are determined by the `PlayerAccess` metadata elements found on resources in the project's resource templates (see [resource-template.json \(p. 285\)](#)). The role's policies are updated by the `PlayerAccess` custom resources that appear in the [deployment-access-template.json \(p. 278\)](#) and in the [resource-template.json \(p. 285\)](#) files. The `PlayerAccessIdentityPool` [Amazon Cognito identity pool](#) resource allows players to assume this role.

For more information, see [PlayerAccessIdentityPool Resource \(p. 285\)](#) and [Access Control and Player Identity \(p. 297\)](#).

PlayerAccess Resource

The `PlayerAccess` resource describes a [PlayerAccessIdentityPool Resource \(p. 285\)](#). This resource is responsible for configuring the player role using the `PlayerAccess` metadata found on the resources to which the player should have access.

For more information, see [Access Control and Player Identity \(p. 297\)](#).

PlayerLoginRole Resource

The `PlayerLoginRole` resources describes the [IAM role](#) that is temporarily assumed by the player as part of the login process.

For more information, see [Access Control and Player Identity \(p. 297\)](#).

PlayerLoginIdentityPool Resource

The `PlayerLoginIdentityPool` resource describes the [Amazon Cognito identity pool](#) that provides the player with a temporary identity during the login process.

For more information, see [Access Control and Player Identity \(p. 297\)](#).

PlayerAccessIdentityPool Resource

The `PlayerAccessIdentityPool` resource describes the [Amazon Cognito identity pool](#) that provides the player with a temporary identity during the login process.

For more information, see [Access Control and Player Identity \(p. 297\)](#).

The project-code Subdirectory

The `project-code` subdirectory contains the source code for the [AWS CloudFormation Custom Resource](#) handler that is used in the project's AWS CloudFormation templates. For information about custom resources, see [Custom Resources \(p. 293\)](#).

It also contains the code that implements the token exchange step of the player login process. For more information, see [Access Control and Player Identity \(p. 297\)](#).

resource-group\{resource-group} subdirectories

The AWS resources used by the game are organized into separate resource groups, as represented by individual `{resource-group}` subdirectories under the parent `resource-group` directory. The `resource-group` directory may contain any number of `{resource-group}` subdirectories, each typically named after your game project.

resource-template.json

A `resource-template.json` file is an [AWS CloudFormation template](#) that defines the AWS resources associated with each resource group. You can specify any AWS resource type supported by AWS CloudFormation in your `resource-template.json` file. For a list of the available resource types, see the AWS CloudFormation [AWS Resource Types Reference](#).

The example `resource-template.json` file that follows defines a `SayHello` Lambda function that is executed by the game to generate a greeting for a player. The generated message is stored in a DynamoDB table.

```
{
  "AWSTemplateFormatVersion": "2010-09-09",
  "Metadata": {
    "CloudCanvas": {
      "Id": "$Revision: #3 $"
    }
  },
  "Parameters": {
    "ProjectResourceHandler": {
      "Type": "String",
      "Description": "Service token of the custom resource handler."
    }
  },
```

```
"ConfigurationBucket": {
  "Type": "String",
  "Description": "Bucket that contains configuration data."
},

"ConfigurationKey": {
  "Type": "String",
  "Description": "Location in the configuration bucket of
configuration data."
},

"ReadCapacityUnits": {
  "Type": "Number",
  "Default": "1",
  "Description": "Number of game state reads per second."
},

"WriteCapacityUnits": {
  "Type": "Number",
  "Default": "1",
  "Description": "Number of game state writes per second."
},

"Greeting": {
  "Type": "String",
  "Default": "Hello",
  "Description": "Greeting used by the SayHello Lambda function."
}
},

"Resources": {
  "Messages": {
    "Type": "AWS::DynamoDB::Table",
    "Properties": {
      "AttributeDefinitions": [
        {
          "AttributeName": "PlayerId",
          "AttributeType": "S"
        }
      ],
      "KeySchema": [
        {
          "AttributeName": "PlayerId",
          "KeyType": "HASH"
        }
      ],
      "ProvisionedThroughput": {
        "ReadCapacityUnits": { "Ref": "ReadCapacityUnits" },
        "WriteCapacityUnits": { "Ref": "WriteCapacityUnits" }
      }
    },
    "Metadata": {
      "CloudCanvas": {
        "FunctionAccess": [
          {
            "FunctionName": "SayHello",
            "Action": "dynamodb:PutItem"
          }
        ]
      }
    }
  }
}
```

```

    ]
  }
},
"SayHelloConfiguration": {
  "Type": "Custom::LambdaConfiguration",
  "Properties": {
    "ServiceToken": { "Ref": "ProjectResourceHandler" },
    "ConfigurationBucket": { "Ref": "ConfigurationBucket" },
    "ConfigurationKey": { "Ref": "ConfigurationKey" },
    "FunctionName": "SayHello",
    "Runtime": "python2.7",
    "Settings": {
      "MessagesTable": { "Ref": "Messages" },
      "Greeting": { "Ref": "Greeting" }
    }
  }
},
"SayHello": {
  "Type": "AWS::Lambda::Function",
  "Properties": {
    "Description": "Example of a function called by the game to
write data into a DynamoDB table.",
    "Handler": "main.say_hello",
    "Role": { "Fn::GetAtt": [ "SayHelloConfiguration",
"Role" ] },
    "Runtime": { "Fn::GetAtt": [ "SayHelloConfiguration",
"Runtime" ] },
    "Code": {
      "S3Bucket": { "Fn::GetAtt": [ "SayHelloConfiguration",
"ConfigurationBucket" ] },
      "S3Key": { "Fn::GetAtt": [ "SayHelloConfiguration",
"ConfigurationKey" ] }
    }
  },
  "Metadata": {
    "CloudCanvas": {
      "PlayerAccess": {
        "Action": "lambda:InvokeFunction"
      }
    }
  }
},
"PlayerAccess": {
  "Type": "Custom::PlayerAccess",
  "Properties": {
    "ServiceToken": { "Ref": "ProjectResourceHandler" },
    "ConfigurationBucket": { "Ref": "ConfigurationBucket" },
    "ConfigurationKey": { "Ref": "ConfigurationKey" },
    "ResourceGroupStack": { "Ref": "AWS::StackId" }
  },
  "DependsOn": [ "SayHello" ]
}
}

```

```
}
```

Resource Template Parameters

This section describes the parameters defined in the example `resource-template.json` file. Parameter values are provided by Cloud Canvas when it uses the template to update an AWS CloudFormation stack.

ProjectResourceHandler Parameter

The `ProjectResourceHandler` parameter identifies the custom resource handler Lambda function used for the project.

ConfigurationBucket Parameter

The `ConfigurationBucket` parameter identifies the configuration bucket.

ConfigurationKey Parameter

The `ConfigurationKey` parameter identifies the location of configuration data in the configuration bucket.

ReadCapacityUnits and WriteCapacityUnits Parameters

The `ReadCapacityUnits` and `WriteCapacityUnits` parameters are used to configure the `Messages` resource defined by the template. Values for parameters such as these are typically provided by the [project-settings.json](#) (p. 268) and can be customized for each deployment.

Resource Template Resources

This section describes the resources defined in the example `resource-template.json` file.

Messages Resource

The `Messages` resource describes a [DynamoDB Table](#). See [AWS::DynamoDB::Table](#) for a description of the AWS CloudFormation DynamoDB table resource definition format.

The `Metadata.CloudCanvas.FunctionAccess` property of the resource definition is used by the `SayHelloConfiguration` custom resource to grant the `SayHello` Lambda function resource permission to write data into the table. For more information, see [Lambda Function Access Control](#) (p. 298).

SayHelloConfiguration Resource

The `SayHelloConfiguration` resource describes a [LambdaConfiguration](#) (p. 295) resource that provides various configuration inputs for the `SayHello` Lambda function resource.

The `Settings` property for this resource is used to pass configuration data to the `SayHello` Lambda function. For more information, see [LambdaConfiguration](#) (p. 295).

SayHello Resource

The `SayHello` resource describes a Lambda function resource that implements some of the game logic. See [AWS::Lambda::Function](#) for a description of the AWS CloudFormation Lambda function resource definition format.

The Lambda function's `Execution Role`, which determines the AWS permissions the function has when it executes, is created by the `SayHelloConfiguration` resource, which uses the `Metadata.CloudCanvas.FunctionAccess` properties that appear on the resources that the function can access.

The `Metadata.CloudCanvas.PlayerAccess` property of the resource definition determines the access that players have to the `SayHello` resource. In this case, they can only invoke the lambda function.

PlayerAccess Resource

The `PlayerAccess` resource in the resource template is a [PlayerAccess \(p. 296\)](#) custom resource. It grants players access to resources specified by the `Metadata.CloudCanvas.PlayerAccess` properties on the definitions of the resources to which they have access.

Note that the `PlayerAccess DependsOn` property lists the resources that define this metadata property. This ensures that AWS CloudFormation creates or updates the `PlayerAccess` resources after the resources with the metadata property have been created or updated.

The lambda-function-code Subdirectory

The `lambda-function-code` subdirectory is present when a resource template defines [Lambda function](#) resources. This directory is where you put the source files that implement those functions.

Lumberyard provided tools uploads the code from this directory when using the template to update the AWS CloudFormation stack.

Resource Deployments

You implement deployments using [AWS CloudFormation stacks](#). You create and manage the stacks using tools provided by Lumberyard.

A project may define any number of deployments, up to the limits imposed by AWS CloudFormation (for more information, see [AWS CloudFormation Limits](#)). Each deployment contains a completely independent set of the resources that the game requires. For example, you can have separate development, test, and release deployments so that your development and test teams can work independently of the deployment used for the released version of the game.

An AWS account that hosts a Lumberyard project contains the following resources:

- `{project}` – An AWS CloudFormation stack that acts as a container for all the project's deployments.
- `{project}-Configuration` – An S3 bucket used to store configuration data.
- `{project}-ProjectResourceHandler` – A Lambda function that implements the handler for the custom resources used in the templates. See [Custom Resources \(p. 293\)](#).
- `{project}-ProjectResourceHandlerExecution` – An IAM role that grants the permissions used by the `ProjectResourceHandler` Lambda function when it is executing.
- `{project}-ProjectPlayerAccessTokenExchangeHandler` – A Lambda function that implements the token exchange step in the player login process. For more information, see [Access Control and Player Identity \(p. 297\)](#).
- `{project}-ProjectPlayerAccessTokenExchangeHandlerRole` – An IAM role that grants the permissions used by the `ProjectPlayerAccessTokenExchangeHandler` Lambda function when it runs.
- `{project}-{deployment}` – AWS CloudFormation stacks for each of the project's deployments.
- `{project}-{deployment}Access` – AWS CloudFormation stacks that control access to each of the project's deployments.

`{project}-{deployment}Access-OwnerPolicy` – An IAM managed policy that grants "owner" access to a deployment. See [Project Access Control \(p. 297\)](#).

- `{project}-{deployment}`Access-Owner – An IAM role that grants "owner" access to a deployment. See [Project Access Control \(p. 297\)](#).
- `{project}-{deployment}`Access-Player – An IAM role that grants "player" access to a deployment. See [Access Control and Player Identity \(p. 297\)](#).
- `{project}-{deployment}`Access-PlayerLoginRole – An IAM role that grants players temporary anonymous access used during the player login process. See [Access Control and Player Identity \(p. 297\)](#).
- `{project}-{deployment}`Access-PlayerAccessIdentityPool – An Amazon Cognito identity pool used for player identity. For more information, see [Access Control and Player Identity \(p. 297\)](#).
- `{project}-{deployment}`Access-PlayerLoginIdentityPool – An Amazon Cognito identity pool that provides the temporary player identity used during the player login process. For more information, see [Access Control and Player Identity \(p. 297\)](#).
- `{project}-{deployment}-{resource-group}` – An AWS CloudFormation stack for each resource group of the project.
- `{project}-{deployment}-{resource-group}-{resource}` – The resources defined by a resource group. Because of how AWS CloudFormation works, parts of these names have unique identifiers appended to them. For example, for a project named MyGame with a deployment named Development and a feature named HighScore, the actual name of a Scores resource would be something like: MyGame-Development-1FLFSUKM3MC4B-HighScore-1T7DK9P46SQF8-Scores-1A1WIH6MZKPRI. The tools provided by Lumberyard hide these actual resource names under most circumstances.

Configuration Bucket

The configuration [Amazon S3 bucket](#) is used to store configuration data for the project. The tools provided with Cloud Canvas manage uploads to this bucket.

The configuration bucket contents are as follows.

```
/
  upload/
    {upload-id}/
      project-template.json
      project-code.zip
      deployment/
        {deployment}/
          deployment-template.json
          resource-group/
            {resource-group}/
              resource-template.json
              lambda-function-code.zip
              lambda-function-code.zip.{function-
name}.configured
      player-access/
        auth-settings.json
```

All the `/upload/{upload-id}/*` objects in this bucket, except the `*.configured` objects, are uploaded from the `{game}/AWS` directory by the Cloud Canvas tools when stack management operations are performed. The uploads for each operation get assigned a unique `{upload-id}` value to prevent concurrent operations from impacting each other.

The `lambda-function-code.zip.{function-name}.configured` objects in this bucket are created by the `LambdaConfiguration` custom resources when settings are injected into the code. See [LambdaConfiguration \(p. 295\)](#) for more information.

The `/player-access/auth-settings.json` file stores the security credentials used to implement player login by using social networks such as Facebook or by using the player's Amazon credentials. This file is created and updated by the `lmb_aws` [add-login-provider](#) (p. 211), [update-login-provider](#) (p. 221), and [remove-login-provider](#) (p. 220) commands.

Resource Mappings

Resource mappings map the friendly names used in a game's [Resource Definitions](#) (p. 267) to the actual names of the resources created for one or more specific [Resource Deployments](#) (p. 289). For example, a DynamoDB table name like `DailyGiftTable` would get mapped to a name like `SamplesProject-DontDieDeployment-78AIXR0N004N-DontDieAWS-1I1ZC6YO7KU7F-DailyGiftTable-1G4G33K16D8ZS` where `SamplesProject` is the name of the project, `DontDieDeployment` is the name of a deployment, and `DontDieAWS` is the name of a resource group. The `78AIXR0N004N`, `1I1ZC6YO7KU7F` and `1G4G33K16D8ZS` parts of the resource name are inserted by AWS CloudFormation to guarantee that the resource name is unique over time. Thus, even if a resource is deleted and a new one with the same logical name is created, the physical resource ID will be different.

Usually different deployments, and consequently different mappings, are used for game development and for the released version of a game. Furthermore, different development, test, and other teams often work with their own deployments so that each team has distinct mappings.

The deployment used by default during development is specified in the `{root}\{game}\AWS\project-settings.json` (p. 268) file and can be overridden for each user by the `{root}\Cache\{game}\pc\user\AWS\user-settings.json` (p. 270) file. You can change the default deployment by using the `lmb_aws` [default-deployment](#) (p. 214) command or by using the [Cloud Canvas Resource Manager](#) (p. 229).

The mappings used during development when the game is launched from the Lumberyard IDE by pressing **Ctrl+G** are stored in the `user-settings.json` (p. 270) file just mentioned. This file is updated automatically when the default deployment changes, when the default deployment is updated, and when Lumberyard Editor is started. It can be refreshed manually by using the `lmb_aws` [update-mappings](#) (p. 222) command.

When a game launcher application created in Lumberyard launches a release build of a game, the mappings for the game are stored in the `{root}\{game}\Config\awsLogicalMappings.json` file. These mappings can be updated manually using the `lmb_aws` [update-mappings --release](#) (p. 222) command, which produces the `awsLogicalMappings.json` file. You can specify the deployment for the release mappings in the `ReleaseDeployment` property of the `project-settings.json` (p. 268) file.

In both cases, the [AWS Client Configuration](#) (p. 305) system is configured with the mapping data. You can use this configuration in AWS flow nodes, with the AWS C++ SDK, and in Lambda functions.

Using Mappings in AWS Flow Nodes

AWS flow nodes that define `TableName` (DynamoDB), `FunctionName` (Lambda), `QueueName` (Amazon SQS), `TopicARN` (Amazon SNS), or `BucketName` (Amazon S3) ports work with mappings. Set the port to a value like `{resource-group}.{resource}` where `{resource-group}` is the name of the resource group that defines the resource, and where `{resource}` is the name of the resource that appears in the `Resources` section of the resource group's `resource-template.json` file. The AWS flow nodes use the [AWS Client Configuration](#) (p. 305) system to look up the actual resource name by referring to the names in the `{resource-group}.{resource}` format. For detailed information on the Cloud Canvas flow graph nodes, see the [Cloud Canvas Flow Graph Node Reference](#) (p. 245).

Using Mappings with the AWS C++ SDK

The [AWS Client Configuration \(p. 305\)](#) system supports the configuration of service specific clients using arbitrary application defined names. The Lumberyard IDE uses names in the `{resource-group}.{resource}` format to define configurations that map from those friendly names to the actual resource name that must be provided when calling AWS C++ SDK APIs. This configuration can be retrieved and used by using C++ code like the following.

Code example: mapping resource names in C++

```
#include <LmbrAWS\IAWSClientManager.h>
#include <LmbrAWS\ILmbrAWS.h>
#include <aws\lambda\LambdaClient.h>
#include <aws\lambda\model\InvokeRequest.h>
#include <aws\lambda\model\InvokeResult.h>
#include <aws\core\utils\Outcome.h>

void InvokeSayHello()
{
    LmbrAWS::IClientManager* clientManager = pEnv->pLmbrAWS-
>GetClientManager();

    // Use {resource-group}.{resource} format name to lookup the configured
    client.
    LmbrAWS::Lambda::FunctionClient client = clientManager-
>GetLambdaManager().CreateFunctionClient("HelloWorld.SayHello");

    // Get the Lambda function resource name using the
    client.GetFunctionName() method.
    Aws::Lambda::Model::InvokeRequest req;
    req.SetFunctionName(client.GetFunctionName());

    // Invoke the Lambda function asynchronously (async isn't required, but
    you should never
    // do network I/O in the main game thread).
    client->InvokeAsync(req,
        [] (const Aws::Lambda::LambdaClient*,
            const Aws::Lambda::Model::InvokeRequest&,
            const Aws::Lambda::Model::InvokeOutcome& outcome,
            const std::shared_ptr<const Aws::Client::AsyncCallerContext>&)
        {
            if(outcome.IsSuccess())
            {
                const Aws::Lambda::Model::InvokeResult& res =
                outcome.GetResult();
                // TODO: process the result
            }
        }
    );
}
```

Using Mappings in Lambda Functions

Lambda function resources defined as part of a resource group often need to access other resources defined by that resource group. To do this, the function code needs a way to map a friendly resource

name to the actual resource name used in AWS API calls. The `LambdaConfiguration` resource provides a way to such mappings, as well as other settings, to the lambda code. For more information, see [LambdaConfiguration](#) (p. 295).

Custom Resources

Cloud Canvas provides a number of [AWS CloudFormation custom resources](#) that can be used in the project, deployment, and resource group AWS CloudFormation template files. These custom resources are implemented by the Lambda function code found in the `{root}\{game}\AWS\project-code` directory and the `ProjectResourceHandler` resource defined in the `{root}\{game}\AWS\project-template.json` file. Rather than static entities, these resources act more like library functions. Each custom resource has input and output properties.

A summary list of custom resources follows.

- [CognitoIdentityPool](#) (p. 293) – Manages Amazon Cognito identity pool resources.
- [EmptyDeployment](#) (p. 294) – Used in the `deployment-template.json` when there are no resource groups defined.
- [ResourceGroupConfiguration](#) (p. 294) – Provides configuration data for a resource-group's AWS CloudFormation stack resource.
- [LambdaConfiguration](#) (p. 295) – Provides configuration data for Lambda function resources and maintains the Lambda function's execution role.
- [PlayerAccess](#) (p. 296) – Maintains the policies on the player role.

CognitoIdentityPool

The `Custom::CognitoIdentityPool` resource is used in the `deployment-access-template.json` file to create and configure Amazon Cognito identity pool resources.

Input Properties

- `ConfigurationBucket`

Required. The name of the Amazon S3 bucket that contains the configuration data.

- `ConfigurationKey`

Required. The Amazon S3 object key prefix where project configuration data is located in the configuration bucket. This property causes the custom resource handler to be executed by AWS CloudFormation for every operation.

- `IdentityPoolName`

Required. The name of the identity pool.

- `UseAuthSettingsObject`

Required. Must be either `true` or `false`. Determines whether the Amazon Cognito identity pool is configured to use the authentication providers created using the `add-login-provider` command.

- `AllowUnauthenticatedIdentities`

Required. Must be either `true` or `false`. Determines whether the Amazon Cognito identity pool is configured to allow unauthenticated identities. See [Identity Pools](#) for more information on Amazon Cognito's support for authenticated and unauthenticated identities.

- `Roles`

Optional. Determines the IAM role assumed by authenticated and unauthenticated users. See [SetIdentityPoolRoles](#) for a description of this property.

Output Properties

- `IdentityPoolName`

The name of the identity pool (same as the `IdentityPoolName` input property).

- `IdentityPoolId`

The physical resource name of the identity pool.

EmptyDeployment

The `Custom::EmptyDeployment` resource is used in the `deployment-template.json` file when there are no resource groups defined. This is necessary to satisfy the AWS CloudFormation requirement that a template define at least one resource.

This resource supports no input or output properties.

ResourceGroupConfiguration

The `Custom::ResourceGroupConfiguration` resource is used in the `deployment-template.json` to identify the location of the copy of the `resource-template.json` file in the configuration bucket that should be used for a specific resource group.

Input Properties

- `ConfigurationBucket`

Required. The name of the Amazon S3 bucket that contains the configuration data.

- `ConfigurationKey`

Required. The Amazon S3 object key prefix where the deployment configuration data is located in the configuration bucket.

- `ResourceGroup`

Required. The name of the resource group that is to be configured.

Output Properties

- `ConfigurationBucket`

The name of the Amazon S3 bucket that contains the configuration data. This is always the same as the `ConfigurationBucket` input property.

- `ConfigurationKey`

The Amazon S3 object key prefix where the specified resource group's configuration data is located in the configuration bucket. This is the input `ConfigurationKey` with the string "ResourceGroup" and the value of `ResourceGroup` appended.

- `TemplateURL`

The Amazon S3 URL of the resource group's copy of the `resource-template.json` in the configuration bucket. This value should be used as the resource group's `TemplateURL` property value.

LambdaConfiguration

The `Custom::LambdaConfiguration` resource is used in `resource-template.json` files to provide configuration data for Lambda function resources.

Input Properties

- `ConfigurationBucket`

Required. The name of the Amazon S3 bucket that contains the configuration data.

- `ConfigurationKey`

Required. The Amazon S3 object key prefix where configuration data for the resource group is located in the configuration bucket.

- `FunctionName`

Required. The friendly name of the Lambda Function resource being configured.

- `Settings`

Optional. Values that are made available to the Lambda function code.

- `Runtime`

Required. Identifies the runtime used for the Lambda function. Cloud Canvas currently supports the following Lambda runtimes: `nodejs`, `python2.7`.

Output Properties

- `ConfigurationBucket`

The name of the Amazon S3 bucket that contains the configuration data. This is always the same as the `ConfigurationBucket` input property.

- `ConfigurationKey`

The Amazon S3 object key prefix where the specified function's zipped up code is located in the configuration bucket.

- `Runtime`

The Lambda runtime used by the function. This is always the same as the input `Runtime` property value.

- `Role`

The ID of the Lambda function execution created for this function.

For information on how the `LambdaConfiguration` custom resource is used to allow Lambda functions to perform specified actions on specific project resources, see [Lambda Function Access Control](#) (p. 298).

PlayerAccess

The `Custom::PlayerAccess` resource is used in `resource-template.json` files to update the player role so that players have the desired access to the resource group's resources. It is also used in the `deployment-access-template.json` file to update the player role so that players have the desired access to the deployment's resources.

Input Properties

- `ConfigurationBucket`

Required. The name of the Amazon S3 bucket that contains the configuration data.

- `ConfigurationKey`

Required. The Amazon S3 object key prefix where configuration data for the deployment is located in the configuration bucket. The value of this property isn't actually used, however since the Cloud Canvas tools insure that the key is different for each AWS CloudFormation operation, the presences of this property has the effect of forcing the custom resource handler to be executed by AWS CloudFormation on for every operation.

- `ResourceGroup`

Optional. The ID of the resource group for which the player role is updated.

- `DeploymentStack`

Optional. The ID of the deployment for which the pcolayer role is updated.

Only one of the `ResourceGroup` and `DeploymentStack` properties must be provided.

Output Properties

The `PlayerAccess` custom resource does not produce any output values.

PlayerAccess Metadata Format

This custom resource looks for `Metadata.CloudCanvas.PlayerAccess` properties on the project's resource group definitions and constructs a policy which is attached to the player role. The policy allows the indicated actions on those resources. The `Metadata.CloudCanvas.PlayerAccess` property has the following form:

```
{
  "AWSTemplateFormatVersion": "2010-09-09",
  "Resources": {
    "...": {
      "Type": "...",
      "Properties": {
        ...
      },
      "Metadata": {
        "CloudCanvas": {
          "PlayerAccess": {
            "Action": [ "{allowed-action-1}", ..., "{allowed-
action-n}" ]
          }
        }
      }
    }
  }
}
```

```
}  
  ...  
}
```

The required `Action` property is the same as defined for an IAM policy and is described in detail in the [IAM Policy Elements Reference](#). Note that a single value can be provided instead of a list of values.

Access Control and Player Identity

Cloud Canvas helps you control access to your game's AWS resources in three ways:

- [Project Access Control](#) (p. 297)
- [Player Access Control](#) (p. 298)
- [Lambda Function Access Control](#) (p. 298)

Project Access Control

It is often necessary to limit project team member access to the project's resources. This can help prevent different development teams from accidentally updating the resources being used by another development team. It is also necessary to prevent project team members from accessing the resources used by the released version of the game, both to prevent accidental changes that could impact the operation of the game but in some cases to also prevent project team members from accessing player's personal information, such as e-mail addresses, which may be stored in those resources.

The default [deployment-access-template.json](#) (p. 278) file provided by Cloud Canvas defines an [OwnerPolicy Resource](#) (p. 284) IAM managed policy resource, which allows a deployment AWS CloudFormation stack to be updated, including creating, updating, and deleting the resources defined by the project's resource groups. This template also defines an [Owner Resource](#) (p. 284). IAM role resource that has the `OwnerPolicy` attached.

If desired, the `OwnerPolicy` resource definition in the `deployment-access-template.json` file can be modified or additional policies can be created. However, be sure that you really understand how IAM permissions work before doing so. Incorrectly using this resource definition can make your AWS account vulnerable to attack and abuse, which could result in unexpected AWS charges (in addition to any other repercussions).

Authorize AWS Use in Lumberyard Editor

To authorize a group of developers to use AWS via Lumberyard Editor, perform the following steps.

To authorize AWS use in Lumberyard Editor

1. Create an IAM user for each developer.
2. Generate the access key and secret keys for each user.
3. Attach a policy to the IAM user that determines what that user is allowed to do. These policies are generated when a project is initialized, or you can apply your own.
4. Deliver the access key and secret key to the developer by a secure method.

Caution

You should not deliver access or secret keys by using email, or check them into source control. Such actions present a significant security risk.

5. In Lumberyard Editor, have each developer navigate to **AWS, Cloud Canvas, Permissions and deployments**.
6. Have the developer add a new profile that uses the access key and secret key that he or she has been provided.

Player Access Control

In order for the game to access AWS resources at runtime, it must use credentials that grant the necessary access when calling AWS APIs. This could be done by creating an IAM user with limited privileges and embedding that user's credentials (both the AWS access key and the secret key) in the game code. But AWS [Amazon Cognito identity pools](#) provide a more powerful and secure solution for this problem.

How Cloud Canvas uses Amazon Cognito identity pools is described in the [Player Identity \(p. 300\)](#) section.

Ultimately player access is controlled by the player role defined in the default Cloud Canvas [deployment-access-template.json \(p. 278\)](#) file. The policies attached to this role are set by the [PlayerAccess Resource \(p. 289\)](#) custom resources that appear in the [resource-template.json \(p. 285\)](#) files.

Lambda Function Access Control

When an AWS Lambda function is executed, it assumes an IAM role that determines the access the function has to other AWS resources. Creating and configuring such roles requires IAM permissions that cannot safely be granted to all the project's team members; doing so would allow them to circumvent the security measures that limit their access to specific deployments.

To implement Lambda-function access control without requiring that the project team members be granted these IAM privileges, you use the Cloud Canvas [LambdaConfiguration \(p. 295\)](#) custom resource. Using the `Metadata.CloudCanvas.FunctionAccess` entries on each of the group resources to which a Lambda function requires access, the handler for the `LambdaConfiguration` resource creates and configures a role for each Lambda function that allows the function to perform the indicated actions on the resources it requires.

The `Metadata.CloudCanvas.Function` property has the following form:

```
{
  "AWSTemplateFormatVersion": "2010-09-09",
  "Resources": {
    "...": {
      "Type": "...",
      "Properties": {
        ...
      },
      "Metadata": {
        "CloudCanvas": {
          "FunctionAccess": {
            "Action": [ "{allowed-action-1}", ..., "{allowed-
action-n}" ],
            "ResourceSuffix": "{resource-suffix}"
          }
        }
      }
    },
    ...
  }
}
```

```
}
}
```

The required `Action` property is the same as defined for an IAM policy and is described in detail in the [IAM Policy Elements Reference](#). Note that a single value can be provided instead of a list of values.

The optional `ResourceSuffix` property value is appended to the resource's ARN in the generated policy. This can be used to further restrict access to the resource. For example, for Amazon S3 buckets it can be used to restrict access to objects with matching names. For more information, see [Resource](#) in the [IAM Policy Elements Reference](#).

The following diagram illustrates how different elements of Lumberyard access control work together.

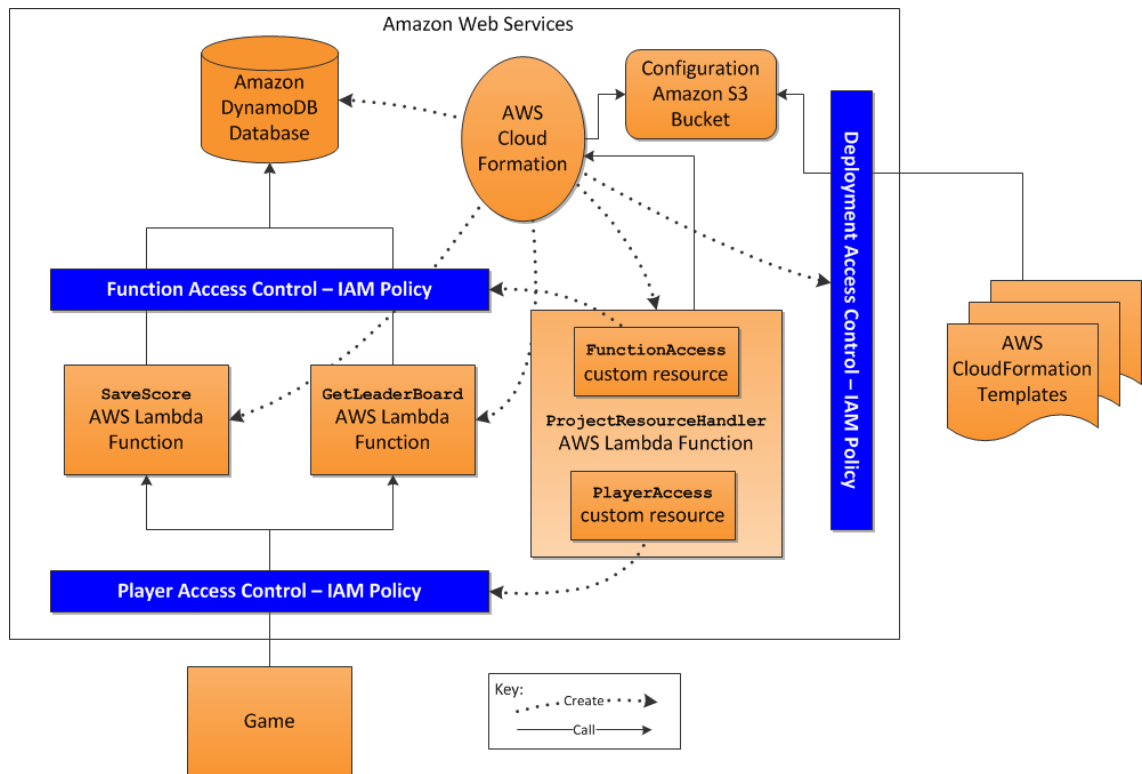

In the diagrammed example, Lambda functions do things like submit a player's high scores to a DynamoDB database or retrieve the top ten scores from it.

The Player Access Control IAM policy allows the game to call Lambda functions on behalf of the player. In turn, the Function Access Control policy determines the AWS resources that Lambda functions can access (in the example, it's a DynamoDB database). This secure arrangement prevents the player from accessing the DynamoDB database directly and offers the following benefits:

- It enables you to validate the input from the client and remove insecure or unwanted inputs. For example, if a client self-reports an impossibly high or low score, you can reject the unwanted value before it can be written to the database.
- It prevents a customer from trying to access another customer's data.
- It prevents malicious attacks.

To create (and later, update as required) the DynamoDB database, Lambda functions, and access control policies, AWS CloudFormation reads the AWS CloudFormation templates from the Amazon

S3 configuration bucket and executes the instructions they contain. AWS CloudFormation reads the `deployment-access-template.json` file and creates a Deployment Access Control IAM policy, which determines which resources AWS CloudFormation can create or update for a particular deployment. This is key in keeping development, test, and live deployments separate and secure from one another.

The templates also use custom resources to implement functionality that AWS CloudFormation by itself cannot perform. In Lumberyard, custom resources are like library functions. For example, the `deployment-access-template.json` file calls the `CognitoIdentityPool` custom resource to create Amazon Cognito identity pools. To create the Function Access Control IAM policy for each Lambda function, the template calls the `LambdaConfiguration` custom resource. The custom resource reads the `FunctionAccess` metadata entries for the particular resources to which the Lambda function should have access and creates the Function Access Control policy that is needed for the current user and deployment.

Similarly, the `resource-template.json` template `PlayerAccess` custom resource is called to create the Player Access Control policy, which determines the Lambda functions and other resources that the game can call and use on behalf of the player.

Player Identity

As described in the preceding section [Player Access Control \(p. 298\)](#), the game must use AWS credentials that grant the desired access when calling AWS APIs (using either the C++ AWS SDK or the AWS flow nodes). Cloud Canvas uses an [Amazon Cognito identity pool](#) to get these credentials.

Using an Amazon Cognito identity pool has the benefit of providing the game with a unique identity for each individual player. This identity can be used to associate the player with their saved games, high scores, or any other data stored in DynamoDB tables, Amazon S3 buckets, or other locations.

Amazon Cognito identity pools support both unauthenticated and authenticated identities. Unauthenticated identities are associated with a single device such as a PC, tablet, or phone, and have no associated user name or password.

Authenticated identities are associated with the identity of an user as determined by an external identity provider such as Amazon, Facebook, or Google. This allows Amazon Cognito to provide the game with the same player identity everywhere a user plays a game. The user's saved games, high scores, and other data effectively follow the user from device to device.

Amazon Cognito allows a user to start with an unauthenticated identity and then associate that identity with an external identity at a later point in time while preserving the Amazon Cognito-provided identity.

Cloud Canvas supports both anonymous (unauthenticated) and authenticated player identities, but authenticated identity support is more complex and requires additional setup and coding.

Anonymous (Unauthenticated) Player Login

The login process for anonymous (unauthenticated) players is shown in the diagram below:

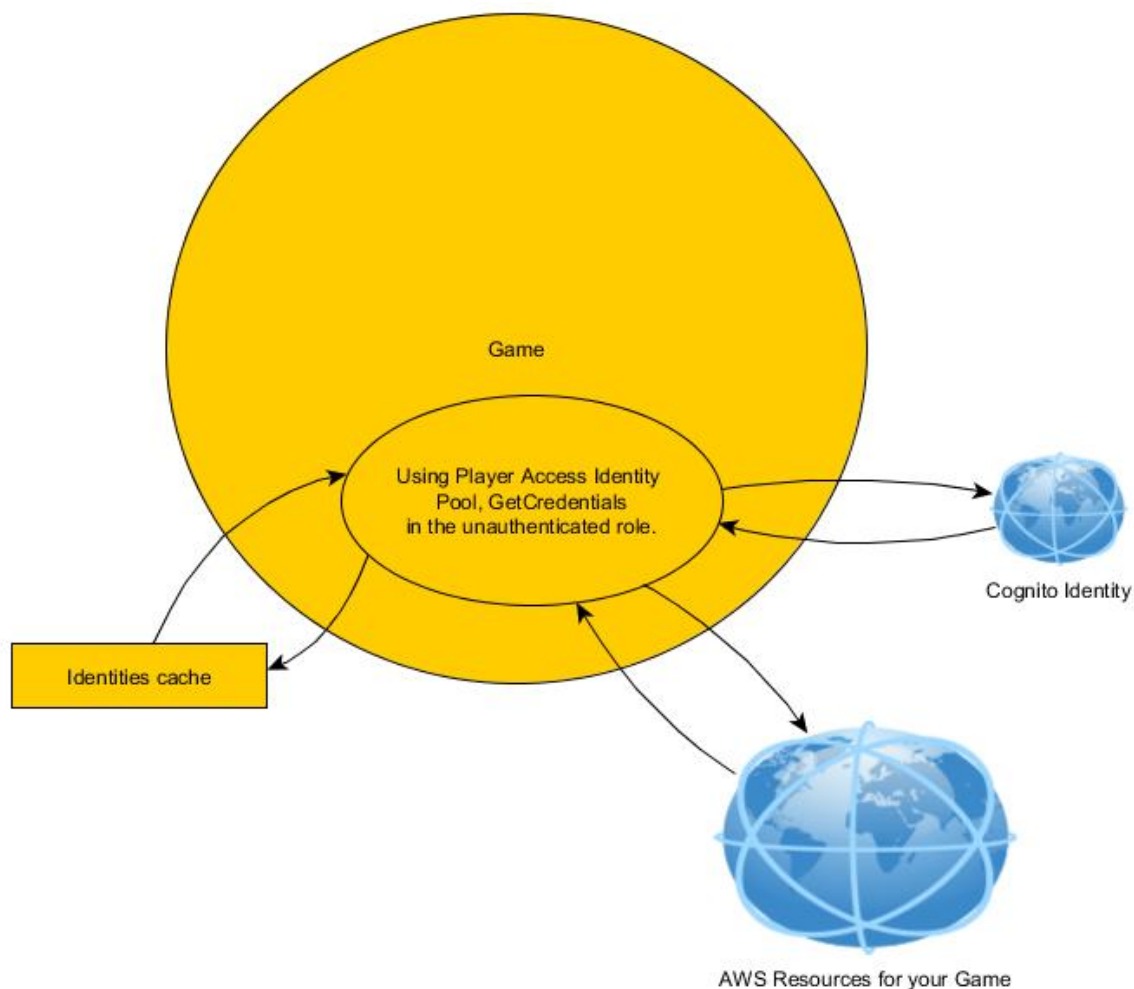

This process takes place automatically when the Cloud Canvas client configuration system is initialized by calling `gEnv->lmbraWS->GetClientManager()->ApplyConfiguration()`, or by using a Cloud Canvas `(AWS):Configuration:ApplyConfiguration` Flow Node.

Authenticated Player Login

In order to understand how to use Cloud Canvas to implement authenticated player identities for your game, you must be familiar with Amazon Cognito's Enhanced (Simplified) Authflow. For information, see the article [Authentication Flow](#) in the [Amazon Cognito Developer Guide](#).

The login process for authenticated player identities, shown in the diagram that follows, is more complex than the anonymous player login process. This login process requires additional setup beyond what Cloud Canvas provides by default.

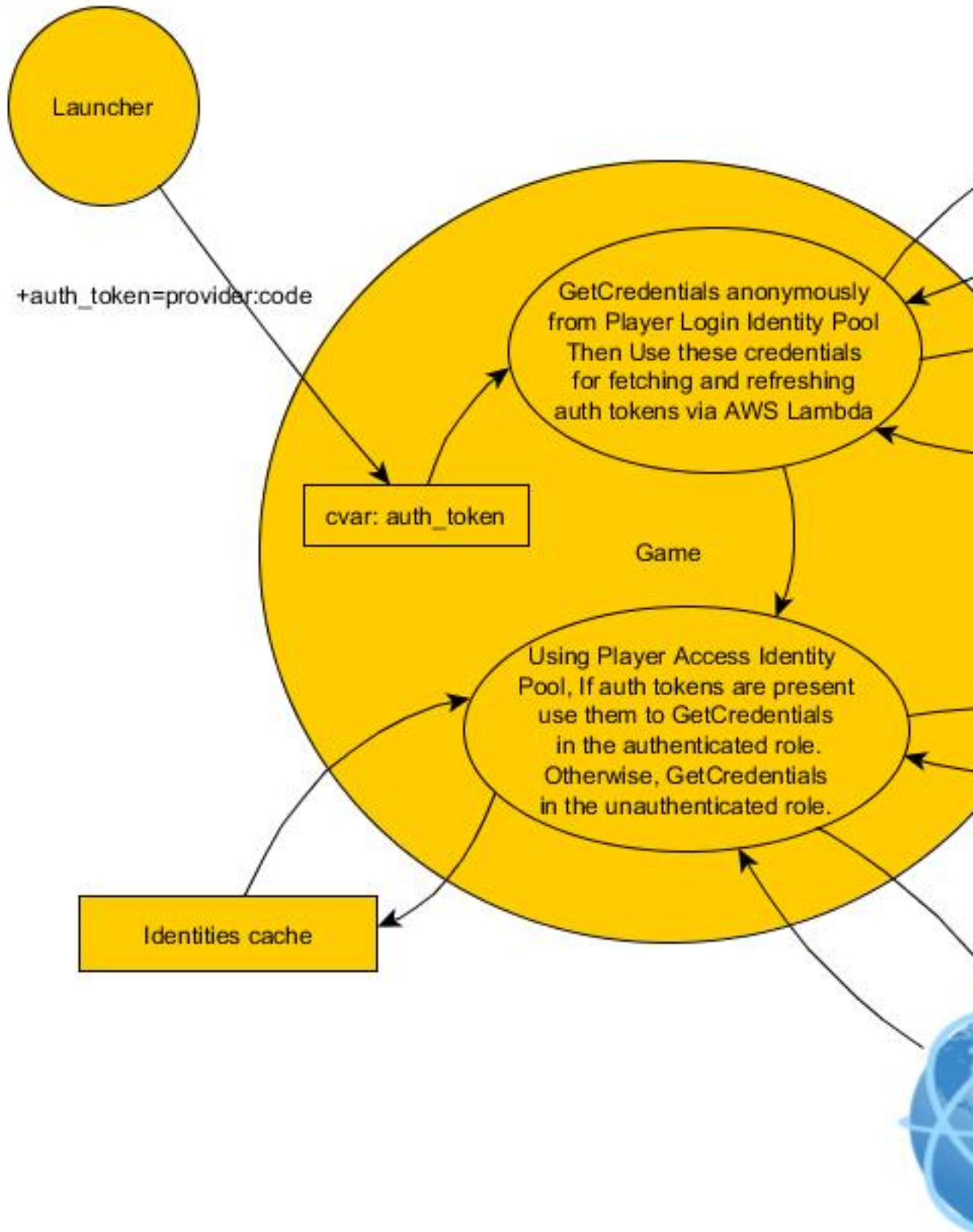

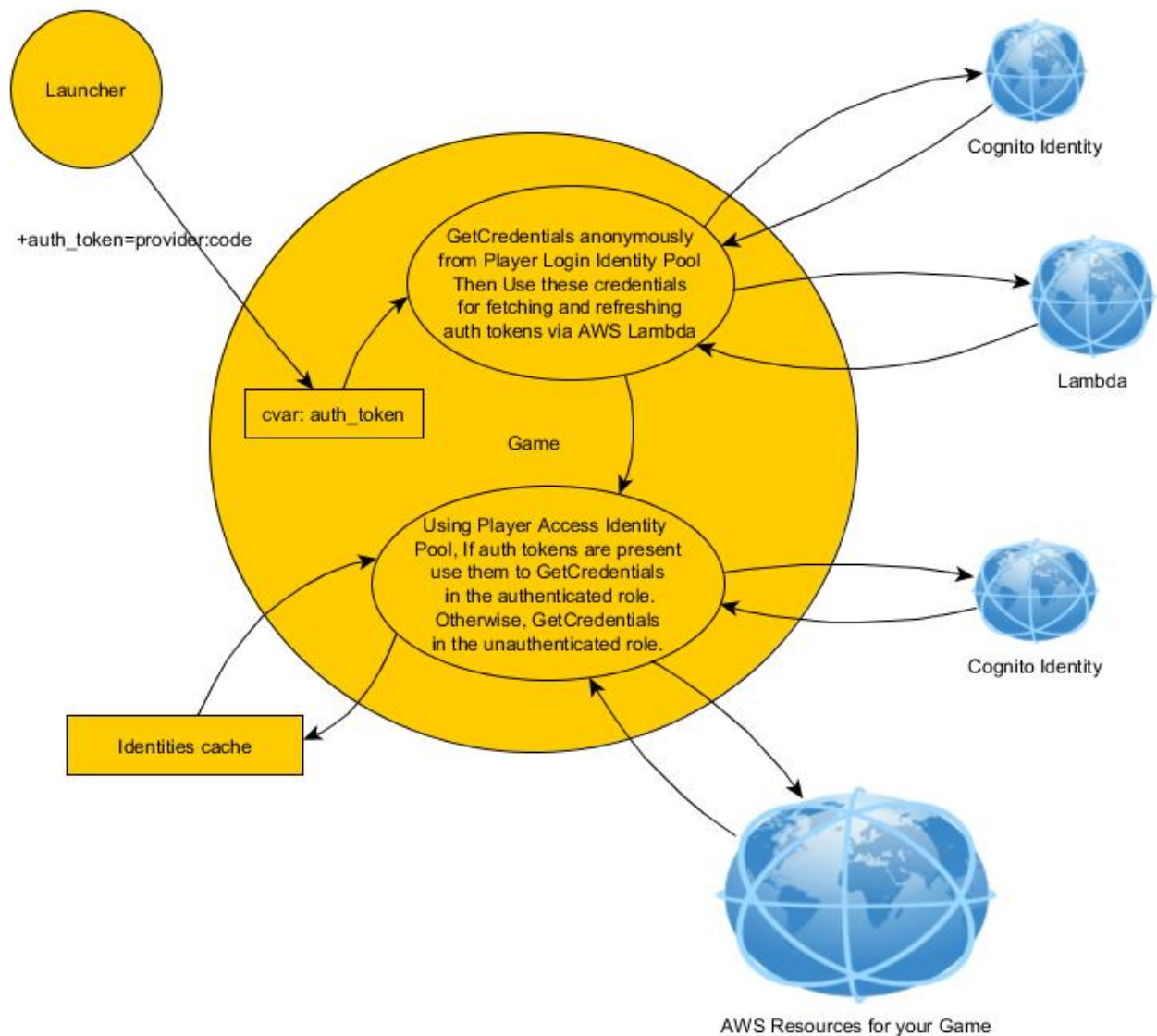

The authenticated player login process takes place automatically when the Cloud Canvas client configuration system is initialized by calling `gEnv->lmbAWS->GetClientManager()->ApplyConfiguration()`, or by using a Cloud Canvas `(AWS):Configuration:ApplyConfiguration` flow node.

The presence of the `auth_token` `cvar` triggers the Cloud Canvas authenticated player login flow. If the `cvar` is not set, the anonymous player login process is used. The value of the `cvar` must be a string of the form `{provider}:{id}`, where `{provider}` identifies an external identity provider that you have configured for your game (see [Configuring External Identity Providers \(p. 304\)](#) in the section that follows) and `{id}` is the player's identity as returned by the login process for that provider.

When `auth_token` is set, Cloud Canvas will pass the provided `{id}` value to the `ProjectPlayerAccessTokenExchangeHandler` Lambda function. The Lambda function calls the external provider's API to with the specified ID and receives a value that is passed to Amazon Cognito to get the player's identity and credentials. The calls made by `ProjectPlayerAccessTokenExchangeHandler` use application IDs and the secret values you provide as part of the external identity provider configuration process.

As shown in the diagram above, Cloud Canvas uses one Amazon Cognito identity pool to get the credentials used to invoke the `ProjectPlayerAccessTokenExchangeHandler` and a different Amazon Cognito identity pool to get the credentials used to access the rest of your game's resources. This is required because access `ProjectPlayerAccessTokenExchangeHandler` is always anonymous.

All the code that implements the authenticated login flow can be found in the `{root}\Code\CryEngine\LmbrAWS\Configuration` directory. A description of the files follows.

- `ClientManagerImpl.*` – Configures the game's AWS clients to use the `TokenRetrievingPersistentIdentityProvider` identity provider.
- `ResourceManagementLambdaBasedTokenRetrievalStrategy.*` – implements the token exchange process that calls the `ProjectPlayerAccessTokenExchangeHandler` Lambda function.
- `TokenRetrievingPersistentIdentityProvider.*` – An implementation of the `PersistentCognitoIdentityProvider` interface defined in the AWS SDK that uses `ResourceManagementLambdaBasedTokenRetrievalStrategy` instances to implement the token exchange process.

Configuring External Identity Providers

Cloud Canvas does not automate the process of retrieving an auth code from an external identity provider and setting the `auth_token` cvar. This is your responsibility as a game developer. Following are some possible implementation methods:

- On a PC, you can have your identity provider redirect its URI to a static web page that redirects the user to a custom URI. You can use the custom URI to launch the game and pass the auth code as a command line argument (for example, `yourGame.exe +auth_token=provider:code`). Cloud Canvas detects this command line argument and logs the user into your game. This only has to be done once since the auth tokens are cached locally.
- You can have your game retrieve the auth code itself (but for many external identity providers, this may require using an embedded web browser). After retrieving the auth code, you can call `gEnv->lmbrAWS->>GetClientManager()->Login(providerName, code)`, or just set the cvar `auth_token`.
- If you have a launcher for your game, you can embed a web browser window in the launcher to allow the player to log in to the external identity provider. You can then retrieve the auth code and launch the game by using the `+auth_token=provider:code` parameter.

External identity providers are configured using the `lmbr_aws add-login-provider` (p. 211), `update-login-provider` (p. 221), and `remove-login-provider` (p. 220) commands. These commands save the configuration in a `/player-access/auth-settings.json` object in the project's configuration bucket so that the `ProjectPlayerAccessTokenExchangeHandler` Lambda function can access it.

Note

You must run `lmbr_aws update-project` after running `add-login-provider`, `update-login-provider`, or `remove-login-provider` so that the [PlayerAccessIdentityPool Resource](#) (p. 285) configuration will be updated to reflect the change.

Automatic Token Refresh

When using Amazon Cognito with external identity providers, it is necessary to periodically refresh the token from that provider and then get updated credentials for that token from Amazon Cognito. Cloud Canvas performs this token refresh process automatically by using the `ProjectPlayerAccessTokenExchangeHandler` Lambda function.

AWS Client Configuration

Access to AWS services from C++ is controlled through AWS client objects. Cloud Canvas provides a layer of abstraction on top of the AWS clients given by the SDK. This enables you to easily apply configuration changes across client objects, including those being used internally by Cloud Canvas flow graph nodes. These changes can be made through C++ or with the provided flow graph nodes.

Configuring AWS Flow Graph Nodes

Lumberyard provides flow graph nodes that perform various AWS operations, such as invoking a Lambda function or reading data from a DynamoDB table. Each flow graph node has a port that identifies the AWS resource to operate on. For example, DynamoDB nodes have a `TableName` port that identifies a DynamoDB table. For detailed information on the Cloud Canvas flow graph nodes, see the [Cloud Canvas Flow Graph Node Reference](#) (p. 245).

By default, the AWS resource uses the value you specify for the name. You can use the default client settings to configure the client that accesses the resource.

To vary the resource name based on game settings

1. In the default client settings, add a parameter reference in the resource name.
2. Use the `Cloud Canvas (AWS):Configuration:SetConfigurationVariable` flow graph node to set the value that replaces the parameter reference in the resource name.

For example, if you aren't using Resource Deployments but still want to manage resources in different stages, you can use `"DailyGift_${stage$}"` for your table name and set the `"${stage$}"` parameter value to `"test"` or `"release"` based on the conditions you choose.

If you want to use different client settings (for example, timeouts) for different resources, you can use the C++ API to set up named configurations. When the resource name provided to the flow graph node matches a named configuration, the configuration is used to set up the client to access the resource.

The configuration-related flows are as follows:

- `ConfigureProxy` – Configures the HTTP proxy host, port, user, and password used for AWS service calls.
- `SetConfigurationVariable` – Sets the parameter value for the AWS resource.
- `GetConfigurationVariableValue` – Replaces the `"${param$}"` substrings in a string with the current parameter value or `" "` if there is no current value.
- `SetDefaultRegion` – Sets the region for all AWS clients in the current project.
- `ApplyConfiguration` – Applies AWS configuration settings set by the other configuration flow graph nodes. This allows you to apply multiple changes at once to prevent changes from being applied out of the desired order.

Configuring Using C++

The Client Manager implementation and the AWS flow graph node implementations are provided through the Cloud Canvas Gem. To use the Client Manager, add the **Cloud Canvas Gem** to your game project by using the Project Configurator. To get the Client Manager in code, call `gEnv->pLmbrAWS->GetClientManager()`. This will return an interface called `IClientManager`.

The Client Manager maintains a set of parameter name to parameter value mappings. You can access these mappings by using the object returned by the `GetConfigurationParameters` method. You can then insert parameter values into certain configuration settings by using `"${param-name$}"`

substrings. If the parameter value contains "\$param-name\$" substrings, these are also replaced with the corresponding parameter value.

AWS client configurations are based on the properties of the object returned by the Client Manager's `GetDefaultClientSettings` method. You can specify named overrides for these settings by using the collection object returned by the `GetClientSettingsOverridesCollection` method. Overrides can aggregate other overrides by name, allowing common configuration settings to be specified once and then reused. These names can include "\$param-name\$" values, which are replaced as described above. If the resource name for an AWS flow graph node matches the name of a client settings overrides collection entry, those overrides are used by the client to access the resource.

Service-specific configurations are provided through the following Client Manager methods: `GetCognitoIdentityManager`, `GetDynamoDBManager`, `GetIAMManager`, `GetLambdaManager`, `GetS3Manager`, `GetSNSManager`, `GetSQSManager`, and `GetSTSManager`.

Each of these service-specific managers provide the following:

- A `GetDefaultClientSettingsOverrides` method that returns an object that can be used to define the default settings for all of a particular service's clients.
- Methods that allow resources to be configured by name.

For example, the DynamoDB manager has a `GetTableClientSettingsCollection` method that you can use to configure settings (the configuration name and resource name associated with the configuration) for a specific DynamoDB table. The resource name can include "\$param-name\$" values, which are replaced as described above.

In an AWS flow graph node, you can use the configuration name as the resource name in order to use that configuration. In this case, the configuration name acts as an alias for the actual resource name. For example, a node could specify "DailyGift" as the table name and the resource configuration "DailyGift" could specify "foo-bar-\$stage\$" as the resource name.

If you use the name "DailyGift_\$stage\$" in a flow graph node and do not define a resource configuration for the name "DailyGift_\$stage\$", a default configuration is created that uses "DailyGift_\$stage\$" for both the configuration name and resource name.

Using Configured Clients from C++

The Client Manager methods (`GetCognitoIdentityManager`, `GetDynamoDBManager`, `GetIAMManager`, `GetLambdaManager`, `GetS3Manager`, `GetSNSManager`, `GetSQSManager`, and `GetSTSManager`) return objects that provide methods for creating clients configured with the settings described above.

The `CreateManagedClient` method returns a client object that is configured using the client settings overrides identified by the provided name. This object can be passed around by value. The client's methods are accessed using the `->` operator.

You can use the resource-specific `CreateXClient` methods (for example, `CreateTableClient` for a DynamoDB table resource) to configure a client to access a specific resource. The returned object has a method for retrieving the resource name (such as `client.GetTableName`), while the client methods are accessed using the `->` operator (e.g. `client->GetItem(...)`).

Important

You can create clients in an unconfigured state. Flow graph nodes and other game components can create clients before the configuration for the clients is fully initialized. For example, the Amazon Cognito credentials provider and configuration parameters may need to be initialized by flow graph nodes that are triggered at game start, before other flow graph nodes or components can access AWS services. Because of this, you must trigger client configuration explicitly once the settings are confirmed complete.

You must call the Client Manager's `ApplyConfiguration` method at least once before clients are ready for use. After you make configuration changes, you must call the method again for those changes to take effect. You can use the `IsReady` method (`client.IsReady()`, not `client->IsReady()`) to determine if a client has been configured.

Component Entity System

The Component Entity System is currently in preview and is undergoing active development. It will replace the legacy [Entity System \(p. 373\)](#).

This guide provides engine and game programmers with examples and best practices for creating and reflecting custom Lumberyard components in C++. For information on using the Component Entity System in Lumberyard Editor, see [Component Entity System](#) in the [Amazon Lumberyard User Guide](#).

Topics

- [Creating a Component \(p. 308\)](#)
- [Reflecting a Component for Serialization and Editing \(p. 310\)](#)
- [Slices and Dynamic Slices \(p. 316\)](#)

Creating a Component

The Component Entity System is currently in preview and is undergoing active development. It will replace the legacy [Entity System \(p. 373\)](#).

A component in Lumberyard is a simple class that inherits from Lumberyard's `AZ::Component`. A component's behavior is determined by its reflected data and the actions it takes when it is activated. This section shows you how to create Lumberyard components programatically. For information about adding and customizing the components available in Lumberyard Editor, see [Component Entity System](#) in the [Amazon Lumberyard User Guide](#).

Component Example

An example component class skeleton follows:

```
class MyComponent
  : public AZ::Component
{
public:
  AZ_COMPONENT(MyComponent, "{0C09F774-DECA-40C4-8B54-3A93033EC381}");

  //////////////////////////////////////
```

```
// AZ::Component interface implementation
void Init() override {}
void Activate() override {}
void Deactivate() override {}
////////////////////////////////////

// Required Reflect function.
static void Reflect(AZ::ReflectContext* context);

// Optional functions for defining provided and dependent services.
static void
GetProvidedServices(AZ::ComponentDescriptor::DependencyArrayType& provided)
static void
GetDependentServices(AZ::ComponentDescriptor::DependencyArrayType&
dependent);
static void
GetRequiredServices(AZ::ComponentDescriptor::DependencyArrayType& required);
static void
GetIncompatibleServices(AZ::ComponentDescriptor::DependencyArrayType&
incompatible);
};
```

Component Elements

The required and optional elements that comprise a component are as follows:

AZ::Component

Every component must include `AZ::Component` somewhere in its inheritance ancestry. Noneditor components generally inherit directly from `AZ::Component`, but you can create your own component class hierarchies, as in the following example:

```
class MyComponent
    : public AZ::Component
```

AZ_COMPONENT macro

Every component must specify the `AZ_COMPONENT` macro in its class definition. The macro takes two arguments:

1. The component type name.
2. A unique UUID. You may use any UUID generator to produce the value. Visual Studio provides this functionality through **Tools, Create GUID**. Use the **Registry Format** setting, and then copy and paste the value that is generated.

A sample `AZ_COMPONENT` macro follows:

```
AZ_COMPONENT(MyComponent, "{0C09F774-DECA-40C4-8B54-3A93033EC381}");
```

AZ::Component functions

To define a component's behavior, you generally override three `AZ::Component` functions: `Init`, `Activate`, and `Deactivate`:

```
void Init() override      {}
void Activate() override  {}
void Deactivate() override {}
```

These functions are as described as follows:

Init() – Optional

Called only once for a given entity. It requires minimal construction or setup work, since the component may not be activated anytime soon. An important best practice is to minimize your component's CPU and memory overhead while the component is inactive.

Activate() – Required

Called when the owning entity is being activated. The system calls your component's `Activate()` function only if all dependent or required services are present. Your `Activate` function is always called after any components that it depends on. In addition the component makeup of an entity never changes while the entity is active, so it is safe to cache pointers or references to other components on the entity in performance-critical situations.

Deactivate() – Required

Called when the owning entity is being deactivated. The order of deactivation is the reverse of activation, so your component is deactivated before the components it depends on. As a best practice, make sure your component returns to a minimal footprint when it is deactivated. In general, deactivation should be symmetric to activation.

Note

Deactivation does not necessarily precede destruction. An entity can be deactivated and then activated again without being destroyed, so ensure that your components support this efficiently. However, when you do destroy your entity, Lumberyard ensures that your `Deactivate()` function is called first. Components must be authored with this in mind.

Reflect() – Required

All components are AZ reflected classes. Because all components must be serializable and editable, they must contain a `Reflect()` function, as in the following example:

```
// Required Reflect function.  
static void Reflect(AZ::ReflectContext* context);
```

For more information, see [Reflecting a Component for Serialization and Editing \(p. 310\)](#).

Logical Services– Optional

Components can define any combination of logical services that they provide, depend on, require, or are incompatible with. To define these logical services, use the following functions:

```
// Optional functions for defining provided and dependent services.  
static  
void GetProvidedServices(AZ::ComponentDescriptor::DependencyArrayType&  
provided)  
static  
void GetDependentServices(AZ::ComponentDescriptor::DependencyArrayType&  
dependent);  
static  
void GetRequiredServices(AZ::ComponentDescriptor::DependencyArrayType&  
required);  
static  
void GetIncompatibleServices(AZ::ComponentDescriptor::DependencyArrayType&  
incompatible);
```

Reflecting a Component for Serialization and Editing

The Component Entity System is currently in preview and is undergoing active development. It will replace the legacy [Entity System \(p. 373\)](#).

Components use AZ reflection to describe the data they serialize and how content creators interact with them.

The following example reflects a component for serialization and editing:

```
class MyComponent
    : public AZ::Component
{
    ...

    enum class SomeEnum
    {
        EnumValue1,
        EnumValue2,
    }
    float m_someFloatField;
    AZStd::string m_someStringField;
    SomeEnum m_someEnumField;
    AZStd::vector<SomeClassThatSomeoneHasReflected> m_things;

    int m_runtimeStateNoSerialize;
}

/*static*/ void MyComponent::Reflect(AZ::ReflectContext* context)
{
    AZ::SerializeContext* serialize =
    azrtti_cast<AZ::SerializeContext*>(context);
    if (serialize)
    {
        // Reflect the class fields that you want to serialize.
        // In this example, m_runtimeStateNoSerialize is not reflected for
        serialization.
        serialize->Class<MyComponent>()
            ->Version(1)
            ->Field("SomeFloat", &MyComponent::m_someFloatField)
            ->Field("SomeString", &MyComponent::m_someStringField)
            ->Field("Things", &MyComponent::m_things)
            ->Field("SomeEnum", &MyComponent::m_someEnumField)
            ;

        AZ::EditContext* edit = serialize->GetEditContext();
        if (edit)
        {
            edit->Class<MyComponent>("My Component", "The World's Most Clever
            Component")
                ->DataElement(AZ::Edit::DefaultHandler,
                &MyComponent::m_someFloatField, "Some Float", "This is a float that means
                X.")
                ->DataElement(AZ::Edit::DefaultHandler,
                &MyComponent::m_someStringField, "Some String", "This is a string that means
                Y.")
                ->DataElement("ComboBox", &MyComponent::m_someEnumField,
                "Choose an Enum", "Pick an option among a set of enum values.")
                    ->EnumAttribute(MyComponent::SomeEnum::EnumValue1, "Value
                    1")
                    ->EnumAttribute(MyComponent::SomeEnum::EnumValue2, "Value
                    2")
                ->DataElement(AZ::Edit::DefaultHandler,
                &MyComponent::m_things, "Bunch of Things", "A list of things for doing Z.")
        }
    }
}
```

```
    }  
    }  
};
```

The preceding example adds five data members to `MyComponent`. The first four data members will be serialized. The last data member will not be serialized because it contains only the runtime state. This is typical; components commonly contain members that are serialized and others that are not.

It is common for fields to be reflected for serialization, but not for editing, when using advanced reflection features such as [change callbacks](#) (p. 315). In these cases, components may conduct complex internal calculations based on user property changes. The result of these calculations must be serialized but not exposed for editing. In such a case, you reflect the field to `SerializeContext`, but not add an entry in `EditContext`. An example follows:

```
serialize->Class<MyComponent>()  
    ->Version(1)  
    ...  
    ->Field("SomeFloat", &MyComponent::m_someFloatField)  
    ->Field("MoreData", &MyComponent::m_moreData)  
    ...  
    ;  
  
...  
  
AZ::EditContext* edit = serialize->GetEditContext();  
if (edit)  
{  
    edit->Class<MyComponent>("My Component", "The World's Most Clever  
Component")  
        ->DataElement(AZ::Edit::DefaultHandler,  
&MyComponent::m_someFloatField, "Some Float", "This is a float that means  
X.")  
            ->EnumAttribute("ChangeNotify", &MyComponent::CalculateMoreData)  
                // m_moreData is not reflected for editing directly.  
                ;  
}
```

Lumberyard has reflection contexts for different purposes, including:

- `SerializeContext` – Contains reflection data for serialization and construction of objects.
- `EditContext` – Contains reflection data for visual editing of objects.
- `BehaviorContext` – Contains reflection for runtime manipulation of objects from Lua, flow graph, or other external sources.
- `NetworkContext` – Contains reflection for networking purposes, including marshaling, quantization, and extrapolation.

Note

This guide covers only `SerializeContext` and `EditContext`.

All of Lumberyard's reflection APIs are designed to be simple, human readable, and human writable, with no forced dependency on code generation.

A component's `Reflect()` function is invoked automatically for all relevant contexts.

The following code dynamically casts the anonymous context provided to a `SerializeContext`, which is how components discern the type of context that `Reflect()` is being called for.

```
AZ::SerializeContext* serialize =  
    azrtti_cast<AZ::SerializeContext*>(context);
```

Serialization

Reflecting a class for serialization involves a [builder pattern](#) style markup in C++, as follows:

```
serialize->Class<TestAsset>()  
    ->Version(1)  
    ->Field("SomeFloat", &MyComponent::m_someFloatField)  
    ->Field("SomeString", &MyComponent::m_someStringField)  
    ->Field("Things", &MyComponent::m_things)  
    ->Field("SomeEnum", &MyComponent::m_someEnumField)  
    ;
```

The example specifies that `m_someFloatField`, `m_someStringField`, `m_things`, and `m_someEnumField` should all be serialized with the component. Field names must be unique and are not user facing.

Tip

We recommend that you keep your field names simple for future proofing. If your component undergoes significant changes and you want to write a data converter to maintain backward data compatibility, you must reference the field names directly.

The preceding example reflects two primitive types—a float, and a string—as well as a container (vector) of some structure. AZ reflection, serialization, and editing natively support a wide variety of types:

- Primitive types, including ints (signed and unsigned, all sizes), floats, and strings
- Enums
- AZStd containers (flat and associative), including `AZStd::vector`, `AZStd::list`, `AZStd::map`, `AZStd::unordered_map`, `AZStd::set`, `AZStd::unordered_set`, `AZStd::pair`, `AZStd::bitset`, `AZStd::array`, fixed C-style arrays, and others.
- Pointers, including `AZStd::smart_ptr`, `AZStd::intrusive_ptr`, and raw native pointers.
- Any class or structure that has also been reflected.

Note

The example omits the reflection code for `SomeClassThatSomeoneHasReflected`. However, you need only reflect the class. After that, you can freely reflect members or containers of that class in other classes.

Editing

When you run Lumberyard tools such as Lumberyard Editor, an `EditContext` and a `SerializeContext` are provided. You can use the robust facilities in these contexts to expose your fields to content creators.

The following code demonstrates basic edit context reflection:

```
AZ::EditContext* edit = serialize->GetEditContext();  
if (edit)  
{  
    edit->Class<TestAsset>("My Component", "The World's Most Clever  
    Component")
```

```
->DataElement(AZ::Edit::DefaultHandler,
&MyComponent::m_someFloatField, "Some Float", "This is a float that means
X.")
->DataElement(AZ::Edit::DefaultHandler,
&MyComponent::m_someStringField, "Some String", "This is a string that means
Y.")
->DataElement("ComboBox", &MyComponent::m_someEnumField, "Choose an
Enum", "Pick an option among a set of enum values.")
->EnumAttribute(MyComponent::SomeEnum::EnumValue1, "Value 1")
->EnumAttribute(MyComponent::SomeEnum::EnumValue2, "Value 2")
->DataElement(AZ::Edit::DefaultHandler, &MyComponent::m_things,
"Bunch of Things", "A list of things for doing Z.")
;
}
```

Although this example demonstrates the simplest usage, many features and options are available when you reflect structures (including components) to the edit context. For the fields to be exposed directly to content creators, the example provides a friendly name and a description (tooltip) as the third and fourth parameters of `DataElement`. For three fields, the first parameter of `DataElement` is the default UI handler `AZ::Edit::DefaultHandler`. The property system's architecture supports the ability to add any number of UI handlers, each valid for one or more field types. A given type can have multiple available handlers, with one handler designated as the default. For example, floats by default use the `SpinBox` handler, but a `Slider` handler is also available.

An example of binding a float to a slider follows:

```
->DataElement("Slider", &MyComponent::m_someFloatField, "Some Float", "This
is a float that means X.")
->Attribute("Min", 0.f)
->Attribute("Max", 10.f)
->Attribute("Step", 0.1f)
```

The `Slider` UI handler expects `Min` and `Max` attributes. Optionally, a value for `Step` may also be provided. The example provides incremental increases of `0.1`. If no `Step` value is provided, a default stepping of `1.0` is used.

Note

The property system supports external UI handlers, so you can implement your own UI handlers in your own modules. You can customize the behavior of the field, the Qt control that it uses, and the attributes that it observes.

Attributes

The example also demonstrates the use of attributes. Attributes are a generic construct on the edit context that allows the binding of literals, or functions that return values, to a named attribute. UI handlers can retrieve this data and use it to drive their functionality.

Attribute values can be bound to the following:

- Literal values
 - `Attribute("Min", 0.f)`
- Static or global variables
 - `Attribute("Min", &g_globalMin)`
- Member variables
 - `Attribute("Min", &MyComponent::m_min)`

- Static or global functions
 - `&SomeGlobalFunction`
- Member functions
 - `&MyComponent::SomeMemberFunction`

Change Notification Callbacks

Another commonly used feature of the edit context is its ability to bind a change notification callback:

```
->DataElement(AZ::Edit::DefaultHandler, &MyComponent::m_someStringField,  
"Some String", "This is a string that means Y.")  
    ->Attribute("ChangeNotify", &MyComponent::OnStringFieldChanged)
```

The example binds a member function to be invoked when this property is changed, which allows the component to conduct other logic. The `ChangeNotify` attribute also looks for an optional returned value that tells the property system if it needs to refresh aspects of its state. For example, if your change callback modifies other internal data that affects the property system, you can request a value refresh. If your callback modifies data that requires attributes be reevaluated (and any bound functions be reinvoked), you can request a refresh of attributes and values. Finally, if your callback conducts work that requires a full refresh (this is not typical), you can refresh the entire state.

The following example causes the property grid to refresh values when `m_someStringField` is modified through the property grid. `RefreshValues` signals the property grid to update the GUI with changes to the underlying data.

```
->DataElement(AZ::Edit::DefaultHandler, &MyComponent::m_someStringField,  
"Some String", "This is a string that means Y.")  
    ->Attribute("ChangeNotify", &MyComponent::OnStringFieldChanged)  
...  
AZ::u32 MyComponent::OnStringFieldChanged()  
{  
    m_someFloatField = 10.0f;  
  
    // We've internally changed displayed data, so tell the property grid to  
    refresh values (cheap).  
    return AZ_CRC("RefreshValues");  
}
```

`RefreshValues` is one of three refresh modes that you can use:

- `RefreshValues` – Refreshes only values. The property grid updates the GUI to reflect changes to underlying data that may have occurred in the change callback.
- `RefreshAttributesAndValues` – Refreshes values but also reevaluates attributes. Since attributes can be bound to data members, member functions, global functions, or static variables, it's sometimes necessary to ask the property grid to re-evaluate them, which may include reinvoking bound functions.
- `RefreshAll` – Completely reevaluates the property grid. This is seldom needed, as `RefreshAttributesAndValues` should cover all requirements for rich dynamic editor reflection.

The following more complex example binds a list of strings as options for a combo box. The list of strings is attached to a string field *Property A*. If you want to modify the options available in the combo box for *Property A* with the values from another *Property B*, you can bind the combo box `StringList` attribute to a member function that computes and returns the list of options. In the `ChangeNotify`

attribute for Property B, you tell the system to reevaluate attributes, which in turn reinvokes the function that computes the list of options, as in this example:

```
...

bool m_enableAdvancedOptions;
AZStd::string m_useOption;

...

->DataElement(AZ::Edit::DefaultHandler,
  &MyComponent::m_enableAdvancedOptions, "Enable Advanced Options", "If set,
  advanced options will be shown.")
  ->Attribute("ChangeNotify", AZ_CRC("RefreshAttributesAndValues"))
->DataElement("ComboBox", &MyComponent::m_useOption, "Options", "Available
  options.")
  ->Attribute("StringList", &MyComponent::GetEnabledOptions)
...

AZStd::vector<const char*> MyComponent::GetEnabledOptions()
{
  AZStd::vector<const char*> options;
  options.reserve(16);

  options.push_back("Basic option");
  options.push_back("Another basic option");

  if (m_enableAdvancedOptions)
  {
    options.push_back("Advanced option");
    options.push_back("Another advanced option");
  }

  return options;
}
```

Slices and Dynamic Slices

The Component Entity System is currently in preview and is undergoing active development. It will replace the legacy [Entity System \(p. 373\)](#).

A slice is a collection of configured [entities \(p. 308\)](#) that is stored as a single unit in a reusable asset. You can use slices to conveniently group entities and other slices for reuse. Slices are similar to [prefabs](#) but are part of the new Component Entity system. Slices can contain component entities, whereas prefabs cannot. Unlike prefabs, slices can be nested into a fully cascading hierarchy. For example, a level, a house, a car, and an entire world are all slices that depend on (cascade) from a number of other slices.

You can generate a slice asset that contains any number of entities that you have placed and configured. These entities can have arbitrary relationships. For example, they can exist in a parent/child transform hierarchy, although this is not required.

After you have created the slice asset, you can use the editor to instantiate the slice asset in your worlds, either by right-clicking in the viewport and choosing **Instantiate Slice**, or by dragging a slice asset into the viewport directly from the **File Browser**. Just as with standard prefab systems, you can

then modify the entities in your slice instance. You can optionally push the changes back to the slice asset, which will affect all instances of that slice asset, as well as any other slices cascading from it.

A slice can contain instances of other slices. Modifications of a slice instance within another slice causes the changes to be stored in the instance as overrides (in the form of a data differential or delta). The modifications stored can be changes such as entity additions, entity removals, or component property changes.

Anatomy of a Slice

The following diagram illustrates an example slice A, which contains references to two other slices B and C. Slice A has two instances each of B and C:

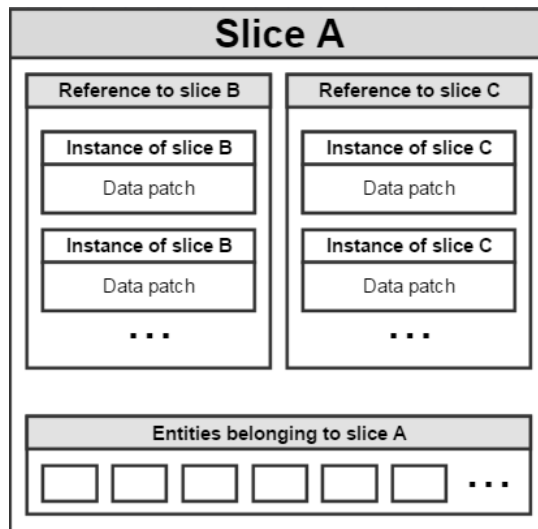

Each instance contains a data patch, which may be empty if no changes or overrides are present. If the instantiation of slice B in slice A has been modified in comparison with the source asset B, the data patch contains the differences. When slice A is instantiated again, it contains instances of slice B, but with the modifications applied. Any nonoverridden fields propagate through the hierarchy. If you change a property value in the slice B asset on disk, the instance of B contained in slice A will reflect that change — if the property for that instance has not already been overridden, as reflected in the instance's data patch.

In addition to references to other slices, slices can contain zero or more entities. These entities are original to this slice and are not acquired through referenced slice instances. A slice does not have to contain references to other slices. A slice that contains only original entities (as represented by the bottom box in the diagram) and no references to other slices is called a *leaf slice*.

Working with Dynamic Slices

Slices are a powerful tool for organizing entity data in your worlds. In the editor, you can choose to cascade slices and organize entity data in any desired granularity and still receive the benefits of data sharing and inheritance throughout the hierarchy. A level-based game, for example, implements each level as its own slice asset that contains instances of many other slices. These slices can potentially cascade many levels deep. You can even choose to create slices from other slices and inherit only the elements that you want.

Standard slice assets (`.slice` files) rely on the editor and cannot be instantiated at run time. However, Lumberyard provides a mechanism for designating any `.slice` asset that you've built as a *dynamic slice*. When you designate a slice as a dynamic slice, the Asset Processor processes and optimizes

the slice for you, producing a `.dynamicslice` file asset. A dynamic slice is simply the run-time version of its source slice, containing only run-time components; the editor-dependent components have been converted to their run-time counterparts. Furthermore, dynamic slices are flattened and no longer maintain a data hierarchy, as doing so would increase memory footprint and reduce instantiation performance.

In the level-based game example previously mentioned, you could designate your giant level slice as a dynamic slice. When your game loads the level, it does so by instantiating the resulting `.dynamicslice` file.

You can choose to generate dynamic slices at whatever granularity is appropriate for your game. Because slices are loaded entirely asynchronously, they are a good choice for streaming strategies. For example, a driving game might represent each city block as a separate slice and choose to load them predictively based on player driving behavior.

To generate a dynamic slice

Right-click any `.slice` asset in the **File Browser**, and click **Set Dynamic Flag**.

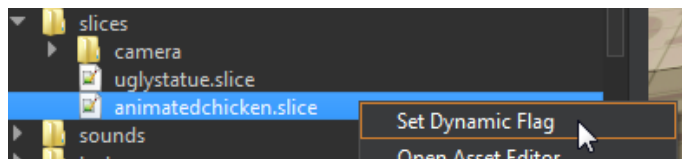

The Asset Processor processes the source `.slice` file and generates a `.dynamicslice` file. The new `.dynamicslice` file appears in the File Browser as its own asset:

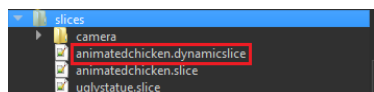

To remove the dynamic slice

Right-click the source `.slice` file and choose **Unset Dynamic Flag**.

The Asset Processor deletes the `.dynamicslice` file from the asset cache for you.

Instantiating Dynamic Slices

You can instantiate dynamic slices from your own components. To do so, [reflect \(p. 310\)](#) a `DynamicSlice` asset reference. You can populate the reference in the usual way, such as dragging a `.dynamicslice` asset from the **File Browser** onto your component's reflected asset property. You can then use the following EBus call to instantiate the referenced dynamic slice at a desired location in the world.

```
// Asset reference member, which must be reflected.
AZ::Data::Asset<AZ::DynamicPrefabAsset> m_sliceAsset;

// Create an instance of the dynamic slice.
AZ::Transform location = ...;
EBUS_EVENT(AzFramework::GameEntityContextRequestBus, InstantiateDynamicSlice,
  m_sliceAsset, location);
```

Lumberyard includes a spawner component that is a good example of this behavior. You can use the spawner component directly or as an example from which to build your own.

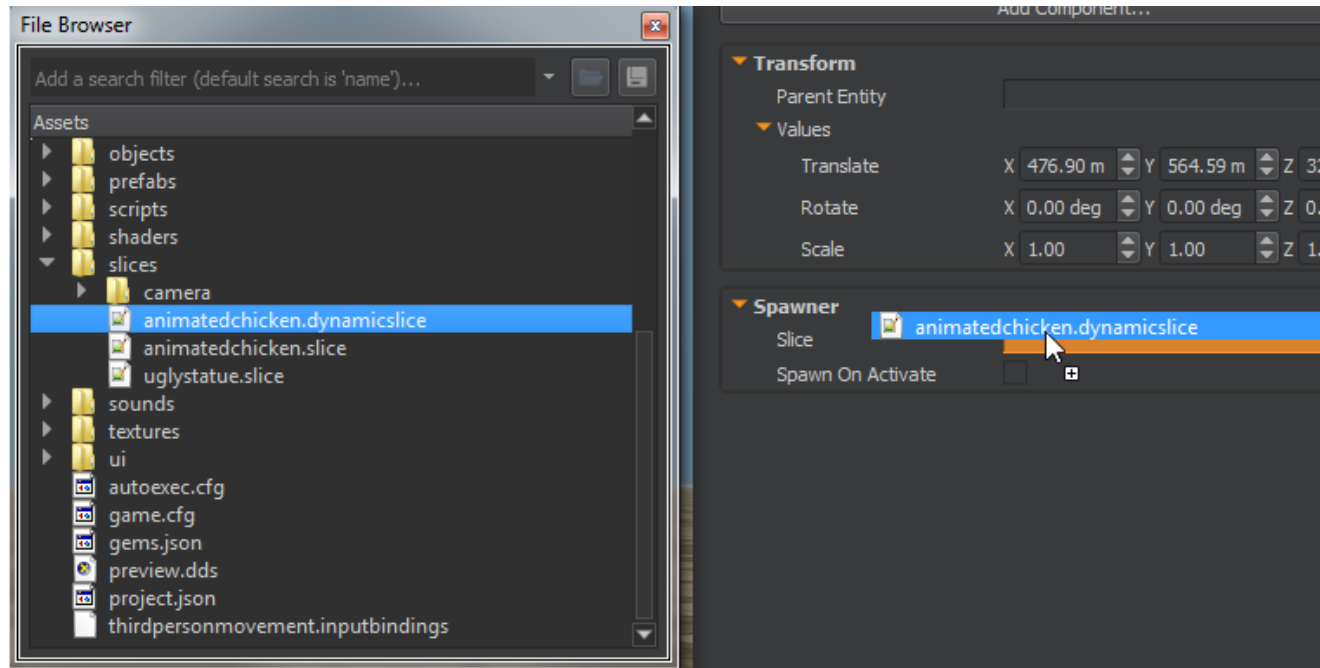

You can see the source code for the spawner component at the file location `dev\Code\Engine\LmbrCentral\source\Scripting\SpawnerComponent.cpp` in the folder in which you installed Lumberyard.

For information on creating an `AZ::Module`, see [Creating an AZ Module](#). For more information about working with slices, see [Working with Slices](#).

Controller Devices and Game Input

This section provides insight into Lumberyard's support for input devices, including information on setting up controls and action maps.

Topics

- [Action Maps \(p. 320\)](#)
- [CryInput \(p. 321\)](#)
- [Setting Up Controls and Action Maps \(p. 323\)](#)

Action Maps

The Action Map Manager provides a high-level interface to handle input controls inside a game. The Action Map system is implemented in Lumberyard, and can be used directly by any code inside Lumberyard or the GameDLL.

Initializing the Action Map Manager

The Action Map Manager is initialized when Lumberyard is initialized. Your game must specify the path for the file `defaultProfile.xml` (by default, the path is `Game/Libs/Config/defaultProfile.xml`). You can do this by passing the path to the manager. For example:

```
IActionMapManager* pActionMapManager = m_pFramework->GetIActionMapManager();
if (pActionMapManager)
{
    pActionMapManager->InitActionMaps(filename);
}
```

Upon initialization, the Action Map Manager clears all existing initialized maps, filters, and controller layouts.

Action Map Manager Events

If you have other systems in place that should know about action map events, you can subscribe to Action Map Manager events using the interface `IActionMapEventListener`.

The following events are available:

- `eActionMapManagerEvent_ActionMapsInitialized` – Action map definitions have been successfully initialized.
- `eActionMapManagerEvent_DefaultActionEntityChanged` – Default action entity has been changed (Manager will automatically assign new action maps to this entity).
- `eActionMapManagerEvent_FilterStatusChanged` – An existing filter has been enabled/disabled.
- `eActionMapManagerEvent_ActionMapStatusChanged` – An existing action map has been enabled/disabled.

Receiving Actions During Runtime

You can enable the feature that allows action maps to receive actions during runtime. Use the following code to enable or disable an action map during runtime:

```
pActionMapMan->EnableActionMap("default", true);
```

To receive actions, implement the `IActionListener` interface in a class.

CryInput

The main purpose of CryInput is to provide an abstraction that obtains input and status from various input devices such as a keyboard, mouse, joystick, and so on.

It also supports sending feedback events back to input devices—for example, in the form of force feedback events.

The common interfaces for the input system can be found in `IInput.h`, in the CryCommon project.

IInput

`IInput` is the main interface of the input system. An instance implementing this interface is created automatically during system initialization in the `InitInput` function (`InitSystem.cpp` in CrySystem, see also `CryInput.cpp` in CryInput).

Only one instance of this interface is created. CrySystem also manages the update and shutdown of the input system.

This `IInput` instance is stored in the `SSystemGlobalEnvironment` structure `gEnv`. You can access it through `gEnv->pInput` or, alternatively, through the system interface by `GetISystem()->GetIInput()`. Access through the `gEnv` variable is the most commonly used method.

IInputEventListener

A common use case within the input system is to create listener classes in other modules (for example, CryGame) by inheriting from `IInputEventListener` and registering/unregistering the listener class with the input system for notifications of input events.

For example, the Action Map System registers itself as an input listener and forwards game events only for the keys defined in the profile configuration files to further abstract the player input from device to the game.

SInputEvent

`SInputEvent` encapsulates information that is created by any input device and received by all input event listeners.

IInputDevice

Input devices normally relate directly to physical input devices such as a joystick, mouse, keyboard, and so on. To create a new input device, you must implement all functions in the `IInputDevice` interface and register an instance of it with the Input System using the `AddInputDevice` function.

The `Init` function is called when registering the `IInputDevice` with the Input System; it is not necessary to manually call it when creating the input devices.

The `Update` function is called at every update of the Input System—this is generally where the state of the device should be checked/updated and the Input Events generated and forwarded to the Input System.

It is common for input devices to create and store a list in `SInputSymbol` of each symbol the input device is able to generate in the `Init` function. Then, in the update function, the symbols for the buttons/axes that changed are looked up and used (via their `AssignTo` function) to fill in most of the information needed for the events, which are then forwarded to the input system.

Example:

```
// function from CInputDevice (accessible only within CryInput)
MapSymbol(...)
{
    SInputSymbol* pSymbol = new SInputSymbol( deviceSpecificId, keyId,
name, type );
    pSymbol->user = user;
    pSymbol->deviceId = m_deviceId;
    m_idToInfo[ keyId ] = pSymbol;
    m_devSpecIdToSymbol[ deviceSpecificId ] = pSymbol;
    m_nameToId[ name ] = deviceSpecificId;
    m_nameToInfo[ name ] = pSymbol;

    return pSymbol;
}
bool CMyKeyboardInputDevice::Init()
{
    ...
    //CreateDeviceEtc();
    ...
    m_symbols[ DIK_1 ] = MapSymbol( DIK_1, eKI_1, "1" );
    m_symbols[ DIK_2 ] = MapSymbol( DIK_2, eKI_2, "2" );
    ...
}
void CMyKeyboardInputDevice::Update( ... )
{
    // Acquire device if necessary
    ...
    // Will probably want to check for all keys, so the following section
might be part of a loop
    SInputSymbol* pSymbol = m_symbols[ deviceKeyId ];
    ...
    // check if state changed
    ...
}
```

```
// This is an example for, when pressed, see ChangeEvent function for  
axis type symbols  
pSymbol->PressEvent( true );  
  
SInputEvent event;  
pSymbol->AssignTo( event, modifiers );  
  
gEnv->pInput->PostInputEvent( event );  
}
```

To forward events to the input system so that event listeners can receive them, use the `PostInputEvent` function from `IInput`.

If adding your input device to `CryInput`, it may be useful to inherit directly from `CInputDevice`, as it already provides a generic implementation for most functions in `IInputDevice`.

Note

This file is included with the full source of CryEngine and is not available in the FreeSDK or GameCodeOnly solutions. For these licenses please derive from `IInputDevice` directly.

Setting Up Controls and Action Maps

This section describes how to create and modify action maps to customize the controls to the needs of your game.

Action map profiles for all supported platforms are located in `Game\Libs\Config\Profile\DefaultProfile.xml`. This default XML file organizes controls into the following sections, each of which is controlled by its own action map:

- multiplayer
- singleplayer
- debug
- flycam
- default
- player
- vehicle
- land vehicle
- sea vehicle
- helicopter

Each action map can be enabled or disabled during runtime from Flow Graph, in Lua scripts, or in C++ code.

See the topic [Default Controller Mapping \(p. 326\)](#) for an overview of the controls in the SDK package.

Action Maps

An action map is a set of key/button mappings for a particular game mode. For example, there is an `<actionmap>` section for helicopter controls called "Helicopter", which means that everything inside that section consists of key and button bindings that apply only when flying a helicopter. To change your common in-game bindings, go to the section starting with `<actionmap name="default">`. There are also sections for multiplayer-specific bindings and, of course, any other vehicles or modes you need.

The following is an overview of a standard action map, in this case the standard debug one:

```
<actionmap name="debug" version="22">
  <!-- debug keys - move to debug when we can switch devmode-->
  <action name="flymode" onPress="1" noModifiers="1" keyboard="f3" />
  <action name="godmode" onPress="1" noModifiers="1" keyboard="f4" />
  <action name="toggleaidebugdraw" onPress="1" noModifiers="1"
keyboard="f11" />
  <action name="togglepdrawhelpers" onPress="1" noModifiers="1"
keyboard="f10" />
  <action name="ulammo" onPress="1" noModifiers="1" keyboard="np_2" />
  <action name="debug" onPress="1" keyboard="7" />
  <action name="thirdperson" onPress="1" noModifiers="1" keyboard="f1" />
  <!-- debug keys - end -->
</actionmap>
```

Versioning

```
<actionmap name="debug" version="22">
```

When the version value is incremented, Lumberyard ensures that the user profile receives the newly updated action map. This is quite useful when deploying new actions in a patch of a game that is already released. If the version stays the same, changes or additions to the action maps are not propagated to the user profile.

Activation Modes

The following activation modes are available:

- `onPress` – The action key is pressed
- `onRelease` – The action key is released
- `onHold` – The action key is held
- `always` – Permanently activated

The activation mode is passed to action listeners and identified by the corresponding Lua constant:

- `eAAM_OnPress`
- `eAAM_OnRelease`
- `eAAM_OnHold`
- `eAAM_Always`

Modifiers available:

- `retriggerable`
- `holdTriggerDelay`
- `holdRepeatDelay`
- `noModifiers` – Action takes place only if no **Ctrl**, **Shift**, **Alt**, or **Win** keys are pressed
- `consoleCmd` – Action corresponds to a console command
- `pressDelayPriority`
- `pressTriggerDelay`
- `pressTriggerDelayRepeatOverride`
- `inputsToBlock` – Specify the input actions to block here
- `inputBlockTime` – Time to block the specified input action

Action Filters

You can also define action filters directly in your `defaultProfile.xml` file. The following attributes are available:

- **name** – How the filter will be identified.
- **type** – Specify `actionFail` to cause an action to fail. Specify `actionPass` to allow the action to succeed.

A sample action filter follows:

```
<actionfilter name="no_move" type="actionFail">
  <!-- actions that should be filtered -->
  <action name="crouch"/>
  <action name="jump"/>
  <action name="moveleft"/>
  <action name="moveright"/>
  <action name="moveforward"/>
  <action name="moveback"/>
  <action name="sprint"/>
  <action name="xi_movey"/>
  <action name="xi_movex"/>
  <!-- actions end -->
</actionfilter>
```

Controller Layouts

Links to the different controller layouts can also be stored in this file:

```
<controllerlayouts>
  <layout name="Layout 1" file="buttonlayout_alt.xml"/>
  <layout name="Layout 2" file="buttonlayout_alt2.xml"/>
  <layout name="Layout 3" file="buttonlayout_leftty.xml"/>
  <layout name="Layout 4" file="buttonlayout_leftty2.xml"/>
</controllerlayouts>
```

Note

The "file" attribute links to a file stored in "libs/config/controller/" by default.

Working with Action Maps During Runtime

In Lumberyard, you can use the console command `i_reloadActionMaps` to re-initialize the defined values. The `ActionMapManager` sends an event to all its listeners to synchronize the values throughout the engine. If you're using a separate `GameActions` file like `GameSDK`, make sure this class will receive the update to re-initialize the actions/filters in place. Keep in mind that it's not possible to define action maps, filters, or controller layouts with the same name in multiple places (for example, action filter `no_move` defined in `defaultProfile.xml` and the `GameActions` file).

To handle actions during runtime, you can use flow graphs or Lua scripts.

- Flow Graph – Input nodes can be used to handle actions. Only digital inputs can be handled from a flow graph. For more information, see [Flow Graph System](#) in the [Amazon Lumberyard User Guide](#).
- Lua script – While actions are usually not intended to be received directly by scripts, it is possible to interact with the Action Map Manager from Lua.

Default Controller Mapping

The default mapping for input on the PC is shown in the following table. To reconfigure the controls for your game, follow the instructions in [Setting Up Controls and Action Maps \(p. 323\)](#) and [Action Maps \(p. 320\)](#).

Player Action	PC
Player Movement	W, A, S, D
Player Aim	Mouse XY
Jump	Spacebar
Sprint	Shift
Crouch	C
Slide (when sprinting)	C
Fire	Mouse 1
Zoom	Mouse 2
Melee	V
Fire Mode	2
Reload	R
Use	F
Toggle Weapon	1
Toggle Explosive	3
Toggle Binoculars	B
Toggle Light (attachment)	L
Third Person Camera	F1

Vehicle Action	PC
Accelerate	W
Boost	Shift
Brake/Reverse	S
Handbrake	Spacebar
Steer	A/D
Look	Mouse XY
Horn	H
Fire	Mouse 1

Vehicle Action	PC
Change Seat	C
Headlights	L

Helicopter Action	PC
Ascend	W
Descend	S
Roll Left	A
Roll Right	D
Yaw Left	Mouse X (left)
Yaw Right	Mouse X (right)
Pitch Up	Mouse Y (up)
Pitch Down	Mouse Y (down)

Multiplayer Action	PC
Show Scoreboard	TAB

Key Naming Conventions

This page lists some of the name conventions used for action maps.

Key Gestures

Letters	"a" - "z"
Numbers	"1" - "0"
Arrows	"up", "down", "left", "right"
Function keys	"f1" - "f15"
Numpad	"np_1" - "np_0", "numlock", "np_divide", "np_multiply", "np_subtract", "np_add", "np_enter", "np_period"
Esc	"escape"
~	"tilde"
Tab	"tab"
CapsLock	"capslock"
Shift	"lshift", "rshift"
Ctrl	"lctrl", "rctrl"

Alt	"alt", "ralt"
spacebar	"space"
-	"minus"
=	"equals"
Backspace	"backspace"
[]	"lbracket", "rbracket"
"\"	"backslash"
;	"semicolon"
'	"apostrophe"
Enter	"enter"
,	"comma"
.	"period"
/	"slash"
Home	"home"
End	"end"
Delete	"delete"
PageUp	"pgup"
PageDown	"pgdn"
Insert	"insert"
ScrollLock	"scrolllock"
PrintScreen	"print"
Pause/Break	"pause"

Mouse Gestures

Left/primary mouse button	"mouse1"
Right/secondary mouse button	"mouse2"
Mouse wheel up	"mwheel_up"
Mouse wheel down	"mwheel_down"
New position along x-axis	"maxis_x"
New position along y-axis	"maxis_y"

CryCommon

The `Code\CryCommon` directory is the central directory for all the engine interfaces (as well as some commonly used code stored there to encourage reuse).

This section includes the following topics:

- [CryExtension](#) (p. 329)
- [CryString](#) (p. 353)
- [ICrySizer](#) (p. 354)
- [Serialization Library](#) (p. 354)

CryExtension

The complexity of Lumberyard can be challenging to both newcomers and experienced users who want to understand, configure, run, and extend it. Refactoring Lumberyard into extensions makes it easier to manage. Existing features can be unplugged (at least to some degree), replaced, or customized, and new features added. Extensions can consolidate code for a single feature in one location. This avoids having to implement a feature piecemeal across a number of the engine's base modules. Refactoring into extensions can also make the system more understandable at a high level.

Lumberyard's extension framework is loosely based on some fundamental concepts found in Microsoft's Component Object Model (COM). The framework defines two base interfaces that each extension needs to implement, namely `ICryUnknown` and `ICryFactory`. These are similar to COM's `IUnknown` and `IClassFactory`. The interfaces serve as a base to instantiate extensions, allow interface type casting, and enable query and exposure functionality.

The framework utilizes the concept of shared pointers and is implemented in a way to enforce their consistent usage to help reduce the chance of resource leaks. A set of C++ templates wrapped in a few macros is provided as [Glue Code Macros](#) (p. 335) that encourage engine refactoring into extensions. The glue code efficiently implements all base services and registers extensions within the engine. Additionally, a few helper functions implement type-safe casting of interface pointers, querying the IDs of extension interfaces, and convenient instantiation of extension classes. Hence, repetitive writing of tedious boilerplate code is unnecessary, and the potential for introducing bugs is reduced. An example is provided in the section [Using Glue Code](#) (p. 343). If the provided glue code is not applicable, then you must implement the interfaces and base services manually, as described in the section [Without Using Glue Code](#) (p. 346).

Clients access extensions through a system wide factory registry. The registry allows specific extension classes to be searched by either name or ID, and extensions to be iterated by using an interface ID.

Composites

The framework allows extensions to expose certain internal objects that they aggregate or are composed of. These so called *composites* are extensions themselves because they inherit from `ICryUnknown`. Composites allow you to reuse desired properties like type information at runtime for safe casting and loose coupling.

Shared and raw interface pointers

Although the framework was designed and implemented to utilize shared pointers and enforce their usage in order to reduce the possibility of resource leaks, raw interface pointers can still be acquired. Therefore, care needs to be taken to prevent re-wrapping those raw interface pointers in shared pointer objects. If the original shared pointer object is not passed during construction so that its internal reference counter can be referred to, the consistency of reference counting will be broken and crashes can occur. A best practice is to use raw interface pointers only to operate on interfaces temporarily, and not store them for later use.

GUIDs

You must use globally unique identifiers (GUIDs) to uniquely identify extensions and their interfaces. GUIDs are essentially 128-bit numbers generated by an algorithm to ensure they only exist once within a system such as Lumberyard. The use of GUIDs is key to implementing the type-safe casting of extension interfaces, which is particularly important in large scale development projects. To create GUIDs, you can use readily available tools like the **Create GUID** feature in Visual Studio or the macro below.

GUIDs are defined as follows.

```
struct CryGUID
{
    uint64 hipart;
    uint64 lopart;

    ...
};

typedef CryGUID CryInterfaceID;
typedef CryGUID CryClassID;
```

Declared in the following framework header files:

- `CryCommon/CryExtension/CryGUID.h`
- `CryCommon/CryExtension/CryTypeID.h`

The following Visual Studio macro can be used to generate GUIDs conveniently within the IDE. The macro writes GUIDs to the current cursor location in the source code editor window. Once added to **Macro Explorer**, the macro can be bound to a keyboard shortcut or (custom) toolbar.

```
Public Module CryGUIDGenModule
```

```
Sub GenerateCryGUID()  
    Dim newGuid As System.Guid  
    newGuid = System.Guid.NewGuid()  
  
    Dim guidStr As String  
  
    guidStr = newGuid.ToString("N")  
    guidStr = guidStr.Insert(16, ", 0x")  
    guidStr = guidStr.Insert(0, "0x")  
  
    REM guidStr = guidStr + vbNewLine  
    REM guidStr = guidStr + newGuid.ToString("D")  
  
    DTE.ActiveDocument.Selection.Text = guidStr  
End Sub  
  
End Module
```

ICryUnknown

ICryUnknown provides the base interface for all extensions. If making it the top of the class hierarchy is not possible or desired (for example, in third party code), you can apply an additional level of indirection to expose the code by using the extension framework. For an example, see [If ICryUnknown Cannot Be the Base of the Extension Class \(p. 351\)](#).

ICryUnknown is declared as follows.

```
struct ICryUnknown  
{  
    CRYINTERFACE_DECLARE(ICryUnknown, 0x1000000010001000, 0x1000100000000000)  
  
    virtual ICryFactory* GetFactory() const = 0;  
  
protected:  
    virtual void* QueryInterface(const CryInterfaceID& iid) const = 0;  
    virtual void* QueryComposite(const char* name) const = 0;  
};  
  
typedef boost::shared_ptr<ICryUnknown> ICryUnknownPtr;
```

- `GetFactory()` returns the factory with which the specified extension object was instantiated. Using the provided glue code this function has constant runtime.
- `QueryInterface()` returns a void pointer to the requested interface if the extension implements it, or NULL otherwise. This function was deliberately declared as protected to enforce usage of type-safe interface casting semantics. For information on casting semantics, see [Interface casting semantics \(p. 333\)](#). When the provided glue code is used, this function has a (worst case) run time that is linear in the number of supported interfaces. Due to glue code implementation details, no additional internal function calls are needed. A generic code generator produces a series of instructions that compares interface IDs and returns a properly cast pointer.
- `QueryComposite()` returns a void pointer to the queried composite if the extension exposes it; otherwise, NULL. As with `QueryInterface()`, this function was deliberately declared as protected to enforce type querying. For information on type querying, see [Querying composites \(p. 334\)](#). The function has a (worst case) run time linear in the number of exposed composites.

- Unlike in COM, `ICryUnknown` does not have `AddRef()` and `Release()`. Reference counting is implemented in a non-intrusive way by using shared pointers that are returned by the framework when extension classes are instantiated.

Declared in the following framework header file:

- `CryCommon/CryExtension/ICryUnknown.h`

ICryFactory

`ICryFactory` provides the base interface to instantiate extensions. It is declared as follows.

```
struct ICryFactory
{
    virtual const char* GetClassName() const = 0;
    virtual const CryClassID& GetClassID() const = 0;
    virtual bool ClassSupports(const CryInterfaceID& iid) const = 0;
    virtual void ClassSupports(const CryInterfaceID*& pIIDs, size_t& numIIDs)
        const = 0;
    virtual ICryUnknownPtr CreateClassInstance() const = 0;

protected:
    virtual ~ICryFactory() {}
};
```

- `GetClassName()` returns the name of the extension class. This function has constant run time when the provided glue code is used.
- `GetClassID()` returns the ID of the extension class. This function has constant run time when the provided glue code is used.
- `ClassSupports(iid)` returns true if the interface with the specified ID is supported by the extension class; otherwise, false. This function has a (worst case) run time linear in the number of supported interfaces when the provided glue code is used.
- `ClassSupports(pIIDs, numIIDs)` returns the pointer to an internal array of IDs enumerating all of the interfaces that this extension class supports as well as the length of the array. This function has constant run time when the provided glue code is used.
- `CreateClassInstance()` dynamically creates an instance of the extension class and returns a shared pointer to it. If the extension class is implemented as a singleton, it will return a (static) shared pointer that wraps the single instance of that extension class. This function has constant run time when the provided glue code is used, except for the cost of the constructor call for non-singleton extensions.
- The destructor is declared protected to prevent explicit destruction from the client side by using `delete`, `boost::shared_ptr<T>`, etc. `ICryFactory` instances exist (as singletons) throughout the entire lifetime of any Lumberyard process and **must not** be destroyed.

Declared in the following framework header file:

- `CryCommon/CryExtension/ICryFactory.h`

ICryFactoryRegistry

ICryFactoryRegistry is a system-implemented interface that enables clients to query extensions. It is declared as follows.

```
struct ICryFactoryRegistry
{
    virtual ICryFactory* GetFactory(const char* cname) const = 0;
    virtual ICryFactory* GetFactory(const CryClassID& cid) const = 0;
    virtual void IterateFactories(const CryInterfaceID& iid, ICryFactory**
    pFactories, size_t& numFactories) const = 0;

protected:
    virtual ~ICryFactoryRegistry() {}
};
```

- `GetFactory(cname)` returns the factory of the extension class with the specified name; otherwise, `NULL`.
- `GetFactory(cid)` returns the factory of the extension class with the specified ID; otherwise, `NULL`.
- `IterateFactory()` if `pFactories` is not `NULL`, `IterateFactory` copies up to `numFactories` entries of pointers to extension factories that support `iid`. `numFactories` returns the number of pointers copied. If `pFactories` is `NULL`, `numFactories` returns the total amount of extension factories that support `iid`.
- The destructor was declared `protected` to prevent explicit destruction from the client side by using `delete`, `boost::shared_ptr<T>`, etc. `ICryFactoryRegistry` is a system interface and that exists throughout the entire lifetime of any CryEngine process and **must not** be destroyed.

Declared in the following framework header file:

- `CryCommon/CryExtension/ICryFactoryRegistry.h`

Additional Extensions

Use the methods defined in `ICryUnknown` for additional functionality.

Interface casting semantics

Interface casting semantics have been implemented to provide syntactically convenient and type-safe casting of interfaces. The syntax was designed to conform with traditional C++ type casts and respects `const` rules.

```
ICryFactory* pFactory = ...;
assert(pFactory);

ICryUnknownPtr pUnk = pFactory->CreateClassInstance();

IMyExtensionPtr pMyExtension = cryinterface_cast<IMyExtension>(pUnk);

if (pMyExtension)
```

```
{  
  // it's safe to work with pMyExtension  
}
```

Interface casting also works on raw interface pointers. However, please consider the guidelines described in the section [Shared and raw interface pointers \(p. 330\)](#).

Declared in the following framework header file:

- CryCommon/CryExtension/ICryUnknown.h

Querying interface identifiers

Occasionally, it is necessary to know the ID of an interface, e.g. to pass it to `ICryFactoryRegistry::IterateFactories()`. This can be done as follows.

```
CryInterfaceID iid = cryiidof<IMyExtension>();
```

Declared in the following framework header file:

- CryCommon/CryExtension/ICryUnknown.h

Checking pointers

Use this extension to check whether pointers to different interfaces belong to the same class instance.

```
IMyExtensionAPtr pA = ...;  
IMyExtensionBPtr pB = ...;  
  
if (CryIsSameClassInstance(pA, pB))  
{  
  ...  
}
```

This works on both shared and raw interface pointers.

Declared in the following framework header file:

- CryCommon/CryExtension/ICryUnknown.h

Querying composites

Extensions can be queried for composites as follows.

```
IMyExtensionPtr pMyExtension = ...;  
  
ICryUnknownPtr pCompUnk = crycomposite_query(pMyExtension, "foo");  
  
IFooPtr pComposite = cryinterface_cast<IFoo>(pCompUnk);  
if (pComposite)  
{  
  // it's safe to work with pComposite, a composite of pMyExtension exposed as  
  // "foo" implementing IFoo  
}
```

A call to `crycomposite_query()` might return `NULL` if the specified composite has not yet been created. To gather more information, the query can be rewritten as follows.

```
IMyExtensionPtr pMyExtension = ...;

bool exposed = false;
ICryUnknownPtr pCompUnk = crycomposite_query(pMyExtension, "foo", &exposed);

if (exposed)
{
    if (pCompUnk)
    {
        // "foo" exposed and created

        IFooPtr pComposite = cryinterface_cast<IFoo>(pCompUnk);
        if (pComposite)
        {
            // it's safe to work with pComposite, a composite of pMyExtension exposed
            // as "foo" implementing IFoo
        }
    }
    else
    {
        // "foo" exposed but not yet created
    }
}
else
{
    // "foo" not exposed by pMyExtension
}
```

As with interface casting composite, queries work on raw interface pointers. However, please consider the guidelines described in the section [Shared and raw interface pointers \(p. 330\)](#).

Declared in the following framework header file:

- `CryCommon/CryExtension/ICryUnknown.h`

Glue Code Macros

The following macros provide glue code to implement the base interfaces and services to support the framework in a thread-safe manner. You are strongly encouraged to use them when you implement an extension.

For examples of how these macros work together, see [Using Glue Code \(p. 343\)](#).

Declared in the following framework header files:

- `CryCommon/CryExtension/Impl/ClassWeaver.h`
- `CryCommon/CryExtension/CryGUID.h`

CRYINTERFACE_DECLARE(iname, iidHigh, iidLow)

Declares an interface and associated ID. Protects the interfaces from accidentally being deleted on client side. That is, it allows destruction only by using `boost::shared_ptr<T>`. This macro is required once per interface declaration.

Parameters

iname

The (C++) name of the interface as declared.

iidHigh

The higher 64-bit part of the interface ID (GUID).

iidLow

The lower 64-bit part of the interface ID (GUID).

CRYINTERFACE_BEGIN()

Start marker of the interface list inside the extension class implementation. Required once per extension class declaration.

CRYINTERFACE_ADD(iname)

Marker to add interfaces inside the extension class declaration. It has to be declared in between `CRYINTERFACE_BEGIN()` and any of the `CRYINTERFACE_END*()` markers. Only declare the interfaces that the class directly inherits. If deriving from an existing extension class or classes, the inherited interfaces get added automatically. If an interface is declared multiple times, duplicates will be removed. It is not necessary to add `ICryUnknown`.

Caution

Other interfaces that are not declared will not be castable by using `cryinterface_cast<T>()`.

Parameters

iname

The (C++) name of the interface to be added.

CRYINTERFACE_END()

End marker of the interface list inside the extension class declaration. Use this if not inheriting from any already existing extension class. Required once per extension class declaration. Mutually exclusive with any of the other `CRYINTERFACE_END*()` markers.

CRYINTERFACE_ENDWITHBASE(base)

End marker of the interface list inside the extension class declaration. Use this if inheriting from an already existing extension class. Required once per extension class declaration. Mutually exclusive with any of the other `CRYINTERFACE_END*()` markers.

Parameters

base

The (C++) name of the extension class from which derived.

CRYINTERFACE_ENDWITHBASE2(base0, base1)

End marker of the interface list inside the extension class declaration. Use this if inheriting from two already existing extension classes. Required once per extension class declaration. Mutually exclusive with any of the other `CRYINTERFACE_END*()` markers.

Parameters

base0

The (C++) name of the first extension class from which derived.

base1

The (C++) name of the second extension class from which derived.

CRYINTERFACE_ENDWITHBASE3(base0, base1, base2)

End marker of the interface list inside the extension class declaration. Use this if inheriting from three already existing extension classes. Required once per extension class declaration. Mutually exclusive with any of the other `CRYINTERFACE_END*()` markers.

Parameters

base0

The (C++) name of the first extension class from which derived.

base1

The (C++) name of the second extension class from which derived.

base2

The (C++) name of the 3rd extension class from which derived.

CRYINTERFACE_SIMPLE(iname)

Convenience macro for the following code sequence (probably the most common extension case):

```
CRYINTERFACE_BEGIN()  
  CRYINTERFACE_ADD(iname)  
CRYINTERFACE_END()
```

Parameters

iname

The (C++) name of the interface to be added.

CRYCOMPOSITE_BEGIN()

Start marker of the list of exposed composites.

CRYCOMPOSITE_ADD(member, membername)

Marker to add a member of the extension class to the list of exposed composites.

Parameters

member

The (C++) name of the extension class member variable to be exposed. It has to be of type `boost::shared_ptr<T>`, where `T` inherits from `ICryUnknown`. This condition is enforced at compile time.

membername

The name (as C-style string) of the composite by which the composite can later be queried at runtime.

CRYCOMPOSITE_END(implclassname)

End marker of the list of exposed composites. Use this if not inheriting from any extension class that also exposes composites. Mutually exclusive with any of the other `CRYCOMPOSITE_END*()` markers.

Parameters

implclassname

The (C++) name of the extension class to be implemented.

CRYCOMPOSITE_ENDWITHBASE(implclassname, base)

End marker of the list of exposed composites. Use this if inheriting from one extension class that also exposes composites. Queries will first search in the current class and then look into the base class to find a composite that matches the requested name specified in `crycomposite_query()`. Mutually exclusive with any of the other `CRYCOMPOSITE_END*()` markers.

Parameters

implclassname

The (C++) name of the extension class to be implemented.

base

The (C++) name of the extension class derived from.

CRYCOMPOSITE_ENDWITHBASE2(implclassname, base0, base1)

End marker of the list of exposed composites. Use this if inheriting from two extension classes that also expose composites. Queries will first search in the current class and then look into the base classes to find a composite matching the requested name specified in `crycomposite_query()`. Mutually exclusive with any of the other `CRYCOMPOSITE_END*()` markers.

Parameters

implclassname

The (C++) name of the extension class to be implemented.

base0

The (C++) name of the first extension class from which derived.

base1

The (C++) name of the second extension class which derived.

CRYCOMPOSITE_ENDWITHBASE3(implclassname, base0, base1, base2)

End marker of the list of exposed composites. Use this if inheriting from three extension classes that also expose composites. Queries will first search in the current class and then look into the base classes to find a composite matching the requested name specified in `crycomposite_query()`. Mutually exclusive with any of the other `CRYCOMPOSITE_END*()` markers.

Parameters

implclassname

The (C++) name of the extension class to be implemented.

base0

The (C++) name of the first extension class from which derived.

base1

The (C++) name of the second extension class from which derived.

base2

The (C++) name of the third extension class from which derived.

CRYGENERATE_CLASS(implclassname, cname, cidHigh, cidLow)

Generates code to support base interfaces and services for an extension class that can be instantiated an arbitrary number of times. Required once per extension class declaration. Mutually exclusive to CRYGENERATE_SINGLETONCLASS().

Parameters

implclassname

The C++ class name of the extension.

cname

The extension class name with which it is registered in the registry.

cidHigh

The higher 64-bit part of the extension's class ID (GUID) with which it is registered in the registry.

cidLow

The lower 64-bit part of the extension's class ID (GUID) with which it is registered in the registry.

CRYGENERATE_SINGLETONCLASS(implclassname, cname, cidHigh, cidLow)

Generates code to support base interfaces and services for an extension class that can be instantiated only once (singleton). Required once per extension class declaration. Mutually exclusive with CRYGENERATE_CLASS().

Parameters

implclassname

The C++ class name of the extension.

cname

The extension class name with which it is registered in the registry.

cidHigh

The higher 64-bit part of the extension's class ID (GUID) with which it is registered in the registry.

cidLow

The lower 64-bit part of the extension's class ID (GUID) with which it is registered in the registry.

CRYREGISTER_CLASS(implclassname)

Registers the extension class in the system. Required once per extension class at file scope.

Parameters

implclassname

The C++ class name of the extension.

MAKE_CRYGUID(high, low)

Parameters

Constructs a CryGUID. Useful when searching the registry for extensions by class ID.

high

The higher 64-bit part of the GUID.

low

The lower 64-bit part of the GUID.

CryExtension Samples

Sample 1 - Implementing a Source Control Plugin by Using Extensions

```
////////////////////////////////////  
// source control interface  
  
struct ISourceControl : public ICryUnknown  
{  
    CRYINTERFACE_DECLARE(ISourceControl, 0x399d8fc1d94044cc, 0xa70d2b4e58921453)  
  
    virtual void GetLatest(const char* filename) = 0;  
    virtual void Submit() = 0;  
};  
  
typedef cryshared_ptr<ISourceControl> ISourceControlPtr;  
  
////////////////////////////////////  
// concrete implementations of source control interface  
  
class CSourceControl_Perforce : public ISourceControl  
{  
    CRYINTERFACE_BEGIN()  
        CRYINTERFACE_ADD(ISourceControl)  
    CRYINTERFACE_END()  
  
    CRYGENERATE_SINGLETONCLASS(CSourceControl_Perforce,  
    "CSourceControl_Perforce", 0x7305bff20ee543e3, 0x820792c56e74ecda)  
  
    virtual void GetLatest(const char* filename) { ... };  
    virtual void Submit() { ... };  
};  
  
CRYREGISTER_CLASS(CSourceControl_Perforce)  
  
class CSourceControl_SourceSafe : public ISourceControl  
{  
    CRYINTERFACE_BEGIN()  
        CRYINTERFACE_ADD(ISourceControl)  
    CRYINTERFACE_END()
```

```
CRYGENERATE_SINGLETONCLASS(CSourceControl_SourceSafe,  
"CSourceControl_SourceSafe", 0x1df62628db9d4bb2, 0x8164e418dd5b6691)  
  
virtual void GetLatest(const char* filename) { ... };  
virtual void Submit() { ... };  
};  
  
CRYREGISTER_CLASS(CSourceControl_SourceSafe)  
  
////////////////////////////////////  
// using the interface (submitting changes)  
  
void Submit()  
{  
    ICryFactoryRegistry* pReg = gEnv->pSystem->GetFactoryRegistry();  
  
    ICryFactory* pFactory = 0;  
    size_t numFactories = 1;  
    pReg->IterateFactories(cryiidof<ISourceControl>(), &pFactory, numFactories);  
  
    if (pFactory)  
    {  
        ISourceControlPtr pSrcCtrl = cryinterface_cast<ISourceControl>(pFactory->  
>CreateClassInstance());  
        if (pSrcCtrl)  
        {  
            pSrcCtrl->Submit();  
        }  
    }  
}
```

Using Extensions

Working with Specific Extension Classes

To work with a specific extension class, a client needs to know the extension's class name or class id and the interface(s) that the class supports. With this information, the class factory can be queried from the registry, an instance created and worked with as in the following example.

```
// IMyExtension.h  
#include <CryExtension/ICryUnknown.h>  
  
struct IMyExtension : public ICryUnknown  
{  
    ...  
};  
  
typedef boost::shared_ptr<IMyExtension> IMyExtensionPtr;
```

```
// in client code  
#include <IMyExtension.h>  
#include <CryExtension/CryCreateClassInstance.h>  
  
IMyExtensionPtr pMyExtension;  
  
#if 0
```

```
// create extension by class name
if (CryCreateClassInstance("MyExtension", pMyExtension))
#else
// create extension by class id, guaranteed to create instance of same kind
if (CryCreateClassInstance(MAKE_CRYGUID(0x68c7f0e0c36446fe,
    0x82a3bc01b54dc7bf), pMyExtension))
#endif
{
    // it's safe to work with pMyExtension
}
```

```
// verbose version of client code above
#include <IMyExtension.h>
#include <CryExtension/ICryFactory.h>
#include <CryExtension/ICryFactoryRegistry.h>

ICryFactoryRegistry* pReg = ...;

#if 0
// search extension by class name
ICryFactory* pFactory = pReg->GetFactory("MyExtension");
#else
// search extension by class id, guaranteed to yield same factory as in
// search by class name
ICryFactory* pFactory = pReg->GetFactory(MAKE_CRYGUID(0x68c7f0e0c36446fe,
    0x82a3bc01b54dc7bf));
#endif

if (pFactory) // see comment below
{
    ICryUnknownPtr pUnk = pFactory->CreateClassInstance();
    IMyExtensionPtr pMyExtension = cryinterface_cast<IMyExtension>(pUnk);
    if (pMyExtension)
    {
        // it's safe to work with pMyExtension
    }
}
```

As an optimization, you can enhance the `if` check as follows.

```
if (pFactory && pFactory->ClassSupports(cryiidof<IMyExtension>()))
{
    ...
}
```

This version of the `if` statement will check interface support before the extension class is instantiated. This check prevents the unnecessary (and potentially expensive) construction and destruction of extensions that are incompatible with a given interface.

Finding Extension Classes that Support a Specific Interface

To determine how many extension classes in the registry support a given interface, and to list them, clients can submit queries similar to the following.

```
// IMyExtension.h
#include <CryExtension/ICryUnknown.h>

struct IMyExtension : public ICryUnknown
```

```
{
    ...
};

// in client code
#include <IMyExtension.h>
#include <CryExtension/ICryFactory.h>
#include <CryExtension/ICryFactoryRegistry.h>

ICryFactoryRegistry* pReg = ...;

size_t numFactories = 0;
pReg->IterateFactories(cryiidof<IMyExtension>(), 0, numFactories);

ICryFactory** pFactories = new ICryFactory*[numFactories];

pReg->IterateFactories(cryiidof<IMyExtension>(), pFactories, numFactories);

...

delete [] pFactories;
```

Implementing Extensions Using the Framework

The following section explains in detail how to implement extensions in Lumberyard. It provides examples that use glue code and do not use glue code. The section also shows you how to utilize the framework in cases where `ICryUnknown` cannot be the base of the extension interface.

Recommended Layout for Including Framework Header Files

The public interface header that will be included by the client should look like the following.

```
// IMyExtension.h
#include <CryExtension/ICryUnknown.h>

struct IMyExtension : public ICryUnknown
{
    ...
};
```

If you are using glue code, declare the implementation class of the extension in the header file as follows.

```
// MyExtension.h
#include <IMyExtension.h>
#include <CryExtension/Impl/ClassWeaver.h>

class CMyExtension : public IMyExtension
{
    ...
};
```

Using Glue Code

The first example shows a possible implementation of the `IMyExtension` class in the previous examples.

```
////////////////////////////////////
// public section

// IMyExtension.h
#include <CryExtension/ICryUnknown.h>

struct IMyExtension : public ICryUnknown
{
    CRYINTERFACE_DECLARE(IMyExtension, 0x4fb87a5f83f74323, 0xa7e42ca947c549d8)

    virtual void CallMe() = 0;
};

typedef boost::shared_ptr<IMyExtension> IMyExtensionPtr;

////////////////////////////////////
// private section not visible to client

// MyExtension.h
#include <IMyExtension.h>
#include <CryExtension/Impl/ClassWeaver.h>

class CMyExtension : public IMyExtension
{
    CRYINTERFACE_BEGIN()
        CRYINTERFACE_ADD(IMyExtension)
    CRYINTERFACE_END()

    CRYGENERATE_CLASS(CMyExtension, "MyExtension", 0x68c7f0e0c36446fe,
        0x82a3bc01b54dc7bf)

public:
    virtual void CallMe();
};

// MyExtension.cpp
#include "MyExtension.h"

CRYREGISTER_CLASS(CMyExtension)

CMyExtension::CMyExtension()
{
}

CMyExtension::~CMyExtension()
{
}

void CMyExtension::CallMe()
{
    printf("Inside CMyExtension::CallMe()...");
}

```

The following example shows how the extension class `MyExtension` can be customized and expanded to implement two more interfaces, `IFoo` and `IBar`.

```
////////////////////////////////////
// public section

```

```
// IFoo.h
#include <CryExtension/ICryUnknown.h>

struct IFoo : public ICryUnknown
{
    CRYINTERFACE_DECLARE(IFoo, 0x7f073239d1e6433f, 0xb59c1b6ff5f68d79)

    virtual void Foo() = 0;
};

// IBar.h
#include <CryExtension/ICryUnknown.h>

struct IBar : public ICryUnknown
{
    CRYINTERFACE_DECLARE(IBar, 0xa9361937f60d4054, 0xb716cb711970b5d1)

    virtual void Bar() = 0;
};

////////////////////////////////////
// private section not visible to client

// MyExtensionCustomized.h
#include "MyExtension.h"
#include <IFoo.h>
#include <IBar.h>
#include <CryExtension/Impl/ClassWeaver.h>

class CMyExtensionCustomized : public CMyExtension, public IFoo, public IBar
{
    CRYINTERFACE_BEGIN()
        CRYINTERFACE_ADD(IFoo)
        CRYINTERFACE_ADD(IBar)
    CRYINTERFACE_ENDWITHBASE(CMyExtension)

    CRYGENERATE_CLASS(CMyExtensionCustomized, "MyExtensionCustomized",
        0x07bfa7c543a64f0c, 0x861e9fa3f7d7d264)

public:
    virtual void CallMe(); // chose to override MyExtension's impl
    virtual void Foo();
    virtual void Bar();
};

// MyExtensionCustomized.cpp
#include "MyExtensionCustomized.h"

CRYREGISTER_CLASS(CMyExtensionCustomized)

CMyExtensionCustomized::CMyExtensionCustomized()
{
}

CMyExtensionCustomized::~CMyExtensionCustomized()
{
}
```

```
void CMyExtensionCustomized::CallMe()
{
    printf("Inside CMyExtensionCustomized::CallMe()...");
}

void CMyExtensionCustomized::Foo()
{
    printf("Inside CMyExtensionCustomized::Foo()...");
}

void CMyExtensionCustomized::Bar()
{
    printf("Inside CMyExtensionCustomized::Bar()...");
}
```

Without Using Glue Code

If for any reason using the glue code is neither desired nor applicable, extensions can be implemented as follows. It is recommended to implement `ICryUnknown` and `ICryFactory` such that their runtime cost is equal to the one provided by the glue code. For more information, see [ICryUnknown \(p. 331\)](#) and [ICryFactory \(p. 332\)](#).

```
////////////////////////////////////
// public section

// INoMacros.h
#include <CryExtension/ICryUnknown.h>

struct INoMacros : public ICryUnknown
{
    // befriend cryiidof and boost::checked_delete
    template <class T> friend const CryInterfaceID&
    InterfaceCastSemantics::cryiidof();
    template <class T> friend void boost::checked_delete(T* x);
protected:
    virtual ~INoMacros() {}

private:
    // It's very important that this static function is implemented for each
    // interface!
    // Otherwise the consistency of cryinterface_cast<T>() is compromised
    // because
    // cryiidof<T>() = cryiidof<baseof<T>>() {baseof<T> = ICryUnknown in most
    // cases}
    static const CryInterfaceID& IID()
    {
        static const CryInterfaceID iid = {0xd0fda1427dee4cceull,
        0x88ff91b6b7be2a1full};
        return iid;
    }

public:
    virtual void TellMeWhyIDontLikeMacros() = 0;
};

typedef boost::shared_ptr<INoMacros> INoMacrosPtr;

////////////////////////////////////
```

```
// private section not visible to client

// NoMacros.cpp
//
// This is just an exemplary implementation!
// For brevity the whole implementation is packed into this cpp file.

#include <INoMacros.h>
#include <CryExtension/ICryFactory.h>
#include <CryExtension/Impl/RegFactoryNode.h>

// implement factory first
class CNoMacrosFactory : public ICryFactory
{
    // ICryFactory
public:
    virtual const char* GetClassName() const
    {
        return "NoMacros";
    }
    virtual const CryClassID& GetClassID() const
    {
        static const CryClassID cid = {0xa4550317690145c1ull,
0xa7eb5d85403dfad4ull};
        return cid;
    }
    virtual bool ClassSupports(const CryInterfaceID& iid) const
    {
        return iid == cryiidof<ICryUnknown>() || iid == cryiidof<INoMacros>();
    }
    virtual void ClassSupports(const CryInterfaceID*& pIIDs, size_t& numIIDs)
const
    {
        static const CryInterfaceID iids[2] = {cryiidof<ICryUnknown>(),
cryiidof<INoMacros>()};
        pIIDs = iids;
        numIIDs = 2;
    }
    virtual ICryUnknownPtr CreateClassInstance() const;

public:
    static CNoMacrosFactory& Access()
    {
        return s_factory;
    }

private:
    CNoMacrosFactory() {}
    ~CNoMacrosFactory() {}

private:
    static CNoMacrosFactory s_factory;
};

CNoMacrosFactory CNoMacrosFactory::s_factory;

// implement extension class
class CNoMacros : public INoMacros
{

```



```
// ICryUnknown
public:
virtual ICryFactory* GetFactory() const
{
    return &CNoMacrosFactory::Access();
};

// befriended boost::checked_delete
// only needed to be able to create initial shared_ptr<CNoMacros>
// so we don't lose type info for debugging (i.e. inspecting shared_ptr)
template <class T> friend void boost::checked_delete(T* x);

protected:
virtual void* QueryInterface(const CryInterfaceID& iid) const
{
    if (iid == cryiidof<ICryUnknown>())
        return (void*) (ICryUnknown*) this;
    else if (iid == cryiidof<INoMacros>())
        return (void*) (INoMacros*) this;
    else
        return 0;
}

virtual void* QueryComposite(const char* name) const
{
    return 0;
}

// INoMacros
public:
virtual void TellMeWhyIDontLikeMacros()
{
    printf("Woohoo, no macros...\n");
}

CNoMacros() {}

protected:
virtual ~CNoMacros() {}
};

// implement factory's CreateClassInstance method now that extension class is
// fully visible to compiler
ICryUnknownPtr CNoMacrosFactory::CreateClassInstance() const
{
    boost::shared_ptr<CNoMacros> p(new CDontLikeMacros);
    return
        ICryUnknownPtr(*static_cast<boost::shared_ptr<ICryUnknown*>>(static_cast<void*>(&p)));
}

// register extension
static SRegFactoryNode g_noMacrosFactory(&CNoMacrosFactory::Access());
```

Exposing Composites

The following example shows how to expose (inherited) composites. For brevity, the sample is not separated into files.

```
////////////////////////////////////  
struct ITestExt1 : public ICryUnknown  
{  
    CRYINTERFACE_DECLARE(ITestExt1, 0x9d9e0dcfa5764cb0, 0xa73701595f75bd32)  
  
    virtual void Call1() = 0;  
};  
  
typedef boost::shared_ptr<ITestExt1> ITestExt1Ptr;  
  
class CTestExt1 : public ITestExt1  
{  
    CRYINTERFACE_BEGIN()  
        CRYINTERFACE_ADD(ITestExt1)  
    CRYINTERFACE_END()  
  
    CRYGENERATE_CLASS(CTestExt1, "TestExt1", 0x43b04e7cc1be45ca,  
0x9df6ccb1c0dclad8)  
  
public:  
    virtual void Call1();  
};  
  
CRYREGISTER_CLASS(CTestExt1)  
  
CTestExt1::CTestExt1()  
{  
}  
  
CTestExt1::~CTestExt1()  
{  
}  
  
void CTestExt1::Call1()  
{  
}  
  
////////////////////////////////////  
class CComposed : public ICryUnknown  
{  
    CRYINTERFACE_BEGIN()  
    CRYINTERFACE_END()  
  
    CRYCOMPOSITE_BEGIN()  
        CRYCOMPOSITE_ADD(m_pTestExt1, "Ext1")  
    CRYCOMPOSITE_END(CComposed)  
  
    CRYGENERATE_CLASS(CComposed, "Composed", 0x0439d74b8dcd4b7f,  
0x9287dcd7e26a3a5)  
  
private:  
    ITestExt1Ptr m_pTestExt1;  
};  
  
CRYREGISTER_CLASS(CComposed)  
  
CComposed::CComposed()  
: m_pTestExt1()  
};
```

```

    {
    CryCreateClassInstance("TestExt1", m_pTestExt1);
    }

CComposed::~CComposed()
{
}

////////////////////////////////////////////////////////////////////////////////////////////////////////////////////////////////
struct ITestExt2 : public ICryUnknown
{
    CRYINTERFACE_DECLARE(ITestExt2, 0x8eb7a4b399874b9c, 0xb96bd6da7a8c72f9)

    virtual void Call2() = 0;
};

DECLARE_BOOST_POINTERS(ITestExt2);

class CTestExt2 : public ITestExt2
{
    {
        CRYINTERFACE_BEGIN()
        CRYINTERFACE_ADD(ITestExt2)
        CRYINTERFACE_END()

        CRYGENERATE_CLASS(CTestExt2, "TestExt2", 0x25b3ebf8f1754b9a,
            0xb5494e3da7cdd80f)

public:
    virtual void Call2();
};

CRYREGISTER_CLASS(CTestExt2)

CTestExt2::CTestExt2()
{
}

CTestExt2::~CTestExt2()
{
}

void CTestExt2::Call2()
{
}

////////////////////////////////////////////////////////////////////////////////////////////////////////////////////////////////
class CMultiComposed : public CComposed
{
    {
        CRYCOMPOSITE_BEGIN()
        CRYCOMPOSITE_ADD(m_pTestExt2, "Ext2")
        CRYCOMPOSITE_ENDWITHBASE(CMultiComposed, CComposed)

        CRYGENERATE_CLASS(CMultiComposed, "MultiComposed", 0x0419d74b8dcd4b7e,
            0x9287dcdf7e26a3a6)

private:
    ITestExt2Ptr m_pTestExt2;
};

```

```

CRYREGISTER_CLASS(CMultiComposed)

CMultiComposed::CMultiComposed()
: m_pTestExt2()
{
    CryCreateClassInstance("TestExt2", m_pTestExt2);
}

CMultiComposed::~~CMultiComposed()
{
}

...

////////////////////////////////////
// let's use it

ICryUnknownPtr p;
if (CryCreateClassInstance("MultiComposed", p))
{
    ITestExt1Ptr p1 = cryinterface_cast<ITestExt1>(crycomposite_query(p,
"Ext1"));
    if (p1)
        p1->Call1(); // calls CTestExt1::Call1()
    ITestExt2Ptr p2 = cryinterface_cast<ITestExt2>(crycomposite_query(p,
"Ext2"));
    if (p2)
        p2->Call2(); // calls CTestExt2::Call2()
}

```

If ICryUnknown Cannot Be the Base of the Extension Class

There are cases where making `ICryUnknown` the base of your extension class is not possible. Some examples are legacy code bases that cannot be modified, third party code for which you do not have full source code access, or code whose modification is not practical. However, these code bases can provide useful functionality (for example, for video playback or flash playback) if you expose them as engine extensions. The following sample illustrates how an additional level of indirection can expose a third party API.

```

////////////////////////////////////
// public section

// IExposeThirdPartyAPI.h
#include <CryExtension/ICryUnknown.h>
#include <IThirdPartyAPI.h>

struct IExposeThirdPartyAPI : public ICryUnknown
{
    CRYINTERFACE_DECLARE(IExposeThirdPartyAPI, 0x804250bbaacf4a5f,
0x90ef0327bb7a0a7f)

    virtual IThirdPartyAPI* Create() = 0;
};

typedef boost::shared_ptr<IExposeThirdPartyAPI> IExposeThirdPartyAPIPtr;

////////////////////////////////////

```

```
// private section not visible to client

// Expose3rdPartyAPI.h
#include <IExposeThirdPartyAPI.h>
#include <CryExtension/Impl/ClassWeaver.h>

class CExposeThirdPartyAPI : public IExposeThirdPartyAPI
{
    CRYINTERFACE_BEGIN()
        CRYINTERFACE_ADD(IExposeThirdPartyAPI)
    CRYINTERFACE_END()

    CRYGENERATE_CLASS(CExposeThirdPartyAPI, "ExposeThirdPartyAPI",
        0xa93b970b2c434a21, 0x86acfe94d8dae547)

public:
    virtual IThirdPartyAPI* Create();
};

// ExposeThirdPartyAPI.cpp
#include "ExposeThirdPartyAPI.h"
#include "ThirdPartyAPI.h"

CRYREGISTER_CLASS(CExposeThirdPartyAPI)

CExposeThirdPartyAPI::CExposeThirdPartyAPI()
{
}

CExposeThirdPartyAPI::~CExposeThirdPartyAPI()
{
}

IThirdPartyAPI* CExposeThirdPartyAPI::Create()
{
    return new CThirdPartyAPI; // CThirdPartyAPI implements IThirdPartyAPI
}
```

Custom Inclusion and Exclusion of Extensions

To enable easy inclusion and exclusion of extensions, Lumberyard provides a global "extension definition" header much like `CryCommon/ProjectDefines.h` that is automatically included in all modules by means of the `platform.h` file. To wrap your extension implementation code, you include a `#define` statement in the extension definition header. To exclude unused extension code from your build, you can also comment out extensions that you are not interested in. Interface headers are not affected by the `#if defined` statements, so the client code compiles as is with or without them.

```
////////////////////////////////////
// public section

// IMyExtension.h
#include <CryExtension/ICryUnknown.h>

struct IMyExtension : public ICryUnknown
{
    ...
};
```

```
typedef boost::shared_ptr<IMyExtension> IMyExtensionPtr;

// ExtensionDefines.h
...
#define INCLUDE_MYEXTENSION
...

////////////////////////////////////
// private section not visible to client

// MyExtension.h
#if defined(INCLUDE_MYEXTENSION)

#include <IMyExtension.h>
#include <CryExtension/Impl/ClassWeaver.h>

class CMyExtension : public IMyExtension
{
    ...
};

#endif // #if defined(INCLUDE_MYEXTENSION)

// MyExtension.cpp
#if defined(INCLUDE_MYEXTENSION)

#include "MyExtension.h"

CRYREGISTER_CLASS(CMyExtension)

...

#endif // #if defined(INCLUDE_MYEXTENSION)
```

Because extensions can be removed from a build, clients must write their code in a way that does not assume the availability of an extension. For more information, see [Using Extensions \(p. 341\)](#).

CryString

Lumberyard has a custom reference-counted string class `CryString` (declared in `CryString.h`) which is a replacement for STL `std::string`. `CryString` should always be preferred over `std::string`. For convenience, `string` is used as a typedef for `CryString`.

How to Use Strings as Key Values for STL Containers

The following code shows good (efficient) and bad usage:

```
const char *szKey= "Test";

map< string, int >::const_iterator iter =
    m_values.find( CONST_TEMP_STRING( szKey ) ); // Good

map< string, int >::const_iterator iter = m_values.find( szKey ); // Bad
```

By using the suggested method, you avoid the allocation, deallocation, and copying of a temporary string object, which is a common problem for most string classes. By using the macro `CONST_TEMP_STRING`, the string class uses the pointer directly without having to free data afterwards.

Further Usage Tips

- Do not use `std::string` or `std::wstring`. Instead, use only `string` and `wstring`, and never include the standard string header `<string>`.
- Use the `c_str()` method to access the contents of the string.
- Because strings are reference-counted, never modify memory returned by the `c_str()` method. Doing so could affect the wrong string instance.
- Do not pass strings via abstract interfaces; all interfaces should use `const char*` in interface methods.
- `CryString` has a combined interface of `std::string` and the MFC `CString`, so you can use both interface types for string operations.
- Avoid doing many string operations at runtime as they often cause memory reallocations.
- For fixed size strings (e.g. 256 chars), use `CryFixedStringT`, which should be preferred over static `char` arrays.

ICrySizer

The `ICrySizer` interface can be implemented to record detailed information about the memory usage of a class.

Note

This information is also available in the Editor under **Engine Memory info**.

How to use the ICrySizer interface

The following example shows how to use the `ICrySizer` interface.

```
void GetMemoryUsage( ICrySizer *pSizer )
{
    {
        SIZER_COMPONENT_NAME( pSizer, "Renderer (Aux Geometries)" );
        pSizer->Add(*this);
    }
    pSizer->AddObject(<element_prow>,<element_count>);
    pSizer->AddObject(<container>);
    m_SubObject.GetMemoryUsage(pSizer);
}
```

Serialization Library

The `CryCommon` serialization library has the following features:

- Separation of user serialization code from the actual storage format. This makes it possible to switch between XML, JSON, and binary formats without changing user code.
- Re-usage of the same serialization code for editing in the `PropertyTree`. You can write the serialization code once and use it to expose your structure in the editor as a parameters tree.

- Enables you to write serialization code in non-intrusive way (as global overloaded functions) without modifying serialized types.
- Makes it easy to change formats. For example, you can add, remove, or rename fields and still be able to load existing data.

Tutorial

The example starts with a data layout that uses standard types, enumerations, and containers. The example adds the `Serialize` method to structures with fixed signatures.

Defining data

```
#include "Serialization/IArchive.h"
#include "Serialization/STL.h"

enum AttachmentType
{
    ATTACHMENT_SKIN,
    ATTACHMENT_BONE
};
struct Attachment
{
    string name;
    AttachmentType type;
    string model;
    void Serialize(Serialization::IArchive& ar)
    {
        ar(name, "name", "Name");
        ar(type, "type", "Type");
        ar(model, "model", "Model");
    }
};
struct Actor
{
    string character;
    float speed;
    bool alive;
    std::vector<Attachment> attachments;
    Actor()
    : speed(1.0f)
    , alive(true)
    {
    }
    void Serialize(Serialization::IArchive& ar)
    {
        ar(character, "character", "Character");
        ar(speed, "speed", "Speed");
        ar(alive, "alive", "Alive");
        ar(attachments, "attachments", "Attachment");
    }
};

// Implementation file:
#include "Serialization/Enum.h"

SERIALIZATION_ENUM_BEGIN(AttachmentType, "Attachment Type")
```



```
SERIALIZATION_ENUM(ATTACHMENT_BONE, "bone", "Bone")
SERIALIZATION_ENUM(ATTACHMENT_SKIN, "skin", "Skin")
SERIALIZATION_ENUM_END()
```

Why are two names needed?

The `ar()` call takes two string arguments: one is called `name`, and the second `label`. The `name` argument is used to store parameters persistently; for example, for JSON and XML. The `label` parameter is used for the `PropertyTree`. The `label` parameter is typically longer, more descriptive, contains white space, and may be easily changed without breaking compatibility with existing data. In contrast, `name` is a C-style identifier. It is also convenient to have `name` match the variable name so that developers can easily find the variable by looking at the data file.

Omitting the `label` parameter (the equivalent of passing `null_ptr`) will hide the parameter in the `PropertyTree`, but it will be still serialized and can be copied together with its parent by using copy-paste.

Note

The `SERIALIZATION_ENUM` macros should reside in the `.cpp` implementation file because they contain symbol definitions.

Serializing into or from a file

Now that the data has been defined, it is ready for serialization. To implement the serialization, you can use `Serialization::SaveJsonFile`, as in the following example.

```
#include <Serialization/IArchiveHost.h>

Actor actor;
Serialization::SaveJsonFile("filename.json", actor);
```

This will output content in the following format:

```
{
  "character": "nanosuit.cdf",
  "speed": 2.5,
  "alive": true,
  "attachments": [
    { "name": "attachment 1", "type": "bone", "model": "model1.cgf" },
    { "name": "attachment 2", "type": "skin", "model": "model2.cgf" }
  ]
}
```

The code for reading data is similar to that for serialization, except that it uses `Serialization::LoadJsonFile`.

```
#include <Serialization/IArchiveHost.h>

Actor actor;
Serialization::LoadJsonFile(actor, "filename.json");
```

The save and load functions used are wrappers around the `IArchiveHost` interface, an instance of which is located in `gEnv->pSystem->GetArchiveHost()`. However, if you have direct access to the archive code (for example, in `CrySystem` or `EditorCommon`), you can use the archive classes directly, as in the following example.

```
#include <Serialization/JSONOArchive.h>
```

```
#include <Serialization/JSONIArchive.h>

Serialization::JSONOArchive oa;

Actor actor;
oa(actor);
oa.save("filename.json");

// to get access to the data without saving:
const char* jsonString = oa.c_str();

// and to load
Serialization::JSONIArchive ia;
if (ia.load("filename.json"))
{
    Actor loadedActor;
    ia(loadedActor);
}
```

Editing in the PropertyTree

If you have the `Serialize` method implemented for your types, it is easy to get it exposed to the `QPropertyTree`, as the following example shows.

```
#include <QPropertyTree/QPropertyTree.h>

QPropertyTree* tree = new QPropertyTree(parent);

static Actor actor;
tree->attach(Serialization::SStruct(actor));
```

You can select enumeration values from the list and add or remove vector elements by using the [2] button or the context menu.

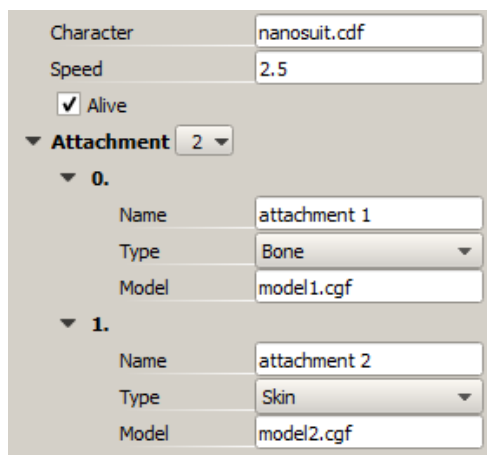

In the moment of attachment, the `Serialize` method will be called to extract properties from your object. As soon as the user changes a property in the UI, the `Serialize` method is called to write properties back to the object.

Note

It is important to remember that `QPropertyTree` holds a reference to an attached object. If the object's lifetime is shorter than the tree, an explicit call to `QPropertyTree::detach()` should be performed.

Use Cases

Non-intrusive serialization

Normally when `struct` or a class instance is passed to the archive, the `Serialize` method of the instance is called. However, it is possible to override this behavior by declaring the following global function:

```
bool Serialize(Serialization::IArchive&, Type& value, const char* name, const char* label);
```

The return value here has the same behavior as `IArchive::operator()`. For input archives, the function returns `false` when a field is missing or wasn't read. For output archives, it always returns `true`.

Note

The return value does not propagate up. If one of the nested fields is missing, the top level block will still return `true`.

The global function approach is useful when you want to:

- Add serialization in non-intrusive way
- Transform data during serialization
- Add support for unsupported types like plain pointers

The following example adds support for `std::pair<>` type to the `Serialize` function:

```
template<class T1, class T2>
struct pair_serializable : std::pair<T1, T2>
{
    void Serialize(Serialization::IArchive& ar)
    {
        ar(first, "first", "First");
        ar(second, "second", "Second");
    }
}

template<class T1, class T2>
bool Serialize(Serialization::IArchive& ar, std::pair<T1, T2>& value, const char* name, const char* label)
{
    return ar(static_cast<pair_serializable<T1, T2>&>(value), name, label);
}
```

The benefit of using inheritance is that you can get access to protected fields. In cases when access policy is not important and inheritance is undesirable, you can replace the previous code with following pattern.

```
template<class T1, class T2>
struct pair_serializable
{
    std::pair<T1, T2>& instance;

    pair_serializable(std::pair<T1, T2>& instance) : instance(instance) {}
    void Serialize(Serialization::IArchive& ar)
```

```
{
    ar(instance.first, "first", "First");
    ar(instance.second, "second", "Second");
}

template<class T1, class T2>
bool Serialize(Serialization::IArchive& ar, std::pair<T1, T2>& value, const
    char* name, const char* label)
{
    pair_serializable<T1, T2> serializer(value);
    return ar(serializer, name, label);
}
```

Registering Enum inside a Class

Normally, `SERIALIZATION_ENUM_BEGIN()` will not compile if you specify enumeration within a class (a "nested enum"). To overcome this shortcoming, use `SERIALIZATION_ENUM_BEGIN_NESTED`, as in the following example.

```
SERIALIZATION_ENUM_BEGIN_NESTED(Class, Enum, "Label")
SERIALIZATION_ENUM(Class::ENUM_VALUE1, "value1", "Value 1")
SERIALIZATION_ENUM(Class::ENUM_VALUE2, "value2", "Value 2")
SERIALIZATION_ENUM_END()
```

Polymorphic Types

The Serialization library supports the loading and saving of polymorphic types. This is implemented through serialization of a smart pointer to the base type.

For example, if you have following hierarchy:

IBase

- ImplementationA
- ImplementationB

You would need to register derived types with a macro, as in the following example.

```
SERIALIZATION_CLASS_NAME(IBase, ImplementationA, "impl_a", "Implementation
A");
SERIALIZATION_CLASS_NAME(IBase, ImplementationA, "impl_b", "Implementation
B");
```

Now you can serialize a pointer to the base type:

```
#include <Serialization/SmartPtr.h>

_smart_ptr<IInterface> pointer;

ar(pointer, "pointer", "Pointer");
```

The first string is used to name the type for persistent storage, and the second string is a human-readable name for display in the PropertyTree.

Customizing presentation in the PropertyTree

There are two aspects that can be customized within the PropertyTree:

1. The layout of the property fields. These are controlled by control sequences in the label (the third argument in `IArchive::operator()`).
2. Decorators. These are defined in the same way that specific properties are edited or represented.

Control characters

Control sequences are added as a prefix to the third argument for `IArchive::operator()`. These characters control the layout of the property field in the PropertyTree.

Layout Control Characters

Prefix	Role	Description
!	Read-only field	Prevents the user from changing the value of the property. The effect is non-recursive.
^	Inline	Places the property on the same line as the name of the structure root. Can be used to put fields in one line in a horizontal layout, rather than in the default vertical list.
^^	Inline in front of a name	Places the property name before the name of the parent structure. Useful to add check boxes before a name.
<	Expand value field	Expand the value part of the property to occupy all available space.
>	Contract value field	Reduces the width of the value field to the minimum. Useful to restrict the width of inline fields.
>N>	Limit field width to N pixels	Useful for finer control over the UI. Not recommended for use outside of the editor.
+	Expand row by default.	Can be used to control which structures or containers are expanded by default. Use this only when you need per-item control. Otherwise, <code>QPropertyTree::setExpandLevels</code> is a better option.
[S]	Apply S control characters to children.	Applies control characters to child properties. Especially useful with containers.

Combining control characters

Multiple control characters can be put together to combine their effects, as in the following example.

```
ar(name, "name", "!^!<Name"); // inline, read-only, expanded value field
```

Decorators

There are two kinds of decorators:

1. Wrappers that implement a custom serialization function that performs a transformation on the original value. For example, `Serialization/Math.h` contains `Serialization::RadiansAsDeg(float&)` that allows to store and edit angles in radians.

2. Wrappers that do no transformation but whose type is used to select a custom property implementation in the PropertyTree. Resource Selectors are examples of this kind of wrapper.

Decorator	Purpose	Defined for types	Context needed
AnimationPath	Selection UI for full animation path.	Any string-like type, like: std::string, string (CryStringT), SCRRef CCryName	
CharacterPath	UI: browse for character path (cdf)		
CharacterPhysicsPath	UI: browse for character .phys-file.		
CharacterRigPath	UI: browse for .rig files.		
SkeletonPath	UI: browse for .chr or .skel files.		
JointName	UI: list of character joints	ICharacterInstance*	
AttachmentName	UI: list of character attachments	ICharacterInstance*	
SoundName	UI: list of sounds		
ParticleName	UI: particle effect selection		
Serialization/ Decorators/Math.h			
RadiansAsDeg	Edit or store radians as degrees	float, Vec3	
Serialization/ Decorators/ Range.h			
Range	Sets soft or hard limits for numeric values and provides a slider UI.	Numeric types	
Serialization/ Callback.h			
Callback	Provides per-property callback function. See Adding callbacks to the PropertyTree (p. 363) .	All types apart from compound ones (structs and containers)	

Decorator example

The following example uses the `Range` and `CharacterPath` decorators.

```
float scalar;
ar(Serialization::Range(scalar), 0.0f, 1.0f); // provides slider-UI
string filename;
ar(Serialization::CharacterPath(filename), "character", "Character"); //
  provides UI for file selection with character filter
```

Serialization context

The signature of the `Serialize` method is fixed. This can prevent the passing of additional arguments into nested `Serialize` methods. To resolve this issue, you can use a serialization context to pass a pointer of a specific type to nested `Serialize` calls, as in the following example.

```
void Scene::Serialize(Serialization::IArchive& ar)
{
    Serialization::SContext sceneContext(ar, this);
    ar(rootNode, "rootNode")
}

void Node::Serialize(Serialization::IArchive& ar)
{
    if (Scene* scene = ar.FindContext<Scene>())
    {
        // use scene
    }
}
```

Contexts are organized into linked lists. Nodes are stored on the stack within the `SContext` instance.

You can have multiple contexts. If you provide multiple instances of the same type, the innermost context will be retrieved.

You may also use contexts with the `PropertyTree` without modifying existing serialization code. The easiest way to do this is to use `CContextList` (`QPropertyTree/ContextList.h`), as in the following example.

```
// CContextList m_contextList;
tree = new QPropertyTree();
m_contextList.Update<Scene>(m_scenePointer);
tree->setArchiveContext(m_contextList.Tail());
tree->attach(Serialization::SStruct(node));
```

Serializing opaque data blocks

It is possible to treat a block of data in the archive in an opaque way. This capability enables the Editor to work with data formats it has no knowledge of.

These data blocks can be stored within `Serialization::SBlackBox`. `SBlackBox` can be serialized or deserialized as any other value. However, when you deserialize `SBlackBox` from a particular kind of archive, you must serialize by using a corresponding archive. For example, if you obtained your `SBlackBox` from `JSONIArchive`, you must save it by using `JSONOArchive`.

Adding callbacks to the PropertyTree

When you change a single property within the property tree, the whole attached object gets de-serialized. This means that all properties are updated even if only one was changed. This approach may seem wasteful, but has the following advantages:

- It removes the need to track the lifetime of nested properties, and the requirement that nested types be referenced from outside in safe manner.
- The content of the property tree is not static data, but rather the result of the function invocation. This allows the content to be completely dynamic. Because you do not have to track property lifetimes, you can serialize and de-serialize variables constructed on the stack.
- The removal of the tracking requirement results in a smaller amount of code.

Nevertheless, there are situations when it is desirable to know exactly which property changes. You can achieve this in two ways: 1) by using the `Serialize` method, or 2) by using `Serialization::Callback`.

1. Using the `Serialize` method, compare the new value with the previous value, as in the following example.

```
void Type::Serialize(IArchive& ar)
{
    float oldValue = value;
    ar(value, "value", "Value");
    if (ar.IsInput() && oldValue != value)
    {
        // handle change
    }
}
```

2. The second option is to use the `Serialization::Callback` decorator to add a callback function for one or more properties, as the following example illustrates.

```
#include <Serialization/Callback.h>
using Serialization::Callback;

ar(Callback(value,
            [](float newValue) { /* handle change */ },
            "value", "Value");
```

Note

`Callback` works only with the `PropertyTree`, and should be used only in Editor code.

`Callback` can also be used together with other decorators, but in rather clumsy way, as the following example shows.

```
ar(Callback(value,
            [](float newValue) { /* handle change*/ },
            [](float& v) { return Range(v, 0.0f, 1.0f); }),
    "value", "Value");
```

Of the two approaches, the callback approach is more flexible, but it requires you to carefully track the lifetime of the objects that are used by the callback lambda or function.

PropertyTree in MFC window

If your code base still uses MFC, you can use the PropertyTree with it by using a wrapper that makes this possible, as the following example shows.

```
#include <IPropertyTree.h> // located in Editor/Include

int CMyWindow::OnCreate(LPCREATESTRUCT pCreateStruct)
{
    ...
    CRect clientRect;
    GetClientRect(clientRect);
    IPropertyTree* pPropertyTree = CreatePropertyTree(this, clientRect);
    ...
}
```

The `IPropertyTree` interface exposes the methods of `QPropertyTree` like `Attach`, `Detach` and `SetExpandLevels`.

Documentation and validation

`QPropertyTree` provides a way to add short documentation in the form of tool tips and basic validation.

The `Doc` method allows you to add tool tips to `QPropertyTree`, as in the following examples.

```
void IArchive::Doc(const char*)
```

```
void SProjectileParameter::Serialize(IArchive& ar)
{
    ar.Doc("Defines projectile physics.");

    ar(m_velocity, "velocity", "Velocity");
    ar.Doc("Defines initial velocity of the projectile.");
}
```

The `Doc` method adds a tool tip to last serialized element. When used at the beginning of the function, it adds the tool tip to the whole block.

The `Warning` and `Error` calls allow you to display warnings and error messages associated with specific property within the property tree, as in the following examples.

```
template<class T> void IArchive::Warning(T& instance, const char*
    format, ...)
template<class T> void IArchive::Error(T& instance, const char* format, ...)
```

```
void BlendSpace::Serialize(IArchive& ar)
{
    ar(m_dimensions, "dimensions", "Dimensions");
    if (m_dimensions.empty())
        ar.Error(m_dimensions, "At least one dimension is required for
        BlendSpace");
}
```

The error message appears as follows.

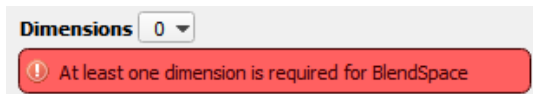

Warning messages look like this:

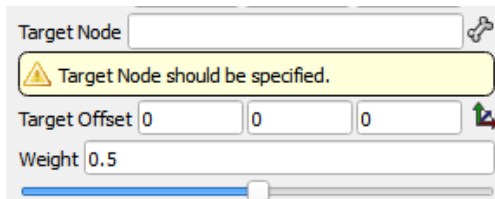

Drop-down menu with a dynamic list

If you want to specify an enumeration value, you can use the `enum` registration macro as described in the [Defining data \(p. 355\)](#) section.

There are two ways to define a drop-down menu: 1) transform your data into `Serialization::StringListValue`, or 2) implement a custom `PropertyRow` in the UI.

A short example of the first approach follows. The example uses a custom reference.

```
// a little decorator that would annotate string as a special reference
struct MyReference
{
    string& str;
    MyReference(string& str) : str(str) {}
};

inline bool Serialize(Serialization::IArchive& ar, MyReference& wrapper,
    const char* name, const char* label)
{
    if (ar.IsEdit())
    {
        Serialization::StringList items;
        items.push_back("");
        items.push_back("Item 1");
        items.push_back("Item 2");
        items.push_back("Item 3");
        Serialization::StringListValue dropDown(items, wrapper.str.c_str());
        if (!ar(dropDown, name, label))
            return false;
        if (ar.IsInput())
            wrapper.str = dropDown.c_str();
        return true;
    }
    else
    {
        // when loading from disk we are interested only in the string
        return ar(wrapper.str, name, label);
    }
}
```

Now you can construct `MyReference` on the stack within the `Serialize` method to serialize a string as a dropdown item, as in the following example.

```
struct SType
{
    string m_reference;
    void SType::Serialize(Serialization::IArchive& ar)
    {
        ar(MyReference(m_reference), "reference", "Reference");
    }
};
```

The second way to define a drop-down menu requires that you implement a custom `PropertyRow` in the UI. This takes more effort, but makes it possible to create the list of possible items entirely within editor code.

Demo and Video Capture

This section contains information on recording videos for benchmarking. Capturing audio and video is also discussed, using either the Perspective view of the Lumberyard Editor or in pure-game mode via the Launcher.

Topics

- [Capturing Video and Audio \(p. 367\)](#)
- [Recording Time Demos \(p. 371\)](#)

Capturing Video and Audio

This tutorial explains how to set up Lumberyard editor (or game) to capture video. Lumberyard outputs video as single frames. If required, it can also output stereo or 5.1 surround sound audio in `.wav` file format. You can edit the output with commonly available video editing software.

Preparation

Before you can start video and audio streams in preparation for capture, you must configure some settings that determine how the video will be captured. You configure these settings by using console commands. To save time, you can create configuration files that execute the necessary commands for you instead of typing the commands directly into the console. Example configuration files are presented later in this topic.

The next sections describe the settings and the console commands that configure them.

Video Settings

Frame Size and Resolution

The height and width of the captured frames in the editor is normally set to the exact view size of your rendered perspective window. To resize the view size, re-scale the perspective window, or right click in the top right of the perspective viewport where the frame size is displayed.

You can also capture higher than rendered images from Lumberyard Editor and Launcher.

The console variables that are now used in conjunction with Capture Frames are:

- `r_CustomResHeight=N` - Specifies the desired frame height in *N* pixels.
- `r_CustomResWidth=M` - Specifies the desired frame width in *M* pixels.

- `r_CustomResMaxSize=P` - Specifies the maximum resolution at which the engine will render the frames in *P* pixels.
- `r_CustomResPreview=R` - Specifies whether or how the preview is displayed in the viewport.
Possible values for *R* are:

Preview status

No
preview

Scaled
to
match
the
size
of
the
viewport

Cropped
to
the
size
of
the
viewport

Frames Per Second

When deciding the number of frames per second to specify, keep in mind the following:

- NTSC standard video is approximately 30 frames per second, which is a good compromise between quality and file size.
- High quality video can have up to 60 frames per second, but the difference in quality of the increased number of frames is barely noticeable and can take up a lot of file space.
- Video at less than 24 FPS (a cinema standard) will not look smooth.

To specify a fixed frame rate, use the command:

```
t_fixedstep N
```

N specifies the time step. Time step is calculated by using the formula

```
step = 1 second / <number of frames>
```

A table of common time step values follows.

**FPS
Step**

0.04
(PAL)

Frame Step

0033333333

00166666667

Video Capture File Format

You can capture pictures in several different file formats. A good choice for average quality is the `.jpeg` file format. The `.tga` or `.bmp` file formats are better for higher quality, and `.hdr` for pictures that use [high-dynamic-range imaging](#).

To specify the capture file format, use the console command

```
capture_file_format N
```

N is `jpg`, `bmp`, `tga` or `hdr`.

Video Capture File Location

By default, recorded frames are stored in the directory `<root>\CaptureOutput`. To specify a custom directory, use the command:

```
capture_folder N
```

N is the name of the custom directory.

Caution

When you start a recording, the captured frames are placed in the currently specified directory and will overwrite existing files with the same name. To avoid losing work, create a directory for each recording, or move the existing files to another directory before you start.

Starting and Ending the Video Recording

After you have specified the values mentioned in the previous sections, you can start the recording by using the command:

```
capture_frames N
```

Setting *N* to `1` starts the recording, and setting *N* to `0` stops it.

Audio Settings

Before you begin, decide if you require audio in stereo or in 5.1 surround format, and then change your audio settings accordingly in the Windows control panel.

Deactivating the Sound System

After loading the level of your game that you want to capture, you must deactivate the sound system so that you can redirect the sound output to a file. To deactivate the sound system, use the command:

```
#Sound.DeactivateAudioDevice()
```

This redirects the sound output to a `.wav` file in the root directory of the game. The sound will not run in realtime, but be linked precisely to the time step that you set previously.

To write the sound capture, use the command:

```
s_OutputConfig N
```

Setting *N* to 3 activates the non-realtime writing of sound to the `.wav` file. Setting *N* to 0 specifies auto-detection (the default).

Reactivating the Sound System

To reset the sound system use the command:

```
#Sound.ActivateAudioDevice()
```

This creates a `.wav` file in the root directory of the game. The file will continue to be written to until you run the following combination of commands to deactivate the audio device:

```
#Sound.DeactivateAudioDevice()
```

```
s_OutputConfig 0
```

```
#Sound.ActivateAudioDevice()
```

Tip

Although these commands reset the sound system, some sounds won't start until they are correctly triggered again. This applies particularly to looped sounds. To get looped sounds to play, start the recording of video and sound first, and then enter any area that triggers the looped sounds that you want to record.

Configuration Files

Creating Configuration Files

- To ensure that multiple recordings use exactly the same settings, create a configuration file that you can use for each of them. This will ensure that all of your captured files have the same format.

An example configuration file:

```
sys_spec = 4  
Fixed_time_step 0.0333333333  
Capture_file_format jpg  
Capture_folder myrecording  
r_width 1280  
r_height 800
```

The command `sys_spec = 4` sets the game graphic settings to "very high" to generate the best appearance.

- To speed up the process of starting and stopping the recording, you can create two configuration files: one to start the video, and one to stop it.

- To start recording, use a config file like the following:

```
#Sound.DeactivateAudioDevice()  
s_OutputConfig 3  
#Sound.ActivateAudioDevice()  
Capture_frames 1
```

- To stop recording, use a config file like the following:

```
Capture_frames 0  
#Sound.DeactivateAudioDevice()  
s_OutputConfig 0  
#Sound.ActivateAudioDevice()
```

Executing the Config Files

To run the config file, open the console and type the following command:

```
Exec N
```

N is the name of the config file.

Recording Time Demos

Overview

Lumberyard Editor can record and play back player input and camera movement.

Note

Recording of some player actions such as vehicle movement are not supported.

To use the feature, you must start game mode in Lumberyard Editor and then record in it. To start game mode, press **Ctrl + G** after a level has been fully loaded, or load the level in pure-game mode.

Output like the following appears both in the console and in the `timedemo.log` file in the directory corresponding to the level used:

```
TimeDemo Run 131 Finished.  
Play Time: 3.96s, Average FPS: 50.48  
Min FPS: 0.63 at frame 117, Max FPS: 69.84 at frame 189  
Average Tri/Sec: 14037316, Tri/Frame: 278071  
Recorded/Played Tris ratio: 0.99
```

Recording Controls

Keybind
Commands

Start
Recording
PrintScreen

Console Commands

EndRecording
Recording
Break

StartPlayback
PrintScreen

Stopdemo
Playback
Break

Related Console Variables

- `stopdemo` - Stop playing a time demo.
- `demo demoname` - Play the time demo from the file specified
- `demo_fixed_timestep` - Specify the number of updates per second.
- `demo_panoramic` - Use a panoramic view when playing back the demo.
- `demo_restart_level N` - Restart the level after each loop. Possible values for *N*: 0 = Off; 1 = use quicksave on first playback; 2 = load level start.
- `demo_ai`: Enable or disable AI during the demo.
- `demo_savestats` - Save level stats at the end of the loop.
- `demo_max_frames` - Specify the maximum number of frames to save.
- `demo_screenshot_frame N` - Make a screenshot of the specified frame during demo playback. If a negative value for *N* is supplied, takes a screenshot every *N* frame.
- `demo_quit`: Quit the game after the demo run finishes.
- `demo_noinfo` - Disable the information display during demo playback.
- `demo_scroll_pause` - Enable the use of the `scrolllock` key to pause demo play and record.
- `demo_num_runs` - Specify the number of times to loop the time demo.
- `demo_profile`: Enable demo profiling.
- `demo_file` - Specify the time demo filename.

Entity System

The Entity system is currently on a path to deprecation in favor of the Lumberyard [Component Entity System](#) (p. 308).

This section covers topics related to the Entity system. Entities are objects, placed inside a level, that players can interact with.

This section includes the following topics:

- [Entity Property Prefixes](#) (p. 373)
- [Creating a New Entity Class](#) (p. 374)
- [Entity Pool System](#) (p. 376)
- [Entity ID Explained](#) (p. 385)
- [Adding Usable Support on an Entity](#) (p. 386)
- [Entity Scripting](#) (p. 387)

Entity Property Prefixes

The Lumberyard Editor supports typed properties where the type is derived from special prefixes in the property name. For a complete list of supported prefixes, refer to the `s_paramTypes` array, defined in `Objects/EntityScript.cpp`. This array maps prefixes to variable types.

The following prefixes are supported by Lumberyard:

```
{ "n",                IVariable::INT, IVariable::DT_SIMPLE,
SCRIPTPARAM_POSITIVE },
{ "i",                IVariable::INT, IVariable::DT_SIMPLE,0 },
{ "b",                IVariable::BOOL, IVariable::DT_SIMPLE,0 },
{ "f",                IVariable::FLOAT, IVariable::DT_SIMPLE,0 },
{ "s",                IVariable::STRING, IVariable::DT_SIMPLE,0 },

{ "ei",               IVariable::INT, IVariable::DT_UIENUM,0 },
{ "es",               IVariable::STRING, IVariable::DT_UIENUM,0 },

{ "shader",           IVariable::STRING, IVariable::DT_SHADER,0 },
{ "clr",               IVariable::VECTOR, IVariable::DT_COLOR,0 },
{ "color",            IVariable::VECTOR, IVariable::DT_COLOR,0 },

{ "vector",           IVariable::VECTOR, IVariable::DT_SIMPLE,0 },
```

```
{ "snd",                IVariable::STRING,  IVariable::DT_SOUND,0 },
{ "sound",             IVariable::STRING,  IVariable::DT_SOUND,0 },
{ "dialog",           IVariable::STRING,  IVariable::DT_DIALOG,0 },

{ "tex",              IVariable::STRING,  IVariable::DT_TEXTURE,0 },
{ "texture",         IVariable::STRING,  IVariable::DT_TEXTURE,0 },

{ "obj",              IVariable::STRING,  IVariable::DT_OBJECT,0 },
{ "object",          IVariable::STRING,  IVariable::DT_OBJECT,0 },

{ "file",             IVariable::STRING,  IVariable::DT_FILE,0 },
{ "aibehavior",      IVariable::STRING,  IVariable::DT_AI_BEHAVIOR,0 },
{ "aicharacter",     IVariable::STRING,  IVariable::DT_AI_CHARACTER,0 },
{ "aipfpropertieslist", IVariable::STRING,
IVariable::DT_AI_PFPROPERTIESLIST,0 },
{ "aiterritory",     IVariable::STRING,  IVariable::DT_AITERRITORY,0 },
{ "aiwave",          IVariable::STRING,  IVariable::DT_AIWAVE,0 },

{ "text",             IVariable::STRING,  IVariable::DT_LOCAL_STRING,0 },
{ "equip",           IVariable::STRING,  IVariable::DT_EQUIP,0 },
{ "reverbpreset",    IVariable::STRING,  IVariable::DT_REVERBPRESET,0 },
{ "eaxpreset",       IVariable::STRING,  IVariable::DT_REVERBPRESET,0 },

{ "aianchor",        IVariable::STRING,  IVariable::DT_AI_ANCHOR,0 },

{ "soclass",         IVariable::STRING,  IVariable::DT_SOCLASS,0 },
{ "soclasses",      IVariable::STRING,  IVariable::DT_SOCLASSES,0 },
{ "sostate",        IVariable::STRING,  IVariable::DT_SOSTATE,0 },
{ "sostates",      IVariable::STRING,  IVariable::DT_SOSTATES,0 },
{ "sopattern",     IVariable::STRING,  IVariable::DT_SOSTATEPATTERN,0 },
{ "soaction",      IVariable::STRING,  IVariable::DT_SOACTION,0 },
{ "sohelper",      IVariable::STRING,  IVariable::DT_SOHELPER,0 },
{ "sonavhelper",   IVariable::STRING,  IVariable::DT_SONAVHELPER,0 },
{ "soanimhelper",  IVariable::STRING,  IVariable::DT_SOANIMHELPER,0 },
{ "soevent",       IVariable::STRING,  IVariable::DT_SOEVENT,0 },
{ "sotemplate",    IVariable::STRING,  IVariable::DT_SOTEMPLATE,0 },
{ "gametoken",     IVariable::STRING,  IVariable::DT_GAMETOKEN, 0 },
{ "seq_",          IVariable::STRING,  IVariable::DT_SEQUENCE, 0 },
{ "mission_",      IVariable::STRING,  IVariable::DT_MISSIONOBJ, 0 },
```

Creating a New Entity Class

The following example creates an entity class called **Fan**.

- Create a new entity definition file with the extension ".ent", for example "GameSDK\Entities\Fan.ent". This file will expose the entity to the engine.

```
<Entity
  Name="Fan"
  Script="Scripts/Entities/Fan.lua"
/>
```

- Create a new Lua script file, for example GameSDK\Entities\Scripts\Fan.lua. The Lua file will define the entity logic.

```
Fan = {
    type = "Fan",
    scripting -- can be useful for scripting

    -- instance member variables
    minrotspeed = 0,
    maxrotspeed = 1300,
    acceleration = 300,
    currrotspeed = 0,
    changespeed = 0,
    currangle = 0,

    -- following entries become automatically exposed to the editor and
    serialized (load/save)
    -- type is defined by the prefix (for more prefix types, search for
    s_paramTypes in /Editor/Objects/EntityScript.cpp)
    Properties = {
        bName = 0, -- boolean example, 0/1
        fName = 1.2, -- float example
        soundName = "", -- sound example
        fileModelName = "Objects/box.cgf", -- file model
    },

    -- optional editor information
    Editor = {
        Model = "Editor/Objects/Particles.cgf", -- optional 3d object that
        represents this object in editor
        Icon = "Clouds.bmp", -- optional 2d icon that
        represents this object in editor
    },
}

-- optional. Called only once on loading a level.
-- Consider calling self:OnReset(not System.IsEditor()); here
function Fan:OnInit()
    self:SetName( "Fan" );
    self:LoadObject( "Objects/Indoor/Fan.cgf", 0, 0 );
    self:DrawObject( 0, 1 );
end

-- OnReset() is usually called only from the Editor, so we also need
OnInit()
-- Note the parameter
function Fan:OnReset(bGameStarts)
end

-- optional. To start having this callback called, activate the entity:
-- self:Activate(1); -- Turn on OnUpdate() callback
function Fan:OnUpdate(dt)
    if ( self.changespeed == 0 ) then
        self.currrotspeed = self.currrotspeed - System.GetFrameTime() *
self.acceleration;
    if ( self.currrotspeed < self.minrotspeed ) then
        self.currrotspeed = self.minrotspeed;
    end
else
```

```
    self.currrotspeed = self.currrotspeed + System.GetFrameTime() *
self.acceleration;
    if ( self.currrotspeed > self.maxrotspeed ) then
        self.currrotspeed = self.maxrotspeed;
    end
end
self.currangle = self.currangle + System.GetFrameTime() *
self.currrotspeed;
local a = { x=0, y=0, z=-self.currangle };
self:SetAngles( a );
end

-- optional serialization
function Fan:OnSave(tbl)
    tbl.currangle = self.currangle;
end

-- optional serialization
function Fan:OnLoad(tbl)
    self.currangle = tbl.currangle;
end

-- optional
function Fan:OnSpawn()
end

-- optional
function Fan:OnDestroy()
end

-- optional
function Fan:OnShutDown()
end

-- optional
function Fan:OnActivate()
    self.changespeed = 1 - self.changespeed;
end
```

Entity Pool System

The topics in this section describe the entity pool system, including how it is implemented, how to register a new entity class to be pooled, and how to debug it. For more information on using entity pools in the Lumberyard Editor, see the Lumberyard User Guide.

This section includes the following topics:

- [Entity Pool Definitions \(p. 377\)](#)
- [Entity Pool Creation \(p. 379\)](#)
- [Creating and Destroying Static Entities with Pools \(p. 380\)](#)
- [Creating and Destroying Dynamic Entities with Pools \(p. 382\)](#)
- [Serialization \(p. 383\)](#)
- [Listener/Event Registration \(p. 384\)](#)
- [Debugging Utilities \(p. 385\)](#)

The following processes must take place when creating an entity pool and preparing it for use. Each of these processes is described in more detail.

1. An entity pool is created by using the information in an entity pool definition.
2. An entity pool is populated with entity containers.
3. An entity pool is validated by testing the entity pool signature of one of the entity containers against the entity pool signature of each `Entity` class mapped to the pool.
4. All entities marked to be created through the pool have an entity pool bookmark created for them.
5. An entity pool bookmark is prepared from or returned to the entity pool, which is mapped to its `Entity` class on demand.

Editor Usage

When running in the Lumberyard Editor, the entity pool system is not fully enabled. All entities are created outside the pools when playing in-game in the Editor. However, all flow node actions with entity pools will still work in the Lumberyard Editor, mimicking the final results that you will see in-game.

Note

The entity pool listeners `OnEntityPreparedFromPool` and `OnEntityReturnedToPool` are still called in the Editor, even though the entity itself is not removed/reused.

Static versus Dynamic Entities

Entities can be either static or dynamic. A static entity is placed in the Editor and exported with the level. This entity always exists. A property associated with the exported information determines whether it should be pooled (and not created during level load) or instead have an entity pool bookmark made for it. A dynamic entity is created at run-time, usually from game code. The information is constructed at run-time, usually just before it is created, and passed on to the Entity system for handling. This information also indicates whether or not it should go through an entity pool.

Entity Pool Definitions

Entity pools must be defined in the file `\Game\Scripts\Entities\EntityPoolDefinitions.xml`. An entity pool definition is responsible for defining the following:

- the empty class that will be used by entity containers when they're not in use
- the entity classes mapped to the pool
- other properties that describe the pool and how it is used.

In general, a pool is initially filled with a defined number of entity containers; that is, empty `CEntity` classes with all the required entity proxies and game object extensions that are normally created when an entity belonging to an entity class mapped to the definition is fully instantiated. For example, a normal AI entity will have the following entity proxies: sound extension, script extension, render extension, and the game object as its user extension; as its game object extension, it will have the `CPlayer` class. All of these classes are instantiated for each empty `CEntity` instance, and is reused by the entities as they are created from the pool.

The following illustrates an entity pool definition:

`EntityPoolDefinitions.xml`

```
<Definition name="AI" emptyClass="NullAI" maxSize="16" hasAI="1"
defaultBookmarked="0" forcedBookmarked="0">
```

```
<Contains>
  <Class>Grunt</Class>
  <Class>Flyer</Class>
</Contains>
</Definition>
```

Empty Class

The empty class is defined using the `emptyClass` attribute, which takes the name of a valid entity class. The purpose of the empty class is to:

- satisfy the engine's requirement to have an entity class associated with an entity at all times; an empty container is initialized/reused to this entity class
- prepare all needed entity proxies and game object extensions needed for the entities

For example, building on the definition shown in the previous section, you would create an empty class called "NullAI" and register it the same way as the other AI classes above. Then:

1. Declare the entity class and map it to its Lua script via the game factory.

GameFactory.cpp

```
REGISTER_FACTORY(pFramework, "NullAI", CPlayer, true);
```

2. Create the Lua script for it. View sample code at `\Game\Scripts\Entities\AI\NullAI.lua`.

These steps will allow Lumberyard to see "NullAI" as a valid entity class. In addition, by mapping `CPlayer` to it, you ensure that the correct game object extension is instantiated for the entity containers. The Lua script needs to create all the entity proxies for the entity containers. In the sample code, a render proxy is created, even though we aren't loading an asset model for this entity. For more details, see the discussion of entity pool signatures in [Entity Pool Creation \(p. 379\)](#).

Entity Class Mapping

In an entity pool definition file, the `<Contains>` section should include maps to all the entity classes that an entity must belong to when it is created through this pool. You can map as many as you want by adding a new `<Class>` node within this section. It is important that each entity have the same dynamic class hierarchy as the empty class when fully instantiated. See [Debugging Utilities \(p. 385\)](#) for useful debugging tools to verify that this is the case.

Other Properties

An entity pool definition can define the following additional properties.

name

Unique identity given to an entity pool, useful for debugging purposes. The name should be unique across all definitions.

maxSize

Largest pool size this pool can reach. By default, this is also the number of entity containers created to fill the pool when loading a level. This value can be overwritten for a level by including an `EntityPools.xml` file inside the level's root directory. This file can only be used to decrease the number of entity containers created per pool; it cannot exceed the `maxSize` value defined here. This is useful when you need to reduce the memory footprint of the entity pools per level. The following example file adjusts the size of an AI entity pool to "2".

LevelEntityPools.xml

```
<EntityPools>
  <AI count="2" />
</EntityPools>
```

hasAI

Boolean value that indicates whether or not the entity pool will contain entities that have AI associated with them. It is important to set this property to TRUE if you are pooling entities with AI.

defaultBookmarked

Boolean value that indicates whether or not an entity belonging to one of the entity classes mapped to this pool is flagged as "created through pool" (see [Creating and Destroying Static Entities with Pools \(p. 380\)](#)). This flag determines whether or not, during a level load, an entity pool bookmark is created for the entity instead of being instantiated.

forcedBookmarked

Boolean value that indicates whether or not an entity belonging to one of the entity classes mapped to this pool must be created through the pool. This property overrides an entity's "created through pool" flag (see [Creating and Destroying Static Entities with Pools \(p. 380\)](#)).

Entity Pool Creation

When loading a level, an entity pool is created for each entity pool definition. On creation, the pool is filled with empty containers (instances of `CEntity` using the `emptyClass` attribute value as the entity class. These empty containers come with some expectations that must be satisfied:

- Containers should be minimal in size. This means you should not load any assets or large amounts of data into them. For example, in the sample Lua script (`\Game\Scripts\Entities\AI\NullAI.lua`), the `NullAI` entity does not define a character model, animation graph, body damage definition, etc.
- Containers should have the same entity proxies and game object extensions created for them as compared to a `CEntity` fully instantiated using each of the mapped entity classes.

Once the pool is created, an entity pool signature is generated using one of the empty containers. An entity pool's signature is a simple container that maps the dynamic class hierarchy of an entity.

One of the functions of the entity pool system is to avoid as much as possible dynamic allocation for delegate classes used by entities. Key examples of these are the entity proxies and game object extensions used by entities. When an entity pool's empty containers are first created, the delegate classes that will be used by the real entities contained in them are also supposed to be created. To ensure that this is the case, the entity pool signature is used. It works as follows:

1. A `TSerialize` writer is created. It is passed to each entity proxy and game object extension that exists in the entity.
2. Each proxy and extension is expected to write some info to the `TSerialize` writer. This information should be unique.
3. Two signatures can then be compared to see if they contain the same written information, verifying they contain the same dynamic class hierarchy.

All of the entity proxies have already been set up to write their information to the `TSerialize` writer. However, if you create a new game object extension (or a new entity proxy), then you will need to set the class up to respond to the Signature helper when needed. To do this, implement the virtual method (Entity Proxy: `GetSignature`; Game Object Extension: `GetEntityPoolSignature`) and write information about the class to the `TSerialize` writer. Generally, all that is needed is to just begin/end

a group with the class name. The function should then return TRUE to mark that the signature is valid thus far.

CActor::GetEntityPoolSignature Example

```
bool CActor::GetEntityPoolSignature( TSerialize signature )
{
    signature.BeginGroup( "Actor" );
    signature.EndGroup();
    return true;
}
```

The section [Debugging Utilities \(p. 385\)](#) discusses how to view the results of entity pool signature tests in order to verify that everything is working as expected.

Creating and Destroying Static Entities with Pools

This topic covers issues related to handling static entities.

Entity Pool Bookmarks

When an entity is marked to be created through the pool, it is not instantiated during the level load process. Instead, an entity pool bookmark is generated for it. The bookmark contains several items:

- Entity ID reserved for the entity, assigned when the level was exported. You will use this entity ID later to tell the system to create the entity.
- Static instanced data that makes the entity unique. This includes the `<EntityInfo>` section from the `mission.xml` file, which contains area information, flow graph information, child/parent links, PropertiesInstance table, etc.
- Serialized state of the entity if it has been returned to the pool in the past. See more details in [Serialization \(p. 383\)](#).

In each entity's `<EntityInfo>` section in the `mission.xml` file (generated when the level is exported from the Editor), there's a `CreatedThroughPool` property. This property can be referenced from the `SEntitySpawnParams` struct. If set to TRUE, the `EntityLoadManager` module will **not** create a `CEntity` instance for the entity. Instead, it will delegate the static instanced data and reserved entity ID to the `EntityPoolManager` to create a bookmark.

CEntityLoadManager::ParseEntities

```
SEntityLoadParams loadParams;
if (ExtractEntityLoadParams(entityNode, loadParams))
{
    if (bEnablePoolUse && loadParams.spawnParams.bCreatedThroughPool)
    {
        CEntityPoolManager *pPoolManager = m_pEntitySystem->GetEntityPoolManager();
        bSuccess = (pPoolManager && pPoolManager->AddPoolBookmark(loadParams));
    }

    // Default to creating the entity
    if (!bSuccess)
    {
        EntityId usingId = 0;
    }
}
```

```
        bSuccess = CreateEntity(loadParams, usingId);  
    }  
}
```

Preparing a Static Entity

To prepare a static entity, call `IEntityPoolManager::PrepareFromPool`, passing in the entity ID associated with the static entity you want to create. In response, the following execution flow takes place:

1. System determines if the request can be processed in this frame. It will attempt to queue up multiple requests per frame and spread them out. If the parameter `bPrepareNow` is set to `TRUE` or if no prepare requests have been handled this frame, the request will be handled immediately. Otherwise, it will be added to the queue. Inside `CEntityPoolManager::LoadBookmarkedFromPool`, the `EntityLoadManager` is requested to create the entity.

Note

Note: If this activity is happening in the Editor, the entity will simply have its `Enable` event called. This will mimic enabling the entity via Flow Graph (unhide it). In this situation, the execution flow skips to the final step.

2. System searches for an entity container (either empty, or still in use) to hold the requested entity. The function `CEntityPoolManager::GetPoolEntity` looks through the active entity pools to find one that contains the entity class of the given static entity. Once the correct pool is found, the container is retrieved from it. The actual order is as follows:
 - a. If a `forcedPoolId` (entity ID of one of the empty containers created to populate the pool) is requested, find that entity container and return it.
 - b. If no `forcedPoolId` is requested, get an entity container from the inactive set (entity containers not currently in use).
 - c. If no inactive containers are available, get one from the active set (entity containers currently in use). This action uses a "weight" value to determine which container to return. A special Lua function in the script is used to request weights for each empty container (`CEntityPoolManager::GetReturnToPoolWeight`). A negative weight means it should not be used at all if possible. The system might pass in an urgent flag, which means the pool is at its maximum size.
 - d. If an empty container can still not be found, an urgent flag will be ignored and the system will try to grow the pool. This is only possible if the pool was not created at its maximum size (this happens when the maximum pool size is overridden for a level with a smaller maximum size). In this case, a new entity container is generated, added to the pool, and immediately used.
3. The retrieved entity container, along with the static instanced data and reserved entity ID gathered from its bookmark, is passed on through the function `CEntityLoadManager::CreateEntity`, which begins the Reload process. `CreateEntity` uses the provided entity container instead of creating a new `CEntity` instance. It will handle calling the Reload pipeline on the entity container, and then install all the static instanced data for the prepared static entity. The Reload pipeline is as follows:
 - a. The function `CEntity::ReloadEntity` is called on the entity container. The `CEntity` instance will clean itself up internally and begin using the static instanced data of the entity being prepared. The Lua script also performs cleanup using the function `OnBeingReused`.
 - b. The Entity system's salt buffer and other internal containers are updated to reflect that this entity container now holds the reserved entity ID and can be retrieved using it.
 - c. Entity proxies are prompted to reload using the static instanced data provided. This is done by calling `IEntityProxy::Reload`; each proxy is expected to correctly reset itself with the new data provided. The Script proxy is always the first to be reloaded so that the Lua script can be correctly associated before the other proxies attempt to use it.

If the game object is being used as the User proxy, all the game object extensions for the container are also prompted to reload. This is done by

calling `IGameObjectExtension::ReloadExtension` on all extensions. If this function returns `FALSE`, the extension will be deleted. Once this is done, `IGameObjectExtension::PostReloadExtension` is called on all extensions. This behavior mimics the `Init` and `PostInit` logic. Each extension is expected to correctly reset itself with the new data provided.

4. If any serialized data exists within the bookmark, the entity container is loaded with that data. This ensures that the static entity resumes the state it was in last time it was returned to the pool. This process is skipped if this is the first time the static entity is being prepared.

At this point, calling `CEntity::GetEntity` or `CEntity::FindEntityByName` will return the entity container that is now housing the static entity and its information.

Returning a Static Entity to the Pool

To return a static entity, call the function `IEntityPoolManager::ReturnToPool`. You must pass in the entity ID associated with the static entity. In response, the following execution flow takes place:

1. The function `CEntityPoolManager::ReturnToPool` finds the bookmark and the entity pool containing the current entity container housing the static entity.
2. Depending on the `bSaveState` argument, the `CEntity` instance is (saved) and its serialized information is added to the bookmark. This ensures that if the static entity is prepared again later, it will resume its current state.
3. The entity container goes through the `Reload` process again. This time, however, the entity container is reloaded using its empty class, effectively removing all references to loaded assets/content and put it back into a minimal state.

At this point, calling `CEntity::GetEntity` or `CEntity::FindEntityByName` to find the static entity will return `NULL`.

Creating and Destroying Dynamic Entities with Pools

The processes for creating and destroying dynamic entities are similar to those for static entities, with one key exception: dynamic entities have no entity pool bookmarks (at least initially). Because they are not exported in the level, they have no static instanced data associated with them and so no bookmark is made for them.

Creating a Dynamic Entity

As with static entities, creating a dynamic entity with the pool starts with calling `IEntitySystem::SpawnEntity`. Construct an `SEntitySpawnParams` instance to describe its static instanced data. When filling in this struct, set the `bCreatedThroughPool` property to `TRUE` if you wish to have the entity be created through the pool. In the following example, a vehicle part from the Vehicle system is being spawned through the pool:

```
SEntitySpawnParams spawnParams;  
spawnParams.sName = pPartName  
spawnParams.pClass = gEnv->pEntitySystem->GetClassRegistry()-  
>FindClass("VehiclePartDetached");  
spawnParams.nFlags = ENTITY_FLAG_CLIENT_ONLY;  
  
spawnParams.bCreatedThroughPool = true;
```

```
IEntity* pSpawnedDebris = gEnv->pEntitySystem->SpawnEntity(spawnParams);
```

Once `SpawnEntity`, the following execution flow takes place:

1. `CEntitySystem::SpawnEntity` will check for an entity pool associated with the provided entity class. If so, it will delegate the workload to the entity pool manager.
2. From within `CEntityPoolManager::PrepareDynamicFromPool`, an entity pool bookmark is created for the new entity. This is done primarily for serialization purposes.
3. The execution flow follows the same sequence as preparing a static entity (see [Creating and Destroying Static Entities with Pools](#) (p. 380)).
4. If the process is successful, the entity container now housing the information is returned. Otherwise, `SpawnEntity` creates a new `CEntity` instance to satisfy the request.

At this point, calling `CEntity::GetEntity` or `CEntity::FindEntityByName` will return the entity container now housing the dynamic entity and its information.

Destroying a Dynamic Entity with the Pool

As with static entities, use `IEntitySystem::RemoveEntity` or any other method that can destroy an entity. The entity pool manager will return the entity container to the pool, freeing it for use elsewhere and removing the dynamic entity in the process. The resulting execution flow differ from destroying static entities in two ways:

- Dynamic entities are not serialized when they are returned.
- The entity pool bookmark associated with the dynamic entity is removed. It is no longer needed.

At this point, calling `CEntity::GetEntity` or `CEntity::FindEntityByName` will return `NULL`.

Serialization

All entities created or prepared through the entity pool system are serialized by the system for game save/load. For this reason, do not serialize those entities marked as coming from the pool (`IEntity::IsFromPool`) in your normal serialization. This is handled in Lumberyard's default implementation for saving and loading the game state.

The entity pool system is serialized from the Entity system's implementation of the `Serialize` function.

Saving Entity Pools

The following process occurs when the game state is being saved:

1. All active entity containers in all entity pools are updated. This results in `CEntityPoolManager::UpdatePoolBookmark` being called for each active entity container. As long as the entity does not have the `ENTITY_FLAG_NO_SAVE` flag set on it, the bookmark is serialized as follows:
 - a. `Serialize Helper` writes to the bookmark's `pLastState` (an `ISerializedObject`), which contains the serialized state of the entity.
 - b. The callback `CEntityPoolManager::OnBookmarkEntitySerialize` runs through the serialization process on the entity. This ensures that the general information, properties and all entity proxies are serialized using their overloaded `Serialize()` implementation.
 - c. Any listeners subscribed to the `OnBookmarkEntitySerialize` callback are able to write data into the bookmark at this time. This is used to also bookmark AI objects along with the entity.

2. All entity pool bookmarks are saved, including the static entity and dynamic entity usage counts.
3. If any prepare requests are currently queued, the prepare request queue is saved.

Loading Entity Pools

The following process occurs when the game state is being loaded:

1. The saved entity pool bookmarks are read in. If the bookmark is marked as containing a dynamic entity, it is read to ensure it exists. Each bookmark's `pLastState` is read in and updated.
2. If the entity pool bookmark contains an entity that was active at the time the game was saved, the entity is created/prepared from the pool once more.
 - a. While the entity is being created/prepared, it will load its internal state using the `pLastState` at its final step, because the object contains information at this point.
 - b. This will also call the `OnBookmarkEntitySerialize` listener callback, allowing other systems to read data from the bookmark.

Listener/Event Registration

There are several listener and various event callbacks dealing with entity pool usage. These callbacks are important for sub-systems that rely on entity registration. They can notify you when an entity has been prepared or returned to the pool so that you can register and unregister it with your subsystems as needed.

IEntityPoolListener

This listener can be subscribed to via `IEntityPoolManager::AddListener`. It contains the following callbacks:

OnPoolBookmarkCreated

Called when an entity pool bookmark has been created. The reserved entity ID for the pooled entity is passed in, along with the static instanced data belonging to it.

OnEntityPreparedFromPool

Called when an entity (static or dynamic) has been prepared from the pool. You are given both the entity ID and the entity container that is now housing the entity. This is called at the end of the prepare entity process.

OnEntityReturnedToPool

Called when an entity (static or dynamic) has been returned to the pool. You are given both the entity ID and the entity container that is currently housing the entity. This is called at the start of the return entity process.

OnPoolDefinitionsLoaded

Called at initialization, with information allowing listeners to set up their own resources for working with the pool. Currently passes the total number of pooled entities that have AI attached.

OnBookmarkEntitySerialize

Called during reads and writes from entity bookmarks, allowing listeners to store additional data in the bookmark.

IEntitySystemSink

This listener has a special callback, `OnReused`, that notifies you when an entity has been reloaded. This is the process an entity container goes through when a static entity is being prepared into it, or a dynamic entity is being created inside it. You are given the entity container that houses the entity as well as the static instanced data belonging to it.

Debugging Utilities

There are several debugging utilities you can use to manage the entity pools and see how they are being used during gameplay.

Debugging Entity Pool Bookmarks

To see the status of all entity pool bookmarks that currently exist during the game, use the following console command.

```
es_dump_bookmarks [filterName] [dumpToDisk]
```

This command causes text to be written to the console and game log file for every bookmark requested.

Arguments

filterName

(Optional) Allows you to filter your request to get bookmarks only for entities whose names contain the specified value as a substring. To display all bookmarks, set this argument to "all" or leave it empty.

dumpToDisk

(Optional) Allows you to output to disk all static instanced data associated with the displayed bookmarks. If supplied and its a non-zero numerical file, data will be stored at `\User\Bookmarks\LevelName\EntityName.xml`.

Data displayed

The following information is displayed for each bookmark:

- Name of the bookmarked entity.
- Layer the bookmarked entity belongs to.
- Entity class name the bookmarked entity uses.
- Reserved entity ID associated with the bookmarked entity.
- If the bookmarked entity has the No Save Entity Flag associated with it.
- If the bookmarked entity is static or dynamic.
- If the bookmarked entity contains any serialized data (and the memory footprint of the information if available).
- If the bookmarked entity contains any static instanced data (and the memory footprint of the information if available).

Entity ID Explained

When referring to a dynamic C++ object, pointers and reference counting can be used, but a better method is to use a weak reference that allows you to remove an object and have all references become invalid. This option limits the need to iterate over all objects to invalidate objects being removed, which results in performance costs.

With each reference, Lumberyard stores a number called the "salt" (also called a "magic number"). This number, together with the **index**, gives the object a unique entity ID over the game lifetime.

Whenever an object is destroyed and the index is reused, the salt is increased and all references with the same index become invalid. To get an entity position/pointer, the entity manager needs to resolve the entity ID; as the salt is different, the method fails.

The class `CSaltBufferArray` handles adding and removing objects and does the required adjustments to the salt. The object array is kept compact for more cache-friendly memory access. Storing `EntityId` references to disc is possible and used for saved games and by the Editor game export. However, when loading a saved game of a level that has been patched and now has more entities, this can result in a severe conflict. To solve this problem, dynamic entities are created starting with a high index counting down, while static entities are created starting with a low index counting up.

Entity IDs have the following limitations:

- A 16-bit index allows up to approximately 65,000 living objects. This should be enough for any non-massive multiplayer game. In a massive multiplayer game, the method described here should not be used by the server. However, it can be used between specific clients and the server.
- A 16-bit salt value allows a game to reuse an index up to approximately 65,000 times. If that happens, the index can no longer be used. This should be enough for any non-massive multiplayer game, when used with some care—don't create and destroy objects (such as bullets) too rapidly. A massive multiplayer game, or any game that supports multi-day game sessions, can run into this limit.

Adding Usable Support on an Entity

Overview

Players may be able to interact with an entity using a key press ('F' by default). Entities that can be interacted with will be enabled with a special on-screen icon inside the game to inform the player that interaction is possible.

To use this feature, you need to create a script that implements two functions: `IsUsable()` and `OnUsed()`.

Preparing the Script

The script should look like this:

```
MakeUsable(NewEntity)

function NewEntity:IsUsable(userId)
    -- code implementation
    return index;
end

function NewEntity:OnUsed(userId, index)
    -- code implementation
end
```

Implementing IsUsable

The `IsUsable()` function is called when a player is aiming the cross-hairs towards the entity. The function will determine if the entity can be interacted with by the player doing the aiming. The function only accepts a single parameter: the player's entity ID.

If the player cannot interact with the entity, the function should return 0. This value causes the UI to not render the "USE" icon over the entity.

If the player can interact with the entity, the function should return a positive value. This value will be stored and later used when calling the `OnUsed()` function.

Implementing OnUsed

The `OnUsed()` function is called when a player presses interacts with the entity (such as by pressing the Use key when the USE icon is active). This function accepts two parameters: (1) the player's entity ID, and (2) the value returned by `IsUsable()`.

Entity Scripting

This section contains topics on using Lua scripting to work with the Entity system.

This section includes the following topics:

- [Structure of a Script Entity \(p. 387\)](#)
- [Using Entity State \(p. 390\)](#)
- [Using Entity Slots \(p. 392\)](#)
- [Linking Entities \(p. 393\)](#)
- [Exposing an Entity to the Network \(p. 394\)](#)

Structure of a Script Entity

To implement a new entity using Lua, two files need to be created and stored in the game directory:

- The Ent file tells the Entity system the location of the Lua script file.
- The Lua script file implements the desired properties and functions.

With the SDK, both the `.ent` and `.lua` files are stored inside the `<Game_Folder>\Scripts.pak` file.

Ent File

The Ent files are all stored inside the `<Game_Folder>\Entities` directory and need to have the `.ent` file extension. The content is XML as follows:

```
<Entity
  Name="LivingEntity"
  Script="Scripts/Entities/Physics/LivingEntity.lua"
/>
```

Entity properties set in the Ent file include:

Name

Name of the entity class.

Script

Path to the Lua script that implements the entity class.

Invisible

Flag indicating whether or not the entity class is visible in Lumberyard Editor.

Lua Script

The Lua script, in addition to implementing the entity class, provides a set of information used by Lumberyard Editor when working with entities on a level. The property values set inside the Lua script are default values assigned to new entity instances. Editor variables specify how entities are drawn in Lumberyard Editor.

The following code excerpt is from the sample project files in your Lumberyard directory (... \dev\Cache\SamplesProject\pc\samplesproject\scripts\entities\physics\livingentity.lua).

```
LivingEntity = {
  Properties = {
    soclasses_SmartObjectClass = "",
    bMissionCritical = 0,
    bCanTriggerAreas = 1,
    DmgFactorWhenCollidingAI = 1,

    object_Model = "objects/default/primitive_capsule.cgf",
    Physics = {
      bPhysicalize = 1, -- True if object should be physicalized at all.
      bPushableByPlayers = 1,
    },
    Living = {
      height = 0, -- vertical offset of collision geometry center
      vector_size = {0.4, 0.4,0.9}, -- collision cylinder dimensions
      height_eye = 1.8, -- vertical offset of camera
      height_pivot = 0.1, -- offset from central ground position that is
      considered entity center
      head_radius = 0.3, -- radius of the 'head' geometry (used for camera
      offset)
      height_head = 1.7, -- center.z of the head geometry
      groundContactEps = 0.004, --the amount that the living needs to move
      upwards before ground contact is lost. defaults to which ever is greater
      0.004, or 0.01*geometryHeight
      bUseCapsule = 1,--switches between capsule and cylinder collider geometry

      inertia = 1, -- inertia koefficient, the more it is, the less inertia is,
      0 means no inertia
      inertiaAccel = 1, -- inertia on acceleration
      air_control = 1, -- air control koefficient 0..1, 1 - special value (total
      control of movement)
      air_resistance = 0.1, -- standard air resistance
      gravity = 9.8, -- gravity vector
      mass = 100, -- mass (in kg)
      min_slide_angle = 60, -- if surface slope is more than this angle, player
      starts sliding (angle is in radians)
      max_climb_angle = 60, -- player cannot climb surface which slope is
      steeper than this angle
      max_jump_angle = 45, -- player is not allowed to jump towards ground if
      this angle is exceeded
      min_fall_angle = 65, -- player starts falling when slope is steeper than
      this
      max_vel_ground = 10, -- player cannot stand of surfaces that are moving
      faster than this
      timeImpulseRecover = 0.3, -- forcefully turns on inertia for that duration
      after receiving an impulse
      nod_speed = 1, -- vertical camera shake speed after landings
    }
  }
}
```

```
bActive = 1,-- 0 disables all simulation for the character, apart from
moving along the requested velocity
collision_types = 271, -- (271 = ent_static | ent_terrain | ent_living |
ent_rigid | ent_sleeping_rigid) entity types to check collisions against

},
MultiplayerOptions = {
  bNetworked= 0,
},

bExcludeCover=0,
},

Client = {},
Server = {},

-- Temp.
_Flags = {},

Editor={
  Icon = "physicsobject.bmp",
  IconOnTop=1,
},
}
```

This information is followed by functions that implement the entity class.

Properties

Entity properties are placed inside the entity class. These properties are assigned to all new instances of the entity class created, visible and editable in Lumberyard Editor as the instance's **Entity Properties** table. The property values set for individual entity instances placed on a level are saved in the level file. When a property of an entity instance is changed in Lumberyard Editor, the `OnPropertyChange()` function called (if it has been implemented for the script entity).

Lumberyard Editor provides the Archetype tool for assigning a common set of properties reused for multiple instance (even across multiple levels). For more information on Archetypes, see [Archetype Entity](#) in the [Amazon Lumberyard User Guide](#).

When specifying entity class property names, use the following prefixes to signal the data type expected for a property value. This enables Lumberyard Editor to validate a property value when set.

Entity class property prefixes

Prefix	Data Type
b	boolean
f	float
i	integer
n	positive integer
s	string
clr	color

Prefix	Data Type
object_	object compatible with Lumberyard (CFG, CGA, CHR or CDF file)

You can add special comments to property values that can be utilized by the engine. For example:

```
--[25,100,0.1,"Damage threshold"]
```

This comment tells the engine the following:

- Value is limited to between 25 and 100.
- The float value uses a step of 0.01 (this limits the fidelity of values).
- The string "Damage threshold" will be displayed in the Lumberyard Editor as a tool tip.

Editor Table

The Editor table provides additional configuration information to Lumberyard Editor on how to handle instances of the entity.

Entity class editor variables

Variable	Description
Model	CGF model to be rendered over an entity instance.
ShowBounds	Flag indicating whether or not a bounding box is drawn around an entity instance when selected.
AbsoluteRadius	
Icon	BMP icon to be drawn over an entity instance.
IconOnTop	Flag indicating whether or not the icon is drawn over or under an entity instance.
DisplayArrow	
Links	

Functions

A script entity can include several callback functions called by the engine or game system. See [Entity System Script Callbacks \(p. 176\)](#) for more information.

Using Entity State

The Entity system provides a simple state-switching mechanism for script entities.

Each state consists of the following:

- Name (string)
- Lua table within the entity table, identified with the state name
- **OnEndState()** function (optional)
- **OnBeginState()** function (optional)

- Additional callback functions (optional) (See [Entity System Script Callbacks \(p. 176\)](#))

To declare states for an entity:

All entity states must be declared in the entity's main table to make the Entity system aware of them. The following examples show how to declare "Opened", "Closed", and "Destroyed" states.

```
AdvancedDoor =
{
  Client = {},
  Server = {},
  PropertiesInstance = ...
  Properties = ...
  States = {"Opened", "Closed", "Destroyed"},
}
```

To define an entity state:

Entity states can be either on the server or client (or both). The definition for a server-side "Opened" state might look as follows:

```
AdvancedDoor.Server.Opened =
{
  OnBeginState = function( self )
    if(self.Properties.bUsePortal==1)then
      System.ActivatePortal(self:GetWorldPos(),1,self.id);
    end;
    self.bUpdate=1;
    self.lasttime=0;
    AI.ModifySmartObjectStates( self.id, "Open-Closed" );
    self:Play(1);
  end,

  OnUpdate = function(self, dt)
    self:OnUpdate();
  end,
}
```

To set an entity's initial state:

Initially, an entity has no state. To set an entity's state, use one of the entity's callback functions (not to be confused with an entity state's callback function) to call its `GotoState()` method, shown in the following example. Once the entity state is set, the entity resides in that state and events will also be directed to that state.

```
function AdvancedDoor:OnReset()
  self:GotoState("Opened");
end
```

To change an entity's state:

Transitioning from the current state to any other state can also be done using the `GotoState()` method, as follows.

```
function AdvancedDoor.Server:OnHit(hit)
  ...
```

```
if (self:IsDead()) then
    self:GotoState("Destroyed");
end
end
```

To query an entity's state:

Querying the state the entity is currently in can be done using the **GetState()** method, as follows.

```
if (self:GetState()=="Opened") then ...
if (self:GetState()~="Opened") then ...
```

Using Entity Slots

Each entity can have slots that are used to hold different resources available in Lumberyard. This topic describes how to work with entity slots.

Allocating a Slot

The following table lists the resources that can be allocated in a slot, along with the ScriptBind function used to allocate it.

Lumberyard resource	Function
static geometry	LoadObject() or LoadSubObject()
animated character	LoadCharacter()
particle emitter	LoadParticleEffect()
light	LoadLight()
cloud	LoadCloud()
fog	LoadFogVolume()
volume	LoadVolumeObject()

Modifying Slot Parameters

Each of these resource may be moved, rotated, or scaled relative to the entity itself.

- SetSlotPos()
- GetSlotPos()
- SetSlotAngles()
- GetSlotAngles()
- SetSlotScale()
- GetSlotScale()

You can add a parenting link between the slots, making it possible to have related positions.

- SetParentSlot()

- `GetParentSlot()`

Slot Management

To determine whether or not a specified slot is allocated, call the function `!IsSlotValid()`.

To free one slot, call `!FreeSlot()`

To free all allocated slots within the entity, call `!FreeAllSlots()`.

Loading a Slot

The following example illustrates loading a slot in a script function.

```
local pos={x=0,y=0,z=0};
self:LoadObject(0,props.fileModel);
self:SetSlotPos(0,pos);
self:SetCurrentSlot(0);
```

Linking Entities

In Lumberyard Editor, you can link an entity to other entities. These links are organized inside the Entity system. Each entity can link to multiple entities. Each link has a name associated to it. See the [Amazon Lumberyard User Guide](#) for more information about grouping and linking objects.

The following example Lua script searches the Entity system for any links to other entities that are named "Generator".

```
function RadarBase:IsPowered()
    local i=0;
    local link = self:GetLinkTarget("Generator", i);

    while (link) do
        Log("Generator %s", link:GetName());

        if (link:GetState() == "PowerOn") then
            if (link.PowerConnect) then
                link:PowerConnect(self.id);
                return true;
            end
        end

        i=i+1;
        link=self:GetLinkTarget("Generator", i);
    end

    return false;
end
```

The following functions are used to read or create entity links:

- `CountLinks`
- `CreateLink`
- `GetLink`

- GetLinkName
- GetLinkTarget
- RemoveAllLinks
- RemoveLink
- SetLinkTarget

Exposing an Entity to the Network

A script entity can be a serialized value on the network. This approach is done by setting the values on the server and having them automatically synchronized on all the clients. It also makes it possible to invoke client/server RMI functions.

Keep in mind the following limitations:

- There is no notification when a serialized value has changed.
- Values are controlled on the server only, there is no way to set values on the client.

Exposing a Script Entity to CryNetwork

To define the network features of an entity, call the ScriptBind function `Net.Expose()`, as illustrated in the following code. This code is written inside a Lua script within the global space, rather than in a function.

```
Net.Expose {
  Class = DeathMatch,
  ClientMethods = {
    ClVictory          = { RELIABLE_ORDERED, POST_ATTACH, ENTITYID, },
    ClNoWinner        = { RELIABLE_ORDERED, POST_ATTACH, },

    ClClientConnect   = { RELIABLE_UNORDERED, POST_ATTACH, STRING, BOOL },
    ClClientDisconnect = { RELIABLE_UNORDERED, POST_ATTACH, STRING, },
    ClClientEnteredGame = { RELIABLE_UNORDERED, POST_ATTACH, STRING, },
  },
  ServerMethods = {
    RequestRevive      = { RELIABLE_UNORDERED, POST_ATTACH, ENTITYID, },
    RequestSpectatorTarget = { RELIABLE_UNORDERED, POST_ATTACH, ENTITYID,
    INT8 },
  },
  ServerProperties = {
    busy = BOOL,
  },
};
```

RMI functions

The RMI function is defined in either the ClientMethods and ServerMethods tables passed to the `Net.Expose()` function.

Order flags:

- UNRELIABLE_ORDERED
- RELIABLE_ORDERED
- RELIABLE_UNORDERED

The following descriptors control how the RMI is scheduled within the data serialization.

RMI attach flag	Description
NO_ATTACH	No special control (preferred)
PRE_ATTACH	Call occurs before data serialized
POST_ATTACH	Call occurs after the data serialized

The following example shows a function declaration:

```
function DeathMatch.Client:ClClientConnect(name, reconnect)
```

The following examples illustrate a function call:

```
self.allClients:ClVictory( winningPlayerId );
```

```
self.otherClients:ClClientConnect( channelId, player:GetName(), reconnect );
```

```
self.onClient:ClClientConnect( channelId, player:GetName(), reconnect );
```

See [RMI Functions \(p. 496\)](#) for more details.

Note

Note: Script networking doesn't have an equivalent to the dependent object RMIs.

ServerProperties table

The entity table also contains a ServerProperties table that indicates which properties need to be synchronized. This is also the place to define the variable type of the value.

Exposing a Script Entity to CryAction

In addition, you must create a game object in CryAction and bind the new game object to the network game session. The following example shows the code placed in the `OnSpawn()` function:

```
CryAction.CreateGameObjectForEntity(self.id);  
CryAction.BindGameObjectToNetwork(self.id);
```

You can also instruct the game object to receive a per-frame update callback, as in the following function call to CryAction:

```
CryAction.ForceGameObjectUpdate(self.id, true);
```

The script entity receive the `OnUpdate()` function callback of its Server table.

```
function Door.Server:OnUpdate(frameTime)  
-- some code  
end
```

Note

Adding update callback code to your script entity can decrease the performance of a game.

Event Bus (EBus)

Event buses (or EBus for short) are a general purpose system for dispatching messages. Ebuses have many advantages:

- **Abstraction** – Minimize hard dependencies between systems.
- **Event-driven programming** – Eliminate polling patterns for more scalable and high performing software.
- **Cleaner application code** – Safely dispatch messages without concern for what is handling them or whether they are being handled at all.
- **Concurrency** – Queue events from various threads for safe execution on another thread or for distributed system applications.
- **Predictability** – Provide support for ordering of handlers on a given bus.
- **Debugging** – Intercept messages for reporting, profiling, and introspection purposes.

The EBus source code can found in the Lumberyard directory location `<root>\dev\Code\Framework\AZCore\AZCore\EBus\EBus.h`.

Bus Configurations

You can configure EBuses for various usage patterns. This section presents common configurations and their applications.

Topics

- [Single Handler](#) (p. 397)
- [Many Handlers](#) (p. 398)
- [EBus with Addresses and a Single Handler](#) (p. 399)
- [EBus with Addresses and Many Handlers](#) (p. 401)

Single Handler

The simplest configuration is a many-to-one (or zero) communication bus, much like a singleton pattern.

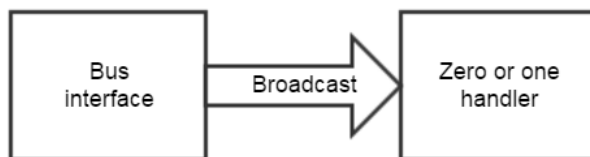

There is at most one handler, to which any sender can dispatch events. Senders need not manually check and de-reference pointers. If no handler is connected to the bus, the event is simply ignored.

```
// One handler is supported.
static const AZ::EBusHandlerPolicy HandlerPolicy =
    AZ::EBusHandlerPolicy::Single;

// The EBus uses a single address.
static const AZ::EBusAddressPolicy AddressPolicy =
    AZ::EBusAddressPolicy::Single;
```

Many Handlers

Another common configuration is one in which many handlers can be present. You can use this configuration to implement observer patterns, subscriptions to system events, or general-purpose broadcasting.

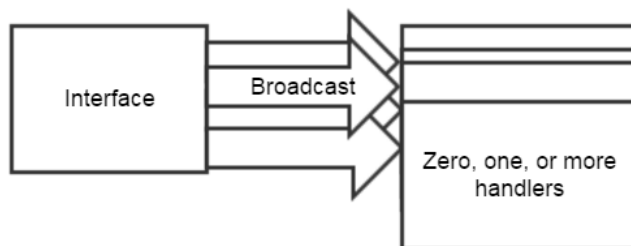

Events to the handlers can be received in defined or undefined order. You specify which one in the `HandlerPolicy` trait.

Example Without Handler Ordering

To handle events in no particular order, simply use the `Multiple` keyword in the `HandlerPolicy` trait, as in the following example:

```
// Multiple handlers. Events received in undefined order.
static const AZ::EBusHandlerPolicy HandlerPolicy =
    AZ::EBusHandlerPolicy::Multiple;

// The EBus uses a single address.
static const AZ::EBusAddressPolicy AddressPolicy =
    AZ::EBusAddressPolicy::Single;
```

Example with Handler Ordering

To handle events in a particular order, use the `MultipleAndOrdered` keyword in the `HandlerPolicy` trait, and then implement a custom handler-ordering function, as in the following example:

```
// Multiple handlers. Events received in defined order.
static const AZ::EBusHandlerPolicy HandlerPolicy =
    AZ::EBusHandlerPolicy::MultipleAndOrdered;

// The EBus uses a single address.
static const AZ::EBusAddressPolicy AddressPolicy =
    AZ::EBusAddressPolicy::Single;

// Implement a custom handler-ordering function
struct BusHandlerOrderCompare : public
    AZStd::binary_function<MyBusInterface*, MyBusInterface*, bool>
{
    AZ_FORCE_INLINE bool operator()(const MyBusInterface* left, const
    MyBusInterface* right) const { return left->GetOrder() < right->GetOrder();
    }
};
```

EBus with Addresses and a Single Handler

EBuses also support addressing based on a custom ID. Events addressed to an ID are received by handlers connected to that ID. If an event is broadcast without an ID, it is received by handlers at all addresses.

A common use for this approach is for communication among the components of a single entity, or between components of a separate but related entity. In this case the entity ID is the address.

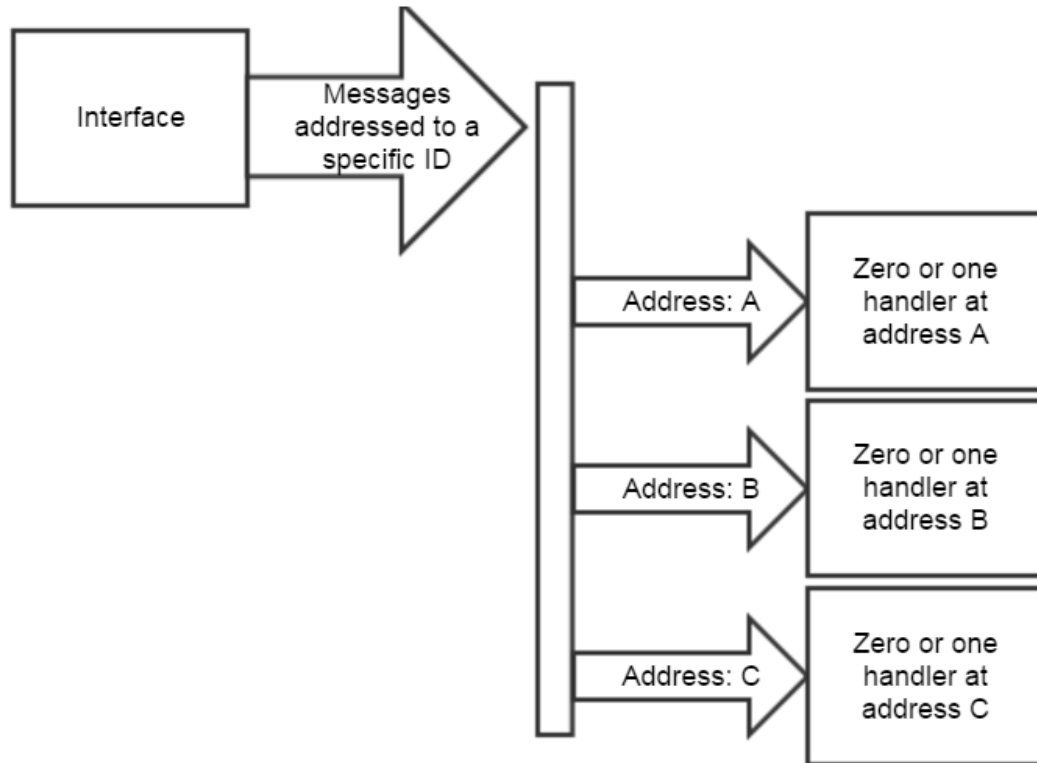

Example Without Address Ordering

In the following example, messages broadcast without an ID arrive at each address in no particular order.

```
// One handler per address is supported.
static const AZ::EBusHandlerPolicy HandlerPolicy =
    AZ::EBusHandlerPolicy::Single;

// The EBus has multiple addresses. Addresses are not ordered.
static const AZ::EBusAddressPolicy AddressPolicy =
    AZ::EBusAddressPolicy::ById;

// Messages are addressed by EntityId.
using BusIdType = AZ::EntityId;
```

Example With Address Ordering

In the following example, messages broadcast with an ID arrive at each address in a specified order.

```
// One handler per address is supported.
static const AZ::EBusHandlerPolicy HandlerPolicy =
    AZ::EBusHandlerPolicy::Single;
```

```
// The EBus has multiple addresses. Addresses are ordered.  
static const AZ::EBusAddressPolicy AddressPolicy =  
    AZ::EBusAddressPolicy::ByIdAndOrdered;  
  
// Messages are addressed by EntityId.  
using BusIdType = AZ::EntityId;  
  
// Addresses are ordered by EntityId.  
using BusIdOrderCompare = AZStd::greater<BusIdType>;
```

EBus with Addresses and Many Handlers

In the previous configuration, only one handler is allowed per address. This is often desirable to enforce ownership of an EBus for a specific ID, as in the singleton case above. However, if you want more than one handler per address, you can configure the EBus accordingly:

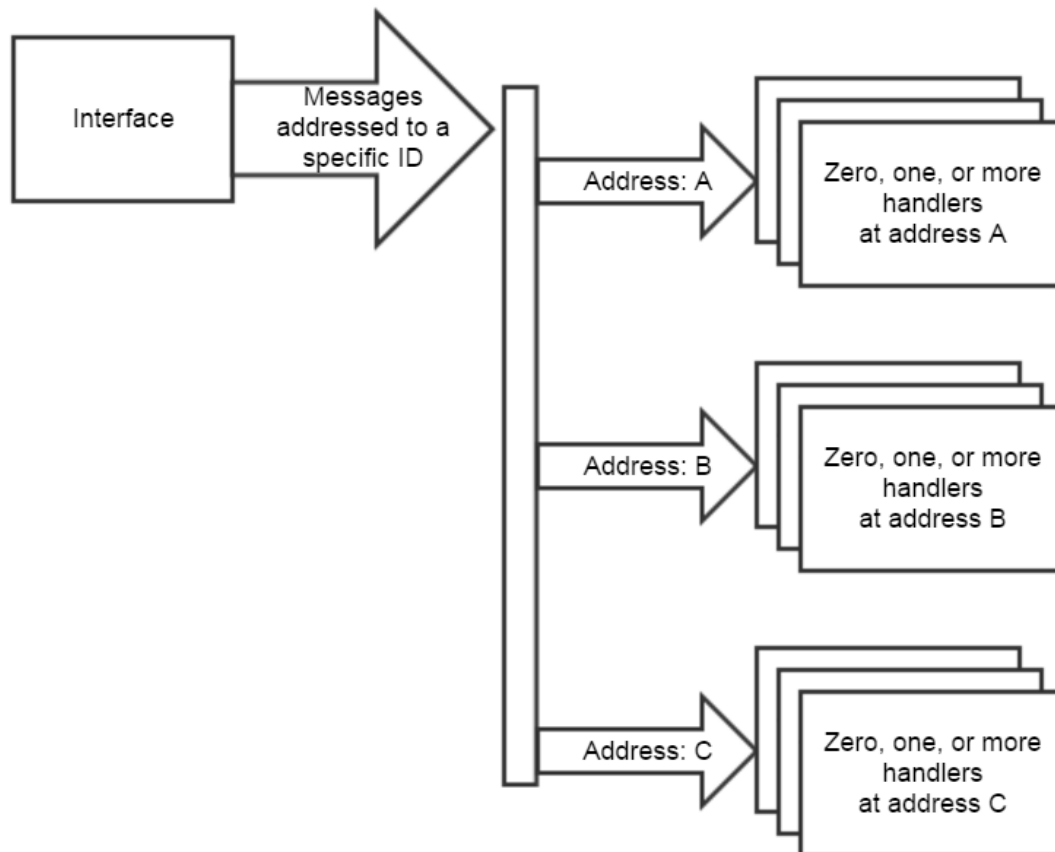

Example: Without Address Ordering

In the following example, messages broadcast with an ID arrive at each address in no particular order. At each address, the order in which handlers receive the message is defined by `EBusHandlerPolicy`, which in this example is simply `ById`:

```
// Allow any number of handlers per address.
```

```
static const AZ::EBusHandlerPolicy HandlerPolicy =  
    AZ::EBusHandlerPolicy::Multiple;  
  
// The EBus has multiple addresses. Addresses are not ordered.  
static const AZ::EBusAddressPolicy AddressPolicy =  
    AZ::EBusAddressPolicy::ById;  
  
// Messages are addressed by EntityId.  
using BusIdType = AZ::EntityId;
```

Example: With Address Ordering

In the following example, messages broadcast with an ID arrive at each address in a specified order. At each address, the order in which handlers receive the message is defined by the `EBusHandlerPolicy`, which in this example is `ByIdAndOrdered`.

```
// Allow any number of handlers per address.  
static const AZ::EBusHandlerPolicy HandlerPolicy =  
    AZ::EBusHandlerPolicy::Multiple;  
  
// The EBus has multiple addresses. Addresses are ordered.  
static const AZ::EBusAddressPolicy AddressPolicy =  
    AZ::EBusAddressPolicy::ByIdAndOrdered;  
  
// We address the bus EntityId.  
using BusIdType = AZ::EntityId;  
  
// Addresses are ordered by EntityId.  
using BusIdOrderCompare = AZStd::greater<BusIdType>;
```

Synchronous vs. Asynchronous

EBus supports both synchronous and asynchronous (queued) messaging.

Synchronous Messaging

Synchronous messages are sent to any and all handlers when an EBus event is invoked. Synchronous messages limit opportunities for asynchronous programming, but they offer the following benefits:

- They don't require storing a closure. Arguments are forwarded directly to callers.
- They let you retrieve an immediate result from a handler (event return value).
- They have no latency.

Asynchronous Messaging

Asynchronous messages have the following advantages:

- They create many more opportunities for parallelism and are much more future proof.
- They support queuing messages from any thread, dispatching them on a safe thread (like the main thread, or any thread that you choose).
- The code used to write them is inherently tolerant to latency and is easily migrated to actor models and other distributed platforms.
- The performance of the code that initiates events doesn't rely on the efficiency of the code that handles the events.

- In performance-critical code, asynchronous messages can improve i-cache and d-cache performance because they require fewer virtual function calls.

For information on declaring an EBus for queing and sending messages asynchronously, see [Asynchronous/Queued Buses \(p. 407\)](#) later in this topic.

Additional Features

EBuses contain other features that address various patterns and use cases:

- **Cache a pointer to which messages can be dispatched** – This is handy for EBuses that have IDs. Instead of looking up the EBus address by ID for each event, you can use the cached pointer for faster dispatching.
- **Queue any callable function on an EBus** – When you use queued messaging, you can queue a lambda or bound function against an EBus for execution on another thread. This is useful for general purpose thread-safe queuing.

Usage and Examples

This section provides examples of how to declare and configure an EBus, implement a handler, send messages, and receive return values.

Topics

- [Declaring an EBus \(p. 403\)](#)
- [EBus Configuration Options \(p. 404\)](#)
- [Implementing a Handler \(p. 405\)](#)
- [Sending Messages to an EBus \(p. 406\)](#)
- [Retrieving Return Values \(p. 406\)](#)
- [Return Values from Multiple Handlers \(p. 407\)](#)
- [Asynchronous/Queued Buses \(p. 407\)](#)

Declaring an EBus

Declaring an EBus is much like declaring any virtual interface class in C++. However, you can specify various configuration options that control how the EBus is generated at compile time and how it behaves.

Here is a simple example of a basic interface and associated EBus.

```
class ExampleInterface : public AZ::EBusTraits
{
public:
    // ----- EBus Configuration -----
    // These override the defaults in EBusTraits.

    // One handler per address is supported.
    static const AZ::EBusHandlerPolicy HandlerPolicy =
    AZ::EBusHandlerPolicy::Single;
```



```
// The EBus contains a single address.
static const AZ::EBusAddressPolicy AddressPolicy =
AZ::EBusAddressPolicy::Single;
// ----- Other -----

~ExampleInterface() override { };

// ----- Handler Interface -----
// Handlers inherit from ExampleInterfaceBus::Handler

// Handlers are required to implement this because it's pure virtual.
virtual void DoSomething() = 0;

// Handlers can override this, but are not required to.
virtual void SomeMessage() { }

// Returns a value and has a parameter.
virtual bool ReturnedValue(int x) = 0;
};

using ExampleInterfaceBus = AZ::EBus<ExampleInterface>;
```

EBus Configuration Options

EBus configuration options are key to controlling how the EBus behaves. The configuration options used in the previous example are explained in the following sections.

HandlerPolicy

The `HandlerPolicy` trait determines how many handlers connect to an address on the EBus and the order in which handlers at each address receive events. The following example specifies a [single handler](#) (p. 397):

```
// One handler per address is supported.
static const AZ::EBusHandlerPolicy HandlerPolicy =
AZ::EBusHandlerPolicy::Single;
```

The `HandlerPolicy` has two common uses:

- A singleton pattern in which various systems post messages or requests to a single system elsewhere in the codebase.
- A pattern where a specific component or an entity handles messages to the EBus. For example, you might have a mesh component that owns an entity. The mesh component handles all mesh-related queries addressed to the entity's ID.

Address Policy

The `AddressPolicy` trait defines how many addresses exist on the EBus. The following example specifies only a single address. An ID is not required.

```
// The EBus contains a single address.
static const AZ::EBusAddressPolicy AddressPolicy =
AZ::EBusAddressPolicy::Single;
```

A common use for a single address policy is a singleton pattern in which various systems post messages or requests to a single system elsewhere in the codebase.

EBusAddressPolicy Options

The `EBusAddressPolicy` has the following options:

- **single** – The EBus uses a single address. No ID is used. The EBus can have a [single handler \(p. 397\)](#) or [many handlers \(p. 398\)](#).
- **ById** – The EBus has multiple addresses. The order in which addresses are notified when broadcasting events without an ID is not specified.
- **ByIdAndOrdered** – The EBus has multiple addresses. However, when broadcasting events without an ID, we want to control the order in which individual addresses are notified. The `BusIdOrderCompare` definition allows for arbitrary customization of ordering.

EBusHandlerPolicy Options

The `EBusHandlerPolicy` has the following options:

- **single** – One handler per address is supported. Uses include an EBus with a [single handler \(p. 397\)](#) or an [EBus with addresses and a single handler \(p. 399\)](#).
- **Multiple** – Any number of handlers are supported. Ordering is ignored. Uses include [many handlers \(p. 398\)](#) or an [EBus with addresses and many handlers \(p. 401\)](#).
- **MultipleAndOrdered** – Any number of handlers are supported, and handlers are notified in a particular order. The `BusHandlerOrderCompare` definition allows for arbitrary customization of ordering.

Implementing a Handler

A handler of an EBus derives from `AZ::EBus<x>::Handler`. For convenience this was defined as `ExampleInterfaceBus` in the [previous example \(p. 403\)](#). This means that the handler can be derived from `ExampleInterfaceBus::Handler`.

```
#include "ExampleInterface.h"

// note: derives from bus handler, rather than directly from ExampleInterface
class MyHandler : protected ExampleInterfaceBus::Handler
{
public:
    void Activate();

protected:
    // Implement the handler interface:
    void DoSomething() override; // note: Override specified.
    void SomeMessage() override;
    bool ReturnedValue(int x) override;
};
```

Note that handlers are not automatically connected to an EBus, but are disconnected automatically because the destructor of `Handler` calls `BusDisconnect`.

In order to actually connect to the EBus and start receiving events, your handler must call `BusConnect()`:

```
void MyHandler::Activate()
{
    // For a single EBus, this would be just BusConnect().
    // For multiple EBuses, you must specify the EBus to connect to:
    ExampleInterfaceBus::Handler::BusConnect();
}
```

You can call `BusConnect()` at any time and from any thread.

If your EBus is addressed, connect to the EBus by passing the EBus ID to `BusConnect()`. To listen on all addresses, call `BusConnect()` without passing in an ID.

```
// connect to the EBus at address 5.
ExampleAddressBus::Handler::BusConnect(5);
```

Sending Messages to an EBus

Anyone who can include the header can send messages to the EBus at any time. Using the previous example, a completely unrelated class can issue a `DoSomething` call on the EBus:

```
#include "ExampleInterface.h"
// note: We don't need to include MyHandler.h
...
...
EBUS_EVENT(ExampleInterfaceBus, DoSomething);

// calls the EBus without reading the result, packs 5 as the first parameter.
EBUS_EVENT(ExampleInterfaceBus, ReturnedValue, 5);
```

If your EBus is addressed, you can send events to a specific address ID. Events broadcast globally are received at all addresses.

```
// broadcasts to ALL HANDLERS on the EBus regardless of address, even if the
// EBus has addresses
EBUS_EVENT(ExampleAddressBus, Test);

// broadcasts only to handlers connected to address 5.
EBUS_EVENT_ID(5, ExampleAddressBus, Test)
```

Retrieving Return Values

If you make a synchronous call (`EBUS_EVENT`), you can also supply a variable in which to place the result:

```
// ALWAYS INITIALIZE YOUR RESULT!!!
// Since there may be nobody connected to the EBus, your result may not be
// populated.
bool result = false;
EBUS_EVENT_RESULT(result, ExampleInterfaceBus, ReturnedValue, 2);
```

In this example, if there are no handlers connected to the EBus, the `result` variable is not modified. If one or more handlers are connected to the EBus, `operator=()` is called on the `result` variable for each handler.

Return Values from Multiple Handlers

In certain cases you might have to aggregate the return value of a function when there are multiple handlers. For example, suppose you want to send a message to all handlers that asks whether any one handler objects to shutting down an application. If any one handler returns true, you should abort the shutdown. The following would not suffice:

```
// Counterexample: returnValue contains only the result of the final handler.
bool returnValue = false;
EBUS_EVENT_RESULT(returnValue, SomeInterface::Bus, DoesAnyoneObject);
```

Because the EBus issues `operator=` for each handler, `returnValue` would contain only the result of the final handler.

Instead, you can create a class to collect your results that overrides `operator=`. There are several built-in types for this, and you can make your own:

```
#include <AZCore/EBus/Results.h>
...
AZ::EBusAggregateResults<bool> results;
EBUS_EVENT_RESULT(results, SomeInterfaceBus, DoesAnyoneObject);

// results now contains a vector of all results from all handlers.

// alternative:
AZ::EBusLogicalResult<bool, AZStd::logical_or<bool> > response(false);
EBUS_EVENT_RESULT(response, SomeInterfaceBus, DoesAnyoneObject);

// response now contains each result, using logical OR operation. So all
// responses are OR'd with each other.
```

Note

Additional building blocks (for example, arithmetic results) are available inside `results.h`.

Asynchronous/Queued Buses

To declare an EBus on which events can be queued and sent asynchronously, add the following to the EBus declaration:

```
static const bool EnableEventQueue = true;
```

You can use `EBUS_QUEUE_EVENT` and its variants to enqueue events on a EBus so that you can flush them later from a controlled location or thread.

To flush the queue at the appropriate location or thread, invoke the following:

```
ExampleInterfaceBus::ExecuteQueuedEvents();
```

File Access

This section covers tools available for tracking and accessing game files.

This section includes the following topics:

- [CryPak File Archives](#) (p. 408)
- [Tracking File Access](#) (p. 416)

CryPak File Archives

The CryPak module enables you to store game content files in a compressed or uncompressed archive.

Features

- Compatible with the standard zip format.
- Supports storing files in an archive or in the standard file system.
- Data can be read in a synchronous and asynchronous way through `IStreamCallback` (max 4GB offset, 4GB files).
- Files can be stored in compressed or uncompressed form.
- Uncompressed files can be read partially if required.
- File name comparison is not case sensitive.
- Supports loading of `.zip` or `.pak` files up to 4GB in size.

Unicode and Absolute Path Handling

Internally, all path-handling code is ASCII-based; as such, no Unicode (16-bit characters for different languages) functions can be used—this is to save memory and for simplicity. Because games can and should be developed with ASCII path names, no real need for Unicode exists. Game productions that don't follow these requirements have issues integrating other languages. For example, because a user might install a game to a directory with Unicode characters, absolute path names are explicitly avoided throughout the whole engine.

Layering

Usually the game content data is organized in several `.pak` files, which are located in the game directory. When a file is requested for an opening operation, the CryPak system loops through all

registered `.pak` files. `.pak` files are searched in order of creation. This allows patch `.pak` files, which have been added to the build later, to be in a preferred position. It is also possible to mix `.pak` files with loose files, which are stored directly in the file system (not in a `.pak` file). If a file exists as a loose file as well as in a `.pak` archive, the loose file is preferred when the game is in **devmode**. However, to discourage cheating in the shipped game, the file stored in the `.pak` is preferred over the loose file when the game is not run in devmode.

Slashes

Usually forward slashes (`/`) are used for internal processing, but users may enter paths that contain backslashes.

Special Folder Handling

You can use the path alias `%USER%` to specify a path relative to the user folder. This might be needed to store user-specific data. Windows can have restrictions on where the user can store files. For example, the program folder might not be writable at all. For that reason, screenshots, game data, and other files should be stored in the user folder. The following are examples of valid file names and paths:

```
%USER%/ProfilesSingle/Lisa.dat  
game/Fred.dat
```

Internals

- A known implementation flaw exists where using more than approximately 1000 files per directory causes problems.
- Format properties:
 - The `.zip` file format stores each file with a small header that includes its path and filename in uncompressed text form. For faster file access, a directory is listed at the end of the file. The directory also stores the path and filename in uncompressed text form (redundant).

Creating a pak file using 7-Zip

To create a `.pak` file with 7-Zip's `7za.exe` command line tool, use the following syntax:

```
7za a -tzip -r -mx0 PakFileName [file1 file2 file3 ...] [dir1 dir2 ...]
```

Dealing with Large Pak Files

The zip RFC specifies two types of `.zip` files, indicated by `.zip` format version 45. Old `.zip` files can have a 4GB offset, but if legacy I/O functions are used, it is only possible to seek +- 2GB, which becomes the practical limit. The 4GB offsets have nothing to do with native machine types and do not change size across platforms and compilers, or configurations. The offsets for older versions of `.zip` files are in a machine independent `uint32`; the offsets for the new version `.zip` files are in `uint64`, appended to the old version `structs`. The version a `.zip` file uses is located in the header of the `.zip` file. Applications are free to not support the newer version. For more information, see the [.ZIP File Format Specification](#).

Manual splits are not necessary, as RC supports auto-splitting:

- `zip_sizesplit` – Split `.zip` files automatically when the maximum configured or supported compressed size has been reached. The default limit is 2GB.

- `zip_maxsize` – Maximum compressed size of the `.zip` file in kilobytes (this gives an explicit limit).

Splitting works in all cases and supports multi-threading and incremental updates. It expands and shrinks the chain of necessary zip-parts automatically. Sorting is honored as much as possible, even in face of incremental modifications, but individual files can be appended to the end of the parts to fill in the leftover space even if this violates the sort order.

For more information about zip files, see [Zip File Format Reference by Phil Katz](#).

Accessing Files with CryPak

In this tutorial you will learn how file reading and writing works through `CryPak`. The tutorial teaches you how to add new files to your project, read files from the file system and from pak archives, and write files to the file system.

Topics

- [Preparation \(p. 410\)](#)
- [Reading Files with CryPak \(p. 411\)](#)
- [Writing to File System Files With CryPak \(p. 413\)](#)
- [Modifying Paks With CryArchive \(p. 415\)](#)
- [CryPak Details \(p. 415\)](#)

Preparation

This tutorial demonstrates two different methods of loading a file: from inside a `.pak` archive, and directly from the file system. Before you can start, you need a file in a `.pak` archive, and a file with the same name (but with different content) in the file system. To verify which file is loaded, the example makes use of the content inside each text file.

To prepare sample files

1. Create a text file named `ExampleText.txt`.
2. Using a text editor, open `ExampleText.txt` and type in the following text:

```
3. This sample was read from the .pak archive
```

4. Save the file.
5. Inside the `GameSDK` directory, create a subfolder called `Examples`.
6. Add the `ExampleText.txt` file to the `Examples` folder so that the path looks like this:

```
<root>\GameSDK\Examples\ExampleText.txt
```

7. Run the following command from the directory `root\GameSDK`:

```
..\Tools\7za.exe a -tzip -r -mx0 Examples.pak Examples
```

This command uses the executable file `7za.exe` (located in the `Tools` folder) to create an archive of the `Examples` folder called `Examples.pak`. Because you ran the command from the `GameSDK` folder, the archive was saved to the `GameSDK` folder. The `.pak` file contains only the file `Examples\ExampleText.txt`.

8. Using a text editor, change the text inside the `<root>\GameSDK\Examples\ExampleText.txt` file to something different, for example:

```
This sample was read from the file system
```

Now you have two different text files with the same destination path, except that one is stored directly in the file system, and the other is inside the .pak file.

Reading Files with CryPak

Now you can write some code to read the information from the `ExampleText.txt` file that you created.

1. Type the following, which contains the `if-else` statement that frames the code. The `ReadFromExampleFile()` function will read the contents of the file and return `true` if it succeeds, and `false` if not.

```
char* fileContent = NULL;
if (!ReadFromExampleFile(&fileContent))
{
    CryWarning(VALIDATOR_MODULE_SYSTEM, VALIDATOR_WARNING,
"ReadFromExampleFile() failed");
}
else
{
    CryLogAlways("ExampleText contains %s", fileContent);
    [...] // this line will be added later on
}
```

If `ReadFromExampleFile()` is successful in reading `ExampleText.txt`, `fileContent` will be the space in memory that contains the text that it read.

2. Type the following, which stubs out the `ReadFromExampleFile()` function.

```
bool ReadFromExampleFile(char** fileContent)
{
    CCryFile file;
    size_t fileSize = 0;
    const char* filename = "examples/exampletext.txt";

    [...]
}
```

- `file` of type `CCryFile` can make use of `CryPak` to access files directly from the file system or from inside a .pak archive.
 - `fileSize` - Defines the end of the message. In this case, reading does not end by detecting the null character `'\0'`.
 - `filename` - Specifies the path of the file to be loaded and is case-insensitive.
3. Type the following, which uses `CryPak` to search the file.

```
char str[1024];
if (!file.Open(filename, "r"))
{
    sprintf(str, "Can't open file, (%s)", filename);
    CryWarning(VALIDATOR_MODULE_SYSTEM, VALIDATOR_WARNING, "%s", str);
    return false;
}
```

- `Open()` invokes `CryPak` to search the file specified by `filename`.
- File access mode `"r"` specifies that a plain text file is going to be read. To read a binary file, use `"rb"` instead.

4. Type the following, which gets the length of the file. If the file is not empty, it allocates the memory required as indicated by the file length. It then reads the file content. It aborts if the size of the content is not equal to the file length.

```
    fileSize = file.GetLength();
    if (fileSize <= 0)
    {
        sprintf(str, "File is empty, (%s)", filename);
        CryWarning(VALIDATOR_MODULE_SYSTEM, VALIDATOR_WARNING, "%s", str);
        return false;
    }

    char* content = new char[fileSize + 1];
    content[fileSize] = '\0';

    if (file.ReadRaw(content, fileSize) != fileSize)
    {
        delete[] content;
        sprintf(str, "Can't read file, (%s)", filename);
        CryWarning(VALIDATOR_MODULE_SYSTEM, VALIDATOR_WARNING, "%s", str);
        return false;
    }
```

- `content` is the local pointer to a `char` array in memory which gets initialized by the length returned by `GetLength()` and an extra null character.
 - `ReadRaw` fills `content` with the information read from the text file. In case of a failure, the allocated memory of `content` is freed.
5. Type the following, which closes the file handle and sets the `fileContent` pointer so that the locally created data can be used outside the function. Finally, it returns `true` since the reading was successful.

```
    file.Close();

    *fileContent = content;
    return true;
```

Note

In the example, the caller of `ReadFromExampleFile()` is responsible for freeing the heap memory which has been allocated to store the data from the text file. Thus, after the data has been used, be sure to add the call `delete[] fileContent;`

6. To check if the reading was successful, run the game and check the `Game.log` file.

Complete example code (file reading)

Calling `ReadFromExampleFile()`

```
char* fileContent = NULL;
if (!ReadFromExampleFile(&fileContent))
{
    CryWarning(VALIDATOR_MODULE_SYSTEM, VALIDATOR_WARNING,
"ReadFromExampleFile() failed");
}
else
{
    CryLogAlways("ExampleText contains %s", fileContent);
}
```

```
        delete[] fileContent;  
    }
```

ReadFromExampleFile() implementation

```
bool ReadFromExampleFile(char** fileContent)  
{  
    CCryFile file;  
    size_t fileSize = 0;  
    const char* filename = "examples/exampletext.txt";  
  
    char str[1024];  
    if (!file.Open(filename, "r"))  
    {  
        sprintf(str, "Can't open file, (%s)", filename);  
        CryWarning(VALIDATOR_MODULE_SYSTEM, VALIDATOR_WARNING, "%s", str);  
        return false;  
    }  
  
    fileSize = file.GetLength();  
    if (fileSize <= 0)  
    {  
        sprintf(str, "File is empty, (%s)", filename);  
        CryWarning(VALIDATOR_MODULE_SYSTEM, VALIDATOR_WARNING, "%s", str);  
        return false;  
    }  
  
    char* content = new char[fileSize + 1];  
    content[fileSize] = '\\0';  
  
    if (file.ReadRaw(content, fileSize) != fileSize)  
    {  
        delete[] content;  
        sprintf(str, "Can't read file, (%s)", filename);  
        CryWarning(VALIDATOR_MODULE_SYSTEM, VALIDATOR_WARNING, "%s", str);  
        return false;  
    }  
  
    file.Close();  
  
    *fileContent = content;  
    return true;  
}
```

Writing to File System Files With CryPak

Writing a file is similar to the process for reading one. To write to files, you use `CCryFile::Write`, which always writes to the file system and never to `.pak` archives. For information on writing files to archive files, see [Modifying Paks With CryArchive \(p. 415\)](#).

1. Type the following, which contains the `if-else` statement that frames the code for writing to a file. The `WriteToExampleFile()` function write will write the contents of the file and return `true` if it succeeds, and `false` if not.

```
char* newContent = "File has been modified";  
bool appendToFile = false;  
if (!WriteToExampleFile(newContent, strlen(newContent), appendToFile))
```

```
    {
        CryWarning(VALIDATOR_MODULE_SYSTEM, VALIDATOR_WARNING,
"WriteToExampleFile() failed");
    }
    else
    {
        CryLogAlways("Text has been written to file, %s", newContent);
    }
}
```

- `WriteToExampleFile()` takes the following three parameters:
 - `newContent` - The text which will be written to `ExampleText.txt` on the file system.
 - `strlen(newContent)` - Returns size of `newContent`, which is the number of bytes to be written.
 - `appendToFile` - true if `newContent` will be added to the already existing content; false if the file will be overwritten.

2. Type the following for the `WriteToExampleFile()` function.

```
bool WriteToExampleFile(char* text, int bytes, bool appendToFile)
{
    CCryFile file;
    const char* filename = "examples/exampletext.txt";

    assert(bytes > 0);
    char* mode = NULL;
    if (appendToFile)
        mode = "a";
    else
        mode = "w";

    char str[1024];
    if (!file.Open(filename, mode))
    {
        sprintf(str, "Can't open file, (%s)", filename);
        CryWarning(VALIDATOR_MODULE_SYSTEM, VALIDATOR_WARNING, "%s", str);
        return false;
    }

    [...]

    file.Close();
    return true;
}
```

- `mode` specifies if the text is to be appended to the existing file or if it will overwrite existing file contents. "w" means 'write' to a clean file, and "a" means 'append' to the existing file.
3. The final step writes the text to the file and returns the number of bytes written, or an error message if none were written.

```
int bytesWritten = file.Write(text, bytes);
assert(bytesWritten == bytes);

if (bytesWritten == 0)
{
    sprintf(str, "Can't write to file, (%s)", filename);
    CryWarning(VALIDATOR_MODULE_SYSTEM, VALIDATOR_WARNING, "%s", str);
    return false;
}
```

```
}
```

- `bytesWritten` tells how many bytes were written by calling the `Write()` function.

Modifying Paks With CryArchive

This section contains a short example that shows how files are added, updated and removed from an archive. The example intentionally uses the `USER` folder instead of the `GameSDK` folder because the `.pak` files inside the `GameSDK` folder are loaded by default at startup and therefore are marked as `Read-Only`. (Files in the `USER` folder are not loaded by default at startup.)

```
string pakFilename = PathUtil::AddSlash("%USER%") + "Examples.pak";
const char* filename = "Examples/ExampleText.txt";
char* text = "File has been modified by CryArchive";
unsigned length = strlen(text);

_smart_ptr<ICryArchive> pCryArchive = gEnv->pCryPak-
>OpenArchive(pakFilename.c_str(), ICryArchive::FLAGS_RELATIVE_PATHS_ONLY
| ICryArchive::FLAGS_CREATE_NEW);
if (pCryArchive)
{
    pCryArchive->UpdateFile(filename, text, length,
ICryArchive::METHOD_STORE, 0);
}
```

- `UpdateFile()` - Modifies an existing file inside the `.pak` archive or creates a new one if it does not exist.
- `ICryArchive::FLAGS_CREATE_NEW` - Forces a new `.pak` file to be created. If you want to add (append) files, remove this flag.
- To remove files or folders from an archive, use one of the following commands in place of `UpdateFile()`: `RemoveFile()`, `RemoveDir()` or `RemoveAll()`.

CryPak Details

Initialization

To ensure that `.pak` files can be accessed from game code at anytime, the `CrySystem` module initializes `CryPak` in `CSystem::Init` by calling the following functions:

- `InitFileSystem(startupParams.pGameStartup);`
- `InitFileSystem_LoadEngineFolders();`

Tip

A good spot to test game initialization is in inside `Game.cpp` at the beginning of `CGame::Init`.

Pak file type priorities

Whether `CryPak` processes files in the file system first, or files in `.pak` files first, depends on the value of `pakPriority`. The default value of `pakPriority` depends on the configuration settings of your build, but it can also manually be changed by assigning the cvar `sys_PakPriority` the values `0`, `1`, `2` or `3`. The meaning of these values is show in the enum `EPakPriority`:

`PakVars.h`

```
enum EPakPriority
{
    ePakPriorityFileFirst = 0,
    ePakPriorityPakFirst = 1,
    ePakPriorityPakOnly = 2,
    ePakPriorityFileFirstModsOnly = 3,
};
```

Pak loading and search priorities

The reason for adding the new pak file to the `GameSDK` folder in this example is because `.pak` files are loaded from the `GameSDK` path first. The loading order and search order of `.pak` file folders are as follows. Note that the loading order and the search order are the reverse of each other.

.pak file load order

1. GameSDK: `<root>\GameSDK*.pak`
2. Engine: `<root>\Engine\
 - a. Engine.pak
 - b. ShaderCache.pak
 - c. ShaderCacheStartup.pak
 - d. Shaders.pak
 - e. ShadersBin.pak`
3. Mods: `root\Mods\MyMod\GameSDK*.pak` (this assumes that you run the game with the command argument `-mod "MyMod"`)

.pak file search order

1. Mods If more than one mod folder exists, they will be checked in the reverse order in which they were added.
2. Engine
3. GameSDK

Tracking File Access

It's possible to track invalid file reads that occur during game run time. The error message `Invalid File Access` occurs when an attempt is made to read or open open files from a thread that is not the streaming thread. These file access operations can cause stalls that can be quite severe.

Note

Only access attempts from the main thread and render thread are logged. This feature is disabled in RELEASE builds.

CVars

The following cvars enable different options for tracking file access.

`sys_PakLogInvalidFileAccess`

1 (default):

- Access is logged to `game.log`.
- Generates a `perfHUD` warning.

- The warning is displayed in red in the upper left corner of the screen.
- A 3 second-stall in non-release builds is induced.

`sys_PakMessageInvalidFileAccess`

- When a file is accessed, creates a popup dialog on the PC. At this point, you can choose to break into the debugger, or continue.

Where invalid access is defined

The points which define when a file access attempt is considered invalid are set by implementing `ICryPak::DisableRuntimeFileAccess` to return true or false. The points may need to be tweaked for single player and multiplayer games.

Exceptions

To add exceptions to file access tracking so that you can ignore files like `game.log`, create an instance of `CDebugAllowFileAccess` in the scope which accesses the file.

Resolving file access callstacks

The files that you collect with `pak_LogInvalidFileAccess 2` must have their callstacks resolved. To do this requires the following tools from the `XenonStackParse` folder of the `Tools` directory.:

- The `.pdb` files from the build
- The `XenonStackParse` tool
- The `ProcessFileAccess.py` helper script

The directory structure for running `ProcessFileAccess.py` should resemble the following:

```
<Root>
--> XenonStackParse
--> FileAccessLogs (this folder should contain the .pdb files)
-----> Processed (this folder contains the output from XenonStackParse)
```

Run `ProcessFileAccess.py` from the `FileAccessLogs` directory (`XenonStackParse` uses the working directory to search for the `.pdb` files). The script creates a folder called `Processed` and a file within it that contains the resolved callstack for each of the log files.

Graphics and Rendering

Lumberyard's rendering technology starts with a modern, physically-based shading core that renders materials based on real world physical parameters (such as base color, metalicity, smoothness, and specularity), allowing you to achieve realistic results using the same physically based parameters used in the highest end film rendering pipelines.

The rendering core is supplemented by a rich set of the most frequently used real time lighting, shading, special effects, and post effects features, such as physical lights, global illumination, volumetric fog, procedural weathering, particle systems, dynamic real time shadows, motion blur, [bokeh](#) depth of field, post color correction, and more.

Lumberyard's rendering engine is tightly integrated with Lumberyard Editor, so the graphical fidelity and performance achieved in your game is what you see in the editor. Changes made in the editor are instantly reflected in the fully rendered scene, allowing for immediate feedback and rapid iteration.

The Lumberyard rendering technology is designed to take maximum advantage of today's high-end PC and console platforms, while maintaining compatibility with older hardware by scaling down graphical features and fidelity without compromising the core visual elements of your scene.

This section includes the following topics:

- [Render Nodes](#) (p. 418)
- [TrueType Font Rendering](#) (p. 422)
- [Generating Stars DAT File](#) (p. 423)
- [Anti-Aliasing and Supersampling](#) (p. 424)

Render Nodes

To visualize objects in a world, Lumberyard defines the concepts of the render node and render element. Render nodes represent general objects in the 3D engine. Among other things, they are used to build a hierarchy for visibility culling, allow physics interactions (optional), and rendering.

For actual rendering, render nodes add themselves to the renderer, passing an appropriate render element that implements the actual drawing of the object. This process happens with the help of render objects, as shown in the sample code below

Creating a New Render Node

The following example creates a render node called **PrismObject**. It is derived from `IRenderNode`, defined in `Code/CryEngine/CryCommon/ IEntityRenderState.h`.

1. Add the interface for `IPrismObjectRenderNode` to `CryEngine/CryCommon/ IEntityRenderState.h` to make it publicly available.

```
struct IPrismRenderNode : public IRenderNode
{
    ...
};
```

2. Add a new enum to the list of already defined render nodes in `CryEngine/CryCommon/ IEntityRenderState.h`.

```
enum EERType
{
    ...
    eERType_PrismObject,
    ...
};
```

3. Add `PrismObjectRenderNode.h` to `Cry3DEngine`.

```
#ifndef _PRISM_RENDERNODE_
#define _PRISM_RENDERNODE_

#pragma once

class CPrismRenderNode : public IPrismRenderNode, public Cry3DEngineBase
{
public:
    // interface IPrismRenderNode
    ...

    // interface IRenderNode
    virtual void SetMatrix(const Matrix34& mat);
    virtual EERType GetRenderNodeType();
    virtual const char* GetEntityClassName() const { return "PrismObject"; }
    virtual const char* GetName() const;
    virtual Vec3 GetPos(bool bWorldOnly = true) const;
    virtual bool Render(const SRenderParams &rParam);
    virtual IPhysicalEntity* GetPhysics() const { return 0; }
    virtual void SetPhysics(IPhysicalEntity*) {}
    virtual void SetMaterial(IMaterial* pMat) { m_pMaterial = pMat; }
    virtual IMaterial* GetMaterial(Vec3* pHitPos = 0) { return m_pMaterial; }
    virtual float GetMaxViewDist();
    virtual void GetMemoryUsage(ICrySizer* pSizer);
    virtual const AABB GetBBox() const { return m_WSBBBox; }
    virtual void SetBBox( const AABB& WSBBBox ) { m_WSBBBox = WSBBBox; }

private:
    CPrismRenderNode();

private:
    ~CPrismRenderNode();

    AABB m_WSBBBox;
    Matrix34 m_mat;
    _smart_ptr< IMaterial > m_pMaterial;
    CREntity* m_pRE;
};
```



```
#endif // #ifndef _PRISM_RENDERNODE_
```

4. Add PrismObjectRenderNode.cpp to Cry3DEngine.

```
#include "StdAfx.h"
#include "PrismRenderNode.h"

CPrismRenderNode::CPrismRenderNode() :m_pMaterial(0)
{
    m_mat.SetIdentity();
    m_WSBBBox = AABB(Vec3(-1, -1, -1), Vec3(1, 1, 1));
    m_pRE = (CREPrismObject*) GetRenderer()-
>EF_CreateRE(eDATA_PrismObject);
    m_dwRndFlags |= ERF_CASTSHADOWMAPS |
    ERF_HAS_CASTSHADOWMAPS;
}

CPrismRenderNode::~CPrismRenderNode()
{
    if (m_pRE)
        m_pRE->Release(false);

    Get3DEngine()->FreeRenderNodeState(this);
}

void CPrismRenderNode::SetMatrix(const Matrix34& mat)
{
    m_mat = mat;
    m_WSBBBox.SetTransformedAABB(mat, AABB(Vec3(-1, -1, -1),
    Vec3(1, 1, 1)));
    Get3DEngine()->RegisterEntity(this);
}

const char* CPrismRenderNode::GetName() const
{
    return "PrismObject";
}

void CPrismRenderNode::Render(const SRenderParams& rParam, const
    SRenderingPassInfo &passInfo)
{
    FUNCTION_PROFILER_3DENGINE;

    if(!m_pMaterial)
        return;

    // create temp render node to submit this prism object to
    the renderer
    CRenderObject *pRO = GetRenderer()-
>EF_GetObject_Temp(passInfo.ThreadID()); // pointer
    could be cached

    if(pRO)
    {
        // set basic render object properties
        pRO->m_II.m_Matrix = m_mat;
        pRO->m_ObjFlags |= FOB_TRANS_MASK;
    }
}

```

```
        pRO->m_fSort = 0;
        pRO->m_fDistance = rParam.fDistance;

        // transform camera into object space
        const CCamera& cam(passInfo.GetCamera());
        Vec3 viewerPosWS(cam.GetPosition());

        // set render object properties
        m_pRE->m_center = m_mat.GetTranslation();

        SShaderItem& shaderItem(m_pMaterial-
>GetShaderItem(0));

        GetRenderer()->EF_AddEf(m_pRE,
        shaderItem, pRO, passInfo, EFSLIST_GENERAL, 0,
        SRendItemSorter(rParam.rendItemSorter));
    }
}

void CPrismRenderNode::GetMemoryUsage(ICrySizer* pSizer) const
{
    SIZER_COMPONENT_NAME(pSizer, "PrismRenderNode");
    pSizer->AddObject(this, sizeof(*this));
}

void CPrismRenderNode::OffsetPosition(const Vec3& delta)
{
    if (m_pRNTmpData) m_pRNTmpData->OffsetPosition(delta);
    m_WSBBox.Move(delta);
    m_mat.SetTranslation(m_mat.GetTranslation() + delta);
    if (m_pRE) m_pRE->m_center += delta;
}

void CPrismRenderNode::FillBBox(AABB & aabb)
{
    aabb = CPrismRenderNode::GetBBox();
}

EERType CPrismRenderNode::GetRenderNodeType()
{
    return eERType_PrismObject;
}

float CPrismRenderNode::GetMaxViewDist()
{
    return 1000.0f;
}

Vec3 CPrismRenderNode::GetPos(bool bWorldOnly) const
{
    return m_mat.GetTranslation();
}

IMaterial* CPrismRenderNode::GetMaterial(Vec3* pHitPos)
{
    return m_pMaterial;
}
```

5. To allow client code to create an instance of the new render node, extend the following function in / Code/CryEngine/Cry3DEngine/3DEngine.cpp

```
...
#include "PrismRenderNode.h"
...
IRenderNode * C3DEngine::CreateRenderNode(EERType type)
{
    switch (type)
    {
        ...
        case eERType_PrismObject:
        {
            IPrismRenderNode* pRenderNode = new CPrismRenderNode();
            return pRenderNode;
        }
        ...
    }
}
```

TrueType Font Rendering

CryFont is used to generate font textures that are required to render text on the screen. The various features of font rendering can be seen by using the `r_DebugFontRendering` console variable.

The output is not only to test the functionality but also to document how the features can be used.

Supported Features

CryFont supports the following features:

- Font shaders – Used to configure the appearance of fonts. Multiple passes with configurable offset and color are supported to enable generation of shadows or outlines. A sample font shader is shown in the following XML example.

```
<fontshader>
  <font path="VeraMono.ttf" w="288" h="416"/>
  <effect name="default">
    <pass>
      <color r="0" g="0" b="0" a="1"/>
      <pos x="1" y="1"/>
    </pass>
  </effect>
  <effect name="console">
    <pass>
      <color r="0" g="0" b="0" a="0.5"/>
      <pos x="2" y="2"/>
    </pass>
  </effect>
</fontshader>
```

The attributes `w` and `h` of the XML font element specify the width and height of the font texture. The order of the passes in XML defines the order in which the passes are rendered. A `<pass>` element without child elements means that the pass is rendered with the default settings. The `<pos>` tag is used to offset the font, while the `<color>` tag is used to set font color and define the transparency (with the alpha channel `a`).

- Unicode – The default font used does not support all Unicode characters (to save memory), but other fonts can be used.
- TrueType fonts as source – Cached in a small texture. Common characters are pre-cached, but runtime updates are possible and supported.
- Colored text rendering
- Adjustable transparency
- Color variations within a string – Use a value of \$0..9 to set one of the 10 available colors. Use \$\$ to print the \$ symbol, and \$o to switch off the feature.
- Returns and tabs within a string
- Text alignment
- Computation of a string's width and height – Used internally to handle center and right alignment.
- Font size variations – Bilinear filtering allows some blurring, but no mipmaps are used so this feature has limitations in minification.
- Proportional and monospace fonts
- Pixel-perfect rendering with exact texel-to-pixel mapping for best quality.

Useful Console Commands

The following console commands provide information about font rendering.

r_DebugFontRendering

Provides information on various font rendering features, useful for verifying function and documenting usage.

- 0=off
- 1=display

r_DumpFontNames

Logs a list of fonts currently loaded.

r_DumpFontTexture

Dumps the texture of a specified font to a bitmap file. You can use `r_DumpFontTexture` to get the loaded font names.

Generating Stars DAT File

The Stars DAT file contains star data that is used in sky rendering. This topic provides information you'll need if you want to modify the data in this file. It assumes you have some familiarity with generating binary files.

Star data is located in `Build\Engine\EngineAssets\Sky\stars.dat`. This data is loaded in the function `CStars::LoadData`, implemented in the file `CRESky.cpp`.

File Format

The Stars DAT file uses a simple binary format; it can be easily modified using an editing tool. The file starts with a header, followed by entries for each star. The header specifies the number of entries in the file.

All types stored in little-endian format, float32 in IEEE-754 format.

Star data provided in the SDK is based on real-world information. Typically, you can also use existing star catalogs to populate this information for you.

The file elements are as follows:

Header (12 bytes)

Name	Offset	Type	Value
Tag	0	uint32	0x52415453 (ASCII: STAR)
Version	4	uint32	0x00010001
NumStars	8	uint32	Number of star entries in the file

Entry (12 bytes)

Name	Offset	Type	Value
RightAscension	0	float32	in radians
Declination	4	float32	in radians
Red	8	uint8	star color, red channel
Green	9	uint8	star color, green channel
Blue	10	uint8	star color, blue channel
Magnitude	11	uint8	brightness, normalized range

Anti-Aliasing and Supersampling

Perceived graphics quality in a game is highly dependent on having clean and stable images. Lumberyard offers an efficient, post-processing-based, anti-aliasing solution that can be controlled in the Console using the console variable `r_AntialiasingMode`. This solution allows game developers to set the amount of anti-aliasing needed to produce graphics that fit their needs, from very sharp images to softer blurred images. Lumberyard also supports supersampling for very high-quality rendering.

Controlling Anti-Aliasing

The following table lists the currently available anti-aliasing modes available in Lumberyard using the CVar `r_AntialiasingMode`.

Mode	CVar Value	Description
No anti-aliasing	0	Disables post-processing-based anti-aliasing. Useful for debugging. Some game developers opt to use a higher resolution rather than spending system resources on anti-aliasing.
SMAA_Low (1X)	1	Enables sub-pixel morphological anti-aliasing (SMAA), which removes jaggies (staircase artifacts) on polygon edges. This mode does not address sub pixel details.
SMAA_Med (1TX)	2	Enables SMAA with basic temporal re-projection to reduce pixel crawling.
SMAA_High (2TX)	3	Enables SMAA with enhanced temporal re-projection, including matrix jittering. This mode usually provides

Mode	CVar Value	Description
		the best image quality but can suffer from occasionally flickering edges.

The images below illustrate the range of graphics quality that can be achieved depending on the anti-alias setting used.





Controlling Supersampling

In addition to anti-aliasing, Lumberyard supports supersampling for very-high-quality rendering. Supersampling renders the scene at a higher resolution and downscales the image to obtain smooth and stable edges. Due to the high internal rendering resolution, supersampling is very performance-heavy and only suitable for games intended to be played on high-end PCs.

Lua Scripting

This section provides reference information and help with scripting in Lua. It also covers how to use tools including the Lua Editor, Lua Remote Debugger and XML loader.

This section includes the following topics:

- [Lua Scripting Reference](#) (p. 427)
- [Integrating Lua and C++](#) (p. 448)
- [Lua Script Usage](#) (p. 449)
- [Lua Editor](#) (p. 450)
- [Using the Lua Remote Debugger](#) (p. 456)
- [Using the Lua XML Loader](#) (p. 457)
- [Recommended Reading](#) (p. 460)

Lua Scripting Reference

This section contains reference information on Lua scripting functions. Functions are organized here based on the system they are defined in.

Topics

- [Common Lua Globals and Functions](#) (p. 427)
- [EntityUtils Lua Functions](#) (p. 431)
- [Math Lua Globals and Functions](#) (p. 434)
- [Physics Lua Functions](#) (p. 444)
- [VR Lua Functions](#) (p. 445)

Common Lua Globals and Functions

- **File location:** `Game/Scripts/common.lua`

- Loaded from: `Game/Scripts/main.lua`

Globals

Use the following globals to avoid temporary Lua memory allocations:

Name	Description
<code>g_SignalData_point</code>	Basic 3D vector value used by g_SignalData .
<code>g_SignalData_point2</code>	Basic 3D vector value used by g_SignalData .
<code>g_SignalData</code>	Used to pass signal data in AI behavior scripts (see: Signals (p. 86)).
<code>g_StringTemp1</code>	Commonly used for temporary strings inside Lua functions.
<code>g_HitTable</code>	Commonly used by the Physics.RaycastWorldIntersection function.

A **g_HitTable** used with **Physics.RaycastWorldIntersection** can contain the following parameters:

Parameter	Description
<code>pos</code>	3D vector world coordinates of the ray hit.
<code>normal</code>	3D normal vector of the ray hit.
<code>dist</code>	Distance of the ray hit.
<code>surface</code>	Type of surface hit.
<code>entity</code>	Script table of entity hit (if one was hit).
<code>renderNode</code>	Script handle to a foliage or static render node.

A **g_SignalData** table can contain the following parameter types:

Type	Description
Vec3	3D vector.
ScriptHandle	Normally used to pass along an entity ID.
Floating Point	Floating point value.
Integer	Integer or number value.
String	String value.

AIReload()

Reloads the **aiconfig.lua** Lua script (`Game/Scripts/AI/`).

AIDebugToggle()

Toggles the `ai_DebugDraw` console variable on and off.

ShowTime()

Logs the current system time to the console. Format is Day/Month/Year, Hours:Minutes.

count()

Returns the number of key-value pairs in a given table.

Parameter	Description
_tbl	Table to retrieve the number of key-value pairs from.

new()

Creates a new table by copying an specified existing table. This function is commonly used to create a local table based on an entity parameter table.

Parameter	Description
_obj	Existing table you want to create a new one from.
norecurse	Flag indicating whether or not to recursively recreate all sub-tables. If set to TRUE, sub-tables will not be recreated.

merge()

Merges two tables without merging functions from the source table.

Parameter	Description
dst	Destination table to merge source table information into.
src	Source table to merge table information from.
recurse	Flag indicating whether or not to recursively merge all sub-tables.

mergef()

Merges two tables including merging functions from the source table.

Parameter	Description
dst	Destination table to merge source table information into.
src	Source table to merge table information from.
recursive	Flag indicating whether or not to recursively merge all sub-tables.

Vec2Str()

Converts a 3D vector table into a string and returns it in the following format: (x: X.XXX y: Y.YYY z: Z.ZZZ).

Parameter	Description
vec	3D vector table to convert. Example: {x=1,y=1,z=1}.

LogError()

Logs an error message to the console and the log file. Message appears in red text in the console.

Parameter	Description
fmt	Formatted message string.
...	Optional argument list. For example: <code>LogError("MyError: %f", math.pi);</code>

LogWarning()

Logs a warning message to the console and the log file. Message appears in yellow text in the console.

Parameter	Description
fmt	Formatted message string.
...	Optional argument list. For example: <code>LogWarning("MyError: %f", math.pi);</code>

Log()

Logs a message to the console and the log file. Commonly used for debugging purposes.

Parameter	Description
fmt	Formatted message string.
...	Optional argument list. For example: <code>Log("MyLog: %f", math.pi);</code>

dump()

Dumps information from a specified table to the console.

Parameter	Description
_class	Table to dump to console. For example: <code>g_localActor</code>
no_func	Flag indicating whether or not to dump the table functions.
depth	Depth of the tables tree dump information from.

EmptyString()

Checks whether or not a given string is set and its length is greater than zero. Returns `TRUE` or `FALSE`.

Parameter	Description
str	String to check for.

NumberToBool()

Checks whether or not a number value is true (non-zero) or false (zero).

Parameter	Description
n	Number to check for.

EntityName()

Retrieves the name of a specified entity ID or entity table. If the entity doesn't exist, this function returns an empty string.

Parameter	Description
entity	Entity table or entity ID to return a name for.

EntityNamed()

Checks whether or not an entity with the specified name exists in the entity system. Returns `TRUE` or `FALSE`. Commonly used for debugging.

Parameter	Description
name	Name of entity to check for.

SafeTableGet()

Checks whether or not a sub-table with a specified name exists in a table. If the sub-table exists, this function returns it; otherwise the function returns `nil`.

Parameter	Description
table	Table to check for the existence of a sub-table.
name	Sub-table name to check for.

EntityUtils Lua Functions

This topic describes the commonly used Lua entity utility functions.

- File location: Game/Scripts/Utils/EntityUtils.lua
- Loaded from: Game/Scripts/common.lua

DumpEntities()

Dumps to console all entity IDs, names, classes, positions, and angles that are currently used in a map. For example:

```
[userdata: 00000002]..name=Grunt1 clsid=Grunt pos=1016.755,1042.764,100.000  
ang=0.000,0.000,1.500  
[userdata: 00000003]..name=Grunt2 clsid=Grunt pos=1020.755,1072.784,100.000  
ang=0.000,0.000,0.500  
...
```

CompareEntitiesByName()

Compares two entities identified by name. This function is commonly used when sorting tables.

Parameter	Description
ent1	Name of first entity table.
ent2	Name of second entity table.

Example

```
local entities = System.GetEntitiesByClass("SomeEntityClass");  
table.sort(entities, CompareEntitiesByName);
```

CompareEntitiesByDistanceFromPoint()

Compares the distance of two entities from a specified point. If the distance is greater for Entity 1 than for Entity 2 (that is, Entity 1 is further away), this function returns `TRUE`, otherwise it returns `FALSE`.

Parameter	Description
ent1	Entity 1 table
ent2	Entity 2 table
point	3D position vector identifying the point to measure distance to.

Example

```
local ent1 = System.GetEntityByName("NameEntityOne");  
local ent2 = System.GetEntityByName("NameEntityTwo");  
  
if(CompareEntitiesByDistanceFromPoint( ent1, ent2,  
g_localActor:GetPos()))then  
    Log("Entity One is further away from the Player than Entity two...");  
end
```

BroadcastEvent()

Processes an entity event broadcast.

Parameter	Description
sender	Entity that sent the event.
event	String based entity event to process.

Example

```
BroadcastEvent(self, "Used");
```

MakeDerivedEntity()

Creates a new table that is a derived version of a parent entity table. This function is commonly used to simplify the creation of a new entity script based on another entity.

Parameter	Description
_DerivedClass	Derived class table.
_Parent	Parent or base class table.

MakeDerivedEntityOverride()

Creates a new table that is a derived class of a parent entity. The derived table's properties will override those from the parent.

Parameter	Description
_DerivedClass	Derived class table.
_Parent	Parent or base class table.

MakeUsable()

Adds usable functionality, such as an **OnUsed** event, to a specified entity.

Parameter	Description
entity	Entity table to make usable.

Example

```
MyEntity = { ... whatever you usually put here ... }
```

```
MakeUsable(MyEntity)

function MyEntity:OnSpawn() ...

function MyEntity:OnReset()
    self:ResetOnUsed()
    ...
end
```

MakePickable()

Adds basic "pickable" functionality to a specified entity. The `bPickable` property is added to the entity's properties table.

Parameter	Description
entity	Entity table to make pickable.

MakeSpawnable()

Adds spawn functionality to a specified entity. Commonly used for **AI** actors during creation.

Parameter	Description
entity	Entity table to make spawnable.

EntityCommon.PhysicalizeRigid()

Physicalizes an entity based on the specified entity slot and its physics properties.

Parameter	Description
entity	Entity table to physicalize.
nSlot	Entity slot to physicalize.
Properties	Physics properties table
bActive	Not used.

Math Lua Globals and Functions

This topic describes the commonly used math global vectors, constants, and functions.

- File location: `Game/Scripts/Utils/Math.lua`
- Loaded from: `Game/Scripts/common.lua`

Global Vectors

The following globals should be used to avoid temporary Lua memory allocations:

Global Name	Description
<code>g_Vectors.v000</code>	Basic zero vector.
<code>g_Vectors.v001</code>	Positive z-axis direction vector.
<code>g_Vectors.v010</code>	Positive y-axis direction vector.
<code>g_Vectors.v100</code>	Positive x-axis direction vector.
<code>g_Vectors.v101</code>	The x and z-axis direction vector.
<code>g_Vectors.v110</code>	The x and y-axis direction vector.
<code>g_Vectors.v111</code>	The x, y and z-axis vector.
<code>g_Vectors.up</code>	Positive z-axis direction vector.
<code>g_Vectors.down</code>	Negative z-axis direction vector.
<code>g_Vectors.temp</code>	Temporary zero vector.
<code>g_Vectors.tempColor</code>	Temporary zero vector. Commonly used for passing rgb color values.
<code>g_Vectors.temp_v1</code>	Temporary zero vector.
<code>g_Vectors.temp_v2</code>	Temporary zero vector.
<code>g_Vectors.temp_v3</code>	Temporary zero vector.
<code>g_Vectors.temp_v4</code>	Temporary zero vector.
<code>g_Vectors.vecMathTemp1</code>	Temporary zero vector.
<code>g_Vectors.vecMathTemp2</code>	Temporary zero vector.

Constants

Constant Name	Description
<code>g_Rad2Deg</code>	Basic radian-to-degree conversion value.
<code>g_Deg2Rad</code>	Basic degree-to-radian conversion value.
<code>g_Pi</code>	Basic Pi constant based on <code>math.pi</code> .
<code>g_2Pi</code>	Basic double-Pi constant based on <code>math.pi</code> .
<code>g_Pi2</code>	Basic half-Pi constant based on <code>math.pi</code> .

IsNullVector()

Checks whether or not all components of a specified vector are null.

Parameter	Description
<code>a</code>	Vector to check.

IsNotNullVector()

Checks whether or not any components of a specified vector is not null.

Parameter	Description
a	Vector to check.

LengthSqVector()

Retrieves the squared length of a specified vector.

Parameter	Description
a	Vector to retrieve length for.

LengthVector()

Retrieves the length of a specified vector.

Parameter	Description
a	Vector to retrieve length for.

DistanceSqVectors()

Retrieves the squared distance between two vectors.

Parameter	Description
a	First vector.
b	Second vector.

DistanceSqVectors2d()

Retrieves the squared distance between two vectors in 2D space (without z-component).

Parameter	Description
a	First vector.
b	Second vector.

DistanceVectors()

Retrieves the distance between two vectors.

Parameter	Description
a	First vector.
b	Second vector.

dotproduct3d()

Retrieves the dot product between two vectors.

Parameter	Description
a	First vector.
b	Second vector.

dotproduct2d()

Retrieves the dot product between two vectors in 2D space (without z-component).

Parameter	Description
a	First vector.
b	Second vector.

LogVec()

Logs a specified vector to console.

Parameter	Description
name	Descriptive name of the vector.
v	Vector to log.

Example

```
LogVec("Local Actor Position", g_localActor:GetPos())
```

Console output:

```
<Lua> Local Actor Position = (1104.018066 1983.247925 112.769440)
```

ZeroVector()

Sets all components of a specified vector to zero.

Parameter	Description
dest	Vector to zero out.

CopyVector()

Copies the components of one vector to another.

Parameter	Description
dest	Destination vector.
src	Source vector.

SumVectors()

Adds up the components of two vectors.

Parameter	Description
a	First vector.
b	Second vector.

NegVector()

Negates all components of a specified vector.

Parameter	Description
a	Vector to negate.

SubVectors()

Copies the componentwise subtraction of two vectors to a destination vector.

Parameter	Description
dest	Destination vector.
a	First vector.
b	Second vector.

FastSumVectors()

Copies the componentwise addition of two vectors to a destination vector.

Parameter	Description
dest	Destination vector.
a	First vector.
b	Second vector.

DifferenceVectors()

Retrieves the difference between two vectors.

Parameter	Description
a	First vector.
b	Second vector.

FastDifferenceVectors()

Copies the componentwise difference between two vectors to a destination vector.

Parameter	Description
dest	Destination vector.
a	First vector.
b	Second vector.

ProductVectors()

Retrieves the product of two vectors.

Parameter	Description
a	First vector.
b	Second vector.

FastProductVectors()

Copies the product of two vectors to a destination vector.

Parameter	Description
dest	Destination vector.
a	First vector.

Parameter	Description
b	Second vector.

ScaleVector()

Scales a specified vector *a* by a factor of *b*.

Parameter	Description
a	Vector.
b	Scalar.

ScaleVectorInPlace(a,b)

Retrieves a new vector based on a copy of vector *a* scaled by a factor *b*.

Parameter	Description
a	First vector.
b	Scalar.

ScaleVectorInPlace(dest,a,b)

Copies vector *a* scaled by the factor of *b* to a destination vector.

Parameter	Description
dest	Destination vector.
a	First vector.
b	Scalar.

NormalizeVector()

Normalizes a specified vector.

Parameter	Description
a	Vector to normalize.

VecRotate90_Z()

Rotates a specified vector by 90 degree around the z-axis.

Parameter	Description
v	Vector to rotate.

VecRotateMinus90_Z()

Rotates a specified vector by -90 degree around the z-axis.

Parameter	Description
v	Vector to rotate.

crossproduct3d()

Copies the result of the cross product between two vectors to a destination vector.

Parameter	Description
dest	Destination vector.
p	First vector.
q	Second vector.

RotateVectorAroundR()

Copies to a destination vector the result of the vector rotation of vector p around vector r by a specified angle.

Parameter	Description
dest	Destination vector.
p	First vector.
r	Second vector.
angle	Rotation angle.

ProjectVector()

Copies to a destination vector the result of the vector projection of vector P to the surface with a specified normal N .

Parameter	Description
dest	Destination vector.
P	Vector to project.

Parameter	Description
N	Surface normal.

DistanceLineAndPoint()

Retrieves the distance between point a and the line between p and q .

Parameter	Description
a	Point to measure from.
p	Vector p.
q	Vector q.

LerpColors()

Performs linear interpolation between two color/vectors with a factor of k .

Parameter	Description
a	Color/vector a.
b	Color/vector b.
k	Factor k.

Lerp()

Performs linear interpolation between two scalars with a factor of k .

Parameter	Description
a	Scalar a.
b	Scalar b.
k	Factor k.

__max()

Retrieves the maximum of two scalars.

Parameter	Description
a	Scalar a.
b	Scalar b.

`__min()`

Retrieves the minimum of two scalars.

Parameter	Description
a	Scalar a.
b	Scalar b.

`clamp()`

Clamps a specified number between minimum and maximum.

Parameter	Description
<code>_n</code>	Number to clamp.
<code>_min</code>	Lower limit.
<code>_max</code>	Upper limit.

`Interpolate()`

Interpolates a number to a specified goal by a specified speed.

Parameter	Description
actual	Number to interpolate.
goal	Goal.
speed	Interpolation speed.

`sgn()`

Retrieves the sign of a specified number (0 returns 0).

Parameter	Description
a	Number to get sign for.

`sgnnz()`

Retrieves the sign of a specified number (0 returns 1).

Parameter	Description
a	Number to get sign for.

sqr()

Retrieves the square of a specified number.

Parameter	Description
a	Number to square.

randomF()

Retrieves a random float value between two specified numbers.

Parameter	Description
a	First number.
b	Second number.

iff()

Checks the condition of a test value and returns one of two other values depending on whether the test value is `nil` or not.

Parameter	Description
c	Test value.
a	Return value if test value is not nil.
b	Return value if test value is nil.

Physics Lua Functions

These functions are commonly used to register new explosion and crack shapes in the physics engine.

File location: `Game/Scripts/physics.lua`

- Loaded from: `Game/Scripts/main.lua`

Physics.RegisterExplosionShape()

Registers a boolean carving shape for breakable objects in the physics engine.

Parameter	Description
sGeometryFile	Name of a boolean shape cgf file.
fSize	Shape's characteristic size.

Parameter	Description
BreakId	Breakability index (0-based) used to identify the breakable material.
fProbability	Shape's relative probability; when several shapes with the same size appear as candidates for carving, these relative probabilities are used to select one.
sSplintersfile	Name of a splinters cgf file, used for trees to add splinters at the breakage location.
fSplintersOffset	Size offset for the splinters.
sSplintersCloudEffect	Name of splinters particle fx; this effect is played when a splinters-based constraint breaks and splinters disappear.

Physics.RegisterExplosionCrack()

Registers a new explosion crack for breakable objects in the physics engine.

Parameter	Description
sGeometryFile	Name of a crack shape cgf file. This type of file must have three helpers to mark the corners, named "1", "2" and "3".
BreakId	Breakability index (0-based) used to identify the breakable material.

VR Lua Functions

You can use Lua bindings to interact programmatically with head-mounted display (HMD) devices that provide Virtual Reality (VR) experiences.

Global Functions

The following functions provide programming interfaces for HMD devices.

Function	Description
<code>HMDDeviceRequestBusSender</code> <code>HMDDeviceRequestBusSender</code>	Returns an <code>HMDDeviceRequestBusSender</code> object that is connected to the specified entity. For more information, see HMDDeviceRequestBusSender Object (p. 445).
<code>ControllerRequestBusSender</code> <code>ControllerRequestBusSender</code>	Returns a <code>ControllerRequestBusSender</code> object that is connected to the specified entity. For more information, see ControllerRequestBusSender Object (p. 446).

HMDDeviceRequestBusSender Object

Contains functions that return information about an HMD and control its pose and tracking level.

Function	Description
Bool IsInitialized()	Returns <code>true</code> if an HMD has successfully initialized on the bus. Returns <code>false</code> if no HMD is connected or failed to initialize.
Void RecenterPose()	Causes the direction that the HMD is currently facing to be considered 'forward'.
Void OutputHMDInfo()	Outputs the information about the currently connected HMD (contained in the <code>HMDDeviceInfo</code> object) to the console and log file.
Void SetTrackingLevel(int)	Sets the tracking level for the HMD. 0 specifies head level tracking (the player is standing); 1 is floor level tracking (the player is seated or on the floor).
HMDDeviceInfo GetDeviceInfo()	Returns an <code>HMDDeviceInfo</code> object that contains device information about a connected HMD. For more information, see struct HMDDeviceInfo (p. 446).
TrackingState GetTrackingState()	Returns a <code>TrackingState</code> object that contains the most recent tracking information about a connected HMD. For more information, see struct TrackingState (p. 447).

ControllerRequestBusSender Object

Returns status information about a controller.

Function	Description
Bool IsConnected(int)	Returns true if the given controller is connected, false if a controller is not connected. Pass 0 for the left controller, pass 1 for the right controller.
Tracking GetTrackingState(int)	Returns a <code>TrackingState</code> object that contains tracking info about a connected controller. Pass 0 for the left controller, pass 1 for the right controller. For more information, see struct TrackingState (p. 447).

struct HMDDeviceInfo

Contains information about a device that displays on the screen when the device is detected.

Field	Description
String productName	Name of the connected HMD. The default is <code>nullptr</code> .
String manufacturer	Name of the company that manufactured the connected HMD. The default is <code>nullptr</code> .
Int renderWidth	The render width for the HMD in pixels. This is normally half the full resolution of the device (rendering is per eye). The default is 0.
Int renderHeight	The render height in pixels for a single eye of the HMD. The default is 0.
Float fovH	The horizontal field of view for both eyes in radians. The default is 0.0f.

Field	Description
Float fovV	The vertical field of view in radians. The default is 0.0f.

struct TrackingState

Stores position and connection state information about the HMD. When an HMD is in use, certain parts of the device can go offline or online. For example, a controller can be disconnected, or the HMD can temporarily lose rotational tracking. You can use the `TrackingState` to determine what part of the pose is currently valid.

Field	Description
PoseState pose	The position and orientation in object space of the HMD. For more information, see struct PoseState (p. 447) .
DynamicsState dynamics	Contains the current state of the physics dynamics for the current device such as linear velocity, angular velocity, and acceleration. For more information, see struct DynamicsState (p. 447) .
Int statusFlags	Bit field that describes the current tracking state. For bit flags, see the enum HMDStatus (p. 448) .

struct PoseState

A specific pose of the HMD device. Each HMD device has its own way of representing its current pose in three dimensional space. This structure acts as a common data set between a connected device and the rest of the system. All data is in a local coordinate space.

Field	Description
Quaternion orientation	A quaternion representing the current orientation in object space of the HMD.
Vector3 position	A three dimensional vector representing the current position of the HMD in object space as an offset from the centered pose.

struct DynamicsState

Dynamics (accelerations and velocities) of the current HMD. Many HMDs have the ability to track the current movements of VR devices for prediction. Not all devices support velocities and accelerations. All data is in a local coordinate space.

Field	Description
Vector3 angularVelocity	A three dimensional vector representing angular velocity in object space.
Vector3 angularAcceleration	A three dimensional vector representing angular acceleration in object space.
Vector3 linearVelocity	A three dimensional vector representing linear velocity in object space.

Field	Description
Vector3 linearAcceleration	A three dimensional vector representing linear acceleration in object space.

enum HMDStatus

The following code shows the status flags for HMDStatus.

```
enum HMDStatus
{
    HMDStatus_OrientationTracked = BIT(1),
    HMDStatus_PositionTracked = BIT(2),
    HMDStatus_CameraPoseTracked = BIT(3),
    HMDStatus_PositionConnected = BIT(4),
    HMDStatus_HmdConnected = BIT(5),
    HMDStatus_IsUsable = HMDStatus_HmdConnected |
    HMDStatus_OrientationTracked,
    HMDStatus_ControllerValid = HMDStatus_OrientationTracked |
    HMDStatus_PositionConnected,
};
```

Integrating Lua and C++

The CryScript system abstracts a Lua virtual machine for use by the other systems and the game code. It includes the following functionality:

- calling script functions
- exposing C++-based variables and functions to scripts
- creating script tables stored in virtual machine memory

The CryScript system is based on Lua 5. More information on the Lua language can be found at <http://www.lua.org>.

Accessing Script Tables

A global script table can be retrieved by calling `IScriptSystem::GetGlobalValue()`. The `IScriptTable` is used to represent all script tables/variables.

Exposing C++ Functions and Values

To expose C++ functions and variables to scripts, you'll need to implement a new class. The easiest way is to derive the `CScriptableBase` class, which provides most of the functionality.

Exposing Constants

To expose constant values to scripts, use the `IScriptSystem::SetGlobalValue()`. For example, to expose a constant named `MTL_LAYER_FROZEN` to our scripts, use the following code:

```
gEnv->pScriptSystem->SetGlobalValue("MTL_LAYER_FROZEN", MTL_LAYER_FROZEN);
```

Exposing Functions

To expose C++ functions to scripts, implement a new class derives from `CScriptableBase`, as shown in the following example.

```
class CScriptBind_Game :
    public CScriptableBase
{
public:
    CScriptBind_Game( ISystem* pSystem );
    virtual ~CScriptBind_Game() {}

    int GameLog( IFunctionHandler* pH, char* pText );
};
```

Add the following code inside the class constructor:

```
Init( pSystem->GetIScriptSystem(), pSystem );
SetGlobalName( "Game" );

#undef SCRIPT_REG_CLASSNAME
#define SCRIPT_REG_CLASSNAME &CScriptBind_Game::

SCRIPT_REG_TEMPLFUNC( GameLog, "text" );
```

In a Lua script, you can access your new `ScriptBind` function as follows:

```
Game.GameLog( "a message" );
```

Lua Script Usage

Lumberyard uses Lua for its scripting language.

The Entity system can attach a script proxy to any entity, which is in the form of a table that can include data and functions. AI behaviors are often written in scripts. Additionally, several game systems, including Actor, Item, Vehicle, and GameRules, rely on scripting to extend their functionality.

The advantages of using scripts include:

- Fast iteration – Scripts can be reloaded within the engine.
- Runtime performance – Careful usage of available resources can result into scripts that run nearly as fast as compiled code.
- Easy troubleshooting – An embedded Lua debugger can be invoked at any time.

Most of the systems in Lumberyard expose `ScriptBind` functions, which allow Lua scripts to call existing code written in C++. See the [ScriptBind Reference \(p. 548\)](#) for more details.

Running Scripts

You can run scripts either by calling script files directly from code or by using console commands.

In code

Scripts are stored in the `\Game\Scripts` directory. To invoke a script file, call the `LoadScript` function from your C++ code. For more information, see [Integrating Lua and C++ \(p. 448\)](#). Another option is to create a script entity, as described in [Entity Scripting \(p. 387\)](#).

In the Console

Script instructions can be executed using the in-game console. This can be done by appending the `#` character before the instructions. This functionality is limited to Lumberyard Editor or when running the launcher in dev mode (using the `-DEVMODE` command-line argument).

Reloading Scripts During Runtime

In Lumberyard Editor it is always possible to reload entities within the user interface. When reloading a script entity, choose the **Reload Script** button, which is found in the Rollup Bar.

You can also use the following `ScriptBind` functions to reload scripts.

- `Script.ReloadScript(filename)`
- `Script.ReloadScripts()`

To invoke these functions from the console, use the following syntax:

```
#Script.ReloadScript("Scripts\\EntityCommon.lua")
```

Lua Editor

Lua Editor is in preview release and is subject to change.

Lumberyard Lua Editor offers an intuitive integrated development environment (IDE) that makes it easy to author, debug, and edit Lua scripts when you create or extend your game. Lua Editor is a standalone application, but can be opened directly from Lumberyard Editor.

Tutorial: Using Lua Editor for Debugging with Lumberyard Editor

This tutorial shows you how to use Lumberyard Editor to create a sample level with a component entity that contains a Lua script component. You open the script in Lua Editor from Lumberyard Editor and perform some sample debugging steps on the script.

To use Lua Editor for debugging

1. In Lumberyard Editor, create a new level by performing one of the following steps:
 - In the **Welcome to Lumberyard Editor** window, click **New level**
 - Click **File, New**
 - Press **Ctrl+N**
2. In the **New Level** dialog box, give the level a name, and then click **OK**.

3. In the **Generate Terrain Texture** dialog box, click **OK** to accept the defaults.
4. Right-click the Lumberyard Editor viewport and select **Create Component Entity**.
5. In **Entity Inspector**, click **Add Component**, and then choose **Rendering, Light**.
6. In **Entity Inspector**, click **Add Component**, and then choose **Scripting, Lua Script**.
7. Scroll down to the bottom of the **Entity Inspector** window and, in the **Lua Script** section, click ... to open the **Preview** window.
8. In the **Preview** window, navigate to **Scripts, components**.
9. Select **lightflicker.lua**, and then click **Open**. (Note: additional sample scripts are located in the Lumberyard directory `\dev\SamplesProject\Scripts`.)
10. In **Entity Inspector**, in the **Lua Script** section, click the empty braces `{ }` to launch Lua Editor.

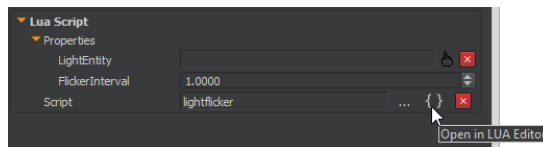

Because the debugging functionality is enabled through network sockets, you must connect Lua Editor to the target that is running the script before you can debug. In this tutorial, you connect to Lumberyard Editor.

Note

Connection is facilitated by [GridHub \(p. 545\)](#), which is Lumberyard's central connection hub for debugging. GridHub starts automatically when Lua Editor is started and must be running in the background for Lua Editor to find targets it can connect to. If for some reason you need to start it manually, you can launch it from `\dev\Bin64\LuaIDE.exe`.

11. In the Lua Editor toolbar, click **Target: None**, and then click **Editor (ID)** to connect to Lumberyard Editor.

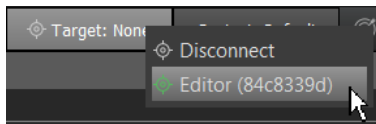

12. In the Lua Editor toolbar, leave **Context** setting at **Default** for the debugging context. The default setting is good for debugging component entity scripts such as the one in this tutorial. The **Cry** option is for debugging legacy scripts such as those associated with Cry entities or the Game SDK.

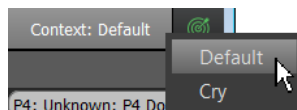

13. Click the attach/detach icon.



14. Press **Alt+Tab** to change focus to Lumberyard Editor, and then press **Alt+Tab** again to return to Lua Editor.

Note

This **Alt+Tab** step is a temporary solution for an issue that will be fixed in a subsequent release of Lua Editor.

When the focus changes to Lumberyard Editor, the attach/detach icon turns green to show that Lua Editor and Lumberyard Editor are connected:

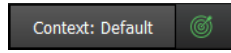

The **Class Reference** window now shows information about the available Lua libraries.

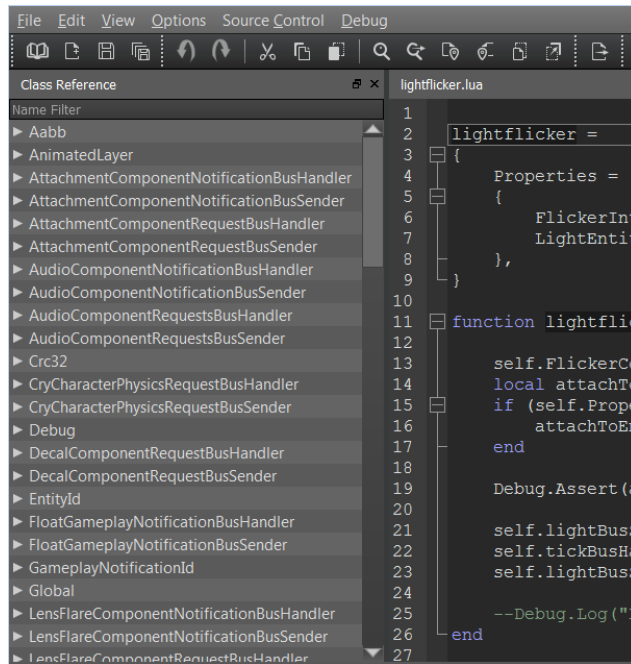

Note



The class reference feature is active only for the default context and component entity scripts. This feature is not active in the Cry context, which exists only for backward compatibility.

After you connect, you can pause the execution of a given script by setting breakpoints.

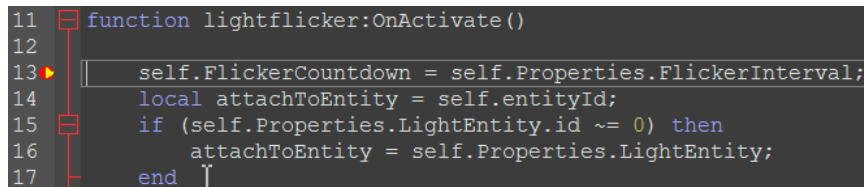
15. In the Lua Editor toolbar, click the **Breakpoints** icon  to show the **Breakpoints** window.
16. In Lua Editor, single-click or double-click one or more line numbers in the `lightflicker.lua` script to set one or more breakpoints. As you add breakpoints, the line number and script path for each are added to the **Breakpoints** window.
17. In Lumberyard Editor, press **Ctrl+G** to run the game, or click **AI/Physics** at the bottom of the viewport to enable game simulation and run scripts. Lua Editor opens with a yellow marker stopped on the first breakpoint that it encounters.



When execution is halted at a breakpoint, more information becomes available in the **Lua Locals**, **Stack**, and **Watched Variables** panes.

18. Click the **Stack** icon  to show the **Stack** window.
19. Click the **Lua Locals** icon  to show local Lua variables.

20. Click **Watched Variables** icon  to open the **Watched Variables** window, where you can specify variables to watch.
21. Press **F11** a few times to step through the code. Note how the contents of the **Stack**, **Lua Locals**, and **Watched Variables** windows change.

Tip

For greater convenience, you can float or dock these windows.







22. To detach from debugging, click the attach/detach icon.



23. In Lumberyard Editor, Press **Esc** to stop the game.

Options Available While Debugging

The following table summarizes common options available while debugging.

Icon	Action	Keyboard Shortcut	Description
	Run in Editor	Alt+F5	Run in Lumberyard Editor.
	Run on Target	Ctrl+F5	Send script to the connected target and run it.
	Run/Continue	F5	Run or continue running the current script.
	Step Into	F11	Step into the function called on the current line.
	Step Out	Shift+F11	Step out of the called function.
	Step Over	F10	Step over the function called on the current line.
	Toggle Breakpoint	F9	Enable or disable a breakpoint on the current line.

Maintaining Separate Search Results

In addition to the usual search capabilities, the **Find** feature can display the results of four different searches separately.

To maintain separate search results

1. Click the **Find** icon  or press **Ctrl+F** to perform searches in the currently open file, or in all open files.

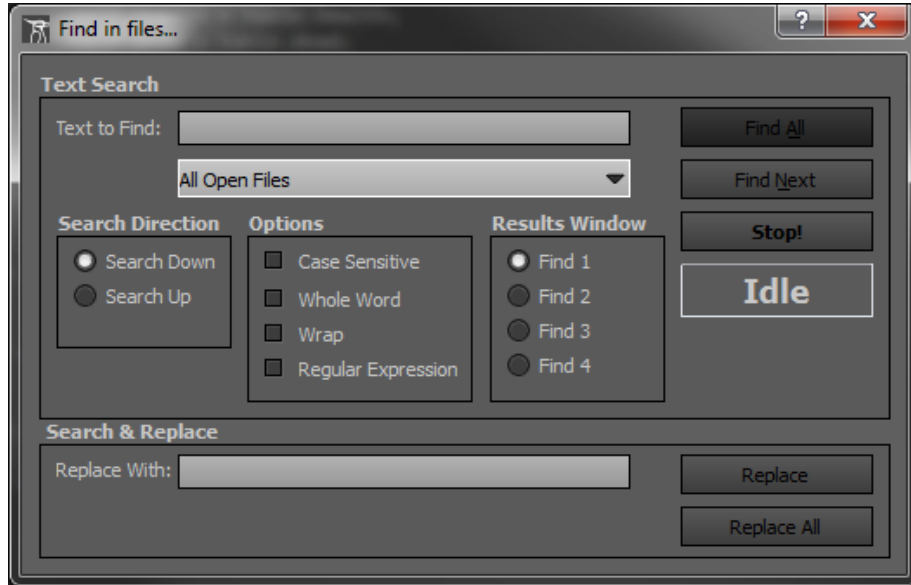

2. Before starting a search, choose **Find 1**, **Find 2**, **Find 3**, or **Find 4** to choose the the window in which you want to see the results. You can maintain the results of four searches separately in the tabbed windows. The search results in the other windows remain unchanged.

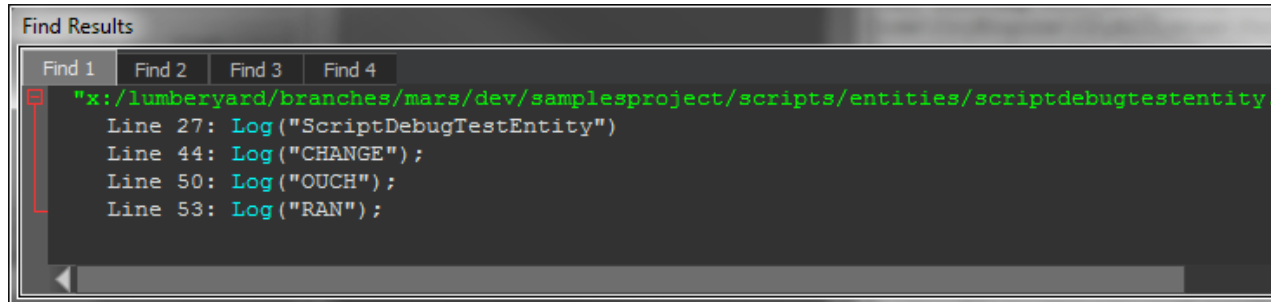

3. To go directly to the line in the code which a search result was found, double-click the line in the search results.

Note

In Lua Editor Preview, the line number shown in the **Find Results** window and the line number in the script pane differ by one.

Tip

For convenience, you can also dock or float the **Find Results** window.

Editing

Lua Editor can open multiple scripts at the same time. Each script has its own tab in the editor. The editor provides a standard set of capabilities for text editing but also includes useful features for editing source code.

The following table summarizes the options available while editing and debugging.

Action	Keyboard Shortcut
Comment selected block	Ctrl+K

Action	Keyboard Shortcut
Copy	Ctrl+C
Cut	Ctrl+X
Find	Ctrl+F
Find in open files	Ctrl+Shift+F
Find next	F3
Fold source functions	Alt+0
Go to line	Ctrl+G
Paste	Ctrl+V
Quick find local	Ctrl+F3
Quick find local reverse	Ctrl+Shift+F3
Redo	Ctrl+Y
Replace	Ctrl+R
Replace in open files	Ctrl+Shift+R
Select all	Ctrl+A
Select to brace ¹	Ctrl+Shift+]]
Transpose lines down	Ctrl+Shift+Down Arrow
Transpose lines up	Ctrl+Shift+Up Arrow
Uncomment selected block	Ctrl+Shift+K
Undo	Ctrl+Z
Unfold source functions	Alt+Shift+0

Perforce Integration

Lua Editor includes Perforce integration features. When you open a file from your Perforce environment, Lua Editor displays the file's status in the top right of the text editing window.

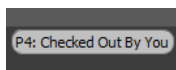
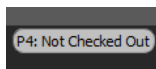

The **Source Control** menu offers **Check Out/Check In** functionality.

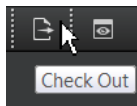

Using the Lua Remote Debugger

Lumberyard includes a standalone visual script debugger for Lua. To start the debugger, you first enable it in the console, and then run the `LuaRemoteDebugger.exe` executable file.

1. In the Lumberyard Editor console or game console, type `lua_debugger 1` or `lua_debugger 2`. This enables enable debugging in one of the following two modes:
 - Mode 1 – The debugger breaks on both breakpoints and script errors.
 - Mode 2 – The debugger breaks only on script errors.
2. Run the Lua remote debugger executable file at the Lumberyard directory location `\dev\Tools\LuaRemoteDebugger\LuaRemoteDebugger.exe`.
3. In the Lua remote debugger, on the **File** menu, choose **Connect**.
4. If you are running the game in the editor (you pressed `Ctrl-G`) and want to debug your scripts, choose **PC (Editor)**. If you want to attach the debugger to the built game executable, choose **PC (Game)**.

For **IP address** and **Port**, type the IP address and port of the computer to which you want to connect. The default options connect to the game on your local computer. The default IP address is 127.0.0.1 (localhost). For **PC (Editor)**, the default port is 9433. For **PC (Game)**, the default port is 9432.

5. Choose **Connect**. In Lumberyard Editor, the console window displays **Lua remote debug client connected**.

The first time you run Lua remote debugger, it prompts you for the scripts folder:

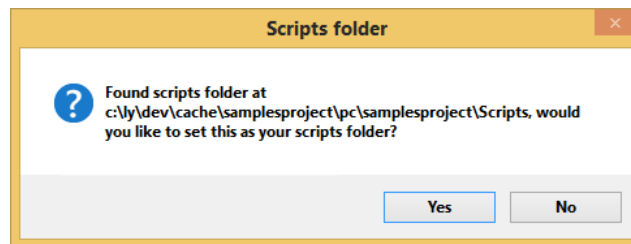

The default folder is the `Scripts` folder of the project that you are running. For example, if you are running the `samplesproject`, the folder is `samplesproject/Scripts`.

6. To accept the default location, click **Yes**.

Note



To change the scripts folder location, choose **File, Set Scripts Folder**.

After you choose the location for your scripts folder, the folder's contents are shown in the navigation tree on the left.

Performing Tasks in the Lua Remote Debugger

To perform specific tasks in the Lua remote debugger, see the following table:

To do this	Do this
Open a script file	Double click the script file in the navigation pane, or press <code>Ctrl+O</code> to open the Find File dialog.
Set a break point	Place the cursor on the line in the script where you want the break to occur, and then click the red dot in the toolbar or press <code>F9</code> . When

To do this	Do this
	program execution stops on a break point, the Call Stack and Locals tabs populate.
Remove a break point	Place the cursor on the line with the breakpoint that you want to remove, and then click the red dot in the toolbar or press F9 .
Use the Breakpoints tab	The Breakpoints tab window displays each of your breakpoints with a check box next to it. To enable or disable a breakpoint, select or clear its check box. In the script window, the breakpoint's status is indicated by its color: red is active; gray is disabled.
To watch (inspect) variable values	When execution is paused on a breakpoint, click the Watch tab, click the first column of a blank row, and then type the name of the variable that you want to watch.
Pause execution	Click the pause (break) button on the toolbar or press Ctrl+Alt+Pause .
Resume execution	Click the play button on the toolbar or press F5 .
Step over a procedure	Click the  toolbar icon or press F10 .
Step into a procedure	Click the  toolbar icon or press F11 .
Step out of a procedure	Click the  toolbar icon or press shift+F11 .
Close a script file	Choose File, Close , or press Ctrl+W
Disconnect from the editor or game	In the Lua debugger, choose File, Disconnect . The Lumberyard console displays a network connection terminated message.

Note

Code changes that you make in the debugger window do not change the loaded script and are discarded after the debugger window is closed.

Using the Lua XML Loader

There is a generic interface for parsing and translating XML files into Lua files. This interface uses an XML file as a definition format that declares what kind of XML is included in a file and what kind of Lua to create from the XML. The format includes some simple validation methods to ensure that the data received is what is expected.

XML Data

The XML loader can distinguish between three kinds of data: properties, arrays, and tables.

Tables

This table represents a Lua-based table:

```
letters = { a="a", b="b", c="c" };
```

In an XML data file, this table would look like this:

```
<letters a="a" b="b" c="c" />
```

The XML definition file would look like this:

```
<Table name="letters">  
  <Property name="a" type="string"/>  
  <Property name="b" type="string"/>  
  <Property name="c" type="string"/>  
</Table>
```

Each element can be marked as optional in the definition file using the attribute `optional="1"`.

Arrays

There are two possible types of arrays. The first type is a simple group of elements, shown in Lua like this:

```
numbers = {0,1,2,3,4,5,6,7,8,9}
```

In the XML data file, the array would look like this:

```
<numbers>  
  <number value="0" />  
  <number value="1" />  
  <number value="2" />  
  <number value="3" />  
  <number value="4" />  
  <number value="5" />  
  <number value="6" />  
  <number value="7" />  
  <number value="8" />  
  <number value="9" />  
</numbers>
```

The data definition file would look like this:

```
<Array name="numbers" type="int" elementName="number" />
```

The second array type is an array of tables. In Lua:

```
wheels = {  
  {size=3, weight=10},  
  {size=2, weight=1},  
  {size=4, weight=20},  
}
```

In the XML data file:

```
<wheels>
```

```
<wheel size="3" weight="10"/>
<wheel size="2" weight="1"/>
<wheel size="4" weight="20"/>
</wheels>
```

The XML definition file:

```
<Array name="wheels" elementName="wheel"> <!-- note no type is attached -->
  <Property name="size" type="float"/>
  <Property name="weight" type="int"/>
</Array>
```

Loading and Saving a Table from Lua

To load and initialize a Lua table:

```
someTable = CryAction.LoadXML( definitionFileName, dataFileName );
```

When storing XML files for scripts, the recommended practice is to keep the definition files with the scripts that use them, but store the data files in a directory outside the Scripts directory.

To save a table from Lua:

```
CryAction.SaveXML( definitionFileName, dataFileName, table );
```

Data Types

The following data types are available, and can be set wherever a "type" attribute is present in the definition file.

- float – Floating point number.
- int – Integer.
- string – String.
- bool – Boolean value.
- Vec3 – Floating point vectors with three components. Values of this type are expressed as follows:
 - XML – "1,2,3"
 - Lua – {x=1,y=2,z=3}

Enums

For string type properties, an optional <Enum> definition can be used. Property values will be validated against the enum.

Example:

```
<Property name="view" type="string">
  <Enum>
    <Value>GhostView</Value>
    <Value>ThirdPerson</Value>
    <Value>BlackScreen</Value>
  </Enum>
```



```
</Property>
```

Enum support for other data types can be added, if necessary.

Example

XML definition file:

```
<Definition root="Data">
  <Property name="version" type="string"/>
  <Table name="test">
    <Property name="a" type="string"/>
    <Property name="b" type="int" optional="1"/>
    <Array name="c" type="string" elementName="Val"/>
    <Array name="d" elementName="Value">
      <Property name="da" type="float"/>
      <Property name="db" type="Vec3"/>
    </Array>
    <Property name="e" type="int"/>
  </Table>
</Definition>
```

Corresponding XML data file:

```
<Data version="Blag 1.0">
  <test
    a="blag"
    e="3">
    <c>
      <Val value="blag"/>
      <Val value="foo"/>
    </c>
    <d>
      <Value da="3.0" db="2.1,2.2,2.3"/>
      <Value da="3.1" db="2.1,2.2,2.3"/>
      <Value da="3.2" db="3.1,3.2,2.3"/>
    </d>
  </test>
</Data>
```

Recommended Reading

The following resources on the Lua language are recommended reading when working with scripts with Lumberyard.

- [Lua 5.1 Reference Manual](#)
- [Programming in Lua, Third Edition](#)
- [Other books](#)

Networking System

GridMate is Lumberyard's networking subsystem. GridMate is designed for efficient bandwidth usage and low-latency communications. You can synchronize objects over the network with GridMate's replica framework. GridMate's session management integrates with major online console services and lets you handle peer-to-peer and client-server topologies with host migration. GridMate also supports in-game achievements, leaderboards, and cloud-based saved games through third-party social services such as Xbox Live, PlayStation Network, and Steam. For an example of how to set up a multiplayer project, see [Multiplayer Sample Project](#) in the [Amazon Lumberyard User Guide](#).

This section discusses the various components of, and setup requirements for, your Amazon Lumberyard game networking environment. For information about a diagnostic tool for networking, see [Profiler \(p. 517\)](#).

Topics

- [Getting Started with Multiplayer \(p. 461\)](#)
- [Session Service \(p. 464\)](#)
- [Carrier \(p. 470\)](#)
- [Synchronizing Game State Using Replicas \(p. 473\)](#)
- [Using OpenSSL \(p. 489\)](#)
- [Controlling Bandwidth Usage \(p. 493\)](#)
- [Network Serialization and Aspects \(p. 495\)](#)
- [RMI Functions \(p. 496\)](#)

Getting Started with Multiplayer

This section describes how to set up a multiplayer server, host a game on it, connect to the game, and use console commands to control the server.

Setting up a Multiplayer Server

After you create and set up a multiplayer level and export the level to Lumberyard, you can run a server to host your new level.

Before you can host your new level, you must do the following:

- Ensure the same SDK build is installed on all the computers you will use to play the level.

- Copy the multiplayer level directory to each SDK installation where you will play.

Example: `\<root>\Game\Levels`

- Identify the IP address of your host server, which will be used to allow other players to join your game.

Hosting a Level

Hosting a level on your server takes just a few steps.

To host a level on the server

1. On your host server, run the game executable.
2. From the console, run the command(s) for the task(s) you want to perform.
 - `sv_port <local_port>` – Sets the inbound port for the multiplayer service. Replace `<local_port>` with the local UDP port you want to use to initialize the socket (optional). Port 64090 is used by default.
 - `mp_host` – Hosts a session. The server listens for incoming connections on the port that you specified in `sv_port`.
 - `map <map_name>` – Launches the specified map. Replace `<map_name>` with the name of the map you want to use.

Connecting to the Server

After the server is running, you can connect to the hosted game from each of the computers you want to use to play the multiplayer game.

To connect to the server

1. On your computer, run the game executable.
2. From the console, run the commands for the tasks that you want to perform.
 - `sv_port <local_port>` – Sets the inbound port for the multiplayer service. Replace `<local_port>` with the local UDP port you want to use to initialize the socket (optional). Port 64090 is used by default. To connect to a server on the same computer, replace `<local_port>` with 0 to use an ephemeral port.
 - Note**
When running a client on the same computer as the server, set the client to use an ephemeral port. Call `sv_port 0` in order to prevent port conflicts.
 - `mp_join <server_addr> <server_port>` – Join a game instance. The `<server_addr>` and `<server_port>` settings are optional. `localhost:64090` is used by default.

Console Command Summary

Use the following commands when working with a network server.

`gm_debugdraw debug_draw_level`

Set the debug draw level. Accepts as a parameter a number whose bits represent the flags for the debug data to draw. For example, when set to 1, displays an overlay with GridMate network statistics and information.

The available bit flags come from the enum `DebugDrawBits` and are as follows:

```
enum DebugDrawBits
{
    Basic          = BIT(0),
    Trace          = BIT(1),
    Stats          = BIT(2),
    Replicas       = BIT(3),
    Actors         = BIT(4),
    EntityDetail   = BIT(5),

    Full           = Basic | Trace | Stats | Replicas | Actors,
    All            = 0xffffffff,
};
```

gm_disconnectDetection

When set to 0, disables disconnect detection. This is useful when you are debugging a server or client and don't want to be disconnected when stepping through code. The default value is 1.

gm_dumpstats

Write GridMate network profiling stats to file.

gm_dumpstats_file

The file to which GridMate profiling stats are written. The default is `net_profile.log`.

gm_net_simulator

Activate GridMate network simulator to simulate latency, packet loss, bandwidth restrictions, and other conditions. For available options, type `gm_net_simulator help`.

gm_setdebugdraw

Display an overlay with detailed GridMate networking statistics and information. A user-friendly helper command for `gm_debugdraw debug_draw_level`. Possible parameters are `Basic`, `Trace`, `Stats`, `Replicas`, and `Actors`.

gm_stats_interval_msec

Set the interval, in milliseconds, for gathering network profiling statistics. The default is 1000.

gm_tracelevel trace_level

Set the GridMate debugging trace verbosity level. The default is 0. The higher the value, the greater the verbosity. Typical values range from 1 to 3.

mphost

Create a session as host. The server listens for incoming connections on the port specified in `sv_port`.

mpjoin [<server_addr>] [<server_port>]

Connect to a server at the optionally specified `<server_addr>` and `<server_port>`. The defaults are `localhost` and `64090`, respectively.

map <map_name>

Loads the level with the specified map name. Replace `<map_name>` with the name of the map you want to use. To view a list of available levels, type `map`, and then press the tab key.

mpdisconnect

Terminate the current game instance session.

sv_port [<local_port>]

Set the local UDP port that initializes the socket. The default port is 64090. To use the ephemeral port, set the port to 0. This is useful if you want to connect to a server on the same computer as the client.

Sample Project

For an example of how to set up a multiplayer project, see [Multiplayer Sample Project](#) in the [Amazon Lumberyard User Guide](#)

Session Service

GridMate's session service provides session connectivity and management. Both hub-and-spoke (client/server) and P2P full-mesh topologies are supported, and multiple sessions can be created for each GridMate instance.

Each session creates its own carrier and replica manager instances, so there is no interaction between sessions. GridMate sessions support host migration when running in P2P mode.

Starting and Stopping the Session Service

To start the session service in GridMate, call:

```
GridMate::StartGridMateService<LANSessionService>(gridmate,  
GridMate::SessionServiceDesc());
```

To stop the service, call:

```
GridMate::StopGridMateService<LANSessionService>(gridmate);
```

This terminates all current sessions and searches.

Start session service example

The following LAN multiplayer service example starts the online service if it has not already been started.

```
IGridMate* gridmate = gEnv->pNetwork->GetGridMate();  
if (gridmate)  
{  
    GridMate::StartGridMateService<LANSessionService>(gridmate,  
GridMate::SessionServiceDesc());  
}
```

Hosting a Session

To host a session, call `SessionService::HostSession()`. The function takes two arguments: `SessionParams` and `CarrierDesc`. The function returns a `GridSession` pointer.

`SessionParams` is used to configure the sessions topology, the number of slots, and the matchmaking properties. The local user to which to bind the current session is also set using `SessionParams`.

`CarrierDesc` is used to set the carrier parameters used for the current session. For `CarrierDesc` parameter descriptions, see [CarrierDesc Parameters \(p. 471\)](#).

The pointer returned by `SessionService::HostSession()` will remain valid until the `GridSessionCallbacks::OnSessionDelete()` event occurs.

Host session example

The following is an example component that creates a GridMate session and listens for clients that connect to the session.

```
// GridMateHost  
#include <AZCore/Component/Component.h>  
#include <AZCore/Component/TickBus.h>
```

```

#include <GridMate/GridMate.h>
#include <GridMate/Session/Session.h>
#include <GridMate/Session/LANSession.h>

class HostComponent
    : public AZ::Component
    , public AZ::TickBus::Handler
    , public GridMate::SessionEventBus::Handler
{
    GridMate::IGridMate* mGridMate;
    GridMate::LANSessionService* mMultiplayerService;
    mMultiplayerService;
    GridMate::GridSession* mSession;
public:
    AZ_COMPONENT(HostComponent, "{41900198-1122-4392-A579-CDDC85A23277}");

    HostComponent() : mSession(nullptr), mGridMate(nullptr),
    mMultiplayerService(nullptr) {}

    // Events from GridMate::SessionEventBus
    void OnSessionCreated(GridMate::GridSession* session) override {};
    void OnSessionError(GridMate::GridSession* session, const
    GridMate::string& error) override {};
    void OnMemberJoined(GridMate::GridSession* session, GridMate::GridMember*
    member) {};
    void OnMemberLeaving(GridMate::GridSession* session,
    GridMate::GridMember* member) {};

    void Init() override { }
    void Activate() override
    {
        // The GridMate specific memory allocators must be created before
        setting up GridMate.
        // If multiple GridMate instances are to be created (e.g. one per
        component) this needs
        // to be called at that time that the ComponentApplication is
        initialized.
        AZ::AllocatorInstance<GridMate::GridMateAllocator>::Create();
        AZ::AllocatorInstance<GridMate::GridMateAllocatorMP>::Create();

        // The port that all game data will be transmitted.
        static const AZ::s32 GAME_SEARCH_PORT = 40000;
        // The port that is listening for clients searching for games on the
        LAN.
        static const AZ::s32 GAME_PORT = 20000;

        // Initialize GridMate and services systems.
        mGridMate = GridMate::GridMateCreate(GridMate::GridMateDesc());
        mMultiplayerService =
        GridMate::StartGridMateService<LANSessionService>(mGridMate,
        GridMate::SessionServiceDesc());

        // Attach this component to the event bus.
        AZ::TickBus::Handler::BusConnect();
        GridMate::SessionEventBus::Handler::BusConnect(mGridMate);

        // Configure the session
        GridMate::LANSessionParams sessionParam;
        sessionParam.m_topology = GridMate::ST_CLIENT_SERVER;
    }
};

```

```
        sessionParam.m_numPublicSlots = 2;
        sessionParam.m_numPrivateSlots = 0;
        sessionParam.m_port = GAME_SEARCH_PORT;
        sessionParam.m_peerToPeerTimeout = 60000;
        sessionParam.m_flags = 0;
        sessionParam.m_numParams = 0;

        // Configure the carrier used by the host.
        GridMate::CarrierDesc carrierDesc;
        carrierDesc.m_enableDisconnectDetection = true;
        carrierDesc.m_connectionTimeoutMS = 10000;
        carrierDesc.m_threadUpdateTimeMS = 30;
        carrierDesc.m_version = 1;
        carrierDesc.m_port = GAME_PORT;

        // Start creating the session.
        // This operation is asynchronous and is only considered complete
when
        // OnSessionCreated() or OnSessionError() events are called.
        mSession = mMultiplayerService->HostSession(params, carrierDesc);
    }

    void Deactivate() override
    {
        if (mSession)
            mSession->Leave(0);
        GridMate::SessionEventBus::Handler::BusDisconnect(mGridMate);
        AZ::TickBus::Handler::BusDisconnect();
        gridMate->UnregisterService(mMultiplayerService);
        mMultiplayerService = nullptr;
        mGridMate = nullptr;
    }

    void OnTick(float dateTime, AZ::ScriptTimePoint t)
    {
        // Update the GridMate system each tick.
        mGridMate->Update();
    }

    static void Reflect(AZ::ReflectContext* context) {};
};
```

Searching for Sessions

To search for available sessions, call `SessionService::StartGridSearch()`. This function returns a `GridSearch` pointer, which on search completion contains a list of found sessions. Search completion events are sent via `GridSessionCallbacks::OnGridSearchComplete()` with the `GridSearch` pointer returned by `SessionService::StartGridSearch()`.

To cancel a search, use `GridSearch::AbortSearch()`.

The `GridSearch` pointer remains valid until the `GridSessionCallbacks::OnGridSearchRelease()` event occurs.

Joining a Session

Sessions can be joined by calling `SessionService::JoinSessionBySearchInfo()` with a `SearchInfo` pointer returned by a search. The function returns a `GridSession`

pointer. When a client has successfully joined a session, an event is sent via `GridSessionCallbacks::OnSessionJoined()`.

The pointer returned by `SessionService::JoinSessionBySearchInfo()` remains valid until the `GridSessionCallbacks::OnSessionDelete()` event occurs.

Join session example

The following example component searches for any `GridMate` session and joins the first one that it finds.

```
// GridMateJoin
#include <AZCore/Component/Component.h>
#include <AZCore/Component/TickBus.h>
#include <GridMate/GridMate.h>
#include <GridMate/Session/LANSession.h>
#include <GridMate/Session/Session.h>

class JoinComponent
    : public AZ::Component
    , public AZ::TickBus::Handler
    , public GridMate::SessionEventBus::Handler
{
    GridMate::IGridMate* mGridMate;
    GridMate::LANSessionService* mMultiplayerService;
    GridMate::GridSession* mSession;
    GridMate::GridSearch* mSearch;
public:
    AZ_COMPONENT(JoinComponent, "{41900198-1122-4392-A579-CDDC85A23277}");

    JoinComponent() : mSession(nullptr), mGridMate(nullptr),
        mMultiplayerService(nullptr) {}

    // Events from GridMate::SessionEventBus
    void OnSessionJoined(GridMate::GridSession* session) override {};
    void OnSessionError(GridMate::GridSession* session, const
        GridMate::string& error) override {};
    void OnMemberJoined(GridMate::GridSession* session, GridMate::GridMember*
        member) {};
    void OnMemberLeaving(GridMate::GridSession* session,
        GridMate::GridMember* member) {};

    void OnGridSearchComplete(GridMate::GridSearch* search)
    {
        if(search->GetNumResults() > 0)
        {
            const GridMate::SearchInfo* result = search->GetResult(0);

            GridMate::CarrierDesc;
            carrierDesc.m_enableDisconnectDetection = true;
            carrierDesc.m_connectionTimeoutMS = 10000;
            carrierDesc.m_threadUpdateTimeMS = 30;
            carrierDesc.m_version = 1;
            carrierDesc.m_port = 0;

            // Join the session.
            // This operation is asynchronous and is only considered complete
when
            // OnSessionJoined() or OnSessionError() events are called.
```



```
        mSession = mMultiplayerService->JoinSessionBySearchInfo(result,
GridMate::JoinParams(), carrierDesc);
    }
}

void Init() override { }
void Activate() override
{
    // The GridMate specific memory allocators must be created before
setting up GridMate.
    // If multiple GridMate instances are to be created (e.g. one per
component) this needs
    // to be called at that time that the ComponentApplication is
initialized.
    AZ::AllocatorInstance<GridMate::GridMateAllocator>::Create();
    AZ::AllocatorInstance<GridMate::GridMateAllocatorMP>::Create();

    // The port that all game data will be transmitted.
    static const AZ::s32 GAME_SEARCH_PORT = 40000;
    // The port that is listening for clients searching for games on the
LAN.
    static const AZ::s32 GAME_PORT = 20000;

    // Initialize GridMate and services systems.
    mGridMate = GridMate::GridMateCreate(GridMate::GridMateDesc() );

    // Attach this component to the event bus.
    AZ::TickBus::Handler::BusConnect();
    GridMate::SessionEventBus::Handler::BusConnect(mGridMate);

    // Search for games on the LAN.
    GridMate::LANSearchParams params;
    params.m_serverPort = GAME_SEARCH_PORT;
    mSearch = mMultiplayerService->StartGridSearch(&params);
}
void Deactivate() override
{
    if(mSession)
        mSession->Leave(0);
    GridMate::SessionEventBus::Handler::BusDisconnect(mGridMate);
    AZ::TickBus::Handler::BusDisconnect();
    GridMate::GridMateDestroy(mGridMate);
    mMultiplayerService = nullptr;
    mGridMate = nullptr;
}

void OnTick(float dateTime, AZ::ScriptTimePoint t)
{
    // Update the GridMate system each tick.
    mGridMate->Update();
}

static void Reflect(AZ::ReflectContext* context) {};
};
```

Reacting to Session Events

GridMate session events are sent via `GridMate::SessionEventBus`. To listen for session events, perform the following steps.

To listen for session events

1. Derive a listener from `SessionEventBus::Listener`.
2. Implement the `GridSessionCallbacks` interface.
3. Use the corresponding `GridMate` pointer to connect the listener.
4. To distinguish between the `GridSession` and `GridSearch` instances, pass the `GridSession` or `GridSearch` pointer together with the event.

Event descriptions

A description of each session event follows.

virtual void OnSessionServiceReady()

Callback that occurs when the session service is ready to process sessions.

virtual void OnGridSearchStart(GridSearch* gridSearch)

Callback when a grid search begins.

virtual void OnGridSearchComplete(GridSearch* gridSearch)

Callback that notifies the title when a game search query is complete.

virtual void OnGridSearchRelease(GridSearch* gridSearch)

Callback when a grid search is released (deleted). It is not safe to hold the grid pointer after this event.

virtual void OnMemberJoined(GridSession* session, GridMember* member)

Callback that notifies the title when a new member joins the game session.

virtual void OnMemberLeaving(GridSession* session, GridMember* member)

Callback that notifies the title that a member is leaving the game session.

Caution

The member pointer is not valid after the callback returns.

virtual void OnMemberKicked(GridSession* session, GridMember* member)

Callback that occurs when a host decides to kick a member. An `OnMemberLeaving` event is triggered when the actual member leaves the session.

virtual void OnSessionCreated(GridSession* session)

Callback that occurs when a session is created. After this callback it is safe to access session features. The host session is fully operational if client waits for the `OnSessionJoined` event.

virtual void OnSessionJoined(GridSession* session)

Called on client machines to indicate that the session has been joined successfully.

virtual void OnSessionDelete(GridSession* session)

Callback that notifies the title when a session will be left.

Caution

The session pointer is not valid after the callback returns.

virtual void OnSessionError(GridSession* session, const string& errorMsg)

Called when a session error occurs.

virtual void OnSessionStart(GridSession* session)

Called when the game (match) starts.

virtual void OnSessionEnd(GridSession* session)

Called when the game (match) ends.

virtual void OnMigrationStart(GridSession* session)

Called when a host migration begins.

```
virtual void OnMigrationElectHost(GridSession* session, GridMember*& newHost)
```

Called to enable the user to select a member to be the new Host.

Note

The value is ignored if it is null, if the value is the current host, or if the member has an invalid connection ID.

```
virtual void OnMigrationEnd(GridSession* session, GridMember* newHost)
```

Called when the host migration is complete.

```
virtual void OnWriteStatistics(GridSession* session, GridMember* member, StatisticsData& data)
```

Called at the last opportunity to write statistics data for a member in the session.

Cloud Hosting with GameLift

Lumberyard supports cloud hosting of dedicated servers through GameLift.

To use GameLift in your project, enable the GameLift gem. For information about gems, see [Gems](#) in the [Amazon Lumberyard User Guide](#).

Developers can access GameLift directly through the C++ API, or by using the flow graph nodes provided by the GameLift gem. For more information about GameLift, see in the [Amazon GameLift Developer Guide](#) and the [Amazon GameLift API Reference](#).

Carrier

Carrier is GridMate's messaging API. GridMate's reliable UDP implementation supports both reliable and unreliable messages. There is no out-of-order delivery. Out-of-order messages are queued if sent reliably, or discarded if sent unreliably.

The carrier sends messages through channels. The purpose of channels is to separate unrelated traffic, such as game state and voice chat. Message ordering is not enforced across channels.

The carrier API also provides hooks for congestion control and traffic simulation.

Channels and Message Priorities

Messages can be sent on different channels and have different priorities. Message ordering is always maintained between messages with the same priority sent on the same channel.

Channels provide a way to separate unrelated messages so that their ordering does not affect one other. When messages arrive out of order, they are either discarded or queued (and therefore delayed) depending on their reliability. Using different channels prevents unrelated messages from being unnecessarily dropped or delayed. For example, object replication traffic and voice chat traffic can be sent on different channels, so a missing reliable message for object replication would not cause voice chat data to be dropped, and vice versa.

Customizable Classes

You can customize the following classes to implement your own networking features:

- **Driver** - Carrier defers actual network operations to the driver, so different implementations can be provided for different platforms. This abstraction makes it possible to use platform-specific protocols from service providers such as Steam or XboxLive. The default implementation uses UDP and supports IPv4 and IPv6.
- **Simulator** - If a network simulator is present, the carrier passes all inbound and outbound traffic through it so different network conditions can be simulated. One simulator instance can be supplied

per carrier instance. The default implementation can simulate different patterns for inbound and/or outbound latency, bandwidth caps, packet loss and packet reordering.

- **Traffic Control** - The traffic control module has two primary functions: provide network statistics and congestion control. Whenever messages are sent or received, they are passed along to the traffic control module so it can update its statistics, and also so it can provide feedback to limit the amount of data being sent. It also decides if messages should be considered lost and resent by the carrier.

CarrierDesc

`CarrierDesc` is the carrier descriptor. When you create a carrier, you use the `CarrierDesc` structure to specify the parameters for the current session.

CarrierDesc Parameters

The following parameters can be supplied during carrier initialization:

Parameter	Data Type	Description
<code>m_address</code>	<code>const char *</code>	Specifies the local communication address to which the driver will bind. A value of 0 specifies any address. The default is <code>nullptr</code> .
<code>m_connectionEvaluationThreshold</code>	<code>float</code>	When a disconnection is detected, specifies the threshold at which all other connections are checked using <code>m_connectionTimeoutMS * m_connectionEvaluationThreshold</code> to see if they are also failing because of a network failure. The default is <code>0.5f</code> .
<code>m_connectionTimeoutMS</code>	<code>unsigned int</code>	Determines the time to allow for a connection attempt. The default is 5000 milliseconds.
<code>m_disconnectDetectionPacketLossPercentage</code>	<code>float</code>	Packet loss percentage threshold. Possible values are from 0.0 to 1.0, where 1.0 is 100 percent. The connection will be dropped after packet loss exceeds the value specified. The default is <code>0.3f</code> .
<code>m_disconnectDetectionRTTThreshold</code>	<code>float</code>	Specifies the RTT (round-trip time) threshold in milliseconds. The connection is dropped when the measured RTT is greater than the value specified. The default is <code>500.0f</code> .
<code>m_driver</code>	<code>class Driver *</code>	Specifies a custom driver implementation. The default is <code>nullptr</code> .
<code>m_driverIsCrossPlatform</code>	<code>bool</code>	Specifies whether the driver maintains cross-platform compatibility. When true, the default driver drops to the most restrictive MTU (maximum transmission unit) across all supported platforms. The default is <code>false</code> .
<code>m_driverIsFullPacket</code>	<code>bool</code>	Specifies whether the driver ignores MTU limits. This parameter applies only to socket drivers and local area networks. An internet packet is usually around 1500 bytes. A value of <code>true</code> enables a maximum packet size of 64 KB. These big packets fail on the Internet but typically do not on local networks. The default is <code>false</code> .
<code>m_driverReceiveBuffer</code>	<code>unsigned int</code>	Specifies the size of the internal receive buffer that the driver uses. A value of 0 specifies the default buffer size. This

Parameter	Data Type	Description
		parameter can be used only if <code>m_driver == null</code> . The default is 0.
<code>m_driverSendBufferSize</code>	unsigned int	Specifies the size of the internal send buffer that the driver uses. A value of 0 specifies the default buffer size. This parameter can be used only if <code>m_driver == null</code> . The default is 0.
<code>m_enableDisconnection</code>	bool	Specifies whether the carrier drops connections when traffic conditions are bad. The default is <code>true</code> . Note This parameter should be set to <code>false</code> only when debugging.
<code>m_familyType</code>	int	Specifies the protocol family that the driver uses. A value of 0 specifies the default family.
<code>m_port</code>	unsigned int	Specifies the local communication port to which the driver binds. A value of 0 specifies the port assigned by the system.
<code>m_securityData</code>	const char *	Specifies a pointer to a string with security data. For example, on Xbox One, this value is the security template name. The default is <code>nullptr</code> .
<code>m_simulator</code>	class Simulator *	Optionally specifies a simulator through which all network messages are filtered. When specified, the carrier passes all inbound and outbound traffic through the specified simulator so that different network conditions can be simulated. You can specify one simulator instance per carrier instance.
<code>m_threadCpuID</code>	int	Restricts the carrier thread to a specific CPU core. The values that can be specified are platform dependent. A value of -1 specifies no restriction. The default is -1.
<code>m_threadInstantResponse</code>	bool	Specifies whether IO events wake up the carrier thread immediately. The default is <code>false</code> . Note Setting this value to <code>true</code> typically uses more bandwidth because messages (especially small messages) are grouped less efficiently.
<code>m_threadPriority</code>	int	Specifies the thread priority for the carrier thread. The values that can be specified are platform dependent. A value of -100000 inherits the priority from calling thread. The default is -100000.
<code>m_threadUpdateTimeMS</code>	int	Specifies, in milliseconds, how often the carrier thread is updated. This parameter is ignored if <code>m_threadInstantResponse</code> is <code>true</code> . Possible values are from 0 through 100. In general, the time interval should be higher than 10 milliseconds. Otherwise, it is more efficient to set <code>m_threadInstantResponse</code> to <code>true</code> . The default is 30 milliseconds.

Parameter	Data Type	Description
<code>m_trafficControl</code>	class TrafficControl* *	Specifies a custom traffic control implementation that controls traffic flow to all connections and that handles issues like network congestion.
<code>m_version</code>	VersionType	Specifies the version of Carrier API that is being used. Carriers with mismatching version numbers are not allowed to connect to each other. The default is 1.

Synchronizing Game State Using Replicas

Game sessions use replicas to synchronize the state of the session. To use a replica, you simply declare the states that need to be synchronized and the remote procedure calls (RPCs) that are supported. After you bind the replica object to the network, the engine does the heavy lifting. There is no need to worry about how to properly route messages or discover remote objects. When you add a local (master) replica to the network, the replica is automatically discovered by remote nodes, and corresponding remote proxy replica objects are created on the remote nodes. Only the owner of the replica is allowed to change state, and new states are automatically propagated to all other nodes. RPCs can be called from any node but are routed to the master (owner) node for verification and processing.

Topics

- [Replicas \(p. 473\)](#)
- [Replica Chunks \(p. 476\)](#)
- [Data Sets \(p. 479\)](#)
- [Remote Procedure Calls \(RPCs\) \(p. 480\)](#)
- [Replica Manager \(p. 482\)](#)
- [Marshaling and Unmarshaling \(p. 483\)](#)
- [Binding Game Objects to the Network Using Components \(p. 484\)](#)

Replicas

Replicas are core components of GridMate's replication system that are created by network-connected GridMate peers. When a peer creates a replica, GridMate propagates the replica over the network to synchronize the replica's state across the session. A locally created and owned replica is called a *master replica*. The copy of the master replica that connected peers receive is called a *proxy replica*. The synchronization and instantiation of replicas is handled by [Replica Manager \(p. 482\)](#).

Replica Chunks

Every replica holds a collection of user-defined [ReplicaChunk \(p. 476\)](#) objects that are synchronized with all the peers in the current session. A replica chunk is a container for user-defined [DataSet \(p. 479\)](#) objects and [Remote Procedure Calls \(RPCs\) \(p. 480\)](#). Any change to a `DataSet` object or a call to an RPC causes the replica to synchronize its state across the session.

Limitations

Replica chunks have the following limitations:

- Each replica can contain only 32 chunks.
- Chunks can be attached or detached only when a replica is not bound to a replica manager.

Creating a Replica and Attaching Chunks

To create a replica, invoke the following method:

```
GridMate::ReplicaPtr replica = GridMate::Replica::CreateReplica();
```

Most use cases require only one chunk per replica. To create a chunk and attach it to a replica by using a single call, use the `CreateAndAttachReplicaChunk` helper function, as in the following example:

```
GridMate::CreateAndAttachReplicaChunk<MyReplicaChunk>(replica, ...);
```

If you just want to attach a chunk to a replica, do the following:

```
replica->AttachReplicaChunk(myChunk);
```

For more information about the creation and propagation of replica chunks, see [Replica Chunks \(p. 476\)](#).

Binding a Replica to the Session Replica Manager

In order for a replica to be synchronized, it must be bound to the session replica manager. After you create a replica and attach chunks to it, get the replica manager from the [GridMate session \(p. 464\)](#), and then bind the replica to it as follows:

```
GridMate::ReplicaManager* replicaManager = session->GetReplicaMgr();  
replicaManager->AddMaster(replica);
```

Proxy replicas are automatically instantiated by remote peers' replica managers and, therefore, automatically bound.

Replica Ownership

When a peer creates a replica and binds it to the session replica manager, that peer becomes the owner of the replica. Each replica can be owned by only one peer. The replica owner is the only peer on the network that has the authority to change the state of the replica (for example, to change the chunks' data sets or directly execute its RPCs). Any state changes performed on a proxy replica are considered invalid and do not propagate throughout the session. RPCs can be called on a proxy replica, but the calls are forwarded to the owner for confirmation before they can be executed. Once this confirmation is given, the RPC is sent to all proxies and also executed locally by the peer. If the master replica denies the execution, no peers receive the RPC call.

Changing Ownership

Replica ownership can be transferred from one peer to another, but the current owner of the replica must agree to the transfer. For information on how a replica owner can prevent transfer of ownership, see [Replica Chunks \(p. 476\)](#).

Ownership transfer happens automatically when a session performs host migration on a peer-to-peer network. You can also request it explicitly by invoking the following method:

```
replica->RequestChangeOwnership(); // Request ownership of a given replica  
for the local peer
```

Ownership transfer is an asynchronous process. When an ownership transfer is completed, each replica chunk is notified of the change by the `OnReplicaChangeOwnership` callback function.

Replica ID

Each replica has a unique ID associated with it. The replica ID is guaranteed to be unique within a particular GridMate session. You can use the replica ID to retrieve a replica from the session replica manager, as in the following example:

```
GridMate::ReplicaManager* replicaManager = session->GetReplicaMgr();
GridMate::ReplicaPtr replica = replicaManager->FindReplica(myReplicaId);

if (replica == nullptr)
{
    // Replica with given ID does not exist
    return;
}

if (replica->IsProxy())
{
    // This is a proxy replica
}

if (replica->IsMaster())
{
    // This is a master replica
}
```

Lifetime

The lifetime of a replica is controlled by a `GridMate::ReplicaPtr`, which is a reference-counted smart pointer. The replica manager retains a reference to every replica that is bound to it. It is therefore safe to omit a reference to the replica from user code; the replica will not get destroyed as long as the reference is held in replica manager. However, you can force the replica manager to release its reference and free the replica by invoking the following method:

```
replica->Destroy();
```

Sample Code

This example creates a user-defined chunk, creates a replica, attaches the chunk to the replica, and binds the replica to the session replica manager.

```
// User-defined ReplicaChunk class to be carried with the replica
class MyChunk : public GridMate::ReplicaChunk
{
public:
    GM_CLASS_ALLOCATOR(MyChunk);
    typedef AZStd::intrusive_ptr<MyChunk> Ptr; // smartptr to hold the chunk
    static const char* GetChunkName() { return "MyChunk"; } // Unique chunk
    name
    bool IsReplicaMigratable() override { return false; } // Replica
    ownership
                                                                    // cannot be
    changed
```



```
MyChunk () : m_data("Data", 0) { } // chunk constructor
void OnReplicaActivate(const ReplicaContext& rc) override // Called when
replica is bound
// to the
replica manager (both
// on local and
remote peers)
{
    // printing out whether it is a proxy or a master replica
    if (IsMaster())
        printf("I am master!\n");
    if (IsProxy())
        printf("I am proxy!\n");
}

GridMate::DataSet<int> m_data; // data this chunk holds
};

GridMate::ReplicaPtr replica = GridMate::Replica::CreateReplica(); //
Creating a replica
GridMate::CreateAndAttachReplicaChunk<MyChunk>(replica); // Creating chunk of
our custom type
// and attaching it
to the replica

GridMate::ReplicaManager* replicaManager = session->GetReplicaMgr(); //
Getting replica manager instance
// from
current session
replicaManager->AddMaster(replica); // Binding replica to the replica
manager,
// making local peer the owner of this
replica

...
// Starting from this point and up until replica destruction, the replica and
MyChunk object
// that the replica is carrying will be synchronized with other peers.
// Other peers receive the new replica and bind it to their replica managers.
When this is done,
// OnReplicaActivate is triggered, and the "I am proxy" message is printed
out on the remote peers.
// Every change of m_data DataSet results in the synchronization of the new
value in
// the master replica with all of the proxy replicas.
```

Replica Chunks

A replica chunk is a user extendable network object. One or more `ReplicaChunk` objects can be owned by a [replica \(p. 473\)](#), which is both a container and manager for replica chunks. A replica is owned by a master peer and is propagated to other network nodes as a proxy replica. The data that a replica chunk contains should generally be related to the other data stored within it. Since multiple chunks can be attached to a replica, unrelated data can be stored in other chunks within the same replica.

A replica chunk can contain [Data Sets \(p. 479\)](#) and/or [Remote Procedure Calls \(RPCs\) \(p. 480\)](#). Data sets store arbitrary data, which only the master replica is able to modify. Any changes are

propagated to the chunks in proxy replicas on the other nodes. RPCs are methods that can be executed on remote nodes. They are first invoked on the master, which decides whether the invocation will be propagated to the proxies.

Replica Chunk Requirements and Limitations

A replica chunk has several important attributes:

- It can have up to 32 `DataSet` definitions.
- It can have up to 256 RPC definitions.
- It is reference counted and therefore must be held by a [smart pointer](#).
- It is not synchronized across the session until the replica manager is ready.

Implementing a New Replica Chunk Type

You have two ways to implement a new replica chunk type: handle data set changes and RPC calls ("game logic") inside the chunk, or outside the chunk. In both cases, the following apply:

- The name of the chunk type must be unique throughout the system. To achieve this, every replica chunk type must implement the static member function `const char* GetChunkName()`. The string returned by the `GetChunkName` function must uniquely identify the chunk type.
- To indicate whether the ownership of this type of chunk is transferrable, every chunk type needs to override the `bool IsReplicaMigratable()` virtual function. If any chunk in a replica is not migratable, the replica's ownership cannot be transferred from one peer to another.
- Every chunk type must define a smart pointer that holds the chunk type instances.

Declaring a Replica Chunk Type with Internal Game Logic Handling

To have your replica chunk class handle game logic directly, it should inherit from `ReplicaChunk`:

```
class MyChunk : public GridMate::ReplicaChunk
{
public:
    GM_CLASS_ALLOCATOR(MyChunk); // Using GridMate's allocator

    MyChunk()
        : m_data("Data", 0) // Initializing integer DataSet
        to zero, and assigning a name for it
        , MyRpcMethodRpc("MyRpcMethodRpc") // Initializing RPC by passing in
        its name; the RPC name is for debugging purposes
    {
    }

    typedef AZStd::intrusive_ptr<DataSetChunk> Ptr; // Defining
    smart pointer type for this chunk
    static const char* GetChunkName() { return "MyChunk"; } // Unique chunk
    type name
    bool IsReplicaMigratable() override { return false; } // Specify
    whether the chunk can participate in replica's ownership changes

    bool MyRpcMethod(int value, const GridMate::RpcContext& context)
    {
        // Handle event here
    }
};
```

```
        return true; // Propagate this call to all proxies
    }

    GridMate::Rpc<GridMate::RpcArg<int>>::BindInterface<MyChunk,
&CustomChunk::MyRpcMethod> MyRpcMethodRpc;
    GridMate::DataSet<int> m_data;
};
```

Declaring a Replica Chunk Type with External Game Logic Handling

To have your replica chunk class act as a simple data carrier and forward data changes and events to a designated handler (an external class), inherit your handler class from `ReplicaChunkInterface`, and your replica chunk class from `ReplicaChunkBase`:

```
class CustomHandler : public GridMate::ReplicaChunkInterface
{
public:
    GM_CLASS_ALLOCATOR(CustomHandler); // using GridMate's allocator

    void DataSetHandler(const int& value, const GridMate::TimeContext&
context)
    {
        // Handle changes
    }

    bool RpcHandler(AZ::u32 value, const GridMate::RpcContext &context)
    {
        // Handle event here
        return true; // Propagate this call to all proxies
    }
};

class MyChunk : public GridMate::ReplicaChunkBase
{
public:
    GM_CLASS_ALLOCATOR(MyChunk); // Using GridMate's allocator

    MyChunk()
        : m_data("Data", 0) // Initializing integer DataSet to
zero and assigning a name for it
        , MyRpcMethodRpc("MyRpcMethodRpc") // Initializing RPC by passing its
name; the RPC's name is used for debugging purposes
    {
    }

    typedef AZStd::intrusive_ptr<DataSetChunk> Ptr; // Defining smart
pointer type for this chunk
    static const char* GetChunkName() { return "MyChunk"; } // Unique chunk
type name
    bool IsReplicaMigratable() override { return false; } // Whether chunk
can participate in replica's ownership changes

    GridMate::DataSet<int>::BindInterface<CustomHandler,
&CustomHandler::DataSetHandler> m_data;
    GridMate::Rpc<GridMate::RpcArg<AZ::u32>>::BindInterface<CustomHandler,
&CustomHandler::RpcHandler> MyRpcMethodRpcPC;
};
```

Registering Chunk Type

Every user-defined replica chunk type should be registered with `ReplicaChunkDescriptorTable` to create the factory required by the [Replica Manager \(p. 482\)](#).

To register replica chunks, use this call:

```
GridMate::ReplicaChunkDescriptorTable::Get().RegisterChunkType<MyChunk>();
```

Attaching a Replica Chunk to the Replica

You must add a replica chunk to a replica before you bind the replica to replica manager. After you bind the replica to replica manager, you cannot add or remove replica chunks to or from the replica.

To create a replica chunk, use this call:

```
MyChunk::Ptr myChunk = GridMate::CreateReplicaChunk<MyReplicaChunk>(<...>);
```

Where `<...>` is forwarded to the `MyReplicaChunk` constructor.

To attach the chunk to a replica, use this call:

```
replica->AttachReplicaChunk(myChunk);
```

Alternatively, you can create the chunk and attach it in one step:

```
GridMate::CreateAndAttachReplicaChunk<MyReplicaChunk>(replica, <...>);
```

After you add the chunk to the replica, the replica retains a smart pointer to the chunk. The chunk is released only when its replica is destroyed.

Data Sets

You can use `DataSet` objects to synchronize the state of a session across the network. When a value in the data set changes, the updates are propagated automatically. Data sets can be of any type, but they must support the assignment and comparison operators. Your `DataSet` declaration can specify a custom marshaler. If you do not specify a marshaler, the your `DataSet` object uses `GridMate::Marshaler<T>`.

A `DataSet` must be declared inside a `ReplicaChunk` object. A `ReplicaChunk` object can contain up to 32 `DataSet` objects. You must supply a debug name to the data set constructor.

The following example declares a `ReplicaChunk` object that has two `DataSet` objects of type `float`. One data set uses the the default marshaler. The other data set uses a custom marshaler called `MyCustomMarshaler`.

```
class MyChunkType : public GridMate::ReplicaChunk
{
public:
    MyChunkType()
        : m_synchedFloat("SynchedFloat")
        , m_synchedHalf("SynchedHalf")
    {

```

```
    }  
  
    GridMate::DataSet<float> m_synchedFloat;  
    GridMate::DataSet<float, MyCustomMarshaler> m_synchedHalf;  
};
```

Data sets can be optionally bound to a callback on the chunk interface so that the callback is called when new data arrives.

```
class MyChunkType : public GridMate::ReplicaChunk  
{  
public:  
    MyChunkType()  
        : m_synchedFloat("SynchedFloat")  
    {  
    }  
  
    // Callback to call when new data arrives.  
    void OnSynchedFloatData(const float& newValue, const  
GridMate::TimeContext& timeContext);  
  
    GridMate::DataSet<float>::BindInterface<MyChunkType,  
amp;MyChunkType::OnSynchedFloatData> m_synchedFloat;  
};
```

[Eventual consistency](#) is guaranteed for data sets. Normally, data sets propagate unreliably. To compensate for potential packet losses, and to minimize latency, GridMate handles events in the following order:

1. A user changes a value in the data set.
2. The new value is broadcast to the remote peers.
3. The data set stops changing.
4. A user-configurable grace period elapses.
5. A last update is sent reliably.
6. To conserve bandwidth, propagation is suspended until the next change.

You can change the length of the grace period in step 4 by calling `SetMaxIdleTime`:

```
...  
GridMate::DataSet<Vector3> m_pos;  
...  
  
...  
m_pos.SetMaxIdleTime(5.f); // Suspend sending if m_pos has not changed for 5  
ticks  
...  
...
```

Remote Procedure Calls (RPCs)

Remote procedure calls (RPCs) allow games to send events or requests through replicas. RPCs are best suited for infrequent or one-off events or for directing messages to a specific node.

In GridMate, RPCs have the following characteristics:

- RPC arguments can be of any type, as long as a valid marshaler is provided.
- All RPC requests are routed to the master replica.
- The RPC handler function in the master replica chooses whether to propagate the RPC to proxy replicas.
- RPCs are not kept in the history, and late-joining clients do not receive RPCs that were requested before the clients joined.

Declaring RPCs

Like data sets, RPCs are declared as replica chunk members. An RPC handler function is bound to the RPC as part of the declaration. RPC requests are forwarded to the handler function along with the arguments and an `RpcContext` associated with the request.

The RPC handler function can perform additional checks before it processes the request. If the handler function returns true when called on the master replica, the RPC is propagated to all the proxy replicas. The return value is ignored when called on proxies.

```
class MyChunkType : public GridMate::ReplicaChunk
{
public:
    // Rpc1 takes two arguments: a float marshaled using default marshaler,
    // and another float marshaled using CustomFloatMarshaler.
    // Requests are handled by MyChunkType::HandleRpc1().
    GridMate::Rpc<GridMate::RpcArg<float>, GridMate::RpcArg<float,
    CustomFloatMarshaler>>::BindInterface<MyChunkType, &HandleRpc1> Rpc1;

    // Handler function bound to Rpc1.
    // Verifies the RPC and if accepted, returns true so it is propagated to
    // all proxies.
    bool HandleRpc1(float v1, float v2, const GridMate::RpcContext&
    rpcContext)
    {
        // The RPC handler can perform additional checks to verify the
    request.
        if (VerifyRpcRequest())
        {
            printf("Execute Rpc1...\n");

            // Return true to propagate to all proxies.
            return true;
        }
        // Return false to stop propagation to proxies.
        return false;
    }

    // Rpc2 has no arguments.
    // Requests are handled by MyChunkType::HandleRpc2().
    GridMate::Rpc<>::BindInterface<MyChunkType, &HandleRpc2,
    GridMate::RpcUnreliable> Rpc2;

    // Handler function bound to Rpc2.
    bool HandleRpc2(const GridMate::RpcContext& rpcContext)
    {
        printf("Execute Rpc2...\n");

        // Never propagate Rpc2 to proxies.
        return false;
    }
};
```

```
    }  
};  
  
void Foo(MyChunkType* myChunkInstance)  
{  
    // Call Rpc1.  
    myChunkInstance->Rpc1(1.f, 2.f);  
  
    // Call Rpc2.  
    myChunkInstance->Rpc2();  
}
```

Replica Manager

The replica manager is a sub-system that is responsible for managing the synchronization of replicas. The replica manager is responsible for the following:

- Marshaling and unmarshaling the replicas in each peer
- Forwarding replicas from one peer to another
- Handling ownership changes of replicas
- Managing replica lifetimes

Managing Replica Lifetimes

The replica manager must do the following:

- Keep track of all replicas by holding a reference-counted pointer to every master and proxy replica object
- Guarantee consistency across the session by capturing and propagating the last state of every replica before a replica is destroyed
- Guarantee that all proxies reach eventual consistency before a replica is deactivated
- Release all GridMate references to a replica object when the object has been destroyed

Binding a New Master Replica to Replica Manager

After a new master replica is created, it must be bound to the replica manager as follows:

```
GridMate::ReplicaManager* replicaManager = session->GetReplicaMgr(); // Get  
    replica manager from the current session  
replicaManager->AddMaster(myReplica1); // Bind replica to replica manager  
replicaManager->AddMaster(myReplica2); // Bind replica to replica manager
```

Proxy replicas are bound to their session's replica managers automatically. Each `ReplicaManager` instance holds a reference to every replica that is bound to it until the user calls `Destroy()` on the replica, or until the `ReplicaManager` itself is destroyed.

Retrieving Replicas from Replica Manager

Every replica has a numeric identifier that is unique in the session. To find a replica by its ID, invoke `FindReplica(<ReplicaId>)`, as in the following example:

```
GridMate::ReplicaPtr replica = replicaManager->FindReplica(<myReplicaId>);
```

```
AZ_Assert(replica != nullptr, "Replica with id=%d not  
found.", <myReplicaId>);
```

How Replica Manager Updates Replicas

The GridMate session triggers the replica manager to perform replica updates on a continuous basis. These updates include the following actions:

- Unmarshaling
- Update from replica
- Update replicas
- Marshaling

Marshaling: Sending data to other peers

Changes in a replica must be replicated to every remote peer in the GridMate session. To communicate a change in one of its replicas, a peer's replica manager serializes the replica object into a send buffer and then sends the object to the network. Replica marshaling occurs in two main phases:

- **Data Preparation** – A premarshaling phase that, based on changes in the replica, determines which RPCs and `DataSet` objects to send. This phase also validates the data integrity of the objects to be sent.
- **Actual Marshaling** – The transformation of a replica object into a byte stream. The actual data that must be marshaled depends on how much new information the master replica has relative to its corresponding remote proxy replica. For example, new proxy replicas require all information about the master replica, including of its [data sets \(p. 479\)](#), [RPCs \(p. 480\)](#), and construction metadata. Previously synchronized proxy replicas require only the information from the master replica that is different, including any pending RPC calls.

Unmarshaling: Receiving data from other peers

In unmarshaling, the replica manager communicates with the remote peers, receives and parses new data from them, and updates its own replicas accordingly. These updates can include accepting new peers, instantiating new proxy replicas, handling ownership changes, or destroying proxy replicas.

Note

For more information about marshaling, see [Marshaling and Unmarshaling \(p. 483\)](#).

Update From Replica: Updating proxy replicas

A change in a custom [ReplicaChunk \(p. 476\)](#) results in an `UpdateFromChunk` callback that causes all proxy replicas to update their state. RPCs from proxy and master replicas are processed and invoked during this step.

Update Replicas: Updating master replicas locally

A change in a custom replica chunk results in an `UpdateChunk` callback that causes all master replicas on a local peer to update their state.

Marshaling and Unmarshaling

As noted in [Marshaling: Sending data to other peers \(p. 483\)](#), marshaling is the sending of changes in replica data to every peer instance in the GridMate session. Data is written to the network using `WriteBuffer`, and data received is read using `ReadBuffer`. Each buffer specifies the [endianness](#) used.

Marshalers are responsible for reading and writing data to and from the buffers. Default marshalers are provided for most built-in data types, and other commonly used data types. Custom marshalers can be implemented to support custom types or custom compression techniques. Default marshalers are implemented by C++ [template specialization](#):

```
namespace GridMate
{
    template<typename T>
    class Marshaler
    {
    public:
        void Marshal(WriteBuffer& wb, const T& value);
        void Unmarshal(T& value, ReadBuffer& rb);
    };
}
```

If a marshaler is not specified with the data set or RPC declaration, the template specialization is used.

Implementation of the default marshaler for AZCore's Vector3 math type can be found in `Code/Framework/GridMate/GridMate/Serialize/MathMarshal.h`:

```
namespace GridMate
{
    template<>
    class Marshaler<AZ::Vector3>
    {
    public:
        typedef AZ::Vector3 DataType;
        static const AZStd::size_t MarshalSize = sizeof(float) * 3;
        void Marshal(WriteBuffer& wb, const AZ::Vector3& vec) const
        {
            Marshaler<float> marshaler;
            marshaler.Marshal(wb, vec.GetX());
            marshaler.Marshal(wb, vec.GetY());
            marshaler.Marshal(wb, vec.GetZ());
        }
        void Unmarshal(AZ::Vector3& vec, ReadBuffer& rb) const
        {
            float x, y, z;
            Marshaler<float> marshaler;
            marshaler.Unmarshal(x, rb);
            marshaler.Unmarshal(y, rb);
            marshaler.Unmarshal(z, rb);
            vec.Set(x, y, z);
        }
    };
}
```

Binding Game Objects to the Network Using Components

Any [ComponentEntity](#) that shares data on the network must include the `NetBindingComponent`. The `NetBindingComponent` creates a [replica](#) (p. 473) for the `ComponentEntity` and can bind any [replica chunk](#) (p. 476) that a component creates to the replica. You can bind base Lumberyard components to the network by just adding the `NetBindingComponent`, but some extra steps are required if you are using custom components.

Custom Components

Use the following steps to enable networking on a custom component.

To enable networking on a custom component

1. Inherit the component from `AzFramework::NetBindable`:

```
#include <AzFramework/Network/NetBindable.h>
class TransformComponent
: public Component
, public AzFramework::NetBindable
```

2. Modify the `AZ_COMPONENT` definition to include `AzFramework::NetBindable`:

```
AZ_COMPONENT(TransformComponent, "{22B10178-39B6-4C12-BB37-77DB45FDD3B6}",
AzFramework::NetBindable);
```

If `AzFramework::NetBindable` is missing, the `NetBindingComponent` will not discover the custom component when it checks for components that have chunks to be added to the replica.

Note

Changing this definition requires that you reexport the affected level.

3. Modify `SerializeContext` to include `AzFramework::NetBindable`:

```
serializeContext->Class<TransformComponent, AZ::Component,
AzFramework::NetBindable>()
```

If `AzFramework::NetBindable` is missing from the serialization definition, the master replica chunk will function correctly, but the proxy replica will not receive its proxy chunk.

Note

Changing this definition requires that you reexport the affected level.

4. Implement the following `AzFramework::NetBindable` interfaces:

```
// Called during network binding on the master. Implementations should
// create and return a new binding.
virtual GridMate::ReplicaChunkPtr GetNetworkBinding() = 0;

// Called during network binding on proxies.
virtual void SetNetworkBinding(GridMate::ReplicaChunkPtr chunk) = 0;

// Called when network is unbound. Implementations should release their
// references to the binding.
virtual void UnbindFromNetwork() = 0;
```

Network Binding Function Details

A number of functions are available for working with component entities on the network.

GetNetworkBinding

Call the `GetNetworkBinding` function only on the master `ComponentEntity`. This function returns a replica chunk and allows the component to initialize any state that the component needs to synchronize across the session. After the chunk is returned, the chunk is automatically attached to the appropriate replica.

SetNetworkBinding

Call the `SetNetworkBinding` function on all proxy `ComponentEntity` objects. The function passes a `ReplicaChunk` object to the component so the component can initialize its internal data to match that of the replica chunk received. The received chunk is already bound to the appropriate replica.

UnbindFromNetwork

Call the `UnbindFromNetwork` function to stop the component from reacting to data updates from the network—for example, when the master no longer exists, has been deactivated, or has relinquished control to the local source.

Creating a Chunk

Before you can fully enable the interface on the component, you must create a replica chunk to store whatever state the component has to share.

```
class TransformReplicaChunk : public GridMate::ReplicaChunk
{
public:
    AZ_CLASS_ALLOCATOR(TransformReplicaChunk, AZ::SystemAllocator, 0);
    static const char* GetChunkName() { return "TransformReplicaChunk"; }
    TransformReplicaChunk()
        : m_localTransform("LocalTransformData")
        , m_entityId()
    {
    }

    void SetEntityId(EntityId entityId)
    {
        m_entityId = entityId;
    }

    const AZ::Transform& GetLocalTransform() const
    {
        return m_localTransform.Get();
    }

    void SetLocalTransform(const AZ::Transform& transform)
    {
        m_localTransform.Set(transform);
    }

    void OnTransformChanged(const AZ::Transform& transform, const
GridMate::TimeContext& tc)
    {
        (void)transform; (void)tc;

        Entity* entity = nullptr;
        EBUS_EVENT_RESULT(entity, ComponentApplicationBus, FindEntity,
m_entityId);
        if (entity)
        {
            TransformComponent* transformComponent = entity-
>FindComponent<TransformComponent>();

            if (transformComponent)
            {
                transformComponent->UpdateFromReplicaChunk();
            }
        }
    }
};
```

```
    }  
  }  
}  
  
private:  
  
    EntityId m_entityId;  
    GridMate::DataSet<AZ::Transform>::BindInterface<TransformReplicaChunk,  
    &TransformReplicaChunk::OnTransformChanged> m_localTransform;  
};
```

In order for the component to react to changes in the `DataSet` object, either the replica chunk must signal to the component when this change occurs (as is done here using the `BindInterface` extension to `DataSet`), or the component must poll the replica chunk and check the `DataSet` object for changes.

Notes

- You must register the new `ReplicaChunk` object. For more information, see [Registering Chunk Type \(p. 479\)](#).
- The `ReplicaChunk` object requires an empty constructor so that it can be unmarshalled.

Example: Filling out the `AzFramework::NetBindable` Interface

The examples below illustrate the use of `GetNetworkBinding`, `SetNetworkBinding` and `UnbindFromNetwork`.

GetNetworkBinding

```
GridMate::ReplicaChunkPtr TransformComponent::GetNetworkBinding()  
{  
    TransformReplicaChunk* replicaChunk =  
    GridMate::CreateReplicaChunk<TransformReplicaChunk>();  
    replicaChunk->SetEntityId(GetEntityId());  
    m_replicaChunk = replicaChunk;  
    UpdateReplicaChunk();  
    return m_replicaChunk;  
}
```

SetNetworkBinding

```
void  
TransformComponent::SetNetworkBinding(GridMate::ReplicaChunkPtr replicaChunk)  
{  
    AZ_Assert(m_replicaChunk == nullptr, "ERROR: Being bound to two replica  
chunks");  
    bool isTransformChunk = replicaChunk != nullptr;  
    AZ_Assert(isTransformChunk, "ERROR: Being bound to invalid chunk type");  
    if (isTransformChunk)  
    {  
        m_replicaChunk = replicaChunk;  
        TransformReplicaChunk* transformReplicaChunk =  
static_cast<TransformReplicaChunk*>(m_replicaChunk.get());  
        transformReplicaChunk->SetEntityId(GetEntityId());  
        UpdateFromReplicaChunk();  
    }  
}
```

```
}
```

UnbindFromNetwork

```
void TransformComponent::UnbindFromNetwork()  
{  
    m_replicaChunk = nullptr;  
}
```

Maintaining State

The last step is to make sure that any local modifications to the desired networkable state do not overwrite the networked state, and to update the replica chunk when the component is in control of the state and the local state changes.

```
// Don't allow external setting of the Transform if it's network controlled.  
void TransformComponent::SetLocalTM(const Transform& tm)  
{  
    if (!IsNetworkControlled())  
    {  
        ForceLocalTM(tm);  
    }  
}  
  
// Helper function to let the replica bypass the previous safety check.  
// Also signals the need to update the replica chunk with the new state.  
void TransformComponent::ForceLocalTM(const Transform& tm)  
{  
    m_localTM = tm;  
    ComputeWorldTM(); // We can use dirty flags and compute it later on  
demand  
    UpdateReplicaChunk();  
}  
  
// Don't manipulate the local TM if it's network controlled.  
// And in the case of the master, update the replica with  
// the new information that changed here.  
void TransformComponent::ComputeLocalTM()  
{  
    if (IsNetworkControlled())  
    {  
        return;  
    }  
  
    if (m_parentTM)  
    {  
        m_localTM = m_parentTM->GetWorldTM().GetInverseFull() * m_worldTM;  
    }  
    else  
    {  
        m_localTM = m_worldTM;  
    }  
    EBUS_EVENT_PTR(m_notificationBus, TransformNotificationBus,  
OnTransformChanged, m_localTM, m_worldTM);  
    UpdateReplicaChunk();  
}
```

```
// Helper method
bool TransformComponent::IsNetworkControlled() const
{
    return m_replicaChunk != nullptr && !m_replicaChunk->IsMaster();
}

// Helper method that updates the replica chunk's transform from the local
// transform.
void TransformComponent::UpdateReplicaChunk()
{
    if (m_replicaChunk && m_replicaChunk->IsMaster())
    {
        TransformReplicaChunk* transformReplicaChunk =
        static_cast<TransformReplicaChunk*>(m_replicaChunk.get());
        transformReplicaChunk->SetLocalTransform(GetLocalTM());
    }
}

// Helper method that updates the local transform from the replica chunk
void TransformComponent::UpdateFromReplicaChunk()
{
    if (m_replicaChunk && !m_replicaChunk->IsMaster())
    {
        TransformReplicaChunk* transformReplicaChunk =
        static_cast<TransformReplicaChunk*>(m_replicaChunk.get());
        ForceLocalTM(transformReplicaChunk->GetLocalTransform());
    }
}
```

Using OpenSSL

GridMate uses the [OpenSSL](#) implementation of [Datagram Transport Layer Security](#) (DTLS) to support encryption of all UDP traffic sent between clients and servers.

Topics

- [Limitations](#) (p. 489)
- [Implementation Support](#) (p. 489)
- [Cipher](#) (p. 490)
- [Building with Encryption](#) (p. 490)
- [Enabling Encryption](#) (p. 491)

Limitations

GridMate's implementation of encryption has the following limitations:

- Only 64-bit Windows is supported.
- Only client-server topologies are supported.

Implementation Support

GridMate supports encryption for the following implementations:

- Server and client authentication
- Self-signed certificates
- A single strong OpenSSL cipher

Cipher

GridMate uses the following single OpenSSL cipher for all encrypted connections: `ECDHE-RSA-AES256-GCM-SHA384`.

This cipher uses the technologies listed in the following table:

Cipher Technologies in GridMate

Technology	Role	Description
ECDHE	Master key exchange	Ephemeral Elliptic Curve Diffie-Hellman anonymous key agreement protocol
RSA	Peer authentication	RSA algorithm used to authenticate client and server
AES256	Symmetric encryption cipher	Advanced Encryption Standard that uses a 256-bit master key
GCM	Block cipher mode of operation	Galois/Counter Mode authenticated encryption algorithm
SHA384	Hashing algorithm	SHA-2 with a 384-bit digest size

Building with Encryption

When you include the GridMate library in your project, encryption support is automatically provided. However, because the GridMate library is statically linked, you must first make some modifications to the [WAF build script](#) (wscript) that uses GridMate.

Building Your Project with Encryption

To use encryption with GridMate, you must modify your `.wscript` file to add a dependency on GridMate, link the OpenSSL library, and specify OpenSSL library paths.

To modify your `.wscript` file to use OpenSSL with GridMate

1. Add the following line to create a dependency on GridMate:

```
use = ['GridMate']
```

2. Add the following line to link the OpenSSL library:

```
win_lib = ['ssleay32', 'libeay32']
```

3. Add the OpenSSL library paths, as in the following example. Within the Lumberyard install directory, these paths are in the folder `dev\Code\SDKs\OpenSSL\lib\`:

```
win_x64_debug_libpath = [ bld.Path('Code/SDKs/OpenSSL/lib/  
vc120_x64_debug') ],
```

```
win_x64_profile_libpath = [ bld.Path('Code/SDKs/OpenSSL/lib/  
vc120_x64_release') ],  
win_x64_release_libpath = [ bld.Path('Code/SDKs/OpenSSL/lib/  
vc120_x64_release') ],  
win_x64_debug_dedicated_libpath = [ bld.Path('Code/SDKs/OpenSSL/lib/  
vc120_x64_debug') ],  
win_x64_profile_dedicated_libpath = [ bld.Path('Code/SDKs/OpenSSL/lib/  
vc120_x64_release') ],  
win_x64_release_dedicated_libpath = [ bld.Path('Code/SDKs/OpenSSL/lib/  
vc120_x64_release') ]
```

Building Without Encryption

If your project uses GridMate, but does not require support for encryption, ensure that the `GridMateForTools` line is in your `.wscript` file:

```
use = ['GridMateForTools']
```

Enabling Encryption

To enable encryption with OpenSSL in a GridMate session, perform the following steps.

To enable encryption in a GridMate session

1. To set the encryption parameters, create an instance of `SecureSocketDesc`. The parameters are described in [SecureSocketDesc](#) (p. 491).
2. Create an instance of `SecureSocketDriver` that passes in the instance of `SecureSocketDesc`. The instance of `SecureSocketDesc` must be available for the duration of the GridMate session.
3. Before hosting or joining a GridMate session, define `CarrierDesc` by setting the `CarrierDesc::m_driver` property to the instance of `SecureSocketDriver`. If no instance of `SecureSocketDriver` is provided, an unencrypted driver is used that provides plaintext communication.
4. You can delete the `SecureSocketDriver` instance at the end of the GridMate session, ideally in the `OnSessionDelete` event on the `SessionEventBus`.

The [GridMate Session Encryption Example](#) (p. 492) at the end of this topic has sample code for these steps.

SecureSocketDesc

The constructor for `SecureSocketDriver` requires a `SecureSocketDesc` object that provides all encryption configuration required for the secure connection. The configuration parameters are described in the following table.

SecureSocketDesc Configuration Parameters

Parameter	Description
<code>m_privateKeyPEM</code>	Base-64 encoded string PEM private key.
<code>m_certificatePEM</code>	Base-64 encoded string PEM public certificate.
<code>m_certificateAuthorityPEM</code>	Base-64 encoded string PEM certificate authority.

Parameter	Description
m_authenticateClient	If set to 1, the client is expected to provide a signed certificate for authentication. To implement this, m_certificatePEM must be set on the client, and the server needs to set up m_certificateAuthorityPEM. The default setting is 0.

Server Authentication Only

You can use the server authentication only configuration when the client needs to verify the authenticity of the server to which it connects. The server has a secret private key and a public certificate signed by a certificate authority. This is the most common configuration.

Server Authentication Only Configuration

Role	Parameters
Client	m_certificateAuthorityPEM
Server	m_privateKeyPEM, m_certificatePEM, m_certificateAuthorityPEM

Client and Server Authentication

Use this configuration when the client must verify authenticity of the server and the server must verify authenticity of the client. The client has its own unique private key and corresponding signed public certificate. The server has its own unique private key and corresponding signed public certificate.

It's possible to share or use the same certificate authority for both, but keys and certificates must be unique to each peer.

Client and Server Authentication Configuration

Role	Parameters
Client	m_privateKeyPEM, m_certificatePEM, m_certificateAuthorityPEM
Server	m_privateKeyPEM, m_certificatePEM, m_certificateAuthorityPEM

Self-signed Certificates

You can use self-signed certificates for development purposes.

Warning

Do not use self-signed certificates for production environments.

When you use self-signed certificates, there is no certificate authority to sign the public certificates. To permit the absence of a certificate authority, set m_certificateAuthorityPEM to the same value as m_certificatePEM.

GridMate Session Encryption Example

The following code snippet enables encryption in a GridMate session.

```
class MyClass : public GridMate::SessionEventBus::Handler
{
```

```
public:
    void OnSessionDelete(GridMate::GridSession* session) override;

private:
    GridMate::SecureSocketDriver* m_secureDriver;
};

void MyClass::JoinSession() {
    // ...

    // Create an instance of SecureSocketDesc and set its encryption
    // parameters.
    GridMate::SecureSocketDesc secureDesc;
    secureDesc.m_privateKeyPEM = "...";
    secureDesc.m_certificatePEM = "...";
    secureDesc.m_certificateAuthorityPEM = "...";

    // Create an instance of SecureSocketDriver that passes in the instance of
    // SecureSocketDesc.
    m_secureDriver = new GridMate::SecureSocketDriver(secureDesc);

    // Before hosting or joining a GridMate session, set the
    // CarrierDesc::m_driver
    // property to the instance of SecureSocketDriver.
    carrierDesc.m_driver = m_secureDriver;

    // ...
}

// At the end of the GridMate session, delete the SecureSocketDriver
// instance in
// the OnSessionDelete event.
void MyClass::OnSessionDelete(GridMate::GridSession* session) {
    // ...

    delete m_secureDriver;
    m_secureDriver = nullptr;

    // ...
}
```

Controlling Bandwidth Usage

[GridMate](#) (p. 461) provides several ways to control the bandwidth that your game uses, including bandwidth throttling and the prioritization of [replica](#) (p. 473) updates.

Controlling the Send Rate

You can use GridMate to control the server send rate, which is a common technique for reducing bandwidth usage in multiplayer games. In this scenario, a multiplayer game is hosted by a dedicated server to which clients send their replica changes at their default rate (for example, 60 frames per second). To reduce bandwidth usage, you lower the server send rate (for example, to 20 transmissions per second). To avoid jitter when this technique is used, the client must be able to interpolate the game state that it receives from the server.

To control the server send rate in GridMate, set the time interval for replica data transmissions:

```
ReplicaMgr* replicaManager = session->GetReplicaMgr(); // Get the replica
manager instance. This assumes the session has been established.
replicaManager->SetSendTimeInterval(100); // Set the send interval to 100
milliseconds. 10 updates per second will be sent.
```

Setting the `SetSendTimeInterval` to 0 sends the data at the engine's frame rate. The default is 0.

Bandwidth Limiter

Another technique is to limit outgoing bandwidth in exchange for increased latency in the replication of objects. In GridMate, you can do this by setting a bandwidth limit on replica manager. To do so, specify a byte limit for `SetSendLimit`, as in the following example:

```
ReplicaMgr* replicaManager = session->GetReplicaMgr(); // Get the replica
manager instance. This assumes the session has been established.
replicaManager->SetSendLimit(10000); // Set the transmission limit to 10
kilobytes per second.
```

Setting `SetSendLimit` to 0 disables the bandwidth limiter. The default is 0.

Controlling Burst Length

You can use the GridMate limiter to accommodate short bursts in bandwidth if your bandwidth usage is not already at its maximum. This can be useful in many game applications. For example, when a user is in a multiplayer lobby, the corresponding bandwidth usage is quite low. However, when the user joins the game, the bandwidth usage spikes as the initial game state replicates from the server to the client. To control the length of the burst permitted, specify the desired number of seconds for `SetSendLimitBurstRange`, as in the following example:

```
ReplicaMgr* replicaManager = session->GetReplicaMgr(); // Get the replica
manager instance. This assumes the session has been established.
replicaManager->SetSendLimitBurstRange(5.f); // Set the maximum permitted
length of the burst to 5 seconds.
```

Bursts in bandwidth usage are allowed for the number of seconds specified, after which the bandwidth is capped to the value set by `SetSendLimit`. The default value for `SetSendLimitBurstRange` is 10 seconds. If bandwidth usage has already reached its limit when the burst occurs, bandwidth usage continues to be capped, and the `SetSendLimitBurstRange` setting has no effect.

Prioritization of Replica Updates

Every [replica chunk](#) (p. 476) has a priority that you can assign. The priority is represented by an integer from 0 through 65534. Larger integers represent higher priorities. Replicas with higher priorities are sent first. The default is 32768.

This prioritization is especially important when you use the bandwidth limiter because you can use it to define which objects are more important and which are less important. If your game has a bandwidth cap and you have prioritized your replicas appropriately, the objects with higher priority are sent more often. The objects with lower priority are sent only when there is enough bandwidth to accommodate them.

For convenience, GridMate provides five predefined priorities that you can use for custom replica chunks:

```
static const ReplicaPriority k_replicaPriorityHighest = 0xFFFFE; // Decimal
65534, highest priority.

static const ReplicaPriority k_replicaPriorityHigh = 0xC000; // Decimal
49152, high priority.

static const ReplicaPriority k_replicaPriorityNormal = 0x8000; // Decimal
32768, normal priority. This is the Default.

static const ReplicaPriority k_replicaPriorityLow = 0x4000; // Decimal
16384, low priority.

static const ReplicaPriority k_replicaPriorityLowest = 0x0000; // Decimal 0,
lowest possible priority.
```

By default, all chunks have normal priority (`k_replicaPriorityNormal`). You can use these predefined priorities as is, or use them to create your own, as in the following example:

```
// A replica chunk with this priority will be sent before all the chunks with
Normal priority, but after all the chunks with High priority:
const ReplicaPriority k_myCustomPriority = (k_replicaPriorityNormal
+ k_replicaPriorityHigh) / 2; // (=Decimal 40960)
```

The priority for the whole replica is the maximum priority found in its chunks. Priority for a chunk can be set after the chunk is created, or at any point during its lifetime, as in the following example:

```
MyChunk::Ptr myChunk = GridMate::CreateReplicaChunk<MyChunk>(...);
myChunk->SetPriority(k_replicaPriorityLow); // Sets low priority for myChunk.
```

Chunks with the same priority are sent and received in the order of their creation. Replicas created earlier are sent and received first.

Tuning Bandwidth at Runtime

You can tune bandwidth usage while the game is running by using the following configuration variables (CVars):

CVar	Description
<code>gm_replicasSendTime</code>	The time, in milliseconds, between replica transmissions. A value of 0 binds the interval to the GridMate tick rate.
<code>gm_replicasSendLimit</code>	The limit, in bytes, of the amount of replica data that can be sent per second. A value of 0 disables the limit.
<code>gm_burstTimeLimit</code>	The time, in seconds, that bursts in bandwidth are allowed. Bursts are allowed only if the bandwidth is not capped when the burst occurs.

Network Serialization and Aspects

All objects that are intended to be synchronized over the network should have a function called `NetSerialize()`. In the `GameObject`, this appears as: `IGameObject::NetSerialize()`.

The `NetSerialize()` function uses a `TSerialize` object of type `ISerialize` to transform relevant data to a stream. The serialization uses different aspects and profiles to distinguish the various types of streams.

Note

Serialized data for a given aspect and profile must remain fixed. For example, if you serialized four floats, you must always serialize four floats.

Aspects

You use aspects to logically group data together.

Aspects are defined as follows:

- `eEA_GameClient` – Information sent from the client to the server, if the client has authority over the object.
- `eEA_GameServer` – The normal server to client data stream.
- `Dynamic/Static` – Data that is constantly changing should be added to the `Dynamic` aspect. Objects that rarely change should be added to the `Static` aspect. Updates are not sent if only one value changes.
- `eEA_Script` – Used where script network data is transported, including any script RMI calls.
- `eEA_Physics` – Used where physics data is transported. It is not divided into client/server because it always uses the same path: (controlling-client) to serve other clients.

Profiles

Profiles allow an aspect's fixed format data to be different. There are potentially eight profiles per aspect, and they are only used for physics aspects (for example, switching between ragdoll and living entity).

RMI Functions

To send remote method invocations (RMIs), use the `InvokeRMI` function, which has the following syntax:

```
void InvokeRMI( IRMIRep& <rep>, ParamsType&& <params>, uint32 <where>, ChannelId <channel> = kInvalidChannelId );
```

Parameters

<rep>

Represents the remote function to be called (the RMI ID).

<params>

Specifies the parameters to pass into the remote function.

<where>

Specifies a flag that determines the category of clients to which the RMI will be sent. For information, see the [RMI Function Flags \(p. 497\)](#) section later in this document.

<channel>

Specifies specific clients to which the RMI will be sent, or specific clients to exclude. For information, see the [RMI Function Flags \(p. 497\)](#) section later in this document.

Ordering RMI Functions

The `IGameObject.h` file includes macros for declaring RMI classes (for example, those beginning with `DECLARE_SERVER_RMI_<...>`). The different declaration types are as follows:

- `PREATTACH` – The RMI is attached at the top of the data update for the object. You can use this declaration type to prepare the remote entity for new incoming data.
- `POSTATTACH` – The RMI is attached at the bottom of the data update, so it is called after the data is serialized. You can use this declaration type to complete an action with the new data.
- `NOATTACH` – The RMI is not attached to a data update, so the RMI cannot rely on the data. You can use this declaration type for calls that don't rely on data.

Ordering Rules

The order for RMIs is only applicable within an object and attachment type set.

For example, in the following ordered list, PLAYER RMI 1, 2, and 3 will arrive in that order; however, ITEM RMI 1 might arrive before or after the following PLAYER RMIs:

- PLAYER RMI 1
- PLAYER RMI 2
- ITEM RMI 1
- PLAYER RMI 3

Using declaration types adds a layer of complication to the order of incoming data:

- `PREATTACH` – Messages are ordered within themselves.
- `POSTATTACH` – Messages are ordered within themselves.
- `NOATTACH` – Messages are ordered within themselves; however, `NOATTACH` can only fall on either side of the following diagram and never in between:



RMI Function Flags

To specify the clients that will receive an RMI, replace the `<where>` parameter in the `InvokeRMI` function with one of the following flags.

Server RMIs

`eRMI_ToClientChannel`

Sends an RMI from the server to a specific client. Specify the destination channel in the `<channel>` parameter.

`eRMI_ToOwningClient`

Sends an RMI from the server to the client that owns the actor.

`eRMI_ToOtherClients`

Sends an RMI from the server to all clients except the client specified. Specify the client to ignore in the `<channel>` parameter.

eRMI_ToRemoteClients

Sends an RMI from the server to all remote clients. Ignores the local client.

eRMI_ToOtherRemoteClients

Sends an RMI from the server to all remote clients except the remote client specified. Ignores the local client. The remote client to ignore is specified in the *<channel>* parameter.

eRMI_ToAllClients

Sends an RMI from the server to all clients.

Client RMIs

eRMI_ToServer

Sends an RMI from the client to the server.

Examples

To define a function to be implemented as RMI, use the `IMPLEMENT_RMI #define` from `IGameObject.h`.

```
#define IMPLEMENT_RMI(cls, name)
```

The following example implements a new function called `Cl_SetAmmoCount` in the `CInventory` class to be used as a client-side RMI, taking one argument of type `TRMIInventory_Ammo`:

```
Class CInventory : public CGameObjectExtensionHelper<CInventory, IInventory>
{
    // ...
    DECLARE_CLIENT_RMI_NOATTACH(Cl_SetAmmoCount, TRMIInventory_Ammo,
    eNRT_ReliableOrdered);
    // ...
};
```

```
IMPLEMENT_RMI(CInventory, Cl_SetAmmoCount)
```

```
{
    // Game code:
    TRMIInventory_Ammo Info(params);
    IEntityClass* pClass = gEnv->pEntitySystem->GetClassRegistry()-
>FindClass(Info.m_AmmoClass.c_str());
    If (pClass)
        SetAmmoCount(pClass, Info.m_iAmount);

    return true;    // Always return true - false will drop connection
}
```

The following line will invoke the function:

```
pInventory->GetGameObject()->InvokeRMI(CInventory::Cl_SetAmmoCount(),
    TRMIInventory_Ammo("Pistol", 10), eRMI_ToAllClients);
```

The following line will invoke the function:

```
pInventory->GetGameObject()->InvokeRMI(CInventory::Cl_SetAmmoCount(),
    TRMIInventory_Ammo("Pistol", 10), eRMI_ToAllClients);
```

Physics

This section describes the Physics system and how to interact with the physics engine.

To create a physical world object, you use the `CreatePhysicalWorld()` function. The `CreatePhysicalWorld()` function returns a pointer to the `IPhysicalWorld` interface. You then fill the world with geometries and physical entities. You control the entities with the functions described in this section. Some functions apply to almost all entities, while others apply to specific entity structures. Other functions control how entities interact and how the world affects them.

The following sections describe these topics in detail:

Topics

- [Geometries \(p. 499\)](#)
- [Physical Entities \(p. 500\)](#)
- [Functions for Entity Structures \(p. 503\)](#)
- [Collision Classes \(p. 511\)](#)
- [Functions for World Entities \(p. 513\)](#)

Geometries

Geometries are first created as independent objects so that they can be used alone via the `IGeometry` interface which they expose and then they can be physicalized and added to physical entities. Geometry physicalization means computing physical properties (volume, inertia tensor) and storing them in a special internal structure. Pointers to these structures can then be passed to physical entities.

Each physicalized geometry has a reference counter which is set to 1 during creation, incremented every time the geometry is added to an entity and decremented every time the geometry is removed or the entity is deleted. When the counter reaches 0, the physical geometry structure is deleted and the corresponding `IGeometry` object is released. The `IGeometry` object is also reference counted.

Geometry Management Functions

Geometry management functions are accessible through the geometry manager, which is a part of physical world. To obtain a pointer to the geometry manager, call the `GetGeomManager()` function.

CreateMesh

The `CreateMesh` geometry management function creates a triangular mesh object from a set of vertices and indices (3 indices per triangle) and returns the corresponding `IGeometry` pointer.

- The engine uses triangle connectivity information in many places, so it is strongly recommended to have meshes closed and manifold. The function is able to recognize different vertices that represent the same point in space for connectivity calculations (there is no tolerance though, it checks only for exact duplicates). Open edges are ok only for geometries that will not be used as parts of dynamic physical entities and only if there will be little or no interaction with them.
- For collision detection the function can create either an OBB or a memory-optimized AABB or a single box tree. Selection is made by specifying the corresponding flag. If both AABB and OBB flags are specified, the function selects the tree that fits the geometry most tightly. Since an OBB tree is tighter in most cases, priority of AABBs can be boosted to save memory (also, AABB checks are slightly faster if the trees are equally tight). The engine can either copy the vertex/index data or use it directly from the pointers provided.
- The `mesh_multycontact_flags` give some hints on whether multiple contacts are possible. Specifying that multiple contacts are unlikely (`mesh_multycontact0`) can improve performance a bit at the expense of missing multiple contacts if they do occur (note that it does not necessarily mean they will be missed, it is a hint for the algorithm to use some optimizations more aggressively). `mesh_multycontact2` disables this optimization and `..1` is a recommended default setting. Convex geometries are detected and some additional optimizations are used for them, although internally there is no separate class for convex objects (this may change in the future).
- Meshes can have per-face materials. Materials are used to look up friction, bounciness, and pierceability coefficients and can be queried by the game as a part of collision detection output.
- The `CreateMesh` function is able to detect meshes that represent primitives (with the specified tolerance) and returns primitive objects instead. In order to activate this detection, the corresponding flags should be specified. Note that primitives can't store materials. They can only have one in the physical geometry structure, so this detection is not used when the material array has more than one material index in it.

CreatePrimitive

`CreatePrimitive`: Creates a primitive geometry explicitly. The corresponding primitive (cylinder, sphere, box, heightfield, or ray) structure should be filled and passed as a parameter, along with its `::type`.

RegisterGeometry

`RegisterGeometry` physicalizes an `IGeometry` object by computing its physical properties and storing them in an auxiliary structure. Material index (`surfaceidx`) can be stored in it; it will be used if the geometry itself does not have any materials specified (such as if it is a primitive). `AddRefGeometry` and `UnregisterGeometry` comprise a reference "sandwich" for it. Note that the latter does not delete the object until its reference count becomes 0.

Geometries and physicalized geometries can be serialized. This saves time when computing OBB trees. That computation is not particularly slow, but serialization is faster.

Physical Entities

Physical entities can be created via calls to the `CreatePhysicalEntity` method of the physical world. `CreatePhysicalEntity` can create the types of entities noted in the following table:

Physical Entity Types

Type	Description
<code>PE_ARTICULATED</code>	An articulated structure, consisting of several rigid bodies connected with joints (a ragdoll, for instance). It is also possible to manually connect several <code>PE_RIGID</code>

Type	Description
	entities with joints, but in this case they will not know that they comprise a single object, and thus some useful optimizations cannot be used.
PE_LIVING	A special entity type to represent player characters that can move through the physical world and interact with it.
PE_PARTICLE	A simple entity that represents a small lightweight rigid body. It is simulated as a point with some thickness and supports flying, sliding and rolling modes. Recommended usage: rockets, grenades and small debris.
PE_RIGID	A single rigid body. Can have infinite mass (specified by setting mass to 0), in which case it will not be simulated but will interact properly with other simulated objects;
PE_ROPE	A rope object. It can either hang freely or connect two purely physical entities.
PE_SOFT	A system of non-rigidly connected vertices that can interact with the environment. A typical usage is cloth objects.
PE_STATIC	An immovable entity. An immovable entity can still be moved manually by setting positions from outside, but in order to ensure proper interactions with simulated objects, it is better to use PE_RIGID entity with infinite mass.
PE_WHEELEDVEHICLE	A wheeled vehicle. Internally it is built on top of a rigid body, with added vehicle functionality (wheels, suspensions, engine, brakes).

Note

PE_RIGID, PE_ARTICULATED and PE_WHEELEDVEHICLE are purely physical entities that comprise the core of the simulation engine. The other entities are processed independently.

Creating and managing entities

When creating and managing entities, keep in mind the following:

- Entities use a two-dimensional, regular grid to speed up broad phase collision detection. The grid should call the `SetupEntityGrid` function before physical entities are created.
- Entities can be created in permanent or on-demand mode and are specified by the parameter `lifeTime` (use 0 for permanent entities). For on-demand mode, the entity placeholders should be created first using `CreatePhysicalPlaceholder`. Physics will then call the outer system to create the full entity whenever an interaction is required in the bounding box for this placeholder.
- If an entity is not involved in any interactions for the specified lifetime, it will be destroyed, with the placeholder remaining. Placeholders require less memory than full entities (around 70 bytes versus 260 bytes). It is possible for an outer system to support hierarchical placeholders, such as meta-placeholders that create other placeholders upon request.
- A sector-based, on-demand physicalization is activated after `RegisterBBoxInPODGrid` is called. Entities are created and destroyed on a sector basis. The sector size is specified in `SetupEntityGrid`.
- You can use `SetHeightfieldData` to set up one special static terrain object in the physical world. You can also create unlimited terrain geometry manually and add it to an entity.

Destroying, suspending, and restoring entities

To destroy, suspend, or restore a physical entity, use `DestroyPhysicalEntity` and set the `mode` parameter to 0, 1, or 2, respectively. Suspending an entity clears all of its connections to other entities, including constraints, without actually deleting the entity. Restoring an entity after suspension will not restore all lost connections automatically. Deleted entities are not destroyed immediately; instead, they

are put into a recycle bin. You might need to remove references to any one-way connections. The recycle bin is emptied at the end of each `TimeStep`. You can also call `PurgeDeletedEntities`.

Physical entity IDs

All physical entities have unique IDs that the physics engine generates automatically. You do not need to specify an ID during creation. You can also set a new ID later. Entities use these IDs during serialization to save dependency information. When reading the saved state, be sure that entities have the same IDs. IDs are mapped to entity pointers by use of an array, so using large ID numbers will result in allocation of an equally large array.

Associations with outside objects

To maintain associations with outside engine objects, physical entities store an additional void pointer and two 16-bit integers (`pForeignData`, `iForeignData`, and `iForeignFlags`). These parameters are set from outside, not by the entities. Use `pForeignData` to store a pointer to the outside engine reference entity and `iForeignData` to store the entity type, if applicable.

For each material index, the physical world stores the friction coefficient, a bounciness (restitution) coefficient, and flags. When two surfaces contact, the contact's friction and bounciness are computed as an average of the values of both surfaces. The flags only affect raytracing.

Simulation type

Physical entities are grouped by their simulation type, in order of increasing "awareness". Certain interface functions, such as ray tracing and querying entities in an area, allow filtering of these entities by type.

- 0 (`bitmask ent_static`) – Static entities. Although terrain is considered static, it does not have a special simulation type. It can be filtered independently with the `ent_terrain` bitmask.
- 1 (`bitmask ent_sleeping_rigid`) – Deactivated, physical objects (rigid bodies and articulated bodies).
- 2 (`bitmask ent_rigid`) – Active, physical objects.
- 3 (`bitmask ent_living`) – Living entities.
- 4 (`bitmask ent_independent`) – Physical entities that are simulated independently from other entities (particles, ropes, and soft objects).
- 6 (`bitmask ent_triggers`) – Entities (or placeholders) that are not simulated and only issue callbacks when other entities enter their bounding box.
- 7 (`bitmask ent_deleted`) – Objects in the recycle bin. Do not use this directly.

Entities that have a lower simulation type are not aware of entities with higher simulation types (types 1 and 2 are considered as one for this purpose), so players (type 3) and particles (type 4) check collisions against physical entities (types 1 and 2) but physical entities do not know anything about them. Similarly, ropes (type 4) can check collisions against players but not the other way. However, entities of higher types can still affect entities with lower types by using impulses and constraints. Most entities expect a particular simulation type (and will automatically set to the proper value).

There are exceptions to the 'awareness hierarchy': for example, articulated entities can be simulated in types 1 and 2 as fully physicalized dead bodies, or in type 4 as skeletons that play impact animations without affecting the environment and being affected by it.

Functions for Physical Entities

Most interactions with physical entities will use the functions `AddGeometry`, `SetParams`, `GetParams`, `GetStatus`, and `Action`.

- `AddGeometry` – Adds multiple geometries (physicalized geometries) to entities. For more details, see the `AddGeometry` section that follows.
- `RemoveGeometry` – Removes geometries from entities.
- `SetParams` – Sets parameters.
- `GetParams` – Gets the simulation input parameters.
- `GetStatus` – Gets the simulation output parameters. `GetStatus` requests the values that an entity changes during simulation.
- `Action` – Makes an entity execute an action, such as adding an impulse.

These functions take structure pointers as parameters. When you want to issue a command, you can create a corresponding structure (for example, as a local variable) and specify only the fields you need. The constructor of each structure provides a special value for all fields that tells the physics engine that the field is unused. You can also do this explicitly by using the `MARK_UNUSED` macro and `is_unused` to verify that the field is unused.

AddGeometry

`AddGeometry` adds a physicalized geometry to an entity. Each geometry has the following properties:

- `id` – A unique part identifier within the bounds of the entity to which the geometry belongs. You can specify the ID or use `AddGeometry` to generate a value automatically. The ID doesn't change if the parts array changes (for example, if some parts from the middle are removed), but the internal parts index might change.
- `position`, `orientation`, and `uniform scaling` – Relative to the entity.
- `mass` – Used for non-static objects; static objects assume infinite mass in all interactions. You can specify the mass or density where the complementary value will be computed automatically (using formula $mass = density * volume$; `volume` is stored in the physicalized geometry structure and scaled if the geometry is scaled).
- `surface_idx` – Used if neither `IGeometry` nor physicalized geometry have surface (material) identifiers.
- `flags` and `flagsCollider` – When an entity checks collisions against other objects, it checks only parts that have a flag mask that intersects its current part's `flagsCollider`. You can use 16-type bits (`geom_colltype`) to represent certain entity groups. Although not enforced, it is good practice to keep these relationships symmetrical. If collision checks are known to be one-sided (for example, entity A can check collisions against entity B but never in reverse), you can choose to not maintain this rule. Certain flags are reserved for special collision groups, such as `geom_colltype1 = geom_colltype_players` and `geom_colltype2 = geom_colltype_explosion` (when explosion pressure is calculated, only parts with this flag are considered). There are also special flags for raytracing and buoyancy calculations: `geom_colltype_ray` and `geom_floats`.
- `minContactDist` – The minimum distance between contacts the current part of the entity might have with another part of an entity. Contacts belonging to different parts are not checked for this. You can leave this unused so it will initialize with a default value based on geometry size. Each part can have both geometry and proxy geometry. Geometry is used exclusively for raytracing and proxy geometry. If no proxy geometry is specified, both geometries are set to be equal to allow the raytracing to test against high-poly meshes without needing to introduce changes to the part array layout.

Functions for Entity Structures

This section describes functions that control general and specific kinds of entity structures.

Topics

- [Common Functions \(p. 504\)](#)

- [Living Entity-Specific Functions](#) (p. 506)
- [Particle Entity-Specific Functions](#) (p. 507)
- [Articulated Entity-Specific Functions](#) (p. 508)
- [Rope Entity-Specific Functions](#) (p. 510)
- [Soft Entity-Specific Functions](#) (p. 510)

Common Functions

[pe_params_pos](#)

Sets the position and orientation of the entity. You can use offset/quaternion/scaling values directly or allow the physics to extract them from a 3x3 (orientation+scaling) or a 4x4 (orientation_scaling+offset) matrix. Physics use a right-to-left transformation order convention, with vectors being columns ($\text{vector_in_world} = \text{Matrix_Entity} * \text{Matrix_Entity_Parts} * \text{vector_in_geometry}$). All interface structures that support matrices can use either row-major or column-major matrix layout in memory (the latter is considered transposed; thus, the corresponding member has T at the end of its name).

There is no per-entity scaling; scaling is only present for parts. When a new scaling is set with `pe_params_pos`, it is copied into each part and overrides any previous individual scalings. This structure also allows you to set the simulation type manually. After changes are made, entity bounds are typically recalculated and the entity is re-registered in the collision hash grid; however, this can be postponed if `bRecalcBounds` is set to 0.

[pe_params_bbox](#)

Sets an entity's bounding box to a particular value, or queries it when used with `GetParams`). The bounding box is recalculated automatically based on the entity's geometries, but you can set the bounding box manually for entities without geometries (for example, triggers) or placeholders. If the entity has geometries, it might recalculate its bounding box later, overriding these values. Bounding boxes are axis-aligned and in the world coordinate system.

[pe_params_outer_entity](#)

Specifies an outer entity for an entity. When a box of interest (its center) is inside the entity with an outer entity, the outer entity is excluded from the set of potential colliders. This allows you to have a building exterior quickly culled away when the region of interest is inside the building's interior. Outer entities can be nested and an optional geometry to test for containment is supported.

[pe_params_part](#)

Sets or queries the entity part's properties. The part can be specified using an internal part index or its ID.

[pe_simulation_params](#)

Sets simulation parameters for entities that can accept these parameters (e.g. physical entities, ropes, and soft entities). `minEnergy` is equal to sleep speed squared. Damping and gravity can be specified independently for colliding and falling state, for example when there are no contacts.

[pe_params_buoyancy](#)

Sets the buoyancy properties of the object and the water plane. The physics engine does not have a list of water volumes, so the outer system must update water plane parameters when they change.

The water surface is assumed to be a perfect plane, so you can simulate bobbing of the waves by disturbing the normal of this surface. `waterFlow` specifies the water movement velocity and affects the object based on its `waterResistance` property). A separate sleeping condition is used in the water (`waterEmin`).

pe_params_sensors

Attaches sensors to entities. Sensors are rays that the entity can shoot to sample the environment around it. It is more efficient to do it from inside the entity step than by calling the world's raytracing function for every ray from outside the entity step. Living entities support vertical-down sensors.

pe_action_impulse

Adds a one-time impulse to an entity. `impulse` is the impulse property (in $N \cdot sec$; impulse P will change the object's velocity by $P/[object\ mass]$). `point` is a point in world space where the impulse is applied and used to calculate the rotational effects of the impulse. The `of_point` momentum can be used to specify the rotational impulse explicitly. If neither the point nor momentum are specified, the impulse is applied to the center of the mass of the object. `iApplyTime` specifies the time when the impulse is applied. By default the value is 2 ("after the next step") to allow the solver an opportunity to reflect the impulse.

pe_action_add_constraint

Adds a constraint between two objects. Points specify the constraint positions in world space. If the second point is used and different from the first point, the solver will attempt to join them.

Relative positions are always fully constrained to be 0 (i.e. the points on the bodies will always be in one spot) and relative rotations can be constrained in twist and bend directions. These directions correspond to rotation around the x-axis and the remaining rotation around a line on the yz-plane (tilt of the x axis) of a relative transformation between the two constraint coordinate frames attached to the affected bodies.

The original position of the constraint frames are specified with `qframe` parameters in world or entity coordinate space (as indicated by the corresponding flag in `flags`). If one or both `qframes` are unused, they are considered to be an identity transformation in either the world or entity frame.

Rotation limits are specified with the `xlimits` and `yzlimits` parameters, with valid element values of 0 (minimum) and 1 (maximum). If the minimum is more than or equal to the maximum, the corresponding relative rotation is prohibited. `pConstraintEntity` specifies an entity that represents the constraint. When passed a `pe_action_add_constraint` pointer, `Action` returns a constraint identifier that can be used to remove the constraint. 0 indicates a failure.

pe_action_set_velocity

Sets the velocity of an object, which is useful for rigid bodies with infinite mass (represented as mass). `pe_action_set_velocity` informs the physics system about the body's velocity, which can help the solver ensure zero relative velocity with the objects contacted. If velocity is not set and only the position is changed, the engine relies solely on penetrations to enforce the contacts. Velocity will not be computed automatically if the position is set manually each frame. The body will continue moving with the specified velocity once it has been set.

pe_status_pos

Requests the current transformation (position, orientation, and scale) of an entity or its part. You can also use `pe_params_pos` with `GetParams`. If matrix pointers are set, the engine will provide data in the corresponding format. The `BBox` member in this structure is relative to the entity's position.

pe_status_dynamics

Retrieves an entity's movement parameters. Acceleration and angular acceleration are computed based on gravity and interactions with other objects. External impulses that might have been added to the entity are considered instantaneous. `submergedFraction` is a fraction of the entity's volume under water during the last frame (only parts with the `geom_float` flag are considered). `waterResistance` contains the maximum water resistance that the entity encountered in one frame since the status was last requested (the accumulated value is cleared when the status is returned). This value can be useful for generating splash effects.

Living Entity-Specific Functions

Living entities use cylinders or capsules as their bounding geometry. Normally the cylinders are hovering above the ground and the entity shoots a single ray down to detect if it is standing on something. This cylinder geometry always occupies the first part slot (it is created automatically). It is possible to add more geometries manually, but they will not be tested against the environment when the entity moves. However, other entities will process them when testing collisions against the entity.

Living entities never change their orientation themselves; this is always set from outside. Normally, living entities are expected to rotate only around the z-axis, but other orientations are supported. However, collisions against living entities always assume vertically oriented cylinders.

pe_player_dimensions (GetParams | SetParams)

Sets the dimensions of the living entity's bounding geometry.

`heightPivot` specifies the z-coordinate of a point in the entity frame that is considered to be at the feet level (usually 0).

`heightEye` is the z-coordinate of the camera attached to the entity. This camera does not affect entity movement, its sole purpose is to smooth out height changes that the entity undergoes (during walking on a highly bumpy surface, such as stairs, after dimensions change and during landing after a period of flying). The camera position can be requested via the `pe_status_living` structure.

`sizeCollider` specifies the size of the cylinder (x is radius, z is half-height, y is unused).

`heightColliders` is the cylinder's center z-coordinate.

The head is an auxiliary sphere that is checked for collisions with objects above the cylinder. Head collisions don't affect movement but they make the camera position go down. `headRadius` is the radius of this sphere and `headHeight` is the z-coordinate of its center in the topmost state (that is, when it doesn't touch anything).

pe_player_dynamics (GetParams | SetParams)

Sets a living entity's movement parameters. Living entities have their 'desired' (also called 'requested') movement velocity (set with `pe_action_move`) and they attempt to reach it. How fast that happens depends on the `kInertia` setting. The greater this value is, the faster the velocity specified by `pe_action_move` is reached. The default is 8. 0 means that the desired velocity will be reached instantly.

`kAirControl` (0..1) specifies how strongly the requested velocity affects movement when the entity is flying (1 means that whenever a new requested velocity is set, it is copied to the actual movement velocity).

`kAirResistance` describes how fast velocity is damped during flying.

`nodSpeed` (default 60) sets the strength of camera reaction to landings.

`bSwimming` is a flag that tells that the entity is allowed to attempt to move in all directions (gravity might still pull it down though). If not set, the requested velocity will always be projected on the ground if the entity is not flying.

`minSlideAngle`, `maxClimbAngle`, `maxJumpAngle` and `minFallAngle` are threshold angles for living entities that specify maximum or minimum ground slopes for certain activities. Note that if an entity's bounding cylinder collides with a sloped ground, the behavior is not governed by these slopes only.

Setting `bNetwork` makes the entity allocate a much longer movement history array which might be required for synchronization (if not set, this array will be allocated the first time network-related actions are requested, such as performing a step back).

Setting `bActive` to 0 puts the living entity to a special 'inactive' state where it does not check collisions with the environment and only moves with the requested velocity (other entities can still collide with it, though; note that this applies only to the entities of the same or higher simulation classes).

pe_action_move

Requests a movement from a living entity. `dir` is the requested velocity the entity will try to reach. If `iJump` is not 0, this velocity will not be projected on the ground, and snapping to the ground will be turned off for a short period of time. If `iJump` is 1, the movement velocity is set to be equal to `dir` instantly. If `iJump` is 2, `dir` is added to it. `dt` is reserved for internal use.

pe_status_living

Returns the status of a living entity.

`vel` is the velocity that is averaged from the entity's position change over several frames.

`velUnconstrained` is the current movement velocity. It can be different from `vel` because in many cases when the entity bumps into an obstacle, it will restrict the actual movement but keep the movement velocity the same, so that if on the next frame the obstacle ends, no speed will be lost.

`groundHeight` and `groundSlope` contain the point's z coordinate and normal if the entity is standing on something; otherwise, `bFlying` is 1. Note that `pGroundCollider` is set only if the entity is standing on a non-static object.

`camOffset` contains the current camera offset as a 3d vector in the entity frame (although only z coordinates actually changes in it).

`bOnStairs` is a heuristic flag that indicates that the entity assumes that it is currently walking on stairs because of often and abrupt height changes.

Particle Entity-Specific Functions

pe_params_particle

Sets particle entity parameters.

During movement, particles trace rays along their paths with the length `size*0.5` (since `size` stands for 'diameter' rather than 'radius') to check if they hit something. When they lie or slide, they position themselves at a distance of `thickness*0.5` from the surface (thus thin objects like shards of glass can be simulated).

Particles can be set to have additional acceleration due to thrust of a lifting force (assuming that they have wings) with the parameters `accThrust` and `accLift` but these should never be used without specifying `kAirResistance`; otherwise, particles gain infinite velocity.

Particles can optionally spin when in the air (toggled with flag `particle_no_spin`). Spinning is independent from linear motion of particles and is changed only after impacts or falling from surfaces.

Particles can align themselves with the direction of the movement (toggled with `particle_no_path_alignment` flag) which is very useful for objects like rockets. That way, the y-axis of the entity is aligned with the heading and the z-axis is set to be orthogonal to y and to point upward ('up' direction is considered to be opposite to particle's gravity).

When moving along a surface, particles can either slide or roll. Rolling can be disabled with the flag `particle_no_roll` (it is automatically disabled on steep slopes). Note that rolling uses the particle material's friction as damping while rolling treats friction in a conventional way. When touching ground, particles align themselves so that their normal (defined in entity frame) is parallel to the surface normal.

Particles can always keep the initial orientation as well (`particle_constant_orientation`) and stop completely after the first contact (`particle_single_contact`). `minBounceVel` specifies the lower velocity threshold after which the particle will not bounce, even if the bounciness of the contact is more than 0.

Articulated Entity-Specific Functions

Articulated entities consist of linked, rigid bodies called structural units. Each structural unit has a joint that connects it to its parent. For the connection structure, you should use a tree with a single root. Linked loops are not allowed.

Articulated entities can simulate body effects without interactions with the environment by using featherstone mode, which you can tweak so that the entity tolerates strong impacts and so that complex body structures have stiff springs. Articulated entities use a common solver for interactive mode.

pe_params_joint

You can use `pe_params_joint` to:

- Create a joint between two bodies in an articulated entity
- Change the parameters of an existing articulated entity
- Query the parameters of an existing articulated entity, when used with `GetParams`

A joint is created between the two bodies specified in the `op` parameter at the pivot point (in the entity frame). When a geometry is added to an articulated entity, it uses `pe_articgeomparams` to specify which body the geometry belongs to (in `idbody`). `idbody` can be any unique number and each body can have several geometries. There are no restrictions on the order in which joints are created, but all bodies in an entity must be connected before the simulation starts.

Joints use Euler angles to define rotational limits. Flags that start with `angle0_` can be specified individually for each angle by shifting left by the 0-based angle index. For example, to lock the z-axis you can use OR the flags with `angle0_locked<<2`). The child body inherits the coordinate frame from the first entity (geometry) that was assigned to it.

Joint angular limits are defined in a relative frame between the bodies that the joint connects. Optionally the frame of the child body can be offset by specifying a child's orientation that corresponds to rotation angles (0,0,0), using `q0`, `pMtx0`, or `pMtx0T`. This can help to get limits that can be robustly represented using Euler angles.

A general rule for limits is to set upper and lower bounds at least 15 to 20 degrees apart (depending on simulation settings and the height of the joint's velocity) and to keep the y-axis limit in the -90..90 degrees range (preferably within safe margins from its ends).

Note

All angles are defined in radians in the parameter structure.

`pe_params_joint` uses 3D vectors to represent groups of three values that define properties for each angle. In addition to limits, each angle can have a spring that will pull the angle to 0 and a dashpot that will dampen the movement as the angle approaches its limit. Springs are specified in acceleration terms: stiffness and damping can stay the same for joints that connect bodies with different masses, and damping can be computed automatically to yield a critically damped spring by specifying `auto_kd` for the corresponding angle.

`joint_no_gravity` makes the joint unaffected by gravity, which is useful if you assume forces that hold the joint in its default position are enough to counter gravity). This flag is supported in featherstone mode.

`joint_isolated_accelerations` makes the joint use a special mode that treats springs like guidelines for acceleration, which is recommended for simulating effects on a skeleton. This flag is supported in featherstone mode.

Effective joint angles are always the sum of q and q_{ext} . If springs are activated, they attempt to drive q to 0. This allows you to set a pose from animation and then apply physical effects relative to it. In articulated entities, collisions are only checked for pairs that are explicitly specified in `pSelfCollidingParts` (this setting is per body or per joint, rather than per part).

pe_params_articulated_body

`pe_params_articulated_body` allows you to set and query articulated entity simulation mode parameters. Articulated entities can be attached to something or be free, and are set by the `bGrounded` flag. When grounded, the entity can:

- Fetch dynamic parameters from the entity it is attached to (if `bInheritVel` is set; the entity is specified in `pHost`)
- Be set using the `a`, `wa`, `w` and `v` parameters

`bCollisionResp` switches between featherstone mode (0) and constraint mode (1).

`bCheckCollisions` turns collision detection on and off. It is supported in constraint mode.

`iSimType` specifies a simulation type, which defines the way in which bodies that comprise the entity evolve. Valid values:

- 0 – joint pivots are enforced by projecting the movement of child bodies to a set of constrained directions |
- 1 – bodies evolve independently and rely on the solver to enforce the joints. The second mode is not supported in featherstone mode. In constraint mode, it is turned on automatically if bodies are moving fast enough.

We recommend setting this value to 1 to make slow motion smoother.

Lying mode

Articulated entities support a lying mode that is enabled when the number of contacts is greater than a specified threshold (`nCollLyingMode`). Lying mode has a separate set of simulation parameters, such as gravity and damping. This feature was designed for ragdolls to help simulate the high damping of a human body in a simple way, for example by setting gravity to a lower value and damping to a higher than usual value.

Standard simulation versus freefall parameters

Standard simulation parameters can be different from freefall parameters. When using the constraint mode, articulated entities can attempt to represent hinge joints (rotational joints with only axis enabled) as two point-to-point constraints by setting the `bExpandHinges` parameter (this value propagates to `joint_expand_hinge` flags for all joints, so you do not need to manually set the value for joints).

Rope Entity-Specific Functions

Ropes are simulated as chains of connected equal-length sticks ("segments") with point masses. Each segment can individually collide with the environment. Ropes can tie two entities together. In this case ropes add a constraint to the entities when the ropes are fully strained and won't affect their movement.

In order to collide with other objects (pushing them if necessary) in a strained state, the rope must use dynamic subdivision mode (set by `rope_subdivide_segs` flag).

`pe_params_rope`

Specifies all the parameters a rope needs to be functional.

Rope entities do not require any geometry. If you do not specify initial point positions, the rope is assumed to be hanging down from its entity position. If you do specify initial point positions, segments should have equal length but within some error margin. Ropes use an explicit friction value (not materials) to specify friction.

If `pe_params_rope` is passed to `GetParams`, `pPoints` will be a pointer to the first vertex in an internal rope vertex structure, and `iStride` will contain the size of it.

Soft Entity-Specific Functions

There are two types of soft entities: *mesh-based* and *tetrahedral lattice-based*. Mesh based entities use a soft, constraint-like solver and are typically cloth objects. Tetrahedral lattice-based entities use a spring solver and are typically jelly-like objects.

The longest edges of all triangles can optionally be discarded with the `sef_skip_longest_edges` flag.

Collisions are handled at the vertex level only (although vertices have a customizable thickness) and work best against primitive geometries rather than meshes.

`pe_params_softbody`

This is the main structure to set up a working soft entity (another one is `pe_simulation_params`).

Thickness

The thickness of the soft entity is the collision size of vertices (they are therefore treated as spheres). If an edge differs from the original length by more than `maxSafeStep`, positional length enforcement occurs.

Damping

Spring damping is defined with `kdRatio` as a ratio to a critically damped value (overall damping from `pe_simulation_params` is also supported).

Wind

Soft entities react to wind if `airResistance` is not 0 (if wind is 0, having non-zero `airResistance` would mean that the entity will look like it is additionally damped - air resistance will attempt to even surface velocity with air velocity).

Water

Soft entities react to water in the same way that they react to wind, but the parameters specified in `pe_params_buoyancy` are used instead. Note that the Archimedean force that acts on vertices submerged in the water will depend on the entity's density which should be defined explicitly in `pe_simulation_params` (dependence will be same as for rigid bodies - the force will be 0 if `waterDensity` is equal to `density`). `collTypes` enables collisions with entities of a particular simulation type using `ent_masks`.

pe_action_attach_points

Can be used to attach some of a soft entity's vertices to another physical entity.

`piVtx` specifies vertex indices.

`points` specify attachment positions in world space. If `points` values are not specified, current vertex positions are the attachment points.

Collision Classes

Use collision classes to filter collisions between two physical entities. A collision class comprises two 32-bit uints, a `type`, and an `ignore`.

You can use collision classes to implement scenarios such as "player only collisions," which are objects passable by AI actors but not passable by players. This feature allows you to configure filtering of the collision between physical entities independently of their collision types.

Setup

Physical entities can have one or more collision classes and can ignore one or more collision classes. To have a physical entity ignore a collision, use the `ignore_collision` attribute of the `<Physics>` element in the `<SurfaceType>` definition, as shown in the following example:

`SurfaceTypes.xml`

```
<SurfaceType name="mat_nodraw_ai_passable">
  <Physics friction="0" elasticity="0" pierceability="15"
  ignore_collision="collision_class_ai"/>
</SurfaceType>
```

All physical entity types such as `LivingEntity` and `ParticleEntity` are supplied with default collision classes like `collision_class_living` and `collision_class_particle`. `LivingEntity` uses one additional game specific collision class: either `collision_class_ai` for AI actors, or `collision_class_player` for players.

`Player.lua`

```
Player = {
  ...
  physicsParams =
  {
    collisionClass=collision_class_player,
  },
  ...
}
```

In the following example, of the classes `LIVING`, `PLAYER`, `TEAM1`, `TEAM2`, `AI`, `AI_1`, and `AI_2`, `player1` belongs to the `LIVING` entity class, the `PLAYER` class, and the `TEAM1` class:

```
SCollisionClass player1(0,0), player2(0,0), ai1(0,0), ai7(0,0), object1(0,0);

player1.type = LIVING|PLAYER|TEAM1;
player2.type = LIVING|PLAYER|TEAM2;
ai1.type = LIVING|AI|AI_1;
ai7.type = LIVING|AI|AI_2;
object1.type = 0;
```

Filtering the collision

Filtering occurs by checking the `type` of one entity against the `ignore` of another entity.

This is done both ways, and if bits overlap, then the collision is ignored. For example:

```
bool ignoreCollision = (A->type & B->ignore) || (A->ignore & B->type);
```

If you want `ai7` to ignore collisions with anything that has `AI_1` set, then add `AI_1` to the `ignore` flags like this:

```
ai7.ignore = AI_1
```

If you want `object1` to ignore all living physical entities, set its `ignore` flag like this:

```
object1.ignore=LIVING
```

Interface

- For code, see `physinterface.h` and `GamePhysicsSettings.h`.
- To access and set the collision classes on the physical entity, use `*pe_collision_class` struct `SCollisionClass pe_params_collision_class`.
- For helpers that set additional ignore maps, see `GamePhysicsSettings.h`.
- In Lua, see `SetupCollisionFiltering` and `ApplyCollisionFiltering`. Lua script-binding is done through `SetPhysicParams(PHYSICPARAM_COLLISION_CLASS)`.

Functions for World Entities

Use the functions in this section to modify entities or a physical world environment.

Advancing the Physical World Time State

The `TimeStep` functions make the entities advance their state by the specified time interval.

If `timeGranularity` in the physical variables is set, the time interval will be snapped to an integer value with the specified granularity (for example, if `timeGranularity` is 0.001, the time interval will be snapped to a millisecond).

Entities that perform the step can be filtered with `ent_flags` in the `flags` parameter.

The `flags` parameter can contain `ent_masks` for [Simulation type \(p. 502\)](#).

The `flags` parameter can also contain the `ent_flagged_only` flag. This flag causes entities to be updated only if the entities have the `pef_update` flag set.

Specifying the `ent_deleted` flag will allow the world to delete entities that have timed out if physics on demand is used.

Most entities have the maximum time step capped. To have larger timesteps, entities have to perform several substeps. The number of substeps can be limited with the physics variable `nMaxSubsteps`.

Returning Entities with Overlapping Bounding Boxes

The function `GetEntitiesInBox` uses the internal entity hash grid to return the number of entities whose bounding boxes overlap a specified box volume. The function supports filtering by [Simulation type \(p. 502\)](#) and optional sorting of the output list by entity mass in ascending order.

Syntax

```
virtual int GetEntitiesInBox(Vec3 ptmin,Vec3 ptmax, IPhysicalEntity **&pList,
    int objtypes, int szListPrealloc=0) = 0;
```

Example call

```
IPhysicalEntity** entityList = 0;
int entityCount = gEnv->pPhysicalWorld->GetEntitiesInBox(m_volume.min,
    m_volume.max, entityList,
    ent_static | ent_terrain | ent_sleeping_rigid | ent_rigid);
```

Parameters

Parameter	Description
<code>ptmin</code>	Minimum point in the space that defines the desired box volume.
<code>ptmax</code>	Maximum point in the space that defines the desired box volume.
<code>pList</code>	Pointer to a list of objects that the function populates.
<code>objtypes</code>	Types of objects that need to be considered in the query.
<code>szListPrealloc</code>	If specified, the maximum number of objects contained in the <code>pList</code> array.

The possible object types are described in the `physinterface.h` header file in the `entity_query_flags` enumerators. A few are listed in the following table:

Entity type flag	Description
<code>ent_static</code>	Static entities
<code>ent_terrain</code>	Terrain
<code>ent_sleeping_rigid</code>	Sleeping rigid bodies
<code>ent_rigid</code>	Rigid bodies

After the function completes, you can easily iterate through the entity list to perform desired operations, as in the following code outline:

```
for (int i = 0; i < entityCount; \++i)
{
    IPhysicalEntity\* entity = entityList[i];

    [...]

    if (entity->GetType() == PE_RIGID)
    {
        [...]
    }

    [...]
}
```

If `ent_allocstate_list` is specified, the function allocates memory for the list (the memory can later be freed by a call to `pWorld->GetPhysUtils()->DeletePointer`). Otherwise, an internal pointer will be returned.

Note

Because the physics system uses this pointer in almost all operations that require forming an entity list, no such calls should be made when the list is in use. If such calls are required and memory allocation is undesired, copy the list to a local pre-allocated array before iterating over it.

Casting Rays in an Environment

The `RayWorldIntersection` physical world function casts rays into the environment.

Depending on the material that the ray hits and the ray properties, a hit can be pierceable or solid.

A pierceable hit is a hit that has a material pierceability higher than the ray's pierceability. Material pierceability and ray pierceability occupy the lowest 4 bits of `material flags` and `RayWorldIntersection flags`.

Pierceable hits don't stop the ray and are accumulated as a list sorted by hit distance. The caller provides the function with an array for the hits. A solid hit (if any) always takes the slot with index 0 and pierceable hits slots from 1 to the end.

Optionally, the function can separate between 'important' and 'unimportant' pierceable hits (importance is indicated by `sf_important` in material flags) and can make important hits have a higher priority (regardless of hit distance) than unimportant ones when competing for space in the array.

By default, `RayWorldIntersection` checks only entity parts with the `geom_colltype_ray` flag. You can specify another flag or combination of flags by setting `flags |= geom_colltype_mask << rwi_colltype_bit`. In this case, all flags should be set in part so that the specified flag can be tested.

`RayTraceEntity` is a more low-level function and checks ray hits for one entity only. `RayTraceEntity` returns only the closest hit.

Alternatively, `CollideEntityWithBeam` can perform a sweep-check within a sphere of the specified radius. In order to detect collisions reliably, the sphere specified should be outside of the object. The `org` parameter corresponds to the sphere center.

Creating Explosions

The function `SimulateExplosion` is used to simulate explosions in a physical world.

The only effect of explosions inside the physics system are impulses that are added to the nearby objects. A single impulse is calculated by integrating impulsive pressure at an area fragment multiplied by this area and scaled by its orientation towards the epicenter.

Impulsive pressure has a falloff proportional to $1/\text{distance}^2$. If `distance` is smaller than `rmin`, it is clamped to `rmin`.

`impulsive_pressure_at_r` is the impulsive pressure at distance `r`.

`SimulateExplosion` can optionally build an occlusion cubemap to find entities occluded from the explosion (`nOccRe_s` should be set to a non-zero cubemap resolution in one dimension in this case). First, static entities are drawn into the cubemap, and then dynamic entities of the types specified in `iTypes` are tested against the map. Thus, dynamic entities never occlude each other.

Passing `-1` to `nOccRes` tells the function to reuse the cubemap from the last call and process only the dynamic entities that were not processed during the last call. This is useful when the code that creates the explosion decides to spawn new entities afterwards, such as debris or dead bodies, and wants to add explosion impulses to them without recomputing the occlusion map.

Due to the projective nature of the cubemap, small objects very close to the epicenter can occlude more than they normally would. To counter this, `rmin_occ` can specify linear dimensions of a small cube that is subtracted from the environment when building the occlusion map. This crops the smaller objects but can make explosions go through thin walls, so a compromise set of dimensions should be used.

`nGrow` specifies the number of occlusion cubemap cells (in one dimension) that dynamic entities are inflated with. This can help explosions to reach around corners in a controllable way. After a call has been made to `SimulateExplosion`, the physics system can return how much a particular entity was affected by by calling `IsAffectedByExplosion`.

`IsAffectedByExplosion` returns fraction from zero to one. The `IsAffectedByExplosion` function performs a lookup into a stored entity list; it does not recompute the cubemap. The explosion epicenter used for generating impulses can be made different from the one used to build a cubemap. For example, you can create explosions slightly below the ground to make things go up instead of sideways. Note that this function processes only parts with `geom_colltype_explosion`.

Profiler

Profiler is in preview release and is subject to change.

Profiler is a Lumberyard tool that can capture, save, and analyze network, CPU, and VRAM usage statistics. You can use the saved data to analyze network usage frame by frame, fix problems in the use of network bandwidth, and optimize the performance of your game.

To capture data, Profiler works with GridHub. When you launch Profiler, GridHub launches automatically as a supporting background process. For more information about GridHub, see [Using GridHub \(p. 545\)](#).

Topics

- [Profiler Tutorial \(p. 517\)](#)
- [Creating and Using Annotations \(p. 527\)](#)
- [Using Profiler for Networking \(p. 531\)](#)
- [Using the Profiler for CPU Usage \(p. 539\)](#)
- [Using Profiler for VRAM \(p. 542\)](#)
- [Using GridHub \(p. 545\)](#)

Profiler Tutorial

Profiler is in preview release and is subject to change.

You can register an application in GridHub and use Profiler to capture, inspect, play back, and export the data that you collect.

Topics

- [Registering Your Application \(p. 518\)](#)
- [Launching Profiler \(p. 518\)](#)
- [Capturing Data \(p. 518\)](#)
- [Inspecting Data \(p. 520\)](#)
- [Playing Back Data \(p. 522\)](#)

- [Exporting Data \(p. 527\)](#)

Registering Your Application

To enable Profiler to capture information from your application, you must first register the application in GridHub. To do so, add `AzFramework::TargetManagementComponent` to the application's `SystemComponent`.

Note: Lumberyard's built-in applications already have this component added by default.

Launching Profiler

Unlike many Lumberyard utilities, you launch Profiler from its own executable file.

To launch profiler

- From the Lumberyard `dev\Bin64\` directory, run `Profiler.exe`.

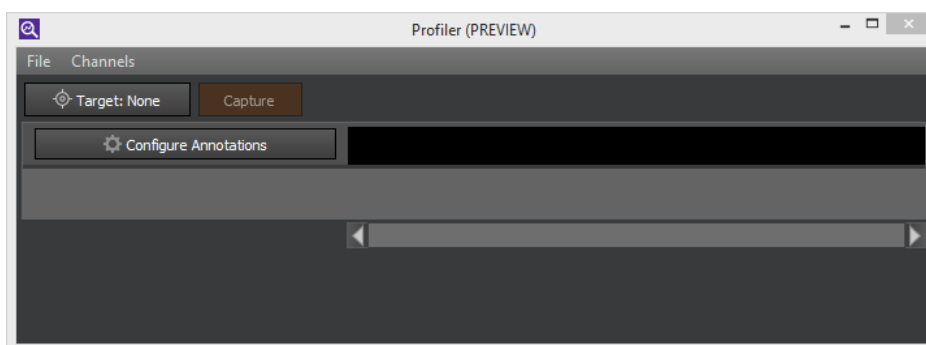

Capturing Data

Profiler has two main modes of use: *capture mode* and *inspection mode*.

To use capture mode, perform the following steps.

To capture data

1. Click **Target**.

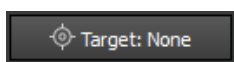

Profiler shows you the applications that are available for profiling:

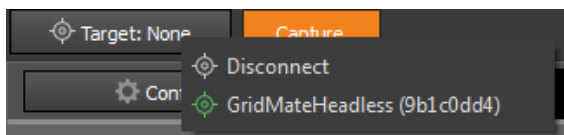

2. Select a target application.

After you have selected a target, the target selector shows the state of the connection to the target. The next time you launch Profiler, it automatically selects your target for you, if it's available.

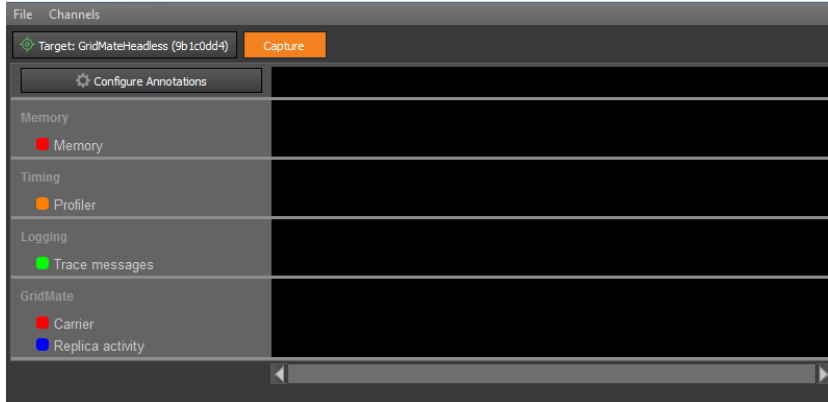

The window is divided horizontally into channels that have associated Profiler instances. A channel is a collection of Profiler instances that relate to a specific system.

- Each Profiler instance in a channel has a unique color. A Profiler instance is active when its color is solid:

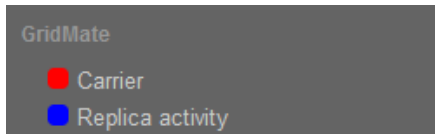

Click the color next to a Profiler instance. The color is no longer solid, showing that the Profiler instance is inactive:

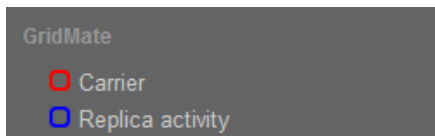

Click the color again to turn on the display and activate the instance again.

- After you have selected a target and chosen the Profiler instances that you want to see, click **Capture**.

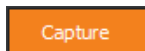

After the capture begins, data begins to populate the channels.

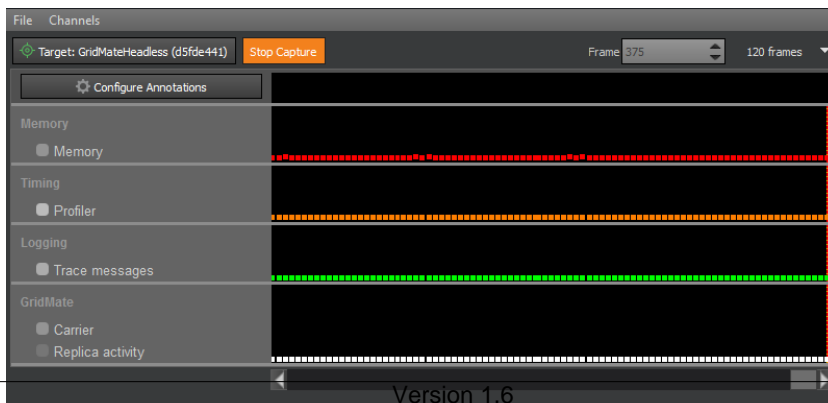

5. To stop the data capture, click **Stop Capture**.

An orange rectangular button with the text "Stop Capture" in white.

6. When prompted, save the captured data to disk. Profiler saves the data in a binary format file with a `.drl` extension, reloads the data from disk, and switches to inspection mode.

Note

If you do not save the data, it will be discarded.

Inspecting Data

You can use profiler to examine the data that you have captured.

To inspect captured data

1. In Profiler, click **File, Open Data**, or press **Ctrl+O**:

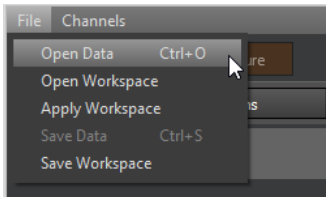

2. Navigate to the `.drl` file that contains your saved data and open it.

The main screen of the Profiler provides an overview of the channels of system information. This example uses a file that has 1162 frames of data:

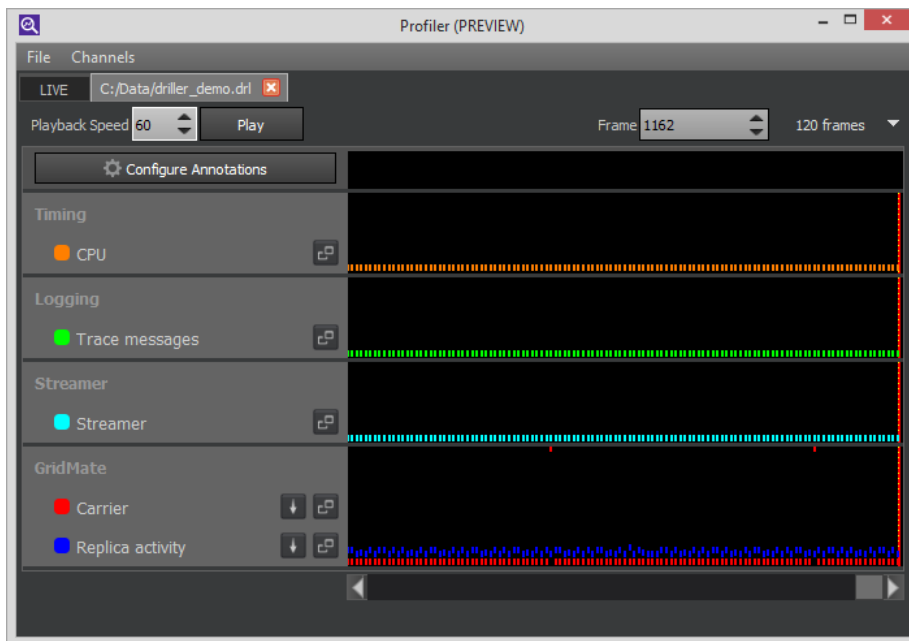

You can use this main view to discover anomalies across channels, or to examine particular areas of interest at a high level.

When you open the main window, the scroll box at the bottom is on the right because the playback stopped at the end of the captured data.

Notice the red vertical line on the right.

3. Click in the channels area of the window.

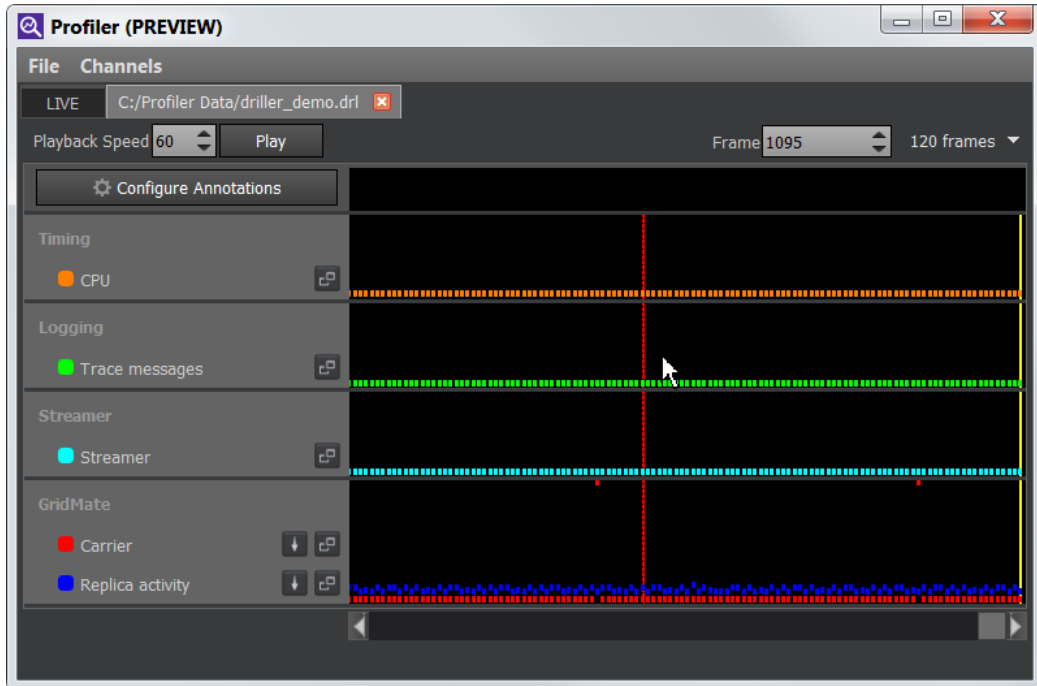

The red vertical line moves to where you clicked. The frame indicator shows the new position of the red line. You can place the red line, which is called the *scrubber*, on any frame that you want to examine in detail. For finer control over the position of the scrubber, you can enter a number in the **Frame** indicator.

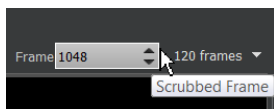

The scrubber moves accordingly.

4. To view detailed information about a frame on which the scrubber rests, the click the **Detailed Profiling Information** icon next to the profiler instance whose data you would like to see:

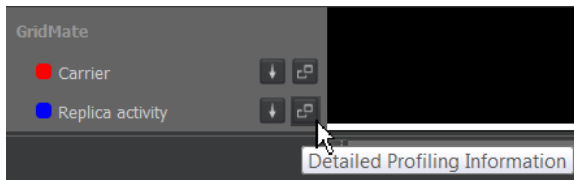

Profiler instance information appears in a detail window.

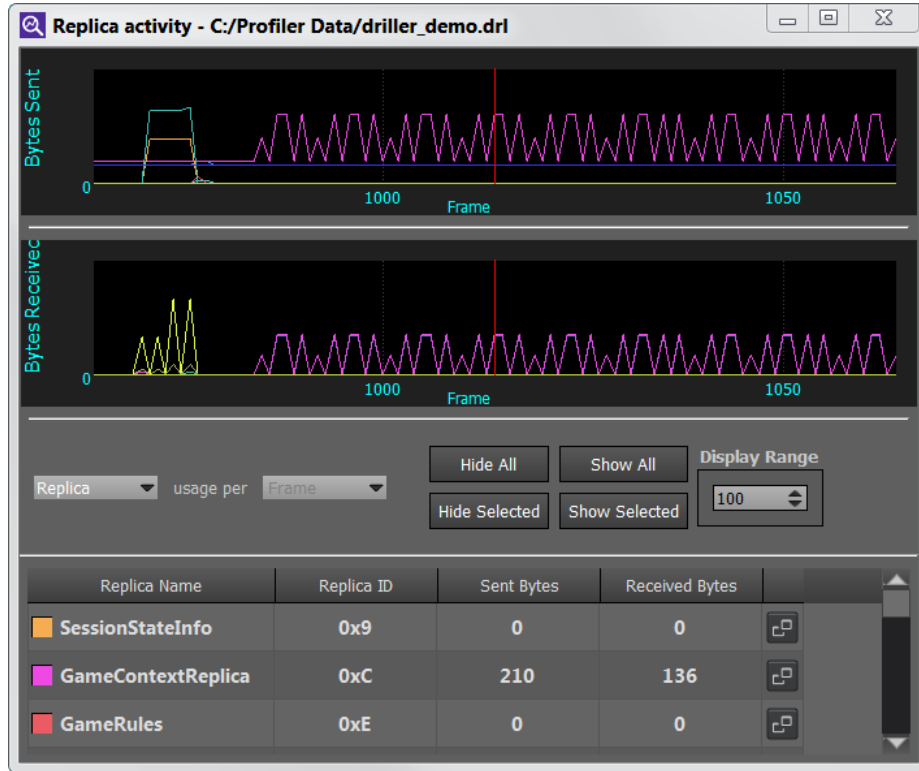

Individual profilers present details in different ways, so their detail windows can look different. For information on system-specific detail windows in Profiler, see [Using Profiler for Networking \(p. 531\)](#), [Using the Profiler for CPU Usage \(p. 539\)](#), and [Using Profiler for VRAM \(p. 542\)](#).

5. To return to capture mode from inspection mode, click the **LIVE** tab.

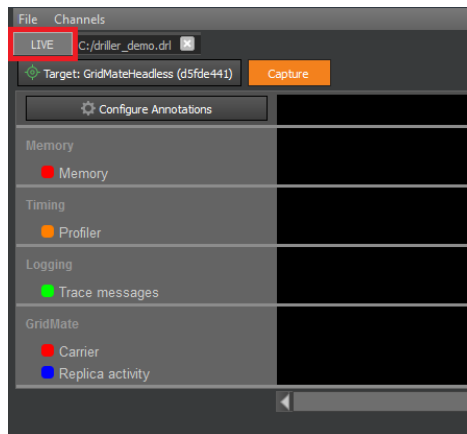

Playing Back Data

You can mark and play back a subset of your captured data.

Notice that after you moved the scrubber the first time, a yellow vertical line appeared on the right at the end of the data:

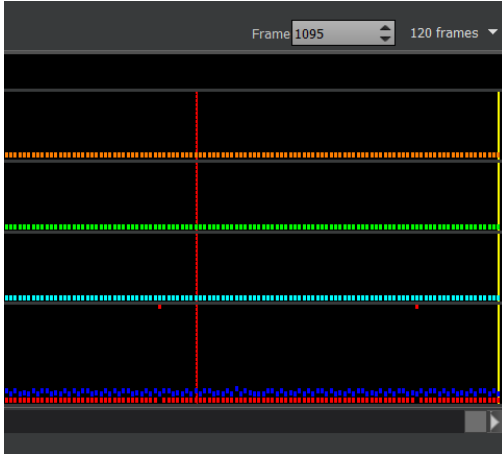

This yellow marker is movable and marks the end of your desired playback range. By default, it is at the end of the captured data but may be obscured by the red scrubber.

1. Scroll the window all the way to the left, to the beginning of the capture range.

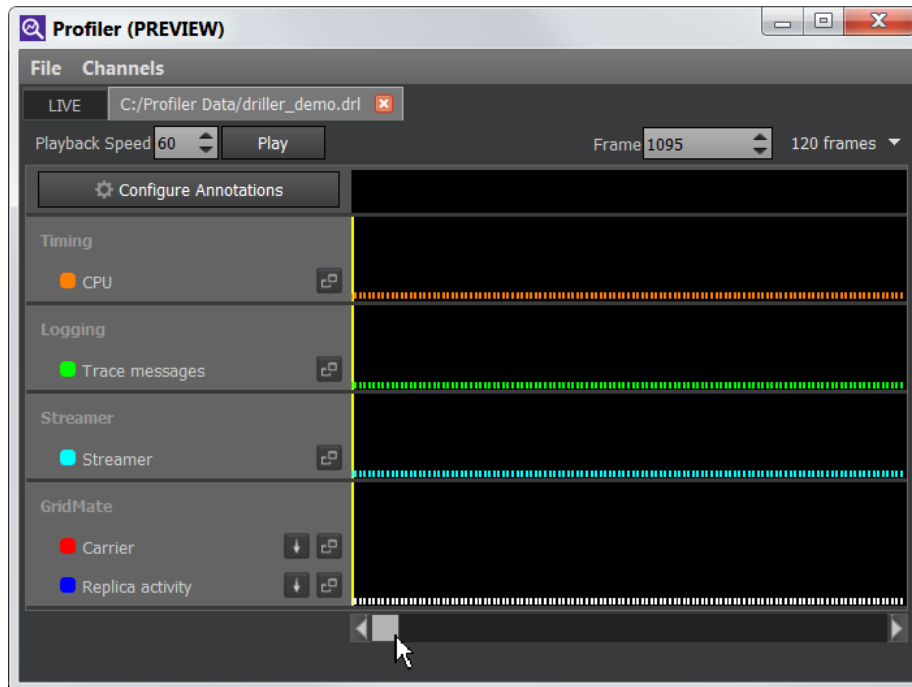

Now a yellow marker also appears at the beginning of the data. You can use these two yellow markers, which by default are at the beginning and end of the capture range, to restrict the range of playback to an area of data that you are interested in. You will use these shortly.

If you have many frames of data (as in this example), the initial view does not show you all frames by default.

2. To see all frames at once, click the **Frame Count Selector**, which determines the number of frames visible, and choose **All frames**:

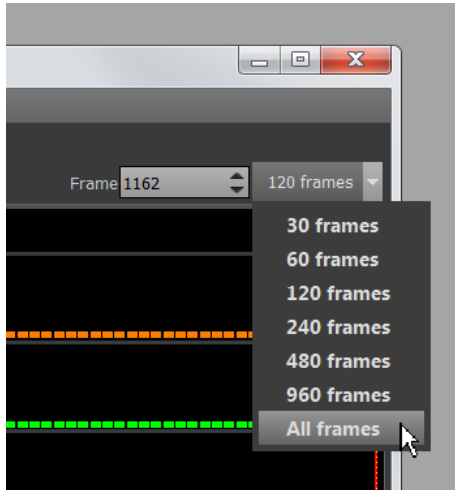

Now you can see the entire range of captured data, with the yellow markers at the beginning and at the end:

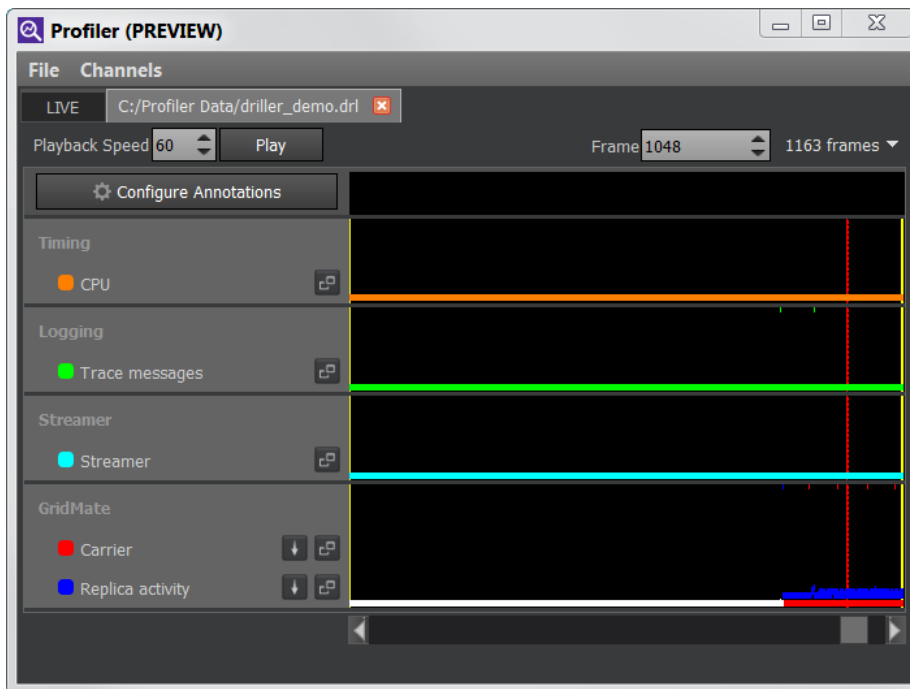

3. Drag the two yellow markers to an area of data that you want to play back. You can ignore the position of the scrubber for now.

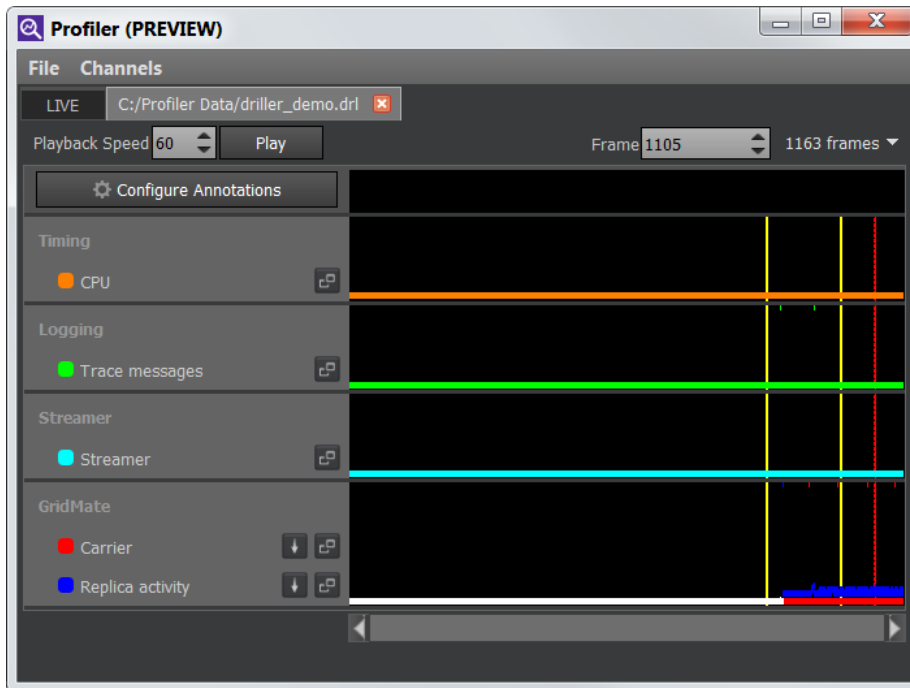

4. Click **Play** to start the playback:

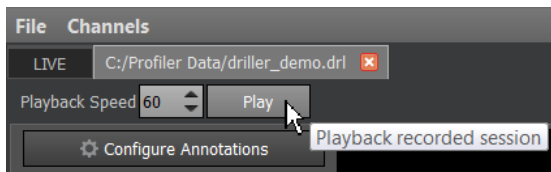

As the data plays back, the scrubber moves from the first yellow marker to the second, and then loops back to the first.

Here are some tips to keep in mind:

- If the playback speed is too fast (the default is 60), use the **Playback Speed** option to adjust it from 1 through 60.
- If you click a location in the playback window during playback, the playback stops and moves the scrubber to the location that you clicked.
- You can place the scrubber on a frame that you are interested in and click the detail button for a profiler instance to see the detail window for the frame.
- For greater convenience and visibility, leave the profiler instance detail window open to see the data change in the detail window as the scrubber loops between markers.

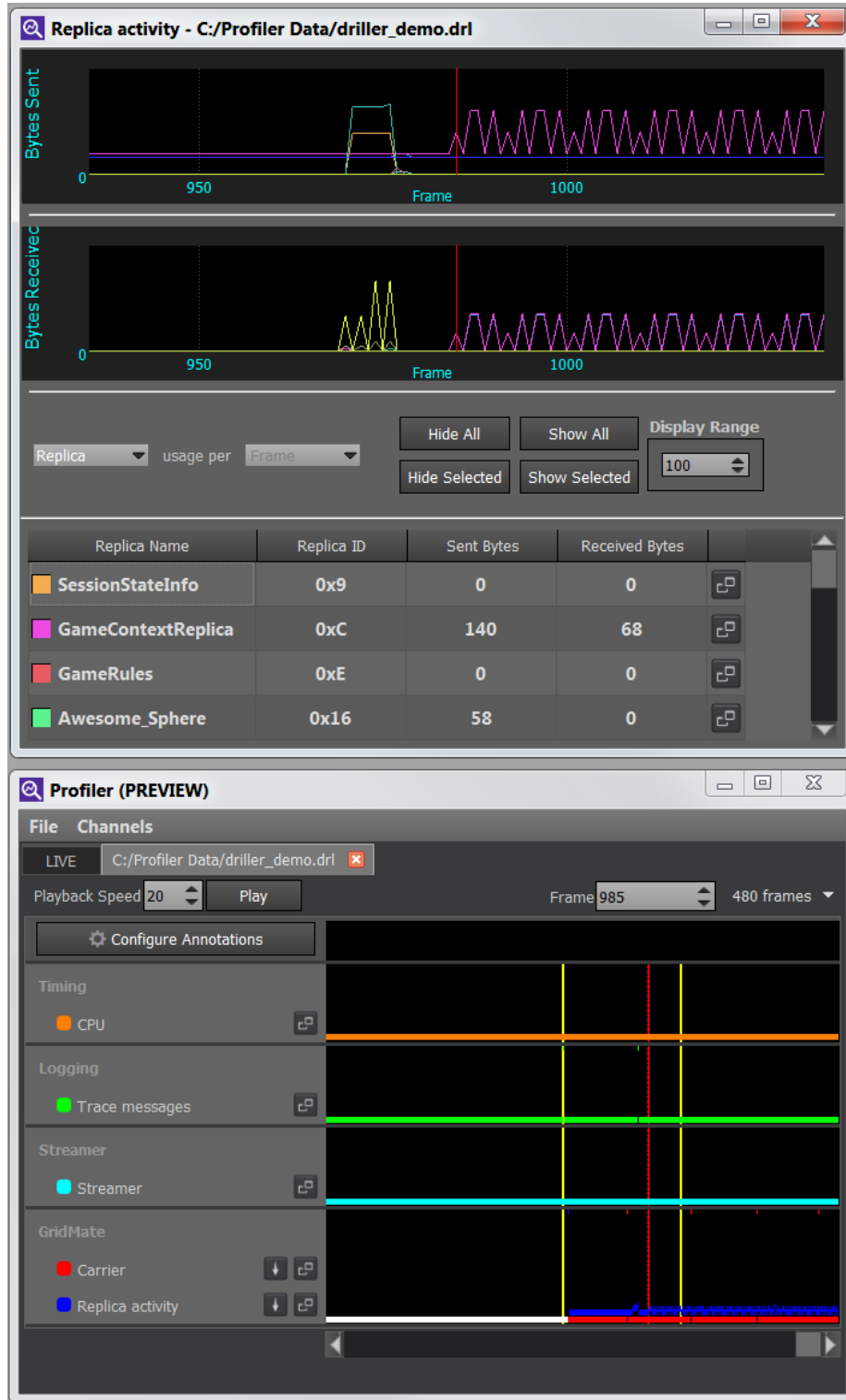

5. Click **Stop** to stop the playback.

Exporting Data

Some Profiler instances have an export option that you can use to save data to a .csv file.

To export data from a Profiler instance to a .csv file

1. Click the **Save to CSV** icon for the Profiler instance whose data you want to save:

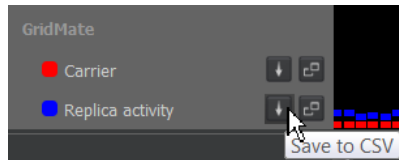

Note

Not all profilers have the data export option.

2. To choose the fields that you want to export, click **Customize** in the export dialog box.

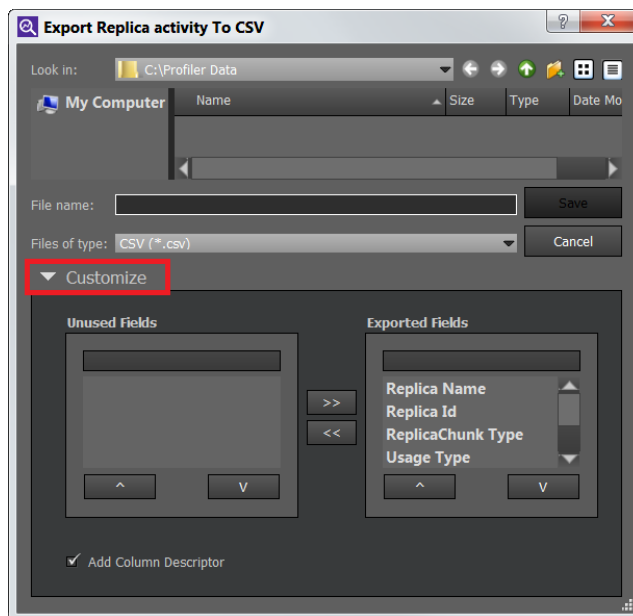

Creating and Using Annotations

Profiler is in preview release and is subject to change.

In Profiler, annotations are a convenient way of highlighting per-frame log information from the data captured from your application. After you learn how annotations are used in Profiler, you can modify your application so that they appear in Profiler.

Topics

- [Using Annotations \(p. 528\)](#)
- [Creating Annotations \(p. 529\)](#)
- [Viewing Annotations in Trace Messages Profiler \(p. 530\)](#)

Using Annotations

Annotations in the Lumberyard Profiler tool flag frames in your captured data that have associated log information. By default, annotations are turned off.

To use annotations

1. To turn on annotations in the Lumberyard Profiler tool, click **Configure Annotations**:

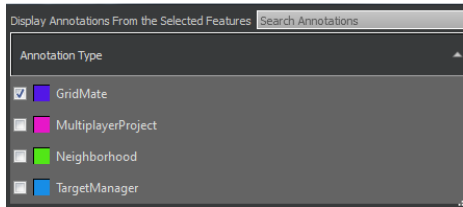
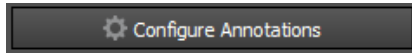

The **Configure Annotations** dialog box contains a list of available annotations and their display colors. For information on creating annotations for your application, see [Creating Annotations \(p. 529\)](#).

2. When you select an annotation in the dialog box, a marker and line of the same color appears in the channel display. Note that you might have to scroll horizontally to find the marker.

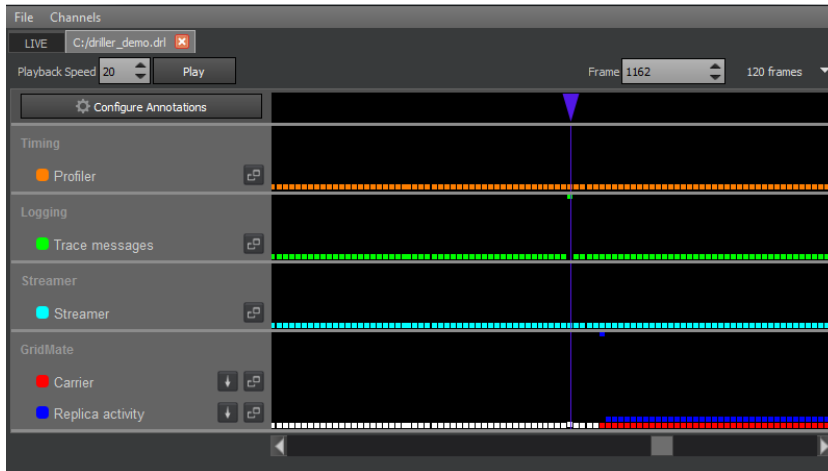

3. To display details for the annotations that occurred on a frame, pause your pointer on an annotation marker. In the example image, IP addresses have been redacted out.

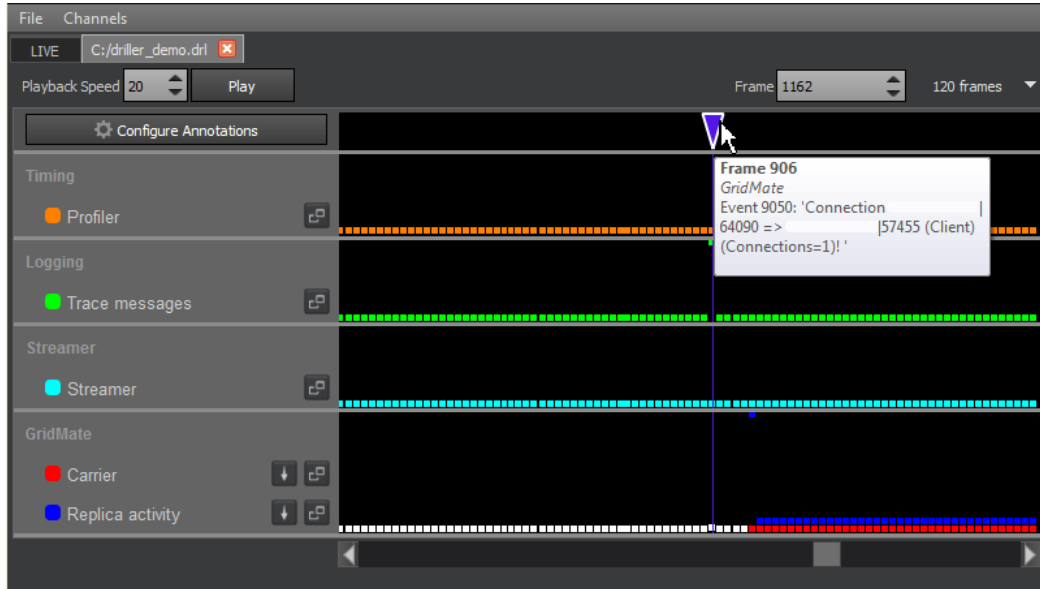

Creating Annotations

To create an annotation, you add one or more lines of C++ logging code to your application. The added code instructs Lumberyard's logging system to include the logging information that you specify as a part of your capture. Lumberyard transforms the logged messages into annotations for you. Then, in Profiler, when you click **Configure Annotations**, you actually choose which system's annotations are displayed (for example, **GridMate** or **MultiplayerProject**).

To create an annotation, place a line of C++ code like the following in your application:

```
AZ_TracePrintf("GridMate", "Connection %s => %s (%s) (Connections=%d!\n")
```

The first parameter is the window (that is, system) of the trace (in this case, *GridMate*), and the second is the content of the trace that will be shown as the annotation.

The example results in the following annotation text:

```
GridMate - Connection <IP_Address>|64090 => <IP_Address>|57455 (Client)  
(Connections=1)!
```

The text displays in Profiler like this:

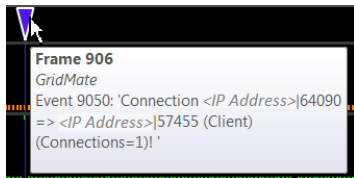

Alternatives to AZ_TracePrintf

In your code, instead of using `AZ_TracePrintf`, you can use `AZ_Error` or `AZ_Warning`, depending on the degree of severity that you want. `AZ_TracePrintf` always logs a message, but is of the lowest concern from an inspection viewpoint.

The following example uses `AZ_Error`:

```
if (networkTableContext.ReadValue(elementIndex,forcedDataSetIndex))
{
    AZ_Error("ScriptComponent",forcedDataSetIndex >= 1 && forcedDataSetIndex
<= ScriptComponentReplicaChunk::k_maxScriptableDataSets,"Trying to
force Property (%s) to an invalid DataSetIndex(%i).",scriptProperty-
>m_name.c_str(),forcedDataSetIndex);
    if (forcedDataSetIndex >= 1 && forcedDataSetIndex <=
ScriptComponentReplicaChunk::k_maxScriptableDataSets)
    {
        networkedTableValue.SetForcedDataSetIndex(forcedDataSetIndex);
    }
}
else
{
    AZ_Error("ScriptComponent",false,"Trying to force Property (%s) to
unknown DataSetIndex. Ignoring field.", scriptProperty->m_name.c_str());
}
```

In the example, if either of the error conditions occur, an annotation is created.

Viewing Annotations in Trace Messages Profiler

Another way to confirm that your annotations are in place is by using the Trace Messages profiler.

In the Profiler **Logging** channel, click the **Trace messages** profiler details icon to see the logging systems currently in place:



The **Trace messages** profiler instance shows all the trace messages that were generated from the start of the capture to the currently analyzed frame. Messages are shown with the oldest message at the top and the newest message at the bottom:

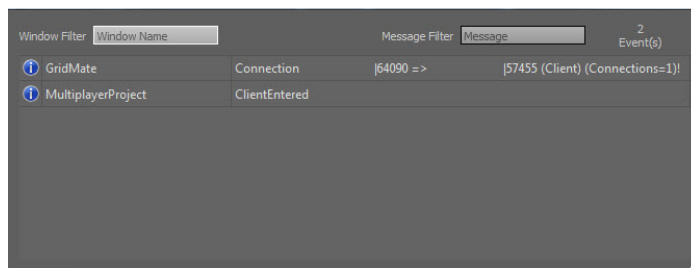

You can use the **Window Filter** to show the system and/or **Message Filter** to show the message text that you are interested in.

The following example, filtered by "GridMate", shows the message specified by the line of code that was added to the application:

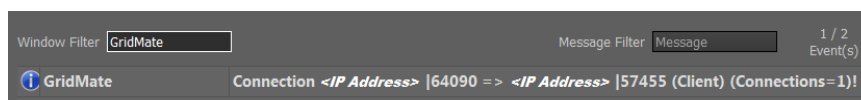

Using Profiler for Networking

Profiler is in preview release and is subject to change.

You can use the Lumberyard Profiler tool to examine how your game uses network bandwidth, including its GridMate carrier connections and replica activity. You can use network-specific profilers to drill down further into the activity of specific replica chunks, RPCs, and data sets.

Prerequisites

This topic assumes familiarity with Lumberyard networking and the Lumberyard Profiler tool. For information on Lumberyard networking, see [Networking System \(p. 461\)](#). For an introduction to the Profiler tool, see [Profiler \(p. 517\)](#).

Topics

- [Carrier Profiler \(p. 531\)](#)
- [Replica Activity Profiler \(p. 532\)](#)

Carrier Profiler

The Profiler tool has a GridMate channel with **Carrier** and **Replica activity** profiler instances. You can use the Carrier profiler detail view to examine the bandwidth usage of a selected GridMate carrier connection.

To open the detail view for the Carrier profiler

- Click the **Detailed Profiling Information** icon for **Carrier** in the GridMate channel:

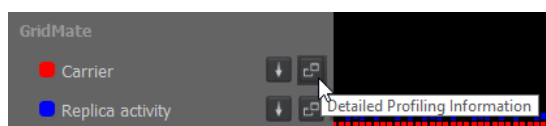

The Carrier profiler detail view resembles the following image:

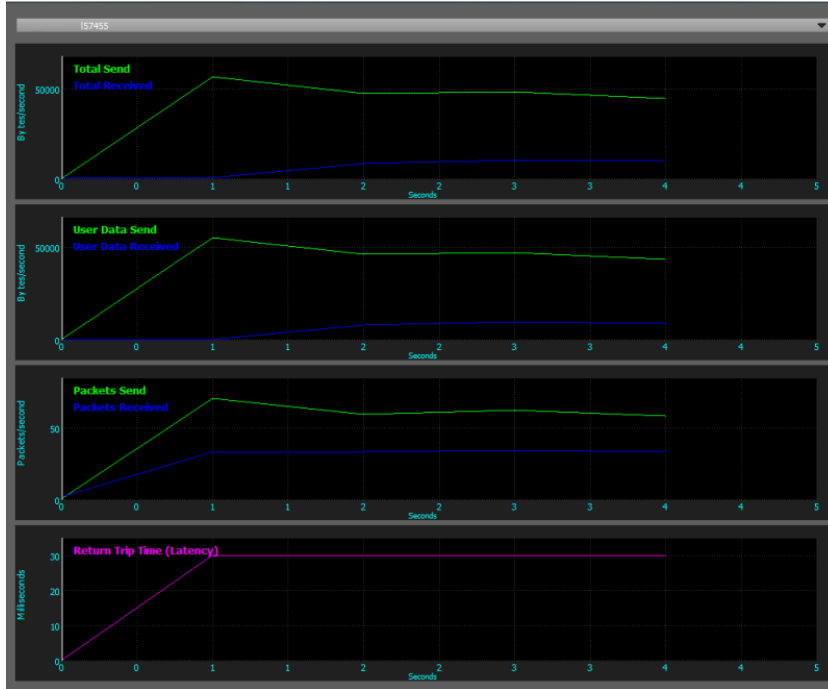

This view uses all of the data supplied in the capture session to show an overview of the bandwidth usage through the GridMate carrier for the selected connection. It includes the following information:

- **Total Sent/Total Received** – The total number of bytes sent and the total number of bytes received on the selected connection.
- **User Data Sent/User Data Received** – The user data sent and the user data received on the selected connection. This data does not include the overhead associated with carrier or connection maintenance.
- **Packets Sent/Packets Received** – The number of packets sent and the number of packets received.
- **Return Trip Time (Latency)** – How many seconds the packets took to make a return trip.

Replica Activity Profiler

You can use the Replica Activity profiler to see how much replica bandwidth your application is using.

To open the Replica Activity profiler

- Click the **Detailed Profiling Information** icon for **Replica activity**.



The Replica Activity profiler detail view has a pair of **Bytes Sent** and **Bytes Received** graphs at the top, a toolbar to control the display in the middle, and a table of replicas at the bottom:



This view is useful for discovering how much bandwidth a single entity is using, and for finding what information is synchronized in response to particular events for particular entities.

Two main detail views are available for replica activity: **Replica** and **Chunk Type**. The view defaults to **Replica**, but Profiler remembers your most recent choice and uses it the next time you view replica activity details.

Using Replica View

In replica view, the table shows how much data each replica used in a given frame.

To change the view to Replica

- In the toolbar, choose **Replica**.

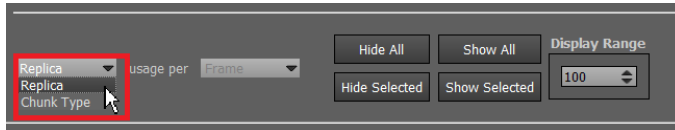

Each replica is represented by its associated color in the graphs above the toolbar. Replica view includes the following information:

- **Bytes Sent** – Shows bandwidth usage in bytes sent by the object for a particular frame.
- **Bytes Received** – Shows bandwidth usage in bytes received by the object for a particular frame.

To display or hide an individual line in the graph

- Double-click the associated row in the tree.

The toolbar also offers the following options:

- **Hide All** – Hides the line graphs of all replicas in the table.
- **Show All** – Shows the line graphs for all replicas in the table.
- **Hide Selected** and **Show Selected** – Use **Ctrl+click** to select individual replicas in the table, and then click **Hide Selected** or **Show Selected** to hide or show the graphs for the replicas that you selected.
- **Display Range** – Determines the number of frames that are shown in the graph, with the currently selected frame in the center. You can use this option to zoom in or out on the data.

To display replica chunk details for a particular replica

- Click its details icon.

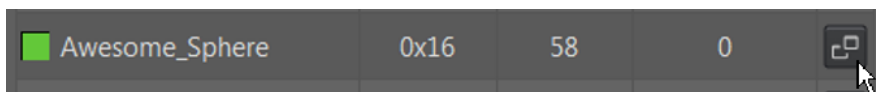

The graph shows the bytes sent and received for a replica chunk, data set, and RCP:



You can use this details view to see what replica chunk types a given replica is using, how much data each replica chunk type is using, and how much bandwidth individual data sets and RPCs are using.

Tip

Click **Expand All** to list all replica chunks in all replicas, and every data set and remote procedure call (RPC) in each replica chunk:

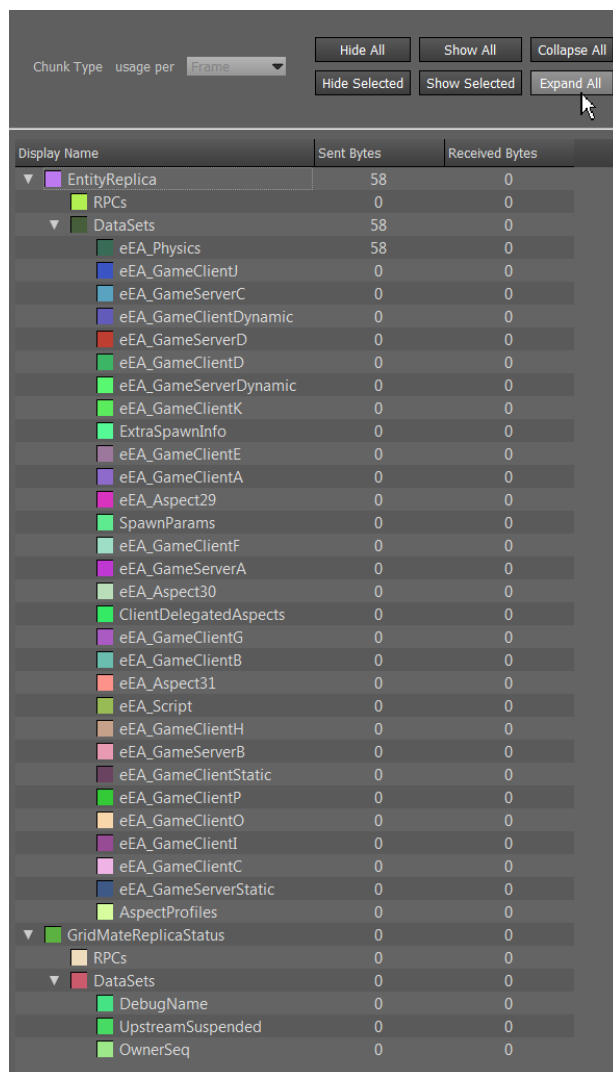

The screenshot shows the Replica Activity Profiler interface. At the top, there are controls for 'Chunk Type' (set to 'usage per frame') and buttons for 'Hide All', 'Show All', 'Collapse All', 'Hide Selected', 'Show Selected', and 'Expand All'. Below these is a table with three columns: 'Display Name', 'Sent Bytes', and 'Received Bytes'. The table lists various data sets and their byte counts. The 'EntityReplica' data set is expanded, showing a list of sub-data sets. The 'DataSets' data set is also expanded, showing a list of sub-data sets. The 'GridMateReplicaStatus' data set is expanded, showing a list of sub-data sets. The 'DataSets' data set under 'GridMateReplicaStatus' is expanded, showing a list of sub-data sets.

Display Name	Sent Bytes	Received Bytes
EntityReplica	58	0
RPCs	0	0
DataSets	58	0
eEA_Physics	58	0
eEA_GameClientJ	0	0
eEA_GameServerC	0	0
eEA_GameClientDynamic	0	0
eEA_GameServerD	0	0
eEA_GameClientD	0	0
eEA_GameServerDynamic	0	0
eEA_GameClientK	0	0
ExtraSpawnInfo	0	0
eEA_GameClientE	0	0
eEA_GameClientA	0	0
eEA_Aspect29	0	0
SpawnParams	0	0
eEA_GameClientF	0	0
eEA_GameServerA	0	0
eEA_Aspect30	0	0
ClientDelegatedAspects	0	0
eEA_GameClientG	0	0
eEA_GameClientB	0	0
eEA_Aspect31	0	0
eEA_Script	0	0
eEA_GameClientH	0	0
eEA_GameServerB	0	0
eEA_GameClientStatic	0	0
eEA_GameClientP	0	0
eEA_GameClientO	0	0
eEA_GameClientI	0	0
eEA_GameClientC	0	0
eEA_GameServerStatic	0	0
AspectProfiles	0	0
GridMateReplicaStatus	0	0
RPCs	0	0
DataSets	0	0
DebugName	0	0
UpstreamSuspended	0	0
OwnerSeq	0	0

To use the Replica Activity profiler tree view

- Do either of the following:
 - Select a row to highlight its corresponding line in the graph.
 - Double-click a row to display or hide the graph for the row.

The following information is available:

- **Display Name** – The debug name associated with the corresponding row of the table.
- **Sent Bytes** – The number of bytes sent for an item, including all information sent by children of the item.
- **Received Bytes** – The number of bytes received by an item, including all information received by children of the item.

Chunk Type View

Chunk type view shows you how much data each chunk type used in a given frame. The view is useful for seeing how much information a particular system might be using across all entities.

To change the view to Chunk Type

- In the toolbar on the main detail page for **Replica activity**, choose **Chunk Type**.

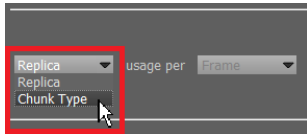

The chunk type view shows how much data a particular replica chunk type is using in a given frame:

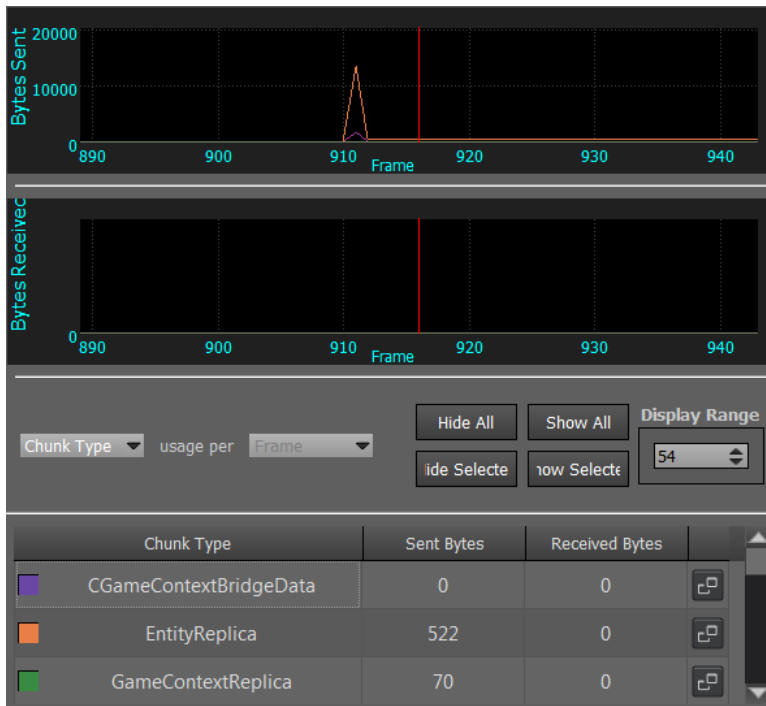

To inspect chunk type details

- Click the details icon for the chunk type:



The details window shows which replicas are using a chunk type's bandwidth, how much data they are using, and how much data the individual data sets and RPCs are using:

Lumberyard Developer Guide
 Replica Activity Profiler

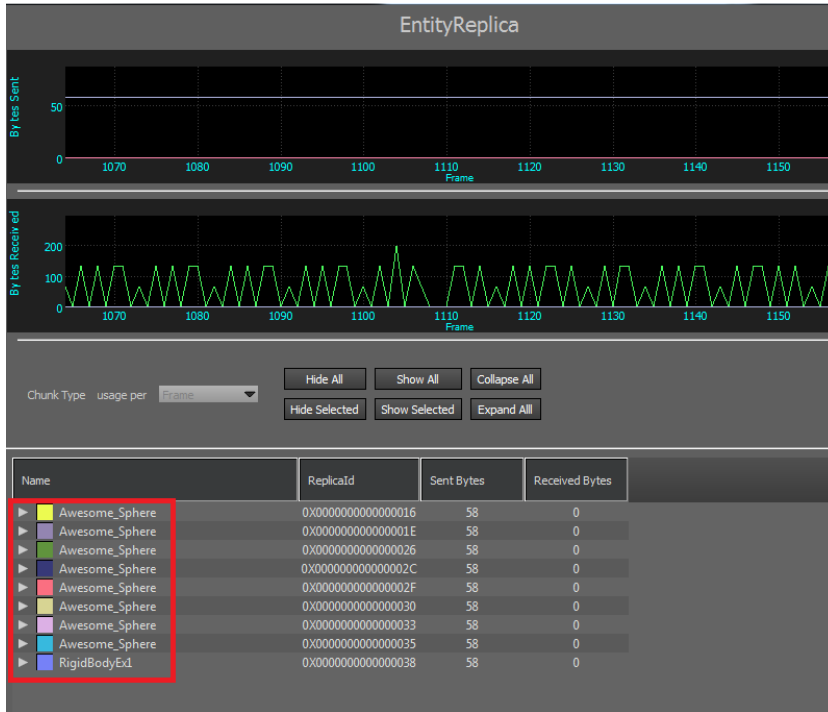

As before, you can expand the items in the tree to see detailed information about each:

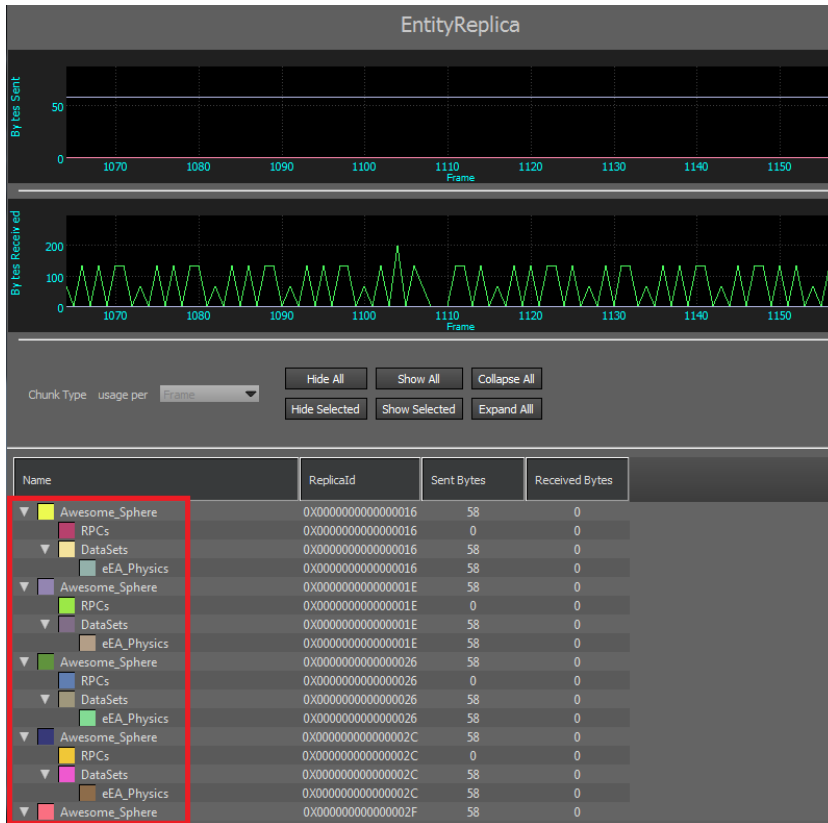

Using the Profiler for CPU Usage

Profiler is in preview release and is subject to change.

The CPU profiler gathers usage statistics about how long a function or method executed, how many times it was executed, who called it, and how much of a frame was spent on it. You can combine this information to get a systemwide view of usage, or isolate particular systems by filtering for specific threads.

To use the CPU profiler

1. To open the detail view for the CPU profiler, click the **Detailed Profiling Information** icon for the CPU profiler instance.



The CPU details view has a graph of CPU usage, a toolbar, and a tree view of calls made in a frame. Each call in the tree view has the same color as its corresponding line in the graph:

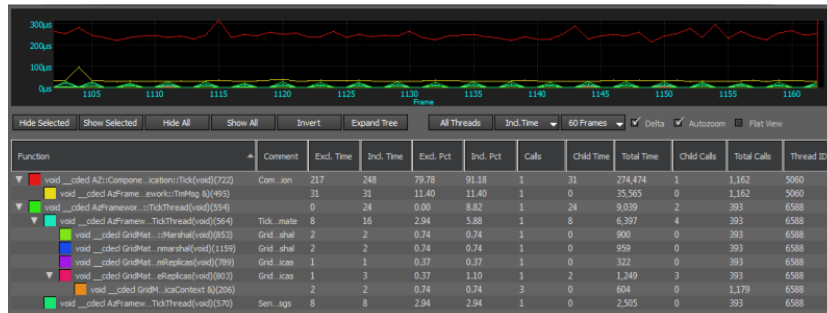

2. Pause your mouse on a line in the graph to see the call that the line represents and to display the specific value for the graph at the area near the cursor.

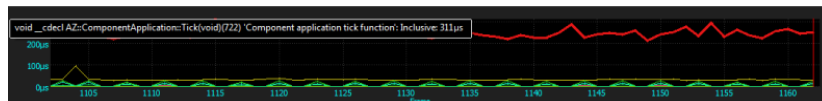

3. To show or hide the line graph of a row in the tree, double-click the row.



Understanding the Tree View

The CPU profiler tree view represents a call hierarchy of profiler log points (called *hooks*). A profiler hook that is active while another call is active shows as a child of the first hook. The hooks act as a stack: The last hook that was pushed onto the stack is the parent of the hook that was pushed onto the stack before it. The tree view has the following information:

Function

The function declaration where the profiler data point was generated.

Comment

A user-defined message that distinguishes specific events in the same function.

Excl. Time (Micro)

(Exclusive time) The time, in microseconds, spent executing this function and no other functions called by this function.

Incl. Time (Micro)

(Inclusive time) The time, in microseconds, spent executing this function and other functions called by this function.

Excl. Pct

(Exclusive percent) Exclusive time represented as a percent of total run time.

Incl. Pct

(Inclusive percent) Inclusive time represented as a percent of total run time.

Calls

The number of calls to this function.

Child Time (Micro)

The time, in microseconds, that functions that were called by this function took to execute.

Total Time (Micro)

A running total of the time, in microseconds, that was spent inside of this function.

Child Calls

How many functions this function called.

Total Calls

The running total of how many times this function was called.

Thread ID

The thread on which this function was executed

Controlling the Display

You can use the toolbar to control how the captured CPU data is displayed:

**Hide Selected**

Hide the graph of the rows selected in tree view.

Show Selected

Show the graph of the rows selected in tree view.

Hide All

Hides the graph of all rows in the tree view.

Show All

Shows the graphs of all rows in the tree view.

Invert

Shows graphs for all rows in the tree view that are hidden; hides the graphs of all rows in the tree view that are showing.

Expand Tree

Expands all rows in the tree view hierarchy.

The right side of the toolbar offers more options:

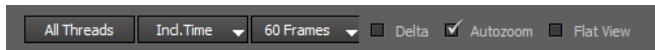

All Threads

Use the thread selector to control which threads are shown in the tree view and in the graph:

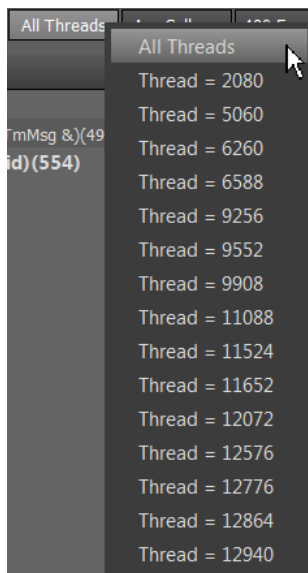

Incl. Time

Use this selector to choose the meaning of the time displayed.

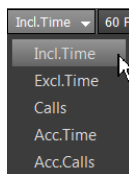

- **Incl. Time** – (Inclusive time) The time spent in this function inclusively.
- **Excl. Time** – (Exclusive time) The time spent in this function exclusively.
- **Calls** – The number of times this function was called in the frame.
- **Acc. Time** – (Accumulated time) The total amount of time spent in this function up to the frame being analyzed.
- **Acc. Calls** – (Accumulated calls) – The total number of times this function was called up to the frame being analyzed.

<number> Frames

Use this selector to choose how frames of history are displayed in the graph:

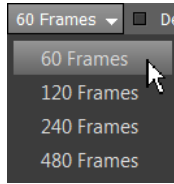

Delta

Unused option.

Autozoom

When selected, maintains the approximate zoom level (number of frames displayed) whenever the graph changes.

Flat View

Flattens the tree of function calls (removes the hierarchical indentation), as in the following image:

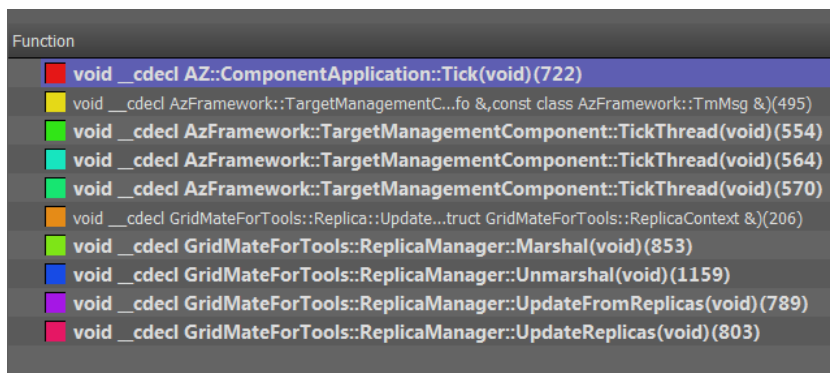

Using Profiler for VRAM

Profiler is in preview release and is subject to change.

You can use the video memory profiler (VRAM profiler) to determine which resources are contributing most to run-time VRAM usage in your game.

The VRAM profiler records the amount of video memory used by a game, including how many memory deallocations and allocations occurred during the capture. This latter information is useful in tracking down rendering performance bottlenecks.

You can also use the memory usage information from VRAM profiler to determine your game's minimum PC GPU (graphics processing unit) memory requirements, or to determine whether your game will run out of memory on a console or mobile device.

Topics

- [Notes \(p. 542\)](#)
- [Understanding the Captured Data \(p. 543\)](#)
- [Inspecting the Data \(p. 543\)](#)

Notes

The VRAM profiler has the following attributes:

- The VRAM profiler has no graph view or tree view.
- The only supported export format is `.csv`. For steps on saving Profiler data to a `.csv` file, see [Exporting Data](#).
- Lumberyard uses a variety of memory pooling schemes, so the actual allocated amount of VRAM is slightly more than what is reported.

Understanding the Captured Data

The following image shows how your saved `.csv` file appears in a spreadsheet application:

	A	B	C
1	Category	Number of Allocations	Memory Usage
2	Texture	449	440542078
3	Buffer	1034	14778088
4			
5	Resource Name	VRAM Allocation Size	
6	\$RT_ShadowPool	67108864	
7	CachedShadowMap_0	35515592	
8	\$AutoDownload_4	16777216	
9	\$AutoDownload_3	16777216	
10	\$AutoDownload_5	16777216	
11	HeightMapAO_Depth_1	11184800	
12	HeightMapAO_Depth_0	8388608	

The captured data contains essentially two tables of information: an overview of memory allocation and usage (divided between texture and buffer assets), and a list of resources with the amount of VRAM that was allocated for each during the capture.

Detailed information about each heading follows.

Category

Indicates the type of allocation:

- **Texture** – Includes texture assets, dynamically generated textures, and frame buffers.
- **Buffer** – Includes vertex and index buffers, constant buffers, and other run-time buffers.

Number of Allocations

The number of allocation events recorded. When the capture starts, all active allocations are sent to the profiler as a starting number. Any new allocations or deallocations will increase or decrease this number.

Memory Usage

The total size, in bytes, of VRAM used.

Resource Name

The name and full path of the allocated resource. A resource name without a path usually denotes a run-time engine resource.

VRAM Allocation Size

The size, in bytes, of the allocation.

Inspecting the Data

When you first open the spreadsheet, the data is unordered. To sort the data, you can use a spreadsheet application:

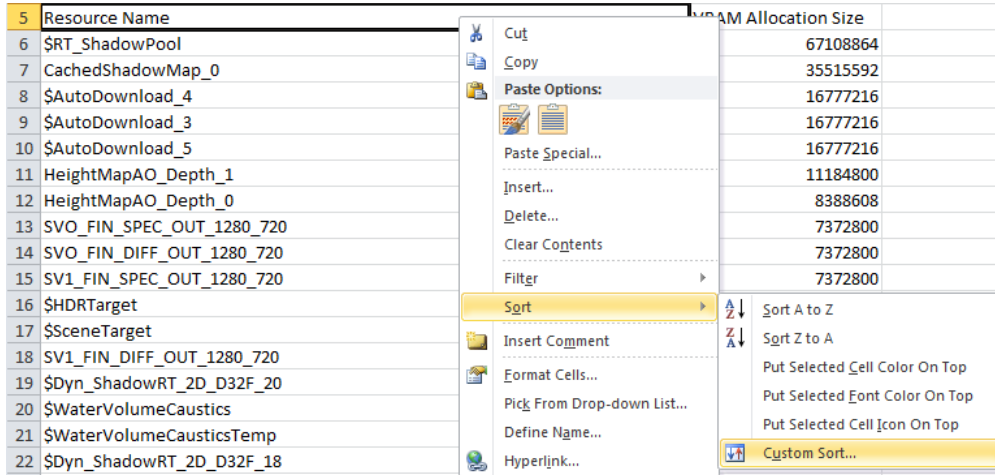

To quickly and easily identify the largest offending assets or run-time resources, sort by **VRAM Allocation Size** in descending order, or by **Resource Name** from A to Z:

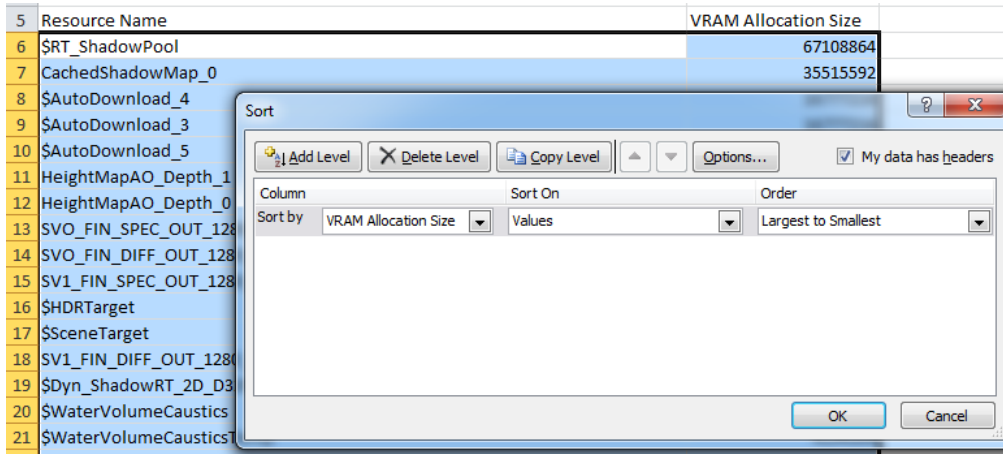

Negative VRAM Allocation Sizes

Some fields may have a negative number for **VRAM Allocation Size**, as in the following image:

1489 ConstantBuffer	-256
---------------------	------

These important occurrences show that a VRAM deallocation event occurred during the capture. If you observe a large number of deallocation entries over a short time period, your game might be experiencing a significance decrease in performance. To improve your game's performance across all platforms, you should aim to have as few idle per-frame VRAM allocations and deallocations as possible.

Why Some Textures Are Not Reported in the .csv File

If you see a lot of allocations named `StreamingTexturePool` or entries like `$TexturePool_9_0000000002C59248`, this means the texture streaming system is active. The texture streaming system allocates all textures by default into a variety of cached texture pools. The VRAM profiler reports the size of the active streaming pools and not the names of the actual texture assets. To obtain the names and sizes of the allocated and loaded textures, set

`r_TexturesStreaming=0` in your system configuration file, and then do another capture. This setting disables the texture streaming system and causes the true sizes of the texture allocations to be reported.

Note

In this situation, it is advisable to do two captures: one with `r_TexturesStreaming` enabled, and one with it disabled. When texture streaming is enabled, your VRAM usage is less because of texture eviction and the loading of lower resolution mipmap levels. The memory reporting is more accurate when texture streaming is enabled, but you get a much clearer view of your worst-case memory usage when texture streaming is disabled.

Using GridHub

GridHub is in preview release and is subject to change.

GridHub is Lumberyard's connection hub for debugging. GridHub acts as a central hub through which specified local clients connect with each other and exchange information. When you run the Lumberyard diagnostic and debugging tools `Profiler.exe` or `LuaIDE.exe` (located in the `\dev\Bin64` directory), GridHub launches as a background process in Windows and enables their functionality. For more information about `Profiler`, see [Profiler \(p. 517\)](#).

Note

Because GridHub listens for connections on the loopback address (`127.0.0.1`), you must run GridHub on the same computer as the target application.

Topics

- [Registering an Application in GridHub \(p. 545\)](#)
- [Viewing and Configuring GridHub \(p. 545\)](#)
- [Troubleshooting GridHub \(p. 547\)](#)

Registering an Application in GridHub

To register an application in GridHub so that `Profiler` can capture information from the application, add `AzFramework::TargetManagementComponent` to the application's `SystemComponent`.

Note

Lumberyard's built-in applications already have this component added by default.

Viewing and Configuring GridHub

When you launch `Profiler.exe` or `LuaIDE.exe`, GridHub starts automatically and is represented by a globe icon in the Windows taskbar.

To view and configure GridHub

1. In the Windows taskbar, right-click the globe icon and choose **Show**:

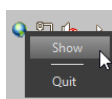

The GridHub window has a configuration bar, a connections pane, and pane for viewing log messages:

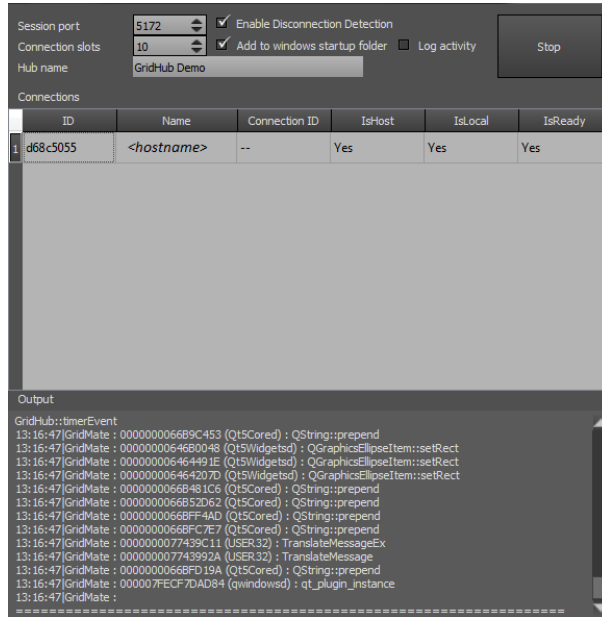

2. You can use the configuration toolbar to view or change GridHub configuration:

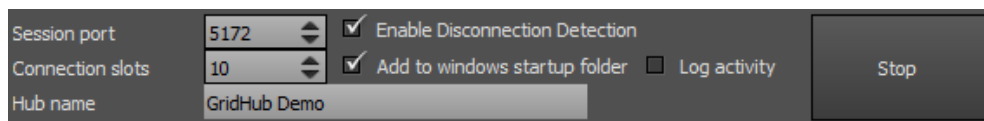

The toolbar options are as follows:

Session port – Specifies the port on which GridHub listens for discovery requests.

Connection slots – Specifies the maximum number of applications that can be connected concurrently to GridHub.

Hub name – The name of your hub. By default, this is the name of the local computer.

Note

The name of the hub must be the neighborhood name to which the TargetManagementComponent connects.

Enable Disconnection Detection – Specifies whether the connection to GridHub is terminated when the source fails to respond.

Add to Windows startup folder – Specifies whether GridHub starts automatically when Windows starts.

Log activity – Starts or stops logging.

Start/Stop – Starts or stops GridHub. When GridHub is off, no connections are discovered or maintained.

3. When GridHub and your target application are active, your target application appears in the GridHub **Connections** list:

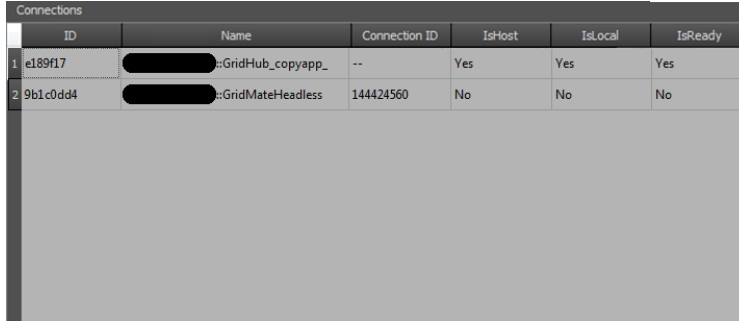

ID	Name	Connection ID	IsHost	IsLocal	IsReady
1 e189f17	[redacted]:GridHub_copyapp_	--	Yes	Yes	Yes
2 9b1c0dd4	[redacted]:GridMateHeadless	144424560	No	No	No

The columns in the **Connections** list provide the following information:

ID – The identifier of the connected application.

Name – The name of the connected application.

Connection ID – The identifier of the connection between GridHub and the application.

IsHost – Whether or not the connection is the connection host

IsLocal – Whether or not the connection is local.

IsReady – Whether or not the application is ready to handle further connections.

4. Use the **Output** window to see the log messages that GridHub generates as it manages connections:

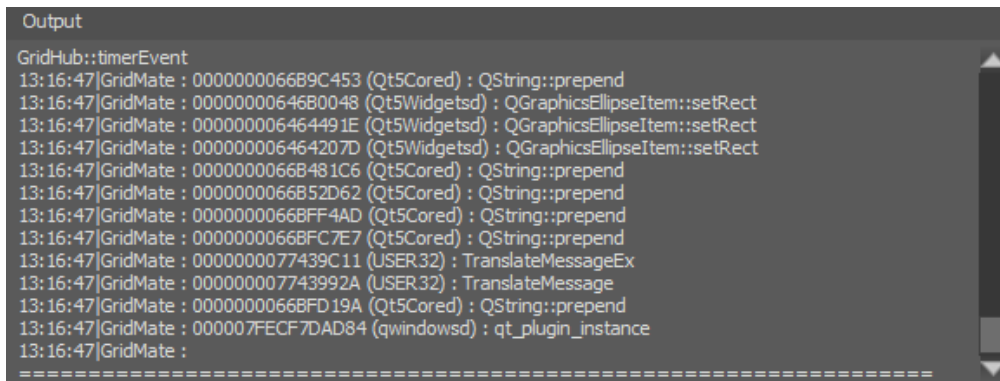

```
Output
GridHub::timerEvent
13:16:47|GridMate : 000000006689C453 (Qt5Cored) : QString::prepend
13:16:47|GridMate : 00000000646B0048 (Qt5Widgets) : QGraphicsEllipseItem::setRect
13:16:47|GridMate : 000000006464491E (Qt5Widgets) : QGraphicsEllipseItem::setRect
13:16:47|GridMate : 000000006464207D (Qt5Widgets) : QGraphicsEllipseItem::setRect
13:16:47|GridMate : 00000000668481C6 (Qt5Cored) : QString::prepend
13:16:47|GridMate : 0000000066852D62 (Qt5Cored) : QString::prepend
13:16:47|GridMate : 00000000668FF4AD (Qt5Cored) : QString::prepend
13:16:47|GridMate : 00000000668FC7E7 (Qt5Cored) : QString::prepend
13:16:47|GridMate : 0000000077439C11 (USER.32) : TranslateMessageEx
13:16:47|GridMate : 000000007743992A (USER.32) : TranslateMessage
13:16:47|GridMate : 00000000668FD19A (Qt5Cored) : QString::prepend
13:16:47|GridMate : 000007FECF7DAD84 (qwindowsd) : qt_plugin_instance
13:16:47|GridMate :
=====
```

When GridHub is terminated, the connections it established are also terminated.

Troubleshooting GridHub

If you experience difficulty using GridHub, check the following:

- Make sure that the neighborhood name in `TargetManagerComponent` is the same as the one in GridHub.
- Make sure that the port that GridHub is listening on is the same port as the one specified for `TargetManagementComponent`.
- Make sure that all applications are running on the same computer. The GridHub socket is bound to the loopback address `127.0.0.1`.

ScriptBind Reference

You can use `ScriptBind` functions in Lua scripts to call existing code written in C++. For more information, see [Lua Script Usage](#) (p. 449).

Topics

- [ScriptBind Engine Functions](#) (p. 548)
- [ScriptBind Action Functions](#) (p. 710)
- [ScriptBind_Boids](#) (p. 756)

ScriptBind Engine Functions

Lists C++ engine functions that you can call from Lua script.

Topics

- [ScriptBind_AI](#) (p. 548)
- [ScriptBind_Entity](#) (p. 617)
- [ScriptBind_Movie](#) (p. 672)
- [ScriptBind_Particle](#) (p. 673)
- [ScriptBind_Physics](#) (p. 676)
- [ScriptBind_Script](#) (p. 679)
- [ScriptBind_Sound](#) (p. 682)
- [ScriptBind_System](#) (p. 683)

ScriptBind_AI

Lists C++ AI functions that can be called from Lua scripts.

AbortAction

Aborts execution of a specified action.

Syntax

```
AI.AbortAction(userId [, actionId ])
```

Parameter	Description
userId	The ID of the entity.
actionId (optional)	Unique ID of the action to be aborted. If 0 (or nil), all actions on the specified entity are aborted.

AddAggressiveTarget

Adds a target to a specified entity's list as an aggressive potential target.

Syntax

```
AI.AddAggressiveTarget(entityId, targetId)
```

Returns True if successfully added.

Parameter	Description
entityId	The ID of the entity.
targetId	Target's entity ID to add.

AddCombatClass

Creates new combat class.

Syntax

```
AI.AddCombatClass(int combatClass, SmartScriptTable pTable, const char* szCustomSignal)
```

Parameter	Description
combatClass	Combat class to add.
pTable	Parameters table.
szCustomSignal	Specifies optional custom OnSeen signal.

AddFormationPoint

Adds a follow-type node to a formation descriptor.

Syntax

```
AI.AddFormationPoint(name, sightangle, distance, offset, [unit_class [,distanceAlt, offsetAlt]])
```

Parameter	Description
name	Name of the formation descriptor.
sightangle	Angle of sight of the node (-180,180; 0 = the entity looks forward).
distance	Distance from the formation's owner.
offset	Offset along the following line (negative = left, positive = right).
unit_class	Class of soldier (see <code>eSoldierClass</code> definition in <code>IAgent.h</code>). DistanceAlt (optional): alternative distance from the formation owner offsetAlt (optional): alternative offset.

AddFormationPointFixed

Adds a node with a fixed offset to a formation descriptor.

Syntax

```
AI.AddFormationPointFixed(name, sightangle, x, y, z [,unit_class])
```

Parameter	Description
name	Name of the formation descriptor.
sightangle	Angle of sight of the node (-180,180; 0 = the entity looks forward).
x, y, z	Offset from formation owner.
unit_class	Class of soldier (see <code>eSoldierClass</code> definition in <code>IAgent.h</code>).

AddPatternBranch

Creates a branch pattern at the specified node. When the entity has approached the specified node (nodeName) and it is time to choose a new point, the rules defined by this function are used to select the new point. This function can associate multiple target points and an evaluation rule.

Syntax

```
AI.AddPatternBranch(nodeName, method, branchNode1, branchNode2, ...,  
branchNodeN)
```

Parameter	Description
nodeName	Name of the node to add branches to.
method	Method used to choose the next node. Valid values include: <ul style="list-style-type: none"> <code>AITRACKPAT_CHOOSE_ALWAYS</code> – Choose the next point from the list in linear sequence.

Parameter	Description
	<ul style="list-style-type: none"> • AITRACKPAT_CHOOSE_LESS_DEFORMED – Choose the least deformed point in the list. Each node is associated with a deformation value (percentage), which describes how much it must move in order to stay within the physical world. These deformation values are summed down to the parent nodes so that deformation at the end of the hierarchy will be caught down the hierarchy. • AITRACKPAT_CHOOSE_RANDOM – Choose a point in the list randomly.

AddPatternNode

Adds a point to the track pattern.

When validating the points, the test is performed from the start position to the end position. Start position is either the pattern origin or, if the parent is provided, the parent position. The end position is either the relative offset from the start position or from the pattern origin; this position is chosen based on the node flag. The offset is clamped to the physical world based on the test method. The points will be evaluated in the same order they are added to the descriptor, and the system does not try to correct the evaluation order. If hierarchies are used (parent name is defined), it is up to the pattern creator to make sure the nodes are created in such an order that the parent is added before it is referenced.

Syntax

```
AI.AddPatternNode(nodeName, offsetx, offsety, offsetz, flags, [parent], [signalValue])
```

Parameter	Description
nodeName	Name of the new point. , Point names are local to the current pattern.
offsetx, offsety, offsetz	Offset from the start position or from the pattern center. See AITRACKPAT_NODE_ABSOLUTE.
flags	<p>Track pattern functionality flags.</p> <p>Node evaluation flags:</p> <ul style="list-style-type: none"> • AITRACKPAT_NODE_START – Node can be used as the first node in the pattern. There can be multiple start nodes. In that case the closest one is chosen. • AITRACKPAT_NODE_ABSOLUTE – Interpret offset as an offset from the pattern center (otherwise the offset is from the start position). • AITRACKPAT_NODE_SIGNAL – A signal "OnReachedTrackPatternNode" will be sent when the node is reached. • AITRACKPAT_NODE_STOP – Advancing will be stopped. It can be continued by calling <code>entity:ChangeAIParameter(AIPARAM_TRACKPATTERN_ADVANCE, 1)</code>. • AITRACKPAT_NODE_DIRBRANCH – For the direction at each pattern node, use the average direction to the branch nodes (otherwise use the direction from the node position to the center of the pattern).
parent (optional)	Parent node position, which will be used as the start position instead of the pattern center.

Parameter	Description
signalValue (optional)	If the signal flag is set, this value is passed as a signal parameter, accessible from the signal handler in <code>data.iValue</code> .

AddPersonallyHostile

Syntax

```
AI.AddPersonallyHostile(ScriptHandle entityID, ScriptHandle hostileID)
```

AgentLookAtPos

Causes the specified entity to look at a certain position.

Syntax

```
AI.AgentLookAtPos(entityId, Vec3 pos)
```

Parameter	Description
entityId	The ID of the entity.
pos	Vec3 to look at.

AllowLowerBodyToTurn

Syntax

```
AI.AllowLowerBodyToTurn(entityID, bAllowLowerBodyToTurn)
```

Parameter	Description
entityId	Entity ID of the agent you want to set the look style to.
bAllowLowerBodyToTurn	True if you want to allow the turning movement of the body, false otherwise.

BeginTrackPattern

Begins the definition of a new track pattern descriptor. The pattern is created by calling `AI.AddPatternPoint()` and `AI.AddPatternBranch()`, and finalized by calling `AI.EndTrackPattern()`.

Syntax

```
AI.BeginTrackPattern(patternName, flags, validationRadius,  
[stateTresholdMin],
```

Parameter	Description
patternName	Name of the new track pattern descriptor.
flags	<p>Track pattern functionality flags.</p> <p>Validation flags describe how the pattern is validated to fit the physical world:</p> <ul style="list-style-type: none"> • <code>AITRACKPAT_VALIDATE_NONE</code> – No validation. • <code>AITRACKPAT_VALIDATE_SWEPTSPHERE</code> – Validate using swept sphere tests, where the sphere radius equals the validation radius plus the entity pass radius. • <code>AITRACKPAT_VALIDATE_RAYCAST</code> – Validate using raycasting, where the hit position is pulled back by the amount of validation radius plus the entity pass radius. <p>Alignment flags describe how, when the pattern is selected to be used, the alignment of the pattern can be changed. Flags are evaluated in the following order:</p> <ul style="list-style-type: none"> • <code>AITRACKPAT_ALIGN_TO_TARGET</code> – Align the pattern so that the y-axis points towards the target each time it is set. If the agent does not have a valid attention target at the time, the pattern is aligned to the world. • <code>AITRACKPAT_ALIGN_RANDOM</code> – Align the pattern randomly each time it is set. The rotation ranges are set using <code>SetRandomRotation()</code>.
validationRadius	Validation radius is added to the entity pass radius when validating the pattern along the offsets.
stateTresholdMin (optional)	If the state of the pattern is 'enclosed' (high deformation) and the global deformation < stateTresholdMin, the state becomes exposed. Default 0.35.
stateTresholdMax (optional)	If the state of the pattern is 'exposed' (low deformation) and the global deformation > stateTresholdMax, the state becomes enclosed. Default 0.4.
globalDeformTreshold (optional)	Deformation of the whole pattern is tracked in range [0..1]. This treshold value can be used to clamp the bottom range, so that values in range [trhd..1] becomes [0..1], default 0.0.
localDeformTreshold (optional)	Deformation of the each node is tracked in range [0..1]. This treshold value can be used to clamp the bottom range, so that values in range [trhd..1] becomes [0..1], default 0.0.
exposureMod (optional)	Importance of the node exposure (how much it is seen by the tracked target) to consider when branching. Valid range is [-1..1], where -1 means to favor unseen nodes and 1 means to favor seen, exposed nodes. Default is 0 (no effect).
randomRotAng (optional)	Flag indicating whether or not to randomly rotate the pattern each time it is set. Rotation is performed in XYZ order. This parameter defines angles (in degrees) around each axis.

CanFireInStance

Syntax

```
AI.CanFireInStance(entityId, stance)
```

Returns true if AI can fire at his target in the specified stance at his current position

Parameter	Description
entityId	The ID of the entity.
stance.	Stance Id (STANCE_*).

CanMelee

Determines whether or not the AI is able to do melee attack.

Syntax

```
AI.CanMelee(entityId)
```

Returns True or false (1 or 0).

Parameter	Description
entityId	The ID of the entity.

CanMoveStraightToPoint

Determines whether or not a specified entity can move in a straight line from its current position to a specified point.

Syntax

```
AI.CanMoveStraightToPoint(entityId, position)
```

Parameter	Description
entityId	The ID of the entity.
position	Position to check path to.

ChangeFormation

Changes the formation descriptor for the current formation of a specified entity's group (if one exists).

Syntax

```
AI.ChangeFormation(entityId, name [,scale])
```

Returns True if the formation change was successful.

Parameter	Description
entityId	Unique entity ID used to identify the group.
name	Name of the formation descriptor.
scale (optional)	Scale factor for the formation (1 = default).

ChangeMovementAbility

Changes the value of an AI movement ability parameter for the entity specified.

Syntax

```
AI.ChangeMovementAbility(entityId, paramEnum, paramValue)
```

Parameter	Description
entityId	The ID of the entity.
paramEnum	Index of the parameter to change. Valid values include: <ul style="list-style-type: none">• <code>AIMOVEABILITY_OPTIMALFLIGHTHEIGHT</code> – Optimal flight height in meters while finding path.• <code>AIMOVEABILITY_MINFLIGHTHEIGHT</code> – Minimum flight height in meters while finding path.• <code>AIMOVEABILITY_MAXFLIGHTHEIGHT</code> – Maximum flight height in meters while finding path.
paramValue	New value for the specified parameter.

ChangeParameter

Updates a parameter value for a specified entity.

Syntax

```
AI.ChangeParameter(entityId, paramEnum, paramValue)
```

Parameter	Description
entityId	The ID of the entity.
paramEnum	The enum of the parameter.
paramValue	The new value for the specified parameter.

CheckForFriendlyAgentsAroundPoint

Syntax

```
AI.CheckForFriendlyAgentsAroundPoint(ScriptHandle entityID, Vec3 point, float radius)
```

CheckMeleeDamage

Determines whether or not the AI performing melee is actually hitting target.

Syntax

```
AI.CheckMeleeDamage(entityId, targetId, radius, minheight, maxheight, angle)
```

Returns (distance,angle) pair between entity and target (degrees) if melee is possible, nil otherwise

Parameter	Description
entityId	The ID of the entity.
targetId	Target's entity ID.
radius.	max distance in 2d to target.
minheight.	min distance in height.
maxheight.	max distance in height.
angle.	FOV to include target.

ClearAnimationTag

Syntax

```
AI.ClearAnimationTag(ScriptHandle entityID, const char* tagName)
```

Parameter	Description
entityId	AI's entity.
tagName.	.

ClearMovementContext

Resets the specified entity's movement context.

Syntax

```
AI.ClearMovementContext(entityId)
```

Parameter	Description
entityId	The ID of the entity.

Parameter	Description
context.	context value.

ClearPotentialTargets

Clears all the potential targets from a specified entity's perception handler.

Syntax

```
AI.ClearPotentialTargets(entityId)
```

Parameter	Description
entityId	The ID of the entity.

ClearTempTarget

Removes the specified entity's temporary potential target so that it is no longer considered for target selection.

Syntax

```
AI.ClearTempTarget(entityId)
```

Returns True if successfully updated.

Parameter	Description
entityId	The ID of the entity.

ConstrainPointInsideGenericShape

Syntax

```
AI.ConstrainPointInsideGenericShape(position, shapeName[, checkHeight])
```

Returns Nearest point inside the specified shape.

Parameter	Description
position	Position to check.
shapeName	Name of the shape to test (returned by <code>AI.GetEnclosingGenericShapeOfType</code>).
checkHeight (optional)	Flag indicating whether or not to test for shape height. (default=false). If set to true, the test will check the space between <code>shape.aabb.min.z</code> and <code>shape.aabb.min.z+shape.height</code> .

CreateFormation

Creates a formation descriptor and adds a fixed node at 0,0,0 (owner's node).

Syntax

```
AI.CreateFormation(name)
```

Parameter	Description
name	Name of the new formation descriptor.

CreateGroupFormation

Creates a group formation with leader (or updates leader).

Syntax

```
AI.CreateGroupFormation(entityId, leaderId)
```

Parameter	Description
entityId	AI's entity.
leaderId.	New leader.

CreateStimulusEvent

Creates a target track stimulus event for the specified entity.

Syntax

```
AI.CreateStimulusEvent(ScriptHandle ownerId, ScriptHandle targetId, const char* stimulusName, SmartScriptTable pData)
```

Parameter	Description
ownerId	Unique ID of the entity that owns and receives the event.
targetId	Unique ID of the entity that sends the event and becomes the target.
stimulusName	Name of the stimulus event.
pData	Event data (see <code>TargetTrackHelpers::SStimulusEvent</code>).

CreateTempGenericShapeBox

Creates a temporary box-shaped generic shape. This temporary shape will be destroyed upon an AI system reset.

Syntax

```
AI.CreateTempGenericShapeBox(Vec3 center, float radius, float height, int type)
```

Returns Shape name.

Parameter	Description
center.	Center point of the box.
radius.	Size of the box in x and y directions.
height	Height of the box.
type	Box shape type (AIAnchor).

DebugReportHitDamage

Creates a debug report for the hit damage.

Syntax

```
AI.DebugReportHitDamage(pVictimEntity, pShooterEntity)
```

Parameter	Description
pVictimEntity.	Victim ID.
pShooterEntity.	Shooter ID.

DestroyAllTPSQueries

Destroys all the tactical point system queries.

Syntax

```
AI2.DestroyAllTPSQueries()
```

DistanceToGenericShape

Syntax

```
AI.DistanceToGenericShape(Vec3 position, const char* shapeName[, int checkHeight])
```

Returns True if the point is inside the specified shape.

Parameter	Description
position	Position to check.

Parameter	Description
shapeName	Name of the shape to test (returned by <code>AI.GetEnclosingGenericShapeOfType</code>).
checkHeight (optional)	Flag indicating whether or not to test for shape height. (default=false). If set to true, the test will check the space between <code>shape.aabb.min.z</code> and <code>shape.aabb.min.z+shape.height</code> .

DropTarget

Clears the target from a specified entity's perception handler.

Syntax

```
AI.DropTarget(entityId, targetId)
```

Parameter	Description
entityId	The ID of the entity.
targetId	Target's entity ID.

EnableCoverFire

Enables or disables fire when the `FIREMODE_COVER` is selected.

Syntax

```
AI.EnableCoverFire(entityId, enable)
```

Parameter	Description
entityId	The ID of the entity.
enable	Boolean.

EnableFire

Enables or disables fire.

Syntax

```
AI.EnableFire(entityId, enable)
```

Parameter	Description
entityId	The ID of the entity.
enable	Boolean.

EnableUpdateLookTarget

Syntax

```
AI.EnableUpdateLookTarget(ScriptHandle entityID, bool bEnable)
```

EnableWeaponAccessory

Enables or disables certain weapon accessory usage.

Syntax

```
AI.EnableWeaponAccessory(entityId, int accessory, bool state)
```

Parameter	Description
entityId	The ID of the entity.
accessory	Enum of the accessory to enable. Possible values (see enum <code>EAIWeaponAccessories</code> in the <code>IAgent.h</code> file): <pre>AIWEPA_NONE = 0, AIWEPA_LASER = 0x0001 AIWEPA_COMBAT_LIGHT = 0x0002 AIWEPA_PATROL_LIGHT = 0x0004</pre>
state	Set to true or false to enable or disable.

EndTrackPattern

Finalizes the track pattern definition. This function should always called to finalize the pattern. Failing to do so will cause erratic behavior.

Syntax

```
AI.EndTrackPattern()
```

Error

The fallback error message used when the system experiences an unhandled exception. The code following should continue if it is running in the editor so that the original cause of the problem can be fixed, but halt execution when it is running in the game.

Syntax

```
AI.Error(szMessage)
```

Parameter	Description
szMessage	The message to write to the log.

EvalPeek

Determines whether or not specified entity can peek from its current position.

Syntax

```
AI.EvalPeek(entityId [, bGetOptimalSide])
```

Returns One of the following values:

- -1 – don't need to peek
- 0 – cannot peek
- 1 – can peek from left
- 2 – can peek from right
- 3 – can peek from left & right

Parameter	Description
entityId	The ID of the entity.
bGetOptimalSide (optional)	Flag indicating whether or not to return the side that best fits the attention target's current location, if the AI object can peek from both sides. The default is false.

ExecuteAction

Executes an action on a set of participants.

Syntax

```
AI.ExecuteAction(action, participant1 [, participant2 [, ... ,  
participantN ] ])
```

Parameter	Description
action	The smart object action name or ID.
participant1	The entity ID of the first participant in the action.
participant2..N (optional)	The entity ID of additional participants.

FindObjectOfType

Searches for the closest AIObject of a specified type in an area around a specified entity or position. Once an AIObject is found, it is devalued and can't be found again for a certain number of seconds (unless turned off in flags).

Syntax

```
AI.FindObjectOfType(entityId, radius, AIOBJECTTYPE, flags [,returnPosition
[,returnDirection]]) AI.FindObjectOfType(position, radius, AIOBJECTTYPE,
[,returnPosition [,returnDirection]])
```

Returns The found AIOBJECT's name.

Parameter	Description
entityId	Unique entity ID used to determine the center position of the search.
position	Vector specifying the center position of the search.
radius	Radius of the search area.
AIOBJECTTYPE	AIOBJECT type to search for (see ScriptBindAI.cpp and Scripts/AIAnchor.lua for a complete list of AIOBJECT types).
flags.	A combination of one or more of the following search filter flags: <ul style="list-style-type: none"> AIFAF_VISIBLE_FROM_REQUESTER – Requires whoever is requesting the object to also have a line of sight to it. AIFAF_VISIBLE_TARGET– Requires a line of sight between target and anchor. AIFAF_INCLUDE_DEVALUED – Include devalued objects. AIFAF_INCLUDE_DISABLED – Include disabled objects.
returnPosition (optional)	Position of the found object.
returnDirection (optional)	Direction of the found object.

FindStandbySpotInShape

Syntax

```
AI.FindStandbySpotInShape(centerPos, targetPos, anchorType)
```

FindStandbySpotInSphere

Syntax

```
AI.FindStandbySpotInSphere(centerPos, targetPos, anchorType)
```

FreeSignal

Sends a signal to anyone in a specified radius around a position.

Syntax

```
AI.FreeSignal(signalType, signalText, position, radius [, entityID
[,signalExtraData]])
```

Parameter	Description
signalType	See AI.Signal.
signalText	See AI.Signal.
position	The center point ({x,y,z} coordinates) from which the signal is sent.
radius	The inside radius of the area to which the signal is sent.
entityID	Optional. The ID of an entity that is a member of a group that should not receive the signal. Entities whose group ID is the value specified will not be sent the signal.
signalExtraData	Optional. See AI.Signal.

GetAIObjectPosition

Retrieves a specified AIObject's position.

Syntax

```
AI.GetAIObjectPosition(entityId | AIObjectName)
```

Returns AI Object position vector {x,y,z}.

Parameter	Description
entityId AIObjectName	Unique entity ID or AIObject name.

GetAnchor

Searches for the closest anchor of a specified type in an area around a specified entity. Once an anchor is found, it is devalued and can't be found again for a certain number of seconds (unless turned off in flags).

Syntax

```
AI.GetAnchor(entityId, radius, AIAnchorType, searchType [,returnPosition  
[,returnDirection]])
```

Returns The found anchor's name.

Parameter	Description
entityId	Unique entity ID used to determine the center position of the search.
radius	Radius of the search area. Alternatively a search range can be specified (min=minRad,max=maxRad).
AIAnchorType	Anchor type to search for. See Scripts/AIAnchor.lua for a complete list of anchor types available.

Parameter	Description
searchType	A combination of one or more of the following search filter flags: <ul style="list-style-type: none"> • AIANCHOR_NEAREST – Nearest anchor of the specified type (default). • AIANCHOR_NEAREST_IN_FRONT – Nearest anchor of the specified type inside the front cone of the entity. • AIANCHOR_NEAREST_FACING_AT – Nearest anchor of the specified type that is oriented towards entity's attention target • AIANCHOR_RANDOM_IN_RANGE – Random anchor of the specified type. • AIANCHOR_NEAREST_TO_REFPOINT – Anchor of the specified type that is nearest to the entity's reference point.
(optional) returnPosition	Position of the found object.
(optional) returnDirection	Direction of the found object.

GetAttentionTargetAIType

Retrieves the AI type (AIOBJECT_*) of a specified entity's attention target .

Syntax

```
AI.GetAttentionTargetAIType(entityId)
```

Returns Attention target's AI type, or AIOBJECT_NONE if no target.

Parameter	Description
entityId	The ID of the entity.

GetAttentionTargetDirection

Retrieves the direction of a specified entity's attention target.

Syntax

```
AI.GetAttentionTargetDirection(entityId, returnDir)
```

Returns Attention target's direction vector {x,y,z}, passed as a return value.

Parameter	Description
entityId	The ID of the entity.

GetAttentionTargetDistance

Retrieves the distance from a specified entity to its attention target.

Syntax

```
AI.GetAttentionTargetDistance(entityId)
```

Returns distance to the attention target.

Parameter	Description
entityId	The ID of the entity.

GetAttentionTargetEntity

Retrieves a specified entity's attention target entity (if it is a specified entity), or the owner entity of a dummy object's attention target (if there is an owner entity).

Syntax

```
AI.GetAttentionTargetEntity(ScriptHandle entityId)
```

Returns Attention target's entity.

Parameter	Description
entityId	The ID of the entity.

GetAttentionTargetOf

Retrieves a specified entity's attention target.

Syntax

```
AI.GetAttentionTargetOf(entityId)
```

Returns Name of attention target. Null if there is no target.

Parameter	Description
entityId	The ID of the entity.

GetAttentionTargetPosition

Retrieves the position of a specified entity's attention target.

Syntax

```
AI.GetAttentionTargetPosition(entityId, returnPos)
```

Returns Attention target 's position vector {x,y,z}, passed as a return value ().

Parameter	Description
entityId	The ID of the entity.

GetAttentionTargetThreat

Syntax

```
AI.GetAttentionTargetThreat(ScriptHandle entityId)
```

GetAttentionTargetType

Retrieves the type (AITARGET_*) of a specified entity's attention target.

Syntax

```
AI.GetAttentionTargetType(entityId)
```

Returns Attention target's type, or AITARGET_NONE if no target.

Parameter	Description
entityId	The ID of the entity.

GetAttentionTargetViewDirection

Retrieves the view direction of a specified entity's attention target.

Syntax

```
AI.GetAttentionTargetViewDirection(entityId, returnDir)
```

Returns Attention target's view direction vector {x,y,z}, passed as a return value.

Parameter	Description
entityId	The ID of the entity.

GetBeaconPosition

Gets the beacon position for a specified entity/object's group.

Syntax

```
AI.GetBeaconPosition(entityId | AIObjectName, returnPos)
```

Returns True if the beacon is found and the position set.

Parameter	Description
entityId AIObjectName	Unique entity ID or AI object name.
returnPos	Beacon position vector {x,y,z}.

GetBehaviorBlackBoard

Retrieves a specified `AIActor` current behaviour's black board (a Lua table).

Syntax

```
AI.GetBehaviorBlackBoard(entity)
```

Returns black board – if there was one nil – Otherwise

Parameter	Description
entityId or entityName.	An <code>AIActor</code> identifier.

GetBehaviorVariable

Returns a behavior variable for the specified actor.

Syntax

```
AI.GetBehaviorVariable(ScriptHandle entityId, const char* variableName)
```

GetBiasedDirection

Retrieves biased direction of certain point.

Syntax

```
AI.GetBiasedDirection(entityId)
```

Parameter	Description
entityId	The ID of the entity.

GetCurrentHideAnchor

Retrieves the name of the anchor that the entity currently is using for cover.

Syntax

```
AI.GetCurrentHideAnchor(entityId)
```

Parameter	Description
entityId	The ID of the entity.

GetDirectAnchorPos

Retrieves the position of a cover point that a specified entity can use to directly attack its attention target.

Syntax

```
AI.GetDirectAttackPos(entityId, searchRange, minAttackRange)
```

Returns Point value, or none if no attack point is available.

Parameter	Description
entityId	The ID of the entity.
AIAnchorType	Anchor type (see <i>Scripts/AIAnchor.lua</i> for a complete list of anchor types).
maxDist	Maximum size of search range.

GetDirLabelToPoint

Retrieves a direction label (front=0, back=1, left=2, right_3, above=4, -1=invalid) to the specified point.

Syntax

```
AI.GetDirLabelToPoint(entityId, point)
```

Parameter	Description
entityId	The ID of the entity.
point	The point to evaluate.

GetEnclosingSpace

Returns the estimated surrounding navigable space in meters.

Syntax

```
AI.GetEnclosingSpace(entityId, Vec3 pos, float rad)
```

Parameter	Description
entityId	The ID of the entity.

Parameter	Description
pos	Check position.
rad	Check radius.

GetDistanceAlongPath

Retrieves the distance between a first and second entity, measured along the first entity's path.

Syntax

```
AI.GetDistanceAlongPath(entityId1, entityid2)
```

Returns Distance along a path. Value can be negative if the second entity is ahead along the path.

Parameter	Description
entityId1	ID for the first entity.
entityId2	ID for the second entity.

GetDistanceToClosestGroupMember

Syntax

```
AI.GetDistanceToClosestGroupMember(ScriptHandle entityId)
```

GetEnclosingGenericShapeOfType

Retrieves the first shape of a certain type that encloses a specified point.

Syntax

```
AI.GetEnclosingGenericShapeOfType(position, type[, checkHeight])
```

Returns Shape name.

Parameter	Description
position	Point to search for an enclosing shape.
type	Shape type to search for (uses anchor types).
checkHeight (optional)	Flag indicating whether or not to test for shape height. (default=false). If set to true, the test checks the space between shape.aabb.min.z and shape.aabb.min.z+shape.height.

GetExtraPriority

Retrieves the extra priority value for a specified enemy entity.

Syntax

```
AI.GetExtraPriority(enemyEntityId)
```

Parameter	Description
enemyEntityId.	The ID of the entity.

GetFactionOf

Retrieves the faction of the specified entity.

Syntax

```
AI.GetFactionOf(ScriptHandle entityID)
```

Returns the faction of the specified entity.

Parameter	Description
entityId	The ID of the entity whose faction to return.

GetFormationLookingPoint

Retrieves the looking point position inside the formation.

Syntax

```
AI.GetFormationLookingPoint(entityId)
```

Returns v3 – table with format {x,y,z} storing the looking point position

Parameter	Description
entityId	AI's entity.

GetFormationPointClass

Adds a follow-type node to a formation descriptor.

Syntax

```
AI.GetFormationPointClass(name, position)
```

Returns class of formation point (-1 if none found).

Parameter	Description
name	Name of the formation descriptor.

Parameter	Description
position	Point index in the formation (1..N).

GetFormationPointPosition

Retrieves an entity's formation point position.

Syntax

```
AI.GetFormationPointPosition(entityId, pos)
```

Returns true if the formation point has been found.

Parameter	Description
entityId	The ID of the entity.
pos	Return value for the position of the entity's formation point.

GetFormationPosition

Retrieves the relative position inside the formation.

Syntax

```
AI.GetFormationPosition(entityId)
```

Returns v3 – table with format {x,y,z} storing the relative position

Parameter	Description
entityId	AI's entity.

GetGroupAveragePosition

Retrieves the average position of a group's members.

Syntax

```
AI.GetGroupAveragePosition(entityId, properties, returnPos)
```

Returns the average position.

Parameter	Description
entityId	Unique entity ID used to determine the group.

Parameter	Description
unitProperties	Binary mask of unit properties type for which the attack is requested, in the following form: UPR_* + UPR* (UPR_COMBAT_GROUND + UPR_COMBAT_FLIGHT) See IAgent.h for a definition of unit properties UPR_*.

GetGroupCount

Retrieves the member count of a specified entity's group.

Syntax

```
AI.GetGroupCount(entityId, flags, type)
```

Returns the count of members for the specified group.

Parameter	Description
entityId	The entity or group ID.
flags	A combination of one or more of the following flags: <ul style="list-style-type: none"> GROUP_ALL – Counts all agents in the group (default). GROUP_ENABLED – Counts enabled agents only (exclusive with all). GROUP_MAX – Include the maximum number of agents during the game (can be combined with all or enabled).
type	The AI object type for which to filter. Counts only the AI objects of the type specified. This parameter cannot be used with the GROUP_MAX flag.

GetGroupMember

Returns entity that is at a specified index position in the specified group.

Syntax

```
AI.GetGroupMember(entityId|groupId, idx, flags, type)
```

Returns the script handler of the requested entity, or null if the requested index value is out of range.

Parameter	Description
entityId groupId	The entity ID or group ID.
idx	Position in the index from 1 to n.
flags	A combination of one or more of the following flags: <ul style="list-style-type: none"> GROUP_ALL – Counts all agents in the group (default). GROUP_ENABLED – Counts enabled agents only (exclusive with all).

Parameter	Description
type	The AI object type for which to filter. Returns only the AI objects of the type specified. This parameter cannot be used with the GROUP_MAX flag..

GetGroupOf

Retrieves the group ID of a specified entity ID.

Syntax

```
AI.GetGroupOf(entityId)
```

Returns the group ID of the specified entity.

Parameter	Description
entityId	The ID of the entity whose group ID to return.

GetGroupScopeUserCount

Syntax

```
AI.GetGroupScopeUserCount(ScriptHandle entityIdHandle, const char*  
groupScopeName)
```

Returns the number of actors inside the group scope if greater than or equal to zero, or nil if an error occurs.

Parameter	Description
entityId	The entity ID of the agent for whom you want to access the group scope.
groupScopeName.	The group scope name.

GetGroupScriptTable

Syntax

```
AI.GetGroupScriptTable(int groupID)
```

GetGroupTarget

Retrieves the most threatening attention target among the AI agents in a specified entity's group. See IAgent.h for a definition of alert status.

Syntax

```
AI.GetGroupTarget(entityId [,bHostileOnly [,bLiveOnly]])
```

Parameter	Description
entityId	Unique entity ID used to determine the group.
bHostileOnly (optional)	Flag indicating whether or not to include only hostile targets in group.
bLiveOnly (optional)	Flag indicating whether or not to include only live targets in group.

GetGroupTargetCount

Retrieves the number of attention targets among the AI agents in a specified entity's group.

Syntax

```
AI.GetGroupTargetCount(entityId [,bHostileOnly [,bLiveOnly]])
```

Parameter	Description
entityId	Unique entity ID used to determine the group.
bHostileOnly (optional)	Flag indicating whether or not to include only hostile targets in group.
bLiveOnly (optional)	Flag indicating whether or not to include only live targets in group.

GetGroupTargetEntity

Syntax

```
AI.GetGroupTargetEntity(int groupID)
```

GetGroupTargetThreat

Syntax

```
AI.GetGroupTargetThreat(int groupID)
```

GetGroupTargetType

Syntax

```
AI.GetGroupTargetType(int groupID)
```

GetLastUsedSmartObject

Retrieves the smart object last used by the user specified.

Syntax

```
AI.GetLastUsedSmartObject(userEntityId)
```

Returns nil if there is no last used smart object or if an error has occurred; otherwise, returns the script table of the entity that was the smart object last used by the user specified.

Parameter	Description
userEntityId	The entity ID of the user to query for the last used smart object.

GetLeader

Gets the name of a specified group leader.

Syntax

```
AI.GetLeader(groupID | entityID)
```

Returns the leader name.

Parameter	Description
groupID	Unique group ID.
entityID	The ID of the entity.

GetMemoryFireType

Syntax

```
AI.GetMemoryFireType(entityId)
```

Returns the method that the puppet uses for firing at its memory target.

Parameter	Description
entityId	The ID of the entity.

GetNavigationType

Retrieves the navigation type at a specified entity's position.

Syntax

```
AI.GetNavigationType(entityId)
```

Returns Navigation type, such as NAV_TRIANGULAR, NAV_WAYPOINT_HUMAN, NAV_ROAD, NAV_VOLUME, NAV_WAYPOINT_3DSURFACE, NAV_FLIGHT, NAV_SMARTOBJECT. See the IAISystem::ENavigationType definition for a complete list.

Parameter	Description
entityId	The ID of the entity.

GetNearestEntitiesOfType

Syntax

```
AI.GetNearestEntitiesOfType(entityId|objectname|position, AIObjectType,
    maxObjects, returnList [,objectFilter [,radius]])
```

Returns the number of found entities.

Parameter	Description
entityId objectname position.	Unique entity ID, AI object name, or position used to pinpoint the center position of the search.
radius	Radius of the search area.
AIObjectType	AIObject type to search for (see ScriptBindAI.cpp and Scripts/AIAnchor.lua for a complete list of AIObject types).
maxObjects	Maximum number of objects to find.
return list	Lua table to hold the list of found entities (Lua handlers).
(optional) objectFilter	A combination of one or more of the following search filter flags: <ul style="list-style-type: none"> AIOBJECTFILTER_SAMEFACTION – Include only AI objects of the same species as the querying object. AIOBJECTFILTER_SAMEGROUP – Include only AI objects of the same group as the querying object (or with no group). AIOBJECTFILTER_NOGROUP – Include only AI objects with a Group ID of AI_NOGROUP. AIOBJECTFILTER_INCLUDEINACTIVE – Include objects that are inactive.

GetNearestHidespot

Retrieves a specified entity's nearest hidepoint within a specified range.

Syntax

```
AI.GetNearestHidespot(entityId, rangeMin, rangeMax [, center])
```

Returns Point position, if found.

Parameter	Description
entityId	The ID of the entity.
rangeMin	Minimum range of search area.
rangeMax	Maximum range of search area
centre (optional)	Center point of the search area. If not specified, the entity's current position is used.

GetNearestPathOfTypeInRange

Retrieves the type of path nearest to a specified point of interest for a specified entity. Paths use the same types as anchors and are specified in the path properties. The function only returns paths that match the entity's navigation caps. Navigation type is also specified in the path properties.

Syntax

```
AI.GetNearestPathOfTypeInRange(entityId, pos, range, type [, devalue, useStartNode])
```

Parameter	Description
entityId	The ID of the entity.
pos	Vector specifying to the point of interest.
range	Search range.
type	Type of path to search for.
devalue (optional)	Time the returned path is marked as occupied.
useStartNode (optional)	Flag indicating whether or not to look a path with any point inside the range (useStartNode=0) or one with a start node inside the range (useStartNode=0).

GetNearestPointOnPath

Locates the point on a path nearest to a specified position.

Syntax

```
AI.GetNearestPointOnPath(entityId, pathname, vPos)
```

Parameter	Description
entityId	The ID of the entity.
pathname	Name of path.
vPos	Position to measure from.

GetObjectBlackBoard

Retrieves a specified object's black board (a Lua table).

Syntax

```
AI.GetObjectBlackBoard(entity)
```

Returns black board – if there is one; otherwise, nil.

Parameter	Description
entityId or entityName.	An AI entity identifier.

GetObjectRadius

Retrieves the radius of a specified AI object.

Syntax

```
AI.GetObjectRadius(entityId)
```

Returns the radius size.

Parameter	Description
entityId	The ID of the entity.

GetParameter

Retrieves the value of an enumerated AI parameter for a specified entity.

Syntax

```
AI.GetParameter(entityId, paramEnum)
```

Returns the value of the parameter.

Parameter	Description
entityId	The ID of the entity.
paramEnum	The index of the parameter to get. See <code>AI.ChangeParameter()</code> for a complete list.

GetPathLoop

Syntax

```
AI.GetPathLoop(entityId, pathname)
```

Returns true if path is successfully looped.

Parameter	Description
entityId	The ID of the entity.
pathname	Name of the path.

GetPathSegNoOnPath

Syntax

```
AI.GetPathSegNoOnPath(entityId, pathname, vPos)
```

Returns Segment ratio (0.0 start point, 100.0 end point).

Parameter	Description
entityId	The ID of the entity.
pathname	Name of path.
vPos	Position.

GetPeakThreatLevel

Syntax

```
AI.GetPeakThreatLevel(ScriptHandle entityId)
```

GetPeakThreatType

Syntax

```
AI.GetPeakThreatType(ScriptHandle entityId)
```

GetPointOnPathBySegNo

Syntax

```
AI.GetPointOnPathBySegNo(entityId, pathname, segNo)
```

Returns Point by segment ratio (0.0 start point, 100.0 end point).

Parameter	Description
entityId	The ID of the entity.
pathname	Name of path.
segNo	Segment ratio.

GetPosturePriority

Sets the specified entity's posture priority.

Syntax

```
AI.GetPosturePriority(ScriptHandle entityId, const char* postureName)
```

GetPotentialTargetCount

Retrieves the total number of a specified entity's potential targets.

Syntax

```
AI.GetPotentialTargetCount(ScriptHandle entityId)
```

Parameter	Description
entityId	The ID of the entity.

GetPotentialTargetCountFromFaction

Retrieves the number of an entity's potential targets that belong to a specified faction.

Syntax

```
AI.GetPotentialTargetCountFromFaction(ScriptHandle entityId, const char* factionName)
```

Parameter	Description
entityId	The ID of the entity.
name	Faction name.

GetPredictedPosAlongPath

Retrieves the predicted position of an AI agent along its path at a specified time.

Syntax

```
AI.GetPredictedPosAlongPath(entityId, time, retPos)
```

Returns True if successful.

Parameter	Description
entityId	The ID of the entity.
time	Time (in seconds) to predict position.
retPos	Return point value of the predicted position .

GetPreviousBehaviorName

Syntax

```
AI.GetPreviousBehaviorName(ScriptHandle entityId)
```

GetPreviousPeakThreatLevel

Syntax

```
AI.GetPreviousPeakThreatLevel(ScriptHandle entityId)
```

GetPreviousPeakThreatType

Syntax

```
AI.GetPreviousPeakThreatType(ScriptHandle entityId)
```

GetProbableTargetPosition

Retrieves the probable target position of a specified entity.

Syntax

```
AI.GetProbableTargetPosition(entityId)
```

Parameter	Description
entityId	The ID of the entity.

GetRefPointDirection

Retrieves a specified entity's reference point direction.

Syntax

```
AI.GetRefPointDirection(entityId)
```

Returns a script vector (x,y,z) reference point direction.

Parameter	Description
entityId	The ID of the entity.

GetRefPointPosition

Retrieves a specified entity's reference point "world" position.

Syntax

```
AI.GetRefPointPosition(entityId)
```

Returns a script vector (x,y,z) reference point position.

Parameter	Description
entityId	The ID of the entity.

GetRefShapeName

Retrieves the name of a specified entity's reference shape.

Syntax

```
AI.GetRefShapeName(entityId)
```

Returns a reference shape name.

Parameter	Description
entityId	The ID of the entity.

GetSoundPerceptionDescriptor

Retrieves information about how the specified entity perceives sound types.

Syntax

```
AI.GetSoundPerceptionDescriptor(entityId, soundType, descriptorTable)
```

Returns true if the information is successfully returned.

Parameter	Description
entityId	Entity to get perception data on.
soundType	Type of sound stimulus to get data for.
descriptorTable	Location to store retrieved data.

GetStance

Retrieves the specified entity's stance.

Syntax

```
AI.GetStance(entityId)
```

Returns entity stance (STANCE_*)

Parameter	Description
entityId	The ID of the entity.

GetSubTypeOf

Retrieves a specified entity's sub type.

Syntax

```
AI.GetSubTypeOf(entityId)
```

Returns the entity sub type (as defined in IAgent.h).

Parameter	Description
entityId	The ID of the entity.

GetTacticalPoints

Retrieves a point matching a description, related to a specified entity. Format of a point is: { x,y,z }.

Syntax

```
AI.GetTacticalPoints(entityId, tacPointSpec, point)
```

Returns true if a valid point is found; otherwise, false.

Parameter	Description
entityId	AI's entity.
tacPointSpec.	A table specifying the points required.
point	Coordinates of the point found.

GetTargetSubType

Retrieves the subtype of a specified entity's current attention target.

Syntax

```
AI.GetTargetSubType(entityId)
```

Returns an attention target subtype. See `IAgent.h` for a list of target type definitions.

Parameter	Description
<code>entityId</code>	The ID of the entity.

GetTargetType

Retrieves the type of a specified entity's current attention target.

Syntax

```
AI.GetTargetType(entityId)
```

Returns an attention target type, such as `AITARGET_NONE`, `AITARGET_MEMORY`, `AITARGET_BEACON`, `AITARGET_ENEMY`. See `IAgent.h` for a list of target type definitions.

Parameter	Description
<code>entityId</code>	The ID of the entity.

GetTotalLengthOfPath

Retrieves total length of the specified path.

Syntax

```
AI.GetTotalLengthOfPath(entityId, pathname)
```

Parameter	Description
<code>entityId</code>	The ID of the entity.
<code>pathname</code>	Name of path.

GetTypeOf

Retrieves a specified entity's type.

Syntax

```
AI.GetTypeOf(entityId)
```

Returns the entity type (as defined in `IAgent.h`).

Parameter	Description
<code>entityId</code>	The ID of the entity.

GetUnitCount

Retrieves the number of units the leader knows about. The leader is identified based on the group ID of the entity.

Syntax

```
AI.GetUnitCount(entityId, unitProperties)
```

Parameter	Description
entityId	The ID of the entity.
unitProperties	Binary mask of unit properties type for which the attack is requested, in the following form: UPR_* + UPR* (UPR_COMBAT_GROUND + UPR_COMBAT_FLIGHT) See IAgent.h for a definition of unit properties UPR_*.

GetUnitInRank

Retrieves the entity that holds the specified rank position in the specified group.

Syntax

```
AI.GetUnitInRank(groupID [,rank])
```

Returns entity script table of the ranked unit.

Parameter	Description
groupID	The ID of the group that contains the entity to retrieve.
rank	The rank position of the entity to retrieve. If null or a value less than or equal to zero is specified, retrieves the entity with the highest rank in the entity. The value of the highest rank is 1.

GoTo

Allows the specified entity to move to a certain destination.

Syntax

```
AI.GoTo(entityId, vDestination)
```

Parameter	Description
entityId	AI's entity.
vDestination.	.

Hostile

Determines whether or not two entities are hostile.

Syntax

```
AI.Hostile(entityId, entity2Id|AIObjectName)
```

Returns true if the entities are hostile.

Parameter	Description
entityId	ID of the first AI entity.
entity2Id AIObjectName	ID of the second AI entity, or Alobject name.

IgnoreCurrentHideObject

Marks the current hide object as unreachable; it will be omitted from future hidespot selections.

Syntax

```
AI.IgnoreCurrentHideObject(entityId)
```

Parameter	Description
entityId	The ID of the entity.

IntersectsForbidden

Determines whether or not the specified line is in a forbidden region.

Syntax

```
AI.IntersectsForbidden(Vec3 start, Vec3 end)
```

Returns intersected position or end (if there is no intersection).

Parameter	Description
start	Vector in format {x,y,z}.
end	Vector in format {x,y,z}.

IsAgentInAgentFOV

Determines whether or not one entity is in the field of view of another entity.

Syntax

```
AI.IsAgentInAgentFOV(entityId, entityId2)
```

Returns the first value true if the agent is within the entity FOV; the second value true if the agent is within the entity's primary FOV, or false if the agent is within the entity's secondary FOV.

Parameter	Description
entityId	The AI entity whose FOV to check.
entityId2.	The entity ID of the agent.

IsAgentInTargetFOV

Determines whether or not the entity is in the FOV of the attention target.

Syntax

```
AI.IsAgentInTargetFOV(entityId, fov)
```

Returns true if in the FOV of the attention target; otherwise, false.

Parameter	Description
entityId	The ID of the entity.
fov	FOV of the enemy in degrees.

IsAimReady

Syntax

```
AI.IsAimReady(ScriptHandle entityIdHandle)
```

IsCoverCompromised

Syntax

```
AI.IsCoverCompromised(entityId)
```

Returns true if the cover has been compromised; otherwise, nil.

Parameter	Description
entityId	AI's entity.

IsEnabled

Checks that the entity is AI-enabled.

Syntax

```
AI.IsEnabled(entityId)
```

Parameter	Description
entityId	The ID of the entity.

IsFireEnabled

Determines whether or not the AI is allowed to fire or not.

Syntax

```
AI.IsFireEnabled(entityId)
```

Returns true if AI is enabled to fire

Parameter	Description
entityId	The ID of the entity.

IsInCover

Determines whether or not the agent is using cover.

Syntax

```
AI.IsInCover(entityId)
```

IsLowHealthPauseActive

Syntax

```
AI.IsLowHealthPauseActive(ScriptHandle entityId)
```

IsLowOnAmmo

Syntax

```
AI.IsLowOnAmmo(entityId)
```

Parameter	Description
entityId	AI's entity.
threshold	The ammo percentage threshold.

IsMoving

Determines whether or not the agent wants to move.

Syntax

```
AI.IsMoving(entityId)
```

Parameter	Description
entityId	The ID of the entity.

IsMovingInCover

Syntax

```
AI.IsMovingInCover(entityId)
```

Returns true – Agent is moving in cover nil – if not

Parameter	Description
entityId	AI's entity.

IsMovingToCover

Determines whether or not the agent is running to cover.

Syntax

```
AI.IsMovingToCover(entityId)
```

Parameter	Description
entityId	AI's entity.

IsOutOfAmmo

Syntax

```
AI.IsOutOfAmmo(entityId)
```

Returns true if the specified entity is out of ammunition; otherwise, nil.

Parameter	Description
entityId	The ID of the AI entity.

IsPersonallyHostile

Syntax

```
AI.IsPersonallyHostile(ScriptHandle entityID, ScriptHandle hostileID)
```

IsPointInFlightRegion

Determines whether or not a specified point is in the flight region.

Syntax

```
AI.IsPointInFlightRegion(point)
```

Returns true if the point is in the flight region.

Parameter	Description
point	Vector in format {x,y,z}.

IsPointInsideGenericShape

Determines whether or not a point is inside a specified shape.

Syntax

```
AI.IsPointInsideGenericShape(position, shapeName[, checkHeight])
```

Parameter	Description
position	Position to check.
shapeName	Name of the shape to test (returned by <code>AI.GetEnclosingGenericShapeOfType</code>).
checkHeight (optional)	Flag indicating whether or not to test for shape height. (default=false). If set to true, the test will check the space between <code>shape.aabb.min.z</code> and <code>shape.aabb.min.z+shape.height</code> .

IsPointInWaterRegion

Determines whether or not the point is in the water region.

Syntax

```
AI.IsPointInWaterRegion(point)
```

Returns a value that indicates water or ground level. Values greater than 0 mean there is water.

IsPunchableObjectValid

Determines whether or not a punchable object is valid.

Syntax

```
AI.IsPunchableObjectValid(userId, objectId, origPos)
```

Parameter	Description
userId.	User ID.
objectId.	Object ID.
origPos.	Object position in the world.

IsTakingCover

Syntax

```
AI.IsTakingCover(entityId, [distanceThreshold])
```

Returns true if the specified agent is either in cover or running to cover; otherwise, nil.

Parameter	Description
entityId	AI's entity.
distanceThreshold.	(Optional) Distance over which an agent that is running to cover is considered to not yet have taken cover.

LoadBehaviors

Syntax

```
AI.LoadBehaviors(const char* folderName, const char* extension)
```

LogComment

Writes additional information to the log for debugging purposes.

Syntax

```
AI.LogComment(szMessage)
```

Parameter	Description
szMessage	The message to write to the log.

LogEvent

Writes event-driven information to the log that for debugging purposes. Events may occur on a per-frame or a per AI update basis.

Syntax

```
AI.LogEvent(szMessage)
```

Parameter	Description
szMessage	The message to write to the log.

LogProgress

Writes progress messages to the log.

Syntax

```
AI.LogProgress(szMessage)
```

Parameter	Description
szMessage	The message to write to the log.

MeleePunchableObject

Syntax

```
AI.MeleePunchableObject(entityId, objectId, origPos)
```

Parameter	Description
entityId	The ID of the AI entity.
objectId	Object ID.
origPos	Position of the melee punchable object.

ModifySmartObjectStates

Adds or removes smart object states for a specified entity.

Syntax

```
AI.ModifySmartObjectStates(entityId, listStates)
```

Parameter	Description
entityId	The ID of the entity.
listStates	The list of state names to be added or removed (such as "Closed, Locked", "Open, Unlocked, Busy").

ParseTables

Syntax

```
AI.ParseTables(int firstTable, bool parseMovementAbility, IFunctionHandler* pH, AIObjectParams& aiParams, bool& updateAlways)
```

Parameter	Description
firstTable	Properties table.
parseMovementAbility	True to parse movement ability, false otherwise.
aiParams	AI parameters.
updateAlways	True to always update; false otherwise.

PlayCommunication

Plays communication on the AI agent.

Syntax

```
AI.PlayCommunication(ScriptHandle entityId, const char* commName, const char* channelName, float contextExpiry)
```

Parameter	Description
entityId	The ID of the entity.
commName	The name of the communication to play.
channelName	The name of the channel where the communication will play.

PlayReadabilitySound

Plays readability sound on the AI agent. This call does not do any filtering like playing readability using signals.

Syntax

```
AI.PlayReadabilitySound(entityId, soundName)
```

Parameter	Description
entityId	The ID of the entity.
soundName	The name of the readability sound signal to play.
stopPreviousSounds (Optional)	True if any currently playing readability should be stopped in favor of this one.

Parameter	Description
responseDelayMin (Optional)	Minimum (or exact, if no maximum) delay for the response readability to play.
responseDelayMax (Optional)	Maximum delay for the response readability to play.

ProcessBalancedDamage

Processes balanced damage.

Syntax

```
AI.ProcessBalancedDamage(pShooterEntity, pTargetEntity, damage, damageType)
```

Parameter	Description
pShooterEntity	Shooter ID.
pTargetEntity	Target ID.
damage	Hit damage.
damageType	Hit damage type.

QueueBubbleMessage

Syntax

```
AI.QueueBubbleMessage(ScriptHandle entityID, const char* message)
```

RecComment

Records a comment with AI Debug Recorder. For information about the AI Debug Recorder, see [Using the AI Debug Recorder](#).

Syntax

```
AI.RecComment(szMessage)
```

Parameter	Description
szMessage	Message line to be displayed in Recorder view.

RegisterDamageRegion

Registers a spherical region that causes damage (so should be avoided in pathfinding). The owner entity position is used as the region center. The function can be called multiple times to update the region position.

Syntax

```
AI.RegisterDamageRegion(entityId, radius)
```

Parameter	Description
entityId	The ID of the entity.
radius	The radius of the spherical region. If less than or equal to zero, the region is disabled.

RegisterInterestedActor

Registers the interested actor with the interest system. Any errors go to the error log.

Syntax

```
AI.RegisterInterestedActor(ScriptHandle entityId, float fInterestFilter,  
float fAngleInDegrees)
```

Returns true if a valid update was performed; otherwise, nil. Nil can be returned if the interest system is disabled or the parameters are not valid.

Parameter	Description
entityId	The ID of the AI entity.

RegisterInterestingEntity

Registers the specified entity with the interest system. Any errors go to the error log.

Syntax

```
AI.RegisterInterestingEntity(ScriptHandle entityId, float radius, float  
baseInterest, const char* actionName, Vec3 offset, float pause, int shared)
```

Returns true if a valid update was performed; otherwise, nil. Nil can be returned if the interest system is disabled or the parameters are not valid.

Parameter	Description
entityId	The ID of the entity.

RegisterTacticalPointQuery

Retrieves a query ID for the specified tactical point query.

Syntax

```
AI.RegisterTacticalPointQuery(querySpecTable)
```

Returns > 0 – If the query was parsed successfully 0 – Otherwise

Parameter	Description
querySpecTable	Table specifying the query. For more information, see AI Tactical Point System (p. 21) .

RegisterTargetTrack

Registers an AI entity to use a specified target track configuration for target selection. The parameter `ai_TargetTracking` must be set to '2'.

Syntax

```
AI.RegisterTargetTrack(entityId, configuration, targetLimit, classThreat)
```

Returns true if successfully registered.

Parameter	Description
entityId	The ID of the entity.
configuration	Target track configuration.
targetLimit	The number of agents who can target the AI at any specified time (0 for infinite).
classThreat (optional)	Initial class threat value.

RemovePersonallyHostile

Syntax

```
AI.RemovePersonallyHostile(ScriptHandle entityId, ScriptHandle hostileID)
```

RequestAttack

In a group with a leader, allows the leader to issue a request for a group attack behavior against the enemy. After this request, the `Cleader` may create an attack leader action (`CLeaderAction_Attack_*`).

Syntax

```
AI.RequestAttack(entityId, unitProperties, attackTypeList [,duration])
```

Parameter	Description
entityId	Unique entity ID used to determine the group leader.

Parameter	Description
unitProperties	Binary mask of unit properties type for which the attack is requested, in the following form: UPR_* + UPR* (UPR_COMBAT_GROUND + UPR_COMBAT_FLIGHT) See IAgent.h for a definition of unit properties UPR_*.
attackTypeList	Lua table containing a prioritized list of preferred attack strategies (leader action subtypes). The list must be in the following format: {LAS_*, LAS_*, ..} (LAS_ATTACK_ROW, LAS_ATTACK_FLANK) which means that the first attempt will be an Attack_row action , and if that fails an attack_flank. See IAgent.h for a definition of LeaderActionSubtype (LAS_*) action types.
duration (optional)	Maximum duration in seconds (default = 0).

RequestToStopMovement

Syntax

```
AI.RequestToStopMovement(ScriptHandle entityId)
```

ResetAgentLookAtPos

Resets the specified entity's previous call to AgentLookAtPos().

Syntax

```
AI.ResetAgentLookAtPos(entityId)
```

Parameter	Description
entityId	The ID of the entity.

ResetAgentState

Resets a particular aspect of the agent's state, such as "lean".

Syntax

```
AI.ResetAgentState(ScriptHandle entityId, const char * stateLabel)
```

Returns nil

Parameter	Description
entityId	The ID of the AI entity.

Parameter	Description
stateLabel	String describing the state that must be reset to default.

ResetParameters

Resets all parameters for a specified entity.

Syntax

```
AI.ResetParameters(entityId, bProcessMovement, PropertiesTable,  
PropertiesInstanceTable)
```

Parameter	Description
entityId	The ID of the entity whose parameters you want to reset.
bProcessMovement	True to reset movement data; otherwise, false.
PropertiesTable	The Lua table that contains the entity's properties.
PropertiesInstanceTable	The Lua table that contains instance-specific entity properties.

ResetPersonallyHostiles

Syntax

```
AI.ResetPersonallyHostiles(ScriptHandle entityId, ScriptHandle hostileID)
```

ScaleFormation

Changes the scale factor of a specified entity's formation (if one exists).

Syntax

```
AI.ScaleFormation(entityId, scale)
```

Returns true if formation scaling was successful.

Parameter	Description
entityId	The ID of the entity.
scale	Scale factor.

SequenceBehaviorReady

Syntax

```
AI.SequenceBehaviorReady(ScriptHandle entityId)
```

SequenceInterruptibleBehaviorLeft

Syntax

```
AI.SequenceInterruptibleBehaviorLeft(ScriptHandle entityId)
```

SequenceNonInterruptibleBehaviorLeft

Syntax

```
AI.SequenceNonInterruptibleBehaviorLeft(ScriptHandle entityId)
```

SetAlarmed

Sets the entity to be "perception alarmed".

Syntax

```
AI.SetAlarmed(entityId)
```

SetAnimationTag

Sets a mannequin animation tag.

Syntax

```
AI.SetAnimationTag(ScriptHandle entityID, const char* tagName)
```

Returns a default result code (in Lua: void).

Parameter	Description
entityId	The ID of the AI entity on which to set the animation tag.
tagName	The name of the animation tag that should be set (case insensitive).

SetAssesmentMultiplier

Sets the assesment multiplier factor for the specified AIObject type.

Syntax

```
AI.SetAssesmentMultiplier(AIObjectType, multiplier)
```

Parameter	Description
AIObjectType	Type of AIObject. See <code>ScriptBindAI.cpp</code> for a complete list of AIObject types.
multiplier	Assesment multiplier factor.

SetAttentiontarget

Sets a new attention target.

Syntax

```
AI.SetAttentiontarget(entityId, targetId)
```

Parameter	Description
entityId	The ID of the entity.
targetId	Target's entity ID.

SetBeaconPosition

Sets the beacon's position for the specified entity/object's group.

Syntax

```
AI.SetBeaconPosition(entityId | AIObjectName, pos)
```

Parameter	Description
entityId AIObjectName	Unique entity ID or AI object name.
pos	Vector {x,y,z} where the beacon position will be set.

SetBehaviorTreeEvaluationEnabled

Syntax

```
AI.SetBehaviorTreeEvaluationEnabled(ScriptHandle entityId, bool enable)
```

SetBehaviorVariable

Sets a behaviour variable for the specified actor.

Syntax

```
AI.SetBehaviorVariable(ScriptHandle entityId, const char* variableName, bool value)
```

SetCollisionAvoidanceRadiusIncrement

Syntax

```
AI.SetCollisionAvoidanceRadiusIncrement(ScriptHandle entityId, float radius)
```

SetContinuousMotion

Syntax

```
AI.SetContinuousMotion(ScriptHandle entityID, bool continuousMotion)
```

SetCoverCompromised

Syntax

```
AI.SetCoverCompromised(entityId)
```

Parameter	Description
entityId	The ID of the AI entity.

SetEntitySpeedRange

Syntax

```
AI.SetEntitySpeedRange(userEntityId, urgency, defaultSpeed, minSpeed, maxSpeed, stance = all)
```

Returns true if the operation was successful and false otherwise

Parameter	Description
usedEntityId	The entity ID of the user for which its last used smart object is needed.
urgency	The integer value specifying the movement urgency (see <code>AgentMovementSpeeds::EAgentMovementUrgency</code>).
defaultSpeed	Floating point value that specifies the default speed.
minSpeed	Floating point value that specifies the minimum speed.

SetExtraPriority

Sets a extra priority value to the specified enemy entity.

Syntax

```
AI.SetExtraPriority(enemyEntityId, increment)
```

Parameter	Description
enemyEntityId	The ID of the entity.

Parameter	Description
float increment	Value to add to the target's priority.

SetFactionOf

Sets the faction to which the specified entity belongs.

Syntax

```
AI.SetFactionOf(ScriptHandle entityID, const char* factionName)
```

Parameter	Description
entityId	The ID of the entity whose faction to return.
factionName	The name of the faction to assign to the specified entity.

SetFactionThreatMultiplier

Sets the threat multiplier factor for the specified species. A return value of 0 indicates that the species is not hostile to any other species.

Syntax

```
AI.SetFactionThreatMultiplier(nSpecies, multiplier)
```

SetFireMode

Sets fire mode immediately.

Syntax

```
AI.SetFireMode(entityId, mode)
```

Parameter	Description
entityId	The ID of the entity.
firemode	New fire mode.

SetFormationAngleThreshold

Sets the relative position inside the formation.

Syntax

```
AI.SetFormationAngleThreshold(entityId, fAngleThreshold)
```

Parameter	Description
entityId	The ID of the AI entity.
fAngleThreshold	New leader orientation angle threshold in degrees.

SetFormationLookingPoint

Sets the relative looking point position inside the formation.

Syntax

```
AI.SetFormationLookingPoint(entityId, v3RelativePosition)
```

Parameter	Description
entityId	The ID of the AI entity.
v3RelativePosition	Table with format {x,y,z} storing the new relative looking point.

SetFormationPosition

Sets the relative position inside the formation.

Syntax

```
AI.SetFormationPosition(entityId, v2RelativePosition)
```

Parameter	Description
entityId	The ID of the AI entity.
v2RelativePosition	Table with format {x,y} storing the new relative position.

SetFormationUpdate

Sets the update flag for a specified entity's formation (if one exists). If this flag is false, the formation is no longer updated.

Syntax

```
AI.SetFormationUpdate(entityId, update)
```

Returns true if the request was successful.

Parameter	Description
entityId	The ID of the entity.

Parameter	Description
update	True to update the flag; otherwise, false.

SetFormationUpdateSight

Sets a random angle rotation for a specified entity's formation sight directions.

Syntax

```
AI.SetFormationUpdateSight(entityId, range, minTime, maxTime)
```

Parameter	Description
entityId	The ID of the entity.
range	Angle of rotation (0,360) around the default sight direction.
minTime (optional)	Minimum timespan for changing the direction (default = 2).
maxTime (optional)	Minimum timespan for changing the direction (default = minTime).

SetIgnorant

Sets the specified AI entity to ignore system signals, visual stimuli and sound stimuli.

Syntax

```
AI.SetIgnorant(entityId, ignorant)
```

Parameter	Description
entityId	The ID of the AI entity.
ignorant	A flag indicating whether or not the entity ignores system signals. 0 specifies do not ignore; 1 specifies ignore.

SetInCover

Syntax

```
AI.SetInCover(entityId, bool inCover)
```

Parameter	Description
entityId	The ID of the AI entity.
inCover	Specifies whether the entity should be set to be in cover or not.

SetLeader

Sets a specified entity as the group leader. This action associates a `CLeader` object with the entity, creating it if one doesn't exist. Only one leader can be set per group.

Syntax

```
AI.SetLeader(entityID)
```

Returns true if successful.

Parameter	Description
entityID	Unique entity ID to set as leader.

SetMemoryFireType

Sets how the AI agent handles firing at its memory target.

Syntax

```
AI.SetMemoryFireType(entityId, type)
```

Parameter	Description
entityId	The ID of the entity.
type	Memory fire type. Possible values from enum <code>EMemoryFireType</code> in <code>IAgent.h</code> : <pre>eMFT_Disabled = 0, // Never allowed to fire at memory eMFT_UseCoverFireTime, // Can fire at memory using the weapon's cover fire time eMFT_Always, // Always allowed to fire at memory</pre>

SetMovementContext

Sets the specified entity's movement context.

Syntax

```
AI.SetMovementContext(ScriptHandle entityId, int context)
```

Parameter	Description
entityId	The ID of the entity.
context	context value .

SetPathAttributeToFollow

Sets the attribute of a specified entity's path.

Syntax

```
AI.SetPathAttributeToFollow(entityId, flag)
```

Parameter	Description
entityId	The ID of the entity.
flag	Attribute to set.

SetPathToFollow

Sets the path for a specified entity to follow.

Syntax

```
AI.SetPathToFollow(entityId, pathName)
```

Parameter	Description
entityId	The ID of the entity.
pathName	Name of the path to be followed.

SetPFBlockerRadius

Syntax

```
AI.SetPFBlockerRadius(entityId, blocker, radius)
```

Parameter	Description
entityId	The ID of the entity.

SetPointListToFollow

Sets a point list for a specified entity's path.

Syntax

```
AI.SetPointListToFollow(entityId, pointlist, howmanypoints, bspline [, navtype])
```

Parameter	Description
entityId	The ID of the entity.
pointList	List of points for the entity to follow, expressed as a set of local vectors: <code>{{x=0.0, y=0.0, z=0.0}, .</code>
howmanypoints	Number of points in the list.
bspline	Flag indicating whether or not the path line is recalculated using spline interpolation.
navtype	(Optional) Navigation type (default = <code>IAISystem::NAV_FLIGHT</code>).

SetPosturePriority

Sets the specified entity's posture priority.

Syntax

```
AI.SetPosturePriority(ScriptHandle entityId, const char* postureName, float priority)
```

SetPostures

Sets the specified entity's postures.

Syntax

```
AI.SetPostures(ScriptHandle entityId, SmartScriptTable postures)
```

Parameter	Description
entityId	The ID of the entity.
postures	The table of postures.

SetRefPointAtDefensePos

Sets a specified entity's reference point position to an intermediate distance between the entity's attention target and a specified point.

Syntax

```
AI.SetRefPointAtDefensePos(entityId, point2defend, distance)
```

Parameter	Description
entityId	The ID of the entity.
point2defend	Point to defend.

Parameter	Description
distance	Maximum distance between reference point and point to defend.

SetRefPointDirection

Sets a specified entity's reference point direction.

Syntax

```
AI.SetRefPointDirection(vRefPointDir)
```

Parameter	Description
vRefPointDir	Direction as a (script)vector (x,y,z) value.

SetRefPointPosition

Sets a specified entity's reference point "world" position.

Syntax

```
AI.SetRefPointPosition(entityId, vRefPointPos)
```

Parameter	Description
entityId	The ID of the entity.
vRefPointPos	World position as a (script)vector (x,y,z) value.

SetRefPointRadius

Sets a specified entity's reference point radius.

Syntax

```
AI.SetRefPointRadius(entityId, radius)
```

Parameter	Description
entityId	The ID of the entity.
radius	The reference point radius.

SetRefpointToAnchor

Sets a reference point to an anchor.

Syntax

```
AI.SetRefpointToAnchor(entityId, rangeMin, rangeMax, findType, findMethod)
```

Parameter	Description
entityId	The ID of the AI entity.
rangeMin	Minimum range.
rangeMax	Maximum range.
findType	Finding type.
findMethod	Finding method.

SetRefpointToPunchableObject

Sets the reference point to the punchable object.

Syntax

```
AI.SetRefpointToPunchableObject(entityId, range)
```

Parameter	Description
entityId	The ID of the AI entity.
range	Range for the punchable object.

SetRefShapeName

Sets the name of a specified entity's reference shape.

Syntax

```
AI.SetRefShapeName(entityId, name)
```

Parameter	Description
entityId	The ID of the entity.
name	Name of the reference shape.

SetSmartObjectState

Sets a single smart object state, replacing all other states.

Syntax

```
AI.SetSmartObjectState(entityId, stateName)
```

Parameter	Description
entityId	The ID of the entity.
stateName	The name of the new state to set for the smart object (such as "Idle").

SetSoundPerceptionDescriptor

Sets information about how the specified entity perceives sound types.

Syntax

```
AI.SetSoundPerceptionDescriptor(entityId, soundType, descriptorTable)
```

Returns True if information successfully saved.

Parameter	Description
entityId	Entity to set perception data for.
soundType	Type of sound stimulus to set data for.
descriptorTable	Perception data to saved.

SetSpeed

Sets the entity's current speed (urgency).

Syntax

```
AI.SetSpeed(entityId, urgency)
```

Parameter	Description
entityId	AI's entity.
urgency	A float value that specifies the movement urgency (see <code>AgentMovementSpeeds::EAgentMovementUrgency</code>).

SetStance

Sets the specified entity's stance.

Syntax

```
AI.SetStance(entityId, stance)
```

Parameter	Description
entityId	The ID of the entity.
stance	The stance value (STANCE_*).

SetTargetTrackClassThreat

Sets the class threat for a specified entity's target track.

Syntax

```
AI.SetTargetTrackClassThreat(entityId, classThreat)
```

Parameter	Description
entityId	The ID of the entity.
classThreat	New class threat value.

SetTempTargetPriority

Sets a specified entity's selection priority for a temporary target over other potential targets.

Syntax

```
AI.SetTempTargetPriority(entityId, priority)
```

Returns True if successfully updated.

Parameter	Description
entityId	The ID of the entity.
priority	New priority value.

SetTerritoryShapeName

Sets the territory shape of the specified AI entity.

Syntax

```
AI.SetTerritoryShapeName(entityId, shapeName)
```

Parameter	Description
entityId	The ID of the entity.
shapeName	Name of the shape to set.

SetUnitProperties

Sets the leader's knowledge about the unit's combat capabilities. The leader is identified based on the group ID of the entity.

Syntax

```
AI.SetUnitProperties(entityId, unitProperties)
```

Parameter	Description
entityId	The ID of the entity.
unitProperties	Binary mask of unit properties in the following form: UPR_* + UPR* (UPR_COMBAT_GROUND + UPR_COMBAT_FLIGHT) See IAgent.h for a definition of the UPR_* unit properties.

SetUseSecondaryVehicleWeapon

Enables or disables the AI object's ability to use the secondary weapon when firing from a vehicle gunner seat if possible.

Syntax

```
AI.SetUseSecondaryVehicleWeapon(entityId, bUseSecondary)
```

Parameter	Description
entityId	The ID of the entity.
bUseSecondary	Specify true to use the secondary weapon; otherwise, false.

Signal

Adds a signal to the sender's signal queue even if another signal with same text is present.

Syntax

```
AI.Signal(signalFilter, signalType, signalText, senderId [, signalExtraData])
```

Parameter	Description
signalFilter	The signal filter.
signalType	The signal type.
signalText	Signal text that is processed by the receivers, either in a Lua callback with the same name as the text or directly by the CAIObject.
senderId	The ID of the sender.

Parameter	Description
signalExtraData	Optional. A Lua table containing additional data. It can contain the following data types: <ul style="list-style-type: none"> • point – A vector in the format {x,y,z}. • point2 – A vector in the format {x,y,z}. • ObjectName – A string. • id – An entity ID. • fValue – A float value. • iValue – An integer value. • iValue2 – A second integer value.

SmartObjectEvent

Executes a smart action.

Syntax

```
AI.SmartObjectEvent(actionName, userEntityId, objectEntityId [, vRefPoint])
```

Returns 0 if a smart object rule was not found or if a non-zero ID was inserted to execute the action.

Parameter	Description
actionName	The name of the smart action.
usedEntityId	The entity ID of the user who wants to execute the smart action, or none if the user is unknown.
objectEntityId	The entity ID of the object on which the smart action is to be executed, or none if the object is unknown.
vRefPoint	Optional. The reference point to be used instead of the user's attention target position.

SoundEvent

Generates a sound event with the specified parameters in the AI system.

Syntax

```
AI.SoundEvent(position, radius, threat, interest, entityId)
```

Parameter	Description
position	Origin of the sound event.
radius	Area the sound event is heard in.
threat	Sound event property.

Parameter	Description
interest	Sound event property.
entityId	Unique entity ID that generates the sound event.

StopCommunication

Stops specified communication.

Syntax

```
AI.StopCommunication(ScriptHandle playID)
```

Parameter	Description
playID	The ID of the communication to stop.

ThrowGrenade

Throws a specified grenade at a target type without interrupting the fire mode.

Syntax

```
AI.ThrowGrenade(entityId, grenadeType, regTargetType)
```

Parameter	Description
entityId	The ID of the entity.
grenadeType	Requested grenade type (see <code>ERequestedGrenadeType</code>).
regTargetType	The grenade target type (see <code>AI_REG_*</code>).

UnregisterInterestedActor

Unregisters the entity with the interest system. Any errors are recorded in the error log.

Syntax

```
AI.UnregisterInterestedActor(ScriptHandle entityId)
```

Parameter	Description
entityId	The ID of the entity.

UnregisterInterestingEntity

Unregisters the specified entity with the interest system. Any errors are recorded in the error log.

Syntax

```
AI.UnregisterInterestingEntity(ScriptHandle entityId)
```

Parameter	Description
entityId	The ID of the entity.

UnregisterTargetTrack

Unregisters an AI object from the target track manager. The parameter `ai_TargetTracking` must be set to '2'.

Syntax

```
AI.UnregisterTargetTrack(entityId)
```

Returns true if successfully unregistered.

Parameter	Description
entityId	The ID of the entity.

UpdateGlobalPerceptionScale

Syntax

```
AI.UpdateGlobalPerceptionScale(float visualScale, float audioScale)
```

UpdateTempTarget

Updates the position of the specified entity's temporary potential target.

Syntax

```
AI.UpdateTempTarget(entityId, vPos)
```

Returns true if successfully updated.

Parameter	Description
entityId	The ID of the entity.
vPos	New position of the temporary target.

UpTargetPriority

Changes a specified entity's target priority value for a specified target, if the target is on the entity's target list.

Syntax

```
AI.UpTargetPriority(entityId, targetId, increment)
```

Parameter	Description
entityId	The ID of the entity.
targetId	The entity ID of the target.
increment	New value for the target priority.

VisualEvent

Generates a visual event with the specified parameters in the AI system.

Syntax

```
AI.VisualEvent(entityId, targetId)
```

Parameter	Description
entityId	The ID of the entity that receives the visual event.
targetId	The ID of the visual target (that the entity is seeing).

Warning

Writes a warning message to the log about data or script errors.

Syntax

```
AI.Warning(szMessage)
```

Parameter	Description
szMessage	The message to write to the log.

ScriptBind_Entity

Lists the entity related Lua script bind functions.

Activate

Activates or deactivates the entity. `Activate` ignores the update policy and forces an entity to activate or deactivate. All active entities are updated every frame.

Warning

Having too many active entities can affect performance.

Syntax

```
Entity.Activate(int bActive)
```

Parameters

Parameter	Description
bActive	Specify true to make the entity active; false to make it inactive.

ActivateOutput

Syntax

```
Entity.ActivateOutput()
```

ActivatePlayerPhysics

Syntax

```
Entity.ActivatePlayerPhysics(bool bEnable)
```

AddConstraint

Syntax

```
Entity.AddConstraint()
```

AddImpulse

Apply an impulse to the entity. At least four parameters need to be provided for a linear impulse. For an additional angular impulse, at least seven parameters need to be provided.

Syntax

```
Entity.AddImpulse(ipart, position, direction, linearImpulse,  
linearImpulseScale, angularAxis, angularImpulse, massScale)
```

Parameters

Parameter	Description
ipart	The index of the part that receives the impulse.
position	The point (in world coordinates) where the impulse is applied. Set this to (0, 0, 0) to ignore it.
direction	The direction in which the impulse is applied.
linearImpulse	The force of the linear impulse.

Parameter	Description
linearImpulseScale	Scaling of the linear impulse. (Default: 1.0)
angularAxis	The axis on which the angular impulse is applied.
angularImpulse	The force of the the angular impulse.
massScale	Mass scaling of the angular impulse. (Default: 1.0)

AttachChild

Syntax

```
Entity.AttachChild(ScriptHandle childEntityId, int flags)
```

AttachSurfaceEffect

Syntax

```
Entity.AttachSurfaceEffect(int nSlot, const char *effect, bool countPerUnit, const char *form, const char *typ, float countScale, float sizeScale)
```

AuxAudioProxiesMoveWithEntity

Set whether AuxAudioProxies should move with the entity or not.

Syntax

```
Entity.AuxAudioProxiesMoveWithEntity(bool const bCanMoveWithEntity)
```

Returns: nil

Parameters

Parameter	Description
bCanMoveWithEntity	Boolean parameter to enable or disable

AwakeCharacterPhysics

Syntax

```
Entity.AwakeCharacterPhysics(int nSlot, const char *sRootBoneName, int nAwake)
```

AwakeEnvironment

Syntax

```
Entity.AwakeEnvironment()
```

AwakePhysics

Syntax

```
Entity.AwakePhysics(int nAwake)
```

BreakToPieces

Breaks static geometry in slot 0 into sub objects and spawn them as particles or entities.

Syntax

```
Entity.BreakToPieces(int nSlot, int nPiecesSlot, float fExplodeImp, Vec3  
vHitPt, Vec3 vHitImp, float fLifeTime, bool bSurfaceEffects)
```

CalcWorldAnglesFromRelativeDir

Syntax

```
Entity.CalcWorldAnglesFromRelativeDir(Vec3 dir)
```

CancelSubpipe

Syntax

```
Entity.CancelSubpipe()
```

ChangeAttachmentMaterial

Syntax

```
Entity.ChangeAttachmentMaterial(const char *attachmentName, const char  
*materialName)
```

CharacterUpdateAlways

Syntax

```
Entity.CharacterUpdateAlways(int characterSlot, bool updateAlways)
```

CharacterUpdateOnRender

Syntax

```
Entity.CharacterUpdateOnRender(int characterSlot, bool bUpdateOnRender)
```

CheckCollisions

Syntax

```
Entity.CheckCollisions()
```

CheckShaderParamCallbacks

Check all the currently set shader param callbacks on the renderproxy with the current state of the entity.

Syntax

```
Entity.UpdateShaderParamCallback()
```

CloneMaterial

Replace material on the slot with a cloned version of the material. Cloned material can be freely changed uniquely for this entity.

Syntax

```
Entity.CloneMaterial(int slot)
```

Parameters

Parameter	Description
slot	ID of the slot on which to clone material.
sSubMaterialName	If this is a non empty string this specific sub-material is cloned.

CopySlotTM

Copies the TM (Transformation Matrix) of the slot.

Syntax

```
Entity.CopySlotTM(int destSlot, int srcSlot, bool includeTranslation)
```

Parameters

Parameter	Description
destSlot	Destination slot identifier.
srcSlot	Source slot identifier.
includeTranslation	True to include the translation, false otherwise.

CountLinks

Counts all outgoing links of the entity.

Syntax

```
Entity.CountLinks()
```

Returns: Number of outgoing links.

CreateAuxAudioProxy

Creates an additional AudioProxy managed by the EntityAudioProxy. The created AuxAudioProxy will move and rotate with the parent EntityAudioProxy.

Syntax

```
Entity.CreateAuxAudioProxy()
```

Returns: Returns the ID of the additionally created AudioProxy.

CreateBoneAttachment

Syntax

```
Entity.CreateBoneAttachment(int characterSlot, const char *boneName, const char *attachmentName)
```

CreateCameraComponent

Create a camera component for the entity. Allows the entity to serve as camera source for material assigned to the entity.

Syntax

```
Entity.CreateCameraComponent()
```

CreateDRSProxy

Creates a Dynamic Response System Proxy

Syntax

```
Entity.CreatedRSPProxy()
```

Returns: Returns the ID of the created proxy.

CreateLink

Creates a new outgoing link for this entity.

Syntax

```
Entity.CreateLink(const char *name)
```

Returns: nothing

Parameters

Parameter	Description
name	Name of the link. Does not have to be unique among all the links of this entity. Multiple links with the same name can coexist.
(optional) targetId	If specified, the ID of the entity the link shall target. If not specified or 0 then the link will not target anything. Default value: 0

CreateRenderComponent

Create a render component object for the entity. Allows an entity to be rendered immediately without loading any assets.

Syntax

```
Entity.CreateRenderComponent()
```

CreateSkinAttachment

Syntax

```
Entity.CreateSkinAttachment(int characterSlot, const char *attachmentName)
```

Damage

Syntax

```
Entity.Damage()
```

DeleteParticleEmitter

Deletes particles emitter from 3dengine.

Syntax

```
Entity.DeleteParticleEmitter(int slot)
```

Parameters

Parameter	Description
slot	slot number

DeleteThis

Deletes the current entity.

Syntax

```
Entity.DeleteThis()
```

DestroyAttachment

Syntax

```
Entity.DestroyAttachment(int characterSlot, const char *attachmentName)
```

DestroyPhysics

Syntax

```
Entity.DestroyPhysics()
```

DetachAll

Syntax

```
Entity.DetachAll()
```

DetachThis

Syntax

```
Entity.DetachThis()
```

DisableAnimationEvent

Syntax

```
Entity.DisableAnimationEvent(int nSlot, const char *sAnimation)
```

DrawSlot

Enables/Disables drawing of object or character at specified slot of the entity.

Syntax

```
Entity.DrawSlot(int nSlot, int nEnable)
```

Parameters

Parameter	Description
nSlot	Slot identifier.
nEnable	1-Enable drawing, 0-Disable drawing.

EnableBoneAnimation

Syntax

```
Entity.EnableBoneAnimation(int characterSlot, int layer, const char  
*boneName, bool status)
```

EnableBoneAnimationAll

Syntax

```
Entity.EnableBoneAnimationAll(int characterSlot, int layer, bool status)
```

EnableDecals

Enables decals.

Syntax

```
Entity.EnableDecals(int slot, bool enable)
```

EnableInheritXForm

Enables/Disable entity from inheriting transformation from the parent.

Syntax

```
Entity.EnableInheritXForm(bool bEnable)
```

EnableMaterialLayer

Syntax

```
Entity.EnableMaterialLayer(bool enable, int layer)
```

EnablePhysics

Syntax

```
Entity.EnablePhysics(bool bEnable)
```

EnableProceduralFacialAnimation

Syntax

```
Entity.EnableProceduralFacialAnimation(bool enable)
```

ExecuteAudioTrigger

Execute the specified audio trigger and attach it to the entity. The created audio object will move and rotate with the entity.

Syntax

```
Entity.ExecuteAudioTrigger(ScriptHandle const hTriggerID, ScriptHandle const hAudioProxyLocalID)
```

Returns: nil

Parameters

Parameter	Description
hTriggerID	the audio trigger ID handle
hAudioProxyLocalID	The ID of the <code>AuxAudioProxy</code> that is local to the <code>EntityAudioProxy</code> . To address the default <code>AuxAudioProxy</code> , pass 1. To address all <code>AuxAudioProxy</code> instances, pass 0.

FadeGlobalDensity

Sets the fade global density.

Syntax

```
Entity.FadeGlobalDensity(int nSlot, float fadeTime, float newGlobalDensity)
```

Parameters

Parameter	Description
nSlot	nSlot identifier.
fadeTime	.
newGlobalDensity	.

ForceCharacterUpdate

Syntax

```
Entity.ForceCharacterUpdate(int characterSlot, bool updateAlways)
```

ForwardTriggerEventsTo

Syntax

```
Entity.ForwardTriggerEventsTo(ScriptHandle entityId)
```

FreeAllSlots

Delete all objects on every slot part of the entity.

Syntax

```
Entity.FreeAllSlots()
```

FreeSlot

Delete all objects from specified slot.

Syntax

```
Entity.FreeSlot(int nSlot)
```

Parameters

Parameter	Description
nSlot	Slot identifier.

GetAIName

Syntax

```
Entity.GetAIName()
```

GetAllAuxAudioProxiesID

Returns the ID used to address all AuxAudioProxy of the parent EntityAudioProxy.

Syntax

```
Entity.GetAllAuxAudioProxiesID()
```

Returns: Returns the ID used to address all AuxAudioProxy of the parent EntityAudioProxy.

GetAngles

Gets the angle of the entity.

Syntax

```
Entity.GetAngles()
```

GetAnimationLength

Syntax

```
Entity.GetAnimationLength(int characterSlot, const char *animation)
```

GetAnimationTime

Syntax

```
Entity.GetAnimationTime(int nSlot, int nLayer)
```

GetArchetype

Retrieve the archetype of the entity.

Syntax

```
Entity.GetArchetype()
```

Returns: name of entity archetype, nil if no archetype.

GetAttachmentBone

Syntax

```
Entity.GetAttachmentBone(int characterSlot, const char *attachmentName)
```

GetAttachmentCGF

Syntax

```
Entity.GetAttachmentCGF(int characterSlot, const char *attachmentName)
```

GetBoneAngularVelocity

Syntax

```
Entity.GetBoneAngularVelocity(int characterSlot, const char *boneName)
```

GetBoneDir

Syntax

```
Entity.GetBoneDir()
```

GetBoneLocal

Syntax

```
Entity.GetBoneLocal(const char *boneName, Vec3 trgDir)
```

GetBoneNameFromTable

Syntax

```
Entity.GetBoneNameFromTable()
```

GetBonePos

Syntax

```
Entity.GetBonePos()
```

GetBoneVelocity

Syntax

```
Entity.GetBoneVelocity(int characterSlot, const char *boneName)
```

GetCenterOfMassPos

Gets the position of the entity center of mass.

Syntax

```
Entity.GetCenterOfMassPos()
```

GetCharacter

Gets the character for the specified slot if there is any.

Syntax

```
Entity.GetCharacter(int nSlot)
```

GetChild

Syntax

```
Entity.GetChild(int nIndex)
```

GetChildCount

Syntax

```
Entity.GetChildCount()
```

GetCurAnimation

Syntax

```
Entity.GetCurAnimation()
```

GetDefaultAuxAudioProxyID

Returns the ID of the default AudioProxy of the parent EntityAudioProxy.

Syntax

```
Entity.GetDefaultAuxAudioProxyID()
```

Returns: Returns the ID of the default AudioProxy of the parent EntityAudioProxy.

GetDirectionVector

Syntax

```
Entity.GetDirectionVector()
```

GetDistance

Syntax

```
float Entity.GetDistance(entityId)
```

Returns: The distance from entity specified with entityId/

GetEntitiesInContact

Syntax

```
Entity.GetEntitiesInContact()
```

GetEntityMaterial

Syntax

```
Entity.GetEntityMaterial()
```

GetExplosionImpulse

Syntax

```
Entity.GetExplosionImpulse()
```

GetExplosionObstruction

Syntax

```
Entity.GetExplosionObstruction()
```

GetFlags

Syntax

```
Entity.GetFlags()
```

GetFlagsExtended

Syntax

```
Entity.GetFlagsExtended()
```

GetGeomCachePrecachedTime

Gets time delta from current playback position to last ready to play frame.

Syntax

```
Entity.GetGeomCachePrecachedTime()
```

GetGravity

Syntax

```
Entity.GetGravity()
```

GetHelperAngles

Syntax

```
Entity.GetHelperAngles()
```

GetHelperDir

Syntax

```
Entity.GetHelperDir()
```

GetHelperPos

Syntax

```
Entity.GetHelperPos()
```

GetLink

Returns the link at given index.

Syntax

```
Entity.GetLink()
```

Returns: The script table of the entity that the i'th link is targeting or nil if the specified index is out of bounds.

Parameters

Parameter	Description
<code>ith</code>	The index of the link that shall be returned.

GetLinkName

Returns the name of the link that is targeting the entity with given ID.

Syntax

```
Entity.GetLinkName(ScriptHandle targetId)
```

Returns: The name of the i'th link targeting given entity or nil if no such link exists.

Parameters

Parameter	Description
targetId	ID of the entity for which the link name shall be looked up.
(optional) ith	If specified, the i'th link that targets given entity. Default value: 0 (first entity)

GetLinkTarget

Returns the ID of the entity that given link is targeting.

Syntax

```
Entity.GetLinkTarget(const char *name)
```

Returns: The ID of the entity that the link is targeting or nil if no such link exists.

Parameters

Parameter	Description
name	Name of the link.
(optional) ith	If specified, the i'th link with given name for which to look up the targeted entity. Default value: 0 (first link with given name)

GetLocalAngles

Syntax

```
Vec3 Entity.GetLocalAngles(vAngles)
```

GetLocalBBox

Syntax

```
Entity.GetLocalBBox()
```

GetLocalPos

Syntax

```
Vec3 Entity.GetLocalPos()
```

GetLocalScale

Syntax

```
float Entity.GetLocalScale()
```

GetLodRatio

Syntax

```
Entity.GetLodRatio()
```

GetMass

Syntax

```
Entity.GetMass()
```

GetMaterial

Syntax

```
Entity.GetMaterial()
```

GetMaterialFloat

Change material parameter.

Syntax

```
Entity.GetMaterialFloat(int slot,int nSubMtlId,const char *sParamName)
```

Returns: Material parameter value.

Parameters

Parameter	Description
slot	ID of the slot on which slot to change material.
nSubMtlId	Specify submaterial by Id.
sParamName	Name of the material parameter.

GetMaterialVec3

Syntax

```
Entity.GetMaterialVec3(int slot,int nSubMtlId,const char *sParamName)
```

GetName

Syntax

```
Entity.GetName()
```

GetParent

Syntax

```
Entity.GetParent()
```

GetParentSlot

Syntax

```
Entity.GetParentSlot(int child)
```

GetPhysicalStats

Some more physics related.

Syntax

```
Entity.GetPhysicalStats()
```

GetPos

Gets the position of the entity.

Syntax

```
Entity.GetPos()
```

GetProjectedWorldBBox

Syntax

```
Entity.GetProjectedWorldBBox()
```

GetRawId

Returns entityId in raw numeric format.

Syntax

```
Entity.GetRawId()
```

GetScale

Gets the scaling value for the entity.

Syntax

```
Entity.GetScale()
```

GetSlotAngles

Gets the slot angles.

Syntax

```
Entity.GetSlotAngles(int nSlot)
```

Parameters

Parameter	Description
nSlot	nSlot identifier.

GetSlotCount

Gets the count of the slots.

Syntax

```
Entity.GetSlotCount()
```

GetSlotHelperPos

Syntax

```
Entity.GetSlotHelperPos(int slot, const char *helperName, bool objectSpace)
```

GetSlotPos

Gets the slot position.

Syntax

```
Entity.GetSlotPos(int nSlot)
```

Parameters

Parameter	Description
nSlot	nSlot identifier.

GetSlotScale

Gets the slot scale amount.

Syntax

```
Entity.GetSlotScale(int nSlot)
```

Parameters

Parameter	Description
nSlot	nSlot identifier.

GetSlotWorldDir

Gets the World direction of the slot.

Syntax

```
Entity.GetSlotWorldDir(int nSlot)
```

Parameters

Parameter	Description
nSlot	Slot identifier.

GetSlotWorldPos

Gets the World position of the slot.

Syntax

```
Entity.GetSlotWorldPos(int nSlot)
```

Parameters

Parameter	Description
nSlot	Slot identifier.

GetSpeed

Syntax

```
Entity.GetSpeed()
```

GetState

Syntax

```
Entity.GetState()
```

GetSubmergedVolume

Syntax

```
Entity.GetSubmergedVolume(int slot, Vec3 planeNormal, Vec3 planeOrigin)
```

GetTimeOfDayHour

Syntax

```
Entity.GetTimeOfDayHour()
```

Returns: current time of day as a float value.

GetTimeSinceLastSeen

Syntax

```
Entity.GetTimeSinceLastSeen()
```

GetTouchedPoint

Retrieves point of collision for rigid body.

Syntax

```
Entity.GetTouchedPoint()
```

GetTouchedSurfaceID

Syntax

```
Entity.GetTouchedSurfaceID()
```

GetTriggerBBox

Syntax

```
Entity.GetTriggerBBox()
```

GetUpdateRadius

Syntax

```
Entity.GetUpdateRadius()
```

GetVelocity

Syntax

```
Entity.GetVelocity()
```

GetVelocityEx

Syntax

```
Entity.GetVelocityEx()
```

GetViewDistanceMultiplier

Get the view distance multiplier.

Syntax

```
Entity.GetViewDistanceMultiplier()
```

GetVolume

Syntax

```
Entity.GetVolume(int slot)
```

GetWorldAngles

Syntax

```
Vec3 Entity.GetWorldAngles(vAngles)
```

GetWorldBBBox

Syntax

```
Entity.GetWorldBBBox()
```

GetWorldBoundsCenter

Gets the world bbox center for the entity (defaults to entity position if no bbox present).

Syntax

```
Entity.GetWorldBoundsCenter()
```

GetWorldDir

Syntax

```
Vec3 Entity.GetWorldDir()
```

GetWorldPos

Syntax

```
Vec3 Entity.GetWorldPos()
```

GetWorldScale

Syntax

```
float Entity.GetWorldScale()
```

GotoState

Syntax

```
Entity.GotoState(const char *sState)
```

HasFlags

Syntax

```
Entity.HasFlags(int flags)
```

HasFlagsExtended

Syntax

```
Entity.HasFlagsExtended(int flags)
```

Hide

Syntax

```
Entity.Hide()
```

HideAllAttachments

Syntax

```
Entity.HideAllAttachments(int characterSlot, bool hide, bool hideShadow)
```

HideAttachment

Syntax

```
Entity.HideAttachment(int characterSlot, const char *attachmentName, bool  
hide, bool hideShadow)
```

HideAttachmentMaster

Syntax

```
Entity.HideAttachmentMaster(int characterSlot, bool hide)
```

IgnorePhysicsUpdatesOnSlot

Ignore physics when updating the position of a slot.

Syntax

```
Entity.IgnorePhysicsUpdatesOnSlot(int nSlot)
```

Parameters

Parameter	Description
nSlot	Slot identifier.

InsertSubpipe

Syntax

```
Entity.InsertSubpipe()
```

IntersectRay

Syntax

```
Entity.IntersectRay(int slot, Vec3 rayOrigin, Vec3 rayDir, float maxDistance)
```

InvalidateTrigger

Syntax

```
Entity.InvalidateTrigger()
```

IsActive

Retrieve active status of entity.

Syntax

```
Entity.IsActive(bActivate)
```

Returns: true - Entity is active. false - Entity is not active.

IsAnimationRunning

Syntax

```
Entity.IsAnimationRunning(int characterSlot, int layer)
```

Returns: nil or not nil

Parameters

Parameter	Description
characterSlot	Index of the character slot.
layer	Index of the animation layer.

IsColliding

Syntax

```
Entity.IsColliding()
```

IsEntityInside

Syntax

```
float Entity.IsEntityInside(entityId)
```

IsEntityInsideArea

Syntax

```
Entity.IsEntityInsideArea(int areaId, ScriptHandle entityId)
```

IsFromPool

Returns if the entity came from an entity pool.

Syntax

```
Entity.IsFromPool()
```

Returns: true - Entity is from a pool. (Bookmarked) false - Entity is not from a pool. (Not bookmarked)

IsGeomCacheStreaming

Syntax

```
Entity.IsGeomCacheStreaming()
```

Returns: true if geom cache is streaming.

IsHidden

Syntax

```
Entity.IsHidden()
```

IsInState

Syntax

```
Entity.IsInState(const char *sState)
```

IsPointInsideArea

Syntax

```
Entity.IsPointInsideArea(int areaId, Vec3 point)
```

IsSlotCharacter

Checks if the slot is a character.

Syntax

```
Entity.IsSlotCharacter(int slot)
```

Parameters

Parameter	Description
slot	Slot identifier.

IsSlotGeometry

Checks if the slot is a geometry.

Syntax

```
Entity.IsSlotGeometry(int slot)
```

Parameters

Parameter	Description
slot	Slot identifier.

IsSlotLight

Checks if the slot is a light.

Syntax

```
Entity.IsSlotLight(int slot)
```

Parameters

Parameter	Description
slot	Slot identifier.

IsSlotParticleEmitter

Checks if the slot is a particle emitter.

Syntax

```
Entity.IsSlotParticleEmitter(int slot)
```

Parameters

Parameter	Description
slot	Slot identifier.

IsSlotValid

Checks if the slot is valid.

Syntax

```
Entity.IsSlotValid(int nSlot)
```

Parameters

Parameter	Description
nSlot	Slot identifier.

IsUsingPipe

Syntax

```
Entity.IsUsingPipe()
```

Returns: True if the entity is running a goalpipe or has it inserted; otherwise, false.

KillTimer

Syntax

```
Entity.KillTimer()
```

LoadCharacter

Load CGF geometry into the entity slot.

Syntax

```
Entity.LoadCharacter(int nSlot, const char *sFilename)
```

Parameters

Parameter	Description
nSlot	Slot identifier.
sFilename	CGF geometry file name.

LoadCloud

Loads the cloud XML file into the entity slot.

Syntax

```
Entity.LoadCloud(int nSlot, const char *sFilename)
```

Parameters

Parameter	Description
nSlot	Slot identifier.
sFilename	Filename.

LoadFogVolume

Loads the fog volume XML file into the entity slot.

Syntax

```
Entity.LoadFogVolume(int nSlot, SmartScriptTable table)
```

Parameters

Parameter	Description
nSlot	Slot identifier.
table	Table with fog volume properties.

LoadGeomCache

Load geom cache into the entity slot.

Syntax

```
Entity.LoadGeomCache(int nSlot,const char *sFilename)
```

Parameters

Parameter	Description
nSlot	Slot identifier.
sFilename	CAX file name.

LoadLight

Load CGF geometry into the entity slot.

Syntax

```
Entity.LoadLight(int nSlot,SmartScriptTable table)
```

Parameters

Parameter	Description
nSlot	Slot identifier.
table	Table with all the light information.

LoadObject

Load CGF geometry into the entity slot.

Syntax

```
Entity.LoadObject(int nSlot,const char *sFilename)
```

Parameters

Parameter	Description
nSlot	Slot identifier.
sFilename	CGF geometry file name.

LoadObjectLattice

Load lattice into the entity slot.

Syntax

```
Entity.LoadObjectLattice(int nSlot)
```

LoadObjectWithFlags

Load CGF geometry into the entity slot.

Syntax

```
Entity.LoadObjectWithFlags(int nSlot, const char *sFilename, const int nFlags)
```

Parameters

Parameter	Description
nSlot	Slot identifier.
sFilename	CGF geometry file name.
nFlags	entity load flags

LoadParticleEffect

Loads CGF geometry into the entity slot.

Syntax

```
Entity.LoadParticleEffect(int nSlot, const char *sEffectName,  
SmartScriptTable table)
```

Parameters

Parameter	Description
nSlot	Slot identifier.
sEffectName	Name of the particle effect (Ex: "explosions/rocket").
(optional) bPrime	Whether effect starts fully primed to equilibrium state.
(optional) fPulsePeriod	Time period between particle effect restarts.
(optional) fScale	Size scale to apply to particles
(optional) fCountScale	Count multiplier to apply to particles
(optional) bScalePerUnit	Scale size by attachment extent
(optional) bCountPerUnit	Scale count by attachment extent
(optional) sAttachType	string for EGeomType
(optional) sAttachForm	string for EGeomForm

LoadSubObject

Load geometry of one CGF node into the entity slot.

Syntax

```
Entity.LoadSubObject(int nSlot, const char *sFilename, const char *sGeomName)
```

Parameters

Parameter	Description
nSlot	Slot identifier.
sFilename	CGF geometry file name.
sGeomName	Name of the node inside CGF geometry.

LoadVolumeObject

Loads volume object.

Syntax

```
Entity.LoadVolumeObject(int nSlot, const char* sFilename)
```

Parameters

Parameter	Description
nSlot	Slot identifier.
sFilename	File name of the volume object.

LookAt

Orient the entity to look at a world space position.

Syntax

```
Entity.LookAt(Vec3 target, Vec3 axis, float angle)
```

Parameters

Parameter	Description
target	The position to look at.
axis	The correction axis. The quat type is not supported.
angle	The correction angle in radians. The quat type is not supported.

MultiplyWithSlotTM

Multiplies with the TM (Transformation Matrix) of the slot.

Syntax

```
Entity.MultiplyWithSlotTM(int slot, Vec3 pos)
```

Parameters

Parameter	Description
slot	Slot identifier.
pos	Position vector.

NetPresent

Syntax

```
Entity.NetPresent()
```

NoBulletForce

Syntax

```
Entity.NoBulletForce(bool state)
```

NoExplosionCollision

Syntax

```
Entity.NoExplosionCollision()
```

PassParamsToPipe

Syntax

```
Entity.PassParamsToPipe()
```

Physicalize

Create physical entity from the specified entity slot.

Syntax

```
Entity.Physicalize(int nSlot, int nPhysicsType, SmartScriptTable physicsParams)
```

Parameters

Parameter	Description
nSlot	Slot identifier of the entity to physicalize. Specify -1 to use geometries from all slots.

Parameter	Description
nPhysicsType	Type of physical entity to create. For possible values, see the nPhysicsType Keys table later in this section.
physicsParams	Table with physicalization parameters. For more information, see the physicsParams Table Keys table later in this section.

nPhysicsType Keys

Physics Type	Meaning
PE_AREA	Physical Area (Sphere,Box,Geometry or Shape).
PE_ARTICULATED	Ragdolls or other articulated physical entities that consist of rigid bodies connected by joints.
PE_LIVING	Live physical entity that can move through the physical world and interact with it.
PE_NONE	No physics.
PE_PARTICLE	A physical particle entity that it has only mass and radius.
PE_RIGID	Rigid body physical entity. Can have infinite mass (specified by setting mass to 0).
PE_ROPE	A physical representation of a rope. The rope can hang freely or connect two physical entities.
PE_SOFT	A system of non-rigidly connected vertices that can interact with the environment. Used for soft body physics like cloth simulation.
PE_STATIC	A static, immovable physical entity.
PE_WHEELEDVEHICLE	Physical vehicle with wheels.

Note

For more information about physical entity types, see [Physical Entities \(p. 500\)](#).

physicsParams Table Keys

Physics Parameter	Description
area	This table must be set when Physics Type is PE_AREA. For more information, see the Area Table Keys table later in this section.
density	Object density, only used if mass is not specified or -1.
flags	Physical entity flags.
living	This table must be set when Physics Type is PE_LIVING. For more information, see the Living Table Keys table later in this section.
mass	Object mass, only used if density is not specified or -1.
particle	This table must be set when Physics Type is PE_PARTICLE. For more information, see the Particle Table Keys table later in this section.
partid	Index of the articulated body part to which the new physical entity will be attached.

Physics Parameter	Description
stiffness_scale	Scale of character joint stiffness (multiplied with stiffness values specified from the exported model)

Particle Table Keys

Particle Parameter	Description
accel_lift	Acceleration that lifts particle with the current speed
accel_thrust	Acceleration along direction of movement
air_resistance	The air resistance coefficient, $F = kv$
constant_orientation	(0,1) Keep constant orientation
gravity	Gravity force vector to the air
mass	Particle mass
min_bounce_vel	Minimal velocity at which particle bounces off the surface
no_path_alignment	(0,1) Do not align particle orientation to the movement path
no_roll	(0,1) Do not roll particle on terrain
no_spin	(0,1) Do not spin particle in air
radius	Particle pseudo radius
single_contact	(0,1) Calculate only one first contact
thickness	Thickness when lying on a surface (if 0, the radius is used)
velocity	Velocity direction and magnitude vector
water_gravity	Gravity force vector when in the water.
water_resistance	Water resistance coefficient, $F = kv$

Living Table Keys

Living Parameter	Description
air_resistance	Air control coefficient 0..1, 1 - special value (total control of movement)
gravity	Vertical gravity magnitude
head_radius	Radius of the head
height	Vertical offset of collision geometry center
height_eye	Vertical offset of the camera
height_head	Vertical offset of the head
height_pivot	Offset from central ground position that is considered the entity center

Living Parameter	Description
inertia	Inertia coefficient, the greater the value, the less the inertia; 0 means no inertia.
mass	Mass of the player (in kg)
max_climb_angle	Player cannot climb surface which slope is steeper than this angle (in radians)
max_jump_angle	Player is not allowed to jump towards ground if this angle is exceeded (in radians)
max_vel_ground	Player cannot stand on surfaces that are moving faster than this (in radians)
min_fall_angle	Player starts falling when slope is steeper than this (in radians)
min_slide_angle	If surface slope is more than this angle, player starts sliding (in radians)
size	Collision cylinder dimensions vector (x,y,z).

Area Table Keys

Area Parameter	Description
box_max	Max vector of bounding box, must be specified if type is AREA_BOX
box_min	Min vector of bounding box, must be specified if type is AREA_BOX
falloff	Ellipsoidal falloff dimensions; 0,0,0 specifies no falloff
gravity	Gravity vector inside the physical area
height	Height of the 2D area (AREA_SHAPE), relative to the minimal Z in the points table
points	A table that contains an indexed collection of vectors in local entity space that define the 2D shape of the area (AREA_SHAPE)
radius	Radius of the area sphere; must be specified if type is AREA_SPHERE.
type	Type of the area, valid values are: AREA_SPHERE, AREA_BOX, AREA_GEOMETRY, or AREA_SHAPE
uniform	Same direction in every point, or always point to the center.

PhysicalizeAttachment

Syntax

```
Entity.PhysicalizeAttachment(int characterSlot, const char* attachmentName,
    bool physicalize)
```

PhysicalizeSlot

Syntax

```
Entity.PhysicalizeSlot(int slot, SmartScriptTable physicsParams)
```

PlayFacialAnimation

Syntax

```
Entity.PlayFacialAnimation(char* name, bool looping)
```

PreLoadParticleEffect

Pre-loads a particle effect.

Syntax

```
Entity.PreLoadParticleEffect(const char *sEffectName)
```

Parameters

Parameter	Description
sEffectName	Name of the particle effect (Ex: "explosions/rocket").

ProcessBroadcastEvent

Syntax

```
Entity.ProcessBroadcastEvent()
```

RagDollize

Syntax

```
Entity.RagDollize(int slot)
```

ReattachSoftEntityVtx

Syntax

```
Entity.ReattachSoftEntityVtx(ScriptHandle entityId, int partId)
```

RedirectAnimationToLayer0

Syntax

```
Entity.RedirectAnimationToLayer0(int characterSlot, bool redirect)
```

RegisterForAreaEvents

Registers the script proxy so that it receives area events for this entity.

Syntax

```
Entity.RegisterForAreaEvents(int enable)
```

Parameters

Parameter	Description
enable	Specify 0 to disable, or any other value to enable.

RemoveAllLinks

Removes all links of an entity.

Syntax

```
Entity.RemoveAllLinks()
```

Returns: nothing

RemoveAuxAudioProxy

Removes the `AuxAudioProxy` corresponding to the passed ID from the parent `EntityAudioProxy`.

Syntax

```
Entity.RemoveAuxAudioProxy(ScriptHandle const hAudioProxyLocalID)
```

Returns: nil

Parameters

Parameter	Description
hAudioProxyLocalID	The ID of the <code>AuxAudioProxy</code> to be removed from the parent <code>EntityAudioProxy</code> .

RemoveDecals

Syntax

```
Entity.RemoveDecals()
```

RemoveLink

Removes an outgoing link from the entity.

Syntax

```
Entity.RemoveLink(const char *name)
```

Returns: nothing

Parameters

Parameter	Description
name	Name of the link to remove.
(optional) ith	If specified, the <i>th link with the name specified that will be removed. Default value: 0 (first link with given name)

RenderAlways

Enables 'always render' on the render node, skipping any kind of culling.

Syntax

```
Entity.RenderAlways(int enable)
```

Parameters

Parameter	Description
enable	Specify 0 to disable, or any other value to enable.

RenderShadow

Syntax

```
Entity.RenderShadow()
```

ReplaceMaterial

Syntax

```
Entity.ReplaceMaterial(int slot, const char *name, const char *replacement)
```

ResetAnimation

Syntax

```
Entity.ResetAnimation(int characterSlot, int layer)
```

ResetAttachment

Syntax

```
Entity.ResetAttachment(int characterSlot, const char *attachmentName)
```

ResetMaterial

Syntax

```
Entity.ResetMaterial(int slot)
```

ResetPhysics

Syntax

```
Entity.ResetPhysics()
```

SelectPipe

Syntax

```
Entity.SelectPipe()
```

SetAIName

Syntax

```
Entity.SetAIName()
```

SetAngles

Sets the angle of the entity.

Syntax

```
Entity.SetAngles(Ang3 vAngles)
```

Parameters

Parameter	Description
vAngles	Angle vector.

SetAnimateOffScreenShadow

Syntax

```
Entity.SetAnimateOffScreenShadow(bool bAnimateOffScreenShadow)
```

SetAnimationBlendOut

Syntax

```
Entity.SetAnimationBlendOut(int characterSlot, int layer, float blendOut)
```

SetAnimationEvent

Syntax

```
Entity.SetAnimationEvent(int nSlot,const char *sAnimation)
```

SetAnimationFlip

Syntax

```
Entity.SetAnimationFlip(int characterSlot, Vec3 flip)
```

SetAnimationKeyEvent

Syntax

```
Entity.SetAnimationKeyEvent(nSlot, sAnimation, nFrameID, sEvent)
```

SetAnimationSpeed

Syntax

```
Entity.SetAnimationSpeed(int characterSlot, int layer, float speed)
```

SetAnimationTime

Syntax

```
Entity.SetAnimationTime(int nSlot,int nLayer,float fTime)
```

SetAttachmentAngles

Syntax

```
Entity.SetAttachmentAngles(int characterSlot, const char *attachmentName,  
Vec3 angles)
```

SetAttachmentCGF

Syntax

```
Entity.SetAttachmentCGF(int characterSlot, const char *attachmentName, const  
char* filePath)
```

SetAttachmentDir

Syntax

```
Entity.SetAttachmentDir(int characterSlot, const char *attachmentName, Vec3  
dir, bool worldSpace)
```

SetAttachmentEffect

Syntax

```
Entity.SetAttachmentEffect(int characterSlot, const char *attachmentName,  
const char *effectName, Vec3 offset, Vec3 dir, float scale, int flags)
```

SetAttachmentLight

Syntax

```
Entity.SetAttachmentLight(int characterSlot, const char *attachmentName,  
SmartScriptTable lightTable, int flags)
```

SetAttachmentObject

Syntax

```
Entity.SetAttachmentObject(int characterSlot, const char *attachmentName,  
ScriptHandle entityId, int slot, int flags)
```

SetAttachmentPos

Syntax

```
Entity.SetAttachmentPos(int characterSlot, const char *attachmentName, Vec3  
pos)
```

SetAudioEnvironmentID

Sets the ID of the audio environment that an entity will specify for the entities that it contains.

Syntax

```
Entity.SetAudioEnvironmentID(ScriptHandle const hAudioEnvironmentID)
```

Returns: nil

Parameters

Parameter	Description
hAudioEnvironmentID	audio environment ID

SetAudioObstructionCalcType

Set the Audio Obstruction/Occlusion calculation type on the underlying GameAudioObject.

Syntax

```
Entity.SetAudioObstructionCalcType(int const nObstructionCalcType,  
ScriptHandle const hAudioProxyLocalID)
```

Returns: nil

Parameters

Parameter	Description
nObstructionCalcType	Obstruction/Occlusion calculation type; Possible values: 0 - ignore Obstruction/Occlusion 1 - use single physics ray 2 - use multiple physics rays (currently 5 per object)
hAudioProxyLocalID	The ID of the AuxAudioProxy that is local to the EntityAudioProxy. To address the default AuxAudioProxy, pass 1. To address all AuxAudioProxy instances, pass 0.

SetAudioProxyOffset

Set offset on the audio proxy attached to the entity.

Syntax

```
Entity.SetAudioProxyOffset(Vec3 const vOffset, ScriptHandle const hAudioProxyLocalID)
```

Returns: nil

Parameters

Parameter	Description
vOffset	The offset vector
hAudioProxyLocalID	The ID of the AuxAudioProxy that is local to the EntityAudioProxy. To address the default AuxAudioProxy, pass 1. To address all AuxAudioProxy instances, pass 0.

SetAudioRtpcValue

Set the specified audio RTPC to the specified value on the current entity.

Syntax

```
Entity.SetAudioRtpcValue(ScriptHandle const hRtpcID, float const fValue, ScriptHandle const hAudioProxyLocalID)
```

Returns: nil

Parameters

Parameter	Description
hRtpcID	The audio RTPC ID handle

Parameter	Description
fValue	The RTPC value
hAudioProxyLocalID	The ID of the <code>AuxAudioProxy</code> that is local to the <code>EntityAudioProxy</code> . To address the default <code>AuxAudioProxy</code> , pass 1. To address all <code>AuxAudioProxy</code> instances, pass 0.

SetAudioSwitchState

Set the specified audio switch to the specified state on the current Entity.

Syntax

```
Entity.SetAudioSwitchState(ScriptHandle const hSwitchID, ScriptHandle const hSwitchStateID, ScriptHandle const hAudioProxyLocalID)
```

Returns: nil

Parameters

Parameter	Description
hSwitchID	The audio switch ID handle
hSwitchStateID	The switch state ID handle
hAudioProxyLocalID	The ID of the <code>AuxAudioProxy</code> that is local to the <code>EntityAudioProxy</code> . To address the default <code>AuxAudioProxy</code> , pass 1. To address all <code>AuxAudioProxy</code> instances, pass 0.

SetCharacterPhysicParams

Syntax

```
Entity.SetCharacterPhysicParams()
```

SetCloudMovementProperties

Sets the cloud movement properties.

Syntax

```
Entity.SetCloudMovementProperties(int nSlot, SmartScriptTable table)
```

Parameters

Parameter	Description
nSlot	Slot identifier.

Parameter	Description
table	Table property for the cloud movement.

SetColliderMode

Syntax

```
Entity.SetColliderMode(int mode)
```

SetCurrentAudioEnvironments

Sets the correct audio environment amounts based on the entity's position in the world.

Syntax

```
Entity.SetCurrentAudioEnvironments()
```

Returns: nil

SetDefaultIdleAnimations

Syntax

```
Entity.SetDefaultIdleAnimations()
```

SetDirectionVector

Syntax

```
Entity.SetDirectionVector(Vec3 dir)
```

SetEnvironmentFadeDistance

Sets the distance over which this entity fades the audio environment for all approaching entities.

Syntax

```
Entity.SetEnvironmentFadeDistance(float const fEnvironmentFadeDistance)
```

Returns: nil

Parameters

Parameter	Description
fEnvironmentFadeDistance	The fade distance in meters.

SetFadeDistance

Sets the distance at which this entity executes fade calculations.

Syntax

```
Entity.SetFadeDistance(float const fFadeDistance)
```

Returns: nil

Parameters

Parameter	Description
fFadeDistance	The fade distance in meters.

SetFlags

Mode: 0: or 1: and 2: xor

Syntax

```
Entity.SetFlags(int flags, int mode)
```

SetFlagsExtended

Mode: 0: or 1: and 2: xor

Syntax

```
Entity.SetFlagsExtended(int flags, int mode)
```

SetGeomCacheDrawing

Activates or deactivates geom cache drawing.

Syntax

```
Entity.SetGeomCacheDrawing(bool active)
```

SetGeomCacheParams

Sets geometry cache parameters.

Syntax

```
Entity.SetGeomCacheParams(bool looping, const char *standIn, const char *standInMaterial, const char *firstFrameStandIn, const char *firstFrameStandInMaterial, const char *lastFrameStandIn, const char *lastFrameStandInMaterial, float standInDistance, float streamInDistance)
```

SetGeomCachePlaybackTime

Sets the playback time.

Syntax

```
Entity.SetGeomCachePlaybackTime(float time)
```

SetGeomCacheStreaming

Activates/deactivates geom cache streaming.

Syntax

```
Entity.SetGeomCacheStreaming(bool active, float time)
```

SetLightColorParams

changes the color related params of an existing light.

Syntax

```
Entity.SetLightColorParams(int nSlot, Vec3 color, float specular_multiplier)
```

SetLinkTarget

Specifies the entity that an existing link shall target. Use this function to change the target of an existing link.

Syntax

```
Entity.SetLinkTarget(const char *name, ScriptHandle targetId)
```

Returns: nothing

Parameters

Parameter	Description
name	Name of the link that shall target given entity.
targetId	The ID of the entity the link shall target. Pass in NULL_ENTITY to make the link no longer target an entity.
(optional) ith	If specified, the <i>th link with given name that targets the specified entity. Default value: 0 (first link with given name)

SetLocalAngles

Syntax

```
Entity.SetLocalAngles(Ang3 vAngles)
```

SetLocalBBox

Syntax

```
Entity.SetLocalBBox(Vec3 vMin,Vec3 vMax)
```

SetLocalPos

Syntax

```
Entity.SetLocalPos(Vec3 vPos)
```

SetLocalScale

Syntax

```
Entity.SetLocalScale(float fScale)
```

SetLodRatio

Syntax

```
Entity.SetLodRatio()
```

SetMaterial

Syntax

```
Entity.SetMaterial()
```

SetMaterialFloat

Change material parameter.

Syntax

```
Entity.SetMaterialFloat(int slot,int nSubMtlId,const char *sParamName,float fValue)
```

Parameters

Parameter	Description
slot	ID of the slot on which to change material.
nSubMtlId	Specify sub-material by ID.
sParamName	Name of the material parameter.
fValue	New material parameter value.

SetMaterialVec3

Syntax

```
Entity.SetMaterialVec3(int slot,int nSubMtlId,const char *sParamName,Vec3  
fValue)
```

SetName

Syntax

```
Entity.SetName()
```

SetParentSlot

Syntax

```
Entity.SetParentSlot(int child, int parent)
```

SetPhysicParams

Syntax

```
Entity.SetPhysicParams()
```

SetPos

Sets the position of the entity.

Syntax

```
Entity.SetPos(Vec3 vPos)
```

Parameters

Parameter	Description
vPos	Position vector.

SetPublicParam

Sets a shader parameter.

Syntax

```
Entity.SetPublicParam()
```

Parameters

Parameter	Description
paramName	The name of the shader parameter.

Parameter	Description
value	The new value of the parameter.

SetRegisterInSectors

Syntax

```
Entity.SetRegisterInSectors()
```

SetScale

Sets the scaling value for the entity.

Syntax

```
Entity.SetScale(float fScale)
```

Parameters

Parameter	Description
fScale	The scale amount.

SetScriptUpdateRate

Syntax

```
Entity.SetScriptUpdateRate(int nMillis)
```

SetSelfAsLightCasterException

Makes the entity render node a caster exception for the light loaded in nLightSlot.

Syntax

```
Entity.SetSelfAsLightCasterException(int nLightSlot)
```

Parameters

Parameter	Description
nLightSlot	Slot where the light is loaded.

SetSlotAngles

Sets the slot angles.

Syntax

```
Entity.SetSlotAngles(int nSlot, Ang3 v)
```

Parameters

Parameter	Description
nSlot	nSlot identifier.
v	Angle to be set.

SetSlotHud3D

Setup flags for use as 3D HUD entity.

Syntax

```
Entity.SetSlotHud3D(int nSlot)
```

Parameters

Parameter	Description
nSlot	Slot identifier.

SetSlotPos

Sets the slot position.

Syntax

```
Entity.SetSlotPos(int slot, Vec3 v)
```

Parameters

Parameter	Description
slot	slot identifier.
v	Position to be set.

SetSlotPosAndDir

Sets the slot position and direction.

Syntax

```
Entity.SetSlotPosAndDir(int nSlot, Vec3 pos, Vec3 dir)
```

Parameters

Parameter	Description
nSlot	nSlot identifier.

Parameter	Description
pos	Position to be set.
dir	Direction to be set.

SetSlotScale

Sets the slot scale amount.

Syntax

```
Entity.SetSlotScale(int nSlot,float fScale)
```

Parameters

Parameter	Description
nSlot	Slot identifier.
fScale	Scale amount for the slot.

SetSlotWorldTM

Sets the World TM (transformation matrix) of the slot.

Syntax

```
Entity.SetSlotWorldTM(int nSlot, Vec3 pos, Vec3 dir)
```

Parameters

Parameter	Description
nSlot	Slot identifier.
pos	Position vector.
dir	Direction vector.

SetStateClientside

Syntax

```
Entity.SetStateClientside()
```

SetTimer

Syntax

```
Entity.SetTimer()
```

SetTriggerBBox

Syntax

```
Entity.SetTriggerBBox(Vec3 vMin,Vec3 vMax)
```

SetUpdatePolicy

Changes the update policy for the entity. Update policy controls when an entity becomes active or inactive (for example, when visible or when in close proximity).

Note

Because all active entities are updated every frame, having too many active entities can affect performance.

Syntax

```
Entity.SetUpdatePolicy(int nUpdatePolicy)
```

Parameters

Parameter	Description
nUpdatePolicy	Update policy constant. See the following table for possible values.

nUpdatePolicy Possible Values

Update Policy	Meaning
ENTITY_UPDATE_NEVER	Never update this entity.
ENTITY_UPDATE_IN_RANGE	Activate entity when in specified radius.
ENTITY_UPDATE_POT_VISIBLE	Activate entity when potentially visible.
ENTITY_UPDATE_VISIBLE	Activate entity when visible in frustum.
ENTITY_UPDATE_PHYSICS	Activate entity when physics awakes, deactivate when physics go to sleep.
ENTITY_UPDATE_PHYSICS_SAME_AS_VISIBLE	Same as ENTITY_UPDATE_PHYSICS, but also activates when visible.
ENTITY_UPDATE_ALWAYS	Entity is always active and updated every frame.

Note

For update policies that require a radius, use [SetUpdateRadius \(p. 668\)](#).

SetUpdateRadius

Syntax

```
Entity.SetUpdateRadius()
```

SetVelocity

Syntax

```
Entity.SetVelocity(Vec3 velocity)
```

SetVelocityEx

Syntax

```
Entity.SetVelocityEx(Vec3 velocity, Vec3 angularVelocity)
```

SetViewDistanceMultiplier

Set the view distance multiplier.

Syntax

```
Entity.SetViewDistanceMultiplier()
```

SetViewDistUnlimited

Syntax

```
Entity.SetViewDistUnlimited()
```

SetVolumeObjectMovementProperties

Sets the properties of the volume object movement.

Syntax

```
Entity.SetVolumeObjectMovementProperties(int nSlot, SmartScriptTable table)
```

Parameters

Parameter	Description
nSlot	Slot identifier.
table	Table with volume object properties.

SetWorldAngles

Syntax

```
Entity.SetWorldAngles(Ang3 vAngles)
```

SetWorldPos

Syntax

```
Entity.SetWorldPos(Vec3 vPos)
```

SetWorldScale

Syntax

```
Entity.SetWorldScale(float fScale)
```

StartAnimation

Syntax

```
Entity.StartAnimation()
```

StopAnimation

Syntax

```
Entity.StopAnimation(int characterSlot, int layer)
```

StopAudioTrigger

Stop the audio event generated by the trigger with the specified ID on this entity.

Syntax

```
Entity.StopAudioTrigger(ScriptHandle const hTriggerID, ScriptHandle const hAudioProxyLocalID)
```

Returns: nil

Parameters

Parameter	Description
hTriggerID	The audio trigger ID handle
hAudioProxyLocalID	The ID of the AuxAudioProxy that is local to the EntityAudioProxy. To address the default AuxAudioProxy, pass 1. To address all AuxAudioProxy instances, pass 0.

ToGlobal

Syntax

```
Entity.ToGlobal(int slotId, Vec3 point)
```

ToLocal

Syntax

```
Entity.ToLocal(int slotId, Vec3 point)
```

TriggerEvent

Syntax

```
Entity.TriggerEvent()
```

UnSeenFrames

Syntax

```
Entity.UnSeenFrames()
```

UpdateAreas

Syntax

```
Entity.UpdateAreas()
```

UpdateLightClipBounds

Update the clip bounds of the light from the linked entities.

Syntax

```
Entity.UpdateLightClipBounds(int nSlot)
```

Parameters

Parameter	Description
nSlot	Slot identifier.

UpdateSlotPhysics

Syntax

```
Entity.UpdateSlotPhysics(int slot)
```

VectorToGlobal

Syntax

```
Entity.VectorToGlobal(int slotId, Vec3 dir)
```

VectorToLocal

Syntax

```
Entity.VectorToLocal(int slotId, Vec3 dir)
```

ScriptBind_Movie

Lists C++ movie functions that can be called from Lua scripts.

AbortSequence

Aborts the specified sequence.

Syntax

```
Movie.AbortSequence(const char *sSequenceName)
```

Parameter	Description
sSequenceName	Sequence name.

PauseSequences

Pauses all the sequences.

Syntax

```
Movie.PauseSequences()
```

PlaySequence

Plays the specified sequence.

Syntax

```
Movie.PlaySequence(const char *sSequenceName)
```

Parameter	Description
sSequenceName	Sequence name.

ResumeSequences

Resume all the sequences.

Syntax

```
Movie.ResumeSequences()
```

StopAllCutScenes

Stops all the cut scenes.

Syntax

```
Movie.StopAllCutScenes()
```

StopAllSequences

Stops all the video sequences.

Syntax

```
Movie.StopAllSequences()
```

StopSequence

Stops the specified sequence.

Syntax

```
Movie.StopSequence(const char *sSequenceName)
```

Parameter	Description
sSequenceName	Sequence name.

ScriptBind_Particle

Lists C++ particle functions that you can call from Lua script.

Attach

Attaches an effect.

Syntax

```
Particle.Attach()
```

CreateDecal

Creates a decal with the specified parameters.

Syntax

```
Particle.CreateDecal(Vec3 pos, Vec3 normal, float size, float lifeTime, const char *textureName)
```

Parameter	Description
pos	The decal position vector.

Parameter	Description
normal	The decal normal vector.
size	The decal size, expressed as a float.
lifeTime	The decal lifetime, expressed as a float.
textureName	The name of the texture.

CreateEffect

Creates a particle effect.

Syntax

```
Particle.CreateEffect(const char *name, SmartScriptTable params)
```

Parameter	Description
name	The name of the particle effect.
params	A SmartScriptTable of effect parameters.

CreateMatDecal

Creates a material decal.

Syntax

```
Particle.CreateMatDecal(Vec3 pos, Vec3 normal, float size, float lifeTime,  
const char *materialName)
```

Parameter	Description
pos	The decal position vector.
normal	The decal normal vector.
size	The decal size, expressed as a float.
lifeTime	The decal lifetime, expressed as a float.
materialName	The name of the material.

DeleteEffect

Deletes the specified particle effect.

Syntax

```
Particle.DeleteEffect(const char *name)
```

Parameter	Description
name	The name of the particle effect to delete.

Detach

Detaches an effect.

Syntax

```
Particle.Detach()
```

IsEffectAvailable

Checks if the specified particle effect is available.

Syntax

```
Particle.IsEffectAvailable(const char *name)
```

Parameter	Description
name	The name of the particle effect to check for availability.

SpawnEffect

Spawns an effect.

Syntax

```
Particle.SpawnEffect(const char *effectName, Vec3 pos, Vec3 dir)
```

Parameter	Description
effectName	The name of the effect to spawn.
pos	The position vector of the effect.
dir	The direction vector of the effect.

SpawnEffectLine

Spawns an effect line.

Syntax

```
Particle.SpawnEffectLine(const char *effectName, Vec3 startPos, Vec3 endPos,  
Vec3 dir, float scale, int slices)
```

Parameter	Description
effectName	The name of the effect.
startPos	The start position of the effect.
endPos	The end position of the effect.
dir	The direction of the effect.
scale	The scale value of the effect, expressed as a float.
slices	The number of slices.

SpawnParticles

Spawns a particle effect.

Syntax

```
Particle.SpawnParticles(SmartScriptTable params, Vec3 pos, Vec3 dir)
```

Parameter	Description
params	A SmartScriptTable of particle effect parameters.
pos	The position vector of the particle effect.
dir	The direction vector of the particle effect.

ScriptBind_Physics

Lists C++ physics functions that you can call from Lua script.

RayTraceCheck

Checks if a ray segment intersects anything from its source to its destination.

Syntax

```
Physics.RayTraceCheck(Vec3 src, Vec3 dst, ScriptHandle  
skipEntityId1, ScriptHandle skipEntityId2)
```

Parameter	Description
src	The origin point of the ray segment.
dst	The end point of the ray segment.
skipEntityId1	Entity ID to skip when checking for intersection.

Parameter	Description
skipEntityId2	Entity ID to skip when checking for intersection.

RayWorldIntersection

Checks if a ray segment intersects anything from its source to its destination.

Syntax

```
Physics.RayWorldIntersection(Vec3 vPos, Vec3 vDir, int nMaxHits, int
iEntTypes [, skipEntityId1 [, skipEntityId2]])
```

Parameter	Description
vPos	The origin point of the ray.
vDir	The direction of the ray.
nMaxHits	The maximum number of hits to return, sorted in nearest to farthest order.
iEntTypes	A bitmask of physical entity types. The ray intersects only with entities that the mask specifies (ent_all,...).
skipEntityId1	Optional. An entity ID to skip when checking for intersection.
skipEntityId2	Optional. An entity ID to skip when checking for intersection.

RegisterExplosionCrack

Registers a new crack for a breakable object.

Syntax

```
Physics.RegisterExplosionCrack(const char *sGeometryFile,int nIdMaterial)
```

Parameter	Description
sGeometryFile	The name of the static geometry file for the crack (CGF).
nMaterialId	The ID of the breakable material to which the crack is applied.

RegisterExplosionShape

Registers a new explosion shape from static geometry.

Note

`RegisterExplosionShape` applies only physical forces; it does not apply any game related explosion damages.

Syntax

```
Physics.RegisterExplosionShape(RegisterExplosionShape(IFunctionHandler  
*pH,const char *sGeometryFile,float fSize,int nIdMaterial,float  
fProbability,const char *sSplintersFile, float fSplintersOffset, const char  
*sSplintersCloudEffect)
```

Parameter	Description
<code>sGeometryFile</code>	The name of the static geometry file (CGF).
<code>fSize</code>	The scale for the static geometry.
<code>nIdMaterial</code>	The ID of the breakable material on which the shape is applied.
<code>fProbability</code>	The preference ratio for using this shape instead of other registered shapes.
<code>sSplintersFile</code>	The name of a CGF file that contains additional non-physicalized splinters to place on cut surfaces.
<code>fSplintersOffset</code>	The lower splinters position in relation to the upper one.
<code>sSplintersCloudEffect</code>	The particle effect when the splinters constraint breaks.

SamplePhysEnvironment

Find the physical entities touched by a sphere.

Syntax

```
Physics.SamplePhysEnvironment(pt, r [, objtypes])
```

Parameter	Description
<code>pt</code>	The center of the sphere.
<code>r</code>	The radius of the sphere.
<code>objtypes</code>	Optional. The types of physical entities that the sphere touches.

SimulateExplosion

Simulates a physical explosion.

Note

`SimulateExplosion` applies only physical forces; it does not apply any game related explosion damages.

Syntax

```
Physics.SimulateExplosion(SmartScriptTable explosionParams)
```

`explosionParams` is a `SmartScriptTable` whose elements are as follows:

`explosionParams` Elements

Parameter	Description
<code>pos</code>	The epicenter of the explosion.
<code>radius</code>	The radius of the explosion.
<code>direction</code>	The direction of the explosion impulse.
<code>impulse_pos</code>	The position of the explosion impulse. This value can be different from the epicenter of the explosion.
<code>impulse_pressure</code>	The pressure of the explosion impulse at the specified radius from the epicenter.
<code>rmin</code>	The minimal radius of the explosion. At this radius, full pressure is applied.
<code>rmax</code>	The maximum radius of the explosion. At this radius, the impulse pressure is close to zero.
<code>hole_size</code>	The size of the hole that the explosion creates in breakable objects.

ScriptBind_Script

Lists C++ script-related functions that you can call from Lua script.

DumpLoadedScripts

Dumps all loaded scripts.

Syntax

```
Script.DumpLoadedScripts()
```

KillTimer

Stops a timer set by the `Script.SetTimer` function.

Syntax

```
Script.KillTimer(ScriptHandle nTimerId)
```

Parameter	Description
<code>nTimerId</code>	The ID of the timer returned by the <code>Script.SetTimer</code> function.

LoadScript

Loads the specified script.

Syntax

```
Script.LoadScript(scriptName)
```

Parameter	Description
scriptName	The name of the script to load.

ReloadEntityScript

Reloads the specified entity script.

Syntax

```
Script.ReloadEntityScript(const char *className)
```

Parameter	Description
className	Name of the entity script.

ReloadScript

Reload the script.

Syntax

```
Script.ReloadScript(scriptName)
```

Parameter	Description
scriptName	The name of the script to reload.

ReloadScripts

Reloads all the scripts.

Syntax

```
Script.ReloadScripts()
```

SetTimer

Sets a script timer. When the timer expires, `SetTimer` calls the Lua function specified.

Syntax

```
Script.SetTimer(int nMilliseconds, HSCRIPTFUNCTION hFunc)
```

Returns the ID assigned to the timer or nil if no ID was specified.

Parameter	Description
nMilliseconds	Delay of the trigger in milliseconds.
luaFunction	<p>The Lua function to call. If userData is specified, luaFunction must be in the format:</p> <pre>LuaCallback = function(userData, nTimerId) -- function body end;</pre> <p>.</p> <p>If userData is not specified, luaFunction must be in the format:</p> <pre>LuaCallback = function(nTimerId) -- function body end;</pre>
userData	Optional. Specifies a user defined table. If userData is specified, the table is passed as the first argument of the callback function.
bUpdateDuringPause	Optional. The timer is updated and triggered even if the game is in pause mode.

SetTimerForFunction

Sets a timer for the specified function.

Syntax

```
Script.SetTimerForFunction(int nMilliseconds, const char *sFunctionName)
```

Returns the ID assigned to the timer, or nil if no ID was specified.

This function has the same parameters as the SetTimer function.

UnloadScript

Unloads the specified script.

Syntax

```
Script.UnloadScript(scriptName)
```

Parameter	Description
scriptName	The name of the script to unload.

ScriptBind_Sound

Lists C++ sound functions that can be called from Lua scripts.

GetAudioEnvironmentID

Get the audio environment `TAudioEnvironmentID` (wrapped into a `ScriptHandle`).

Syntax

```
Sound.GetAudioEnvironmentID(const char* const sEnvironmentName)
```

Returns: `ScriptHandle` with the `TAudioEnvironmentID` value, or nil if the `sEnvironmentName` is not found.

Parameter	Description
<code>sEnvironmentName</code>	The unique name of an audio environment.

GetAudioRtpcID

Get the RTPC `TAudioControlID` (wrapped into a `ScriptHandle`).

Syntax

```
Sound.GetAudioRtpcID(const char* const sRtpcName)
```

Returns: `ScriptHandle` with the `TAudioControlID` value, or nil if the `sRtpcName` is not found.

Parameter	Description
<code>sRtpcName</code>	The unique name of an audio RTPC.

GetAudioSwitchID

Get the switch `TAudioControlID` (wrapped into a `ScriptHandle`).

Syntax

```
Sound.GetAudioSwitchID(const char* const sSwitchName)
```

Returns: `ScriptHandle` with the `TAudioControlID` value, or nil if the `sSwitchName` is not found.

Parameter	Description
<code>sSwitchName</code>	The unique name of an audio switch.

GetAudioSwitchStateID

Get the `SwitchState` `TAudioSwitchStateID` (wrapped into a `ScriptHandle`).

Syntax

```
Sound.GetAudioSwitchStateID(const ScriptHandle hSwitchID, const char* const  
sSwitchStateName)
```

Returns: ScriptHandle with the TAudioSwitchStateID value, or nil if the sSwitchStateName is not found.

Parameter	Description
sSwitchStateName	The unique name of an audio switch state.

GetAudioTriggerID

Get the trigger TAudioControlID (wrapped into a ScriptHandle).

Syntax

```
Sound.GetAudioTriggerID(const char* const sTriggerName)
```

Returns: ScriptHandle with the TAudioControlID value, or nil if the sTriggerName is not found.

Parameter	Description
sTriggerName	The unique name of an audio trigger.

SetAudioRtpcValue

Globally sets the specified audio RTPC to the specified value.

Syntax

```
Sound.SetAudioRtpcValue( hRtpcID, fValue )
```

Returns: nil

Parameter	Description
hRtpcID	The audio RTPC ID handle.
fValue	The RTPC value.

ScriptBind_System

This class implements Lua script functions that expose system functionalities.

ActivatePortal

Activates or deactivates a portal.

Syntax

```
System.ActivatePortal(Vec3 vPos, bool bActivate, ScriptHandle nID)
```

Parameters

Parameter	Description
vPos	Position vector.
bActivate	True to activate the portal, false to deactivate.
nID	Entity identifier.

AddCCommand

Adds a C command to the system.

Syntax

```
System.AddCCommand(const char* sCCommandName, const char* sCommand, const char* sHelp)
```

Parameters

Parameter	Description
sCCommandName	C command name.
sCommand	Command string.
sHelp	Help for the command usage.

ApplicationTest

Test the application with the specified parameters.

Syntax

```
System.ApplicationTest(const char* pszParam)
```

Parameters

Parameter	Description
pszParam	Parameters.

Break

Breaks the application with a fatal error message.

Syntax

```
System.Break()
```

BrowseURL

Browses a URL address.

Syntax

```
System.BrowseURL(const char* szURL)
```

Parameters

Parameter	Description
szURL	URL string.

CheckHeapValid

Checks the heap validity.

Syntax

```
System.CheckHeapValid(const char* name)
```

Parameters

Parameter	Description
name	Name string. The default is <noname>.

ClearConsole

Clears the console.

Syntax

```
System.ClearConsole()
```

ClearKeyState

Clear the key state.

Syntax

```
System.ClearKeyState()
```

CreateDownload

Syntax

```
System.CreateDownload()
```

DebugStats

Syntax

```
System.DebugStats(bool cp)
```

DeformTerrain

Deforms the terrain.

Syntax

```
System.DeformTerrain()
```

DeformTerrainUsingMat

Deforms the terrain using material.

Syntax

```
System.DeformTerrainUsingMat()
```

Draw2DLine

Draws a 2D line.

Syntax

```
System.Draw2DLine(p1x, p1y, p2x, p2y, float r, float g, float b, float alpha)
```

Parameters

Parameter	Description
p1x	X value of the start point of the line.
p1y	Y value of the start point of the line.
p2x	X value of the end point of the line.
p2y	Y value of the end point of the line.
r	Red component for the label color. Default is 1.
g	Green component for the label color. Default is 1.
b	Blue component for the label color. Default is 1.
alpha	Alpha component for the label color. Default is 1.

DrawLabel

Draws a label with the specified parameter.

Syntax

```
System.DrawLabel(Vec3 vPos, float fSize, const char* text [, float r [, float g [, float b [, float alpha]]]])
```

Parameters

Parameter	Description
vPos	Position vector.
fSize	Size for the label.
text	Text of the label.
r	Red component for the label colour. Default is 1.
g	Green component for the label colour. Default is 1.
b	Blue component for the label colour. Default is 1.
alpha	Alpha component for the label colour. Default is 1.

DrawLine

Draws a line.

Syntax

```
System.DrawLine(Vec3 p1, Vec3 p2, float r, float g, float b, float alpha)
```

Parameters

Parameter	Description
p1	Start position of the line.
p2	End position of the line.
r	Red component for the label color. Default is 1.
g	Green component for the label color. Default is 1.
b	Blue component for the label color. Default is 1.
alpha	Alpha component for the label color. Default is 1.

DrawText

Draws text.

Syntax

```
System.DrawText(float x, float y, const char* text, const char* fontName, float size, float r, float g, float b, float alpha)
```

Parameters

Parameter	Description
x	X position for the text. The default is 0.
y	Y position for the text. The default is 0.
text	Text to be displayed. The default is an empty string.
fontName	Font name. The default is default.
size	Text size. The default is 16.
r	Red component for the label color. The default is 1.
g	Green component for the label color. The default is 1.
b	Blue component for the label color. The default is 1.
alpha	Alpha component for the label color. The default is 1.

DumpMemoryCoverage

Dumps memory coverage.

Syntax

```
System.DumpMemoryCoverage()
```

This function is useful for investigating memory fragmentation. When `#System.DumpMemoryCoverage()` is called from the console, `DumpMemoryCoverage` adds a line to the `MemoryCoverage.bmp` file, which is generated the first time there is a maximum line count.

DumpMemStats

Dumps memory statistics.

Syntax

```
System.DumpMemStats(bUseKB)
```

Parameters

Parameter	Description
bUseKB	True to use KB, false otherwise. The default is false.

DumpMMStats

Dumps the MM statistics.

Syntax

```
System.DumpMMStats()
```

DumpWinHeaps

Dumps windows heaps.

Syntax

```
System.DumpWinHeaps()
```

EnableOceanRendering

Enables/disables ocean rendering.

Syntax

```
System.EnableOceanRendering()
```

Parameters

Parameter	Description
bOcean	True to activate the ocean rendering, false to deactivate it.

EnumAAFormats

Enumerates multisample anti-aliasing formats.

Syntax

```
System.EnumAAFormats()
```

EnumDisplayFormats

Enumerates display formats.

Syntax

```
System.EnumDisplayFormats()
```

Error

Shows a message text with the error severity.

Syntax

```
System.Error(const char* sParam)
```

Parameters

Parameter	Description
sParam	Text to be logged. The default is an empty string.

ExecuteCommand

Executes a command.

Syntax

```
System.ExecuteCommand(const char* szCmd)
```

Parameters

Parameter	Description
szCmd	Command string.

GetConfigSpec

Gets the config specification.

Syntax

```
System.GetConfigSpec()
```

GetCurrAsyncTime

Gets the current asynchronous time.

Syntax

```
System.GetCurrAsyncTime()
```

GetCurrTime

Gets the current time.

Syntax

```
System.GetCurrTime()
```

GetCVar

Gets the value of a console variable.

Syntax

```
System.GetCVar(const char* sCVarName)
```

Parameters

Parameter	Description
sCVarName	Name of the variable.

GetEntities

Returns a table with all the entities currently present in a level.

Syntax

```
System.GetEntities(Vec3 center, float radius)
```

Parameters

Parameter	Description
center	Center position vector for the area where to get entities. The default is (0, 0, 0).
radius	Radius of the area. The default is 0.

GetEntitiesByClass

Gets all the entities of the specified class.

Syntax

```
System.GetEntitiesByClass(const char* EntityClass)
```

Parameters

Parameter	Description
EntityClass	Entity class name.

GetEntitiesInSphere

Gets all the entities contained into the specified sphere.

Syntax

```
System.GetEntitiesInSphere(Vec3 center, float radius)
```

Parameters

Parameter	Description
center	center position vector for the sphere where to look at entities.
radius	Radius of the sphere.

GetEntitiesInSphereByClass

Gets all the entities contained into the specified sphere for the specific class name.

Syntax

```
System.GetEntitiesInSphereByClass(Vec3 center, float radius, const char* EntityClass)
```

Parameters

Parameter	Description
center	center position vector for the sphere where to look at entities.
radius	Radius of the sphere.
EntityClass	Entity class name.

GetEntity

Gets an entity from its ID.

Syntax

```
System.GetEntity(entityId)
```

Parameters

Parameter	Description
entityId	Entity identifier (svtNumber or ScriptHandle).

GetEntityByName

Retrieve entity table for the first entity with specified name. If multiple entities with same name exist, first one found is returned.

Syntax

```
System.GetEntityByName(const char *sEntityName)
```

Parameters

Parameter	Description
sEntityName	Name of the entity to search.

GetEntityClass

Gets an entity class from its ID.

Syntax

```
System.GetEntityClass(entityId)
```

Parameters

Parameter	Description
entityId	Entity identifier (svtNumber or ScriptHandle).

GetEntityIdByName

Retrieve entity Id for the first entity with specified name. If multiple entities with same name exist, first one found is returned.

Syntax

```
System.GetEntityIdByName(const char *sEntityName)
```

Parameters

Parameter	Description
sEntityName	Name of the entity to search.

GetFrameID

Gets the frame identifier.

Syntax

```
System.GetFrameID()
```

GetFrameTime

Gets the frame time.

Syntax

```
System.GetFrameTime()
```

GetHDRDynamicMultiplier

Gets the HDR dynamic multiplier.

Syntax

```
System.GetHDRDynamicMultiplier()
```

GetLocalOSTime

Gets the local operating system time.

Syntax

```
System.GetLocalOSTime()
```

GetNearestEntityByClass

Gets the nearest entity with the specified class.

Syntax

```
System.GetNearestEntityByClass(Vec3 center, float radius, const char *className)
```

Parameters

Parameter	Description
center	Center position vector for the area where to look at entities.
radius	Radius of the sphere.
className	Entity class name.

GetOutdoorAmbientColor

Gets the outdoor ambient color.

Syntax

```
System.GetOutdoorAmbientColor()
```

GetPhysicalEntitiesInBox

Gets all the entities contained into the specified area.

Syntax

```
System.GetPhysicalEntitiesInBox(Vec3 center, float radius)
```

Parameters

Parameter	Description
center	Center position vector for the area where to look at entities.
radius	Radius of the sphere.

GetPhysicalEntitiesInBoxByClass

Gets all the entities contained into the specified area for the specific class name.

Syntax

```
System.GetPhysicalEntitiesInBoxByClass(Vec3 center, float radius, const char *className)
```

Parameters

Parameter	Description
center	Center position vector for the area where to look at entities.
radius	Radius of the sphere.
className	Entity class name.

GetPostProcessFxParam

Gets a post processing effect parameter value.

Syntax

```
System.GetPostProcessFxParam(const char* pszEffectParam, value)
```

Parameters

Parameter	Description
pszEffectParam	Parameter for the post processing effect.
value	Value for the parameter (float or string).

GetScreenFx

Gets a post processing effect parameter value.

Note

This is a convenience wrapper function for `GetPostProcessFxParam`.

Syntax

```
System.GetScreenFx(const char* pszEffectParam, value)
```

Parameters

Parameter	Description
pszEffectParam	Parameter for the post processing effect.
value	Value for the parameter (float or string).

GetSkyColor

Retrieve color of the sky (outdoor ambient color).

Syntax

```
Vec3 System.GetSkyColor()
```

Returns: Sky color as an {x,y,z} vector (x=r,y=g,z=b).

GetSkyHighlight

Retrieves sky highlighting parameters. See [SetSkyHighlight \(p. 707\)](#) for a description of the parameters.

Syntax

```
System.GetSkyHighlight(SmartScriptTable params)
```

GetSunColor

Retrieve color of the sun outdoors.

Syntax

```
Vec3 System.GetSunColor()
```

Returns: Sun Color as an {x,y,z} vector (x=r,y=g,z=b).

GetSurfaceTypeIdByName

Gets the surface type identifier by its name.

Syntax

```
System.GetSurfaceTypeIdByName(const char* surfaceName)
```

Parameters

Parameter	Description
surfaceName	Surface name.

GetSurfaceTypeNameById

Gets the surface type name by its identifier.

Syntax

```
System.GetSurfaceTypeNameById(int surfaceId)
```

Parameters

Parameter	Description
surfaceId	Surface identifier.

GetSystemMem

Gets the amount of the memory for the system.

Syntax

```
System.GetSystemMem()
```

GetTerrainElevation

Gets the terrain elevation of the specified position.

Syntax

```
System.GetTerrainElevation(Vec3 v3Pos)
```

Parameters

Parameter	Description
v3Pos	Position of the terraint to be checked.

GetUserName

Gets the username on this machine.

Syntax

```
System.GetUserName()
```

GetViewCameraAngles

Gets the view camera angles.

Syntax

```
System.GetViewCameraAngles()
```

GetViewCameraDir

Gets the view camera direction.

Syntax

```
System.GetViewCameraDir()
```

GetViewCameraFov

Gets the view camera fov.

Syntax

```
System.GetViewCameraFov()
```

GetViewCameraPos

Gets the view camera position.

Syntax

```
System.GetViewCameraPos()
```

GetViewCameraUpDir

Gets the view camera up-direction.

Syntax

```
System.GetViewCameraUpDir()
```

GetWind

Gets the wind direction.

Syntax

```
System.SetWind()
```

IsDevModeEnable

Checks if game is running in dev mode (cheat mode), which enables certain script function facilities (god mode, fly mode etc.).

Syntax

```
System.IsDevModeEnable()
```

IsEditing

Checks if the system is in pure editor mode - that is, not editor game mode.

Syntax

```
System.IsEditing()
```

IsEditor

Checks if the system is the editor.

Syntax

```
System.IsEditor()
```

IsHDRSupported

Checks if the HDR is supported.

Syntax

```
System.IsHDRSupported()
```

IsMultiplayer

Checks if the game is multiplayer.

Syntax

```
System.IsMultiplayer()
```

IsPointIndoors

Checks if a point is indoors.

Syntax

```
System.IsPointIndoors(Vec3 vPos)
```

Parameters

Parameter	Description
vPos	Position vector. The default is (0, 0, 0).

IsPointVisible

Checks if the specified point is visible.

Syntax

```
System.IsPointVisible(Vec3 point)
```

Parameters

Parameter	Description
point	Point vector.

IsPS20Supported

Checks if the PS20 is supported.

Syntax

```
System.IsPS20Supported()
```

IsValidMapPos

Checks if the position is a valid map position.

Syntax

```
System.IsValidMapPos(Vec3 v)
```

Parameters

Parameter	Description
v	Position vector. The default is (0, 0, 0).

LoadFont

Loads a font.

Syntax

```
System.LoadFont(const char* pszName)
```

Parameters

Parameter	Description
pszName	Font name.

LoadLocalizationXml

Loads Excel exported XML file with text and dialog localization data.

Syntax

```
System.LoadLocalizationXml(const char *filename)
```

Log

Logs a message to the log file and console.

Syntax

```
System.Log(const char* sText)
```

Parameters

Parameter	Description
sText	Text to be logged.

LogAlways

Logs data even if the verbosity setting is 0.

Syntax

```
System.LogAlways(const char* sText)
```

Parameters

Parameter	Description
sText	Text to be logged.

LogToConsole

Logs a message to the console.

Syntax

```
System.LogToConsole(const char* sText)
```

Parameters

Parameter	Description
sText	Text to be logged.

PrepareEntityFromPool

Prepares the given bookmarked entity from the pool, bringing it into existence.

Syntax

```
System.PrepareEntityFromPool(entityId)
```

Parameters

Parameter	Description
entityId	Entity identifier (number or ScriptHandle).
bPrepareNow	(optional) When another entity preparation is already in progress, specifies whether the pooled entity should be prepared immediately instead of putting it in a queue.

ProjectToScreen

Projects to the screen (not guaranteed to work if used outside Renderer).

Syntax

```
System.ProjectToScreen(Vec3 vec)
```

Parameters

Parameter	Description
vec	Position vector.

Quit

Quits the program.

Syntax

```
System.Quit()
```

QuitInNSeconds

Quits the application in the specified number of seconds.

Syntax

```
System.QuitInNSeconds(float fInNSeconds)
```

Parameters

Parameter	Description
fInNSeconds	Number of seconds before quitting.

RayTraceCheck

Checks world and static objects.

Syntax

```
System.RayTraceCheck(Vec3 src, Vec3 dst, int skipId1, int skipId2)
```

RayWorldIntersection

Shoots rays into the world.

Syntax

```
System.RayWorldIntersection(Vec3 vPos, Vec3 vDir, int nMaxHits, int iEntTypes)
```

Parameters

Parameter	Description
vPos	Position vector. The default is (0, 0, 0).
vDir	Direction vector. The default is (0, 0, 0).

Parameter	Description
nMaxHits	Maximum number of hits.
iEntTypes	

RemoveEntity

Removes the specified entity.

Syntax

```
System.RemoveEntity(ScriptHandle entityId)
```

Parameters

Parameter	Description
entityId	Entity identifier.

ResetPoolEntity

Resets the entity's bookmarked, which frees memory.

Syntax

```
System.ResetPoolEntity(entityId)
```

Parameters

Parameter	Description
entityId	Entity identifier (svtnumber or ScriptHandle).

ReturnEntityToPool

Syntax

```
System.ReturnEntityToPool(entityId)
```

Returns: the bookmarked entity to the pool, destroying it.

Parameters

Parameter	Description
entityId	Entity identifier (svtnumber or ScriptHandle).

SaveConfiguration

Saves the configuration.

Syntax

```
System.SaveConfiguration()
```

ScanDirectory

Scans a directory.

Syntax

```
System.ScanDirectory(const char* pszFolderName, int nScanMode)
```

Parameters

Parameter	Description
pszFolderName	Folder name.
nScanMode	Scan mode for the folder. Can be: SCANDIR_ALL (0), SCANDIR_FILES (1), or SCANDIR_SUBDIRS (2).

ScreenToTexture

Syntax

```
System.ScreenToTexture()
```

SetBudget

Sets system budget.

Syntax

```
System.SetBudget(int sysMemLimitInMB, int videoMemLimitInMB, float  
frameTimeLimitInMS, int soundChannelsPlayingLimit, int soundMemLimitInMB,  
int soundCPULimitInPercent, int numDrawCallsLimit)
```

Parameters

Parameter	Description
sysMemLimitInMB	Limit of the amount of system memory in MB. The default is 512.
videoMemLimitInMB	Limit of the amount of video memory in MB. The default is 256.
frameTimeLimitInMS	Limit of the frame time in MS. The default is 50.0f.
soundChannelsPlayingLimit	Limit of the number of sound channels playing. The default is 64.
soundMemLimitInMB	Limit of the sound memory in MB. The default is 64.
soundCPULimitInPercent	Limit of the sound CPU usage in percent. The default is 5.
numDrawCallsLimit	Limit of the number of draw calls. The default is 2000.

SetConsoleImage

Sets the console image.

Syntax

```
System.SetConsoleImage(const char* pszName, bool bRemoveCurrent)
```

Parameters

Parameter	Description
pszName	The name of the texture image.
bRemoveCurrent	True to remove the current image; otherwise false.

SetCVar

Sets the value of a console variable.

Syntax

```
System.SetCVar(const char* sCVarName, value)
```

Parameters

Parameter	Description
sCVarName	Name of the variable.
value	Value of the variable (float or string).

SetGammaDelta

Sets the gamma/delta value.

Syntax

```
System.SetGammaDelta(float fDelta)
```

Parameters

Parameter	Description
fDelta	Delta value. The default is 0.

SetOutdoorAmbientColor

Sets the outdoor ambient color.

Syntax

```
System.GetOutdoorAmbientColor(v3Color)
```

Parameters

Parameter	Description
v3Color	Outdoor ambient color value.

SetPostProcessFxParam

Sets a post processing effect parameter value.

Syntax

```
System.SetPostProcessFxParam(const char* pszEffectParam, value)
```

Parameters

Parameter	Description
pszEffectParam	Parameter for the post processing effect.
value	Value for the parameter (svtNumber, svtObject, or svtString).

SetScissor

Sets the scissoring screen area.

Syntax

```
System.SetScissor(float x, float y, float w, float h)
```

SetScreenFx

Sets a post processing effect parameter value.

Note

This is a convenience wrapper function for `SetPostProcessFxParam`.

Syntax

```
System.SetScreenFx(pszEffectParam, value)
```

Parameters

Parameter	Description
pszEffectParam	Parameter for the post processing effect.
value	Value for the parameter (svtNumber, svtObject, or svtString).

SetSkyColor

Set color of the sky (outdoors ambient color).

Syntax

```
System.SetSkyColor(Vec3 vColor)
```

Parameters

Parameter	Description
vColor	Sky Color as an { x , y , z } vector (x=r,y=g,z=b).

SetSkyHighlight

Set sky highlighting parameters.

Syntax

```
System.SetSkyHighlight(SmartScriptTable params)
```

Parameters

Parameter	Description
params	Table with sky highlighting parameters.

Params Table Parameters

Highlight Parameter	Description
color	Sky highlight color
direction	Direction of the sky highlight in world space.
pos	Position of the sky highlight in world space.
size	Sky highlight scale.

SetSunColor

Set the color of the sun, only relevant outdoors.

Syntax

```
System.SetSunColor(Vec3 vColor)
```

Parameters

Parameter	Description
vColor	Sun color as an { x , y , z } vector (x=r,y=g,z=b).

SetViewCameraFov

Sets the view camera fov.

Syntax

```
System.SetViewCameraFov(float fov)
```

SetVolumetricFogModifiers

Sets the volumetric fog modifiers.

Syntax

```
System.SetVolumetricFogModifiers(float gobalDensityModifier, float  
atmosphereHeightModifier)
```

Parameters

Parameter	Description
gobalDensityModifier	Modifier for the global density.
atmosphereHeightModifier	Modifier for the atmosphere height.

SetWaterVolumeOffset

SetWaterLevel is not supported by the 3D engine for now.

Syntax

```
System.SetWaterVolumeOffset()
```

SetWind

Sets the wind direction.

Syntax

```
System.SetWind(Vec3 vWind)
```

Parameters

Parameter	Description
vWind	Wind direction. The default value is (0, 0, 0).

ShowConsole

Shows or hides the console.

Syntax

```
System.ShowConsole(int nParam)
```

Parameters

Parameter	Description
nParam	1 to show the console, 0 to hide. The default is 0.

ShowDebugger

Shows the debugger.

Syntax

```
System.ShowDebugger()
```

SpawnEntity

Spawns an entity.

Syntax

```
System.SpawnEntity(SmartScriptTable params)
```

Parameters

Parameter	Description
params	Entity parameters.

ViewDistanceGet

Gets the view distance.

Syntax

```
System.ViewDistanceSet()
```

ViewDistanceSet

Sets the view distance.

Syntax

```
System.ViewDistanceSet(float fViewDist)
```

Parameters

Parameter	Description
fViewDist	View distance.

Warning

Shows a message text with the warning severity.

Syntax

```
System.Warning(const char* sParam)
```

Parameters

Parameter	Description
sParam	The text to be logged. The default value is an empty string.

ScriptBind Action Functions

Lists C++ action functions that can be called from Lua scripts.

Topics

- [ScriptBind_Action](#) (p. 710)
- [ScriptBind_ActionMapManager](#) (p. 724)
- [ScriptBind_ActorSystem](#) (p. 726)
- [ScriptBind_GameStatistics](#) (p. 727)
- [ScriptBind_GameToken](#) (p. 729)
- [ScriptBind_Inventory](#) (p. 730)
- [ScriptBind_ItemSystem](#) (p. 732)
- [ScriptBind_Network](#) (p. 735)
- [ScriptBind_UIAction](#) (p. 735)
- [ScriptBind_Vehicle](#) (p. 747)
- [ScriptBind_VehicleSeat](#) (p. 754)
- [ScriptBind_VehicleSystem](#) (p. 755)

ScriptBind_Action

Lists the action related Lua script bind functions. When parameters are present, the data types indicated in the signatures reflect those of the underlying C++ function.

ActivateEffect

Activates the effect specified.

Syntax

```
Action.ActivateEffect(const char * name)
```

Parameter	Description
name	Specifies the effect to activate.

ActivateExtensionForGameObject

Activates a specified extension for a game object.

Syntax

```
Action.ActivateExtensionForGameObject(ScriptHandle entityId, const char *extension, bool activate)
```

Parameter	Description
entityId	The identifier of the entity.
extension	The name of the extension.
activate	Specify <code>true</code> to activate the extension or <code>false</code> to deactivate it.

AddAngleSignal

Adds an angle for the signal.

Syntax

```
Action.AddAngleSignal(ScriptHandle entityId, float fAngle, float fFlexibleBoundary, const char *sSignal)
```

Parameter	Description
entityId	The identifier of the entity.
fAngle	The angle value.
fFlexibleBoundary	The size of the flexible boundary.
sSignal	The string for the signal.

AddRangeSignal

Adds a range for the signal.

Syntax

```
Action.AddRangeSignal(ScriptHandle entityId, float fRadius, float fFlexibleBoundary, const char *sSignal)
```

Parameter	Description
entityId	The identifier of the entity.
fRadius	The adius of the range area.
fFlexibleBoundary	Flexible boundary size.

Parameter	Description
sSignal	String for signal.

AddTargetRangeSignal

Adds a target range signal that has the parameters specified.

Syntax

```
Action.AddTargetRangeSignal(ScriptHandle entityId, ScriptHandle targetId,  
float fRadius, float fFlexibleBoundary, const char *sSignal)
```

Parameter	Description
entityId	The identifier of the entity.
targetId	The identifier of the target.
fRadius	The radius of the range area.
fFlexibleBoundary	The size of the flexible boundary.
sSignal	The string for the signal.

BanPlayer

Bans a specified player.

Syntax

```
Action.BanPlayer(ScriptHandle entityId, const char* message)
```

Parameter	Description
entityId	The identifier of the entity.
message	The message for the ban.

BindGameObjectToNetwork

Binds a specified game object to the network.

Syntax

```
Action.BindGameObjectToNetwork(ScriptHandle entityId)
```

Parameter	Description
entityId	The identifier of the entity to bind to the network.

CacheItemGeometry

Caches an item geometry.

Syntax

```
Action.CacheItemGeometry(const char *itemName)
```

Parameter	Description
itemName	The string name of the item.

CacheItemSound

Caches an item sound.

Syntax

```
Action.CacheItemSound(const char *itemName)
```

Parameter	Description
itemName	The string name of the item.

ClearEntityTags

Clears the tag for the specified entity.

Syntax

```
Action.ClearEntityTags(ScriptHandle entityId)
```

Parameter	Description
entityId	The identifier of the entity.

ClearStaticTag

Clears the specified static tag for the specified entity.

Syntax

```
Action.ClearStaticTag(ScriptHandle entityId, const char *staticId)
```

Parameter	Description
entityId	The identifier of the entity.
staticId	The identifier of the static tag.

ConnectToServer

Connects to the server specified.

Syntax

```
Action.ConnectToServer(char* server)
```

Parameter	Description
server	String that specifies the server to connect to.

CreateGameObjectForEntity

Creates a game object for the entity ID specified.

Syntax

```
Action.CreateGameObjectForEntity(ScriptHandle entityId)
```

Parameter	Description
entityId	The identifier of the entity.

DestroyRangeSignaling

Removes range signaling.

Syntax

```
Action.DestroyRangeSignaling(ScriptHandle entityId)
```

Parameter	Description
entityId	The identifier of the entity.

DisableSignalTimer

Disables the signal timer.

Syntax

```
Action.DisableSignalTimer(ScriptHandle entityId, const char *sText)
```

Parameter	Description
entityId	The identifier of the entity.

Parameter	Description
sText	The text for the signal.

DontSyncPhysics

Instructs the engine to not synchronize physics for the specified entity.

Syntax

```
Action.DontSyncPhysics(ScriptHandle entityId)
```

Parameter	Description
entityId	The identifier of the entity.

EnableRangeSignaling

Enables or disables range signaling for the specified entity.

Syntax

```
Action.EnableRangeSignaling(ScriptHandle entityId, bool bEnable)
```

Parameter	Description
entityId	The identifier of the entity.
bEnable	Enable or disable range signaling.

EnableSignalTimer

Enables the signal timer.

Syntax

```
Action.EnableSignalTimer(ScriptHandle entityId, const char *sText)
```

Parameter	Description
entityId	The identifier of the entity.
sText	The text for the signal.

ForceGameObjectUpdate

Forces the game object to be updated.

Syntax

```
Action.ForceGameObjectUpdate(ScriptHandle entityId, bool force)
```

Parameter	Description
entityId	The identifier of the entity.
force	Specify true to force the update; specify false otherwise.

GetClassName

Returns the class name, if available, for specified `classId`.

Syntax

```
Action.GetClassName(int classId)
```

GetPlayerList

Retrieves the current players list.

Syntax

```
Action.GetPlayerList()
```

GetServer

Gets the server that corresponds to the number specified.

Syntax

```
Action.GetServer(int number)
```

Parameter	Description
number	The number of the server.

GetServerTime

Gets the current time on the server.

Syntax

```
Action.GetServerTime()
```

GetWaterInfo

Gets information about the water at the position specified.

Syntax

```
Action.GetWaterInfo(Vec3 pos)
```

Parameter	Description
pos	The position for which information will be returned.

HasAI

Returns `true` if the entity has an AI object associated with it and has been registered with the AI System

Syntax

```
Action.HasAI(ScriptHandle entityId)
```

IsChannelOnHold

Checks if the channel specified is on hold.

Syntax

```
Action.IsChannelOnHold(int channelId)
```

Parameter	Description
channelId	The identifier of the channel.

IsChannelSpecial

Returns `true` if the channel is special.

Syntax

```
Action.IsChannelSpecial()
```

IsClient

Returns `true` if the current script runs on a client.

Syntax

```
Action.IsClient()
```

IsGameObjectProbablyVisible

Returns `true` if the specified object is likely visible.

Syntax

```
Action.IsGameObjectProbablyVisible(ScriptHandle gameObject)
```

Parameter	Description
gameObject	The game object to check for likely visibility.

IsGameStarted

Returns `true` if the game has started.

Syntax

```
Action.IsGameStarted()
```

IsImmersivenessEnabled

Returns `true` if immersive multiplayer is enabled.

Syntax

```
Action.IsImmersivenessEnabled()
```

IsRMIServer

Returns `true` if the current script is running on an RMI (Remote Method Invocation) server.

Syntax

```
Action.IsRMIServer()
```

IsServer

Returns `true` if the current script runs on a server.

Syntax

```
Action.IsServer()
```

LoadXML

Loads XML data from the file specified. For more information, see [Using the Lua XML Loader \(p. 457\)](#).

Syntax

```
Action.LoadXML(const char * definitionFile, const char * dataFile)
```

Parameter	Description
definitionFile	Name of an XML file that declares the kind of data that is included in <code>dataFile</code> .

Parameter	Description
dataFile	The name of the XML file that contains the Lua data described in definitionFile.

PauseGame

Puts the game into pause mode.

Syntax

```
Action.PauseGame(bool pause)
```

Parameter	Description
pause	Specify true to set the game in pause mode. Specify false to resume the game.

Persistent2DText

Adds persistent 2D text.

Syntax

```
Action.Persistent2DText(const char* text, float size, Vec3 color, const char* name, float timeout)
```

Parameter	Description
text	The text to be displayed.
size	The size of the 2D text.
color	The the color of the 2D text.
name	The the name assigned to the 2D text.
timeout	The timeout for the 2D text.

PersistentArrow

Adds a persistent arrow to the world.

Syntax

```
Action.PersistentArrow(Vec3 pos, float radius, Vec3 dir, Vec3 color, const char* name, float timeout)
```

Parameter	Description
pos	The position of the arrow.

Parameter	Description
radius	The radius of the arrow.
dir	The direction of the arrow.
color	The color of the arrow.
name	The name assigned to the arrow.
timeout	The timeout for the arrow.

PersistentEntityTag

Adds a persistent entity tag.

Syntax

```
Action.PersistentEntityTag(ScriptHandle entityId, const char *text)
```

Parameter	Description
entityId	The identifier of the entity.
text	The text for the entity tag.

PersistentLine

Adds a persistent line to the world.

Syntax

```
Action.PersistentLine(Vec3 start, Vec3 end, Vec3 color, const char* name,  
float timeout)
```

Parameter	Description
start	The starting position of the line.
end	The ending position of the line.
color	The color of the line.
name	The name assigned to the line.
timeout	The timeout for the line.

PersistentSphere

Adds a persistent sphere to the world.

Syntax

```
Action.PersistentSphere(Vec3 pos, float radius, Vec3 color, const char* name,  
float timeout)
```

Parameter	Description
pos	The position of the sphere.
radius	The radius of the sphere.
color	The color of the sphere.
name	The name assigned to the sphere.
timeout	The timeout for the sphere.

PreLoadADB

Use this function to pre-cache ADB files.

Syntax

```
Action.PreLoadADB(const char* adbFileName)
```

Parameter	Description
adbFileName	The path and filename of the animation ADB file which is to be pre-loaded.

RefreshPings

Refreshes pings for all servers.

Syntax

```
Action.RefreshPings()
```

RegisterWithAI

Registers the entity to the AI system and creates an AI object associated with it.

Syntax

```
Action.RegisterWithAI()
```

ResetRangeSignaling

Resets range signaling.

Syntax

```
Action.ResetRangeSignaling(ScriptHandle entityId)
```

Parameter	Description
entityId	The identifier of the entity.

ResetSignalTimer

Resets the rate for the signal timer.

Syntax

```
Action.ResetSignalTimer(ScriptHandle entityId, const char *sText)
```

Parameter	Description
entityId	The identifier of the entity.
sText	Th text for the signal.

ResetToNormalCamera

Resets the camera to the last valid view stored.

Syntax

```
Action.ResetToNormalCamera()
```

SaveXML

Saves the specified XML data to the file system.

Syntax

```
Action.SaveXML(const char * definitionFile, const char * dataFile,  
SmartScriptTable dataTable)
```

Parameter	Description
definitionFile	Name of an XML file that declares the kind of data that is included in dataFile. For more information, see Using the Lua XML Loader (p. 457) .
dataFile	The name of the XML file that contains the Lua data described in definitionFile.
dataTable	The name of the data table.

SendGameplayEvent

Sends an event for the gameplay.

Syntax

```
Action.SendGameplayEvent(ScriptHandle entityId, int event)
```

Parameter	Description
entityId	The identifier of the entity.
event	The integer of the event.

SetAimQueryMode

Sets the aim query mode for the AI proxy. By default, the AI proxy queries the movement controller if the character is aiming. You can override this behavior by using a different keyword for the `mode` parameter.

Syntax

```
Action.SetAimQueryMode(ScriptHandle entityId, int mode)
```

Parameter	Description
entityId	The identifier of the entity.
mode	Specifies one of the following values: <code>QueryAimFromMovementController</code> (the default), <code>OverriddenAndAiming</code> , or <code>OverriddenAndNotAiming</code>

SetNetworkParent

Sets the network parent.

Syntax

```
Action.SetNetworkParent(ScriptHandle entityId, ScriptHandle parentId)
```

Parameter	Description
entityId	The identifier of the entity.
parentID	The identifier of the parent network.

SetSignalTimerRate

Sets the rate for the signal timer.

Syntax

```
Action.SetSignalTimerRate(ScriptHandle entityId, const char *sText, float fRateMin, float fRateMax)
```

Parameter	Description
entityId	The identifier of the entity.
sText	The text for the signal.
fRateMin	The minimum rate for the signal timer.
fRateMax	The maximum rate for the signal timer.

SetViewCamera

Saves the previous valid view and overrides it with the current camera settings.

Syntax

```
Action.SetViewCamera()
```

ScriptBind_ActionMapManager

The action map manager provides a high-level interface to handle input controls inside a game. An action map is a set of key or button mappings for a particular game mode (such as controlling a helicopter). For more information, see [Controller Devices and Game Input \(p. 320\)](#).

EnableActionFilter

Enables or disables a specified action filter. An action filter allows actions like `moveleft` or `moveright` to succeed or fail. For more information, see [Action Filters \(p. 325\)](#).

Syntax

```
ActionMapManager.EnableActionFilter( name, enable )
```

Parameter	Description
name	The name of the filter.
enable	Specify <code>true</code> to enable the filter, or <code>false</code> to disable it.

EnableActionMap

Enables or disables an action map.

Syntax

```
ActionMapManager.EnableActionMap(const char *name, bool enable)
```

Parameter	Description
name	The name of the action map to enable or disable.

Parameter	Description
enable	Specify <code>true</code> to enable the action map, or <code>false</code> to disable it.

EnableActionMapManager

Enables or disables the action map manager.

Syntax

```
ActionMapManager.EnableActionMapManager( enable, resetStateOnDisable )
```

Parameter	Description
enable	Enables or disables the action map manager. Specify <code>true</code> to enable the action map manager, or <code>false</code> to disable it.
resetStateOnDisable	Resets the action states when the action map manager is disabled.

GetDefaultActionEntity

Retrieves the currently set default action entity.

Syntax

```
ActionMapManager.GetDefaultActionEntity()
```

InitActionMaps

Initializes the action maps and filters found in the file specified.

Syntax

```
ActionMapManager.InitActionMaps( path )
```

Parameter	Description
path	The XML file path.

IsFilterEnabled

Queries whether the filter specified is currently enabled.

Syntax

```
ActionMapManager.IsFilterEnabled( filterName )
```

Parameter	Description
filterName	The name of the filter whose status to check.

LoadControllerLayoutFile

Loads the given controller layout into the action map manager.

Syntax

```
ActionMapManager.LoadControllerLayoutFile( layoutName )
```

Parameter	Description
layoutName	The name of the layout.

LoadFromXML

Loads information from an XML file.

Syntax

```
ActionMapManager.LoadFromXML(const char *name)
```

Parameter	Description
name	The name of the XML file to load.

SetDefaultActionEntity

Sets a new default action entity. The action map manager assigns new action maps to the action entity that you set as the default.

Syntax

```
ActionMapManager.SetDefaultActionEntity( id, updateAll )
```

Parameter	Description
id	Specifies the <code>EntityId</code> of the action entity that is to become the default.
updateAll	Updates all existing action map assignments.

ScriptBind_ActorSystem

Lists C++ actor system functions that can be called from Lua scripts.

CreateActor

Creates an actor.

Syntax

```
ActorSystem.CreateActor(ScriptHandle channelId, SmartScriptTable actorParams)
```

Parameter	Description
channelId	Identifier for the network channel.
actorParams	Parameters for the actor.

ScriptBind_GameStatistics

Lists C++ game statistics functions that can be called from Lua script.

AddGameElement

Adds a game element to specified scope.

Syntax

```
GameStatistics.AddGameElement(scopeID, elementID, locatorID, locatorValue [, table])
```

Parameter	Description
scopeID	The identifier of the scope.
elementID	The identifier of the element to be added.
locatorID	The identifier of the locator.
locatorValue	The value of the locator.
table	Optional. The table of the element.

BindTracker

Syntax

```
GameStatistics.BindTracker(name, tracker)
```

Parameter	Description
name	The name of the tracker to bind.
tracker	The IStatsTracker* to be bound.

CurrentScope

Returns the ID of current scope, or -1 if the stack is empty.

Syntax

```
GameStatistics.CurrentScope()
```

Event

Syntax

```
GameStatistics.Event()
```

PopGameScope

Removes the scope from the top of the stack.

Syntax

```
GameStatistics.PopGameScope([checkScopeId])
```

Parameter	Description
checkScopeId	Optional. The identifier of the scope to be removed from the top of the stack.

PushGameScope

Pushes a scope on top of the stack.

Syntax

```
GameStatistics.PushGameScope(scopeID)
```

Parameter	Description
scopeID	The identifier of the scope to be placed on top of the stack.

RemoveGameElement

Removes the element that has the supplied parameter values from the specified scope.

Syntax

```
GameStatistics.RemoveGameElement(scopeID, elementID, locatorID, locatorValue)
```

Parameter	Description
scopeID	The identifier of the scope.
elementID	The identifier of the element to be removed.
locatorID	The identifier of the locator.
locatorValue	The value of the locator.

StateValue

Syntax

```
GameStatistics.StateValue()
```

UnbindTracker

Syntax

```
GameStatistics.UnbindTracker(name, tracker)
```

Parameter	Description
name	The name of the tracker to unbind.
tracker	The IStatsTracker* to unbind.

ScriptBind_GameToken

Lists C++ game token functions that can be called from Lua script.

DumpAllTokens

Dump all game tokens with their values to the log.

Syntax

```
GameToken.DumpAllTokens()
```

GetToken

Gets the value of a game token.

Syntax

```
GameToken.GetToken(const char *sTokenName)
```

Parameter	Description
sTokenName	The name of the token whose value to get.

SetToken

Sets the value of a game token.

Syntax

```
GameToken.SetToken(const char* tokenName, any tokenValue)
```

Parameter	Description
tokenName	The name of the token.
tokenValue	The value to set.

ScriptBind_Inventory

Lists C++ inventory management functions that you can call from Lua script.

Clear

Clears the inventory.

Syntax

```
Inventory.Clear()
```

Destroy

Destroys the inventory.

Syntax

```
Inventory.Destroy()
```

Dump

Dumps the inventory.

Syntax

```
Inventory.Dump()
```

GetAmmoCapacity

Gets the capacity for the specified ammunition.

Syntax

```
Inventory.GetAmmoCapacity(const char *ammoName)
```

Parameter	Description
ammoName	The name of the ammunition.

GetAmmoCount

Gets the amount of the specified ammunition name.

Syntax

```
Inventory.GetAmmoCount(const char *ammoName)
```

Parameter	Description
ammoName	The name of the ammunition.

GetCurrentItem

Gets the current item.

Syntax

```
Inventory.GetCurrentItem()
```

GetCurrentItemId

Gets the identifier of the current item.

Syntax

```
Inventory.GetCurrentItemId()
```

GetGrenadeWeaponByClass

Gets grenade weapon by class name.

Syntax

```
Inventory.GetGrenadeWeaponByClass(const char *className)
```

Parameter	Description
className	The name of the class.

GetItemByClass

Gets item by class name.

Syntax

```
Inventory.GetItemByClass(const char *className)
```

Parameter	Description
className	The name of the class.

HasAccessory

Checks if the inventory contains the specified accessory.

Syntax

```
Inventory.HasAccessory(const char *accessoryName)
```

Parameter	Description
accessoryName	The name of the accessory.

SetAmmoCount

Sets the amount of the specified ammunition.

Syntax

```
Inventory.SetAmmoCount(const char *ammoName, int count)
```

Parameter	Description
ammoName	The name of the ammunition.
count	The count of the ammunition.

ScriptBind_ItemSystem

Lists C++ functions for actor items and items in packs that you can call from Lua script.

GetPackItemByIndex

Gets a pack item from its index.

Syntax

```
ItemSystem.GetPackItemByIndex(const char *packName, int index)
```

Parameter	Description
packName	The name of the pack.

Parameter	Description
index	The index of the item to retrieve.

GetPackNumItems

Get the number of items in the specified pack.

Syntax

```
ItemSystem.GetPackNumItems(const char* packName)
```

Parameter	Description
packName	The name of the pack whose item count to retrieve.

GetPackPrimaryItem

Gets the primary item of the specified pack.

Syntax

```
ItemSystem.GetPackPrimaryItem(const char *packName)
```

Parameter	Description
packName	The name of the pack whose primary item to retrieve.

GiveItem

Gives the specified item.

Syntax

```
ItemSystem.GiveItem(const char *itemName)
```

Parameter	Description
itemName	The name of the item.

GiveItemPack

Gives the item pack specified to the actor specified .

Syntax

```
ItemSystem.GiveItemPack(ScriptHandle actorId, const char *packName)
```

Parameter	Description
actorId	The actor identifier.
packName	The name of the pack.

Reset

Resets the item system.

Syntax

```
ItemSystem.Reset()
```

SerializePlayerLTLInfo

Serializes player level to level (LTL) information.

Syntax

```
ItemSystem.SerializePlayerLTLInfo(bool reading)
```

Parameter	Description
reading	Boolean value.

SetActorItem

Sets an actor item.

Syntax

```
ItemSystem.SetActorItem(ScriptHandle actorId, ScriptHandle itemId, bool keepHistory)
```

Parameter	Description
actorId	The actor identifier.
itemId	The item identifier.
keepHistory	True to keep the history; otherwise, false.

SetActorItemByName

Sets an actor item by name.

Syntax

```
ItemSystem.SetActorItemByName(ScriptHandle actorId, const char *name, bool keepHistory)
```

Parameter	Description
actorId	The actor identifier.
name	The name of the actor item.
keepHistory	True to keep the history; otherwise, false.

ScriptBind_Network

Lists C++ network functions that you can call from Lua script.

Expose

Syntax

```
Network.Expose()
```

ScriptBind_UIAction

CallFunction

Calls a function of the UI flash asset or the UIEventSystem.

Syntax

```
UIAction.CallFunction(elementName, instanceID, functionName, [arg1], [arg2], [...])
```

Parameter	Description
elementName	The UI element name as defined in the XML or UIEventSystem name as defined in a .cpp file.
instanceID	The ID of the instance (if an instance with the specified ID does not exist, it will be created). -1 specifies all instances. If used on UIEventSystem, no instance ID is ignored.
functionName	Function or event name.
args	List of arguments (optional).

DisableAction

Disables the UI Action.

Syntax

```
UIAction.DisableAction(actionName)
```

Parameter	Description
actionName	UI Action name.

EnableAction

Enables the UI Action.

Syntax

```
UIAction.EnableAction(actionName)
```

Parameter	Description
actionName	UI Action name.

EndAction

Ends a UI Action. This can be only used within a UIAction Lua script!

Syntax

```
UIAction.EndAction(table, disable, arguments)
```

Parameter	Description
table	Must be <code>self</code> .
disable	If true, this action is disabled when it terminates.
arguments	The arguments to return from this action.

GetAlpha

Get move clip alpha value.

Syntax

```
UIAction.GetAlpha(elementName, instanceID, mcName)
```

Parameter	Description
elementName	The UI element name as defined in the XML.

Parameter	Description
instanceID	The ID of the instance (if an instance with the specified ID does not exist, it will be created). -1 specifies all instances.
mcName	The movie clip name as defined in the XML.

GetArray

Returns a table with values of the array.

Syntax

```
UIAction.GetArray(elementName, instanceID, arrayName)
```

Parameter	Description
elementName	The UI element name as defined in the XML.
instanceID	The ID of the instance (if an instance with the specified ID does not exist, it will be created). -1 specifies all instances.
arrayName	Array name as defined in the XML.

GetPos

Get movie clip position.

Syntax

```
UIAction.GetPos(elementName, instanceID, mcName)
```

Parameter	Description
elementName	The UI element name as defined in the XML.
instanceID	The ID of the instance (if an instance with the specified ID does not exist, it will be created). -1 specifies all instances.
mcName	The movie clip name as defined in the XML.

GetRotation

Get movie clip rotation.

Syntax

```
UIAction.GetRotation(elementName, instanceID, mcName)
```

Parameter	Description
elementName	The UI element name as defined in the XML.
instanceID	The ID of the instance (if an instance with the specified ID does not exist, it will be created). '-1' for all instances
mcName	The movie clip name as defined in the XML.

GetScale

Get movie clip scale.

Syntax

```
UIAction.GetScale(elementName, instanceID, mcName)
```

Parameter	Description
elementName	The UI element name as defined in the XML.
instanceID	The ID of the instance (if an instance with the specified ID does not exist, it will be created). -1 specifies all instances.
mcName	The movie clip name as defined in the XML.

GetVariable

Gets a variable of the UI flash asset.

Syntax

```
UIAction.GetVariable(elementName, instanceID, varName)
```

Parameter	Description
elementName	The UI element name as defined in the XML.
instanceID	The ID of the instance (if an instance with the specified ID does not exist, it will be created). -1 specifies all instances.
varName	Variable name as defined in the XML.

GotoAndPlay

Call `GotoAndPlay` on a movie clip.

Syntax

```
UIAction.GotoAndPlay(elementName, instanceID, mcName, frameNum)
```

Parameter	Description
elementName	The UI element name as defined in the XML.
instanceID	The ID of the instance (if an instance with the specified ID does not exist, it will be created). -1 specifies all instances.
mcName	The movie clip name as defined in the XML.
frameNum	The frame number.

GotoAndPlayFrameName

Call `GotoAndPlay` on a movie clip by frame name.

Syntax

```
UIAction.GotoAndPlayFrameName(elementName, instanceID, mcName, frameName)
```

Parameter	Description
elementName	The UI element name as defined in the XML.
instanceID	The ID of the instance (if an instance with the specified ID does not exist, it will be created). -1 specifies all instances.
mcName	The movie clip name as defined in the XML.
frameName	The name of the frame.

GotoAndStop

Call `GotoAndStop` on a movie clip.

Syntax

```
UIAction.GotoAndStop(elementName, instanceID, mcName, frameNum)
```

Parameter	Description
elementName	The UI element name as defined in the XML.
instanceID	The ID of the instance (if an instance with the specified ID does not exist, it will be created). -1 specifies all instances.
mcName	The movie clip name as defined in the XML.
frameNum	The frame number.

GotoAndStopFrameName

Call GotoAndStop on a movie clip by frame name.

Syntax

```
UIAction.GotoAndStopFrameName(elementName, instanceID, mcName, frameName)
```

Parameter	Description
elementName	The UI element name as defined in the XML.
instanceID	The ID of the instance (if an instance with the specified ID does not exist, it will be created). -1 specifies all instances.
mcName	The movie clip name as defined in the XML.
frameName	The name of the frame.

HideElement

Hide the UI flash asset.

Syntax

```
UIAction.HideElement(elementName, instanceID)
```

Parameter	Description
elementName	The UI element name as defined in the XML.
instanceID	The ID of the instance (if an instance with the specified ID does not exist, it will be created). -1 specifies all instances.

IsVisible

Get movie clip visible state.

Syntax

```
UIAction.IsVisible(elementName, instanceID, mcName)
```

Parameter	Description
elementName	The UI element name as defined in the XML.
instanceID	The ID of the instance (if an instance with the specified ID does not exist, it will be created). -1 specifies all instances.
mcName	The movie clip name as defined in the XML.

RegisterActionListener

Register a callback function for a `UIAction` event. The callback function must have form:
`CallbackName(actionName, eventName, argTable)`

Syntax

```
UIAction.RegisterActionListener(table, actionName, eventName,  
callbackFunctionName)
```

Parameter	Description
<code>table</code>	The script that receives the callback (can be <code>self</code> to refer the current script).
<code>actionName</code>	The UI action name.
<code>eventName</code>	The name of the event that is fired from the UI action (can be <code>OnStart</code> or <code>OnEnd</code>) Warning If an empty string is specified, all events will be received.
<code>callbackFunctionName</code>	The name of the script function that will receive the callback.

RegisterElementListener

Register a callback function for a `UIElement` event. The callback function must have form:
`CallbackName(elementName, instanceId, eventName, argTable)`

Syntax

```
UIAction.RegisterElementListener(table, elementName, instanceID, eventName,  
callbackFunctionName)
```

Parameter	Description
<code>table</code>	The script that receives the callback (can be <code>self</code> to refer the current script).
<code>elementName</code>	The UI element name as defined in the XML.
<code>instanceID</code>	The ID of the instance (if an instance with the specified ID does not exist, it will be created). <code>-1</code> specifies all instances.
<code>eventName</code>	The name of the event that is fired from the UI element. If an empty string is specified, all events will be received.
<code>callbackFunctionName</code>	name of the script function that will receive the callback.

RegisterEventSystemListener

Register a callback function for a `UIEventSystem` event. The callback function must have form:
`CallbackName(actionName, eventName, argTable)`

Syntax

```
UIAction.RegisterEventSystemListener(table, eventSystem, eventName,  
callbackFunctionName)
```

Parameter	Description
<code>table</code>	The script that receives the callback (can be <code>self</code> to refer the current script).
<code>eventSystem</code>	The UI event system name.
<code>eventName</code>	The name of the event that is fired from <code>UIEventSystem</code> . If an empty string is specified, all events will be received.
<code>callbackFunctionName</code>	name of the script function that will receive the callback.

ReloadElement

Reloads the UI flash asset.

Syntax

```
UIAction.ReloadElement(elementName, instanceID)
```

Parameter	Description
<code>elementName</code>	The UI element name as defined in the XML.
<code>instanceID</code>	The ID of the instance (if an instance with the specified ID does not exist, it will be created). <code>-1</code> specifies all instances.

RequestHide

Send the fade out signal to the UI flash asset.

Syntax

```
UIAction.RequestHide(elementName, instanceID)
```

Parameter	Description
<code>elementName</code>	The UI element name as defined in the XML.

Parameter	Description
instanceID	The ID of the instance (if an instance with the specified ID does not exist, it will be created). -1 specifies all instances.

SetAlpha

Set movie clip alpha value.

Syntax

```
UIAction.SetAlpha(elementName, instanceID, mcName, fAlpha)
```

Parameter	Description
elementName	The UI element name as defined in the XML.
instanceID	The ID of the instance (if an instance with the specified ID does not exist, it will be created). -1 specifies all instances.
mcName	The movie clip name as defined in the XML.
fAlpha	Alpha value (0-1).

SetArray

Sets an array of the UI flash asset.

Syntax

```
UIAction.SetArray(elementName, instanceID, arrayName, values)
```

Parameter	Description
elementName	The UI element name as defined in the XML.
instanceID	The ID of the instance (if an instance with the specified ID does not exist, it will be created). -1 specifies all instances.
arrayName	The array name as defined in the XML.
values	Table of values for the array.

SetPos

Set movie clip position.

Syntax

```
UIAction.SetPos(elementName, instanceID, mcName, vPos)
```

Parameter	Description
elementName	The UI element name as defined in the XML.
instanceID	The ID of the instance (if an instance with the specified ID does not exist, it will be created). -1 specifies all instances.
mcName	The movie clip name as defined in the XML.
vPos	position.

SetRotation

Set movie clip rotation.

Syntax

```
UIAction.SetRotation(elementName, instanceID, mcName, vRotation)
```

Parameter	Description
elementName	The UI element name as defined in the XML.
instanceID	The ID of the instance (if an instance with the specified ID does not exist, it will be created). -1 specifies all instances.
mcName	The movie clip name as defined in the XML.
vRotation	The rotation.

SetScale

Set movie clip scale.

Syntax

```
UIAction.SetScale(elementName, instanceID, mcName, vScale)
```

Parameter	Description
elementName	The UI element name as defined in the XML.
instanceID	The ID of the instance (if an instance with the specified ID does not exist, it will be created). -1 specifies all instances.
mcName	The movie clip name as defined in the XML.

Parameter	Description
vScale	scale.

SetVariable

Sets a variable of the UI flash asset.

Syntax

```
UIAction.SetVariable(elementName, instanceID, varName, value)
```

Parameter	Description
elementName	The UI element name as defined in the XML.
instanceID	The ID of the instance (if an instance with the specified ID does not exist, it will be created). -1 specifies all instances.
varName	Variable name as defined in the XML.
value	Value to set.

SetVisible

Set movie clip visible state.

Syntax

```
UIAction.SetVisible(elementName, instanceID, mcName, bVisible)
```

Parameter	Description
elementName	The UI element name as defined in the XML.
instanceID	The ID of the instance (if an instance with the specified ID does not exist, it will be created). -1 specifies all instances.
mcName	The movie clip name as defined in the XML.
bVisible	visible.

ShowElement

Displays the UI flash asset.

Syntax

```
UIAction.ShowElement(elementName, instanceID)
```

Parameter	Description
elementName	The UI element name as defined in the XML.
instanceID	The ID of the instance (if an instance with the specified ID does not exist, it will be created). -1 specifies all instances.

StartAction

Starts a UI Action.

Syntax

```
UIAction.StartAction(actionName, arguments)
```

Parameter	Description
actionName	UI Action name.
arguments	The arguments to pass to this action.

UnloadElement

Unloads the UI flash asset.

Syntax

```
UIAction.UnloadElement(elementName, instanceID)
```

Parameter	Description
elementName	The UI element name as defined in the XML.
instanceID	The ID of the instance (if an instance with the specified ID does not exist, it will be created). -1 specifies all instances.

UnregisterActionListener

Unregister callback functions for a UIAction event.

Syntax

```
UIAction.UnregisterActionListener(table, callbackFunctionName)
```

Parameter	Description
table	The script that receives the callback (can be <code>self</code> to refer the current script).

Parameter	Description
callbackFunctionName	The name of the script function that receives the callback. If "" is specified, all callbacks for this script will be removed.

UnregisterElementListener

Unregister callback functions for a UIElement event.

Syntax

```
UIAction.UnregisterElementListener(table, callbackFunctionName)
```

Parameter	Description
table	The script that receives the callback (can be <code>self</code> to refer the current script).
callbackFunctionName	The name of the script function that receives the callback. If "" is specified, all callbacks for this script will be removed.

UnregisterEventSystemListener

Unregister callback functions for a UIEventSystem event.

Syntax

```
UIAction.UnregisterEventSystemListener(table, callbackFunctionName)
```

Parameter	Description
table	The script that receives the callback (can be <code>self</code> to refer the current script).
callbackFunctionName	The name of the script function that receives the callback. If "" is specified, all callbacks for this script will be removed.

ScriptBind_Vehicle

Lists C++ vehicle system functions that you can call from Lua script.

AddSeat

Adds a seat to the vehicle.

Syntax

```
Vehicle.AddSeat(SmartScriptTable paramsTable)
```

Parameter	Description
paramsTable	The seat parameters in SmartScriptTable format.

ChangeSeat

Makes the actor change the seat inside the vehicle.

Syntax

```
Vehicle.ChangeSeat(ScriptHandle actorHandle, int seatId, bool  
isAnimationEnabled)
```

Parameter	Description
actorHandle	The actor identifier.
seatId	The seat identifier.
isAnimationEnabled	True if animation is enabled; otherwise, false.

Destroy

Destroys the vehicle.

Syntax

```
Vehicle.Destroy()
```

DisableEngine

Disables or enables the engine of the vehicle.

Syntax

```
Vehicle.DisableEngine(bool disable)
```

Parameter	Description
disable	True to disable the engine; false to enable.

EnableMovement

Enables or disables the movement of the vehicle.

Syntax

```
Vehicle.EnableMovement(bool enable)
```

Parameter	Description
enable	True to enable movement; false to disable.

EnterVehicle

Makes the specified actor enter the vehicle.

Syntax

```
Vehicle.EnterVehicle(ScriptHandle actorHandle, int seatId, bool  
isAnimationEnabled)
```

Parameter	Description
actorHandle	The actor identifier.
seatId	The seat identifier.
isAnimationEnabled	True if animation is enabled; otherwise, false.

ExitVehicle

Makes the actor leave the vehicle.

Syntax

```
Vehicle.ExitVehicle(ScriptHandle actorHandle)
```

Parameter	Description
actorHandle	The actor identifier.

GetComponentDamageRatio

Gets the damage ratio of the specified component.

Syntax

```
Vehicle.GetComponentDamageRatio(const char* pComponentName)
```

Parameter	Description
pComponentName	The name of the component.

GetHelperDir

Gets the helper direction.

Syntax

```
Vehicle.GetHelperDir(const char* name, bool isInVehicleSpace)
```

Parameter	Description
name	The name of the helper.
isInVehicleSpace	True if the helper is in the vehicle space; otherwise, false.

GetHelperPos

Gets the helper position.

Syntax

```
Vehicle.GetHelperPos(const char* name, bool isInVehicleSpace)
```

Parameter	Description
name	The name of the helper.
isInVehicleSpace	True if the helper is in the vehicle space; otherwise, false.

GetHelperWorldPos

Gets the helper position in the world coordinates.

Syntax

```
Vehicle.GetHelperWorldPos(const char* name)
```

Parameter	Description
name	The name of the helper.

GetSeatForPassenger

Returns a vehicle seat ID for the specified passenger.

Syntax

```
Vehicle.GetSeatForPassenger(ScriptHandle passengerId)
```

Parameter	Description
passengerId	The passenger ID.

GetVehicle

Gets the vehicle identifier.

Syntax

```
Vehicle.GetVehicle()
```

HasHelper

Checks if the vehicle has the specified helper.

Syntax

```
Vehicle.HasHelper(const char* name)
```

Parameter	Description
name	The name of the helper.

IsDestroyed

Checks if the vehicle is destroyed.

Syntax

```
Vehicle.IsDestroyed()
```

IsInsideRadius

Checks if the vehicle is inside the specified radius.

Syntax

```
Vehicle.IsInsideRadius(Vec3 pos, float radius)
```

Parameter	Description
pos	The {x,y,z} position vector.
radius	The radius, expressed as a float.

IsUsable

Checks if the vehicle is usable by the user.

Syntax

```
Vehicle.IsUsable(ScriptHandle userHandle)
```

Parameter	Description
userHandle	The user identifier.

MultiplyWithWorldTM

Multiplies with the world transformation matrix.

Syntax

```
Vehicle.MultiplyWithWorldTM(Vec3 pos)
```

Parameter	Description
pos	The {x,y,z} position vector.

OnHit

Triggers an event that occurs after the vehicle is hit.

Syntax

```
Vehicle.OnHit(ScriptHandle targetId, ScriptHandle shooterId, float damage, Vec3 position, float radius, int hitTypeId, bool explosion)
```

Parameter	Description
targetId	The target identifier.
shooterId	The shooter identifier.
damage	The amount of damage, expressed as a float.
position	The {x,y,z} position vector.
radius	Radius of the hit, expressed as a float.
hitTypeId	The type of damage, expressed as an integer.
explosion	True if the hit causes an explosion, otherwise false.

OnSpawnComplete

Calls back into the game code for when vehicle spawn has been completed.

Syntax

```
Vehicle.OnSpawnComplete()
```

OnUsed

Triggers an event when the user uses the specified vehicle.

Syntax

```
Vehicle.OnUsed(ScriptHandle userHandle, int index)
```

Parameter	Description
userHandle	The user identifier.
index	The seat identifier.

ProcessPassengerDamage

Processes passenger damages.

Syntax

```
Vehicle.ProcessPassengerDamage(ScriptHandle passengerId, float actorHealth,  
float damage, int hitTypeId, bool explosion)
```

Parameter	Description
passengerId	The passenger identifier.
actorHealth	The health of the actor.
damage	The amount of damage.
hitTypeId	The type of damage.
explosion	True if there is an explosion; otherwise, false.

Reset

Resets the vehicle.

Syntax

```
Vehicle.Reset()
```

ResetSlotGeometry

Syntax

```
Vehicle.ResetSlotGeometry(int slot, const char* filename, const char*  
geometry)
```

Parameter	Description
slot	The number of the slot.
filename	The filename.
geometry	The slot geometry.

ScriptBind_VehicleSeat

Lists C++ vehicle seat functions that you can call from Lua script.

GetPassengerId

Gets the passenger identifier.

Syntax

```
VehicleSeat.GetPassengerId()
```

GetVehicleSeat

Gets the vehicle seat identifier.

Syntax

```
VehicleSeat.GetVehicleSeat()
```

GetWeaponCount

Gets the number of weapons available on this seat.

Syntax

```
VehicleSeat.GetWeaponCount()
```

GetWeaponId

Gets the weapon identifier.

Syntax

```
VehicleSeat.GetWeaponId(int weaponIndex)
```

Parameter	Description
weaponIndex	Weapon identifier.

IsDriver

Checks if the seat is the driver seat.

Syntax

```
VehicleSeat.IsDriver()
```

IsFree

Checks if the seat is free.

Syntax

```
VehicleSeat.IsFree(ScriptHandle actorHandle)
```

Parameter	Description
actorHandle	Passenger identifier.

IsGunner

Checks if the seat is the gunner seat.

Syntax

```
VehicleSeat.IsGunner()
```

Reset

Resets the vehicle seat.

Syntax

```
VehicleSeat.Reset()
```

SetAIWeapon

Sets the weapon artificial intelligence.

Syntax

```
VehicleSeat.SetAIWeapon(ScriptHandle weaponHandle)
```

Parameter	Description
weaponHandle	Weapon identifier.

ScriptBind_VehicleSystem

Lists C++ vehicle system functions that you can call from Lua script.

GetOptionalScript

Get an (optional) script for the named vehicle.

Syntax

```
VehicleSystem.GetOptionalScript(char* vehicleName)
```

GetVehicleImplementations

Get a table of all implemented vehicles.

Syntax

```
VehicleSystem.GetVehicleImplementations()
```

ReloadSystem

Reloads the vehicle system with default values.

Syntax

```
VehicleSystem.ReloadSystem()
```

SetTpvDistance

Distance of camera in third person view.

Syntax

```
VehicleSystem.SetTpvDistance(float distance)
```

SetTpvHeight

Height of camera in third person view.

Syntax

```
VehicleSystem.SetTpvHeight(float height)
```

ScriptBind_Boids

These functions create simulated flocks of bird-like objects ([boids](#)) or other animals and control their behavior.

CanPickup

Syntax

Checks if the boid can be picked up.

```
Boids.CanPickup(flockEntity, boidEntity)
```

Parameter	Description
flockEntity	Valid entity table containing flock.
boidEntity	Valid entity table containing boid.

CreateBugsFlock

Creates a bugs flock and binds it to the given entity.

Syntax

```
Boids.CreateBugsFlock(entity, paramsTable)
```

Parameter	Description
entity	Valid entity table.
paramTable	Table with parameters for flock (see sample scripts).

CreateFishFlock

Creates a fish flock and binds it to the given entity.

Syntax

```
Boids.CreateFishFlock(entity, paramsTable)
```

Parameter	Description
entity	Valid entity table.
paramTable	Table with parameters for flock (see sample scripts).

CreateFlock

Creates a flock of boids and binds it to the given entity.

Syntax

```
Boids.CreateFlock(entity, paramsTable)
```

Parameter	Description
entity	Valid entity table.
nType	The type of flock. Possible values are <code>Boids.FLOCK_BIRDS</code> , <code>Boids.FLOCK_FISH</code> , or <code>Boids.FLOCK_BUGS</code> .
paramTable	Table with parameters for flock (see sample scripts).

EnableFlock

Enables or disables a flock in the entity.

Syntax

```
Boids.EnableFlock(entity, paramsTable)
```

Parameter	Description
entity	Valid entity table containing flock.
bEnable	Specify true to enable the flock; false to disable.

GetUsableMessage

Gets the appropriate localized UI message for the specified flock.

Syntax

```
Boids.GetUsableMessage(flockEntity)
```

Parameter	Description
flockEntity	Valid entity table containing flock.

OnBoidHit

Event that occurs on boid hit.

Syntax

```
Boids.OnBoidHit(flockEntity, boidEntity, hit)
```

Parameter	Description
flockEntity	Valid entity table containing flock.
boidEntity	Valid entity table containing boid.

Parameter	Description
hit	Valid entity table containing hit information.

OnPickup

Forwards the appropriate pickup action to the boid object.

Syntax

```
Boids.OnPickup(flockEntity, boidEntity, bPickup, fThrowSpeed)
```

Parameter	Description
flockEntity	Valid entity table containing flock.
boidEntity	Valid entity table containing boid.
bPickup	Pickup, or drop or throw.
fThrowSpeed	Specifies the throw speed. By default, a value greater than 5.f kills the boid. This has no effect on the pickup action.

SetAttractionPoint

Sets the one time attraction point for the boids.

Syntax

```
Boids.SetAttractionPoint(entity, paramsTable)
```

Parameter	Description
entity	Valid entity table containing flock.
point	The one time attraction point.

SetFlockParams

Sets the parameters of the flock for the specified entity.

Syntax

```
Boids.SetFlockParams(entity, paramsTable)
```

Parameter	Description
entity	Valid entity table containing flock.

Parameter	Description
paramTable	Table with parameters for flock (see sample scripts).

SetFlockPercentEnabled

Specifies the percentage of boid objects that are rendered in flocks. You can use this to enable flocks gradually.

Syntax

```
Boids.SetFlockPercentEnabled(entity, paramsTable)
```

Parameter	Description
entity	Valid entity table containing flock.
nPercent	Possible values are from 0 through 100. If 0, no boids are rendered; if 100, all boids are rendered.

System

This section contains topics on general system issues, including memory handling, streaming, and localization. It also provides information on logging and console tools.

Topics

- [Memory Handling \(p. 761\)](#)
- [Streaming System \(p. 764\)](#)
- [Text Localization and Unicode Support \(p. 773\)](#)
- [CryLog \(p. 778\)](#)
- [CryConsole \(p. 780\)](#)

Memory Handling

This article discusses some memory and storage considerations related to game development.

Hardware Memory Limitations

Developing for game consoles can be challenging due to memory limitations. From a production point of view, it is tempting to use less powerful hardware for consoles, but the expectations for console quality are usually higher in an increasingly competitive market.

Choosing a Platform to Target

It is often better to choose only one development platform, even if multiple platforms are targeted for production. Choosing a platform with lower memory requirements eases production in the long run, but it can degrade the quality on other platforms. Some global code adjustments (for example, TIF setting "globalreduce", TIF preset setting "don't use highest LOD") can help in reducing memory usage, but often more asset-specific adjustments are needed, like using the TIF "reduce" setting. If those adjustments are insufficient, completely different assets are required (for example, all LODs of some object are different for console and PC). This can be done through a CryPak feature. It is possible to bind multiple pak files to a path and have them behave as layered. This way it is possible

to customize some platforms to use different assets. Platforms that use multiple layers have more overhead (memory, performance, I/O), so it is better to use multiple layers on more powerful hardware.

Budgets

Budgets are mostly game specific because all kinds of memory (for example, video/system/disk) are shared across multiple assets, and each game utilizes memory differently. It's a wise decision to dedicate a certain amount of memory to similar types of assets. For example, if all weapons roughly cost the same amount of memory, the cost of a defined number of weapons is predictable, and with some careful planning in production, late and problematic cuts can be avoided.

Allocation Strategy with Multiple Modules and Threads

The Lumberyard memory manager tries to minimize fragmentation by grouping small allocations of similar size. This is done in order to save memory, allow fast allocations and deallocations and to minimize conflicts between multiple threads (synchronization primitives for each bucket). Bigger allocations run through the OS as that is quite efficient. It is possible to allocate memory in other than the main thread, but this can negatively impact the readability of the code. Memory allocated in one module should be deallocated in the same module. Violating this rule might work in some cases, but this breaks per module allocation statistics. The simple `Release()` method ensures objects are freed in the same module. The string class (`CryString`) has this behavior built in, which means the programmer doesn't need to decide where the memory should be released.

Caching Computational Data

In general, it is better to perform skinning (vertex transformation based on joints) of characters on the GPU. The GPU is generally faster in doing the required computations than the CPU. Caching the skinned result is still possible, but memory is often limited on graphics hardware, which tends to be stronger on computations. Under these conditions, it makes sense to recompute the data for every pass, eliminating the need to manage cache memory. This approach is advantageous because character counts can vary significantly in dynamic game scenes.

Compression

There are many lossy and lossless compression techniques that work efficiently for a certain kind of data. They differ in complexity, compression and decompression time and can be asymmetric. Compression can introduce more latency, and only few techniques can deal with broken data such as packet loss and bit-flips.

Disk Size

Installing modern games on a PC can be quite time consuming. Avoiding installation by running the game directly from a DVD is a tempting choice, but DVD performance is much worse than hard drive performance, especially for random access patterns. Consoles have restrictions on game startup times and often require a game to cope with a limited amount of disk memory, or no disk memory at all. If a game is too big to fit into memory, streaming is required.

Total Size

To keep the total size of a build small, the asset count and the asset quality should be reasonable. For production it can make sense to create all textures in double resolution and downsample the content with the Resource Compiler. This can be useful for cross-platform development and allows later

release of the content with higher quality. It also eases the workflow for artists as they often create the assets in higher resolutions anyway. Having the content available at higher resolutions also enables the engine to render cut-scenes with the highest quality if needed (for example, when creating videos).

Many media have a format that maximizes space, but using the larger format can cost more than using a smaller one (for example, using another layer on a DVD). Redundancy might be a good solution to minimize seek times (for example, storing all assets of the same level in one block).

Address Space

Some operating systems (OSes) are still 32-bit, which means that an address in main memory has 32-bits, which results in 4 GB of addressable memory. Unfortunately, to allow relative addressing, the top bit is lost, which leaves only 2 GB for the application. Some OSes can be instructed to drop this limitation by compiling applications with large address awareness, which frees up more memory. However, the full 4 GB cannot be used because the OS also maps things like GPU memory into the memory space. When managing that memory, another challenge appears. Even if a total of 1 GB of memory is free, a contiguous block of 200 MB may not be available in the virtual address space. In order to avoid this problem, memory should be managed carefully. Good practices are:

- Prefer memory from the stack with constant size (SPU stack size is small).
- Allocating from the stack with dynamic size by using `alloca()` is possible (even on SPU), but it can introduce bugs that can be hard to find.
- Allocate small objects in bigger chunks (flyweight design pattern).
- Avoid reallocations (for example, reserve and stick to maximum budgets).
- Avoid allocations during the frame (sometimes simple parameter passing can cause allocations).
- Ensure that after processing one level the memory is not fragmented more than necessary (test case: loading multiple levels one after another).

A 64-bit address space is a good solution for the problem. This requires a 64-bit OS and running the 64-bit version of the application. Running a 32-bit application on a 64-bit OS helps very little. Note that compiling for 64-bit can result in a bigger executable file size, which can in some cases be counterproductive.

Bandwidth

To reduce memory bandwidth usage, make use of caches, use a local memory access pattern, keep the right data nearby, or use smaller data structures. Another option is to avoid memory accesses all together by recomputing on demand instead of storing data and reading it later.

Latency

Different types of memory have different access performance characteristics. Careful planning of data storage location can help to improve performance. For example, blending animation for run animation needs to be accessible within a fraction of a frame, and must be accessible in memory. In contrast, cut-scene animations can be stored on disk. To overcome higher latencies, extra coding may be required. In some cases the benefit may not be worth the effort.

Alignment

Some CPUs require proper alignment for data access (for example, reading a float requires an address dividable by 4). Other CPUs perform slower when data is not aligned properly (misaligned data access). As caches operate on increasing sizes, there are benefits to aligning data to the new sizes. When new features are created, these structure sizes must be taken into consideration. Otherwise, the feature might not perform well or not even work.

Virtual Memory

Most operating systems try to handle memory quite conservatively because they never know what memory requests will come next. Code or data that has not been used for a certain time can be paged out to the hard drive. In games, this paging can result in stalls that can occur randomly, so most consoles avoid swapping.

Streaming

Streaming enables a game to simulate a world that is larger than limited available memory would normally allow. A secondary (usually slower) storage medium is required, and the limited resource is used as a cache. This is possible because the set of assets tends to change slowly and only part of the content is required at any given time. The set of assets kept in memory must adhere to the limits of the hardware available. While memory usage can partly be determined by code, designer decisions regarding the placement, use, and reuse of assets, and the use of occlusion and streaming hints are also important in determining the amount of memory required. Latency of streaming can be an issue when large changes to the set of required assets are necessary. Seek times are faster on hard drives than on most other storage media like DVDs, Blue-Rays or CDs. Sorting assets and keeping redundant copies of assets can help to improve performance.

Split screen or general multi-camera support add further challenges for the streaming system. Tracking the required asset set becomes more difficult under these circumstances. Seek performance can get worse as multiple sets now need to be supported by the same hardware. It is wise to limit gameplay so that the streaming system can perform well. A streaming system works best if it knows about the assets that will be needed beforehand. Game code that loads assets on demand without registering them first will not be capable of doing this. It is better to wrap all asset access with a handle and allow registration and creation of handles only during some startup phase. This makes it easier to create stripped down builds (minimal builds consisting only of required assets).

Streaming System

The Lumberyard streaming engine takes care of the streaming of meshes, textures, music, sounds, and animations.

Low-level Streaming System

CryCommon interfaces and structs

The file `IStreamEngine.h` in CryCommon contains all the important interfaces and structs used by the rest of the engine.

First of all there is the `IStreamEngine` itself. There is only one `IStreamingEngine` in the application and it controls all the possible I/O streams. Most of the following information comes directly from the documentation inside the code, so it's always good to read the actual code in `IStreamEngine.h` file for any missing information.

The most important function in `IStreamEngine` is the `StartRead` function which is used to start any streaming request.

IStreamEngine.h

```
UNIQUE_IFACE struct IStreamEngine
{
public:
```

```
// Description:  
// Starts asynchronous read from the specified file (the file may be on  
a  
// virtual file system, in pak or zip file or wherever).  
// Reads the file contents into the given buffer, up to the given size.  
// Upon success, calls success callback. If the file is truncated or  
for other  
// reason can not be read, calls error callback. The callback can be  
NULL  
// (in this case, the client should poll the returned IReadStream  
object;  
// the returned object must be locked for that)  
// NOTE: the error/success/progress callbacks can also be called from  
INSIDE  
// this function  
// Return Value:  
// IReadStream is reference-counted and will be automatically deleted  
if  
// you don't refer to it; if you don't store it immediately in an auto-  
pointer,  
// it may be deleted as soon as on the next line of code,  
// because the read operation may complete immediately inside  
StartRead()  
// and the object is self-disposed as soon as the callback is called.  
virtual IReadStreamPtr StartRead (const EStreamTaskType tSource, const  
char* szFile, IStreamCallback* pCallback = NULL, StreamReadParams* pParams =  
NULL) = 0;  
};
```

The following are the currently supported streaming task types. This enum should be extended if you want to stream a new object type.

IStreamEngine.h

```
enum EStreamTaskType  
{  
    eStreamTaskTypeCount          = 13,  
    eStreamTaskTypePak            = 12, // Pak file itself  
    eStreamTaskTypeFlash          = 11, // Flash file object  
    eStreamTaskTypeVideo          = 10, // Video data (when streamed)  
    eStreamTaskTypeReadAhead      = 9,  // Read ahead data used for file reading  
prediction  
    eStreamTaskTypeShader         = 8,  // Shader combination data  
    eStreamTaskTypeSound          = 7,  
    eStreamTaskTypeMusic          = 6,  
    eStreamTaskTypeFSBCache       = 5,  // Complete FSB file  
    eStreamTaskTypeAnimation      = 4,  // All the possible animations types  
(dba, caf, ..)  
    eStreamTaskTypeTerrain        = 3,  // Partial terrain data  
    eStreamTaskTypeGeometry       = 2,  // Mesh or mesh lods  
    eStreamTaskTypeTexture        = 1,  // Texture mip maps (currently mip0 is  
not streamed)  
};
```

A callback object can be provided to the `StartStream` function to be informed when the streaming request has finished. The callback object should implement the following `StreamAsyncOnComplete` and `StreamOnComplete` functions.

IStreamEngine.h

```
class IStreamCallback
{
public:
    // Description:
    // Signals that reading the requested data has completed (with or
    // without error).
    // This callback is always called, whether an error occurs or not, and
    // is called
    // from the async callback thread of the streaming engine, which
    // happens
    // directly after the reading operation
    virtual void StreamAsyncOnComplete (IReadStream* pStream, unsigned
    nError) {}

    // Description:
    // Same as the StreamAsyncOnComplete, but this function is called from
    // the main
    // thread and is always called after the StreamAsyncOnComplete
    // function.
    virtual void StreamOnComplete (IReadStream* pStream, unsigned nError) =
    0;
};
```

When starting a read request, you can also provide the optional parameters shown in the following code.

IStreamEngine.h

```
struct StreamReadParams
{
public:

    // The user data that'll be used to call the callback.
    DWORD_PTR dwUserData;

    // The priority of this read
    EStreamTaskPriority ePriority;

    // Description:
    // The buffer into which to read the file or the file piece
    // if this is NULL, the streaming engine will supply the buffer.
    // Notes:
    // DO NOT USE THIS BUFFER during read operation! DO NOT READ from it,
    // it can lead to memory corruption!
    void* pBuffer;

    // Description:
    // Offset in the file to read; if this is not 0, then the file read
    // occurs beginning with the specified offset in bytes.
    // The callback interface receives the size of already read data as
    nSize
    // and generally behaves as if the piece of file would be a file of its
    // own.
    unsigned nOffset;

    // Description:
```

```
// Number of bytes to read; if this is 0, then the whole file is read,  
// if nSize == 0 && nOffset != 0, then the file from the offset to the  
end is read.  
// If nSize != 0, then the file piece from nOffset is read, at most  
nSize bytes  
// (if less, an error is reported). So, from nOffset byte to nOffset +  
nSize - 1 byte in the file.  
unsigned nSize;  
  
// Description:  
// The combination of one or several flags from the stream engine  
general purpose flags.  
// See also:  
// IStreamEngine::EFlags  
unsigned nFlags;  
};
```

The return value of the `StartRead` function is an `IReadStream` object which can be optionally stored on the client. The `IReadStream` object is refcounted internally. When the callback object can be destroyed before the reading operation is finished, the readstream should be stored separately, and the abort should be called on it. Doing this will clean up the entire read request internally and will also call the async and sync callback functions.

The `Wait` function can be used to perform a blocking reading requests on the streaming engine. This function can be used from an async reading thread that uses the Lumberyard streaming system to perform the actual reading.

IStreamEngine.h

```
class IReadStream : public CMultiThreadRefCount  
{  
public:  
    virtual void Abort() = 0;  
    virtual void Wait( int nMaxWaitMillis=-1 ) = 0;  
};
```

Internal flow of a read request

The Lumberyard stream engine uses extra worker and IO threads internally. For every possible IO input, a different `StreamingIOThread` is created which can run independently from the others.

Currently the stream engine has the following IO threads:

- Optical – Streaming from the optical data drive.
- Hard disk drive (HDD) – Streaming from installed data on the hard disk drive (this could be a fully installed game, or shadow copied data).
- Memory – Streaming from packed in-memory files, which requires very little IO.

When a reading request is made on the streaming engine, it first checks which IO thread to use, and computes the sortkey. The request is then inserted into one of the `StreamingIOThread` objects.

After the reading operation is finished, the request is forwarded to one of the decompression threads if the data was compressed, and then into one of the async callback threads. The amount of async callback threads is dependent on the platform, and some async callback threads are reserved for specific streaming request types such as geometry and textures. After the async callback has been processed, the finished streaming request is added to the streaming engine to be processed on the

main thread. The next update on the streaming engine from the main thread will then call the sync callback (`StreamOnComplete`) and clean up the temporary allocated memory if needed.

For information regarding the IO/WorkerThreads please check the `StreamingIOThread` and `StreamingWorkerThread` class.

Read request sorting

Requests to the streaming engine are **not** processed in a the same order as which they have been requested. The system tries to internally 'optimize' the order in which to read the data, to maximize the read bandwidth.

When reading data from an optical disc , it is very important to reduce the amount of seeks. (This is also true when reading from a hard disk drive, but to a lesser extent). A single seek can take over 100 milliseconds, while the actual read time might take only a few milliseconds. Some official statistics from the 360 XDK follow.

- Outer diameter throughput : 12x (approximately 15 MB per second).
- Inner diameter throughput : 5x (6.8 MB per second).
- Average seek (1/3rd stroke) time : 110 ms typical, 140 ms maximum.
- Full stroke seek time : 180 ms typical, 240 ms maximum.
- Layer switch time : 75 ms.

The internal sorting algorithm takes the following rules into account in the following order.

- **Priority of the request** – High priority requests always take precedence, but too many of them can introduce too many extra seeks.
- **Time grouping** – Requests made within a certain time are grouped together to create a continuous reading operation on the disc for every time group. The default value is 2 seconds, but can be changed using the following cvar: `sys_streaming_requests_grouping_time_period`. Time grouping has a huge impact on the average completion time of the requests. It increases the time of a few otherwise quick reading requests, but drastically reduces the overall completion time because most of the streaming requests are coming from random places on the disc.
- **Actual offset on disc** – The actual disc offset is computed and used during the sorting. Files which have a higher offset get a higher priority, so it is important to organize the layout of the disc to reflect the desired streaming order.

For information regarding sorting, please refer to the source code in `StreamAsyncFileRequest::ComputeSortKey()`. The essential sorting code follows.

CAsyncIOFileRequest::ComputeSortKey

```
void CAsyncIOFileRequest::ComputeSortKey(uint64 nCurrentKeyInProgress)
{
    .. compute the disc offset (can be requested using CryPak)

    // group items by priority, then by snapped request time, then sort by
    disk offset
    m_nDiskOffset += m_nRequestedOffset;
    m_nTimeGroup = (uint64)(gEnv->pTimer->GetCurrTime() / max(1,
g_cvars.sys_streaming_requests_grouping_time_period));
    uint64 nPriority = m_ePriority;

    int64 nDiskOffsetKB = m_nDiskOffset >> 10; // KB
    m_nSortKey = (nDiskOffsetKB) | (((uint64)m_nTimeGroup) << 30) |
(nPriority << 60);
```

```
}
```

Streaming statistics

The streaming engine can be polled for streaming statistics using the `GetStreamingStatistics()` function.

Most of the statistics are divided into two groups, one collected during the last second, and another from the last reset (which usually happens during level loading). Statistics can also be forcibly reset during the game.

The `SMediaTypeInfo` struct gives information per IO input system (hard disk drive, optical, memory).

IStreamEngine.h

```
struct SMediaTypeInfo
{
    // stats collected during the last second
    float fActiveDuringLastSecond;
    float fAverageActiveTime;
    uint32 nBytesRead;
    uint32 nRequestCount;
    uint64 nSeekOffsetLastSecond;
    uint32 nCurrentReadBandwidth;
    uint32 nActualReadBandwidth;    // only taking actual reading time into
    account

    // stats collected since last reset
    uint64 nTotalBytesRead;
    uint32 nTotalRequestCount;
    uint64 nAverageSeekOffset;
    uint32 nSessionReadBandwidth;
    uint32 nAverageActualReadBandwidth; // only taking actual read time into
    account
};
```

The `SRequestTypeInfo` struct gives information about each streaming request type, such as geometry, textures, and animations.

IStreamEngine.h

```
struct SRequestTypeInfo
{
    int nOpenRequestCount;
    int nPendingReadBytes;

    // stats collected during the last second
    uint32 nCurrentReadBandwidth;

    // stats collected since last reset
    uint32 nTotalStreamingRequestCount;
    uint64 nTotalReadBytes;    // compressed data
    uint64 nTotalRequestDataSize; // uncompressed data
    uint32 nTotalRequestCount;
    uint32 nSessionReadBandwidth;

    float fAverageCompletionTime; // Average time it takes to fully
    complete a request
```

```
float fAverageRequestCount; // Average amount of requests made per second  
};
```

The following example shows global statistics that contain all the gathered data.

IStreamEngine.h

```
struct SStatistics  
{  
    SMediaTypeInfo hddInfo;  
    SMediaTypeInfo memoryInfo;  
    SMediaTypeInfo opticalInfo;  
  
    SRequestTypeInfo typeInfo[eStreamTaskTypeCount];  
  
    uint32 nTotalSessionReadBandwidth; // Average read bandwidth in total  
    from reset - taking full time into account from reset  
    uint32 nTotalCurrentReadBandwidth; // Total bytes/sec over all types and  
    systems.  
  
    int nPendingReadBytes; // How many bytes still need to be read  
    float fAverageCompletionTime; // Time in seconds on average takes to  
    complete read request.  
    float fAverageRequestCount; // Average requests per second being done to  
    streaming engine  
    int nOpenRequestCount; // Amount of open requests  
  
    uint64 nTotalBytesRead; // Read bytes total from reset.  
    uint32 nTotalRequestCount; // Number of request from reset to the  
    streaming engine.  
  
    uint32 nDecompressBandwidth; // Bytes/second for last second  
  
    int nMaxTempMemory; // Maximum temporary memory used by the streaming  
    system  
};
```

Streaming debug information

Different types of debug information can be requested using the following CVar:
sys_streaming_debug x.

Streaming and Levelcache Pak Files

As mentioned earlier, it is very important to minimize the seeks and seek distances when reading from an optical media drive. For this reason, the build system is designed to optimize the internal data layout for streaming.

The easiest and fastest approach is to not do any IO at all, but read the data from compressed data in memory. For this, small paks for startup and each level are created. These are loaded into memory during level loading. Some paks remain in memory until the end of the level. Others are only used to speed up the level loading. All small files and small read requests should ideally be diverted to these paks.

A special RC_Job build file is used to generate these paks: Bin32/rc/RCJob_PerLevelCache.xml. These paks are generated during a normal build pipeline. The internal management in the engine is

done by the CResourceManager class, which uses the global `SystemEvents` to preload or unload the paks.

Currently, the following paks are loaded into memory during level loading (`sys_PakLoadCache`).

- **level.pak** – Contains all actual level data, and should not be touched after level loading anymore.
- **xml.pak**
- **dds0.pak** – Contains all lowest mips of all the textures in the level.
- **cgf.pak** and **cga.pak** – Only load when CGF streaming is enabled.

The following paks are cached into memory during the level load process (`sys_PakStreamCache`).

- **dds_cache.pak** - Contains all dds files smaller than 6 KB (except for dds.0 files).
- **cgf_cache.pak** - Contains all cgf files smaller than 32 KB (only when CGF streaming is enabled).

Important

Be sure that these paks are available. Without them, level loading can take up to a few minutes, and streaming performance is greatly reduced.

The information regarding all the resources of a level are stored in the `resourcelist.txt` and `auto_resourcelist.txt`. These files are generated by an automatic testing system which loads each level and executes a prerecorded playthrough on it. These `resourcelist` files are used during the build phase to generate the level paks.

All data not in these in memory paks is handled through IO on the optical drive or hard disk drive, and it is also best to reduce the amount of seeks here. This optimization phase is also performed during the build process using the resource compiler.

All the data which can be streamed is extracted from all the resource lists from all levels, and is removed from the default pak files (for example, `objects.pak`, `textures.pak`, `animations.pak`) and put into new optimized paks for streaming inside a streaming folder.

The creating of the streaming paks uses the following rules:

- Split by **extension**: Different extension files are put into different paks (for example, `dds`, `caf`, `dba`, `cgf`) so that files of the same type can be put close to each other. This enables them to be read in bursts. The paks are also used to increase the priority of certain file types during request sorting by using the disc offset.
- Split by **DDS type**: Different `dds` types are sorted differently to increase the priority of different types (for example, diffuse maps get higher priority than normal maps). The actual distance in the pak is used during the sorting of the request.
- Split by **DDS mip**: The highest mips are put into a separate pak file. They usually take more than 60% of the size of all the smaller mips and can then be streamed with a lower priority. This greatly reduces the average seek time required to read the smaller textures. The texture streaming system internally optimizes the reads to reflect these split texture data.
- Sort **alphabetically**: Default alphabetical sorting is required because some of the data (such as CGF's during MP level loading), are loaded in alphabetical order. Changing this sort order can have a severe impact on the loading times.

The actual sorting code is hardcoded in the resource compiler, and can be found at: `Code\Tools\RC\ResourceCompiler\PakHelpers.cpp`.

Important

If you make changes to the sorting operator in the resource compiler, be sure to make the same changes to the texture streaming and streaming engine sorting operators.

Single Thread IO Access and Invalid File Access

It is very important that only a single thread access a particular IO device at one time. If multiple threads read from the same IO device concurrently, then the reading speed is more than halved, and it may take a number of seconds to read just a few kilobytes. This occurs because the IO reading head will partially read a few kilobytes for one thread, and then read another few kilobytes for another thread while always performing expensive seeks in between.

The solution is to exclusively read from `StreamingIOThreads` during gameplay. Lumberyard will by default show an **Invalid File Access** warning in the top left corner when reading data from the wrong thread, and will stall deliberately for three seconds to emulate the actual stall when reading from an optical drive.

High Level Streaming Engine Usage

It is very easy to extend the current streaming functionality using the streaming engine. In this section, a small example class is presented that shows how to add a new streaming type.

First, create a class which derives from the `IStreamCallback` interface, which informs about streaming completion, and add some basic functionality to read a file. The file can either be read directly or use the streaming engine. When the data is read directly, it calls the `ProcessData` function to parse the loaded data. The function is also called from the `async` callback. Some processing can be performed here on the data if needed because it does not run on the main thread.

The default parameters are used when starting a reading request on the streaming engine. It is also possible to specify the final data storage to help reduce the number of dynamic allocations performed by the streaming engine.

The class also stores the read stream object in order to get information about the streaming request or to be able to cancel the request when the callback object is destroyed. The pointer is reset in the sync callback because after the call it will no longer be referenced by the streaming engine.

CNewStreamingType

```
#include
class CNewStreamingType : public IStreamCallback
{
public:
    CNewStreamingType() : m_pReadStream(0), m_bIsLoaded(false) {}
    ~CNewStreamingType()
    {
        if (m_pReadStream)
            m_pReadStream->Abort();
    }

    // Start reading some data
    bool ReadFile(const char* acFilename, bool bUseStreamingEngine)
    {
        if (bUseStreamingEngine)
        {
            StreamReadParams params;
            params.dwUserData = eLoadFullData;
            params.ePriority = estpNormal;
            params.nSize = 0; // read the full file
            params.pBuffer = NULL; // don't provide any buffer, but copy data
            when streaming is done

            m_pReadStream = g_pISystem->GetStreamEngine()-
            >StartRead(eStreamTaskTypeNewType, acFilename, this, &params);
        }
    }
};
```

```
    }
    else
    {
        // old way of reading file in a sync way (blocking call!)
        const char* acData = 0;
        size_t stSize = 0;

        .. read file directly using CryPak or fopen/fread

        ProcessData(acData, stSize);
        m_bIsLoaded = true;
    }

    return m_bIsLoaded;
}

// Check if the data is ready and loaded
bool IsLoaded() const { return m_bIsLoaded; }

protected:

// implement the IStreamCallback function
void StreamAsyncOnComplete(IReadStream* pStream, unsigned nError)
{
    if(nError)
    {
        return;
    }

    const char* acData = (char*)pStream->GetBuffer();
    size_t stSize= pStream->GetBytesRead();

    ProcessData(acData, stSize);
    m_bIsLoaded = true;
}

void StreamOnComplete (IReadStream* pStream, unsigned nError)
{
    m_pReadStream = 0;
}

// process the actual loaded data
void ProcessData(const char* acData, size_t stSize);

// store the stream callback object to be sure it can be canceled when
the object is destroyed
IReadStreamPtr m_pReadStream;
// Extra flag used to check if the data is ready
bool m_bIsLoaded;
}
```

Text Localization and Unicode Support

Because games are typically localized to various languages, your game might have to use text data for many languages.

This document provides programming-related information regarding localization, including localization information specific to Lumberyard.

Terminology

The following table provides brief descriptions of some important terms related to localization and text processing.

Term	Description
character	A unit of textual data. A character can be a glyph or formatting indicator. Note that a glyph does not necessarily form a single visible unit. For example, a diacritical mark [˘] and the letter [a] are separate glyphs (and characters), but can be overlaid to form the character [á].
Unicode	A standard maintained by the Unicode Consortium that deals with text and language standardization.
UCS	Universal Character Set, the standardized set of characters in the Unicode standard (also, ISO-10646)
(UCS) code-point	An integral identifier for a single character in the UCS defined range, typically displayed with the U prefix followed by hexadecimal, for example: U+12AB
(text) encoding	A method of mapping (a subset of) UCS to a sequence of code-units, or the process of applying an encoding.
code-unit	An encoding-specific unit integral identifier used to encode code-points. Many code-units may be used to represent a single code-point.
ASCII	A standardized encoding that covers the first 128 code-points of the UCS space using 7- or 8-bit code-units.
(ANSI) code-page	A standardized encoding that extends ASCII by assigning additional meaning to the higher 128 values when using 8-bit code-units There are many hundreds of code-pages, some of which use multi-byte sequences to encode code-points.
UTF	UCS Transformation Format, a standardized encoding that covers the entire UCS space.
UTF-8	A specific instance of UTF, using 8-bit code-units. Each code-point can take 1 to 4 (inclusive) code-units.
UTF-16	A specific instance of UTF, using 16-bit code-units. Each code-point can take 1 or 2 code-units.
UTF-32	A specific instance of UTF, using 32-bit code-units. Each code-point is directly mapped to a single code-unit.
byte-order	How a CPU treats a sequence of bytes when interpreting multi-byte values. A byte-orderTypically either little-endian or big-endian format
encoding error	A sequence of code-units that does not form a code-point (or an invalid code-point, as defined by the Unicode standard)

What encoding to use?

Since there are many methods of encoding text, the question that should be asked when dealing with even the smallest amount of text is, "In what encoding is this stored?" This is an important question because decoding a sequence of code-units in the wrong way will lead to encoding errors, or even worse, to valid decoding that yields the wrong content.

The following table describes some common encodings.

Encoding	Code-unit size	Code-point size	Maps the entire UCS space	Trivial to encode/decode	Immune to byte-order differences	Major users
ASCII	7 bits	1 byte	no	yes	yes	Many English-only apps
(ANSI) code-page	8 bits	varies, usually 1 byte	no	varies, usually yes	yes	Older OS functions
UTF-8	8 bits	1 to 4 bytes	yes	no	yes	Most text on the internet, XML
UTF-16	16 bits	2 to 4 bytes	yes	yes	no	Windows "wide" API, Qt
UCS-2	16 bits	2 bytes	no	yes	no	None (replaced with UTF-16)
UTF-32 UCS-4	32 bits	4 bytes	yes	yes	no	Linux "wide" API

Because there is no single "best" encoding, you should always consider the scenario in which it will be used when choosing one.

Historically, different operating systems and software packages have chosen different sets of supported encodings. Even C++ follows different conventions on different platforms. For example, the "wide character" `wchar_t` is 16-bits on Windows, but 32-bits on Linux.

Because Lumberyard products can be used on many platforms and in many languages, full UCS coverage is desirable. The follow table presents some conventions used in Lumberyard:

Text data type	Encoding	Reason
Source code	ASCII	We write our code in English, which means ASCII is sufficient.
Text assets	UTF-8	Assets can be transferred between machines with potentially differing byte-order, and may contain text in many languages.
Run-time variables	UTF-8	Since transforming text data from or to UTF-8 is not free, we keep data in UTF-8 as much as possible. Exceptions must be made when interacting

Text data type	Encoding	Reason
		with libraries or operating systems that require another encoding. In these cases all transformations should be done at the call-site.
File and path names	ASCII	File names are a special case with regards to case-sensitivity, as defined by the file system. Unicode defines 3 cases, and conversions between them are locale-specific. In addition, the normalization formats are typically not (all) accounted for in file-systems and their APIs. Some specialized file-systems only accept ASCII. This combination means that using the most basic and portable sub-set should be preferred, with UTF-8 being used only as required.

General principles

- Avoid using non-ASCII characters in source code. Consider using escape sequences if a non-ASCII literal is required.
- Avoid using absolute paths. Only paths that are under developer control should be entered. If possible, use relative ASCII paths for the game folder, root folder, and user folder. When this is not possible, carefully consider non-ASCII contents that may be under a user's control, such as those in the installation folder.

How does this affect me when writing code?

Since single-byte code-units are common (even in languages that also use double-byte code-units), single-byte string types can be used almost universally. In addition, since Lumberyard does not use ANSI code-pages, all text must be either ASCII or UTF-8.

The following properties hold for both ASCII and UTF-8.

- The NULL-byte (integral value 0) only occurs when a NULL-byte is intended (UTF-8 never generates a NULL-byte as part of multi-byte sequences). This means that C-style null-terminated strings act the same, and CRT functions like `strlen` will work as expected, except that it counts code-units, not characters.
- Code-points in the ASCII range have the same encoded value in UTF-8. This means that you can type English string literals in code and treat them as UTF-8 without conversion. Also, you can compare characters in the ASCII range directly against UTF-8 content (that is, when looking for an English or ASCII symbol sub-string).
- UTF-8 sequences (containing zero or more entire code-points) do not carry context. This means they are safe to append to each other without changing the contents of the text.

The difference between position and length in code-units (as reported through `string::length()`, `strlen()`, and similar functions) and their matching position and length in code-points is largely irrelevant. This is because the meaning of the sequence is typically abstract, and the meaning of the bytes matters only when the text is interpreted or displayed. However, keep in mind the following caveats.

- **Splitting strings** – When splitting a string, it's important to do one of the following.
 1. Recombine the parts in the same order after splitting, without interpreting the splitted parts as text (that is, without chunking for transmission).
 2. Perform the split at a boundary between code-points. The positions just before and just after any ASCII character are always safe.

- **API boundaries** – When an API accepts or returns strings, it's important to know what encoding the API uses. If the API doesn't treat strings as opaque (that is, interprets the text), passing UTF-8 may be problematic for APIs that accept byte-strings and interpret them as ASCII or ANSI. If no UTF-8 API is available, prefer any other Unicode API instead (UTF-16 or UTF-32). As a last resort, convert to ASCII, but understand that the conversion is lossy and cannot be recovered from the converted string. Always read the documentation of the API to see what text encoding it expects and perform any required conversion. All UTF encodings can be losslessly converted in both directions, so finding any API that accepts a UTF format gives you a way to use UTF encoding.
- **Identifiers** – When using strings as a "key" in a collection or for comparison, avoid using non-ASCII sequences as keys, as the concept of "equality" of UTF is complex due to normalization forms and locale-dependent rules. However, comparing UTF-8 strings byte-by-byte is safe if you only care about equality in terms of code-points (since code-point to code-unit mapping is 1:1).
- **Sorting** – When using strings for sorting, keep in mind that locale-specific rules for the order of text are complex. It's fine to let the UI deal with this in many cases. In general, make no assumptions of how a set of strings will be sorted. However, sorting UTF-8 strings as if they were ASCII will actually sort them by code-point. This is fine if you only require an arbitrary fixed order for `std::map` look-up, but displaying contents in the UI in this order may be confusing for end-users that expect another ordering.

In general, avoid interpreting text if at all possible. Otherwise, try to operate on the ASCII subset and treat all other text parts as opaque indivisible sequences. When dealing with the concept of "length" or "size", try to consider using in code-units instead of code-points, since those operations are computationally cheaper. In fact, the concept of the "length" of Unicode sequences is complex, and there is a many-to-many mapping between code-points and what is actually displayed.

How does this affect me when dealing with text assets?

In general, always:

- Store text assets with UTF-8 encoding.
- Store with Unicode NFC (Normalization Form C). This is the most common form of storage in text editing tools, so it's best to use this form unless you have a good reason to do otherwise.
- Store text in the correct case (that is, the one that will be displayed). Case-conversion is a complex topic in many languages and is best avoided.

Utilities provided in CryCommon

Lumberyard provides some utilities to make it easy to losslessly and safely convert text between Unicode encodings. In-depth technical details are provided in the header files that expose the `UnicodeFunctions.h` and `UnicodeIterator.h` utilities.

The most common use cases are as follows.

```
string utf8;
wstring wide;
Unicode::Convert(utf8, wide); // Convert contents of wide string and store
                              into UTF-8 string
Unicode::Convert(wide, utf8); // Convert contents of UTF-8 string to wide
                              string
```

```
string ascii;
```

```
Unicode::Convert<Unicode::eEncoding_ASCII, Unicode::eEncoding_UTF8>(ascii,  
utf8); // Convert UTF-8 to ASCII (lossy!)
```

Important

The above functions assume that the input text is already validly encoded. To guard against malformed user input or potentially broken input, consider using the `Unicode::ConvertSafe` function.

Further reading

For an introduction to Unicode, see [The Absolute Minimum Every Software Developer Absolutely, Positively Must Know About Unicode and Character Sets \(No Excuses!\)](#).

For official information about Unicode, see [The Unicode Consortium](#).

CryLog

CryLog Logging Functionality

You can log in Lumberyard by using the following global functions.

- `CryLog` (`eMessage`)
- `CryLogAlways` (`eAlways`)
- `CryError` (`eError`)
- `CryWarning` (`eWarning`)
- `CryComment` (`eComment`)

If more control is required, the `ILog` interface can be used directly by using the following syntax.

```
gEnv->pLog->LogToFile("value %d", iVal);
```

Verbosity Level and Coloring

You can control the verbosity of logging with the console variables `log_Verbosity` and `log_FileVerbosity`.

The following table shows the levels of verbosity and color convention. In the console, warnings appear in yellow, and errors appear in red.

Message	verbosity 0	verbosity 1	verbosity 2	verbosity 3	verbosity 4	Color in console
<code>eAlways</code>	X	X	X	X	X	
<code>eErrorAlways</code>	X	X	X	X	X	red
<code>eWarningAlways</code>	X	X	X	X	X	yellow
<code>eInput</code>	?	?	?	?	?	
<code>eInputResponse</code>	?	?	?	?	?	

Message	verbosity 0	verbosity 1	verbosity 2	verbosity 3	verbosity 4	Color in console
eError		X	X	X	X	red
eWarning	-	-	X	X	X	yellow
eMessage	-	-		X	X	
eComment	-	-	-	-	X	

Key

- X – the message type is logged to the console or file
- ? – some special logic is involved

Tip

Full logging (to console and file) can be enabled by using `log_Verbosity 4`.

Log Files

The following log file sources write to the log files indicated.

Source	Log file
Lumberyard Editor	Editor.log
Game	game.log (default)
Error messages	Error.log

Console Variables

The following console variables relate to logging.

`log_IncludeTime`

```
Toggles time stamping of log entries.
Usage: log_IncludeTime [0/1/2/3/4/5]
0=off (default)
1=current time
2=relative time
3=current+relative time
4=absolute time in seconds since this mode was started
5=current time+server time
```

`ai_LogFileVerbosity`

```
None = 0, progress/errors/warnings = 1, event = 2, comment = 3
```

`log_Verbosity DUMPTODISK`

```
defines the verbosity level for log messages written to console
-1=suppress all logs (including eAlways)
0=suppress all logs(except eAlways)
1=additional errors
2=additional warnings
3=additional messages
4=additional comments
```

CryConsole

The console is a user interface system which handles console commands and console variables. It also outputs log messages and stores the input and output history.

Color coding

The game console supports color coding by using the color indices 0..9 with a leading \$ character. The code is hidden in the text outputted on the console. Simple log messages through the `ILog` interface can be used to send text to the console.

```
This is normal $1one$2two$3three and so on
```

In the preceding example, one renders in red, two in green, and three (and the remaining text) in blue.

Dumping all console commands and variables

All console commands and console variables can be logged to a file by using the command `DumpCommandsVars`. The default filename is `consolecommandsandvars.txt`.

To restrict the variables that should be dumped, a sub-string parameter can be passed. For example, the command

```
DumpCommandsVars i_
```

logs all commands and variables that begin with the sub-string "i_". (for example, `i_giveallitems` and `i_debug_projectiles`).

Console Variables

Console variables provide a convenient way to expose variables which can be modified easily by the user either by being entered in the console during runtime or by passing it as command-line argument before launching the application.

More information on how to use command-line arguments can be found in the [Command Line Arguments](#) article.

Console variables are commonly referred to as `CVar` in the code base.

Registering new console variables

For an integer or float based console variable, it is recommended to use the `ICConsole::Register()` function to expose a C++ variable as a console variable.

To declare a new string console variable, use the `IConsole::RegisterString()` function.

Accessing console variables from C++

Console variables are exposed using the `ICVar` interface. To retrieve this interface, use the `IConsole::GetCVar()` function.

The most efficient way to read the console variable value is to access directly the C++ variable bound to the console variable proxy.

Adding New Console Commands

The console can easily be extended with new console commands. A new console command can be implemented in C++ as a static function which follows the `ConsoleCommandFunc` type. Arguments for this console command are passed using the `IConsoleCmdArgs` interface.

The following code shows the skeleton implementation of a console command:

```
static void RequestLoadMod(IConsoleCmdArgs* pCmdArgs);

void RequestLoadMod(IConsoleCmdArgs* pCmdArgs)
{
    if (pCmdArgs->GetArgCount() == 2)
    {
        const char* pName = pCmdArgs->GetArg(1);
        // ...
    }
    else
    {
        CryLog("Error, correct syntax is: g_loadMod modname");
    }
}
```

The following code will register the command with the console system:

```
IConsole* pConsole = gEnv->pSystem->GetIConsole();
pConsole->AddCommand("g_loadMod", RequestLoadMod);
```

Console Variable Groups

Console variable groups provide a convenient way to apply predefined settings to multiple console variables at once.

Console variables are commonly referred to as `CVarGroup` in the code base. Console variable groups can modify other console variables to build bigger hierarchies.

Warning

Cycles in the assignments are not detected and can cause crashes.

Registering a new variable group

To register a new variable group, add a new `.cfg` text file to the `GameSDK\config\CVarGroups` directory.

```
sys_spec_Particles.cfg
```

```
[default]
; default of this CVarGroup
= 4
e_particles_lod=1
e_particles_max_emitter_draw_screen=64

[1]
e_particles_lod=0.75
e_particles_max_emitter_draw_screen=1

[2]
e_particles_max_emitter_draw_screen=4

[3]
e_particles_max_emitter_draw_screen=16
```

This creates a new console variable group named `sys_spec_Particles` that behaves like an integer console variable. By default, this variable has the state 4 (set in the line following the comment in the example).

On changing the variable, the new state is applied. Console variables not specified in the `.cfg` file are not set. All console variables need to be part of the default section. An error message is output in case of violation of this rule.

If a console variable is not specified in a custom section, the value specified in the default section is applied.

Console variable group documentation

The documentation of the console variable group is generated automatically.

`sys_spec_Particles`

Console variable group to apply settings to multiple variables

```
sys_spec_Particles [1/2/3/4/x]:
... e_particles_lod = 0.75/1/1/1/1
... e_particles_max_screen_fill = 16/32/64/128/128
... e_particles_object_collisions = 0/1/1/1/1
... e_particles_quality = 1/2/3/4/4
... e_water_ocean_soft_particles = 0/1/1/1/1
... r_UseSoftParticles = 0/1/1/1/1
```

Checking if a console variable group value represents the state of the variables it controls

From the console

In the console you can type in the console variable group name and press tab. If the variable value is not represented, it will print the value of `RealState`.

```
sys_spec_Particles=2 [REQUIRE_NET_SYNC] RealState=3
sys_spec_Sound=1 [REQUIRE_NET_SYNC] RealState=CUSTOM
sys_spec_Texture=1 [REQUIRE_NET_SYNC]
```

By calling the console command `sys_RestoreSpec` you can check why the `sys_spec_` variables don't represent the right states.

From C++ code

From the code you can use the member function `GetRealIVal()` and compare its return value against the result of `GetIVal()` in `ICVar`.

Deferred execution of command line console commands

The commands that are passed via the command line by using the `+` prefix are stored in a separate list as opposed to the rest of the console commands.

This list allows the application to distribute the execution of those commands over several frames rather than executing everything at once.

Example

Consider the following example.

```
--- autotest.cfg ---
hud_startPaused = "0"
wait_frames 100
screenshot autotestFrames
wait_seconds 5.0
screenshot autotestTime

-- console --
crYSIS.exe -devmode +map island +exec autotest +quit
```

In the example, the following operations were performed:

- Load the island map.
- Wait for 100 frames.
- Take a screenshot called `autotestFrames`.
- Wait for 5 seconds.
- Take a screenshot called `autotestTime`.
- Quit the application.

Details

Two categories of commands are defined: blocker and normal.

For each frame, the deferred command list is processed as a fifo. Elements of this list are consumed as long as normal commands are encountered.

When a blocker is consumed from the list and executed, the process is delayed until the next frame. For instance, commands like `map` and `screenshot` are blockers.

A console command (either command or variable) can be tagged as a blocker during its declaration using the `VF_BLOCKFRAME` flag.

The following synchronization commands are supported.

Optional Title

Command	Type	Description
wait_frames <i>num</i> :	<int>	Wait for <i>num</i> frames before the execution of the list is resumed.
wait_seconds <i>sec</i> :	<float>	Wait for <i>sec</i> seconds before the execution of the list is resumed.

CVar Tutorial

This tutorial shows you how to modify existing and create console variables (CVars). CVars can be used to control many configurable behaviors in Lumberyard. You can also use them in your game.

Note

This brief tutorial is intended for programmers. Most of the content uses code.

Creating CVars

To create a console variable

1. In your code editor, open the `Code\GameSDK\GameDll\GameCVars.h` file, which declares all game-specific CVars.
2. Locate the `SCVars` struct. Inside the struct, declare a new variable, as in the following example.

```
struct SCVars
{
    int g_tutorialVar; //add this line

    //... pre-existing code ...
};
```

The variable you added will be used to store the current value of the variable. If you need to store fractional numbers, you can also add a variable of the type `float`.

Next, you will register the CVar with the game engine so that its value can be changed by using the console.

3. In the same `Code\GameSDK\GameDll\GameCVars.cpp` file, locate the `InitCVars` function.

```
void SCVars::InitCVars(IConsole *pConsole)
{
    m_releaseConstants.Init( pConsole );

    REGISTER_CVAR(g_tutorialVar, 42, VF_NULL, "This CVar was added using the
tutorial on CVars"); //add this line

    //... pre-existing code ...
}
```

4. Specify a default value and help text for the variable. You can initialize the variable with any value that is valid for the type with which the variable was declared in the header file. The preceding example specifies 42 as the default value and some help text that will be shown to users.
5. When your game unloads, be sure to un-register the variable. In the `Code\GameSDK\GameDll\GameCVars.cpp` file, locate and use the `ReleaseCVars` function, as shown in the following example.

```
void SCVars::ReleaseCVars()
{
    IConsole* pConsole = gEnv->pConsole;

    pConsole->UnregisterVariable("g_tutorialVar", true); //add this line

    //... pre-existing code ...
}
```

6. After you finish making changes, don't forget to compile your code.

Using the CVar

You can now change the value of the CVar that you created by using code, the console, and `.cfg` files.

From code

To access the value of the variable in your game code, use the `g_pGameCVars` pointer, as shown in the following example.

```
int myTutorialVar = g_pGameCVars->g_tutorialVar;
```

From the console

To change the value of the cvar from the console, use the syntax `cvar_name=cvar_value`. The following example sets the value of the `g_tutorialVar` console variable to 1337.

```
g_tutorialVar = 1337
```

From `.cfg` files

It's also possible to change the default CVar value from one of the `.cfg` files. Whenever a CVar is assigned a value, its previous value is discarded. Therefore, the last assignment is the one that is current.

The following list shows the order of initialization for console variables.

1. The value specified in the `GameCVars.cpp` file when `REGISTER_CVAR` is used. (A change here requires compiling.)
2. The value specified in the `system.cfg` file.
3. The value specified in the user's `user.cfg` file.
4. Any value assigned at game runtime.

Tip

To change the default value of an existing CVar without having to compile, add a line to `system.cfg` file to override the default.

Lumberyard Blog, Forums, and Feedback

As we continue to improve Lumberyard, we want to thank everyone in our developer community. Without your participation in the forums, your messages, and your bug reports, Lumberyard wouldn't be as strong as it is.

- Keep sending your feedback to <lumberyard-feedback@amazon.com>.
- If you haven't spoken up on the [forums](#) yet, we would love to have you.
- You can also keep up with new changes on our [blog](#) and leave comments to let us know what you think.