

The Pentagon Event: The Honegger Hypothesis Refuted

by

Victoria Ashley, David Chandler, Jonathan H. Cole, Jim Hoffman,

Ken Jenkins, Frank Legge, and John D. Wyndham

April, 2016

Affiliations:

Victoria Ashley, MA	Scholars for 9/11 Truth and Justice
David Chandler, MS	Scientists for 9/11 Truth
Jonathan H. Cole, P.E.	Scholars for 9/11 Truth and Justice
Jim Hoffman, MFA	Scientists for 9/11 Truth
Ken Jenkins, BS	Scientists for 9/11 Truth
Frank Legge, PhD	Scientists for 9/11 Truth
John D. Wyndham, PhD	Scientists for 9/11 Truth

A. Introduction	5
Pentagon Layout and Event Location.....	6
B. Pentagon Theories.....	7
Overview	7
The Official Narrative	7
Meysan’s “No Plane” Hypothesis	7
Other Theories	8
The Honegger Hypothesis.....	8
What the Authors Conclude	9
Summary.....	9
C. Flight AA 77 on 9/11	10
Departure from Dulles.....	10
The Flight	10
Barbara Olsen.....	12
Flight Data Recorder (FDR)	12
Summary.....	13
D. A Large Plane Approaches the Pentagon	14
The Approach Path.....	14
Descriptions of the Large Plane	16
Ground Effect.....	18
The Military Helicopter.....	19
Summary.....	20
E. The Main Pentagon Event	21
Plane Impact and Jet Fuel Explosion	21
Event Time	22

Lack of Seismic Signal	24
Five Frames	24
Penetration and Damage.....	27
Summary.....	29
F. Observations Outside the Pentagon.....	30
Downed Light Poles	30
Generator Trailer, Fence, Low Concrete Wall, Warning Lights and Spools	32
The Pristine Lawn	38
Height of the Fuselage Top on Impact	39
Façade Damage.....	41
Wreckage Near the Heliport	43
Summary.....	44
G. Observations Inside the Pentagon	45
Damage to Columns	45
Internal Debris	46
One or Three “Exit Holes?”	48
C Ring Hole.....	50
Summary.....	53
H. Were Pre-Planted Explosives Used?	55
Overview.....	55
Honegger’s Physical Evidence for Pre-Planted Explosives	55
Witnesses Who Inferred a Bomb from the Odor of Cordite (S-01:38:00)	61
Other Witnesses and Observations That Might Indicate Bombs (S-01:39:56)	62
Multiple Primary Explosions (According to Honegger) (S-01:49:14)(S-01:50:50):	63
Summary.....	65
I. Other Issues.....	65

J. Summary and Conclusion	66
Appendix A - Pentagon Eyewitness Testimony.....	67
Eyewitnesses to Plane Impact = 64 (listed here) or more.....	67
Eyewitnesses to Light Poles Being Struck by a Large Plane = 14.....	72
Eyewitnesses to a Silver Plane = 16	72
Eyewitnesses to a White Plane = 4	72
Eyewitnesses to Plane Wreckage Inside the Pentagon = 11	73
Witnesses Who Detected Cordite by Its Odor = 4	74
Witnesses Who Detected Jet Fuel by Its Odor, Feel and Appearance = 20	74
Other Witnesses and Observations That Might Indicate Bombs = 13.....	74
Appendix B - Boeing 757-200 Front Views and Calculations.....	76
Appendix C - Boeing 757-200 Specifications	78
Appendix D - Geometry of the Plane Approach.....	82
Appendix E - Plane Parts Found Near the C Ring Hole	83
The Landing Strut	83
The Wheel Hub and Tire	83
Entry/Exit Doors and the Plane Exit Hole	83 <u>6</u>
Appendix F – Toronto Selected Excerpts	87
From Barbara Honegger’s 2011 Toronto Hearings Presentation	87
Appendix G – Seattle Selected Excerpts	90
From Barbara Honegger’s 2013 Seattle Presentation	90
Appendix H - Websites, Papers, and Articles.....	90 <u>4</u>
Websites	94
Papers	94
Articles and Videos.....	95

The Pentagon Event: The Honegger Hypothesis Refuted

Victoria Ashley, David Chandler, Jonathan H. Cole, Jim Hoffman, Ken Jenkins, Frank Legge, and John D. Wyndham¹

Abstract: The question of whether or not a large plane hit the Pentagon on September 11, 2001 has been vigorously debated by critics of the government's account ever since the event itself. Recently, Barbara Honegger² has become a leading and visible proponent of the "pre-planted explosives only" hypothesis, with the added claim that a large plane was destroyed outside the Pentagon wall without damaging the wall. This paper shows that this hypothesis cannot address the physical and eyewitness evidence that overwhelmingly points to large plane impact as the primary cause of damage and death.

A. Introduction

A great deal has been written about the Pentagon event on 9/11 and a large number of theories have been put forward, starting with Thierry Meyssan's "no-plane" hypothesis (see *Section B*). Previous papers, articles, videos and websites by the present authors on these theories are listed in Appendix H.

A major paper on the generic "no plane" and other theories by one of the authors already exists³. It is therefore not the goal of this paper to discuss the many different proposed theories except in passing. Readers can best consider the aforementioned paper along with this paper. See Appendix B for a *Summary of the Flight Path Damage and Debris* based largely on previous papers.

Barbara Honegger is currently the most prominent researcher to advocate "explosives only," but she is by no means alone in holding this viewpoint⁴. However, Honegger has become the de facto standard bearer for "no plane impact" theories since her work, postulating pre-planted explosives, is the only Pentagon research to have been accepted and published at the Toronto Hearings of 2011 (see Appendix F). These hearings included a prominent body of scholars, expert witnesses and international panel members engaged in 9/11 research and its evaluation. Having attained recognition and peer-reviewed status in a significant portion of the academic community, Honegger's presentation of an "explosives only" hypothesis must now be addressed in research papers by those with opposing viewpoints.

This paper addresses the main points in Honegger's work that argue against large plane impact and for the use of pre-planted explosives at the Pentagon. References will be made to the First Edition of

¹ The authors' names are in alphabetical order. This paper embodies the combined research efforts of all the authors over a period of more than a decade. The lead writer was John D. Wyndham.

² Barbara Honegger, MS, is a journalist who, as a whistleblower, published a book, *October Surprise* (1989,) that exposed the Reagan administration's involvement in the Iran-Contra scandal. For many years she was Senior Military Affairs Journalist at the [Naval Postgraduate School](#). In 2006 she wrote an appendix with the title *The Pentagon Attack Papers* in Jim Marrs' book *The Terror Conspiracy*.

³ John D. Wyndham, *The Pentagon Attack: Problems with Theories Alternative to Large Plane Impact*, http://www.scientistsfor911truth.org/docs/Theories_Alternative_April_2016.pdf

⁴ See, for example, *The Five-Sided Fantasy Island* by Richard Stanley & Jerry Russell, <http://www.911-strike.com/pentagon.htm>, 2004

Honegger's 2013 talk in Seattle⁵, WA and to a very similar presentation and paper from the 2011 Toronto Hearings⁶. There is also a Second Edition of Honegger's 2013 Seattle talk (see Appendix G). As with all versions of the "no plane impact" hypothesis, there is a failure to follow the scientific method by omitting relevant evidence and by failing to examine the consequences at each stage of the analysis.

The position of the authors of this paper is that a large plane, a Boeing 757-200, and most probably Flight AA 77, did impact the Pentagon west wall on 9/11, and was responsible for all or most of the damage. Compelling physical and eyewitness evidence for large plane impact that contradicts the "pre-planted explosives only" hypothesis provides the need for this paper⁷.

Pentagon Layout and Event Location

Figure A-1 from the Pentagon Building and Performance Report (PBPR) shows some relevant Pentagon features. The main damage area was approximately in the middle of the west wall (fully shown).



Figure A-1 (PBPR Figure 3.2) Pentagon event location

Pentagon offices are located in five rings numbered A through E, beginning with the innermost ring. The outermost E ring, followed by the D and C rings as one proceeds inward, sustained all of the structural damage. Wedge 1 extends from the lower right building corner to the mid-point of the west wall. Wedge 2 adjoins Wedge 1 at the left. The A & E driveway lies between rings C and B.

The large plane impact hole was just inside Wedge 1 close to Wedge 2. Wedge 2 also sustained considerable damage. Note the locations of the Vent Structure and Generator, both of which sustained damage. The Vent Structure was surrounded by a low concrete wall while a wire fence enclosed the Generator. The Heliport control tower is part of the structures labeled Security Building.

⁵ Barbara Honegger's First Edition 2013 Seattle Talk: <https://www.youtube.com/watch?v=HtFXylj61s>

⁶ The 9/11 Toronto Report, ed. J. Gourley, 2012, chap 13 and <https://www.youtube.com/watch?v=qQguLmOEGYM>

⁷ **This paper references statements and slides in the First Edition of Honegger's Seattle talk as S-hh:mm:ss = Seattle video time.** Appendix G lists these references for both the First and Second Editions of the Seattle video by time for each section in the paper. **PBPR = Pentagon Building and Performance Report.** See also previous writings on the Pentagon by the authors in Appendix H.

B. Pentagon Theories

Overview

From the outset, the events of 9/11 provided a fertile field for questioning and independent research. At the Pentagon many eyewitnesses saw a large, commercial jetliner impact the building at around 9:38 am. But news media, and those who emerged from the building after the event, wondered at the lack of large pieces of plane debris. Thousands of tiny pieces of plane debris were not recognized or understood as being evidence of a plane crash. To these after-the-fact witnesses, the crash scene was puzzling. To some, the plane impact sounded like a bomb. Others thought a missile had struck the building. In the ensuing speculation, few people considered the fact that there existed no prior public knowledge or experience of what the scene might look like when a large airliner crashed into a building at high speed.

The fact that the FBI almost immediately confiscated security camera tapes, combined with the lack of release of any video that clearly showed the plane's approach and impact, naturally fueled speculation as to "what - if anything - hit the Pentagon". Nevertheless, the goal of any proper inquiry is to collect all the facts and piece together the most logical hypothesis that addresses all those known facts. Any hypothesis that cannot address all the facts is either incomplete, or incorrect.

The Official Narrative

Official sources⁸ give this account: An American Airlines Boeing 757-200, flight AA 77 from Dulles International Airport, was hijacked by five men of Middle East origin. Under the control of inexperienced pilot, Hani Hanjour, it was brought back to a point about 5 miles south west of the Pentagon, where it commenced a descending spiral to the right. After turning about 330 degrees, the course of the plane gradually straightened until it was aiming directly at the Pentagon. The plane continued its descent at high speed and hit the west wall of the Pentagon, which it largely penetrated, close to the ground. On the way it struck five light poles, a fence, a generator trailer and a low concrete wall. Inside the Pentagon the damage, debris and locations of human remains were all consistent with impact by a large aircraft, travelling in the direction delineated by the damaged light poles. This direction was about 61 degrees East of North, making an angle of about 52 degrees with the Pentagon west wall.

Except for the hijacker story, the official narrative is in accord with the physical and eyewitness evidence for the plane flight.

Meysan's "No Plane" Hypothesis

The hypothesis that no plane hit the Pentagon was introduced a few weeks after September 11, 2001 when French journalist and activist Thierry Meyssan put up a web page and published an article *The Mysteries of the Attack on the Pentagon* (The Voltaire Network, October 8, 2001). Meyssan's earliest explanation was that a truck bomb had been used. In early 2002, Meyssan wrote a book, *9/11: The Big Lie*, followed by another book, *Pentagate*, that postulated a missile strike. Meyssan's evidence for his theory focused mainly on the apparent absence of large plane parts outside the building. It is likely that he was unaware of what happens when a plane at high speed hits a concrete barrier (F-4 Phantom

⁸ *The 9/11 Commission Report and The Pentagon Building and Performance Report (PBPR)*

experiment⁹). He knew of only one downed light pole, whereas later research showed there were five downed poles that give a lower limit of about 100 feet to the plane wingspan.

What his book, *The Big Lie*, did was to pair a reasonably compelling and competent analysis of “who benefited” from the crime with a highly misleading analysis of the Pentagon attack. The Pentagon event is the primary 'physical evidence' that he mentions, while paying scant attention to the glaring anomalies in other aspects of the 9/11 events. That and the fact that his books were presented early on and were translated into dozens of languages¹⁰ gave Meyssan's ideas a head start, and perhaps unwarranted credibility, amongst those members of the public who were already skeptical of official accounts of 9/11.

Other Theories

Following Meyssan's “no plane” hypothesis and an initial decoding of incomplete Flight Data Recorder (FDR) data that had the plane too high at the Pentagon, various hypotheses were suggested by independent researchers. These included a missile had hit the Pentagon; the plane flew over the Pentagon; the plane was a small plane; the plane was a Global Hawk (two vertical tail fins) or a Navy A-3 Skywarrior (wingspan 74 feet); bombs were responsible for some, most, or all of the damage and deaths; or some combinations of the foregoing.

For example, the Citizen Investigation Team (CIT)¹¹ proposed a flight path close to the Pentagon that had the plane flying North of the Citgo gas station and over the Pentagon. Also, Barbara Honegger, whose work is the focus of this paper, proposed a “bombs only” explanation for the damage.

However, none of these alternative explanations can satisfactorily explain all the physical and eyewitness evidence, as previous papers by the authors, together with this paper, demonstrate. At this time, the use of pre-planted explosives has not been ruled out, but the evidence for this is weak and needs further investigation (see section H).

Honegger's Hypothesis

Honegger's hypothesis is that pre-planted explosives or bombs were responsible for *all* the damage and deaths at the Pentagon on 9/11. For example, in the Toronto Hearings talk¹², in the Q and A session, Honegger explicitly rules out impact by a Boeing 757 or any plane, stating that “we don't have to go there.” The inference is that pre-planted explosives explain all the damage.

In the Seattle talk¹³ Honegger adds a new dimension to her hypothesis by claiming that a large, white plane was shot down and destroyed by a helicopter close to the Pentagon wall at the Heliport area. There was no damage to the Pentagon from this and no deaths. Honegger further states at S-00:54:35 (Seattle video time) “there is no evidence of any other plane destruction except the white plane” Thus Honegger completely rules out any form of plane impact with the Pentagon building, claiming that

⁹ F-4 Phantom experiment: <https://www.youtube.com/watch?v=AB4IEa7tJw>

¹⁰ Translations of Thierry Meyssan's book: http://911review.com/disinfo/imgs/biglie_languages.jpg

¹¹ Ranke, C. and A. Marquis, “National Security Alert”, <http://www.citizeninvestigationteam.com/evidence>

¹² Barbara Honegger, *Toronto Hearings talk* (2011): <https://www.youtube.com/watch?v=qQguLmOEGYM>

¹³ Barabara Honegger, *Seattle talk* (2013): <https://www.youtube.com/watch?v=HtFXylj61s>

all damage and fatalities were caused by pre-planted explosives (it is unclear whether any deaths are attributed to the “white” plane that was destroyed outside the Pentagon walls).

To sustain this hypothesis, Honegger relies largely on two fallen and stopped Pentagon clocks, while ignoring similar clocks as well as key eyewitness testimony and other physical evidence. The balance of this paper focuses on her hypothesis and utilizes specific slides and times from her Seattle presentation. A list of Honegger’s recent presentations on the Pentagon, similar to the Seattle talk, can be found in Appendix G.

What the Authors Conclude

In previous websites¹⁴, articles¹⁵ and papers¹⁶, the authors of this paper have concluded that a large plane, a Boeing 757-200, most probably Flight AA 77, did in fact impact the Pentagon on 9/11. While some questions still remain, there is no compelling reason at this time to question the identity of the plane. Large plane impact is the only mechanism that can readily explain the scores of eyewitness accounts as well as a vast array of physical evidence. None of the alternative theories presented can address all the available evidence of the plane approach and destruction at the Pentagon, if considered in accord with the scientific method¹⁷. See Appendix B for a Summary of the Flight Path Damage and Debris.

How the plane was piloted remains an open field for research¹⁸. The presence of the hijackers on the plane is not established beyond a reasonable doubt, much less their piloting of the plane. A current working hypothesis is that the plane was under remote control, at the very least for its final moments before impact.

The Pentagon “no plane” and “no plane impact” theories early captured the imagination of those who were most skeptical of official accounts. However, using the scientific method – an approach which considers all the available evidence and the consequences of hypotheses - large plane impact by a Boeing 757-200 is shown to be by far the most probable explanation for the Pentagon event on 9/11.

Summary

A Boeing 757-200, Flight AA 77, flew from Dulles Airport in Washington on 9/11 and eventually crashed into the Pentagon west wall at 9:37:46 am to within a few seconds. Various theories that postulate a missile, a smaller plane, a fly-over, or a “bombs-only” scenario are not in accord with the physical or eyewitness evidence.

¹⁴ Jim Hoffman <http://911research.wtc7.net/essays/pentagon/>, Frank Legge, <http://scienceof911.com.au/pentagon/>,

¹⁵ Frank Legge, *Science, Activism, and the Pentagon Debate*, 2014, http://www.scientistsfor911truth.org/docs/Legge_Pentagon_Letter.pdf,

¹⁶ See www.scientistsfor911truth.org, Papers section, Pentagon and www.scientificmethod911.org, Pentagon section and also Appendix H

¹⁷ John D. Wyndham, *The Pentagon Attack: Problems with Theories Alternative to Large Plane Impact*, 2013 http://www.scientistsfor911truth.org/docs/Theories_Alternative_April_2016.pdf, Table 1, version 3. Originally published in the Journal of 9/11 Studies, December 2011, <http://www.journalof911studies.com/volume/2010/Wyndham1.pdf>

¹⁸ Captain Field McConnell – *Remote Control of 9/11 Planes* - <https://www.youtube.com/watch?v=I5NnBQJ5at4>

C. Flight AA 77 on 9/11

In the following sections we refer to the Flight Data Recorder (FDR) for Flight AA 77. The FDR data was released by the National Transportation Safety Board (NTSB) in January, 2002. Based on a detailed analysis of the FDR data, there is no reason at this time to doubt the authenticity of this data.

Departure from Dulles

According to official sources such as the NTSB, Flight AA 77, a Boeing 757-200, took off from Washington Dulles airport at 8:20 am on 9/11 bound for Los Angeles. It carried 58 passengers, four flight attendants and two pilots. It was hijacked enroute, turned back toward Washington and, under the control of hijacker Hani Hanjour, crashed into the Pentagon West wall at 09:37:46 am.

A video, purporting to show some of the five (5) alleged hijackers - Hani Hanjour, Nawaf al-Hazmi, Salem al-Hazmi, Khalid al-Mihdhar, and Majed Moqed - passing through the Dulles airport checkpoints, surfaced from unofficial sources but appears to lack authenticity. None of the Dulles Airport staff could authenticate the presence of the "hijackers." Furthermore, Brenda Brown, who checked in the first class passengers, alleged to include Hani Hanjour and the al-Hazmi brothers (*9/11 Commission Report*), could not recall that any passengers were Arab males. It is therefore not established that Hani Hanjour, the supposed pilot for Flight AA 77 and the Pentagon impact, was even on the plane¹⁹.

Honegger's slide at S-02:00:09 from the Bureau of Transportation Statistics (BTS) of civilian flights on 9/11 does not show a flight 77. However, the departure of flight AA 77 is confirmed by both radar and FDR data, as well as by airport personnel such as Brenda Brown. This evidence, as a whole, contradicts the theory that it was not Flight AA 77 that took off from Dulles airport that day.

The Flight

According to official sources, flight AA 77 from Dulles continued on its assigned route until about 8:54 am when it was hijacked²⁰. At 8:56 the plane turned back toward Washington and then commenced a long, controlled descent of about 10,000 feet. The transponder was turned off at one point, but the radar data does not depend on the transponder signal. The plane leveled off for a few minutes of erratic flying then commenced another controlled descent of about 17,000 feet to about 7000 feet. As it approached the Pentagon it performed a descending 330 degree spiral to the right, then finally dived toward the Pentagon and impacted it directly. The lack of experience of the alleged pilot, Hani Hanjour, together with the recorded erratic behavior of the plane raised serious concerns with this story. There is a growing consensus among researchers that the plane was remotely guided for some of the time and certainly at the end. This, however, is outside the scope of this paper.

Frank Legge and Warren Stutt have examined the flight path using radar and FDR data²¹. They note that researchers John Farmer and Tom Lusch thoroughly examined the recorded radar data and were able to

¹⁹ Consensus 9/11 website: <http://www.consensus911.org/point-video-2/> *Point Video-2: Was the Airport Video of the Alleged AA 77 Hijackers Authentic?*

²⁰ Jim Hoffman, <http://911research.wtc7.net/planes/attack/flight77.html>

²¹ Frank Legge and Warren Stutt, *Flight AA77 on 9/11: New FDR Analysis...*, 2011
http://www.journalof911studies.com/volume/2010/Calibration%20of%20altimeter_92.pdf

trace the flight all the way from Dulles to a point just south of the Sheraton Hotel. There were seven radar stations that picked up the plane during the course of its flight, three of which continued to record its position after the transponder signal was lost²².

Close to the Pentagon, the plane passed a mile or two in front of C-130 pilot Steve O'Brien, who identified it as an American Airlines 757 or 767²³. O'Brien was directed to follow the plane and observed a fireball in a location near the Pentagon and reported the plane had crashed. Subsequently he reported that it was the Pentagon that the plane had hit. It is true, as Honegger points out, that O'Brien did not see the actual crash. However, the inference from the fireball and approximate location given by O'Brien, together with his observation shortly afterwards of the fire and smoke at the Pentagon, is compelling evidence. No other fireball, plane or event locations were reported at that time.

At S-01:59:05 and at S-02:01:30, Honegger argues that Flight AA 77 did not get anywhere near the Pentagon and did not hit it. Her evidence is that Indianapolis FAA ATC was tracking the plane, lost its signal when the transponder was turned off and reported the plane missing or crashed; the plane was already descending before turning back East; air traffic controllers at Dulles, including Danielle O'Brien, conjectured from the "speed, the maneuverability" that the blip they were tracking was a military plane. Using the FDR data, Legge has shown that this conjecture is unwarranted – the plane underwent no maneuver beyond or even approaching the capabilities of a Boeing 757. Two figures (see Figures C-1a and C-1b) from a paper by Legge show an excellent match between the radar and FDR data.

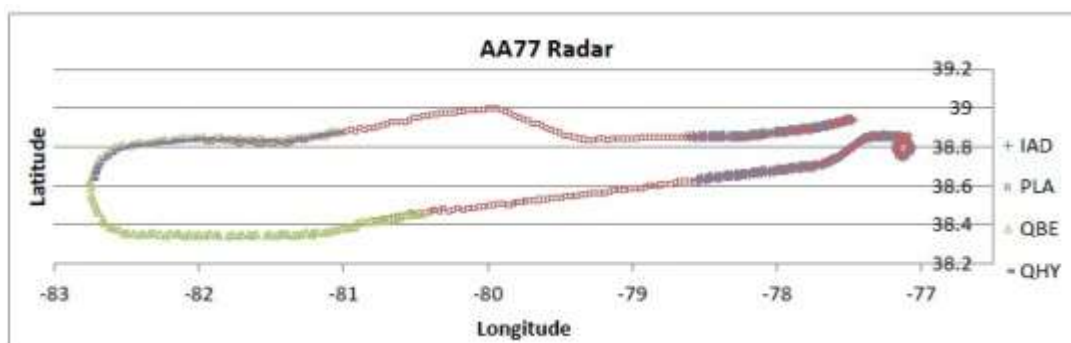

Figure C-1a

[Figure 6 from Frank Legge's *The 9/11 Attack on the Pentagon: the Search for Consensus*
IAD, PLA, QBE, and QHY are radar tracking stations.

The continuous radar data matching the FDR data indicates that Honegger's assertions, as well as suggestions that a plane swap took place, are mistaken. There is no reason to doubt that Flight AA 77 travelled from Dulles to its impact at the Pentagon. The radar track of AA 77 is continuous from Dulles to the vicinity of the Sheraton and is supported by the FDR data. From there, the FDR data and many eyewitnesses (see Appendix A) tracked the plane all the way to impact. As shown in later sections, the physical evidence fully supports impact by a large plane with dimensions matching a Boeing 757.

²² Frank Legge, *The 9/11 Attack on the Pentagon: The Search for Consensus*, Journal of 9/11 Studies, 2012 <http://www.journalof911studies.com/resources/Legge-Letter-June.pdf> page 12

²³ History Commons, Profile: Steve O'Brien http://www.historycommons.org/entity.jsp?entity=steve_o_brien

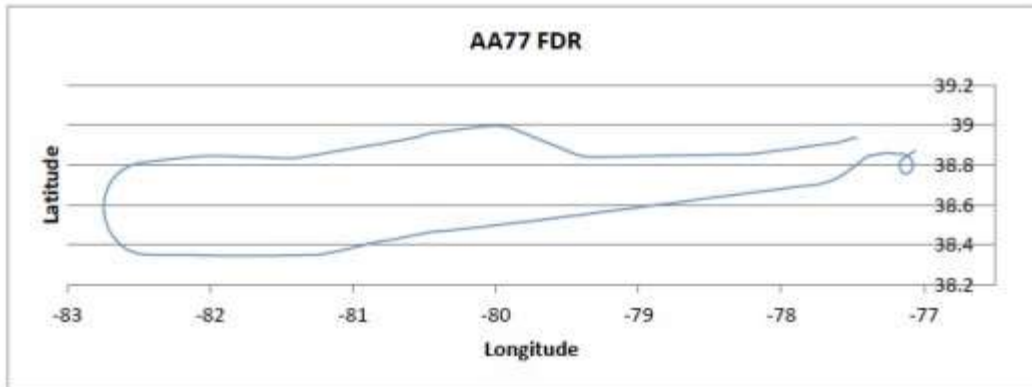

Figure C-1b

[Figure 7 from Frank Legge's *The 9/11 Attack on the Pentagon: the Search for Consensus*
The course of AA 77 from the FDR data closely matches the radar data.

Barbara Olsen

In a slide at S-00:14:27 Honegger briefly presents facts about Barbara Olson and her alleged cell phone calls from Flight AA 77 on 9/11. Barbara Olson was a commentator on CNN and the wife of US Solicitor General Theodore "Ted" Olson who argued for the Bush side in the case *Bush v. Gore* arising from the 2000 Florida elections. Barbara Olson was on Flight AA 77 and allegedly made calls to her husband using either a cell phone or plane seatback phone. She is credited with informing her husband of the hijackers with box cutters and of being the only source of the box cutter story.

This story has been the subject of much debate²⁴. Ted Olson changed his account from cell phone usage to seatback phones, but it is argued the plane was flying too high for cell phones to work and Boeing 757s had no seatback phones, according to American Airlines spokespersons. At the Moussaoui trial in 2006²⁵, the FBI reported that Barbara Olson attempted only one call and that call was "unconnected."

The issue of Barbara Olson's phone calls is complicated and its details will not be analyzed here. At S-00:14:27 Honegger uses the FBI's report to claim that, "without ... [Barbara Olson's calls] ... there is zero evidence Flight 77 returned East and the official story about the Pentagon falls apart." But her absolute claim is highly questionable because the continuous radar data and FDR data both show that Flight 77 turned back east and was seen by C-130 pilot Steve O'Brien shortly before it crashed into the Pentagon.

Flight Data Recorder (FDR)

The Flight Data Recorder (FDR) for Flight AA 77 was found and its contents obtained through Freedom of Information Act (FOIA) requests. While some groups have questioned the authenticity of the FDR data, Legge and Stutt can find no evidence that the FDR file is not legitimate or that there is anything anomalous in the data. It did, however, need expert treatment to decode the final data frame. Researcher John Farmer long ago noted that 4 to 6 seconds appeared missing from the file. Warren

²⁴ David Ray Griffin, *9/11: Ten Years Later*, Olive Branch press 2011, chapter 5, page 124.

²⁵ Consensus 9/11 website: *Point Video-2*, <http://www.consensus911.org/point-pc-2/>

Stutt, who independently received a copy through an FOIA request, discovered and was able to decode the last frame and determined that the time of last recording was 09:37:52²⁶.

Charges have been made that the FDR data claimed for AA Flight 77 exhibits several anomalies. Many of these charges are speculative and the anomalies possibly unresolvable without more information. Two such anomalies cited by Honegger are: (1) the aircraft type and fleet data were missing, and (2) time stamps indicate the FDR data was downloaded four hours before the FDR was reportedly found inside the C ring hole (S-2:00:35).

These charges have been responded to as follows:

- Aircraft fleet and individual ID were found within the data file by Warren Stutt. It has been decoded as aircraft 35, fleet 1, but cannot be further interpreted without access to American Airlines records. Stutt concluded that Dennis Cimino, Honegger's source, was wrong to expect to find aircraft ID and fleet ID in the text header of the AA 77 FDR file. Other FDR files from different aircraft from various sources, for that make and model of FDR, do not have those ID fields in their text headers either²⁷.
- Two locations were reported for discovery of the FDR: just inside the impact hole and just inside the C ring hole. It was reported that the FDR file was downloaded at a time four hours prior to its discovery. These varying reports are arguably due to the confusion that day or the time being wrong on the computer to which the file was downloaded. Stutt has 5 copies of the FDR file from various sources and they have various modification dates but the same contents²⁸. As previously stated, Warren Stutt was able to decode the final frame and could find nothing anomalous. He found nothing that would indicate the file had been tampered with.

The FDR data's authenticity is supported by its agreement with the radar data and by internal evidence.²⁹ The fully and properly decoded FDR file tracks the plane all the way from Dulles International Airport to its descent to the correct level to hit the light poles and the Pentagon. The trajectory matches the radar data as shown in Figure C-1.

Summary

The flight of AA 77 from Dulles to impact at the Pentagon is established through many independent lines of evidence that include the physical evidence at the Pentagon, the many eyewitnesses including C-130 pilot Steve O'Brien, the radar data and the FDR data. The presence of hijackers on the plane and the "box cutter" story are not established. Barbara Honegger's assertion that Flight AA 77 did not reach the Pentagon is not supported by the evidence.³⁰

²⁶ Legge and Stutt: http://www.journalof911studies.com/volume/2010/Calibration%20of%20altimeter_92.pdf

²⁷ <http://www.internationalskeptics.com/forums/showpost.php?p=9329692&postcount=4347>

²⁸ Warren Stutt, private communication, 08/05/2015.

²⁹ See paper by Legge and Stutt, *ibid*, and the talk "Going Beyond Speculation" by David Chandler at the 2015 Oakland Film Festival, <https://www.youtube.com/watch?v=E9-O6iqJnOA>.

³⁰ The assertion that the evidence for large plane impact at the Pentagon rests largely on the FDR data, is without foundation. The conclusion of large plane impact is also reached through other lines of evidence, such as the radar data, and especially through the strong eyewitness and physical damage evidence. See Appendix B.

D. A Large Plane Approaches the Pentagon

The Approach Path

The approach path of a large plane, most probably AA Flight 77, a Boeing 757-200, is well established by several lines of evidence that include radar data, FDR data, eyewitnesses, and physical damage. Legge and Chandler,³¹ in their Figure D-1, show four (4) radar tracks (colored rectangles) that trace the approach path to a point south-west of the Navy Annex and about six (6) seconds before impact. The yellow line is the path for the last 20 seconds from the FDR. The plane's heading was 61 degrees East of North, at an angle of 52 degrees with the Pentagon west wall, or 38 degrees with the normal to the wall.

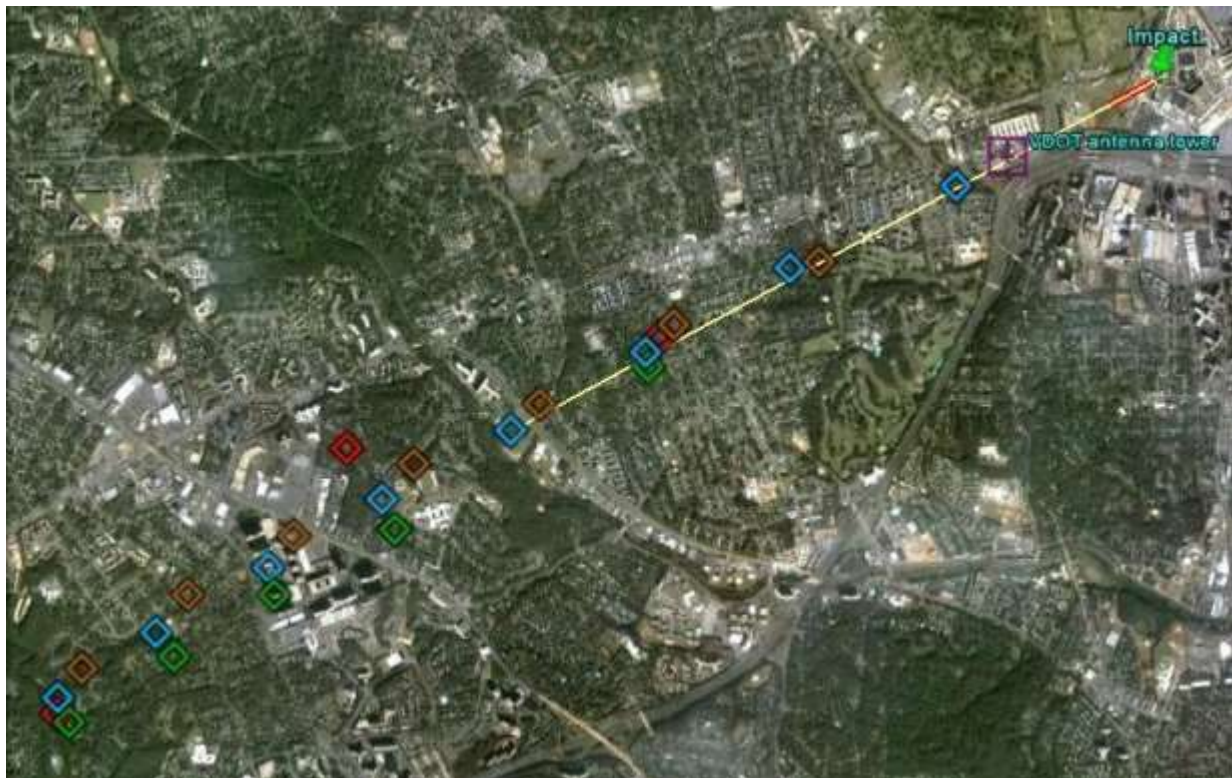

Figure D-1

Figure 1 from Legge and Chandler: Four radar tracks approach the Navy Annex. The yellow line is the last 20 seconds of the FDR data, aligned with the trail of damage. It shows no deviation over this distance.

The testimony of witnesses such as Deb Anlauf, William Lagasse, Robert Turcios, Chadwick Brooks, Ed Paik, Terry Morin, Albert Hemphill and Sean Boger³² are in reasonable conformity with this path. Attempts by the Citizen Investigation Team (CIT) to reinterpret this eyewitness evidence and the

³¹ Frank Legge and David Chandler, *The Pentagon Attack on 9/11: A Refutation of the Pentagon Flyover Hypothesis Based On Analysis of the Flight Path*, http://sti911.org/legge/Legge_Chandler_NOC_Refutation.html, 2011

³² Discussion page, *Comment 1*, http://www.scientificmethod911.org/reviewpages/legge_refutation.html

approach path (NOC or north of Citgo hypothesis) have been shown to be without foundation³³. Closer to the Pentagon, other eyewitnesses observed the plane as it flew at an angle into the Pentagon west wall, hitting objects such as light poles, a generator trailer, and a low concrete wall. The outside physical damage lines up with the path shown in Figure D-1. The impact hole, the internal damage pattern and abraded columns and the C ring exit hole also line up with the approach path in Figure D-1³⁴. Thus a very substantial body of evidence supports the path in Figure D-1 and also Figures G-6 and H-1.

To her initial credit (S-00:38:50), Honegger does not at first dispute that a plane came, as she says, on a “South path, “South of that centerline [between Wedge 1 and Wedge 2]”, and “South of the Navy Annex (Seattle first edition only).” She quotes (S-00:43:00) multiple unnamed witnesses who saw the left wing scrape or appear to scrape the ground at or near the Heliport. She stresses that Alan Wallace, who came from behind the fire truck parked near the Heliport building, saw the plane on his left. All of her descriptions to this point, as well as the eyewitness testimony, fully support impact at column 14 in Wedge 1, which is the impact point and hole supported by the approach path described above.

Despite this evidence that she has just delivered, Honegger then proceeds with a major conflicting claim:

Honegger’s Major Claim: A “white” plane was destroyed at or near the Heliport tower about 120 feet north of the “alleged” impact hole, at a time of 9:32:30, and without damaging the Pentagon wall. See the Figure AppD-1 in Appendix D.

- Honegger’s main evidence for this sudden change of path is the debris near the Heliport³⁵.
- The only evidence for the time of 9:32:30 is the fallen and stopped Heliport clock³⁶.
- The only evidence for a “white” plane is a few witnesses and a piece of white plane debris³⁷.

Despite the fact that the “white” plane was supposedly traveling at high speed toward the wall, the wall was not damaged in any way by plane fragments. As shown in detail in later sections, Honegger has misinterpreted both the debris field and the stopped clock time. She has ignored the great majority of witnesses who saw a silver plane and the large amount of plane debris that was silver (see next section). As will be shown, her final “path” and “time” have no ultimate evidentiary foundation, and contradict her own initial words and proffered witnesses.

Added Note: Starting at S-00:54:20, Honegger gives a highly speculative and convoluted account involving multiple planes, in line with the CIT hypothesis of a north of Citgo approach and plane flyover. The CIT north path hypothesis has been fully rebutted elsewhere³⁸. Honegger states she does not

³³ Legge and Chandler, <http://www.foreignpolicyjournal.com/2011/12/27/addendum-to-the-paper-refuting-the-pentagon-flyover-hypothesis/>, Chandler and Cole, http://911speakout.org/?page_id=219 and Victoria Ashley, http://www.911review.com/articles/ashley/pentagon_con.html.

³⁴ “The site data indicate that the aircraft fuselage impacted the building at column line 14 at an angle of approximately 42 degrees to the normal to the face of the building, at or slightly below the second-story slab.” PBPR, page 35

³⁵ See F. Observations Outside the Pentagon – subsection *Wreckage Near the Heliport*

³⁶ See E. The Main Pentagon Event – subsection *Event Time*

³⁷ See D. A Large Plane Approaches the Pentagon – subsection *Descriptions of the Large Plane*

³⁸ Frank Legge and David Chandler, *The Pentagon Attack on 9/11: A Refutation of the Pentagon Flyover Hypothesis Based on Analysis of the Flight Path*, 2011, http://stj911.org/legge/Legge_Chandler_NOC_Refutation.html

believe in CIT's plane flyover. However, in her talk in Washington, D.C. September 2013, she does state that the plane destroyed (according to her) outside the wall approached on a north path as CIT claims³⁹.

Descriptions of the Large Plane

Starting at 9:00:40:30, Honegger argues that a white plane approached the Pentagon and was destroyed outside the wall near the fire station, 120 to 150 feet north of the official impact hole. Therefore, she concludes, the plane could not have been flight AA77 or a normal, silver American Airlines Boeing-757-200 commercial jet. Although she claims multiple witnesses saw a white plane, she names only three in the Seattle talk who testified to this: Jim Sutherland, Alan Wallace and Mark Skipper who were Pentagon firemen. In addition Honegger presents a small piece of white plane debris found by Penny Elgas. There are in fact many more witnesses who saw a silver plane, and 16 of these are listed in Appendix A. Many other witnesses identified the plane as an American Airlines commercial jet. Photographs taken on 9/11 at the Pentagon show workers holding pieces of silver plane debris. See Figures D-2 and D-3.



Figure D-2 - Silver plane debris at Pentagon



Figure D-3 - Silver plane debris at Pentagon

³⁹ B. Honegger, Washington D.C. Talk, 2013, 00:14:50: <https://www.youtube.com/watch?v=PrFIWaWgCWw>

Honegger recounts that Wallace and Skipper saw the plane at the “last second” and ducked for cover. Wallace said the stripes on the plane were orange, but Honegger assures us that the stripes were almost certainly orange-red or red. If Wallace was mistaken about the color of the stripes, could he not also have been mistaken about the color of the plane that he glimpsed for possibly less than a second? Regarding Penny Elgas’ piece of white fiberglass/graphite debris (S-00:44:30), there are many parts of a Boeing 757-200 made of composite materials. In addition, the tails and nose of American Airlines 757-200s appear to be as white as the white stripes along the fuselage. See Figures D-4 and D-5.

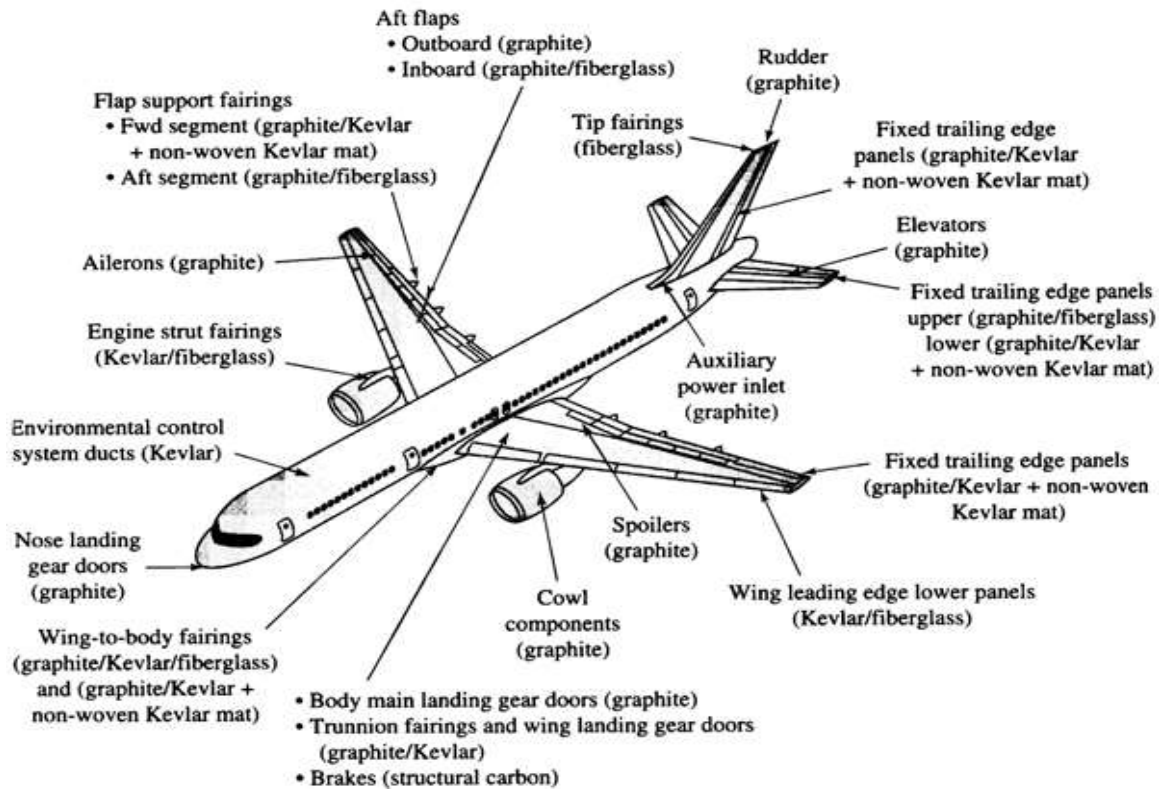

Figure D-4 - List of Composite parts in the main structure of the Boeing 757-200 aircraft. (Source: Boeing commercial Airplane company) <http://www.aml.engineering.columbia.edu/ntm/level1/ch05/html/l1c05s03.html>

In the photograph (Figure D-5) of an American Airlines Boeing 757-200, the nose, which uses composite materials, is white in color. Honegger at S-00:45:00 shows a photograph of a Global Hawk drone painted white but with stripes and markings to look like an AA 757-200. However, the two almost vertical tail fins look nothing like a Boeing-757-200 and could not have fooled many of the witnesses who were knowledgeable about aircraft. At S-00:46:37 Honegger shows a photograph of a large piece of wreckage that is silver, but omits to mention this fact in her narrative.

In her Washington, D.C. talk⁴⁰ (September, 2013), Honegger names several more “white” plane witnesses, but the testimonies of police officers Lagasse and Brooks illustrate the dangers of relying on visual impressions of a minority based on a fleeting glimpse while ignoring actual plane pieces.



Figure D-5
Boeing 757-200 Illustrating white nose

Pentagon police officers William Lagasse and Chadwick Brooks⁴¹ (2006 interviews by Craig Ranke) both saw the same low-flying plane at the same time, one or two seconds before impact, and from the same location (Citgo gas station area). Lagasse identified it as an American airlines plane, “bright silver,” “non-painted,” “aluminum,” “shiny” whereas Brooks, under Ranke’s prompting, agreed the plane was “off-white” in color. Brooks himself said it was a “champagne” color. Brooks did not recall the plane’s markings but thought it was “United.” Such a discrepancy between these witnesses prompts caution when considering color testimony by a minority of witnesses.

To summarize, Honegger’s contention that the plane was white, as a whole, is refuted by the physical evidence and by a large number of eyewitnesses. The plane debris (Elgas) made of composite materials does not rule out a Boeing 757-200 or Flight AA 77.

Ground Effect

At S-00:59:20 Honegger introduces the well-known argument that, because of what is known as ground effect, the plane could not have flown closer to the ground than 56 feet, so it would have impacted at the fourth and fifth floor levels. She quotes experienced pilots Russ Wittenberg and Ralph Kolstad in support of this objection.

⁴⁰ Barbara Honegger, Washington talk, 2013, <https://www.youtube.com/watch?v=PrFIWaWgCWw>, 01:27:20

⁴¹ National Security Alert website, *The PentaCon: Smoking Gun Version*, 2007, <http://www.citizeninvestigationteam.com/videos/pentacon-sgv> (Lagasse at 40:20), (Brooks at 37:20)

The physical evidence, such as the downed light poles (discussed in detail later), confirms that a large plane did fly low. In addition, many witnesses actually reported that they saw a large commercial jetliner, identified as a Boeing 757, fly low and close to the ground. Moreover, the testimony of Honegger's expert pilots is contradicted by other experts and by actual experience. For example, at an air show in Portugal, Evora 2007, an Airbus A310 repeatedly flew low, sometimes with the gear down and full flaps but most importantly with at least one pass at a relatively high speed, with no concern about any ground effect. This aircraft, with a wingspan of 144 feet and length of 153 feet, is similar in size to a Boeing 757-200 (see Figure D-6 from a video of the event⁴²). The height of the plane above the runway is little more than the diameter of the fuselage.



Figure D-6

Portugal, Evora 2007 - TAP Airbus A310 flying very low at high speed

In addition, a website⁴³ founded in 1997 and currently staffed by nine engineers and scientists working in the aerospace field, features an article which explains that, because of the high speed and low angle of attack, ground effect is not a relevant factor, particularly with an aircraft that is under automatic control. The article relates the experience of two commercial airline pilots who tried this kind of approach in a flight training simulator and had no problems. Accordingly, it is possible to fly a large plane low and fast without being significantly affected by any ground effect.

Therefore Honegger's ground effect objection is not a credible obstacle in light of all the other evidence, experience and information relevant to the behavior of large aircraft flown at high speeds close to the ground.

The Military Helicopter

Honegger's claim, that a white plane was destroyed at 9:32:30 outside the Pentagon wall at the Heliport without damaging the wall itself, hangs on a single thread – her contention that the Heliport clock that stopped at 9:32:30 is conclusive proof of an event occurring precisely at that time. This claim is not

⁴² Portugal Airshow, Evora 2007, <https://www.youtube.com/watch?v=9rZER-Qw3rE>

⁴³ Aerospaceweb, www.aerospaceweb.org/ - See the article *Pentagon & Boeing 757 Ground Effect*.

supported by the evidence. Of four known Pentagon “stopped clocks,” two show times around 9:37 am close to the official time of plane impact of 9:37:46.

There are two reasonable explanations for why the fallen clocks record differing times. First, it has been shown experimentally that the clock hands, especially the larger minute hand, could easily have moved back because of their forward momentum when the clock case suddenly stopped after falling⁴⁴. Second, the clocks in question are not synchronized chronographs, but rather ordinary wall clocks that may or may not have been set correctly or run accurately. Thus Honegger’s clock evidence is unreliable. To rely so heavily on just two unreliable fallen clocks while other similar clocks differ, and to ignore other pertinent evidence, does not follow sound scientific inquiry. A large number of witnesses saw a silver plane impact the Pentagon wall and disappear inside. They reported only one main event – the impact of a single large plane, and the subsequent fireball at 9:37:46. See the section *Event Time*.

Despite overwhelming evidence for large plane impact at 9:37:46, Honegger postulates (S-00:47:10) that a military helicopter that arrived at the Heliport at 9:27:51 and departed at 9:32:33 was responsible for shooting down the “white” plane and destroying it just outside the Pentagon wall without any debris hitting the wall. She mentions two witnesses who saw a helicopter, then later saw a massive fireball, but these witnesses give no corroboration as to time whatsoever. One can only conclude that the witnesses saw the helicopter land and take off, then later, at 9:37:46, saw the fireball from the plane impact.

Finally, Honegger’s claim violates known laws of physics regarding momentum in that it proposes a weapon, or mechanism, whereby all the debris lost its horizontal velocity and simply dropped to the ground in the Heliport area. After years of asserting that no plane hit the Pentagon because of a supposed lack of plane debris, Honegger now postulates an entire plane and its parts should be found outside the Pentagon wall near the Heliport. But she never assesses the debris to inquire whether it could possibly have amounted to a large plane.

There is no eyewitness testimony that could possibly be construed to support this hypothesis of plane destruction outside the Pentagon wall. Therefore it fails the scientific method being entirely speculative and scientifically unsound.

Summary

The plane’s path made an angle of about 52 degrees with the Pentagon west wall. The physical evidence and majority of witnesses point to a silver plane. Honegger’s attempts to rule out an American Airlines plane based on color and ground effect lack validity. Likewise, her claim that a “white” plane was shot down by a helicopter at the Heliport at 09:32:30 lacks scientific credibility and corroborating evidence.

⁴⁴ John D. Wyndham, *The Pentagon Attack: The Event Time Revisited*, 2013, http://www.scientistsfor911truth.org/docs/Pentagon_Event_Time_Mar19_2013.pdf

E. The Main Pentagon Event

Plane Impact and Jet Fuel Explosion

This section is both a review of preceding sections and an overview of subsequent sections.

Large Plane Impact and Explosion: As set forth in this paper, there is substantial evidence that a large plane, most probably a Boeing 757-200 and Flight AA 77, impacted the Pentagon west wall on 9/11 at 9:37:46 am to within a few seconds. The plane created a damage trail including the downed light poles and the C ring hole. The plane's path made an angle of about 52 degrees with the Pentagon west wall and was consistent with both radar and FDR data. The plane impact was observed by more than 60 eyewitnesses who saw the plane hit the Pentagon wall, followed by a huge fireball of exploding jet fuel. Many witnesses testified to the presence of jet fuel after the impact. The main event at the Pentagon on 9/11 was a large plane impact and jet fuel explosion.

Secondary Explosions: The jet fuel explosion at 9:37:46, though by far the largest explosion, was not the only explosion heard or seen that day. For the next half hour or so, there were a number of secondary explosions reported mainly because of their sound. Pentagon police officer William LaGasse, who saw the plane impact from the Citgo gas station, drove to the Pentagon but had to leave because of "secondary explosions from compressed natural gas and welding equipment ..." ⁴⁵. According to witness Ted Anderson, "Nearby, tanks full of propane and aviation fuel had begun igniting, and they soon began exploding, one by one... (...) Back in the building again ... secondary and third-order explosions started going off. One of them was a fire department car exploding ..." ⁴⁶.

Honegger's Hypothesis: Honegger uses this evidence of secondary explosions to assert that there was no plane impact but rather a number of primary explosions all caused by pre-planted explosives (cordite) or even "thermite. Since thermite is an incendiary rather than an explosive, Honegger presumably means nanothermite. She bolsters her hypothesis using the times of stopped watches and clocks. She further asserts that a white plane was destroyed in mid-air by a helicopter near the Heliport tower at the time given by the Heliport stopped clock, and as evidenced by excessive debris found there, but that this destruction caused no damage to the Pentagon wall. Honegger excludes an American Airlines Boeing 757-200 because the latter has a silver fuselage and several witnesses saw it as white.

Misinterpretations: Honegger misinterprets or ignores much physical evidence, and has ignored large numbers of eyewitnesses to plane impact. There was only one large, primary explosion, and this occurred at the time of plane impact at 09:37:46. A few witnesses claimed they detected cordite by its odor, but many more witnesses detected jet fuel. The unverified time pieces cannot be relied on as giving accurate times and are contradicted by other stopped clocks. The debris at the Heliport tower area is a natural result of the Boeing 757-200's speed, angle of approach and fragmentation. As seen by a majority of witnesses and evidenced by plane debris, the plane was not white but silver. The claimed "destruction" of the "white" plane near the wall without any damage to the wall violates physical laws.

⁴⁵ William Lagasse, Library of Congress Interview, 2001: [http://memory.loc.gov/cgi-bin/query/h?ammem/afc911bib:@field\(DOCID+@lit\(afc911000152\)\)](http://memory.loc.gov/cgi-bin/query/h?ammem/afc911bib:@field(DOCID+@lit(afc911000152)))

⁴⁶ See Secondary Explosions : <http://arabesque911.blogspot.com/2007/04/911-and-pentagon-attack-what.html>

Event Time

Earlier papers and websites by the present authors focused on showing the strong evidence that a large plane, most probably a Boeing 757-200 and Flight AA 77, struck the Pentagon west wall on 9/11, followed immediately by a jet fuel explosion. Initial reports gave the time of impact as anywhere from about 9:30 am until as late as 10:00 am (see Honegger's slide at S-01:22:50), but finally arrived at the official time of 9:37:46. The precise time at which this main event occurred was not considered to be of great significance until Honegger sought to establish an alternative hypothesis that pre-planted explosives were the cause of the damage, and that the main explosive event occurred at an earlier time of 9:32:30 am or even 9:30 am. Since then articles and papers have been written to investigate and subsequently refute the earlier event time claims⁴⁷.

Honegger's main evidence includes times from personal time pieces or watches (for example, those of April Gallop, 9:30 am, and Robert Andrews, 9:32 am) and two stopped clocks that apparently fell off walls at the Pentagon (S-00:37:12). The evidence from two Pentagon clocks is shown in Figure E-1.



Figure E-1: Pentagon wall clocks cited by Honegger and others
Left: Heliport clock, 9:32:30. Right: Navy Area clock, 9:31:40

The clocks in Figure E-1 show times of 9:32:30 (left, Heliport clock) and 9:31:40 (right, Navy Area clock). Honegger's initial claim of an earlier time around 9:32 am has now expanded to a claim of primary events or explosions at 9:30 (Gallop's wristwatch), 9:31:40 (Navy Area clock), 9:32:30 (Heliport clock)

⁴⁷ Adam Larson, *Overwhelming Evidence for 9:38*, 2009, <http://frustratingfraud.blogspot.com/2008/08/overwhelming-evidence-for-938.html> and John D. Wyndham, *The Pentagon Attack: The Event Time Revisited*, 2013, http://www.scientistsfor911truth.org/docs/Pentagon_Event_Time_Mar19_2013.pdf

and 9:34:10 (Doubletree Hotel security camera). See section H, Figure H-5 for more details. It is noteworthy that at S-01:22:09 Honegger herself suggests that Gallop's watch may be off by 2 ½ minutes, thus illustrating the speculative nature of her interpretations.

The essential problem with the clocks is that, for wristwatches and wall clocks, there is no way to verify that they were initially set at the correct time or were synchronized with standard time. Moreover, for the fallen clocks, it has been established by experiment⁴⁸ that the hands of clocks identical to the Heliport clock can move back if the clock falls and hits the ground. Depending on its orientation when hitting the ground, the backward movement of the minute hand can be zero, a few minutes or as much as 17 minutes. These clocks are battery operated and, as observed experimentally, the batteries can dislodge when the clock is dropped. This dislodgement stops the clock. The conclusion is that the earlier event time evidence based solely from fallen clocks and wristwatches is untrustworthy, unprovable and therefore seriously flawed. Furthermore, Honegger has excluded from consideration two other Pentagon clocks⁴⁹ whose hands stopped at approximately 9:36:27 and 9:37 or a little later. These clocks are shown in Figure E-2 and may have fallen in such a way that there was little or no hand movement. Or they may have read a time later than 9:37 am, but fell in such a way that the minute hand moved back. In either case, the clock readings cannot be deemed reliable.⁵⁰



Figure E-2

- (a) Left: Stopped clock from room 3E452 near “hinge” of collapsed floors, 9:36:27
(b) Right: Burnt clock, approximately 9:37

The scientific method requires that all available evidence be considered and addressed. Not only are the clock readings subject to error, but Honegger has not considered two fallen clocks that directly refute her hypothesis. In her own words, we ask “what violent event” occurred at approximately 9:36 to 9:37

⁴⁸ John D. Wyndham, *The Pentagon Attack: The Event Time Revisited 2013*, http://www.scientistsfor911truth.org/docs/Pentagon_Event_Time_Mar19_2013.pdf

⁴⁹ Goldberg et al. *Pentagon 9/11*, Historical Office, Office of the Secretary of Defense, 2007 and Discovery video at 1:46:02, <http://internationallicensing.discovery.com/PFDExt/player.html#/?id=36148>

⁵⁰ In a 2013 talk in Washington, D.C., Honegger erroneously claims that researcher “Wyndham” does not make the same argument for other Pentagon clocks. See <https://www.youtube.com/watch?v=PrFIWaWgCWw>, 01:17:05.

am? Honegger's chart shown in Figure H-5 has no suggestion of an event in this time frame. But clearly these clocks would support the official time of 9:37:46 am if they could be trusted. However, all clock/watch evidence is unreliable as explained above. Nevertheless, as shown in references cited, there are at least 10 strong items of evidence, not from personal watches and clocks, that support the official time of 9:37:46. These include radar evidence and John Farmer's thorough analysis that gives a time of 9:37:50. This evidence, together with Honegger's evidence is summarized in *The Pentagon Attack: The Event Time Revisited*, cited previously. Honegger at S-1:23:40 does not mention that the FAA later corrected its initial time of 9:32 am to agree with the official time.

To summarize, Honegger's clock evidence has no compelling scientific validity or legitimacy to override competing evidence, evidence that includes the problems of initial settings, movement of the minute hand due to impact from falling, and direct evidence from other clocks. The scientific conclusion is that there was one major event, plane impact and jet fuel explosion at 9:37:46 to within a few seconds.

Lack of Seismic Signal

At S-01:14:35 Honegger relates that the Army asked seismologists to check the five (5) closest readout stations for a seismic signal related to the plane impact at the Pentagon. No signal was found. At S-01:15:35 Dave Gapp, a top air force pilot and crash investigator, asserts that if a Boeing 757 struck anywhere near ground level there would be such a signal. However, Terry C. Wallace, Southern Arizona Seismic Observatory, who is considered an authority in this area, is reported⁵¹ as having stated the following: "I looked pretty hard -- and to be honest I can't find any [event] CONCLUSIVELY above the noise. I calculated an expected magnitude assuming that the impact was on the wall, not vertical (like UA flight), and got a magnitude of 0.8. The noise at all the stations (closest is 60 km away) is above this." Thus, according to this expert, a detectable seismic signal was not expected to occur. The lack of a seismic signal, especially when no signal would be expected, does not rule out plane impact.

Considering the complexities involved, including those involving the nature of the building and the earth's internal structure, Honegger's attempt, using seismic data, to completely rule out a plane impact that is supported by physical as well as eyewitness evidence, is not credible.

Five Frames

By all accounts, there were about 85 video surveillance cameras in the vicinity of the Pentagon that might have captured some part of the Pentagon event. The FBI confiscated the recordings from all of those cameras soon after the event. This act by the government fueled the suspicions of those questioning a large plane impact. No such video confiscations were known to have taken place in NYC.

Nevertheless, the ongoing lack of access to most of the 85 videos in no way rules out a large plane impact. In addition, because of their low resolution, distant locations and low frame rates, it is probable that very few of the 85 cameras captured any useful footage of the event.

The notorious "5 frames" were first released in March of 2002. After the Moussaoui trial in 2006, the government released two videos⁵², of which the most discussed is an extended version of the same five-

⁵¹ "Eric Bart's Pentagon Attack Eyewitness Account Compilation," 9-11 Research, <http://911research.wtc7.net/pentagon/evidence/witnesses/bart.html>

⁵² *Pentagon Crash Video Released*, 2006, <http://www.military.com/NewsContent/0,13319,97486,00.html>

frame sequence. That video was taken from a security checkpoint north of the impact hole. It shows white smoke trailing the approach of some mostly hidden object, then a massive fireball, and then debris fragments raining down and landing near the cameras six to nine seconds after the impact. The recordings from four (4) surveillance cameras were released in 2006 as the result of an FOIA request by Judicial Watch⁵³ that had been first submitted in December of 2004. One recording was an extended version of the 5 frames from 2002 totaling 200 frames, and another was from an identical adjacent camera mounted in the post that appears in the 5-frame sequence, the same post that mostly obstructed the first camera's view of the plane. The second camera had an unobstructed view, and has one frame which appears to show the plane at the right side of the frame, and appears to have the same type of white smoke trail that shows up in the 5-frame sequence. In a way similar to the identical first (5-frames) camera, the recordings from this second camera deliver a low resolution image of distant objects, so it is not clear what is revealed by the second camera's frames either, but what does appear in the footage of the second camera vaguely resembles an out-of-focus large American Airlines plane.⁵⁴



Figure E-3

(a) Second camera – raw footage

(b) Second camera – enhanced footage

The 5-frame sequence as released in 2002 has date/time stamps added, with the date 9/12/2001, along with the word “plane” in the first frame, and “impact” in the second and following frames (the frames with the fireball). See Figure E-4.



Figure E-4: Five-frame sequence

Some have thought that the added date being off by a day was a suspicious flaw that reveals fraud, but the later releases of the 200 frames without the date/time stamp showed that the date/time overlay in the frames released in 2002 was not added in real time, but could have been added the following day, that is, on 9/12/2001.

⁵³ *Pentagon Attack Footage*, 2006, <http://911research.wtc7.net/pentagon/evidence/footage.html>

⁵⁴ See also *9/11 Pentagon Attack Footage Flight 77 Analysis*, 2012, <https://www.youtube.com/watch?v=0f6t4dMtc00&feature=youtu.be> for an analysis of the 2nd camera.

Honegger shows a surveillance camera frame with the fireball at S-01:16:10 and later (S-01:48:50), and states that the fireball is evidence only for an explosion OR the “white” plane being blown up. As seen in the frames from both cameras, and as noted here, there was a large fireball explosion as would be produced by atomized jet fuel, but the preponderance of eyewitness and physical evidence points to a plane, specifically a silver plane, not a white plane nor an internal explosion, as being the cause of that fireball after plane impact.

One of the first of the five frames (see Figure E-5) shows a fuzzy object resembling a plane tail projecting upwards above and behind the top of a metal box that obscures most of the approaching object itself. In the next frame, this fuzzy tail-like image is gone, and the fireball is seen coming from the side of the Pentagon building.



Figure E-5: Fuzzy tail-like image and white smoke trail

A computer graphic simulation⁵⁵ by Mike Wilson illustrating a 757-sized plane impact at the Pentagon incorporates this five-frame sequence and clearly illustrates how a 757 would be almost completely obscured by the post, except for the tail. See Figure E-6.

A few researchers have questioned the five frames as doctored, staged and/or fraudulent, but there is no substantial evidence for such fraud. Further research and analysis of the frames from the two on-site surveillance cameras, and in particular of their common multiplexer and recorder system, may eventually provide additional evidence for large plane impact.

The trailing white smoke has been interpreted in at least four (4) different ways: (a) as missile smoke, (b) as caused by a light pole lamp that was ingested by the right engine of a large plane, (c) as caused by tree branches ingested by the right engine of a large plane, or (d) as fuel venting from wing damage caused by collisions with light poles. Any of the last three interpretations are consistent with the large plane theory.

⁵⁵ Mike Wilson, Integrated Consultants, Inc., *911 Case Study: Pentagon Flight 77*, 2006, <http://www.youtube.com/watch?v=YVDdjLQkUV8>



Figure E-6: Frame from Mike Wilson simulation video

In conclusion, the footage from the only two surveillance cameras with any known useful image information about the Pentagon event is fuzzy, vague and unsatisfactory. What little we can conclude, however, is that the footage from both cameras supports the large plane theory, and one camera may even show a full, unobstructed view of the plane, but at very low resolution.

Penetration and Damage

A large number of eyewitnesses, more than 60 and as much as 100 or more (see Appendix A), saw the large plane, most probably a Boeing 757-200, impact the Pentagon wall. Many witnesses indicated the plane penetrated the building. The façade damage, a hole big enough for the fuselage and most of the wings to enter, and the interior damage consisting of large amounts of debris, missing, curved and abraded columns, and the C ring exit hole all support plane penetration. It is reasonable to conclude that the plane was fragmented by the impact with exterior and interior columns and traveled as a highly focused stream of debris fragments that broke through into the A & E driveway⁵⁶.

Honegger never acknowledges or explains the large number of eyewitnesses to plane impact. This omission is another violation of the scientific method. In opposition to the above explanation of what happened, Honegger, starting at S-01:05:10, raises three objections discussed here: the strength of the reinforced wall, the internal debris flow focus, and Dwain Deets' "no penetrator path" diagram.

The Reinforced Pentagon Wall

The Pentagon west wall, two feet thick at Wedge 1, had recently been reinforced to consist, starting at the outside, of 6 inches of Indiana limestone, 8 inches of bricks, and 10 inches of concrete with steel and Kevlar mesh. Honegger claims that "A Plane Couldn't Have Penetrated The Newly-Hardened Outer Wall" since "the entire wall [was] like a huge bomb and plane-proof vest." Such a statement requires proof, but none is given. Here are a few points to consider:

- If the wall was bomb proof, then the bombs' theory also fails.

⁵⁶ John D. Wyndham, *The Pentagon Attack: Eyewitnesses, Debris Flow and Other Issues*, 2016
http://www.scientistsfor911truth.org/docs/Eyewitnesses_DebrisFlow_FandE_Mar4_2016.pdf page 12

- There was a tremendous amount of kinetic energy in the impacting plane, equivalent to 706 10-ton trucks traveling at 60 mph⁵⁷ or more than half a ton of TNT.
- The “entire” wall was not reinforced. Some of the blast-proof windows remained intact, others popped out. The limestone facing was not structural but a veneer⁵⁸.
- Whether it was a bomb or a plane, the wall was in fact penetrated. Many witnesses (over 60) who saw a plane impact the wall, creating a hole and 90 foot gash.

The damage trail outside and inside the Pentagon, together with the many witnesses, indicates that the plane did penetrate the outer wall. The evidence supports penetration.

Internal Debris Flow

The plane fuselage penetrated the building initially as a metal cylinder 12 to 13 feet in diameter and 175 feet in length. As it fragmented, many particles would remain in a generally cylindrical shape, while other particles would spread out throughout the ground floor. Sufficient focused debris could reach the C ring wall and create the hole there. The idea of “refocusing” appears to have originated with Honegger herself. There would be no need for the debris to “refocus” itself as claimed.

Deet’s “No Penetrator Path” Diagram

At S-01:08:00, Honegger presents a diagram developed by NASA research engineer, Dwain Deets. This diagram purports to show that “there isn’t a single path between the official story entrance point or impact point of flight 77 and the alleged exit hole in the C ring that does not have multiple still-standing columns in the way that would have dispersed this alleged quasi-liquid slurry.”

Deets’ diagram has been analyzed in other papers⁵⁹. This analysis finds no significant impediment to debris reaching the C ring wall and punching a hole there. Initial debris flow cleared a path 12.33 feet wide and about 158 feet in length along the damage path up to the blue column in the middle of the D ring (Figure E-7). Major column failure ends 158 feet in from the impact point. However, since the plane was fragmented, it could pass between columns. The columns’ cross-section size is greatly exaggerated in the diagram used by Deets (similar to Figure E-7). Given that each column presents only an apparent width of 1.67 feet in this 12.33 foot wide path, and is oriented for the easiest possible debris flow, it does not seem surprising at all that a sufficient quantity of debris, including relatively large parts, could reach the C ring wall and break through it. See Figure H-1.

Honegger does not mention that, after creating this diagram, Deets later changed his view⁶⁰ and now supports a Boeing 757 impact at the Pentagon. In any case, Deets’ diagram does not support her

⁵⁷ Ibid., page 16

⁵⁸ B. J. Novitski, *Pentagon Battered but Firm*, 2001, www.architectureweek.com/2001/1003/news_1-2.html

⁵⁹ John D. Wyndham, *The Pentagon Attack: Eyewitnesses, Debris Flow and Other Issues*, 2016, http://www.scientistsfor911truth.org/docs/Eyewitnesses_DebrisFlow_FandE_Mar4_2016.pdf Appendix D

⁶⁰ Dwain Deets, *The Pentagon 757*, Advancing the Truth Conference, Washington, D.C., 2013, http://www.scientistsfor911truth.org/docs/Deets_The_Pentagon_757.pdf

contention since the main debris flow took out all the columns for 158 feet after which it flowed easily around those few remaining in its way to make the C ring hole.

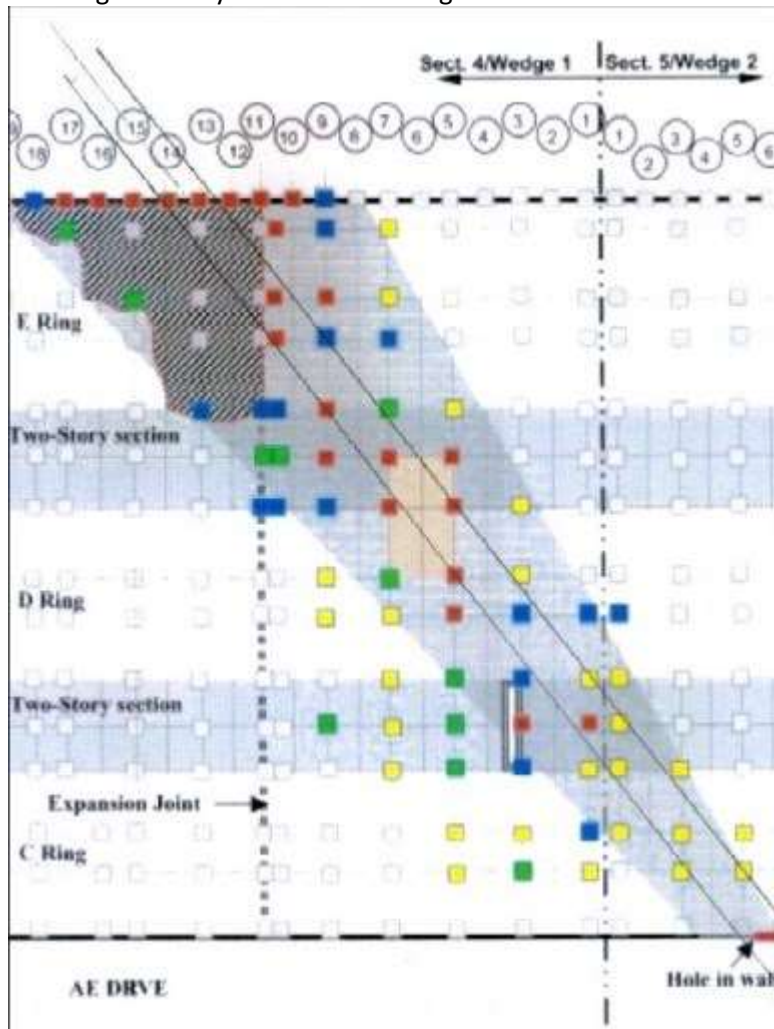

Figure E-7

Plane debris main penetration path (two parallel lines 12.33 feet apart)

From http://www.scientistsfor911truth.org/docs/Theories_Alternative_April_2016.pdf Appendix D, Figure 2

Summary

On 9/11 a large plane, most likely a Boeing 757-200 and Flight AA 77, penetrated the west wall of the Pentagon at about 09:37:46 am. This conclusion is supported by multiple eyewitnesses⁶¹, the physical evidence of the external and internal damage path, and the radar and FDR data. In objecting to this conclusion, Honegger cites the following: the exterior wall, in her opinion, could not have been breached; the debris flow in the interior could not have created the C ring hole; interior columns provided no penetration path. These objections are without scientific basis, as shown in this section.

⁶¹ See Ken Jenkins, *The Pentagon Plane Puzzle*, 2015 video at <https://www.youtube.com/watch?v=E9-O6iqJnOA> and Appendix A.

F. Observations Outside the Pentagon

The evidence presented by Barbara Honegger for pre-planted explosives, both inside and outside the Pentagon building, is discussed in the major section *H. Were Pre-Planted Explosives Used?*

Downed Light Poles

The five downed light poles outside the Pentagon on 9/11 are familiar to all Pentagon researchers. Two explanations are proposed for this damage: (A) the poles were knocked down by impact with the wings of a large plane as it flew low toward the Pentagon and impacted the west wall; (B) the poles were pre-staged or broken in situ by some, possibly explosive, mechanism so as to appear as if a large plane had knocked them down (staged evidence theory). Theory (A) is a well-developed explanation supported by multiple eyewitnesses, while (B) is a hypothesis proposed by Honegger and others.

Honegger argues against theory (A) by citing aviation “experts” who claim that any impact with the 240 pound poles would have sheared off the wings and exploded the fuel in the wing fuel tanks. She also gives examples of planes whose fuselage and wings were damaged by impact with birds and light poles.

Honegger’s presentation (S-01:01:35) on the light poles does not accord with the scientific method in several important ways: (1) she ignores all eyewitness evidence that a large plane did hit the poles; (2) except for their weight, she ignores the physical details of the broken poles; (3) she ignores the physical evidence of the light poles distance apart and the separation of the low concrete wall and generator trailer, that corroborate the dimensions of a Boeing 757-200; (4) she does not examine the details of hypothesis (B) which must apply as the consequence of rejecting theory (A).

Here is the evidence:

1. Multiple eyewitnesses give clear accounts of the low-flying plane striking light poles and other objects. Some of these witnesses are listed in Appendix A - *Eyewitnesses to Light Poles Being Struck by a Large Plane*. Despite the objections of the proffered experts, the plane was observed to hit the light poles without exploding or losing its wings as testified by eyewitnesses such as D.S. Khavkin (knocked down a number of street lamp poles) and Don Mason (struck three light poles).

2. The poles were on bases and, for the protection of motorists, were designed to break away from these bases when struck. The poles consisted of two parts, a tall tapered column section to which was attached a cantilever truss that extended outward and held the lamp head at a height of 40 feet (see figure F-1). The long tapered portion of the poles was 36 feet in length, had a diameter of 10 inches at base and 6 inches at top, and was made of 1/8 inch thick aluminum. The poles weighed 247 pounds. The poles were severed between about 23 feet and 31 feet above their bases (see Figure F-2), becoming progressively shorter as the Pentagon was approached⁶².

⁶² Frank Legge and Warren Stutt, figure 8, *Flight AA77 on 9/11: New FDR Analysis ...*, http://www.journalof911studies.com/volume/2010/Calibration%20of%20altimeter_92.pdf



Figure F-1 – View showing light poles on roads next to Pentagon



Figure F-2 – Downed light pole sections

The two pieces appear to be the result of the pole being sliced in two.



Figure F-3 – Pole that entered Loyde England's taxi cab

All the severed light poles were found to be bent. The long portion of the pole that pierced the windshield of Loyde England's taxi cab has a very pronounced curve as seen in figure F-3. The extent of this bend is not surprising as it was the pole hit highest from the ground. These curves are the expected result of the impact of a plane wing, whereas creating the curve by mechanical means in situ in real time would be virtually impossible. The curvature is the natural result of a high speed impact working against the inertia and structural integrity of the material. The alternative notion that these poles were damaged beforehand and then planted unnoticed on the morning of 9/11 is not credible and has no evidence to support it. In addition, the form of the damage at the impact point on the poles is consistent

with impact by a relatively soft object, such as a plane wing, travelling at a very high speed. See the analysis⁶³ of Loyde England's testimony in Appendix C of *Reply to Fletcher and Eastman*.

3. The separation of the light poles along the flight or damage path indicates a plane wing span of at least 100 feet. This comports well with the wingspan of a Boeing 757-200 which is almost 125 feet. Furthermore there were light poles just outside the path swept by the plane's wings that were not hit, giving an upper limit of about 130 feet to the wingspan (see Figure G-6). Thus the physical evidence that a Boeing 757-200 struck the light poles and hit the Pentagon is compelling and substantiates the eyewitness testimonies. In contrast, Honegger presents no eyewitness or physical evidence to substantiate her hypothesis that the broken poles were staged.

4. The consequences of a hypothesis must be tested against the evidence or observations. There is no credible support for hypothesis (B), either from eyewitnesses or from a proposed mechanism whereby the light pole damage took place. To be successful, this hypothesis would require the co-opting or suppression of multiple witnesses who would inevitably be present in the vicinity and whose identities could not be known. Hypothesis (B) leads to insurmountable difficulties and should therefore be discarded. See also Appendix B of *Theories Alternative*⁶⁴.

To summarize, Honegger's whole argument for hypothesis (B) rests on presumed "expert" testimony that it would be impossible for a plane to strike the light poles without shearing off its wings and/or exploding. However, a large number of eyewitnesses saw the plane strike the light poles on 9/11. In addition, Honegger fails to provide any credible, alternative explanation of the light pole damage. The conclusion is that a large plane did hit and knock down the light poles.

Generator Trailer, Fence, Low Concrete Wall, Warning Lights and Spools

As shown previously in section D. *A Large Plane Approaches the Pentagon*, the path of the plane across the Pentagon lawn from the highway bridge and into the building is clearly corroborated by the following trail of physical damage: (1) the downed light poles, (2) the damage to the generator trailer and fence as well as to the low concrete wall, (3) the impact hole in the west wall, (4) the internal column damage, and (5) the C ring exit hole. The area of the generator trailer and low concrete wall (see the diagram in Appendix D) is of particular interest since the damage allows an estimate of the engine separation (about 43 feet, matching a Boeing 757-200) as well as the height of the left engine (just above ground level at the concrete wall, explaining the "pristine" lawn). This evidence by itself is enough to rebut Honegger's hypothesis as to where the plane approached and its impact. However, Honegger omits to mention the generator⁶⁵ and low concrete wall, and omits to mention or discounts the other physical evidence. Clearly, for example, the north end of the generator - which possibly weighed more than 50,000 pounds - was swung around toward the Pentagon by a massive blow from the plane's right engine.

Each feature of the generator trailer and low concrete wall area, and what we can learn from it, is described in the following subsections.

⁶³ http://www.scientistsfor911truth.org/docs/Eyewitnesses_DebrisFlow_FandE_Mar4_2016.pdf

⁶⁴ http://www.scientistsfor911truth.org/docs/Theories_Alternative_April_2016.pdf

⁶⁵ In the Seattle talk, 2nd edition, Honegger says the wing hit "here" (the generator, according to the official story)

The Generator Trailer and Fence:

Eyewitnesses⁶⁶ such as Bruce Elliott, Jerry Henson, Don Mason⁶⁷ and Frank Probst testified to seeing the generator trailer struck by the plane's right wing or engine. After first striking the fence, the engine struck the north end of the heavy generator trailer at a point approximately 5 to 8 feet from the ground, creating a large gouge as shown in Figure F-4.



Figure F-4 Generator trailer and fence
The north end of the trailer is gouged

Another gouge about 6 to 10 feet away from the engine damage matches the distance of the right engine from the first flap canoe⁶⁸ on the plane's wing (see Figure F-5). This gouge makes an angle of roughly 45 degrees with the long side of the generator and is consistent with the plane's direction.

⁶⁶ See links to eyewitness testimony in Appendix A.

⁶⁷ Don Mason, PBPR p 13, witness to generator strike and 3 light poles – saw Frank Probst

⁶⁸ First flap canoe: The flap track fairings are the canoe-shaped fairings that protect and streamline the wing flap operating mechanisms.

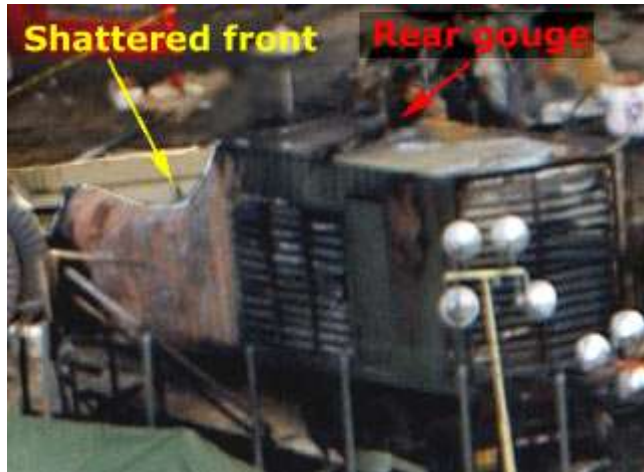

Figure F-5 Generator trailer with gouge

The impulse of the blow caused the generator to rotate towards the Pentagon about its south end and lose its front supports (landing gear)⁶⁹. With this evidence, and since staging this damage in real time by applying an external force to move the heavy trailer unobserved is not at all credible, the damaged trailer provides very compelling and irrefutable evidence that a large plane traveled on a trajectory to hit the Pentagon wall at the impact hole. Honegger omits to discuss this significant evidence. Based on the generator damage, the right engine was too high to have gouged the lawn as the plane flew over it.

The Low Concrete Wall:

Eyewitness Frank Probst⁷⁰ reported that the plane's left engine hit a low concrete wall and blew apart. This created a gouge in the low concrete wall as shown in Figures F-6 and F-7.

⁶⁹ Jim Hoffman, Damage to Generator and Retaining Wall Fits a 757's Profile
<http://911research.wtc7.net/essays/pentagon/>

⁷⁰ Frank Probst (Bart's List – See Appendix A): "The plane's right wing went through a generator trailer "like butter," Probst said. The starboard engine hit a low cement wall and blew apart." Probst viewed the plane from behind and confuses starboard with port. The wall was struck by the left or port engine. From the PBPR, page 36: "This is consistent with eyewitness statements that the right wing struck a large generator before the aircraft struck the building and that the left engine struck a ground-level, external vent structure. It is possible that these impacts, which occurred not more than 100 ft before the nose of the aircraft struck the building, may have damaged the wings and caused debris to strike the Pentagon facade and the Heliport control building."



Figure F-6 Low concrete wall gouge

The gouge indicates that the left engine was very close to the ground at this point. However, as shown in Figures F-9 and F-11 and in these photographs, the ground slopes up as one approaches the concrete wall from the highway and from the generator trailer and then slopes down toward the Pentagon west wall. Thus the left engine did not gouge the lawn as it was just above ground level at a high point. The two red lights to the left of the gouge are warning lights.



Figure F-7 Low concrete wall and small spool

The Warning Lights:

It has been suggested that the plane's engine did not create the gouge in the low concrete wall because, if it had done so, the warning lights (red on a white stand – possibly aviation lights but not confirmed as such) would have been knocked down. This notion arises from an examination only of photographs that do not indicate the depth of the lights behind the wall. Figure F-8 together with Figure F-6 shows that the lights are in the corner where two sides of the low concrete wall meet at a right angle and therefore were not in the path of the left engine.



Figure F-8 Warning lights and collapsed section (see red lights at bottom right)

The Spools

Starting at a spot adjacent to the low concrete wall and proceeding toward the Pentagon west wall, there were five cable spools (four large and one small) apparently close to or in the path of the plane. A claim, made by critics who doubt that a large plane hit the Pentagon, is that two large, upright spools would have been knocked down by the plane, but were in fact still standing after the impact. Honegger repeats this claim at 5-00:58:45 by stating that “spools 6 feet high were not bowled over”. This claim would ideally require careful examination, taking into account the positions of the spools, the ground slopes around the spool area, the height at which the plane was flying, and its possible angle of roll and pitch. At present there may not be sufficient data to make this examination without incurring a possible error of a few feet. Since a great many witnesses saw the plane impact, it would be incumbent upon critics to prove that all these witnesses were mistaken before asserting that the plane could not have cleared the spools. However, Honegger simply ignores the witnesses to impact.

The spools are shown in Figures F-9 and F-10 and other photographs in this paper. Because of foreshortening and the different angles and distances from which they were photographed, the spool sizes and locations appear to vary. For reference purposes, we will number the spools starting with those farthest away from the Pentagon wall and proceeding toward the wall.

Spool 1: A large spool with visible cable standing upright just to the right of the gouge in the low concrete wall; the leftmost spool in Figure F-4.

Spool 2: A small spool next to spool 1.

Spool 3: A large spool with visible cable, upright but tilted to one side (the left); the spool seen through the break in the generator fence in Figure F-4.

Spool 4: A large upright spool seen as the leftmost upright spool in Figure F-9, and directly behind spool 2 (small spool) in Figure F-10. In Figures F-7 and F-8, spool 4 is lying on its side.

Spool 5: A large spool lying on its side; the leftmost spool in Figures F-8, F-9, and F-10.



Figure F-9 Spools with fire mostly extinguished



Figure F-10 Spools with fire ongoing

Pickering's diagram in Appendix D does not accurately portray the positions of the five spools. In an analysis by one author⁷¹, it was pointed out that "The conclusion that ... objects remained standing close to the point of impact seems inescapable on the basis of post-crash photographs. However, most such photographs were taken from the highway at least 500 feet from the building, resulting in apparent distances near the building being highly foreshortened." In Figure F-9, the upright spool [spool 4] nearest the building is actually about 30 feet from it. Spools 1 and 2 to the right of spool 4 are at least 80 feet from the facade. The fence in the right portion of the photograph is about 100 feet from the facade. A study of various photographs supports this analysis. Spool 3, the upright but tilted spool, is considerably nearer the Pentagon wall than spools 1 and 2, as can be seen in Figure F-4.

From the plane's geometry (left engine to fuselage lateral separation) and the position of the left engine when it struck the low concrete wall, it is highly likely that spool 1 was between the left engine and the plane fuselage, and had adequate clearance. If the plane had a roll to the left as it approached the wall, as described by eyewitnesses and as indicated by the impact mark of the left wing on the wall (5 degrees roll to left), this would increase the height of the fuselage as it passed over spools 3 and 4. In addition, the ground slopes down from the location of spools 1 and 2 toward the Pentagon wall, giving further clearance. While it may not be possible with current data to precisely resolve this question for all spools, the evidence from available data suggests that the plane missed the spools by a few feet or more. The other evidence (eyewitness and physical) presented in this section, that a large plane flew toward and impacted the Pentagon west wall, is considerable and definitive.

The Pristine Lawn

From about S-00:34:30 to S-00:46:30 in her Seattle talk, Honegger, through photographs and commentary, stresses the apparent pristine nature of the lawn outside the Pentagon west wall in a direction perpendicular to the official impact hole. Based on the pristine lawn, her arguments that a large plane did not impact at the official impact hole are: (1) the engines of a Boeing 757-200 extend nine feet "beneath the bottom of the plane" (S-00:33:30), and "would have gouged the lawn" (S-00:34:20); (2) the lack of airplane debris on the lawn opposite the impact hole is further proof that no plane hit at the impact hole. Both of these arguments are incorrect.

Regarding argument (1), as shown in the section *F. Height of the Fuselage Top on Impact*, the engines of a Boeing 757-200 do NOT extend nine feet below the bottom of the plane. Physical and eyewitness evidence shows that the plane rolled to the left, the left engine hit a low concrete wall, and that neither engine made a gouge in the lawn because both were some inches or feet above the lawn.

Regarding argument (2), Honegger shows a well-known photograph of the "pristine lawn" at S-00:34:35. This photograph is deceptive because of foreshortening; the lawn appears to reach almost to the Pentagon west wall, but in reality the photograph shows only the lawn up to about 95 feet from the west wall. Other photographs reveal much debris within the space 95 feet from the west wall and in a direction perpendicular to the impact hole.

⁷¹ Jim Hoffman, *Pentagon Damage*, <http://911research.wtc7.net/pentagon/analysis/conclusions/damage.html>



Figure F-11 Pristine lawn

Examine the photograph in Figure F-11, which shows the same scene as Honegger’s “pristine lawn” photograph but taken from a different angle. The firemen nearest the center are in front of the gouge in the low concrete wall in the background. On their right can be seen a large standing spool. On their left and just visible is the white box that is part of the warning lights. At the right of the photograph can be seen the fence that encloses the generator trailer. Note the incline of the fire truck left of center – the ground rises up, showing that the low concrete wall that was gouged was on higher ground than the surrounding lawn. The plane was rolled to the left, and the left engine hit the low concrete wall almost at ground level there, which was higher than the level of the lawn in the foreground. Given these facts, there is no mystery as to the absence of a gouge in the pristine lawn.

Finally, consult the schematic diagram showing the positions of the generator trailer fence and low concrete wall in Appendix D. The pristine lawn shown by Honegger, and in Figure F-11, lies beyond the trailer fence that is parallel to the Pentagon wall, and is therefore 95 feet or more from the building. Most of the readily visible debris was closer to the building than the fence and also was found in a direction north of the impact point for reasons explained in the section *F. Wreckage Near the Heliport*.

Height of the Fuselage Top on Impact

From S-00:32:00 to S-00:35:00 in the Seattle video, Honegger attempts to prove that a Boeing 757-200 could not possibly have impacted the Pentagon at the observed impact hole. She argues this because *her information and calculation* shows that the top of the fuselage above ground was less than the distance between the top of the fuselage and the bottom of the engines, and the lawn was not gouged. Her argument is based on the following observations and information found in the Pentagon Building and Performance Report (PBPR) and elsewhere:

Honegger’s Data

1. The plane engines did not gouge the lawn as seen in photographs.

2. "The top of the fuselage [body] was no more than 20 feet above the ground." [This quote is Honegger's own version of a statement on page 14 in the PBPR].
3. The plane fuselage is 12 feet 4 inches in diameter and Honegger claims the "huge engines extend 9 feet beneath the bottom [of the fuselage] and the wings."

As shown next, Honegger's attempt to dismiss the large plane impact theory in a single, simple calculation, without regard to errors or inaccuracies in the numbers, and with a margin of only 1 foot 4 inches between possibility and impossibility, has little merit. Her numbers and her version and interpretation of the Pentagon Building and Performance Report statement are incorrect. Honegger is attempting a complex calculation while ignoring a cumulative effect of any inaccuracies in the measurements. The 1 foot 4 inch discrepancy in her calculation is simply too small to conclude anything.

Revised, Corrected and Extended Data

1. It is true that the engines did not gouge the lawn. The left engine struck the low concrete wall, so that the bottom of this engine was a few inches at most above ground at that time. According to eyewitness Frank Probst, the left engine "blew apart" on impact with the low concrete wall. This occurred just before the nose of the plane hit the Pentagon wall. On impact with the Pentagon west wall the plane had a negative roll (bank to left) very close to 5 degrees (Legge and Stutt). This roll must be factored into the calculation of the height of the fuselage above ground. Also to be considered is the plane's negative pitch of about 1.2 degrees. This negative pitch means that the nose of the plane will strike the wall a little lower than it would if the plane were travelling horizontally. See appendix B for calculations of top of fuselage height adjustments because of roll and pitch.
2. The actual statement on page 14 in the PBPR is this: "Two photographs (figures 3.3 and 3.7), when compared, seem to show that the top of the fuselage of the aircraft was no more than approximately 20 ft above the ground when the first photograph of this series was taken." Compare this with Honegger's rendition on her slide at S-00:33:46 as quoted above. Honegger omits the word "approximately," and fails to disclose the plane's location when the first photograph (figure 3.3) was taken. Figures 3.3 through 3.7 are in fact the well-known 5 frames said to show the plane before and as it strikes the Pentagon. Not only was the plane 320 feet from the Pentagon wall in figure 3.3 and pitched slightly down, but it would be impossible to obtain any accurate measurement of fuselage height from a distant smoke trail (figure 3.3) or a shadow (figure 3.7). In short, Honegger's "no more than 20 feet above the ground" is very questionable data. The fact that the height of the top of the entry hole was 26 feet places an upper limit on the height of the fuselage that is significantly greater than 20 feet.
3. Honegger's calculation is also inaccurate because her information on the plane's geometry and dimensions is incorrect. The horizontal diameter of a Boeing 757-200 fuselage is 12 feet 4 inches, but the fuselage vertical diameter is actually 13 feet 2 inches. In other words, its fuselage cross section is not round or circular. In addition, the engines do not extend 9 feet below the fuselage bottom or wings because of the wing geometry relative to the fuselage. In Honegger's Seattle talk, an artist's rendition (S-00:32:29) depicting a Boeing 757-200 about to impact the Pentagon shows the engines (side view) below the fuselage. This is incorrect. Front and side views of actual Boeing 757-200 planes all show that the line of the fuselage at bottom visually

passes approximately through the center of the engines. See, for example, Figures F-12 and F-13.



Figure F-12 – Boeing 757-200 front view



Figure F-13 – Boeing 757-200 side view

A calculation (see Appendix B) based on the Boeing 757-200 specifications in Appendix C gives a distance (top of fuselage to bottom of an engine) of 18.21 feet.

Adjusting for roll and pitch, height at the low concrete wall, and possible ground slope (see Appendix B), the top of the plane fuselage was 18.34 plus 1 to 3 feet above ground when the plane impacted the Pentagon west wall. As shown above, Honegger's 20 feet high limit does not apply. This calculation and result show that the observations and data are in reasonable agreement with the impact of a Boeing 757-200. This calculation is supported by other physical evidence such as the downed light poles, low concrete wall/generator trailer damage, and the multiple eyewitnesses to plane impact, all of which Honegger either discounts without proper explanation or omits to mention at all.

All this evidence refutes the assertion that the impact of a Boeing 757-200 could not have occurred at the observed impact hole.

Façade Damage

As shown by Jim Hoffman in early articles, the major façade damage consisted of a hole 18 feet wide and extending to the top of the second floor for a height of 26 feet, together with a large first floor gash approximately 96 feet in width⁷².

At S-00: 57:20 Honegger shows a photograph of the Pentagon façade damage, specifically the ground floor area from column 14 to column 18. The column numbers in her photograph are from Figure 7.9 in the Pentagon Building and Performance Report (PBPR) (see Figure H-1). For reference purposes here, column 16 is claimed by Honegger to be the fat "column" behind spool 4 in Figure F-14. Column 14 is where the nose of the plane hit. To the right of this point, there appear to be remnants of columns 15, 16, and 17 all sloping to the left from top to ground, while column 18 is clearly visible as upright but, according to the PBPR, functionally impaired. Column 18 is just to the right of the small spool seen in

⁷² Jim. Hoffman, *Pentagon Façade Damage Fits a 757*, <http://911research.wtc7.net/essays/pentagon/#façade>

Figure F-14. Honegger's chief claim here is that columns 15, 16 and 17 are "bowed out," not in, as would be expected from the impact of the large plane and its right engine. See also Figure F-15.



Figure F-14 Façade damage with some fire
Taken at a less oblique angle facing the façade

There are several major problems with this claim. Refer to Figures F-14 and F-15 which are photographs taken from different angles, and also to the explanations at this site⁷³:

- It is not at all certain that the sloping remnants are in fact the remains of columns 15, 16 and 17. They could well be parts of the first floor ceiling that have dropped down.
- The "remnant" of column 16 in particular is too wide to be an external column. The region extending into the building from the column 16 "remnant" is smooth suggesting it is part of the second story floor slab.
- The top ends of the column "remnants" for 15, 16, and 17 do not quite match the positions of the columns as numbered in Honegger's diagram.
- If the column "remnants" were bowed out, they would appear to be less, not more, vertical as the view shifts from Figure F-14 to Figure F-15.
- Although the column "remnants" do not appear to be bowed out, based on the above analysis, plane entry that bowed them in, followed by an inside jet fuel explosion in the building that could bow them out, would arguably render their direction of slope indeterminate.

⁷³ ERROR: 'Surviving Columns Preclude 757 Crash' <http://911review.com/errors/pentagon/columns.html>



Figure F-15 Façade damage with raging fire
Taken at a more oblique angle facing the façade

To conclude, Honegger's attempt to rule out large plane impact at the impact locality based on the façade damage is not persuasive. In any event, to assert what could not have happened in a highly complex and unprecedented event involving both impact and explosion is speculative.

Wreckage Near the Heliport

During the segment from about S-00:35:00 to S-00:46:00 in her Seattle presentation, Honegger emphasizes the "huge amount" of plane wreckage found near the Heliport at a point 120 to 150 feet north of the official impact hole (see Appendix D). She notes that as one gets closer to the Pentagon wall, the amount of debris increases. Her point is that this is where the plane destruction happened, and not at the official impact hole. Her contention here is scientifically unsound because it does not take into account the plane's speed and direction of flight, both of which affect the debris distribution pattern.

When the plane struck the Pentagon it was traveling in a roughly north-east direction with a ground speed of 815 feet/second (FDR) and at an angle of 52 degrees with the Pentagon west wall. Before the plane was pulverized by the collision, each part of the plane had a velocity component in a northerly direction, parallel to the wall, of $815 \times \cosine 52 \text{ degrees} = 815 \times 0.6157 = 502 \text{ feet/second}$. After the collision, many pieces of the plane that were pulverized at the wall but remained outside the building would still have a velocity of up to 502 feet/second in a northerly direction and would therefore tend to travel preferentially toward the Heliport area and fire station.

This entirely expected behavior is NOT an indication of a destructive event north of the official impact hole, but a confirmation that the plane did impact where the façade damage indicates – at the large hole and gash that lie in the main damage path centered on column 14. The debris tended to travel north in accord with the laws of physics.

Summary

Several more pieces of evidence that support impact by a Boeing 757-200 were discussed in this section: the downed light poles and the generator trailer/low concrete wall damage. The geometry of the light poles sets a lower limit of 100 feet for the plane's wingspan (about 125 feet for a Boeing 757-200). The geometry of the struck generator and low concrete wall implies an engine separation that matches that of a Boeing 757-200 (42.5 feet) to within a foot or two.

Other issues discussed in this section are ones used by Honegger and others to challenge large plane impact. Honegger's interpretations of the pristine lawn, height of fuselage on impact, and the façade damage were shown to be faulty and unscientific.

The evidence of wreckage near the Heliport was shown to support large plane impact at the official impact hole at column 14 rather than the destruction of a plane near the Heliport.

G. Observations Inside the Pentagon

For eyewitness descriptions and photographs of plane parts found inside the Pentagon, see Appendix A and Appendix E. The evidence presented by Barbara Honegger for pre-planted explosives, both inside and outside the Pentagon building, is discussed in the major section *H. Were Pre-Planted Explosives Used?*

Damage to Columns

As shown in other sections of this paper, Honegger's treatment of the damaged columns focuses on two areas: the fact that outer columns were missing and some column "remnants" appeared to be bowed out rather than in. Although she refers to PBPR figure 7.9 (Figure H-1), she pays no attention to the overall damage pattern highly suggestive of plane impact and penetration, or to the physical appearance of many columns which is also highly indicative of plane debris flow in the direction of the plane path.



Figure G-1 Curved and abraded column

For example, at S-01:33:40 Honegger shows, without comment, the steel bar spiral reinforcement inside a ground-floor concrete column. The column has an overall marked curve. Many other columns not stripped of concrete also exhibit such a curve, and the remaining concrete is clearly abraded or spalled. See Figures G-1, G-2, and G-3. Such damage is not indicative of a pre-planted bomb or explosive device attached to the column. However, a high-speed flow of thousands of small metal plane fragments could well create this effect. The columns are, as best determined by the investigators who wrote the PBPR, curved in a direction consistent with a force whose direction matches the plane entry angle (38 degrees to the normal to the E ring wall) to within a few degrees⁷⁴. This coincides with the direction of flow of the fragmented plane debris. Thus the abraded and curved appearance of the columns is fully explained

⁷⁴ PBPR Page 34: "The orientations of the distorted columns and the columns that were severed all indicated a common direction for the loads that caused the damage. The direction of column distortion consistently formed an angle of approximately 42 degrees with the normal to the west exterior wall of the Pentagon." Also see PBPR p.29.

by large plane impact, while the bomb hypothesis cannot explain these observations. Honegger does not mention this evidence.



Figure G-2

PBPR Figure 5.20 Column 3L with large deformation

Internal Debris

Photographs of the interior of the Pentagon first floor area reveal widespread debris as seen in Figures G-3 and G-4. Note the curved and abraded columns indicating the high-speed flow of thousands of pieces of plane debris. Note also the intact ceilings – a bomb would have also damaged or collapsed the ceiling, but instead the debris and damage indicate a horizontal force or flow of material.



Figure G-3 Internal debris and curved columns

Figure G-4 shows a piece of silver metal hanging from the ceiling with another large piece of metal debris up against one of the bowed columns.



Figure G-4 Curved columns and aluminum metal

Other interior photographs show wire wrapped around some of the columns⁷⁵. The bomb hypothesis espoused by Honegger clearly cannot explain the widespread internal and external debris, damage or directional characteristics, and, apart from some of the facade damage and an uplifted slab (see section

⁷⁵ Jim Hoffman, *What the Physical Evidence Shows*, <http://911research.wtc7.net/essays/pentagon/>

H), Honegger never attempts such an explanation. The overall debris and damage are altogether consistent with large plane impact, plane penetration, and subsequent shredding of the plane by internal columns and other objects. For eyewitness accounts of plane parts, see Appendix A.

One or Three “Exit Holes?”

For some years Honegger has presented to her audiences an aerial photograph of the Pentagon with a legend specifying “exit holes.” According to Honegger she obtained this photograph shortly after 9/11 from the Washington Post which in turn obtained it from the Pentagon. In the photograph, there are three marked “EXIT HOLES” labelled 1, 2 and 3. See Figure G-5 and slides beginning at S-01:13:15.

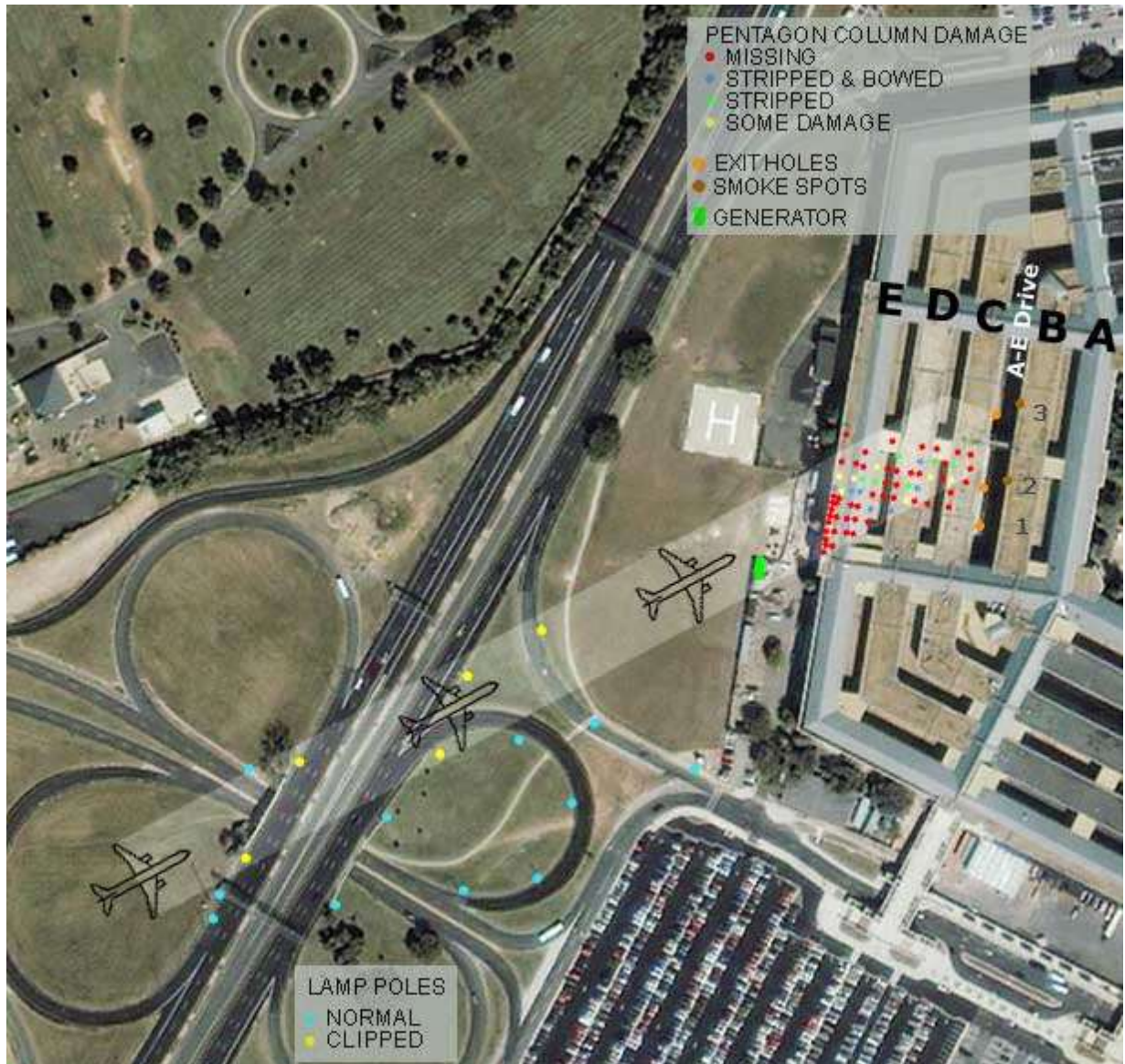

Figure G-5
Aerial photograph with three marked “Exit” holes

Hole 1 is a door, hole 2 is a roll-up door larger in width, and hole 3 is the C Ring hole where debris from the large plane broke through into the A & E driveway. In her text (book) version of her Toronto Hearings' talk, Honegger acknowledges that holes 1 and 2 are doorways, but she does not mention this fact in her Toronto or Seattle live presentations where she compares Figure G-5 with a similar figure showing only one "EXIT HOLE," the C Ring hole (see Figure G-6).



Figure G-6
Aerial photograph showing one exit hole

Honegger uses Figures G-5 and G-6 to make these two points:

1. According to Honegger, hole 3 (C Ring hole) was created, not by plane debris travelling at high speed, but by workers who, using shaped charges, made the hole for "the rescue workers to clean out the debris" (quoting Terry Mitchell) and for " ... Exit of Pentagon Personnel and Entry of Rescue and Clean-Up Teams" (slide at S-01:11:45). She argues that this is why the Pentagon in Figure G-5 refers to all three holes as "EXIT HOLES." However, the diagram in Figure G-5 is both technically and scientifically incorrect.
2. Honegger then claims that an "alleged" 9/11 truth researcher, whom she does not name, has put out on "his" website this "doctored" diagram (Figure G-6) where he has "changed" the original Washington Post graphic to show only a single plane exit hole. As shown below, Honegger's charge is completely unfounded. The diagram in Figure G-6 is both technically and scientifically correct and freely available to all on the Internet.

Rebuttal to Honegger's Point 1:

Hole 3, the C ring hole, lines up perfectly with the plane damage path delineated by the downed light poles, the damage to the fence, the generator damage, the damage on the low concrete wall, the plane entry hole, and the missing, damaged and bowed columns on the first floor. The initial debris photographed outside the C Ring hole in the A & E driveway also lines up with the plane damage path. It is not credible that, on the morning of 9/11 after the main event (shown previously to be plane impact), workers would make a somewhat circular hole perfectly aligned along the exact center of the plane damage path and then move debris into the A & E driveway and place it along the same pathway. Shaped charges would not have blown material along the plane path as observed. Plane debris was found in the rubble outside the C Ring hole. It is equally not credible that the damage path was staged⁷⁶.

Rebuttal to Honegger's Point 2:

Figure G-6 appears to be a corrected version of Figure G-5 since it would be simple to crop and modify G-5 to produce G-6 but not so simple to edit G-6 to produce G-5. However G-6 can be obtained by anyone from the web at, for example, the following location. It was no doubt obtained in this way by the unnamed Pentagon researcher.

<https://www.google.com/search?q=bart+%2B+pentagon+%2B+approach&sa=N&biw=1366&bih=598&tbm=isch&tbo=u&source=univ&ei=93cnVcyXI8KfsAWWjYDYDw&ved=0CBwQsAQ4Cg&dpr=1>

It is clear that holes 1 and 2 differ markedly from hole 3. Holes 1 and 2, being doorways for entry and exit, cannot correctly be called "exit holes," so that the legend in Figure G-5 is in error. There is only one true "exit hole" and Figure G-6 correctly shows this exit hole. Honegger's analysis of this issue, where she presents two doorways as "exit holes" and then impunes the integrity of another Pentagon researcher, falls well short of valid, ethical science. Honegger does not allow for error on the part of whoever produced Figure G-5. She claims that all the damage was staged. These claims are untenable.

C Ring Hole

According to the *Pentagon Building Performance Report (PBPR)* of January, 2003, "*The impact effects [of the plane traveling through the Pentagon interior] may be represented as a violent flow through the structure of a "fluid" consisting of aviation fuel and solid fragments.*"⁷⁷ This theory appears essentially correct and has been discussed in previous papers by the authors⁷⁸. The plane and its contents, even though shredded by multiple impacts, still had sufficient energy for the material to flow through and around the Pentagon columns, bending and breaking them, like an avalanche of snow that is able to flow around and through a forest of trees. The debris retained enough focus to break through the unreinforced masonry C ring wall and create a somewhat circular opening known as the "C ring hole".

Abraded columns, with miscellaneous wire and other debris wrapped around them, bent in the direction of plane passage, provide convincing evidence that plane debris did travel through the first floor. Debris in the A & E driveway contained plane parts (see Figure G-7) and was distributed at an angle to the

⁷⁶ http://www.scientistsfor911truth.org/docs/Theories_Alternative_April_2016.pdf Appendix B

⁷⁷ Pentagon Building and Performance Report, page 46

⁷⁸ http://www.scientistsfor911truth.org/docs/Eyewitnesses_DebrisFlow_FandE_Mar4_2016.pdf

building, aligned with the direction of plane travel. See Appendix E for a description of the landing strut, found just inside the C ring hole, and the wheel hub and tire found outside in the A & E driveway near the C ring exit hole. As shown in Appendix E, there were at least four (4) doors for access between the A & E driveway and the interior of the C ring in the damaged area, so no additional access was needed for rescue personnel. The proposed theory of plane debris flow matches the physical evidence.

Honegger disputes this theory and claims that the hole was *not* caused by an aircraft, but rather caused by shaped charges in order to provide access to the area by Pentagon and rescue personnel. She further states that it is virtually impossible for a plane to travel through the column network; therefore, the circular hole could not have been from any plane. In her Toronto talk Honegger repeats a widely-held misconception that the plane traveled through the walls of “3 of 5 rings”. The plane actually traveled through the walls of only two rings, E and C, since the intervening D ring had no wall on the first and second floor levels. This can be seen in Figure G-8(a) where a viewer standing in the A&E driveway outside the C ring wall can see light coming through the E ring windows.



Wheel hub found outside C ring hole

Figure G-7

In a slide at S-01:11:45 Honegger speculates that “The Hole Was Made for Exit of Pentagon Personnel and Entry of Rescue and Clean-Up Teams.” This hypothesis is based on statements in a news briefing on September 15, 2001 by Terry Mitchell, chief, Audiovisual Division, Office of the Assistant Secretary of Defense for Public Affairs (OASD (PA)) who took photographs of the damage. Speaking of the debris outside the C ring hole, Mitchell stated: *“They suspect this is where part of the aircraft came through.” “I didn’t see any evidence of an aircraft down there.” “This pile here is all Pentagon metal. None of that is aircraft whatsoever. As you can see, they’ve punched a hole in here. This was punched by the rescue workers to clean it out.”*⁷⁹ Mitchell’s assertions here about aircraft wreckage and about how the hole was created are demonstrably false.

⁷⁹Yale Law School, *DoD News Briefing on Pentagon Renovation 11:00 a.m. EDT; September 15, 2001*
http://avalon.law.yale.edu/sept11/dod_brief09.asp

If rescue workers had punched the hole, we could reasonably expect that an account or photographs of this work would exist, but there is no such account. Mitchell’s statement about the “pile” is faulty – plane parts were found in the pile and can be seen in Figure G-7 and other photographs in Appendix E. According to Adam Larson, the day before Mitchell spoke, markings had been added to the wall in the A & E driveway on each side of the C ring hole⁸⁰. Honegger shows these markings in another slide at S-01:11:15 and correctly states that the markings were added after the hole was made. These markings, shown in Figure G-8 (a), may have misled Mitchell as to how the hole was created. Honegger uses them to support her hypothesis that the hole was made, not by plane debris, but on purpose using explosives.

On the right side of the hole, the words “Punch Out” had been written. Punch-out is used in many different contexts, such as to punch out an opponent in a boxing ring, punch out or bail out of an airplane, or punch in and punch out at a time clock in a work environment. In the construction industry it is widely used to mean a list (punch list or punch out list) of details to be finished in a construction job. As used in construction, it is a to-do list and not a directive to punch a hole in a wall or other object.

As earlier photographs show (see Figure G-8(b)), the hole was there before the marking, so it would make no sense to add “Punch Out” later as a directive. Evidence presented below strongly suggests that the construction-terminology meaning of “Punch Out” was adapted here to mean a list of bodies found/removed. See Figure G-9 below for “Punch Out” used to label bodies removed.



(a) Later photograph with markings



(b) Earlier photograph with smoke emerging

Figure G-8 - C ring hole

On the left side of the C ring hole is a marking added some days after September 11. This is the international symbol for victim, V. A line through the V indicates the victim is deceased, a circle around the V indicates the body has been removed. Many bodies were probably removed through the C ring hole. At S-01:10:10 Honegger shows a figure that she incorrectly attributes to the PBPR. The figure, dated June 2008, is a “Screenshot of Flash Presentation depicting where body fragments were found on the first floor of the Pentagon after Flight 77 hit. This was used in the trial of Zacarias Moussaoui.”⁸¹

⁸⁰ Adam Larson: <http://frustratingfraud.blogspot.com/2007/07/punch-out-for-carlsons-backhoe-theory.html>

⁸¹ U. S. Government: https://commons.wikimedia.org/wiki/File:FirstFloor_Pentagon_Bodies.png

This figure (see Figures G-9 and G-10) shows locations of body or body fragments of victims by number. The words “Punch Out” in very small letters appear at the top and very close to the body numbers in the A & E driveway, further supporting their interpretation as a list rather than a directive to punch a hole in the wall. The list could be of bodies that were removed through the C ring hole.

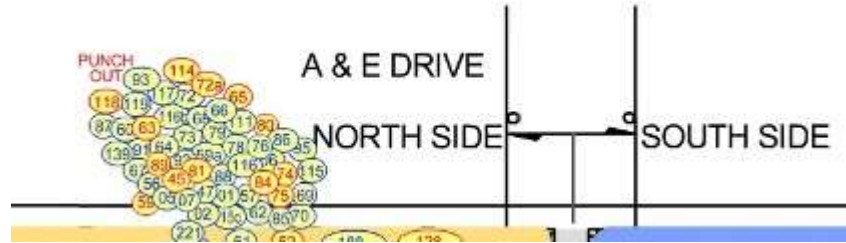

Figure G-9 – Detail of Figure G-10 showing “Punch Out” label

At S-01:11:48 Honegger presents a slide showing the theory of mechanical engineer Michael Meyer that the C ring hole was created using shaped charges, and that a round hole could not have been created by a flow of plane debris. Meyer’s theory has been fully rebutted elsewhere⁸². Shaped charges could not have blown the wall and debris in the direction of the plane’s path. The large amount of debris and plane parts would have had to be planted unobserved after the main event. To be unobserved, the shaped charges would need to have been timed to coincide with the other explosives that Honegger postulates. It would take an enormous amount of planning and activity, susceptible to discovery, to line up the light poles and generator/trailer/low concrete wall damage with the C ring hole. Lastly, as shown in the last citation, the hole approximately matches a debris flow with the shape of the plane fuselage.

Honegger’s explanation of the C ring hole raises severe difficulties that she does not address, and is therefore highly unlikely to be true. The evidence supports the conclusion that the hole was created by plane debris traveling at high speed.

Summary

The damage to internal columns and the large amount of internal debris on the first floor are strong evidence that a large plane entered the building and was shredded by the supporting columns. Many columns were removed or damaged, and many were abraded and bent in the direction of the debris flow. Pre-planted explosives could not conceivably have created this pattern of damage. The C ring hole and the debris in the A & E driveway, strewn in the direction of the plane path, are further evidence of large plane impact and penetration.

Of the damage evidence presented in this section, Honegger discusses only the C ring hole, attributing its creation to workers who wanted an exit hole after the main event. This explanation is shown to be not credible. Her interpretation of a figure showing three “exit holes” and her charge of malfeasance on the part of another, unnamed researcher are also shown to be spurious.

⁸² http://www.scientistsfor911truth.org/docs/Theories_Alternative_April_2016.pdf Page 15 and Appendix B



THE PENTAGON

FIRST FLOOR - WEST

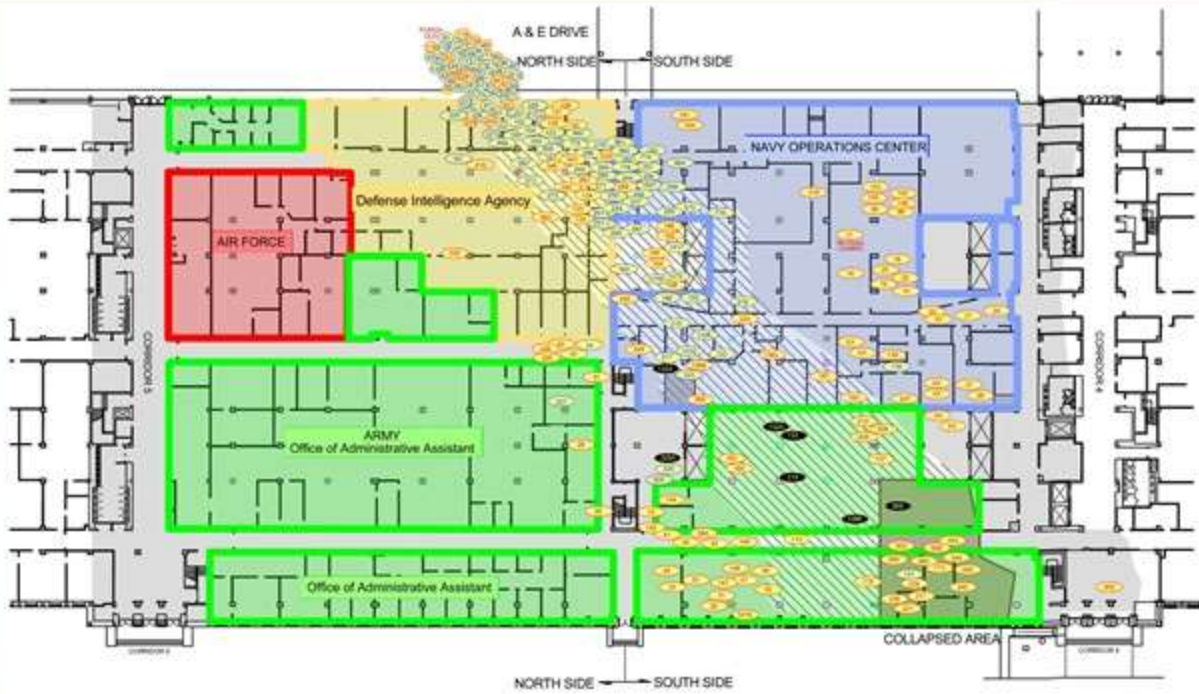

Figure G-10 – Pentagon first floor body fragments

H. Were Pre-Planted Explosives Used?

Overview

Barbara Honegger's central thesis is that ***all*** physical damage at the Pentagon resulted from the use of pre-planted explosives such as bombs (cordite⁸³) or thermite. To reach this conclusion, Honegger ignores or discounts by misinterpretation the considerable, even overwhelming, physical and eyewitness evidence for large plane impact and instead emphasizes physical and witness testimony that points to, or could point to, pre-planted explosives. The authors of this paper do not maintain that ***no*** pre-planted explosives whatsoever could have been used. Rather they assert that Honegger's thesis is an unwarranted distortion of the actual evidence. Such a distortion, if widely promulgated, will undermine any effort to achieve public acceptance of the scientific facts about 9/11 from independent researchers.

The evidence for pre-planted explosives is not nearly as strong as Honegger asserts. Unlike for large plane impact, where plane parts and jet fuel were found, there is NO actual physical evidence, such as unreacted material or explosive residues, that would indicate pre-planted explosives such as cordite and thermite. All evidence for pre-planted explosives comes in the form of witness interpretations of odor and sound, and in Honegger's own interpretations of physical events and photographs that might indicate pre-planted explosives. In many cases Honegger misinterprets this evidence, and ignores competing interpretations and evidence, as shown in this section.

Plane parts were found in the building (see Appendix A and Appendix E) and on the lawn and external areas after the main event. Jet fuel was determined to be in the lungs of Brian Birdwell⁸⁴ and Kevin Shaeffer by a doctor⁸⁵. Shaeffer also testified to feeling a liquid, which he took to be jet fuel, on the floor inside the secure part of the building where he was the sole survivor. In contrast, for pre-planted explosive evidence, we must rely solely on witness testimony based on sound and odor. While there are a number of witnesses who inferred cordite from the odor and/or bombs from the sound, there are many more who detected the odor of jet fuel. These two groups of witnesses are listed in Appendix A.

In the following sections we examine Honegger's evidence for pre-planted explosives, and the witness testimony for cordite. Honegger herself is the only person who has suggested thermite (used primarily to melt steel, but not concrete) was used and there is no credible corroborating evidence for this.

Honegger's Physical Evidence for Pre-Planted Explosives

Second Story Floor Breached Upward (S-01:29:30):

The Pentagon Building and Performance Report (PBPR) mentions an area where the second floor slab (first floor ceiling) is breached upward. This area is shown as the orange rectangle marked "Slab deflected upward" in PBPR figure 7.9 (Figure H-1) reproduced below. PBPR figure 5.27 (Figure H-2), also reproduced below, shows the upward breach (or part of it).

⁸³ Wikipedia, *Cordite*, <https://en.wikipedia.org/wiki/Cordite> NB: Cordite has not been in use since World War II.

⁸⁴ *9/11 Pentagon Eyewitness Accounts*,

http://whatreallyhappened.com/WRHARTICLES/911_pentagon_eyewitnesses.html

⁸⁵ Kevin P. Shaeffer, U.S. Naval Institute, 2011, <http://www.usni.org/magazines/proceedings/2011-09/never-forget>

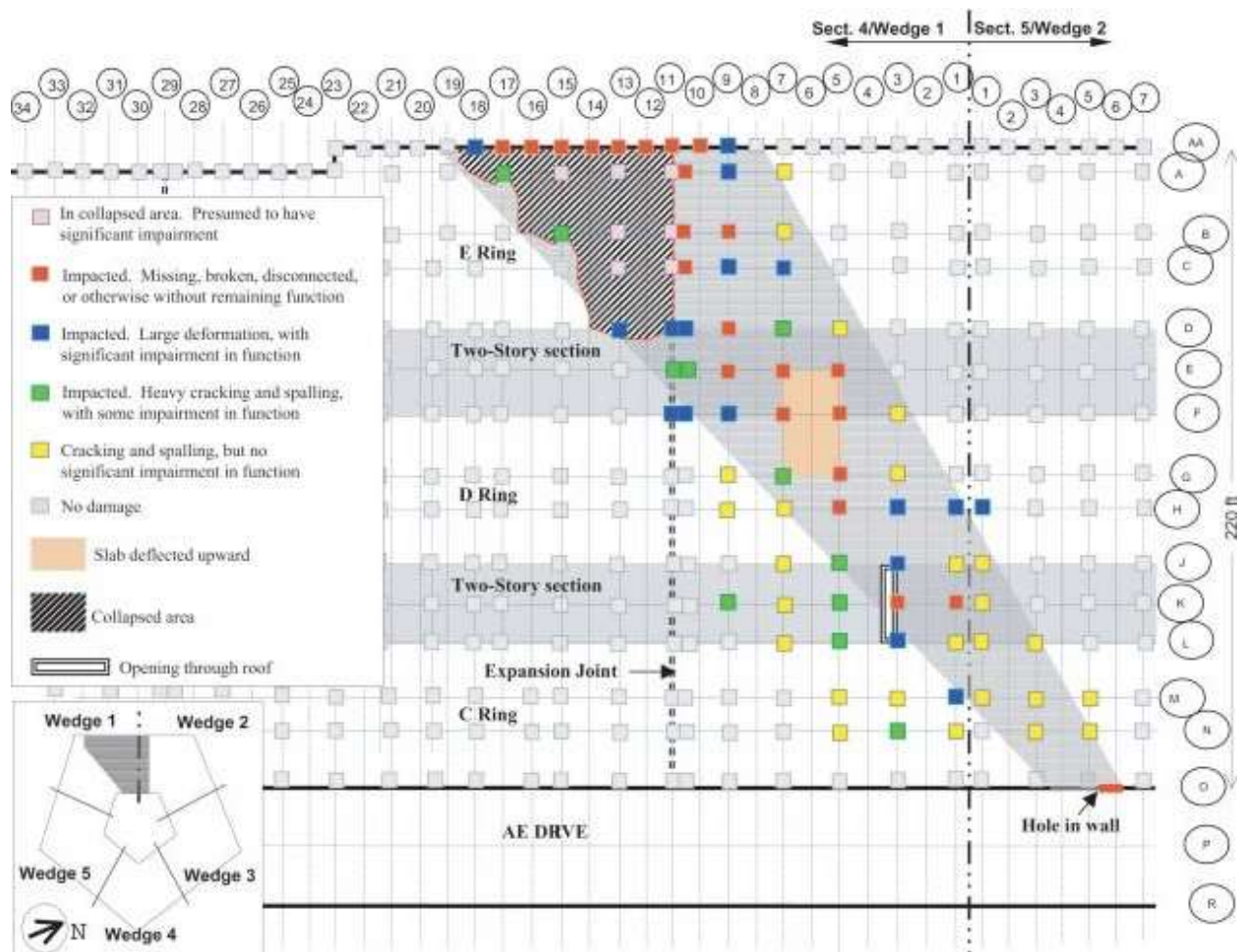

Figure H-1
 Pentagon Building and Performance Report Figure 7.9



Figure H-2
 Pentagon Building and Performance Report
 Figure 5.27 Breached second-floor slab

In a slide at S-01:31:05 in her Seattle presentation, Honegger claims the upward deflection was caused by a “Major Primary ... Explosion” that was heard and felt by witnesses McKeown and Thurman who had offices in the D ring. Thurman described the “explosion” as “massive.” The slide also claims that the

PBPR states that the upward deflection was “probably due to an independent [of any plane impact] explosion, as fire would have at most collapsed the second floor downward.” The authors, using several different keywords from this quote, have failed to find it in the PBPR, and conclude that the PBPR made no such statement about an independent explosion. This quote, incorrectly attributed by Honegger to the PBPR, can be traced to Russell Pickering through a different version of it given by Honegger in her Toronto Hearings presentation⁸⁶. In the Toronto Hearings version of the quote, Honegger quotes Pickering’s words exactly but attributes them to the PBPR. In her Seattle talk, she rewords the quote, but still attributes it to the PBPR. Since her entire hypothesis is based on the idea that pre-planted explosives were used, any support for this idea from the PBPR would carry considerable weight in the public’s mind. Thus Honegger’s mistreatment of this quote needs to be publicly corrected. The PBPR made no such statement.

Honegger’s claim about the cause of the upward breach is altogether speculative for several reasons:

- Having invoked PBPR figure 7.9 (Figure H-1) as evidence, Honegger completely ignores the implications of most of the data in this figure. She never addresses the overall damage pattern that is highly consistent with large plane impact at the west wall followed by fragmentation of the fuselage and debris passage at high speed through the interior ending at the C ring hole. Was this pattern planned to simulate a plane impact? How did a massive explosion at the orange rectangle create such a pattern? Honegger does not explain the implications of her hypothesis.
- As shown below for other witnesses, the fireball that occurred when the plane’s fuel ignited just after impact did sound like an explosion, even to witnesses who saw the impact. The fireball was in fact a type of explosion. Thurman’s description of a “two-part explosion” – a “percussion blast” and a “massive explosion ... at the same time” – matches very well with (1) a plane impact at high speed and (2) a fireball when the fuel exploded. In focusing on the orange rectangle, Honegger ignores all

⁸⁶ *Pickering’s Original Words*: ‘In the ASCE report, a “raised section” of the interior floor is cited. That could only have come from an explosion. Fire - alone - would have, at best, collapsed the floor. The explosion, suggested by the raised floor section, might represent an independent explosion, accounting for the perfectly round [sic] “official” blast hole in the “C” ring; with the unaccountable scattered aircraft parts.’ [underlines added by authors]

See <https://home.comcast.net/~skydrifter/exp.htm> [unreachable when checked on 04/15/2016]

Russell Pickering website – see “Why a Missile?” section. In 2006 Pickering changed his opinion to support large plane impact at the Pentagon. See <http://www.webcitation.org/64gylmgJQ>.

Honegger’s Toronto Quote Attributed to the PBPR (page 263-4): ‘Significantly, in the report on its investigation of the damage to the building – the *Pentagon Building Performance Report* – the American Society of Civil Engineers states that the sole upward-thrust section of the second-floor slab in the alleged “plane penetration path” was likely due to an “independent” explosion, not impact and fire, as the official story claims an impactor penetrated essentially level and fire would have at the most collapsed the floor downwards: “the explosion suggested by the raised [second-] floor section, might represent an independent explosion.”’ [underlines added by authors]

Honegger’s Seattle Quote Attributed to the PBPR: the upward deflection was “probably due to an independent [of any plane impact] explosion, as fire would have at most collapsed the second floor downward.”

the other data in Figure H-1 that indicates the directional pattern of damage along the plane path, damage that is unexplained by her theory.

- The relatively minor upward breach in PBPR figure 5.27 (Figure H-2) and the limited area in which it occurred is highly unlikely to be the result of a “massive” explosion, but more likely a local anomaly caused by high-speed plane debris. The orange rectangle in PBPR figure 7.9 (Figure H-1) where the upward deflection occurred is directly in the center of the line of travel of the plane debris and is bounded by five red (severely impacted) columns, indicating an anomaly in the damage pattern caused by the plane debris.
- As noted on page 34 of the PBPR and shown in PBPR figure 5.29 (Figure H-3), “Some floor beams were completely stripped from the underside of the slab above” in the area of the orange rectangle. Since the slab above the floor beams is still largely intact, this stripping was most likely caused by the passage of the plane debris parallel to the slab and not by an explosion that also lifted up parts of the slab.



Figure H-3
Pentagon Building and Performance Report
Figure 5.29 Stripped floor beams under second-floor slab

- As previously mentioned, Kevin Shaeffer, who was close to the area of upward breach, testified to the presence of jet fuel, both in his lungs and as a liquid on the floor of the first floor area.

For the above reasons, Honegger’s “upward breach” evidence is not indicative of pre-planted explosives but instead supports damage from large plane impact.

Daryl Donley Explosion Photograph (S-01:31:23):

Honegger shows Daryl Donley’s well-known photograph⁸⁷ (Figure H-4) of an explosion or conflagration at or near the plane entry hole and suggests it is the explosion reported by McKeown and Thurman. However, it is established and widely known that this cannot be the case, since McKeown and Thurman

⁸⁷ Daryl Donley, *September 11, 2001 Pentagon Photographs*, <http://daryldonley.com/> and <http://www.zoominfo.com/p/Daryl-Donley/48112230>

reported only one major “explosion.” The event shown in Donley’s photograph occurred several minutes after he observed the plane fly into the Pentagon when he retrieved his camera from his car and began taking photographs.



Figure H-4
Daryl Donley photograph taken some minutes after plane impact

In a telephone interview, Donley, Assistant Director of Operations for the National Symphony Orchestra, describes the major explosion of jet fuel when the plane hit: “I saw the plane fly into the Pentagon and turn into a huge fireball two and a half times the size of the Pentagon height wise. I looked out of my passenger window and the plane was next to me, at level, about probably 100 feet or so away, and then I followed it and saw it fly into the Pentagon.” At another time he stated: “It just was amazingly precise; it completely disappeared into the Pentagon.”

Donley describes the fireball that occurred upon plane impact as being 2½ times the Pentagon height. The photograph in Figure H-4 is #14 in his sequence that he began, according to his own account, several minutes or more after plane impact. This photograph shows a minor secondary explosion or flare up one-fifth the size of the main fuel explosion. It was taken many minutes after the main event. Also in Donley’s photograph the dense black and grey smoke clouds that resulted from the main event of plane impact and jet fuel ignition are well established, showing that the main event occurred some minutes or more before this photograph was taken. The fireball in Donley’s photograph (Figure H-4) has been attributed to the explosion of welding equipment and even to the conflagration of a small tree.

Honegger’s account of Donley’s photograph is confused and speculative, to the point of her suggesting it “may or may not be” the explosion in the famous “five frames” and that it looks like a thermite explosion. She compares it with a photograph of the F-4 Phantom experiment, a plane hitting an impenetrable concrete wall, and notes the two photographs are “nothing like” each other. Given the likely origin of the Donley “fireball,” this makes perfect sense. Whatever the cause, the Donley “fireball”

is not the fireball that occurred upon plane impact or that Thurman heard, and is not credible evidence for pre-planted explosives that Honegger claims led to the Pentagon damage.

It is also highly questionable to use a photograph such as Donley's to try to prove a hypothesis of pre-planted explosives without revealing that Donley is a highly credible eyewitness to large plane impact. Honegger neglects to mention this connection and thus ignores crucial evidence.

Columns Turned to Mush (S-01:32:30):

Steve Wolter, President of American Petrography Services, examined samples of Pentagon concrete to advise on its repair or replacement. For some samples, the intense heat of the jet fuel fires that burned for several days "drove out the water attached to the cement molecules" and "literally disintegrated the paste and turned it to mush." A National Geographic News article states: "some samples had a reddish hue or tints of bright orange. These samples came from columns near the crash site. The red and orange colors come from tiny amounts of iron in the rock that were oxidized in extreme heat."⁸⁸

Honegger cites Wolter's findings and speculates that the concrete was subject to a thermite reaction that led to the formation of iron. However, unlike the powder (dust) from the New York Towers, there is no evidence of temperatures greater than those produced by jet fuel fires, or that hotter temperatures were needed to produce the observed effects in the concrete. The thermite reaction does not produce iron oxide whose color is reddish, but can start with a fine mixture of iron oxide and aluminum to produce molten iron and aluminum oxide. There is no evidence of molten iron at the Pentagon. The use of thermite to destroy steel beams and columns is well documented but that is not the case for concrete. Thus Honegger's suggestion is speculative and not evidence for pre-planted explosives.

Bowed Out Columns (S-01:35:00):

Pentagon façade damage was previously discussed in the main section *F*. Honegger returns to the first floor missing or damaged exterior columns by way of the PBPR figure 7.9 (Figure H-1). She states that figure 7.9 "falsely claims" that eight (8) exterior columns were destroyed and points to columns 10 through 17 inclusive that are marked as red in PBPR figure 7.9. She illustrates her statement by showing a photograph in which only four (4) of the eight columns appear to be totally missing. Honegger also reiterates her claim that the column remnants, for example, those of columns 15, 16 and 17, are "bowed out," and thus provide proof of an internal explosion rather than plane impact.

It is possible that some of the column remnants are of columns knocked in and mostly destroyed by the plane, but which were effectively hinged at the top end and swung out under gravity or because of the fuel explosion. However, as shown previously in the subsection *F. Façade Damage*, the column "remnants" are more likely parts of the first floor ceiling that collapsed and they are not bowed out. Thus this "proof" of explosion fails. In addition, according to the legend at the left on figure 7.9 (Figure H-1), a red column is defined as "Impacted. Missing, broken, disconnected, or otherwise without remaining function." This definition includes much more than "missing" columns – it does in fact include

⁸⁸ Kerry Hall, "Concrete Autopsy," National Geographic News, 2002, http://news.nationalgeographic.com/news/2002/07/0709_020708_TVpentagon.html

what is seen in Honegger's photograph even if the "remnants" were parts of the original columns. Thus a charge of falsehood on the part of the PBPR also fails.

Computers on Fire (S-01:58:45):

The only fires April Gallop claimed she saw were coming out of computers in the Army Financial Audit Area nearby her office in Wedge 2. It is likely these fires were caused by current surge due to the impacting event, and were not indicative of explosives. Any such surge would tend to manifest itself preferentially in devices such as computers. This would explain why only the computers were on fire.

Witnesses Who Inferred a Bomb from the Odor of Cordite (S-01:38:00)

As shown previously, there are at least 60 eyewitnesses who saw a large plane fly into the Pentagon followed by a huge fireball from the exploding jet fuel. A large amount of physical evidence supports the plane impact. Many witnesses within earshot who did not see the plane impact described the noise of this event as like a "bomb." One can deduce from this information that the sound of a large plane, whose fuel explodes after the plane hits a structure like the Pentagon at high speed, is like that of an exploding bomb. By completely ignoring and discounting the evidence for plane impact, Honegger gives undue credence to verbal accounts of a "bomb" going off as pointing to pre-planted explosives. These accounts deserve no such unique consideration, since this interpretation is based on omission of evidence for large plane impact.

Eyewitness Terry Morin, who saw the plane approach the Pentagon and could still see the tail when "the flash and subsequent fireball" rose above the Pentagon stated: "For those formerly in the military, it sounded like a 2000 lb bomb going off" ⁸⁹ According to Morin, the sound was very loud. If someone like Morin, who was familiar with the sound of a bomb, but who also saw the plane, could describe the impact and fireball as sounding like a "bomb," it is improper to give undue credence to reports of bombs from those who did not see the plane and therefore based their impressions on sound and expectation alone. One should also remember that the exploding jet fuel from the plane was in the nature of an explosion. For these reasons, we regard the list of witnesses who claimed to have detected cordite from its odor as stronger witnesses to bombs than those who inferred this from sound only.

Honegger's list of those who inferred a bomb has been presented and discussed in different books, talks and papers ⁹⁰. However, as explained above, merely inferring a bomb cannot be claimed as evidence for a bomb or explosives. Therefore we list Honegger's "bomb" witnesses in Appendix A in two groups: (a) those witnesses who claimed they detected cordite from its odor. This excludes April Gallop since Gallop's early and later testimony stated only that she did not smell jet fuel; (b) all other witnesses whom Honegger suggests provide evidence for bombs (see next section).

Also given in Appendix A is a list of witnesses who described the odor of jet fuel. These lists reveal that there are only four (4) witnesses to cordite, whereas there are 20 witnesses to jet fuel. Some of the latter were physically examined by doctors since the jet fuel had entered their lungs, and others described liquid fuel. Lacking any information about the witnesses' ability to distinguish between the

⁸⁹ Terry Morin, *Eyewitness Account of Pentagon Attack*, 2001,

http://remember911.albertarose.org/survivor_pentagonwitness.htm

⁹⁰ See for example, Appendix B, http://www.scientistsfor911truth.org/docs/Theories_Alternative_April_2016.pdf

odor of cordite and that of jet fuel, the only conclusion we can reach at present is that the primary odor observed was probably that of jet fuel and that this odor supports large plane impact rather than an explosive such as cordite.

Other Witnesses and Observations That Might Indicate Bombs (S-01:39:56)

The 13 witnesses listed under this heading in Appendix A were presented by Honegger, and have been discussed by Wyndham in *Theories Alternative* (Appendix B) and others. Because, as has been stated, the plane impact and fuel explosion did sound like a bomb going off, little credence can be given to sound-only testimonies as proof of pre-planted explosives. Despite Honegger's attempts to define a series of main explosions based on various times (see *Multiple Primary Explosions* below), it is most probable, if not certain, that McKeown, Thurman, Gallop (whose testimony has varied in reliability⁹¹), Nielsen, and Shaeffer are all describing the same main event – plane impact and subsequent fuel explosion at 09:37:46 am. Rumsfeld and his three-star aide offer no special insights and are also referring to the main event. The account by the Washington Post reporters is difficult to assess without knowing in which direction they were travelling, but in any case pertains only to the temperature and not the question of bombs. This leaves five (5) testimonies worthy of a second look here.

The plane debris terminated at the A & E driveway just beyond the C Ring hole. According to the PBPR, the damage and bodies did not extend beyond the A & E driveway into the B and A rings and central courtyard. However, according to Honegger, witnesses Andrews, Burgess and the Unnamed Marine Major do indicate that there was damage and dead bodies in the B and A rings.

Andrews, Robert - Assistant Secretary of Defense for Special Operations on 9/11, said "... my aide and I had to walk over dead bodies on the inside of the A ring ..." in a sworn affidavit (Honegger).

Burgess, Lisa - Stars and Stripes reporter walking across the courtyard on the Pentagon innermost corridor, heard two booms, one large, one smaller, whose shock wave knocked her against the wall.

Marine Major (unnamed) – [said] to the Washington Post that the B ring between the 4th and 5th corridors was decimated, with intense heat, so you could not enter.

Hathaway, Rear Adm. – told Honegger that Kevin Shaeffer was not the sole survivor of the NCC; there were 18 to 19 survivors who were in the hardened Intel room (room 8) shown at S-01:56:00.

These testimonies need confirmation. The PBPR makes no mention of bodies or damage in rings B and A. Lisa Burgess may provide a clue as to what occurred from a shock wave that knocked her against the wall in the courtyard. This could imply even stronger shock waves in the B and A rings leading to some deaths from blunt collisions with walls. This evidence requires further research for verification and analysis.

Correa, Victor - Lt. Col., also inferred bombs and noticed windows bowing out and then in again.

⁹¹ http://www.scientistsfor911truth.org/docs/Eyewitnesses_DebrisFlow_FandE_Mar4_2016.pdf Page 11

This behavior could be caused by a sudden pressure build-up as plane material thrust into the building followed by a pressure release perhaps connected with the fuel explosion.

Multiple Primary Explosions (According to Honegger) (S-01:49:14)(S-01:50:50):

The evidence presented earlier shows that the Pentagon main event was large plane impact and a massive explosion of the jet fuel that was in the plane. This occurred within seconds of 9:37:46, the latter being the official time of plane impact. Following this main event, there were a number of minor or secondary explosive events from natural causes, such as igniting fuel cylinders. These were noted by a number of witnesses, a photographer (Donley) and newscasters. These secondary explosions do not provide evidence for pre-planted explosives or other main or “primary” events.

Honegger, however, claims that “There were multiple primary inside explosions. Independent of any impact.” According to this claim, plane impact never occurred and there were, according to various timepieces, “multiple primary ... explosions” that created all the observed damage and death. At S-01:50:50 Honegger shows a summary slide (Figure H-5) based on her analysis of the times of inside (yellow text) and outside (white text) “explosions.” As we show by examining individual time entries on this slide, Honegger’s scenario conflicts with witness testimony to plane impact and a main explosion⁹².

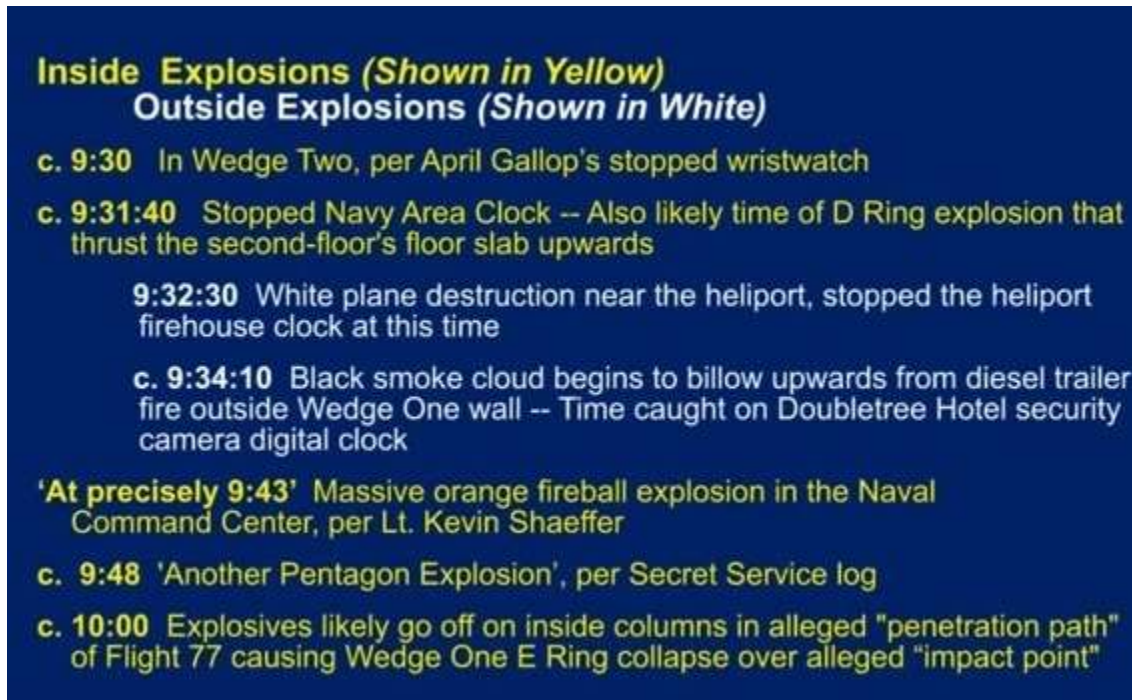

Figure H-5
Honegger’s Seattle slide of “Primary Explosion Times”

⁹² Honegger’s slide (Figure H-5) shows four explosive events within about 4 minutes, starting at 09:30 am, but the “Five Frames” sequence shows only one explosive event in over 3 minutes of recordings from two cameras.

c. 9:30 – *Honegger’s Claim*: a “massive” event experienced by April Gallop occurred at 9:30 am as per Gallop’s stopped watch. *Discussion*: It took Gallop and her companions at least several minutes to exit the building through a window near the Heliport tower. During this period, neither Gallop nor her companions reported or experienced further massive explosions at 9:31:40, 9:32:30 or 9:34:10. At S-01:22:09 Honegger, speaking of April Gallop, says “her watch may have been slightly off” so that Gallop may in fact have experienced the event at 09:32:30! *Conclusion*: Gallop’s wristwatch is unreliable evidence. Gallop experienced the effects of plane impact and fuel explosion at 9:37:46, but was far enough away from the point of impact not to see any plane parts or experience the effects of jet fuel.

c. 9:31:40 - *Honegger’s Claim*: A Navy Area clock was stopped at this time because of a large explosion that likely lifted up the D ring floor slab. *Discussion*: There are two other fallen clocks besides the Navy and Heliport clocks cited by Honegger, and these give times of 9:36:27 (room 3E452) and approximately 9:37 (burnt clock) (see Figures E-2a and E-2b). The Navy Area clock hands most probably moved back when the clock fell and struck the floor⁹³. Neither Gallop, her companions, nor other witnesses support this time for an event. The floor slab was lifted up by the passage of plane debris, as shown by the stripped support girders and fuel explosion. *Conclusion*: The stopped clock and uplifted slab were part of the main event of plane impact and fuel explosion at 9:37:46. There was no separate event at 9:31:40.

c. 9:32:30 - *Honegger’s Claim*: The Heliport firehouse clock was stopped at this time when a white plane was destroyed at or near that location outside the Pentagon building, creating a large amount of debris. *Discussion*: There are two other fallen clocks besides the Navy and Heliport clocks cited by Honegger, and these give times of 9:36:27 (room 3E452) and approximately 9:37 (burnt clock) (see Figures E-2a and E-2b). The Heliport clock hands most probably moved back when the clock fell and struck the ground.

No witnesses reported the destruction of the “white” plane. It is very likely that dozens of witnesses would have seen a missile from a helicopter striking a plane, but no one reported such an event. There is no compelling evidence for a white plane flying toward the Pentagon before impact – most witnesses reported a silver plane. No one was injured by the “debris” or “destruction that would have occurred as rescuers gathered there to rescue people like April Gallop. There was no damage to the Pentagon façade from such an explosion, which violates physical laws, since all parts of the “plane” would have had to somehow stop short of the façade. Honegger is proposing an event that violates physical laws of force and motion, an event that supposedly happened in plain view of many witnesses but which no one saw.

The observed debris was from the large plane impact at 9:37:46 that had a strong velocity component in a direction toward the Heliport. *Conclusion*: The fallen Heliport clock was part of the main event of plane impact and fuel explosion at 9:37:46 that created the debris. Honegger’s “white plane destroyed” hypothesis is refuted at all points – this never happened.

c. 9:34:10 - *Honegger’s Claim*: The Doubletree Hotel security camera caught a black smoke cloud at this time coming from the diesel trailer outside the Pentagon West wall. *Discussion*: This was the main event of large plane impact and fuel explosion. The security camera time was likely wrong – the event happened within a few seconds of 9:37:46. *Conclusion*: The hotel security camera gave an inaccurate

⁹³ http://www.scientistsfor911truth.org/docs/Pentagon_Event_Time_Mar19_2013.pdf

time like Gallop's wristwatch and the two fallen clocks cited by Honegger. This event was the main event of plane impact at 9:37:46.

c. 9:43 - Honegger's Claim: Kevin Shaeffer in the Naval Command Center (NCC) on the first floor experienced a massive fireball at this time. *Discussion:* The NCC and Intel room 8 was very close to the path of plane debris and jet fuel which caused the explosion experienced by Shaeffer. In the days after 9/11, 9:43 am was a much quoted time for the large plane impact that occurred at 9:37:46. This erroneous time was later corrected, for example, by Col. Alan Scott, a NORAD officer active on 9/11, who told the 9/11 Commission in May 2003 that the time was shifted first due to an "entry camera for the parking lot, which happened to be oriented towards the Pentagon at the time of impact, and the recorded time is 9:37" (Adam Larson)⁹⁴. That Honegger lists 9:43 for Shaeffer is surprising since, if there had been major explosions as early as 9:30 am, as she claims, Shaeffer would undoubtedly have left the building long before 9:43 am. *Conclusion:* Kevin Shaeffer experienced the results of large plane impact at a time of 9:37:46 am.

The later times of 9:48 and 10:00 are those of secondary explosions mentioned above. To these should be added 10:10 am at which time a news team reported live an explosive event at the Pentagon (S-00:56:30). The above analysis shows that Honegger's explosion times' sequence (Figure H-5) lacks logical coherence and cannot explain the eyewitness testimony or the behavior of those inside and outside the Pentagon in the time period during which the main event and secondary explosions took place.

Summary

Overall the evidence for pre-planted explosives is weak. This evidence is dependent on interpretations of odor and sound from witnesses who did not see the large plane impact the Pentagon and on times from clocks and personal timepieces whose readings often conflict with each other and cannot be verified. It is possible bombs went off concealed by the large plane impact and fuel explosion, but definitive proof of this is lacking at this time.

I. Other Issues

From about S-02:05:00 until her conclusion around S-02:40:00, Honegger covers a variety of topics that do not have significant bearing on the question of what physically happened at the Pentagon on 9/11. These topics in themselves are of interest to those wanting background information on the people and politics surrounding 9/11 and its aftermath.

This segment of the Seattle presentation touches on issues such as the anthrax attacks of late 2001, the missing 2.3 trillion dollars, the influence of neo-cons in creating a "New Pearl Harbor," and statements by Lawrence Wilkerson and Wesley Clark that shed light on the politics leading to 9/11 and the Middle East wars. Also mentioned by Honegger are Hollywood propaganda movies, Gandhi and the 2012 Malaysia International Conference on 9/11⁹⁵, Judge Ferdinando Imposimato and Guantanamo. In these non-scientific matters, Honegger provides interesting information on the subject of 9/11.

⁹⁴ Adam Larson, *The Elastic Timeline*, 2007, <http://frustratingfraud.blogspot.com/2007/11/pentagon-attack-timeline-questions-part.html>

⁹⁵ Malaysia International Conference on 9/11 <http://www.visibility911.org/international-conference-on-911-revisited-seeking-the-truth-19-11-2012/>

J. Summary and Conclusion

At S-02:05:20, Honegger presents a summary slide of her version of what happened at the Pentagon on 9/11. All these conclusions are contradicted by the evidence shown in this paper. There is significant, even overwhelming, evidence that contradicts Barbara Honegger's main hypothesis, that a large plane did not hit the Pentagon on 9/11 and that all damage and deaths were caused by pre-planted explosives. Likewise, her claim that a white plane was destroyed next to the Heliport area is without foundation. The scientific evidence is consistent with a Boeing 757-200, most likely flight AA 77, hitting the Pentagon on 9/11 at about 9:37:46 am and with the impact hole being centered on column 14.

Honegger's hypothesis relies largely on two fallen and stopped Pentagon clocks. This hypothesis ignores similar clocks that tell a different story and the experimentally observed behavior of dropped clocks. Honegger's analysis omits to mention a host of eyewitness and physical evidence that contradicts her hypothesis. It ignores and violates basic physical laws of force and motion, and consistently misinterprets or distorts the evidence presented. It makes no effort to follow the scientific method, and, in one or two instances, violates ethical research methods by rewording quoted statements and/or attributing them to the wrong source. Honegger's assertions about the integrity of other, highly qualified researchers in her Seattle⁹⁶ and Washington, D.C. talks⁹⁷ are particularly regrettable.

In short, Barbara Honegger's analysis presents an altogether erroneous picture of what happened at the Pentagon, to the detriment of those searching for the truth in this area, to the general public, and to the cause of legitimate scientific inquiry.

On the positive side, Barbara Honegger's presentations and outpouring of information have drawn many to consider the details of the events of 9/11. Nevertheless, these events, affecting as they do the lives of so many, are best approached with a commitment to follow the principles of the scientific method by examining all the available evidence, eschewing all personal bias and other personal considerations, and by testing each hypothesis for its consequences.

Acknowledgments

The authors would like to thank Christopher Gruener, MA, LMHC, A. Hamid Mumin, PhD and James Smart, PhD for reading and editing the manuscript and making helpful suggestions. Thanks are also due to Warren Stutt for commenting on the FDR section and confirming details of his work on the FDR data. A number of edits and other changes were made in response to comments by Kevin Ryan, BS and anonymous reviewers to whom thanks are due.

Contact Policy

Those wishing to engage with the authors on any questions arising from a reading of this paper are encouraged to do so through the Contact Us pages at either Scientists for 9/11 Truth or the Scientific Method 9/11 websites.⁹⁸

⁹⁶ See section G. *Observations Inside the Pentagon, One or Three "Exit Holes?"*

⁹⁷ Barbara Honegger, *Washington DC talk*, 2013, <https://www.youtube.com/watch?v=PrFIWaWgCWw> 01:17:05 to 01:17:55

⁹⁸ Go to either www.scientistsfor911truth.org or www.scientificmethod911.org.

Appendix A - Pentagon Eyewitness Testimony

There are a number of lists containing eyewitness accounts of what happened at the Pentagon on 9/11. The witnesses and their statements given below are derived mainly from these lists.

Bart's List

<http://911research.wtc7.net/pentagon/evidence/witnesses/bart.html>

Arabesque

<http://arabesque911.blogspot.com/2007/04/911-and-pentagon-attack-what.html>

Frank Legge's Spreadsheet

http://www.scientistsfor911truth.org/papers.html#papers_pentagon

Ken Jenkins' Video

<https://www.youtube.com/watch?v=E9-O6iqJnOA>

What Really Happened

http://whatreallyhappened.com/WRHARTICLES/911_pentagon_eyewitnesses.html

American Memory Project of the Library of Congress

<http://memory.loc.gov/cgi-bin/query/S?ammem/afc911bib:@field%28SUBJ+@od1%28Pentagon++Va++%29%29>

www.911myths.com [unreachable when checked on 04/15/16]

http://www.911myths.com/index.php/American_Airlines_Flight_77_Crash_Evidence

Eyewitnesses to Plane Impact = 64 (listed here) or more

Anderson, Steve – “I witnessed the jet hit the Pentagon on September 11... [It] slammed into the west wall of the Pentagon.”

Anlauf, Deb & Jeff – “I saw this plane right outside my window... Then it shot straight across from where we are and flew right into the Pentagon... It was just this huge fireball that crashed into the wall (of the Pentagon).”

Bease, Maurice – “Because of the direction the aircraft was coming from, it looked like it was coming straight at me.” “I dropped to the ground and lost sight of it. Moments later, I heard and felt the aircraft impact the side of the building.”⁹⁹

Bergan, Susan – “[Saw] a big jetliner skim the treetops and slam into the side of the Pentagon.”

⁹⁹ Cedric Haller, *Marine recalls firsthand account of 9/11 attack on Pentagon*, DVDIS, 2014, <https://www.dvidshub.net/news/143533/marine-recalls-firsthand-account-9-11-attack-pentagon#.VbsJaZXbLIU>

Boger, Sean – “I just watched it hit the building. It exploded ... I could actually hear the metal going through the building.”

Bouchoux, Donald R. - “[The plane] impacted the side of the building.”

Bradley, Pam - “[I] saw the plane hit the Pentagon.”

Brooks, Chadwick – “ ... awfully low ... just go nose dive into the Pentagon ... full throttle ... clip the lamp pole ...” “... just the sheer impact ... it just literally disintegrated the plane.”

Candelario, Joseph - “This aircraft then made a sharp turn and flew towards the Pentagon and seconds later crashed into it.”

Chu, Jimmy – “[Saw the] plane explode into the fortress-like walls of the Pentagon.”

Cissell, James R. – “ ... I saw this plane coming in and it was low - and getting lower.” “If you couldn't touch it from standing on the highway, you could by standing on your car.” “It came in in a perfectly straight line.” “It didn't slow down. I want to say it accelerated. It just shot straight in.”

Day, Wayne T. - “[one employee] was in front of one of the blast-resistant windows [inside of the Pentagon as he saw the plane coming in to crash]...”

DiPaula, Michael – “[The plane] nearly shearing the roof off the trailer before slamming into the E ring.”

Dobbs, Mike – “[he saw the plane] strike the building. ‘It seemed to be almost coming in slow motion,’ he said later Tuesday. ‘I didn't actually feel it hit, but I saw it and then we all started running.’”

Donley, Daryl – “I saw it fly right into the Pentagon ... ‘It just was amazingly precise... It completely disappeared into the Pentagon.’”

Eberle, Bobby – “The airliner crashed into the Pentagon and exploded.”

Elgas, Penny – “it gently rocked and slowly glided straight into the Pentagon.”

El Hallan, Aziz – “a huge aero plane ... 757 American Airlines ... the plane crashed in the Pentagon.”¹⁰⁰

Flyler, Kim – “The plane hit the building.”

Hemphill, Albert – “He impacted low on the Westside of the building to the right of the helo[copter], tower.” “What instantly followed was a large yellow fireball accompanied by an extremely bass sounding, deep thunderous boom.”

Gerard, Steven – “Jet right into the side of the Pentagon ... A huge fireball.”

¹⁰⁰ Fox5 News Interview, *Pentagon Plane Crash Witness Aziz El Hallan*, September 11, 2001, <https://www.youtube.com/watch?v=Gkm5-1GN2b0>

Johnson, Megan – “plane flew directly in front of her car into the Pentagon.”

Kean, Terrance – “I saw this very, very large passenger jet.” “It just plowed right into the side of the Pentagon. The nose penetrated into the portico. And then it sort of disappeared, and there was fire and smoke everywhere ... It was very sort of surreal.”

Kizildrgli, Aydan – “[He saw the plane] strike a western wall of the huge five-sided building that is the headquarters of the nation’s military.” “There was a big boom,” he said. “Everybody was in shock. I turned around to the car behind me and yelled ‘Did you see that?’ Nobody could believe it.”

Kopf, Peter – “the jet hit the Pentagon, creating a ‘huge fireball’.”

Lagasse, William – “American Airlines 757 flew ... in front of me ... first thing I did was call our communications and I merely stated an aircraft has just flown into the side of the building.”

Leonard, Robert – “I saw it, there’s just no question at all, that the plane went into the Pentagon wall.”

Liebner, Lincoln – “The plane came in hard and level and was flown full throttle into the building, dead center mass, Maj. Leibner said. “The plane completely entered the building... The plane went into the building like a toy into a birthday cake ... The aircraft went in between the second and third floors.”

M. K. – “It hit the pentagon. It happened so fast ... it was in the air one moment and in the building the next ... I still have a hard time believing it, but every time I look out the window, it seems to be more real than it did the time before.”

Marra, David – “helicopter pad ... The wing touched there.”

Mason, Don – “The aircraft struck the building between the Heliport fire station and the generator ... ”

McGraw, Stephen – “I saw it crash into the building ... My only memories really were that it looked like a plane coming in for a landing.”

Middleton, William Sr. – “A groundskeeper who watched in horror as the plane crashed into the Pentagon ... The jet accelerated in the final few hundred yards before it tore into the building.”

Mitchell, Mitch – “We watched it go in. It struck the Pentagon, and there was no indication whatever that it was doing anything other than performing a direct attack on that building.”

Morin, Terry – “The tail was barely visible when I saw the flash and subsequent fireball rise approximately 200 feet above the Pentagon ... the aircraft had been flown directly into the Pentagon without hitting the ground first or skipping into the building.”

Mosley, James – “I saw ...this big silver plane run into the side of the Pentagon.”

Narayanan, Vin – “The hijacked jet slammed into the Pentagon at a ferocious speed. But the Pentagon’s wall held up like a champ. It barely budged as the nose of the plane curled upwards and crumpled

before exploding into a massive fireball. The people who built that wall should be proud. Its ability to withstand the initial impact of the jet probably saved thousands of lives.”

O'Brien, Steve – “the plane is either a 757 or a 767 and its silver fuselage means it is probably an American Airlines plane.” [Saw the plane, saw a crash, later identified crash site as the Pentagon].

Owens, Mary Ann – “The nose crashed into the southwest wall of the Pentagon. Still gripping the wheel, I could feel both the car and my heart jolt at the moment of impact. An instant inferno blazed about 125 yards from me. The plane, the wall and the victims disappeared under coal-black smoke, three-storey tall flames and intense heat.”

Pak, Zinovy – “[He] saw a plane crash into the building.”

Patterson, Steve – “[It] headed for the Pentagon “at a frightening rate ... just slicing into that building ...”Then this thing just became part of the Pentagon ... he saw the Pentagon “envelope” the plane.”

Perry, Scott – “I saw it crash.”

Peterson, Christine – “then the plane crashed ... Where did the plane go? ... I expected it to bounce off the Pentagon wall in pieces.”

Probst, Frank – “I was standing on the sidewalk (parallel to the site of impact) ... and I saw this plane coming right at me at what seemed like 300 miles an hour. I dove towards the ground and watched this great big engine from this beautiful airplane just vaporize,” “It looked like a huge fireball, pieces were flying out everywhere.” “[plane] Went through generator trailer, low concrete wall.”

Ramey, Wanda – “[It] crashed into the west side of the building ... It happened so fast. One second I saw the plane and next it was gone.” Recalling those moments again, Ramey said it appeared the building sucked the plane up inside.”

Renzi, Rick – “The impact created a huge yellow and orange fireball, he added.”

Riskus, Steve – “I am sorry to rain on your parade, but I saw the plane hit the building. It did not hit the ground first ... It did not hit the roof first ... and yes, it did impact the Pentagon ... There was none of this hitting-the-ground first crap I keep hearing ...”

Sabre, Qawly – “The whole building shook. We heard a loud bang, and wall of fire came at us,” said Qawiy Sabre who “was working in the outer ring when he saw the plane coming toward the Pentagon. He ducked to the floor and flames passed over him.”

Sepulveda, Noel – “... struck a light pole ... hit a second light pole ... The plane dipped its nose and crashed into the southwest side of the Pentagon.”

Skarlet – “It was headed straight for the building. It made no sense ... A huge jet. Then it was gone. A massive hole in the side of the Pentagon gushed smoke. ‘Buildings don't eat planes. That plane, it just vanished. There should have been parts on the ground. It should have rained parts on my car. The

airplane didn't crash. Where are the parts?' That's the conversation I had with myself on the way to work ... There was a plane. It didn't go over the building. It went into the building."

Skipper, Mark – "... we saw the plane ... we started running ... we heard the explosion and the incredible crash."

Smith, Dennis – "[He saw the plane] seconds before it exploded into the building."

Stanley, G.T. – "I saw it hit the building."

Sucherman, Joel – "The plane slammed into the west wall of the Pentagon 100 yards away."

Sutherland, Jim – "[he saw it] fly 50 feet over I-395 in a straight line, striking the side of the Pentagon."

Taylor, Shari – "And then he just slammed into the Pentagon."

Thompson, Carla – "I glanced up just at the point where the plane was going into the building ...I saw an indentation in the building and then it was just blown-up up — red, everything red."

Timmerman, Don "Tim" – "It added power on its way in ... The nose hit, and the wings came forward and it went up in a fireball."

Vignola, Dawn – "Dawn Vignola and her roommate Hugh 'Tim' Timmerman saw American Flight 77 hit the Pentagon, September 11, 2001"

Wallace, Alan – "Wallace hadn't gotten far when the plane hit. 'I hadn't even reached the back of the van when I felt the fireball. It slammed into the building just a couple hundred feet from him ... Wallace switched on the truck's radio. We have had a commercial carrier crash into the west side of the Pentagon at the Heliport, Washington Boulevard side."

Walter, Mike - "I was sitting in the northbound on 27 and the traffic was, you know, typical rush-hour -- it had ground to a standstill. I looked out my window and I saw this plane, this jet, an American Airlines jet, coming. And I thought, 'This doesn't add up, it's really low.' "And I saw it. I mean it was like a cruise missile with wings. It went right there and slammed right into the Pentagon. "

Washington, Rodney – "[The plane went] into the Pentagon."

Wheelhouse, Keith – "They watched the jet approach and slam into the Pentagon." "He's [C-130 pilot] in a transport plane, you watch a jumbo jet flying low, drop its nose and gun it," Wheelhouse said. "What's he going to do?"

Winslow, Dave – "It ploughed right into the Pentagon."

Wright, Don – "It was about 9:35 and I was looking out our twelfth floor windows ... I watched this, looked like a commuter plane, two engine, come down from the South, real low, proceed right on and crash right into the Pentagon."

Eyewitnesses to Light Poles Being Struck by a Large Plane = 14

The following eyewitnesses testified to seeing a plane strike light poles or other objects on approach to the Pentagon. These can all be found in Frank Legge's Spreadsheet and /or other witness compilations cited above. This is not a complete list of known such witnesses.

Bright, Mark – knocked down street lights
Brooks, Chadwick – hit lamp pole
Elliott, Bruce –struck utility pole wire
England, Lloyd – taxi cab damaged by pole
Gaines, Kat – struck top of telephone poles
Hagos, Afework – hit lamp posts
Hovis, Tom – picked off trees and light poles
Khavkin, D.S. – knocked down a number of street lamp poles
Mason, Don – struck three light poles
McGraw, Stephen – knocked over street lamp at edge of road – saw “just after” (Aldo Marquis)
Probst, Frank – clipped antenna off Jeep Cherokee - three street lights had been sheared in half (Bart)
Riskus, Steve – knocked over a few light poles
Sepulveda, Noel – struck a light pole, hit a second light pole
Washington, Rodney – [plane] knocking over light poles

Eyewitnesses to a Silver Plane = 16

Cleveland, Allen – A silver passenger jet, mid-sized ... I know it was silver
Hemphill, Albert – Immediately, the large silver cylinder of an aircraft appeared in my window
Hurst, Joe – I saw little bits of silver falling from the sky
Morin, Terry – The plane had a silver body with red and blue stripes down the fuselage
Mosley, James – “I looked over and saw this big silver plane
Munsey, Christopher – A silver, twin-engine American Airlines jetliner
O'Brien, Steve - either a 757 or 767 and its silver fuselage means it is probably an American Airlines plane
O'Keefe, John - I saw a silver plane I immediately recognized it as an American Airlines jet
Patterson, Steve – He saw a silver commuter jet fly past the window of his 14th-floor apartment
Ryan, James – I see an American Airlines plane, silver plane
“Steve” – I saw the jet just before it crashed. Something big and silver
Storti, Steve - Then he caught the glint of silver out of the corner of his eye. He looked up to see a passenger plane with the trademark stainless-steel fuselage and stripes of American Airlines
Sucherman, Joel – “It was a silver jet with the markings along the windows that spoke to me as an American Airlines jet
Walter, Mike – I saw a big silver plane and those double A's
Wyatt, Ian - I look up, it looks like a silver American Airlines, twin-engine plane
Zakhem, Madelyn – It was huge! It was silver

Eyewitnesses to a White Plane = 4

Bease, Maurice – Had a “split-second” glimpse only – “He did not even have time to duck”
Mark Skipper – Fleeting glimpse only
Jim Sutherland -

Alan Wallace – Fleeting glimpse only – observed stripes as orange, not red

Eyewitnesses to Plane Wreckage Inside the Pentagon = 11¹⁰¹

1) "Most of the wreckage was in **very small pieces** and most was carried out in drywall buckets. Some was large enough to identify -- including the tail number on the aircraft. I don't think there's any doubt about what it was and who owned it." (From a letter by an employee of the Pentagon)

2) "DC Matthew" wrote about his work inside the Pentagon: "After about 15 minutes shoveling up chunks of carpet and brick, I found a piece of circuit board, and a **chunk** of the plane. When I say a chunk of it, I mean a piece that was about **3 oz of twisted aluminum**. The biggest piece I've seen so far is about the size of a refrigerator."

3) While searching through wreckage inside the building, firefighters, Carlton Burkhammer and Brian Moravitz, "spotted an **intact seat** from the plane's cockpit with a **chunk** of the floor still attached." Burkhammer also "spotted **lime-green pieces** from the interior of the plane" within the building.

4) CMSgt. John Monaccio wrote: "I was in room 1B461. The plane's inertia carried **aircraft remains** all the way through the building coming to rest on the outside walls of our offices. We discovered **cockpit wreckage** at our feet while attempting to rescue people from a Navy operations area."

5) ARFF Captain Michael Defina said: "The only way you could tell that an aircraft was inside was that we saw pieces of the **nose gear**."

6) Navy Lt. Commander David Tarantino described the A-E Drive punch out hole: "They found an area where fire surrounded a hole in a wall that was blown out. They heard cries from people who were trapped and saw a **plane tire**."

7) Lt. Kevin Schaeffer from the Navy Command Center recalled that, "On a service road that circled the Pentagon between the B and C rings, a **chunk** of the 757's **nose cone** and front **landing gear** lay on the pavement a few feet away, resting against the B Ring wall."

8) "The nose of the plane just barely juttred out into A/E Drive (the street that runs around the inside of the building). It made a perfectly round, 5-foot hole in the wall. There was one set of **landing gear** (presumably from the nose) out in A/E Drive. But most of the plane's **skin** was in pieces not much bigger than a piece of notebook paper." (From a letter by an employee of the Pentagon)

9) "I thought it was a terrorist bomb. . . .But then I saw the **landing gear**. It was on the ground in the alley between the B and C rings. When I saw it there, not only did I realize an airplane had struck the Pentagon but it was clear that the plane had come through the E, D, and C buildings to get there." (Paul K. Carlton, Jr., U.S. Air Force surgeon general, quoted by Dean Murphy, "September 11: An Oral History," p. 216.

10) Rep. Ted Tiahrt wrote: "In the C and B rings the plane had punched a hole you could a drive a truck around in, and I saw an **airplane tire**. It made it very real."

¹⁰¹ Sarah Roberts, *Photos Of Flt 77 Wreckage Inside The Pentagon*, <http://www.rense.com/general32/phot.htm>

11) When LTC Victor Correa went back inside the Pentagon, "he found out what caused the horrific attack he survived earlier that morning; he saw the **nose cone** and the **landing gear** of the airliner."

Witnesses Who Detected Cordite by Its Odor = 4

[Note: Cordite has not been in use since World War II]

Goldsmith, Gilah

Danner, Samuel

Perkal, Don – I could smell the cordite

Shelton, Hugh – General – The smell of cordite was overwhelming

Witnesses Who Detected Jet Fuel¹⁰² by Its Odor, Feel and Appearance = 20

Birdwell, Brian - would not have survived because of the jet fuel in his lungs.

Blunt, Ed - the destruction ... was extensive on the interior because of ... the fire and fuel once the jet entered

Day, Wayne T. - Jet fuel was on him and it irritated his eyes, but he didn't get burned.

DiPaula, Michael - covered with airplane fuel, he was briefly listed by authorities as missing.

Evey, Walker Lee - Fires from the plane's 20,000 gallons of fuel melted windows into pools of liquid glass.

Hahr, Matt – jet fuel was on him

Henson, Jerry - Now fires were burning closer as deposits of jet fuel ignited. "You could hear them lighting off

Jarvis, Will - Will Jarvis ... knows what aviation fuel smells like. That smell was his only clue that a plane had crashed into the Pentagon.

Kirk, Mark Steven - The first thing you smell is the burning. And then you can smell the aviation fuel

Mayer, Thom – Dr., staff head at Fairfax hospital – There was jet fuel all over the place

Morin, Terry - the heat inside the building generated from the 8,500 gallons of jet fuel was, in their words, 'unbelievable.'

Plaugher, Edward - flames and hot spots at the Pentagon, fed by jet fuel and mountains of rubble.

Pfeil-stucker, Daniel C. Jr - Then he smelled jet fuel and smoke.

Ramos, Maryann – physician assistant who interviewed victims – a whole plane with jet fuel

Rosati, Arthur – You could smell the jet fuel, it was unbearable.

Schickler, Rob - you can smell the burning concrete and burning jet fuel.

Shaeffer, Kevin – the air ... reeking of kerosene [jet fuel]

Slater, Mike - I saw a mass of oily smoke and thought of the oil fields of Kuwait.

Turner, Ron – Vietnam helicopter pilot - a huge fireball followed by the black cloud of a fuel burn – same as explosions of jet fighters and helicopters

Yates, John - His glasses ... were smeared with something—unburned jet fuel

Other Witnesses and Observations That Might Indicate Bombs = 13

In addition to the four (4) witnesses who detected cordite. Honegger lists these witnesses:

¹⁰² Eyewitness Statements On Jet Fuel - <http://www.ratical.org/ratville/CAH/F77penta04.html>

Andrews, Robert - Assistant Secretary of Defense for Special Operations on 9/11, (“my aide and I had to walk over dead bodies on the inside of the A ring”), in a sworn affidavit

Burgess, Lisa - Stars and Stripes reporter (walking across the courtyard on the Pentagon innermost corridor, heard two booms, one large, one smaller, whose shock wave knocked her against the wall)

Correa, Victor - Lt. Col. also inferred bombs.

Gallop, April – thought it was a bomb – gave conflicting accounts of touching computer and exiting

Hathaway, Rear Adm. – Kevin Shaeffer was not the sole survivor of the NCC, there were 18 to 19 survivors who were in the hardened Intel room (room 8) shown at 1:56:00. [This testimony was reported by Honegger as being a private communication to her from Hathaway].

Marine Major (unnamed) - to the Washington Post (the B ring between the 4th and 5th corridors was decimated, with intense heat, so you could not enter)

McKeown - Naval Command Center Lt. McKeown (heard a series of bombs)

Nielsen, Michael - Fort Monmouth TDY Financial Auditor (“100s ran down the hall shouting bombs”)

Donald Rumsfeld – When asked question about what happened, Rumsfeld responded: “A bomb?”

Three star aide to Rumsfeld: Asked Charles Leiddig if he felt the explosion

Schaeffer, Kevin - Lt. Naval Command Center (“entire command center exploded in a gigantic orange fireball”)

Thurman - Lt. Col. Thurman (like a bomb, two part explosion)

Washington Post reporters (unnamed) - on 9/11 (the deeper you went into the building, the hotter)

Appendix B - Boeing 757-200 Front Views and Calculations

The two photographs shown below are front views of Boeing 757-200 airplanes. The center fuel tank is visible underneath the fuselage. This feature is also shown in the front views in the Boeing 757-200 specifications (hereafter referred to as the “757-200 specs”) on pages 13 and 15 of the *757-200/300 Airplane Characteristics for Airport Planning* as reproduced in Appendix C.



Figure AppB-1 Boeing 757-200 front view



Figure AppB-2 Boeing 757-200 front view

From the 757-200 specs we obtain the following measurements for the geometry of a Boeing 757-200 by taking, where applicable, the mean of the Minimum and Maximum stated values:

Fuselage vertical diameter = 13.17 feet	; A - B
Engine separation (center to center) = 42.5 feet	; General Dimensions
Distance of top of fuselage to bottom of engine = 18.21 feet	; A - L
Depth of center fuel tank below fuselage = 1.5 feet	; figure B-2
Distance bottom tank to engine bottom = 3.54 feet	; (18.21 – 13.17 - 1.5)

The depth of the center fuel tank below the fuselage is not given in the 757-200 specs and is difficult to measure accurately from the diagrams. Calibrating the photograph in figure B-2 using 42.5 feet for the engine separation, one obtains 1.5 feet for the tank depth, and this is the value used in this paper.

Height of Fuselage Top on Impact

From the Boeing 757-200 specs, the distance of top of fuselage to bottom of an engine is 18.21 feet. This value is now adjusted for roll, pitch, and ground slope.

Calculation of Adjustment for Roll

Half the distance between the bottoms of the left and right engines is 21.25 feet. With a negative roll of 5 degrees at impact, the top of the fuselage will be higher than for level flight by a distance = $21.25 \times \tan 5 \text{ degrees} = 21.25 \times .0875 = 1.86 \text{ feet}$.

Calculation of Adjustment for Pitch

When the left engine hit the low concrete wall, a point on the fuselage, midway between a line drawn between the fronts of the two engines, would be 83 feet from the Pentagon wall. With a negative pitch of 1.2 degrees, the front of the plane would be on a trajectory to hit the wall at a distance lower than if the flight were level given by $83 \times \tan 1.2 \text{ degrees} = 83 \times .0209 = 1.73 \text{ feet}$.

Net Adjustment and Summary

The net adjustment for roll and pitch is $1.86 - 1.73 = 0.13$ or 0.13 feet higher. Since the left engine hit the low concrete wall almost at ground level, the top of the fuselage was therefore $18.21 + 0.13 = 18.34$ feet above ground when the plane impacted the Pentagon west wall, provided the ground was level between the low concrete wall and the Pentagon west wall. However the ground slopes downward from the low concrete wall, so the final result is closer to 18.34 plus 1 to 3 feet.

Summary of the Flight Path Damage and Debris

Readers are reminded of the strong evidence for large plane impact and penetration provided by the damage path, many elements of which line up exactly with the flight path direction from the SW at an angle of 52 degrees with the Pentagon west wall. These elements include the clipped tree,¹⁰³ five downed light poles, generator-trailer damage, low concrete wall damage, the façade hole, outside plane debris (strewn to the north because of the angle of impact), the missing, bowed and abraded (in the flight path direction) internal columns, the first floor suddenly filled with debris with the ceiling intact, inside plane debris, the C ring hole, and the debris with plane parts strewn in the A & E driveway along the flight path. These elements all confirm a flight path that is supported by eyewitness accounts, the radar data and the FDR data. In addition, the light poles' separation gives a wingspan in the range 100 ft to 130 ft (Boeing 757 wingspan is 124 ft 10 in), while the low concrete wall and generator-trailer damage separation indicates an engine separation of approximately 43 ft (Boeing 757 engine separation is 42.5 ft). There are over 62 eyewitnesses who saw impact. Fourteen (14) witnesses saw the light poles struck. Four witnesses saw the right engine/wing hit the generator trailer, while one witness saw the left engine hit the low concrete wall. Multiple witnesses traced the passage of the plane as it flew from the Sheraton Hotel (last radar reading) to impact at the Pentagon. The properly-decoded FDR data traces the plane's path all the way to impact.

Such a confluence of physical, eyewitness and other evidence provides an overwhelming case for a large plane, most probably a Boeing 757-200 and flight AA 77, impacting and penetrating the Pentagon on 9/11. No other theory has even ventured to explain all this evidence using a missile, bombs etc.

¹⁰³ See David Chandler's complete talk, Oakland Film Festival, September 2015, slide at 01:01:48, <https://www.youtube.com/watch?v=E9-O6iqJnOA> and Tom Hovis, *Eyewitnesses to Light Poles* (Appendix A)

Appendix C - Boeing 757-200 Specifications

General Dimensions

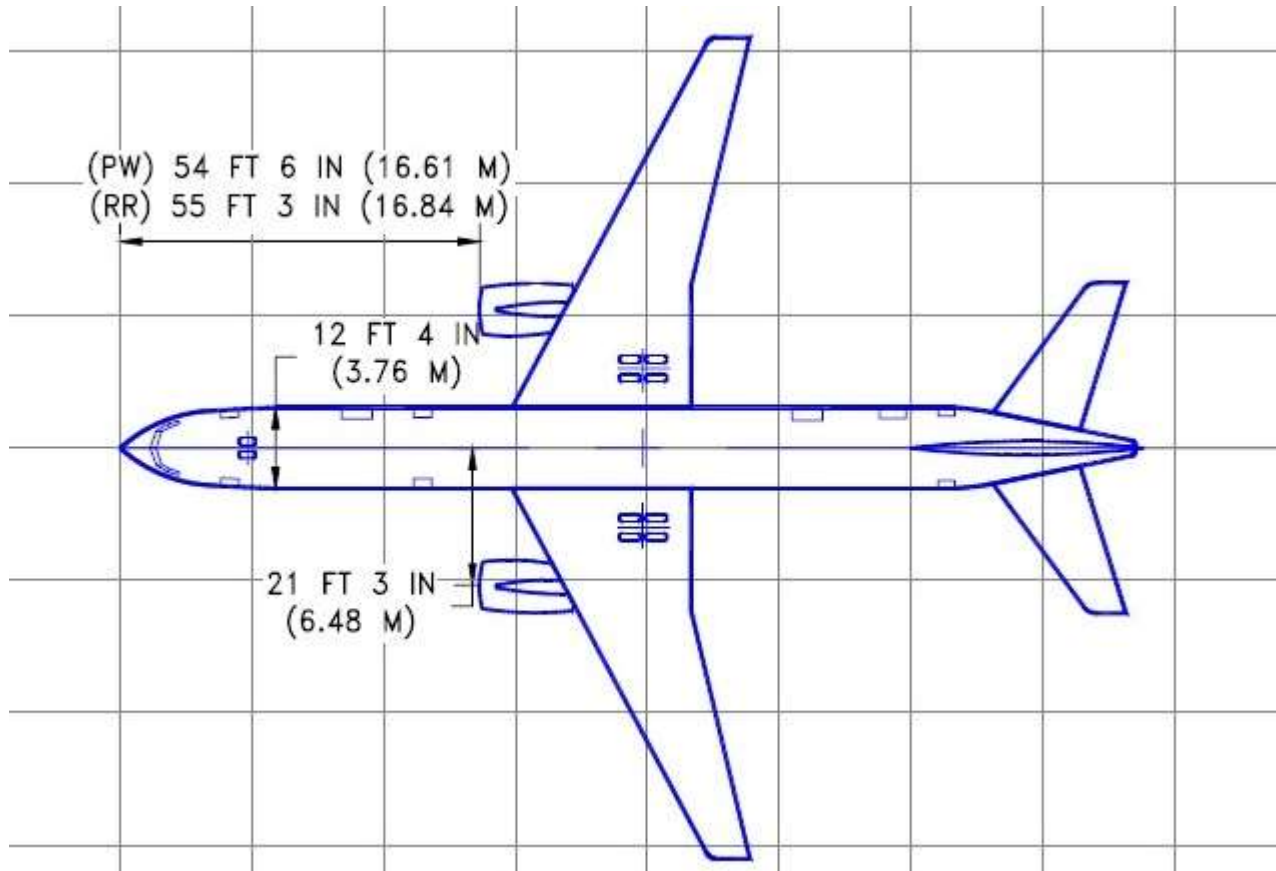

Notes

The diagrams and tables in this appendix are from pages 13 and 15 of the document **757-200/300** *Airplane Characteristics for Airport Planning* published by Boeing Commercial Airplanes, August 2002.

http://www.boeing.com/assets/pdf/commercial/airports/acaps/757_23.pdf

An American Airlines Boeing 757-200 is sometimes referred to as a Boeing 757-223, a Boeing 757-200 bought by customer 23 = American Airlines.

<http://www.aerospaceweb.org/question/planes/q0048.shtml>

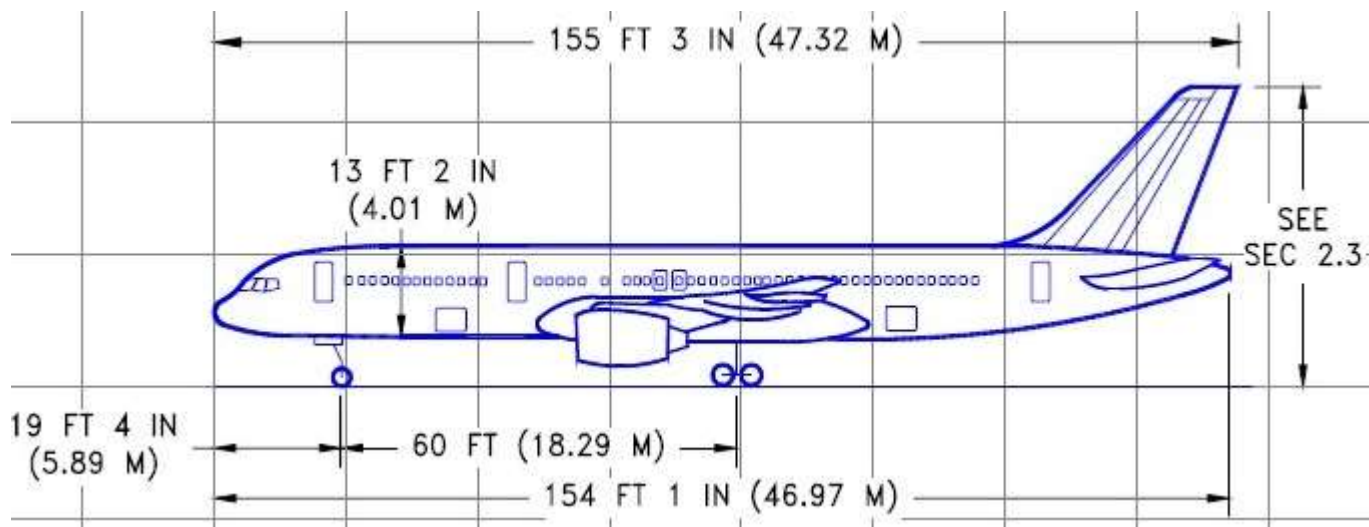

General Dimensions (continued)

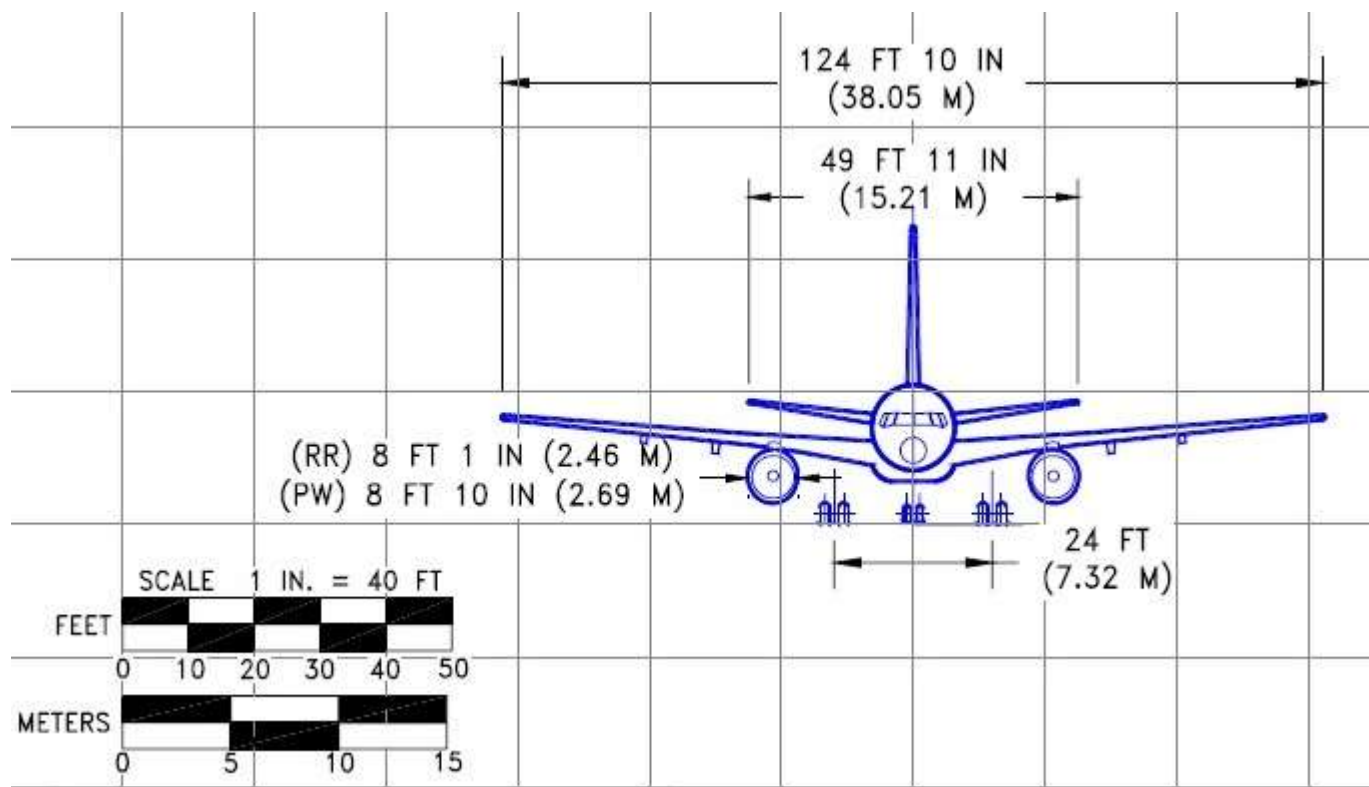

Ground Clearances

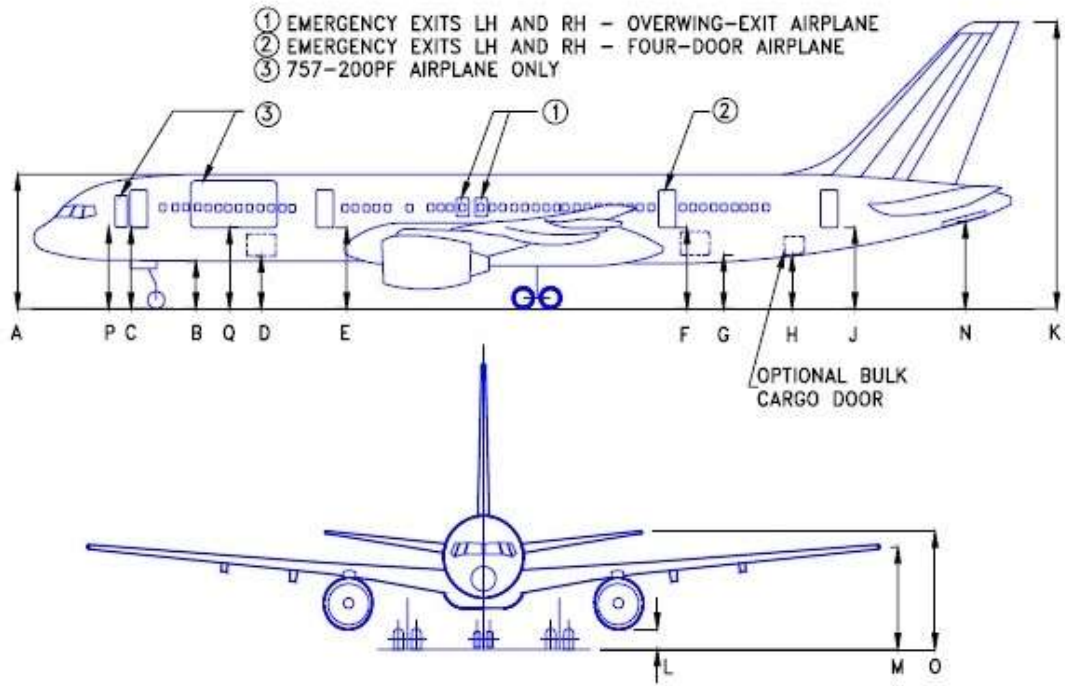

	MINIMUM*		MAXIMUM*		MODEL APPLICABILITY
	FEET - INCHES	METERS	FEET - INCHES	METERS	
A	20 - 6	6.25	21 - 2	6.45	-200, -200PF
B	7 - 4	2.24	8 - 0	2.44	-200, -200PF
C	12 - 5	3.79	13 - 2	4.01	-200
D	8 - 1	2.46	8 - 9	2.67	-200, -200PF
E	12 - 7	3.84	13 - 2	4.01	-200
F	12 - 9	3.89	13 - 3	4.04	-200
G	7 - 9	2.36	8 - 3	2.51	-200, -200PF
H	8 - 6	2.59	9 - 1	2.77	-200
J	12 - 9	3.89	13 - 7	4.14	-200
K	44 - 3	13.49	45 - 1	13.74	-200, -200PF
L	2 - 5	0.74	2 - 10	0.86	-200, -200PF
M	15 - 4	4.67	16 - 1	4.90	-200, -200PF
N	12 - 5	3.78	13 - 3	4.04	-200, -200PF
O	18 - 7	5.66	19 - 8	5.99	-200, -200PF
P	12 - 5	3.79	13 - 2	4.01	-200PF
Q	12 - 6	3.81	13 - 2	4.01	-200PF

NOTES: VERTICAL CLEARANCES SHOWN OCCUR DURING MAXIMUM VARIATIONS OF AIRPLANE ATTITUDE. COMBINATIONS OF AIRPLANE LOADING AND UNLOADING ACTIVITIES THAT PRODUCE THE GREATEST POSSIBLE VARIATIONS IN ATTITUDE WERE USED TO ESTABLISH THE VARIATIONS SHOWN.

* NOMINAL DIMENSIONS

Appendix D - Geometry of the Plane Approach

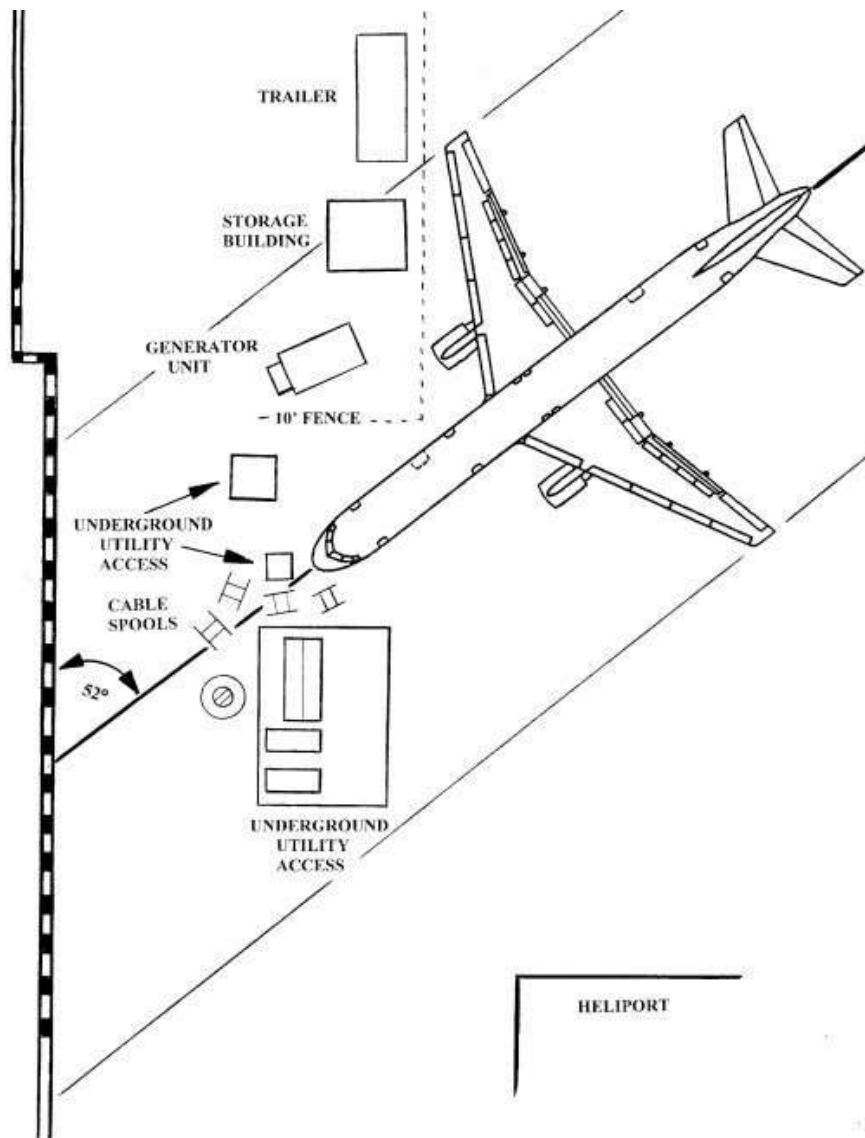

Figure AppD-1

The distance between mid points of the engines is 42.5 feet. North is toward the bottom of the figure.
The Heliport Tower (not shown) is beyond (north of or below) the Heliport pad (shown).

This figure is from Russell Pickering's "Pentagon Research," <http://home.comcast.net/~skydrifter/exp.htm>

Appendix E - Plane Parts Found Near the C Ring Hole

The Landing Strut

The landing strut shown in Figure AppE-1 was found near the C ring exit hole but on the inside of the Pentagon.



Figure AppE-1 Landing gear

The Wheel Hub and Tire

According to TLC's "Pentagon Under Fire," aired 9/11/02, this wheel hub was found near the exit hole.



Figure AppE-2 Wheel hub

The wheel hub in Figure AppE-2 has been shown to be essentially identical to this hub from a Boeing 757 landing gear in Figure AppE-3.



Figure AppE-3 Boeing 757 landing gear

In the next photograph, Figure AppE-4, an object that looks like a wheel hub is visible (2). A semi-circular part of the plane appears at left (1). Also notice that the majority of the debris is to the individual's right, or at an angle that is consistent with the flight path direction in relation to the wall. Other evidence shows the plane's path made a 52 degree angle with the wall.



Figure AppE-4 Plane parts and debris angle

Navy Lt. Commander David Tarantino described the A-E Drive punch out hole: "They found an area where fire surrounded a hole in a wall that was blown out. They heard cries from people who were trapped and saw a **plane tire**."

Rep. Ted Tiahrt wrote: "In the C and B rings the plane had punched a hole you could a drive a truck around in, and I saw an **airplane tire**. It made it very real."

In the following photograph, Figure AppE-5, is a large remnant of a tire (2). Also shown is a wheel rim (1). The debris angle (3) is also clearly visible. A single doorway lies in the direction pointed to by (4). Note the black smoke residue on the wall above. Beyond, on the other side of a fence partition is so-called "exit hole" number 2, a large doorway.



Figure AppE-5 Plane parts and debris angle

Note the spacing of the ribs on the tire fragment (2), which are similar to the ribs found on Michelin aircraft tires shown in the following picture.



Figure AppE-6 Michelin aircraft tires

According to the Michelin website: “MICHELIN® Aircraft tires are currently original equipment on Boeing's 737, 757, 747-400 aircraft and is approved by Boeing as a replacement tire supplier on almost all of its current aircraft.”

Michelin offers two tire sizes, one for the main landing gear H40x14.5-19 with a 24 or 26 ply rating depending on the series, and a smaller size for the nose gear H31x13.0-12 with a 20 ply rating. Although the rib pattern appears to match Michelin aircraft tires, we cannot be certain. However, Bridgestone, Goodyear and other manufacturers also offer similar ribbed aircraft sizes and plys for the Boeing 757.

Entry/Exit Doors and the Plane Exit Hole

As shown in Figure G-5 in *Section G*, three openings in the C ring wall were originally described by unidentified persons as plane “exit holes.” In Figure G-5 and Figure AppE-7(a) these are numbered 1, 2, and 3. Two of these “exit holes,” numbered 1 and 2, are actually doors for entry and exit. Figure AppE-7(b) shows the large doorway that was numbered “exit hole” 2. There is only one true plane exit hole, the circular-appearing C ring hole numbered as 3. As previously noted, Figure G-6, showing one plane “exit hole” is a more accurate, corrected version of Figure G-5.



Figure AppE-7

(a) The three so-called “exit holes”
1 and 2 are doorways, 3 is the plane exit hole

(b) “Exit hole” 2 is a large doorway
Note the small access door to the left

Note that the three so-called “exit holes” each have black smoke residue on the portions of the building above them. Two of the three “exit holes”, numbered 2 and 3, have smoke spots on the walls opposite them, as indicated by the legend and brown dots in Figure G-5. Note in Figure AppE-7(b) that the single doorway (unnumbered) just to the left of the large doorway (#2) has no smoke residue above it. It is likely this door was closed when impact occurred, while “exit holes” 1 and 2 were open or blown open. The debris outside the large doorway (#2) substantiates these possibilities.

From Figure AppE-5 and the photographs just discussed, we have established that there were at least four (4) doorways for access between the A & E driveway and the inside of the C ring in the damaged area. In light of this, claims, that the C ring hole (#3) or plane exit hole was created for rescue personnel using shaped charges set precisely in line with the plane path, is seen to be entirely unfounded and without reason.

Appendix F – Toronto Selected Excerpts

From Barbara Honegger's 2011 Toronto Hearings Presentation

<https://www.youtube.com/watch?v=qQguLmOEGYM>

The Toronto Hearings consisted of testimony by chosen expert witnesses, including two of the authors of this paper, David Chandler and Jon Cole. On the Pentagon issue, Barbara Honegger was chosen as the sole expert witness with a mandate to talk only about the evidence for explosions inside the Pentagon. Nevertheless, during her talk it became clear that Honegger did not believe a large plane such as a Boeing 757 had struck the Pentagon. Honegger emphasized that pre-planted explosives were responsible for all the deaths and damage. In the Q & A segment she stated this hypothesis explicitly.

The expert witnesses were heard by an international panel of four “highly credible” individuals “open to objectively assessing the evidence.” The international panel consisted of:

- Ferdinando Imposimato, the Honorary President of the Supreme Court of Italy;
- Herbert Jenkins, Professor Emeritus of Psychology at McMaster University;
- Richard B. Lee, Distinguished Professor Emeritus of Anthropology at the University of Toronto;
- David Johnson, Professor Emeritus of Urban and Regional Planning at the University of Tennessee.

Honegger's presentation at the Toronto Hearings lasted a little over 30 minutes, followed by a Q & A period of about 9 minutes. She rapidly presented a great deal of information, causing one member of the international panel to remark on the “tons of new material.” In the Q & A session, the panel asked Honegger some pointed and searching questions which, given the circumstances such as time limits, were not addressed satisfactorily by Honegger. However, these questions brought out some of the fundamental difficulties with her hypothesis. As of this date (April 2016), Honegger has yet to address these difficulties in a credible manner.

Here are the main concerns voiced by the international panel, in the order in which they occurred. The Q & A period begins at 00:33:00 in the video cited above.

Richard B. Lee: “Are you saying that the explosions went off several minutes before the alleged impact of the alleged aircraft?”

Barbara Honegger: “Yes, absolutely.”

Honegger then cites April Gallop's stopped wristwatch, the stopped Heliport clock and a clock in the Naval Command Center, the testimony of Alberto Gonzales, and the FAA, all giving a time of just after 09:30 am. Honegger correctly gives the official time of large plane impact as 09:37:46.

As shown in this paper and other papers by the authors, the wristwatch times are unverifiable, the clock times are subject to backward movement of the minute hand from impact with the ground or floor after falling, there are other stopped clocks that give times of around 09:37, and the FAA later changed its time to be close to the official time. These arguments and evidence all contradict Honegger's analysis.

David Johnson: "We were shown pieces of aircraft on video, on television, we were shown pieces of the engine on the ground, we were shown a part of the tail ... how were these things spread around before the attack, I'm still very confused about that"

Barbara Honegger: "the evidence is simply not there that a 757 of any kind hit the Pentagon"

David Johnson: "which means that the debris which was spread around was planted?"

Barbara Honegger: "Not necessarily, it could be from something else" "there is tremendous ... controversy and debate over whether there was a plane ... we don't have to go there ..."

As shown in this paper and in other papers by the present authors, there was a great deal of airplane debris both inside and outside the Pentagon.

Honegger completely ignores the evidence of more than 60 eyewitnesses who saw a large plane, described by many as an American Airlines 757 or 737, impact the Pentagon. She discredits the downed light poles that give a lower limit to the wingspan of 100 feet (Boeing 757-200 wingspan = 125 feet); she ignores the low concrete wall and generator trailer damage whose separation matches the engine separation of a Boeing 757-200, the shape and size of the impact hole, the internal curved columns and debris, the plane parts found outside and inside the Pentagon, and other evidence such as the radar and FDR data. Honegger never explains what the "something else" could be.

Herbert Jenkins: "Well I think it might still be useful to go there because of public perceptions ... there are many eyewitness accounts of planes of the size of the Boeing 757 going into the Pentagon, we have to deal with that, do we not?"

Barabara Honegger: "We do, and you would have to talk to the people who organized the conference, I'd be happy to do that talk later." "Lee said we'll do it in DC, there's going to be a conference on the Pentagon in Washington DC in the not too distant future."

However, Honegger, in her Seattle talk over a year later (January, 2013), and in Washington DC (September, 2013) never addressed the large number of eyewitnesses to plane impact.¹⁰⁴

Ferdinando Imposimato: "your reconstruction of the evidence is very impressive ... was the evidence gathered from actual witness present to the event ... were they all under oath?"

Barabara Honegger: "my research is a combination, of course, of scholarly research looking at the evidence ... one of my major sources is ... Professor Griffin's books ... but also going to original sources ... newspapers, the magazines ... gives you ideas as to who to interview ... in the case of April Gallop whom

¹⁰⁴ <https://www.youtube.com/watch?v=HtFXyj61s> and <https://www.youtube.com/watch?v=PrFIWaWgCWw>

I consider the most important witness ... her desk ... was only about 35 to 40 feet from the alleged entrance hole ... she saw no plane parts, no luggage, nothing, wasn't burned ... I have done a two hour, under oath, videotaped sworn testimony of April Gallop."

Honegger makes much of Gallop's stopped watch as indicating an explosive event at 09:30am without realizing that this evidence is completely unverifiable as to the watch's initial setting. In her later Washington, DC talk, Honegger pinpoints April Gallop's desk as being in Wedge 2 about 150 feet north of the official impact hole. Gallop was therefore relatively far removed from the point where the plane fuselage struck the wall, and therefore survived the impact without seeing any plane parts or smelling jet fuel. After exiting the building with her child and others through a window near the Heliport Tower, Gallop collapsed, was possibly unconscious, and was removed to a spot on the lawn near the highway. From there Gallop was taken by ambulance to hospital. Thus Gallop had little or no opportunity to see what struck the Pentagon and is in reality one of the least important and least reliable of the witnesses to the event.

Ferdinando Imposimato: "there are survivors that you know that weekend meet as witness ..."

Barabara Honegger: "there are, whether they would be willing to or not they would have to be promised security ... yes, I know who they are"

The survivor/witnesses referred to are most probably the group that exited the building with Gallop.

Richard B. Lee: "you had some amazing slides ... but some of them were whizzing by at a great rate ... I find it intriguing that the official Pentagon photograph from the air shows three exit holes in ring C ... has no one you know thought to comment on that?"

Barabara Honegger: "I did, I discovered it" "many people have noticed that there were three holes with the ... big black smoke around them ... I'm the first person who put together the Pentagon's own data to the Washington Post ... the day after 9/11 that was published ... showing three exit holes" "all the original reports ... were right after 09:30 ... the government needed for some reason ... to say the Pentagon was attacked by a Boeing 757 almost six to seven minutes later ."

In her Toronto talk, in the Q & A session, Honegger fails to disclose to the international panel that, of the three "exit holes," two were doorways through which smoke escaped. There is only one real "exit hole" – the approximately round C ring exit hole that lines up with the plane path. See *G. Observations Inside the Pentagon*, "One or Three 'Exit Holes?'" and "C ring Hole."

However, in her printed and published (2012) Toronto talk (*The 9/11 Toronto Report*, page 257), Honegger does disclose that two "exit holes" were doorways. Having now disclosed the true nature of two of the holes, one would expect Honegger to declare this in later talks. But at Seattle in January 2103, Honegger again fails to disclose to her audience the true nature, as doorways, of two of the holes. See S-01:13:15. In her Washington, D.C. talk (September, 2013 at 00:42:00), Honegger yet again fails to disclose that two of the three "exit holes" were doorways. These omissions at later dates by Honegger clearly establish the misrepresentation in this segment of her Toronto, Seattle and Washington talks, a misrepresentation made all the more conspicuous because of her charge of malfeasance directed at an unnamed Pentagon researcher who posted a figure correctly showing only one plane "exit hole."

Appendix G – Seattle Selected Excerpts

From Barbara Honegger’s 2013 Seattle Presentation

First Edition (2013): <https://www.youtube.com/watch?v=HtFXyjIj61s>

Second Edition (2015): <https://www.youtube.com/watch?v=VXBk8JqwFlw&feature=youtu.be>

BH = Barbara Honegger

FIRST EDITION - TIME	SECOND EDITION - TIME	TOPIC
B. PENTAGON THEORIES		
Honegger’s Hypothesis		
00:54:35	00:52:10	BH: “no other plane destruction except white plane”
C. FLIGHT AA 77 on 9/11		
Departure from Dulles		
02:00:09		BTS slide of civilian slides on 9/11
The Flight		
01:59:05 02:01:30	01:55:55	BH: “AA77 did not get anywhere near Pentagon”
Barbara Olsen		
00:14:27	00:13:07	Barbara Olson – BH: “zero evidence”
Flight Data Recorder		
02:00:35		FDR found inside C ring hole
D. A LARGE PLANE APPROACHES		
The Approach Path		
00:38:50	removed	BH:” Plane came on a South path”
	00:36:42	BH: “White plane came North of Navy Annex”
00:43:00	00:40:47	BH: “Multiple witnesses saw left wing scrape”
00:54:20	00:51:40	BH: Convoluted account of N of CITGO planes
Descriptions of the Large Plane		
00:40:30		BH: “Plane was white, not silver”
00:44:30		Penny Elgas – white fiberglass debris
00:45:00	00:39:42	Global Hawk drone painted white but with stripes and markings to look like an AA 757-200.
00:46:37	00:44:25	Large piece of silver wreckage
Ground Effect		
00:59:20	00:55:20	Discussion of ground speed effect

FIRST EDITION - TIME	SECOND EDITION - TIME	TOPIC
The Military Helicopter		
00:47:10	00:44:35	BH postulates that helicopter shoots down plane
E. THE MAIN PENTAGON EVENT		
Event Time		
01:22:50	01:18:45	Slide of plane impact times – 9:30 am to 10 am
00:37:12	00:35:08	Stopped clocks
01:22:09	01:18:00	BH: April Gallop’s watch may be off by 2 ½ mins
01:23:40	01:19:15	FAA corrects its initial time of 9:32 am
Lack of Seismic Signal		
01:14:35	01:10:30	Army seismologists check for seismic signal
01:15:35	01:11:25	Dave Gapp predicts a signal from a plane impact
Five Frames		
01:16:10	01:12:00	Impact fireball: BH asserts this is evidence only for an explosion or “white plane” destruction
01:48:50	01:41:50	
Penetration and Damage		
01:05:10	01:01:04	BH gives three objections to plane penetration
01:08:00	01:03:57	Deet’s “no penetrator path” diagram
F. OBSERVATIONS OUTSIDE THE PENTAGON		
Downed Light Poles		
01:01:35	00:57:32	BH discusses the downed light poles
The Spools		
00:58:45	00:54:45	BH discusses the cable spools
The Pristine Lawn		
00:34:30 to 00:46:30	00:32:26	The apparent “pristine” nature of the lawn
00:33:30	00:31:41	The plane engines extend below the fuselage
00:34:20	00:31:58	The question of why the lawn was not gouged
00:34:35	00:32:30	Photograph of the “pristine lawn”
Height of the Fuselage Top		
00:32:00 to 00:35:00	00:30:49	BH argues fuselage top too high for impact hole
00:33:46		BH uses five frames for fuselage height of 20 ft
00:32:29	00:30:43	Artist rendition of 757 above lawn
Façade Damage		
00:57:20	00:53:20	Photograph of Pentagon façade damage
Wreckage Near the Heliport		
00:35:00 to 00:46:00	00:33:09	Wreckage near the heliport

G. OBSERVATIONS INSIDE THE PENTAGON		
Damage to Columns		
01:33:40	01:29:12	Curved steel bar reinforcement inside column
One or Three “Exit Holes?”		
01:13:15	01:09:50	Slide showing three “Exit Holes”
01:11:45	01:07:35	BH hypothesis for creation of C ring hole
C Ring Hole		
01:11:45	01:07:35	BH hypothesis for creation of C ring hole
01:11:15	01:07:13	Markings at C ring hole
01:10:10	01:04:30	Graphic showing locations of body fragments
01:11:48	01:07:48	Meyer’s theory of C ring hole creation
H. WERE PRE-PLANTED EXPLOSIVES USED?		
Honegger’s Physical Evidence for Pre-Planted Explosives		
01:29:30	01:26:00	Second story floor breached upward
01:31:05	01:26:51	BH claims “Major Primary ... Explosion”
Daryl Donley Explosion Photo		
01:31:23	01:27:00	The nature of the explosion – was it major?
Columns Turned to Mush		
01:32:30	01:28:10	Reports of column turned to “mush”
Bowed Out Columns		
01:35:00	01:30:30	Columns that appear to be “bowed out”
Computers on Fire		
01:58:45		April Gallop observes computers on fire
Witnesses to Odor of Cordite		
01:38:00	01:34:30	Witnesses who smelled cordite
Other Witnesses to Bombs		
01:39:56	01:35:40	Other witnesses who inferred bombs
01:56:00	01:47:20	Hathaway: Survivors in NCC hardened room
Multiple Primary Explosions		
01:49:14	01:42:30	BH claims multiple primary explosions
01:50:50	01:42:30	BH slide showing inside/outside explosions
01:22:09	01:18:00	BH: Gallop’s “watch ... slightly off”
00:56:30	01:30:00	Secondary explosion at 10:10 am
I. OTHER ISSUES		
02:05:00 to 02:40:00	01:57:00	BH presents a variety of other issues
J. SUMMARY AND CONCLUSION		
02:05:20	01:55:15	BH summarizes her main conclusions

Talks by Barbara Honegger on the Pentagon

Barbara Honegger's main talks on the Pentagon are titled *Behind the Smoke Curtain*.

Toronto Hearings, September 2011, <https://www.youtube.com/watch?v=qQguLmOEGYM>

Seattle, January, 2013, <https://www.youtube.com/watch?v=HtFXylj61s>

Seattle, January, 2013 – Second Edition,
<https://www.youtube.com/watch?v=VXBk8JqwFlw&feature=youtu.be>

Washington, D.C., September 2013, <https://www.youtube.com/watch?v=PrFIWaWgCWw> ,
Panel: <https://www.youtube.com/watch?v=YHdRss0ofuc>

Appendix H - Websites, Papers, Articles and Videos

by the Authors and Contributors

On The Pentagon Event

Websites

<http://911research.wtc7.net/essays/pentagon/> - Jim Hoffman, March, 2006.

<http://911review.com/errors/pentagon/index.html> - Jim Hoffman

<http://stj911.org/evidence/pentagon.html> - Victoria Ashley

<http://9-11tv.org/> - Ken Jenkins

http://911speakout.org/?page_id=219 – David Chandler and Jonathan H. Cole

<http://scienceof911.com.au/pentagon/> - Frank Legge

<http://warrenstutt.com/> - Warren Stutt

http://www.scientistsfor911truth.org/papers.html#papers_pentagon – Scientists for 9/11 Truth

<http://www.scientificmethod911.org/pentagon.html> - Scientific Method 9/11, John Wyndham

Papers

Frank Legge, "What Hit the Pentagon? Misinformation and its Effect on the Credibility of 9/11 Truth," July, 2009

<http://www.journalof911studies.com/volume/2009/WhatHitPentagonDrLeggeAug.pdf>

David Chandler and Jonathan Cole, "Joint Statement on the Pentagon" January, 2011.

http://911speakout.org/?page_id=219

Frank Legge, and Warren Stutt, "Flight AA77 on 9/11: New FDR Analysis Supports the Official Flight Path..." January, 2011

http://www.journalof911studies.com/volume/2010/Calibration%20of%20altimeter_92.pdf

Frank Legge and David Chandler, "The Pentagon Attack on 9/11: A Refutation of the Pentagon Flyover Hypothesis Based on Analysis of the Flight Path," Sept., 2011

<http://stj911.org/contributions/index.html>

and its Addendum: <http://www.foreignpolicyjournal.com/2011/12/27/addendum-to-the-paper-refuting-the-pentagon-flyover-hypothesis/>

John D. Wyndham, "The Pentagon Attack: Problems with Theories Alternative to Large Plane Impact, <http://www.journalof911studies.com/volume/2010/Wyndham1.pdf>
Revised - version (3)

http://www.scientistsfor911truth.org/docs/Theories_Alternative_April_2016.pdf

Frank Legge, "The 9/11 Attack on the Pentagon: the Search for Consensus," June, 2012.

<http://www.journalof911studies.com/resources/Legge-Letter-June.pdf>

John D. Wyndham, "The Pentagon Attack: The Event Time Revisited," March, 2013.

http://www.scientistsfor911truth.org/docs/Pentagon_Event_Time_Mar19_2013.pdf

John D. Wyndham, "The Pentagon Attack: Eyewitnesses, Debris Flow and Other Issues - A Reply to Fletcher and Eastman," April, 2013.

http://www.scientistsfor911truth.org/docs/Eyewitnesses_DebrisFlow_FandE_Mar4_2016.pdf

Articles and Videos

Jim Hoffman, "*Pentagon* -- Exterior Impact Damage," February, 2003

<http://911review.com/articles/stjarna/eximpactdamage.html>

Jim Hoffman, "The Pentagon No-757-Crash Theory: Booby Trap for 9/11 Skeptics," Nov. 2004.

<http://911research.wtc7.net/essays/pentagontrap.html>

Victoria Ashley, "To Con a Movement: Exposing CIT's PentaCon 'Magic Show'," July, 2009.

http://www.911review.com/articles/ashley/pentacon_con.html - Victoria Ashley

Jim Hoffman, "Google Earth Exposes Pentagon Flyover Farce," July 26, 2009.

<http://911research.wtc7.net/essays/pentacon/index.html>

Frank Legge, "Science, Activism, and the Pentagon Debate," April, 2014.

http://www.scientistsfor911truth.org/docs/Legge_Pentagon_Letter.pdf

Ken Jenkins: "Pentagon Plane Puzzle + David Chandler: Going Beyond Speculation,"

<https://www.youtube.com/watch?v=E9-O6iqJnOA>